





		Overview	3/2
Contactors		DIL...M Contactors AC Operated AC Operated, Reversing DC Operated AC/DC Operated, DC Hp ratings	3/4 3/6 3/8 3/10
		DIL Universal Contactors AC/DC Operated	3/11
		Contactors Selection & Ordering Guide	3/12
Starters		Non-Combination Starters AC Operated, FVNR Starters AC Operated, FVR Starters AC Operated, Two-Speed Starters	3/14 3/15 3/16
		PKZ 2 Self-Protected Combination Starters FVNR Open type FVNR and FVR	3/20 3/21
		Combination Starters Breaker Type, FVNR and FVR Fusible Type, FVNR, Class J Fusible Type, FVNR, Class R FVR, Class J FVR, Class R	3/22 3/24 3/25 3/26 3/27
		Full Voltage Starters, Factory Modifications	3/28
		Reduced Voltage Starters - Selection Guide	3/29
		Reduced Voltage, Non-Combination Starters Autotransformer Type Star-Delta Type	3/30 3/31
		Reduced Voltage Starters, Factory Modifications	3/32
		Overload Relay Suffix Codes	3/33
		Field Modification Kits	3/34
Accessories & Technical Data		Accessories Replacement Coils	3/35 3/45
		Coil Voltages Contactor Selection Guide	3/46 3/48
		Technical Data Enclosure Suffix - Dimensional Data	3/50 3/58
			
		Dimensions	3/61



DIL...M

- 1 Main Contactor** – Page 3/4
 - Main Contacts
 - 3 & 4 power poles (**DIL 00M**)
 - 3 pole + 4th pole side-mounted (**DIL 0M, 1M, 2M**)
 - Magnet System
 - AC Coil Range: 12 – 600 V, 50, 60, 50/60 Hz
 - DC Coil Range: 12 – 250 V DC
 - Coils also available for non-standard voltages
 - Added Reliability
 - Standard AC coils are dual voltage, each optimized at 60 Hz and 50 Hz. Example: 120 V 60 Hz / 110 V 50 Hz
 - Coils are also available in single voltage, single frequency; single voltage, dual frequency and DC. Magnet system characteristics for standard AC coils feature a broader response range than required by standards:
 - Pull-in: 80 – 110%, Drop-out: 40 – 60% of coil rating.

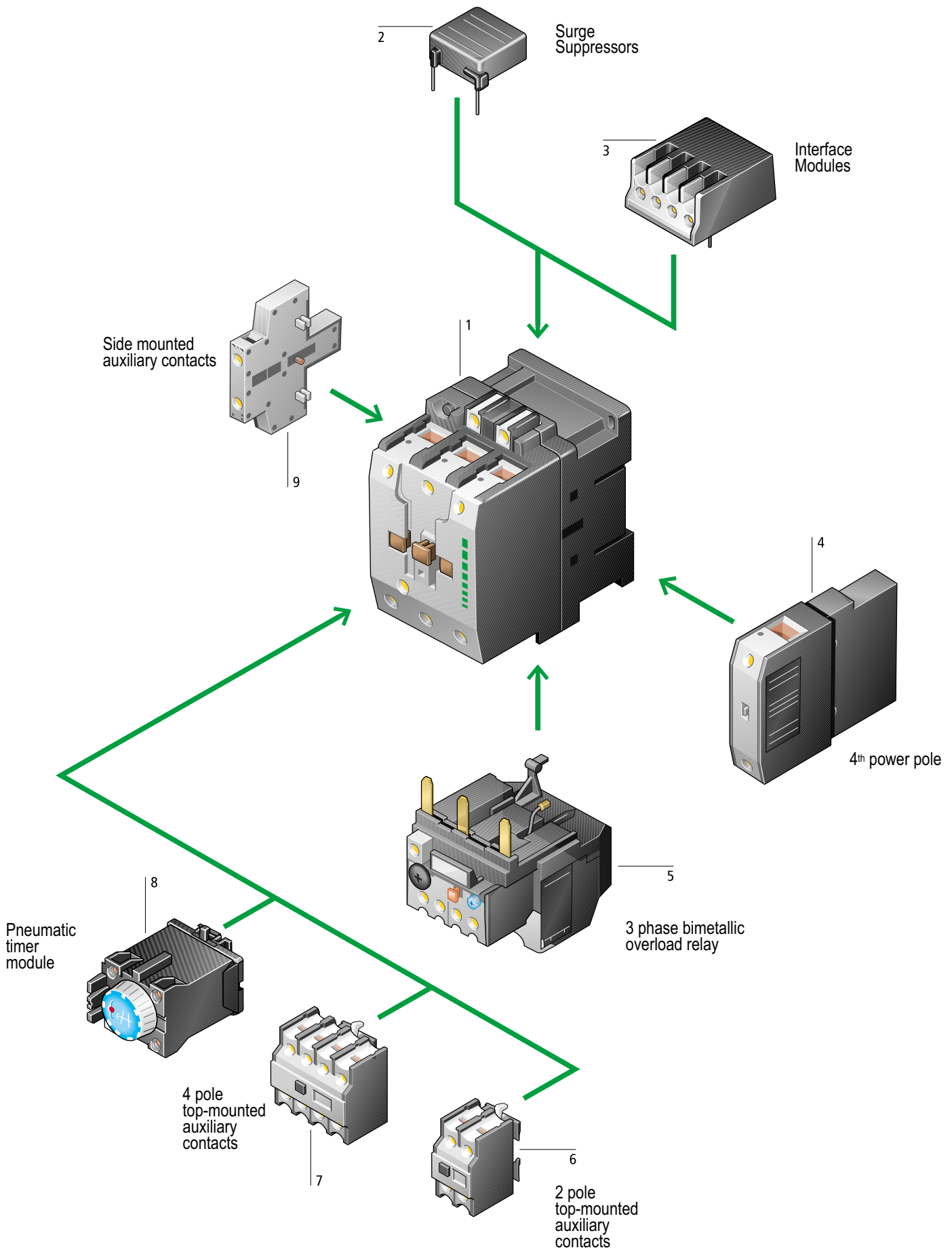
- 2,3,8 Accessories** – Page 3/35
 - Pneumatic timer module
 - Mechanical latch module (for **DIL 00M, 00AM**)
 - Interface modules (to enable energizing from low level sources)
 - Surge Suppressors
 - Mechanical Interlock

- 4 Add-on Power Pole** – Page 3/36
 - 4TH power pole can be added on to contactors type **DIL 0M** through **DIL 2M**.

- 5 3 Phase Bimetallic Overload Relay for DIL...M Starters** – Page 3/33
 - Plug-in or separately mounted
 - Phase failure sensitive to IEC, UL & CSA
 - Ambient compensated to IEC, UL & CSA
 - Accurate and reliable tripping
 - Hand (supplied from factory) or automatic reset, Test button to simulate trip, OFF button to open the N.C. contact only, Yellow trip indicator flag
 - Type **Z00, Z1, Z5**

















- 6,7,9 Auxiliary Contacts** – Page 3/35
 - Maximum 5
 - Top-mounted contacts, 2 & 4 pole
 - Side-mounted contacts, 1 & 2 pole (not for **DIL 00(A)M**)
 - Time delayed contacts, 1 N.O. & 1 N.C.
 - Overlapping contacts, 1 Early Make, 1 Late Break
 - Safety feature* - Positively driven auxiliary contacts
 - In accordance with ZH 1/457 safety circuit requirements:
 - All N.O. & N.C. contacts can never be simultaneously closed, with the exception of overlapping contacts.
 - For contactor type **DIL 0(A)M, 1(A)M, 2(A)M**: Only side-mounted auxiliary contacts.

- Mounting**
 - Modularly designed system, available as components or as completely assembled units
 - Provisions for both Panel and DIN rail mounting
 - All terminal and mounting screws, for both contactors and overload relays, can be fastened with the identical screwdriver (Size 2 posidrive)
 - Finger-safe termination design for compliance with worldwide standards
 - Screw-clamp terminal connections for more secure tightening of conductors
 - Fast-on connectors available for more convenient control and coil circuit tap-offs

- UL / CSA / CE / IEC / EN 60 947**
 - DIL...M** and **DIL** universal contactors, **ZE / Z00 / Z1 / Z5 / ZW7** overload relays are:
 - UL listed
 - CSA certified
 - CE marked
 - IEC/EN 60 947 compliant
 - Suitable for worldwide markets

Contactors – DIL...M AC Operated

UL / CSA / IEC / CE

1	2		3				4		5		6		7	
Snap-on fastening to DIN rail or panel mounting	Rating data UL/CSA maximum Horsepower rating (HP) 50/60 Hz				IEC 60 947/EN 60 947 Maximum 3-phase Motor Ratings (kW) 50/60 Hz				General Purpose Cont. Current	Standard auxiliary contacts		Type Important: Add coil voltage and frequency from page 3/46 - 3/47 to end of type. See page 3/5 for more details.	Price	
	1 phase		3 phase		AC-3									
	115 V HP	200 V HP	230 V HP	200 V HP	230 V HP	460 V HP	575 V HP	220 V kW						380 V kW
	3-pole 1/4 3/4 1		1 1/2 2 3 3	1.5 3 3 -	15/13.5	1 0	DIL EEM-10	See Price List						
						0 1	DIL EEM-01		See Price List					
	1/2 1 1 1/2		2 3 5 5	2.2 4 4 -	15/13.5	1 0	DIL EM-10	See Price List						
						0 1	DIL EM-01		See Price List					
	4-pole 1/2 1 1 1/2		2 3 5 5	2.2 4 4 -	15/13.5	0 0	DIL EM-4	See Price List						
						0 0	DIL 00M 4		See Price List					
	1/2 1 1 1/2		3 3 5 7 1/2	2.2 4 5.5 -	20/18	0 0	DIL 00M 4	See Price List						
						0 0	DIL 00M		See Price List					
	1/2 1 1 1/2		3 3 5 7 1/2	2.2 4 5.5 -	20/18	0 0	DIL 00M	See Price List						
						1 0	DIL 00M-10		See Price List					
						0 1	DIL 00M-01	See Price List						
						0 0	DIL 00AM		See Price List					
	1 2 2		3 3 7 1/2 10	3 5.5 7.5 -	20/18	0 0	DIL 00AM	See Price List						
						1 0	DIL 00AM-10		See Price List					
						0 1	DIL 00AM-01	See Price List						
						0 0	DIL 0M		See Price List					
	2 2 3		7 1/2 7 1/2 10 15	4 7.5 11 -	35/31	0 0	DIL 0M	See Price List						
						0 0	DIL 0AM		See Price List					
	2 3 5		7 1/2 10 15 20	5.5 11 15 -	35/31	0 0	DIL 0AM	See Price List						
						0 0	DIL 1M		See Price List					
	3 5 5		10 10 20 25	7.5 15 18.5 -	55/50	0 0	DIL 1M	See Price List						
						0 0	DIL 1AM		See Price List					
	3 5 7 1/2		10 15 25 30	11 18.5 22 -	55/50	0 0	DIL 1AM	See Price List						
						0 0	DIL 2M		See Price List					
	3 7 1/2 10		15 20 40 40	15 22 30 -	90/81	0 0	DIL 2M	See Price List						
						0 0	DIL 2AM		See Price List					
	5 10 15		20 25 50 50	18.5 30 37 -	90/81	0 0	DIL 2AM	See Price List						
						0 0	DIL 3M 80		See Price List					
	7 1/2 15 15		25 30 60 75	22 37 55 37	100/90	0 0	DIL 3M 80	See Price List						
						0 0	DIL 4M 115		See Price List					
	10 25 25		40 50 100 125	37 55 90 55	130	0 0	DIL 4M 115	See Price List						
						0 0	DIL M 185/22		See Price List					
						2 2	DIL M 185/22	See Price List						
						2 2	DIL M 225/22		See Price List					
						2 2	DIL M 250/22	See Price List						
						2 2	DIL M 300/22		See Price List					
						2 2	DIL M 300/22	See Price List						
						2 2	DIL M 400/22		See Price List					
						2 2	DIL M 400/22	See Price List						
						2 2	DIL M 500/22		See Price List					
						2 2	DIL M 500/22	See Price List						
						2 2	DIL M 500/22		See Price List					

Note: For larger sizes please consult Moeller Electric.

Magnetic Contactors
Magnetic Starters
3

Accessory and Ordering Guide

DIL EEM, EM

1. Overload Relay Page 4/2
2. Surge Suppressor Page 3/38
Auxiliary contacts Page 3/35
Accessories Page 3/35

DIL 3M 80, 4M 115

1. Overload Relay Page 4/4
2. Surge Suppressor Page 3/38
Accessories Page 3/35

**Energization options for contactors
DIL M185...500 with electronically
controlled magnet systems**

Conventionally:
Using terminals A1 – A2
for supply feed

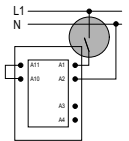

Directly from a PLC output:
Using terminals A3 – A4
to connect to the PLC

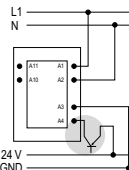

Using low power sources:
Using terminals A10 – A11
for connection to low power
sources such as limit
switches, sensors, solid
state relays etc...

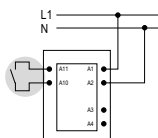

DIL 00M...2AM

1. Overload relay Page 4/2
2. Interface module Page 3/43
3. Pneumatic Timer Module Page 3/40
4. Mechanical Latching Module Page 3/40
5. 4th Power pole (DIL 0M...2M) Page 3/36
Accessories Page 3/35

DIL M 185...500
Accessories Page 3/36

**For enclosed contactor information,
consult Moeller Electric Corporation.**

Additional Information	Page
Technical Data	3/50
Dimensions	3/61
Overload Relays	4/2
Accessories	3/35

Stock Coil Voltages



24 V 60 Hz (through DIL 4M 115)	12 V DC (DIL EM only)
120 V 60 Hz / 110 V 50 Hz	24 V DC (through DIL 4M 115)
208 V 60 Hz	120 V DC
240 V 60 Hz / 230 V 50 Hz	
480 V 60 Hz / 415 V 50 Hz	
600 V 60 Hz	
	For a complete listing of standard and special coils, see page 3/46

How to Order

To Order Specify:	Example:
1 Type Number	Type Number
2 Accessories	Coil Voltage
3 Coil Voltage	DIL 0M/11 120V 60 HZ

Contactors – Reversing, System DIUL AC Operated

UL / CSA / IEC / CE

1	2				3			4		5	6
Snap-on fastening to DIN rail or panel mounting	Rating data UL/CSA maximum Horsepower rating (HP) 50/60 Hz				IEC/EN 60 947 Maximum 3-phase Motor Ratings (kW) 50/60 Hz			Standard Auxiliary Contacts		Type open	Price
	3-phase				AC-3					Important: Add coil voltage and frequency from page 3/46 - 3/47 to end of type. See page 3/7 for more details.	
	200 V HP	230 V HP	460 V HP	575 V HP	220 V kW	380 V kW	660 V kW	NO	NC		\$
 	2	3	5	5	2.2	4	4	2	1	DIUL EM/21/MV	See Price List
	3	3	7½	10	3	5.5	–	1	1	DIUL 00AM/11/MV	See Price List
	7½	7½	10	15	4	7.5	–	1	1	DIUL 0M/11/MV	See Price List
	7½	10	15	20	5.5	11	–	1	1	DIUL 0AM/11/MV	See Price List
	10	10	20	25	7.5	15	–	1	1	DIUL 1 M/11/MV	See Price List
	10	15	25	30	11	18.5	–	1	1	DIUL 1 AM/11/MV	See Price List
	15	20	40	40	15	22	–	1	1	DIUL 2 M/11/MV	See Price List
	20	25	50	50	18.5	30	–	1	1	DIUL 2 AM/11/MV	See Price List
	25	30	60	75	22	37	55	2	2	DIUL 3M 80/11/XMV	See Price List
	40	50	100	125	37	55	90	2	2	DIUL 4M 115/11/XMV	See Price List
	30	30	60	75	32	45	55	2	2	DIUL 3-22-V	See Price List
	40	50	100	100	55	75	90	2	2	DIUL 4-22-V	See Price List
	60	75	150	175	65	110	132	2	2	DIUL 6-22-V	See Price List
	75	100	200	250	90	160	200	2	2	DIUL 8-22-V	See Price List
	125	150	300	350	110	200	–	2	2	DIUL 8A-22-V	See Price List

Note: Reversing contactors are provided standard with a mechanical interlock and minimum 1NO and 1NC auxiliary contact per contactor (1 NC contact per contactor is normally used as an electrical interlock).

Additional Information	Page
Technical Data	3/50
Dimensions	3/61
Overload Relays	4/2
Accessories	3/35

Accessory and Ordering Guide

DIUL 00M - DIUL 4M 115

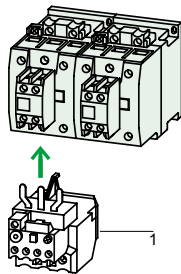

		Page
	Auxiliary contacts	3/35
	Mechanical interlock	3/40
1.	Overload relays	4/2
	Accessories	3/35
	Technical information	3/50

For enclosed contactor information, consult Moeller Electric Corporation.

Additional Information	Page
Technical Data	3/50
Dimensions	3/61
Overload Relays	4/2
Accessories	3/35











Stock Coil Voltages	
24 V 60 Hz (through DIUL 4M 115)	
120 V 60 Hz / 110 V 50 Hz	
208 V 60 Hz	
240 V 60 Hz / 230 V 50 Hz	
480 V 60 Hz / 415 V 50 Hz	For a complete listing of standard and special coils, see page 3/46
600 V 60 Hz	

How to Order

<p>To Order Specify:</p> <p>1 Type Number</p> <p>2 Accessories</p> <p>3 Coil Voltage</p>	<p>Example: 10 HP @ 460 V AC, 3 PH reversing contactors with 1NO and 1NC standard auxiliary contacts and 120 V 60 Hz coil</p> <table border="0" style="width: 100%;"> <tr> <td style="text-align: center;">Type Number</td> <td style="text-align: center;">Coil Voltage</td> </tr> <tr> <td style="text-align: center; border: 1px solid black; padding: 2px;">DIUL 0M/11/MV</td> <td style="text-align: center; border: 1px solid black; padding: 2px;">120 V 60 Hz</td> </tr> </table>	Type Number	Coil Voltage	DIUL 0M/11/MV	120 V 60 Hz
Type Number	Coil Voltage				
DIUL 0M/11/MV	120 V 60 Hz				

Contactors – DIL...M-G
DC Operated

UL / CSA / IEC / CE

1	2		3				4	5		6		7					
Snap-on fastening to DIN rail or panel mounting	Rating data UL/CSA maximum Horsepower rating (HP) 50/60 Hz							IEC 60 947/EN 60 947 Maximum 3-phase Motor Ratings (kW) 50/60 Hz				General Purpose Continuous Current	Standard auxiliary contacts		Type Important: Add coil voltage from page 3/46 - 3/47 to end of type. See page 3/9 for more details.	Price \$	
	1 phase			3 phase				AC-3					open/ enclosed Amps	NO			NC
	115 V HP	200 V HP	230 V HP	200 V HP	230 V HP	460 V HP	575 V HP	220 V kW	380 V kW	660 V kW	1000 V kW						
	3-pole 1/4 3/4 1			1 1/2	2	3	3	1.5	3	3	-	15/13.5	1	0	DIL EEM-10-G	See Price List	
	0	1	DIL EEM-01-G	See Price List													
	1/2 1 1 1/2			2	3	5	5	2.2	4	4	-	15/13.5	1	0	DIL EM-10-G	See Price List	
	0	1	DIL EM-01-G	See Price List													
	4-pole 1/2 1 1 1/2			2	3	5	5	2.2	4	4	-	15/13.5	0	0	DIL EM-4-G	See Price List	
	1/2	1	1 1/2	3	3	5	7 1/2	2.2	4	5.5	-	20/18	0	0	DIL 00M 4-G		
	3-pole 1/2 1 1 1/2			3	3	5	7 1/2	2.2	4	5.5	-	20/18	0	0	DIL 00M-G	See Price List	
	1	0	DIL 00M-G-10	See Price List													
	0	1	DIL 00M-G-01														
	1 2 2			3	3	7 1/2	10	3	5.5	7.5	-	20/18	0	0	DIL 00AM-G	See Price List	
	1	0	DIL 00AM-G-10	See Price List													
	0	1	DIL 00AM-G-01														
	2 2 3			7 1/2	7 1/2	10	15	4	7.5	11	-	35/31	0	0	DIL 0M-G	See Price List	
	2	3	5	7 1/2	10	15	20	5.5	11	15	-	35/31	0	0	DIL 0AM-G		
	3 5 5			10	10	20	25	7.5	15	18.5	-	55/50	0	0	DIL 1M-G	See Price List	
	3	5	7 1/2	10	15	25	30	11	18.5	22	-	55/50	0	0	DIL 1AM-G		
	3 7 1/2 10			15	20	40	40	15	22	30	-	90/81	0	0	DIL 2M-G	See Price List	
	5	10	15	20	25	50	50	18.5	30	37	-	90/81	0	0	DIL 2AM-G		
	7 1/2 15 15			25	30	60	75	22	37	55	37	100/90	0	0	DIL 3M 80	See Price List	
	10	25	25	40	50	100	125	37	55	90	55	130	0	0	DIL 4M 115		
				50	60	125	150	55	90	175	108	225	2	2	DIL M 185/22	See Price List	
				60	75	150	200	70	110	215	108	250	2	2	DIL M 225/22		
				75	100	200	250	75	132	240	108	350	2	2	DIL M 250/22		
				100	125	250	300	90	160	286	132	350	2	2	DIL M 300/22	See Price List	
				125	150	300	400	125	200	344	132	450	2	2	DIL M 400/22		
				150	200	400	500	155	250	344	132	550	2	2	DIL M 500/22		

Note: For larger sizes please consult Moeller Electric.

Magnetic Contactors
Magnetic Starters
3

Accessory and Ordering Guide

DIL EEM-G, EM-G

1. Overload Relay Page 4/2
2. Surge Suppressor Built-in Page 3/35
Auxiliary contacts Page 3/35
Accessories Page 3/35

DIL 3M 80, 4M 115

1. Overload Relay Page 4/4
2. Surge Suppressor Built-in Page 3/35
Accessories Page 3/35

Energization options for contactors DIL M185...500 with electronically controlled magnet systems

Conventionally:
Using terminals A1...A2
for supply feed

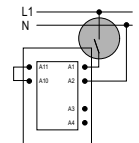

Directly from a PLC output:
Using terminals A3...A4 to
connect to the PLC

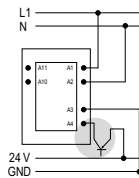

Using low power sources:
Using terminals A10...A11
for connection to low power
sources such as limit
switches, sensors, solid
state relays etc...

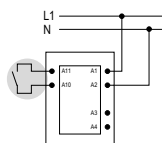

DIL 00M-G...2AM-G

1. Overload relay Page 4/2
2. Interface module Page 3/43
3. Pneumatic Timer Module Page 3/40
4. Mechanical Latching Module Page 3/40
5. 4th Power pole (DIL 0M-G...2M-G) Page 3/36
Accessories Page 3/35

DIL M 185...500
Accessories Page 3/36

For enclosed contactor information, consult Moeller Electric Corporation.

Additional Information	Page
Technical Data	3/50
Dimensions	3/61
Overload Relays	4/2
Accessories	3/35

Stock Coil Voltages

DIL EM-G: 12, 24, 110 V DC
DIL 00M-G through 4M 115: 24, 48, 120, 240 V DC







See page 3/46 for other available coil voltages, some of which may require use of a DC interposing relay.

How to Order

To Order Specify:	Example:
1 Type Number	10 HP @ 460 V AC, 3 PH contactor with 1NO and 1NC standard auxiliary contacts and 24 VDC coil
2 Accessories	Type Number
3 Coil Voltage	Coil Voltage
	DIL 0M-G/11
	24 VDC

Contactors – DIL...M(-G) DC Horsepower Ratings

UL / CSA / IEC / CE

1	2		3		6	7	6	7
<p>The following DIL...M(-G) contactors are identical to the ones shown on pages 3/4 & 3/8. Below are the DC motor horsepower ratings associated to each type (these are not shown on pages 3/4 & 3/8).</p>	Rating data UL/CSA maximum Horsepower rating (HP) 3 Poles		Standard auxiliary contacts		Type Important: Add coil voltage and frequency from page 3/46 - 3/47 to end of type. AC OPERATED	Price \$	Type Important: Add coil voltage from page 3/46 - 3/47 to end of type. DC OPERATED	Price \$
	125 V DC HP	250 V DC HP	NO	NC				
	1	2	0	0	DIL 00M	See Price List See Price List See Price List See Price List	DIL 00M-G	See Price List See Price List See Price List See Price List
	1	2	1	0	DIL 00M-10		DIL 00M-G-10	
	1	2	0	1	DIL 00M-01		DIL 00M-G-01	
	1	2	0	0	DIL 00M 4		DIL 00M 4-G	
	1½	3	0	0	DIL 00AM	See Price List See Price List See Price List	DIL 00AM-G	See Price List See Price List See Price List
	1½	3	1	0	DIL 00AM-10		DIL 00AM-G-10	
	1½	3	0	1	DIL 00AM-01		DIL 00AM-G-01	
	2	5	0	0	DIL 0AM	See Price List See Price List	DIL 0AM-G	See Price List See Price List
	2	5	0	0	DIL 0AM		DIL 0AM-G	
	5	10	0	0	DIL 1AM	See Price List See Price List	DIL 1AM-G	See Price List See Price List
	5	10	0	0	DIL 1AM		DIL 1AM-G	
	7½	15	0	0	DIL 2AM	See Price List See Price List	DIL 2AM-G	See Price List See Price List
	10	20	0	0	DIL 2AM		DIL 2AM-G	
	10	20	0	0	DIL 3M 80	See Price List See Price List	DIL 3M 80	See Price List See Price List
	15	30	0	0	DIL 4M 115		DIL 4M 115	

Magnetic Contactors
Magnetic Starters

3

1				2			3	4		5		6	7		8
Rating Data UL/CSA maximum Horse- power rating (HP) 50/60 Hz				AC 4 Inching and Plugging 30,000 Operations			General use con- tinuous current	Standard auxiliary contacts		AC Operated non-reversing		DC Operated non-reversing			
3 phase				3 phase						Type	Price	Type	Price		
							open (90% if enclosed)			Important: Add coil voltage and frequency from page 3/46 - 3/47 to end of type. See below for more details.		Important: Add coil voltage from page 3/46 - 3/47 to end of type. See below for more details.			
200 V HP	230 V HP	460 V HP	575 V HP	230 V HP	460 V HP	575 V HP		Amps	NO	NC		\$		\$	
30	30	60	75	20	40	50	120	2	2	DIL 3-22	See Price List	See Price List	DIL 3-22/G	See Price List	See Price List
40	50	100	100	25	50	60	160	2	2	DIL 4-22	See Price List	See Price List	DIL 4-22/G	See Price List	See Price List
60	75	150	175	50	100	125	210	2	2	DIL 6-22	See Price List	See Price List	DIL 6-22/G	See Price List	See Price List
75	100	200	250	60	125	150	360	2	2	DIL 8-22	See Price List	See Price List	DIL 8-22/G	See Price List	See Price List
125	150	300	350	-	-	-	400	2	2	DIL 8A-22	See Price List	See Price List	DIL 8A-22/G	See Price List	See Price List

Magnetic Contactors
Magnetic Starters

3

Additional Information	Page
Technical Data	3/50
Dimensions	3/61
Overload Relays	4/2
Accessories	3/35

Stock Coil Voltages	
24 V 60 Hz	120 V DC
120 V 60 Hz / 110 V 50 Hz	
208 V 60 Hz	
240 V 60 Hz / 220 V 50 Hz	
See page 3/46 for other available coil voltages. Some DC coils may require use of a DC interposing relay.	

General

Moeller Electric's DIL "Universal" contactors can provide a cost-effective solution for motor switching in applications that do not require the full modularity of DIL...M contactors. They are UL listed and CSA certified and in compliance with IEC/EN 60 947 standards. Universal Contactors are also CE marked. 2NO and 2NC auxiliary contacts are provided standard for each contactor. Each auxiliary contact can be reversed to achieve 3NO + 1NC, 1NO + 3NC or 4NC contact configurations. Optional NO-early make and NC-late break contacts are also available.

How to Order

To Order Specify:	Example: 100 HP @ 460 V AC (column 1), 3 PH contactor, 2NO and 2NC auxiliary contacts and 120 V 60 Hz coil
1 Type Number	Type Number
2 Coil Voltage	Coil Voltage
	DIL 4-22
	120 V 60 Hz

At Moeller Electric, everything starts with quality and service.

Moeller Electric's line of heavy duty starters are designed to withstand the most severe applications. They are built to meet your requirements, whether for installation across the street or across the ocean. Whatever the application, nearby Moeller Electric technical experts stand ready to help you select the right combination of components for the job.

The following pages list the most popular starter types and accessories. If you require a modification that you do not see here, just give us a call and we will be most pleased to discuss your needs.

For quality starters and quick delivery, there is no better place to start looking than Moeller Electric.

Magnetic starter ordering information.

Moeller Electric magnetic motor starters utilize reliable Type **DIL** contactor(s) and precision Type **Z** bimetallic overload relay(s). The starter catalog numbers are a modular representation of the main starter components and make it easy to see at a glance, what is actually being provided.

For your convenience, the buildup of catalog numbers for the most frequently used starters are explained on this page.

Magnetic starter catalog number identification

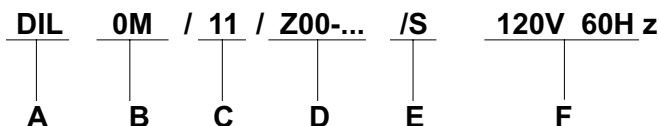

A - Starter Type

- DIL** = Non-reversing
- DIUL** = Reversing
- M** = Combination
- MW** = Combination Reversing
- 2S** = Two Speed
- AT** = Autotransformer
- SD** = Star Delta

B - Contactor Frame Size

Moeller Electric Type **DIL** contactors are available in a variety of sizes to match the motor being started.

C - Auxiliary Contact

Starters rated 10 HP and greater come standard with 1 normally open (NO) and one normally closed (NC) auxiliary contact. Additional contacts can be added in the field or specified as follows:

<u>Suffix Code</u>	<u># of Auxiliary Contacts</u>
10 =	1 NO - 0 NC
11 =	1 NO - 1 NC
20 =	2 NO - 0 NC
22 =	2 NO - 2 NC

D - Overload Relay

The starters listed on the following pages include the base overload type designation (beginning with **Z**) and some of these have the overload fully identified. For those starters where the **Z** is followed by ... , you must select the proper overload relay current range. In order to do this, find out the motor full load amp rating and select the overload range accordingly. See page 3/33 for listings of overload relay code suffixes.

The overload relay is calibrated for long time tripping at 125% of the dial setting and therefore, for motors with a service factor of 1.15 or greater, use the motor nameplate full load current to select the dial setting. For motors with a service factor of less than 1.15, multiply the motor nameplate full load current by 0.9 and use the resulting value to set the overload relay dial.

E - Enclosure Suffix

- /S** = General Purpose, Type 1
- /SD** = Dust and Drip Resistant, Type 12
- /DW** = Outdoor use, Type 3R
- /I** = Corrosion Resistant, Type 12, 13, Indoor 4X
- no suffix = Open Type (no enclosure)

F - Coil Voltage

The standard contactor coil voltage is 120 V 60 Hz. Most starters can be provided with a different coil voltage in the range from 12 V DC to 480 V AC. See Page 3/46 and 3/47 for a listing of the available coil voltages. Simply add the appropriate coil voltage to the end of the starter catalog number.

Selecting and Completing the Type Number

The following is an explanation of the HOW TO ORDER box.

Each box contains an ordering example. For this example (from page 3/12), suppose a full-voltage, non-reversing, non-combination starter in a general purpose Type 1 enclosure and with a contactor coil voltage of 120 V 60 Hz.

How to Order

To Order Specify: Type Number Overload Relay Suffix (page 3/33) Enclosure Suffix Coil Voltage (page 3/46) Accessories	Type Number Example: DIL 0M/11/Z00-16/S 120 V 60 Hz			
	Type	Overload Relay Suffix	Enclosure Suffix	Coil Voltage
	DIL 0M/11/Z00-	16	/S	120 V 60 Hz
	Ⓐ	Ⓑ	Ⓒ	Ⓓ

Ⓐ Type

This is the basic starter type. It includes:

- DIL** = Non-reversing, across-the-line starter.
- 0M** = Contactor frame size (10 HP @ 460 V AC, 3-ph). Accessories such as control transformers are chosen according to contactor frame size.
- /11** = Auxiliary contacts- 1 NO, 1 NC.
- /Z00-** = Type **Z00** overload relay (motor current setting range suffix to be added).

Ⓑ Overload Relay Suffix

Z00- = This part requires completion by adding a suffix code from page 3/33.

Example: For the 10 HP motor at 460 V AC, 3-ph, the motor full load current is 14 (if possible, use actual nameplate rating). Following the guidelines found on the previous page, select an overload setting range within the **Z00-** type from page 3/33 that includes the 14 A motor FLC. The first choice would be the **Z00-16** with an adjusted range of 10 to 16 A. The suffix number to be inserted into the starter catalog number is the maximum of the setting range, or in this case, **16**.

Ⓒ Enclosure Suffix

- /S** = General purpose indoor, Type 1
- /SD** = Dust and drip resistant, Type 12.
- /DW** = Weather resistant outdoor, Type 3R.
- /I** = Corrosion resistant non-metallic indoor, Type 4X or 13.

For the starter in question, therefore, the correct enclosure suffix would be **/S**. Other enclosure types are also available - contact Moeller Electric.

Ⓓ Coil Voltage

From page 3/46, select the required coil voltage; in this case, **120 V 60 Hz**.

Starters, Non-Combination Full Voltage Non-Reversing

Magnetic Starters

3

1	2	3	4	5	6	7
UL/CSA Maximum HP Rating 50/60 Hz Consult Moeller Electric for export applications requiring kilowatt-rated starters complying with IEC standards 3 phase HP Ratings@ 200 V HP 230 V HP 460 V HP 575 V HP	Standard Auxiliary Contacts NO NC	Type¹⁾ Insert overload relay suffix code ... from page 3/33. Note: Suffix has already been provided in certain types.	Enclosed General Purpose Enclosure Type 1 Add suffix /S to type Price \$	Industrial use Dusttight Enclosure Type 12, add suffix /SD to type For Weatherproof Type 3R, add suffix /DW to type Price \$	Insulating Material Enclosure Corrosion resistant Dusttight Type 12, 13, Indoor 4X, add suffix /I to type Price \$	Open Without Enclosure Price \$
DIL...M Contactors						
1 1/2 2 3 3	1 0	DIL EEM-10/ZE-...	See Price List	See Price List	See Price List	See Price List
2 3 5 5	1 0	DIL EM-10/ZE-...	See Price List	See Price List	See Price List	See Price List
3 3 5 5	1 0	DIL 00M-10/Z00-...	See Price List	See Price List	See Price List	See Price List
3 3 7 1/2 10	1 0	DIL 00AM-10/Z00-...	See Price List	See Price List	See Price List	See Price List
5 7 1/2 10 15	1 1	DIL 0M/11/Z00-...	See Price List	See Price List	See Price List	See Price List
- - 15 20	1 1	DIL 0AM/11/Z00-24	See Price List	See Price List	See Price List	See Price List
7 1/2 - - -	1 1	DIL 0M/11/Z1-40	See Price List	See Price List	See Price List	See Price List
- 10 - -	1 1	DIL 0AM/11/Z1-40	See Price List	See Price List	See Price List	See Price List
10 - 20 25	1 1	DIL 1M/11/Z1-40	See Price List	See Price List	See Price List	See Price List
- - 25 30	1 1	DIL 1AM/11/Z1-40	See Price List	See Price List	See Price List	See Price List
- 15 - -	1 1	DIL 1AM/11/Z1-57	See Price List	See Price List	See Price List	See Price List
15 20 40 40	1 1	DIL 2M/11/Z1-57	See Price List	See Price List	See Price List	See Price List
- - - 50	1 1	DIL 2AM/11/Z1-57	See Price List	See Price List	See Price List	See Price List
20 - - -	1 1	DIL 2AM/11/Z1-63	See Price List	See Price List	See Price List	See Price List
- 25 50 -	1 1	DIL 2AM/11/Z1-75	See Price List	See Price List	See Price List	See Price List
25 30 60 75	1 1	DIL 3M 80/11/Z5-100	See Price List	See Price List	See Price List	See Price List
40 50 100 125	1 1	DIL 4M 115/11/Z5-...	See Price List	See Price List	See Price List	See Price List
DIL Universal Contactors						
30 30 60 75	2 2	DIL 3-22/Z4-100	See Price List	See Price List	See Price List	See Price List
40 50 100 100	2 2	DIL 4-22/Z4-... ²⁾	See Price List	See Price List	See Price List	See Price List
60 75 150 175	2 2	DIL 6-22/Z4-... ²⁾	See Price List	See Price List	See Price List	See Price List
75 - 200 -	2 2	DIL 8-22/Z4-240 ³⁾	See Price List	See Price List	See Price List	See Price List
- 100 - 250	2 2	DIL 8-22/ZW7-290 ³⁾	See Price List	See Price List	See Price List	See Price List
125 150 300 350	2 2	DIL 8A-22/ZW7-400 ³⁾	See Price List	See Price List	See Price List	See Price List

1 phase HP Ratings @

1) UL listed overload relays Types **ZE, Z00, Z1** and **Z5** are normally supplied with the starters on this page. For more flexibility, they can also be field installed. Consult Moeller Electric for additional details.
 2) These starters with suffix /I enclosures are available in Types 12 and 13 only.
 3) These starters are not available with suffix /I enclosures.

DIL...M Contactors						
1/4 3/4 1	1 0	DIL EEM-10/ZE-...	See Price List	See Price List	See Price List	See Price List
1/2 1 1 1/2	1 0	DIL EM-10/ZE-...	See Price List	See Price List	See Price List	See Price List
1 2 2 1/2	1 0	DIL 00M-10/Z00-...	See Price List	See Price List	See Price List	See Price List
1 2 2 1/2	1 0	DIL 00AM-10/Z00-...	See Price List	See Price List	See Price List	See Price List
2 2 3	1 1	DIL 0M/11/Z00-...	See Price List	See Price List	See Price List	See Price List
2 3 3	1 1	DIL 0AM/11/Z00-...	See Price List	See Price List	See Price List	See Price List
3 5 5	1 1	DIL 1M/11/Z1-40	See Price List	See Price List	See Price List	See Price List
3 5 7 1/2	1 1	DIL 1AM/11/Z1-40	See Price List	See Price List	See Price List	See Price List
3 - -	1 1	DIL 2M/11/Z1-40	See Price List	See Price List	See Price List	See Price List
- 7 1/2 10	1 1	DIL 2M/11/Z1-57	See Price List	See Price List	See Price List	See Price List
5 - -	1 1	DIL 2AM/11/Z1-57	See Price List	See Price List	See Price List	See Price List
- 10 -	1 1	DIL 2AM/11/Z1-63	See Price List	See Price List	See Price List	See Price List
- - 15	1 1	DIL 2AM/11/Z1-75	See Price List	See Price List	See Price List	See Price List

How to Order: see page 3/12 & 3/13 for detailed instructions and selection hints

To Order Specify: Type Number Overload Relay suffix Enclosure Suffix Coil Voltage Accessories	Catalog Number			
	Type	Overload Relay Suffix	Enclosure Suffix	Add coil voltage from page 3/46-47
	DIL 0M/11/Z00-	10	/S	120 V 60 Hz

Additional Information	Page
Technical Data	3/50
Dimensions	3/61
Overload Relays	4/2
Accessories	3/35
Factory Modifications	3/28

Starters, Non-Combination Full Voltage Reversing

1				2		3		4		5		6		7	
UL/CSA Maximum HP Rating 50/60 Hz				Standard Auxiliary Contacts		Type		Enclosed						Open	
Consult Moeller Electric for export applications requiring kilowatt-rated starters complying with IEC standards						Insert overload relay suffix code ... from page 3/33.		General Purpose Enclosure Type 1		Industrial use Dusttight Enclosure Type 12, add suffix /SD to type		Insulating Material Enclosure Corrosion resistant Dusttight Type 12, 13, Indoor 4X, add suffix /I to type		Without Enclosure	
3 phase HP Ratings@						Note: Suffix has already been provided in certain types.		Add suffix /S to type		For Weatherproof Type 3R, add suffix /DW to type					
200 V HP	230 V HP	460 V HP	575 V HP	NO	NC			Price \$	Price \$	Price \$	Price \$	Price \$	Price \$	Price \$	Price \$
DIL...M Contactors															
1½	2	3	3	0	1	DIUL EEM-01/ZE-...		See Price List	See Price List	See Price List	See Price List	See Price List	See Price List	See Price List	See Price List
2	3	5	5	0	1	DIUL EM-01/ZE-...		See Price List	See Price List	See Price List	See Price List	See Price List	See Price List	See Price List	See Price List
3	3	5	5	0	1	DIUL 00M-01/Z00-.../MV		See Price List	See Price List	See Price List	See Price List	See Price List	See Price List	See Price List	See Price List
3	3	7½	10	0	1	DIUL 00AM-01/Z00-.../MV		See Price List	See Price List	See Price List	See Price List	See Price List	See Price List	See Price List	See Price List
5	7½	10	15	1	1	DIUL 0M/11/Z00-.../MV		See Price List	See Price List	See Price List	See Price List	See Price List	See Price List	See Price List	See Price List
-	-	15	20	1	1	DIUL 0AM/11/Z00-24/MV		See Price List	See Price List	See Price List	See Price List	See Price List	See Price List	See Price List	See Price List
7½	-	-	-	1	1	DIUL 0M/11/Z1-40/MV		See Price List	See Price List	See Price List	See Price List	See Price List	See Price List	See Price List	See Price List
-	10	-	-	1	1	DIUL 0AM/11/Z1-40/MV		See Price List	See Price List	See Price List	See Price List	See Price List	See Price List	See Price List	See Price List
10	-	20	25	1	1	DIUL 1M/11/Z1-40/MV		See Price List	See Price List	See Price List	See Price List	See Price List	See Price List	See Price List	See Price List
-	-	25	30	1	1	DIUL 1AM/11/Z1-40/MV		See Price List	See Price List	See Price List	See Price List	See Price List	See Price List	See Price List	See Price List
-	15	-	-	1	1	DIUL 1AM/11/Z1-57/MV		See Price List	See Price List	See Price List	See Price List	See Price List	See Price List	See Price List	See Price List
15	20	40	40	1	1	DIUL 2M/11/Z1-57/MV		See Price List	See Price List	See Price List	See Price List	See Price List	See Price List	See Price List	See Price List
-	-	-	50	1	1	DIUL 2AM/11/Z1-57/MV		See Price List	See Price List	See Price List	See Price List	See Price List	See Price List	See Price List	See Price List
20	-	-	-	1	1	DIUL 2AM/11/Z1-63/MV		See Price List	See Price List	See Price List	See Price List	See Price List	See Price List	See Price List	See Price List
-	25	50	-	1	1	DIUL 2AM/11/Z1-75/MV		See Price List	See Price List	See Price List	See Price List	See Price List	See Price List	See Price List	See Price List
25	30	60	75	1	1	DIUL 3M 80/11/Z5-100/XMV		See Price List	See Price List	See Price List	See Price List	See Price List	See Price List	See Price List	See Price List
40	50	100	125	1	1	DIUL 4M 115/11/Z5-.../XMV ¹⁾		See Price List	See Price List	See Price List	See Price List	See Price List	See Price List	See Price List	See Price List
DIL Universal Contactors															
30	30	60	75	2	2	DIUL 3-22/Z4-100-V ¹⁾		See Price List	See Price List	See Price List	See Price List	See Price List	See Price List	See Price List	See Price List
40	50	100	100	2	2	DIUL 4-22/Z4-...-V ²⁾		See Price List	See Price List	See Price List	See Price List	See Price List	See Price List	See Price List	See Price List
60	75	150	175	2	2	DIUL 6-22/Z4-...-V ²⁾		See Price List	See Price List	See Price List	See Price List	See Price List	See Price List	See Price List	See Price List
75	-	200	-	2	2	DIUL 8-22/Z4-240-V ²⁾		See Price List	See Price List	See Price List	See Price List	See Price List	See Price List	See Price List	See Price List
-	100	-	250	2	2	DIUL 8-22/ZW7-...-V ²⁾		See Price List	See Price List	See Price List	See Price List	See Price List	See Price List	See Price List	See Price List
125	150	300	350	2	2	DIUL 8A-22/ZW7-...-V ²⁾		See Price List	See Price List	See Price List	See Price List	See Price List	See Price List	See Price List	See Price List

1) These starters with suffix /I enclosures are available in Types 12 and 13 only.
 2) These starters are not available with suffix /I enclosures.

For larger size Starters, consult Moeller Electric.

How to Order: see page 3/12 & 3/13 for detailed instructions and selection hints

To Order Specify:	Type Number		
	Type	Overload Relay Suffix	Enclosure Suffix
Type Number	DIUL 0M/11/Z00-.../MV	24	/SD
Overload Relay suffix			
Enclosure Suffix			
Coil Voltage			120 V 60 HZ
Accessories			Add coil voltage from page 3/46-47

Additional Information	Page
Technical Data	3/50
Dimensions	3/61
Overload Relays	4/2
Accessories	3/35
Factory Modifications	3/28

Starters, Non-Combination Two Speed

1	2	3	4	5
UL/CSA ¹⁾ Maximum HP Rating 50/60 Hz	2-Speed, 2-Winding (Separate Winding) Wye-Connected motors (YY) ²⁾	Enclosed ³⁾	2-Speed, 1-Winding (Consequent pole) motors	Enclosed ³⁾
3 phase	Type Insert overload relay suffix code ... from page 3/33.	Includes two 3-phase bimetallic overload relays	Type Insert overload relay suffix code ... from page 3/33.	Includes two 3-phase bimetallic overload relays
200 V HP 230 V HP 460 V HP 575 V HP		Price \$		Price \$
Constant or Variable Torque DIL...M Contactors		See Price List		See Price List
3 3 5 5 - 3 7 1/2 10 5 7 1/2 10 15 7 1/2 - - - - - 15 20 - 10 - - 10 - 20 25 - 15 25 30 15 20 40 40 20 25 50 50	2S2W 00M/Z00-.../Z00-.../S 2S2W 00AM/Z00-.../Z00-.../S 2S2W 0M/Z00-.../Z00-.../S 2S2W 0M/Z1-.../Z00-.../S 2S2W 0AM/Z00-.../Z1-.../S 2S2W 0AM/Z1-.../Z1-.../S 2S2W 1M/Z1-.../Z1-.../S 2S2W 1AM/Z1-.../Z1-.../S 2S2W 2M/Z1-.../Z1-.../S 2S2W 2AM/Z1-.../Z1-.../S	See Price List	2S1W 00M/Z00-.../Z00-.../S 2S1W 00AM/Z00-.../Z00-.../S 2S1W 0M/Z00-.../Z00-.../S 2S1W 0M/Z1-.../Z00-.../S 2S1W 0AM/Z00-.../Z1-.../S 2S1W 0AM/Z1-.../Z1-.../S 2S1W 1M/Z1-.../Z1-.../S 2S1W 1AM/Z1-.../Z1-.../S 2S1W 2M/Z1-.../Z1-.../S 2S1W 2AM/Z1-.../Z1-.../S	See Price List
DIL Universal Contactors		See Price List		See Price List
30 - - - 40 50 100 100 60 75 150 150 75 - 200 200 - 100 - 250 100 - 250 300 125 150 300 350	2S2W 3-22/Z4-.../Z1-.../S 2S2W 4-22/Z4-.../Z1-.../S 2S2W 6-22/Z4-.../Z4-.../S 2S2W 8-22/Z4-.../Z4-.../S 2S2W 8-22/ZW7-.../Z4-.../S 2S2W 8A-22/ZW7-.../Z4-.../S 2S2W 8A-22/ZW7-.../ZW7-.../S	See Price List	2S1W 3-22/Z4-.../Z1-.../S 2S1W 4-22/Z4-.../Z1-.../S 2S1W 6-22/Z4-.../Z4-.../S 2S1W 8-22/Z4-.../Z4-.../S 2S1W 8-22/ZW7-.../Z4-.../S 2S1W 8A-22/ZW7-.../Z4-.../S 2S1W 8A-22/ZW7-.../ZW7-.../S	See Price List
Constant Horsepower DIL...M Contactors		See Price List		See Price List
2 2 3 3 - - 5 7 1/2 5 5 7 1/2 10 - 7 1/2 10 15 7 1/2 - 15 20 - 10 20 25 10 15 30 30 15 20 40 40	2S2W 00M/Z00-.../Z00-.../S 2S2W 00AM/Z00-.../Z00-.../S 2S2W 0M/Z00-.../Z00-.../S 2S2W 0AM/Z00-.../Z00-.../S 2S2W 1M/Z1-.../Z1-.../S 2S2W 1AM/Z1-.../Z1-.../S 2S2W 2M/Z1-.../Z1-.../S 2S2W 2AM/Z1-.../Z1-.../S	See Price List	2S1W 00M/Z00-.../Z00-.../S 2S1W 00AM/Z00-.../Z00-.../S 2S1W 0M/Z00-.../Z00-.../S 2S1W 0AM/Z00-.../Z00-.../S 2S1W 1M/Z1-.../Z1-.../S 2S1W 1AM/Z1-.../Z1-.../S 2S1W 2M/Z1-.../Z1-.../S 2S1W 2AM/Z1-.../Z1-.../S	See Price List
DIL Universal Contactors		See Price List		See Price List
25 25 50 60 30 40 75 75 50 60 100 125 - - 125 150 60 75 150 200 - 100 200 250 100 - - -	2S2W 3-22/Z1-.../Z1-.../S 2S2W 4-22/Z4-.../Z1-.../S 2S2W 6-22/Z4-.../Z1-.../S 2S2W 8-22/Z4-.../Z1-.../S 2S2W 8-22/Z4-.../Z4-.../S 2S2W 8-22/ZW7-.../Z4-.../S 2S2W 8A-22/ZW7-.../Z4-.../S	See Price List	2S1W 3-22/Z1-.../Z1-.../S 2S1W 4-22/Z4-.../Z1-.../S 2S1W 6-22/Z4-.../Z1-.../S 2S1W 8-22/Z4-.../Z1-.../S 2S1W 8-22/Z4-.../Z4-.../S 2S1W 8-22/ZW7-.../Z4-.../S 2S1W 8A-22/ZW7-.../Z4-.../S	See Price List

- 1) UL listed Starters through 50 HP at 460 V.
- 2) Separate winding Starters are for Wye-Connected motors only. For other winding configurations, use corresponding price from Column 5 and supply a motor winding connection diagram in addition to the complete ordering information referenced below.
- 3) General Purpose Enclosure Type 1. For other special purpose enclosures consult Moeller Electric.

Complete Ordering Information:

State **Type** from column 2 or 4.
Insert the **Overload Relay Suffix** codes from page 3/33 (corresponding to the Motor full load currents at each speed).
Complete **Type** with **Coil Voltage** rating from 3/46-47.

Also provide the following useful motor data for faster order processing:

Line Voltage and Horsepower, Phase and Frequency.
Control Voltage and Frequency, if different from Line Voltage.
2-Speed, 2-Winding or 2-Speed, 1-Winding. Include Full Load Current at each speed.
Constant or Variable Torque, or Constant Horsepower.
Motor Connection Diagram for nonstandard separate winding motors.

For Factory Modification see page 3/28.

Type PKZ 2/ZM/S-SP Motor Starters: A Higher Level of Protection And Versatility

General:

The **PKZ 2/ZM/S-SP** is a self-protected starter, the **FIRST** motor controller to be UL listed and CSA certified under Type E, the category for self-protected control devices. In other words, it is a combination motor controller featuring main disconnect, over-current, overload and motor switching functions in one compact unit.

In addition, the **PKZ 2/ZM/S-SP** incorporates the latest technological advances in current limitation to provide a high short circuit interrupting rating and continuity of service capability.

The **PKZ 2/ZM/S-SP** is a **stand-alone device which does not require any backup protection up to its maximum interrupting rating!** It is available in both Full Voltage Non-Reversing and Full Voltage Reversing versions.

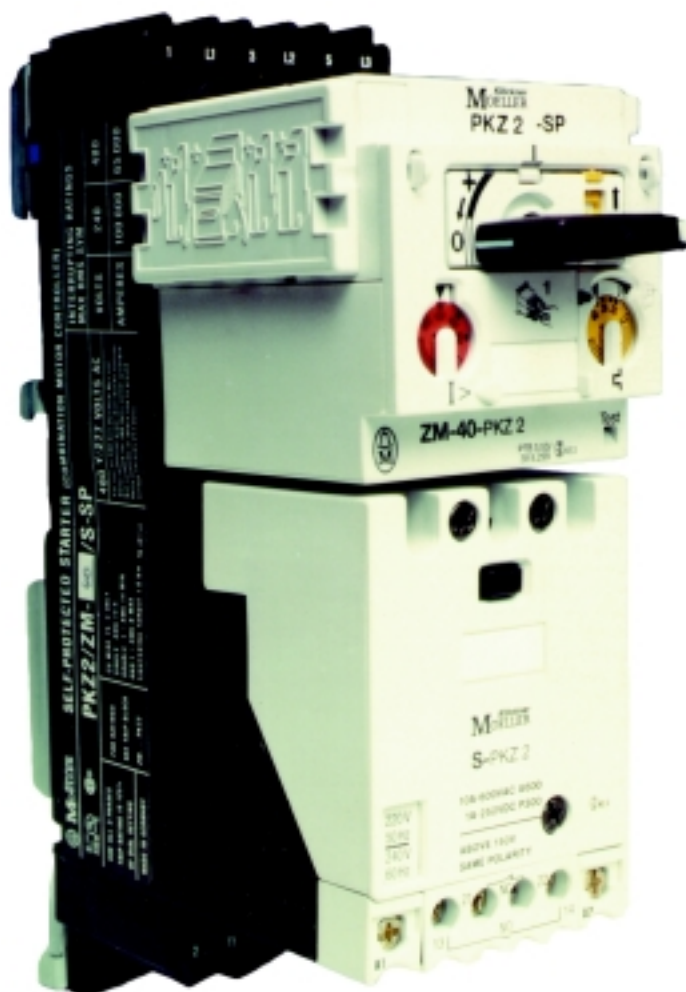

Features

- UL listed, self-protected combination motor controller, UL 508/CSA 22.2 No. 14 category E.
- Fuseless, high fault interrupting current-limiting design, with separate main contacts for disconnect and contactor.
- Its modular construction integrates both thermal and magnetic trips.
- It controls and protects motors up to 30 HP at 460 V, 25 HP at 575 V.
- One basic device accommodates up to 11 different plug-in trip modules, simplifies engineering and reduces stocking costs.
- Suitable for PLC controlled, fully automated operation.
- Differentiated overload and short-circuit trip indication.
- A wide range of accessories.

Contents

Description	Page
Application Hints.....	3/18
Features & Benefits.....	3/19
Full Voltage, Non-Reversing.....	3/20
complete with trip module	
Full Voltage, Non-Reversing and.....	3/21
reversing without trip module	
Plug-in trip module.....	3/21
Accessories.....	7/28
Technical Data.....	3/51

Starters – Combination Self-protected

All-In-One Starter Eliminates Upstream Circuit Breaker or Fuses

Application:

As per the intent of NEC Article 430, the self-protected control device will perform the functions of Motor Disconnecting Means (Part J), Motor Branch-Circuit, Short-Circuit and Ground-Fault Protection (Part D), Motor Controller (Part G) and Motor Overload Protection (Part C). Up to the maximum rated short circuit current available, NO upstream circuit breaker or set of fuses is required.

The **PKZ 2/ZM-.../S-SP** has 2 sets of main contacts, both current-limiting in design. This provides it with a high interrupting rating and the capability to

protect itself against damage under fault conditions. No contact welding can ensue thus providing for continuity of service.

Each unit consists of a basic frame (disconnect switch and contactor) rated to switch a motor load of 30 HP @ 460 V AC. Eleven plug-in trip modules are available to cover motor loads ranging from fractional HP sizes through 30 HP @ 460 V AC. As a result, stocking of parts is minimized and use of the starter for other motor loads may be as simple as plugging-in a new trip module and setting the trip response dials.

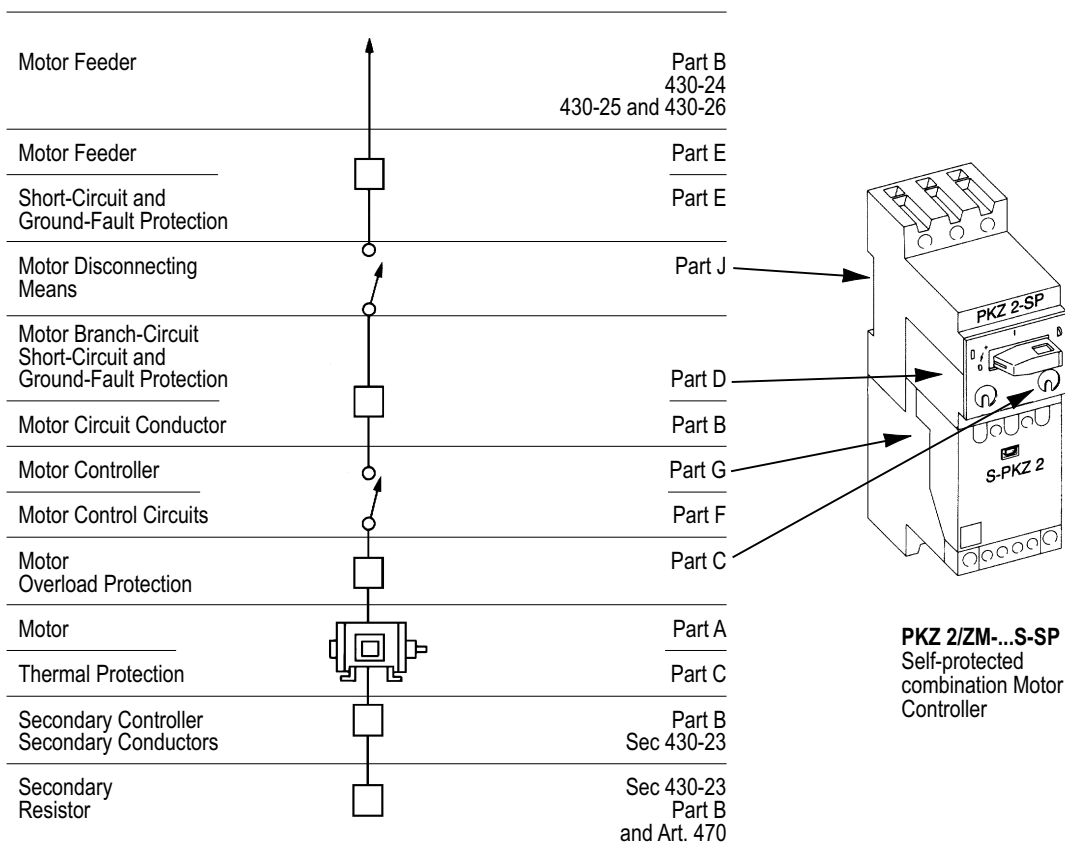

Diagram 430-1 from NEC Article 430

Choose the PKZ 2/ZM-.../S-SP starter for maximum protection and flexibility.

- UL Listed for use on circuits capable of delivering 65,000 RMS Sym amps @480Y/277 V AC and 42,000 RMS Sym amps @ 600Y/347 V AC
- NO backup short circuit protection required (replaces the fuses or circuit breakers required by other conventional starters)
- Plug-in trip modules can be removed/installed without disturbing power wiring
- Field-adjustable, coordinated and sealable settings for motor overload and short circuit trip response
- Compact design allows installation in hard-to-fit areas
- Exceeds IEC "Type 2" coordination without the need for additional fuses or circuit breaker
- Removal of trip block (for maintenance or servicing) provides visible electrical isolation gap between line disconnecting and contactor portions
- All live parts (including terminals) are shrouded against accidental contact ("finger proof" per IEC 536), even with the plug-in trip module removed
- Maximum continuity of service (protects itself against damage from fault currents)

The **PKZ 2/ZM-.../S-SP** Self-Protected Starter comes standard as a one piece construction featuring a Main Disconnect and a Contactor. The unit can be either panel or rail mounted. Integral power takeoffs are provided between the Disconnect and Contactor for control circuit feed. Adjustable Motor protective thermal-magnetic Trip modules are set in accordance with the Motor Full Load Current and plugged directly into the base of the Disconnect. Trip modules and accessories can all be field installed for maximum versatility.

The Main Disconnect and Contactor modules can also be separately mounted. This is particularly suitable for Full Voltage Reversing applications which combine the **PKZ 2-SP** disconnect with two mechanically interlocked **S-PKZ 2** contactors (see page 3/21).

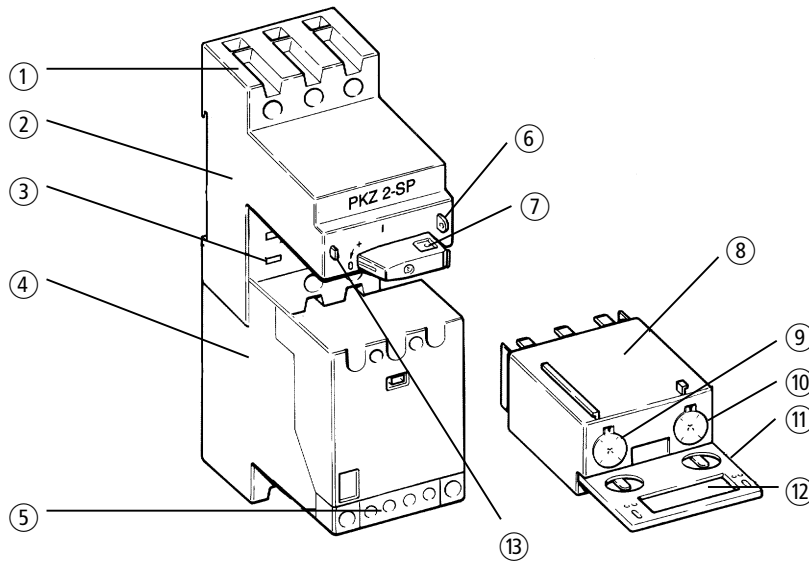

- ① Both field wiring terminals on the line side (Disconnect) and load side (Contactor) have large Service Entrance spacings typical of molded case circuit breakers.
- ② The Main Disconnect isolating contacts are current limiting in design.
- ③ Visible, "finger-touch-proof" open circuit power path when Trip Module is removed.
- ④ The Contactor Motor Switching contacts are also current limiting in design and significantly enhance the device's overall interrupting ability.
- ⑤ The Contactor comes standard with 1 NO and 1 NC auxiliary contacts. 2 NO also available.
- ⑥ The Trip Module can be set and then sealed with a wire lock.
- ⑦ Padlockable Handle with ON, OFF and TRIP (+) indication.
- ⑧ Field-interchangeable plug-in Motor Protective Trip Modules with Coordinated Overload and Short-Circuit protection built-in.
- ⑨ Adjustable magnetic trip dial, range: 8.5 – 14 times Trip Module rating.
- ⑩ Adjustable thermal trip dial, range: 0.6 – 1 times Trip Module rating (set to Motor FLC).
- ⑪ Test-to-trip slot.
- ⑫ Coding feature to differentiate Trip Modules.
- ⑬ Short-circuit trip indicator **K-AGM-PKZ 2** provides visual indication of short circuit trip condition and differentiation between short circuit and general trip due to overload and/or voltage trips.



ZMR...-PKZ 2

Trip Module Type ZMR

Under overload and short circuit fault conditions the standard trip module will open the Main Disconnect portion of the **PKZ 2** Self-Protected starter, much like the operation of an inverse time molded case circuit breaker.

As an option, the trip module Type **ZMR** can be provided. It features a set of auxiliary contacts which are actuated under overload conditions. Similar to the operation of an overload relay in a conventional combination controller, the N.C. contact can be used to de-energize the contactor coil circuit in the event of an overload and the N.O. contact can be used to annunciate the condition. A short circuit fault will trip open the Main disconnect instantaneously just like the standard trip module.

The **ZMR** module is ideal for applications which need to take full advantage of the Self-Protected Starter's capabilities over conventional combination controllers, but wish to retain the operating features of a conventional overload relay in a starter. See page 7/26 for further info.

Starters – Combination Self-protected, Full Voltage Non-Reversing

Standard Features

- UL listed/CSA certified, self-protected combination motor controller, UL 508/CSA 22.2 No.14 Type E.
- Main Disconnect and Contactor modules rated max 42 A, 30 HP @ 460 V AC; max. 27 A, 25 HP @ 575 V AC.
- Stand-alone device, no back-up overcurrent protection required up to its full interrupting rating, 100/65/42 kA @ 240/480/600 V AC.
- Continuity of service (protects itself against damage under fault conditions).
- For additional safety, plug-in trip module, which creates an open circuit path to the motor when removed.
- Adjustable thermal and magnetic trips; built-in phase loss differential trip.
- Built-in 1 NO & 1 NC auxiliary contacts in the contactor portion. 2 N.O. also available.
- Electrical life: 1 million operations, AC-3 (30 HP at 460 V AC)
- Adapter plate for rail or panel mounting.
- Tap-off terminals on load side of disconnect for easy control circuit feed.
- Full range of accessories including voltage trips, standard and differentiated trip indicating auxiliary contacts, remote control drive.
- Environmentally safe! No cadmium, asbestos, mercury, PCB's. No Fluorocarbons produced during manufacture.
- Enclosed starters provided with door interlocking and padlockable handle.

1				2		3	4	5		6	7	8
UL/CSA Maximum HP Rating 50/60 Hz 3 Phase				Adjustable current range		Adjust- able Thermal settings (set to motor FLC) ¹⁾	Adjust- able Instanta- neous Trip Range	Type When ordering Specify: - Type - Enclosure Suffix from columns 6, 7 or 8, if applicable - Coil voltage and frequency (See example at bottom of page) Standard coil voltages: AC: 24, 120, 208, 240,480, 600 60 Hz DC: 24 V	Open		Enclosed	
200 V HP	230 V HP	460 V HP	575 V HP	Amps	Amps				Price \$	Price \$	Price \$	Price \$
In this range, select devices in accordance with motor FLC				0.4-0.6	5-8		PKZ 2/ZM-0.6/S-SP	See Price List	See Price List	See Price List	See Price List	See Price List
	1/2	3/4	1	0.6-1.0	8-14		PKZ 2/ZM-1/S-SP	See Price List	See Price List	See Price List	See Price List	See Price List
	1/3	1	1 1/2	1.0-1.6	14-22		PKZ 2/ZM-1.6/S-SP	See Price List	See Price List	See Price List	See Price List	See Price List
1/2	1/2	1	1 1/2	1.6-2.4	20-35		PKZ 2/ZM-2.4/S-SP	See Price List	See Price List	See Price List	See Price List	See Price List
1	1	2	3	2.4-4.0	35-55		PKZ 2/ZM-4/S-SP	See Price List	See Price List	See Price List	See Price List	See Price List
1 1/2	1 1/2	3	5	4.0-6.0	50-80		PKZ 2/ZM-6/S-SP	See Price List	See Price List	See Price List	See Price List	See Price List
2	3	5	7 1/2	6-10	80-140		PKZ 2/ZM-10/S-SP	See Price List	See Price List	See Price List	See Price List	See Price List
3	5	10	10	10-16	130-220		PKZ 2/ZM-16/S-SP	See Price List	See Price List	See Price List	See Price List	See Price List
7 1/2	7 1/2	20	25	16-27	200-350		PKZ 2/ZM-25/S-SP	See Price List	See Price List	See Price List	See Price List	See Price List
10	10	20	–	24-32	275-425		PKZ 2/ZM-32/S-SP	See Price List	See Price List	See Price List	See Price List	See Price List
10	15	30	–	32-42	350-500		PKZ2/ZM-40/S-SP	See Price List	See Price List	See Price List	See Price List	See Price List

- 1) Set bimetal trips (yellow dial) to motor FLC
 - Tripping current = 125% of setting
 - For motors of Service Factor 1.0, set dial to 0.9 of Motor FLC setting
 - Ambient compensated
 - Phase failure sensitive
- 2) For type 4X, consult Moeller Electric.

Additional Information	Page
Technical Data	3/50
Dimensions	7/38
Accessories	7/28
Factory Modifications	3/28

How to Order

To Order Specify:	Type Number
Type Number	Type
Enclosure Suffix	Enclosure Suffix
Coil Voltage	Coil Voltage
Accessories	
	PKZ 2/ZM-1/S-SP /DW 120V 60Hz



A 30 HP, 460 V self protected combination motor controller: **PKZ 2-SP** installed in a NEMA 1 enclosure with fused control transformer, extra auxiliary contact and pilot devices

Self-Protected, Full Voltage, Non Reversing and Reversing, Open Type

Select the appropriate FVNR/FVR open style basic starters and trip modules from the tables below



PKZ 2/S-SP...
Non-Reversing starter

FVNR-Self-Protected. Full Voltage Non-Reversing basic starter (without trip module)

Maximum HP rating 3 phase				Type	Price \$
200 V	230 V	460 V	575 V	PKZ 2/S-SP...	See Price List
10	15	30	25	Specify coil voltage Standard: (AC) 24,120, 208, 240, 480, 600V, 60Hz (DC) 24 V	See Price List

The PKZ 2/S-SP (...) Self-Protected Full Voltage Non-Reversing starter is the same device as featured on page 3/20 but without the trip module ZM-...-PKZ 2. It is fully ready to be mounted and wired in its own enclosure, MCC unit or panel assembly. The HP values shown above are the maximum allowable and are dependent on the trip module chosen. The ZM-...-PKZ 2 trip modules which are shown below can be later selected in accordance with desired motor HP and FLC and plugged into the disconnect to complete the starter. Trip modules can be field installed for maximum flexibility.



PKZ 2/S-SP-FVR...
Reversing starter

FVR-Self-Protected. Full Voltage Reversing basic starter (without trip module)

Maximum HP rating 3 phase				Type	Price
200 V	230 V	460 V	575 V	PKZ 2/S-SP-FVR...	See Price List
10	15	30	25	Specify coil voltage Standard: (AC) 24,120, 208, 240, 480, 600V, 60Hz (DC) 24 V	See Price List

The PKZ 2/S-SP (...) Self-Protected Full Voltage Reversing starter is supplied with factory mounted and wired disconnect and mechanically interlocked contactors. Its features and ratings are otherwise identical to the FVNR starter. It is fully ready to be mounted and wired in its own enclosure, MCC unit or panel assembly. The HP values shown above are the maximum allowable and are dependent on the trip module chosen. The ZM-...-PKZ 2 trip modules which are shown below can be later selected in accordance with desired motor HP and FLC and plugged into the disconnect to complete the starter. Trip modules can be field installed for maximum flexibility.



Trip module ZM-...-PKZ 2¹⁾ plugs into the PKZ 2 Disconnect to complete starter. See page 7/26 for more info on ZM-...-PKZ 2 trip modules.

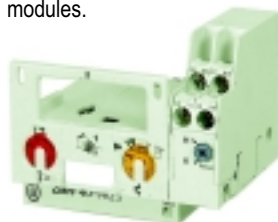

Trip module ZMR-...-PKZ 2¹⁾ plugs into the PKZ 2 Disconnect to complete starter. Includes 1N.O. & 1 N.C. overload relay trip & signalling contacts. See page 7/26 for more info on ZMR-...-PKZ 2 trip modules.

Trip Modules – ZM-...-PKZ 2

Maximum HP rating 3 phase				Adjustable thermal current range ¹⁾	Adjustable instantaneous trip range	Type	Price	Type Includes 1N.O. & 1 N.C. overload relay trip & signalling contacts	Price
200 V HP	230 V HP	460 V HP	575 V HP	Amps	Amps		\$		\$
In this range, select devices in accordance with motor FLC				0.4-0.6	5-8	ZM-0.6-PKZ 2	See Price List	ZMR-0.6-PKZ 2	See Price List
		1/2	1/2	0.6-1.0	8-14	ZM-1-PKZ 2	See Price List	ZMR-1-PKZ 2	See Price List
		1/3	3/4	1.0-1.6	14-22	ZM-1.6-PKZ 2	See Price List	ZMR-1.6-PKZ 2	See Price List
	1/2	1	1 1/2	1.6-2.4	20-35	ZM-2.4-PKZ 2	See Price List	ZMR-2.4-PKZ 2	See Price List
1	1	2	3	2.4-4.0	35-55	ZM-4-PKZ 2	See Price List	ZMR-4-PKZ 2	See Price List
1 1/2	1 1/2	3	5	4.0-6.0	50-80	ZM-6-PKZ 2	See Price List	ZMR-6-PKZ 2	See Price List
2	3	5	7 1/2	6-10	80-140	ZM-10-PKZ 2	See Price List	ZMR-10-PKZ 2	See Price List
3	5	10	10	10-16	130-220	ZM-16-PKZ 2	See Price List	ZMR-16-PKZ 2	See Price List
7 1/2	7 1/2	20	25	16-27	200-350	ZM-25-PKZ 2	See Price List	ZMR-25-PKZ 2	See Price List
10	10	20	-	24-32	275-425	ZM-32-PKZ 2	See Price List	ZMR-32-PKZ 2	See Price List
10	15	30	-	32-42	350-500	ZM-40-PKZ 2	See Price List	ZMR-40-PKZ 2	See Price List

- 1) ZM-...-PKZ 2 & ZMR-...-PKZ 2 Trip Modules:
- Thermal trips (yellow dial) set to motor Full Load Current
 - Tripping current = 125% of setting
 - For motors of Service Factor 1.0, set dial to 0.9 of Motor FLC setting
 - Ambient compensated
 - phase failure sensitive

UL listed/CSA certified maximum interrupting ratings	
240 V AC	100 kA RMS sym
480 Y/277 V AC	65 kA RMS sym
600 Y/347 V AC	42 kA RMS sym
Up to 27 A :	Suitable for maximum 600 V AC power distribution system when the voltage between any phase to ground does not exceed 347 V
Up to 42 A :	Suitable for maximum 480 V AC power distribution systems when the voltage between any phase to ground does not exceed 277 V

Additional Information	Page
Technical Data	3/50
Dimensions	7/38
Overload Relays	4/2
Accessories	7/28
Factory Modifications	3/28

Starters – Combination Breaker Type, Full Voltage, Non Reversing

Magnetic Starters

3

1				2		3		4		5		6		7	
UL/CSA Maximum HP Rating 50/60 Hz				Standard Auxiliary Contacts		Type ¹⁾ Insert overload relay suffix code ... from page 3/33 (Suffix has already been provided on certain types.)		Enclosed							
3 phase								General Purpose Enclosure		Weather-proof enclosure		Dusttight enclosure Industrial		Insulating Material Enclosure	
								Type 1		Type 3R		Type 12		Type 12	
								Add suffix /S to type		Add suffix /DW to type		Add suffix /SD to type		Add suffix /I to type	
200 V HP	230 V HP	460 V HP	575 V HP	NO	NC			Price \$	Price \$	Price \$	Price \$				
DIL...M System Contactors								See Price List	See Price List	See Price List	See Price List	See Price List	See Price List	See Price List	See Price List
3	3	5	–	1	0	M 00M-10/ZM/Z00-...									
–	–	7½	–	1	0	M 00AM-10/ZM/Z00-...									
5	7½	10	15	1	1	M 0M/11/ZM/Z00-...									
7½	10	15	20	1	1	M 0AM/11/ZM6/Z-...									
10	–	20	25	1	1	M 1M/11/ZM6/Z1-40									
–	15	30	30	1	1	M 2M/11/ZM6/Z1-...									
15	20	40	40	1	1	M 2M/11/ZM6/Z1-57									
20	25	50	50	1	1	M 2AM/11/ZM6/Z1-...									
25	30	60	75	1	1	M 3M 80/11/ZM6/Z5-...									
30	40	75	100	1	1	M 4M 115/11/ZM6/Z5-...									
40	50	100	125	1	1	M 4M 115/11/ZM9/Z5-...									
DIL Universal Contactors								See Price List	See Price List	See Price List	See Price List	See Price List	See Price List	See Price List	See Price List
30	30	60	75	2	2	M 3-22/ZM6/Z4-...									
–	40	75	100	2	2	M 4-22/ZM6/Z4-...									
40	50	100	–	2	2	M 4-22/ZM9/Z4-140									
60	75	150	150	2	2	M 6-22/ZM9/Z4-...									
–	–	–	200	2	2	M 8-22/ZM9/Z4-...									
75	–	200	–	2	2	M 8-22/ZM10/Z4-240									
–	100	–	250	2	2	M 8-22/ZM10/ZW7-...									
125	150	300	300	2	2	M 8A-22/ZM10/ZW7-...									

1) UL listed short circuit withstand for DIL...M...(M) starters (using DIL...M System contactors through 50 HP at 460V) is 25 kA RMS sym. at 480 V AC.

How to Order

To Order Specify: Type Number Overload Relay suffix Enclosure Suffix Coil Voltage Accessories	Type Number (for 10 HP @ 460 V AC)			
	Type	Overload Relay Suffix	Enclosure Suffix	Add Coil Voltage from p. 3/46-47
	M 0M/11/ZM/Z00-	16	/S	120 V 60 Hz

Additional Information	Page
Technical Data	3/50
Dimensions	3/61
Overload Relays	4/2
Accessories	3/35
Factory Modifications	3/28

Starters – Combination Breaker Type, Full Voltage, Reversing

1				2		3		4		5		6		7			
UL/CSA Maximum HP Rating 50/60 Hz 3 phase				Standard Auxiliary Contacts		Type¹⁾ Insert overload relay suffix code ... from page 3/33 (Suffix has already been provided on certain types.)		Enclosed									
								General Purpose Enclosure	Weather-proof enclosure	Dusttight enclosure Industrial	Insulating Material Enclosure						
								Type 1	Type 3R	Type 12	Type 12						
								Add suffix /S to type	Add suffix /DW to type	Add suffix /SD to type	Add suffix /I to type						
200 V HP	230 V HP	460V HP	575 V HP	NO	NC			Price \$	Price \$	Price \$	Price \$						
DIL...M System Contactors																	
3	3	5	–	0	1	MW 00M-01/ZM/Z00-... ²⁾		See Price List	See Price List	See Price List	See Price List	See Price List	See Price List	See Price List	See Price List		
–	–	7½	–	0	1	MW 00AM-01/ZM/Z00-... ²⁾		See Price List	See Price List	See Price List	See Price List	See Price List	See Price List	See Price List	See Price List		
5	7½	10	15	1	1	MW 0M/11/ZM/Z00-...		See Price List	See Price List	See Price List	See Price List	See Price List	See Price List	See Price List	See Price List		
7½	10	15	20	1	1	MW 0AM/11/ZM6/Z-...-...		See Price List	See Price List	See Price List	See Price List	See Price List	See Price List	See Price List	See Price List		
10	–	20	25	1	1	MW 1M/11/ZM6/Z1-40		See Price List	See Price List	See Price List	See Price List	See Price List	See Price List	See Price List	See Price List		
–	15	30	30	1	1	MW 2M/11/ZM6/Z1-...		See Price List	See Price List	See Price List	See Price List	See Price List	See Price List	See Price List	See Price List		
15	20	40	40	1	1	MW 2M/11/ZM6/Z1-57		See Price List	See Price List	See Price List	See Price List	See Price List	See Price List	See Price List	See Price List		
20	25	50	50	1	1	MW 2AM/11/ZM6/Z1-...		See Price List	See Price List	See Price List	See Price List	See Price List	See Price List	See Price List	See Price List		
25	30	60	75	1	1	MW 3M 80/11/ZM6/Z5-...		See Price List	See Price List	See Price List	See Price List	See Price List	See Price List	See Price List	See Price List		
30	40	75	100	1	1	MW 4M 115/11/ZM6/Z5-...		See Price List	See Price List	See Price List	See Price List	See Price List	See Price List	See Price List	See Price List		
40	50	100	125	1	1	MW 4M 115/11/ZM9/Z5-...		See Price List	See Price List	See Price List	See Price List	See Price List	See Price List	See Price List	See Price List		
DIL Universal Contactors																	
30	30	60	75	2	2	MW 3-22/ZM6/Z4-...		See Price List	See Price List	See Price List	See Price List	See Price List	See Price List	See Price List	See Price List		
–	40	75	100	2	2	MW 4-22/ZM6/Z4-...		See Price List	See Price List	See Price List	See Price List	See Price List	See Price List	See Price List	See Price List		
40	50	100	–	2	2	MW 4-22/ZM9/Z4-140		See Price List	See Price List	See Price List	See Price List	See Price List	See Price List	See Price List	See Price List		
60	75	150	150	2	2	MW 6-22/ZM9/Z4-...		See Price List	See Price List	See Price List	See Price List	See Price List	See Price List	See Price List	See Price List		
–	–	–	200	2	2	MW 8-22/ZM9/Z4-...		See Price List	See Price List	See Price List	See Price List	See Price List	See Price List	See Price List	See Price List		
75	–	200	–	2	2	MW 8-22/ZM10/Z4-240		See Price List	See Price List	See Price List	See Price List	See Price List	See Price List	See Price List	See Price List		
–	100	–	250	2	2	MW 8-22/ZM10/ZW7-...		See Price List	See Price List	See Price List	See Price List	See Price List	See Price List	See Price List	See Price List		
125	150	300	300	2	2	MW 8A-22/ZM10/ZW7-...		See Price List	See Price List	See Price List	See Price List	See Price List	See Price List	See Price List	See Price List		

1) UL listed short circuit withstand for MW...M/ starters (using DIL...M System contactors through 50 HP at 460V) is 25 kA RMS sym. at 480 V AC.
2) Contactors equipped with 1 NC auxiliary contact only for electrical interlocking purposes. For additional auxiliary contacts see page 3/35.

How to Order

To Order Specify:	Type Number (for 30 HP @ 460 V AC)			
Type Number	Type	Overload Relay Suffix	Enclosure Suffix	Add Coil Voltage from p. 3/46-47
Overload Relay suffix	MW 2M/11/ZM6/Z1-...	57	/S	120 V 60 Hz
Enclosure Suffix				
Coil Voltage				
Accessories				

Additional Information	Page
Technical Data	3/50
Dimensions	3/61
Overload Relays	4/2
Accessories	3/35
Factory Modifications	3/28

Starters – Combination Fusible & Non-Fusible, Full Voltage, Non Reversing, Class J

1				2		3		4		5		6		7		8		9		
UL/CSA Maximum HP Rating 50/60 Hz				Disconnect switch Size	Class J Time Delay Fuse Clips Size ¹⁾	Standard Auxiliary Contacts		Type ²⁾ Insert overload relay suffix code ... from page 3/33 For optimal motor protection, obtain actual motor nameplate full load amp rating and select overload per instructions found on pages 3/12 – 3/13. Consult Moeller Electric if motor FLA falls outside the overload frame size suggested.		Enclosed										
3 phase										General Purpose Enclosure	Weather-proof enclosure	Dusttight enclosure Industrial	Insulating Material Enclosure							
200 V HP	230 V HP	460 V HP	575 V HP							Amps	Amps	NO	NC	Type 1	Type 3R	Type 12	Type 12			
								Add suffix /S to type	Add suffix /DW to type	Add suffix /SD to type	Add suffix /I to type									
								Price \$	Price \$	Price \$	Price \$									
3	3	5	7 1/2	30	30	1	0	M 00M/10/P2-30FC23/Z00-...	See Price List	See Price List	See Price List	See Price List	See Price List	See Price List	See Price List	See Price List	See Price List	See Price List	See Price List	
-	-	7 1/2	10	30	30	1	0	M 00AM/10/P2-30FC23/Z00-...	See Price List	See Price List	See Price List	See Price List	See Price List	See Price List	See Price List	See Price List	See Price List	See Price List	See Price List	
5	5	10	15	30	30	1	1	M 0M/11/P2-30FC23/Z00-...	See Price List	See Price List	See Price List	See Price List	See Price List	See Price List	See Price List	See Price List	See Price List	See Price List	See Price List	
7 1/2	7 1/2	-	-	30	60	1	1	M 0M/11/P2-30FC26/Z00-...	See Price List	See Price List	See Price List	See Price List	See Price List	See Price List	See Price List	See Price List	See Price List	See Price List	See Price List	
-	10	15	20	30	60	1	1	M 0AM/11/P2-30FC26/Z00-...	See Price List	See Price List	See Price List	See Price List	See Price List	See Price List	See Price List	See Price List	See Price List	See Price List	See Price List	
-	-	20	25	30	60	1	1	M 1M/11/P2-30FC26/Z1-...	See Price List	See Price List	See Price List	See Price List	See Price List	See Price List	See Price List	See Price List	See Price List	See Price List	See Price List	
10	-	-	-	60	60	1	1	M 1M/11/P2-60FC26/Z1-...	See Price List	See Price List	See Price List	See Price List	See Price List	See Price List	See Price List	See Price List	See Price List	See Price List	See Price List	
-	-	30	30	60	60	1	1	M 2M/11/P2-60FC26/Z1-40	See Price List	See Price List	See Price List	See Price List	See Price List	See Price List	See Price List	See Price List	See Price List	See Price List	See Price List	
-	15	-	40	60	60	1	1	M 2M/11/P2-60FC26/Z1-57	See Price List	See Price List	See Price List	See Price List	See Price List	See Price List	See Price List	See Price List	See Price List	See Price List	See Price List	
15	20	40	-	60	100	1	1	M 2M/11/P2-60FC110/Z1-...	See Price List	See Price List	See Price List	See Price List	See Price List	See Price List	See Price List	See Price List	See Price List	See Price List	See Price List	
20	25	50	50	100	100	1	1	M 2AM/11/P2-100FC110/Z1-...	See Price List	See Price List	See Price List	See Price List	See Price List	See Price List	See Price List	See Price List	See Price List	See Price List	See Price List	
30	30	60	75	100	200	2	2	M 3-22/P2-100-62003J/Z4-...	See Price List	See Price List	See Price List	See Price List	See Price List	See Price List	See Price List	See Price List	See Price List	See Price List	See Price List	
Combination Starters										See Price List	See Price List	See Price List	See Price List	See Price List	See Price List	See Price List	See Price List	See Price List	See Price List	
Non-Fusible Disconnect Switch Type										See Price List	See Price List	See Price List	See Price List	See Price List	See Price List	See Price List	See Price List	See Price List	See Price List	See Price List
3	3	5	7	30	None	1	1	M 00M/11/P2-30/Z00-...	See Price List	See Price List	See Price List	See Price List	See Price List	See Price List	See Price List	See Price List	See Price List	See Price List	See Price List	
-	-	7 1/2	10	30	None	1	1	M 00AM/11/P2-30/Z00-...	See Price List	See Price List	See Price List	See Price List	See Price List	See Price List	See Price List	See Price List	See Price List	See Price List	See Price List	
7 1/2	7 1/2	10	15	30	None	1	1	M 0M/11/P2-30/Z00-...	See Price List	See Price List	See Price List	See Price List	See Price List	See Price List	See Price List	See Price List	See Price List	See Price List	See Price List	
-	10	15	20	30	None	1	1	M 0AM/11/P2-30/Z00-...	See Price List	See Price List	See Price List	See Price List	See Price List	See Price List	See Price List	See Price List	See Price List	See Price List	See Price List	
10	-	20	25	60	None	1	1	M 1M/11/P2-60/Z1-...	See Price List	See Price List	See Price List	See Price List	See Price List	See Price List	See Price List	See Price List	See Price List	See Price List	See Price List	
15	20	40	40	60	None	1	1	M 2M/11/P2-60/Z1-...	See Price List	See Price List	See Price List	See Price List	See Price List	See Price List	See Price List	See Price List	See Price List	See Price List	See Price List	
20	25	50	50	100	None	1	1	M 2AM/11/P2-100/Z1-...	See Price List	See Price List	See Price List	See Price List	See Price List	See Price List	See Price List	See Price List	See Price List	See Price List	See Price List	
30	30	60	75	100	None	2	2	M 3-22/P2-100/Z 4-...	See Price List	See Price List	See Price List	See Price List	See Price List	See Price List	See Price List	See Price List	See Price List	See Price List	See Price List	

Contact Moeller Electric for larger sizes.

- 1) Recommended Class J Time-Delay Fuse Ampacity. Range: 1.25 to 1.5 times motor full load current
- 2) UL listed short circuit withstand of fusible starters with class J fuses is 100 kA RMS sym. at 480 V AC.

How to Order

To Order Specify:	Type Number			
Type Number	Type	Overload Relay Suffix	Enclosure Suffix	Add Coil Voltage from p. 3/46-47
Overload Relay suffix	M 0M/11/P2-30FC26/Z00-	16	/S	120 V 60 Hz
Enclosure Suffix				
Coil Voltage				
Accessories				

Additional Information	Page
Technical Data	3/50
Dimensions	3/61
Overload Relays	4/2
Accessories	3/35
Factory Modifications	3/28

Magnetic Starters
3

Starters – Combination Fusible, Full Voltage, Non Reversing, Class R

1				2	3	4		5		6				7	8	9
UL/CSA Maximum HP Rating 50/60 Hz				Disconnect switch Size	Class R Time Delay Fuse Clips Size ¹⁾	Standard Auxiliary Contacts		Type Insert overload relay suffix code ... from page 3/33 For optimal motor protection, obtain actual motor nameplate full load amp rating and select overload per instructions found on pages 3/12 - 3/13. Consult Moeller Electric if motor FLA falls outside the overload frame size suggested.		Enclosed				Weather-proof enclosure	Dusttight enclosure Industrial	Insulating Material Enclosure
3 phase						General Purpose Enclosure				Type 1	Type 3R	Type 12	Type 12			
200 V HP	230 V HP	460 V HP	575 V HP	Amps	Amps	NO	NC			Add suffix /S to type	Add suffix /DW to type	Add suffix /SD to type	Add suffix /I to type			
3	3	–	–	30	30	1	0	M 00M/10/P2-30FC33/Z00-...		See Price List				See Price List		
–	–	5	7½	30	30	1	0	M 00M/10/P2-30FC43/Z00-...			See Price List			See Price List		
–	–	7½	10	30	30	1	0	M 00AM/10/P2-30FC43/Z00-...				See Price List		See Price List		
5	5	10	–	30	30	1	1	M 0M/11/P2-30FC33/Z00-...				See Price List		See Price List		
–	–	10	15	30	30	1	1	M 0M/11/P2-30FC43/Z00-...		See Price List				See Price List		
7½	–	–	–	30	60	1	1	M 0M/11/P2-30FC43/Z1-...		See Price List	See Price List			See Price List		
–	10	–	–	30	60	1	1	M 0AM/11/P2-30FC43/Z1-...		See Price List	See Price List			See Price List		
–	–	15	20	30	60	1	1	M 0AM/11/P2-30FC46/Z00-...		See Price List	See Price List			See Price List		
–	–	20	25	30	60	1	1	M 1M/11/P2-30FC46/Z1-...		See Price List	See Price List			See Price List		
10	–	–	–	60	60	1	1	M 1M/11/P2-60FC43/Z1-...		See Price List	See Price List			See Price List		
–	–	30	30	60	60	1	1	M 2M/11/P2-60FC46/Z1-40		See Price List	See Price List			See Price List		
–	15	–	–	60	60	1	1	M 2M/11/P2-60FC43/Z1-...		See Price List	See Price List			See Price List		
–	–	–	40	60	60	1	1	M 2M/11/P2-60FC46/Z1-57		See Price List	See Price List			See Price List		
15	20	40	–	60	100	1	1	M 2M/11/P2-60FC310/Z1-...		See Price List	See Price List			See Price List		
20	25	50	50	100	100	1	1	M 2AM/11/P2-100FC310/Z1-...		See Price List	See Price List			See Price List		
30	–	–	–	100	200	2	2	M 3-22/P2-100-22003R/Z4-...		See Price List	See Price List			See Price List		
25	30	60	75	100	200	2	2	M 3-22/P2-100-62003R/Z4-...		See Price List	See Price List			See Price List		

Contact Moeller Electric for larger sizes.

1) Recommended Class R Rejection-Time-Delay Fuse Ampacity
Range: 1.25 to 1.5 times motor full load current

Starters – Combination Fusible & Non-Fusible, Full Voltage, Reversing, Class J

Magnetic Starters
3

1				2		3		4		5		6		7		8		9	
UL/CSA Maximum HP Rating 50/60 Hz				Disconnect switch Size	Class J Time Delay Fuse Clips Size ¹⁾	Standard Auxiliary Contacts		Type ²⁾		Enclosed									
3 phase						Insert overload relay suffix code ... from page 3/33		General Purpose Enclosure	Weather-proof enclosure	Dusttight enclosure Industrial	Insulating Material Enclosure								
200 V HP	230 V HP	460 V HP	575 V HP			NO	NC	Type 1	Type 3R	Type 12	Type 12								
				Amps	Amps	For optimal motor protection, obtain actual motor nameplate full load amp rating and select overload per instructions found on pages 3/12 - 3/13. Consult Moeller Electric if motor FLA falls outside the overload frame size suggested.		Add suffix /S to type	Add suffix /DW to type	Add suffix /SD to type	Add suffix /I to type	Price \$	Price \$	Price \$	Price \$				
3	3	5	7 1/2	30	30	0	1	MW 00M-01/P2-30FC23/Z00-... ³⁾	See Price List	See Price List	See Price List	See Price List	See Price List	See Price List	See Price List	See Price List	See Price List	See Price List	See Price List
-	-	7 1/2	10	30	30	0	1	MW 00AM-01/P2-30FC23/Z00-... ³⁾	See Price List	See Price List	See Price List	See Price List	See Price List	See Price List	See Price List	See Price List	See Price List	See Price List	See Price List
-	5	10	15	30	30	1	1	MW 0M/11/P2-30FC23/Z00-...	See Price List	See Price List	See Price List	See Price List	See Price List	See Price List	See Price List	See Price List	See Price List	See Price List	See Price List
7 1/2	7 1/2	-	-	30	60	1	1	MW 0M/11/P2-30FC26/Z00-...	See Price List	See Price List	See Price List	See Price List	See Price List	See Price List	See Price List	See Price List	See Price List	See Price List	See Price List
-	-	15	20	30	60	1	1	MW 0AM/11/P2-30FC23/Z00-...	See Price List	See Price List	See Price List	See Price List	See Price List	See Price List	See Price List	See Price List	See Price List	See Price List	See Price List
-	10	-	-	30	60	1	1	MW 0AM/11/P2-30FC26/Z00-...	See Price List	See Price List	See Price List	See Price List	See Price List	See Price List	See Price List	See Price List	See Price List	See Price List	See Price List
-	-	20	25	30	60	1	1	MW 1M/11/P2-30FC26/Z1-...	See Price List	See Price List	See Price List	See Price List	See Price List	See Price List	See Price List	See Price List	See Price List	See Price List	See Price List
10	-	-	-	60	60	1	1	MW 1M/11/P2-60FC26/Z1-...	See Price List	See Price List	See Price List	See Price List	See Price List	See Price List	See Price List	See Price List	See Price List	See Price List	See Price List
-	-	30	30	60	60	1	1	MW 2M/11/P2-60FC26/Z1-40	See Price List	See Price List	See Price List	See Price List	See Price List	See Price List	See Price List	See Price List	See Price List	See Price List	See Price List
-	15	-	40	60	60	1	1	MW 2M/11/P2-60FC26/Z1-57	See Price List	See Price List	See Price List	See Price List	See Price List	See Price List	See Price List	See Price List	See Price List	See Price List	See Price List
15	20	40	-	60	100	1	1	MW 2M/11/P2-60FC110/Z1-...	See Price List	See Price List	See Price List	See Price List	See Price List	See Price List	See Price List	See Price List	See Price List	See Price List	See Price List
20	25	50	50	100	100	1	1	MW 2AM/11/P2-100FC110/Z1-...	See Price List	See Price List	See Price List	See Price List	See Price List	See Price List	See Price List	See Price List	See Price List	See Price List	See Price List
30	30	60	75	100	200	2	2	MW 3-22/P2-100-62003J/Z 4-...	See Price List	See Price List	See Price List	See Price List	See Price List	See Price List	See Price List	See Price List	See Price List	See Price List	See Price List

Combination Starters Non-Fusible Disconnect Switch Type

3	3	5	7 1/2	30	None	1	1	MW 00M/11/P2-30/Z00-...	See Price List	See Price List	See Price List	See Price List	See Price List	See Price List	See Price List	See Price List	See Price List	See Price List	See Price List
-	-	7 1/2	10	30	None	1	1	MW 00AM/11/P2-30/Z00-...	See Price List	See Price List	See Price List	See Price List	See Price List	See Price List	See Price List	See Price List	See Price List	See Price List	See Price List
7 1/2	7 1/2	10	15	30	None	1	1	MW 0M/11/P2-30/Z00- ...	See Price List	See Price List	See Price List	See Price List	See Price List	See Price List	See Price List	See Price List	See Price List	See Price List	See Price List
-	10	15	20	30	None	1	1	MW 0AM/11/P2-30/Z00- ...	See Price List	See Price List	See Price List	See Price List	See Price List	See Price List	See Price List	See Price List	See Price List	See Price List	See Price List
10	-	20	25	60	None	1	1	MW 1M/11/P2-60/Z1-...	See Price List	See Price List	See Price List	See Price List	See Price List	See Price List	See Price List	See Price List	See Price List	See Price List	See Price List
15	20	40	40	60	None	1	1	MW 2M/11/P2-60/Z1-...	See Price List	See Price List	See Price List	See Price List	See Price List	See Price List	See Price List	See Price List	See Price List	See Price List	See Price List
20	25	50	50	100	None	1	1	MW 2AM/11/P2-100/Z1-...	See Price List	See Price List	See Price List	See Price List	See Price List	See Price List	See Price List	See Price List	See Price List	See Price List	See Price List
30	30	60	75	100	None	2	2	MW 3-22/P2-100/Z4-...	See Price List	See Price List	See Price List	See Price List	See Price List	See Price List	See Price List	See Price List	See Price List	See Price List	See Price List

Contact Moeller Electric for larger sizes.

- 1) Recommended Class J Time-Delay Fuse Ampacity. Range: 1.25 to 1.5 times motor full load current
- 2) UL listed short circuit withstand of fusible starters with class J fuses is 100 kA RMS sym. at 480 V AC.
- 3) Contactors equipped with 1 NC auxiliary contact only for electrical interlocking purposes. For additional auxiliary contacts see page 3/35.

How to Order

To Order Specify:	Type Number			
Type Number	Type	Overload Relay Suffix	Enclosure Suffix	Add Coil Voltage from p. 3/46-47
Overload Relay suffix	MW 1M/11/P2-30FC26/Z1-	40	/S	120 V 60 Hz
Enclosure Suffix				
Coil Voltage				
Accessories				

Additional Information	Page
Technical Data	3/50
Dimensions	3/61
Overload Relays	4/2
Accessories	3/35
Factory Modifications	3/28

Starters – Combination Fusible, Full Voltage, Reversing, Class R

1				2	3	4		5	6	7	8	9			
UL/CSA Maximum HP Rating 50/60 Hz				Discon-nect switch Size	Class R Time Delay Fuse Clips Size ¹⁾	Standard Auxiliary Contacts		Type	Enclosed						
3 phase									General Purpose Enclosure				Weather-proof enclosure	Dusttight enclosure Industrial	Insulating Material Enclosure
200 V HP	230 V HP	460 V HP	575 V HP						Amps	Amps	NO	NC	Type 1	Type 3R	Type 12
								Insert overload relay suffix code ... from page 3/33	Add suffix /S to type	Add suffix /DW to type	Add suffix /SD to type	Add suffix /I to type			
								For optimal motor protection, obtain actual motor nameplate full load amp rating and select overload per instructions found on pages 3/12 - 3/13. Consult Moeller Electric if motor FLA falls outside the overload frame size suggested.	Price \$	Price \$	Price \$	Price \$			
3	3	–	–	30	30	0	1	MW 00M-01/P2-30FC33/Z00-... ²⁾	See Price List	See Price List	See Price List	See Price List			
–	–	5	7½	30	30	0	1	MW 00M-01/P2-30FC43/Z00-... ²⁾	See Price List	See Price List	See Price List	See Price List			
–	–	7½	10	30	30	0	1	MW 00AM-01/P2-30FC43/Z00-... ²⁾	See Price List	See Price List	See Price List	See Price List			
5	5	–	–	30	30	1	1	MW 0M/11/P2-30FC33/Z00-...	See Price List	See Price List	See Price List	See Price List			
–	–	10	15	30	30	1	1	MW 0M/11/P2-30FC43/Z00-...	See Price List	See Price List	See Price List	See Price List			
7½	–	–	–	30	60	1	1	MW 0M/11/P2-30FC43/Z1-...	See Price List	See Price List	See Price List	See Price List			
–	10	–	–	30	60	1	1	MW 0AM/11/P2-30FC43/Z1-...	See Price List	See Price List	See Price List	See Price List			
–	–	15	20	30	60	1	1	MW 0AM/11/P2-30FC43/Z00-...	See Price List	See Price List	See Price List	See Price List			
–	–	20	25	30	60	1	1	MW 1M/11/P2-30FC46/Z1-...	See Price List	See Price List	See Price List	See Price List			
10	–	–	–	60	60	1	1	MW 1M/11/P2-60FC43/Z1-...	See Price List	See Price List	See Price List	See Price List			
–	–	25	30	60	60	1	1	MW 2M/11/P2-60FC46/Z1-40	See Price List	See Price List	See Price List	See Price List			
–	15	–	–	60	60	1	1	MW 2M/11/P2-60FC43/Z1-...	See Price List	See Price List	See Price List	See Price List			
–	–	30	40	60	60	1	1	MW 2M/11/P2-60FC46/Z1-57	See Price List	See Price List	See Price List	See Price List			
15	20	40	–	60	100	1	1	MW 2M/11/P2-60FC310/Z1-...	See Price List	See Price List	See Price List	See Price List			
20	25	50	50	100	100	1	1	MW 2AM/11/P2-100FC310/Z1-...	See Price List	See Price List	See Price List	See Price List			
25	30	60	75	100	200	2	2	MW 3-22/P2-100-62003R/Z4-...	See Price List	See Price List	See Price List	See Price List			
30	–	–	–	100	200	2	2	MW 3-22/P2-100-22003R/Z4-...	See Price List	See Price List	See Price List	See Price List			

Contact Moeller Electric for larger sizes.

- 1) Recommended Class R Rejection-Time-Delay Fuse Ampacity.
Range: 1.25 to 1.5 times motor full load current
- 2) Contactors equipped with 1 NC auxiliary contact only for electrical interlocking purposes. For additional auxiliary contacts see page 3/35.

How to Order

To Order Specify:	Type Number			
Type Number Overload Relay suffix Enclosure Suffix Coil Voltage Accessories	Type	Overload Relay Suffix	Enclosure Suffix	Add Coil Voltage from p. 3/46-47
	MW 0M/11/P2-30FC43/Z00-	16	/S	120 V 60 Hz

Additional Information	Page
Technical Data	3/50
Dimensions	3/61
Overload Relays	4/2
Accessories	3/35
Factory Modifications	3/28



Starters – Full Voltage Factory Modifications

Ordering Information:

Order by description

The standard modifications shown on this page are those available for factory installation. Prices for these modifications are shown in the alphanumeric price book under "Starters - Full Voltage Factory Modifications". The enclosure may or may not change with the addition of any of these items. When accurate dimensions of the enclosure are required, refer to your nearest Moeller Electric distributor or sales office.

Description	Enclosure Type	Price addition all sizes \$	Description	Price addition all sizes \$
Pilot Devices in Cover				
Push Buttons			Control Circuit	
"START-STOP" or "ON-OFF" Double push button	1, 12, 12K, 3R 13, 3, 4, 4X	See Price List	Separate control circuit Fused control circuit – 250 V, 1 or 2 fuses Fused control circuit – 600 V, 2 fuses	See Price List
"START-STOP" or "ON-OFF" Double push button with indicating light	1, 12, 12K, 3R 13, 3, 4, 4X	See Price List	Auxiliary Relays	See Price List
Standard 1 unit push button	1, 12, 12K, 3R	See Price List	Control relay, maximum of 4 poles – unwired – wired	See Price List
Standard 2 unit push button	1, 12, 12K, 3R	See Price List	Timing relay	See Price List
Standard 3 unit push button	1, 12, 12K, 3R	See Price List	Terminal Block wired – per pole	See Price List
Selector Switches			Auxiliary Relays for Multi-speed Starter Only	
"HAND-O-AUTO" Selector Switch	1, 12, 12K, 3R, 4X	See Price List	Compelling relay	See Price List
"MAN-AUTO" Selector Switch	1, 12, 12K, 3R, 4X	See Price List	Accelerating relay – 2 speed	See Price List
Pilot Lights			Time decelerating relay – 2 speed	See Price List
Pilot light (specify color)	1, 12, 12K, 3R 13, 3, 4, 4X	See Price List	Phase reversal and failure relay	See Price List
Push-to-test light or illuminated push button	1, 12, 12K, 3R 13, 3, 4, 4X	See Price List	Overload Relays	See Price List
			Ambient compensated, phase failure sensitive 3 Phase bimetallic O/L relay Type Z... supplied as standard P.T.C. Thermistor Tripping Unit	See Price List
			Name Plates	See Price List
			Special nameplates, 3" x 1"	See Price List

Price addition to Starter – Select using contactor frame size

Description	(E)EM 00M 00AM 0M \$	0AM 1M 1AM \$	2M 2AM \$	3-22 4-22 \$	3M 80 \$	4M 115 6-22 \$	8-22 8a-22 \$	PKZ 2 Self- Protected Starter \$
Control Circuit Transformers	See Price List	See Price List	See Price List	See Price List	See Price List	See Price List	See Price List	See Price List
Transformer 60 Hz with fused primary	See Price List	See Price List	See Price List	See Price List	See Price List	See Price List	See Price List	See Price List
Transformer with additional capacity up to 100 V, 60 Hz with fused primary	See Price List	See Price List	See Price List	See Price List	See Price List	See Price List	See Price List	See Price List
Overload Relay	See Price List	See Price List	See Price List	See Price List	See Price List	See Price List	See Price List	See Price List
Omit overload relay – deduct	See Price List	See Price List	See Price List	See Price List	See Price List	See Price List	See Price List	See Price List
Mechanical Interlock for Contactors	See Price List	See Price List	See Price List	See Price List	See Price List	See Price List	See Price List	See Price List
Disconnect Device (for Multi-speed Starters only)	See Price List	See Price List	See Price List	See Price List	See Price List	See Price List	See Price List	See Price List
Disconnect switch – non-fusible	See Price List	See Price List	See Price List	See Price List	See Price List	See Price List	See Price List	See Price List
– fusible	See Price List	See Price List	See Price List	See Price List	See Price List	See Price List	See Price List	See Price List
Circuit Breaker	See Price List	See Price List	See Price List	See Price List	See Price List	See Price List	See Price List	See Price List

Application

Reduced voltage starting is required when there are limitations on inrush current or when the load cannot stand the mechanical shock of starting. Starting current and starting torque can be reduced by reducing the applied voltage to the motor stator terminals. A change in voltage applied to the stator results in a change of flux proportional to primary voltage. Stator and rotor currents vary in proportion to applied stator voltage. Since motor torque is proportional to the product of flux and rotor current, torque is proportional to the square of the voltage applied to the stator. The commonly used types of reduced voltage or current motor starters are Autotransformer, Star-Delta, Part Winding, Primary Resistor and Reactor.

Comparison Chart for Reduced Voltage Starters

	Autotransformer Starter Type AT (page 3/30)	Star-Delta Starter Type SD (page 3/31)	Part Winding Starter Type PW ¹⁾	Primary Resistor Starter Type PR ¹⁾	Reactor Starter Type R ¹⁾
Motor Re-quirements	Can be used with any standard squirrel cage motor.	Requires a special motor with 6 leads brought out (Delta wound stator).	Requires a special motor in which the stator windings are divided into two or more equal parts with six leads provided. Also dual voltage motors can be used on the lower range.	Can be used with any standard squirrel cage motor.	Can be used with any standard squirrel cage motor.
Descrip-tion of Operation	The motor is connected to the line through the reduced voltage taps of an autotransformer for the starting interval and then directly across the line for running condition.	This method requires two main or line contactors to connect the motor winding in delta connection for running. A third contactor is used to form the star point on the starting step.	Like the star-delta starter, this starter requires no external equipment. One winding is connected to the line for starting. After a time interval the second or run contactor connects the other motor winding to the line in parallel with the first winding.	A high resistance is connected in series with the motor on starting and after a time interval this resistance is short-circuited and motor is connected directly to the line.	The motor is connected to the line through the reduced voltage taps of a reactor for the starting interval and then directly across the line for running condition.
Starting Characteristics in percent of normal:	Autotransformer taps at: 80- 65- 50% Current 64 42 25% Torque 64 42 25%	100% ↑ 33% 33%	100% ↑ Line voltage 60% 45%	80% 100% ↑ ↑ 80% 65% 64% 42%	Variable with tap setting and load.
Advan-tages	High torque efficiency. All the power taken from the line, except for transformer losses, is transmitted to the motor. The starting current and torque are easily adjusted by changing autotransformer taps. Closed circuit transition.	The star-delta starter provides low inrush current with high torque efficiency, without the use of any external equipment. Open circuit transition is standard but closed transition can be achieved with the use of resistors and an additional contactor.	Part-winding starting provides one-step acceleration at a reduced current. So that the second current inrush is not objectionable. Closed circuit transition.	This type provides almost as smooth starting as the reactor type starter. The current becomes lower and the voltage at the motor terminals rises as the motor accelerates. Closed circuit transition.	This type provides the smoothest starting of all reduced voltage starting methods. More suitable for jogging or inching service. Closed circuit transition.
Limita-tions	Torque remains practically constant for the first step and practically constant at another value for the second step.	Starting characteristics depend on motor design and cannot be adjusted. Requires special delta wound motor.	Requires special motor or dual-voltage motor on low range. Torque efficiency is usually poor for high speed motors.	Unavoidable power loss in resistor. Low torque efficiency. Duty cycle limited by thermal capacity of resistor.	Taps must be selected on job site to obtain starting voltage level suitable for the load.
Applica-tions	Applications where there are limitations on starting voltage and current. Most widely used.	Low starting torque applications.	Commercial air conditioning equipment.	Geared or belted drives, and other delicate applications.	Textile machinery, and other driven loads requiring smooth shock-less starting.
Approxi-mate Price Comparison (% of Type AT)	100%	60%	40%	More than 100%	More than 100%

1) Please contact Moeller Electric for information about these items.

Starters – Reduced Voltage Autotransformer Type

Magnetic Starters
3

1				2	3		4		5		
UL/CSA Maximum HP Rating 50/60 Hz				Type	Enclosed						
3 phase					General Purpose Enclosure Type 1 Add suffix /S to type		Dusttight enclosure Industrial Use Type 12 Add suffix /SD to type		Weatherproof enclosure Type 3R Add suffix /DW to type		
200 V HP	230 V HP	460 V HP	575 V HP	Price \$		Price \$		Price \$			
DIL...M Contactors				Insert overload relay suffix code ... from page 3/33							
–	–	15	20	AT 0AM/22/Z00-...		See Price List	See Price List	See Price List	See Price List	See Price List	See Price List
–	–	20	25	AT 1M/22/Z1-40		See Price List	See Price List	See Price List	See Price List	See Price List	See Price List
–	15	25	30	AT 1AM/22/Z1-...		See Price List	See Price List	See Price List	See Price List	See Price List	See Price List
15	–	30	–	AT 2M/22/Z1-...		See Price List	See Price List	See Price List	See Price List	See Price List	See Price List
–	20	40	40	AT 2M/22/Z1-57		See Price List	See Price List	See Price List	See Price List	See Price List	See Price List
20	–	–	50	AT 2AM/22/Z1-...		See Price List	See Price List	See Price List	See Price List	See Price List	See Price List
–	25	50	–	AT 2AM/22/Z1-75		See Price List	See Price List	See Price List	See Price List	See Price List	See Price List
25	30	60	75	AT 3M 80/22/Z5-100		See Price List	See Price List	See Price List	See Price List	See Price List	See Price List
40	50	100	125	AT 4M 115/22/Z5-...		See Price List	See Price List	See Price List	See Price List	See Price List	See Price List
DIL... Universal Contactors											
30	–	–	–	AT 3-22/Z4-100		See Price List	See Price List	See Price List	See Price List	See Price List	See Price List
–	40	75	–	AT 4-22/Z4-...		See Price List	See Price List	See Price List	See Price List	See Price List	See Price List
40	50	100	100	AT 4-22/Z4-...		See Price List	See Price List	See Price List	See Price List	See Price List	See Price List
50	–	–	125	AT 6-22/Z4-...		See Price List	See Price List	See Price List	See Price List	See Price List	See Price List
60	60	125	150	AT 6-22/Z4-...		See Price List	See Price List	See Price List	See Price List	See Price List	See Price List
–	75	150	–	AT 6-22/Z4-...		See Price List	See Price List	See Price List	See Price List	See Price List	See Price List
75	–	–	–	AT 8-22/Z4-...		See Price List	See Price List	See Price List	See Price List	See Price List	See Price List
–	100	–	–	AT 8-22/ZW7-290		See Price List	See Price List	See Price List	See Price List	See Price List	See Price List
–	–	200	200	AT 8-22/Z4-240		See Price List	See Price List	See Price List	See Price List	See Price List	See Price List
–	–	–	250	AT 8-22/ZW7-290		See Price List	See Price List	See Price List	See Price List	See Price List	See Price List
100	–	–	–	AT 8A-22/ZW7-290		See Price List	See Price List	See Price List	See Price List	See Price List	See Price List
125	125	–	–	AT 8A-22/ZW7-400		See Price List	See Price List	See Price List	See Price List	See Price List	See Price List
–	150	250	–	AT 8A-22/ZW7-400		See Price List	See Price List	See Price List	See Price List	See Price List	See Price List
–	–	300	300	AT 8A-22/ZW7-400		See Price List	See Price List	See Price List	See Price List	See Price List	See Price List

Autotransformer with thermal protection

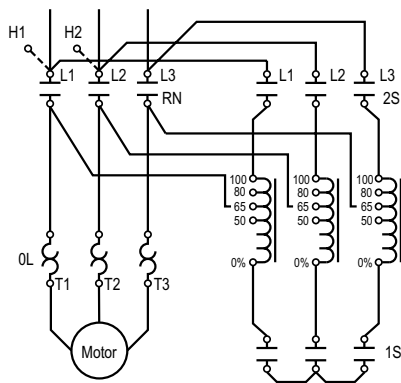

Standard Features

- 3 phase overload protection.
- Reset button in cover.
- Auxiliary contacts are standard on all starters.
- Closed transition, by 3 core dry type autotransformer duty cycle of one 15 second period out of each 4 minutes for one hour followed by a rest period of 2 hours.
- 65% and 80% voltage taps available on all sizes.
- Additional 50% tap for 60 HP and larger starters.
- All starters are normally connected to the 65% tap at the factory.
- Autotransformer supplied with thermal protection.

How to Order

To Order Specify:	Type Number	Overload Relay Suffix	Enclosure Suffix	Add Coil Voltage from p. 3/46-47
Type Number Overload Relay suffix Enclosure Suffix Coil Voltage Accessories	Type AT 2M/22/Z1-...	57	/S	120 V 60 Hz

Additional Information	Page
Technical Data	3/50
Dimensions	3/61
Overload Relays	4/2
Accessories	3/35
Factory Modifications	3/32

Starters – Reduced Voltage Star-Delta Open Transition Type

1	2	3	4	5
UL/CSA Maximum HP Rating 50/60 Hz	Type Insert overload relay suffix code ... from page 3/33 ¹⁾	Enclosed		
3 phase		General Purpose Enclosure Type 1 Add suffix /S to type	Dusttight enclosure Industrial Use Type 12 Add suffix /SD to type	Weatherproof enclosure Type 3R Add suffix /DW to type
200 V HP 230 V HP 460 V HP 575 V HP		Price \$	Price \$	Price \$
Open Transition²⁾ DIL...M Contactors		See Price List	See Price List	See Price List
– – 15 20	SD 0M/22/Z00-...			
– – 25 30	SD 0AM/22/Z00-...			
– 15 30 40	SD 1M/22/Z1-...			
– 25 40 50	SD 1AM/22/Z1-...			
25 30 50 60	SD 2M/22/Z1-...			
30 40 75 75	SD 2AM/22/Z1-...			
40 50 100 125	SD 3M 80/22/Z4-...			
DIL... Universal Contactors		See Price List	See Price List	See Price List
50 – 100 –	SD 3-22/Z4-...			
60 75 150 150	SD 4-22/Z4-...			
100 125 250 250	SD 6-22/Z4-...			
– 150 350 400	SD 8-22/ZW7-...			
200 250 500 –	SD 8A-22/ZW7-...			

1) Overload relays selected for setting at 58% of Motor FLC.
2) For Star-Delta Closed Transition starters, please consult Moeller Electric.

Open transition starter

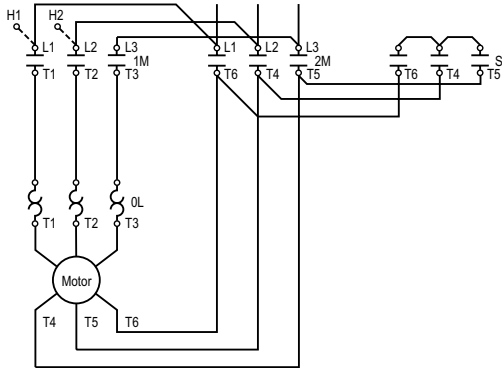

Standard Features

- 3 phase overload protection for setting at 58% of Motor FLC.
- Reset button in cover.
- Standard auxiliary contacts.

How to Order

To Order Specify:	Type Number	Overload Relay Suffix	Enclosure Suffix	Add Coil Voltage from p. 3/46-47
Type Number Overload Relay suffix Enclosure Suffix Coil Voltage Accessories	Type SD 1M/22/Z1-...	40	/S	120 V 60 Hz

Additional Information	Page
Technical Data	3/50
Dimensions	3/61
Overload Relays	4/2
Accessories	3/35
Factory Modifications	3/32

Starters – Reduced Voltage Factory Modifications

Ordering Information:

Order by description

The standard modifications shown on this page are those available for factory installation. Prices for these modifications are shown in the alphanumeric price book under "Starters - Reduced Voltage Factory Modifications". The enclosure may or may not change with the addition of any of these items. When accurate dimensions of the enclosure are required, refer to your nearest Moeller Electric distributor or sales office.

Description	Enclosure Type	Price addition all sizes	Description	Price addition all sizes
		\$		\$
Pilot Devices in Cover				
Push Buttons			Auxiliary Relays	
"START-STOP" or "ON-OFF" Double push button	1, 12, 12K, 3R 13, 3, 4, 4X	See Price List See Price List	Control relay, maximum of 4 poles	– unwired – wired
"START-STOP" or "ON-OFF" Double push button with indicating light	1, 12, 12K, 3R 13, 3, 4, 4X	See Price List See Price List	Timing relay	
Standard 1 unit push button	1, 12, 12K, 3R	See Price List	Terminal Block wired – per pole	
Standard 2 unit push button	1, 12, 12K, 3R	See Price List	Overload Relays	
Standard 3 unit push button	1, 12, 12K, 3R	See Price List	Ambient compensated, phase failure sensitive 3 Phase bimetallic O/L relay Type Z... supplied as standard P.T.C. Thermistor Tripping	
Selector Switches			Meters	
"HAND-O-AUTO" Selector Switch	1, 12, 12K, 3R	See Price List	Ammeter, maximum 3 1/2" panel type	
"MAN-AUTO" Selector Switch	1, 12, 12K, 3R	See Price List	Current transformer	
Pilot Lights			Voltmeter, maximum 3 1/2" panel type direct reading to 600 V	
Pilot light (specify color)	1, 12, 12K, 3R 13, 3, 4, 4X	See Price List See Price List	3 phase ammeter or voltmeter switch	
Push-to-test light or illuminated push button	1, 12, 12K, 3R 13, 3, 4, 4X	See Price List See Price List	Elapsed time meter	
Control Circuit			Name Plates	
Separate control circuit			Special nameplates, 3" x 1"	
Fused control circuit				
250 V, 1 or 2 fuses				
600 V, 2 fuses				

Price addition to Starter – Select using contactor frame size

Description	(E)EM 00M 00AM 0M	0AM 1M 1AM	2M 2AM	3-22 4-22	3M 80	4M 115 6-22	8-22	8A-22
	\$	\$	\$	\$	\$	\$	\$	\$
Control Circuit Transformers								
Transformer 60 Hz with fused primary	See Price List	See Price List	See Price List	See Price List	See Price List	See Price List	See Price List	See Price List
Transformer with additional capacity up to 100 VA, 60 Hz with fused primary	See Price List	See Price List	See Price List	See Price List	See Price List	See Price List	See Price List	See Price List
Disconnect Device								
– non-fusible	See Price List	See Price List	See Price List	See Price List	See Price List	See Price List	See Price List	See Price List
– fusible	See Price List	See Price List	See Price List	See Price List	See Price List	See Price List	See Price List	See Price List
Circuit Breaker	See Price List	See Price List	See Price List	See Price List	See Price List	See Price List	See Price List	See Price List
Reversing Starters								
To change non-reversing to reversing	See Price List	See Price List	See Price List	See Price List	See Price List	See Price List	See Price List	See Price List

Overload relay selection:

1. Select the appropriate starter by HP and motor voltage from the previous starter selection pages.
2. Determine motor full load current from motor nameplate data or by using NEC Table 430-150 (3 phase) or Table 430-148 (1 phase) located on the inside back cover of this catalog.
3. Select the overload relay whose adjustable current range includes the FLC determined above. Insert the suffix code in the starter type.

EXAMPLE:

1. Selected starter is 3 phase, 10 HP @ 460 V AC, Non-Combination, Full Voltage Non-Reversing.
From page 3/12, starter type is:

DIL 0M/11/Z00-...

2. **Motor Full Load Current** from NEC Table 430-150 (see back inside cover) for 10 HP @ 460 V AC (3 phase) is:

14 Amps

3. The 14 Amps falls within the adjustable setting range of 10 – 16 corresponding to the Overload Relay suffix code of **Z00-16** from the table below.
The suffix code "16" is added to complete the starter part number.
The desired contactor coil voltage from pages 3/46-47 is specified at the end to complete the starter ordering information.

Complete Starter Type: **DIL 0M/11/Z00-16 120V 60Hz**

Overload Relay Suffix Code Selection Table

Type	Adjustable setting range	Suffix code
Z00	0.1 – 0.16	0.16
Z00	0.16 – 0.24	0.24
Z00	0.24 – 0.4	0.4
Z00	0.4 – 0.6	0.6
Z00	0.6 – 1.0	1.0
Z00	1.0 – 1.6	1.6
Z00	1.6 – 2.4	2.4
Z00	2.4 – 4	4
Z00	4 – 6	6
Z00	6 – 10	10
Z00	10 – 16	16
Z00	16 – 24	24
Z1	6 – 10	10
Z1	10 – 16	16
Z1	16 – 24	24
Z1	24 – 40	40
Z1	40 – 57	57
Z1	50 – 63	63
Z1	63 – 75	75
Z4	50 – 70	70
Z4	70 – 100	100
Z4	100 – 140	140
Z4	140 – 180	180
Z4	180 – 240	240
Z5	70 – 100	100
Z5	95 – 125	125
Z5	120 – 160	160
Z5	160 – 225	225
Z5	200 – 250	250
ZW7	42 – 63	63
ZW7	60 – 90	90
ZW7	85 – 125	125
ZW7	110 – 160	160
ZW7	160 – 240	240
ZW7	190 – 290	290
ZW7	270 – 400	400
ZW7	360 – 540	540

For overload relay technical information see page 4/11.



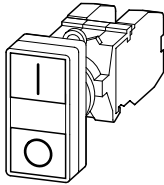
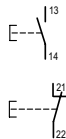
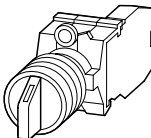
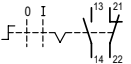
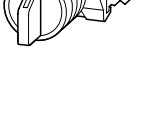
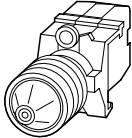
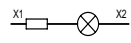



Field Modification Kits

1	2	3	4	5	
Illustrations	Symbols and legend plates	Description	Type For use in enclosures with lift-off or hinged covers	Price \$	
Double Pushbutton					
		Double pushbutton mounting in single hole Contacts: 1 NO, 1 NC	QDD/K11-CS	See Price List	
		Double pushbutton with transformer type indicating light for mounting in single hole VAC: Primary Secondary 115-125 6 220-240 6 480-500 6	QDDL/K11/FT125/6-CS QDDL/K11/FT240/6-CS QDDL/K11/FT480/6-CS	See Price List	
Selector Switches					
	2 positions		Two position selector switch with legend plate. Maintained position. Contacts: 1 NO 1 NO, 1 NC	RWK1V/K10-CS RWK1V/K11-CS	See Price List
					
Indicating Light red (incandescent)					
		Transformer type indicating light VAC: Primary Secondary 115-125 6 220-240 6 480-500 6	RL-RT/FT125/6-CS RL-RT/FT220/6-CS RL-RT/FT500/6-CS	See Price List	
Control Transformers¹⁾ Including primary fuse block and fuses					
	VA Rating	For use with contactor:			
	50	DIL EEM, EM DIL 00M, DIL 00AM DIL 0M, DIL 0AM DIL 1M, DIL 1AM	T50-230-460/120-PR	See Price List	
	75	DIL 2M, DIL 2AM, S-PKZ2	T75-230-460/120-PR	See Price List	
	100	DIL 3-22,-NA, DIL 3M 80, DIL 4-22-NA DIL M 185, DIL M 225, DIL M 250	T100-230-460/120-PR	See Price List	
	150	DIL 4M 115, DIL 6-22-NA, DIL M 300 DIL M 400, DIL M 500	T150-230-460/120-PR	See Price List	
	500	DIL 8-22-NA, DIL 8A-22-NA	T500-230-460/120-PR	See Price List	

1) The standard enclosure may or may not have room for the addition of a control transformer. Consult Moeller Electric. Transformers are dual voltage primary: 220–240 V/440–480 V; single voltage secondary: 110–120 V. Class CC primary fusing supplied as standard. Consult Moeller Electric for secondary fusing options and fuseless primary/secondary protection alternatives.



Magnetic Contactors
Magnetic Starters

3

1	2	3	4	5	6
	Number of Contacts NO = Normally Open NC = Normally Closed	For use with Contactor frame size	Type	Price	Remarks
	NO	NC		\$	
Auxiliary Contacts – Top Mounted¹⁾					
2-Pole					
	1	1	DIL 00AM	11 DIL M	Contactor Frame Size DIL EEM, EM . The following auxiliary contact combinations are possible: DIL (E)EM-01(-G) 02 DIL E DIL (E)EM-10(-G) 11 DIL E DIL EM4(-G) 20 DIL E 11 DDIL E + 04 DIL E 13 DIL E 22 DIL E 40 DIL E 22 DDIL E DIL (E)EM-10(-G) 22 DIL EM DIL EM4(-G) + 02 DIL EM 11 DIL EM
	0	2	DIL 0(A)M	02 DIL	
	2	0	DIL 1(A)M	20 DIL	
	1	1	DIL (E)EM-10(-G)	11 DIL EM	
	0	2	DIL EM4(-G)	02 DIL EM	
	0	2	DIL (E)EM-01(-G)	02 DIL E	
	2	0	DIL (E)EM-10(-G)	20 DIL E	
	1	1	DIL EM4(-G)	11 DDIL E ²⁾	
	1	1		11 DIL E	
4-Pole					
	2	2	DIL 00AM	22 DIL M	Contactor Frame Size DIL 00M...2AM . The following auxiliary contact combinations are possible: DIL 00AM 11 DIL M DIL 00M(4) 02 DIL DIL 0(A)M 20 DIL DIL 1(A)M 22 DIL M DIL 2(A)M 31 DIL M 22 DDIL M + 04 DIL 13 DIL 40 DIL 31 DIL 22 DIL
	3	1	DIL 0(A)M	31 DIL M	
	2	2	DIL 1(A)M	22 DDIL M ²⁾	
	0	4	DIL 2(A)M	04 DIL	
	1	3		13 DIL	
	4	0		40 DIL	
	3	1		31 DIL	
	2	2		22 DIL	
	2	2	DIL (E)EM-10(-G)	22 DIL EM	
	0	4	DIL EM4(-G)		
	0	4	DIL (E)EM-01(-G)	04 DIL E	
	1	3	DIL (E)EM-10(-G)	13 DIL E	
	2	2	DIL EM4(-G)	22 DIL E	
	3	1		31 DIL E	
	4	0		40 DIL E	
	2	2		22 DDIL E ²⁾	

1) Refer to next page for side-mounted auxiliary contact combinations
 2) Includes one early-make and one late-break contact pair

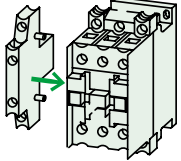
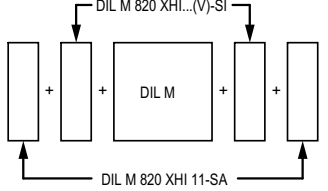
Contactors – Accessories

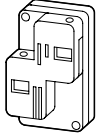
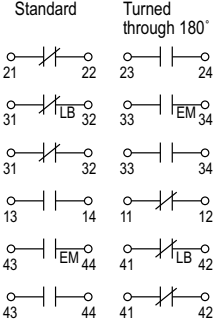
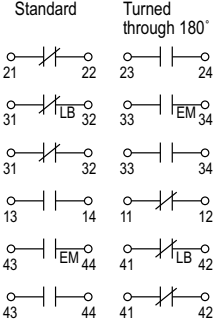
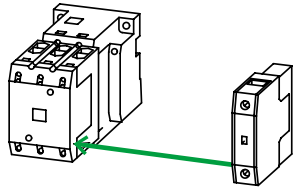
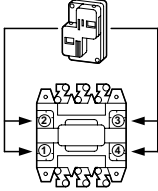
1	2	3	4	5	6
	Number of Contacts NO = Normally Open NC = Normally Closed NO NC	For use with Contactor frame size	Type	Price	Notes
				\$	
Auxiliary Contacts-Side Mounted					
	1	0	DIL 0(A)M DIL 1(A)M DIL 2(A)M	10 S DIL M 01 S DIL M 11 S DIL M	<p>01 S DIL M 10 S DIL M 11 S DIL M</p> <p>Maximum: 4 side-mounted contacts, 1 block on each side for DIL 0(A)M...2(A)M contactors. Maximum of 5 contacts possible when combined with top-mounted contacts. ...S DIL M contacts cannot be combined with DIL M 820... contacts.</p> 
	1	1	DIL 0M through DIL M 500	DIL M 820-XHI 11-SI DIL M 820-XHI 11V-SI ²⁾	<p>DIL M 820-XHI 11-SI DIL M 820-XHI 11V-SI DIL M 820-XHI 11-SA</p> 
	1	1	DIL 3M 80 through DIL M 500	DIL M 820-XHI 11-SA	<p>DIL 3M 80 through M 500: Maximum of 8 contacts possible, 2 blocks on each side. DIL M 820-XHI 11(V)-SI contact blocks can only be mounted on the inside directly to the contactor. (reference diagram above) DIL M 820-XHI 11-SA contact blocks can only be mounted on the outside to the DIL M 820...SI contact blocks. (reference diagram above) Auxiliary contact blocks can not be mounted between a mechanical interlock and the contactor.</p>
	<p>DIL 0(A)M through 2(A)M: Maximum of 4 contacts possible, 1 DIL M 820-XHI 11(V)-SI block on each side. The DIL M 820... contact blocks can not be used in conjunction with the DIL 0(A)M-G contactor.</p>				
	<p>Power Pole open/enclosed</p>				
	<p>1 Pole</p> 	<p>Ratings: 35/30 (A) Continuous current</p> <p>55/44 75/60</p>	<p>DIL 0M DIL 1M DIL 2M</p>	<p>N DIL 0M N DIL 1M N DIL 2M</p>	<p>See Price List</p>
<p>Auxiliary Contacts for Universal Contactors</p>					
<p>1 Pole</p> 	<p>DIL 3-22 DIL 4-22 DIL 6-22 DIL 8(A)-22</p>	<p>HSI-1 HSII-1 HSIII-1 HSI-2 HSII-2 HSIII-2</p>	<p>Standard</p>  <p>Turned through 180°</p>  <p>EM = Early Make LB = Late Break</p>	<p>See Price List</p>	<p>See Price List</p>
<p>DIL 3-22 through DIL 8A-22 contactors are supplied with 4 auxiliary contacts (2 NO & 2 NC). Each single pole auxiliary contact can be exchanged for another or its function can be modified by turning it through 180°. See right and conversion information on following page for further information.</p>					
<p>N DIL ...M</p>  <p>Maximum 1 additional pole only. Mounts on left or right side.</p>					
<p>HS...</p>  <p>See following page for auxiliary contact conversion information. Maximum number of NO contacts: DIL 3 – DIL 6 = 3 NO DIL 8 – DIL 8A = 7 NO</p>					

1) Late-break contact
2) Includes one early-make and one late break contact pair.

Magnetic Contactors
Magnetic Starters
3

Auxiliary contact combinations for system **DIL M** contactors **DIL 0M** through **DIL 2AM**.

Auxiliary contact modules for side and top mounting can be combined for up to a maximum of 5 auxiliary contacts.

The diagram at right shows the possible contact configurations which can be realized by combining side and top-mounted auxiliary contact modules.

DIL 0(A)M(-G) to DIL 2(A)M(-G)

For side mounting

For top mounting

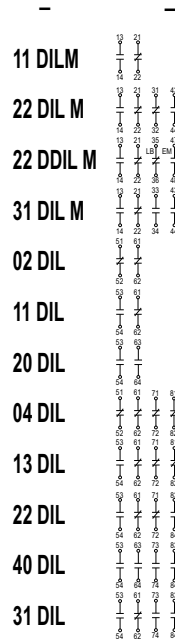

	10 S DIL M 01 S DIL M	2 x 10 S DIL M 2 x 01 S DIL M	11 S DIL M	2 x 11 S DIL M
Contactor with no auxiliary contacts	x	x	x	x
11 DILM	x	x	x	-
22 DIL M	x	-	-	-
22 DDIL M	x	-	-	-
31 DIL M	x	-	-	-
02 DIL	x	x	x	-
11 DIL	x	x	x	-
20 DIL	x	x	x	-
04 DIL	x	-	-	-
13 DIL	x	-	-	-
22 DIL	x	-	-	-
40 DIL	x	-	-	-
31 DIL	x	-	-	-

x = Possible - = Not possible

Conversion of auxiliary contacts for Universal Contactors

Type of auxiliary contact circuit diagram

Auxiliary contact

Position	Type of auxiliary contact circuit diagram				Auxiliary contact	
	1	2	3	4	NO	NC
Standard	HS I-2 	HS I-1 	HS III-1 	HS III-2 	2	2
as above but HS III-1 turned through 180°	HS I-2 	HS I-1 	HS III-1 	HS III-2 	3	1
as above but HS III-1 turned through 180°	HS I-2 	HS I-1 	HS III-1 	HS III-2 	1	3
as above but HS 1-2 and HS III-2 turned through 180°	HS I-2 	HS I-1 	HS III-1 	HS III-2 	-	4
HS III-1 and HS III-2 replaced by HS II-1 and HS II-2 (see page 3/36) as above	HS I-2 	HS I-1 	HS II-1 	HS II-2 	2	2
as above but HS II-1 turned through 180°	HS I-2 	HS I-1 	HS II-1 	HS II-2 	3	1
as above but HS II-2 turned through 180°	HS I-2 	HS I-1 	HS II-1 	HS II-2 	1	3
as above but HS II-2 and HS II-2 turned through 180°	HS I-2 	HS I-1 	HS II-1 	HS II-2 	-	4

EM = Early Make
LB = Late Break



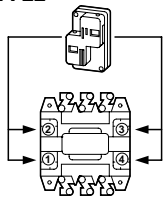







DIL 3-22 through DIL 8A-22









On contactors **DIL 3** to **DIL 8A**, a single-pole auxiliary contact can be exchanged for another single-pole auxiliary contact (see above) or its function can be modified by turning it through 180°. By turning, the NO auxiliary contact becomes NC and NC becomes NO, 4 NO contacts not permissible for **DIL 3 – DIL 6**.

Up to 4 additional auxiliary contacts can be mounted on **DIL 8** and **DIL 8A**. Maximum of 7 NO contacts. Permissible auxiliary contacts combination, either 2 X standard or 2 X same "sond (form...)"



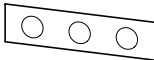



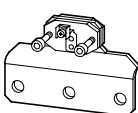

Contactors and Starters – Accessories

1	2	3	4	5	6	
		For use with	Type	Price	Remarks	
				\$		
Suppressors						
RC suppressors						
						
  	24 – 48 V	EEM, EM	RC DIL E 48	See Price List	For AC operated devices.	
	110 – 250 V		RC DIL E 250	See Price List	Drop out delay should be taken into consideration	
	24 – 48 V	00(A)M	RCB DIL 48	See Price List		
	110 – 250 V	0(A)M	RCB DIL 250	See Price List		
	380 – 415 V	1(A)M	RCB DIL 415	See Price List		
		2(A)M				
	24 – 48 V	3M 80	RCS DIL 48	See Price List		
	110 – 250 V	4M 115	RCS DIL 250	See Price List		
	380 – 415 V		RCS DIL 415	See Price List		
	Varistor suppressors					
						
	  	24 – 48 V	EEM, EM	VG DIL E 48	See Price List	For use with AC operated devices. The DC operated devices have built-in surge suppressors as standard. (DIL (E)EM-...-G)
110 – 250 V			VG DIL E 250	See Price List		
380 – 415 V			VG DIL E 415	See Price List		
12 – 24 V		00(A)M	VGB DIL 24	See Price List	For use with AC 50/60 Hz operated devices (DIL 00M through DIL 4M 115) and DC operated devices (DIL 00M-G through DIL 2AM-G) .	
24 – 48 V		0(A)M	VGB DIL 48	See Price List		
110 – 250 V		1(A)M	VGB DIL 250	See Price List	DC operated devices DIL 3M 80 and 4M 115 have varistor surge suppressors built-in.	
380 – 415 V		2(A)M	VGB DIL 415	See Price List		
12 – 24 V		00(A)M	VGC DIL 24	See Price List	For use with AC and DC operated contactors (DIL 00(A)M....2(A)M) .	
24 – 48 V		0(A)M	VGC DIL 48	See Price List		
110 – 250 V		1(A)M	VGC DIL 250	See Price List		
380 – 415 V		2(A)M	VGC DIL 415	See Price List		
Free-wheel diode suppressor						
		12-250V DC	FD B DIL	See Price List	For DC operated devices. Drop out delay should be taken into consideration.	
		00(A)M		See Price List		
		0(A)M		See Price List		
		1(A)M		See Price List		
		2(A)M		See Price List		

Magnetic Contactors
Magnetic Starters
3

1	2	3	4	5	6
		For use with type	Type	Price \$	Remarks
Star-point Bridges					
		00(A)M	S 1 DIL 00M	See Price List	Finger-safe design
		0(A)M	S 1 DIL 0M	See Price List	
		1(A)M	S 1 DIL 1M	See Price List	
		2(A)M	S 1 DIL 2M	See Price List	
		3M 80	S 1 DIL 3M	See Price List	
		4M 115	S 1 DIL 4M	See Price List	
		M 185, M 225, M 250 M 300, M 400	DIL M 400-XS1	See Price List	With type DIL M 400-XS1 , a DIL M 400-XHB cover is included for protection against accidental contact.
		M 500	DIL M 500-XS1	See Price List	With type DIL M 500-XS1 , a DIL M 500-XHB cover is included for protection against accidental contact.
Paralleling Bridges For main contacts					
		4-pole	EEM, EM	P 1 DIL EM	Finger safe design. Increases the open continuous current (ACI) value of the contactor by a factor of 2.5. P 1 DIL EM and P 1 DIL 00M are 4 pole units. 2 per set. The 4 th pole can be broken off.
		00(A)M		P 1 DIL 00M	
		3-pole	0(A)M	P 1 DIL 0M	
		1(A)M	P 1 DIL 1M		
		2(A)M	P 1 DIL 2M		
		3M 80	P 1 DIL 3M		
		4M 115	P 1 DIL 4M	See Price List	
		M 185	DIL M 185-XP1	See Price List	

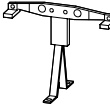
Contactors and Starters – Accessories





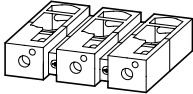
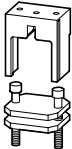
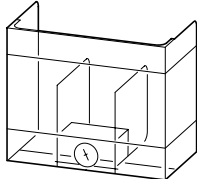

1	2	3	4	5
	For use with DIL...	Type	Price \$	Remarks
 <p>Paralleling links For auxiliary contacts</p>		All top mounting auxiliary contacts	BT 480 ¹⁾	Not insulated. Standard quantity: 100
	 <p>Adaptor For cable lug connection</p>	3M 80 4M 115	AK DIL 3M AK DIL 4M	1 set = 6 pieces For connecting cables with crimped lugs. Set includes 2 terminal covers.
 <p>Mechanical Interlocks</p>		EEM, EM	MV DIL E	For contactors with the same or different magnet systems, mounted vertically or horizontally. Distance between contactors: 0 mm Mechanical lifespan: 2.5 x 10 ⁶ operations Additional auxiliary contacts can be fitted.
		00(A)M 0(A)M 1(A)M 2(A)M	MV DIL M	For contactors of the same or different frame sizes but with the same magnet system, mounted vertically or horizontally. Distance between contactors: 15 mm Mechanical lifespan: 5 x 10 ⁶ operations
		3M 80 through M 500	DIL M 500-XMV	For contactors with the same or different magnet systems, mounted vertically or horizontally. An auxiliary contact cannot be placed between the mechanical interlock and the contactor. Distance between contactors: DIL 3M 80-DIL 4M 115: 10 mm DIL M 185-DIL M 500: 15 mm Mechanical lifespan: 5 x 10 ⁶ operations
		3-22 4-22 6-22 8(A)-22	V DIL 3 V DIL 4 V DIL 6 V DIL 8	For contactors with the same or different magnet systems, mounted vertically or on surfaces inclined to within 30° of vertical. Distance between contactors according to dimensions, page 3/65 Mechanical lifespan: 1 x 10 ⁶ operations
	 <p>Pneumatic Timer Module Convertible 0.2 – 30 s and 20 – 180 s</p>	On-delay with 1 NO/ 1 NC Off-delay with 1 NO/ 1 NC	0(A)M - 2AM R 0(A)M - 2AM R	TPE 11 DIL TPD 11 DIL
 <p>Mechanical Latching Module For DC operation pulse duration of 200 ms maximum.</p>	DC operation AC operation	00(A)M R 00(A)M R	V-G DIL V-DIL	

1) Must be ordered in standard quantity.

1	2	3	4	5
	For use with	Type	Price \$	Remarks
Control circuit terminals				
	DIL 0(A)M	ZK DIL 0M	See Price List	Pressure wire connectors mounted directly to the main terminals for control circuit tap-off. 15 A, 600 V max. AWG 18 – 14
	DIL 1(A)M DIL 2(A)M	ZK DIL 1M	See Price List	
	DIL 3M 80 DIL 4M 115	ZK DIL M	See Price List	
	DIL 3	BZ 260	See Price List	
	DIL 4	BZ 185	See Price List	
	DIL 6	BZ 184	See Price List	
	DIL 8(A)	BZ 240	See Price List	
Terminal Kits¹⁾ with control circuit terminals				
 	DIL M 185 DIL M 225	DIL M 225-XKU-S	See Price List	For cable connection, single or multi-stranded conductors and flexibus.
	DIL M 250 DIL M 300 DIL M 400	DIL M 400-XKU-S	See Price List	For cable connection, single or multi-stranded conductors and flexibus.
	DIL M 500	DIL M 650-XKB-S	See Price List	For bus and flexibus connection.
Terminal Covers				
	DIL M 185 DIL M 225 DIL M 250 DIL M 300 DIL M 400 DIL M 400-XS1	DIL M 400-XHB	See Price List	Cover provides protection against shock hazards and accidental contact.
	DIL M 500 DIL M 500-XS1	DIL M 500-XHB	See Price List	
	DIL 3	HV-DIL 3	See Price List	For line and load terminals (2 pieces).
	DIL 4	HV-DIL 4	See Price List	
	DIL 6	HV-DIL 6	See Price List	
	DIL 8(A)	HV-DIL 8	See Price List	



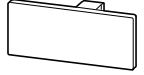
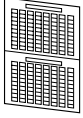
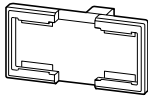
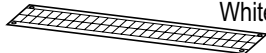

1) UL/CSA pending

Contactors – Accessories

1	2	3	4	5
	For use with	Type	Price	Remarks
			\$	
Connection tabs for fast-on connectors				
	For auxiliary contact and coil connections	DIL (E)EM, DIL 00(A)M DIL 0(A)M, DIL 1(A)M DIL 2(A)M, DIL 3M 80, DIL 4M 115, DIL 3, 4, 6, 8(A)	BT 483 ¹⁾	Use connectors with insulated sleeves. Standard quantity: 100
Tamper-proof cover				
	Transparent	DIL (E)EM	H DIL E	Cover snap-fits onto the device and can be sealed to prevent tampering.
		TPE TPD	PL-DIL T	Cover is fastened via a screw. Sealable to prevent access.
Couplers				
	Provides a mechanical link for stability when groups of components are mounted together in combinations. Mounts between contactors.	DIL (E)EM	V0 DIL E	0 mm spacing between contactors (Std. qty: 50)
		DIL 00(A)M, DIL 0(A)M DIL 1(A)M, DIL 2(A)M	V0 DIL	0 mm spacing between contactors (Std. qty: 20)
			V5/15 DIL	5 mm spacing between contactors, can be used with DC magnet systems 15 mm spacing between contactors, for mechanical interlock between two contactors (Std. qty: 10)
			V10/A 5 DIL	10 mm spacing between contactors, for side mounting auxiliary contacts between contactors 5 mm spacing between contactors, can be used with DC magnet systems without permanent connection (Std. qty: 10)
Component Labelling System				
Clip-in Label Plate				
	8 x 10 mm	...DIL	KG 10 ¹⁾	Clip-in type label nameplate can be marked with felt-tip pen or adhesive labels. Clips onto 2 pole auxiliary contact modules. Standard quantity: 500
	8 x 20 mm	...DIL E, DIL ER... ...DIL, DIL R...	KG 20 ¹⁾	
Label Plate with Mounting Stud				
	8 x 17.5 mm	DIL...	XGKS-Z	For use with Moeller equipment with the corresponding mounting hole. Standard quantity: 500
Adhesive Labels²⁾				
	7.5 x 17 mm	XGKS-Z KG 20	XGKE-GE	For inscription using laser printer, plotter, marker pen, photocopier Standard quantity: Pad of 25 sheets, 240 labels per sheet, perforated and self-adhesive, for use with label plates.
	Yellow (RAL 1018)			
Adapter with Mounting Stud				
	Light Grey (RAL 7035)	DIL...	XGKA-Z	Secures label type XGKS-T on Moeller equipment with corresponding mounting hole. Standard quantity: 250
Card of Label Plates²⁾				
	8 x 17.5 mm White	XGKS...	XGKS-T	Can be inscribed by marker pen or plotter by Phoenix Contact or others. Standard quantity: 10 cards. 40 labels per card.

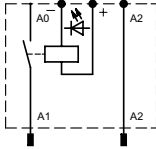
1) Must be ordered in standard quantity.

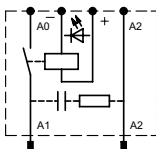
2) Consult Moeller Electric for inscription software.

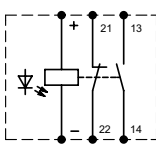
1	2	3	4	5	6	7
	Ratings	Connection Diagram	For use with Contactor frame Size	Type	Price \$	Remarks
	<p>Interface Module, plug in</p>  <p>Actuating voltage & current: 24 V DC, 11 mA max.</p> <p>Output, Pilot duty rating: B 300/R 300</p>		<p>DIL 00(A)M DIL 0(A)M DIL 1(A)M DIL 2(A)M</p>	VS 1 DIL	See Price List	<p>For energizing of contactors and relays from low level 24 V DC inputs. The VS 1 and VS 2 plug directly into DIL M coil terminals (and DIL R relays, see previous chapter) whereas the ETS 4-VS 3 mounts separately on a DIN rail and is suitable for all contactors and relays. The VS 2 and ETS 4-VS 3 are equipped with surge suppressors. In cases where the rated coil current of a device exceeds 2 Amps, use a DIL ER-G as an interface relay.</p>
	<p>Interface Module with built-in Surge Suppressor</p>  <p>Actuation voltage & current: 24 V DC, 11 mA max.</p> <p>Output, Pilot duty rating: B 300/R 300</p>		<p>DIL 00(A)M DIL 0(A)M DIL 1(A)M DIL 2(A)M</p>	VS 2 DIL	See Price List	
	<p>Interface Module, for separate mounting</p>  <p>Actuating voltage & current: 24 V DC, 11 mA max.</p> <p>Output, Pilot duty rating: B 300</p>		<p>All contactors and relays</p>	ETS 4-VS3	See Price List	

Application Notes

Interface modules incorporate contacts which are actuated upon energizing of the module from low power 24 V DC sources such as the outputs of sensors and programmable controllers. These contacts can then be used to switch in the high inrush coils of electromechanical relays and contactors which normally would be too much of a burden for these outputs. This also enables the relays and contactors to be energized directly from the AC line, thus saving the expense of more costly DC magnet systems for these components.

Control Circuit Reliability:

24 V DC voltage and current tolerances are as per DIN EN 61 131-2: At minimum actuation levels of 17 V and 5.4 mA, the error rate is less than 1 fault in 100 million operations.

At Moeller Electric, It All Starts With Quality

When you're looking for a motor starter that you can install and forget, you need look no further than your authorized Moeller Electric Key Distributor. There you'll find the culmination of over 100 years of devotion to quality and dependability.

The critical components found in Moeller Electric starters are designed and produced by Moeller Electric, all with the mission to produce a starter that installs easily, in a minimum amount of space and that will withstand the rigors of a tough industrial environment.

Moeller Electric starters can be found in most environments and locations around the world. From nuclear power generating stations to cement plants, from New York City to Guangzhou, China, Moeller Electric magnetic motor starters are busy starting and stopping motors, day after day, with no required maintenance.

Call or visit your authorized Moeller Electric Key Distributor today !



Which Standard to Follow?

Moeller Electric's heavy-duty, industrial starters are built to withstand the most severe applications where requirements for continuous operation can place heavy demands on control equipment.

Starters are manufactured to meet or exceed the standard(s) that are applicable to your application. Whether this requires NEMA, UL/CSA, European CE or any other standard, we will quickly supply, either off-the-shelf or custom-built, all at a very cost-effective price.



What Flavor?

Moeller Electric starters are available in a wide variety of sizes and types and many standard features that you may be now paying extra for:

Three phase bimetallic, ambient compensated overload ... no need to purchase, stock and install separate overload "heaters".

Contacting coil pulls-in and seals-in at 80 to 110 percent of the marked rating.

Contacting coil magnet system is balanced to minimize contact bounce, one of

1	2	3	4	5	6	7	8	
For use with Contactor DIL...		AC Type Insert coil voltage (...) and frequency. See pages 3/46-47	Price Standard Coil \$	Price Non-Standard Coil \$	DC Type¹⁾ Insert coil voltage (...). See pages 3/46-47	Price Standard Coil \$	Price Non-Standard Coil \$	
00(A)M		J-DIL 00M (...)	See Price List	See Price List	G-DIL 00M (...)	See Price List	See Price List	
0(A)M		J-DIL 0M (...)	See Price List	See Price List	G-DIL 0M (...)	See Price List	See Price List	
1(A)M		J-DIL 1M (...)	See Price List	See Price List	G-DIL 1M (...)	See Price List	See Price List	
2(A)M		J-DIL 2M (...)	See Price List	See Price List	G-DIL 2M (...)	See Price List	See Price List	
3M 80			J-DIL 3M (...)	See Price List	See Price List	G-DIL 3M (...)	See Price List	See Price List
4M 115			J-DIL 4M (...)	See Price List	See Price List	G-DIL 4M (...)	See Price List	See Price List
PKZ 2	J-S-PKZ 2 (...)		See Price List	See Price List		See Price List	See Price List	
M 185 M 225 M 250		DILM250-XSP/E (...)	See Price List	See Price List	DILM250-XSP/E (...)	See Price List	See Price List	
M 300 M 400 M 500		DILM500-XSP/E (...)	See Price List	See Price List	DILM500-XSP/E (...)	See Price List	See Price List	
3		J-DIL 3 (...)	See Price List	See Price List	G-DIL 3 (...)	See Price List	See Price List	
4		J-DIL 4 (...)	See Price List	See Price List	G-DIL 4 (...)	See Price List	See Price List	
6		J-DIL 6 (...)	See Price List	See Price List	G-DIL 6 (...)	See Price List	See Price List	
8		J-DIL 8 (...)	See Price List	See Price List	G-DIL 8 (...)	See Price List	See Price List	
8A		J-DIL 8A (...)	See Price List	See Price List	G-DIL 8 (...)	See Price List	See Price List	

1) Coils G-DIL 3M and G-DIL 4M are protected against overvoltages by means of varistor suppressors as standard.

Contactors – Coils

Select the appropriate coil voltage for your system from the following list of standard and non-standard AC and DC coils. Select by contactor type. Insert coil voltage and frequency after the contactor or starter type number.

Example:

contactor	overload relay	enclosure suffix	coil voltage
DIL 0AM/11	/Z00-16	/S	120V 60Hz

AC	DC																																						
<p>DIL EEM, EM contactors</p> <p>Standard coils</p> <table border="1"> <tr> <td>12 V 50 Hz 24 V 50 Hz 48 V 50 Hz 240 V 50 Hz</td> <td>24 V 60 Hz 110 V 60 Hz 115 V 60 Hz 600 V 60 Hz</td> <td>42 V 50 Hz, 48 V 60Hz 110 V 50 Hz, 120V 60Hz 190 V 50 Hz, 220 V 60Hz 220 V 50 Hz, 240 V 60Hz 230 V 50 Hz, 240 V 60Hz 380 V 50 Hz, 440 V 60Hz 400 V 50 Hz, 440 V 60Hz 415 V 50 Hz, 480 V 60Hz</td> <td>24 V 50/60 Hz 42 V 50/60 Hz 110 V 50/60 Hz 230 V 50/60 Hz</td> </tr> </table> <p>DIL M contactors</p> <p>Standard coils</p> <table border="1"> <tr> <td>24 V 50 Hz 48 V 50 Hz 240 V 50 Hz 500 V 50 Hz</td> <td>24 V 60 Hz 115 V 60 Hz 208 V 60 Hz 600 V 60 Hz</td> <td>42 V 50 Hz, 48 V 60Hz 110 V 50 Hz, 120V 60Hz 190 V 50 Hz, 220 V 60Hz 220 V 50 Hz, 240 V 60Hz 230 V 50 Hz, 240 V 60Hz 380 V 50 Hz, 440 V 60Hz 400 V 50 Hz, 440 V 60Hz 415 V 50 Hz, 480 V 60Hz</td> <td>24 V 50/60 Hz 42 V 50/60 Hz 110 V 50/60 Hz 230 V 50/60 Hz 380 V 50/60 Hz</td> </tr> </table> <p>Non-standard coils²⁾</p> <table border="1"> <tr> <td>DIL 00M</td> <td>12-600 V 50 Hz or 12-600 V 60Hz</td> <td>12-250 V DC</td> </tr> <tr> <td>DIL 00AM</td> <td></td> <td></td> </tr> <tr> <td>DIL 0M</td> <td>12-600 V 50 Hz or 12-600 V 60Hz</td> <td>12-250 V DC</td> </tr> <tr> <td>DIL 0AM</td> <td></td> <td></td> </tr> <tr> <td>DIL 1M</td> <td>24-600 V 50 Hz or 24-600 V 60Hz</td> <td>12-250 V DC</td> </tr> <tr> <td>DIL 1AM</td> <td></td> <td></td> </tr> <tr> <td>DIL 2M</td> <td>24-600 V 50 Hz or 24-600 V 60Hz</td> <td>12-250 V DC</td> </tr> <tr> <td>DIL 2AM</td> <td></td> <td></td> </tr> <tr> <td>DIL 3M 80</td> <td>24-600 V 50 Hz or 24-600 V 60Hz</td> <td>24-250 V DC</td> </tr> <tr> <td>DIL 4M 115</td> <td></td> <td></td> </tr> </table>	12 V 50 Hz 24 V 50 Hz 48 V 50 Hz 240 V 50 Hz	24 V 60 Hz 110 V 60 Hz 115 V 60 Hz 600 V 60 Hz	42 V 50 Hz, 48 V 60Hz 110 V 50 Hz, 120V 60Hz 190 V 50 Hz, 220 V 60Hz 220 V 50 Hz, 240 V 60Hz 230 V 50 Hz, 240 V 60Hz 380 V 50 Hz, 440 V 60Hz 400 V 50 Hz, 440 V 60Hz 415 V 50 Hz, 480 V 60Hz	24 V 50/60 Hz 42 V 50/60 Hz 110 V 50/60 Hz 230 V 50/60 Hz	24 V 50 Hz 48 V 50 Hz 240 V 50 Hz 500 V 50 Hz	24 V 60 Hz 115 V 60 Hz 208 V 60 Hz 600 V 60 Hz	42 V 50 Hz, 48 V 60Hz 110 V 50 Hz, 120V 60Hz 190 V 50 Hz, 220 V 60Hz 220 V 50 Hz, 240 V 60Hz 230 V 50 Hz, 240 V 60Hz 380 V 50 Hz, 440 V 60Hz 400 V 50 Hz, 440 V 60Hz 415 V 50 Hz, 480 V 60Hz	24 V 50/60 Hz 42 V 50/60 Hz 110 V 50/60 Hz 230 V 50/60 Hz 380 V 50/60 Hz	DIL 00M	12-600 V 50 Hz or 12-600 V 60Hz	12-250 V DC	DIL 00AM			DIL 0M	12-600 V 50 Hz or 12-600 V 60Hz	12-250 V DC	DIL 0AM			DIL 1M	24-600 V 50 Hz or 24-600 V 60Hz	12-250 V DC	DIL 1AM			DIL 2M	24-600 V 50 Hz or 24-600 V 60Hz	12-250 V DC	DIL 2AM			DIL 3M 80	24-600 V 50 Hz or 24-600 V 60Hz	24-250 V DC	DIL 4M 115			<p>12 V DC 24 V DC 48 V DC 60 V DC 110 V DC 220 V DC</p> <p>24 V DC 48 V DC 60 V DC 110 V DC 120V DC 220 V DC 240 V DC</p>
12 V 50 Hz 24 V 50 Hz 48 V 50 Hz 240 V 50 Hz	24 V 60 Hz 110 V 60 Hz 115 V 60 Hz 600 V 60 Hz	42 V 50 Hz, 48 V 60Hz 110 V 50 Hz, 120V 60Hz 190 V 50 Hz, 220 V 60Hz 220 V 50 Hz, 240 V 60Hz 230 V 50 Hz, 240 V 60Hz 380 V 50 Hz, 440 V 60Hz 400 V 50 Hz, 440 V 60Hz 415 V 50 Hz, 480 V 60Hz	24 V 50/60 Hz 42 V 50/60 Hz 110 V 50/60 Hz 230 V 50/60 Hz																																				
24 V 50 Hz 48 V 50 Hz 240 V 50 Hz 500 V 50 Hz	24 V 60 Hz 115 V 60 Hz 208 V 60 Hz 600 V 60 Hz	42 V 50 Hz, 48 V 60Hz 110 V 50 Hz, 120V 60Hz 190 V 50 Hz, 220 V 60Hz 220 V 50 Hz, 240 V 60Hz 230 V 50 Hz, 240 V 60Hz 380 V 50 Hz, 440 V 60Hz 400 V 50 Hz, 440 V 60Hz 415 V 50 Hz, 480 V 60Hz	24 V 50/60 Hz 42 V 50/60 Hz 110 V 50/60 Hz 230 V 50/60 Hz 380 V 50/60 Hz																																				
DIL 00M	12-600 V 50 Hz or 12-600 V 60Hz	12-250 V DC																																					
DIL 00AM																																							
DIL 0M	12-600 V 50 Hz or 12-600 V 60Hz	12-250 V DC																																					
DIL 0AM																																							
DIL 1M	24-600 V 50 Hz or 24-600 V 60Hz	12-250 V DC																																					
DIL 1AM																																							
DIL 2M	24-600 V 50 Hz or 24-600 V 60Hz	12-250 V DC																																					
DIL 2AM																																							
DIL 3M 80	24-600 V 50 Hz or 24-600 V 60Hz	24-250 V DC																																					
DIL 4M 115																																							
<p>DIL 3-22 Universal Contactors</p> <p>Standard coils</p> <table border="1"> <tr> <td>24 V 50 Hz 48 V 50 Hz 240 V 50 Hz 500 V 50 Hz</td> <td>24 V 60 Hz 110 V 60 Hz 115 V 60 Hz 208 V 60 Hz 600 V 60 Hz</td> <td>36 V 50 Hz, 42 V 60 Hz 42 V 50 Hz, 48 V 60 Hz 110 V 50 Hz, 120V 60 Hz 190 V 50 Hz, 220 V 60 Hz 220 V 50 Hz, 240 V 60 Hz 230 V 50 Hz, 240 V 60 Hz 380 V 50 Hz, 440 V 60 Hz 400 V 50 Hz, 440 V 60 Hz 415 V 50 Hz, 480 V 60 Hz</td> </tr> </table> <p>Non-standard coils²⁾</p> <table border="1"> <tr> <td>24-600 V 50 Hz or 24-600 V 60Hz</td> <td>24 V DC¹⁾ 48 V DC¹⁾ 60 V DC 110 V DC 120V DC 220 V DC 240 V DC</td> </tr> </table>	24 V 50 Hz 48 V 50 Hz 240 V 50 Hz 500 V 50 Hz	24 V 60 Hz 110 V 60 Hz 115 V 60 Hz 208 V 60 Hz 600 V 60 Hz	36 V 50 Hz, 42 V 60 Hz 42 V 50 Hz, 48 V 60 Hz 110 V 50 Hz, 120V 60 Hz 190 V 50 Hz, 220 V 60 Hz 220 V 50 Hz, 240 V 60 Hz 230 V 50 Hz, 240 V 60 Hz 380 V 50 Hz, 440 V 60 Hz 400 V 50 Hz, 440 V 60 Hz 415 V 50 Hz, 480 V 60 Hz	24-600 V 50 Hz or 24-600 V 60Hz	24 V DC ¹⁾ 48 V DC ¹⁾ 60 V DC 110 V DC 120V DC 220 V DC 240 V DC																																		
24 V 50 Hz 48 V 50 Hz 240 V 50 Hz 500 V 50 Hz	24 V 60 Hz 110 V 60 Hz 115 V 60 Hz 208 V 60 Hz 600 V 60 Hz	36 V 50 Hz, 42 V 60 Hz 42 V 50 Hz, 48 V 60 Hz 110 V 50 Hz, 120V 60 Hz 190 V 50 Hz, 220 V 60 Hz 220 V 50 Hz, 240 V 60 Hz 230 V 50 Hz, 240 V 60 Hz 380 V 50 Hz, 440 V 60 Hz 400 V 50 Hz, 440 V 60 Hz 415 V 50 Hz, 480 V 60 Hz																																					
24-600 V 50 Hz or 24-600 V 60Hz	24 V DC ¹⁾ 48 V DC ¹⁾ 60 V DC 110 V DC 120V DC 220 V DC 240 V DC																																						

1) Requires the addition of a DC interposing relay DIL R-22-G.
2) There is an additional cost for non-standard coils.

AC			DC	
DIL 4-22, DIL 6-22 Universal Contactors				
Standard coils	<p>48 V 50 Hz</p> <p>240 V 50 Hz</p> <p>500 V 50 Hz</p>	<p>110 V 60 Hz</p> <p>115 V 60 Hz</p> <p>208 V 60 Hz</p> <p>600 V 60 Hz</p>	<p>42 V 50 Hz, 48 V 60 Hz</p> <p>110 V 50 Hz, 120 V 60 Hz</p> <p>190 V 50 Hz, 220 V 60 Hz</p> <p>220 V 50 Hz, 240 V 60 Hz</p> <p>230 V 50 Hz, 240 V 60 Hz</p> <p>380 V 50 Hz, 440 V 60 Hz</p> <p>400 V 50 Hz, 440 V 60 Hz</p> <p>415 V 50 Hz, 480 V 60 Hz</p>	<p>24 V DC¹⁾</p> <p>48 V DC¹⁾</p> <p>60 V DC</p> <p>110 V DC</p> <p>120 V DC</p> <p>220 V DC</p> <p>240 V DC</p>
Non-standard coils²⁾ 42-600 V 50 Hz or 42-600 V 60Hz				
DIL 8-22, DIL 8A-22 Universal Contactors				
Standard coils	<p>240 V 50 Hz</p> <p>500 V 50 Hz</p>	<p>110 V 60 Hz</p> <p>115 V 60 Hz</p> <p>208 V 60 Hz</p> <p>600 V 60 Hz</p>	<p>110 V 50 Hz, 120 V 60 Hz</p> <p>190 V 50 Hz, 220 V 60 Hz</p> <p>220 V 50 Hz, 240 V 60 Hz</p> <p>230 V 50 Hz, 240 V 60 Hz</p> <p>380 V 50 Hz, 440 V 60 Hz</p> <p>400 V 50 Hz, 440 V 60 Hz</p> <p>415 V 50 Hz, 480 V 60 Hz</p>	<p>24 V DC¹⁾</p> <p>48 V DC¹⁾</p> <p>60 V DC</p> <p>110 V DC</p> <p>120 V DC</p> <p>220 V DC</p> <p>240 V DC</p>
Non-standard coils²⁾ 110-600 V 50 Hz or 110-600 V 60Hz				
S-PKZ 2 Contactor for PKZ 2/ZM-.../S-SP Self-protected Combination Controller				
Standard coils		<p>24 V 60 Hz</p> <p>208 V 60 Hz</p> <p>600 V 60 Hz</p>	<p>110 V 50 Hz, 120 V 60 Hz</p> <p>230 V 50 Hz, 240 V 60 Hz</p> <p>415 V 50 Hz, 480 V 60 Hz</p>	

1) Requires the addition of a DC interposing relay DIL R-22-G.
 2) There is an additional cost for non-standard coils.

DIL M 185/22, DIL M 225/22, DIL M 250/22, DIL M 300/22, DIL M 400/22, DIL M 500/22 Contactors

Coils including electronic module	RDC 48	Coil Range: 24-48 V DC
	RA 110	Coil Range: 48-110 V 40-60 Hz/DC
	RA 250	Coil Range: 110 - 250 V 40-60 Hz/DC
	RAC 500	Coil Range: 250-500 V 40-60Hz

Note: Part numbers in green shaded area above must be added to complete contactor type (p 3/4, 8) and replacement coil type (p 3/45).

Example: **DIL M185/22 (RA 110)**
DIL M250-XSP/E (RA 110)

Contactors

By far the most common application of contactors is the control of electric motors. As a prime mover, the 3 phase AC motor, in particular the squirrel cage motor, dominates the field, and most of them are controlled by contactors. Contactors are expected to start, stop, reverse, plug, jog and sequence motors and, in conjunction with overload relays, to protect motors in the event of overloads.

The load rating stated in HP is the basic data required to enable the correct selection of contactors to be made, but this figure by itself is not always sufficient. The type of load, its operating cycle, switching frequency and total life required, all influence the overall stress on contactors.

The electrical durability tests of contactors, outlined in Appendix B of IEC 60 947-4, are used by manufacturers to establish contactor ratings which incorporate a sufficient and verifiable switching capability to cover a broad range of applications as defined in the IEC Utilization categories (e.g. AC-3, AC-4). The IEC 60 947 standard states that, with respect to its resistance to electrical wear, a contactor or starter is by convention characterized by the number of ON-LOAD operating cycles corresponding to the different utilization categories which can be made without repair or replacement. The IEC Utilization categories AC-3 and AC-4 are most often encountered in contactor applications and are outlined below. See Section 13 for additional details.

The curves at right provide a reliable guide for selection based on the electrical life desired.

Normal switching duty AC-3 Operating characteristic: Starting: From rest for squirrel-cage motors Stopping: After attaining full running speed

Typical applications:	Compressors	Lifts	Mixers
	Pumps	Escalators	Agitators
	Fans	Conveyors	Centrifuges
	Valves	Bucket elevators	Air conditioning systems

Electrical characteristics: Drives in general in manufacturing and processing machines

Make: up to 6 x rated motor current
Break: 1 x rated motor current
100% AC-3

Extreme switching duty AC-4 Operating characteristic: Switching, plugging, reversing for squirrel-cage motors

Typical applications: Printing presses
Wire drawing machines
Centrifuges
Special drives for manufacturing and processing machines

Electrical characteristics: Make: 6 x rated motor current
Break: 6 x rated motor current

Utilization category: 100% AC-4

Determination of the maximum number of operations per hour in relation to rating and utilization category

P_n = Maximum motor rating (kW/HP) of the contactor per pages 3/4 & 3/8 Ops/h = Maximum number of operations per hour

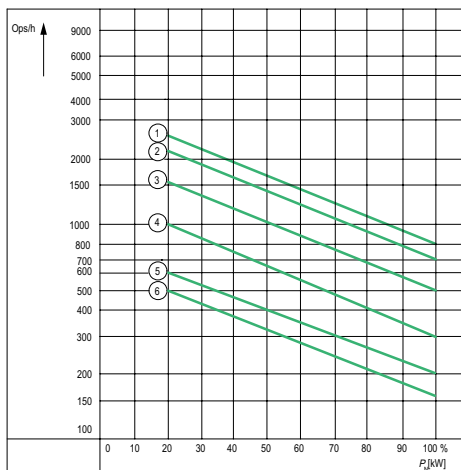
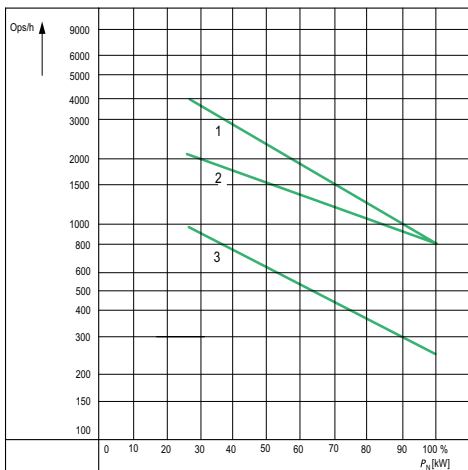

Type	AC 1	AC 3	AC 4
DIL 3M80	1	1	4
DIL 4M115	1	1	4
DIL M 185	1	2	5
DIL M 225	1	2	5
DIL M 250	1	2	5
DIL M 300	2	3	6
DIL M 400	2	3	6
DIL M 500	2	3	6

Type	AC 1	AC 3	AC 4
DIL E(E)M	2	1	3
DIL 00(A)M(-G)	2	1	3
DIL 0(A)M(-G)	2	1	3
DIL 1(A)M(-G)	2	1	3
DIL 2(A)M(-G)	2	1	3

Contactor life expectancy based on utilization categories at 460 V, 50/60 Hz

AC-3

Electrical characteristics: Make: 6 times motor FLC
Break: 1 times motor FLC
Normal switching duty (100% AC-3)

Y Axis (ordinate):

Bold Numbers (HP) - 3 phase motor HP rating at 50 - 60 Hz
Green Numbers (A) - 3 phase motor FLC at 50 - 60 Hz

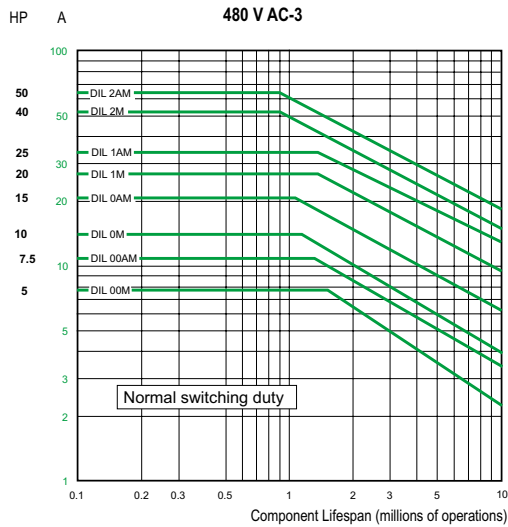

AC-4

Electrical characteristics: Make: 6 times motor FLC
Break: 6 times motor FLC
Extreme switching duty (inching, plugging) (100% AC-4)

Y Axis (ordinate):

Bold Numbers (HP) - 3 phase motor HP rating at 50 - 60 Hz
Green Numbers (A) - 3 phase motor FLC at 50 - 60 Hz

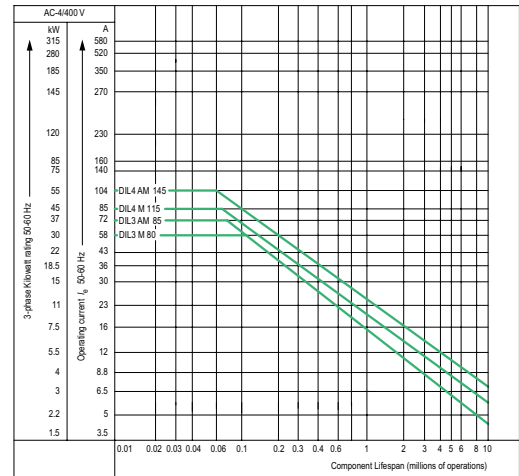
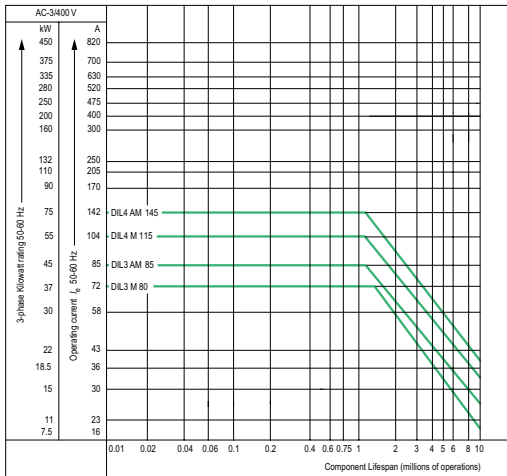
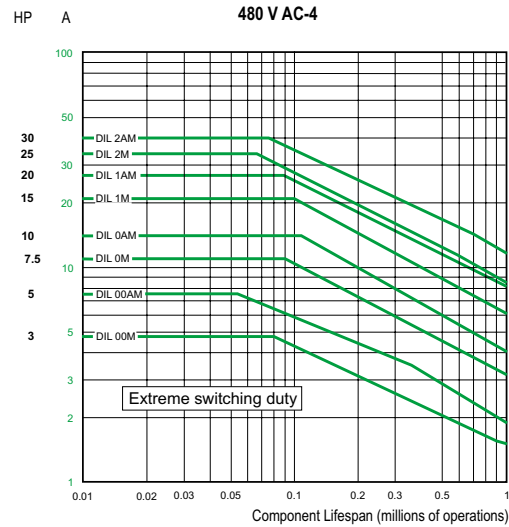

S-PKZ 2

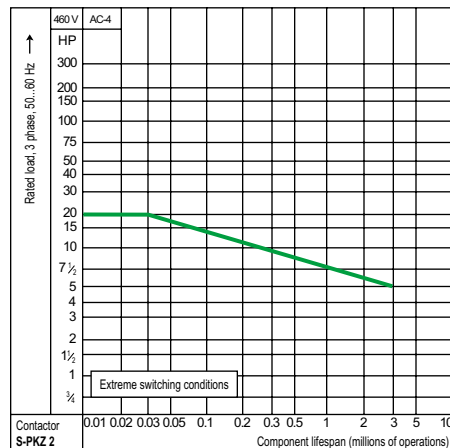
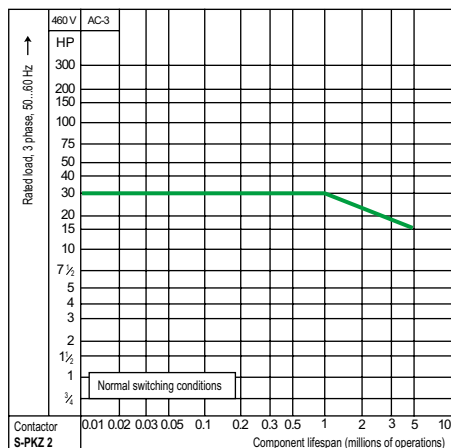

Note: AC 3 and AC 4 Lifespan values for DIL 3M 80 to 4M 145 are determined at 400 V AC. Apply a derating factor of 0.9 (90%) for corresponding 460 V AC values.

Contactors – System DIL M

Technical Data

			EEM	EM	00M	00AM	0M	0AM	
General									
Specifications			UL, CSA, IEC/EN 60 947, CE, DIN VDE 0660						
Mechanical life span									
AC operated		x 10 ⁶ operations	10	10	10	10	10	10	
DC operated		x 10 ⁶ operations	20	20	10	10	10	10	
Max. operating frequency, mechanical									
AC operated		ops/h	9000	9000	7000	7000	9000	9000	
DC operated		ops/h	9000	9000	9000	9000	9000	5000	
Max. operating frequency electrical			see diagram on Page 3/49						
Climatic Proofing			Damp heat, constant to, IEC/EN 60 068-2-3 Damp heat, cyclic, to IEC/EN 60 068-2-30						
Ambient temperature	Open	max./min. C°	+50/-25	+50/-25	+50/-25	+50/-25	+50/-25	+50/-25	
	Enclosed	max./min. C°	+40/-25	+40/-25	+40/-25	+40/-25	+40/-25	+40/-25	
Impact resistance of make (break) contacts		g	10(8)	10(8)	10	10	8	8	
Dimensions			Page 3/61						
Main contacts									
Rated coil voltage		V AC / V DC	600/250	600/250	600/250	600/250	600/250	600/250	
Rated making capacity (IEC/EN 60 947)		A	110	110	200	200	270	270	
Rated breaking capacity									
IEC/EN 60 947	220/230 V	A	90	90	130	130	230	230	
	380/400 V	A	90	90	120	120	230	230	
	500 V	A	64	64	120	120	230	230	
	660/690 V	A	54	54	100	100	210	210	
Contactor life span		Operations	See pages 3/48 – 49						
AC-1 duty									
Rated thermal current $I_{th} \hat{=}$ Rated operating current I_e									
50/60 Hz									
three-pole	Open	A	20	20	20	20	35	35	
	Enclosed	A	16	16	16	16	30	30	
single-pole	Open	A	50	50/60	50	50	85	85	
	Enclosed	A	40	40/50	40	40	75	75	
(three/four current paths in parallel)									
AC-3 duty									
Rated operating current I_e (Open and enclosed)									
50/60 Hz									
	220/230 V	A	6.6	8.8	8.8	12	15.5	22.5	
	380/400 V	A	6.6	8.8	8.8	12	15.5	22.5	
	500 V	A	5	6.4	9	12	17	22.5	
	660/690 V	A	3.5	4.8	6.7	9	13	17.5	
AC-4 duty									
Rated operating current I_e (Open and enclosed)									
50/60 Hz									
	220/230 V	A	5	6.6	6.6	8.7	11.5	15.5	
	380/400 V	A	5	6.6	6.6	8.5	11.5	15.5	
	500 V	A	3.7	5	6.4	9	11.5	17	
	660/690 V	A	2.9	3.4	4.9	6.7	9	13	
Magnet system									
Pick-up values									
AC operated (dual voltage coils)									
50 Hz, 60 Hz	Pick-up	x V coil	0.8 - 1.1	0.8-1.1	0.8-1.1	0.8-1.1	0.8-1.1	0.8-1.1	
DC operated ¹⁾	Pick-up	x V coil	–	–	0.85 - 1.1	0.85-1.1	0.85-1.1	0.85-1.1	
Power consumption of the coil									
AC operated (dual voltage coils)									
50 Hz, 60 Hz	Pick-up	VA/W	25/22	25/22	67/52	67/52	100/72	100/72	
	Sealed	VA/W	4.6/1.3	4.6/1.3	8.6/2.5	8.6/2.5	10/3	10/3	
DC operated ¹⁾	Pick-up	W	2.6	2.6	9.5	9.5	10	10	
	Sealed	W	2.6	2.6	9.5	9.5	10	10	
Duty factor DF		%	100	100	100	100	100	100	
Switching times at 100% rated coil voltage (guide only)									
Main contacts AC operated Closing delay			ms	14-21	14-21	14-22	14-22	9-19	9-19
Opening delay			ms	8-18	8-18	5-14	5-14	5-13	5-13
Arcing time			ms	12	12	≤ 10	≤ 10	< 20	< 20

1) True DC voltage or derived from a full wave 3-phase bridge rectifier of filtered 1-phase AC supply.

			EEM	EM	00M	00AM	0M	0AM
Auxiliary contacts								
Pilot duty rating (UL/CSA)	AC		A600	A600	A600	A600	A600	A600
	DC		P300	P300	P300	P300	P300	P300
Operating current I _e IEC/EN 60 947								
AC-15	220/240 V	A	6	6	6	6	6	6
	380/415 V	A	3	3	4	4	4	4
	500 V	A	1.5	1.5	1.5	1.5	1.5	1.5
DC-13	24/60/110/220 V	A	2.5/2.5/1.5/1.5	2.5/2.5/1.5/1.5	10/6/3/1	10/6/3/1	10/6/3/1	10/6/3/1
	L/R ≤ 15 ms							
Terminal capacity								
Main contacts (1 or 2 conductors per terminal)								
Solid ¹⁾	1 x (...)	mm ²	(.75-2.5)	(.75-2.5)	(.75-4)	(.75-4)	(1-6)	(1-6)
	2 x (...)	mm ²	(.75-2.5)	(.75-2.5)	(.75-4)	(.75-4)	(1-6)	(1-6)
Flexible with ferrule	1 x (...)	mm ²	(.75-1.5)	(.75-1.5)	(.75-4)	(.75-4)	(1-6)	(1-6)
	2 x (...)	mm ²	(.75-1.5)	(.75-1.5)	(.75-4)	(.75-4)	(1-6)	(1-6)
Solid or stranded	Min – Max	AWG	18-14	18-14	18-10	18-10	16-10	16-10
Tightening torque		Nm	1.2	1.2	1.2	1.2	1.8	1.8
Auxiliary contacts								
Solid	1 x (...)	mm ²	(.75-2.5)	(.75-2.5)	(.75-4)	(.75-4)	(.75-4)	(.75-4)
	2 x (...)	mm ²	(.75-2.5)	(.75-2.5)	(.75-4)	(.75-4)	(.75-4)	(.75-4)
Flexible with ferrule	1 x (...)	mm ²	(.75-1.5)	(.75-1.5)	(.75-2.5)	(.75-2.5)	(.75-2.5)	(.75-2.5)
	2 x (...)	mm ²	(.75-1.5)	(.75-1.5)	(.75-2.5)	(.75-2.5)	(.75-2.5)	(.75-2.5)
Solid or stranded	Min - Max	AWG	18-14	18-14	18-12	18-12	18-12	18-12
Tightening torque		Nm	1.2	1.2	1.2	1.2	1.2	1.2

1) Maximum of one size difference admissible when using 2 conductors.

			PKZ 2/ZM-.../S-SP
Specifications			UL 508/CSA 22.2 No. 14, Category E self-protected control devices
Maximum continuous current	A		42 at 480 V AC
	A		27 at 600 V AC
Maximum HP ratings 3 phase at	200 V		10 HP
	230 V		15 HP
	460 V		30 HP
	575 V		25 HP
UL listed/CSA certified maximum interrupting ratings			
240 V AC	kA RMS	sym	100
480 Y/277 V AC	kA RMS	sym	65
600 Y/347 V AC	kA RMS	sym	42
System Rating			600 Y/347 V AC, up to 27 A 480 Y/277 V AC, up to 42 A
			Up to 27 A: Suitable for maximum 600 V AC power distribution systems when the voltage between any phase to ground does not exceed 347 V
			Up to 42 A: Suitable for maximum 480 V AC power distribution systems when the voltage between any phase to ground does not exceed 277 V

Additional technical data on the **PKZ 2** can be found in section 7 of this catalog.

Mounting positions

DIL EEM, EM: As required, except with terminals A1 and A2 inverted



DIL 00M...2 AM:

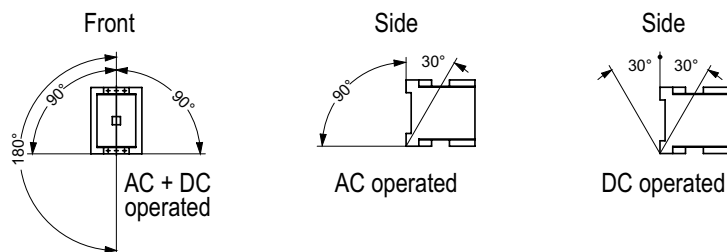

For DC operated devices a distance of at least 5 mm separating each contactor must be maintained.

PKZ 2/ZM-.../S-SP

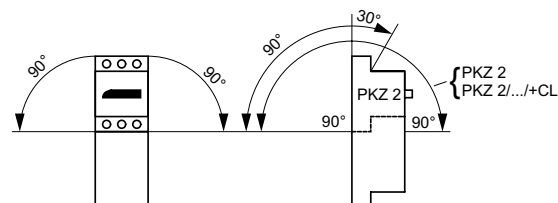

Contactors – System DIL M

Technical Data

Magnetic Starters

3

			1M	1AM	2M	2AM	3M 80	4M 115
General								
Specifications			UL, CSA, IEC/EN 60 947, CE, DIN VDE 0660					
Mechanical life span								
AC operated		x 10 ⁶ operations	10	10	10	10	10	10
DC operated		x 10 ⁶ operations	10	10	10	10	3	3
Max. operating frequency, mechanical								
AC operated		ops/h	9000	5000	5000	5000	5000	5000
DC operated		ops/h	5000	5000	5000	5000	1000	1000
Max. operating frequency electrical			see diagram on Page 3/49					
Climatic Proofing			Damp heat, constant to, IEC/EN 60 068-2-3 Damp heat, cyclic, to IEC/EN 60 068-2-30					
Ambient temperature								
	Open	max./min. C°	+50/-25	+50/-25	+50/-25	+50/-25	+55/-25	+55/-25
	Enclosed	max./min. C°	+40/-25	+40/-25	+40/-25	+40/-25	+40/-25	+40/-25
Impact resistance of make contacts			g					
			8	8	8	8	10	10
Dimensions			see Page 3/61					
Main contacts								
Rated Voltage (UL/CSA)			V AC / V DC					
			600/250	600/250	600/250	600/250	600/250	600/250
Rated making capacity (IEC/EN 60 947)			A					
			730	730	950	950	1300	1800
Rated breaking capacity								
IEC/EN 60 947	220/230 V	A	380	380	750	750	1100	1800
	380/400 V	A	380	380	600	600	1100	1800
	500 V	A	355	355	600	600	1100	1800
	660/690 V	A	255	255	545	545	650	1200
	1000 V	A	–	–	–	–	330	630
Contactor life span			Operations					
			See pages 3/48...49					
AC-1 duty (IEC/EN 60 947)								
Rated thermal current I _{th} = Rated operating current I _e								
50/60 Hz								
three-pole	Open	A	55	55	90	90	104	167
	Enclosed	A	44	44	80	80	90	140
single-pole	Open	A	140	140	225	225	250	400
	Enclosed	A	110	110	200	200	225	350
AC-3 duty (IEC/EN 60 947)								
Rated operating current I _e (Open ¹⁾)								
50/60 Hz								
	220/230 V	A	30	38	50	62	75	104
	380/400 V	A	30	36	43	58	72	104
	500 V	A	28	32	43	54	64	106
	660/690 V	A	21	25	33	42	60	98
	1000 V	A	–	–	–	–	28	40
AC-4 duty (IEC/EN 60 947)								
Rated operating current I _e (Open ¹⁾)								
50/60 Hz								
	220/230 V	A	22.5	30	37	49	64	86
	380/400 V	A	22.5	30	36	43	58	85
	500 V	A	22.5	28	32	43	54	78
	660/690 V	A	17.5	21	25	33	49	60
	1000 V	A	–	–	–	–	28	40
Magnet system								
Pick-up values								
AC operated (dual voltage coils)								
50 Hz, 60 Hz	Pick-up	x V coil	0.8 - 1.1	0.8 - 1.1	0.8 - 1.1	0.8 - 1.1	0.8 - 1.1	0.8 - 1.1
DC operated ²⁾								
	Pick-up	x V coil	0.85 -1.1	0.85 -1.1	0.85 -1.1	0.85 -1.1	0.8 - 1.1	0.8 - 1.1
Power consumption of the coil								
AC operated (dual voltage coils)								
50 Hz, 60 Hz	Pick-up	VA/W	136/88	136/88	185/106	185/106	320/150	550/220
	Sealed	VA/W	15/4	15/4	16.5/5.8	16.5/5.8	26/7	40/10
DC operated ²⁾								
	Pick-up	W	14.5	14.5	16	16	230	360
	Sealed	W	14.5	14.5	16	16	5	5.7
Duty factor DF			%					
			100	100	100	100	100	100
Switching times at 100% rated coil voltage (guide only)								
Main contacts AC operated								
	Closing delay	ms	11-19	11-19	14-22	14-22	20-24	18-28
	Opening delay	ms	6-13	6-13	5-15	5-15	8-13	7-11
	Arcing time	ms	< 20	< 20	< 20	< 20	10-20	10-25

1) At maximum allowable ambient temperature

2) True DC voltage or derived from a full wave 3-phase bridge rectifier of filtered 1-phase AC supply.

			1M	1AM	2M	2AM	3M 80	4M 115
Auxiliary contacts								
Pilot duty rating (UL/CSA)	AC		A600	A600	A600	A600	A600	A600
	DC		P300	P300	P300	P300	P300	P300
Operating current I _e IEC/EN 60 947								
AC-15	220/240 V	A	6	6	6	6	6	6
	380/415 V	A	4	4	4	4	4	4
	500 V	A	1.5	1.5	1.5	1.5	1.5	1.5
DC-13	24/60/110/220 V	A	10/6/3/1	10/6/3/1	10/6/3/1	10/6/3/1	10/6/3/1	10/6/3/1
	L/R ≤ 15 ms							
Terminal capacity								
Main contacts (1 or 2 conductors per terminal)								
Solid ¹⁾	1 x (...)	mm ²	(2.5-10)	(2.5-10)	(2.5-16)	(2.5-16)	(6-16)	–
	2 x (...)	mm ²	(2.5-10)	(2.5-10)	(2.5-16)	(2.5-16)	(6-16)	–
Flexible with ferrule	1 x (...)	mm ²	(2.5-16)	(2.5-16)	(2.5-25)	(2.5-25)	(4-50)	(16-70)
	2 x (...)	mm ²	(2.5-10)	(2.5-10)	(2.5-10)	(2.5-10)	(4-50)	(16-70)
Solid or stranded	Min – Max	AWG	12 – 4	12 – 4	12 – 2	12 – 2	10 – 2	6 – 2/0
Tightening torque		Nm	4	4	4	4	6	10
Auxiliary contacts								
Solid	1 x (...)	mm ²	(.75-4)	(.75-4)	(.75-4)	(.75-4)	(.75-4)	(.75-4)
	2 x (...)	mm ²	(.75-4)	(.75-4)	(.75-4)	(.75-4)	(.75-4)	(.75-4)
Flexible with ferrule	1 x (...)	mm ²	(.75-2.5)	(.75-2.5)	(.75-2.5)	(.75-2.5)	(.75-2.5)	(.75-2.5)
	2 x (...)	mm ²	(.75-2.5)	(.75-2.5)	(.75-2.5)	(.75-2.5)	(.75-2.5)	(.75-2.5)
Solid or stranded	Min – Max	AWG	18 – 12	18 – 12	18 – 12	18 – 12	18 – 12	18 – 12
Tightening torque		Nm	1.2	1.2	1.2	1.2	1.2	1.2

1) Maximum of one size difference admissible when using 2 conductors.

Mounting positions

DIL 00M...2 AM:

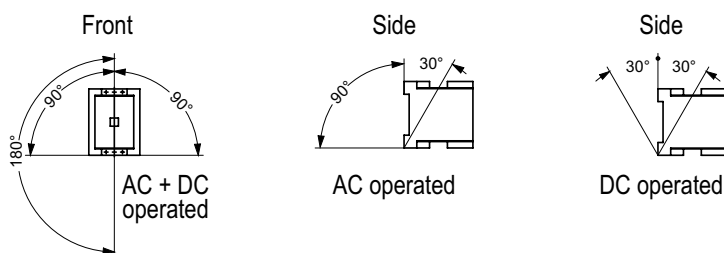

For DC operated devices a distance of at least 5 mm separating each contactor must be maintained.

DIL 3M 80...DIL M 500:

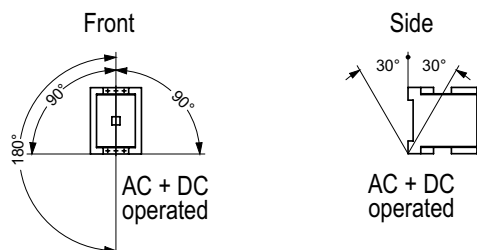

Contactors – System DIL M... Technical Data

			M 185	M 225	M 250	M 300	M 400	M 500
General Specifications			UL, CSA, IEC/EN 60 947, CE, DIN VDE 0660					
Mechanical lifespan								
AC operated		x 10 ⁶ ops	10	10	10	10	10	10
DC operated		x 10 ⁶ ops	10	10	10	10	10	10
Climatic Proofing			Damp heat, constant to IEC/EN 60 068, Pt. 2-3 Damp heat, cyclic, to IEC/EN 60 068, Pt. 2-30					
Ambient temperature	Open	max./min. C°	+60/-25	+60/-25	+60/-25	+60/-25	+60/-25	+60/-25
Mounting position		Refer to	P. 3/53	P. 3/53	P. 3/53	P. 3/53	P. 3/53	P. 3/53
impact resistance	Main contacts, Duration 10 ms		g	10	10	10	10	10
Dimensions		mm	See pages 3/61					
Main Contacts								
Rated max. voltage (per IEC)		V	1000	1000	1000	1000	1000	1000
Rated making capacity, AC cos φ to IEC/EN 60 947		A	3000	3000	3000	6000	6000	6000
Rated breaking capacity, AC cos φ to IEC/EN 60 947	220/230 V	A	2500	2500	2500	5000	5000	5000
	380/400 V	A	2500	2500	2500	5000	5000	5000
	500 V	A	2500	2500	2500	5000	5000	5000
	660/690 V	A	2500	2500	2500	3600	3600	3600
	1000 V	A	760	760	760	950	950	950
Contactor life span- AC3, AC4		ops	See pages 3/48 – 49					
Current heat loss (3 pole) at conventional free air thermal current rating I _{th} at I _e AC-3/400 V		W	36	55	48	69	120	120
Continuous current UL/CSA 50/60 Hz 3 pole	open	A	225	250	350	350	450	550
AC 1-duty IEC/EN 60 947								
Continuous current I _{th}								
Δ Rated operating current I _e 50/60 Hz 3 pole:	open at 40°C	A	276	306	367	429	551	674
	open at 50°C	A	246	274	329	383	493	602
	open at 55°C	A	235	261	313	366	470	574
	open at 60°C	A	225	250	300	350	450	550
AC 3-duty								
Rated operating current I _e (open at max. ambient temperature) 50/60 Hz	220/230 V	A	185	225	250	300	400	500
	380/400 V	A	185	225	250	300	400	500
	500 V	A	185	225	250	300	400	500
	660/690 V	A	185	225	250	300	360	360
	1000 V	A	76	76	76	95	95	95
AC 4-duty								
Rated operating current I _e (open at max. ambient temperature) 50/60 Hz	220/230 V	A	136	164	200	240	296	360
	380/400 V	A	136	164	200	240	296	360
	500 V	A	136	164	200	240	296	360
	660/690 V	A	136	164	200	240	296	296
	1000 V	A	76	76	76	95	95	95
Main Terminals via Terminal Kits (standard bolt-on termination)								
Terminal capacity								
Multi-stranded with ferrule	Min.	mm ²	50	70	70	70	70	70
	Max.	mm ²	120	240	240	240	240	240
(Cu cable)	one conductor	Min.-Max. AWG-kcmil	6 - 350	6 - 350	1/0 - 600	1/0 - 600	1/0 - 600	1)
	two conductor	Min.-Max. AWG-kcmil	6 - 350	6 - 350	1/0 - 500	1/0 - 500	1/0 - 500	
Tightening torque		Nm	24	24	24	24	24	24
Main Contacts DC								
IEC/EN 60 947 (open) I _e operating current								
DC-1, DC-3, DC-5 duty	60-220 V DC	A	300	300	300	400	400	400

1) Terminal Kit type **DIL M 650-XKB-S** suitable for flat Cu Flexibus connection only. Bolt-on termination (supplied standard) can accommodate crimped cable lug connection.

			M 185	M 225	M 250	M 300	M 400	M 500
Magnet System								
(U _c = Rated Coil Voltage)								
Pick-up values								
AC or DC ¹⁾ operated	Pick-up	xU _c	0.7-1.15	0.7-1.15	0.7-1.15	0.7-1.15	0.7-1.15	0.7-1.15
	Drop-out	xU _c	0.2- 0.6	0.2- 0.6	0.2- 0.6	0.2- 0.6	0.2- 0.6	0.2- 0.6
Power consumption of the coil								
AC operated at 100% U _c	Pick-up	VA	250	250	250	450	450	450
		W	200	200	200	350	350	350
Multi-Voltage coils	Sealing	VA	3.3	3.3	3.3	3.3	3.3	3.3
		W	4.3	4.3	4.3	4.3	4.3	4.3
DC operated ¹⁾ at 100% U _c	Pick-up	W	170	170	170	350	350	350
	Sealing	W	4.3	4.3	4.3	4.3	4.3	4.3
Duty factor DF		%	100	100	100	100	100	100
Switching times at 100% rated coil voltage main contacts								
AC operated	making delay	ms	≤ 100	≤ 100	≤ 100	≤ 80	≤ 80	≤ 80
	breaking delay	ms	≤ 80	≤ 80	≤ 80	≤ 80	≤ 80	≤ 80
DC operated ¹⁾	making delay	ms	≤ 100	≤ 100	≤ 100	≤ 80	≤ 80	≤ 80
	breaking delay	ms	≤ 80	≤ 80	≤ 80	≤ 80	≤ 80	≤ 80
Stability of Magnet System under variable control voltage conditions (U _s = Control Voltage Supply Rating)								
Behavior of magnet system during:								
Voltage Interruptions								
	(0...0.2 x U _s)	≤ 10ms	Magnet system bridges the time gap. Contactor remains energized.					
	(0...0.2 x U _s)	> 10ms	Contactor drops out.					
Voltage dips								
	(0.2...0.6 x U _s)	≤ 12ms	Magnet system bridges the time gap. Contactor remains energized.					
	(0.2...0.6 x U _s)	> 12ms	Contactor drops out.					
	(0.6...0.7 x U _s)		Contactor remains energized.					
Voltage surges								
	(1.15...1.3 x U _s)		Contactor remains energized.					
	(> 1.3 x U _s)	≤ 3 sec.	Contactor remains energized.					
	(> 1.3 x U _s)	> 3 sec.	Contactor drops out. ²⁾					
Start-up								
	(0...0.7 x U _s)		Contactor does not energize.					
	(0.7...1.15 x U _s)		Contactor energizes.					
	(> 1.15 x U _s)		Contactor does not energize.					
Maximum allowable resistance of contact used to energize contactor via A11 terminal		mΩ	≤ 500	≤ 500	≤ 500	≤ 500	≤ 500	≤ 500
Maximum allowable leakage current of electronic output used to energize contactor via A11 terminal		mA	≤ 1	≤ 1	≤ 1	≤ 1	≤ 1	≤ 1
PLC Signal level, in accordance with EN 61 131 (Type 2)								
	High	V	15	15	15	15	15	15
	Low	V	5	5	5	5	5	5
Auxiliary Contacts								
Rated voltage		V	600	600	600	600	600	600
Pilot duty rating (UL/CSA)		AC	A 600	A 600	A 600	A 600	A 600	A 600
		DC	P 300	P 300	P 300	P 300	P 300	P 300
IEC 947 Operating Current I _e								
AC-15	220/240 V	A	6	6	6	6	6	6
	380/415 V	A	4	4	4	4	4	4
	500 V	A	1.5	1.5	1.5	1.5	1.5	1.5
DC-13	24/60 V	A	10/6	10/6	10/6	10/6	10/6	10/6
	L/R ≤ 15 ms	A	3/1	3/1	3/1	3/1	3/1	3/1
Terminal capacity (one or two conductors)								
Solid	Minimum	mm ²	1 x (.75-2.5)	1 x (.75-2.5)	1 x (.75-2.5)	1 x (.75-2.5)	1 x (.75-2.5)	1 x (.75-2.5)
	Maximum	mm ²	2 x (.75-2.5)	2 x (.75-2.5)	2 x (.75-2.5)	2 x (.75-2.5)	2 x (.75-2.5)	2 x (.75-2.5)
Flexible with ferrule	Minimum	mm ²	1 x (.75-2.5)	1 x (.75-2.5)	1 x (.75-2.5)	1 x (.75-2.5)	1 x (.75-2.5)	1 x (.75-2.5)
	Maximum	mm ²	2 x (.75-2.5)	2 x (.75-2.5)	2 x (.75-2.5)	2 x (.75-2.5)	2 x (.75-2.5)	2 x (.75-2.5)
Solid or stranded	Min – Max	AWG	18 – 12	18 – 12	18 – 12	18 – 12	18 – 12	18 – 12
Tightening torque		Nm	1.2	1.2	1.2	1.2	1.2	1.2

1) Pure DC or from 3 phase bridge rectifier or at least two-pulse bridge rectifier.

2) Some damage to the magnet system cannot be ruled out.

Contactors – DIL Universal

Technical Data

			DIL 3	DIL 4	DIL 6	DIL 8	DIL 8A
General							
Specifications			UL, CSA, IEC/EN 60 947, CE , DIN VDE 0660				
Mechanical life-span							
AC operated		x 10 ⁶ operations	10-15	10-15	10-15	10-15	1
DC operated		x 10 ⁶ operations	1.5	1.5	1.5	0.4	0.4
Climatic Test			Damp heat, constant to IEC/EN 60 068, Pt. 2-3 Damp heat, cyclic, to IEC/EN 60 068, Pt. 2-30				
Ambient temperature	open	max./min. C°	+50/-25	+50/-25	+50/-25	+50/-25	+50/-25
	enclosed	max./min. C°	+40/-25	+40/-25	+40/-25	+40/-25	+40/-25
Mounting position			Either vertical or inclined up to 30° in any direction from vertical				
Impact resistance of NO (NC) contacts, Duration 20 ms, (make/break)		g	7(4)	10(8)	13(9)	7(5)	7(5)
Dimensions			See pages 3/61				
Main Contacts							
Rated Voltage		V	600	600	600	600	600
Rated making capacity, AC cos = 0.35 cos = 1		A	1600	2100	2500	2900	3700
		A	1620	2200	2600	3400	3900
Rated breaking capacity, AC cos = 0.35 50 – 60 Hz	220-230 V	A	970	1800	2500	2900	3000
	380-400 V	A	970	1800	2500	2900	3000
	500 V	A	800	1700	1900	2900	2900
	660-690 V	A	620	1070	1120	1500	1100
Contactor life span AC1, AC3, AC4			ops Consult Moeller Electric				
Current heat loss (3 poles) At continuous current rating I _{th}		W	25	75	116	120	125
Continuous current UL/CSA 50-60 Hz 3 pole	open	A	140	160	210	360	400
	enclosed	A	126	144	189	324	360
AC 1-duty IEC/EN 60 947 Continuous current I _{th} Δ Rated operating current I _e 50-60 Hz 3 pole:	open	A	140	225	250	420	500
	enclosed	A	125	170	200	350	400
AC 3-duty Rated operating current I _e open and enclosed 50-60 Hz	230 V	A	103	170	204	300	360
	500 V	A	78	127	182	285	355
	660 V	A	60	98	140	214	–
AC 4-duty Rated operating current I _e open and enclosed 50-60 Hz	230 V	A	52	75	125	180	250
	500 V	A	54	78	127	182	220
	660 V	A	42	60	98	140	–
Main Terminals							
Wire capacity One Conductor (Cu cable)	Min.	AWG	#6	#6	#6	#1/0	#1/0
	Max.	AWG	#2/0	250 kcmil	300 kcmil	500 kcmil	500 kcmil
Wire capacity Two Conductors (Cu cable)	Min.	AWG	#18	#18	#18	#1/0	#1/0
	Max.	AWG	#4	#2	#1/0	250 kcmil	250 kcmil

				DIL 3	DIL 4	DIL 6	DIL 8	DIL 8A
Magnet System								
Pick-up and drop-out values								
AC operated		pick-up		0.8-1.1	0.8-1.1	0.8-1.1	0.8-1.1	0.8-1.1
		drop-out		0.4-0.6	0.4-0.6	0.4-0.6	0.4-0.6	0.4-0.6
DC operated ¹⁾								
		pick-up		0.85-1.1	0.85-1.1	0.85-1.1	0.85-1.1	0.85-1.1
		drop-out		0.2-0.4	0.2-0.4	0.2-0.4	0.2-0.4	0.2-0.4
Power consumption of the coil AC operated								
dual voltage coils ...V, 50 Hz . . .V, 60 Hz		pick-up	VA/W	300/126	410/172	580/190	1265/350	1370/410
		seal	VA/W	36/8.5	46/13	55/16	88/30	92/35
DC operated ¹⁾								
(with economy resistor)		pick-up	W	300	360	360	525	525
		seal	W	18	14	14	21	21
Duty factor DF								
			%	100	100	100	100	100
Switching times at 100% rated coil voltage main contacts								
AC operated								
		making delay	ms	25-34	22-47	21-38	19-32	20-35
		breaking delay	ms	10-15	10-15	9-14	15-25	12-20
DC operated ¹⁾								
		making delay	ms	27-30	29-33	31-34	25-30	25-30
		breaking delay	ms	18-20	18-20	20-34	20-25	20-25
Reversing contactors								
change-over time at 110% Control Voltage								
			ms	27-37	27-47	25-40	25-37	27-42
Arcing time (AC)								
			ms	<20	<20	<20	<20	<20
Auxiliary Contacts								
Rated voltage				V	600	600	600	600
Pilot duty rating (UL/CSA)				AC	A 600	A 600	A 600	A 600
				DC	N 300	N 300	N 300	N 300
IEC Operating Current I _e								
AC-15								
	220-240 V		A	6	6	6	6	6
	380-415 V		A	4	4	4	4	4
	500 V		A	1.5	1.5	1.5	1.5	1.5
DC-13								
	24/60/110/220 V		A	6/2.5/1.5/0.6	6/2.5/1.5/0.6	6/2.5/1.5/0.6	6/2.5/1.5/0.6	6/2.5/1.5/0.6
	L/R ≤ 15 ms		A					
Terminal capacity								
one or two conductors				Min.	18	18	18	18
				Max.	14	14	14	14

1) True DC voltage or derived from a full wave 3-phase bridge rectifier or filtered 1-phase AC supply

Enclosure Suffix - Dimensional Data

AC MAGNETIC FULL VOLTAGE NON-REVERSING STARTERS (PAGE 3/14)

Type	Enclosure - w x h x d		
	/S cm (inches)	/SD, /DW cm (inches)	/I cm (inches)
DIL			
(E)EM/ZE-... 00(A)M/11/Z00-...	17 x 24 x 15 (6 ⁵ / ₈ x 9 ¹ / ₂ x 6)	23 x 40 x 17.5 (9 x 15 ³ / ₄ x 7)	18.75 x 25 x 15 (7 ³ / ₄ x 9 ⁷ / ₈ x 6)
0M/11/Z00-... 0AM/11/Z00-...			
1M/11/Z1-... 1AM/11/Z1-...			
2M/11/Z1-... 2AM/11/Z1-...		23 x 40 x 17.5 (9 x 15 ³ / ₄ x 7)	37.5 x 25 x 17.5 (14 ³ / ₄ x 9 ⁷ / ₈ x 7)
2AM/11+Z1-75	23 x 30 x 17.5 (9 x 11 ⁷ / ₈ x 7)		
3M 80/11/Z5	27 x 60 x 17.5 (10 ⁵ / ₈ x 23 ¹ / ₂ x 7)	27 x 60 x 17.5 (10 ⁵ / ₈ x 23 ¹ / ₂ x 7)	37.5 x 25 x 22.5 (14 ³ / ₄ x 9 ⁷ / ₈ x 8 ⁷ / ₈)
4M 115/11/Z5			37.5 x 37.5 x 22.5 (14 ³ / ₄ x 14 ³ / ₄ x 8 ⁷ / ₈)
3-22/Z4-...	27 x 60 x 17.5 (10 ⁵ / ₈ x 23 ¹ / ₂ x 7)	27 x 60 x 17.5 (10 ⁵ / ₈ x 23 ¹ / ₂ x 7)	37.5 x 37.5 x 22.5 (14 ³ / ₄ x 14 ³ / ₄ x 8 ⁷ / ₈)
4-22/Z4-...			42.1 x 79.6 x 27.5 (16 ¹ / ₂ x 31 ¹ / ₃ x 9 ⁷ / ₈)
6-22/Z4-...	50 x 80 x 17.5 (19 ⁵ / ₈ x 31 ¹ / ₂ x 7)	50 x 80 x 17.5 (19 ⁵ / ₈ x 31 ¹ / ₂ x 7)	42.1 x 79.6 x 25 (16 ¹ / ₂ x 31 ¹ / ₃ x 9 ⁷ / ₈)
8-22/Z4-... 8-22/ZW7-... 8A-22/ZW7-...			— — —

AC MAGNETIC FULL VOLTAGE REVERSING STARTERS (PAGE 3/15)

Type	Enclosure - w x h x d		
	/S cm (inches)	/SD, /DW cm (inches)	/I cm (inches)
DIUL...			
(E)EM-... 00(A)M-01/Z00-... 0(A)M/11/Z00-...	17 x 24 x 15 (6 ⁵ / ₈ x 9 ¹ / ₂ x 7)	23 x 40 x 17.5 (9 x 15 ³ / ₄ x 7)	37.5 x 25 x 15 (14 ³ / ₄ x 9 ⁷ / ₈ x 6)
0(A)M/11+Z1-...	23 x 30 x 17.5 (9 x 11 ⁷ / ₈ x 7)		
1M/11/Z1-... 1AM/11/Z1-...	23 x 40 x 17.5 (9 x 15 ³ / ₄ x 7)		37.5 x 25 x 15 (14 ³ / ₄ x 9 ⁷ / ₈ x 6)
2(A)M/11/Z1-... 2AM/11+Z1-75			
3M 80/11/Z5-...	27 x 60 x 17.5 (10 ⁵ / ₈ x 23 ¹ / ₂ x 7)	27 x 60 x 17.5 (10 ⁵ / ₈ x 23 ¹ / ₂ x 7)	37.5 x 37.5 x 22.5 (14 ³ / ₄ x 14 ³ / ₄ x 8 ⁷ / ₈)
4M 115/11/Z5-...	50 x 60 x 17.5 (19 ⁵ / ₈ x 23 ¹ / ₂ x 7)	50 x 60 x 17.5 (19 ⁵ / ₈ x 23 ¹ / ₂ x 7)	37.5 x 37.5 x 22.5 (14 ³ / ₄ x 14 ³ / ₄ x 8 ⁷ / ₈)
3-22/Z4-...	50 x 60 x 17.5 (19 ⁵ / ₈ x 23 ¹ / ₂ x 7)	50 x 60 x 17.5 (19 ⁵ / ₈ x 23 ¹ / ₂ x 7)	42.1 x 79.6 x 22.5 (16 ¹ / ₂ x 31 ¹ / ₃ x 9 ⁷ / ₈)
4-22/Z4-...	50 x 60 x 17.5 (19 ⁵ / ₈ x 23 ¹ / ₂ x 7)	50 x 60 x 17.5 (19 ⁵ / ₈ x 23 ¹ / ₂ x 7)	—
6-22/Z4-...	50 x 80 x 17.5 (19 ⁵ / ₈ x 31 ¹ / ₂ x 7)	50 x 80 x 17.5 (19 ⁵ / ₈ x 31 ¹ / ₂ x 7)	—
8-22/Z4-... 8-22/ZW7-... 8A-22/ZW7-...	80 x 120 x 27.5 (31 ¹ / ₂ x 47 ¹ / ₄ x 10)	80 x 120 x 27.5 (31 ¹ / ₂ x 47 ¹ / ₄ x 10)	— — —

COMBINATION STARTERS - BREAKER TYPE (PAGE 3/22)

Type	Enclosure - w x h x d		
	/S cm (inches)	/SD, /DW cm (inches)	/I cm (inches)
M			
00(A)M-10/ZM/Z00-... 0M/11/ZM/Z00-...	23 x 40 x 17.5 (9 x 15 ³ / ₄ x 7)	23 x 40 x 17.5 (9 x 15 ³ / ₄ x 7)	37.5 x 25 x 15 (14 ³ / ₄ x 9 ⁷ / ₈ x 6)
0AM/11/ZM6/Z-... 1M/11/ZM6/Z1-40 2M/11/ZM6/Z1-57 2AM/11/ZM6/Z1-...	27 x 60 x 17.5 (10 ¹ / ₂ x 23 ¹ / ₂ x 7)	27 x 60 x 17.5 (10 ¹ / ₂ x 23 ¹ / ₂ x 7)	37.5 x 25 x 17.5 (14 ³ / ₄ x 9 ⁷ / ₈ x 7)
3M 80/11/ZM6/Z5			37.5 x 37.5 x 22.5 (14 ³ / ₄ x 14 ³ / ₄ x 8 ⁷ / ₈)
4M 115/11/ZM6/Z5 4M 115/11/ZM9/Z5	50 x 60 x 17.5 (19 ⁵ / ₈ x 23 ¹ / ₂ x 7)	50 x 60 x 17.5 (19 ⁵ / ₈ x 23 ¹ / ₂ x 7)	42.1 x 79.6 x 22.5 (16 ⁵ / ₈ x 31 ³ / ₈ x 8 ⁷ / ₈)
3-22/ZM6/Z4-... 3-22/ZM6/Z4-100 4-22/ZM6/Z4-... 4-22/ZM6/Z4-140			
4-22/ZM9/Z4-140 6-22/ZM9/Z4-...	50 x 60 x 17.5 (19 ⁵ / ₈ x 23 ¹ / ₂ x 7)	50 x 60 x 17.5 (19 ⁵ / ₈ x 23 ¹ / ₂ x 7)	- -
8-22/ZM9/Z4-240 8-22/ZM10/ZW7-... 8A-22/ZM10/ZW7-...	80 x 100 x 27.5 (31 ¹ / ₂ x 39 ³ / ₈ x 11)	80 x 100 x 27.5 (31 ¹ / ₂ x 39 ³ / ₈ x 11)	- - -

COMBINATION REVERSING STARTERS - BREAKER TYPE (PAGE 3/23)

Type	Enclosure - w x h x d		
	/S cm (inches)	/SD, /DW cm (inches)	/I cm (inches)
MV			
00M-01/ZM/Z00-... 00AM-01/ZM/Z00-...	27 x 60 x 17.5 (10 ¹ / ₂ x 23 ¹ / ₂ x 7)	27 x 60 x 17.5 (10 ¹ / ₂ x 23 ¹ / ₂ x 7)	37.5 x 25 x 15 (14 ³ / ₄ x 9 ⁷ / ₈ x 6)
0M/11/ZM/Z00-... 0AM/11/ZM6/Z-... 1M/11/ZM6/Z1-40	27 x 60 x 17.5 (10 ¹ / ₂ x 23 ¹ / ₂ x 7)	27 x 60 x 17.5 (10 ¹ / ₂ x 23 ¹ / ₂ x 7)	37.5 x 37.5 x 17.5 (14 ³ / ₄ x 14 ³ / ₄ x 7)
2M/11/ZM6/Z1-... 2AM/11/ZM6/Z1-...	27 x 60 x 17.5 (10 ¹ / ₂ x 23 ¹ / ₂ x 7)	27 x 60 x 17.5 (10 ¹ / ₂ x 23 ¹ / ₂ x 7)	37.5 x 37.5 x 17.5 (14 ³ / ₄ x 14 ³ / ₄ x 7)
3M 80/11/ZM6/Z5-... 4M 115/11/ZM6/Z5-... 4M 115/11/ZM9/Z5-...	50 x 60 x 17.5 (19 ¹ / ₂ x 23 ¹ / ₂ x 7)	50 x 60 x 17.5 (19 ¹ / ₂ x 23 ¹ / ₂ x 7)	42.1 x 79.6 x 22.5 (16 ⁵ / ₈ x 31 ³ / ₈ x 8 ⁷ / ₈)
3-22/ZM6/Z4-...	60 x 80 x 17.5 (23 ¹ / ₂ x 31 ¹ / ₂ x 7)	60 x 80 x 17.5 (23 ¹ / ₂ x 31 ¹ / ₂ x 7)	42.1 x 79.6 x 22.5 (16 ⁵ / ₈ x 31 ³ / ₈ x 8 ⁷ / ₈)
4-22/ZM6/Z4-... 4-22/ZM9/Z4-140 6-22/ZM9/Z4-...	60 x 80 x 17.5 (23 ¹ / ₂ x 31 ¹ / ₂ x 7)	60 x 80 x 17.5 (23 ¹ / ₂ x 31 ¹ / ₂ x 7)	- - -
8-22/ZM9/Z4-... 8-22/ZM10/Z4-... 8-22/ZM10/ZW7-... 8A-22/ZM10/ZW7-...	80 x 120 x 27.5 (31 ¹ / ₂ x 47 ¹ / ₄ x 11)	80 x 120 x 27.5 (31 ¹ / ₂ x 47 ¹ / ₄ x 11)	- - - -

The enclosure may or not change with the addition of modifications. When accurate dimensions of the enclosure are required, refer to your nearest Moeller Electric Office.

COMBINATION STARTERS - SELF-PROTECTED TYPE, FVNR (PAGE 3/20)

Type	Enclosure - w x h x d		
	/S cm (inches)	/SD, /DW cm (inches)	/I cm (inches)
PKZ 2/ZM.../S-SP	23 x 40 x 17.5 (9 x 15 ³ / ₄ x 7)	23 x 40 x 17.5 (9 x 15 ³ / ₄ x 7)	37.5 x 25 x 12.5 (14 ³ / ₄ x 9 ⁷ / ₈ x 6)

COMBINATION STARTERS - DISCONNECT TYPE (PAGE 3/24)

Type	Enclosure - w x h x d		
	/S cm (inches)	/SD, /DW cm (inches)	
M			
00M/11/P2-30 00AM/11/P2-30 0M/11/P2-30 0AM/11/P2-30 0AM/11/P2-60 1M/11/P2-60 1M/11/P2-30 1M/11/P2-60 1AM/11/P2-60 2M/11/P2-60 2M/11/P2-100 2AM/11/P2-100 2AM/11/P2-100	/Z00-.../S /Z00-.../S /Z00-.../S /Z00-.../S /Z1-.../S /Z1-.../S /Z1-40/S /Z1-40/S /Z1-.../S /Z1-57/S /Z1-57/S /Z1-.../S /Z4-.../S	27 x 60 x 17.5 (10 ¹ / ₂ x 23 ¹ / ₂ x 7)	27 x 60 x 17.5 (10 ¹ / ₂ x 23 ¹ / ₂ x 7)

COMBINATION REVERSING STARTERS - DISCONNECT TYPE (PAGE 3/26)

Type	Enclosure - w x h x d		
	/S cm (inches)	/SD, /DW cm (inches)	
MW			
00M/11/P2-30 00AM/11/P2-30 0M/11/P2-30 0AM/11/P2-30 0AM/11/P2-60 1M/11/P2-60 1M/11/P2-30 1M/11/P2-60 1AM/11/P2-60 2M/11/P2-60 2M/11/P2-100 2AM/11/P2-100 2AM/11/P2-100	/Z00-.../S /Z00-.../S /Z00-.../S /Z00-.../S /Z1-.../S /Z1-.../S /Z1-40/S /Z1-40/S /Z1-.../S /Z1-57/S /Z1-57/S /Z1-.../S /Z4-.../S	27 x 60 x 17.5 (10 ¹ / ₂ x 23 ¹ / ₂ x 7)	27 x 60 x 17.5 (10 ¹ / ₂ x 23 ¹ / ₂ x 7)

Enclosure Suffix - Dimensional Data

AC MAGNETIC TWO-SPEED STARTER – 1 WINDING (PAGE 3/16)

Type	Enclosure - w x h x d	
	/S cm (inches)	/SD, /DW cm (inches)
2S1W 00M/Z00-.../Z00-... 2S1W 00AM/Z00-.../Z00-... 2S1W 0M/Z00-.../Z00-... 2S1W 0AM/Z00-.../Z00-...	23 x 40 x 17.5 (9 x 15 ³ / ₄ x 7)	23 x 40 x 17.5 (9 x 15 ³ / ₄ x 7)
2S1W 1M/Z1-.../Z1-... 2S1W 1AM/Z1-.../Z1-... 2S1W 2M/Z1-.../Z1-... 2S1W 2AM/Z1-.../Z1-...	27 x 60 x 17.5 (10 ¹ / ₂ x 23 ¹ / ₂ x 7)	27 x 60 x 17.5 (10 ¹ / ₂ x 23 ¹ / ₂ x 7)
2S1W 3-22/Z1-.../Z1-...	50 x 80 x 17.5 (19 ⁵ / ₈ x 31 ¹ / ₂ x 7)	50 x 80 x 17.5 (19 ⁵ / ₈ x 31 ¹ / ₂ x 7)
2S1W 4-22/Z4-.../Z1-... 2S1W 6-22/Z4-.../Z1-...	60 x 100 x 17.5 (23 ¹ / ₂ x 39 ³ / ₈ x 7)	60 x 100 x 17.5 (23 ¹ / ₂ x 39 ³ / ₈ x 7)
2S1W 8-22/Z4-.../Z1-... 2S1W 8-22/Z4-.../Z4-... 2S1W 8-22/ZW7-.../Z4-... 2S1W 8A-22/ZW7-.../Z4-...	80 x 120 x 27.5 (31 ¹ / ₂ x 47 ¹ / ₄ x 11)	80 x 120 x 27.5 (31 ¹ / ₂ x 47 ¹ / ₄ x 11)

AC MAGNETIC TWO-SPEED STARTER – 2 WINDING (PAGE 3/16)

Type	Enclosure - w x h x d	
	/S cm (inches)	/SD, /DW cm (inches)
2S2W 00M/Z00-.../Z00-... 2S2W 00AM/Z00-.../Z00-... 2S2W 0M/Z00-.../Z00-... 2S2W 0AM/Z00-.../Z00-...	23 x 40 x 17.5 (9 x 15 ³ / ₄ x 7)	23 x 40 x 17.5 (9 x 15 ³ / ₄ x 7)
2S2W 1M/Z1-.../Z1-... 2S2W 1AM/Z1-.../Z1-... 2S2W 2M/Z1-.../Z1-... 2S2W 2AM/Z1-.../Z1-...	27 x 60 x 17.5 (10 ¹ / ₂ x 23 ¹ / ₂ x 7)	27 x 60 x 17.5 (10 ¹ / ₂ x 23 ¹ / ₂ x 7)
2S2W 3-22/Z1-.../Z1-...	50 x 60 x 17.5 (19 ⁵ / ₈ x 23 ¹ / ₂ x 7)	50 x 60 x 17.5 (19 ⁵ / ₈ x 23 ¹ / ₂ x 7)
2S2W 4-22/Z4-.../Z1-... 2S2W 6-22/Z4-.../Z1-...	50 x 80 x 17.5 (19 ⁵ / ₈ x 31 ¹ / ₂ x 7)	50 x 80 x 17.5 (19 ⁵ / ₈ x 31 ¹ / ₂ x 7)
2S2W 8-22/Z4-.../Z1-... 2S2W 8-22/Z4-.../Z4-... 2S2W 8-22/ZW7-.../Z4-... 2S2W 8A-22/ZW7-.../Z4-...	80 x 120 x 27.5 (31 ¹ / ₂ x 47 ¹ / ₄ x 11)	80 x 120 x 27.5 (31 ¹ / ₂ x 47 ¹ / ₄ x 11)

DIL E(E)M-...
DIL E(E)M-...-G

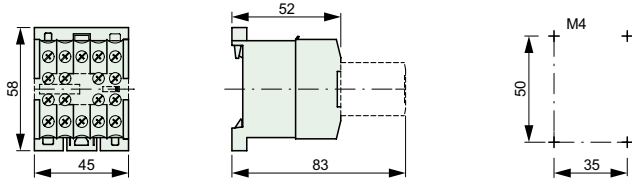

DIL	00 M (-G) 00 AM (-G) 00 M 4 (-G)	0 M (-G) 0 AM (-G)	1 M (-G) 1 AM (-G)	2 M (-G) 2 AM (-G)
a	45 (45)	45 (45)	60 (60)	70 (70)
a1	35 (35)	35 (35)	50 (50)	60 (60)
a4	-	55 (55)	70 (70)	80 (80)
a5	-	60 (60)	80 (80)	90 (90)
b	77 (77)	91 (91)	98 (98)	118 (118)
b1	39 (39)	46 (46)	49 (49)	59 (59)
b2	60 (60)	75 (75)	75 (75)	90 (90)
c (w/out H DIL)	74 (99)	79 (104)	97 (122)	102 (127)
c (with H DIL)	76.5 (101.5)	86.3 (113.3)	-	-
c1	107 (132)	112 (137)	130 (155)	135 (160)
c2	136 (161)	141 (166)	159 (184)	164 (189)
c3	136	-	-	-

DIL 00M to DIL 2AM
DIL 00M-G to DIL 2AM-G

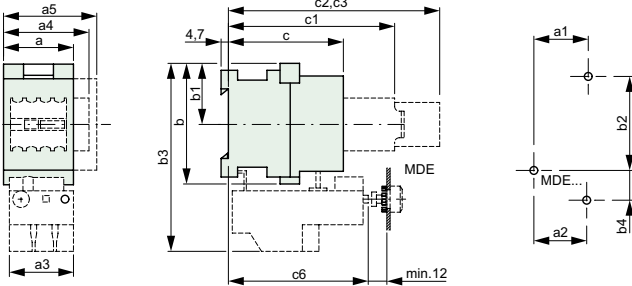

Overload Relays	00	00	1	1
Z				
a2	34 (34)	34 (34)	42 (42)	47 (47)
a3	45 (45)	45 (45)	60 (60)	60 (60)
b3	120 (120)	133 (133)	153 (153)	171 (171)
b4	19 (19)	18 (18)	26 (26)	27 (27)
c6	90 (115)	96 (121)	91 (116)	91 (116)

Maintain a minimum spacing of 5 mm between DC operated DIL 00M-G to DIL 2AM-G contactors mounted side by side.

2 M4 x 16	2 M5 x 16
00 (A)M	1 (A)M
0 (A)M	2 (A)M

DIL 3M 80
DIL 4M 115

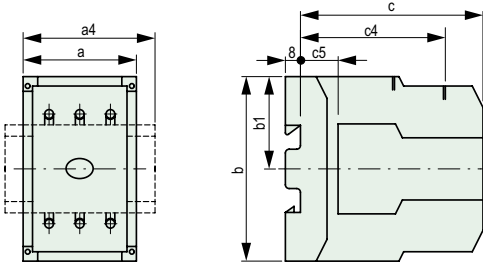

DIL	3 M 80	4 M 115
a	100	120
a1	80	100
a4	112	130
b	130	150
b1	65	75
b2	110	130
c (w/out H DIL)	127	137
c4	77	79
c5	20	47

2 M5 x 20	2 M6 x 20
DIL 3M 80	DIL 4M 115
Z 5-.../SK 3	Z 5-.../SK 4

DIL 3M 80 + Z5-.../SK3
DIL 4M 115 + Z5-.../SK4

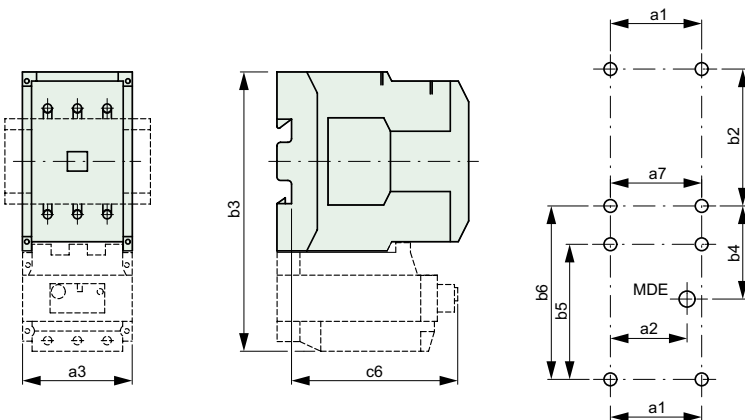

Overload Relays	5-.../SK 3	5-.../SK 4
Z		
a2	57	67
a3	100	120
a7	80	80
b3	238	263
b4	51	56
b5	74	74
b6	95	100
c6	125	125

a4 = With side mounting auxiliary contact module on DIL 0M to DIL 2AM, with second side mounting auxiliary contact module type DIL M 820-XHI11-SA on DIL 3M 80 to DIL 4M 115
a5 = With N DIL...M 4th pole module
c1 = With ...DIL M auxiliary contact module
c2 = With TP...11 DIL pneumatic timer module
c3 = With V(-G) DIL mechanical latching module

Contactors – Starters Dimensions

DIL M 185 DIL M 300
 DIL M 225 DIL M 400
 DIL M 250 DIL M 500

- ① DIL M 820-XHI...-SI
- ② DIL M 820-XHI11-SA
- ③ DIL M ...-XMV

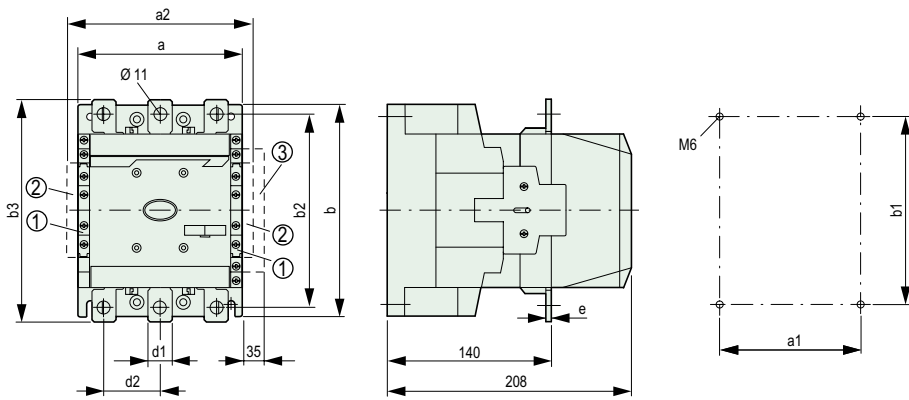

DIL	M 185	M 225	M 250	M 300	M 400	M 500
a	140	140	140	160	160	160
a1	120	120	120	130	130	130
a2	160	160	160	180	180	180
b	180	180	180	200	200	200
b1	160	160	160	180	180	180
b2	164	164	164	184	184	189
b3	189	189	189	209	209	219
d1	20	20	25	25	25	35
d2	48	48	48	48	48	57
e	5	5	5	6	6	6

Contactors with Terminals Covers

DIL M 185 to DIL M 500 with DIL M...-XHB

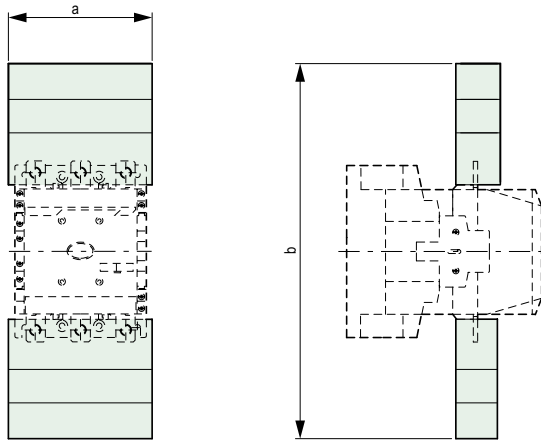

DIL M 185	DIL M 500
DIL M 225	
DIL M 250	
DIL M 300	
DIL M 400	
DIL M 185-XP1	

a	150	174
b	384	369

DIL M 185 to DIL M 250 with Z5-.../FF 250

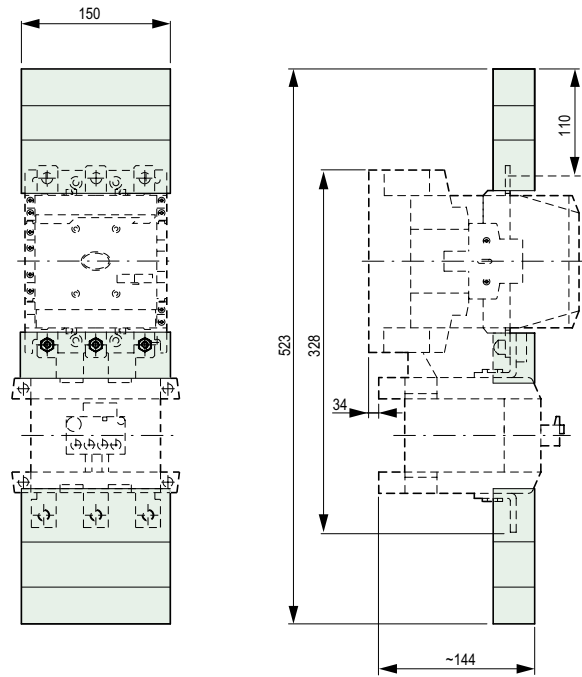

Contactors with Star Point bridges and Terminal Covers

DIL M...-XS1

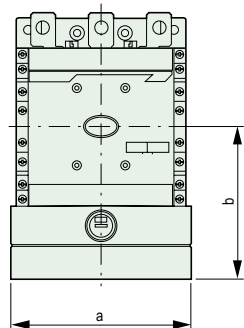

DIL M	185 – 250	300 – 400	500
a	150	150	176
b	127	137	146

Contactors – Starters Dimensions

Universal Contactors

DIL 3-22/Z4 Reset Button
 DIL 4-22/Z4 MDE-287
 DIL 6-22/Z4
 DIL 8-22/Z4
 DIL 8A-22/Z4

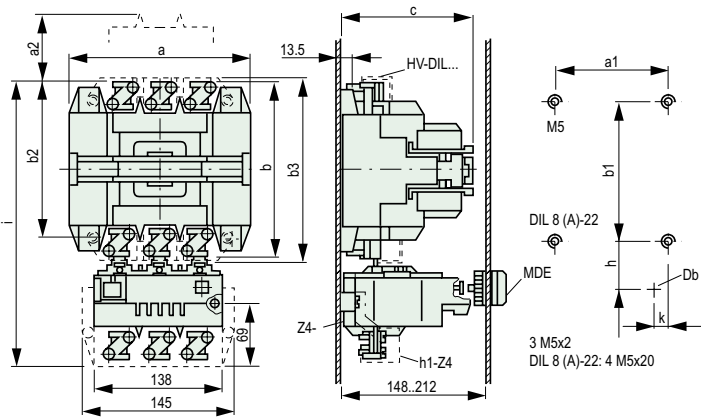

DIL Z	3-22 4.../K 3	4-22 4...	6-22 4...	8(A)-22 4.../K 8
a = b	136	158	182	230
c	131	141	150	190
a1 = b1	118	136	150	192
a2	70	70	70	90
b2	127	147	166	211
h	54	58	57	69
i	254	278	296	353
k	14	23	30	51
b3	152	176	200	252

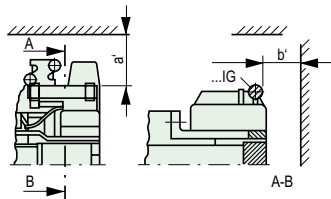

Minimum clearance a' and b' between DIL.../G and neighboring components

DIL	3-22/G	4-22/G	6-22/G	8(A)-22/G
a'	65	65	65	65
b'	15	15	15	10

DIL 8-22/ZW7
 DIL 8A-22/ZW7

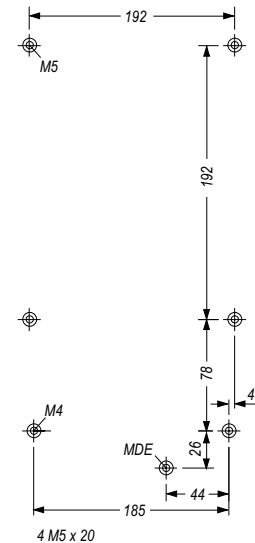
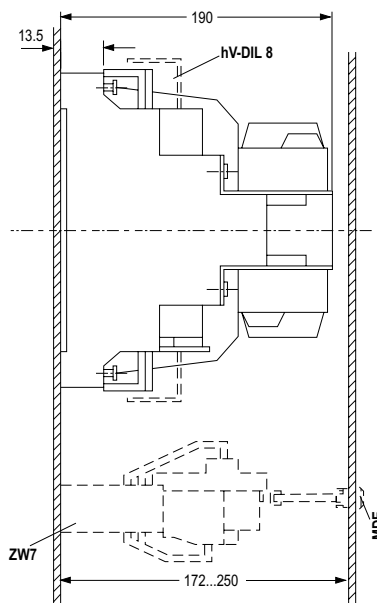
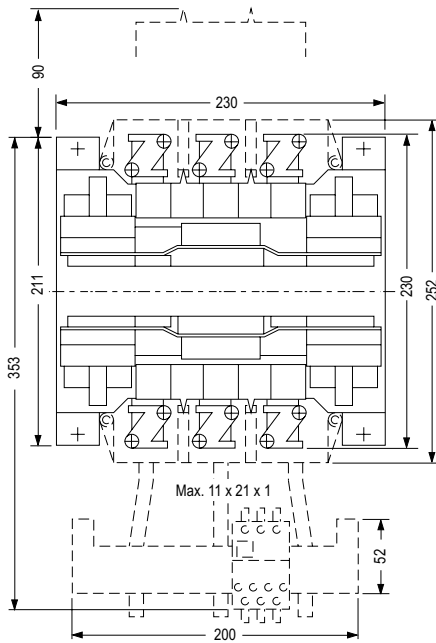

Reversing Contactors

DIUL E(E)M

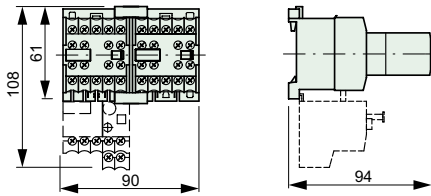

DIUL 00 (A)M/11 to DIUL 2 (A)M/11

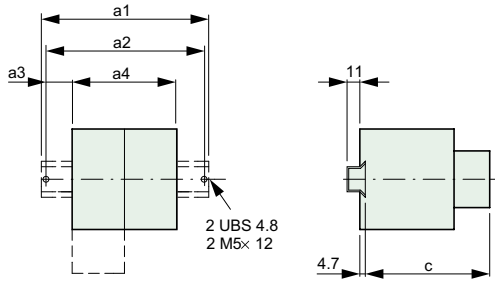

DIUL	00 AM	0 M 0 AM	1 M	2 M
a1	114	114	164	189
a2	100	100	150	175
a3	5	5	15	17.5
a4	90	90	120	140
c	107	112	130	135

Note: Width increases by 15 mm for reversing contactors with mechanical interlock

DIUL 3 M 80/11 to DIUL 4 M 115/11

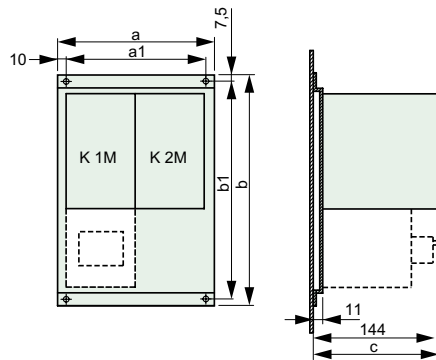

DIUL	3 M 80	4 M 115
a	225	265
a1	205	245
b	268	294
b1	253	279
c	146	156

Note: Width increases by 10 mm for reversing contactors with mechanical interlock

DIUL 3 to 8 A:

Consult Moeller Electric Corporation

Contactors – Starters Dimensions

Surge Suppressors

RC DIL E
VG DIL E

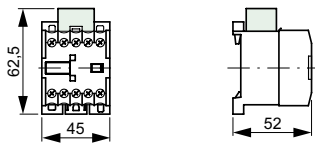

RC B DIL...
RC S DIL...
FD B DIL...
VG B DIL...
VG C DIL...

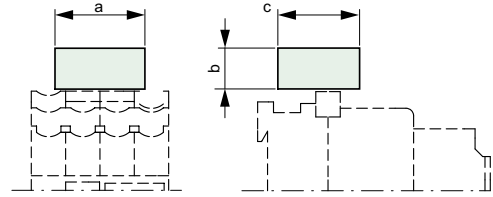

	RC B DIL	RC S DIL	FD B DIL	VG B DIL	VG C DIL
a	33	33	33	33	38
b	15	15	15	15	8
c	30	30	30	30	33

Interface Modules

VS1 DIL
VS2 DIL

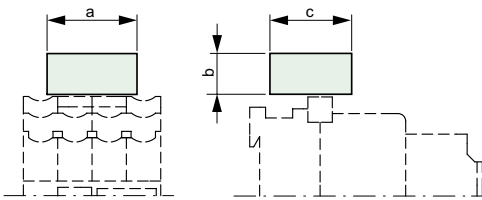

	VS1 DIL	VS2 DIL
a	45	
b	26	
c	55	

ETS 4-VS 3

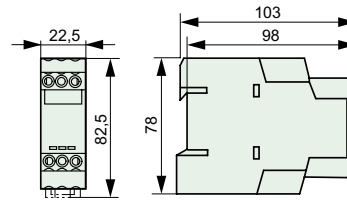

Paralleling Bridges

P1 DIL EM

P1 DIL... M

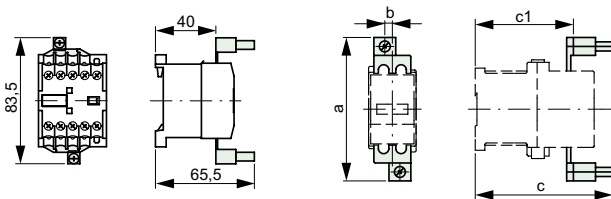

For Type DIL...	a	b	c	c1
00(A)M(-G)	95	5	91	(116) 65 (90)
0(A)M(-G)	114	-	103	(128) 69 (94)
1(A)M(-G)	170	9	138	(163) 79 (101)
2(A)M(-G)	188	12	138	(163) 79 (101)
3M 80	195	19	150	88
4M 115	244	17	182	92

Star-point Bridges

S1 DIL...M

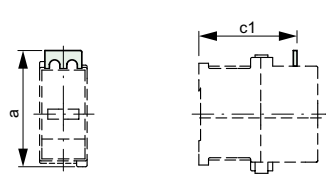

Type	a	c1
S1 DIL 00M	77	65
S1 DIL 0M	91	69
S1 DIL 1M	106	79
S1 DIL 2M	126	79
S1 DIL 3M	150	92
S1 DIL 4M	169	93

Adapter

AK DIL...M

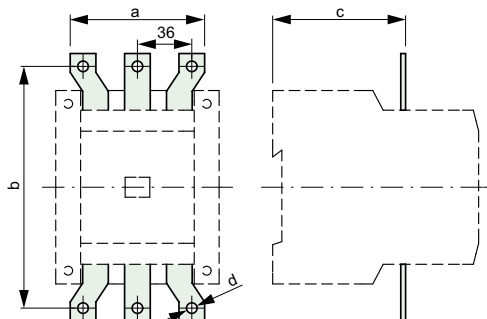

Type	AK DIL...	
For DIL	3M 80	4M 115
a	89	94
b	160	190
c	88	91
d	7	8.4

Tamper-proof Transparent Cover

H DIL E

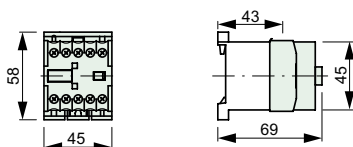

Supplementary Terminals

ZK DIL 0M
ZK DIL 1M
ZK DIL M
HK DIL M

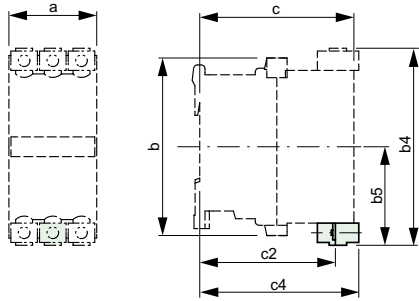

DIL	ZK DIL 0M		ZK DIL 1M		ZK DIL M			
	0M 0AM	(-G) (-G)	1M 1AM	(-G) (-G)	2M 2AM	(-G) (-G)	3M 80	4M 115
a	45	(45)	60	(60)	70	(70)	100	120
b	91	(91)	98	(98)	118	(118)	–	–
b4	101	(101)	98	(98)	112.5	(112.5)	136	166
b5	50.5	(50.5)	49	(49)	56.3	(56.3)	68	83
c	79	(104)	97	(122)	102	(127)	127	137
c2 (max. with HK DIL M)	69.5	(94.5)	80.5	(105.5)	80.5	(105.5)	102	105
c4 (max. with HK DIL M)	81.5	(106.5)	92.5	(117.5)	92.5	(117.5)	118	121
HK DIL M...								
DIL	1M 1AM	(-G) (-G)	2M 2AM	(-G) (-G)				
a	60	(60)	70	(70)				
b	98	(98)	118	(118)				
b4	104.5	(104.5)	123	(123)				
b5	52.3	(52.3)	61.5	(61.5)				
c	97	(122)	102	(127)				
c2	73.5	(98.5)	74.2	(99.2)				
c4	107.4	(132.4)	107.7	(132.7)				

Mechanical Interlocks

MV DIL M
DIL M 500-XMV

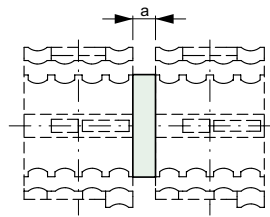

DIL	00M(-G) up to 2AM(-G)	3M 80 up to 4M 115	DIL M 185 up to DIL M 500
a	15	10	15

MV DIL E

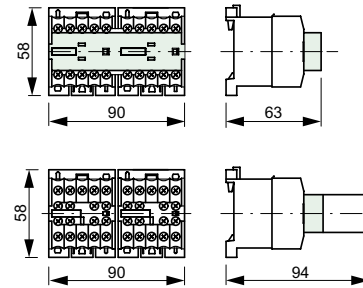

V-DIL....:

Consult Moeller Electric Corporation

Cable Terminal Blocks
DIL M...-XKU-S

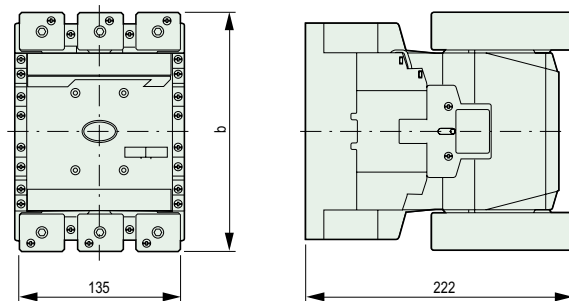

For DIL M	185 – 225	250	300 – 400
b	198	198	218

DIL M 500-XKB-S

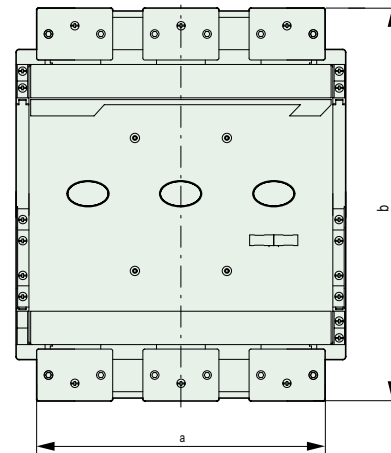

For DIL M	500
a	171
b	232

