

# Pegasus

## Contact blocks

Spring loaded Terminals



AUTOMATION TECHNOLOGIES

### SPRING LOADED TERMINALS

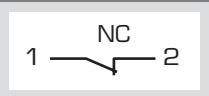
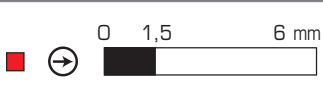
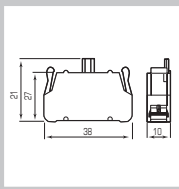
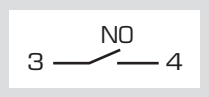
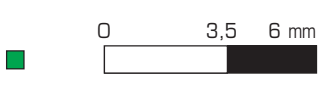
		CONTACT BLOCKS				
DESIGNATION	FUNCTIONS	CODE	DIMENSIONS			
			PCW01			
						

### LAMPHOLDER BA9s

DESIGNATION	POWER SUPPLY	CODE	DIMENSIONS
	 <p>BA9s lamp socket 250V 2,4 w max bulb not included</p>	PCWAD	

### LAMPHOLDER WITH BUILT-IN LED

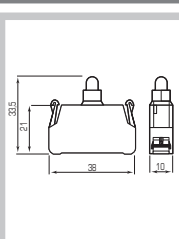
DESIGNATION	POWER SUPPLY	CODE	DIMENSIONS
	AC/DC 12V	PCW5L12	
	AC/DC 24V	PCW5L24	
	AC/DC 48V	PCW5L48	
	AC/DC 110V	PCW5L110	
	AC 220V	PCW5L220	

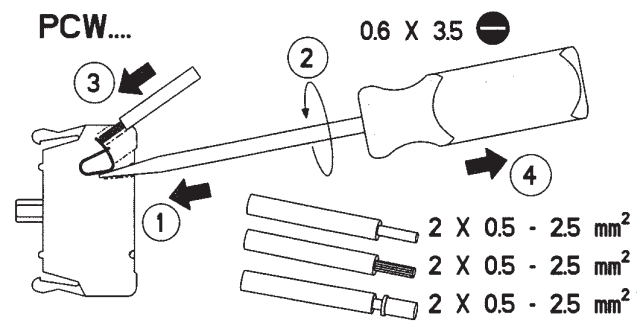
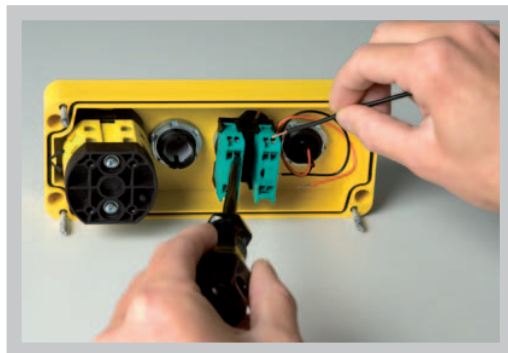





# Pegasus

## Contact blocks

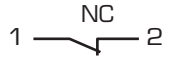
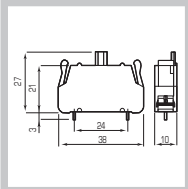
Welding terminals

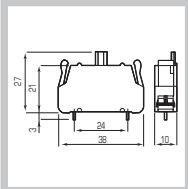
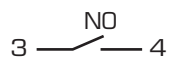
### CONTACT BLOCKS

CONTACT BLOCKS				
DESIGNATION	FUNCTIONS	CODE	DIMENSIONS	
	NC 	  	PSC01	
	NO 	 	PSC10	

### LAMPHOLDER BA9s

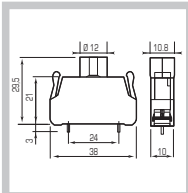
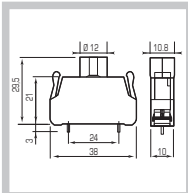
DESIGNATION	POWER SUPPLY	CODE	DIMENSIONS
	 BA9s lamp socket 250V 2,4 w max bulb not included	PSCAD	

### LAMPHOLDER WITH BUILT-IN LED

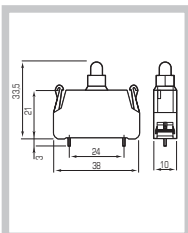
DESIGNATION	POWER SUPPLY	CODE	DIMENSIONS
	AC/DC 12V	PSC5L12	
	AC/DC 24V	PSC5L24	
	AC/DC 48V	PSC5L48	
	AC/DC 110V	PSC5L110	
	AC 220V	PSC5L220	

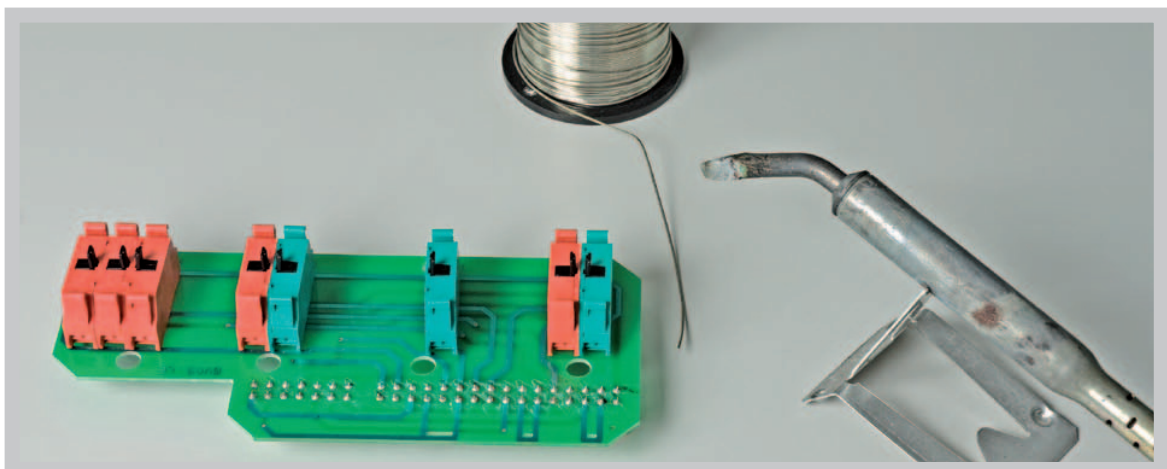

# Pegasus



## Contact blocks

Screw terminals



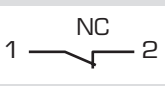

AUTOMATION TECHNOLOGIES

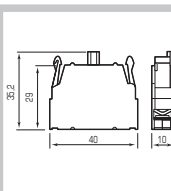
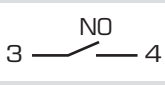
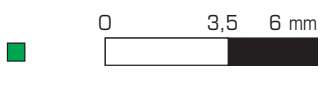
### CONTACT BLOCKS

		CONTACT BLOCKS				
DESIGNATION	FUNCTIONS	CODE	DIMENSIONS			
			PL004001			
			PL004002			

### LAMPHOLDER BA9s

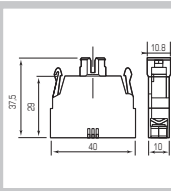
DESIGNATION	POWER SUPPLY	CODE	DIMENSIONS		
	 <p>BA9s lamp socket 250V 2,4 w max bulb not included</p>	PL004007			

### LAMPHOLDER WITH BUILT-IN LED

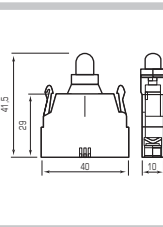
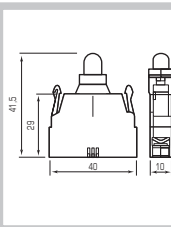
DESIGNATION	POWER SUPPLY	CODE	DIMENSIONS			
		AC/DC 12V	PL0045L12			
	AC/DC 24V	PL0045L24				
	AC/DC 48V	PL0045L48				
	AC/DC 110V	PL0045L110				
	AC 220V	PL0045L220				

### POWER SUPPLY WITH DIODE AND RESISTORS

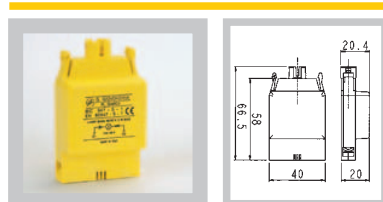

DESIGNATION	POWER SUPPLY	CODE
<b>1</b> BA9s	110/130V Lamp 4B/60V 2W max	PL004RD1
	220/240V Lamp 110/130V 2W max	PL004RD2

### POWER SUPPLY WITH TRANSFORMER

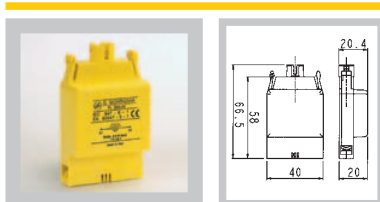

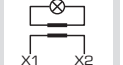
DESIGNATION	POWER SUPPLY	CODE
<b>1</b> BA9s	Input 110/130V Output 24V	PL004TR1
	Input 220/240V Output 24V	PL004TR2
	Input 380/440V Output 24V	PL004TR3

### POWER SUPPLY WITH FLASHING LIGHT

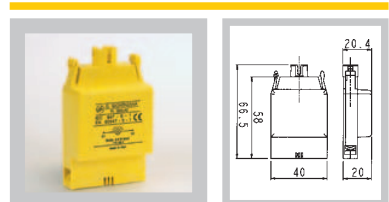

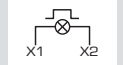
DESIGNATION	POWER SUPPLY	CODE
<b>1</b> BA9s	24V Lamp 24V-2,6 max	PL004LA1
	110/130V 110/130V-2,6 max	PL004LA2

**1** Lamp supply separately