

topline

**PCS 991
Manual**

for the PCS 900 operating consoles

Intelligent soft-key actions ■
Logging • Statistics • Reporting ■
Operating & Monitoring ■

The operating consoles PCS topline offer the highest degree of perfection, unparalleled in design and function. PCS topline keeps everything under control - from the PCS mini to the PCS maxi, with a superior operating culture and an unlimited setup freedom.

PCS, the first programmable operating console with a large selection of "ready-to-use" operating functions or operating tools which are simply selected via instructions. You can realize even the most unusual operating requests at ease and in a minimum of time.

Today this way and tomorrow that way

One standard hardware for virtually thousands of different operating situations. Without extensive wiring and dozens of I/O points.

PCS for operating. What else?



- **Machine operation using 20 freely assignable keys;** these F01 to F20 labeled keys can be application specifically inscribed and are provided to the controller as status bits. In addition, situation-related soft-key actions can be assigned to these keys.
- **40 freely usable LEDs:** These can be assigned the indicating states »ON«, »DARK«, »FLASHING«, »INVERS FLASHING«. A green and a yellow LED is allocated to each function key.
- **Display of background bitmaps** separately for the areas status, working and soft-key.
- **Representation of any freely programmable characters** on the display.
- **Display of fixed texts with integrated variable values;** 9 variable formats are available for representation.
- **Setting up of several priority levels which can be changed related to situations;** This working-condition related management significantly offloads the programmable controller program.
- **Representation of the contents of a maximum of 214 programmable controller words as variables;** In addition, 55 internal (predefined) variables are available.
- **Modification of the contents of any word within the transfer area;** separate editors are available for every variable format.
- **Monitoring of rising or falling edges of a maximum of 1024 consecutive bits;** The assignment of texts, the management of 3 priority levels (information, warnings and faults) keeping the timely sequence as much as possible, organization of the FIRST MESSAGE, LAST MESSAGE, the individually settable clearing behavior are tasks which are managed by the PCS 950 by itself.
- **Logging of messages** with the CAME, WENT and ACKNOWLEDGED times is made by the PCS 950 itself. A logging memory is available for displayable (HISTORY) as well as for printable (MESSAGE PRINTER) texts.
- **Printing of shift-related or order-related pages** with any integrated internal or external variables.
- **Communication monitoring (wire-break, short circuit);** A very efficient data transfer is secured by the integrated priority management in connection with the intelligent package length optimization, the high thrupt rate and the fault tolerance.
- **8 timers** with 8 daily repeating on-the-second ON/OFF switching points which can be freely edited as internal variables.

Complete automatization

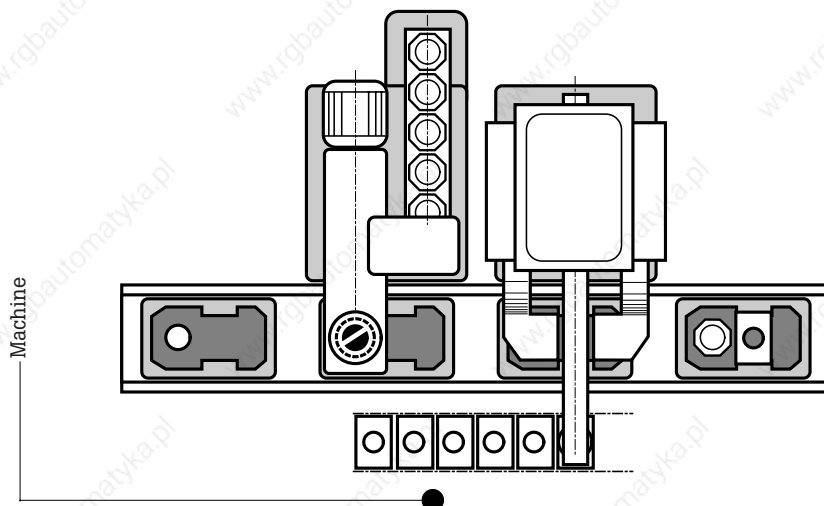
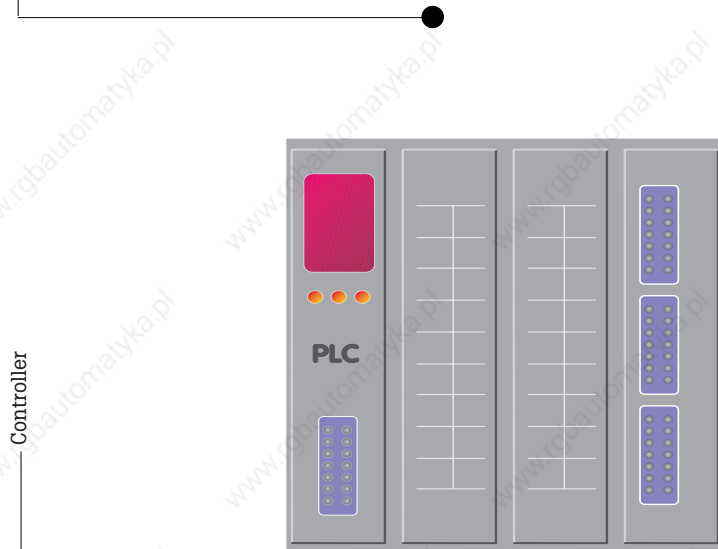
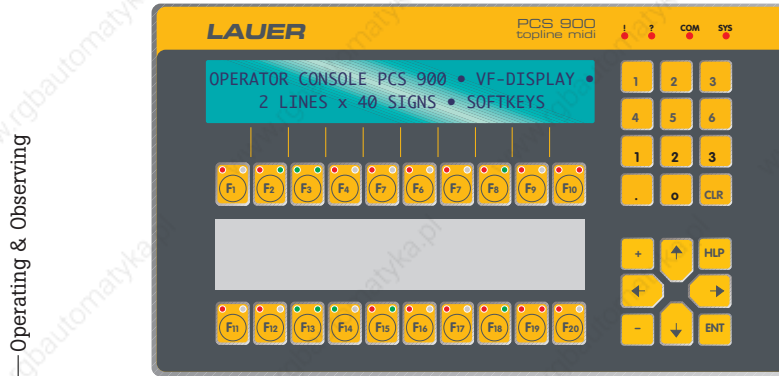
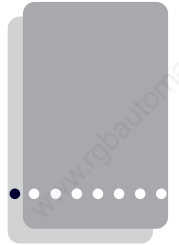

Midi operating console PCS 900

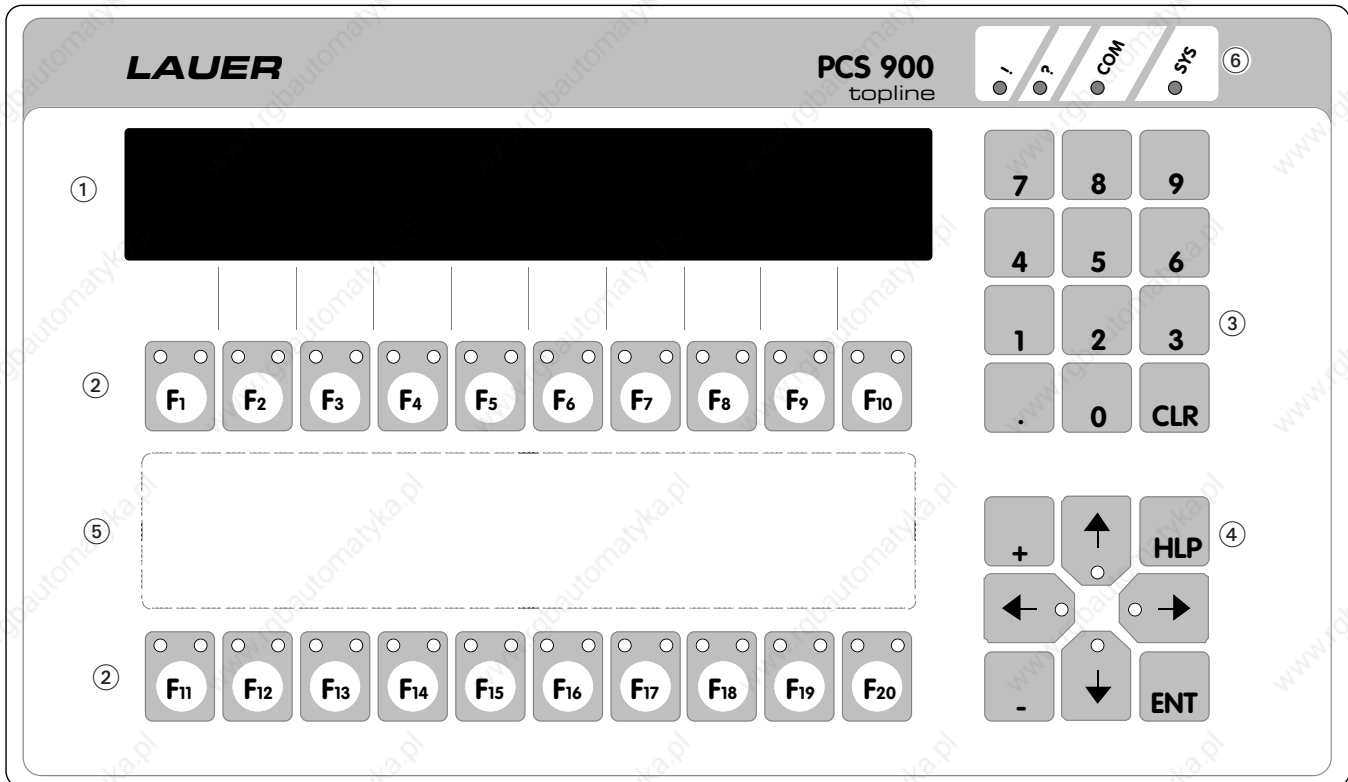

- ① VF display, 2 lines x 40 characters ② Function keys F1...F20, each containing two status LEDs ③ Numeric keypad for preset values ④ 8 control keys for menu operation and preset value input, cursor keys with LED ⑤ Function key labeling ⑥ Important information about the PCS status

The modular operating console PCS 900 is equipped with a VF display and offers the maximum freedom of configuration.

The display enables any representation of information and variables by means of idle pages, operating pages, messages, help pages, status and softkey rows.

Via an internal bus, one module offering a wide range of functions can be plugged in at the rear. This is a prerequisite for an extremely flexible use of PCS midi.

PCS status (⑥)

!	Message active
!	Priority > idle priority, currently inhibited
?	Operator prompt, input expected
COM	Communication not yet established
COM	Communication interrupted
SYS	Bios active
COM, ! = LED continuously ON, COM, ! = LED flashing	

Specifications and dimensions

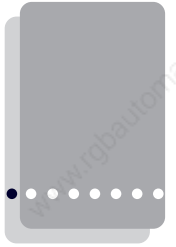

External dimensions	325 mm x 190 mm, mounting depth without connector: 65 mm
Weight:	approx. 1000 g
Operating voltage:	+19 VDC ... 30 VDC, protected against polarity reversal
Current consumption:	I_{av} @ 24 VDC 450 mA I_{max} @ 19 VDC (with cassettes max. 100 mA additionally) 650 mA
Data storage:	flash EEPROM, min. 10000 write cycles
Noise immunity:	see manufacturer information
Protection class IEC 529:	rear: IP 20; front (after installation): IP 65
Humidity:	0...75%, exposure time of at least 48 hours
Vibration resistance:	3 g @ 50 and 100 Hz in all directions, min. 1 hour
Temperature:	storage: -25...+70 °C operation: 0...+50 °C
Front foil:	polyester
Pushbuttons:	mechanical with tactile touch
Display:	VF display, 2 lines x 40 characters, 5 x 8 matrix
Fuse:	400 mA, small fuse, slow-blow, 1 spare fuse

Warning!

The device is exclusively intended for being installed in another machine. Commissioning is prohibited, until conformity of the final product with the regulation 89/392/EWG has been ascertained.

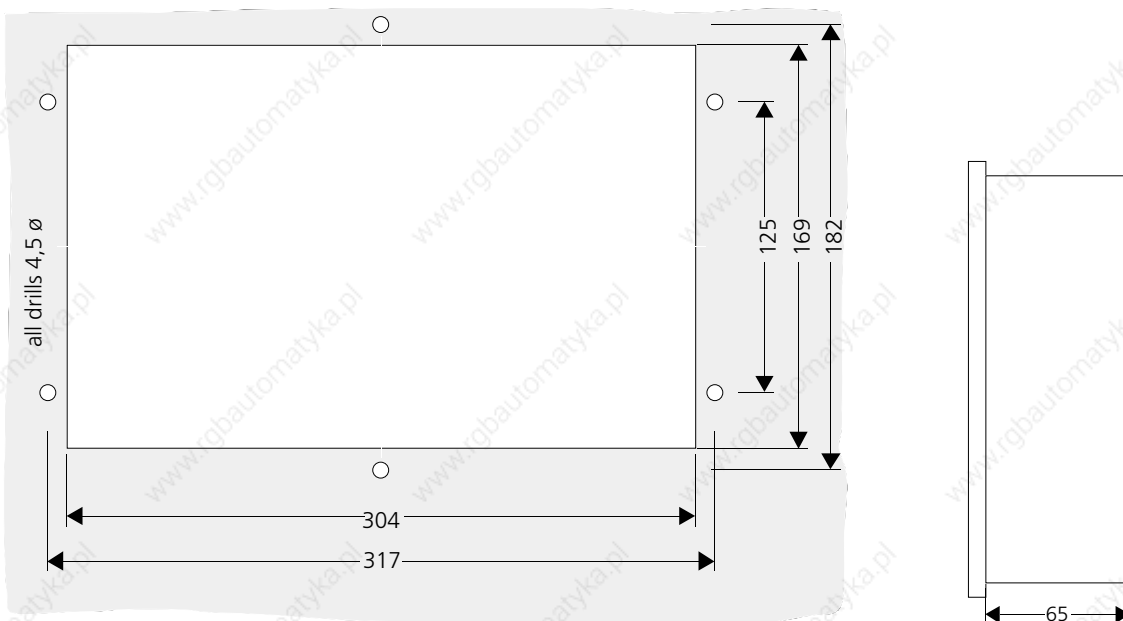

Programming and communication

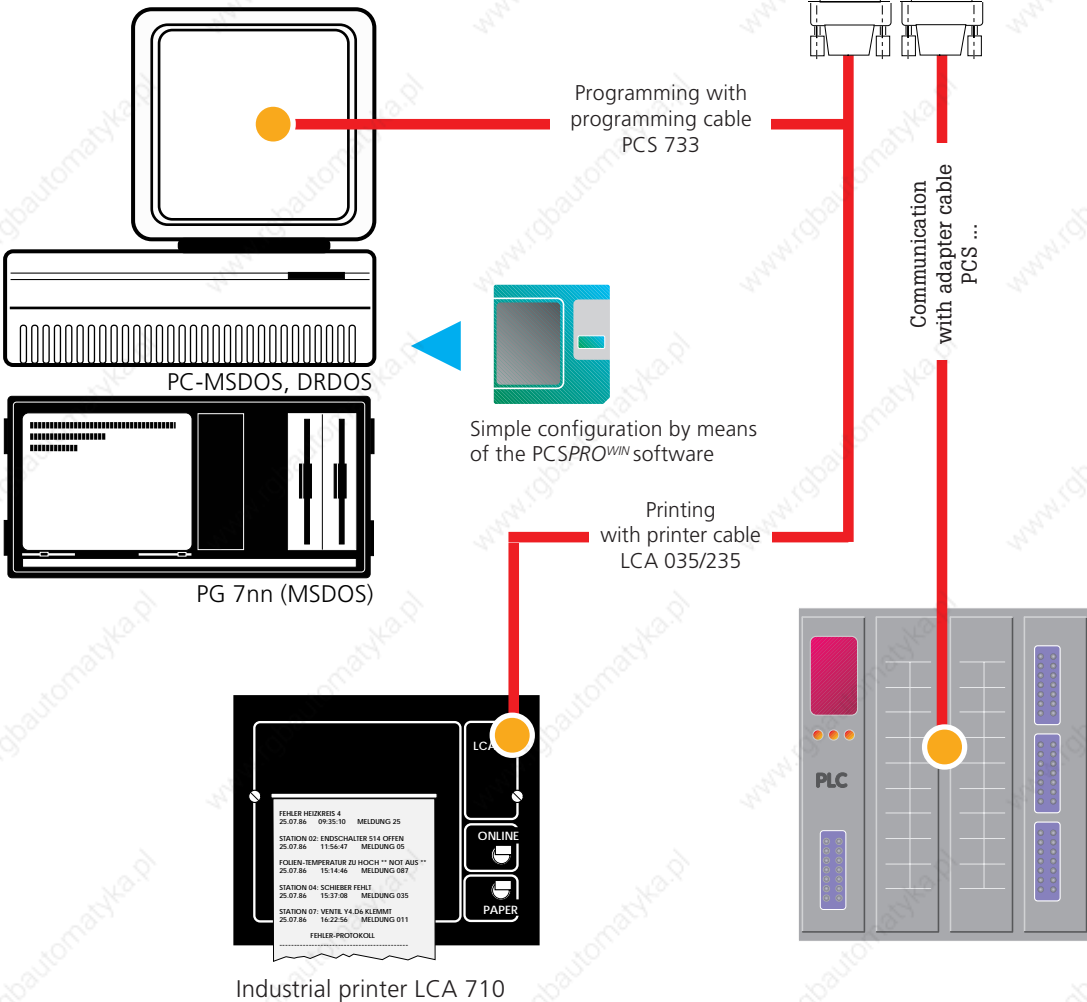
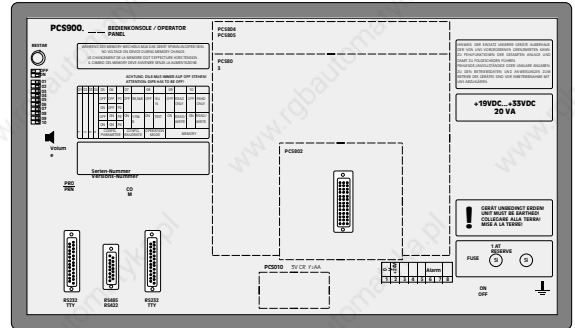
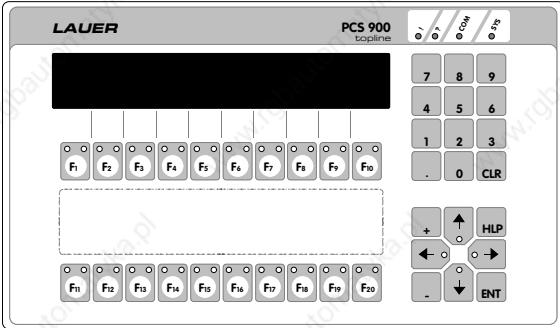

Functions and tools of the PCS midi

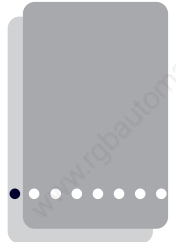

PCS midi represents a coherent operating concept for different programmable controller systems. The operating console PCS 950 offers a wide range of functions and tools for operating and observing.

- 20 function keys (softkey definable), each with two stat yellow - OFF, ON, FLASHING, INV
- Any number of switches which as desired (text or semi-graphic
- Any number of selector switch labeled as desired (text or semi-graphic) with 256 switch positions.
- Key switch or code lock allow access rights.
- Date and time can be set from synchronization) from the controller.
- 8 timers, each with 8 cams
- Numeric BCD/BIN preset value keypad or IN/DEC keys. Up to 8 variables per line.
- Simple input of ASCII preset value
- The bit pattern of a word (word represented and modified in the controller)
- Numeric display of binary actual up to 5 digits (0..65.535 (0..4.294.967.295))
- Automatic conversion of the preset values from BCD/BIN into the device vice versa with sign, limit value
- 1024 message pages with ten message priorities and with 5 channels
- 256 pages with 8 variables per page for idle pages.
- Logging, machine report and output to the PC.
- 127 operating pages
- Analog input of preset values as well as of actual values
- Up to 2 languages with different characters can be configured (when using cassette).

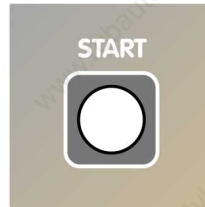

Keys



Binary preset value input



Message texts

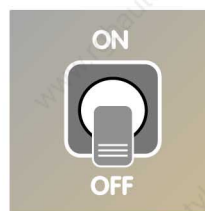

Switch

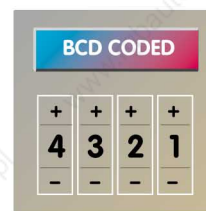

BCD preset value input



Operating and idle texts



Selector switch



ASCII preset value input

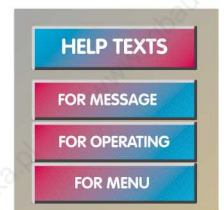

Help texts

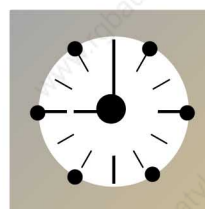

Timer



Change data word flag



Logging, Statistics, Report



BIN/DEZ-conversion



Numeric actual value



Date and time

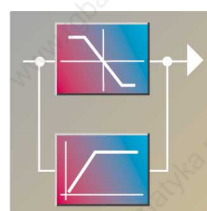

Limit values, scaling



2 languages

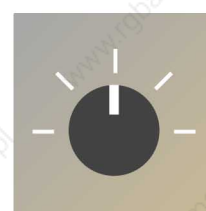

Analog preset value input



Preset value input via a menu

Simple communication principle

The electrical connection between a programmable controller of any type and the PCS is effected by a special adapter cable.

Data communication is based on a principle which can easily be understood:

The PCS writes functions or preset values into previously defined programmable controller word areas. These functions or values are then read and interpreted by the programmable controller.

The programmable controller writes functions or actual values into previously defined word areas. These functions or values are then automatically read and interpreted by the PCS.

Depending on the programmable controller, a maximum of 256 words (with 16 bits each) or a total of 4096 I/O, are available for PCS/programmable controller communication.

The words from W 00 up to W 40 are permanently assigned in the PCSmidi (see pages 8 to 15). Words 41 to 255 are available for any operating projects. The words can be assigned individually.

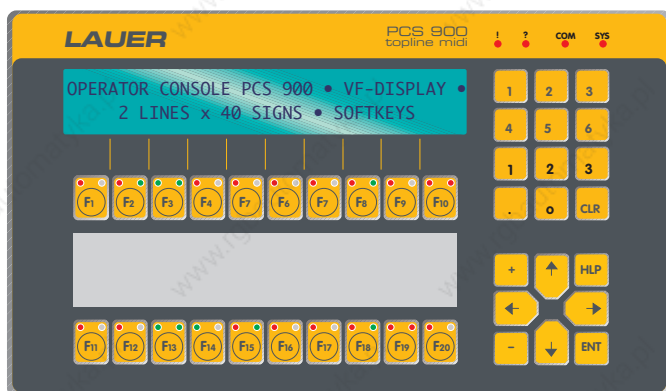
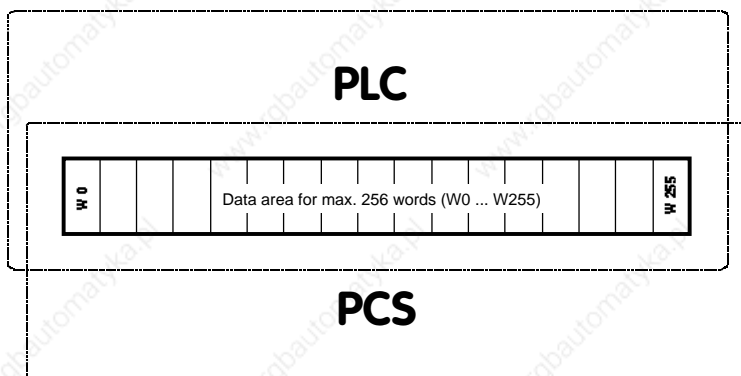
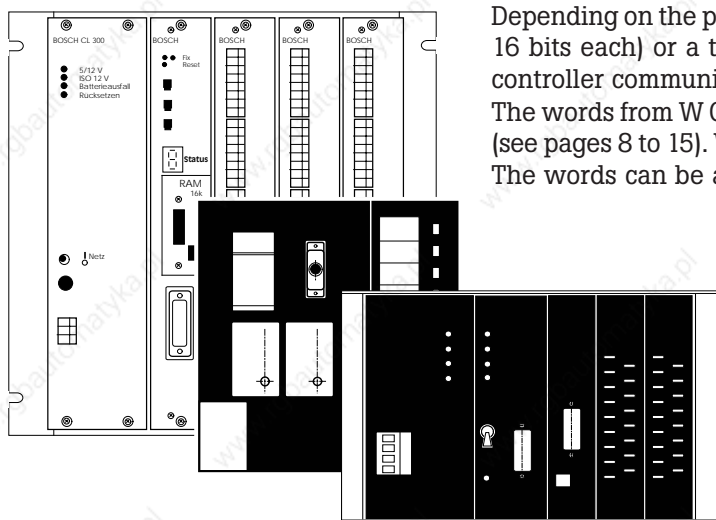

Additional keyboard PCS 891

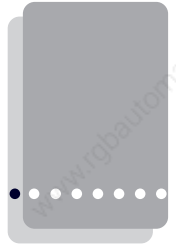

The additional keyboard PCS 891 expands the function key area of the PCS operating console by adding 28 keys and 28 LEDs. Thus a total of 48 function keys and 38 LEDs are available. The 28 keys and 28 LEDs require 56 data bits which are assigned to words W7, 8 and 28 to 31 in the PCS 900. The function keys and LEDs of the PCS 891 correspond entirely to those of the operating console (except for softkey functionality).

To connect the additional keyboard PCS 891 to the PCS operating console, a cable and an adapter cassette are used. For PCS 891 installation, simply plug this cassette into the Memory Pack female connector.

The adapter cassette of the PCS 891 also contains the EEPROM (memory capacity of 64 kBytes corresponds to the Memory Pack PCS 802).

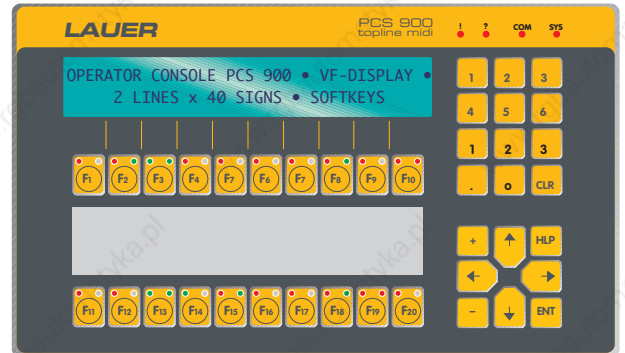

- ① = Adapter and EEPROM cassette of the PCS 891
- ② = Cable (part of the PCS 891) for operating console connection, length: approx. 300 mm
- ③ = Additional keyboard PCS 891

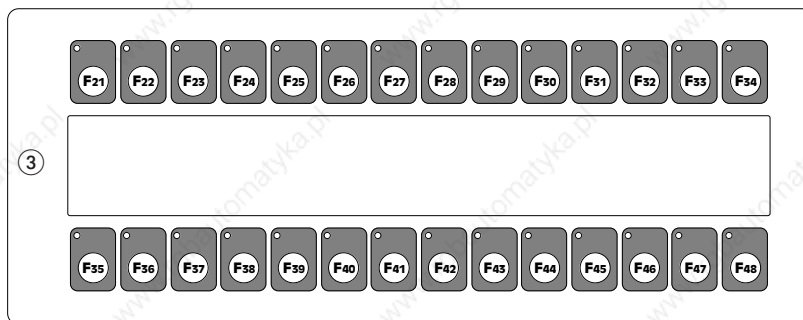
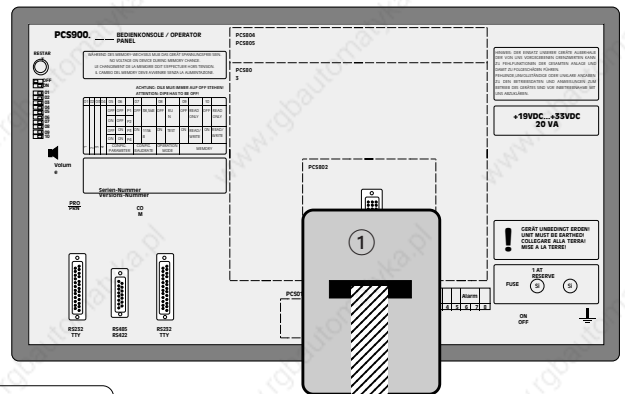

Additional keyboard PCS 891

Operation of the additional keyboard requires:

- Memory Pack PCS 891
- Connection cable between Memory Pack and the additional keyboard
- Additional keyboard

Attention!

Connection of the additional keyboard is only allowed after removing power of the PCS 900. Removing the additional keyboard or switching ON or OFF the power supply voltage of the additional keyboard is not allowed during operation.

Assignment of the additional control elements (LEDs and keys)

The PCS 900 words mentioned above are valid. The additional keyboard requires the following words: W 7, 8 and 28, 29, 30, 31 (reserved for the additional keyboard).

LED	{	W 28	15	14	13	12	11	10	9	8	7	6	5	4	3	2	1	0
		W 29	L21	L22	L23	L24	L25	L26	L27	L28	L29	L30	L31	L32	L33	L34	—	—
			L35	L36	L37	L38	L39	L40	L41	L42	L43	L44	L45	L46	L47	L48	—	—

LED-flashing	{	W 30	15	14	13	12	11	10	9	8	7	6	5	4	3	2	1	0
		W 31	L21	L22	L23	L24	L25	L26	L27	L28	L29	L30	L31	L32	L33	L34	—	—
			L35	L36	L37	L38	L39	L40	L41	L42	L43	L44	L45	L46	L47	L48	—	—

F-keys	{	W 7	15	14	13	12	11	10	9	8	7	6	5	4	3	2	1	0
		W 8	F21	F22	F23	F24	F25	F26	F27	F28	F29	F30	F31	F32	F33	F34	—	—
			F35	F36	F37	F38	F39	F40	F41	F42	F43	F44	F45	F46	F47	F48	—	—

— Status

0 = keyboard not connected
1 = keyboard connected

Automux S5

If communication between the PCS and the Siemens S5 is established via the L1 standard protocol or the AS511 protocol, always one programmer interface is occupied.

Since small-sized PLC systems are equipped with only one programmer interface, limitations have to be considered during startup, i.e. the programmer and the PCS cannot be used simultaneously.

Automux PCS 809 is able to cope with these limitations. The PCS 809 expands the interface between the programmable controller and the programmer so that the controller can be operated simultaneously by the programmer and the PCS. Switching occurs automatically in the MUX.

The PCS 809 is designed as a startup tool. After commissioning, the PCS operator console is connected directly to the programmer interface of the programmable controller.

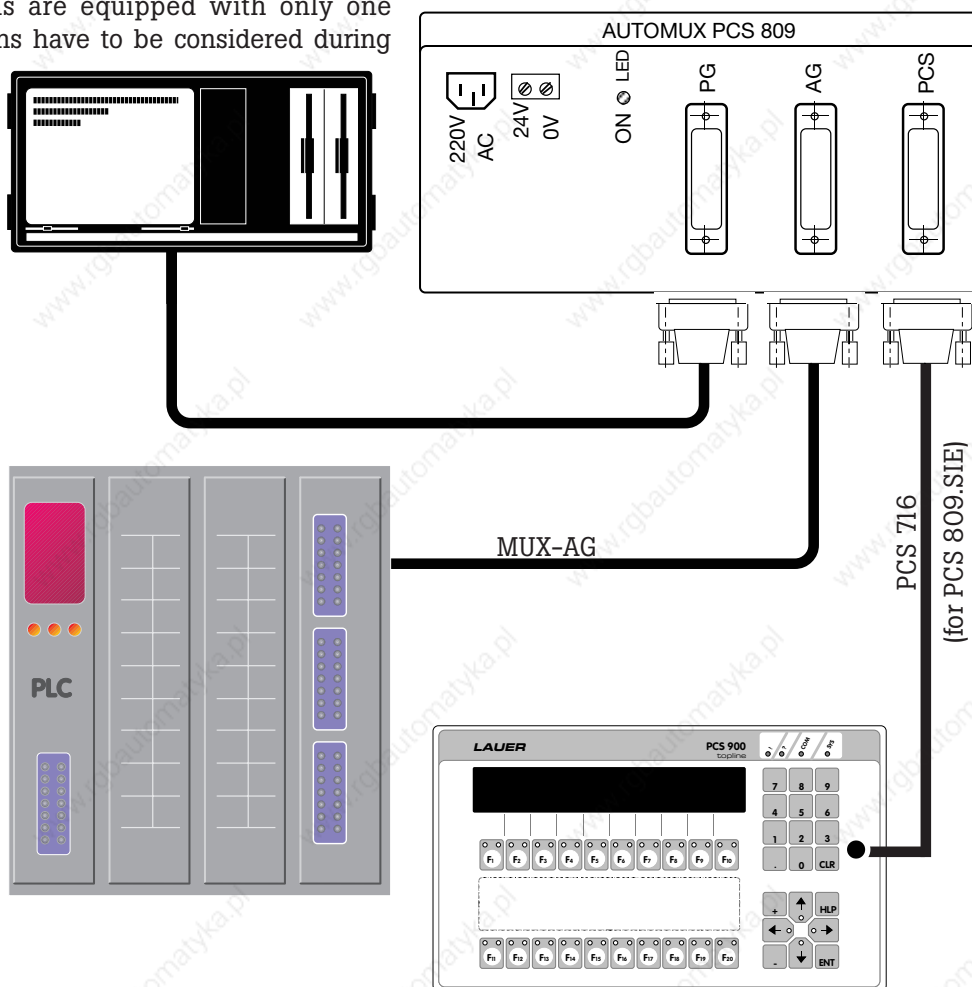

We recommend Automux PCS 809 to be used, if PCS topline and one of the following programmable controllers should be connected: Programmable controllers supplied by Siemens: S5-90U, S5-95U, S5-100U, S5-115U, S5-135U/Programmable controllers supplied by Bosch/Programmable controllers supplied by Mitsubishi and others. Automux PCS 809 is supplied with the adapter cable MUX /AG.

Data word and data bit assignment

Communication between PCS midi and a programmable controller of any type is effected by words (flags and others). A clearly defined task or function is assigned to each word W.

Data word	Function	PCS	PLC
-----------	----------	-----	-----

1. System area: W0..3:

W0..2	Reserved for internal functions, not available to the user		
W3	Error word for communication (see driver manual PCS 91.xxx)		

2. Status area: PCS status (written into the programmable controller)

KEYS:

W4	Key bits F1...F8, F9...F10, Arrow Down, Arrow Up, Arrow Right, Arrow Left, -, +		▶▶▶▶
W5	F11...F20, CLR, ENTER, DIL 4-1, HELP, ·, 9..0, Reserve		▶▶▶▶
W6-W7	Reserved for additional keyboard (e.g. PCS 891)		▶▶▶▶

TIME AND DATE

W9-12	Year, month, day, day of week, hour, minute, second		▶▶▶▶ ◀◀◀◀
-------	--	--	--------------

Data word and data bit assignment

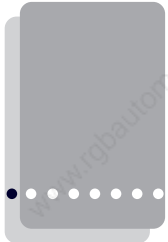

W4	<table border="1"> <thead> <tr><th>15</th><th>14</th><th>13</th><th>12</th><th>11</th><th>10</th><th>9</th><th>8</th></tr> </thead> <tbody> <tr><td>F1</td><td>F2</td><td>F3</td><td>F4</td><td>F5</td><td>F6</td><td>F7</td><td>F8</td></tr> </tbody> </table>	15	14	13	12	11	10	9	8	F1	F2	F3	F4	F5	F6	F7	F8	<table border="1"> <thead> <tr><th>7</th><th>6</th><th>5</th><th>4</th><th>3</th><th>2</th><th>1</th><th>0</th></tr> </thead> <tbody> <tr><td>F9</td><td>F10</td><td>▲</td><td>▼</td><td>▶</td><td>◀</td><td>-</td><td>+</td></tr> </tbody> </table>	7	6	5	4	3	2	1	0	F9	F10	▲	▼	▶	◀	-	+
15	14	13	12	11	10	9	8																											
F1	F2	F3	F4	F5	F6	F7	F8																											
7	6	5	4	3	2	1	0																											
F9	F10	▲	▼	▶	◀	-	+																											
W5	<table border="1"> <thead> <tr><th>15</th><th>14</th><th>13</th><th>12</th><th>11</th><th>10</th><th>9</th><th>8</th></tr> </thead> <tbody> <tr><td>F11</td><td>F12</td><td>F13</td><td>F14</td><td>F15</td><td>F16</td><td>F17</td><td>F18</td></tr> </tbody> </table>	15	14	13	12	11	10	9	8	F11	F12	F13	F14	F15	F16	F17	F18	<table border="1"> <thead> <tr><th>7</th><th>6</th><th>5</th><th>4</th><th>3</th><th>2</th><th>1</th><th>0</th></tr> </thead> <tbody> <tr><td>F19</td><td>F20</td><td>CLR</td><td>ENT</td><td>DIL4</td><td>DIL3</td><td>DIL2</td><td>DIL1</td></tr> </tbody> </table>	7	6	5	4	3	2	1	0	F19	F20	CLR	ENT	DIL4	DIL3	DIL2	DIL1
15	14	13	12	11	10	9	8																											
F11	F12	F13	F14	F15	F16	F17	F18																											
7	6	5	4	3	2	1	0																											
F19	F20	CLR	ENT	DIL4	DIL3	DIL2	DIL1																											
W6	<table border="1"> <thead> <tr><th>15</th><th>14</th><th>13</th><th>12</th><th>11</th><th>10</th><th>9</th><th>8</th></tr> </thead> <tbody> <tr><td>X</td><td>X</td><td>X</td><td>X</td><td>HLP</td><td>•</td><td>9</td><td>8</td></tr> </tbody> </table>	15	14	13	12	11	10	9	8	X	X	X	X	HLP	•	9	8	<table border="1"> <thead> <tr><th>7</th><th>6</th><th>5</th><th>4</th><th>3</th><th>2</th><th>1</th><th>0</th></tr> </thead> <tbody> <tr><td>7</td><td>6</td><td>5</td><td>4</td><td>3</td><td>2</td><td>1</td><td>0</td></tr> </tbody> </table>	7	6	5	4	3	2	1	0	7	6	5	4	3	2	1	0
15	14	13	12	11	10	9	8																											
X	X	X	X	HLP	•	9	8																											
7	6	5	4	3	2	1	0																											
7	6	5	4	3	2	1	0																											
W7	<table border="1"> <thead> <tr><th>15</th><th>14</th><th>13</th><th>12</th><th>11</th><th>10</th><th>9</th><th>8</th></tr> </thead> <tbody> <tr><td></td><td></td><td colspan="4">Keys reserved</td><td></td><td></td></tr> </tbody> </table>	15	14	13	12	11	10	9	8			Keys reserved						<table border="1"> <thead> <tr><th>7</th><th>6</th><th>5</th><th>4</th><th>3</th><th>2</th><th>1</th><th>0</th></tr> </thead> <tbody> <tr><td></td><td></td><td colspan="4">Keys reserved</td><td></td><td></td></tr> </tbody> </table>	7	6	5	4	3	2	1	0			Keys reserved					
15	14	13	12	11	10	9	8																											
		Keys reserved																																
7	6	5	4	3	2	1	0																											
		Keys reserved																																
W8	<table border="1"> <thead> <tr><th>15</th><th>14</th><th>13</th><th>12</th><th>11</th><th>10</th><th>9</th><th>8</th></tr> </thead> <tbody> <tr><td></td><td></td><td colspan="4">Keys reserved</td><td></td><td></td></tr> </tbody> </table>	15	14	13	12	11	10	9	8			Keys reserved						<table border="1"> <thead> <tr><th>7</th><th>6</th><th>5</th><th>4</th><th>3</th><th>2</th><th>1</th><th>0</th></tr> </thead> <tbody> <tr><td></td><td></td><td colspan="4">Keys reserved</td><td></td><td></td></tr> </tbody> </table>	7	6	5	4	3	2	1	0			Keys reserved					
15	14	13	12	11	10	9	8																											
		Keys reserved																																
7	6	5	4	3	2	1	0																											
		Keys reserved																																
W9	<table border="1"> <thead> <tr><th>15</th><th>14</th><th>13</th><th>12</th><th>11</th><th>10</th><th>9</th><th>8</th></tr> </thead> <tbody> <tr><td colspan="4">Mi enium</td><td colspan="4">Century</td></tr> </tbody> </table>	15	14	13	12	11	10	9	8	Mi enium				Century				<table border="1"> <thead> <tr><th>7</th><th>6</th><th>5</th><th>4</th><th>3</th><th>2</th><th>1</th><th>0</th></tr> </thead> <tbody> <tr><td colspan="4">Decade</td><td colspan="4">Year</td></tr> </tbody> </table>	7	6	5	4	3	2	1	0	Decade				Year			
15	14	13	12	11	10	9	8																											
Mi enium				Century																														
7	6	5	4	3	2	1	0																											
Decade				Year																														
W10	<table border="1"> <thead> <tr><th>15</th><th>14</th><th>13</th><th>12</th><th>11</th><th>10</th><th>9</th><th>8</th></tr> </thead> <tbody> <tr><td colspan="4">Month (tens)</td><td colspan="4">Month (digits)</td></tr> </tbody> </table>	15	14	13	12	11	10	9	8	Month (tens)				Month (digits)				<table border="1"> <thead> <tr><th>7</th><th>6</th><th>5</th><th>4</th><th>3</th><th>2</th><th>1</th><th>0</th></tr> </thead> <tbody> <tr><td colspan="4">Day (tens)</td><td colspan="4">Day (digits)</td></tr> </tbody> </table>	7	6	5	4	3	2	1	0	Day (tens)				Day (digits)			
15	14	13	12	11	10	9	8																											
Month (tens)				Month (digits)																														
7	6	5	4	3	2	1	0																											
Day (tens)				Day (digits)																														
W11	<table border="1"> <thead> <tr><th>15</th><th>14</th><th>13</th><th>12</th><th>11</th><th>10</th><th>9</th><th>8</th></tr> </thead> <tbody> <tr><td colspan="8">Day of week (01...07)</td></tr> </tbody> </table>	15	14	13	12	11	10	9	8	Day of week (01...07)								<table border="1"> <thead> <tr><th>7</th><th>6</th><th>5</th><th>4</th><th>3</th><th>2</th><th>1</th><th>0</th></tr> </thead> <tbody> <tr><td colspan="8">hour (00...23)</td></tr> </tbody> </table>	7	6	5	4	3	2	1	0	hour (00...23)							
15	14	13	12	11	10	9	8																											
Day of week (01...07)																																		
7	6	5	4	3	2	1	0																											
hour (00...23)																																		
W12	<table border="1"> <thead> <tr><th>15</th><th>14</th><th>13</th><th>12</th><th>11</th><th>10</th><th>9</th><th>8</th></tr> </thead> <tbody> <tr><td colspan="8">Minute (00...59)</td></tr> </tbody> </table>	15	14	13	12	11	10	9	8	Minute (00...59)								<table border="1"> <thead> <tr><th>7</th><th>6</th><th>5</th><th>4</th><th>3</th><th>2</th><th>1</th><th>0</th></tr> </thead> <tbody> <tr><td colspan="8">Second (00...59)</td></tr> </tbody> </table>	7	6	5	4	3	2	1	0	Second (00...59)							
15	14	13	12	11	10	9	8																											
Minute (00...59)																																		
7	6	5	4	3	2	1	0																											
Second (00...59)																																		

Data word and data bit assignment

Data word

Function

PCS PLC

transmission direction

PCS-STATUS

W13-17

Acknowledgement bit, timer, (W14) number of old printer messages, (W15) number of new printer messages, (W16) priority status, (W17) priority number, text number on the display

▶▶▶▶

PRESET VALUE STATUS

W18-19

Data word number, length, (W19) bit mask

▶▶▶▶

Data word and data bit assignment

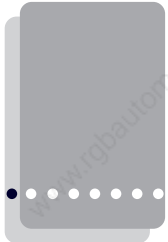

W13

15	14	13	12	11	10	9	8
Pr. Stop	Log Stop	Lifo	Hist. del.	Hist. arriv	Pr. bu. full	Hist. bu. full	Re-served

7	6	5	4	3	2	1	0
S7	S6	S5	S4	S3	S2	S1	S0

W14

15	14	13	12	11	10	9	8
Number of old printer messages (high byte)							

7	6	5	4	3	2	1	0
Number of old printer messages (low byte)							

W15

15	14	13	12	11	10	9	8
Number of new printer messages (high byte)							

7	6	5	4	3	2	1	0
Number of new printer messages (low byte)							

W16

15	14	13	12	11	10	9	8
RESERVED							

7	6	5	4	3	2	1	0
Offi activ	Re-serve	Re-cipe-activ ^{*)}	Hist-ory	Fail-ures	War-nings	Infor-mation	Menu

W17

15	14	13	12	11	10	9	8
8	4	2	1	X	X	512	256
Displayed priority				Text no. on displ. (high)			

7	6	5	4	3	2	1	0
128	64	32	16	8	4	2	1
Text number on display (low byte)							

W18

15	14	13	12	11	10	9	8
128	64	32	16	8	4	2	1
Data word preset value							

7	6	5	4	3	2	1	0
X	X	X	16	8	4	2	1
Preset value length byte							

W19

15	14	13	12	11	10	9	8
15	14	13	12	11	10	9	8
Bit mask high byte							

7	6	5	4	3	2	1	0
7	6	5	4	3	2	1	0
Bit mask low byte							

Data word and data bit assignment

Data word	Function	PCS transmission direction	PLC
3. Command area (read from the programmable controller)			
LED STATUS, DISPLAY And MEMORY MODE			
W20	LED driving, F1..F10, green	←←←←	
W21	LED driving, F1..F10, flashing green	←←←←	
W22, 23	LED driving, F1..F10, yellow, flashing yellow	←←←←	
W24, 25	LED driving, F11..F10, green, flashing green	←←←←	
W26, 27	LED driving, F11..F10, yellow, flashing yellow	←←←←	
W28..33	Reserved for additional keyboard (e.g. PCS 891)	←←←←	
W34	Bit map number for working area	←←←←	
W35	Status page and softkey row number	←←←←	

Data word and data bit assignment

W20	<table border="1"> <thead> <tr><th>15</th><th>14</th><th>13</th><th>12</th><th>11</th><th>10</th><th>9</th><th>8</th></tr> </thead> <tbody> <tr><td>1</td><td>2</td><td>3</td><td>4</td><td>5</td><td>6</td><td>7</td><td>8</td></tr> <tr><td colspan="8">LED driving, green</td></tr> </tbody> </table>	15	14	13	12	11	10	9	8	1	2	3	4	5	6	7	8	LED driving, green								<table border="1"> <thead> <tr><th>7</th><th>6</th><th>5</th><th>4</th><th>3</th><th>2</th><th>1</th><th>0</th></tr> </thead> <tbody> <tr><td>9</td><td>10</td><td colspan="2">Failures</td><td colspan="2">Warnings Disp. modes</td><td colspan="2">Information</td></tr> </tbody> </table>	7	6	5	4	3	2	1	0	9	10	Failures		Warnings Disp. modes		Information	
15	14	13	12	11	10	9	8																																			
1	2	3	4	5	6	7	8																																			
LED driving, green																																										
7	6	5	4	3	2	1	0																																			
9	10	Failures		Warnings Disp. modes		Information																																				
W21	<table border="1"> <thead> <tr><th>15</th><th>14</th><th>13</th><th>12</th><th>11</th><th>10</th><th>9</th><th>8</th></tr> </thead> <tbody> <tr><td>1</td><td>2</td><td>3</td><td>4</td><td>5</td><td>6</td><td>7</td><td>8</td></tr> <tr><td colspan="8">LED driving, flashing green</td></tr> </tbody> </table>	15	14	13	12	11	10	9	8	1	2	3	4	5	6	7	8	LED driving, flashing green								<table border="1"> <thead> <tr><th>7</th><th>6</th><th>5</th><th>4</th><th>3</th><th>2</th><th>1</th><th>0</th></tr> </thead> <tbody> <tr><td>9</td><td>10</td><td colspan="2">Failures</td><td colspan="2">Warnings Memory mode</td><td colspan="2">Information</td></tr> </tbody> </table>	7	6	5	4	3	2	1	0	9	10	Failures		Warnings Memory mode		Information	
15	14	13	12	11	10	9	8																																			
1	2	3	4	5	6	7	8																																			
LED driving, flashing green																																										
7	6	5	4	3	2	1	0																																			
9	10	Failures		Warnings Memory mode		Information																																				
W22	<table border="1"> <thead> <tr><th>15</th><th>14</th><th>13</th><th>12</th><th>11</th><th>10</th><th>9</th><th>8</th></tr> </thead> <tbody> <tr><td>1</td><td>2</td><td>3</td><td>4</td><td>5</td><td>6</td><td>7</td><td>8</td></tr> <tr><td colspan="8">LED driving, yellow</td></tr> </tbody> </table>	15	14	13	12	11	10	9	8	1	2	3	4	5	6	7	8	LED driving, yellow								<table border="1"> <thead> <tr><th>7</th><th>6</th><th>5</th><th>4</th><th>3</th><th>2</th><th>1</th><th>0</th></tr> </thead> <tbody> <tr><td>9</td><td>10</td><td colspan="6">Reserved</td></tr> </tbody> </table>	7	6	5	4	3	2	1	0	9	10	Reserved					
15	14	13	12	11	10	9	8																																			
1	2	3	4	5	6	7	8																																			
LED driving, yellow																																										
7	6	5	4	3	2	1	0																																			
9	10	Reserved																																								
W23	<table border="1"> <thead> <tr><th>15</th><th>14</th><th>13</th><th>12</th><th>11</th><th>10</th><th>9</th><th>8</th></tr> </thead> <tbody> <tr><td>1</td><td>2</td><td>3</td><td>4</td><td>5</td><td>6</td><td>7</td><td>8</td></tr> <tr><td colspan="8">LED driving, flashing yellow</td></tr> </tbody> </table>	15	14	13	12	11	10	9	8	1	2	3	4	5	6	7	8	LED driving, flashing yellow								<table border="1"> <thead> <tr><th>7</th><th>6</th><th>5</th><th>4</th><th>3</th><th>2</th><th>1</th><th>0</th></tr> </thead> <tbody> <tr><td>9</td><td>10</td><td colspan="6">Reserved</td></tr> </tbody> </table>	7	6	5	4	3	2	1	0	9	10	Reserved					
15	14	13	12	11	10	9	8																																			
1	2	3	4	5	6	7	8																																			
LED driving, flashing yellow																																										
7	6	5	4	3	2	1	0																																			
9	10	Reserved																																								
W24	<table border="1"> <thead> <tr><th>15</th><th>14</th><th>13</th><th>12</th><th>11</th><th>10</th><th>9</th><th>8</th></tr> </thead> <tbody> <tr><td>11</td><td>12</td><td>13</td><td colspan="4">LED driving, green</td><td>17</td><td>18</td></tr> </tbody> </table>	15	14	13	12	11	10	9	8	11	12	13	LED driving, green				17	18	<table border="1"> <thead> <tr><th>7</th><th>6</th><th>5</th><th>4</th><th>3</th><th>2</th><th>1</th><th>0</th></tr> </thead> <tbody> <tr><td>19</td><td>20</td><td colspan="2">Arrow-LED int/ext</td><td colspan="4">Arrow-LED in Menu stat.</td></tr> </tbody> </table>	7	6	5	4	3	2	1	0	19	20	Arrow-LED int/ext		Arrow-LED in Menu stat.										
15	14	13	12	11	10	9	8																																			
11	12	13	LED driving, green				17	18																																		
7	6	5	4	3	2	1	0																																			
19	20	Arrow-LED int/ext		Arrow-LED in Menu stat.																																						
W25	<table border="1"> <thead> <tr><th>15</th><th>14</th><th>13</th><th>12</th><th>11</th><th>10</th><th>9</th><th>8</th></tr> </thead> <tbody> <tr><td>11</td><td>12</td><td>13</td><td>14</td><td>15</td><td>16</td><td>17</td><td>18</td></tr> <tr><td colspan="8">LED driving, flashing green</td></tr> </tbody> </table>	15	14	13	12	11	10	9	8	11	12	13	14	15	16	17	18	LED driving, flashing green								<table border="1"> <thead> <tr><th>7</th><th>6</th><th>5</th><th>4</th><th>3</th><th>2</th><th>1</th><th>0</th></tr> </thead> <tbody> <tr><td>19</td><td>20</td><td colspan="2">Arrow-LED int/ext</td><td colspan="4">Arrow-LED in Menu blinker</td></tr> </tbody> </table>	7	6	5	4	3	2	1	0	19	20	Arrow-LED int/ext		Arrow-LED in Menu blinker			
15	14	13	12	11	10	9	8																																			
11	12	13	14	15	16	17	18																																			
LED driving, flashing green																																										
7	6	5	4	3	2	1	0																																			
19	20	Arrow-LED int/ext		Arrow-LED in Menu blinker																																						
W26	<table border="1"> <thead> <tr><th>15</th><th>14</th><th>13</th><th>12</th><th>11</th><th>10</th><th>9</th><th>8</th></tr> </thead> <tbody> <tr><td>11</td><td>12</td><td>13</td><td>14</td><td>15</td><td>16</td><td>17</td><td>18</td></tr> <tr><td colspan="8">LED driving, yellow</td></tr> </tbody> </table>	15	14	13	12	11	10	9	8	11	12	13	14	15	16	17	18	LED driving, yellow								<table border="1"> <thead> <tr><th>7</th><th>6</th><th>5</th><th>4</th><th>3</th><th>2</th><th>1</th><th>0</th></tr> </thead> <tbody> <tr><td>19</td><td>20</td><td colspan="6">Reserved</td></tr> </tbody> </table>	7	6	5	4	3	2	1	0	19	20	Reserved					
15	14	13	12	11	10	9	8																																			
11	12	13	14	15	16	17	18																																			
LED driving, yellow																																										
7	6	5	4	3	2	1	0																																			
19	20	Reserved																																								
W27	<table border="1"> <thead> <tr><th>15</th><th>14</th><th>13</th><th>12</th><th>11</th><th>10</th><th>9</th><th>8</th></tr> </thead> <tbody> <tr><td>11</td><td>12</td><td>13</td><td>14</td><td>15</td><td>16</td><td>17</td><td>18</td></tr> <tr><td colspan="8">LED driving, flashing yellow</td></tr> </tbody> </table>	15	14	13	12	11	10	9	8	11	12	13	14	15	16	17	18	LED driving, flashing yellow								<table border="1"> <thead> <tr><th>7</th><th>6</th><th>5</th><th>4</th><th>3</th><th>2</th><th>1</th><th>0</th></tr> </thead> <tbody> <tr><td>19</td><td>20</td><td colspan="6">Reserved</td></tr> </tbody> </table>	7	6	5	4	3	2	1	0	19	20	Reserved					
15	14	13	12	11	10	9	8																																			
11	12	13	14	15	16	17	18																																			
LED driving, flashing yellow																																										
7	6	5	4	3	2	1	0																																			
19	20	Reserved																																								
W28	<table border="1"> <thead> <tr><th>15</th><th>14</th><th>13</th><th>12</th><th>11</th><th>10</th><th>9</th><th>8</th></tr> </thead> <tbody> <tr><td colspan="8">LED - RESERVED</td></tr> </tbody> </table>	15	14	13	12	11	10	9	8	LED - RESERVED								<table border="1"> <thead> <tr><th>7</th><th>6</th><th>5</th><th>4</th><th>3</th><th>2</th><th>1</th><th>0</th></tr> </thead> <tbody> <tr><td colspan="8">RESERVED</td></tr> </tbody> </table>	7	6	5	4	3	2	1	0	RESERVED															
15	14	13	12	11	10	9	8																																			
LED - RESERVED																																										
7	6	5	4	3	2	1	0																																			
RESERVED																																										
W29	<table border="1"> <thead> <tr><th>15</th><th>14</th><th>13</th><th>12</th><th>11</th><th>10</th><th>9</th><th>8</th></tr> </thead> <tbody> <tr><td colspan="8">LED - RESERVED</td></tr> </tbody> </table>	15	14	13	12	11	10	9	8	LED - RESERVED								<table border="1"> <thead> <tr><th>7</th><th>6</th><th>5</th><th>4</th><th>3</th><th>2</th><th>1</th><th>0</th></tr> </thead> <tbody> <tr><td colspan="8">RESERVED</td></tr> </tbody> </table>	7	6	5	4	3	2	1	0	RESERVED															
15	14	13	12	11	10	9	8																																			
LED - RESERVED																																										
7	6	5	4	3	2	1	0																																			
RESERVED																																										
W30	<table border="1"> <thead> <tr><th>15</th><th>14</th><th>13</th><th>12</th><th>11</th><th>10</th><th>9</th><th>8</th></tr> </thead> <tbody> <tr><td colspan="8">LED - RESERVED</td></tr> </tbody> </table>	15	14	13	12	11	10	9	8	LED - RESERVED								<table border="1"> <thead> <tr><th>7</th><th>6</th><th>5</th><th>4</th><th>3</th><th>2</th><th>1</th><th>0</th></tr> </thead> <tbody> <tr><td colspan="8">RESERVED</td></tr> </tbody> </table>	7	6	5	4	3	2	1	0	RESERVED															
15	14	13	12	11	10	9	8																																			
LED - RESERVED																																										
7	6	5	4	3	2	1	0																																			
RESERVED																																										
W31	<table border="1"> <thead> <tr><th>15</th><th>14</th><th>13</th><th>12</th><th>11</th><th>10</th><th>9</th><th>8</th></tr> </thead> <tbody> <tr><td colspan="8">LED - RESERVED</td></tr> </tbody> </table>	15	14	13	12	11	10	9	8	LED - RESERVED								<table border="1"> <thead> <tr><th>7</th><th>6</th><th>5</th><th>4</th><th>3</th><th>2</th><th>1</th><th>0</th></tr> </thead> <tbody> <tr><td colspan="8">RESERVED</td></tr> </tbody> </table>	7	6	5	4	3	2	1	0	RESERVED															
15	14	13	12	11	10	9	8																																			
LED - RESERVED																																										
7	6	5	4	3	2	1	0																																			
RESERVED																																										
W32	<table border="1"> <thead> <tr><th>15</th><th>14</th><th>13</th><th>12</th><th>11</th><th>10</th><th>9</th><th>8</th></tr> </thead> <tbody> <tr><td colspan="8">LED - RESERVED</td></tr> </tbody> </table>	15	14	13	12	11	10	9	8	LED - RESERVED								<table border="1"> <thead> <tr><th>7</th><th>6</th><th>5</th><th>4</th><th>3</th><th>2</th><th>1</th><th>0</th></tr> </thead> <tbody> <tr><td colspan="8">RESERVED</td></tr> </tbody> </table>	7	6	5	4	3	2	1	0	RESERVED															
15	14	13	12	11	10	9	8																																			
LED - RESERVED																																										
7	6	5	4	3	2	1	0																																			
RESERVED																																										
W33	<table border="1"> <thead> <tr><th>15</th><th>14</th><th>13</th><th>12</th><th>11</th><th>10</th><th>9</th><th>8</th></tr> </thead> <tbody> <tr><td colspan="8">LED-RESERVED</td></tr> </tbody> </table>	15	14	13	12	11	10	9	8	LED-RESERVED								<table border="1"> <thead> <tr><th>7</th><th>6</th><th>5</th><th>4</th><th>3</th><th>2</th><th>1</th><th>0</th></tr> </thead> <tbody> <tr><td colspan="8">RESERVED</td></tr> </tbody> </table>	7	6	5	4	3	2	1	0	RESERVED															
15	14	13	12	11	10	9	8																																			
LED-RESERVED																																										
7	6	5	4	3	2	1	0																																			
RESERVED																																										
W34	<table border="1"> <thead> <tr><th>15</th><th>14</th><th>13</th><th>12</th><th>11</th><th>10</th><th>9</th><th>8</th></tr> </thead> <tbody> <tr><td colspan="8">LED - RESERVED</td></tr> </tbody> </table>	15	14	13	12	11	10	9	8	LED - RESERVED								<table border="1"> <thead> <tr><th>7</th><th>6</th><th>5</th><th>4</th><th>3</th><th>2</th><th>1</th><th>0</th></tr> </thead> <tbody> <tr><td>Activated bitmap</td><td colspan="7">Bit map number for working area</td></tr> </tbody> </table>	7	6	5	4	3	2	1	0	Activated bitmap	Bit map number for working area														
15	14	13	12	11	10	9	8																																			
LED - RESERVED																																										
7	6	5	4	3	2	1	0																																			
Activated bitmap	Bit map number for working area																																									
W35	<table border="1"> <thead> <tr><th>15</th><th>14</th><th>13</th><th>12</th><th>11</th><th>10</th><th>9</th><th>8</th></tr> </thead> <tbody> <tr><td colspan="8">Status page number</td></tr> </tbody> </table>	15	14	13	12	11	10	9	8	Status page number								<table border="1"> <thead> <tr><th>7</th><th>6</th><th>5</th><th>4</th><th>3</th><th>2</th><th>1</th><th>0</th></tr> </thead> <tbody> <tr><td colspan="8">Softkey row number</td></tr> </tbody> </table>	7	6	5	4	3	2	1	0	Softkey row number															
15	14	13	12	11	10	9	8																																			
Status page number																																										
7	6	5	4	3	2	1	0																																			
Softkey row number																																										

Data word and data bit assignment

Data word	Function	PCS transmission direction	PLC
COMMAND WORDS			
W36	Enable priorities + disable transmission + activation bits	◀◀◀◀	
W37	Printer driving, disable specific LEDs + message block transmission	◀◀◀◀	
W38	Idle text number + operating text number	◀◀◀◀	
W39	Print job	◀◀◀◀	
W40	Operating printer text number	◀◀◀◀	

Data word and data bit assignment

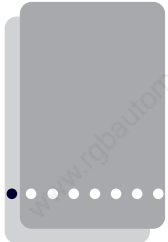

W36

15	14	13	12	11	10	9	8
OFF LINE	Re- ser- ved	En- able Re- cipe*)	Hist- ory	S	W	H	M
Enable priorities							

7	6	5	4	3	2	1	0
Dis- able Comm C/D/E	Dis- able date	Dis- able time	Dis- able LED F-keys	Enable alarm output	Oper. hours coun- ter	Hist- ory Start	Sync Time

W37

15	14	13	12	11	10	9	8
Pr. stop Mess.	Log. stop	Lifo	Hist- ory delet.	Disab. beep	Disab. mess. LED	Disab. HLP LED	Disab. Menu LED

7	6	5	4	3	2	1	0
MB7	MB6	MB5	MB4	MB3	MB2	MB1	MB0
Enable message block transfer							

W38

15	14	13	12	11	10	9	8
Stat/ Flash	64	32	16	8	4	2	1
Idle text number (0...127)							

7	6	5	4	3	2	1	0
Pre- set -P	64	32	16	8	4	2	1
Operating text number (1...127)							

W39

15	14	13	12	11	10	9	8
Print job / Pointer adjustment (high byte)							

7	6	5	4	3	2	1	0
Print job / Pointer adjustment (low byte)							

W40

15	14	13	12	11	10	9	8
OPER. PRINTER TEXT NUMBER (Print form) HIGH BYTE							

7	6	5	4	3	2	1	0
OPER. PRINTER TEXT NUMBER (Print form) LOW BYTE							

Data word and data bit assignment

Data word Function

PCS PLC
transmission direction

4. Message area: W41..110

MESSAGE BLOCKS

W41-48	Block 1	◀◀◀◀▶▶▶▶
W49-56	Block 2	◀◀◀◀▶▶▶▶
W57-64	Block 3	◀◀◀◀▶▶▶▶
W65-72	Block 4	◀◀◀◀▶▶▶▶
W73-80	Block 5	◀◀◀◀▶▶▶▶
W81-88	Block 6	◀◀◀◀▶▶▶▶
W89-96	Block 7	◀◀◀◀▶▶▶▶
W97-104	Block 8	◀◀◀◀▶▶▶▶

5. Expansion area: W105..W109

This area is reserved for possible extensions.

6. Variable area: W110..255

W110..255	Can be used for variables.	◀◀◀◀▶▶▶▶
-----------	----------------------------	----------

Data word and data bit assignment

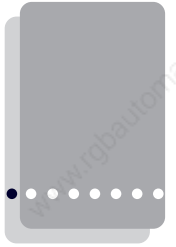

W41

15	14	13	12	11	10	9	8
M15	M14	M13	M12	M11	M10	M9	M8

7	6	5	4	3	2	1	0
M7	M6	M5	M4	M3	M2	M1	M0

⋮

⋮

W104

15	14	13	12	11	10	9	8
M1023	M1022	M1021	M1020	M1019	M1018	M1017	M1016

7	6	5	4	3	2	1	0
M1015	M1014	M1013	M1012	M1011	M1010	M1009	M1008

W110

15	14	13	12	11	10	9	8
Any external variable BIT, (C)STRING, BIN...,VBIN...,BCD..							

7	6	5	4	3	2	1	0
Any external variable BIT, (C)STRING, BIN...,VBIN...,BCD..							

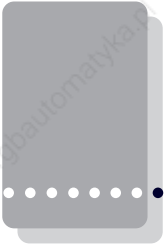

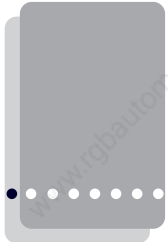

Technical manual

PCS 900

Table of contents

1.	General information	28
1.1	The layout of the manual	28
1.2	Division of the memory	28
2.	Operating elements	29
2.1	DIL-switches	29
2.2	Luminous displays	29
2.3	Reset key an ON/OFF switch	30
2.4	Keys	30
3.	Connections	31
3.1	Operating voltage	31
3.2	Serial interfaces	31
3.2.1	Configuration/Programming	32
3.2.2	Connection displacement RS485/RS422	32
3.2.3	Connection displacement RS232/TTY	32
3.3	Programming cable PCS 733	33
3.4	Cassette connection	33
4.	BIOS	34
4.1	Selection of the data record	34
4.2	Selection of the copying function	34
5.	Technical data	35
5.1	Technical data of the PCS 900	35
5.2	PCS 900 dimensions	36
6.	Function	37
6.1	Application areas	37
6.2	Operating elements an displays	38
6.2.1	LED displays	38
6.2.2	Character present in the display	39
6.2.3	Keys	40
6.2.3.1	Evaluation of keys in the PLC	40
6.2.4	Accoustic signal	40

Table of contents

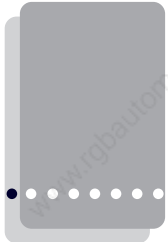

7.	Parameterisation of the PCS 900	41
7.1	General outline	41
7.1.1	Variables	41
7.1.2	Texts	42
7.1.3	Menus	42
7.2	Variables	42
7.2.1	External variable formats	43
7.2.1.1	Variables format BIT	46
7.2.1.2	Variables format STRING	46
7.2.1.3	Variables format CSTRING	47
7.2.1.4	Variables format BCD	48
7.2.1.5	Variables format BIN	49
7.2.1.6	Variables format WORD	52
7.2.1.7	Variables format ASCII	53
7.2.2	Internal variable formats	54
7.2.2.1	Implementation of the internal variables	56
7.2.3	Treatment of variables	60
7.3	Text groups	61
7.4	Menus/Menu layout	62
7.4.1	Starting the menus	62
7.4.2	Quitting the menus	62
7.4.3	Building up the menus	63
7.4.4	Variables in the menu	63
7.4.5	Arrow keys in the menus	64
7.5	Priority administration	68
7.5.1	ON/OFF switch conditions	69
7.5.2	Default text priority	70
7.5.3	Menu priority	70
7.5.4	Message priorities	70
7.5.4.1	Storage characteristics	71
7.5.4.2	Deletion characteristic	72
7.5.4.3	Display characteristics	73
7.5.5	History display	73
7.5.5.1	Activating the history display	73
7.5.5.2	Variables in the history memory	74
7.5.5.3	Deletion of the history memory	74
7.5.6	Communications error priority	74
7.5.7	Offline menu	74
7.6	Printer	75
7.6.1	Printer texts	75
7.6.2	Message printer	76
7.6.2.1	Message registration	76
7.6.3	Operating printer	76
7.6.4	Printout	77
7.6.4.1	LOW-LEVEL protocol	77
7.6.4.2	Page protocol (message printer)	78
7.7	Timer	79
7.8	Alarm outlet/contact	79
7.9	Real time clock	80
7.10	Operation time clock	80

Table of contents

8.	Driving the PCS 900	81
8.1	Brief review of the transfer area	83
8.2	System area	87
8.3	Status area	87
8.3.1	Function, control and tenner keys	87
8.3.2	Date and time	88
8.3.3	PCS status	88
8.3.3.1	Control bits	88
8.3.3.2	Printer status	89
8.3.3.3	Priorities status	89
8.3.3.4	Nominal value status	90
8.4	Command area	91
8.4.1	LED status	91
8.4.2	Display and storage characteristics	92
8.4.3	Command word A-E	93
8.4.3.1	Priorities release/activation	93
8.4.3.2	Configurition bits	94
8.4.3.3	Default text/menu number	95
8.4.3.4	Message printer command	96
8.4.3.5	Operating printer command	96
8.5	Message area	97
8.6	Variables area	98
9.	General user information	99
9.1	Safety related information	99
9.2	Quality and support	100
	Index	101

Ideograms and symbols

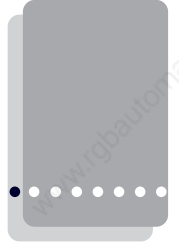

The following symbols and ideograms are used in this manual.

Warning!

Possibly dangerous situation which can cause death and most serious injuries.



Caution!

Possibly dangerous situation which can cause light and less serious injuries.

Attention!

Possibly harmful situation which can cause damage to the product or its environment.



Information and notes which must additionally be observed.

1.1 The layout of the manual

The first part of the manual describes the operating elements, connections and the BIOS. The functionality which is currently available is written in part 2. As the PCSPRO alone decides on the functionality it is incorporated in the manual. In case of doubt, the PCSPRO help system will enlighten you. Creation of a data record is only possible with the PCSPRO software. This software also takes on the task of combining the data record with the firmware, with the driver and with an optional additional function. A selection can be made on the transfer as to whether all the data should be loaded into the internal Flash-Eprom or merely that the data record is loaded onto the cassette.

All the drivers merely deal with the linkage to the various PLC systems and are independent from the functionality anchored in the firmware. Information on the special drivers, such as the representation of the driving blocks within the PLC are dealt with in a separate manual PCS 91.x; for example, PCS 91.SIE, linkage of the PCS with the PLC by the Siemens company. These manuals contains descriptions of all the linkage possibilities of the products of the particular manufacturers.

1.2 Division of the memory

The PCS 900 memory divides itself up in various ways such as outlined here:

- **EPROM**
The PCS 900 contains a fixed EPROM block (BIOS), in which there is simply a previously loaded program as well as the necessary program for the display and keyboard operation. If the files in the remaining memory are not feasible then the corresponding messages will appear in the display.
- **FLASH-EPROM**
There are 256 kbytes available here for firmware, data records, drivers and additional functions. This memory area can as a whole be electrically deleted. The contents of this memory determines the entire functionality of the PCS 900.
- **ADDITIONAL CASSETTE**
This additional cassette basically contains Flash-Eprom. The size of the memory varies between the different cassettes. As a rule this cassette contains a further data record, such as texts, menus or variables. This alternative data record can be activated with a menu contained in the Bios. Another use of this cassette is the transport of firmware, files, drivers and additional functionalities. In addition to this any amount of internal memory capacity can be copied onto the cassette. The size of the cassettes will determine how many cassettes are required.
- **BATTERY BUFFERED RAM**
All protected low-voltage files are filed in this internal memory (64 kbyte). This area is administered solely by the firmware.

Operating elements

2.1 DIL-switches

On the rear side there are 10 numbered DIL-switches.

- DIL 1 to 4 = PLC bits. These switches can be used by the firmware.
 DIL 5, DIL 6 = Configuration parameter (driver) e.g. baud rate, selection of interface.
- | | | |
|-----|-----|-------------------|
| OFF | OFF | = Configuration 1 |
| ON | OFF | = Configuration 2 |
| OFF | ON | = Configuration 3 |
| ON | ON | = Configuration 4 |

For details see driver manual PCS 91.x

DIL 7= Transfer-baud rate with the PCSPRO

- | | |
|-----|----------------|
| ON | = 115.0 kbaud |
| OFF | = 38.5 kbaud*) |

DIL 8 = Operation Mode

- | | |
|-----|-----------------------------------|
| ON | = stop, service program expected. |
| OFF | = run, normal operation |

!!This switch must be in the OFF position during running!!

DIL 9 = Write protection of internal Flash-EEPROM

- | | |
|-----|-----------------------------|
| ON | = EEPROM can be overwritten |
| OFF | = EEPROM write protected |

DIL 10 = Internal applicatio

!! This switch must be in the ON position during running !!

*) With regard to the PCS 900, the no.7 switch determines the transfer baudrate. The PCSPRO conveys this baudrate automatically. After programming has been completed, the DIL-switch no.9 should be switched to the OFF position, otherwise the reception of data cannot be guaranteed under all circumstances. In normal circumstances, including switching on and off at any time, there will be no loss of data.

2.2 Luminous displays

Every luminous display can be in one of four states: OFF, ON, FLASHING, and INVERSE FLASHING. The FLASHING state consists of a 75% bright phase and a 25% dark phase, that of the INVERSE FLASHING is made up of a 75% dark phase and a 25% bright phase. The above 4 LEDs indicate the state of the operating conditions of the PCS. All the LEDs with the exception of the SYS are administered through the firmware.

ATTENTION	OPERATING REQUEST	COMMUNICATIONS ERROR	OPERATING SYSTEM
!	?	COM	SYS

- **SYS-LED**

It shines as soon as the PCS 900 is working in BIOS. This is the case if there is no firmware after starting the OFFLINE MENUS to switch over data records or cassette copying procedure with the <HELP> <+> <CLR> or after the commencement of the PCSPRO transfer.

- **OPERATING REQUEST (?)**

see description of function

- **ATTENTION (!)**

see description of function

- **COMMUNICATION ERROR (ØM)**

SHINING: Communication hasn't been started up since the switch-on.

FLASHING: Communication to the PLC has been interrupted!

For explicit information refer to the driver specifications.

2.3 Reset key an ON/OFF switch

The reset key is above the 10 DIL-switches. It releases a software reset, which under normal circumstances is not necessary. The ON/OFF switch facilitates a cassette change.

THE PCS MUST BE SWITCHED OFF DURING THE CASSETTE EXCHANGE!

2.4 Keys

The PCS 900 possesses 20 function keys, 10 control keys and 10 numerical keys. The function of the keys is determined by the firmware.

Connections

3.1 Operating voltage

The operating voltage connections 1(0V) and 2 (24V) are laid as screw terminals with wire up to 2 mm thick. With regard to power supply and operating voltage limitations, refer to the chapter entitled, „Technical data“.

Att ention!

The operating voltage earthing and 0V wires are laid out separately in the apparatus. The earthing wire is around the casing, at the interference filter and at pole 1 of the serial interfaces. In the best interests of immunity to interference , the casing should be earthed. The earthing can be done as compact as possible with 4 mm. Furthermore the 0V is to be zeroed in the vicinity of the feeder mains (in accordance with the VDE regulations).



The alarm outlet is a relais contact (closer) between connections 6 and 7. This contact may only be permitted with the low-voltage (24V) and maximum 0.5A. The fuse protection follows internally through a PTC which protects the contact to a limited degree.

The contact drive is determined by the firmware.

3.2 Serial interfaces

The PCS 900 possesses a „combination“ interface COM and an RS232/TTY interface PRN. On the 25 pole JD socket there is either an RS 232 (V24) or alternatively an active or passive TTY (line current interface), available. On the 15 pole JD plug there is an RS 422 or alternatively an RS 485 interface available. Please refer to the performance of this in the driver manual PCS 91.x

- **COM**

This interface is configured with software as RS232, TTY, RS485 or RS422. The RS232 connection is made with the 25 pole SUB-D-socket and the PS485 and RS422 with the 15 pole SUB-D-socket. A simultaneous application of both sockets at the same time is NOT wise. This interface is served by the loaded driver and must be correspondingly configured within the PCSPRO. Normally 4 configurations can be configured. The selection is then made with the DIL-switches 5 and 6 (refer to driver manual PCS 91.x).

- **PRN**

This interface can be switched on as an RS232 or as an TTY interface. It is served through the firmware and can be parameterized within the firmware. The parameterization must be done with an internal variable. This variable is deposited in the fixed low-voltage RAM.

3.2.1 Configuration/Programming

Using the RS232 interface, you can carry out the configuration of the PCS 900 from a PC/PG with the configurations connection cable PCS 733 and the PCSPRO. The start of the configuration, i.e. programming is recognized by the DSR inlet. Whereby the PCS is ready to transfer programs. Please note that for programming, the EEPROM must be written with the DIL-switch 9 in the ON position. Recognition is given by interfaces independant of the previous set configuration. If the PLC simulation is to be done with the PCSPRO, then this is only possible on the COM interface.

Att ention!

The level at the DSR (pin 6) is determined through the PC outlet DTR (25 pole: pin 20, 9 pole: pin 4). If after booting the PC/PG or after leaving a program, the level of the pin is not yet defined, it can be that the PCS happens to be in the configuration mode providing the configuration's cable PCS 733 is plugged in.

In this case the PCS program is stopped and the SYS-LED shines.

Any actual PLC communication would be stopped. The only recourse is to pull out the PCS 733 cable. The PCS software PCS PRO sets the level to this pin direction.

3.2.2 Connection displacement RS485/RS422

(View from the back on the plugs)

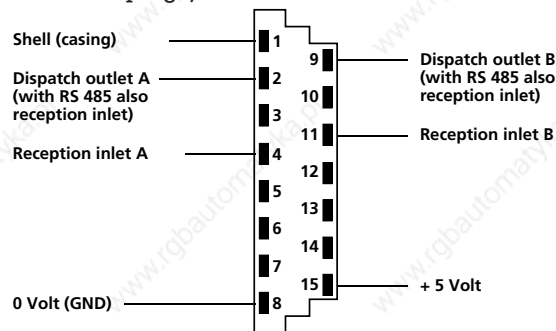

Depending on your driver and the applied PLC, you must use a special communication cable. Furthermore the DIL switches 5 and 6 must be set correlating to the programmed driver parameter. For information on this please refer to the corresponding driver manual PCS 91.x.

3.2.3 Connection displacement RS232/TTY

(View from the back onto the sockets)

There are a total of 4 separate line sources of current for the TTY (2 per interface, AB).

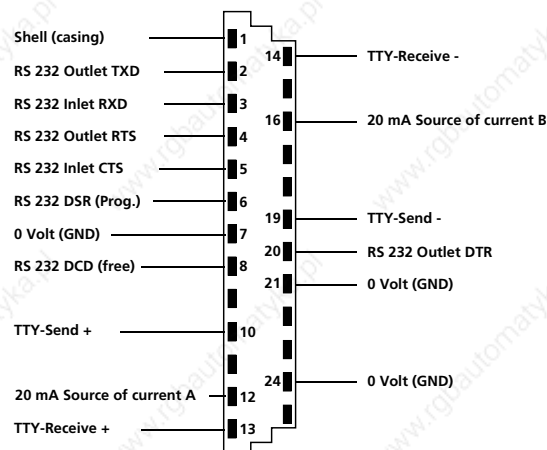
**Att ention!**

If external line sources of current are used, then the maximum primary voltage may be 15 volts at the most. Furthermore it must be a real source of current with a maximum of 22mA!

Connections

3.3 Programming cable PCS 733

You will require the cable described below for the transfer of the configuration, i.e. data record (driver, functions, variables, texts and menus).

Furthermore this cable can be used for the simulation of the PLC at the PC.

Connexion PC/PG

PCS	Female connector 25 pin	PIN	Kabel PCS 733	Male connector	PC 25 pin	PC 9 pin
	DSR	6		DTR	20	6
	RTS	4		CTS	5	8
	CTS	5		RTS	4	7
	TXD	2		RXD	3	2
	RXD	3		TXD	2	3
	GND	7		GND	7	5
	Screen	1		1	Screen	
		Hood		Hood		

3.4 Cassette connection

The 32 pole socket terminal offers the possibility of running the following cassettes.

- PCS 802 Memory cassette with 64 kbytes Flash-Eprom
- PCS 803 Memory cassette with 32 kbytes Flash-Eprom (an additional 6 analogue outlets, 6 digital inlets)
- PCS 804 Interbus-S-connection with 64 kbytes Flash-Eprom
- PCS 805 AEG bit bus cassette with 64 kbytes Flash-Eprom
- PCS 806 Memory cassette with 128 kbytes Flash-Eprom
- PCS 891 Memory cassette with 64 kbytes Flash-Eprom and additional keyboard.

4.1 Selection of the data record

The PCS 900 stores at a fixed low-voltage, whether it should run on the internal data record or the external data record on cassette. If this value is not clear, then there is either a warning before the start of the firmware, to be confirmed with [ENTER] or a demand for a selection between -1 - or -2-. Finally there will be a fresh start with a renewed check up on the system.

4.2 Selection of the copying function

The selection occurs by pressing the HELP key and at the same time the CLR key. The keys have the following denotation within the copying function:

- **ENTER**

This is the confirmation key which enables you to achieve the next stage of the course you intend to pursue.

- **CLR**

This key again enables you to momentarily break off from the menu heading WITHOUT and alterations being made.

- **[ARROW RIGHT] and [ARROW LEFT]**

You require these keys for the selection of the source or target memory block. The occupied and deleted blocks are marked with the corresponding characters. The width of the cursor corresponds to the memory extension of the inserted cassette. There are 32 kbytes per character.

The following points are to be born in mind when applying the copying function:

- If copying is being carried out on the cassette, ALL the occupied blocks on the cassette(s) must be copied. As only deleted blocks can be overwritten when reading-in into the internal Flash-Eprom, several more cassettes must eventually be made available. Should the data record be larger than 64kbytes, there would be a need, for example, to have 4 x PCS 802 cassettes.
- If copying is done from the cassette into the internal Flash-Eprom, the order of sequence must be from left to right. Best of all number the cassette accordingly.
- At the moment the individual blocks are to be found at the following addresses:

040000 (1. cursor point left)	Firmware (up to 104 kbytes)
05A000 (within the 4th position)	Additional Functionalities
05E000 (within the 4th position)	Driver
060000-07FFFF (5th to 8th position)	Datarecord according to size

Technical data

5.1 Technical data of the PCS 900

Dimensions:	Front panel section: 3041 mm * 1691 mm The boring (4.5 mm) clearances: horizontal 317 mm, vertical 125 mm Plug inlet depth: 65 mm, with sub-D-socket and cable 105 mm External dimensions 325 mm * 190 mm
Weight:	1000 grams
Operating voltage:	19..33 V DC, reverse battery protection
Current consumption:	Iav = 450 mA at 24 volts I _{max} = 650 mA at 19 volts; and in addition cassettes with max. 100mA
Resistance to jamming:	According to IEC 801-4: operating voltage: 2kV TTY connection through signal linkage: 3 kV According to IEC 801-1: discharge on back panel: 8 kV Discharge on front panel: 8kV These values do not cause any irregularities during operation. Eceeding the values causes a controlled error message, only after double values have occured can you expect to have functional faults Before any damage can occure through ionizing faults, a soldered fine-wire fuse responds to the situation.
Protective System:	According to IEC 529: rear side: IP 20, Front side: IP 65. This can be achieved with the appropriate extension.
Humidity:	0.75%, min. 48 hrs interaction time
Shakeproof ability:	3 g at 50 Hz in every direction, min 5 hrs. 3 g at 100 Hz in every direction, min 1 hr.
Temperature:	Storage: -25..70 °C Operation: 0..50 °C
Data Reception:	Flash-EEPROM, min 10000 writing cycles
Front foil:	Polyester
Dimensions of the inlay foil:	223 0 -0.4 mm * 39.0 0 -0.4 mm * 0.1 mm (-0.2mm)
Keys:	Mechanical with press point
Display:	2 * 40 characters 5*8-matrix, 5mm character height
Fuse:	400mA, small fuse, carriers, 1 reserve fuse.

5.2 PCS 900 dimensions

FRONT PANEL SECTION: 304 1 mm x 169 1 mm

EXTERIOR MEASUREMENTS: 325 mm x 190 mm

BUILT-IN DEPTH: ca. 61 mm

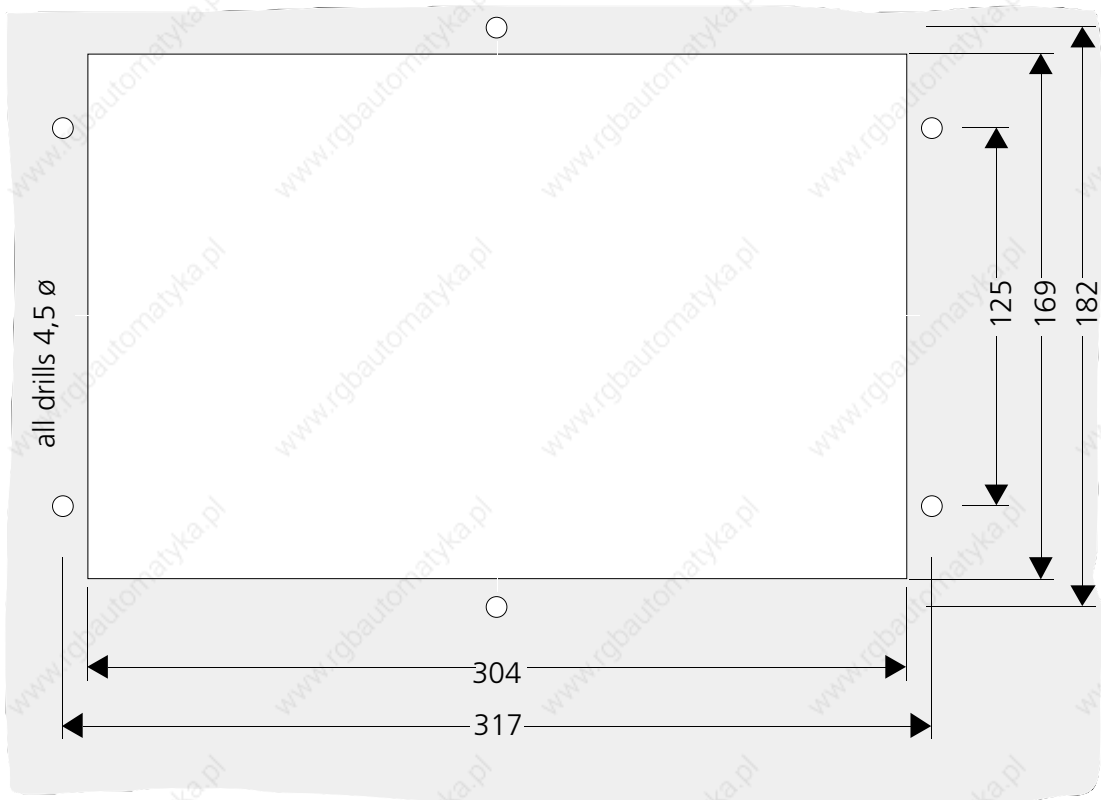

Function

The actual functionality is determined by the firmware, which the PCSPRO together with the respective data record and the PLC specific driver, transfers into the PCS 900. The file ending of the DOS data is .FRM. As the functionality will be extended in a compatible upwards direction, this manual does not necessarily represent the latest developments. The help system integrated in the PCSPRO describes the respective latest position.

6.1 Application areas

The operator panel PCS 900 permits the simple fulfilment of the following tasks.

- **1. MACHINE OPERATION WITH 20 FREELY APPLICABLE KEY BUTTONS;** These key buttons labelled from F01 to a maximum F20 can be labelled at will and are available in the control to be used as status bits.
- **2. 40 FREELY AVAILABLE LED'S;** These can represent the status „SHINING“, „DARK“, „FLASHING“, and „INVERSE FLASHING“. Every function key is allocated to a green LED as well as a red one.
- **3. PRESENTATION OF ANY FREELY PROGRAMMABLE CHARACTERS;** in the display.
- **4. PRESENTATION OF FIXED TEXT IN CONNECTION WITH VARIABLE VALUES.** There are 9 basic formats for the presentation.
- **5. ORGANIZATION OF SEVERAL PRIORITY LEVELS WHICH ARE CHANGED ACCORDING TO THE SITUATION.** This practice orientated administration considerably relieves the PLC program.
- **6. PRESENTATION OF THE CONTENTS OF UP TO A MAX. OF 214 PC WORDS AS VARIABLES.** In addition there are 83 internal - predefined - variables available.
- **7. ADJUSTMENT OF THE CONTENTS OF ANY WORDS WITHIN THE TRANSFER BLOCK.** Individual editors are integrated for every variable format.
- **8. MONITORING OF UP TO A MAX. 1024 SUCCESSIVE BITS ON ASCENDING AND FALLING FLANKS.** The arrangements of texts, the administration at 3 priority levels; references, warnings and faults; the extensive maintenance of the time sequence, the organization of FIRST MESSAGE, LAST MESSAGE and CYCLICAL display, the individual setting of the deletion characteristics and the presentation forms NORMAL AND FLASHING, are all tasks which the PCS 900 accomplishes with ease.
- **9. LOGGING THE MESSAGES** with the times ARRIVED, DEPARTED and QUITTED is executed by the PCS as a matter of course. There is a log memory for displayable HISTORY texts as well as for printable MESSAGE PRINTER texts.
- **10. PRINTING OF SHIFT OR ORDER COMMISSIONED PAGES with any amount of external and internal variables.**
- **11. MONITORING COMMUNICATION (RUPTURED WIRE, SHOR CIRCUIT);** an exceptionally efficient data transfer is maintained through the integrated priority administration in connection with an intelligent optimization of the packet length as well as the high data record throughput rate and the protocol error tolerance.
- **12. 8 AUTOMATIC SWITCHES** each with 8 daily repeating, accurate to the second, ON/OFF switch points, which can be freely edited as internal variables.

6.2 Operating elements and displays

6.2.1 LED displays

All illuminated displays have 4 states:- OFF, ON, FLASHING, INVERSE FLASHING. The FLASHING state consists of a 75% bright phase, and a 25% dark phase, the INVERSE FLASHING STATE consists of a 75% dark phase and a 25% bright phase.

The 20 green and 20 red LED's of the function keys can be freely contacted by the PLC. They are controlled by the LED STATUS - words W20 to W27.

The 4 upper LED's show the operating condition of the PCS. All the LED's with the exception of the SYS are administered by the firmware.

FAULT	OPERATING REQUEST	COMMUNICATIONS ERROR	OPERATING SYSTEM
!	?	COM	SYS

- **OPERATING REQUEST (?)**

SHINING: the PCS is waiting for the keys to be touched, i.e. the quitting or deletion of messages, the input of nominal values, the closing of menus.

FLASHING: If a message with deletion behaviour 4 is being displayed, this LED flashes as long as the corresponding message bit is log. 1 (the message cannot be deleted). If the message bit is 0, then the message shines continually and it can be quitted with <CLR>. If the <HLP> key is pressed and a help text on the actual current priority has been programmed, then this LED flashes intermittently with the (!)-LED.

- **MENU, REFERENCE, WARNING, FAULT (!)**

SHINING: a REFERENCE, a WARNING or a FAULT is shown in the display.

FLASHING: a MENU, a WARNING, a REFERENCE or a FAULT is switched on, but is not displayed owing to the switched on priority locked position in command word A (W36; bit 8..11) (at the moment). If the <HLP> key is pressed and a help text for the actual current priority has been programmed, then this LED (!) flashes intermittently with the (?) -LED.

- **COMMUNICATION FAULT (COM)**

SHINING: the communication hasn't been started since the switch-on.

FLASHING: the communication to the PLC has been interrupted! When there is continuous communication the LED is off. If there is a break in communication after it has already been running, an acoustic error message will be briefly activated and the LED set to flashing.

- **ARROW KEY LED's IN MENUS**

In this mode the (!)-LED mode is dark or flashing. The arrow key LED's can be locked by the bit 8 in the command word B (W37).

SHINING: further editable nominal values can be reached with this <ARROW> key.

FLASHING: activating these keys enables the menu nodes to be quitted.

- **ARROW KEY LED's IN MESSAGES AND HISTORY TEXTS**

In this mode the (!)-LED light is static. The arrow key LED's can be locked by the bit 10 in the command word B (W37). Shines.

<ARROW-ABOVE>: the main lines of this message can be activated.

<ARROW-BELOW>: the successive pages of this message can be displayed.

Function

- <ARROW-LEFT>: the manual selection possibility is switched on and it can be switched to older messages.
- <ARROW-RIGHT>: the manual selection possibility is switched on and it can be switched to more recent messages.

- **ARROW KEY LED'S IN HELP TEXTS**

In this mode the (!)-LED flashes alternately with the (?)-LED. The arrow key LED's can be locked by the bit 9 in the command word B (W37). Shines.

- <ARROW-ABOVE>: the main lines of the help text can be activated.
- <ARROW-BELOW>: the successive pages of the help text can be displayed.

6.2.2 Character present in the display

2 operating lines are available, each with 40 characters without any limitations. There is no automatic fading-in. The applicable character set comprises the characters H10 to HFF, whereby the following divisions have to be observed.

- **H00 to H0F (0 to 15)**

These characters are required internally and cannot be inserted in the texts.

- **H10 to H7F (16 to 127)**

These characters correspond to the IBM-Codepage 437 (Western Europe) and are firmly anchored in the BIOS. They can be inserted at will.

- **H80 to HFF (128 to 255)**

These characters can be changed any amount of times within the PCSPRO and can be freely applied to texts. The most commonly used Codepages are delivered along with the PCSPRO:

- 850 Roman character set
- 865 Norwegian character set
- 860 Portuguese character set
- 852 Hungarian character set
- 866 Cyrillic (Eastern Europe) character set

Also available are the 7 bit character sets of the PCS 200 in the areas 128 to 255 in the PCSPRO (Cyrillic, Serbocroatian and Katakana).

The flashing of individual characters (→ nominal value input) is administered by the PLC itself. The operating texts can be switched on as a complete flashing entity in the default text priority by bit 15 log. 1 in the command word C (W38). With message texts this can occur for every priority above bit 0-5 in the word 20. This changeover can be initiated by the PLC at any time.

6.2.3 Keys

They are divided up into function keys, tenner keyboards and control keys. All the keys even in the PLC will be made available as key bits. As long as a bit is activated, a log. 1 appears in the corresponding bit of the word block. The „pressing“ of a key releases a short acoustic signal; the so called keyboard click. Some keys also produce repeat acoustic signals on account of their „REPEAT“ functions.

The function keys <F1> to <F20> are only transferred to the PLC. They have no internal functions.

Depending on the displayed priority, the tenner keyboard and the control keys have PCS internal functions and are therefore only to be used in the PLC with limitations.

- **DEFAULT PRIORITY (0)**

Here the <HLP> key has merely internal functions.

- **MENU PRIORITY (1)**

Here the tenner keys <0..9> and also the control keys <+>, <->, <>, <ARROW>, <CLR>, <ENTER>, and <HLP> have internal functions.

- **MESSAGE PRIORITIES (2, 3, 4)**

Depending on the programming of the PCS (deletion behaviour, number of message text lines, message help text) the [ARROW] keys and the [CLR] and [HLP] keys have internal functions.

- **HISTORY (5)**

Here <HLP> as well as <ARROW> have internal functions.

- **OFFLINE-MENU (8)**

Here <ENTER> has a special function, all other keys with the exception of the F-keys, conclude the OFFLINE-MENU.

- **HELP-KEY**

This key permits the display of the HELP key in all priorities. If they have several lines, then they can be leafed using <ARROW-BELOW/ABOVE>.

On activating unauthorized keys, the acoustic error message rings outside the DEFAULT PRIORITY.

6.2.3.1 Evaluation of keys in the PLC

Should the control/tenner keys be evaluated in the PLC, then the following is to be taken into consideration:

- <HELP> and <ARROW-ABOVE/BELOW> may basically not be used.
- If the evaluation of the actual available priorities in word 17 is under consideration, it is to be remembered that the transfer of this PCS status takes longer than the transfer of the keys. Therefore there can be no guarantee that the PCS status and the keys will be consistently transferred. As a rule the data is consistent after 2 transfer phases, however this cannot be guaranteed.

Clarity is only guaranteed if all the priorities are locked i.e. word 36, bits 8 to 15 are written to zero, and the bits 12-15 = 0, are received in word 17.

6.2.4 Acoustic signal

3 acoustic signals stand ready for use:

- a brief keyboard click on „pressing“ a key.
- when „held down“, a key with the „REPEAT“ function rings a „REPEAT“ click.
- a 0.5 second long acoustic error message if there's a misuse of a key.

The volume of the acoustic signal can be set on the rear side of the PCS 900 with a potentiometer. If the acoustic error message should cause annoyance, it can be switched off with the word 37 bit 11, with log. 1.

Parameterisation of the PCS 900

7.1 General outline

The PCS 900 works simultaneously on a maximum of 8 priority levels. Only one priority, however, can possess the so called „Focus“, at any one time. That particular priority which possesses the focus can describe the display and question the keyboard. The various priorities can be switched on and off independent of the focus. All the priorities which are active are marked in the PCS status; word 16 bits 0-7; with a log. 1, so that the PLC program can react accordingly. When a priority is switched on or switched off is explained in a separate chapter. Basically the highest switched on priority possesses the focus, when the PLC program locks (suppressed) this priority; word 36 bits 8-15). If a priority is suppressed, then the next lower valued one will be examined. The lowest priority can never be depressed and is always switched on. The following levels are occupied at the moment:

- DEFAULT PRIORITY (0)
- MENU PRIORITY (1)
- REFERENCE PRIORITY (2)
- WARNING PRIORITY (3)
- FAULT PRIORITY (4)
- HISTORY PRIORITY (5)
- at the moment not occupied (6)
- COMMUNICATION CANCELLATION (7)
- OFFLINE PRIORITY (8)

The particular priority which possess the focus will be numerically registered in the word 17, bits 12-15 in the PLC.

7.1.1 Variables

Variables are stand-ins in a text. A maximum of 8 variables can be registered per text line. These variables are to be found in the PLC usually as of word 110. If all the message bits are not required, then the unoccupied area may also be used for variables (see also message bits...). In the PCS they are presented according to type, in text or in numerical form. You differentiate here between ACTUAL-, NOMINAL- and NOMINAL-P values.

ACTUAL VALUES are variables which cannot be amended by the PCS. They are simply presented in the display with their value.

NOMINAL-and **NOMINAL-P**values are variables which can be both presented by the PCS as well as amended by it. You will find the amended, written value, in the word address, which you specified, with the variable definitions. The extension (-P) enables you to obtain a key function. It is therefore possible, for example, to only allow certain specified operating groups access to definite nominal values. If NOMINAL-P variables are barred for the operator; in word 38 bit 7 on log. 0, these variables are presented as ACTUAL values and cannot be amended.

7.1.2 Texts

They divide themselves up into PRINTABLE TEXTS and DISPLAYABLE TEXTS. The operating, message, history and help texts are displayable texts, and the message printer and operating printer texts are printable texts.

- Operating texts are applied in the priority 0 (default text) as well as in the priority 1 (menus). They are always 2 lines.
- Depending on the programming, message texts are applied in references (priority 2), warnings (priority 3) or faults (priority 4). They may have a maximum of 32 lines.
- History texts are marked in the history memory (priority 5) and may actually contain internal variables for text number, time arrived, departed and quitted, identity number, actual date/time, operating time clock, as well as the number of history texts (actual value).
- Message printer texts are registered in the message memory for the printer and linked to the message texts.
- Message printer texts are numerical call texts, which are not saved but are printed immediately by the printer.
- In so far as they are configured, help texts appear for the priorities 0 to 5 on pressing the <HLP> key. As soon as the key is released, the text disappears again. Like the message texts, a help text has a maximum of 32 lines.

7.1.3 Menus

Menus are collections of „nodes“. Every node is given an operating text number. A node of a menu is the so called start node. The operating text defined with this node is the first one to appear in the display after the startup of the menu with word 38, bit 0..7. Branching out into other nodes can be done from this node, including individual definition, with the <ARROW KEYS>. The branching out possibilities are displayed in the arrow key LED's, in so far as bit 8 in the command word B (W37) is log. 1.

Basically all variables must be declared in a text before being inserted. In the same way texts which are to be applied in menus, must have previously been formulated.

All the elements are fully dealt with in the following chapters.

7.2 Variables

Variables can be inserted in all texts. From this position the PCS reserves places for the variables. Whereby the presentation form and the length is gleaned from the description of the variable. A maximum of 8 variables per text line may be inserted. With the formulation of texts the PCSPRO takes into account the extra variable lengths in each line automatically.

A difference is made between **INTERNAL** and **EXTERNAL** variables. The source value of the EXTERNAL variable is in the PLC. An appertaining variable description must be created for this variable. The description of the external variables is deposited in the PLC on configuration. With some internal variables the starting value or the inscriptions; depending on the language(!); must be complemented in the variable description.

The variable types (V)BIN(0)-1,A permit an additional scaling. That means that a specified value block (source block) in the PLC is reproduced on another presentation block (target block) in the PCS (limitation: the multiplier must be positive!).

With all the BIN (binary) the number of pre- and post comma positions, as well as the limiting values - minimum and maximum values - are programmable as consonants.

BCD (0)-1,2 permits the specification of a minimum and maximum value as well as a definable position number (digits).

Every variable can be defined as an ACTUAL, NOMINAL or as a NOMINAL-P value.

Parameterisation of the PCS 900

7.2.1 External variable formats

Before going into each one in detail, here is a preview.

- **1. BIT**

A character string (inscription) is allocated to each one of the two possible states of a bit in the PLC. The character string can be selected freely and may have a maximum length of a display line which is 40 characters. It may not contain any variable itself. The length of both inscriptions determines the place to be reserved. The bit variable is written into the PLC immediately after each amendment.

- **2. STRING**

A character string (inscription) can be allocated to each value of the lowest valued byte of a word in the PLC. Whereupon the maximum number of inscriptions is 256. The maximum length of an inscription amounts to one display line which equals 40 characters. The place to be reserved is determined by the longest inscription. The character string itself may not contain any more variables.

- **3. CSTRING**

A character string (inscription) can be allocated to each value of the lowest byte of a word in the PLC. Whereupon the maximum number of inscriptions is 256. The maximum length of an inscription amounts to one display line which equals 40 characters. The place to be reserved is determined by the longest inscription. The character string itself may not contain any more variables. The CSTRING variable differentiates itself from the STRING variable in that after every amendment it is immediately written into the PLC.

- **4. BCD**

Values with selectable position numbers (digits) are displayed. These digits must be evident in the PLC in BCD format. The fading in of a decimal point is not possible. Non-used leading digits are ignored on reading the ACTUAL value and are zeroed on the writing of the NOMINAL(-P)-value. The following variable formats are possible:

BCD-1:selectable digit number between 1 and a maximum of 4. This variable requires a word in the PLC.

BCDO-1:as in BCD-1, however pre-zeroes are presented instead of blanks.

BCD-2:selectable digit number between 1 and maximum 8. This variable requires a double word in the PLC.

BCDO-2:as in BCD-2, however pre-zeroes instead of space characters are presented.

- **5. BIN**

The 16 bit value of a word or the 32 bit value of a double word is presented in the PLC in fixed point format as a non-operative number. The variable requires maximum 11 digit places (with decimal points). It is possible to fade in a decimal point by selecting from the pre- and post comma positions. Whereby the place for the decimal point in the display must be considered as well. Furthermore with a 16 bit variable, a scaling is possible, that means a conversion of the value block of the PLC into the PCS and also in the opposite direction from the PCS into the PLC. The presentable area in the PLC is with a 16 bit variable between \$0 and \$FFFF, with a 32 bit variable between \$0 and \$FFFFFFFF. In the PCS the presentable value area is between 0 and max. 4 294 967 295.

The following variable formats are possible:

BIN-1 this variable occupies one word in the PLC. The number of pre-commas is definable between 1 and maximum 10. The number of post commas is between 0 (without decimal point) and a maximum of 9. As soon as the post comma position has been specified, the variable requires more room for a character in order to blend in the decimal point. If there is a difference between the minimum value of the PLC and the minimum value of the PCS, or the maximum value of the PLC with that in the PCS, then it is about a scalable BIN variable. With this type of variable, the input of the pre-comma positions are separate from the after post positions, in the event that after post positions are given. Post comma positions are entered post activating the <.> key. This kind of numerical input is also known as pocket calculator input.

BINO-1 as BIN-1, however pre-zeroes instead of blanks are presented.

BIN-A: as BIN-1, however the value is not entered according to the pocket calculator input method, but according to the value input by „pushing through“ from beyond the decimal point (from right to left).

BINO-A: as BIN-1, however the value is not entered according to the pocket calculator input method, but according to the value input by „pushing through“ from beyond the decimal point (from right to left). Furthermore pre-zeroes are presented instead of blanks.

BIN-2: this variable occupies a double value in the PLC. The number of pre-comma positions is definable between 1 and maximum 10. The number of post comma positions lies between 0 (without decimal point) and a maximum of 9. As soon as a decimal point is specified, the variable requires more room for a character in order to blend in the decimal point. With this type of variable and in the event that post comma positions are given, the input of the pre-comma positions are separate from the post comma positions. On activating the <.> key, post comma positions are entered. This kind of numerical input is also known as pocket calculator input.

BINO-2: as BIN-2, however pre-zeroes instead of blanks are presented.

BIN-B: as BIN -2, however the value is not entered according to the pocket calculator method but the value input is done by „pushing through“ beyond the decimal point from right to left.

BINO-B: as in BIN-2, however the value is not entered according to the pocket calculator method but the value input is done by „pushing through“ beyond the decimal point from right to left . Furthermore pre-zeroes instead of blanks are presented.

- **6. VBIN**

The 16 bit value of a word or the 32 bit value of a double word in the PLC is are presented as an indicator affected number in fixed point format. The variable requires at the most a 12 digit position (basically with an operational sign and on a selection basis with a decimal point). A decimal point fade-in is made possible with the selection of pre- and post comma positions. Whereby the position for the decimal point and the operational sign in the display must be considered. Furthermore a scaling is possible with the 16 bit variable, that means a conversion of the value block PLC -> PCS and in the reverse direction PCS -> PLC. The presentable area in the PLC lies with a 16 bit variable between \$8000 and \$7FFF, and with a 32 bit variable between \$0000000 and \$7FFFFFFF. In the PCS the presentable value area is between -2 147 483 648 and max. 2 147 483 647. The operational sign can be amended with the help of <> or <-> key.

Parameterisation of the PCS 900

The following variable formats are possible:

VBIN-1: This variable occupies a word in the PLC. The number of pre-comma positions is definable between 1 and maximum 10. The number of post comma positions lies between 0 (without decimal point) and a maximum of 9. As soon as the post comma positions have been specified, the variable requires more room for a character in order to fade in the decimal point. If the minimum value of the PLC is different to the minimum value of the PCS, or respectively, the maximum value of the PLC from that of the PCS, then a scalable VBIN variable is involved. In the event that post comma positions arise with this kind of variable, the input of the pre-comma positions is separate to the post comma positions. On activating the <.>, post comma positions are entered. This kind of numerical input is also known as pocket calculator input.

VBINO-1 as VBIN-1, however pre-zeroes are presented instead of blanks.

VBIN-A: as VBIN-1, however the value is not entered according to the pocket calculator method, but the value input is done by „pushing through“ beyond the decimal point from right to left.

V-BINO-A: as in VBIN-1, however the value is not entered according to the pocket calculator method, but the value input is done by „pushing through“ beyond the decimal point from right to left. Furthermore pre-zeroes are presented instead of blanks.

VBIN-2: This value occupies a double word in the PLC. The number of pre-comma positions is definable between 1 and a maximum of 10. The number of pre-comma positions lies between 0 (without decimal point) and maximum 9. As soon as the post comma positions have been specified, the variable requires more room for a character in order to fade in the decimal point. In the event that post comma positions arise with this kind of variable, then the input of the pre-comma positions is separate to the post comma positions. On activating the [.] , post comma positions are entered. This kind of numerical input is also known as pocket calculator input.

VBINO-2: as VBIN-2, however pre-zeroes are presented instead of blanks.

VBIN-B: as VBIN-2, however the value is not entered according to the pocket calculator method, but the value input is done by „pushing through“ beyond the decimal point from right to left.

VBINO-B: as in VBIN-2, however the value is not entered according to the pocket calculator method, but the value input is done by „pushing through“ beyond the decimal point from right to left. Furthermore pre-zeroes are presented instead of blanks.

- **7. WORD**

The 16 bit value of a word in the PLC is presented in bit format. A positioning of a cursor on the individual bits is possible with the keys [] and [-]. A single bit can be set back with the [0] key and set with the [1] key. This data format requires a definite 17 character place in a line. A blank is inserted to enhance the optical separation between the HIGH and LOW byte.

- **8. ASCII**

Up to 32 characters (16 words) in the PLC can be presented as ASCII characters or amended. With the keys [] and [-] the ASCII characters can be presented with the next highest or respectively, the next lowest ASCII-Code. The [.] key shoves the cursor one place to the right. After the last character has been entered, and the [.] has been activated, the cursor again pops up on the 1st character. Figures can be keyed in directly.

7.2.1.1 Variables format BIT

A single bit within a planned word can be presented as an actual value or as a nominal value. It is set with the <+> key and set back with the <-> key. The amendment is carried out at once after each activation of the key. The remaining bits of the corresponding word are not influenced by the write back.

EXAMPLE:

Assume that you have deposited the PCSPRO a bit variable on word 130 as NOMINAL value. You have chosen bit 15 for the bit number. You have programmed the character string (inscription) for the log. bit state 0 with „CLOSED“ and for the log bit state 1 with „OPEN“. To summarize this:

Word number:	130
Class:	NOMINAL
Variable format:	BIT
Bit position:	15
Inscription 0 (APO):	CLOSED
Inscription 1 (AP1):	OPEN

The variable is inserted in the operating text 0 as follows:

VALVE 0 IS IN THE STATE

If the bit 30.15 = 0, then with the selected operating test there appears in the display:

VALVE 0 IS IN THE CLOSED STATE

If the bit 30.15 = 1, then with the selected operating text 0, there appears in the display:

VALVE 0 IS IN THE OPEN STATE

If this operating text is within a menu call, a switch from one state to another can be made by pressing the <+> and <-> keys.

7.2.1.2 Variables format STRING

Up to 256 texts with the content of the lowest valued bytes of a word can be connected as an actual value. The value of the lowest valued byte as nominal value within a menu can be incremented with <+> and decremented with <->. Whereby no intermediate value is written in the PLC.

EXAMPLE: It is assumed that with the PCSPRO you have filed a string variable on word 131 as NOMINAL-P value. The character strings (inscriptions) 0..2 are programmed with „SERVICE“, „SETTING OPERATION“ and „AUTOMATIC RUNNING“.

Parameterisation of the PCS 900

Here is a summary:

Word number: 131
 Class: NOMINAL-P
 Variables format: STRING
 Inscription 0 (APO): SERVICE
 Inscription 1 (AP1): SETTING UP OPERATION
 Inscription 2 (AP2): AUTOMATIC RUNNING
 The variable is inserted in the operating text 15 as follows:

KIND OF OPERATION:  FURTHER:>

If the value 1 is in the lower valued byte of word 131, then there appears in the active operating text 15 in the display:

KIND OF OPERATION: SETTING UP OPERATION FURTHER:>

If the variable is applied in a menu, then the value in word 131 can be decremented with the key <-> to the value 0 and can be incremented with the <+> key to the value 2. It is to be noted, however, that an amended value is only written back in the word after <ENT> or after the variable field has been quitted. If the value is to be written immediately into the PLC, then refer to CSTRING.

Attention!

1. The bits in the higher valued byte of word 131 are ignored on reading. On being written back into the PLC they are set to zero. This is an aid to assist you in determining if there have been amendments caused by the PLC program.
- 2.* If the previous value is not amended, there will be no writing back; not even the bits 8..15.
3. A maximum of 256 inscriptions are permitted (including 0).
4. The limitation orientates itself according to the number of programmed inscriptions; the minimum value is always 0.
5. At least 3 inscriptions must have been filed, otherwise the variable is to be declared as BIT.
- 6.* It is impossible to quit the input field with a value outside the limiting value after an editing has been started.
7. Restoring the original value is possible at any time with the <CLR> key.
 - * These points only apply if the menu options correspond to the standard setting!



7.2.1.3 Variables format CSTRING

As an actual value, this variable type has a similar function to the STRING type.

If the variable is applied in a menu, then the value at the planned word address can be decremented with the key <-> until 0 or incremented with the <+> key. In contrast to STRING, an amended value is immediately written into the PLC, i.e. after the amendment.

EXAMPLE:

With the PCSPRO you have filed a CSTRING variable on word 132 as NOMINAL value. The character strings (inscriptions) are programmed with „JANUARY“, „FEBRUARY“, „MARCH“, „APRIL“, „MAY“ till „DECEMBER“. Here is a summary:

Word number: 32
 Class: NOMINAL
 Variables format: CSTRING
 Inscription 0 (APO): JANUARY
 Inscription 1 (AP1): FEBRUARY
 till inscription 11 (AP11): DECEMBER

The variable is inserted in the operating text 20 as follows:

FILL UP MONTH: □□□□□□□□□□ FURTHER:>

If the value 5 is in the low-byte of word 32, then with the selected operating text 20, there appears in the display:

FILL UP MONTH: JUNE FURTHER:>

Att ention!

1. The bits in the higher valued byte of word 132 are ignored on reading. On being written back into the PLC they are set to zero. This is an aid to assist you in determining if there have been amendments caused by the PLC program.
2. A maximum of 256 inscriptions are permitted (including 0).
3. The limitation orientates itself according to the number of programmed inscriptions; the minimum value is always 0.
4. At least 3 inscriptions must have been filed, otherwise the variable is to be declared as BIT.
5. It is impossible to quit the input field with a value outside the limiting value after an editing has been started.
- 6.* Restoring the original value with the <CLR> key is not possible.
 - * These points only apply if the menu options correspond to the standard setting.



7.2.1.4 Variables format BCD

As an actual value there will be a maximum of 4 positions per word numerically presented. Respectively one place represents the numerical value 0-9 from 4 bits.

The BCD variable formats divide themselves up into the following sub groups:

Variabletype	16 Bit	32 Bit	Number of digits	Leading zero padding
1. BCD-1	x		1..4	
2. BCDO-1	x		1..4	x
3. BCD-2		x	1..8	
4. BCDO-2		x	1..8	x

Parameterisation of the PCS 900

It is assumed that you have filed one BCD variable (BCD-2) on word 133 as NOMINAL-P value. You want to display 8 digits. The minimum value that can be entered should be 90 and the maximum 50 000 000. Here is a summary:

Word number: 133
 Class: NOMINAL-P
 Variable format: BCD-2
 Number of digits: 8
 Minimum value: 90
 Maximum value: 50000000

The variable is inserted in the operating text 100 as follows:

FINISHED NOS. OF PIECES: [] FURTHER:>

If \$0045 is the value in word 133, and \$5673 is the value in word 134, then on selecting the operating text 100, there appears in the display:

FINISHED NOS. OF PIECES: 455673 FURTHER:>

The 2 leading-zeroes are suppressed, because here it is about the variables format BCD-.. ! If you want the pre-zeroes to be displayed then instead of BCD-.. insert the variables format BCDO-..!

Att ention!

1. Unnecessary higher valued bits are ignored and written back to 0.
2. Scaling and decimal point fading-in are not possible.
- 3.* Intermediate values are not written back. Writing back is done first after <ENTER> or on quitting the variables field.
 - * This point is only valid, if the menu options correspond to the standard setting!
4. Balanced inputs are also possible: <1> <0> <+> in the above example would lead to the intermediate result of 455683. As in this case it concerns an intermediate result, it is not written back although afterwards the cursor discontinues flashing!
- 5.* It is impossible to leave the input field with a value outside the limiting value after editing has been started.
6. Incrementing and decrementing can also be done on account of the operational signs (with auto repeat).
7. A restoration of the old value is possible at any time with the key <CLR>.
 - * This point only applies, if the menu options correspond to the standard setting!



7.2.1.5 Variables format BIN

As actual value the binary value of one or two words is changed and converted. In the presentation there is a decimal point after each numerical digit specification, eventually an operational sign and the presentation of the pre-zeroes is also taken into consideration.

7

Parameterisation of the PCS 900

The BIN variables format divide themselves up into the following sub groups:

Variablename	16 Bit	32 Bit	Pocket calc. input	Skaling	Sign	Lead.-zero padding
1. BIN-1	x		x	x		
2. BIN-A	x			x		
3. BIN-2		x	x			
4. BIN-B		x				
5. VBIN-1	x		x	x	x	
6. VBIN-A	x			x	x	
7. VBIN-2		x	x		x	
8. VBIN-B		x			x	
9. BINO-1	x		x	x		x
10. BINO-A	x			x		x
11. BINO-2		x	x			x
12. BINO-B		x				x
13. VBINO-1	x		x	x	x	x
14. VBINO-A	x			x	x	x
15. VBINO-2		x	x		x	x
16. VBINO-B		x			x	x

Parameterisation of the PCS 900

The difference between (V)BIN(O)-1 resp. (V)BIN(O)-2 and (V)BIN(O)-A resp. (V)BIN(O)-B is the art of editing.

- (V)BIN(O)-1, (V)BIN(O)-2: pocket calculator input with separate pre-comma and post comma inputs (of course only if the after comma positions are to hand). The switch over occurs with the <.> key.
- (V)BIN(O)-A, (V)BIN(O)-B: pushing through from right to left via the decimal point. The <.> key has no function here.

It is assumed that you have filed a BIN- Variable (BIN-1) on word 42 as NOMINAL value. You wish to be able to present and enter two pre-commas and one post comma position. You also want to introduce a scaling. In the PCS values between 0 and 100 (0 and 10.0) may be entered. However this value area in the PLC should be reproduced on 0..4095 (\$0..\$OFFF). Preceding zeroes should be suppressed
Summary:

Word number:	42
Class:	NOMINAL
Variables format:	BIN-1
Pre-comma positions:	2
Post comma positions:	0
PCS minimum value:	0
PCS maximum value:	100
PLC minimum value:	0
PLC maximum value:	4095

The variable is inserted in the operating text 120 as follows:

ANALOGUE VOLTAGE: VOLT FURTHER:>

If the value \$0800 (2048) is in word 42, then with the selected operating text 120 there appears in the display.

ANALOGUE VOLTAGE: 5.0 VOLT FURTHER:>

Operation as nominal value variable in a menu:

- The value can be amended with the digit keys.
(V)BIN(O)-1(2): pre-comma and post comma separate. Change made with <.>.
(V)BIN(O)-A(B): simple pushing through from right to left, whereby the decimal point is jumped over.
- Balanced input possible (though not with the VBIN variables!): e.g <.> <2> <>: new presentation (example): 5.2!
Keys <+> / <->:
BIN(O)-1,2,A,B: 1 is added / subtracted (also after <.>).
VBIN(O)-1,2,A,B: change of operational sign can be done at any time.

Att ention!

- * only amended values are written back within the limiting values.
- if the original value is beyond the limiting values, then inverse arrows are presented.
- if a value is entered beyond the limiting values; which is only possible with direct digit input; the checkup is undertaken with <ENTER> or on quitting the field. In the case of error, the minimum value is presented as long as the value entered was smaller than the minimum value. In addition the accoustic warning signal rings and for the moment nothing will be written in the PLC.
- It is not possible to quit the inverse field. For example, if the first variable in a menu text is beyond the limiting values, then no more paging can be done. First of all the value must be corrected. An approved value is entered for BIN using the <+>, <-> or <CLR> keys and with VBIN only with <CLR> or with digital input.
- * The specified value blocks (PLC and PCS) may only be negative variables with VBIN(0). In this instance merely the minus character has to be set before the corresponding value(s).
 - * This point only applies if the menu options correspond to the standard setting !



7.2.1.6 Variables format WORD

The word at the specified address is presented with 0 and 1 binary. For example, a nominal value is filed on word 135:

Word number: 135
 Class: NOMINAL
 Variables format: WORD

The variable is inserted in the operating text 99 as follows:

W 35 BINARY:  FURTHER:>

If the value \$5A5A is in word 135, then after having selected operating text 99, the following appears in the display.

W 35 BINARY: 01011010 01011010 FURTHER: >

If the variable is applied in a menu, the cursor can be moved bit by bit with the help of the <+> and <-> keys. Through the keys <0> and <1> the standing bit on the cursor position can be set to log 0 or 1. An amended value will be written back into the word 135 first after <ENT> has been pressed or the variables field has been quitted.

Att ention!

- * if the previous value was not amended, then there'll be no writing back.
- a restoration of the original word is possible at any time with the <CLR>.
- the variables format WORD occupy 17 characters in the display. The highest valued 8 bits are separated from the lowest valued 8 bits with a blank „SPACE“!
- * This point is only valid if the menu options correspond to the standard settings!



Parameterisation of the PCS 900

7.2.1.7 Variables format ASCII

The ASCII variable permits the input of any number of strings. The string length must be an even number (maximum 32 digits). Every character can be entered (H00 to HFF).

Example: An ASCII variable is filed as NOMINAL value on word 136. You want to be able to present and enter a 16 digit serial number.

Word number: 136
 Class: NOMINAL
 Variables format: ASCII
 Number of digits: 16 (8 words)

The variable is inserted into the operating text 90 as follows:

SERIAL NUMBER: ██████████ FURTHER:>

If the words contain W136=\$4557, W137=\$4120, W138=\$344E, W139=\$4542, W140=\$2D38, W141=\$3131, W142=\$3530 and W143=\$3533 (corresponds to the string „EWA-4NEB 8115033“), then on selecting operating text 90, there appears in the display:

SERIAL NUMBER: EWA-4NEB 8115033 FURTHER:>

If the variable is applied in a menu, then the cursor (flashing position) with the help of the <.> key can be shoved one place to the right. If the cursor happens to be at the end of a variable, (character string), and you press the <.> key, the cursor will return to the beginning of the variable. With the aid of the <+> and <-> key, every character, including special ones, can be selected. An amended value will first be written binary in the transfer block after <ENTER> has been pressed or the variable field as of word 136 (W136..W144) has been quitted. Apart from the value nothing else is amended.

As every character can be displayed, there will be not check of the limiting values.

Att ention!

- * if the previous value is not amended, then there will be no writing back.
- a restoration of the previous value is possible at any time with <CLR> key.
- only even numbered character lengths are allowed!



7.2.2 Internal variable formats

83 previously defined internal variables are at your service. They can be most practically applied if they are in specific text bundles. PCSPRO checks this out before the assignment begins.

If there is an x in the presentation length, then the project manager is to decide himself on the length. For example, this occurs in the formulation of the language dependent inscriptions, for the weekday. Besides that every nominal value can be occupied with a default value. After the transfer of the data record, this default value will be initialized in the fixed non-voltage RAM (with the exception of time, date and operating time clock). If the nominal value is used in a menu, then the running time of the apparatus can be altered. The string constants, Z075 to Z082 can be amended within the PCSPRO and serve to format the printout.

Firmware	Prev ref.	PCSPRO description	Type	Class	Pres. lgn	Def. val.
[Z001]	ZP	[INFORMATIONS]	INT_BIN-2	ACT	4	0
[Z002]	ZQ	[WARNINGS]	INT_BIN-2	ACT	4	0
[Z003]	ZR	[FAULTS]	INT_BIN-2	ACT	4	0
[Z004]	ZT	[MENU_NUMBER]	INT_BIN-2	ACT	3	0
[Z005]	ZU	[DISP_CYCLE_ACT]	INT_BIN-2	ACT	2	0
[Z006]	ZV	[DISP_CYCLE_NOM]	INT_BIN-2	NOM	2	0
[Z007]	ZX	[COM_ERRORS]	INT_BIN-2	ACT	2	0
[Z008]	ZA	[TEXT_NUMBER]	INT_BIN-2	ACT	4	0
[Z009]	ZC	[TIME_MSG_COMES]	INT_TIME_MSG_COMES	ACT	17	0
[Z010]	ZD	[TIME_MSG_GOES]	INT_TIME_MSG_GOES	ACT	17	0
[Z011]	ZE	[TIME_MSG_QUITT]	INT_TIME_MSG_QUITT	ACT	17	0
[Z012]	ZG	[TIME_HOURS]	INT_BINO-2	NOM	2	0
[Z013]	ZH	[TIME_MINUTES]	INT_BINO-2	NOM	2	0
[Z014]	ZI	[TIME_SECONDS]	INT_BINO-2	NOM	2	0
[Z015]	ZL	[DATE_YEAR]	INT_BINO-2	NOM	2	0
[Z016]	ZK	[DATE_MONTH]	INT_BINO-2	NOM	2	0
[Z017]	ZJ	[DATE_DAY]	INT_BINO-2	NOM	2	0
[Z018]	ZN	[WEEKDAY_ACT]	INT_STRING	ACT	x	0
[Z019]	ZO	[WEEKDAY_NOM]	INT_STRING	NOM	x	0
[Z020]	ZY	[TIME]	INT_TIME	ACT	8	0
[Z021]	ZZ	[DATE]	INT_DATE	ACT	8	0
[Z022]		[TIMER]	INT_STRING	NOM	16	0
[Z023]		[CAM_NUMBER]	INT_BIN-2	NOM	1	0
[Z027]		[BAUD_RATE]	INT_STRING	NOM	5	1
[Z028]		[PARITY]	INT_STRING	NOM	5	1
[Z029]		[DATA_BIT]	INT_STRING	NOM	1	0
[Z030]		[STOP_BIT]	INT_STRING	NOM	1	1
[Z031]		[RS232/TTY]	INT_STRING	NOM	5	0
[Z032]		[HISTORY_TEXTS]	INT_BIN-2	ACT	4	0
[Z033]		x80 [MSGTEXT_LINE01]	INT_MSG_TEXT_LN	ACT	40	0
..	..					
[Z064]		x9F [MSGTEXT_LINE32]	INT_MSG_TEXT_LN	ACT	40	0
[Z065]		[OPER_TIME_ACT]	INT_BIN-2	ACT	10	0
[Z066]		[OPER_TIME_NOM]	INT_BIN-2	NOM	10	0
[Z067]		[HISTORY_INDEX]	INT_BIN-2	ACT	5	0
[Z068]		[PRINTER_INDEX]	INT_BIN-2	ACT	5	0
[Z069]		[TIMER_ON_HOUR]	INT_BINO-2	NOM	2	0

Parameterisation of the PCS 900

[Z070]	[TIMER_ON_MIN]	INT_BINO-2	NOM	2	0
[Z071]	[TIMER_ON_SEC]	INT_BINO-2	NOM	2	0
[Z072]	[TIMER_OFF_HOUR]	INT_BINO-2	NOM	2	0
[Z073]	[TIMER_OFF_MIN]	INT_BINO-2	NOM	2	0
[Z074]	[TIMER_OFF_SEC]	INT_BINO-2	NOM	2	0
[Z075]	[PRINTER_TEXTS]	IST_BIN-2	ACT	4	0
[Z076]	<TAB>	INT_PRINTERSEQU.	ACT	0	H09
[Z077]	<ESC>	INT_PRINTERSEQU.	ACT	0	H1B
[Z078]	<LF>	INT_PRINTERSEQU.	ACT	0	H0D HOA
[Z079]	<PF>	INT_PRINTERSEQU.	ACT	0	H0C
[Z080]	<Bd+>	INT_PRINTERSEQU.	ACT	0	H1B H45
[Z081]	<Bd->	INT_PRINTERSEQU.	ACT	0	H1B H46
[Z082]	<Un+>	INT_PRINTERSEQU.	ACT	0	H1B H2D H31
[Z083]	<Un->	INT_PRINTERSEQU.	ACT	0	H1B H2D H30

7.2.2.1 Implementation of the internal variables

	10 MESSAGE PRINTER TEXT	9 OPERATING PRINTER TEXT	8 HELP TEXT FOR HISTORY PRIORITY	7 HELP TEXT FOR FAULT PRIORITY	6 HELP TEXT FOR WARNING PRIORITY	5 HLP-REF.	4 HLP-MENU	3 HLP-DEFAULT	2 HISTORY TEXT	1 MESSAGE TEXT	0 OPERATING TEXT
[Z001] [INFORMATION]	X	-	X	X	X	X	X	X	X	X	-
[Z002] [WARNINGS]	X	X	-	X	X	X	X	X	X	X	-
[Z003] [FAULTS]	X	X	-	X	X	X	X	X	X	X	-
[Z004] [MENU_NUMBER]	X	X	-	X	X	X	X	X	X	X	-
[Z005] [DISP_CYCLE_ACT]	X	X	-	X	X	X	X	X	X	X	-
[Z006] [DISP_CYCLE_NOM]	X	X	-	X	X	X	X	X	X	X	-
[Z007] [COM_ERR]	X	X	-	X	X	X	X	X	X	X	-
[Z008] [TEXT NUMBER]	X	X	X	X	X	X	X	X	X	X	X
[Z009] [TIME_MSG_COME]	-	X	X	-	-	X	X	X	X	-	X
[Z010] [TIME_MSG_GONE]	-	X	X	-	-	X	X	X	X	-	X
[Z011] [TIME_MSG_QUIT]	-	X	X	-	-	X	X	X	X	-	X
[Z012] [TIME_HOURS]	X	-	-	-	-	-	-	-	-	-	-
[Z013] [TIM_MINUTES]	X	-	-	-	-	-	-	-	-	-	-
[Z014] [TIME_SECONDS]	X	-	-	-	-	-	-	-	-	-	-
[Z015] [DATE_YEAR]	X	-	-	-	-	-	-	-	-	-	-
[Z016] [DATE_MONTH]	X	-	-	-	-	-	-	-	-	-	-
[Z017] [DATE_DAY]	X	-	-	-	-	-	-	-	-	-	-
[Z018] [WEEKDAY_ACT]	X	X	X	X	X	X	X	X	X	X	X
[Z019] [WEEKDAY_NOM]	X	-	-	-	-	-	-	-	-	-	-
[Z020] [TIME]	X	X	X	X	X	X	X	X	X	X	X
[Z021] [DATE]	X	X	X	X	X	X	X	X	X	X	X
[Z022] [TIMER]	X	-	-	-	-	-	-	-	-	-	-

Parameterisation of the PCS 900

	10 MESSAGE PRINTER TEXT																					
	9 OPERATING PRINTER TEXT																					
	8 HELP TEXT FOR HISTORY PRIORITY																					
	7 HELP TEXT FOR FAULT PRIORITY																					
	6 HELP TEXT FOR WARNING PRIORITY																					
	5 HLP-REF.																					
	4 HLP-MENU																					
	3 HLP-DEFAULT																					
	2 HISTORY TEXT																					
	1 MESSAGE TEXT																					
	0 OPERATING TEXT																					
[Z023] [CAMs_NUMBER]		X	-	-	-	-	-	-	-	-	-	-	-	-	-	-	-	-	-	-	-	-
[Z027] [BAUD RATE]		X	-	-	X	X	X	X	X	X	X	X	-	-	-	-	-	-	-	-	-	-
[Z028] [PARITY]		X	-	-	X	X	X	X	X	X	X	-	-	-	-	-	-	-	-	-	-	-
[Z029] [DATA BIT]		X	-	-	X	X	X	X	X	X	X	-	-	-	-	-	-	-	-	-	-	-
[Z030] [STOP BIT]		X	-	-	X	X	X	X	X	X	X	-	-	-	-	-	-	-	-	-	-	-
[Z031] [RS232/TTY]		X	-	-	X	X	X	X	X	X	X	-	-	-	-	-	-	-	-	-	-	-
[Z032] [HISTORY TEXT]		X	X	X	X	X	X	X	X	X	X	X	-	-	-	-	-	-	-	-	-	-
[Z033..64] [MSG_TXT_LINE1..32]		-	-	X	-	-	-	-	-	-	-	X	-	X	-	-	-	-	-	-	-	-
[Z065] [OPPER_TIME_NOM]		X	X	X	X	X	X	X	X	X	X	X	X	X	X	X	X	X	X	X	X	X
[Z066] [OPPER_TIME_ACT]		X	-	-	-	-	-	-	-	-	-	-	-	-	-	-	-	-	-	-	-	-
[Z067] [HISTORY_ENTRY]		-	-	X	-	-	-	-	-	-	-	X	-	-	-	-	-	-	-	-	-	-
[Z068] [PRINTER_ENTRY]		-	-	-	-	-	-	-	-	-	-	-	-	-	-	-	-	-	-	-	X	-
[Z069] [TIMER_ON_HOUR]		X	-	-	-	-	-	-	-	-	-	-	-	-	-	-	-	-	-	-	-	-
[Z070] [TIMER_ON_MINUTE]		X	-	-	-	-	-	-	-	-	-	-	-	-	-	-	-	-	-	-	-	-
[Z071] [TIMER_ON_SEC]		X	-	-	-	-	-	-	-	-	-	-	-	-	-	-	-	-	-	-	-	-
[Z072] [TIMER_OFF_HOUR]		X	-	-	-	-	-	-	-	-	-	-	-	-	-	-	-	-	-	-	-	-
[Z073] [TIMER_OFF_MINUTE]		X	-	-	-	-	-	-	-	-	-	-	-	-	-	-	-	-	-	-	-	-
[Z074] [TIMER_OFF_SEC]		X	-	-	-	-	-	-	-	-	-	-	-	-	-	-	-	-	-	-	-	-
[Z075] [PRINTER TEXT]		X	X	-	X	X	X	X	X	X	X	X	-	-	-	-	-	-	-	-	-	-
[Z076] <TAB>		-	-	-	-	-	-	-	-	-	-	-	X	X	-	-	-	-	-	-	-	-
[Z077] <ESC>		-	-	-	-	-	-	-	-	-	-	-	X	X	-	-	-	-	-	-	-	-
[Z078] <LF>		-	-	-	-	-	-	-	-	-	-	-	X	X	-	-	-	-	-	-	-	-
[Z079] <FF>		-	-	-	-	-	-	-	-	-	-	-	X	X	-	-	-	-	-	-	-	-

Parameterisation of the PCS 900

- **TIME_HOURS/MINUTES/SECONDS/ DATE_MONTH/YEAR/DA WEEKDAY**

These variables permit the time positions. As it only makes sense to write constant values on the time, all 7 variables within a menu node are used. The momentarily values of the time are saved intermittently when getting into the nodes, and if at least 1 value has been amended before quitting the node, it is written in its entirety.

- **AUTOMATIC_TIME_CLOCK**

The 8 automatic time clocks can be indicated textually here. This value serves as an index on the respective automatic time clock. The length is fixed to be 16 characters !

- **CAM_NUMBER**

8 ON/OFF times can be programmed inside every automatic time clock. The 8 time blocks are systematized in a bit and the result of each time switch is written into the PLC. The index of one of these 8 time first pairs is this cam number. If only one cam number is used, then this variable will not be required. In this case the EXTRA_ON/OFF variable directs itself to the first first pair.

- **BAUD RATE, PARITY, DATA BIT, STOP BIT, RS232/TTY**

This parameter determines the configuration of the PRN interface. As nominal value they can be amended to ONLINE. They are saved at fixed low-voltage and for the data transfer they are initialized on the default values inserted here.

- **HISTORY TEXTS/PRINTER TEXTS**

This variable indicates the number of messages that are in the history memory that is displayable messages or respectively in the message printer memory.

- **MESSAGE TEXT_LINES_32**

This variable sets the number of lines of the corresponding message text in the log or message printer text. By formulating a general block text, it is possible to cover every message (refer to the block texts).

- **OPR_HRS_ACTUAL_ / NOMINAL**

The nominal value is the only way to set the operating hours counter to a specific value. No initialization is carried out by the operating hours counter with data record exchange. If however a firmware with a new stand is loaded, then the operating hours counter is set to 0. In this case the appertaining message appears in the display. It can then be corrected by this variable.

- **HISTORY_ENTER, PRINTER_ENTER**

A counter is incremented for every logged message in order to satisfy the uninterrupted logging. As the memories can rewrite themselves, there is the possibility that gaps can occur. It only makes sense to have this number in history texts and message printer texts. On deletion of the memory it is set to 0 and counts up to 9999. As of 10000 inverse fields appear. As of 65535 1 it will be zeroed.

- **EXTRA_ON/OFF_HOURS/MINUTES/SECONDS**

These lines can be amended to ONLINE. They are administered internally by the indices AUTOMATIC TIME SWITCH and CAM NUMBER. The planned values are initialized when the data record exchange takes place. If the nominal values are amended to ONLINE, they are saved in the fixed low-voltage block. An amendment of the individual parts is immediately taken into consideration, whereby the following is relevant:

- If the ON switch time and the OFF switch time is the same, then this cam is inactive.
- If the ON switch time is smaller than the OFF switch time, then this cam is active daily.
- If the ON switch time is larger than the OFF switch time, then this cam is actively engaged in the daytime.

- **TAB, ESC, L \ddot{U} FF, Bd, Un**

Any amount of up to 8 character long strings are hidden behind these constants. They include all the characters with the exception of H00. The significance doesn't necessary correlate to the name, as these strings can be formulated any amount of times in the PCSPRO. They can only be applied in the message printer texts and the operating printer texts.

7.2.3 Treatment of variables

All the variables are automatically read through the PCS or respectively, as of the specified word number. The PLC specific word number (DW, MW, DM, Counter..) respectively description, can be found out with the assistance of the driver manual PCS 91.x. This also applies to nominal values, whereby the selected value is presented as the given value (see also chapter variables in menus"). The following rules apply for the freshening up of variables (ACTUAL values or non-active NOMINAL(-P)-values):

- A continual freshening up occurs in all priority classes. The freshening up rate is dependent on various factors: from the number of variables in the display, the type of driver, the speed of transfer (baud rate), the number of tasks, which can fit into a transfer packet as well as the reply time of the PLC, which is independent to the PLC cycle time. The speed of the freshening up rate taking place under the most favourable circumstances is around 8 per second.
- As eventually not all variables which are required in the display or for the operating printer can be gathered in one transfer cycle, it can happen that with the PCS 900, the values will come out of various PLC cycles. Nevertheless the display of the values takes place first when all the variable values have become available.
- There is no difference between internal and external variables. As long as the variable values have not been transferred, empty fields (SPACE's) will be presented in the display. If the read-in value is outside the limiting values deposited in the PCS, inverse arrows; depending on the sub level or exceeding level; will be presented in the variable field.
- NOMINAL-P-variables will be handled just like the ACTUAL values as long as the bit 7 in word 38 is log. 0.
- NOMINAL(-P)-variables will first be read in and underlined and presented „frozen“. The result of this being that an amendment of the word through the PLC after the „freezing“ of this variable, is no longer recognizable. As soon as a key has been activated for the editing of the nominal value, a flashing cursor appears and the rest of the variable is presented static (underlined). This doesn't apply with balanced inputs or with the variable BIT and CSTRING as these are written in at once.
- In the PCSPRO the writing back of the nominal values for every menu is to be specified individually. For this in the menu selection window the focus must be set on a menu and the [circa symbol] must be entered in the keyboard which on a German keyboard is [Alt-Gr Q]. For normal applications, the standard proceedings should be sufficient. These standard proceedings are described here as follows:
 - if a nominal value (NOMINAL or NOMINAL-P) was amended, it will be written by activating the [ENTER] key or by quitting the variable field. An exception is made for the end of the menu. In this case whatever the circumstances, the last presented value is written.
 - if an active NOMINAL-P-value is in the display and is set to zero in word 14 bit 7, then the first editable NOMINAL-value of this display side will be looked for and will be presented underlined (not yet edited).
 - after a NOMINAL(-P)-value was written by the PCS, then it will be read twice (different PLC-cycles). Finally it is compared with the previous edited value. If these values differentiate, the

Parameterisation of the PCS 900

acoustic warning signal rings and the momentary value of the PLC is presented underlined. This enables the PLC to make a dynamic test of the limiting values. First after confirming the proposed value of the PLC by pressing [ENTER] or with a permitted [ARROW KEY], the menu field will be quitted, respectively the menu will be concluded, provided this was the cause of the transfer.

- if the dynamic limiting value test with scalable binary variables is to be implemented, then care has to be taken that in the case of variables where the PLC area is larger than the PCS area, the correct value („level“) is given by the PLC. Here is an example about it: the PCS value block is from 0..1000, and that of the PLC from 0..65535. The value 10 in the PCS display corresponds the value 721 in the PLC. Should the value 670 now be written by the PLC, then the menu could never be concluded as the value (655) written by the PCS still differentiates itself from 670.

7.3 Text groups

There exists 11 groups of texts that can be freely formulated. In the following outline the maximum number of texts and the maximum number of lines will be given. That doesn't mean that all the maximum values can be exploited. The maximum data record size is 128 kbytes and the texts are dynamically allocated. That means that non-filed texts will not occupy any memory space.

1. **256 OPERATING TEXTS:** 2 line texts, from which the first 128 will be used as DEFAULT TEXTS and all the remaining operating texts as MENU TEXTS.
2. **1024 MESSAGE TEXTS:** texts pages which can be up to 32 lines long. These texts are firmly allocated to the message bits and are displayed as REFERENCES, WARNINGS AND FAULTS.
3. **1024 HISTORY TEXTS.** These texts pages can be up to 32 lines and are shown with the display of the history memory. They are linked to the message texts.
4. **1024 MESSAGE PRINTER TEXTS.** These text pages are used for the printout of the message printer memory and are specifically print formulated.
5. **255 OPERATING PRINTER TEXTS.** These specifically print formulated texts can be numerically called in the PLC and immediately printed. The maximum line length is 132, and the maximum number of lines is 126.
6. **1 HELP TEX FOR THE DEAFULT PRIORITY** is a maximum 32 line long text page, which can be brought into ONLINE operation any time with the <HLP> key.
7. **256 HELP TEXTS FOR MENU PRIORITIES.**They can be allocated to the operating text numbers (max. 32 lines).
8. **1 HELP TEX FOR THE REFERENCE PRIORITY** with maximum 32 lines
9. **1 HELP TEX FOR THE WARNINGS PRIORITY** with maximum 32 lines
10. **1 HELP TEX FOR THE AULTS PRIORITY** with maximum 32 lines
11. **1 HELP TEX FOR THE HISDRY PRIORITY.** It can be reached during the display of the history memory with <HELP>, maximum 32 lines.

A so called DEFAULT TEXT can be formulated in every text group. This DEFAULT TEXT will first be displayed within the specified number block, if no main text has been filed under that requested number.

In the displayed texts which contain more than 2 lines it is possible to switch to the next display pages; also known as extra lines; by pressing the <ARROW-BELOW> key and then switching back to the first display page; also known as main lines by pressing the <ARROW-UPWARDS> key. The LED's shine in the arrow keys accordingly, when one leafing is possible. If a text only consists of an uneven line number, then the bottom line in the display is empty.

Texts, or respectively values, that can be amended within the text are realized through VARIABLE. Besides almost permanently having the variable values on the part of the PLC, at the ready there is therefore no recourse to have additional PLC programs. In all the priorities, the variables are cyclically refreshed.

Remark: This block text replaces the default texts of the PCS 200. The difference to that one is that here only one through going block is permitted. On reading-in the data record of the PCS 200, only the first found default text is read in as block text.

7.4 Menus/Menu layout

There are a total of 127 menus with the numbers 1 to 127 available. A menu consists of one or several nodes (1..255), whereby on operating text (0..255) must be allocated to each node.

Every menu is a collection of between 1 and maximum 255 menu points (nodes). The starting and ending of a menu is caused by the PLC. Any further switching on of the menu headings is left alone to the operator to decide.

A number is planned from 1 to 255 for every node. These numbers may be given out several times in various menus. The actual node number is shown in word 16, bit 8..15.

More nodes can be reached within a menu by means of the arrow keys, whereby the structure can be freely programmed. The first specified node is the initial node, respectively the start node. On calling the menu the operating text allocated to the start node is displayed.

Through the status of bit 7 of the command word C (W38), the operator can decide at any time whether nominal-P variables can be amended or not. If the bit 7 = 0, then only pure NOMINAL values can be amended. If the bit D7 = 1, then NOMINAL and NOMINAL-P variables can be amended.

If a NOMINAL-P value is focused (underlined) and bit 7 in word 38 is set to log. 0, then the focus finally finds itself on the first editable NOMINAL value of this display page. All the nominal and actual values which are not focused will be continually refreshed like actual values.

7.4.1 Starting the menus

The PLC program writes a menu number (1..127) on the lowest valued byte of the command word B (W38), bit 0..6.

The bit 7 of command word B (W38) decides every time whether or not a NOMINAL-P value may be amended or not. If the bit 7 is log. 0, and the current edited nominal value concerns a NOMINAL-P value, then the variable position will be quitted. If after focusing, the bit is 0, then a nominal-P variable will be dealt with like an actual value (jump over).

7.4.2 Quitting the menus

Quitting the menus is done through the PLC, whereby the menu number of the command word C (W38), i.e. the bits 0..6 are set to log. 0.

Quitting the menu is treated per standard as menu conclusion, i.e. an amended nominal value is written into the PLC by activating a key such as <ENTER>.

The menu can only first be left when an amended nominal value was read twice from the data block of the PLC and is in agreement with the previous written value*. Whereupon the PLC can recognize and reject closures or minimum and maximum excesses (dynamic testing of limiting values). If the nominal value is not taken over by the PLC, and thereby overwritten at once, the input field remains active (underlined) with the currently proposed variable value from the PLC. A menu can first be concluded after the comparison of the written nominal value with the read-in nominal value shows that they are in agreement. In order to indicate to the operator that this nominal value input is not reliable, a REFERENCE text could be displayed for example, which in turn, must be quitted with the <CLR> key. This quitting doesn't influence the nominal value at all. It is simply like an interruption.

An exception applies to nominal values, whose given value lies outside the limiting values; being presented as inverse fields. In so far as no editing is taking place, the menu can still be quitted.

Parameterisation of the PCS 900

The actual menu end can be recognized via the negative flank of bit 0 in word 16 (PCS status)

* only applies when standard values are inserted in the PCSPRO for menu options.

7.4.3 Building up the menus

Each of the maximum 127 possible menus (1..127) can possess a particular structure. If complex structures are to be involved, it is recommendable to proceed in the following way and separately for each menu:

- first of all the structure is put down on paper, whereby the node connections are joined together with various coloured lines. There is a different colour for each arrow key.
- finally an operating text number is allocated to each node. Similar operating texts can be entirely used in several menus. This also saves location !
- finally all the nodes are marked with any numbers between (1..255).
- in conclusion branches are formulated for each node, whereby all the parameters are taken from the drawing.

The programming of menu nodes in the PCSPRO is self-explanatory. The PCSPRO checks the credibility of the menu definition during the editing of the menus. Care is to be taken that menus do not contain unattainable nodes. Individually this means, that each menu node must be able to be reached from the start node. Apart from that there are no limitations, i.e. within every node, every arrow key can be allocated to a particular target node within the same menu.

In formulating the operating texts it is wise to conjure up an intelligent operating guide system. It is quite possible to have node points without variables which are to the exclusive advantage of the operating guide. Clarity should also be achieved by using the (programmable) special characters ARROW UPWARDS, ARROW DOWNWARDS as well as ARROW RIGHT and ARROW LEFT. For example \$18 = arrow upwards, \$19 = arrow downwards, \$1A = arrow right, \$1B = arrow left.

In so far as the arrow key LED's in the menus are released (bit 8 of command word B (W37) is log. 0), the operator is lead in addition, with optical displays, through the menu. If the arrow key LED shines statically, then it means that another variable within the same menu node can be selected. If an LED flashes, then activating this key will cause the currently displayed menu node to be quitted.

7.4.4 Variables in the menu

On calling a new menu or menu node, the first nominal value on having just been read out of the PLC, will first be presented underlined („frozen“). If this given value lies outside the defined limiting values, then inverse fields will be displayed instead of the nominal value. With just one touch on an editing key <CLR> (also partly <+> or <->,) a permitted value is presented. This applies, in so far as this particular value in the PLC is smaller than the minimum value, of the minimum value and is in the reversed situation with the maximum value.

If the given value was once amended, except for balancing inputs, then the input position is marked with a flashing cursor.

If the underline is continuous, then the variable is in the so called CLEAR mode. On activating an editing key, the EDIT mode is switched on. With the continual variable types BIT AND CSTRING, there is no EDIT mode, as writing back is done immediately after amendment. A further exception is the balancing input. After the calculation of the new intermediate result the variable is completely underlined, although the edit mode is active. After CLR, a switch back is made to the CLEAR mode and the initial value arising out of the PLC, is again displayed.



Attention!

As long as the cursor is flashing, it merely concerns the presentation of an intermediate result. That means that the current value being shown in the display is not in accord with the value in the control! Numerical values can also be amended in the addition or subtraction modes (also known as balancing inputs):

<Digit>, <Digit>, .. <Plus>, possible with BCD(0) and BIN(0)-1,2,A,B. After that the editor is again in the basic state (variables underlined). In this case it is at the same dealing with an intermediate result that still hasn't been written back!

In the same cycle in which the nominal value is written back, the word address in word 18 bits 8 to 15 is registered. In the lower valued byte, there is the number of bytes that were last written back. In the case of a bit variable, there is a 0 here and in word 19, the bit mask of the nominal value. Here is that particular bit position 1 at which the bit was amended. If word 18 in the PLC program is investigated, a nominal value amendment can be detected. It is recommended that after processing the nominal value, the word 18 is zeroed with the PLC program.

7.4.5 Arrow keys in the menus

It is permissible in a node to have arrow keys to further nodes as well as to a further variable. If a non-permissible arrow key is pressed, an acoustic error message rings, in so far as bit 8 of word 37 is log. 0. The permissible arrow keys will in addition be optically displayed, in so far as bit 8 of word 37 is log. 0. If an LED shines statically, then a further variable on the same display page can be selected. If on the other hand an LED flashes, then this node can be quitted.

If several nominal value variables are used in a text, they can be reached through the arrow keys. If there are several nodes in the activated menu, the arrow keys have a double significance (variable, node changeover). If this is not desired, then only one nominal value variable or one node per menu may be declared.

- **<ARROW LEFT> <RIGHT>:**

if several nominal value variables are used in a text, all the lines of a display page will be considered as lying alongside one another and the next variable will be sort after. In case the arrow key LED's are released, and a futher editable nominal value variable is on hand in the direction of the arrow, the LED will shine statically. If the actual variable happens to be the last or the first one, then the next node will be sort after. If this is to hand, then position will be taken up on the 1. variable top left. In case the arrow key LED's are released and a successive node is on hand in the arrow direction, this LED will flash. If there is no node there, then an acoustic error message will ring out after this key has been touched.

- **<ARROW DOWNWARDS> <UPWARDS>:**

if variables are distributed over several display lines, then the first variable (left) in that particular line will be selected which corresponds to the direction of the arrow. If the arrow key LED's are released, then the appertaining LED shines in this case. If there is no nominal value variable in this line, then the next node in the direction of the arrow will be sort after. In so far as the arrow key LED's have been released, then in this case the appertaining LED flashes. If there are no nodes there, an acoustic error message will follow on touching this key.

- **<ARROW-DOWNWARDS>**

in the last line is always looking for the next node. Otherwise the first editable variable of the subsequent line will be selected.

The ending of a menu can be recognized in word 16, bit 0. If the bit is log. 0, then the menu is no longer active. The precise time of the conclusion can be recognized through negative flank detection.

Parameterisation of the PCS 900

Operation of the Integrated Editors

Variable	Key	Function
BIT	PLUS	Sets a bit that was log. 0 to log. 1 (It's written at once into the PLC.)
	MINUS	Deletes a bit, that was log.1 to log. 0 (It's written at once into the PLC.)
	* ARROWS	Quits this variable if possible. Searches for the next variable or next node in the direction of the arrow.
STRING	* PLUS	Increments the value of a variable, as long as the value is within the limiting values.
	* MINUS	Decrements the value of a variable, as soon as the value is within the limiting values.
	CLR	Restores the previous value in the display; the last read-in value from the PLC.
	ENTER	Writes the selected value in the PLC, in so far as it was amended but not yet dispatched.
CSTRING	* ARROWS	Write the selected value in so far as it was amended and not yet dispatched and they search for the next variables, resp. the next menu nodes in the direction of the arrows
	* PLUS	Increments the value of a variable, as long as the value is within the limiting values (as opposed to STRING is at once written in the PLC).
	* MINUS	Decrements the value of a variable, as soon as the value is within the limiting values (as opposed to STRING is at once written in the PLC)
	CLR	Restores the previous value in the display; (the last read-in value from the PLC)
BCD-1 BCD-2 BCDO-1 BCDO-2	* ARROWS	Quits the variable, if permissible. Searches for the next variable or the next variable or next node in the direction of arrow.
	* PLUS/ MINUS	Adds/subtracts n within the limiting values (balanced input) whereby: * n = 1 if no digital input follows, i.e. * n = input value, if digital input is about to follow.
	CLR	Restores the previous value in the display (the last read-in value from the PLC)
	ENTER	Writes the selected value, in so far as it was amended and not yet dispatched
	* ARROWS	Writes the selected value, in so far as it was amended and not yet dispatched and they search for the next menu node in the direction of the arrow.
	* DIGITS	Enable direct input;

Variable	Key	Function
BIN-A	* PLUS/	adds/subtracts n within the limiting values
BIN-B	MINUS	(balanced input) whereby:
BINO-A		* n = 1 if no digital input follows, i.e.
BINO-B		* n = input value, if digital input is about to follow
	CLR	Restores the previous values in the value the last read-in value from the PLC)
	ENTER	Writes the selected value in the PLC, in so far as it was amended and not yet dispatched
	* ARROWS	Writes the selected value, in so far as it was amended and not yet dispatched and they search for the next variable, resp. the next menu node in the dir. of the arrow
	* DIGITS	Enable direct input; digits shoved from right to left (also beyond an actual decimal point)
BIN-1	* PLUS/	adds/subtracts n within the limiting values
BIN-2	MINUS	(balanced input) whereby:
BINO-1		* n = 1 if no digital input follows, i.e.
BINO-2		* n = input value, if digital input is about to follow
	CLR	Restores the previous values in the display; (the last read-in value from the PLC)
	ENTER	Writes the selected value in the PLC in so far as it was amended and not yet dispatched.
	* ARROWS	Writes the selected value, in so far as it was amended and not yet dispatched and they search for the next variable, resp. the next menu node in the dir. of the arrow
	* DIGITS	Enable direct input; digits are entered according to the pocket calculator principle
	(*)POINT	Changes to post comma positions, in so far as post comma positions are defined
VBIN-A	* PLUS	Gives the operational sign „ „
VBIN-B	* MINUS	Gives the operational sign „-“
VBINO-A	CLR	Restores the previous value in the display
VBINO-B		(the last read-in value from the PLC
	ENTER	Writes the selected value in the PLC, in so far as it was amended but not yet dispatched
	* ARROWS	Write the selected value in so far as it was amended and not yet dispatched and they search for the next variables, resp. the next menu nodes in the direction of the arrows.
	* DIGITS	Enable direct input; digits are shoved from right to left (even beyond an actual decimal point)
VBIN-1	* PLUS	Gives the operational sign „ „
VBIN-2	* MINUS	Gives the operational sign „-“
VBINO-1		
VBINO-2		
	CLR	Restores the previous value in the display (the last read-in value from the PLC)

Parameterisation of the PCS 900

Variable	Key	Function
	ENTER	Writes the selected value in the PLC, in so far as it was amended but not yet dispatched
	* ARROWS	Write the selected value in so far as it was amended and not yet dispatched and they search for the next variables, resp. the next menu nodes in the dir. of the arrows
	* DIGITS	Enable direct input; digits are entered according to the pocket calculator principle
	(*)POINT	Changes to post comma positions, in so far as post comma positions are defined
WORD	* PLUS	Moves the cursor one bit position to the right in the direction of the least significant bit LSB
	* MINUS	Moves the cursor one bit position to the left in the direction of the most significant bit MSB
	CLR	Restores the previous value in the display; (the last read-in value from the PLC)
	ENTER	Writes the selected value in the PLC, in so far as it was amended but not yet dispatched
	* ARROWS	Write the selected value in so far as it was amended and not yet dispatched and search for the next variables, resp. the next menu nodes in the dir. of the arrows
	* DIGITS	Only the keys <0> and <1> are useful: <0> sets one bit on 0 and moves the cursor ,if possible, one position to the right. If the cursor reaches the end of the variable, then it will be positioned on most significant bit (MSB) <1> sets the bit on 1 and moves the cursor , if possible, one position to the right. If the cursor reaches the end of the variable, then it will be positioned on the most significant bit (MSB)

Variable	Key	Function
ASCII	* PLUS	Presents the character with next highest presentable character code If the end of the character list is reached the first presentable character appears in the character table
	* MINUS	Presents the character with the next smallest presentable character code there If the beginning of the character code is the last character from the character list appears.
	CLR	Restores the previous value in the display (the last read-in value from the PLC)
	ENTER	Writes the selected value in the PLC, in so far as it was amended but not yet dispatched
	* ARROWS	Write the selected value in so far as it was amended and not yet dispatched and they search for the next variables, resp. the next menu nodes in the dir. of the arrows
	* POINT	Moves the cursor one position to the right. If the variable end has been reached, then the cursor will again be set on the first character of the variables.
	* DIGITS	Enables a direct input of the digits and switches the input position further.

* = Autorepeat

All the functions described here refer to the standard parameterization of the menu options.

7.5 Priority administration

In the PCS 900 several priorities can active at the same time (out of a total of 8). The respectively highest switched on and released priority receives the „focus“, i.e. it can put texts in the display and process keyboard codes. If a priority is switched off or blocked, the focus will be freshly delegated. Priorities which are blocked, work merely in the background. For example, despite this factor, message bits will be evaluated and the results will be registered in the history memory and in the printer message memory.

The behaviour of the PCS can be redirected out of the PCS status; which is made available in the PLC transfer block in the words 16 and 17, as well as in the locking bits in the command word A (W36); in the following manner:

- Word 16 (bit 0..7) displays all the switched on priorities, even if they are blocked and for the time being do not possess the focus.
- Word 17 (bit 12..15) shows the priority that is currently on view in the display. This is the highest valued active released priority.
- In the command word A (W37, bit 8..11) every priority with the exception of the default priority can be individually suppressed at any time. This can, for example, be so applied that a menu; so long as it is active; may not be interrupted by a Reference, Warning or Fault.

Activating the <HELP> key does not cause any priority change, as long as the key is depressed, the actual priority in question, retains the focus, which it also possessed before the activation of the key.

Parameterisation of the PCS 900

The locking of priorities may be carried out in the PLC at any time. It is however to be born in mind, that if this happens during the operation of the apparatus; such as the input of nominal values, the further switching in messages or history; can lead to unwelcome action. Therefore there is a 0.5 second blocked time interval during priority exchange. During this period every control or tenner key was rejected. During this time the accoustic warning signal rings after a key has been activated. (The conditions for this were: bit 11 of value 37 = 0).

7.5.1 ON/OFF switch conditions

The instructions for switching a priority ON or OFF are as follows:

lowest	0 =	DEFAULT TEXT	{Operating texts 0..127}
:		displayed if no higher priority is switched on	
:			
:	*)	1 = MENU	{Operating texts 0..255}
:		activated and concluded through the PLC (word 38 Bits 0-7)	
:	*)	2 = REFERENCE	{Message texts 0.1023}
:		activated through 0 → 1, transfer of at least one message bit, to which a text is allocated with the REFERENCE priority, deactivated according to each selected deletion behaviour of the corresponding REFERENCE message text	
:	*)	3 = WARNINGS	{Message texts 0.1023}
:		activated through 0 → 1, transfer of at least one message bit, to which a text is allocated with the	
:		WARNINGS priority, deactivated according to each selected deletion behaviour of the corresponding	
:		WARNINGS message text.	
:	*)	4 = FAULTS	{Message texts 0.1023}
:		activated through 0 → 1, transfer of at least one message bit, to which a text is allocated with the FAULTS priority, deactivated according to each selected deletion behaviour of the corresponding FAULTS message text.	
:		5 = HISTORY DISPLAY	{History texts 0.1023}
:		activated by setting bit 1 in word 36, deactivated by setting back bit 1 in word 36	
:		6 = not used at the moment	
:	**)	7 = ERROR PRIORITY	{fixed Text}
:		activated through interfaces or start test error mainly deactivated through PLC-RESET-command, PLC Stop/Run - transfer of fresh start	
:	*)	8 = OFFLINE-MENU activated through <HELP> + <CLR>	{fixed Text}

Highest (during live communication can be blocked through bit 15 in word 36)

***) This error incident is mainly given out by the drivers in the error word W3 of the PLC. The execution of this error word is determined by the particular driver and therefore to be gleaned from the corresponding manual PCS 91.x.

*) If the PLC communication isn't running, this is always attainable!

7.5.2 Default text priority

The operating texts 0..127 belong to this priority class (0). They can be applied as default texts. The operating texts can and are used in menus. The PLC alone decides as to which default text (bit 8..14 in word 38) is to be displayed and as to whether or not the default text should flash (bit 15 in word 38). The digit and control keys do not have any function here. If however they are activated, the acoustic error message is suppressed so that the control keys can be used for control tasks. An exception is the <HLP> key, which brings filed help texts in the default priority, onto the display. NOMINAL, NOMINAL-P- and ACTUAL values be applied as variables, though nominal values must not be entered. Every variable is cyclically refreshed up. The DEFAULT TEXT No.0 possesses a special place. It immediately appears after switching on the PCS, even if communication with the PLC was not yet started. If there is a variable in default text 0, then this variable will be replaced with a blank, until the variable can be read out of the PLC. This is an elegant way to check if the communication has been started. If a default text is chosen that was not filed, then the previous displayed default text remains active.

7.5.3 Menu priority

127 menus are ready to be used by this priority class (2). The menus are marked with numbers from 1..127. A menu consists of one or more nodes (1..255), whereby an operating text (0..255) must be allocated to each node.

A menu is called with the command word C (W38), bit 0..6.

The prerequisite for starting a menu priority is that a menu is programmed.

The actual node number is shown in word 16, bit 8..15 as status. More nodes can be reached within a menu using the arrow keys whereby the structure can be freely programmed. The first specified node is the initial node, respectively start node. On calling the menu, a spring is made to the initial node. Whether the nominal-P variable can be amended or not is determined by the bit 7 in word 14. If the bit 7 is log. 0, then only pure nominal value variables (NOMINAL) can be amended. If bit 7 is log. 1, then NOMINAL and NOMINAL-P variables can be amended. This bit can be amended by the PLC at any time, e.g. node dependent.

7.5.4 Message priorities

In these priority classes (2,3 and 4) texts are called by setting bits in the message block word 41 to maximum word 104. A MESSAGE TEXT with a maximum of 32 lines is allocated to each of the 1024 bits. An individual MESSAGE PRIORITY can be allocated to each one of the 128 texts. This is determined during programming. Here are details about it:

- **REFERENCE PRIORITY (Priority 2)**
- **WARNING PRIORITY (Priority 3)**
- **FAULT PRIORITY (Priority 4)**

These priority classes differentiate themselves only in the level of priority and not in the function. For every priority class however, there is an individual storage characteristic (word 12 bit 0..5) and an individual display characteristic (word 20 bit 0..5) which are controlled by the PLC and therefore liable to be switched over at any time. With reference to this matter, refer to the next chapter. If a message bit is set, to which no message text, no protocol text and no message printer text is filed, then there will be no reaction.

Parameterisation of the PCS 900

7.5.4.1 Storage characteristics

- **LAST VALUE MESSAGE WITHOUT MANUAL SELECTION POSSIBILITIES:** every 0 -> 1 transfer brings its text into the display at once. The previous entries remain in the memory. In case the latest message text is deleted, the next latest one will appear in the display.
- **LAST VALUE MESSAGE WITH MANUAL SELECTION POSSIBILITY:** the respectively latest text call is written into the display at once and a blocking period is started for the manual operation. After the blocking period is over, leaving can be done to the previous messages with the <ARROW LEFT> key and to the latest messages with the <ARROW RIGHT> key. The text entries can at any time be freely deleted; depending on their particular deletion characteristics; from the memory. If the bit 10 in word 37 is log. 0, then in so far as more than one message is active, the manual selection possibility is displayed including that with the left and right arrow key LED's.
- **CYCLICAL DISPLAY WITHOUT MANUAL SELECTION POSSIBILITY:** this kind of storage represents the FIRST VALUE MESSAGE. If however, several texts are switched on, then the entries roll in a cycle with a programmed rolling time. If a further switch on is made in the help text, then the rolling time will begin anew. In principle every deletion possibility is also possible here, however you are recommended to use deletion behaviour 1.

Example: The cyclical display is activated. Momentarily more than two messages of the same priority are active. All the messages are programmed with the deletion behaviour 2, therefore they can be deleted manually. The operator notices that the currently displayed message can be quitted and he/she presses the <CLR> key. Here, for example, at the same time, the cyclical display switches onto the next message and so the wrong message is quitted !

The written storage characteristics can be separately set for each priority at any time with the bits 0..5 in word 20 (Reference, Warning and Fault). Whereby a priority changeover can lead to an amendment of the storage characteristics, for example. The change of the storage characteristics only has a bearing on the presentation characteristic and not on the input characteristic. In order to avoid faulty operating, a blocking period of 0,5 seconds for the control keys is built in after the priority changeover.

- **FIRST VALUE MESSAGE WITH MANUAL SELECTION POSSIBILITY:** the first bit which has a positive flank (0 -> 1 transfer) puts its text into the display. If still further bits are inserted, then these texts can be reached with the key <ARROW RIGHT>. Switching back is achieved with the <ARROW LEFT> key. The text entries can at any time be freely deleted; depending on their particular deletion characteristics; from the memory. If the bit 10 in word 37 is log. 0, then in so far as more than one message is active, the manual selection possibility is displayed including that with the left and right arrow key LED's. The written storage characteristics can be separately set for each priority at any time with the bits 0..5 in word 20 (Reference, Warning and Fault). Whereby a priority changeover can lead to an amendment of the storage characteristics, for example. The change of the storage characteristics only has a bearing on the presentation characteristic and not on the input characteristic. In order to avoid faulty operating, a blocking period of 0,5 seconds for the control keys is built in after the priority changeover. STORAGE CHARACTERISTICS: These bits decide in which order of sequence the message memory of the PCS 900 should be displayed. They may be amended at any time and regardless of the time of day, an amendment will be taken into consideration in the display at once.
 - 00: last message without selection possibility
 - 01: last message with selection possibility
 - 10: cyclical display without selection possibility
 - 11: first message with selection possibility.

Basically an attempt is made, to enter the periodic appearance of the flanks into the correct time order of succession. >In order to preserve the time characteristic of machine operation, the messages are collected in blocks, each one with 128 bits. If more bits are set in a cycle, then the lower text numbers within the blocks have a higher priority.

7.5.4.2 Deletion characteristic

<p>The deletion characteristics of every message bit can be separately programmed. It is determined with the programming of PCSPRO. There are 5 forms of deletion:</p>
<p>Deletion characteristics 1, or deletion with the PLC:</p> <p>The text remains switched as long as the appertaining bit = 1.</p> <p>If the PLC sets bit back, the message text will be deleted. The bit is principally read by the PLC. The operating requirements-LED (?) is off.</p>
<p>Deletion characteristic 2, or manual deletion by setting back the message bit: the text is switched on by an 0 -> 1 transfer and can be quitted by <CLR>. Whereupon the message bit in the PLC is deleted as a result of the deleted message bit, the text is switched off.</p>
<p>A setting back of the message bit on the part of the PLC, has the same effect as pressing the <CLR> key.</p> <p>The message bit in the PLC program may only be set once for this deletion behaviour (- no continuous instructions ! -), otherwise after pressing <CLR>, the message will be displayed again.</p> <p>After activating the <CLR>, the operating requirements-LED (?) goes off at once.</p>
<p>Deletion characteristic 3, or manual deletion without setting back the message bit: the text is switched on by an 0->1 transfer. The switching off of the text is possible at any time and must be independant from the status of the message bit which is quitted by the <CLR> key. The message bit itself (in the PLC) must be set back by the PLC program. On activating the <CLR>, the operating requirements-LED (?) goes off at once.</p>
<p>Deletion characteristic 4, or manual deletion, if the message bit is 0. The text is switched on by an 0->1 transfer. The text can first be switched off by the <CLR> key, when the message bit has been set to 0 by the PLC. The state of the message bit is displayed by the operating requirements-LED (?):flashing: the bit is still log. 1, therefore deletion is not possible continuous light: the bit is log. 0, the message may be deleted.</p>
<p>Deletion characteristic 5 with quitting: with increasing flanks, the text is presented flashing and underlined. As long as the bit is 1, the underline remains. If CLR is activated, the flashing will stop.</p> <p>Deletion will first be done when the bit is again 0 and the CLR has been activated.</p>

Parameterisation of the PCS 900

7.5.4.3 Display characteristics

An individual display characteristic for the message priorities can be controlled at any time by the PLC.

There are four display characteristics:

- 00: the message text is static.
- 01: message text with flashing underline
- 10: flashing message text
- 11: flashing text with flashing underline

7.5.5 History display

The PCS 900 can save up to 128 messages. 2 separate memories are provided for the printer and display. An entry is made in the display memory, as soon as the times ARRIVED, DEPARTED, and QUITTED (only with deletion behaviour 3,4 and 5) are established. Both memories can overwrite themselves, i.e. an entry is always possible. However it cannot be guaranteed that the presentation of the stored messages is perfect. In order to facilitate an analysis, the variable [HISTORY_INDEX] is applied, which will give a consecutive number from 0 to 65535 to each entry.

The HISTORY TEXTS are entered. If no specific history text is requested, the corresponding lines of the message text can be reached using the variable [MSGTXT_LINE01] to [MSGTXT_LINE32]. Thereby a general formular for all messages can be created by formulating the HISTORY BLOCK TEXT. It is to be noted, however, that external variables are not displayed. Actually it is possible to show these continually updated in the history help text.

7.5.5.1 Activating the history display

Several requirements have to be fulfilled for this:

- bit 1 on word 36 (activating bit) must be 1.
- bit 12 on word 36 (locking bit) must be 1.
- at least one message must have been entered into the memory. This can be read in bit 11 of word 13: a log. 1 indicates to messages in the protocol memory.

If the word 36, bit 1 of 0 goes to 1, the last entered message will be abandoned. Using <ARROW_LEFT> leafing can be done in the direction of older messages. If there are any of these, the arrow left LED shines. Using the <ARROW_RIGHT> leafing can be done in the direction of more recent messages. If the priority (6) is closed (word 36 bit 12) then the next smaller and active priority will be displayed. The 1 after 0-transfer of the bit 1 in word 36 switches off the display of history memory again.

7.5.5.2 Variables in the history memory

The following variables are saved:

- The text number [TEXT NUMBER]
- The ident number [HISTORY_INDEX]
- Date and Time [TIME_MSG_COMES]
- Date and Time [TIME_MSG_QUITT]
- Date and Time [TIME_MSG_GOES]
- [MSGTEXT_LINE01] to [MSGTEXT_LINE32]

All other displayed variables are being continually refreshed. Variables which are not displayed will only be represented with blanks.

7.5.5.3 Deletion of the history memory

The history memory can be deleted with the positive flanks of bit 12 in word 37 (command word B). The ident number [HISTORY_ENTER] begins again with 0. In bit 12 word 13 is recognizable, when the PCS has recognized the deletion command.

7.5.6 Communications error priority

The priority level (7) described here is administered by the PLC driver. The appertaining texts cannot be amended. The headlines are the same for every driver, the significance of the second line is explained in the appertaining driver manual.

This priority is activated as soon as the first flowing communication with the PLC has been interrupted.

```
===== COMMUNICATION ERROR =====
XXXXXXXXXXXXXXXXXXXXXXXXXXXX
```

The ending of this priority is only possible with the fresh start of the communication at the PLC.

7.5.7 Offline menu

This priority (8) is attainable with continuous communication via the key combination <HELP> <CLR>, providing that has been released with bit 15 = log. 1 in word 36 (command word A) (bit = 1). This priority is a preliminary stage to the actual OFFLINE MENU, that can only work WITHOUT continuous communication. A safety inquiry (in a fixed English text) follows, which must be confirmed with <ENTER>. Every other key concludes this priority.

Attention!

If confirmation is done with ENTER, the communication will be interrupted at once. After returning from the OFFLINE MENU, a fresh start is carried out. In addition a communication fresh start must be released from the PLC!

Parameterisation of the PCS 900

7.6 Printer

The printer output of the PCS 900 covers the following work places:

- **OPERATING PRINTER**

255 numerically different printer texts in word 40 will any amount of variables can be called up for this printer. The next is printed out as soon as possible. This call is not saved.

- **MESSAGE PRINTER**

Here messages, similar to those in the history memory, are saved. They are later printable (on a continuous basis too). The memory comprises 1024 messages. These messages cannot contain any PLC variables. The memory is at a fixed low-voltage, and on the command of the PLC it can be printed out forwards or backwards as well as several times too. The relevant control addresses are word 37 (command word B), word 39 (command word D), as well as the status in the words 13, 14, and 15.

The print output of the OPERATING PRINTER is considered to be of a higher priority than that of the MESSAGE PRINTER, i.e. that an OPERATING PRINTER order will also be treated between the individual MESSAGE PRINTER pages.

7.6.1 Printer texts

The printer texts (OPERATING and MESSAGE PRINTER) may contain every text except H00. Within the PCSPRO the input line is limited to 132 characters and the number of lines to 126. The actual line length on the printer is determined by the explicit inserted printer control character.

For simplification, the pseudo variables <TAB, <LF>, <FF>, Fe >, <Un > and <Un-> can be inserted. These represent 8 separate (in Hex) editable character strings of maximum 8 characters.

- **VARIABLES IN MESSAGE PRINTER TEXTS**

The following variables are saved:

- **[TEXT NUMBER]: message number**
- **[PRINTER_INDEX]: ident number from 0 to 9999**
- **[TIME_MSG_COMES]**
- **[TIME_MSG_GOES]**
- **[TIME_MSG_QUITT]**
- **[MSGTXT_LN1] to [MSG_TXT_LN32]**

The remaining printable variables are read at the time of printing. Variables that cannot be printed; e.g. variables in message text lines; are presented as blanks with their specific lengths.

- **VARIABLES IN OPERATING PRINTER TEXTS**

Here all the PLC variables and all the internal variables may be used, which do not refer to messages.

7.6.2 Message printer

7.6.2.1 Message registration

An registration is basically linked to the messages. The registration can be severed with bit 14 in word 37 (command word B) (bit = 1: ignore registration). A return message of this bit is in bit 14 of word 13. In order to that the print output can be individually adapted, every message printer text contains several attributes:

- **ARRIVED**

The text is registered as soon as a positive flank of the message bit is recognized. In this text, only the ARRIVED time is appropriate.

- **DEPARTED**

The text is registered on the negative flank of the message bit (independent of the deletion characteristics). The variable [TIME_MES_QUITS] is not useful or respectively, valid in all deletion characteristics.

- **QUITTED**

The text is registered by activating the <CLR> (only with deletion characteristics 2..5). Eventually the [TIME_MSG_GOES] is not valid here.

It is also possible not to select any of these attributes. In this case there is no registration. If more than one attribute is set, then there will be a multiple registration of the same text.

And even to plan in the background, the following conditions must be fulfilled:

- No displayable message text may be planned (even the block text may not be covered by this number).
- In the message printer text, either the attribute ARRIVED or DEPARTED is to be set. As a variable, respectively only [TIME_MSG_COMES] or [TIME_MSG_GOES] is valid.

If only the ARRIVED attribute is set, then during background logging, the PCS sets the corresponding message bit back into the PLC.

In order to improve orientation in the protocol memory, the number of older messages in W14 and the number of fresher messages in W15 are made available in the PLC. The sum of both values gives the number of messages currently in the message protocol memory. These values are independent of the printing direction. If the bit 13 from command word B is log. 0 (FIFO principle), then the number of messages still to be printed is in word 15. If bit 13 from command word B is log. 1 (LIFO principle), then the number of messages still to be printed is in word 14.

- **RING MEMORY**

If the message protocol memory should actually become full (that would be 1024 messages), every fresh entry overwrites the old one. Should the overwritten entry be that particular one that should be immediately printed, then this printout is carried out to the full, and depending on the printing direction, the next relevant entry is dealt with or the printing order is concluded. It is only possible to write a correct log using the variable [PRINTER_INDEX].

7.6.3 Operating printer

Writing is done straight onto the printer with this print control. This is initiated by an operating printer text number > 0 in the command word E (word 40). When the task is completed, the PCS 900 sets this word back to 0. If an operating printer text is to be printed, so long as the message printer is running, then the operating printer is taken into consideration at the end of each message. Finally the message printer is handled again.

Parameterisation of the PCS 900

7.6.4 Printout

Differentiation must be made between the CHARACTER and SIDE protocols. As every printer is not always temporarily ready to accept oncoming characters, there must exist a time orientated handshake on the interface. The PLC takes over the page protocol. It will be decided from a message orientation point of view, as to which protocol entry should be printed.

EVERY PRINTOUT MUST BE RELEASED BY THE SPS



7.6.4.1 LOW-LEVEL protocol

There are two procedure which can be applied here:

- **XON/XOFF (with RS232 and TY)**

The printer sends XOFF if there's no readiness and XON if there's readiness. After the start of a new run, the PCS fundamentally chooses printer readiness. Pulling the printer cable out during the XOFF phase can lead to the PCS will never again receiving XON. Therefore temporarily connected printers can cause difficulties. Some printers offer the so called PERMANET XON as a safeguard, i.e. every 2 seconds XON is repeated with printer readiness.

XON/XOFF offers the advantage, of fulfilling its task without need for the extra handshake leads, enabling the TTY operation to be possible.

- **RTS/CTS (only with RS 232)**

The printer outlet RTS is connected to the CTS inlet of the PCS 900 printer interface. On some printers this signal is also referred to as BUSY signal. A HIGH potential enables the printer outlet to be free. If however, the printer is removed, the printout is retained.

Owing to the additional control lead, the RS 232 configuration must be selected (without potential separation). The following signals will be required by the PCS-lateral:

TXD	Dispatch date
CTS	Handshake
GND	0 Volt (identical with 0 volt supply voltage)
SCHIRM	identical with shell (no 0 volt !)

7.6.4.2 Page protocol (message printer)

Here the print order must be conferred, the print direction determined, the print order released and eventually the printer indicator adjustment. Thereupon the entire printing procedure can be adapted to the customer's specific requirements with just a few PLC lines. The following tools are available in word 37 (command word b), word 39 (command word D) and word 40 (command word E):

- **PRINTER CANCELLATION (W 37 BIT 15)**

This bit; if it is log. 1; terminates every current order in print and every indicator setting. The command word D (word 39) is zeroed through PCS and nothing is carried out.

- **PRINTER DIRECTION (W 37 BIT 13)**

This bit decides on the direction of the print and the adjustment of the indicator:

- * log. 1 (LIFO). The printer prints in the direction of older messages. Indicator orders (negative value on command word D = word 37) is in the direction of more recent messages.
- * log. = (FIFO). The printer prints the messages in the order or sequence as entering (in the direction of more recent messages). Indicator orders ensue in the direction of the older messages (negative value on command word D = word 37). The PCS only reads this bit in connection with a new print/indicator order; intermediate amendments are ignored.

- **PRINT / INDICATOR ORDER (Wbrd 39)**

A preoperational afflicted value must be written on this word in order to release a corresponding action. If the order is completed or the end of the log memory is attained, then the PCS sets the value to 0. This however, is only useful if bit 15 of word 37 (command word B) is log. 0.

- **POSITIVE VALUE**

releases a print order. The value are is 1 to 32767 (KH0001 to KH 7FFF).

- **NEGATIVE VALUE**

releases an indicator adjustment. The direction is determined by BIT 13. The value area is -32767 to -1 (KH8001 to KHFFFF).

* -32768

releases the deletion of the entire log memory (KH8000). Finally 0 new and 0 old messages are registered in W14 and W15.



Att ention!

Every print order and every indicator adjustment ceases AT ONCE on switching off the PCS 900!

Parameterisation of the PCS 900

7.7 Timer

There are 8 automatic time switches available in word 13, bits 0..7 of the PCS 900. Each one of these automatic time switches has up to 8 cams. There is a switch-on time and switch-off time for each cam. The times repeat themselves daily. The specifications include hours, minutes and seconds. The 8 cams are aligned in a bit and then transferred as a complete byte. Transfer only occurs if there's an adjustment or a communication fresh start. In the PLC there must be an appropriate preoccupation in case there is a break in communications. The switching-on and switching-off time can be appointed in advance. If the respective times are used as nominal values in menus, such as variables, [NODE_NUMBER], [AUTO_ON/OFF_HRS/MINS/SECS], then they can be amended to ONLINE in addition. The amended values remain in the fixed low-voltage RAM. The following are applicable to the values:

- **SWITCH-ON TIME = SWITCH-OFF TIME**

This cam is not taken into consideration

- **SWITCH-ON TIME < SWITCH-OFF TIME**

In the daytime this cam is log. 1, the last possible switch-off time is 23:59:59 hrs.

- **SWITCH-ON TIME > SWITCH-OFF TIME**

This cam is active from the switch-on time to midnight and beyond until the switch-off time the following day. As the situation must be continually evaluated, a position on the clock is immediately apparent as soon as the cam is relinquished.

Attention!

This applies in the same way when amending the on/off switch time. That means that when the on/off switch time is amended, it leads to the immediate setting/or setting back of the cams. In order to be able to define an unmistakable on/off switch time, you should not evaluate the cams during the setting of the menu nodes.



7.8 Alarm outlet/contact

There is a non-potential relais contact available between the connectors 6 and 7. These are closed when all of the following requirements have been fulfilled:

- The PCS 900 has been switched on and has an operating voltage.
- Communication to the PLC is in operation.
- There is at least one message switched on under the nomenclature alarm contact.
- And the release bit, bit 3 in word 36, command word A, is on log.1

If one of these requirements is absent, then the contact remains open.

7.9 Real time clock

Usually the time and date are freely disposable in words 9 to 12 in the PLC. If the PLC possesses its own real time clock, the PCS clock can be synchronized to it. For this bit 6 and 5 in word 36 must first be set to 1 (transfer block). If an 0->1 transfer is set on bit 0, then the PCS reads the time, date and weekday from the PLC one cycle later, goes on to amend the internal clock accordingly and sets bit 0 in word 36 back.

7.10 Operation time clock

The fixed low-voltage driven operation time clock in the PCS is presented by the internal variable [OPR_HRS_ACT]. On switching on the device it is checked to make sure it works. If it isn't working, an English written error text appears in the display simultaneously to the switch on. In an emergency, the operating hours can be set by the internal variable [OPR_HRS_NOMINAL]. The operation time clock only runs as long as the communication to the PLC is running and bit 1 from word 36 is set.

Driving the PCS 900

Driving the PCS 900 is done via a transfer block, which has a maximum of 256 words and is in the PLC. The PLC controls all the functions of the PCS with these words. It grabs „writing“ and „reading“ onto this data. The control of the communication between PLC and PCS is organized by the accompanying operating software and explained by the manual PCS 91.x along with it. Safeguarding data and communication protocol is taken over by the communication processor (e.g. PCS 810-1), respectively the operating system of the PLC and the PCS.

As the transfer area; for example, with regard to length, size, and functionality; is dependent on the parameterized driver, then the corresponding „Driver Manual PCS 91.x“ should be used as well.

Basically two data exchange principles are made available:

The first principle of data exchange is the expander driver (example : L1). Data exchange occurs via the dispatch and reception department. Here the PCS writes the „orders“ and reads the answer dates. In order to carry out this „task“ in the transfer area, you need an expander program in the PLC. This expander program can considerably overburden the cycle time. The exchanged amount of data is small and the speed of the communication reaction is fast. Access to the transfer area can occur at any time, except by interrupting the program. This principle lends itself to the PLC system which can indirectly address and whose cycle time is of no great significance. The second principle is the direct driver (example: AS511). This type of driver writes and reads directly into the transfer area of the PLC. Thereupon there is no need for an expander program in the PLC. The amount of exchanged data is therefore large and the communication reaction time slower. As the exchange is not synchronized to the PLC cycle, then access to the transfer area in the PLC program may only be done synchronized. Synchronisation is done through a word from transfer area. The encumbrance to the PLC cycle time is small. This principle is used in systems which do not have indirect addressing or with those that must have a minimum encumbrance to the cycle time.

1. System Area: W0..3

W0..2 applied internally, barred to the user

W3 Error word for the communication. For details see „Driver manual“ PCS 91.x

2. Status Area: Status PCS is written in the PLC.

Keys

W4 Key bits [F1..F8], [F9..F10], [AR.DOWN], [AR.ABOVE], [AR.RIGHT], [AR.LEFT], [-], []

W5[F11-F20], [CLR], [ENTER], DIL 4-1

[HELP], [.] , [9..0], Reserve

W6-W7 Rest

Time and Date

W9-12 Year, month, day, weekday, hour, minute, second

PCS Status

W13-17 Receipt bits, time switch, (W14) number of old printer messages, (W15) number of new printer messages, (W16) node numbers, priority status, (W17), numerical priority, text number in the display.

Nominal value status

W18-19 Data word number, length, (W19), bit mask

3. Command area: (read from the PLC)**LED Status, Display and Memory Modes**

W20 LED-Drive F1..F10, green display mode messages,
W21 LED-Drive F1..F10, flashing green storage modes messages
W22,23 LED-Drive F1..F10 red, flashing red
W22,23 LED-Drive F11..F20, green, flashing green
W26,27 LED-Drive F11..F20, red, flashing green, rest reserve
W28..35 Reserve

Command Wrds

W36 Release priorities transfer block activation of priorities
W37 Printer Drive, Blocking for specific LEDs message block transfer
W38 Default text number menu number
W39 Print order
W40 Operating printer-text number

4. Message area: W41..110**Message Blocks**

W41-48 Block 1
W49-56 Block 2
W57-64 Block 3
W65-72 Block 4
W73-80 Block 5
W81-88 Block 6
W89-96 Block 7
W97-104 Block 8

5. Extension areas: W105..109

The area is reserved for future possible extensions

6. Variables area: W30..255

W105...255 free for variables

Driving the PCS 900

8.1 Brief review of the transfer area

W4	<table border="1"> <tr><td>15</td><td>14</td><td>13</td><td>12</td><td>11</td><td>10</td><td>9</td><td>8</td></tr> <tr><td>F1</td><td>F2</td><td>F3</td><td>F4</td><td>F5</td><td>F6</td><td>F7</td><td>F8</td></tr> </table>	15	14	13	12	11	10	9	8	F1	F2	F3	F4	F5	F6	F7	F8	<table border="1"> <tr><td>7</td><td>6</td><td>5</td><td>4</td><td>3</td><td>2</td><td>1</td><td>0</td></tr> <tr><td>F9</td><td>F10</td><td>▲</td><td>▼</td><td>▶</td><td>◀</td><td>-</td><td>+</td></tr> </table>	7	6	5	4	3	2	1	0	F9	F10	▲	▼	▶	◀	-	+
15	14	13	12	11	10	9	8																											
F1	F2	F3	F4	F5	F6	F7	F8																											
7	6	5	4	3	2	1	0																											
F9	F10	▲	▼	▶	◀	-	+																											
W5	<table border="1"> <tr><td>15</td><td>14</td><td>13</td><td>12</td><td>11</td><td>10</td><td>9</td><td>8</td></tr> <tr><td>F11</td><td>F12</td><td>F13</td><td>F14</td><td>F15</td><td>F16</td><td>F17</td><td>F18</td></tr> </table>	15	14	13	12	11	10	9	8	F11	F12	F13	F14	F15	F16	F17	F18	<table border="1"> <tr><td>7</td><td>6</td><td>5</td><td>4</td><td>3</td><td>2</td><td>1</td><td>0</td></tr> <tr><td>F19</td><td>F20</td><td>CLR</td><td>ENT</td><td>DIL4</td><td>DIL3</td><td>DIL2</td><td>DIL1</td></tr> </table>	7	6	5	4	3	2	1	0	F19	F20	CLR	ENT	DIL4	DIL3	DIL2	DIL1
15	14	13	12	11	10	9	8																											
F11	F12	F13	F14	F15	F16	F17	F18																											
7	6	5	4	3	2	1	0																											
F19	F20	CLR	ENT	DIL4	DIL3	DIL2	DIL1																											
W6	<table border="1"> <tr><td>15</td><td>14</td><td>13</td><td>12</td><td>11</td><td>10</td><td>9</td><td>8</td></tr> <tr><td>X</td><td>X</td><td>X</td><td>X</td><td>HLP</td><td>•</td><td>9</td><td>8</td></tr> </table>	15	14	13	12	11	10	9	8	X	X	X	X	HLP	•	9	8	<table border="1"> <tr><td>7</td><td>6</td><td>5</td><td>4</td><td>3</td><td>2</td><td>1</td><td>0</td></tr> <tr><td>7</td><td>6</td><td>5</td><td>4</td><td>3</td><td>2</td><td>1</td><td>0</td></tr> </table>	7	6	5	4	3	2	1	0	7	6	5	4	3	2	1	0
15	14	13	12	11	10	9	8																											
X	X	X	X	HLP	•	9	8																											
7	6	5	4	3	2	1	0																											
7	6	5	4	3	2	1	0																											
W7	<table border="1"> <tr><td>15</td><td>14</td><td>13</td><td>12</td><td>11</td><td>10</td><td>9</td><td>8</td></tr> <tr><td colspan="8">Keys reserved</td></tr> </table>	15	14	13	12	11	10	9	8	Keys reserved								<table border="1"> <tr><td>7</td><td>6</td><td>5</td><td>4</td><td>3</td><td>2</td><td>1</td><td>0</td></tr> <tr><td colspan="8">Keys reserved</td></tr> </table>	7	6	5	4	3	2	1	0	Keys reserved							
15	14	13	12	11	10	9	8																											
Keys reserved																																		
7	6	5	4	3	2	1	0																											
Keys reserved																																		
W8	<table border="1"> <tr><td>15</td><td>14</td><td>13</td><td>12</td><td>11</td><td>10</td><td>9</td><td>8</td></tr> <tr><td colspan="8">Keys reserved</td></tr> </table>	15	14	13	12	11	10	9	8	Keys reserved								<table border="1"> <tr><td>7</td><td>6</td><td>5</td><td>4</td><td>3</td><td>2</td><td>1</td><td>0</td></tr> <tr><td colspan="8">Keys reserved</td></tr> </table>	7	6	5	4	3	2	1	0	Keys reserved							
15	14	13	12	11	10	9	8																											
Keys reserved																																		
7	6	5	4	3	2	1	0																											
Keys reserved																																		
W9	<table border="1"> <tr><td>15</td><td>14</td><td>13</td><td>12</td><td>11</td><td>10</td><td>9</td><td>8</td></tr> <tr><td colspan="4">Mi enium</td><td colspan="4">Century</td></tr> </table>	15	14	13	12	11	10	9	8	Mi enium				Century				<table border="1"> <tr><td>7</td><td>6</td><td>5</td><td>4</td><td>3</td><td>2</td><td>1</td><td>0</td></tr> <tr><td colspan="4">Decade</td><td colspan="4">Year</td></tr> </table>	7	6	5	4	3	2	1	0	Decade				Year			
15	14	13	12	11	10	9	8																											
Mi enium				Century																														
7	6	5	4	3	2	1	0																											
Decade				Year																														
W10	<table border="1"> <tr><td>15</td><td>14</td><td>13</td><td>12</td><td>11</td><td>10</td><td>9</td><td>8</td></tr> <tr><td colspan="4">Month (tens)</td><td colspan="4">Month (digits)</td></tr> </table>	15	14	13	12	11	10	9	8	Month (tens)				Month (digits)				<table border="1"> <tr><td>7</td><td>6</td><td>5</td><td>4</td><td>3</td><td>2</td><td>1</td><td>0</td></tr> <tr><td colspan="4">Day (tens)</td><td colspan="4">Day (digits)</td></tr> </table>	7	6	5	4	3	2	1	0	Day (tens)				Day (digits)			
15	14	13	12	11	10	9	8																											
Month (tens)				Month (digits)																														
7	6	5	4	3	2	1	0																											
Day (tens)				Day (digits)																														
W11	<table border="1"> <tr><td>15</td><td>14</td><td>13</td><td>12</td><td>11</td><td>10</td><td>9</td><td>8</td></tr> <tr><td colspan="8">Day of week (01...07)</td></tr> </table>	15	14	13	12	11	10	9	8	Day of week (01...07)								<table border="1"> <tr><td>7</td><td>6</td><td>5</td><td>4</td><td>3</td><td>2</td><td>1</td><td>0</td></tr> <tr><td colspan="8">hour (00...23)</td></tr> </table>	7	6	5	4	3	2	1	0	hour (00...23)							
15	14	13	12	11	10	9	8																											
Day of week (01...07)																																		
7	6	5	4	3	2	1	0																											
hour (00...23)																																		
W12	<table border="1"> <tr><td>15</td><td>14</td><td>13</td><td>12</td><td>11</td><td>10</td><td>9</td><td>8</td></tr> <tr><td colspan="8">Minute (00...59)</td></tr> </table>	15	14	13	12	11	10	9	8	Minute (00...59)								<table border="1"> <tr><td>7</td><td>6</td><td>5</td><td>4</td><td>3</td><td>2</td><td>1</td><td>0</td></tr> <tr><td colspan="8">Second (00...59)</td></tr> </table>	7	6	5	4	3	2	1	0	Second (00...59)							
15	14	13	12	11	10	9	8																											
Minute (00...59)																																		
7	6	5	4	3	2	1	0																											
Second (00...59)																																		
W13	<table border="1"> <tr><td>15</td><td>14</td><td>13</td><td>12</td><td>11</td><td>10</td><td>9</td><td>8</td></tr> <tr><td>Pr. Stop</td><td>Log Stop</td><td>Lifo</td><td>Hist. del.</td><td>Hist. arriv.</td><td>Pr. bu. full</td><td>Hist. bu. full</td><td>Re-served</td></tr> </table>	15	14	13	12	11	10	9	8	Pr. Stop	Log Stop	Lifo	Hist. del.	Hist. arriv.	Pr. bu. full	Hist. bu. full	Re-served	<table border="1"> <tr><td>7</td><td>6</td><td>5</td><td>4</td><td>3</td><td>2</td><td>1</td><td>0</td></tr> <tr><td>S7</td><td>S6</td><td>S5</td><td>S4</td><td>S3</td><td>S2</td><td>S1</td><td>S0</td></tr> </table>	7	6	5	4	3	2	1	0	S7	S6	S5	S4	S3	S2	S1	S0
15	14	13	12	11	10	9	8																											
Pr. Stop	Log Stop	Lifo	Hist. del.	Hist. arriv.	Pr. bu. full	Hist. bu. full	Re-served																											
7	6	5	4	3	2	1	0																											
S7	S6	S5	S4	S3	S2	S1	S0																											
W14	<table border="1"> <tr><td>15</td><td>14</td><td>13</td><td>12</td><td>11</td><td>10</td><td>9</td><td>8</td></tr> <tr><td colspan="8">Number of old printer messages (high byte)</td></tr> </table>	15	14	13	12	11	10	9	8	Number of old printer messages (high byte)								<table border="1"> <tr><td>7</td><td>6</td><td>5</td><td>4</td><td>3</td><td>2</td><td>1</td><td>0</td></tr> <tr><td colspan="8">Number of old printer messages (low byte)</td></tr> </table>	7	6	5	4	3	2	1	0	Number of old printer messages (low byte)							
15	14	13	12	11	10	9	8																											
Number of old printer messages (high byte)																																		
7	6	5	4	3	2	1	0																											
Number of old printer messages (low byte)																																		
W15	<table border="1"> <tr><td>15</td><td>14</td><td>13</td><td>12</td><td>11</td><td>10</td><td>9</td><td>8</td></tr> <tr><td colspan="8">Number of new printer messages (high byte)</td></tr> </table>	15	14	13	12	11	10	9	8	Number of new printer messages (high byte)								<table border="1"> <tr><td>7</td><td>6</td><td>5</td><td>4</td><td>3</td><td>2</td><td>1</td><td>0</td></tr> <tr><td colspan="8">Number of new printer messages (low byte)</td></tr> </table>	7	6	5	4	3	2	1	0	Number of new printer messages (low byte)							
15	14	13	12	11	10	9	8																											
Number of new printer messages (high byte)																																		
7	6	5	4	3	2	1	0																											
Number of new printer messages (low byte)																																		

W16	<table border="1"> <thead> <tr><th>15</th><th>14</th><th>13</th><th>12</th><th>11</th><th>10</th><th>9</th><th>8</th></tr> </thead> <tbody> <tr><td></td><td></td><td></td><td colspan="3">RESERVED</td><td></td><td></td></tr> </tbody> </table>	15	14	13	12	11	10	9	8				RESERVED					<table border="1"> <thead> <tr><th>7</th><th>6</th><th>5</th><th>4</th><th>3</th><th>2</th><th>1</th><th>0</th></tr> </thead> <tbody> <tr><td>Offl activ</td><td>Re- serve</td><td>Re- cipe- activ*)</td><td>Hist- ory</td><td>Fail- ures</td><td>War- nings</td><td>Infor- mation</td><td>Menu</td></tr> </tbody> </table>	7	6	5	4	3	2	1	0	Offl activ	Re- serve	Re- cipe- activ*)	Hist- ory	Fail- ures	War- nings	Infor- mation	Menu																
15	14	13	12	11	10	9	8																																											
			RESERVED																																															
7	6	5	4	3	2	1	0																																											
Offl activ	Re- serve	Re- cipe- activ*)	Hist- ory	Fail- ures	War- nings	Infor- mation	Menu																																											
W17	<table border="1"> <thead> <tr><th>15</th><th>14</th><th>13</th><th>12</th><th>11</th><th>10</th><th>9</th><th>8</th></tr> </thead> <tbody> <tr><td>8</td><td>4</td><td>2</td><td>1</td><td>X</td><td>X</td><td>512</td><td>256</td></tr> <tr><td colspan="4">Displayed priority</td><td colspan="4">Text no. on displ. (high)</td></tr> </tbody> </table>	15	14	13	12	11	10	9	8	8	4	2	1	X	X	512	256	Displayed priority				Text no. on displ. (high)				<table border="1"> <thead> <tr><th>7</th><th>6</th><th>5</th><th>4</th><th>3</th><th>2</th><th>1</th><th>0</th></tr> </thead> <tbody> <tr><td>128</td><td>64</td><td>32</td><td>16</td><td>8</td><td>4</td><td>2</td><td>1</td></tr> <tr><td colspan="8">Text number on display (low byte)</td></tr> </tbody> </table>	7	6	5	4	3	2	1	0	128	64	32	16	8	4	2	1	Text number on display (low byte)							
15	14	13	12	11	10	9	8																																											
8	4	2	1	X	X	512	256																																											
Displayed priority				Text no. on displ. (high)																																														
7	6	5	4	3	2	1	0																																											
128	64	32	16	8	4	2	1																																											
Text number on display (low byte)																																																		
W18	<table border="1"> <thead> <tr><th>15</th><th>14</th><th>13</th><th>12</th><th>11</th><th>10</th><th>9</th><th>8</th></tr> </thead> <tbody> <tr><td>128</td><td>64</td><td>32</td><td>16</td><td>8</td><td>4</td><td>2</td><td>1</td></tr> <tr><td colspan="8">Data word preset value</td></tr> </tbody> </table>	15	14	13	12	11	10	9	8	128	64	32	16	8	4	2	1	Data word preset value								<table border="1"> <thead> <tr><th>7</th><th>6</th><th>5</th><th>4</th><th>3</th><th>2</th><th>1</th><th>0</th></tr> </thead> <tbody> <tr><td>X</td><td>X</td><td>X</td><td>16</td><td>8</td><td>4</td><td>2</td><td>1</td></tr> <tr><td colspan="8">Preset value length byte</td></tr> </tbody> </table>	7	6	5	4	3	2	1	0	X	X	X	16	8	4	2	1	Preset value length byte							
15	14	13	12	11	10	9	8																																											
128	64	32	16	8	4	2	1																																											
Data word preset value																																																		
7	6	5	4	3	2	1	0																																											
X	X	X	16	8	4	2	1																																											
Preset value length byte																																																		
W19	<table border="1"> <thead> <tr><th>15</th><th>14</th><th>13</th><th>12</th><th>11</th><th>10</th><th>9</th><th>8</th></tr> </thead> <tbody> <tr><td>15</td><td>14</td><td>13</td><td>12</td><td>11</td><td>10</td><td>9</td><td>8</td></tr> <tr><td colspan="8">Bit mask high byte</td></tr> </tbody> </table>	15	14	13	12	11	10	9	8	15	14	13	12	11	10	9	8	Bit mask high byte								<table border="1"> <thead> <tr><th>7</th><th>6</th><th>5</th><th>4</th><th>3</th><th>2</th><th>1</th><th>0</th></tr> </thead> <tbody> <tr><td>7</td><td>6</td><td>5</td><td>4</td><td>3</td><td>2</td><td>1</td><td>0</td></tr> <tr><td colspan="8">Bit mask low byte</td></tr> </tbody> </table>	7	6	5	4	3	2	1	0	7	6	5	4	3	2	1	0	Bit mask low byte							
15	14	13	12	11	10	9	8																																											
15	14	13	12	11	10	9	8																																											
Bit mask high byte																																																		
7	6	5	4	3	2	1	0																																											
7	6	5	4	3	2	1	0																																											
Bit mask low byte																																																		
W20	<table border="1"> <thead> <tr><th>15</th><th>14</th><th>13</th><th>12</th><th>11</th><th>10</th><th>9</th><th>8</th></tr> </thead> <tbody> <tr><td>1</td><td>2</td><td>3</td><td>4</td><td>5</td><td>6</td><td>7</td><td>8</td></tr> <tr><td colspan="8">LED driving, green</td></tr> </tbody> </table>	15	14	13	12	11	10	9	8	1	2	3	4	5	6	7	8	LED driving, green								<table border="1"> <thead> <tr><th>7</th><th>6</th><th>5</th><th>4</th><th>3</th><th>2</th><th>1</th><th>0</th></tr> </thead> <tbody> <tr><td>9</td><td>10</td><td>Failures</td><td>Warnings Disp. modes</td><td>Information</td><td></td><td></td><td></td></tr> </tbody> </table>	7	6	5	4	3	2	1	0	9	10	Failures	Warnings Disp. modes	Information											
15	14	13	12	11	10	9	8																																											
1	2	3	4	5	6	7	8																																											
LED driving, green																																																		
7	6	5	4	3	2	1	0																																											
9	10	Failures	Warnings Disp. modes	Information																																														
W21	<table border="1"> <thead> <tr><th>15</th><th>14</th><th>13</th><th>12</th><th>11</th><th>10</th><th>9</th><th>8</th></tr> </thead> <tbody> <tr><td>1</td><td>2</td><td>3</td><td>4</td><td>5</td><td>6</td><td>7</td><td>8</td></tr> <tr><td colspan="8">LED driving, flashing green</td></tr> </tbody> </table>	15	14	13	12	11	10	9	8	1	2	3	4	5	6	7	8	LED driving, flashing green								<table border="1"> <thead> <tr><th>7</th><th>6</th><th>5</th><th>4</th><th>3</th><th>2</th><th>1</th><th>0</th></tr> </thead> <tbody> <tr><td>9</td><td>10</td><td>Failures</td><td>Warnings Memory mode</td><td>Information</td><td></td><td></td><td></td></tr> </tbody> </table>	7	6	5	4	3	2	1	0	9	10	Failures	Warnings Memory mode	Information											
15	14	13	12	11	10	9	8																																											
1	2	3	4	5	6	7	8																																											
LED driving, flashing green																																																		
7	6	5	4	3	2	1	0																																											
9	10	Failures	Warnings Memory mode	Information																																														
W22	<table border="1"> <thead> <tr><th>15</th><th>14</th><th>13</th><th>12</th><th>11</th><th>10</th><th>9</th><th>8</th></tr> </thead> <tbody> <tr><td>1</td><td>2</td><td>3</td><td>4</td><td>5</td><td>6</td><td>7</td><td>8</td></tr> <tr><td colspan="8">LED driving, yellow</td></tr> </tbody> </table>	15	14	13	12	11	10	9	8	1	2	3	4	5	6	7	8	LED driving, yellow								<table border="1"> <thead> <tr><th>7</th><th>6</th><th>5</th><th>4</th><th>3</th><th>2</th><th>1</th><th>0</th></tr> </thead> <tbody> <tr><td>9</td><td>10</td><td colspan="6">Reserved</td><td></td></tr> </tbody> </table>	7	6	5	4	3	2	1	0	9	10	Reserved													
15	14	13	12	11	10	9	8																																											
1	2	3	4	5	6	7	8																																											
LED driving, yellow																																																		
7	6	5	4	3	2	1	0																																											
9	10	Reserved																																																
W23	<table border="1"> <thead> <tr><th>15</th><th>14</th><th>13</th><th>12</th><th>11</th><th>10</th><th>9</th><th>8</th></tr> </thead> <tbody> <tr><td>1</td><td>2</td><td>3</td><td>4</td><td>5</td><td>6</td><td>7</td><td>8</td></tr> <tr><td colspan="8">LED driving, flashing yellow</td></tr> </tbody> </table>	15	14	13	12	11	10	9	8	1	2	3	4	5	6	7	8	LED driving, flashing yellow								<table border="1"> <thead> <tr><th>7</th><th>6</th><th>5</th><th>4</th><th>3</th><th>2</th><th>1</th><th>0</th></tr> </thead> <tbody> <tr><td>9</td><td>10</td><td colspan="6">Reserved</td><td></td></tr> </tbody> </table>	7	6	5	4	3	2	1	0	9	10	Reserved													
15	14	13	12	11	10	9	8																																											
1	2	3	4	5	6	7	8																																											
LED driving, flashing yellow																																																		
7	6	5	4	3	2	1	0																																											
9	10	Reserved																																																
W24	<table border="1"> <thead> <tr><th>15</th><th>14</th><th>13</th><th>12</th><th>11</th><th>10</th><th>9</th><th>8</th></tr> </thead> <tbody> <tr><td>11</td><td>12</td><td>13</td><td colspan="3">LED driving, green</td><td>17</td><td>18</td></tr> </tbody> </table>	15	14	13	12	11	10	9	8	11	12	13	LED driving, green			17	18	<table border="1"> <thead> <tr><th>7</th><th>6</th><th>5</th><th>4</th><th>3</th><th>2</th><th>1</th><th>0</th></tr> </thead> <tbody> <tr><td>19</td><td>20</td><td>Arrow-LED int/ext</td><td>▼</td><td>▲</td><td>▶</td><td>◀</td><td></td></tr> <tr><td colspan="8">Arrow-LED in Menu stat.</td></tr> </tbody> </table>	7	6	5	4	3	2	1	0	19	20	Arrow-LED int/ext	▼	▲	▶	◀		Arrow-LED in Menu stat.															
15	14	13	12	11	10	9	8																																											
11	12	13	LED driving, green			17	18																																											
7	6	5	4	3	2	1	0																																											
19	20	Arrow-LED int/ext	▼	▲	▶	◀																																												
Arrow-LED in Menu stat.																																																		
W25	<table border="1"> <thead> <tr><th>15</th><th>14</th><th>13</th><th>12</th><th>11</th><th>10</th><th>9</th><th>8</th></tr> </thead> <tbody> <tr><td>11</td><td>12</td><td>13</td><td>14</td><td>15</td><td>16</td><td>17</td><td>18</td></tr> <tr><td colspan="8">LED driving, flashing green</td></tr> </tbody> </table>	15	14	13	12	11	10	9	8	11	12	13	14	15	16	17	18	LED driving, flashing green								<table border="1"> <thead> <tr><th>7</th><th>6</th><th>5</th><th>4</th><th>3</th><th>2</th><th>1</th><th>0</th></tr> </thead> <tbody> <tr><td>19</td><td>20</td><td>Arrow-LED int/ext</td><td>▼</td><td>▲</td><td>▶</td><td>◀</td><td></td></tr> <tr><td colspan="8">Arrow-LED in Menu blinker</td></tr> </tbody> </table>	7	6	5	4	3	2	1	0	19	20	Arrow-LED int/ext	▼	▲	▶	◀		Arrow-LED in Menu blinker							
15	14	13	12	11	10	9	8																																											
11	12	13	14	15	16	17	18																																											
LED driving, flashing green																																																		
7	6	5	4	3	2	1	0																																											
19	20	Arrow-LED int/ext	▼	▲	▶	◀																																												
Arrow-LED in Menu blinker																																																		
W26	<table border="1"> <thead> <tr><th>15</th><th>14</th><th>13</th><th>12</th><th>11</th><th>10</th><th>9</th><th>8</th></tr> </thead> <tbody> <tr><td>11</td><td>12</td><td>13</td><td>14</td><td>15</td><td>16</td><td>17</td><td>18</td></tr> <tr><td colspan="8">LED driving, yellow</td></tr> </tbody> </table>	15	14	13	12	11	10	9	8	11	12	13	14	15	16	17	18	LED driving, yellow								<table border="1"> <thead> <tr><th>7</th><th>6</th><th>5</th><th>4</th><th>3</th><th>2</th><th>1</th><th>0</th></tr> </thead> <tbody> <tr><td>19</td><td>20</td><td colspan="6">Reserved</td><td></td></tr> </tbody> </table>	7	6	5	4	3	2	1	0	19	20	Reserved													
15	14	13	12	11	10	9	8																																											
11	12	13	14	15	16	17	18																																											
LED driving, yellow																																																		
7	6	5	4	3	2	1	0																																											
19	20	Reserved																																																

Driving the PCS 900

W26

15	14	13	12	11	10	9	8
11	12	13	14	15	16	17	18
LED driving, yellow							

7	6	5	4	3	2	1	0
19	20	Reserved					

W27

15	14	13	12	11	10	9	8
11	12	13	14	15	16	17	18
LED driving, flashing yellow							

7	6	5	4	3	2	1	0
19	20	Reserved					

W28

15	14	13	12	11	10	9	8
LED - RESERVED							

7	6	5	4	3	2	1	0
RESERVED							

W29

15	14	13	12	11	10	9	8
LED - RESERVED							

7	6	5	4	3	2	1	0
RESERVED							

W30

15	14	13	12	11	10	9	8
LED - RESERVED							

7	6	5	4	3	2	1	0
RESERVED							

W31

15	14	13	12	11	10	9	8
LED - RESERVED							

7	6	5	4	3	2	1	0
RESERVED							

W32

15	14	13	12	11	10	9	8
LED - RESERVED							

7	6	5	4	3	2	1	0
RESERVED							

W33

15	14	13	12	11	10	9	8
LED-RESERVED							

7	6	5	4	3	2	1	0
RESERVED							

W34

15	14	13	12	11	10	9	8
LED - RESERVED							

7	6	5	4	3	2	1	0
Activate bitmap	Bit map number for working area						

W35

15	14	13	12	11	10	9	8
Status page number							

7	6	5	4	3	2	1	0
Softkey row number							

W36

15	14	13	12	11	10	9	8
OFF LINE	Re- ser- ved	En- able Re- cipe *)	Hist- ory	S	W	H	M
Enable priorities							

7	6	5	4	3	2	1	0
Dis- able Comm C/D/E	Dis- able date	Dis- able time	Dis- able LED F-keys	Enable alarm output	Oper. hours coun- ter	Hist- ory Start	Sync Time

W37

15	14	13	12	11	10	9	8
Pr. stop Mess.	Log. stop	Lifo	Hist- ory delet.	Disab. beep	Disab. mess. LED	Disab. HLP LED	Disab. Menu LED

7	6	5	4	3	2	1	0
MB7	MB6	MB5	MB4	MB3	MB2	MB1	MB0
Enable message block transfer							

15	14	13	12	11	10	9	8	7	6	5	4	3	2	1	0
Stat/Flash	64	32	16	8	4	2	1	Pre-set -P	64	32	16	8	4	2	1
Idle text number (0...127)								Operating text number (1...127)							

W38

15	14	13	12	11	10	9	8	7	6	5	4	3	2	1	0
Print job / Pointer adjustment (high byte)								Print job / Pointer adjustment (low byte)							

W39

15	14	13	12	11	10	9	8	7	6	5	4	3	2	1	0
OPER. PRINTER TEXT NUMBER (Print form) HIGH BYTE								OPER. PRINTER TEXT NUMBER (Print form) LOW BYTE							

W40

15	14	13	12	11	10	9	8	7	6	5	4	3	2	1	0
M15	M14	M13	M12	M11	M10	M9	M8	M7	M6	M5	M4	M3	M2	M1	M0
⋮								⋮							

W41

15	14	13	12	11	10	9	8	7	6	5	4	3	2	1	0
M1023	M1022	M1021	M1020	M1019	M1018	M1017	M1016	M1015	M1014	M1013	M1012	M1011	M1010	M1009	M1008

W104

15	14	13	12	11	10	9	8	7	6	5	4	3	2	1	0
Any external variable BIT, (C)STRING, BIN...VBIN...BCD..								Any external variable BIT, (C)STRING, BIN...VBIN...BCD..							

W110

Driving the PCS 900

8.2 System area

The words WO..2 are reserved for driver dependent functions.

W3	15	14	13	12	11	10	9	8	7	6	5	4	3	2	1	0
	Errors detected by the PLC are recorded here								-	-	-	-	-	-	-	-

The errors detected by the PLC are recorded in the HIGH byte of word 3. As these errors are dependent on the driver it is advisable to refer to the manual PCS 91.x. Should a communications error arise, then the reason for it can be read there. It is especially important to have this information to hand when giving out information over the telephone.

This error ends the communication (PLC-laterally realized!). First after a COMMUNICATION-RESET by the PLC is an attempt again made to recommence the communication. A return is made to the previously active position in the PCS. Owing to a throughput of customer specific predisplacement and emergency programmes in the PLC, information can be lost. If you wish, you can avoid this by undertaking the appropriate programming.

8.3 Status area

Here, the PCS writes, the key bits, time, date as well as the PCS status.

8.3.1 Function, control and tenner keys

W4	15	14	13	12	11	10	9	8	7	6	5	4	3	2	1	0
	F1	F2	F3	F4	F5	F6	F7	F8	F9	F10	▲	▼	▶	◀	-	+

W5	15	14	13	12	11	10	9	8	7	6	5	4	3	2	1	0
	F11	F12	F13	F14	F15	F16	F17	F18	F19	F20	CLR	ENT	DIL4	DIL3	DIL2	DIL1

W6	15	14	13	12	11	10	9	8	7	6	5	4	3	2	1	0
	X	X	X	X	HLP	•	9	8	7	6	5	4	3	2	1	0

These key bits are log. 1 as long as the corresponding key is pressed down and the communication is functioning without a fault. The control keys in LOW byte of W15 should only be used with care as they are required in various priorities, for example in the menu priority for the editing of nominal values.

Words 7 and 8 are reserved for the keyboard extension (PCS 891).

8.3.2 Date and time

W9	15	14	13	12	11	10	9	8	7	6	5	4	3	2	1	0
	Mi enium				Century				Decade				Year			

W10	15	14	13	12	11	10	9	8	7	6	5	4	3	2	1	0
	Month (tens)				Month (digits)				Day (tens)				Day (digits)			

The date appears as BCD digits. However it is not valid, if the millenium is > 0 . In this matter the millenium in the fresh run program should be reserved with KH0000. If the year is < 93 , then 20xx is taken.

W11	15	14	13	12	11	10	9	8	7	6	5	4	3	2	1	0
	Day of week (01...07)				hour (00...23)											

W12	15	14	13	12	11	10	9	8	7	6	5	4	3	2	1	0
	Minute (00...59)				Second (00...59)											

Furthermore these contents are only of use if $W9 < 0$ is. Although a rate of seconds can be run off the seconds, it is to be noted that the registration of a new time (especially with long PLC cycles) can be delayed by up to a second. Otherwise the contents are always valid, as the PCS always refreshes the W9..W12 in a cycle.

8.3.3 PCS status

8.3.3.1 Control bits

W13	15	14	13	12	11	10	9	8	7	6	5	4	3	2	1	0
	Pr. Stop	Log Stop	Lifo	Hist. del.	Hist. arriv	Pr. bu. full	Hist. bu. full	Re-served	S7	S6	S5	S4	S3	S2	S1	S0

The individual bits have the following significance:

- 0-7: Automatic Time Clock
- 11: At least one message in the history memory
- 12: Answer bit to the deletion request of the history memory
- 13: Print direction, respectively indicator adjustment,
1 = newest entry first, then in the direction of the oldmessages.
- 14: DO NOT enter printer messages, if log. 1 is.
- 15: Cancel print order or indicator adjustment

Driving the PCS 900

8.3.3.2 Printer status

W14	15	14	13	12	11	10	9	8	7	6	5	4	3	2	1	0
	Number of old printer messages (high byte)								Number of old printer messages (low byte)							
W15	15	14	13	12	11	10	9	8	7	6	5	4	3	2	1	0
	Number of new printer messages (high byte)								Number of new printer messages (low byte)							

These figures always refer to the message to be printed next. If the printer has printed out the latest message in the FIFO mode, then the value 0 is in W15 and the total number of messages in the memory; max. 128; are in W14. When it is in the LIFO mode, the printer prints in the direction of the older messages. When it has printed them all out, the value 0 is in W 14 and the total number of messages is in W15.

8.3.3.3 Priorities status

The actual node number is only valid (1..255) as long as the menu is active. You can see if a menu is active by reading the same word in bit 0.

W16	15	14	13	12	11	10	9	8	7	6	5	4	3	2	1	0
	RESERVED								Offl-activ	Re-serve	Re-cipe-activ*)	Hist-ory	Fail-ures	War-nings	Infor-ma-tion	Menu

There is a low-byte in log. 1 for every switched on priority (independent of locking or focus).

That particular priority will be numerically displayed in word 17, that possess the focus. For example, a message bit is active and its text has the class fault, the fault priority is not closed and the history memory is switched off, then there number 4 appears in bits 12 to 15 and message number of that particular message appears in the display in the bits 0 to 9. It can be deduced from the priority that it concerns a message text.

W17	15	14	13	12	11	10	9	8	7	6	5	4	3	2	1	0
	8	4	2	1	X	X	512	256	128	64	32	16	8	4	2	1
Displayed priority								Text number on display (low byte)								

The following values are possible:

- 0: Default priority
- 1: Menu priority
- 2: Reference priority
- 3: Warning priority
- 4: Fault priority
- 5: History priority
- 6: Free
- 7: Communication error (is not displayed here, see W3)
- 8: Offline priority (respectively preliminary stage to actual offline menu)

8.3.3.4 Nominal value status

W18	15	14	13	12	11	10	9	8	7	6	5	4	3	2	1	0
	128	64	32	16	8	4	2	1	X	X	X	16	8	4	2	1
	Data word preset value								Preset value length byte							

HIGH-byte, bit

0..7: Latest written nominal value word number (binary)

The word number of the latest edited nominal value can be binary read here. If a PLC program is waiting for the input of a particular nominal value, W 18, or only the HIGH-byte, can be zeroed before. As soon as the value in this byte \diamond 0 is., the nominal value input can be evaluated in the PLC program. If this doesn't correspond to the expected nominal value, then W8 must be zeroed again and continue to wait etc.

LOW-byte, bit

5..7: at the moment not used

0..4: latest written nominal value length (binary, number of bytes)

If a nominal value was written by the PCS, the style of variables can be evaluated through the evaluation of the bits 0..4, the number of written bytes and the successive written bit mask.

Number of bytes:

0: bit variable

2: 16 bit variable as (C)STRING;BCD(0)-1;(V)BIN(0)-1,A; WORD;ASCII

4: 32 bit variable as (C)STRING;BCD(0)-2;(V)BIN(0)-2,B;ASCII

>4: ASCII variable

If a bit variable (number of bytes = 0) was written, the amended bit number can be determined with the displayed mask in W19.

W19	15	14	13	12	11	10	9	8	7	6	5	4	3	2	1	0
	15	14	13	12	11	10	9	8	7	6	5	4	3	2	1	0
	Bit mask high byte								Bit mask low byte							

With a bit variable, the bit number can be conveyed from the bit mask of W19. That bit which has amended itself, will be registered in the bit mask with a log. 1. All the other bits appear with log. 0. The new status of the corresponding bits can be determined by joining the registered word number in W18 and the bit mask.

Example:

A bit variable that was programmed on word 41 (bit 11) as NOMINAL value, is amended in a menu (previously log. 0, after pressing the [] became log. 1). Thereafter the following values exist in W18 and W19.

W18: 00101001 xxx00000

W19: 00001000 00000000

Through logical „joining“ of the words W19 and W41 you attain the value 00001000 00000000, therefore \diamond 0. Thereby bit 11 is set to log. 1.

Driving the PCS 900

8.4 Command area

In this area the PCS 900 can be controlled by writing the individual words.

These are the LEDs, as well as the command words A-E with locking bits, transfer blocking, default text numbers, menu numbers, message printer orders and operating printer orders.

8.4.1 LED status

W20	<table border="1"> <thead> <tr><th>15</th><th>14</th><th>13</th><th>12</th><th>11</th><th>10</th><th>9</th><th>8</th></tr> </thead> <tbody> <tr><td>1</td><td>2</td><td>3</td><td>4</td><td>5</td><td>6</td><td>7</td><td>8</td></tr> <tr><td colspan="8">LED driving, green</td></tr> </tbody> </table>	15	14	13	12	11	10	9	8	1	2	3	4	5	6	7	8	LED driving, green								<table border="1"> <thead> <tr><th>7</th><th>6</th><th>5</th><th>4</th><th>3</th><th>2</th><th>1</th><th>0</th></tr> </thead> <tbody> <tr><td>9</td><td>10</td><td>Failures</td><td>Warnings Disp. modes</td><td colspan="4">Information</td></tr> </tbody> </table>	7	6	5	4	3	2	1	0	9	10	Failures	Warnings Disp. modes	Information			
15	14	13	12	11	10	9	8																																			
1	2	3	4	5	6	7	8																																			
LED driving, green																																										
7	6	5	4	3	2	1	0																																			
9	10	Failures	Warnings Disp. modes	Information																																						
W21	<table border="1"> <thead> <tr><th>15</th><th>14</th><th>13</th><th>12</th><th>11</th><th>10</th><th>9</th><th>8</th></tr> </thead> <tbody> <tr><td>1</td><td>2</td><td>3</td><td>4</td><td>5</td><td>6</td><td>7</td><td>8</td></tr> <tr><td colspan="8">LED driving, flashing green</td></tr> </tbody> </table>	15	14	13	12	11	10	9	8	1	2	3	4	5	6	7	8	LED driving, flashing green								<table border="1"> <thead> <tr><th>7</th><th>6</th><th>5</th><th>4</th><th>3</th><th>2</th><th>1</th><th>0</th></tr> </thead> <tbody> <tr><td>9</td><td>10</td><td>Failures</td><td>Warnings Memory mode</td><td colspan="4">Information</td></tr> </tbody> </table>	7	6	5	4	3	2	1	0	9	10	Failures	Warnings Memory mode	Information			
15	14	13	12	11	10	9	8																																			
1	2	3	4	5	6	7	8																																			
LED driving, flashing green																																										
7	6	5	4	3	2	1	0																																			
9	10	Failures	Warnings Memory mode	Information																																						
W22	<table border="1"> <thead> <tr><th>15</th><th>14</th><th>13</th><th>12</th><th>11</th><th>10</th><th>9</th><th>8</th></tr> </thead> <tbody> <tr><td>1</td><td>2</td><td>3</td><td>4</td><td>5</td><td>6</td><td>7</td><td>8</td></tr> <tr><td colspan="8">LED driving, yellow</td></tr> </tbody> </table>	15	14	13	12	11	10	9	8	1	2	3	4	5	6	7	8	LED driving, yellow								<table border="1"> <thead> <tr><th>7</th><th>6</th><th>5</th><th>4</th><th>3</th><th>2</th><th>1</th><th>0</th></tr> </thead> <tbody> <tr><td>9</td><td>10</td><td colspan="6">Reserved</td></tr> </tbody> </table>	7	6	5	4	3	2	1	0	9	10	Reserved					
15	14	13	12	11	10	9	8																																			
1	2	3	4	5	6	7	8																																			
LED driving, yellow																																										
7	6	5	4	3	2	1	0																																			
9	10	Reserved																																								
W23	<table border="1"> <thead> <tr><th>15</th><th>14</th><th>13</th><th>12</th><th>11</th><th>10</th><th>9</th><th>8</th></tr> </thead> <tbody> <tr><td>1</td><td>2</td><td>3</td><td>4</td><td>5</td><td>6</td><td>7</td><td>8</td></tr> <tr><td colspan="8">LED driving, flashing yellow</td></tr> </tbody> </table>	15	14	13	12	11	10	9	8	1	2	3	4	5	6	7	8	LED driving, flashing yellow								<table border="1"> <thead> <tr><th>7</th><th>6</th><th>5</th><th>4</th><th>3</th><th>2</th><th>1</th><th>0</th></tr> </thead> <tbody> <tr><td>9</td><td>10</td><td colspan="6">Reserved</td></tr> </tbody> </table>	7	6	5	4	3	2	1	0	9	10	Reserved					
15	14	13	12	11	10	9	8																																			
1	2	3	4	5	6	7	8																																			
LED driving, flashing yellow																																										
7	6	5	4	3	2	1	0																																			
9	10	Reserved																																								
W24	<table border="1"> <thead> <tr><th>15</th><th>14</th><th>13</th><th>12</th><th>11</th><th>10</th><th>9</th><th>8</th></tr> </thead> <tbody> <tr><td>11</td><td>12</td><td>13</td><td colspan="4">LED driving, green</td><td>17</td><td>18</td></tr> </tbody> </table>	15	14	13	12	11	10	9	8	11	12	13	LED driving, green				17	18	<table border="1"> <thead> <tr><th>7</th><th>6</th><th>5</th><th>4</th><th>3</th><th>2</th><th>1</th><th>0</th></tr> </thead> <tbody> <tr><td>19</td><td>20</td><td>Arrow-LED int/ext</td><td>▼</td><td>▲</td><td>▶</td><td>◀</td><td>Arrow-LED in Menu stat.</td></tr> </tbody> </table>	7	6	5	4	3	2	1	0	19	20	Arrow-LED int/ext	▼	▲	▶	◀	Arrow-LED in Menu stat.							
15	14	13	12	11	10	9	8																																			
11	12	13	LED driving, green				17	18																																		
7	6	5	4	3	2	1	0																																			
19	20	Arrow-LED int/ext	▼	▲	▶	◀	Arrow-LED in Menu stat.																																			
W25	<table border="1"> <thead> <tr><th>15</th><th>14</th><th>13</th><th>12</th><th>11</th><th>10</th><th>9</th><th>8</th></tr> </thead> <tbody> <tr><td>11</td><td>12</td><td>13</td><td>14</td><td>15</td><td>16</td><td>17</td><td>18</td></tr> <tr><td colspan="8">LED driving, flashing green</td></tr> </tbody> </table>	15	14	13	12	11	10	9	8	11	12	13	14	15	16	17	18	LED driving, flashing green								<table border="1"> <thead> <tr><th>7</th><th>6</th><th>5</th><th>4</th><th>3</th><th>2</th><th>1</th><th>0</th></tr> </thead> <tbody> <tr><td>19</td><td>20</td><td>Arrow-LED int/ext</td><td>▼</td><td>▲</td><td>▶</td><td>◀</td><td>Arrow-LED in Menu blinker</td></tr> </tbody> </table>	7	6	5	4	3	2	1	0	19	20	Arrow-LED int/ext	▼	▲	▶	◀	Arrow-LED in Menu blinker
15	14	13	12	11	10	9	8																																			
11	12	13	14	15	16	17	18																																			
LED driving, flashing green																																										
7	6	5	4	3	2	1	0																																			
19	20	Arrow-LED int/ext	▼	▲	▶	◀	Arrow-LED in Menu blinker																																			
W26	<table border="1"> <thead> <tr><th>15</th><th>14</th><th>13</th><th>12</th><th>11</th><th>10</th><th>9</th><th>8</th></tr> </thead> <tbody> <tr><td>11</td><td>12</td><td>13</td><td>14</td><td>15</td><td>16</td><td>17</td><td>18</td></tr> <tr><td colspan="8">LED driving, yellow</td></tr> </tbody> </table>	15	14	13	12	11	10	9	8	11	12	13	14	15	16	17	18	LED driving, yellow								<table border="1"> <thead> <tr><th>7</th><th>6</th><th>5</th><th>4</th><th>3</th><th>2</th><th>1</th><th>0</th></tr> </thead> <tbody> <tr><td>19</td><td>20</td><td colspan="6">Reserved</td></tr> </tbody> </table>	7	6	5	4	3	2	1	0	19	20	Reserved					
15	14	13	12	11	10	9	8																																			
11	12	13	14	15	16	17	18																																			
LED driving, yellow																																										
7	6	5	4	3	2	1	0																																			
19	20	Reserved																																								
W27	<table border="1"> <thead> <tr><th>15</th><th>14</th><th>13</th><th>12</th><th>11</th><th>10</th><th>9</th><th>8</th></tr> </thead> <tbody> <tr><td>11</td><td>12</td><td>13</td><td>14</td><td>15</td><td>16</td><td>17</td><td>18</td></tr> <tr><td colspan="8">LED driving, flashing yellow</td></tr> </tbody> </table>	15	14	13	12	11	10	9	8	11	12	13	14	15	16	17	18	LED driving, flashing yellow								<table border="1"> <thead> <tr><th>7</th><th>6</th><th>5</th><th>4</th><th>3</th><th>2</th><th>1</th><th>0</th></tr> </thead> <tbody> <tr><td>19</td><td>20</td><td colspan="6">Reserved</td></tr> </tbody> </table>	7	6	5	4	3	2	1	0	19	20	Reserved					
15	14	13	12	11	10	9	8																																			
11	12	13	14	15	16	17	18																																			
LED driving, flashing yellow																																										
7	6	5	4	3	2	1	0																																			
19	20	Reserved																																								

A green and a yellow LED are at the disposal of each function key [F1..F8].

As every LED has 2 bits at its disposal, each LED can take on 4 states:

- out
- on
- flashing (75% bright phase, 25% dark phase)
- inverse flashing (25% bright phase, 75% dark phase)

If one LED is flashing and another is inverse flashing, the shine alternately. The bright phase of one LED is by the other one the dark phase and opposite.

The state of an LED arises from the 2 bits belonging to one another of word Wx and Wx 1. (W20 and W21, W22 and W23, W24 and W25, W26 and W27).

Classification of the LED statuses:

Wx , Bitnr. y	Wx 1, Bitnr. y	Status
0	0	OFF
0	1	INVERSE FLASH.
1	0	ON
1	1	FLASHING

Example:

W20: ...

W21: ...

→ green LED's via F5..F8 : NORMAL SHINING

→ green LED's via F9..F10: INVERSE FLASHING

W20

15	14	13	12	11	10	9	8	7	6	5	4	3	2	1	0
1	2	3	4	5	6	7	8	9	10	Failures		Warnings Disp. modes		Information	
LED driving, green															

8.4.2 Display and storage characteristics

DISPLAY MODES

The display mode bits determine whether a message text should be displayed static, flashing or underlined. These bits for (R)eferences, (W)arnings and (F)aults can at any time be separately amended by the PLC. These bits are ignored with deletion characteristic 5.

- 00 Normal presentation
- 01 Flashing underline
- 10 Flashing Text
- 11 Flashing Text with flashing underline

W21

15	14	13	12	11	10	9	8	7	6	5	4	3	2	1	0
1	2	3	4	5	6	7	8	9	10	Failures		Warnings Memory mode		Information	
LED driving, flashing green															

Driving the PCS 900

STORAGE CHARACTERISTICS

These bits determine the sequence in which the PCS 900 message memory should be displayed. They may be amended at any time. Should at any time an amendment occur in the display, it will be taken at once.

- 00: Latest message without selection possibility
- 01: Latest message with selection possibility
- 10: Cyclical display (without selection possibility)
- 11: First message with selection possibility

The further switching on of other messages by hand with <ARROW_RIGHT/LEFT> is only possible in the mode 01 - latest message with selection possibility - and mode 11 - first message with selection possibility. From this point you can either leaf to the older messages with <ARROW-LEFT> and to the latest messages with <ARROW-RIGHT>.

If the bit 10 in the command word A (W37) is log. 0, then the arrow-LED's in addition show the leafing possibilities within the message text page and from the oldest message to the more recent message - manual selection possibility.

The various deletion possibilities and the leafing on the help lines are written in the chapter „MESSAGE PRIORITIES“.

8.4.3 Command word A-E

These words control the functionality of the PCS 900. They contain release bits, transfer blocks, time control, default text number, menu number, printer control, message printer and printer control operating printer.

8.4.3.1 Priorities release/activation

Command word A:

W36

15	14	13	12	11	10	9	8	7	6	5	4	3	2	1	0
OFF LINE	Re- ser- ved	En- able Re- cipe*)	Hist- ory	S	W	H	M	Dis- able Comm C/D/E	Dis- able date	Dis- able time	Dis- able LED F-keys	Enable alarm output	Oper. hours coun- ter	Hist- ory Start	Sync Time
								Enable priorities							

The individual bits have the following significance.

- 15 The possibility is opened with log. 1, to attain the preliminary stage of the offline menu with [HELP] [CLR].
- 14 Free
- 13 Free
- 12: The display of the history memory is released with log. 1 and suppressed with 0. After a temporary suppression a return is again made to the same message as before the suppression.
- 11: The display of the fault priority is released with log. 1 and suppressed with 0.
- 10: The display of the warning priority is released with log. 1 and suppressed with 0.
- 9: The display of the reference priority is released with log. 1 and suppressed with 0.
- 8: The display of the menu priority is released with log. 1 and suppressed with 0. Even a nominal value input that has already begun will be temporarily interrupted.
- 7: The transfer of the command words C, D and E can be suppressed with log. 1 (saving on cycle time) and with 0 the transfer is again released (normal case).

- 6: The transfer of the date can be locked with log. 1 (saving on cycle time) and with log. 0 the transfer is active. If the PLC clock is to be transferred into the PCS, then bits 5 and 6 must = log. 1.
- 5: The transfer of the time can be locked with log. 1, and with log. 0 it is released. If the PLC clock is to be transferred into the PCS, then bit 5 and 6 must = log. 1!
- 4: The transfer of the F-key-LEDs can be halted on mass with log. 1 (saving on cycle time, 8 words!).
- 3: The alarm signal is released with log. 1. Furthermore additional requirements must be met (refer to description). With log. 0, the alarm relays is always switched off, i.e. the contact is open.
- 2: The operating time clock is activated with log. 1. In order that the operating time clock works properly, the communication to the PLC must operate smoothly too.
- 1: The display of the history memory is activated with the log. 1, and with log. 0 it is switched off. With each flank (0->1) the latest message is activated, in so far as one is entered in the log memory.
- 0: With every log. 1, this allows the unique transfer of the time from the PLC into the PCS. It may only be set here. The PCS sets it in the same PLC cycle to 0, after the transfer process has been carried out.

8.4.3.2 Configuration bits

Command word B:

W37

15	14	13	12	11	10	9	8	7	6	5	4	3	2	1	0
Pr. stop Mess.	Log. stop	Lifo	History delet.	Disab. beep	Disab. mess. LED	Disab. HLP LED	Disab. Menu LED	MB7	MB6	MB5	MB4	MB3	MB2	MB1	MB0
								Enable message block transfer							

- 15: A continuous print order; only message printer; can be cancelled with log. 1. As long as the bit is 1, then every print order is quitted at once or not carried out. This bit is respectively inspected before the printout of a message. If the printer however, is not ready, and is in the middle of executing a message, then this cancellation cannot take place. In order to establish that this cancellation was recognized by the PCS, this bit is reflected in word 13 at the same bit position.
- 14: An entry in the message printer memory can be suppressed with log. 1. Before a message can be entered, the PCS checks this bit. In order to be sure that the PCS has read this bit, there will be a reflection in word 13 at the same position.
- 13: Log. 0 permits the printer to print out in the direction of the most recent messages, and log. 1 in the direction of the older messages. This bit is checked out before the execution of a message printout. In order to be sure that the PCS has recognized this bit, it is reflected in word 13 at the same bit position.
- 12: The history memory for the display, can be deleted with a positive flank (0 -1 transfer). In order to be sure that the PCS has recognized this bit, it is reflected in word 15 at the same bit position.
- 11: The PCS warning signal for incorrect operation can be switched off with the log. 1.
- 10: The LEDs in the arrow keys within the message priority as well as the history priority can be suppressed with log. 1 (forced switch-off).
- 9: The LEDs in the arrow keys within the HELP texts can be switched off with log. 1 (forced switch-off).

Driving the PCS 900

- 8: The LEDs in the arrow keys within the menus can be suppressed with log. 1 (forced switch-off).
- 0-7: Log. 1 enables the transfer of the message blocks to be activated separately. In order to save cycle time for example, all blocks can be blocked with log. 0 and in the case of an error, be released with log. 1.

Attention!

The blocking of transfers can lead to undesirable effects, if they occur at the wrong moment. For example after the blocking of a transfer; with the exception of deletion characteristics 4; a set message cannot not for time being be deleted although the message bit in the PLC is on log. 0.! Therefore only apply blocking to the transfer if you are sure that this will not lead to any unpleasant effects!



8.4.3.3 Default text/menu number

Command word C:

W38

15	14	13	12	11	10	9	8
Stat/Flash	64	32	16	8	4	2	1
Idle text number (0...127)							

7	6	5	4	3	2	1	0
Pre-set -P	64	32	16	8	4	2	1
Operating text number (1...127)							

- 15: Log. 1, if a displayed text should flash.
- 8-14: Conveys the default text number (0..127) in binary code.

Default text number

This is the operating text number that will be displayed so long as the default text priority is activated. The default text number that is identical with the operating text number can be amended at any time through the PLC. The variables; nominal values; contained in the text cannot be amended (edited). The default text; operating text; no. 0 appears every time the PCS 900 is switched on and even without communication.

If bit 15 is log. 1, then the entire default text can switched on flashing. If the bit 15 is log. 0, then the default text appears static.

Example: Default text 23 should be displayed flashing. Thereby the value 10010111 x00000000 is to be written on the word 38.

- 7: If NOMINAL-P variables are allowed to be edited in the menu priority then there is log. 1.
- 0..6: Conveys the activated menu number in binary code (1..127, where 0 = menu end).

Menu number:

You can activate or end a menu by writing a value on bit 0..6. It can be started by writing a binary coded value > 0, therefore 1..127 on bit 0. The first text to reach the display is the defined operating text for the initial node i.e. start node. If one or more NOMINAL variables get into a menu node, then the first one will be activated. At first it appears underlined. Now nominal values can be entered and branched out in the menu with the [ARROW KEYS] corresponding to your own created menu definitions. Providing bit 8 in word 37 = command word A is log. 0, then a useful help to you at any time are the arrow key LEDs.

If you want to end a menu, then simply zero the bits 0..6. Whether this menu end should be a CANCELLATION or an ACCEPTANCE of nominal values, can be programmed for every menu in the PCSPRO. The standard setting is ACCEPTANCE.

The NOMINAL-P variable can be amended at any time in the actual displayed menu nodes with bit 7 = log. 1. As soon as the bit log. is 0, the NOMINAL-P variable can no longer be amended. Hereby „key switch“ dependent menus, respectively variables enable themselves to be formulated. NOMINAL-P variables are then treated like ACTUAL values.

If during the editing of a NOMINAL-P value, bit 7 goes from 1 to 0, this is a cancellation. Nothing is written back and the cursor positions itself anew on the first NOMINAL value in the node. As of PCSPRO (>VO.C), this can be parameterized for every menu.

8.4.3.4 Message printer command

Command word D:

W39

15	14	13	12	11	10	9	8
Print job / Pointer adjustment (high byte)							

7	6	5	4	3	2	1	0
Print job / Pointer adjustment (low byte)							

The message printer is controlled with this word. On writing a 16 bit number $\diamond 0$ one of the three following commands will be carried out.

- Number larger than 0, smaller/same H7FFF (<32767)
This is a print order. The printer tries to print out as many messages as either this number specifies or the number of messages there are in the memory. It concerns itself with those messages that are not yet printed. The direction is determined by the LIFO bit.
- Number smaller than 0 (-1 to -32767)
This is an indicator adjustment. This number is put back as far as possible in the message message printer. The direction depends on the LIFO bit. If this bit is 0, then it will be adjusted in the direction of the older messages. If this bit is 1, then it will be adjusted in the direction of the more recent messages.
- H8000 or -32768
This number causes a deletion of the message printer memory.

After a successful completion, the PCS writes this word to zero. Only after this has been done can a new order be accepted.

8.4.3.5 Operating printer command

Command word E:

W40

15	14	13	12	11	10	9	8
OPER. PRINTER TEXT NUMBER (Print form) HIGH BYTE							

7	6	5	4	3	2	1	0
OPER. PRINTER TEXT NUMBER (Print form) LOW BYTE							

The operating printer is controlled with this word. An operating printer formular is printed by writing a 16 bit number $\diamond 0$. After completion of the print order or when this operating printer text is no longer on hand, then the PCS writes this word to zero. It's first after this that a new order can be accepted.

Driving the PCS 900

8.5 Message area

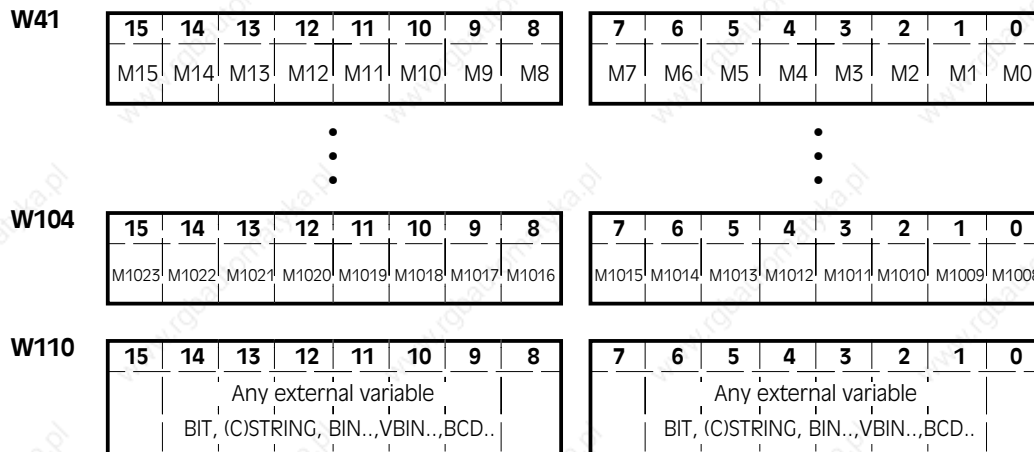

- W41-W48: MESSAGEBLOCK 0
- W49-W56: MESSAGEBLOCK 1
- W57-W64: MESSAGEBLOCK 2
- W65-W72: MESSAGEBLOCK 3
- W73-W80: MESSAGEBLOCK 4
- W81-W88: MESSAGEBLOCK 5
- W89-W96: MESSAGEBLOCK 6
- W97-W104: MESSAGEBLOCK 7

A MESSAGE TEXT is allocated to every bit (0..511, each with max. 32 lines), whereby every text can possess a specific priority (F,W,R) and a specific deletion characteristic (1-5).

- **CONVERTING MESSAGE TEXT NUMBERS INTO DW NUMBERS**

W = Pre-comma positions of (message text/16) 41

Bit = Post comma positions of (message text/16) * 16

Example:

Search for the bit position of the message text 165.

$$165 / 16 = 10.3125$$

$$10 \quad 41 \quad 51$$

$$0.3125 * 16 = 5$$

The message text number 165 corresponds to W51 bit5.

- **EVALUATION**

Maximum 1 message block is collected per PLC cycle. Should an evaluation take place in every cycle, then only 1 message block may be used and the parameter PLC CYCLE TIME must be selected large enough (refer to the TECHNICAL APPENDIX).

- **FRESH RUN**

As the message memory of the PCS is fixed low-voltage, then this should also be the case with the PLC. Otherwise any messages for the log memory in new runs will have to be entered several times.

- **TRANSFER**

A bit is scheduled for every message block in command word B W37) with which the transfer can be printed. If these bits are amended during running, then this should only occur after all the bits of this block have been zeroed. Otherwise these bits are initialized only on a fresh run and are not amended after that.

8.6 Variables area

The variable area lies between word W110 and the maximum word W255. If this area should not be enough, then the extension area W105 to W109 can be used. This area is specially designed for eventual extensions and therefore should only be used with caution (PLC-program amendment!). If none or not all the messages can be used, then the words 41..104 can be brought in for variables.

For further information on the various variable types please refer to the chapter „VARIABLES/TEXTS/MENUS“.

Before the data exchange all the variables; nominal and actual values; must be written in the corresponding words. After the data exchange, maximum one nominal value; corresponding to the nominal value status in W18 and 19; must be read back from the corresponding words.

It is recommendable to address variables of the same display page in bundles! This also partly helps to save PLC cycle time.

The allocation of addresses for the individual variables occurs within the PCSPRO.

The variable formats STRING, CSTRING, BCD, BIN, WORD and ASCII use the words right-aligned and ascending, e.g. BIN-2, on W50..W51. W50 is HIGH word and W51 LOW word. The format BIT can be applied to every individual bit. In order to refer to all 16 bits in a bit manner, 16 BIT variables must be set up. One and the same word can be source, and target for several variables and even different formats. Concerning the nominal value, it is recommended to only allocate one variable to a word. However, one or more actual value variables and even various formats can be allocated simultaneously to this word.

Prominent unused bits in the STRING, CSTRING, BCD(O)-1 (lengths 1..3) and BCD(O)-2 (lengths 1..7) types of nominal values are ignored on being read and on being written back into the PLC are set to 0. The BIT type amends only the bit referred to!

Nominal values should be occupied before the fresh start in respect of their permissible MIN-/MAX values as they require this as pro forma value for editing. If they are outside the MIN/MAX area, inverse fields will be displayed on presentation. As they are nominal values, these can first be left after the correction.

With 32 bit variables, the word with the lower number has the greater value and the word with the higher number has the lesser value.

Type BIT and CSTRING variables are immediately written in the PLC after the amendment. All the other ones are first written after <ENTER> or on quitting the variable field which can be parameterized.

General user information

9.1 Safety related information

- The device may only be connected to the systems specified by Systeme Lauer.
- The device meets the current technical state of the art.
- Only trained and qualified persons who have familiarized themselves with the product are allowed to install and operate the device.
- The responsibility of persons operating the device must be clearly determined in order to avoid undefined competencies.
- The relevant safety regulations and standards must be observed.
- Opening of the device is not allowed. Systeme Lauer is not responsible for resulting damages.
- Before commissioning the device, this instruction manual must be read thoroughly.
- Modifications of or changes to the design of the device are not allowed. Systeme Lauer is not responsible for resulting damages.
- The supply voltage of the device must be within the range specified in the section „Specifications“. Systeme Lauer is not responsible for damages resulting from non-compliance to this requirement.
- The latest manuals and documentation are valid.

The specifications published by Systeme Lauer were determined with our methods and facilities; characteristics are only guaranteed in this respect. The user is responsible for testing and determining the suitability for the specific application or for use under actual conditions. Systeme Lauer does not assume any warranty for this.

Modifications reserved

9.2 Quality and support

Quality is the most important factor in our company. From the electronic component to the manufactured device, quality is completely tested by qualified personal.

For this purpose, national and international test standards (ISO, TÜV, VDE, CE, Germanischer Lloyd) are applied. Each PCS is tested to 100% at different temperatures (5 ... 55°C) and test voltages (19 ... 33 VDC) and submitted to a permanent test under worst case conditions during 48 hours. This assures a maximum of quality!

Our products are not only characterized by a maximum economy and reliability, but also by a comprehensive and complete service.

- Qualified application support by qualified sales engineers.
- Our support is available to you every day by word and deed. Use our direct info line, if you have questions concerning the PCS topline.
- Intensive and practice-orientated training for our products.
Either in our training center or, after agreement, in your company.
- You do not only receive demo devices, but you are also supported during your first application by our specialists.
- Current information about our products by „lauer aktuell“
- Update service for our software

From advice to user support, from hotline to service, from manual to training - a comprehensive individual service is guaranteed.

Who for whom?



Wherever you need us, we are everywhere.
 dynamic, creative and powerful.

With the experience of a worldwide successful operating company.

The following chart gives you an overview who's the right person to talk to. Simply select the corresponding number!

By the way...

...you can find all our products and services in our product information.

Mailbox: 07 022/9660 225

Company: 100565 1525

Internet: 100565 1525@compuservec.com

Distribution				
Sales manager total	Henzler			
	07022/9660 240			
Sales manager Germany	Raif			
	07022/9660 242			
Sale processing	Gröger	Mönkemeier	Lehner	
	07022/9660 241	07022/9660 244	07022/9660 243	
Order processing	Feiler		Estner-Lenz	
	07022/9660 260		07022/9660 261	
Information processing	Koop		Maly	
	07022/9660 123		07022/9660 123	

Technical Support SIC					
Support manager	Schauwecker				
	07022/9660 220				
Support		Arndt	Gekeler	Hauber	Kolbus
		07022/9660 226	07022/9660 221	07022/9660 223	07022/9660 222
Training & Exercise			Gekeler (EASYWARE)		Kolbus (LCA+PCS)
			07022/9660 221		07022/9660 222
responsible for product line					
LC Astarline	■	■	■	■	■
LC Astandard	■	■	■	■	■
PC Stopline	■	■	■	■	■
PC Classic	■	■	■	■	■
VPC Exclusiv, VPC compact	■	■	■	■	■
VPC EASYWARE	■	■	■	■	■
TeleService TSN	■	■	■	■	■
responsible for net & bus					
INTERBUS	■	■	■	■	■
PROFIBUS	■	■	■	■	■
ArcNET	■	■	■	■	■
responsible for PLC driver					
ABB	■	■	■	■	■
AEG	■	■	■	■	■
Allen Bradley	■	■	■	■	■
B&R	■	■	■	■	■
Bosch	■	■	■	■	■
Cegelec	■	■	■	■	■
Crouzet	■	■	■	■	■
Eberle	■	■	■	■	■
Festo	■	■	■	■	■
GE Fanuc	■	■	■	■	■
Hitachi	■	■	■	■	■
IPC	■	■	■	■	■
IZUMI IDEC	■	■	■	■	■
KLM	■	■	■	■	■
Matsushita	■	■	■	■	■
Mitsubishi	■	■	■	■	■
OMRON	■	■	■	■	■
PC	■	■	■	■	■
Philips	■	■	■	■	■
Sala	■	■	■	■	■
Samsung	■	■	■	■	■
Siemens	■	■	■	■	■
Sprecher & Schuh	■	■	■	■	■
Sulzer	■	■	■	■	■
Teco	■	■	■	■	■
Telemecanique	■	■	■	■	■
Toshiba	■	■	■	■	■

A

Acoustic signal	40
ACTUAL VALUES	41
ADDITIONAL CASSETTE	28
Alarm outlet	80
Application areas	37
Arrow keys in the menus	64
ASCII	45

B

BATTERY BUFFERED RAM	28
BCD	43
BIN	43
BIOS	34
BIT	43
Building up the menus	63

C

CAM_NUMBER	59
Cassette connection	33
COM	31
Command area	92
Command word A	94
Command word B	95
Command word C	96
Command word D	97
Command word E	98
COMMUNICATION ERROR	30
Configuration	32
Configuration bits	95
Connections	31
Copying function	34
CSTRING	43
Current consumption	35

D

Data Reception	35
Data record	34
DEFAULT PRIORITY	40
Default text	96
Default text priority	70
Deletion characteristic	72
Dimensions	35
Display	35
Display characteristic	73
DISPLAY MODES	93
Driving the PCS 900	81

E

EPROM	28
Evaluation of keys	40
External variable formats	43

F

FLASH-EPROM	28
Front foil	35
Function	37
Fuse	35

G

General outline	41
-----------------------	----

H

HELP-KEY	40
HISTORY	40
History display	73
Humidity	35

I

Inlay foil	35
Internal variable formats	54

K

Keys	30, 35
------------	--------

L

LED displays	38
LOW-LEVEL protocol	77
Luminous displays	29

M

Menu number	96
MENU PRIORITY	40
Menu priority	70
Menus	42, 62
Message area	98
MESSAGE PRINTER	75
Message printer	76
Message printer command	97
MESSAGE PRIORITIES	40
Message priorities	70

N

Nominal value status	90
----------------------------	----

Index

O

Offline menu	75
OFFLINE-MENU	40
Operating elements	29, 38
OPERATING PRINTER	75
Operating printer	77
Operating printer command	98
OPERATING REQUEST	30
Operating voltage	31, 35
Operation time clock	81

P

Page protocol	78
PCS 733	33
PCS status	89
Printer	75
Printer status	89
Printer texts	75
Printout	77
Priorities release	94
Priorities status	89
Priority administration	68
PRN	31
Protective System	35
Programming	32
Programming cable	33

Q

Quitting the menus	62
--------------------------	----

R

Real time clock	80
Reset key	30
Resistance to jamming	35
RS232/TTY	32
RS485/RS422	32

S

Serial interfaces	31
Shakeproof ability	35
Starting the menus	62
Status area	88
STORAGE CHARACTERISTICS	93
Storage characteristics	71
STRING	43
System area	87

T

Technical data	35
Temperature	35
Text groups	61
TEXT NUMBER	58
Texts	42
Timer	79
Treatment of variables	60

V

Variables	41
Variables area	98
Variables in the menu	63
VBIN	44

W

Weight	35
WORD	45



- Operating instructions, manuals and software are copyrighted. All rights are reserved. Copying, duplicating and translating in whole or in part is not forbidden. An exception is valid for the making of a backup copy of the software for your own use.
- This manual describes our product PCS 900. We reserve the right to make changes to the manual at any time without prior notice.
- We cannot guarantee the accuracy of programs and data stored on floppy disk nor their error-free condition. We only guarantee that programs are executable within the application described in the manual.
- Since floppy disks are data carriers which can be manipulated we can only guarantee that they are physically undamaged. The liability is limited to supplying a replacement.
- We assume no responsibility for misprints. Liability is limited to damages where the misinformation is shown to be intentional.
- We always gladly welcome any ideas on improvements as well as notes on faults.
- The agreements are valid also for the special appendices to this manual.