

Siemens

MICRO MASTER MIDI MASTER Voltage-Source DC Link Converters for AC Drives up to 45 kW

Catalog DA 64 · 1996

Introduction

Applications,
Technical features,
Overview of the options

1

Design and description

Power section,
Open-loop and closed-loop control

2

Communications, operator control and visualization

Keypad, interface,
Control terminal strips, plain text operator control panel
PROFIBUS module, operator control via PC
Monitoring, diagnostics, parameter list

3

Technical data

4

Selection and ordering data

MICRO/MIDI MASTER

5

Options

Internal brake resistor, braking unit
Radio interference suppression filter, output reactor
Output dV/dt filters, commutating reactors
Selection and ordering data, options

6

Induction-motor drives

Engineering information,
Motor-converter assignment
Line supply voltages 1-ph. 230 V to 3-ph. 500 V AC

7

Special-motor drives

Reluctance motors,
Permanent-magnet synchronous motors

8

Dimensions

MICRO/MIDI MASTER and options

9

- All the dimensions in this catalog are stated in mm.

All product designations are trade-marks of product names of Siemens AG or other companies.

1.1	Applications	1/2
1.2	Technical features	1/2
1.3	Overview of the options	1/3

MICRO MASTER

MIDI MASTER

1. Introduction

1.1 Applications

MICRO MASTER and MIDI MASTER are drive converters with an output range from 250 W to 37 kW, outputs up to 45 kW are possible if the square-law torque characteristic is utilized

They are voltage-source DC link drive converters utilizing fully-digital microprocessor technology. A 7-key membrane keyboard or an optional plain text operator control panel, which can be simply inserted, guarantees a high, unified operator control friendliness.

MICRO MASTER and MIDI MASTER were especially conceived for general AC variable-speed drives. As a result of their wide voltage range from

- 1/3-ph. 208-240 V AC \pm 10 %
- 3-ph. 380-500 V AC \pm 10 %
- 3-ph. 525-575 V AC \pm 10 %

they are suitable for all single- and multi-motor drives for operation worldwide, where a line supply with fixed frequency and voltage must be converted into a three-phase system with variable frequency and voltage

MICRO MASTER and MIDI MASTER are a unified product family, which set new standards when it comes to reliability

- Components, technology and manufacturing processes are of an extremely high quality, and reflect the many years of experience which Siemens has in variable-speed drive technology.
- A comprehensive protection concept makes them completely safe in operation
- Incorrect operator control cannot damage the unit

The excellent price/performance ratio as a result of the high standard performance and low space requirements are some of the highlights of this new product series

All of the drive converters are equipped with the well-proven FCC closed-loop control (Flux Current Control), which automatically adapts the drive converter to the load thus guaranteeing optimum motor efficiency

Simple technological controls, e. g. for pressure or temperature, can be implemented using the integrated standard PID speed controller.

Induction motors such as standard three-phase squirrel-cage induction motors, synchronous motors or reluctance motors can be used with the drive converters

MICRO MASTER and MIDI MASTER can be used to control the speed of pump and fan drives as well as constant torque drives where there are no special requirements regarding the dynamic performance:

- fans in heating and ventilation systems
- pumps in district heating stations and in water supplies
- compressors, extruders, centrifuges and dosing pumps in the chemical and petrochemical industry as well as in the foodstuff industry
- conveyor and transport systems and roller tables in production and transport systems
- packaging and textile machines

1.2 Technical features

- MICRO MASTER: Rated motor output from 0.25 to 5.5 kW in degree of protection IP 21, NEMA 1
- MIDI MASTER: Rated motor output from 5.5 to 37 kW
 - for square-law V/f characteristics (variable torque, VT) up to 45 kW
 - with degree of protection IP 21, NEMA 1 or optionally degree of protection Schutzart IP 54
- 0-650 Hz output frequency with a high 0.01 Hz frequency resolution
- integrated PID speed or technology controller for standard applications, for example, pressure or temperature control
- MICRO MASTER units have an integrated braking chopper
- MICRO MASTER for 3-ph. 230 V AC supplies can also be connected to single-phase supplies
- single-phase MICRO MASTER drives have an integrated radio interference suppression filter
- extremely simple start-up: no setting work required for standard applications
- auto-calibration of the stator resistance

MICRO MASTER

- comprehensive drive converter and motor protection (protection for undervoltage and overvoltage, ground faults, short-circuit, overtemperature, overload, stall, supplementary PTC input for motor protection)
- FCC for optimum load equalization and high efficiency
- optional automatic or freely-parameterizable characteristic boost for optimum starting
- overload: 150 % for 60 s, referred to the rated output current
- unified membrane keyboard with 7 keys for open-loop control and operator control
- up to 31 drive converters can be coupled through a serial RS 485 interface, therefore providing a simple coupling to a PLC (e.g. SIMATIC)
- PROFIBUS module as option for coupling to PROFIBUS DP
- state-of-the-art IGBTs for low-loss operation
- certified in accordance with DIN ISO 9001, VDE, UL, Canadian UL
- conforms to all of the requirements of the EEC Low-Voltage Directive 73/23/EEC, documented with the EEC Declaration of Conformance and CE mark
- integrated, adjustable DC current brake for fast stopping
- integrated, programmable sequence control to control an external holding brake
- slip compensation for high speed stability, even without tachometer and closed-loop control
- restart-on-the-fly circuit to switch to a motor which is still rotating
- automatic restart after power failure or fault
- flexible setpoint input via fixed frequencies, motorized potentiometer, inching setpoint via analog input or serial interface
- high-resolution 10-bit setpoint channel for fine speed adjustment

MIDI MASTER

- setpoint channel 0/2 V ... 10 V or 0/4 mA ... 20 mA
- two freely-programmable ramp-function generators (0.1 s - 650 s) with adjustable rounding-off
- up to 8 independent fixed frequencies
- suppressible resonant frequency
- 0/4 mA ... 20 mA analog output
- 5 binary inputs which can be parameterized
- 2 binary outputs which can be parameterized

1.3 Overview of the options

MICRO MASTER and MIDI MASTER can be expanded by a series of options, which are described in detail in sections 8 and 9:

- plain text operator control panel
- SIMOVIS PC program
- PROFIBUS module
- radio interference suppression filter
- brake resistor
- braking unit for MIDI MASTER
- output reactor
- output dV/dt filter
- commutating reactor

MICRO MASTER

MIDI MASTER

2.1 Power section

2/2

2.2 Open-loop and closed-loop control

2/4

2. Design and description

MICRO MASTER and MIDI MASTER are a unified series of drive converters, which are ready to be connected to the supply and which include all of the components required for operation



Fig 2.1: The MICRO MASTER and MIDI MASTER family

The series consists of, depending on the supply voltage and output, the three various basic MICRO MASTER, MIDI MASTER sizes, with degree of protection IP 21, and MIDI MASTER with degree of protection IP 54. All of the drive converters can be mounted next to each other without any intermediate clearances between them.

The electrical connections are realized at the bottom. The power and control terminals are accessible after the housing cover has been removed (Figs. 2.2 and 2.3).

2.1 Power section

The power section is cooled using heatsinks at the back of the unit and for drive converters with outputs above 750W, also using an integrated fan (air intake from below).

All of the units have an uncontrolled input rectifier, a capacitor-buffered DC voltage link, and a PWM inverter with IGBT transistors.

The DC link is pre-charged via resistors and pre-charging relays when the unit is connected to the line supply, whereby the inrush current is limited.

A main switch or load disconnecter is also provided to electrically isolate the unit from the line supply. Slow-acting line fuses can also be used for protection (Table 2.1).

MICRO MASTER for input voltages 3-ph. 230 V AC (MM25/2 to MM300/2) can also be operated from single-phase 230 V AC supplies.

Caution:

In this case, the drive converters may not be connected to a three-phase supply, as the 3-ph. 400 V AC would destroy the drive converter.

All MICRO MASTER for 1-ph. 230 V AC supply voltages (MM25 to MM220) and 3-ph. 230 V AC (MM25/2 to MM300/2) can also be operated from 2-ph. 208 V AC line supplies.

It is possible to operate MICRO MASTERS from ungrounded line supplies if the drive converter is connected through an isolating transformer. It is also possible to operate a MICRO MASTER without isolating transformer. However, in this case, the drive converter shuts down if a ground fault develops at the converter output.

Presently, it is not permissible to operate MIDI MASTERS from ungrounded line supplies.

MICRO MASTER

MIDI MASTER

Supply voltage	Version	Rated fuse current	
1-ph. 230 V AC	MM25, MM25/2 MM37, MM37/2 MM55, MM55/2	10 A	
	MM75, MM75/2	16 A	
	MM110, MM110/2 MM150, MM150/2	20 A	
	MM220, MM220/2	25 A	
	MM300/2 ¹⁾	30 A	
	3-ph. 230 V AC	MM25/2 MM37/2 MM55/2 MM75/2	10 A
MM110/2 MM150/2		16 A	
MM220/2 MM300/2		20 A	
3-ph. 380 - 500 V AC		MM150/3	10 A
		MM220/3 MM300/3	16 A
	MM400/3 MM550/3	20 A	
3-ph. 230 V AC	MD550/2	50 A	
	MD750/2 MD1100/2	63 A	
	MD1500/2	80 A	
	MD1850/2 MD2200/2	100 A	
	3-ph. 380 - 500 V AC	MD750/3 MD1100/3	32 A
MD1500/3 MD1850/3		50 A	
MD2200/3 MD3000/3		80 A	
MD3700/3		100 A	
3-ph. 525 - 575 V AC		MD750/4	25 A
	MD1100/4 MD1500/4	32 A	
	MD1850/4	40 A	
	MD2200/4	50 A	
	MD3000/4	63 A	
	MD3700/4	80 A	

1) with additional 4 EM6100-3CB commutating reactor

Table 2.1: Recommended line fuses (slow acting)

The DC link voltage is converted into a pulsed variable frequency and voltage system by the inverter. State-of-the-art power transistors (IGBT) and PWM (Pulsed Width Modulation) offer the following advantages

- low drive converter and motor losses
- motor voltage frequency, 0 to 650 Hz
- motor voltage, 0 V to the line supply voltage
- almost sinusoidal motor currents
- high motor utilization
- high pulse frequency up to 16 kHz
- converter-related motor noise is eliminated at 16 kHz
- drive converter protected against at short-circuits and ground faults
- drive converter output no-load proof
- the motor can also be disconnected while the drive converter is operational (motor contactor, repair switch)

2.2 Open-loop and closed-loop control

Field-current control (Flux Current Control, FCC)

The closed-loop field current control can be used to full advantage for single-induction motor drives (parameter P077=1, factory setting).

FCC is a simple but effective method to implement a closed-loop control circuit without encoder. FCC provides a high drive efficiency by keeping the motor flux constant so that the motor always operates with the optimum magnetizing current. In this case, the drive converter calculates the required voltage in real time using a motor model

To set up the drive, only the rating plate data of the connected induction motor have to be entered (parameters P081 to P085). These parameters are factory set with the data of Siemens 4-pole 1LA5 motors, and should be adapted if other motors are used.

Optimum operation is achieved if the stator resistance is automatically measured (parameter P089) (auto-calibration, parameter P088=1).

FCC cannot be used for:

- Synchronous or reluctance motors
- Multi-motor drives, group drives (several motors connected in parallel at the drive converter output)
- If the motor and drive converter outputs differ by a factor of 2.5 or greater.
In these cases, a V/f characteristic must be parameterized
- P077=0 for applications with linear torque characteristics
- P077=2 for applications with pump or fan characteristics (square-law torque characteristics, variable torque, VT).

For MIDI MASTER when a square-law torque characteristic is used, this permits a significantly higher motor current whereby in almost all cases, the rated output is achieved using the next largest motor (the motor current can be increased via parameter P083).

For a specific output, fan and pump drives can have a smaller drive converter.

Closed-loop PID control

All MICRO MASTER and MIDI MASTER units have a simple PID controller integrated as standard with an additional encoder input for an analog actual value (0 - 5 V or 0 - 20 mA 8-bit resolution).

Without any additional circuitry or software, this technological control function allows slowly changing quantities, for example, temperature or pressure, to be controlled. Closed-loop speed control is also possible for slow processes

For PID controls, the reference value is entered directly as far as the controlled variable is concerned (0 - 100%). This allows universal control of all quantities which are directly sensed from a transmitter, which can be fed back and which can be influenced by the motor speed

If an analog setpoint is not required, the standard analog input is available as actual value channel with a higher resolution (0 - 10 V or 0 - 20 mA, 10 bits).

Further characteristics of the PID control

- any display scaling can be selected (P010, P001)
- separate setting of the P, I and D components
- selectable sampling interval and filtering
- flexible adaption to the actual value generator/transmitter
- the motor can be shutdown below the minimum frequency - this can be parameterized (P220)
- message can be output at the minimum and maximum motor frequency - this can be parameterized (relay output, P061 and P062).

The setting is realized via parameters P201 to P212

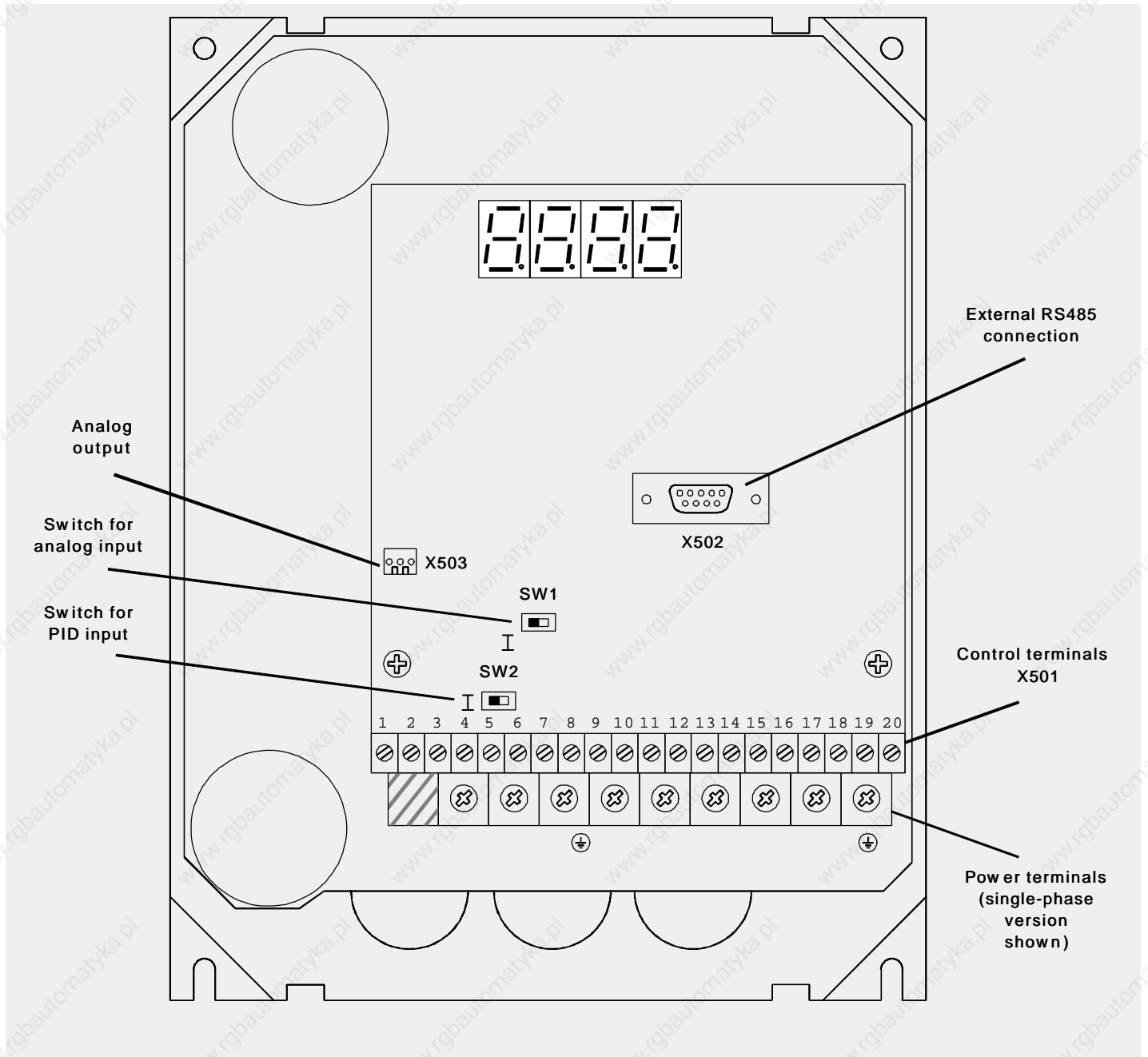

Fig 2.2: MICRO MASTER - Inner design

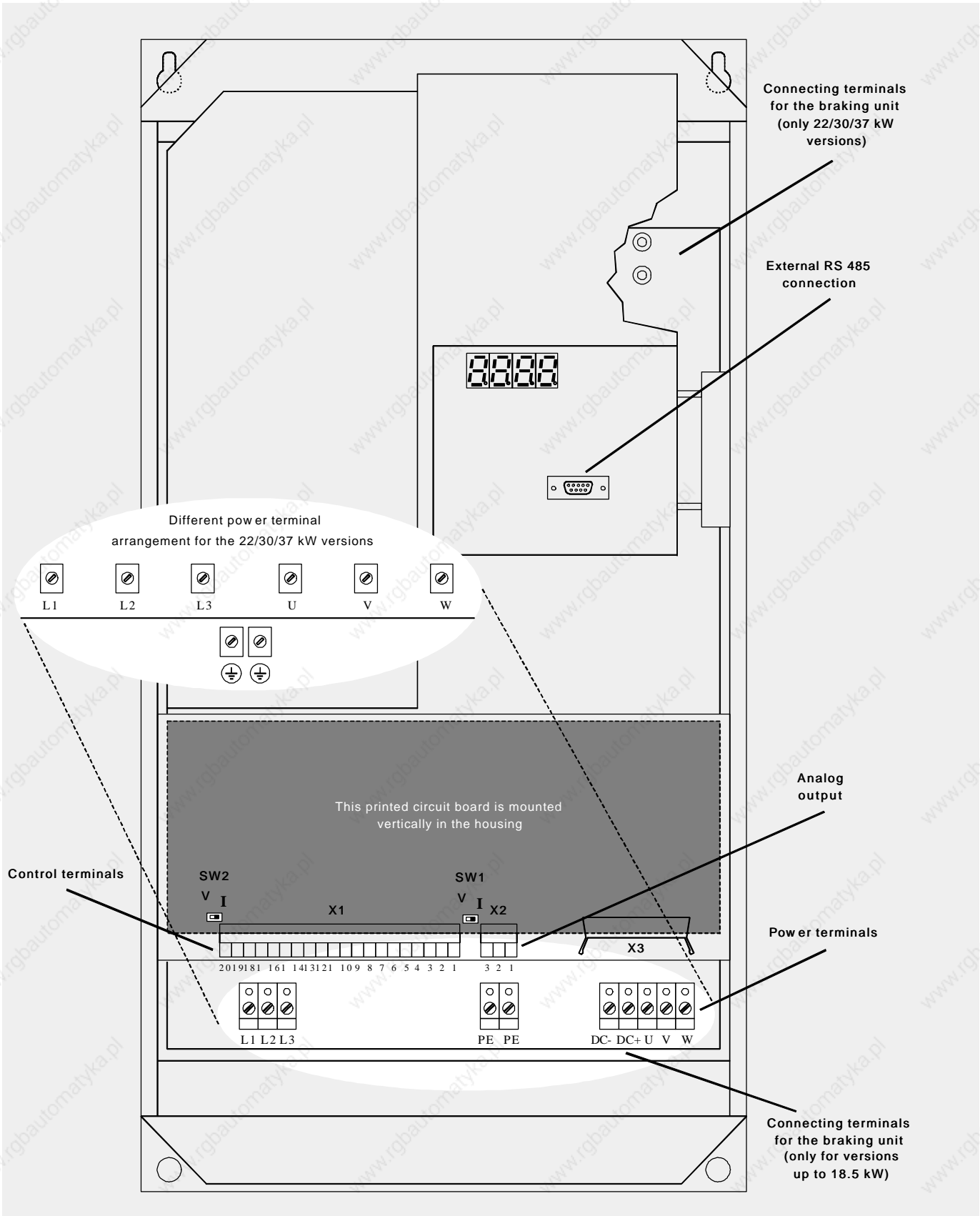

Fig. 2.3: MIDI MASTER - Inner design

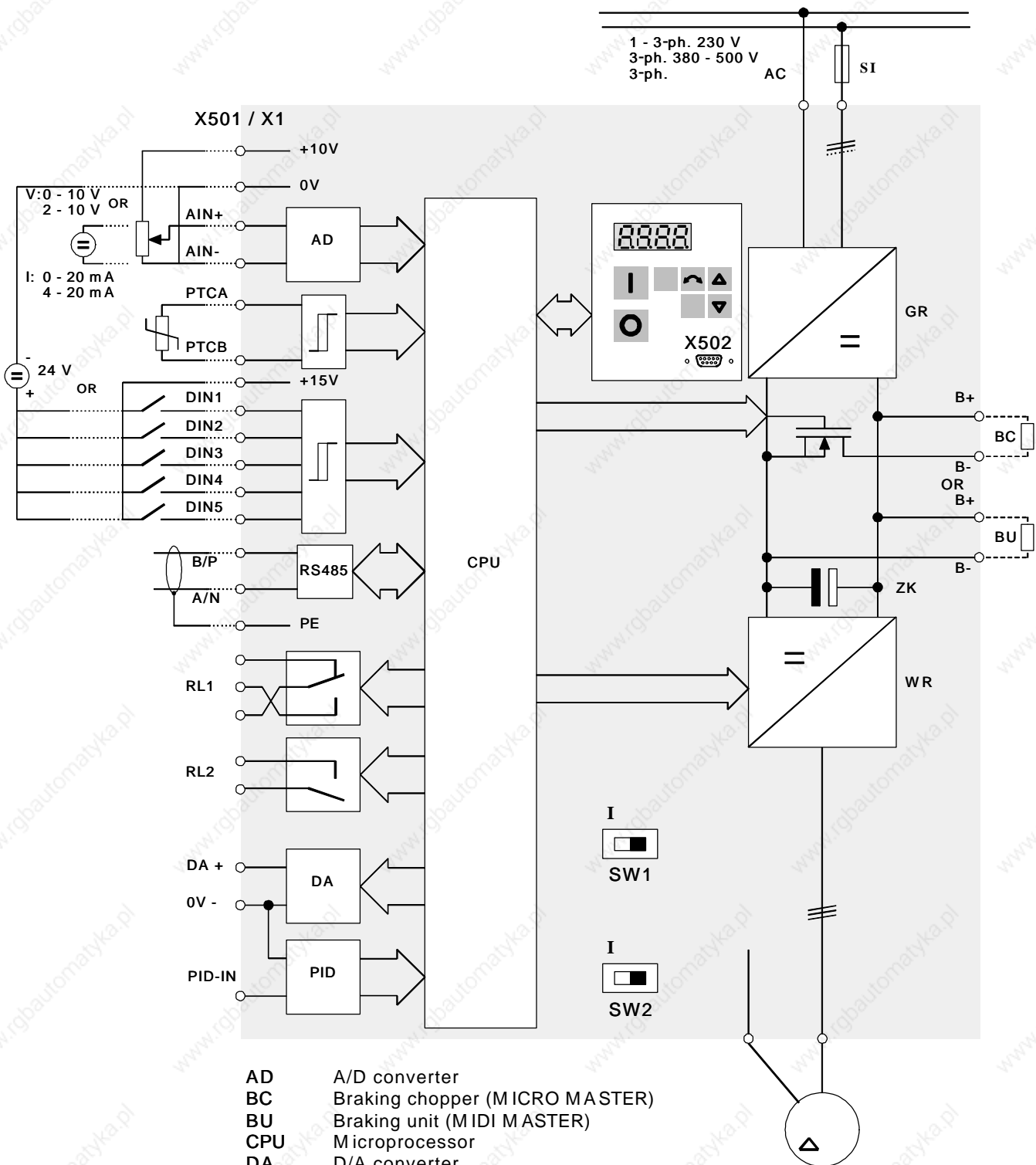

Fig 2.4: MICRO/MIDI MASTER - block circuit diagram

3.1	Standard membrane keypad	3/2
3.2	Serial RS485 interface	3/2
3.3	Control terminal strips	3/3
3.4	Plain text operator control panel OPM (option)	3/5
3.5	PROFIBUS module OPMP (option)	3/6
3.6	Operator control via PC with SIMOVIS (option)	3/8
3.7	Monitoring and diagnostics	3/8
3.8	Parameter list	3/9

MICRO MASTER **MIDI MASTER**

3. Communications, operator control and visualization

The operator control and visualization of MICRO MASTER and MIDI MASTER is unified
 The drive converters can be controlled, visualized and parameterized either at the drive converter itself or externally:

1. At the drive converter via
 - ### the 7-key membrane keypad included as standard
 - ### the optional OPM plain text operator control panel
 - ### or the control terminal strip
2. Externally via
 - ### the serial RS 485 interface
 - ### the optional OPM plain text operator control panel
 - ### the optional PROFIBUS module
 - ### or a PC with SIMOVIS

3.1 Standard membrane keypad

The operator control and parameterizing unit includes the following functions:

- Drive converter start-up
- Operator control
 - On/off, raise/lower setpoint
 - clockwise/counter-clockwise direction of rotation
 - selection, inching frequency via the jog key
- Displaying setpoints and actual values
- Displaying and changing parameters
- Displaying drive converter statuses
- Displaying alarm and fault messages
- Starting and stopping with a preset frequency

The function keys can be individually inhibited
 The OFF key is always active for safety reasons

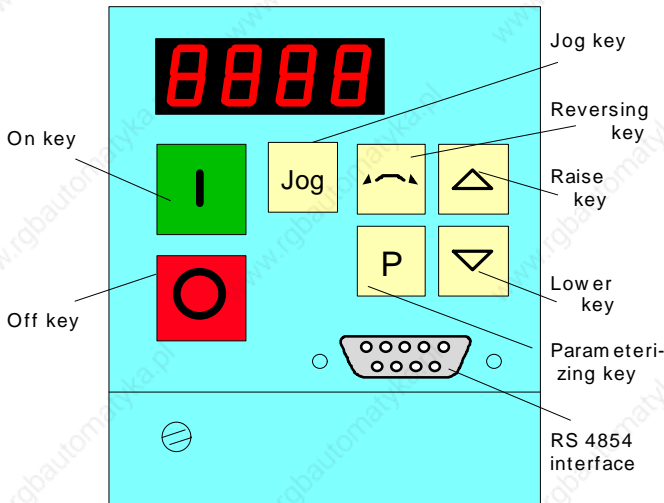

Fig. 3.1.1: Standard membrane keypad

There is a 9-pin SUB-D socket connector (X502) on the membrane keypad as RS 485 interface
 The optional OPM plain text operator control panel, the optional PROFIBUS module or an interface converter RS 485/RS 232 to communicate with a PC (e.g. SIMOVIS operator control software) can be connected here.

3.2 Serial RS 485 interface

The RS 485 interface of the MICRO MASTER and MIDI MASTER operates with the USS protocol, can be networked with 31 nodes through a bus and permits a maximum data transmission rate of 19.2 kbit/s.

The RS 485 interface is accessible via a SUB-D socket connector and control terminal strip (refer to section 3.3).

Note:
 Also refer to the documentation: "Using the USS protocol for 6SE21 SIMOVERT drive converters and MICRO MASTER"
 Order No. E20125-B0001-S302-A1 (German)
 Order No. E20125-B0001-S302-A1-7600 (English)

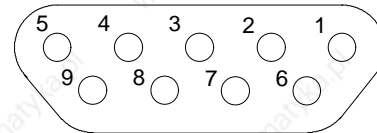

Fig. 3.2.1: Pin assignment of the SUB-D socket connector (X502)

Terminal	Function, information
X502:1	NC (not connected)
X502:2	NC
X502:3	Send- and receive line RS 485, two wire, positive differential input/output B/P
X502:4	NC
X502:5	Reference potential, OV
X502:6	5V power supply
X502:7	NC
X502:8	Send- and receive line, RS 485, two wire negative differential input/output A/N
X502:9	NC

Table 3.2.1: Pin assignment of the SUB-D socket connector (X502)

Note:
 If the RS 485 connection on the front panel is to be used, then the internal RS 485 connections (terminals 13 and 14) may not be used.

MICRO MASTER	MIDI MASTER
--------------	-------------

3.3 Control terminal strips

All of the functions required to operate and monitor MICRO MASTER and MIDI MASTER are accessible via control terminal strips

- Control commands, e.g. on/off, clockwise/counter-clockwise, inching
- Analog setpoint inputs
- Digital setpoint inputs, e.g. fixed frequency
- Digital outputs, e.g. operation, alarm
- Analog outputs, e.g. frequency setpoint, output current

The response times of the inputs are as follows

- Digital input
10 - 20 ms, depending on the debounce time (P056)
- Analog input
approx. 15 ms for step signals (> 0.5 V)
- RS 485 interface:
approx. 5 - 20 ms

Function	No.	Description
Analog inputs	1	Floating 0 ... 10 V; 2 ... 10 V (33 kΩ impedance) 0 ... 20 mA; 4 ... 20 mA (300 Ω load resistor)
Analog input for the PID controller	1	Non-floating 0 ... 5 V; 0 ... 20 mA
Analog outputs	1	Non-floating 0 ... 20 mA; 4 ... 20 mA (500 Ω load resistor for 0/2 ... 10 V)
Binary inputs	5	Non-floating 13 - 33 V; max 8 mA < 4 V = low, > 9 V = high (impedance approx. 5 kΩ)
Binary outputs	2	Relay output 1 changeover contact relay output 2 NO contacts 240 V AC/1 A 24 V DC/2 A

Table 3.3.1: Parameterizable input and outputs of the control terminal strips

	Value	Function	Comment
1	+	Analog output	0/4-20 mA 0-500 Ω
2	0V	Ground	
3	+	PID input	0-5 V 0-20 mA

Table 3.3.2 Terminal strip X503 and X2 for MICRO MASTER and MIDI MASTER





















Note:

In order to prevent noise, loads driven by relays must be provided with RC circuits.

Ensure that the contactors in the cabinets have damping circuitry - either RC circuits for AC contactors or free-wheeling diodes for DC contactors. The damping elements must be connected directly at the coils. Overvoltage-limiting varistors are also effective. These measures are extremely important if the contactors are driven by relays in the drive converter.

MICRO MASTER

MIDI MASTER

		Value	Function	Comment
	1	P10+ +10 V	Power supply	max. 3 mA
	2	O V 0 V	Power supply	Ground
	3	AIN+ 0-10 V/0-20 mA or 2-10 V/4-20 mA	Analog input	Positive (+) connection
	4	AIN-	Analog input	Negative (-) connection
	5	PTCA	Input motor PTC thermistor	
	6	PTCB	Input motor PTC thermistor	
	7	P15+ +15 V	Power supply for DIN 1-5	max. 20 mA
	8	DIN1	Digital input 1	13 - 33 V
	9	DIN2	Digital input 2	13 - 33 V
	10	DIN3	Digital input 3	13 - 33 V
	11	DIN4	Digital input 4	13 - 33 V
	12	DIN5	Digital input 5	13 - 33 V
	13	B/P	RS 485, line 'B' (+)	For USS protocol
	14	A/N	RS 485, line 'A' (-)	For USS protocol
	15	PE	PE protective ground	
	16	RL1A	Relay 1	NC contact
	17	RL1B	Relay 1	NO contact
	18	RL1C	Relay 2	Common
	19	RL2B	Relay 2	NO contact
	20	RL2C	Relay 2	Common

max. cross-section for control cables: 1.5 mm²

Table 3.3.4: Terminal strip X501 and X1

MICRO MASTER MIDI MASTER

3.4 Plain text operator control panel OPM (option)

The expanded operator control panel (OPM) is conceived for use with MICRO MASTER and MIDI MASTER. The OPM simplifies operator control using an easily-understandable text display.

The OPM has the following characteristics

- illuminated LCD screen with 64 characters
- 5 selectable languages
- as main control device for up to 31 inverters, networked via the USS bus
- can read and write parameters
- CMOS storage for up to 31 parameter sets
- menu-prompted screen options
- simple installation

The optional OPM plain text operator control panel (degree of protection IP 54) is directly inserted at the SUB-D socket of the standard membrane keyboard, and screwed to the front cover

The OPM can be simply screwed to the cabinet door using two mounting screws.

The OPM plain text operator control panel can also be connected via a 3 m cable so that it can be used as handheld terminal, or can be mounted in a cabinet unit

Thus, a favorably-priced alternative is available to cabinet measuring instruments, which display physical measured quantities.

The operator control panel is automatically activated when it is inserted in the drive converter

An illuminated LC display in the OPM displays plain text with 4 x 16 characters. It is possible to select either German, English, French, Spanish or Italian

Dimensions H x W x D	97 mm x 75 mm x 25 mm
Current drain at 5V	200 mA
Degree of protection	IP 54
Display	LCD 4 x 16 characters

Table 3.4.1: Technical data

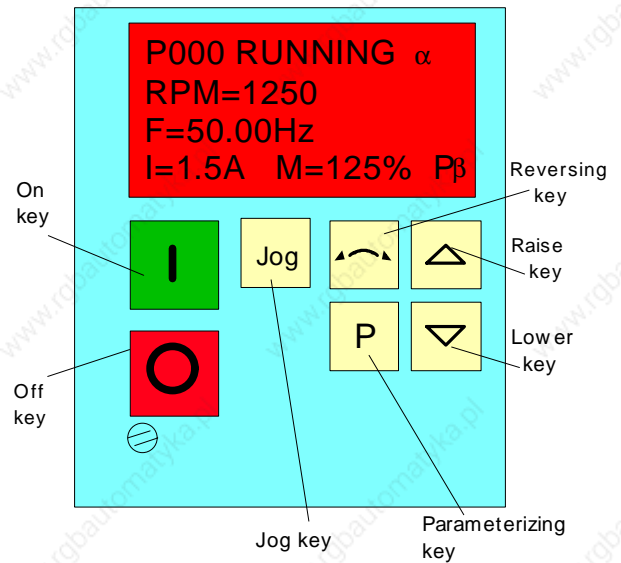

Fig. 3.4.1: OPM plain text operator control panel

Examples of plain text displays

Operating display:

P000 RUNNING α
RPM=1250
F=50.00Hz
I=1.5A M=125% Pβ

- 1st line: Operating status and direction of rotation (arrow)
- 2nd line: RPM = motor speed
- 3rd line: F = frequency (can be set by depressing the raise and lower buttons)
- 4th line: I = motor current, M = torque

Fault display, diagnostics:

Overtemp.
Ambient tempera-ture too high
F005 Pβ

Designation	Order No.
OPM plain text operator control panel	6SE 3190-0XX87-8BF0
Connecting cable, membrane keyboard OPM 3 m	6SX 7010-0AB03

Table 3.4.2: Ordering information

MICRO MASTER	MIDI MASTER
---------------------	--------------------

3.5 PROFIBUS module OPMP (option)

A drive converter can be controlled via a PROFIBUS-DP type serial bus (SINEC L2-DP) using the PROFIBUS module (OPMP).

Features:

- Permits fast cyclic communications via a PROFIBUS connection.
- It can control up to 125 converters using PROFIBUS-DP protocol (with repeaters).
- Certified by the PROFIBUS User Organisation (PNO) for open communications in conformance with points under DIN 19245 Part 3. It can be used with other PROFIBUS-DP/SINEC L2-DP peripheral devices on the serial bus
- Can be easily configured using Siemens COM ET 200 software (a parameterization floppy disk is supplied with it).
- Simple integration into a SIMATIC S5 PLC using the DVA_S5 software package
- Common module for MICRO MASTER and MIDI MASTER
- Easy connection. The OPMP is inserted onto the operator control panel, just like the optional OPM plain text operator control panel, and screwed into place
- No separate power supply necessary.
- Integrated bus terminating resistor
- Comprehensive diagnostics
- Parameterization using keys on the OPMP
- Approx. 20 msec response time to process data
- Output frequency control (and therefore motor speed) via
 - (1) Digital frequency setpoint
 - (2) Analog setpoint (current or voltage).
 - (3) Motorized potentiometer
 - (4) Fixed frequency.
 - (5) Remote data transfer via PROFIBUS-DP

PROFIBUS-DP is specified as Standard Draft in DIN 19245 Part 3. Data transfer with OPMP is realized in accordance with the specifications of VDI/VDE Directive 3689 "PROFIBUS profile, variable-drives".

Process data, i.e. control words and setpoints, or status information and actual values as well as parameters can be written into or read out of each telegram. Optionally, parameterization and control can be remotely handled, or each separately set locally at the drive converter

The net data structure is designated as parameter-process data objects (PPO). OPMP supports PPO types 1 and 3

When commissioning the bus system, it is possible to configure, from the master, which PPO type is used by the PROFIBUS-DP master to address the drive converter. The relevant PPO type is selected dependent on the task of the particular drive in the automation group

Process data is transferred in each telegram. It is processed with the highest priority and in the shortest time segments. The drive is controlled in the automation network, e.g. power on/power off, setpoints entered, etc

The user has free access to all of the drive converter parameters via the bus system, using the parameter area. For example: reading out detailed diagnostic information, fault messages, etc. Thus, additional information can be selected to visualize the drive from a higher-level system, e.g. a PC, without diminishing the performance of the process data transfer.

PROFIBUS is connected via the SUB-D socket at the front of the OPMP. The pin assignment is as follows

Pin	3	PROFIBUSconnection	P
Pin	8	PROFIBUSconnection	N

Further, the cable shield must be connected at the housing of the SUB-D connector. The following cable lengths and data transfer rates are possible

Data transfer rate (Kbit/s)	Max. cable length of a segment (m)
9.6	1200
19.2	1200
93.75	1200
187.5	1000
500	400
1500	200

Table 3.5.1: Data transfer rate and cable length

MICRO MASTER

MIDI MASTER

A segment can be extended by using RS 485 repeaters.
 Recommendation: For example SINEC L2 repeater RS 485 (Order No.: 6GK1510-0AC00).

To ensure noise-free PROFIBUS-DP operation, the bus cable must be terminated at both ends using bus terminating resistors. The OPMP includes an integrated switch for bus termination (refer to Fig. 3.5.1).

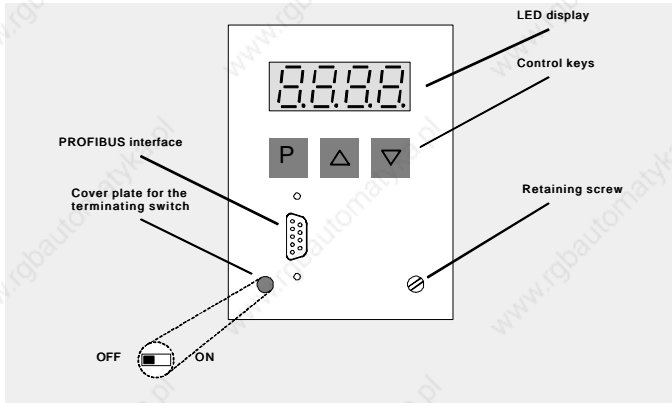

Fig. 3.5.1: PROFIBUS module OPMP

The system is parameterized and controlled locally from the OPMP, exactly the same as via the standard membrane keyboard. The parameter set is always the same. Several parameters are not used and several parameters are additionally available for the OPMP (detailed description is provided in the OPMP manual).

The system is parameterized and controlled locally from the OPMP, exactly the same as via the standard membrane keyboard. The parameter set is always the same. Several parameters are not used and several parameters are additionally available for the OPMP (detailed description is provided in the OPMP manual).

As the OPMP does not have start/stop buttons, it must be powered up and down via the remote control or the digital inputs (switches).

A floppy disk is supplied with the OPMP to configure the PROFIBUS-DP system. This floppy disk contains a master drive converter file and for appropriate configuring software for PROFIBUS-DP master (e.g. COM ET 200 V4.x) a type description file. The master drive converter file (SIEM8023.GSD) is a WINWORD file and the description file (SI8023Tx.200) is an ASCII file.

Brief instructions for smooth communications between the PROFIBUS master and OPMP:

- The bus cable between both devices must be connected correctly.
- The PROFIBUS master must be configured correctly so that communications can be realized with a DP slave using PPO type 1 or PPO type 3 (only PPO type 1, if the PPO type cannot be configured via remote operator control).
- For COM ET 200 software, the correct type description file must be used, so that an IM 308B/C can be configured as bus master.
- The bus must be operational (for a SIMATIC module, the operator control panel switch must be set to RUN).
- The bus baud rate must not exceed 1.5 Mbd.
- The drive converter must be powered up.
- The slave address for the OPMP (parameter P918) must be set so that it corresponds to the slave address configured at the PROFIBUS master, and must be uniquely defined on the bus.
- Installation should be in conformance with EMC directives and regulations (*this is described in detail in the manual*).

Dimensions H x W x D	97 mm x 75 mm x 25 mm
Degree of protection	IP 21
Display	LED 4 x 7 Segment

Table 3.5.2: Technical data

Designation	Order No.
PROFIBUS module OPMP	6SE3190-0XX87-8PB0
Block package for SIMATIC S5 DVA_S5	6DD1800-0SW0

Table 3.4.2: Ordering information

Designation	Order No.
PROFIBUS module OPMP instruction manual (5 languages)	6SE3186-4AK00
Function blocks for SIMATIC S5 AG115U, 135U, 155U; net data transfer with SIMOREG and SIMOVERT drives via SINEC L2DP	E20125-C0002-S302-A1 (De) E20125-C0002-S302-A1-7600 (En)

Table 3.4.3: Documentation

3.6 Operator control via PC with SIMOVIS (option)

Using the SIMOVIS operator control program, MICRO MASTER and MIDI MASTER can be controlled and visualized via a graphic man-machine interface from the PC.

SIMOVIS functions:

- ###** Menu-prompted start-up
- ###** Setting and visualization of all parameters
- ###** Controlling the drive converters (setpoints, control commands)
- ###** User-friendly evaluation of faults and alarms
- ###** Reading-in and reading-out (UPREAD/DOWNLOAD) as well as storing parameter sets
- ###** Bus operation with up to 31 drive converters

The PC is connected to the serial interface of the drive converter via an RS 232/RS 485 interface converter. The connection is realized via the SUB-D socket connector of the membrane keyboard or the X501 control terminal strips (also refer to Sections 3.2 and 3.3).

Note:

Observe the connection and connector assignment of the interface converter (instruction manual).

Designation	Order No.
SIMOVIS for MICRO MASTER and MIDI MASTER	6SE3190-0XX87-8SA0

Table 3.6.1: Ordering information

3.7 Monitoring and diagnostics

Alarm messages

Alarm messages indicate drive converter faults. However, these do not cause the drive to be shutdown. They are not acknowledged and are automatically reset once their cause has been removed.

The display flashes if alarm messages are available.

A group alarm message as well as several alarms can be output via the binary outputs (control terminal strip, parameter P061, P062). The last alarm is stored in a parameter (P931) until the drive converter is shutdown.

Further, alarm messages can be externally evaluated via the serial interface.

A differentiation can be made between the following alarm message sources:

- Current limiting active
- Voltage limiting active
- Slip limit value exceeded
- Motor overtemperature.

Fault messages

When a fault occurs, the drive converter is shutdown (the inverter pulses are inhibited), and an error code is displayed. The associated fault/error cause as well as measures to remove the fault are specified in the instruction manual.

The fault message is stored in a parameter (P930).

The fault memory can be read out via the operator control panel or the interface. A sum error message can also be assigned to the binary outputs (control terminal strip, parameters P061, P062).

The drive converter can be reset after the fault has been removed. The fault can be acknowledged via the P key of the particular operator control panel (depress twice), via the control terminal strip (parameters P051-55) or via the serial interface.

After acknowledgment, the drive converter switches to "power on inhibit". The "power on inhibit" can be cancelled by the "off" command. The unit then goes into the "ready to power up" status.

MICRO MASTER

MIDI MASTER

3.8 Parameter list

• = The parameters can also be changed during operation

◆◆◆ = The set value is dependent on the drive converter type

Parameter	Function	Range [factory setting]
P000	Operating display	-
P001 •	Display selection	0 - 7 [0]
P002 •	Ramp-up time (seconds)	0 - 650.0 [10.0]
P003 •	Ramp-down time (seconds)	0 - 650.0 [10.0]
P004 •	Smoothing (seconds)	0 - 40.0 [0.0]
P005 •	Digital frequency setpoint (Hz)	0.00 - 650.00 [0.00]
P006	Frequency setpoint type selection	0 - 2 [0]
P007	Enable/disable front panel	0 - 1 [1]
P009 •	Parameter protection setting	0 - 3 [0]
P010	Display scaling	0.00 - 500.00 [1.00]
P011	Frequency setpoint memory	0 - 1 [0]
P012 •	Minimum motor frequency (Hz)	0.00 - 650.00 [0.00]
P013 •	Maximum motor frequency (Hz)	0.00 - 650.00 [50.00]
P014 •	Skip frequency (Hz)	0.00 - 650.00 [0.00]
P015 •	Automatic restart	0 - 1 [0]
P016 •	Start on the fly	0 - 4 [0]
P017 •	Smoothing type	1 - 2 [1]
P018 •	Automatic restart after fault	0 - 1 [0]
P021 •	Minimum analog frequency (Hz)	0.00 - 650.00 [0.00]
P022 •	Maximum analog frequency (Hz)	0.00 - 650.00 [50.00]
P023 •	Analog input type	0 - 2 [0]
P024 •	Analog setpoint addition	0 - 1 [0]
P025 •	Analog output	0 - 105 [0]
P031 •	Jog frequency right (Hz)	0.00 - 650.00 [5.00]
P032 •	Jog frequency left (Hz)	0.00 - 650.00 [5.00]
P033 •	Jog ramp-up time (seconds)	0 - 650.0 [10.0]

Parameter	Function	Range [factory setting]
P034 •	Jog ramp-down time (seconds)	0 - 650.0 [10.0]
P041 •	1st fixed frequency (Hz)	0.00 - 650.00 [5.00]
P042 •	2nd fixed frequency (Hz)	0.00 - 650.00 [10.00]
P043 •	3rd fixed frequency (Hz)	0.00 - 650.00 [20.00]
P044 •	4th fixed frequency (Hz)	0.00 - 650.00 [40.00]
P045	Inversion fixed setpoints for fixed frequencies 1 - 4	0 - 7 [0]
P046	5th fixed frequency (Hz)	0.00 - 650.00 [0.00]
P047	6th fixed frequency (Hz)	0.00 - 650.00 [0.00]
P048	7th fixed frequency (Hz)	0.00 - 650.00 [0.00]
P049	8th fixed frequency (Hz)	0.00 - 650.00 [0.00]
P050	Inversion fixed setpoints 5 - 8	0 - 7 [0]
P051	Selection control function, DIN1 (terminal 8)	0 - 17 [1]
P052	Selection control function DIN2 (terminal 9) fixed frequency 4	0 - 17 [2]
P053	Selection control function DIN3 (terminal 10) fixed frequency 3. If set to 17, this enables the most significant bit of the 3-bit BCD (see table)	0 - 17 [6]
P054	Selection control function DIN4 (terminal 11) fixed frequency 2	0 - 17 [6]
P055	Selection control function DIN5 (terminal 12) fixed frequency 1	0 - 17 [6]
P056	Digital input debounce time	0 - 2 [0]
P061	Selection relay output RL1	0 - 13 [6]
P062	Selection relay output RL2	0 - 13 [8]
P063	External brake release delay (seconds)	0 - 20.0 [1.0]
P064	External brake stopping time (seconds)	0 - 20.0 [1.0]
P065	Current threshold for relay (A)	0 - 99.9 [1.0]
P070	Braking Resistor Duty Cycle (MICRO MASTER only)	0 - 4 [0]
P071 •	Slip compensation (%)	0 - 200 [0]
P072 •	Slip limit (%)	0 - 500 [250]
P073 •	DC injection braking (%)	0 - 250 [0]

MICRO MASTER

MIDI MASTER

Parameter	Function	Range [factory setting]
P074 •	Motor derating curve as temperature protection	0 - 3 [0]
P075 •	Braking resistance (Ohm)	0/50 - 250 [0]
P076 •	Pulse frequency	0 - 10 [0 oder 4]
P077	Control mode	0 - 2 [1]
P078 •	Continuous boost (%)	0 - 250 [100]
P079 •	Starting boost (%)	0 - 250 [0]
P081	Nominal frequency for motor (Hz)	0.00 - 650.00 [50.00]
P082	Nominal speed for motor (RPM)	0 - 9999 [◇◇◇◇]
P083	Nominal current for motor (A)	0.1 - 99.9 [◇◇◇◇]
P084	Nominal voltage for motor (V)	0 - 1000 [◇◇◇◇]
P085	Nominal power for motor (kW)	0 - 50.0 [◇◇◇◇]
P086 •	Motor current limit (%)	0 - 250 [150]
P087 •	Motor PTC enable	0 - 1 [0]
P088	Automatic calibration	0 - 1 [1]
P089 •	Stator resistance (Ohm)	0.01 - 100.00 [◇◇◇◇]
P091 •	Slave address	0 - 30 [0]
P092 •	Baud rate	3 - 7 [6]
P093 •	Timeout (seconds)	0 - 240 [0]
P094 •	Serial link nominal system setpoint (Hz)	0.00 - 650.00 [50.00]
P095 •	USS compatibility	0 - 2 [0]
P101 •	Operation for Europe / USA	0 - 1 [0]
P111	Inverter power rating (kW/hp)	0.0 - 50.0 [◇◇◇◇]
P121	Enable/disable RUN button	0 - 1 [1]
P122	Enable/disable FORWARD/REVERSE button	0 - 1 [1]
P123	Enable/disable JOG button	0 - 1 [1]
P124	Enable/disable ↑ button and ↓ button	0 - 1 [1]
P131 •	Frequency setpoint (Hz)	0.00 - 650.00 [-]

Parameter	Function	Range [factory setting]
P132 •	Motor current (A)	0.0 - 99.9 [-]
P133 •	Motor torque (% of nominal value)	0 - 250 [-]
P134 •	DC link voltage (V)	0 - 1000 [-]
P135 •	Motor RPM	0 - 9999 [-]
P201 •	Select PID control	0 - 2 [0]
P202 •	P-part, PID controller	0.0 - 999.9 [1.0]
P203 •	I-part, PID controller	0.00 - 99.99 [0.00]
P204 •	D-part, PID controller	0.0 - 999.9 [0.0]
P205 •	Sampling rate	1 - 2400 [1]
P206 •	Actual value smoothing	0 - 255 [0]
P207 •	Enabling I-part	0 - 100 [100]
P208	Transmitter type	0 - 1 [0]
P210	Transmitter actual value	0.00 - 100.00 [-]
P211 •	Balance 0 %	0.00 - 100.00 [0.00]
P212 •	Balance 100 %	0.00 - 100.00 [100.00]
P220	Switching off with minimal frequency	0 - 1 [0]
P720 •	Special input/output functions	0 - 7 [0]
P721	Analog input voltage (V)	0.00 - 10.00 [-]
P722 •	Analog output current (mA)	0.0 - 20.0 [-]
P723	State of digital inputs	0 - 31 [-]
P724 •	Relay output control	0 - 3 [0]
P910 •	Local/Remote mode	0 - 4 [0]
P922	Software version	0 - 9999 [-]
P923 •	Equipment system number	0 - 255 [0]
P930	Most recent fault code	0 - 9999 [-]
P931	Most recent warning type	0 - 9999 [-]
P944	Reset to factory default settings	0 - 1 [0]
P971 •	EEPROM storage control	0 - 1 [1]

MICRO MASTER

MIDI MASTER

4. Technical data

4

MICRO MASTER

MIDI MASTER

4. Technical data

Rated voltage:	1/3-ph. 208-240 V AC $\pm 10\%$ 3-ph. 380-500 V AC $\pm 10\%$ 3-ph. 525-575 V AC $\pm 10\%$
Supply frequency:	47 Hz to 63 Hz
Power factor:	Basic line fundamental: $\cos \phi \downarrow 0.98$ Total: $\lambda \downarrow 0.70$
Output frequency range:	0 Hz to 650 Hz
Resolution:	0.01 Hz
Overload capability:	150 % for 60 s, referred to the rated current
Protective measures against:	Drive converter overtemperature Motor overtemperature Over- and undervoltage
Additional protective measures:	Short-circuit and ground-fault protection Motor stall protection, no-load proof
Operating mode:	4 quadrants possible
Open- and closed-loop control:	FCC FCC (field current control), V/f characteristic
Analog setpoint input:	0 - 10 V/2 - 10 V (recommended potentiometer 4.7 k Ω) 0 - 20 mA/4 - 20 mA
Sensor input for the PID controller:	0 - 5 V/0 - 20 mA (8 bits)
Analog output:	0 - 20 mA/4 - 20 mA @ 0 - 500 Ω
Analog setpoint resolution:	10 bits
Setpoint stability:	analog < 1 % digital < 0.02 %
Motor temperature monitoring:	PTC thermistor input, I^2t monitoring
Ramp times:	0 - 650 s
Control outputs:	2, 240 V AC/1 A relays; 24 V DC/2 A
Interface:	RS 485
Drive converter efficiency:	97 %
Power loss at 4 kHz:	approx. 3 %
Ambient temperature:	0 $^{\circ}\text{C}$ to +40 $^{\circ}\text{C}$ (without housing cover up to 50 $^{\circ}\text{C}$)
Max. heatsink temperature:	65 $^{\circ}\text{C}$
Cooling type:	Self-ventilation or forced ventilation, depending on the rated output
Relative air humidity:	90 % without moisture condensation
Installation height above sea level:	< 1000 m
Degree of protection:	IP 21, (NEMA1), for MIDI MASTER, optionally IP 54
Radio interference suppression:	In accordance with DIN VDE 0875, Part 11 (EN 55011) - standard Class A1 for MICRO MASTER 1-ph. 230 V AC - options Class B1 including class A1
Operation from ungrounded supplies:	MICRO MASTER: The drive converter is shutdown if a ground fault develops at the drive converter output MIDI MASTER: Presently not permissible

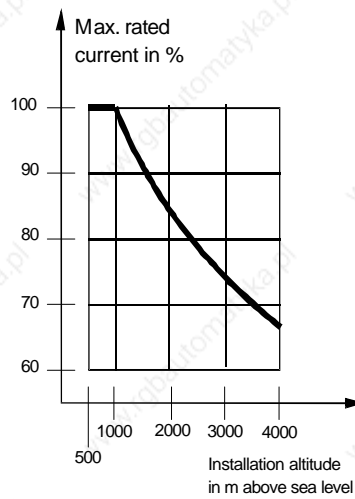
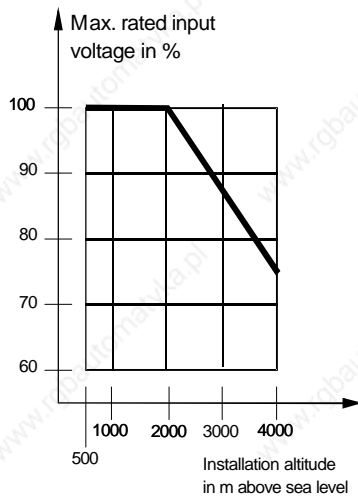
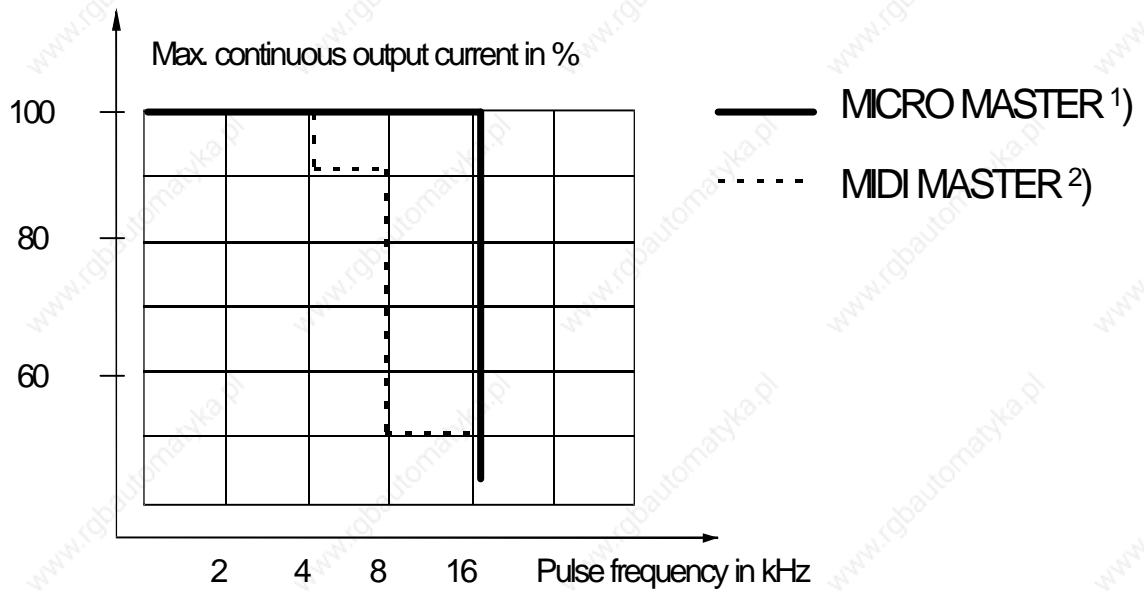

1) for MM400/3 and MM550/3 up to 6/96
80 % at 8 kHz, 60 % at 16 kHz

2) > 4 kHz for a square-law load characteristic (VT)
presently, no higher output or current possible

MICRO MASTER

MIDI MASTER

5.1	MICRO MASTER	5/2
5.2	MIDI MASTER, IP 21	5/3
5.3	MIDI MASTER, IP 54	5/4

MICRO MASTER

MIDI MASTER

5.1 Selection and ordering data MICRO MASTER

Rated motor output	Continuous drive converter output	Input current	Rated output current	Continuous output current	Short-time current	Output current	Drive converter type	Drive converter	Approx. weight	Dimensions HxWxD	Cable cross-section		
											recommended	max ¹⁾	
kW	kVA	A	A	A	A	A		Order No.	kg	mm	mm ²	mm ²	mm ²
Supply voltage 1-ph. 208 V to 230 V AC													
0.25	0.66	3.0	1.5	1.6	2.2		MM25	6SE3111-5BA40	1.9	182x112x113	1.0	1.0	2.5
0.37	0.88	3.8	2.0	2.3	3.0		MM37	6SE3112-1BA40	1.9	182x112x113	1.0	1.0	2.5
0.55	1.14	5.5	2.6	2.9	3.9		MM55	6SE3112-8BA40	1.9	182x112x113	1.0	1.0	2.5
0.75	1.50	6.5	3.4	3.7	5.1		MM75	6SE3113-6BA40	1.9	182x112x113	1.5	1.0	2.5
1.10	2.10	14.0	4.8	5.2	7.2		MM110	6SE3115-2BB40	2.6	184x149x152	2.5	1.5	2.5
1.50	2.80	18.0	6.4	7.0	9.6		MM150	6SE3116-8BB40	2.6	184x149x152	2.5	1.5	2.5
2.20	4.00	20.0	9.0	10.0	13.5		MM220	6SE3121-0BC40	5.0	215x185x175	2.5	1.5	2.5
Supply voltage 1/3-ph. 208 V to 230 V AC													
0.25	0.66	2.1	1.5	1.6	2.2		MM25/2	6SE3111-5CA40	1.8	182x112x113	1.0	1.0	2.5
0.37	0.88	3.0	2.0	2.3	3.0		MM37/2	6SE3112-1CA40	1.8	182x112x113	1.0	1.0	2.5
0.55	1.14	4.2	2.6	2.9	3.9		MM55/2	6SE3112-8CA40	1.8	182x112x113	1.0	1.0	2.5
0.75	1.50	5.0	3.4	3.7	5.1		MM75/2	6SE3113-6CA40	1.8	182x112x113	1.0	1.0	2.5
1.10	2.10	7.0	4.8	5.2	7.2		MM110/2	6SE3115-2CB40	2.4	184x149x142	1.5	1.5	2.5
1.50	2.80	9.5	6.4	7.0	9.6		MM150/2	6SE3116-8CB40	2.4	184x149x142	1.5	1.5	2.5
2.20	4.00	12.0	9.0	10.0	13.5		MM220/2	6SE3121-0CC40	4.5	215x185x162	2.5	1.5	2.5
3.00	5.20	14.5	11.8	12.7	17.7		MM300/2 ²⁾	6SE3121-3CC40	4.5	215x185x162	2.5	2.5	2.5
Supply voltage 3-ph. 380 V to 500 V AC													
at 400 V						at 460 V up to 500 V							
1.50	2.80	5.5	3.8	4.2	5.7	3.4	MM150/3	6SE3114-0DC40	5.0	215x185x162	1.0	1.0	2.5
2.20	4.00	7.5	5.5	6.1	8.2	4.8	MM220/3	6SE3115-8DC40	5.0	215x185x162	1.5	1.0	2.5
3.00	5.20	10.0	7.2	7.7	10.8	6.4	MM300/3	6SE3117-3DC40	5.0	215x185x162	1.5	1.0	2.5
4.00	7.00	12.5	9.5	10.2	14.2	7.6	MM400/3	6SE3121-0DC40	5.0	215x185x162	2.5	1.0	2.5
5.50	9.00	16.0	12.0	13.2	18.0	11.0	MM550/3	6SE3121-3DC40	5.0	215x185x162	2.5	1.5	2.5

¹⁾ When higher cable cross-sections are used, cable lugs are recommended; the cable cross-section can then be expanded

²⁾ Can only be connected to single-phase supplies using an additional commutating reactor 4EM6100-3CB

MICRO MASTER MM25/2 to MM300/2 can be connected-up to either single-phase or three-phase supplies. For connection to single-phase supplies, the input currents increase to the values specified for MM25 to MM220 (for MM300/2 to 25 A).

The MICRO MASTER MM25 to MM220 for connection to single-phase supplies include an integrated radio interference suppression filter.

5.2. Selection and ordering data MIDI MASTER IP 21

Rated motor output	Continuous drive converter output	Input current ¹⁾	Rated output current	Continuous output current	Short-time current	Output current	Drive converter type	Drive converter	Approx. weight	Dimensions HxWxD	Cable cross-section		
											recommended	max	
											Input	Output	Input/Output
kW	kVA	A	A	A	A	A	Order No.	kg	mm	mm ²	mm ²	mm ²	
Supply voltage 3-ph. 208 V to 230 V AC													
5.50	9.10	32.0	22.0	22.0	33.0		MD550/2	6SE3122-3CG40	20.5	450x275x200	6	4	16
7.50	10.90	32.0	28.0	28.0	VT		MD550/2	6SE3122-3CG40	20.5	450x275x200	6	6	16
7.50	12.70	45.0	28.0	28.0	42.0		MD750/2	6SE3123-1CG40	24.0	550x275x202	10	6	16
11.00	15.40	45.0	42.0	42.0	VT		MD750/2	6SE3123-1CG40	24.0	550x275x202	10	10	16
11.00	17.60	61.0	42.0	42.0	63.0		MD1100/2	6SE3124-2CH40	25.0	550x275x202	16	10	16
15.00	21.40	75.0	54.0	54.0	81.0		MD1500/2	6SE3125-4CH40	28.0	650x275x278	25	16	35
18.50	25.50	75.0	68.0	68.0	VT		MD1500/2	6SE3125-4CH40	28.0	650x275x278	25	16	35
18.50	25.90	87.0	68.0	68.0	102.0		MD1850/2	6SE3126-8CJ40	30.0	650x275x278	35	16	35
22.00	29.70	87.0	80.0	80.0	VT		MD1850/2	6SE3126-8CJ40	30.0	650x275x278	35	25	35
22.00	30.70	90.0	80.0	80.0	120.0		MD2200/2	6SE3127-5CJ40	32.0	650x275x278	35	25	35
27.00	35.80	90.0	90.0	90.0	VT		MD2200/2	6SE3127-5CJ40	32.0	650x275x278	35	35	35
Supply voltage 3-ph. 380 V to 500 V AC													
at 400 V						at 460 V up to 500 V							
7.50	12.70	30.0	16.5	19.0	24.7	14.0	MD750/3	6SE3121-7DG40	19.5	450x275x200	6	4	16
11.00	17.70	30.0	23.5	23.5	VT	21.0	MD750/3	6SE3121-7DG40	19.5	450x275x200	6	4	16
11.00	17.70	32.0	23.5	26.0	35.2	21.0	MD1100/3	6SE3122-4DG40	20.5	450x275x200	6	4	16
15.00	21.50	32.0	30.0	30.0	VT	27.0	MD1100/3	6SE3122-4DG40	20.5	450x275x200	6	6	16
15.00	21.50	41.0	30.0	32.0	45.0	27.0	MD1500/3	6SE3123-0DH40	24.0	550x275x202	10	6	16
18.50	26.00	41.0	37.0	37.0	VT	34.0	MD1500/3	6SE3123-0DH40	24.0	550x275x202	10	6	16
18.50	26.00	49.0	37.0	38.0	55.5	34.0	MD1850/3	6SE3123-5DH40	25.0	550x275x202	16	10	16
22.00	30.80	49.0	43.5	43.5	VT	40.0	MD1850/3	6SE3123-5DH40	25.0	550x275x202	16	10	16
22.00	30.80	64.0	43.5	45.0	65.2	40.0	MD2200/3	6SE3124-2DJ40	28.0	650x275x278	25	10	35
30.00	40.80	64.0	58.0	58.0	VT	52.0	MD2200/3	6SE3124-2DJ40	28.0	650x275x278	25	16	35
30.00	40.80	79.0	58.0	58.0	87.0	52.0	MD3000/3	6SE3125-5DJ40	30.0	650x275x278	35	16	35
37.00	49.90	79.0	70.5	70.5	VT	65.0	MD3000/3	6SE3125-5DJ40	30.0	650x275x278	35	25	35
37.00	49.90	96.0	70.5	72.0	105.7	65.0	MD3700/3	6SE3126-8DJ40	32.0	650x275x278	35	25	35
45.00	58.20	96.0	84.0	84.0	VT	77.0	MD3700/3	6SE3126-8DJ40	32.0	650x275x278	35	25	35
Supply voltage 3-ph. 525 V to 575 V AC													
7.50	12.00	18.0	11.0	11.0	16.5		MD750/4	6SE3121-1FG40	19.5	450x275x200	4	2.5	16
11.00	14.60	18.0	17.0	17.0	VT		MD750/4	6SE3121-1FG40	19.5	450x275x200	4	2.5	16
11.00	16.80	24.0	17.0	17.0	25.5		MD1100/4	6SE3121-7FG40	20.5	450x275x200	4	4	16
15.00	19.70	24.0	22.0	22.0	VT		MD1100/4	6SE3121-7FG40	20.5	450x275x200	4	4	16
15.00	20.30	29.0	22.0	22.0	33.0		MD1500/4	6SE3122-2FH40	24.0	550x275x202	6	4	16
18.50	24.40	29.0	27.0	27.0	VT		MD1500/4	6SE3122-2FH40	24.0	550x275x202	6	4	16
18.50	24.60	34.0	27.0	27.0	40.5		MD1850/4	6SE3122-7FH40	25.0	550x275x202	10	6	16
22.00	28.30	34.0	32.0	32.0	VT		MD1850/4	6SE3122-7FH40	25.0	550x275x202	10	6	16
22.00	29.30	45.0	32.0	32.0	48.0		MD2200/4	6SE3123-2FJ40	28.0	650x275x278	10	10	35
30.00	37.80	45.0	41.0	41.0	VT		MD2200/4	6SE3123-2FJ40	28.0	650x275x278	10	10	35
30.00	38.80	55.0	41.0	41.0	61.5		MD3000/4	6SE3124-1FJ40	30.0	650x275x278	16	10	35
37.00	46.70	55.0	52.0	52.0	VT		MD3000/4	6SE3124-1FJ40	30.0	650x275x278	16	10	35
37.00	47.40	65.0	52.0	52.0	78.0		MD3700/4	6SE3125-2FJ40	32.0	650x275x278	25	16	35
45.00	55.20	65.0	62.0	62.0	VT		MD3700/4	6SE3125-2FJ40	32.0	650x275x278	25	16	35

¹⁾ Without utilizing the higher output for square-law load characteristics (VT), the input current is reduced and lies typically approx. 10 % above the output current.

VT: For square-law load characteristics (pump and fan applications, "variable torque"), an increased continuous output current without short-time overload is possible.

For MD1100/2, presently no higher output is possible for VT

MICRO MASTER	MIDI MASTER
--------------	-------------

5.3 Selection and ordering data MIDI MASTER IP 54

Rated motor output kW	Continuous drive converter output kVA	Input current ¹⁾ A	Rated output current A	Continuous output current A	Short-time current A	Output current A	Drive converter type	Drive converter Order No.	Dimensions HxWxD mm	Cable cross-section		
										recommended		max
										Input mm ²	Output mm ²	Input/ Output mm ²
Supply voltage 3-ph. 208 V to 230 V AC												
5.50	9.10	32.0	22.0	22.0	33.0		MD550/2-IP 54	6SE3122-3CS45	675x360x351	6	4	16
7.50	10.90	32.0	28.0	28.0	VT		MD550/2-IP 54	6SE3122-3CS45	675x360x351	6	6	16
7.50	12.70	45.0	28.0	28.0	42.0		MD750/2-IP 54	6SE3123-1CS45	775x360x422	10	6	16
11.00	15.40	45.0	42.0	42.0	VT		MD750/2-IP 54	6SE3123-1CS45	775x360x422	10	10	16
11.00	17.60	61.0	42.0	42.0	63.0		MD1100/2-IP 54	6SE3124-2CS45	775x360x422	16	10	16
15.00	21.40	75.0	54.0	54.0	81.0		MD1500/2-IP 54	6SE3125-4CS45	875x360x483	25	16	35
18.50	25.50	75.0	68.0	68.0	VT		MD1500/2-IP 54	6SE3125-4CS45	875x360x483	25	16	35
18.50	25.90	87.0	68.0	68.0	102.0		MD1850/2-IP 54	6SE3126-8CS45	875x360x483	35	16	35
22.00	29.70	87.0	80.0	80.0	VT		MD1850/2-IP 54	6SE3126-8CS45	875x360x483	35	25	35
22.00	30.70	90.0	80.0	80.0	120.0		MD2200/2-IP 54	6SE3127-5CS45	875x360x483	35	25	35
27.00	35.80	90.0	90.0	90.0	VT		MD2200/2-IP 54	6SE3127-5CS45	875x360x483	35	35	35
Supply voltage 3-ph. 380 V to 500 V AC												
at 400 V							at 460 V up to 500 V					
7.50	12.70	30.0	16.5	19.0	24.7	14.0	MD750/3-IP 54	6SE3121-7DS45	675x360x351	6	4	16
11.00	17.70	30.0	23.5	23.5	VT	21.0	MD750/3-IP 54	6SE3121-7DS45	675x360x351	6	4	16
11.00	17.70	32.0	23.5	26.0	35.2	21.0	MD1100/3-IP 54	6SE3122-4DS45	675x360x351	6	4	16
15.00	21.50	32.0	30.0	30.0	VT	27.0	MD1100/3-IP 54	6SE3122-4DS45	675x360x351	6	6	16
15.00	21.50	41.0	30.0	32.0	45.0	27.0	MD1500/3-IP 54	6SE3123-0DS45	775x360x422	10	6	16
18.50	26.00	41.0	37.0	37.0	VT	34.0	MD1500/3-IP 54	6SE3123-0DS45	775x360x422	10	6	16
18.50	26.00	49.0	37.0	38.0	55.5	34.0	MD1850/3-IP 54	6SE3123-5DS45	775x360x422	16	10	16
22.00	30.80	49.0	43.5	43.5	VT	40.0	MD1850/3-IP 54	6SE3123-5DS45	775x360x422	16	10	16
22.00	30.80	64.0	43.5	45.0	65.2	40.0	MD2200/3-IP 54	6SE3124-2DS45	875x360x483	25	10	35
30.00	40.80	64.0	58.0	58.0	VT	52.0	MD2200/3-IP 54	6SE3124-2DS45	875x360x483	25	16	35
30.00	40.80	79.0	58.0	58.0	87.0	52.0	MD3000/3-IP 54	6SE3125-5DS45	875x360x483	35	16	35
37.00	49.90	79.0	70.5	70.5	VT	65.0	MD3000/3-IP 54	6SE3125-5DS45	875x360x483	35	25	35
37.00	49.90	96.0	70.5	72.0	105.7	65.0	MD3700/3-IP 54	6SE3126-8DS45	875x360x483	35	25	35
45.00	58.20	96.0	84.0	84.0	VT	77.0	MD3700/3-IP 54	6SE3126-8DS45	875x360x483	35	25	35
Supply voltage 3-ph. 525 V to 575 V AC												
7.50	12.00	18.0	11.0	11.0	16.5		MD750/4-IP 54	6SE3121-1FS45	675x360x351	4	2.5	16
11.00	14.60	18.0	17.0	17.0	VT		MD750/4-IP 54	6SE3121-1FS45	675x360x351	4	2.5	16
11.00	16.80	24.0	17.0	17.0	25.5		MD1100/4-IP 54	6SE3121-7FS45	675x360x351	4	4	16
15.00	19.70	24.0	22.0	22.0	VT		MD1100/4-IP 54	6SE3121-7FS45	675x360x351	4	4	16
15.00	20.30	29.0	22.0	22.0	33.0		MD1500/4-IP 54	6SE3122-2FS45	775x360x422	6	4	16
18.50	24.40	29.0	27.0	27.0	VT		MD1500/4-IP 54	6SE3122-2FS45	775x360x422	6	4	16
18.50	24.60	34.0	27.0	27.0	40.5		MD1850/4-IP 54	6SE3122-7FS45	775x360x422	10	6	16
22.00	28.30	34.0	32.0	32.0	VT		MD1850/4-IP 54	6SE3122-7FS45	775x360x422	10	6	16
22.00	29.30	45.0	32.0	32.0	48.0		MD2200/4-IP 54	6SE3123-2FS45	875x360x483	10	10	35
30.00	37.80	45.0	41.0	41.0	VT		MD2200/4-IP 54	6SE3123-2FS45	875x360x483	10	10	35
30.00	38.80	55.0	41.0	41.0	61.5		MD3000/4-IP 54	6SE3124-1FS45	875x360x483	16	10	35
37.00	46.70	55.0	52.0	52.0	VT		MD3000/4-IP 54	6SE3124-1FS45	875x360x483	16	10	35
37.00	47.40	65.0	52.0	52.0	78.0		MD3700/4-IP 54	6SE3125-2FS45	875x360x483	25	16	35
45.00	55.20	65.0	62.0	62.0	VT		MD3700/4-IP 54	6SE3125-2FS45	875x360x483	25	16	35

¹⁾ Without utilizing the higher output for square-law load characteristics (VT), the input current is reduced and lies typically approx. 10 % above the output current.
 VT: For square-law load characteristics (pump and fan applications, "variable torque"), an increased continuous output current without short-time overload is possible.
 For MD1100/2, presently no higher output is possible for VT.

MICRO MASTER

MIDI MASTER

6.1	Internal brake resistor for MICRO MASTER	6/2
6.2	Braking unit and brake resistor for MIDI MASTER	6/2
6.3	Radio interference suppression filter	6/3
6.4	Output reactor	6/5
6.5	Output dV/dt filter	6/6
6.6	Commutating reactor	6/6
6.7	Selection and ordering data, options	6/7

6. Options**6.1 Internal brake resistor for
MICRO MASTER**

MICRO MASTER has an integrated brake chopper. An external brake resistor can be connected which then provides significantly improved braking.

When a motor brakes, braking energy is generated, which can either be converted into heat in the motor (DC current brake, parameter P073), or it can be fed to the drive converter, whereby the DC link voltage increases. In order to prevent overvoltage conditions in the drive converter, the braking energy must be dissipated in an external brake resistor.

The maximum braking power is defined by the DC link voltage V_d and the brake resistor R_B : $P_{\text{brake}} = (V_d)^2/R_B$. For MICRO MASTER, for 1/3-ph. 230 V AC line supply voltages, the DC link voltage increases up to approx. 400 V, for 3-ph. 380 V - 500 V AC, up to approx. 800 V AC.

Internal resistors are available for the MICRO MASTER, which consist of a panel which is adapted to the particular MICRO MASTER (has the same footprint), mounted under the MICRO MASTER.

If the brake resistor is correctly parameterized (P075), then MICRO MASTER thermally monitors and protects the resistor. The internal resistors are designed for a continuous braking power of 5 % regarding the maximum braking power (parameter P070, factory setting, refer to Fig. 6.1.1). When using the internal resistor, it is not permissible to change this value, as otherwise the resistor will not be protected and could be destroyed.

Fig. 6.1.1 Duty cycle of the braking chopper for a 5 % factory setting

In addition to the internal brake resistors, an additional/other external resistor can be used. The resistor may not have a resistance less than 50Ω (at 1/3-ph. 230 V AC) or 85Ω (at 3-ph. 380 - 500 V AC), as otherwise the drive converter will be damaged. By changing the power-on duration, it may be possible to increase the

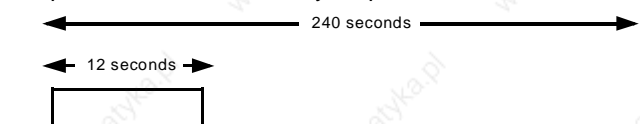

continuous braking power and an adaption made to the external brake resistor (parameter P070).

6.2 Brake unit and brake resistor for MIDI MASTER

Using the brake unit and brake resistor options, the regenerative energy is converted into heat, thus significantly improving the braking effect. The increased DC link voltage, which occurs during regenerative operation, is therefore limited to the maximum permissible value.

The brake unit should be mounted directly next to the MIDI MASTER, and connected to the drive converter DC link using short feeder cables (C/L+ and DC+ the brake unit to DC+ of the MIDI MASTER, D/L- and DC- to DC-).

The brake units for 575 V supply voltages already have an internal load resistor, which can briefly (0.4 seconds) dissipate the full braking power. For these drive converters, with an external brake resistor, the maximum power is available for 3 seconds (and 66 % of the maximum power for 20 seconds), and the continuous power is significantly higher (refer to Fig. 6.2.2 and section 6.7). The internal brake resistor should then be disabled by removing a jumper (H1-H2) (refer to Fig. 6.2.1).

For drive converters without internal brake resistor, the maximum braking power is available for 5 seconds, and the continuous power is 10 % of the peak power.

The minimum permissible resistance value for each brake unit is specified in the tables (section 6.7) (for maximum brake unit power).

The maximum braking power may not exceed 200 % of the drive converter output.

Degree of protection of the brake unit and the external brake resistors: IP 20 (for 575 V supply voltage: IP 21).

Caution: The external brake resistors may not be installed below the drive converter and brake unit. If the resistors are located together with the drive converter and brake unit in a cabinet, it should be guaranteed that the maximum ambient temperature of the drive converters is not exceeded. The power section of the brake unit is monitored, and, when a fault occurs, this is indicated by an LED which is continuously lit, and a signal is output via electrically isolated relay contacts. Under normal operating conditions, the relay is closed, and drops-out when a fault develops. These contacts should be used to control the drive converter line contactor.

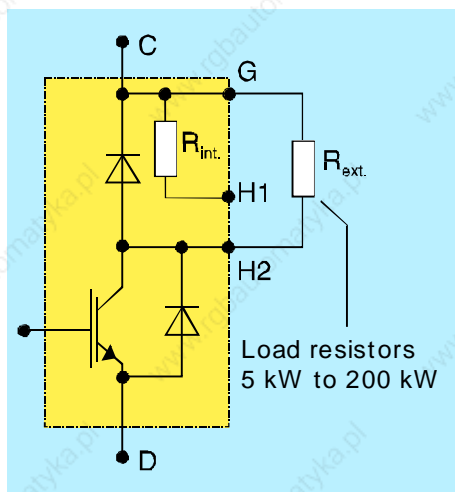

Fig. 6.2.1: Block diagram of the brake unit with internal and external brake resistor

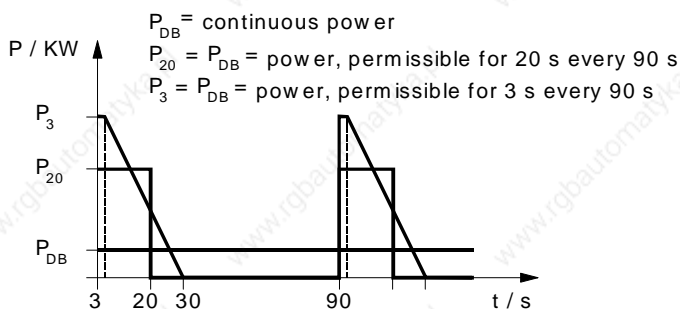

Fig. 6.2.2: Load diagram for a brake unit with internal and external load resistor

Note:

When using the internal load resistor, P_{20} can only be used for 2.5 seconds and $P_3 = P_{max}$ only for 0.4 seconds braking time.

6.3 Radio interference suppression filter

For MICRO MASTER and MIDI MASTER, the EEC-EMC Directive "89/336/EEC" is relevant for the electromagnetic compatibility: All manufacturers of equipment which can be autonomously operated, must, effective 1.1.1996, fulfill the relevant EMC Laws and provide the associated documentation. This is also valid for products which are generally available on the open market and which may be connected-up and commissioned by non-specialist personnel. The manufacturer can make a declaration that the appropriate legislation is conformed to or he can use a competent body in the sense of the EMC Law.

MICRO MASTER and MIDI MASTER cannot be autonomously operated. They must be used with other components, for example, a motor, to create a unit which can be autonomously operated. Further, the equipment can only be installed by competent electrical installation specialists. Thus, no EMC-EEC Declaration of Conformance can be made for a drive converter alone, and therefore it is not necessary that the EMC Law is maintained.

All requirements of the EEC Low-Voltage Directive 73/23/EEC are maintained, which is documented by the EEC Declaration of Conformance and the CE mark.

When the specified installation regulations are observed, appropriately qualified personnel can professionally install the equipment, thus fulfilling the relevant EMC Laws.

Depending on the particular application area, different EMC characteristics are specified, which can be sub-divided into the following three classes. As MICRO MASTER and MIDI MASTER already fulfill the most stringent demands regarding noise immunity, independent of the drive converter type (EN 50082-2), then in the following, a differentiation is only made regarding the noise emission:

Category 1: General industrial applications

Fulfilling the EMC product standard for electric drives (Power Drive System, PDS) IEC 22G-WG4 (Cv) 22 for industrial networks. A "Competent Body" must be involved until this new standard is valid and comes into force.

EMC phenomena	Standard	Limit value for the complete installation
Noise emission	EN 55011	Class A1 - not for every drive
Cable-borne noise	EN 55011	Class A1 - not for every drive

Table 6.3.1: Limit values for complete industrial systems, standard product

Within an industrial system, it is not necessary that every individual drive maintains limit value A1, as long as all of the system components have industrial noise immunity, thus mean that they do not mutually disturb each other. However, the overall plant itself must be electromagnetically compatible with its environment.

Here, especially ungrounded networks should be classified (IT networks), as in this case, it is not possible to provide each drive with noise suppression filters due to physical limitations.

MICRO MASTER

MIDI MASTER

Category 2: Connected to industrial line supplies via EMC filter

Maintaining the limit values specified in the basic industrial standards EN50081-2 (and EN50082-2, noise immunity)

EMC phenomena	Standard	Limit value for the drive unit
Noise emission	EN 55011	Class A1
Cable-borne noise	EN 55011	Class A1

Table 6.3.2: Limit values for industry, basic standard

This only involves autonomous products, which are operated from industrial line supplies, but which do not fall under the EMC product standard for electric drives (Category 1).

Category 3: Connection to public line supplies via EMC filter (domestic areas)

Maintaining the limit values specified in the basic standard for public line supplies EN50081-1 (and EN50082-1, noise immunity)

EMC phenomena	Standard	Limit value for the drive unit
Noise emission	EN 55022	Class B1
Cable-borne noise	EN 55022	Class B1

Table 6.3.3: Limit values for public line supplies

MICRO MASTER and MIDI MASTER assignment

MICRO MASTER MM25 to MM220 for single-phase line supply connection already include an integrated radio interference suppression filter.

Depending on the drive converter type and additional option, MICRO MASTER and MIDI MASTER have the following maximum values, and therefore can be classified in the categories above:

Drive converter type	EMC Category	Radio interference suppression
MM25-MM220	Cat. 2	Class A1
MM25/2-MM300/2	Cat. 1	---
MM25/2-MM220/2 with external filter (refer to Page 6.7), only for single-phase connection	Cat. 2 ¹⁾	Class A1
MM25/2-MM220/2 with external filter and metallized cover (filter set, refer to 6.7), only for single-phase connection	Cat. 3	Class B1
MM25/2-MM300/2 with external filter (refer to 6.7), for three-phase connection	Cat. 2 ¹⁾	Class A1
MM220/2-MM300/2 with external filter and metallized cover (filter set, refer to 6.7), for three-phase connection	Cat. 3	Class B1
MM150/3-MM550/3	Cat. 1	---
MM150/3-MM550/3 with external filter (refer to 6.7)	Cat. 2 ¹⁾	Class A1
MM150/3-MM550/3 with external filter and metallized cover (filter set, refer to 6.7)	Cat. 3	Class B1
MD550/2-MD2200/2	Cat. 1	---
MD550/2-MD1850/2 with external filter (refer to 6.7)	Cat. 2 ¹⁾	Class A1
MD550/2-MD1850/2 with external filter and metallized cover (filter set, refer to 6.7)	Cat. 3	Class B1
MD750/3-MD3700/3	Cat. 1	---
MD750/3-MD3700/3 with external filter (refer to 6.7)	Cat. 2 ¹⁾	Class A1
MD750/3-MD3700/3 with external filter and metallized cover (filter set, refer to 6.7)	Cat. 3	Class B1
MD750/4-MD3700/4	Cat. 1	---

¹⁾ If the noise emission is reduced by mounting the equipment in a sheet steel enclosure or by other means, then generally Category 3 (Class B1) can be achieved.

Table 6.3.4: Assignment of MICRO MASTER and MIDI MASTER

Categories 2 and 3 are achieved using **shielded motor cables** up to a **cable length of 25 meters**. For Category 3, a shielded cable is required between the filter and drive converter. The upper limit values are maintained for the factory set pulse frequency; modulation type 3 ("noise") is generally not suitable for maximum cable lengths.

MICRO MASTER

MIDI MASTER

The noise suppression filters are located in the drive converter line feeder cable, and are used to suppress cable-borne noise.

In order to reduce the noise emission, the drive converters can either be mounted in a housing or a metallized cover (MICRO MASTER) or an additional metallized cover (MIDI MASTER) used.

The following installation guidelines must be maintained to ensure that the drive converters are noise-suppressed:

- The line filter and the converter must be mounted on a common mounting panel in the cabinet (e.g. on the cabinet rear panel). The contact between the mounting panel and the various devices must be established through the largest possible surface area and must provide a good electrical connection. The contact surfaces must be bare and any paint must be removed. If required, additional contact washers or serrated washers should be used.
- The line filters should be located directly where the feeder cables enter the cabinet. If this is not possible, the line feeder cable must be shielded all the way to the line filter. The shield must be connected to the mounting panel where the line feeder cable enters the cabinet and at the line filter.
- If a line filter and commutating reactors are simultaneously used, then the commutating reactor must be located between the drive converter and line filter, and this must be shielded at all sides using metal panels.
- The line filter and the drive converter must be connected using a shielded cable. The shield must be connected using shield clamps at both ends through the largest possible surface area.
- The line feeder cable must be routed separately away from motor, control and signal cables.
- The motor, control and signal cables must be shielded. The shields must always be connected at both ends using shield clamps through the largest possible surface area.

- The shield must be connected with the mounting panel through the largest possible surface area using suitable clamps to provide a good electrical connection (if required, use cable shield connecting rails).
- If cables enter the cabinet or drive converter through glands, then these must be metallic and must be designed so that they provide good electrical contact to the shield. The glands must be electrically connected with the cabinet or drive converter.

Caution:

It is not permissible to use radio interference suppression filters and filters to reduce cable-borne noise when the drive converter is connected to non-grounded line supplies.

6.4 Output reactor

If long motor feeder cables are used, or several parallel motor feeder cables for multi-motor drives, the converter could shutdown with the "overcurrent" fault messages, caused as a result of capacitive re-charging currents. Thus, for long motor feeder cables, an output reactor must be connected between the drive converter and motor feeder cables.

If an output reactor is not used, the motor cables may only be a maximum of 25 meters (MICRO MASTER, shielded), or a maximum of 50 meters (MIDI MASTER, shielded). Unshielded motor feeder cables may not exceed a total length of 50 meters (MICRO MASTER) or 100 meters (MIDI MASTER). If output reactors are used, the maximum cable length is increased to 200 meters (shielded).

If the shielded motor cable is routed in a cable duct or along a metallic surface, then the maximum length is reduced to the values specified above for shielded cables.

6.5 Output dV/dt filters

Voltage-limiting dV/dt filters must be connected between the drive converter and the motor for motors with a low or unknown voltage strength of the insulation system.

Siemens standard 1LA5/6 motors only require dV/dt filters above supply voltages 500 V +10 %. 230 V supply voltages are uncritical for almost all commercially available motors.

Up to a maximum motor cable feeder length of 150 m (100 m, shielded), the dV/dt filters limit the voltage rate of rise to values < 500 V/μs, and the typical voltage peaks to < 1000 V at $v_{\text{supply}} \leq 575$ V.

Note:

For multi-motor drive supply, the sum of all the cable lengths must be less or equal to the specified value above.

dV/dt filters can be used up to a maximum frequency of 300 Hz. It is only possible to use dV/dt filters at 2 kHz pulse frequencies, and preferably 4 kHz.

The dV/dt filter must be mounted as close as possible to the drive converter.

The dV/dt filter is also connected at the drive converter DC link (C/L+ of the filter to DC+ of the MIDI MASTER, D/L - at DC-). These connecting cables should be kept as short as possible (< = 3m).

6.6. Commutating reactors

Commutating reactors can be used to limit the line harmonics. The commutating reactor inductance reduces the harmonics in the drive converter line current. Commutating reactors are recommended if the ratio between the system fault level and the apparent drive output is > 100:1.

MICRO MASTER

MIDI MASTER

6.7 Selection and ordering data, options

Communication options

Designation	Order No.
OPM plain text operator control panel	6SE3190-0XX87-8BF0
OPMP PROFIBUS module	6SE3190-0XX87-8PB0
SIMOVIS for MICRO MASTER and MIDI MASTER (German, English)	6SE3190-0XX87-8SA0
Connecting cable, membrane keyboard - OPM (3 m)	6SX7010-0AB03
Block package for SIMATIC S5 DVA_S5 (software)	6DD1800-0SW0

Documentation

Designation	Order No.
Instruction manual for MICRO MASTER and MIDI MASTER (included with the units) (in German, English, French, Italian and Spanish)	6SE3186-4AA00
Instruction manual for the OPMP PROFIBUS module (included with the equipment) (in German, English, French, Italian and Spanish)	6SE 3186-4AK00
Instruction manual for d/dt filters 6SE70... (MASTER DRIVES series) (not included with the equipment)	on request
Function blocks for SIMATIC S5 115U, 135U, 155U PLCs; Net data transfer with SIMOREG and SIMOVERT drives via SINEC L2DP	E20125-C0002-S302-A1 (G) E20125-C0002-S302-A1-7600 (E)

MICRO MASTER, MIDI MASTER braking unit, radio interference suppression filter and OPMP are supplied with an Instruction Manual at no charge.

MICRO MASTER

MIDI MASTER

MICRO MASTER		Braking power		Internal resistor		External brake resistor	
Type	Order No.	with internal resistor		Order No.	Resistance Ω	Order No.	Resistance Ω
		max kW	Duration W				
Supply voltage 1-ph. 208 V to 230 V AC:							
MM25	6SE3111-5BA40	0.8	40	6SE3190-0BA87-2RA0	200	6SE2000-1RA10	270
MM37	6SE3112-1BA40	0.8	40	6SE3190-0BA87-2RA0	200	6SE2000-1RA10	270
MM55	6SE3112-8BA40	0.8	40	6SE3190-0BA87-2RA0	200	6SE2000-1RA10	270
MM75	6SE3113-6BA40	0.8	40	6SE3190-0BA87-2RA0	200	6SE2000-1RA10	270
MM110	6SE3115-2BB40	1.6	80	6SE3190-0BB87-2RA0	100	6SE2000-1RA10	270
MM150	6SE3116-8BB40	1.6	80	6SE3190-0BB87-2RA0	100	6SE2000-1RA10	270
MM220	6SE3121-0BC40	3.0	150	6SE3190-0BC87-2RA0	50	6SE2000-1RA10	270
Supply voltage 1/3-ph. 208 V to 230 V AC:							
MM25/2	6SE3111-5CA40	0.8	40	6SE3190-0BA87-2RA0	200	6SE2000-1RA10	270
MM37/2	6SE3112-1CA40	0.8	40	6SE3190-0BA87-2RA0	200	6SE2000-1RA10	270
MM55/2	6SE3112-8CA40	0.8	40	6SE3190-0BA87-2RA0	200	6SE2000-1RA10	270
MM75/2	6SE3113-6CA40	0.8	40	6SE3190-0BA87-2RA0	200	6SE2000-1RA10	270
MM110/2	6SE3115-2CB40	1.6	80	6SE3190-0BB87-2RA0	100	6SE2000-1RA10	270
MM150/2	6SE3116-8CB40	1.6	80	6SE3190-0BB87-2RA0	100	6SE2000-1RA10	270
MM220/2	6SE3121-0CC40	3.0	150	6SE3190-0BC87-2RA0	50	6SE2000-1RA10	270
MM300/2 1)	6SE3121-3CC40	3.0	150	6SE3190-0BC87-2RA0	50	6SE2000-1RA10	270
Supply voltage 3-ph. 380 V to 500 V AC:							
MM150/3	6SE3114-0DC40	3.0	150	6SE3190-0DC87-2RA0	250	6SE2000-1RA10	270
MM220/3	6SE3115-8DC40	3.0	150	6SE3190-0DC87-2RA0	250	6SE2000-1RA10	270
MM300/3	6SE3117-3DC40	3.0	150	6SE3190-0DC87-2RA0	250	6SE2000-1RA10	270
MM400/3	6SE3121-0DC40	3.0	150	6SE3190-0DC87-2RA0	250	6SE2000-1RA10	270
MM550/3	6SE3121-3DC40	3.0	150	6SE3190-0DC87-2RA0	250	6SE2000-1RA10	270

1) An additional 4EM6100-3CB commutating reactor must be used when connecting the drive converters to single-phase supplies.

MICRO MASTER

MIDI MASTER

MICRO MASTER		Radio interference suppression filter		Radio interference suppression filter set (filter + metal cover)		Output reactor	dV/dt output filter
Type	Order No.	Class	Order No.	Class	Order No.	$f_{max} = 120 \text{ Hz}$ $f_{pulse} \leq 4 \text{ kHz}$	$f_{max} = 300 \text{ Hz}$ $f_{pulse} \leq 4 \text{ kHz}$
Supply voltage 1-ph. 208 V to 230 V AC:							
MM25	6SE3111-5BA40	A1; Integrated				6SE7016-1ES87-1FE0	technically not required
MM37	6SE3112-1BA40	A1; Integrated				6SE7016-1ES87-1FE0	
MM55	6SE3112-8BA40	A1; Integrated				6SE7016-1ES87-1FE0	
MM75	6SE3113-6BA40	A1; Integrated				6SE7016-1ES87-1FE0	
MM110	6SE3115-2BB40	A1; Integrated				4EP3601-3DB	
MM150	6SE3116-8BB40	A1; Integrated				4EP3601-3DB	
MM220	6SE3121-0BC40	A1; Integrated				4EP3601-3DB	
MM25/2	6SE3111-5CA40	A1	6SE3090-0BA07-0FB1	B1	6SE3190-0BA87-0FB0	6SE7016-1ES87-1FE0	
MM37/2	6SE3112-1CA40	A1	6SE3090-0BA07-0FB1	B1	6SE3190-0BA87-0FB0	6SE7016-1ES87-1FE0	
MM55/2	6SE3112-8CA40	A1	6SE3090-0BA07-0FB1	B1	6SE3190-0BA87-0FB0	6SE7016-1ES87-1FE0	
MM75/2	6SE3113-6CA40	A1	6SE3090-0BA07-0FB1	B1	6SE3190-0BA87-0FB0	6SE7016-1ES87-1FE0	
MM110/2	6SE3115-2CB40	A1	6SE3090-0BC07-0FB1	B1	6SE3190-0BB87-0FB0	4EP3601-3DB	
MM150/2	6SE3116-8CB40	A1	6SE3090-0BC07-0FB1	B1	6SE3190-0BB87-0FB0	4EP3601-3DB	
MM220/2	6SE3121-0CC40	A1	6SE3090-0BC07-0FB1	B1	6SE3190-0BC87-0FB0	4EP3601-3DB	
MM300/2 ¹⁾	6SE3121-3CC40					4EP3601-3DB	
Supply voltage 3-ph. 208 V to 230 V AC:							
MM25/2	6SE3111-5CA40	A1	6SE3190-0DC87-0FB1			6SE7016-1ES87-1FE0	technically not required
MM37/2	6SE3112-1CA40	A1	6SE3190-0DC87-0FB1			6SE7016-1ES87-1FE0	
MM55/2	6SE3112-8CA40	A1	6SE3190-0DC87-0FB1			6SE7016-1ES87-1FE0	
MM75/2	6SE3113-6CA40	A1	6SE3190-0DC87-0FB1			6SE7016-1ES87-1FE0	
MM110/2	6SE3115-2CB40	A1	6SE3190-0DC87-0FB1			4EP3601-3DB	
MM150/2	6SE3116-8CB40	A1	6SE3190-0DC87-0FB1			4EP3601-3DB	
MM220/2	6SE3121-0CC40	A1	6SE3190-0DC87-0FB1	B1	6SE3190-0DC87-0FB0	4EP3601-3DB	
MM300/2	6SE3121-3CC40	A1	6SE3190-0DC87-0FB1	B1	6SE3190-0DC87-0FB0	4EP3601-3DB	
Supply voltage 3-ph. 380 V to 500 V AC:							
MM150/3	6SE3114-0DC40	A1	6SE3190-0DC87-0FB1	B1	6SE3190-0DC87-0FB0	4EP3601-3DB	6SE7016-2FB87-1FD0
MM220/3	6SE3115-8DC40	A1	6SE3190-0DC87-0FB1	B1	6SE3190-0DC87-0FB0	4EP3601-3DB	6SE7016-2FB87-1FD0
MM300/3	6SE3117-3DC40	A1	6SE3190-0DC87-0FB1	B1	6SE3190-0DC87-0FB0	4EP3601-3DB	6SE7021-5FB87-1FD0
MM400/3	6SE3121-0DC40	A1	6SE3190-0DC87-0FB1	B1	6SE3190-0DC87-0FB0	4EP3601-3DB	6SE7021-5FB87-1FD0
MM550/3	6SE3121-3DC40	A1	6SE3190-0DC87-0FB1	B1	6SE3190-0DC87-0FB0	4EP3601-3DB	6SE7021-5FB87-1FD0

¹⁾ An additional 4EM6100-3CB commutating reactor must be used when connecting the drive converters to single-phase supplies.

Maximum cable lengths						
Drive converter	Standard	Reactor	dV/dt filter	Standard	Reactor	dV/dt filter
	unshielded cables			shielded cables		
MICRO MASTER	50 m	200 m ²⁾	150 m ³⁾	25 m	200 m ²⁾	100 m ³⁾

²⁾ For MICRO MASTER, for motor outputs up to 550 W, above 125 m,

the next larger drive converter must be selected (derating)

³⁾ dV/dt filters are technically not required for 1/3-ph. 230 V AC.

MICRO MASTER

MIDI MASTER

MIDI MASTER	Braking power		Braking unit			External brake resistor				
	Type	max kW	Duration external internal W	Order No.	Weight kg	Dimensions HxWxD mm	Order No.	Resistance Ω	Weight kg	Dimensions HxWxD mm
Supply voltage 3-ph. 208 V to 230 V AC:										
MD550/2 - MD2200/2	7.5	750	6SE3190-0CX87-2DA0	2.2	250x104x146	6SE7021-6CS87-2DC0	20	6.5	180x145x540	
	15	1500	6SE3190-0CX87-2DA0	2.2	250x104x146	6SE7023-2CS87-2DC0	10	12.5	360x145x540	
Supply voltage 3-ph. 380 V to 500 V AC:										
MD750/3 - MD3700/3	7.5	750	6SE3190-0DX87-2DA0	2.2	250x104x146	6SE7018-0ES87-2DC0	80	6	180x145x540	
	15	1500	6SE3190-0DX87-2DA0	2.2	250x104x146	6SE7021-6ES87-2DC0	40	11.5	360x145x540	
	30	3000	6SE3190-0DX87-2DA0	2.2	250x104x146	6SE7023-2ES87-2DC0	20	17	302x430x485	
Supply voltage 3-ph. 525 V to 575 V AC:										
MD750/4 - MD3700/4	15	2500	6SE3190-0FX87-2DA0		450x179x200	6SE7021-3FS87-2DC0	62	11.5	360x145x540	
		630	6SE3190-0FX87-2DA0							
	30	5000	6SE3190-0FX87-2DA0	450x179x200	6SE7022-5FS87-2DC0	31	17	302x430x485		
		630	6SE3190-0FX87-2DA0							

When assigning the braking unit and brake resistor to MIDI MASTER, it must be ensured that the maximum braking power does not exceed 200% of the drive converter output.

MICRO MASTER

MIDI MASTER

MIDI MASTER		Radio interference suppression filter	Metallized cover	Commutating reactor		Output reactor	dV/dt output filter
Type	Order No.	Order No.	Order No.	Order No.	Rated current in A	$f_{max} = 120 \text{ Hz}$ $f_{pulse} \leq 4 \text{ kHz}$	$f_{max} = 300 \text{ Hz}$ $f_{pulse} \leq 4 \text{ kHz}$
Supply voltage 3-ph. 208 V to 230 V AC:							
MD550/2	6SE3122-3CG40	6SE2100-1FC20	6SE3190-0DG87-0FC0	4EP3700-2UK	35.5	4EP3700-5DB	technically not required
MD750/2	6SE3123-1CG40	6SE2100-1FC20	6SE3190-0DH87-0FC0	4EP3800-2UK	50	4EP3700-5DB	
MD1100/2	6SE3124-2CH40	6SE2100-1FC21	6SE3190-0DH87-0FC0	4EP3800-7UK	63	4EP3700-6DB	
MD1500/2	6SE3125-4CH40	6SE2100-1FC21	6SE3190-0DJ87-0FC0	4EP3900-2UK	80	6SE7028-2HS87-1FE0	
MD1850/2	6SE3126-8CJ40	6SE2100-1FC21 ¹⁾	6SE3190-0DJ87-0FC0	4EP3900-2UK	80	6SE7028-2HS87-1FE0	
MD2200/2	6SE3127-5CJ40	-----	-----	4EP4000-2UK	100	6SE7028-2HS87-1FE0	
Supply voltage 3-ph. 380 V to 500 V AC:							
MD750/3	6SE3121-7DG40	6SE2100-1FC20	6SE3190-0DG87-0FC0	4EP3600-5UK	28	4EP3700-5DB	6SE7021-5FB87-1FD0
MD1100/3	6SE3122-4DG40	6SE2100-1FC20	6SE3190-0DG87-0FC0	4EP3700-2UK	35.5	4EP3700-5DB	6SE7022-2FC87-1FD0
MD1500/3	6SE3123-0DH40	6SE2100-1FC20	6SE3190-0DH87-0FC0	4EP3700-5UK	40	4EP3700-5DB	6SE7023-4FC87-1FD0
MD1850/3	6SE3123-5DH40	6SE2100-1FC20	6SE3190-0DH87-0FC0	4EP3800-2UK	50	4EP3700-5DB	6SE7024-7FC87-1FD0
MD2200/3	6SE3124-2DJ40	6SE2100-1FC21	6SE3190-0DJ87-0FC0	4EP3800-7UK	63	4EP3700-7DB	6SE7024-7FC87-1FD0
MD3000/3	6SE3125-5DJ40	6SE2100-1FC21	6SE3190-0DJ87-0FC0	4EP3900-2UK	80	6SE7028-2HS87-1FE0	6SE7026-0HE87-1FD0
MD3700/3	6SE3126-8DJ40	6SE2100-1FC21 ²⁾	6SE3190-0DJ87-0FC0	4EP4000-2UK	100	6SE7028-2HS87-1FE0	6SE7028-2HE87-1FD0
Supply voltage 3-ph. 525 V to 575 V AC:							
MD750/4	6SE3121-1FG40			4EP3600-2UK	16	6SE7022-2FS87-1FE0	6SE7021-5FB87-1FD0
MD1100/4	6SE3121-7FG40			4EP3600-3UK	22.4	6SE7023-4FS87-1FE0	6SE7022-2FC87-1FD0
MD1500/4	6SE3122-2FH40			4EP3700-6UK	31.5	6SE7023-4FS87-1FE0	6SE7023-4FC87-1FD0
MD1850/4	6SE3122-7FH40			4EP3700-1UK	35.5	6SE7023-4FS87-1FE0	6SE7023-4FC87-1FD0
MD2200/4	6SE3123-2FJ40			4EP3800-1UK	50	6SE7024-7FS87-1FE0	6SE7023-4FC87-1FD0
MD3000/4	6SE3124-1FJ40			4EP3800-1UK	50	6SE7026-0HS87-1FE0	6SE7024-7FC87-1FD0
MD3700/4	6SE3125-2FJ40			4EP3900-1UK	63	6SE7028-2HS87-1FE0	6SE7024-7FC87-1FD0

¹⁾ Up to a motor output of 18.5 kW

²⁾ Up to a motor output of 37 kW

Maximum cable length						
Converter	Standard	Reactor	dV/dt filter	Standard	Reactor	dV/dt filter
	unshielded cables			shielded cables		
MIDI MASTER	100 m	200 m	150 m ³⁾	50 m	200 m	100 m ³⁾

³⁾ dV/dt filters are technically not required for 3-ph. 230 V AC

7.1	Engineering information	7/2
7.2	Motor-drive converter assignment for standard Siemens 1LA2, 1LA5 and 1LA6 motors	7/6
7.2.1	1-ph. 230 V AC line supply voltage - integrated ratio interference suppression filter	7/6
7.2.2	1-ph. 230 V AC line supply voltage	7/8
7.2.3	3-ph. 230 V AC line supply voltage	7/10
7.2.4	3-ph. 400 V AC line supply voltage	7/14
7.2.5	3-ph. 500 V AC line supply voltage	7/18

7. Induction-motor drives

7.1 Engineering information

A detailed description of the motors is provided in the following catalogs:

- M 11: Three-phase 1LA5 and 1LA6 low-voltage motors
- DA 47: Reluctance motors: Synchronous motors for variable-speed drives
- DA 48: SIEMOSYN motors: permanent-magnet synchronous motors

The engineering guidelines specified here refer to Siemens 1LA2, 1LA5 and 1LA6 induction motors as well as Siemens force-ventilated 1LA5 motors. If third-party induction motors are used, their specific engineering data must be observed.

All types of load characteristics are possible; only the most important will be discussed here:

- Constant-torque drives
with $M = \text{const.}$ ("Constant Torque", CT)
- Fan and pump drives
with $M \sim n^2$ ("Variable Torque", VT).

Torque utilization of the motors:

Which motor is best suited for a specific application depends on its permissible torque characteristic over the speed.

The typical characteristics of the permissible continuous torque for a self-ventilated motor with a 50 Hz rated frequency is illustrated in Fig. 7.1.1. As a result of the low cooling effect at low speeds, the torque which can be utilized is significantly lower than at 50 Hz. The torque de-rating factor is not the same for all motors. The assignment tables from Page 7/6 onwards specify the torque de-rating as a function of the speed in the frequency range up to $f = 50$ Hz when utilized to temperature rise class F.

For frequencies above rated frequency f_n , the voltage remains constant as soon as the maximum drive converter output voltage has been reached. In this range, the motor is operated in field weakening. The torque which can be thermally utilized decreases with approx. f_n/f . As the stall torque decreases with $(f_n/f)^2$, the safety margin to the stall torque decreases, and the drive load capability is lower.

For MICRO MASTER and MIDI MASTER drives with a field-weakening range $f = 50$ Hz to 100 Hz, the output up to 100 Hz decreases; for 1LA5 and 1LA6 motors by approximately 10%, and for 1LA2 motors by approximately 20% with respect to the values specified in the tables.

The assignment tables indicate that Siemens 1LA2/1LA5/1LA6 induction motors, when utilized according to temperature rise class F, in the control range 1:2, can generally be operated at 100% rated torque. When utilized according to temperature rise class B, the permissible torque for 1LA2/1LA5/1LA6 motors must be reduced by approx. 10%.

Force-ventilated motors:

In addition to self-ventilated 1LA2, 1LA5 and 1LA6 motors, force-ventilated 1LA5 motors can also be used. According to Fig. 7.1.1, the permissible S1-torque can be used, at rated frequency, down to standstill.

It is practical to use force-ventilated motors, if

- high torque utilization is required, even at the lowest speeds
- standard motors with pole numbers greater than 4 are to be operated at speeds $>$ approx. 2200 RPM (e.g. in the field-weakening range). Thus, for self-ventilated motors the fan noise is decreased.

Maximum speeds:

The maximum mechanical speeds for 1LA5 and 1LA6 motors are specified in Catalog M11, Page 59.

Motor protection:

This is realized using PTC thermistors. In this case, the PTC thermistor is connected at the control terminal strip. If the motor protection function is activated (parameter P087 = 1), the drive converter is shutdown if a high signal level is present at the PTC input (fault code F004 is displayed).

The internal I^2t calculation also allows the motor to be thermally monitored. Various motor-output de-rating curves can be parameterized (P074), which limit the motor current as a function of the frequency, and provide an alarm (P931 = 5; motor overtemperature). Presently, this function is being expanded to also provide shutdown.

The "alarm" and "fault" signals can also be output via the binary outputs.

MICRO MASTER

MIDI MASTER

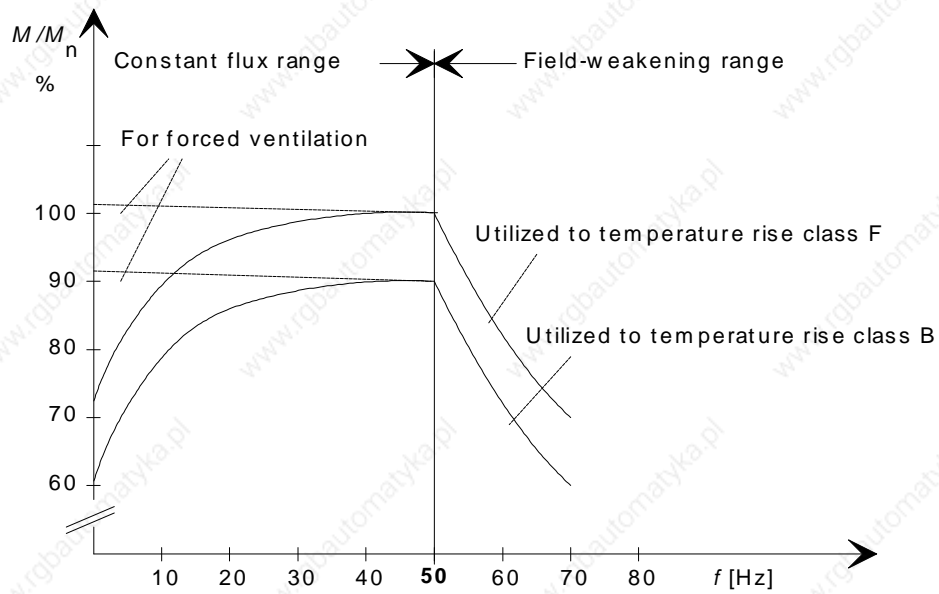

Fig. 7.1.1: Typical characteristic of the permissible torque for force-ventilated motors (e.g. 1LA2/1LA5/1LA6) with 50 Hz rated frequency. Precise values for 1LA2, 1LA5 and 1LA6 motors can be taken from the assignment tables on page 7/6 onwards.

assignment tables

Connecting motors through longer feeder cables:

Long feeder cables between the motor and drive converter or several parallel motor feeder cables (group drives), result in additional re-charging currents due to the cable capacitance; the drive converters must also supply these additional currents. This can activate the drive converter current limiting and cause the unit to shutdown with an "overcurrent" fault message (F002). Further, when fed from PWM drive converters with long motor feeder cables, voltage spikes at the motor can occur due to voltage reflections.

Depending on the drive converter supply voltage, motor frame size and cable length between the motor and drive converter, output reactors or dV/dt filters are required and/or larger drive converters must be selected.

Further, to reduce the cable capacitance, a higher cable cross-section should be used (for MICRO MASTER up to 3 kW: 2.5 mm², up to 5.5 kW: 4 mm²; for MIDI MASTER up to 5.5 kW: 6 mm², up to 15 kW: 10 mm², for MD 1500/2: 16 mm², up to 22 kW, 16 mm², up to 37 kW, 25 mm²).

For MICRO MASTER, it is generally more favorable to select a higher-rating drive converter than to use an output reactor or dV/dt filter. For cable lengths up to 125 meters, it is sufficient to use the next largest MICRO MASTER or MIDI MASTER; up to 200 meters, the next but one largest (i.e. 2 steps higher) MICRO MASTER/MIDI MASTER should be used (both shielded and unshielded cables).

- **Output reactors**

Compensate capacitive re-charging currents for long cables (refer to section 6.4).

The maximum cable lengths are specified in table 7.1.1.

Note:

For multi-motor drives, the sum of the cable lengths must be taken into account.

The output reactor ordering data is specified in section 6 "Options". In this case, the maximum permissible output frequency is 120 Hz at a maximum pulse frequency of 4 kHz.

- **dV/dt filters**

may be required for motors with a low voltage strength of the insulation system (refer to section 6.5).

The maximum cable lengths are specified in table 7.1.1.

Note:

For group supply, the sum of the cable lengths must be taken into account.

The ordering data of the dV/dt filters is specified in section 6 "Options". The maximum permissible output frequency is 300 Hz at a maximum pulse frequency of 4 kHz.

MICRO MASTER

MIDI MASTER

Maximum cable lengths						
Drive converter	Standard	Reactor	dV/dt filter	Standard	Reactor	dV/dt filter
	Unshielded cables			Shielded cables		
MICRO MASTER	50 m	200 m ¹⁾	150 m ²⁾	25 m	200 m ¹⁾	100 m ²⁾
MIDI MASTER	100 m	200 m	150 m ²⁾	50 m	200 m	100 m ²⁾

¹⁾ For MICRO MASTER, up to motor outputs of 550 W, above 125 m, the next largest drive converter should be selected (de-rating).

²⁾ For 1/3-ph. 230 V AC, dV/dt filters are technically not required.

Table 7.1.1: Maximum permissible cable lengths

Operating motors with degree of protection "d":

Siemens 1MJ6 induction motors can be operated from the line supply (direct online) as well as from a drive converter, as explosion-protected motors with flameproof enclosure "d". The flameproof enclosure ensures explosion protection for the drives. The Physikalisch-Technische Bundesanstalt (German regulatory body) has issued a general certificate of conformance for converter operation of these motors. 1MJ6 motors include PTC thermistors, which are integrated into the stator winding. If 1MJ6 motors are to be connected to drive converters, then, just like the 1LA5 and 1LA6 motors having the same output, the maximum permissible torque must be reduced.

1MJ6 motors have, as standard, a terminal box with degree of protection increased safety "e" (EEx e). Voltage peaks can occur at the motor when fed from a PWM converter if long motor feeder cables are used due to voltage reflection. The terminal boxes, degree of protection EEx e are only permitted for the following maximum voltage peaks due to the air- and creepage distances:

- up to frame size 225M (660 V terminal boxes) for voltage peaks up to 1078 V.
- from frame size 250M (100 V terminal boxes) for voltage peaks up to 1633 V.

In order that these maximum permissible voltage peaks are not exceeded at the terminal boxes, the following should be observed:

230 V supply voltage:

When using 1MJ motors (EEx e terminal boxes) no restriction

400 V supply voltage:

- only possible when using standard 4 kHz switching frequency
- output reactor and flameproof terminal boxes (k53)
- or: dV/dt filter

460 V to 500 V supply voltage:

- only possible when using the standard 4 kHz switching frequency
- dV/dt filter

575 V supply voltage:

- only possible when using the standard 4 kHz switching frequency
- flameproof terminal boxes (K53)
- dV/dt filter

Note:

For 1MJ motors, PTC thermistors and tripping devices (refer to catalog NS2) are specified. Code for installing PTC thermistors in the motor:

A15 for tripping 1MJ motors

A16 for alarm and tripping 1MJ motors.

Motor - drive converter assignment:

The induction motors assigned in tables on Page 7/6 and onwards guarantee an optimum utilization of the motor and drive converter.

Rated motor current greater than the rated drive converter current:

If the drive is to have a larger motor than that specified in the assignment tables (e.g. if the drive is to be exclusively operated in the partial-load range), then the following limit should be observed:

The maximum drive converter current (short-time current) should be greater than or at least the same as the rated motor current of the connected motor or, if applicable, the sum of the rated motor currents of the connected motors (for multi-motor drives).

Otherwise, the peak currents which can occur could cause the drive to be tripped due to overcurrent, as the leakage inductance and therefore the current ripple is higher for larger motors.

Lowest permissible rated motor current at the drive converter:

FCC closed-loop field current control:

If the FCC control is activated ($P077 = 1$), the rated motor current must be at least 40% of the rated drive converter current.

V/f characteristic ($P077 = 0$ or 2):

In this case, operation of far smaller motors than those assigned in the table does not cause a problem. However, the slip compensation and the I^2t calculation of the motor may no longer be able to be correctly executed.

Constant-torque drives with 1LA2, 1LA5, 1LA6 motors: ("Constant Torque", CT)

In this case, the torque must be reduced according to the speed control range. The assignment tables include these values for speed control ranges 1:2, 1:5 and 1:10. The motor-drive converter assignment has been selected, so that

starting from the permissible S1 torque, a brief 50% overload is possible for 60 s.

Thus, generally an adequate reserve is provided for breakaway and accelerating torques (refer to Fig. 7.1.2).

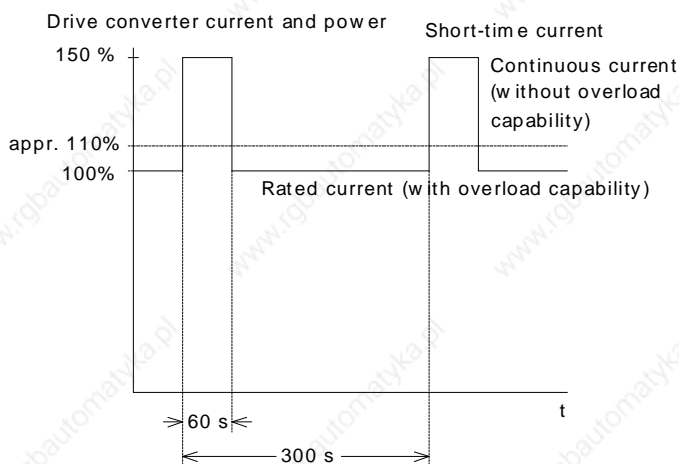

Fig. 7.1.2: Definition of the overload, continuous and rated drive converter values

Fan and pump drives with 1LA2, 1LA5, 1LA6 motors: ("Variable Torque", VT)

Fan and pump drives with load characteristic $M \sim n^2$ only require the full torque at rated speed. Generally, increased starting torques for load surges are not encountered. Thus, the drive converter requires no overload capability.

For fan- and pump drives, the motors and converters are assigned in the tables, so that

the motor current at full torque at the rated operating point is less than or equal to the continuous drive converter current.

The favorable pulse pattern allows, in almost all situations at the rated operating point, the same shaft outputs as for line supply operation (direct online), if the motors are utilized according to temperature rise class F.

For MIDI MASTER, when the square-law voltage-frequency characteristic ($P077 = 2$) is used, a significantly higher continuous current is possible, so that in almost all cases the rated output is achieved with the next largest motor ("Variable Torque", VT).

Thus, for any specified output, fan and pump drives can use a smaller drive converter.

Information regarding the tables:

These tables allow a drive package consisting of motor and drive converters to be quickly selected. 2-, 4-, 6- and 8-pole induction motors and rated motor voltages of 230 V, 400 V and 500 V at 50 Hz are listed. This is based on the fact that the motors are utilized according to temperature rise class F, and continuous operation S1. The tables only cover single-motor drives with operation in the constant-flux range. For special applications, the motor currents must be individually determined, and then the drive converter selected (e.g. for group drives, field-weakening operation or high overload).

The shaft output P_{list} specified in the tables refers to the rated speed n_n of the particular motor. The permissible S1 torque in the appropriate speed range (for constant-torque applications), and at the appropriate speed point (for fan and pump applications), is obtained as follows:

$$M_{permissible} = \frac{P_{list} \cdot 9550}{n_n} \text{ in Nm}$$

P_{list} : shaft output in kW at n_n specified in the table

n_n : rated motor speed in RPM

MICRO MASTER

MIDI MASTER

7.2 Motor - drive converter assignment for standard 1LA2, 1LA5 and 1LA6 Siemens motors

7.2.1 1-ph. 230 V AC supply voltage - integrated radio interference suppression filter

1LA2, 1LA5 2-pole motors, 3-ph. 230 V AC

Shaft output for converter supply (utilized according to temperature rise class F)				1LA2, 1LA5 three-phase squirrel-cage induction motors				MICRO MASTER			
VT		CT		3-ph. 230 V AC rated voltage							
Load charac- teristic $M \sim n^2$ VT	Load characteristic $M = \text{const.}$ Speed control range			Rated output at 50 Hz kW	Order number for existing systems	Order number for new applications	Frame size	Output at 3-ph. 230 V AC kVA	Order No.	Type	
	1:2	1:5	1:10								
kW	kW	kW	kW	kW				kVA			
0.26	0.25	0.2	0.15	0.25	1LA5 063-2AA1 .	1LA2 063-2AA1 .	63	0.66	6SE3111-5BA40	MM25	
0.33	0.31	0.25	0.2	0.37	1LA5 070-2AA1 .	1LA2 070-2AA1 .	71	0.66	6SE3111-5BA40	MM25	
0.38	0.37	0.25	0.2	0.37	1LA5 070-2AA1 .	1LA2 070-2AA1 .	71	0.88	6SE3112-1BA40	MM37	
0.50	0.44	0.4	0.32	0.55	1LA5 073-2AA1 .	1LA2 073-2AA1 .	71	0.88	6SE3112-1BA40	MM37	
0.57	0.55	0.4	0.32	0.55	1LA5 073-2AA1 .	1LA2 073-2AA1 .	71	1.14	6SE3112-8BA40	MM55	
0.68	0.61	0.6	0.4	0.75	1LA5 080-2AA1 .	1LA2 080-2AA1 .	80	1.14	6SE3112-8BA40	MM55	
0.78	0.75	0.6	0.4	0.75	1LA5 080-2AA1 .	1LA2 080-2AA1 .	80	1.5	6SE3113-6BA40	MM75	
0.9	0.83	0.83	0.7	1.1	1LA5 083-2AA1 .	1LA2 083-2AA1 .	80	1.5	6SE3113-6BA40	MM75	
1.15	1.1	0.9	0.7	1.1	1LA5 083-2AA1 .	1LA2 083-2AA1 .	80	2.1	6SE3115-2BB40	MM110	
1.25	1.15	1.15	0.9	1.5	1LA5 090-2AA1 .	1LA2 090-2AA1 .	90 S	2.1	6SE3115-2BB40	MM110	
1.55	1.5	1.2	0.9	1.5	1LA5 090-2AA1 .	1LA2 090-2AA1 .	90 S	2.8	6SE3116-8BB40	MM150	
1.8	1.6	1.6	1.4	2.2	1LA5 096-2AA1 .	1LA2 096-2AA1 .	90 L	2.8	6SE3116-8BB40	MM150	
2.3	2.2	1.8	1.4	2.2	1LA5 096-2AA1 .	1LA2 096-2AA1 .	90 L	4.0	6SE3121-0BC40	MM220	
2.7	2.4	2.4	1.8	3	1LA5 106-2AA1 .	1LA2 106-2AA1 .	100 L	4.0	6SE3121-0BC40	MM220	

1LA2, 1LA5 4-pole motors, 3-ph. 230 V AC

Shaft output for converter supply (utilized according to temperature rise class F)				1LA2, 1LA5 three-phase squirrel-cage induction motors				MICRO MASTER			
VT		CT		3-ph. 230 V AC rated voltage							
Load charac- teristic $M \sim n^2$ VT	Load characteristic $M = \text{const.}$ Speed control range			Rated output at 50 Hz kW	Order number for existing systems	Order number for new applications	Frame size	Output at 3-ph. 230 V AC kVA	Order No.	Type	
	1:2	1:5	1:10								
kW	kW	kW	kW	kW				kVA			
0.26	0.25	0.19	0.14	0.25	1LA5 070-4AB1 .	1LA2 070-4AB1 .	71	0.66	6SE3111-5BA40	MM25	
0.38	0.37	0.28	0.2	0.37	1LA5 073-4AB1 .	1LA2 073-4AB1 .	71	0.88	6SE3112-1BA40	MM37	
0.57	0.55	0.4	0.3	0.55	1LA5 080-4AA1 .	1LA2 080-4AB1 .	80	1.14	6SE3112-8BA40	MM55	
0.78	0.75	0.6	0.4	0.75	1LA5 083-4AA1 .	1LA2 083-4AB1 .	80	1.5	6SE3113-6BA40	MM75	
1.15	1.1	0.8	0.6	1.1	1LA5 090-4AA1 .	1LA2 090-4AA1 .	90 S	2.1	6SE3115-2BB40	MM110	
1.55	1.5	1.1	0.8	1.5	1LA5 096-4AA1 .	1LA2 096-4AA1 .	90 L	2.8	6SE3116-8BB40	MM150	
2.3	2.2	1.7	1.3	2.2	1LA5 106-4AA1 .	1LA2 106-4AA1 .	100 L	4.0	6SE3121-0BC40	MM220	

Last position of the Motor Order No.:

The types of construction for the 1LA2 and 1LA5 motors are the same.
The following types of construction are only available for the 1LA2 motors:
- 0, 1, 2 and 6.
Refer to Catalog M 11• 1996.

MICRO MASTER

MIDI MASTER

1LA2, 1LA5 6-pole motors, 3-ph. 230 V AC

Shaft output for converter supply (utilized according to temperature rise class F)				1LA2, 1LA5 three-phase squirrel-cage induction motors				MICRO MASTER		
VT		CT		3-ph. 230 V AC rated voltage						
Load characteristic $M \sim n^2$ VT	Load characteristic M = const. Speed control range			Rated output at 50 Hz kW	Order number for existing systems	Order number for new applications	Frame size	Output at 3-ph. 230 V AC kVA	Order No.	Type
	1:2	1:5	1:10							
kW	kW	kW	kW	kW				kVA		
0.25	0.25	0.17	0.13	0.25	1LA5 073-6AA1 .	1LA2 073-6AB1 .	71	0.66	6SE3111-5BA40	MM25
0.37	0.34	0.25	0.18	0.37	1LA5 080-6AA1 .	1LA2 080-6AB1 .	80	0.88	6SE3112-1BA40	MM37
0.55	0.47	0.38	0.27	0.55	1LA5 083-6AA1 .	1LA2 083-6AA1 .	80	1.14	6SE3112-8BA40	MM55
0.75	0.67	0.52	0.38	0.75	1LA5 090-6AA1 .	1LA2 090-6AA1 .	90 S	1.5	6SE3113-6BA40	MM75
1.1	0.95	0.77	0.55	1.1	1LA5 096-6AA1 .	1LA2 096-6AA1 .	90 L	2.1	6SE3115-2BB40	MM110
1.5	1.35	1.0	0.77	1.5	1LA5 106-6AA1 .	1LA2 106-6AA1 .	100 L	2.8	6SE3116-8BB40	MM150
2.2	1.9	1.6	1.2	2.2	1LA5 113-6AA1 .	1LA2 113-6CA1 .	112 M	4.0	6SE3121-0BC40	MM220

1LA5 8-pole motors, 3-ph. 230 V AC

Shaft output for converter supply (utilized according to temperature rise class F)				1LA2, 1LA5 three-phase squirrel-cage induction motors				MICRO MASTER		
VT		CT		3-ph. 230 V AC rated voltage						
Load characteristic $M \sim n^2$ VT	Load characteristic M = const. Speed control range			Rated output at 50 Hz kW	Order number for existing systems	Order number for new applications	Frame size	Output at 3-ph. 230 V AC kVA	Order No.	Type
	1:2	1:5	1:10							
kW	kW	kW	kW	kW				kVA		
0.19	0.18	0.17	0.12	0.25	1LA5 083-8AB1 .	1LA5 083-8AB1 .	80	0.66	6SE3111-5BA40	MM25
0.37	0.35	0.24	0.18	0.37	1LA5 090-8AB1 .	1LA5 090-8AB1 .	90 S	0.88	6SE3112-1BA40	MM37
0.52	0.48	0.37	0.28	0.55	1LA5 096-8AB1 .	1LA5 096-8AB1 .	90 L	1.14	6SE3112-8BA40	MM55
0.7	0.63	0.53	0.4	0.75	1LA5 106-8AB1 .	1LA5 106-8AB1 .	100 L	1.5	6SE3113-6BA40	MM75
1.1	1.0	0.8	0.6	1.1	1LA5 107-8AB1 .	1LA5 107-8AB1 .	100 L	2.1	6SE3115-2BB40	MM110
1.35	1.2	1.1	0.8	1.5	1LA5 113-8AB1 .	1LA5 113-8AB1 .	112 M	2.8	6SE3116-8BB40	MM150
2.0	1.8	1.6	1.2	2.2	1LA5 130-8CB1 .	1LA5 130-8CB1 .	132 S	4.0	6SE3121-0BC40	MM220

Last position of the Motor Order No.:

The types of construction for the 1LA2 and 1LA5 motors are the same.
The following types of construction are only available for the 1LA2 motors:
- 0, 1, 2 and 6.
Refer to Catalog M 11• 1996.

MICRO MASTER

MIDI MASTER

7.2.2 1-ph. 230 V AC supply voltage

All MM25/2 to MM300/2 MICRO MASTER can also be connected to three-phase supplies, refer to 7.2.3.

1LA2, 1LA5 2-pole motors, 3-ph. 230 V AC

Shaft output for converter supply (utilized according to temperature rise class F)				1LA2, 1LA5 three-phase squirrel-cage induction motors				MICRO MASTER			
VT		CT		3-ph. 230 V AC rated voltage							
Load charac- teristic $M \sim n^2$ VT	Load characteristic $M = \text{const.}$ Speed control range			Rated output at 50 Hz kW	Order number for existing systems	Order number for new applications	Frame size	Output at 3-ph. 230 V AC kVA	Order No.	Type	
	1:2	1:5	1:10								
kW	kW	kW	kW	kW				kVA			
0.26	0.25	0.2	0.15	0.25	1LA5 063-2AA1 .	1LA2 063-2AA1 .	63	0.66	6SE3111-5CA40	MM25/2	
0.33	0.31	0.25	0.2	0.37	1LA5 070-2AA1 .	1LA2 070-2AA1 .	71	0.66	6SE3111-5CA40	MM25/2	
0.38	0.37	0.25	0.2	0.37	1LA5 070-2AA1 .	1LA2 070-2AA1 .	71	0.88	6SE3112-1CA40	MM37/2	
0.50	0.44	0.4	0.32	0.55	1LA5 073-2AA1 .	1LA2 073-2AA1 .	71	0.88	6SE3112-1CA40	MM37/2	
0.57	0.55	0.4	0.32	0.55	1LA5 073-2AA1 .	1LA2 073-2AA1 .	71	1.14	6SE3112-8CA40	MM55/2	
0.68	0.61	0.6	0.4	0.75	1LA5 080-2AA1 .	1LA2 080-2AA1 .	80	1.14	6SE3112-8CA40	MM55/2	
0.78	0.75	0.6	0.4	0.75	1LA5 080-2AA1 .	1LA2 080-2AA1 .	80	1.5	6SE3113-6CA40	MM75/2	
0.9	0.83	0.83	0.7	1.1	1LA5 083-2AA1 .	1LA2 083-2AA1 .	80	1.5	6SE3113-6CA40	MM75/2	
1.15	1.1	0.9	0.7	1.1	1LA5 083-2AA1 .	1LA2 083-2AA1 .	80	2.1	6SE3115-2CB40	MM110/2	
1.25	1.15	1.15	0.9	1.5	1LA5 090-2AA1 .	1LA2 090-2AA1 .	90 S	2.1	6SE3115-2CB40	MM110/2	
1.55	1.5	1.2	0.9	1.5	1LA5 090-2AA1 .	1LA2 090-2AA1 .	90 S	2.8	6SE3116-8CB40	MM150/2	
1.8	1.6	1.6	1.4	2.2	1LA5 096-2AA1 .	1LA2 096-2AA1 .	90 L	2.8	6SE3116-8CB40	MM150/2	
2.3	2.2	1.8	1.4	2.2	1LA5 096-2AA1 .	1LA2 096-2AA1 .	90 L	4.0	6SE3121-0CC40	MM220/2	
2.7	2.4	2.4	1.8	3	1LA5 106-2AA1 .	1LA2 106-2AA1 .	100 L	4.0	6SE3121-0CC40	MM220/2	
2.9	2.8	2.5	1.8	3	1LA5 106-2AA1 .	1LA2 106-2AA1 .	100 L	5.2	6SE3121-3CC40	MM300/2 ¹⁾	

1LA2, 1LA5 4-pole motors, 3-ph. 230 V AC

Shaft output for converter supply (utilized according to temperature rise class F)				1LA2, 1LA5 three-phase squirrel-cage induction motors				MICRO MASTER			
VT		CT		3-ph. 230 V AC rated voltage							
Load charac- teristic $M \sim n^2$ VT	Load characteristic $M = \text{const.}$ Speed control range			Rated output at 50 Hz kW	Order number for existing systems	Order number for new applications	Frame size	Output at 3-ph. 230 V AC kVA	Order No.	Type	
	1:2	1:5	1:10								
kW	kW	kW	kW	kW				kVA			
0.26	0.25	0.19	0.14	0.25	1LA5 070-4AB1 .	1LA2 070-4AB1 .	71	0.66	6SE3111-5CA40	MM25/2	
0.38	0.37	0.28	0.2	0.37	1LA5 073-4AB1 .	1LA2 073-4AB1 .	71	0.88	6SE3112-1CA40	MM37/2	
0.57	0.55	0.4	0.3	0.55	1LA5 080-4AA1 .	1LA2 080-4AB1 .	80	1.14	6SE3112-8CA40	MM55/2	
0.78	0.75	0.6	0.4	0.75	1LA5 083-4AA1 .	1LA2 083-4AB1 .	80	1.5	6SE3113-6CA40	MM75/2	
1.15	1.1	0.8	0.6	1.1	1LA5 090-4AA1 .	1LA2 090-4AA1 .	90 S	2.1	6SE3115-2CB40	MM110/2	
1.55	1.5	1.1	0.8	1.5	1LA5 096-4AA1 .	1LA2 096-4AA1 .	90 L	2.8	6SE3116-8CB40	MM150/2	
2.3	2.2	1.7	1.3	2.2	1LA5 106-4AA1 .	1LA2 106-4AA1 .	100 L	4.0	6SE3121-0CC40	MM220/2	
2.8	2.6	2.3	1.7	3	1LA5 107-4AA1 .	1LA2 107-4AA1 .	100 L	5.2	6SE3121-3CC40	MM300/2 ¹⁾	

Last position of the Motor Order No.:

The types of construction for the 1LA2 and 1LA5 motors are the same.
The following types of construction are only available for the 1LA2 motors:
- 0, 1, 2 and 6.
Refer to Catalog M 11 • 1996.

¹⁾ with additional 4EM6100-3CB commutating reactor.

MICRO MASTER

MIDI MASTER

1LA2, 1LA5 6-pole motors, 3-ph. 230 V AC

Shaft output for converter supply (utilized according to temperature rise class F)					1LA2, 1LA5 three-phase squirrel-cage induction motors			MICRO MASTER		
VT		CT			3-ph. 230 V AC rated voltage					
Load characteristic $M \sim n^2$ VT	Load characteristic $M = \text{const.}$ Speed control range			Rated output at 50 Hz kW	Order number for existing systems	Order number for new applications	Frame size	Output at 3-ph. 230 V AC kVA	Order No.	Type
	1:2	1:5	1:10							
kW	kW	kW	kW	kW				kVA		
0.25	0.25	0.17	0.13	0.25	1LA5 073-6AA1 .	1LA2 073-6AB1 .	71	0.66	6SE3111-5CA40	MM25/2
0.37	0.34	0.25	0.18	0.37	1LA5 080-6AA1 .	1LA2 080-6AB1 .	80	0.88	6SE3112-1CA40	MM37/2
0.55	0.47	0.38	0.27	0.55	1LA5 083-6AA1 .	1LA2 083-6AA1 .	80	1.14	6SE3112-8CA40	MM55/2
0.75	0.67	0.52	0.38	0.75	1LA5 090-6AA1 .	1LA2 090-6AA1 .	90 S	1.5	6SE3113-6CA40	MM75/2
1.1	0.95	0.77	0.55	1.1	1LA5 096-6AA1 .	1LA2 096-6AA1 .	90 L	2.1	6SE3115-2CB40	MM110/2
1.5	1.35	1.0	0.77	1.5	1LA5 106-6AA1 .	1LA2 106-6AA1 .	100 L	2.8	6SE3116-8CB40	MM150/2
2.2	1.9	1.6	1.2	2.2	1LA5 113-6AA1 .	1LA2 113-6CA1 .	112 M	4.0	6SE3121-0CC40	MM220/2
2.6	2.5	2.2	1.7	3	1LA5 130-6CA1 .	1LA2 130-6CA1 .	132 S	5.2	6SE3121-3CC40	MM300/2 ¹⁾

1LA5 8-pole motors, 3-ph. 230 V AC

Shaft output for converter supply (utilized according to temperature rise class F)					1LA2, 1LA5 three-phase squirrel-cage induction motors			MICRO MASTER		
VT		CT			3-ph. 230 V AC rated voltage					
Load characteristic $M \sim n^2$ VT	Load characteristic $M = \text{const.}$ Speed control range			Rated output at 50 Hz kW	Order number for existing systems	Order number for new applications	Frame size	Output at 3-ph. 230 V AC kVA	Order No.	Type
	1:2	1:5	1:10							
kW	kW	kW	kW	kW				kVA		
0.19	0.18	0.17	0.12	0.25	1LA5 083-8AB1 .	1LA5 083-8AB1 .	80	0.66	6SE3111-5CA40	MM25/2
0.37	0.35	0.24	0.18	0.37	1LA5 090-8AB1 .	1LA5 090-8AB1 .	90 S	0.88	6SE3112-1CA40	MM37/2
0.52	0.48	0.37	0.28	0.55	1LA5 096-8AB1 .	1LA5 096-8AB1 .	90 L	1.14	6SE3112-8CA40	MM55/2
0.7	0.63	0.53	0.4	0.75	1LA5 106-8AB1 .	1LA5 106-8AB1 .	100 L	1.5	6SE3113-6CA40	MM75/2
1.1	1.0	0.8	0.6	1.1	1LA5 107-8AB1 .	1LA5 107-8AB1 .	100 L	2.1	6SE3115-2CB40	MM110/2
1.35	1.2	1.1	0.8	1.5	1LA5 113-8AB1 .	1LA5 113-8AB1 .	112 M	2.8	6SE3116-8CB40	MM150/2
2.0	1.8	1.6	1.2	2.2	1LA5 130-8CB1 .	1LA5 130-8CB1 .	132 S	4.0	6SE3121-0CC40	MM220/2
2.5	2.3	2.1	1.7	3	1LA5 133-8CB1 .	1LA5 133-8CB1 .	132 M	5.2	6SE3121-3CC40	MM300/2 ¹⁾

Last position of the Motor Order No.:

The types of construction for the 1LA2 and 1LA5 motors are the same.
The following types of construction are only available for the 1LA2 motors:
- 0, 1, 2 and 6.
Refer to Catalog M 11• 1996.

¹⁾ with additional 4EM6100-3CB commutating reactor.

MICRO MASTER

MIDI MASTER

7.2.3 3-ph. 230 V AC supply voltage

1LA2, 1LA5 2-pole motors, 3-ph. 230 V AC

Shaft output for converter supply (utilized according to temperature rise class F)				1LA2, 1LA5 three-phase squirrel-cage induction motors				MICRO MASTER and MIDI MASTER			
VT		CT		3-ph. 230 V AC rated voltage							
Load characteristic $M = \text{const.}$ Speed control range VT	Load characteristic $M = \text{const.}$ Speed control range			Rated output at 50 Hz kW	Order number for existing systems	Order number for new applications	Frame size	Output at 3-ph. 230 V AC kVA	Order No.	Type	
	1:2 kW	1:5 kW	1:10 kW								
0.26	0.25	0.2	0.15	0.25	1LA5 063-2AA1 .	1LA2 063-2AA1 .	63	0.66	6SE3111-5CA40	MM25/2	
0.33	0.31	0.25	0.2	0.37	1LA5 070-2AA1 .	1LA2 070-2AA1 .	71	0.66	6SE3111-5CA40	MM25/2	
0.38	0.37	0.25	0.2	0.37	1LA5 070-2AA1 .	1LA2 070-2AA1 .	71	0.88	6SE3112-1CA40	MM37/2	
0.50	0.44	0.4	0.32	0.55	1LA5 073-2AA1 .	1LA2 073-2AA1 .	71	0.88	6SE3112-1CA40	MM37/2	
0.57	0.55	0.4	0.32	0.55	1LA5 073-2AA1 .	1LA2 073-2AA1 .	71	1.14	6SE3112-8CA40	MM55/2	
0.68	0.61	0.6	0.4	0.75	1LA5 080-2AA1 .	1LA2 080-2AA1 .	80	1.14	6SE3112-8CA40	MM55/2	
0.78	0.75	0.6	0.4	0.75	1LA5 080-2AA1 .	1LA2 080-2AA1 .	80	1.5	6SE3113-6CA40	MM75/2	
0.9	0.83	0.83	0.7	1.1	1LA5 083-2AA1 .	1LA2 083-2AA1 .	80	1.5	6SE3113-6CA40	MM75/2	
1.15	1.1	0.9	0.7	1.1	1LA5 083-2AA1 .	1LA2 083-2AA1 .	80	2.1	6SE3115-2CB40	MM110/2	
1.25	1.15	1.15	0.9	1.5	1LA5 090-2AA1 .	1LA2 090-2AA1 .	90 S	2.1	6SE3115-2CB40	MM110/2	
1.55	1.5	1.2	0.9	1.5	1LA5 090-2AA1 .	1LA2 090-2AA1 .	90 S	2.8	6SE3116-8CB40	MM150/2	
1.8	1.6	1.6	1.4	2.2	1LA5 096-2AA1 .	1LA2 096-2AA1 .	90 L	2.8	6SE3116-8CB40	MM150/2	
2.3	2.2	1.8	1.4	2.2	1LA5 096-2AA1 .	1LA2 096-2AA1 .	90 L	4.0	6SE3121-0CC40	MM220/2	
2.7	2.4	2.4	1.8	3	1LA5 106-2AA1 .	1LA2 106-2AA1 .	100 L	4.0	6SE3121-0CC40	MM220/2	
3.1	3	2.5	1.8	3	1LA5 106-2AA1 .	1LA2 106-2AA1 .	100 L	5.2	6SE3121-3CC40	MM300/2	
3.6	3.3	3.3	2.6	4	1LA5 113-2AA1 .	1LA2 113-2CA1 .	112 M	5.2	6SE3121-3CC40	MM300/2	
4.1	4	3.3	2.6	4	1LA5 113-2AA1 .	1LA2 113-2CA1 .	112 M	9.1	6SE3122-3CG40	MD550/2	
5.6	5.5	4.4	3.8	5.5	1LA5 130-2CA1 .	1LA2 130-2CA1 .	132 S	9.1	6SE3122-3CG40	MD550/2	
7.7	7.0	6.0	5.1	7.5	1LA5 131-2CA1 .	1LA2 131-2CA1 .	132 S	10.9	6SE3122-3CG40	MD550/2	
7.7	7.5	6.0	5.1	7.5	1LA5 131-2CA1 .	1LA2 131-2CA1 .	132 S	12.7	6SE3123-1CG40	MD750/2	
11.1	7.9	7.9	7.6	11	1LA5 163-2CA1 .	1LA5 163-2CA1 .	160 M	15.4	6SE3123-1CG40	MD750/2	
11.1	11	8.8	7.6	11	1LA5 163-2CA1 .	1LA5 163-2CA1 .	160 M	17.6	6SE3124-2CH40	MD1100/2	
11.6	11.6	11.6	10.6	15	1LA5 164-2CA1 .	1LA5 164-2CA1 .	160 M	20.7	6SE3124-2CH40	MD1100/2 ¹⁾	
15.2	15	12.4	10.6	15	1LA5 164-2CA1 .	1LA5 164-2CA1 .	160 M	21.4	6SE3125-4CH40	MD1500/2	
18.7	15.8	15.5	13.3	18.5	1LA5 166-2CA1 .	1LA5 166-2CA1 .	160 L	25.5	6SE3125-4CH40	MD1500/2	
18.7	18.5	15.5	13.3	18.5	1LA5 166-2CA1 .	1LA5 166-2CA1 .	160 L	25.9	6SE3126-8CJ40	MD1850/2	
22	21	18.2	16	22	1LA5 183-2AA1 .	1LA5 183-2AA1 .	180 M	29.7	6SE3126-8CJ40	MD1850/2	
22	22	18.2	16	22	1LA5 183-2AA1 .	1LA5 183-2AA1 .	180 M	30.7	6SE3127-5CJ40	MD2200/2	
28	25	25	22	30	1LA5 206-2AA1 .	1LA5 206-2AA1 .	200 L	35.8	6SE3127-5CJ40	MD2200/2	

¹⁾ presently, higher outputs are not possible for VT

For MIDI MASTER, degree of protection IP54: replace the last 3 digits of the Order No. by "S45", refer to section 3.5.

Last position of the Motor Order No.:

The types of construction for the 1LA2 and 1LA5 motors are the same.

The following types of construction are only available for the 1LA2 motors:

- 0, 1, 2 and 6.

Refer to Catalog M 11 • 1996.

MICRO MASTER

MIDI MASTER

1LA2, 1LA5 4-pole motors, 3-ph. 230 V AC

Shaft output for converter supply (utilized according to temperature rise class F)				1LA2, 1LA5 three-phase squirrel-cage induction motors				MICRO MASTER and MIDI MASTER			
VT		CT		3-ph. 230 V AC rated voltage				Output at 3-ph. 230 V AC kVA	Order No.	Type	
Load charac- teristic $M \sim n^2$ VT	Load characteristic $M = \text{const.}$ Speed control range			Rated output at 50 Hz kW	Order number for existing systems	Order number for new applications	Frame size				
	1:2	1:5	1:10								
kW	kW	kW	kW	kW							
0.26	0.25	0.19	0.14	0.25	1LA5 070-4AB1 .	1LA2 070-4AB1 .	71	0.66	6SE3111-5CA40	MM25/2	
0.31	0.29	0.28	0.2	0.37	1LA5 073-4AB1 .	1LA2 073-4AB1 .	71	0.66	6SE3111-5CA40	MM25/2	
0.38	0.37	0.28	0.2	0.37	1LA5 073-4AB1 .	1LA2 073-4AB1 .	71	0.88	6SE3112-1CA40	MM37/2	
0.49	0.42	0.4	0.3	0.55	1LA5 080-4AA1 .	1LA2 080-4AB1 .	80	0.88	6SE3112-1CA40	MM37/2	
0.57	0.55	0.4	0.3	0.55	1LA5 080-4AA1 .	1LA2 080-4AB1 .	80	1.14	6SE3112-8CA40	MM55/2	
0.64	0.57	0.57	0.4	0.75	1LA5 083-4AA1 .	1LA2 083-4AB1 .	80	1.14	6SE3112-8CA40	MM55/2	
0.78	0.75	0.6	0.4	0.75	1LA5 083-4AA1 .	1LA2 083-4AB1 .	80	1.5	6SE3113-6CA40	MM75/2	
0.85	0.78	0.78	0.6	1.1	1LA5 090-4AA1 .	1LA2 090-4AA1 .	90 S	1.5	6SE3113-6CA40	MM75/2	
1.15	1.1	0.8	0.6	1.1	1LA5 090-4AA1 .	1LA2 090-4AA1 .	90 S	2.1	6SE3115-2CB40	MM110/2	
1.2	1.1	1.1	0.8	1.5	1LA5 096-4AA1 .	1LA2 096-4AA1 .	90 L	2.1	6SE3115-2CB40	MM110/2	
1.55	1.5	1.1	0.8	1.5	1LA5 096-4AA1 .	1LA2 096-4AA1 .	90 L	2.8	6SE3116-8CB40	MM150/2	
1.6	1.5	1.5	1.3	2.2	1LA5 106-4AA1 .	1LA2 106-4AA1 .	100 L	2.8	6SE3116-8CB40	MM150/2	
2.3	2.2	1.7	1.3	2.2	1LA5 106-4AA1 .	1LA2 106-4AA1 .	100 L	4.0	6SE3121-0CC40	MM220/2	
2.4	2.2	2.2	1.7	3	1LA5 107-4AA1 .	1LA2 107-4AA1 .	100 L	4.0	6SE3121-0CC40	MM220/2	
3.1	3	2.4	1.7	3	1LA5 107-4AA1 .	1LA2 107-4AA1 .	100 L	5.2	6SE3121-3CC40	MM300/2	
3.1	2.9	2.9	2.3	4	1LA5 113-4AA1 .	1LA2 113-4CA1 .	112 M	5.2	6SE3121-3CC40	MM300/2	
4.2	4	3.2	2.3	4	1LA5 113-4AA1 .	1LA2 113-4CA1 .	112 M	9.1	6SE3122-3CG40	MD550/2	
5.7	5.5	4.4	3.7	5.5	1LA5 130-4CA1 .	1LA2 130-4CA1 .	132 S	9.1	6SE3122-3CG40	MD550/2	
7.5	5.9	5.9	5.3	7.5	1LA5 133-4CA1 .	1LA2 133-4CA1 .	132 M	10.9	6SE3122-3CG40	MD550/2	
7.7	7.5	6.2	5.3	7.5	1LA5 133-4CA1 .	1LA2 133-4CA1 .	132 M	12.7	6SE3123-1CG40	MD750/2	
11.2	7.6	7.6	7.6	11	1LA5 163-4CA1 .	1LA2 163-4AA1 .	160 M	15.4	6SE3123-1CG40	MD750/2	
11.2	11	9.1	7.9	11	1LA5 163-4CA1 .	1LA2 163-4AA1 .	160 M	17.6	6SE3124-2CH40	MD1100/2	
12.1	12.1	12.1	10.9	15	1LA5 166-4CA1 .	1LA2 166-4AA1 .	160 L	20.7	6SE3124-2CH40	MD1100/2 ¹⁾	
15.3	15	12.7	10.9	15	1LA5 166-4CA1 .	1LA2 166-4AA1 .	160 L	21.4	6SE3125-4CH40	MD1500/2	
18.7	15.7	14.6	12.4	18.5	1LA5 183-4AA1 .	1LA5 183-4AA1 .	180 M	25.5	6SE3125-4CH40	MD1500/2	
18.7	18.5	14.6	12.4	18.5	1LA5 183-4AA1 .	1LA5 183-4AA1 .	180 M	25.9	6SE3126-8CJ40	MD1850/2	
22.2	20	17.8	15.2	22	1LA5 186-4AA1 .	1LA5 186-4AA1 .	180 L	29.7	6SE3126-8CJ40	MD1850/2	
22.2	22	17.8	15.2	22	1LA5 186-4AA1 .	1LA5 186-4AA1 .	180 L	30.7	6SE3127-5CJ40	MD2200/2	
27	24	24	21	30	1LA5 207-4AA1 .	1LA5 207-4AA1 .	200 L	35.8	6SE3127-5CJ40	MD2200/2	

¹⁾ presently, higher outputs are not possible for VT

For MIDI MASTER, degree of protection IP54: replace the last 3 digits of the Order No. by "S45", refer to section 5.

Last position of the Motor Order No.:

The types of construction for the 1LA2 and 1LA5 motors are the same.

The following types of construction are only available for the 1LA2 motors:

- 0, 1, 2 and 6.

Refer to Catalog M 11 • 1996.

MICRO MASTER

MIDI MASTER

1LA2, 1LA5 6-pole motors, 3-ph. 230 V AC

Shaft output for converter supply (utilized according to temperature rise class F)				1LA2, 1LA5, 1LA6 three-phase squirrel-cage induction motors				MICRO MASTER and MIDI MASTER		
VT	CT			3-ph. 230 V AC rated voltage						
Load characteristic $M \sim n^2$ VT	Load characteristic M = const.			Rated output at 50 Hz kW	Order number for existing systems	Order number for new applications	Frame size	Output at 3-ph. 230 V AC kVA	Order No.	Type
	Speed control range									
	1:2 kW	1:5 kW	1:10 kW							
0.25	0.25	0.17	0.13	0.25	1LA5 073-6AA1 .	1LA2 073-6AB1 .	71	0.66	6SE3111-5CA40	MM25/2
0.37	0.34	0.25	0.18	0.37	1LA5 080-6AA1 .	1LA2 080-6AB1 .	80	0.88	6SE3112-1CA40	MM37/2
0.55	0.47	0.38	0.27	0.55	1LA5 083-6AA1 .	1LA2 083-6AA1 .	80	1.14	6SE3112-8CA40	MM55/2
0.75	0.67	0.52	0.38	0.75	1LA5 090-6AA1 .	1LA2 090-6AA1 .	90 S	1.5	6SE3113-6CA40	MM75/2
1.1	0.95	0.77	0.55	1.1	1LA5 096-6AA1 .	1LA2 096-6AA1 .	90 L	2.1	6SE3115-2CB40	MM110/2
1.5	1.35	1.0	0.77	1.5	1LA5 106-6AA1 .	1LA2 106-6AA1 .	100 L	2.8	6SE3116-8CB40	MM150/2
2.2	1.9	1.6	1.2	2.2	1LA5 113-6AA1 .	1LA2 113-6CA1 .	112 M	4.0	6SE3121-0CC40	MM220/2
2.9	2.7	2.2	1.7	3	1LA5 130-6CA1 .	1LA2 130-6CA1 .	132 S	5.2	6SE3121-3CC40	MM300/2
2.9	2.7	2.7	2.2	4	1LA5 133-6CA1 .	1LA2 133-6CA1 .	132 M	5.2	6SE3121-3CC40	MM300/2
4.1	4	3.0	2.2	4	1LA5 133-6CA1 .	1LA2 133-6CA1 .	132 M	9.1	6SE3122-3CG40	MD550/2
5.7	5.1	4.2	3.4	5.5	1LA5 134-6CA1 .	1LA2 134-6CA1 .	132 M	9.1	6SE3122-3CG40	MD550/2
6.6	5.2	5.2	4.6	7.5	1LA5 163-6CA1 .	1LA5 163-6CA1 .	160 M	10.9	6SE3122-3CG40	MD550/2
7.7	6.6	5.5	4.6	7.5	1LA5 163-6CA1 .	1LA5 163-6CA1 .	160 M	12.7	6SE3123-1CG40	MD750/2
10.4	6.9	6.9	6.9	11	1LA5 166-6CA1 .	1LA5 166-6CA1 .	160 L	15.4	6SE3123-1CG40	MD750/2
11.2	10.4	8.5	7	11	1LA5 166-6CA1 .	1LA5 166-6CA1 .	160 L	17.6	6SE3124-2CH40	MD1100/2
11.7	11.7	11.5	9.7	15	1LA5 186-6AA1 .	1LA5 186-6AA1 .	180 L	20.7	6SE3124-2CH40	MD1100/2 ¹⁾
15.2	15	11.5	9.7	15	1LA5 186-6AA1 .	1LA5 186-6AA1 .	180 L	21.4	6SE3125-4CH40	MD1500/2
18.7	15.4	14.4	12.2	18.5	1LA5 206-6AA1 .	1LA5 206-6AA1 .	200 L	25.5	6SE3125-4CH40	MD1500/2
18.7	18.5	14.4	12.2	18.5	1LA5 206-6AA1 .	1LA5 206-6AA1 .	200 L	25.9	6SE3126-8CJ40	MD1850/2
22.2	19.3	17.4	14.7	22	1LA5 207-6AA1 .	1LA5 207-6AA1 .	200 L	29.7	6SE3126-8CJ40	MD1850/2
22.2	22	17.4	14.7	22	1LA5 207-6AA1 .	1LA5 207-6AA1 .	200 L	30.7	6SE3127-5CJ40	MD2200/2
27	24	24	24	30	1LA6 223-6AA1 .	1LA5 223-6AA1 .	225 M	35.8	6SE3127-5CJ40	MD2200/2

¹⁾ presently, higher outputs are not possible for VT

For MIDI MASTER, degree of protection IP54: replace the last 3 digits of the Order No. by "S45", refer to section 5.

Last position of the Motor Order No.:

The types of construction for the 1LA2 and 1LA5 motors are the same.

The following types of construction are only available for the 1LA2 motors:

- 0, 1, 2 and 6.

Refer to Catalog M 11 • 1996.

MICRO MASTER

MIDI MASTER

1LA5, 1LA6 8-pole motors, 3-ph. 230 V AC

Shaft output for converter supply (utilized according to temperature rise class F)				1LA5, 1LA6 three-phase squirrel-cage induction motors				MICRO MASTER and MIDI MASTER		
VT	CT			3-ph. 230 V AC rated voltage						
	Load characteristic M = const. Speed control range			Rated output at 50 Hz kW	Order number for existing systems	Order number for new applications	Frame size	Output at 3-ph. 230 V AC kVA	Order No.	Type
Load charac- teristic $M \sim n^2$ VT	1:2 kW	1:5 kW	1:10 kW							
0.19	0.18	0.17	0.12	0.25	1LA5 083-8AB1 .	1LA5 083-8AB1 .	80	0.66	6SE3111-5CA40	MM25/2
0.37	0.35	0.24	0.18	0.37	1LA5 090-8AB1 .	1LA5 090-8AB1 .	90 S	0.88	6SE3112-1CA40	MM37/2
0.52	0.48	0.37	0.28	0.55	1LA5 096-8AB1 .	1LA5 096-8AB1 .	90 L	1.14	6SE3112-8CA40	MM55/2
0.7	0.63	0.53	0.4	0.75	1LA5 106-8AB1 .	1LA5 106-8AB1 .	100 L	1.5	6SE3113-6CA40	MM75/2
1.1	1.0	0.8	0.6	1.1	1LA5 107-8AB1 .	1LA5 107-8AB1 .	100 L	2.1	6SE3115-2CB40	MM110/2
1.35	1.2	1.1	0.8	1.5	1LA5 113-8AB1 .	1LA5 113-8AB1 .	112 M	2.8	6SE3116-8CB40	MM150/2
2.0	1.8	1.6	1.2	2.2	1LA5 130-8CB1 .	1LA5 130-8CB1 .	132 S	4.0	6SE3121-0CC40	MM220/2
2.6	2.5	2.1	1.7	3	1LA5 133-8CB1 .	1LA5 133-8CB1 .	132 M	5.2	6SE3121-3CC40	MM300/2
2.7	2.5	2.5	2.2	4	1LA5 163-8CB1 .	1LA5 163-8CB1 .	160 M	5.2	6SE3121-3CC40	MM300/2
4.1	4	2.9	2.2	4	1LA5 163-8CB1 .	1LA5 163-8CB1 .	160 M	9.1	6SE3122-3CG40	MD550/2
5.7	5	4	3.4	5.5	1LA5 164-8CB1 .	1LA5 164-8CB1 .	160 M	9.1	6SE3122-3CG40	MD550/2
6.3	5	5	4.7	7.5	1LA5 166-8CB1 .	1LA5 166-8CB1 .	160 L	10.9	6SE3122-3CG40	MD550/2
7.7	6.3	5.7	4.7	7.5	1LA5 166-8CB1 .	1LA5 166-8CB1 .	160 L	12.7	6SE3123-1CG40	MD750/2
10.5	7.0	7	6.8	11	1LA5 186-8AB1 .	1LA5 186-8AB1 .	180 L	15.4	6SE3123-1CG40	MD750/2
11.1	10.5	8.2	6.8	11	1LA5 186-8AB1 .	1LA5 186-8AB1 .	180 L	17.6	6SE3124-2CH40	MD1100/2
10.9	10.9	10.8	8.8	15	1LA5 207-8AB1 .	1LA5 207-8AB1 .	200 L	20.7	6SE3124-2CH40	MD1100/2 ¹⁾
15.2	14	10.8	8.8	15	1LA5 207-8AB1 .	1LA5 207-8AB1 .	200 L	21.4	6SE3125-4CH40	MD1500/2
18.5	14.7	14.7	14.7	18.5	1LA6 220-8AB1 .	1LA6 220-8AB1 .	225 S	25.5	6SE3125-4CH40	MD1500/2
19	18.5	17	16.1	18.5	1LA6 220-8AB1 .	1LA6 220-8AB1 .	225 S	25.9	6SE3126-8CJ40	MD1850/2
22	18.9	18.9	18.9	22	1LA6 223-8AB1 .	1LA6 223-8AB1 .	225 M	29.7	6SE3126-8CJ40	MD1850/2
22.6	22	20.2	19.1	22	1LA6 223-8AB1 .	1LA6 223-8AB1 .	225 M	30.7	6SE3127-5CJ40	MD2200/2
	23	23	23	30	1LA6 253-8AB1 .	1LA6 253-8AB1 .	250 M	35.8	6SE3127-5CJ40	MD2200/2

¹⁾ presently, higher outputs are not possible for VT

For MIDI MASTER, degree of protection IP54: replace the last 3 digits of the Order No. by "S45", refer to section 5.

Last position of the Motor Order No.:

The types of construction for the 1LA2 and 1LA5 motors are the same.

The following types of construction are only available for the 1LA2 motors:

- 0, 1, 2 and 6.

Refer to Catalog M 11 • 1996.

MICRO MASTER

MIDI MASTER

7.2.4 3-ph. 400 V AC supply voltage

1LA2, 1LA5, 1LA6 2-pole motors, 3-ph. 400 V AC

Shaft output for converter supply (utilized according to temperature rise class F)				1LA2, 1LA5, 1LA6 three-phase squirrel-cage induction motors			MICRO MASTER and MIDI MASTER				
VT	CT			3-ph. 400 V AC rated voltage							
	Load characteristic M = const. Speed control range M ~ n ² VT	Speed control range			Rated output at 50 Hz kW	Order number for existing systems	Order number for new applications	Frame size	Output at 3-ph. 400 V AC kVA	Order No.	Type
1:2		1:5	1:10								
kW	kW	kW	kW	kW				kVA			
1.6	1.5	1.2	0.9	1.5	1LA5 090-2AA1 .	1LA2 090-2AA1 .	φ	90 S	2.8	6SE3114-0DC40	MM150/3
1.9	1.7	1.7	1.4	2.2	1LA5 096-2AA1 .	1LA2 096-2AA1 .	φ	90 L	2.8	6SE3114-0DC40	MM150/3
2.3	2.2	1.8	1.4	2.2	1LA5 096-2AA1 .	1LA2 096-2AA1 .	φ	90 L	4.0	6SE3115-8DC40	MM220/3
2.8	2.5	2.5	1.9	3	1LA5 106-2AA1 .	1LA2 106-2AA1 .	φ	100 L	4.0	6SE3115-8DC40	MM220/3
3.2	3	2.5	1.9	3	1LA5 106-2AA1 .	1LA2 106-2AA1 .	φ	100 L	5.2	6SE3117-3DC40	MM300/3
3.7	3.5	3.3	2.6	4	1LA5 113-2AA1 .	1LA2 113-2CA1 .	φ	112 M	5.2	6SE3117-3DC40	MM300/3
4.1	4	3.3	2.6	4	1LA5 113-2AA1 .	1LA2 113-2CA1 .	φ	112 M	7.0	6SE3121-0DC40	MM400/3
4.7	4.4	4.4	3.8	5.5	1LA5 130-2CA1 .	1LA2 130-2CA1 .	φ	132 S	7.0	6SE3121-0DC40	MM400/3
5.6	5.5	4.4	3.8	5.5	1LA5 130-2CA1 .	1LA2 130-2CA1 .	φ	132 S	9.0	6SE3121-3DC40	MM550/3
6.4	5.7	5.7	5.1	7.5	1LA5 131-2CA1 .	1LA2 131-2CA1 .	φ	132 S	9.0	6SE3121-3DC40	MM550/3
7.7	7.5	6.1	5.1	7.5	1LA5 131-2CA1 .	1LA2 131-2CA1 .	φ	132 S	12.7	6SE3121-7DG40	MD750/3
11.1	8	8	7.6	11	1LA5 163-2CA1 .	1LA2 163-2AB6 .	♦	160 M	17.7	6SE3121-7DG40	MD750/3
11.1	11	8.8	7.6	11	1LA5 163-2CA1 .	1LA2 163-2AB6 .	♦	160 M	17.7	6SE3122-4DG40	MD1100/3
14.2	11.1	11.1	10.6	15	1LA5 164-2CA1 .	1LA2 164-2AB6 .	♦	160 M	21.5	6SE3122-4DG40	MD1100/3
15.2	14.2	12.4	10.6	15	1LA5 164-2CA1 .	1LA2 164-2AB6 .	♦	160 M	21.5	6SE3123-0DH40	MD1500/3
18.7	15.1	15.1	13.3	18.5	1LA5 166-2CA1 .	1LA2 166-2AA6 .	♦	160 L	26	6SE3123-0DH40	MD1500/3
18.7	18.5	15.7	13.3	18.5	1LA5 166-2CA1 .	1LA2 166-2AA6 .	♦	160 L	26	6SE3123-5DH40	MD1850/3
22	19.8	18	16	22	1LA5 183-2AA1 .	1LA2 183-2AA6 .	♦	180 M	30.8	6SE3123-5DH40	MD1850/3
22	22	18	16	22	1LA5 183-2AA1 .	1LA2 183-2AA6 .	♦	180 M	30.8	6SE3124-2DJ40	MD2200/3
30	23	23	22	30	1LA5 206-2AA1 .	1LA2 206-2AA6 .	♦	200 L	40.8	6SE3124-2DJ40	MD2200/3
30	30	25	22	30	1LA5 206-2AA1 .	1LA2 206-2AA6 .	♦	200 L	40.8	6SE3125-5DJ40	MD3000/3
37	31	31	27	37	1LA5 207-2AA1 .	1LA2 207-2AA6 .	♦	200 L	49.9	6SE3125-5DJ40	MD3000/3
37	37	31	27	37	1LA5 207-2AA1 .	1LA2 207-2AA6 .	♦	200 L	49.9	6SE3126-8DJ40	MD3700/3
45	39	38	35	45	1LA6 223-2AB1 .	1LA6 223-2AB6 .	♦	225 M	58	6SE3126-8DJ40	MD3700/3

φ These motors must be connected in a star circuit configuration.

♦ These motors must be connected in a delta circuit configuration.

For MIDI MASTER, degree of protection IP54: replace the last 3 digits of the Order No. by "S45", refer to section 5.

Last position of the Motor Order No.:

The types of construction for the 1LA2 and 1LA5 motors are the same.

The following types of construction are only available for the 1LA2 motors:

- 0, 1, 2 and 6.

Refer to Catalog M 11 • 1996.

MICRO MASTER

MIDI MASTER

1LA2, 1LA5, 1LA6 4-pole motors, 3-ph. 400 V AC

Shaft output for converter supply (utilized according to temperature rise class F)				1LA2, 1LA5, 1LA6 three-phase squirrel-cage induction motors				MICRO MASTER and MIDI MASTER			
VT		CT		3-ph. 400 V AC rated voltage							
Load characteristic $M \sim n^2$ VT	Load characteristic M = const. Speed control range			Rated output at 50 Hz kW	Order number for existing systems	Order number for new applications	Frame size	Output at 3-ph. 400 V AC kVA	Order No.	Type	
	1:2 kW	1:5 kW	1:10 kW								
1.6	1.5	1.1	0.8	1.5	1LA5 096-4AA1 .	1LA2 096-4AA1 .	φ	90 L	2.8	6SE3114-0DC40	MM150/3
1.7	1.5	1.5	1.3	2.2	1LA5 106-4AA1 .	1LA2 106-4AA1 .	φ	100 L	2.8	6SE3114-0DC40	MM150/3
2.3	2.2	1.7	1.3	2.2	1LA5 106-4AA1 .	1LA2 106-4AA1 .	φ	100 L	4.0	6SE3115-8DC40	MM220/3
2.3	2.5	2.4	1.8	3	1LA5 107-4AA1 .	1LA2 107-4AA1 .	φ	100 L	4.0	6SE3115-8DC40	MM220/3
3.2	3	2.4	1.8	3	1LA5 107-4AA1 .	1LA2 107-4AA1 .	φ	100 L	5.2	6SE3117-3DC40	MM300/3
3.2	3	3	2.4	4	1LA5 113-4AA1 .	1LA2 113-4CA1 .	φ	112 M	5.2	6SE3117-3DC40	MM300/3
4.2	4	3.2	2.4	4	1LA5 113-4AA1 .	1LA2 113-4CA1 .	φ	112 M	7.0	6SE3121-0DC40	MM400/3
4.6	4.3	4.3	3.7	5.5	1LA5 130-4CA1 .	1LA2 130-4CA1 .	φ	132 S	7.0	6SE3121-0DC40	MM400/3
5.7	5.5	4.5	3.7	5.5	1LA5 130-4CA1 .	1LA2 130-4CA1 .	φ	132 S	9.0	6SE3121-3DC40	MM550/3
6	5.4	5.4	5.3	7.5	1LA5 133-4CA1 .	1LA2 133-4CA1 .	φ	132 M	9.0	6SE3121-3DC40	MM550/3
7.7	7.5	6.2	5.3	7.5	1LA5 133-4CA1 .	1LA2 133-4CA1 .	φ	132 M	12.7	6SE3121-7DG40	MD750/3
11	7.7	7.7	7.7	11	1LA5 163-4CA1 .	1LA2 163-4AA1 .	φ	160 M	17.7	6SE3121-7DG40	MD750/3
11.2	11	9.1	7.9	11	1LA5 163-4CA1 .	1LA2 163-4AA1 .	φ	160 M	17.7	6SE3122-4DG40	MD1100/3
15	11.6	11.6	10.9	15	1LA5 166-4CA1 .	1LA2 166-4AA1 .	φ	160 L	21.5	6SE3122-4DG40	MD1100/3
15.3	15	12.7	10.9	15	1LA5 166-4CA1 .	1LA2 166-4AA1 .	φ	160 L	21.5	6SE3123-0DH40	MD1500/3
18.5	15	14.6	12.4	18.5	1LA5 183-4AA1 .	1LA2 183-4AA6 .	•	180 M	26	6SE3123-0DH40	MD1500/3
18.7	18.5	14.6	12.4	18.5	1LA5 183-4AA1 .	1LA2 183-4AA6 .	•	180 M	26	6SE3123-5DH40	MD1850/3
22	18.7	17.8	15.2	22	1LA5 186-4AA1 .	1LA2 186-4AA6 .	•	180 L	30.8	6SE3123-5DH40	MD1850/3
22	22	17.8	15.2	22	1LA5 186-4AA1 .	1LA2 186-4AA6 .	•	180 L	30.8	6SE3124-2DJ40	MD2200/3
30	22	22	21	30	1LA5 207-4AA1 .	1LA2 207-4AA6 .	•	200 L	40.8	6SE3124-2DJ40	MD2200/3
30	30	24	21	30	1LA5 207-4AA1 .	1LA2 207-4AA6 .	•	200 L	40.8	6SE3125-5DJ40	MD3000/3
37	30	30	30	37	1LA6 220-4AA1 .	1LA6 220-4AA6 .	•	225 S	49.9	6SE3125-5DJ40	MD3000/3
37	37	33	30	37	1LA6 220-4AA1 .	1LA6 220-4AA6 .	•	225 S	49.9	6SE3126-8DJ40	MD3700/3
45	37	37	35	45	1LA6 223-4AA1 .	1LA6 223-4AA6 .	•	225 M	58	6SE3126-8DJ40	MD3700/3

φ These motors must be connected in a star circuit configuration.

• These motors must be connected in a delta circuit configuration.

For MIDI MASTER, degree of protection IP54: replace the last 3 digits of the Order No. by "S45", refer to section 5.

Last position of the Motor Order No.:

The types of construction for the 1LA2 and 1LA5 motors are the same.

The following types of construction are only available for the 1LA2 motors:

- 0, 1, 2 and 6.

Refer to Catalog M 11• 1996.

MICRO MASTER

MIDI MASTER

1LA2, 1LA5, 1LA6 6-pole motors, 3-ph. 400 V AC

Shaft output for converter supply (utilized according to temperature rise class F)				1LA5, 1LA6 three-phase squirrel-cage induction motors				MICRO MASTER and MIDI MASTER			
VT		CT		3-ph. 400 V AC rated voltage							
Load characteristic $M \sim n^2$ VT	Load characteristic M = const. Speed control range			Rated output at 50 Hz kW	Order number for existing systems	Order number for new applications	Frame size	Output at 3-ph. 400 V AC kVA	Order No.	Type	
	1:2 kW	1:5 kW	1:10 kW								
1.5	1.35	1.0	0.75	1.5	1LA5 106-6AA1 .	1LA2 106-6AA1 .	⌀	100 L	2.8	6SE3114-0DC40	MM150/3
2.2	2.0	1.6	1.2	2.2	1LA5 113-6AA1 .	1LA2 113-6CA1 .	⌀	112 M	4.0	6SE3115-8DC40	MM220/3
3.0	2.8	2.2	1.7	3	1LA5 130-6CA1 .	1LA2 130-6CA1 .	⌀	132 S	5.2	6SE3117-3DC40	MM300/3
4.0	3.7	3.0	2.3	4	1LA5 133-6CA1 .	1LA2 133-6CA1 .	⌀	132 M	7.0	6SE3121-0DC40	MM400/3
5.4	4.9	4.2	3.4	5.5	1LA5 134-6CA1 .	1LA2 134-6CA1 .	⌀	132 M	9.0	6SE3121-3DC40	MM550/3
7.7	6.8	5.5	4.6	7.5	1LA5 163-6CA1 .	1LA2 163-6AA6 .	•	160 M	12.7	6SE3121-7DG40	MD750/3
10.1	7.1	7.1	7	11	1LA5 166-6CA1 .	1LA2 166-6AA6 .	•	160 L	17.7	6SE3121-7DG40	MD750/3
11.2	10.1	8.5	7	11	1LA5 166-6CA1 .	1LA2 166-6AA6 .	•	160 L	17.7	6SE3122-4DG40	MD1100/3
14.6	11.5	11.5	9.7	15	1LA5 186-6AA1 .	1LA2 186-6AA6 .	•	180 L	21.5	6SE3122-4DG40	MD1100/3
15.2	14.6	11.5	9.7	15	1LA5 186-6AA1 .	1LA2 186-6AA6 .	•	180 L	21.5	6SE3123-0DH40	MD1500/3
18.2	14.7	14.4	12.2	18.5	1LA5 206-6AA1 .	1LA2 206-6AA6 .	•	200 L	26	6SE3123-0DH40	MD1500/3
18.7	18.2	14.4	12.2	18.5	1LA5 206-6AA1 .	1LA2 206-6AA6 .	•	200 L	26	6SE3123-5DH40	MD1850/3
21	18.2	17.4	14.7	22	1LA5 207-6AA1 .	1LA2 207-6AA6 .	•	200 L	30.8	6SE3123-5DH40	MD1850/3
22	21	17.4	14.7	22	1LA5 207-6AA1 .	1LA2 207-6AA6 .	•	200 L	30.8	6SE3124-2DJ40	MD2200/3
30	22	22	22	30	1LA6 223-6AA1 .	1LA6 223-6AA6 .	•	225 M	40.8	6SE3124-2DJ40	MD2200/3
31	30	28	26	30	1LA6 223-6AA1 .	1LA6 223-6AA6 .	•	225 M	40.8	6SE3125-5DJ40	MD3000/3
36	30	30	30	37	1LA6 253-6AA1 .	1LA6 253-6AA6 .	•	250 M	49.9	6SE3125-5DJ40	MD3000/3
37	36	32	30	37	1LA6 253-6AA1 .	1LA6 253-6AA6 .	•	250 M	49.9	6SE3126-8DJ40	MD3700/3
44	37	37	37	45	1LA6 280-6AA1 .	1LA6 280-6AA6 .	•	280 S	58	6SE3126-8DJ40	MD3700/3

⌀ These motors must be connected in a star circuit configuration.

• These motors must be connected in a delta circuit configuration.

For MIDI MASTER, degree of protection IP54: replace the last 3 digits of the Order No. by "S45", refer to section 5.

Last position of the Motor Order No.:

The types of construction for the 1LA2 and 1LA5 motors are the same.

The following types of construction are only available for the 1LA2 motors:

- 0, 1, 2 and 6.

Refer to Catalog M 11 • 1996.

MICRO MASTER

MIDI MASTER

1LA5, 1LA6 8-pole motors, 3-ph. 400 V AC

Shaft output for converter supply (utilized according to temperature rise class F)				1LA5, 1LA6 three-phase squirrel-cage induction motors				MICRO MASTER and MIDI MASTER		
VT	CT			3-ph. 400 V AC rated voltage						
Load characteristic $M \sim n^2$ VT	Load characteristic M = const. Speed control range			Rated output at 50 Hz kW	Order number for existing systems	Order number for new applications	Frame size	Output at 3-ph. 400 V AC kVA	Order No.	Type
	1:2 kW	1:5 kW	1:10 kW							
1.4	1.3	1.1	0.8	1.5	1LA5 113-8AB1 .	1LA5 113-8AB1 .	112 M	2.8	6SE3114-0DC40	MM150/3
2.2	1.9	1.5	1.2	2.2	1LA5 130-8CB1 .	1LA5 130-8CB1 .	132 S	4.0	6SE3115-8DC40	MM220/3
2.8	2.6	2.1	1.7	3	1LA5 133-8CB1 .	1LA5 133-8CB1 .	132 M	5.2	6SE3117-3DC40	MM300/3
3.7	3.5	2.9	2.2	4	1LA5 163-8CB1 .	1LA5 163-8CB1 .	160 M	7.0	6SE3121-0DC40	MM400/3
5.2	4.7	4	3.4	5.5	1LA5 164-8CB1 .	1LA5 164-8CB1 .	160 M	9.0	6SE3121-3DC40	MM550/3
7.7	6.4	5.7	4.7	7.5	1LA5 166-8CB1 .	1LA5 166-8CB1 .	160 L	12.7	6SE3121-7DG40	MD750/3
10	7	7	6.8	11	1LA5 186-8AB1 .	1LA5 186-8AB1 .	180 L	17.7	6SE3121-7DG40	MD750/3
11.1	10	8.2	6.8	11	1LA5 186-8AB1 .	1LA5 186-8AB1 .	180 L	17.7	6SE3122-4DG40	MD1100/3
13.4	10.5	10.5	8.8	15	1LA5 207-8AB1 .	1LA5 207-8AB1 .	200 L	21.5	6SE3122-4DG40	MD1100/3
15.2	13.4	10.8	8.8	15	1LA5 207-8AB1 .	1LA5 207-8AB1 .	200 L	21.5	6SE3123-0DH40	MD1500/3
17.4	14	14	14	18.5	1LA6 220-8AB1 .	1LA6 220-8AB1 .	225 S	26	6SE3123-0DH40	MD1500/3
18.7	17.4	16.8	16	18.5	1LA6 220-8AB1 .	1LA6 220-8AB1 .	225 S	26	6SE3123-5DH40	MD1850/3
21	17.8	17.8	17.8	22	1LA6 223-8AB1 .	1LA6 223-8AB1 .	225 M	30.8	6SE3123-5DH40	MD1850/3
22	21	20	19	22	1LA6 223-8AB1 .	1LA6 223-8AB1 .	225 M	30.8	6SE3124-2DJ40	MD2200/3
28	21	21	21	30	1LA6 253-8AB1 .	1LA6 253-8AB1 .	250 M	40.8	6SE3124-2DJ40	MD2200/3
30	28	27	26	30	1LA6 253-8AB1 .	1LA6 253-8AB1 .	250 M	40.8	6SE3125-5DJ40	MD3000/3
35	29	29	29	37	1LA6 280-8AB1 .	1LA6 280-8AB1 .	280 S	49.9	6SE3125-5DJ40	MD3000/3
37	35	34	30	37	1LA6 280-8AB1 .	1LA6 280-8AB1 .	280 S	49.9	6SE3126-8DJ40	MD3700/3
43	36	36	36	45	1LA6 283-8AB1 .	1LA6 283-8AB1 .	280 M	58	6SE3126-8DJ40	MD3700/3

For MIDI MASTER, degree of protection IP54: replace the last 3 digits of the Order No. by "S45", refer to section 5.

Last position of the Motor Order No.:

The types of construction for the 1LA2 and 1LA5 motors are the same.

The following types of construction are only available for the 1LA2 motors:

- 0, 1, 2 and 6.

Refer to Catalog M 11 • 1996.

MICRO MASTER

MIDI MASTER

7.2.5 3-ph. 500 V AC supply voltage

1LA5, 1LA6 2-pole motors, 3-ph. 500 V AC

Shaft output for converter supply (utilized according to temperature rise class F)				1LA5, 1LA6 three-phase squirrel-cage induction motors			MICRO MASTER and MIDI MASTER		
VT		CT		3-ph. 500 V AC rated voltage					
Load characteristic M ~ n ² VT kW	Load characteristic M = const. Speed control range			Rated output at 50 Hz kW	Order No.	Frame size	Output at 3-ph. 500 V AC kVA	Order No.	Type
	1:2 kW	1:5 kW	1:10 kW						
1.6	1.5	1.2	0.9	1.5	1LA5 090-2AA3 .	90 S	3.2	6SE3114-0DC40	MM150/3
2.1	1.9	1.8	1.4	2.2	1LA5 096-2AA3 .	90 L	3.2	6SE3114-0DC40	MM150/3
2.3	2.2	1.8	1.4	2.2	1LA5 096-2AA3 .	90 L	4.6	6SE3115-8DC40	MM220/3
3	2.8	2.5	1.9	3	1LA5 106-2AA3 .	100 L	4.6	6SE3115-8DC40	MM220/3
3.2	3	2.5	1.9	3	1LA5 106-2AA3 .	100 L	5.9	6SE3117-3DC40	MM300/3
4	3.8	3.3	2.6	4	1LA5 113-2AA3 .	112 M	5.9	6SE3117-3DC40	MM300/3
4.1	4	3.3	2.6	4	1LA5 113-2AA3 .	112 M	7.2	6SE3121-0DC40	MM400/3
4.7	4.4	4.4	3.8	5.5	1LA5 130-2CA3 .	132 S	7.2	6SE3121-0DC40	MM400/3
5.6	5.5	4.4	3.8	5.5	1LA5 130-2CA3 .	132 S	10.5	6SE3121-3DC40	MM550/3
7.3	6.7	6.1	5.1	7.5	1LA5 131-2CA3 .	132 S	10.5	6SE3121-3DC40	MM550/3
7.7	7.5	6.1	5.1	7.5	1LA5 131-2CA3 .	132 S	13.3	6SE3121-7DG40	MD750/3
11.1	8.5	8.5	7.6	11	1LA5 163-2CA3 .	160 M	18.2	6SE3121-7DG40	MD750/3
11.1	11	8.8	7.6	11	1LA5 163-2CA3 .	160 M	20	6SE3122-4DG40	MD1100/3
15.2	12.5	12.4	10.6	15	1LA5 164-2CA3 .	160 M	23.4	6SE3122-4DG40	MD1100/3
15.2	15	12.4	10.6	15	1LA5 164-2CA3 .	160 M	25.7	6SE3123-0DH40	MD1500/3
18.7	17.1	15.7	13.3	18.5	1LA5 166-2CA3 .	160 L	29.4	6SE3123-0DH40	MD1500/3
18.7	18.5	15.7	13.3	18.5	1LA5 166-2CA3 .	160 L	32.4	6SE3123-5DH40	MD1850/3
22	22	18	16	22	1LA5 183-2AA3 .	180 M	34.6	6SE3123-5DH40	MD1850/3
22	22	18	16	22	1LA5 183-2AA3 .	180 M	38.1	6SE3124-2DJ40	MD2200/3
30	27	25	22	30	1LA5 206-2AA3 .	200 L	45	6SE3124-2DJ40	MD2200/3
30	30	25	22	30	1LA5 206-2AA3 .	200 L	49.5	6SE3125-5DJ40	MD3000/3
37	35	31	27	37	1LA5 207-2AA3 .	200 L	56.3	6SE3125-5DJ40	MD3000/3
37	37	31	27	37	1LA5 207-2AA3 .	200 L	61.9	6SE3126-8DJ40	MD3700/3
45	45	38	35	45	1LA6 223-2AB5 .	225 M	66.7	6SE3126-8DJ40	MD3700/3

For MIDI MASTER, degree of protection IP54: replace the last 3 digits of the Order No. by "S45", refer to section 5.

Last position of the Motor Order No.:

The types of construction for the 1LA2 and 1LA5 motors are the same.

The following types of construction are only available for the 1LA2 motors:

- 0, 1, 2 and 6.

Refer to Catalog M 11 • 1996.

MICRO MASTER

MIDI MASTER

1LA5, 1LA6 4-pole motors, 3-ph. 500 V AC

Shaft output for converter supply (utilized according to temperature rise class F)				1LA5, 1LA6 three-phase squirrel-cage induction motors			MICRO MASTER and MIDI MASTER		
VT		CT		3-ph. 500 V AC rated voltage					
Load characteristic $M \sim n^2$ VT	Load characteristic $M = \text{const.}$ Speed control range			Rated output at 50 Hz	Order No.	Frame size	Output at 3-ph. 500 V AC	Order No.	Type
	1:2	1:5	1:10						
kW	kW	kW	kW	kW			kVA		
1.6	1.5	1.1	0.8	1.5	1LA5 096-4AA3 .	90 L	3.2	6SE3114-0DC40	MM150/3
1.8	1.7	1.7	1.3	2.2	1LA5 106-4AA3 .	100 L	3.2	6SE3114-0DC40	MM150/3
2.3	2.2	1.7	1.3	2.2	1LA5 106-4AA3 .	100 L	4.6	6SE3115-8DC40	MM220/3
3	2.5	2.4	1.8	3	1LA5 107-4AA3 .	100 L	4.6	6SE3115-8DC40	MM220/3
3.2	3	2.4	1.8	3	1LA5 107-4AA3 .	100 L	5.9	6SE3117-3DC40	MM300/3
3.5	3.2	3.2	2.4	4	1LA5 113-4AA3 .	112 M	5.9	6SE3117-3DC40	MM300/3
4.2	4	3.2	2.4	4	1LA5113-4AA3 .	112 M	7.2	6SE3121-0DC40	MM400/3
4.6	4.3	4.3	3.7	5.5	1LA5 130-4CA3 .	132 S	7.2	6SE3121-0DC40	MM400/3
5.7	5.5	4.5	3.7	5.5	1LA5 130-4CA3 .	132 S	10.5	6SE3121-3DC40	MM550/3
6.8	6.4	6.2	5.3	7.5	1LA5 133-4CA3 .	132 M	10.5	6SE3121-3DC40	MM550/3
7.7	7.5	6.2	5.3	7.5	1LA5 133-4CA3 .	132 M	13.3	6SE3121-7DG40	MD750/3
11.2	8.3	8.3	7.9	11	1LA5 163-4CA3 .	160 M	18.2	6SE3121-7DG40	MD750/3
11.2	11	9.1	7.9	11	1LA5 163-4CA3 .	160 M	20	6SE3122-4DG40	MD1100/3
15.3	13.2	12.7	10.9	15	1LA5 166-4CA3 .	160 L	23.4	6SE3122-4DG40	MD1100/3
15.3	15	12.7	10.9	15	1LA5 166-4CA3 .	160 L	25.7	6SE3123-0DH40	MD1500/3
18.7	17	14.6	12.4	18.5	1LA5 183-4AA3 .	180 M	29.4	6SE3123-0DH40	MD1500/3
18.7	18.5	14.6	12.4	18.5	1LA5 183-4AA3 .	180 M	32.4	6SE3123-5DH40	MD1850/3
22	22	17.5	15	22	1LA5 186-4AA3 .	180 L	34.6	6SE3123-5DH40	MD1850/3
22	22	17.5	15	22	1LA5 186-4AA3 .	180 L	38.1	6SE3124-2DJ40	MD2200/3
30	26	24	21	30	1LA5 207-4AA3 .	200 L	45	6SE3124-2DJ40	MD2200/3
30	30	24	21	30	1LA5 207-4AA3 .	200 L	49.5	6SE3125-5DJ40	MD3000/3
37	34	33	30	37	1LA6 220-4AA5 .	225 S	56.3	6SE3125-5DJ40	MD3000/3
37	37	33	30	37	1LA6 220-4AA5 .	225 S	61.9	6SE3126-8DJ40	MD3700/3
45	43	37	35	45	1LA6 223-4AA5 .	225 M	66.7	6SE3126-8DJ40	MD3700/3

For MIDI MASTER, degree of protection IP54: replace the last 3 digits of the Order No. by "S45", refer to section 5.

Last position of the Motor Order No.:

The types of construction for the 1LA2 and 1LA5 motors are the same.
The following types of construction are only available for the 1LA2 motors:
- 0, 1, 2 and 6.
Refer to Catalog M 11 • 1996.

MICRO MASTER

MIDI MASTER

LA5, 1LA6 6-pole motors, 3-ph. 500 V AC

Shaft output for converter supply (utilized according to temperature rise class F)				1LA5, 1LA6 three-phase squirrel-cage induction motors			MICRO MASTER and MIDI MASTER		
VT		CT		3-ph. 500 V AC rated voltage					
Load characteristic M ~ n ² VT	Load characteristic M = const.			Rated output at 50 Hz	Order No.	Frame size	Output at 3-ph. 500 V AC	Order No.	Type
	Speed control range								
kW	1:2	1:5	1:10	kW			kVA		
1.6	1.5	1.0	0.75	1.5	1LA5 106-6AA3 .	100 L	3.2	6SE3114-0DC40	MM150/3
1.6	1.5	1.5	1.2	2.2	1LA5 113-6AA3 .	112 M	3.2	6SE3114-0DC40	MM150/3
2.3	2.1	1.6	1.2	2.2	1LA5 113-6AA3 .	112 M	4.6	6SE3115-8DC40	MM220/3
2.5	2.3	2.2	1.7	3	1LA5 130-6CA3 .	132 S	4.6	6SE3115-8DC40	MM220/3
3.1	3	2.2	1.7	3	1LA5 130-6CA3 .	132 S	5.9	6SE3117-3DC40	MM300/3
3.2	2.9	2.9	2.3	4	1LA5 133-6CA3 .	132 M	5.9	6SE3117-3DC40	MM300/3
4.1	3.7	3.0	2.3	4	1LA5 133-6CA3 .	132 M	7.2	6SE3121-0DC40	MM400/3
4.0	3.8	3.8	3.4	5.5	1LA5 134-6CA3 .	132 M	7.2	6SE3121-0DC40	MM400/3
5.7	5.5	4.2	3.4	5.5	1LA5 134-6CA3 .	132 M	10.5	6SE3121-3DC40	MM550/3
5.9	5.6	5.5	4.6	7.5	1LA5 163-6CA3 .	160 M	10.5	6SE3121-3DC40	MM550/3
7.7	7.1	5.5	4.6	7.5	1LA5 163-6CA3 .	160 M	13.3	6SE3121-7DG40	MD750/3
11.2	7.5	7.5	7	11	1LA5 166-6CA3 .	160 L	18.2	6SE3121-7DG40	MD750/3
11.2	11	8.5	7	11	1LA5 166-6CA3 .	160 L	20	6SE3122-4DG40	MD1100/3
15.2	12.7	11.5	9.7	15	1LA5 186-6AA3 .	180 L	23.4	6SE3122-4DG40	MD1100/3
15.2	15	11.5	9.7	15	1LA5 186-6AA3 .	180 L	25.7	6SE3123-0DH40	MD1500/3
18.7	16.7	14.4	12.2	18.5	1LA5 206-6AA3 .	200 L	29.4	6SE3123-0DH40	MD1500/3
18.7	18.5	14.4	12.2	18.5	1LA5 206-6AA3 .	200 L	32.4	6SE3123-5DH40	MD1850/3
22	21	17.4	14.7	22	1LA5 207-6AA3 .	200 L	34.6	6SE3123-5DH40	MD1850/3
22	22	17.4	14.7	22	1LA5 207-6AA3 .	200 L	38.1	6SE3124-2DJ40	MD2200/3
31	26	26	26	30	1LA6 223-6AA5 .	225 M	45	6SE3124-2DJ40	MD2200/3
31	30	28	26	30	1LA6 223-6AA5 .	225 M	49.5	6SE3125-5DJ40	MD3000/3
37	34	32	30	37	1LA6 253-6AA5 .	250 M	56.3	6SE3125-5DJ40	MD3000/3
37	37	32	30	37	1LA6 253-6AA5 .	250 M	61.9	6SE3126-8DJ40	MD3700/3
45	43	40	40	45	1LA6 280-6AA5 .	280 S	66.7	6SE3126-8DJ40	MD3700/3

For MIDI MASTER, degree of protection IP54: replace the last 3 digits of the Order No. by "S45", refer to section 5.

Last position of the Motor Order No.:

The types of construction for the 1LA2 and 1LA5 motors are the same.

The following types of construction are only available for the 1LA2 motors:

- 0, 1, 2 and 6.

Refer to Catalog M 11 • 1996.

MICRO MASTER

MIDI MASTER

1LA5, 1LA6 8-pole motors, 3-ph. 500 V AC

Shaft output for converter supply (utilized according to temperature rise class F)				1LA5, 1LA6 three-phase squirrel-cage induction motors			MICRO MASTER and MIDI MASTER		
VT	CT			3-ph. 500 V AC rated voltage					
	Load characteristic M ~ n ² VT	Load characteristic M = const.			Rated output at 50 Hz	Order No.	Frame size	Output at 3-ph. 500 V AC	Order No.
Speed control range									
	1:2	1:5	1:10						
kW	kW	kW	kW	kW			kVA		
1.5	1.4	1.1	0.8	1.5	1LA5 113-8AB3 .	112 M	3.2	6SE3114-0DC40	MM150/3
2.2	2.1	1.5	1.2	2.2	1LA5 130-8CB3 .	132 S	4.6	6SE3115-8DC40	MM220/3
3	2.8	2.1	1.7	3	1LA5 133-8CB3 .	132 M	5.9	6SE3117-3DC40	MM300/3
3.8	3.5	2.9	2.2	4	1LA5 163-8CB3 .	160 M	7.2	6SE3121-0DC40	MM400/3
5.7	5.4	4	3.4	5.5	1LA5 164-8CB3 .	160 M	10.5	6SE3121-3DC40	MM550/3
7.7	6.8	5.7	4.7	7.5	1LA5 166-8CB3 .	160 L	13.3	6SE3121-7DG40	MD750/3
11.1	7.6	8.2	6.8	11	1LA5 186-8AB3 .	180 L	18.2	6SE3121-7DG40	MD750/3
11.1	11	8.2	6.8	11	1LA5 186-8AB3 .	180 L	20	6SE3122-4DG40	MD1100/3
15	11.7	10.8	8.8	15	1LA5 207-8AB3 .	200 L	23.4	6SE3122-4DG40	MD1100/3
15.2	15	10.8	8.8	15	1LA5 207-8AB3 .	200 L	25.7	6SE3123-0DH40	MD1500/3
18.7	15.8	15.8	15.8	18.5	1LA6 220-8AB5 .	225 S	29.4	6SE3123-0DH40	MD1500/3
18.7	18.5	16.8	16	18.5	1LA6 220-8AB5 .	225 S	32.4	6SE3123-5DH40	MD1850/3
22	20	20	19	22	1LA6 223-8AB5 .	225 M	34.6	6SE3123-5DH40	MD1850/3
22	22	20	19	22	1LA6 223-8AB5 .	225 M	38.1	6SE3124-2DJ40	MD2200/3
30	24	24	24	30	1LA6 253-8AB5 .	250 M	45	6SE3124-2DJ40	MD2200/3
30	30	27	26	30	1LA6 253-8AB5 .	250 M	49.5	6SE3125-5DJ40	MD3000/3
37	32	32	30	37	1LA6 280-8AB5 .	280 S	56.3	6SE3125-5DJ40	MD3000/3
37	37	34	30	37	1LA6 280-8AB5 .	280 S	61.9	6SE3126-8DJ40	MD3700/3
45	41	40	37	45	1LA6 283-8AB5 .	280 M	66.7	6SE3126-8DJ40	MD3700/3

For MIDI MASTER, degree of protection IP54: replace the last 3 digits of the Order No. by "S45", refer to section 5.

Last position of the Motor Order No.:

The types of construction for the 1LA2 and 1LA5 motors are the same.

The following types of construction are only available for the 1LA2 motors:

- 0, 1, 2 and 6.

Refer to Catalog M 11 • 1996.

MICRO MASTER

MIDI MASTER

8.1	1FP5 reluctance motors	8/2
8.2	SIEMOSYN 1FU permanent-magnet synchronous motors	8/3

8 Special-motor drives

8.1 1FP5 reluctance motors

Description

1FP5 reluctance motors are three-phase synchronous motors without external or permanent-magnet excitation. Synchronous operation is achieved by a special rotor design.

The 1FP5 series has 4 poles, and covers an output range from 0.19 - 8.5 kW at 50 Hz. The speed range extends up to 6000 RPM. The synchronous pull-out torque is 135% of the rated torque according to VDE 0530.

The external motor dimensions as well as the flange- and foot dimensions are the same as those for standard 1LA5 induction motors.

Application: These motors can be used for any application where load-independent speed synchronism and/or a frequency-proportional speed is required.

Reluctance motors are suitable as single-motor drives running in synchronism as well as for multi-motor drives, e.g. for drives which are operating in parallel, or are coupled with one another through a material web, which must run in synchronism to maintain a specific speed ratio with respect to one another.

Technical data

4-pole 1FP5 reluctance motors: data for 50 Hz/190 V_{fmax} = 100 Hz/380 V

Type	Output (50 Hz) [kW]	Torque [Nm]	Rated current [A] (50 Hz)	Starting current [A] at 50 Hz
1FP5 070-4	0.19	1.2	1.9	5.2
1FP5 073-4	0.3	1.9	2.6	9.3
1FP5 080-4	0.4	2.5	3.5	12.8
1FP5 083-4	0.55	3.5	4.7	18.8
1FP5 090-4	0.75	4.7	6.0	26
1FP5 096-4	1.0	6.3	7.5	35
1FP5 106-4	1.5	9.5	9.8	45
1FP5 107-4	1.8	11.5	11.8	57
1FP5 113-4	2.4	15.3	15.9	95
1FP5 130-4	3.3	21	21.4	138
1FP5 133-4	4.5	28.6	28.5	200
1FP5 163-4	6.3	40.1	39.1	274
1FP5 166-4	8.5	54.1	51.7	388

Please refer to Catalog DA 47• 1995 for additional ordering and technical data (Order No. E20002-K4047-A101-A2-7600)

Engineering information

The drive converters should be selected, so that the motor currents can be provided, taking into account the starting currents when switching-in individual motors or motor groups.

If the motor should also develop full torque in the lower speed range, then the drive converter must be dimensioned for approx. 200-300% rated motor current.

Thus, for a constant-torque drive, the lowest frequency defines the required drive converter output. The current boost (P078) defines, in the lower speed range, the stall torque which can be achieved, and should therefore be set so that it is appreciably higher than 100 (%). A high current boost (P078 > 100 %) is also required in no-load and partial-load operation, so that the drive does not oscillate.

Drives with reluctance motors are not suitable for applications requiring high-dynamic performance and short accelerating times.

The voltage-frequency characteristic must be selected as control concept (P077 = 0 or 2) and slip compensation must be disabled (P071 = 0).

8.2 Permanent-magnet 1FU SIEMOSYN synchronous motors

Description

SIEMOSYN motors are three-phase permanent-magnet synchronous motors.

Synchronous operation of the 1FU3/4 motors is achieved by using permanent magnets in the rotor. The rotor still has a short-circuit cage, permitting asynchronous acceleration, and which acts as a damping cage when running in synchronism.

The 1FU series, as 2-, 4- or 6-pole motor, covers an output range from 0.15 - 6.0 kW at 50 Hz. The speed control range extends up to 24000 RPM. The external dimensions of the motors as well as the flange and foot dimensions are the same as those for the 1LA5 standard induction motors.

Application: Applications for SIEMOSYN motors are the same as those for reluctance motors with a significantly better power factor and efficiency. Further, high-speed applications can be realized.

Note: 1FU2 external-rotor motors on request.

Technical data

1FU3 SIEMOSYN motors: 4-, 6-pole; data for 50 Hz/200 V_{fmax} = 100 Hz/400 V

Type	Output (50 Hz) [kW]	Torque [Nm]	Rated current [A] (50 Hz)	Starting current [A] at 50 Hz
1FU3 074-4TP7.	0.3	1.9	4.6	15.8
1FU3 074-6TP7.	0.25	2.4	3.2	8.6
1FU3 084-4TP7.	0.3	1.9	3.2	19
1FU3 087-4TP7.	0.5	3.2	5.0	26
1FU3 087-6TP7.	0.55	5.2	5.1	20
1FU3 097-4TP7.	0.6	3.8	5.4	39
1FU3 097-6TP7.	0.8	7.6	9.5	37
1FU3 114-4TP7.	1.3	8.3	14	77
1FU3 114-6TP7.	1.4	13.4	14.8	66
1FU3 115-4TP7.	1.5	9.5	16.5	106
1FU3 115-6TP7.	1.8	17.2	17.8	62
1FU3 134-4TP7.	2.6	16.5	35.8	266
1FU3 134-6TP7.	2.8	26.7	32.5	130
1FU3 167-6TP7.	5.5	52.5	63	279

Please refer to Catalog DA 47• 1995 for additional ordering and technical data (Order No. E20002-K4047-A101-A1, in German only).

Engineering information:

The drive converters should be selected so that the motor currents can be provided, taking into account the starting (inrush currents) when switching-in individual motors or motor groups.

The drive converter must be dimensioned for approximately 200% - 300% of the rated motor current if the motor is to provide full torque, even in the lower speed range.

Thus, for a constant torque drive, the lowest frequency defines the necessary drive converter output. The current boost (P078) defines, in the lower speed range, the achievable stall torque, and must therefore be set significantly higher than 100 (%).

It should be noted that in this case, the no-load current is even greater than the load current.

In order to permit the high current required in the lower speed range, the motor current limiting (P086) must also be correspondingly increased.

The voltage-frequency characteristic must be selected as open-loop control concept (P077 = 0 or 2), and the slip compensation function must be disabled (P071 = 0).

An automatic stator resistance measurement (auto-calibration, P088), is not possible for synchronous motors. The stator resistance must therefore, if required, be manually entered.

MICRO MASTER

MIDI MASTER

1FU4 SIEMOSYN motors: 2-pole; data for 50 Hz/67 $V_{fmax} = 300$ Hz/400 V

Type	Output (50 Hz) [kW]	Torque [Nm]	Rated current [A] (50 Hz)	Starting current [A] at 50 Hz
1FU4 081-2TE7.	0.4	1.3	5.5	23
1FU4 084-2TE7.	0.7	2.2	10.2	46
1FU4 087-2TE7.	0.9	2.9	13.8	72

1FU4 SIEMOSYN motors: 2-pole; data for 50 Hz/100 $V_{fmax} = 200$ Hz/400 V

Type	Output(50 Hz) [kW]	Torque [Nm]	Rated current [A] (50 Hz)	Starting current [A] at 50 Hz
1FU4 101-2TJ7.	1.0	3.2	9.5	50
1FU4 104-2TJ7.	1.25	4.0	12.5	73
1FU4 107-2TJ7.	1.7	5.4	15.1	90
1FU4 108-2TJ7.	2.3	7.3	20	103
1FU4 118-2TJ7.	3.2	10.2	25.5	150

Please refer to Catalog DA 47• 1995 for additional ordering and technical data
(Order No. E20002-K4047-A101-A1, in German only).

MICRO MASTER

MIDI MASTER

9.1	MICRO MASTER, IP 21	9/2
9.2	MIDI MASTER, IP 21	9/3
9.3	MIDI MASTER, IP 54	9/3
9.4	Options	9/4

MICRO MASTER

MIDI MASTER

9. Dimensions

9.1. MICRO MASTER dimensions, IP 21

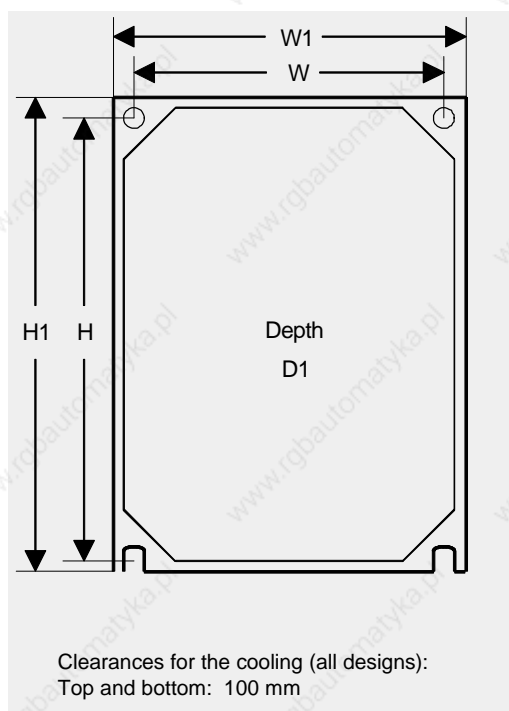

MICRO MASTER	H mm	W mm	H1 mm	W1 mm	D1 mm	Drilled holes
MM25						
MM25/2						
MM37						
MM55	173	103	182	112	113	4 x Ø 4.5 mm, M4
MM55/2						
MM75						
MM75/2						
MM110					152	
MM110/2	174	138	184	149	142	4 x Ø 4.8 mm, M4
MM150					152	
MM150/2					142	
MM220					175	
MM220/2						
MM300/2						
MM150/3	204	174	215	185	162	4 x Ø 5.6 mm, M5
MM220/3						
MM300/3						
MM400/3						
MM550/3						

MICRO MASTER

MIDI MASTER

9.2. MIDI MASTER dimensions, IP 21

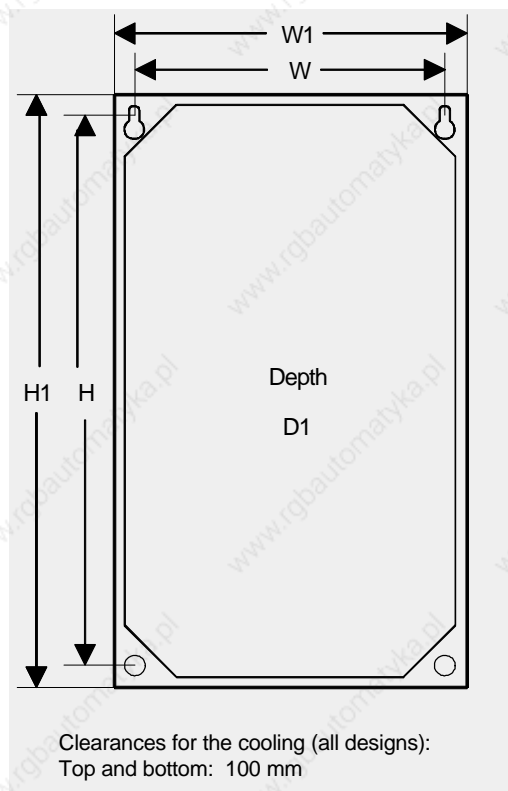

MIDI MASTER	H mm	W mm	H1 mm	W1 mm	D1 mm	Drilled holes
MD550/2 MD 750/3 MD1100/3 MD750/4 MD1100/4	430	235	450	275	200	4 x Ø 8.5 mm, M8
MD750/2 MD1100/2 MD1500/3 MD1850/3 MD1500/4 MD1850/4	530	235	550	275	202	
MD1500/2 MD1850/2 MD2200/2 MD2200/3 MD3000/3 MD3700/3 MD2200/4 MD3000/4 MD3700/4	630	235	650	275	278	

9.3. MIDI MASTER dimensions, IP 54

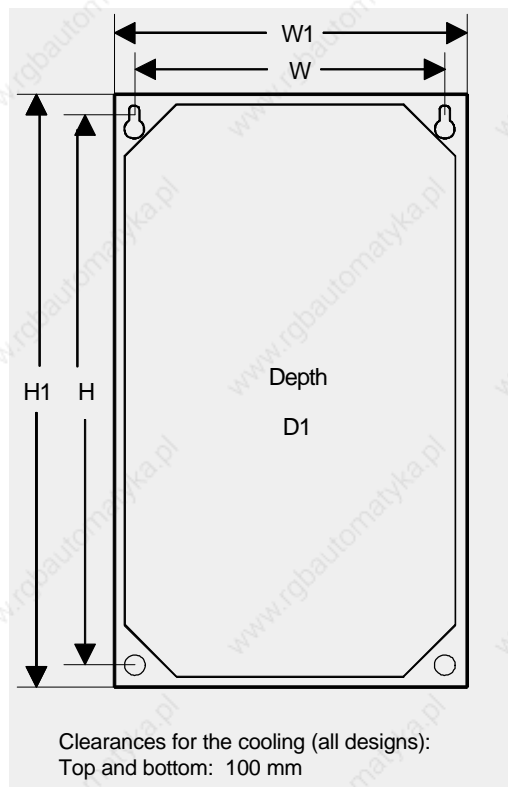

MIDI MASTER	H mm	W mm	H1 mm	W1 mm	D1 mm	Drilled holes
MD550/2-IP 54 MD 750/3-IP 54 MD1100/3-IP 54 MD750/4-IP 54 MD1100/4-IP 54	634	312.7	675	360	351	4 x Ø 8.5 mm, M8
MD750/2-IP 54 MD1100/2-IP 54 MD1500/3-IP 54 MD1850/3-IP 54 MD1500/4-IP 54 MD1850/4-IP 54	734	312.7	775	360	422	
MD1500/2-IP 54 MD1850/2-IP 54 MD2200/2-IP 54 MD2200/3-IP 54 MD3000/3-IP 54 MD3700/3-IP 54 MD2200/4-IP 54 MD3000/4-IP 54 MD3700/4-IP 54	834	312.7	875	360	483	

MICRO MASTER

MIDI MASTER

9.4. Dimensions for options

Options	Order No.	External dimensions			Mounting dimensions	
		Height mm	Width mm	Depth mm	Drilled holes	Clearances mm
OPM Plain text operator control panel	6SE3190-0XX87-0FB0	97	75	25	2 x M5 diagonal ¹⁾	45 x 65 ¹⁾
OPMP Profibus module	6SE3190-0XX87-8PB0	97	75	25	2 x M5 diagonal ¹⁾	45 x 65 ¹⁾
Brake resistor for MICRO MASTER	6SE3190-0BA87-2RA0	112	184	10	4 x Ø 4.5 mm. M4	173 x 103
	6SE3190-0BB87-2RA0	150	186	10	4 x Ø 4.8 mm. M4	174 x 138
	6SE3190-0BC87-2RA0	186	216	10	4 x Ø 5.6 mm. M5	204 x 174
	6SE3190-0DC87-2RA0	186	216	10	4 x Ø 5.6 mm. M5	204 x 174
External brake resistor	6SE2000-1RA10	318	44	94	2 x Ø 6 mm	287
	6SE7021-6CS87-2DC0	180	145	540		
	6SE7023-2CS87-2DC0	360	145	540		
	6SE7018-0ES87-2DC0	180	145	540		
	6SE7021-6ES87-2DC0	360	145	540		
	6SE7023-2ES87-2DC0	302	430	485		
	6SE7021-3FS87-2DC0	360	145	540		
	6SE7022-5FS87-2DC0	302	430	485		
Single-phase commutating reactor for MM300/2 for 1-ph. AC	4EM6100-3CB	135.5	110	106	4 x M5	92 x 87.5

1) For panel mounting of the OPM plain text operator control panel

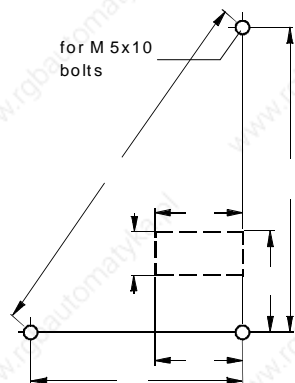

OPM mounting points for panel mounting (viewed from the front)

MICRO MASTER

MIDI MASTER

Braking units

with integrated brake resistor

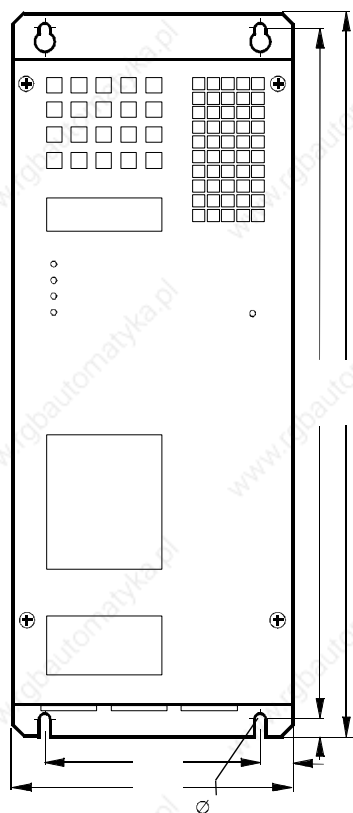

6SE3190-0FX87-2DA0

Braking units

without integrated brake resistor

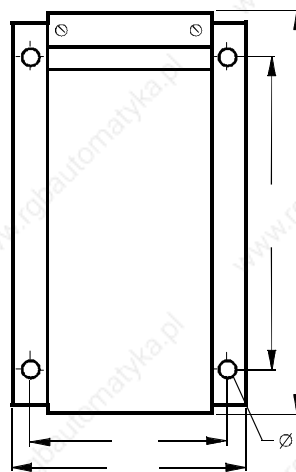

6SE3190-0CX87-2DA0
6SE3190-0DX87-2DA0

MICRO MASTER

MIDI MASTER

Radio interference suppression filter

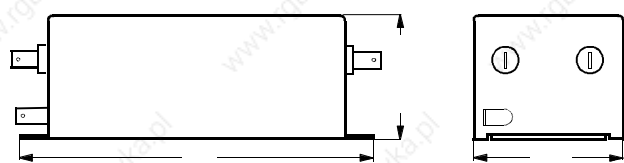

6SE3090-0BA07-0FB0/1
6SE3190-0BA87-0FB0

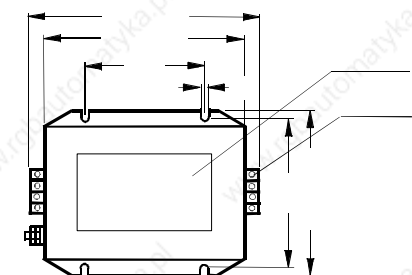
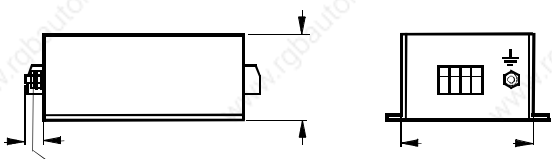

6SE3190-0DC87-0FB0/1

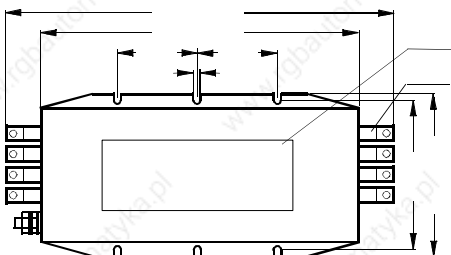
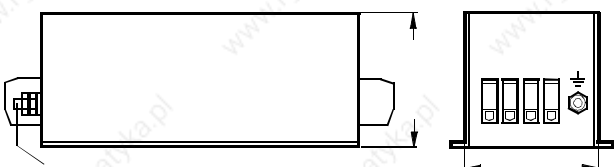

6SE2100-1FC21

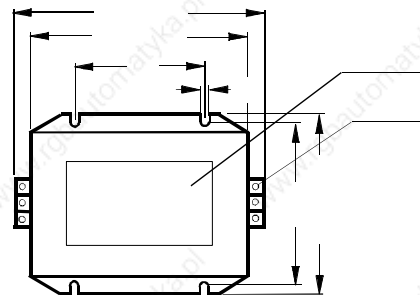
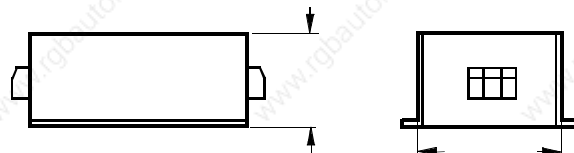

6SE3090-0BC07-0FB0/1
6SE3190-0BB87-0FB0
6SE3190-0BC87-0FB0

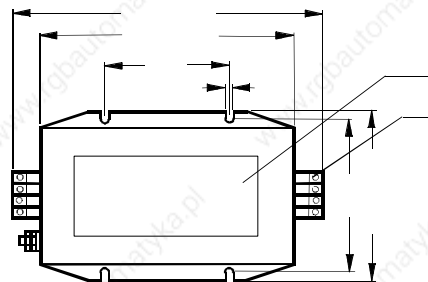
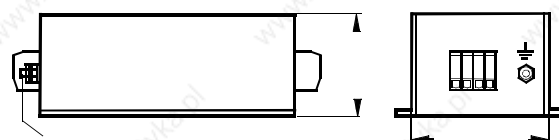

6SE2100-1FC20

MICRO MASTER

MIDI MASTER

dV/dt filters
(MASTER DRIVES series)

Sizes B and C

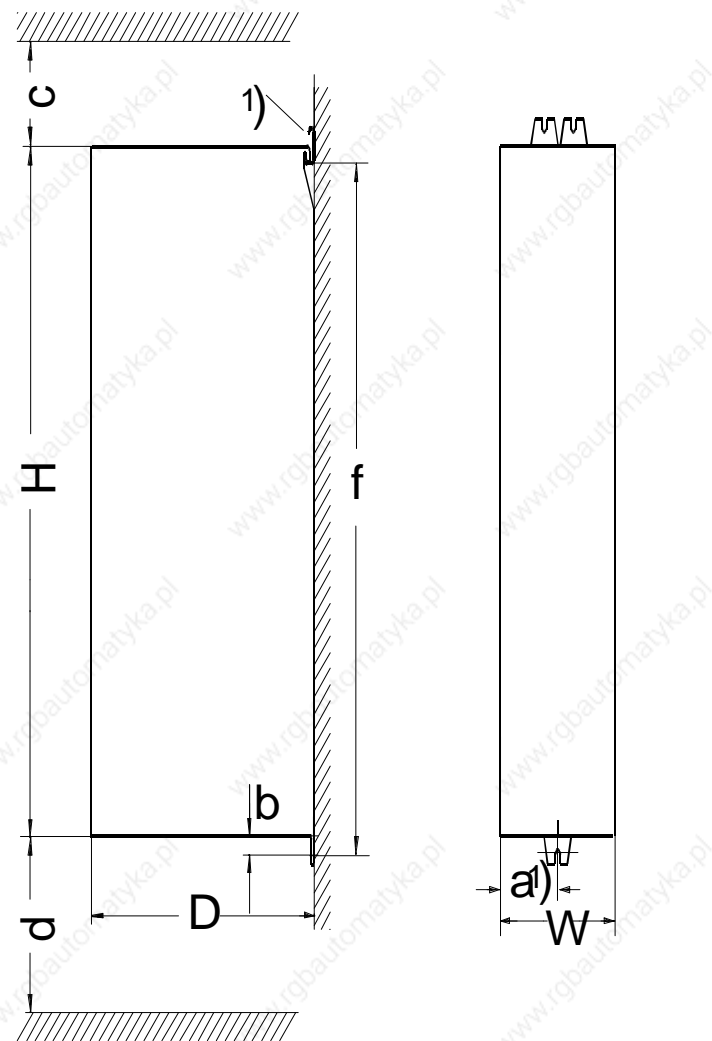

Size E

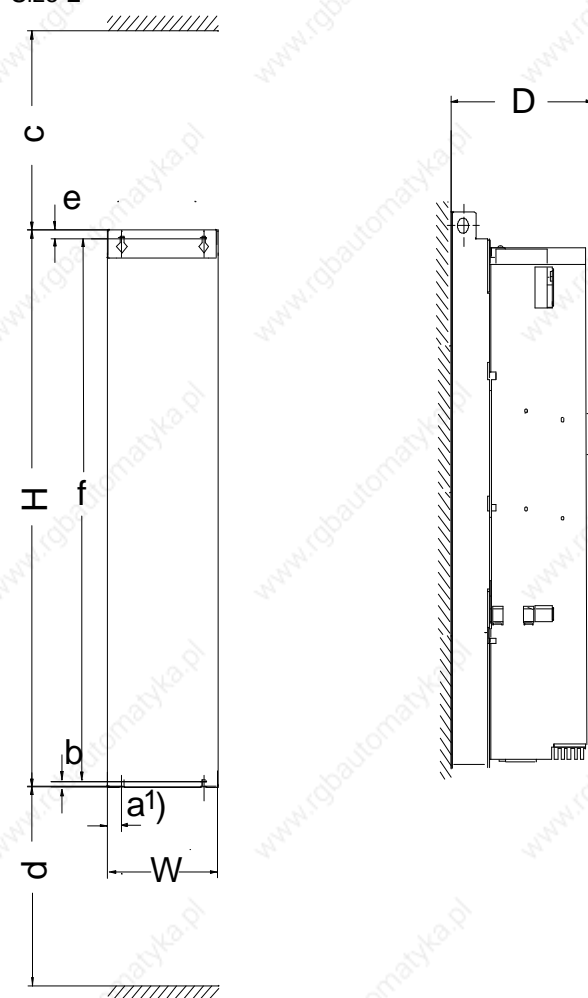

dV/dt filters

Size	B	C	E
H [mm]	425	600	1050
W [mm]	135	180	250
D [mm]	350	350	350
a [mm]	67.5	90	45 ¹⁾
b [mm]	16	16	10
c [mm]	100	100	350
d [mm]	250	250	400
f [mm]	425	600	1025
Weight approx. [kg]	20	27	55

¹⁾ 2 lugs, left and right

Size:

B: 6SE7016-2FB87-1FD0
6SE7021-5FB87-1FD0

C: 6SE7022-2FC87-1FD0
6SE7023-4FC87-1FD0
6SE7024-7FC87-1FD0

E: 6SE7026-0HE87-1FD0
6SE7028-2HE87-1FD0

Output reactors and 4EP three-phase commutating reactors

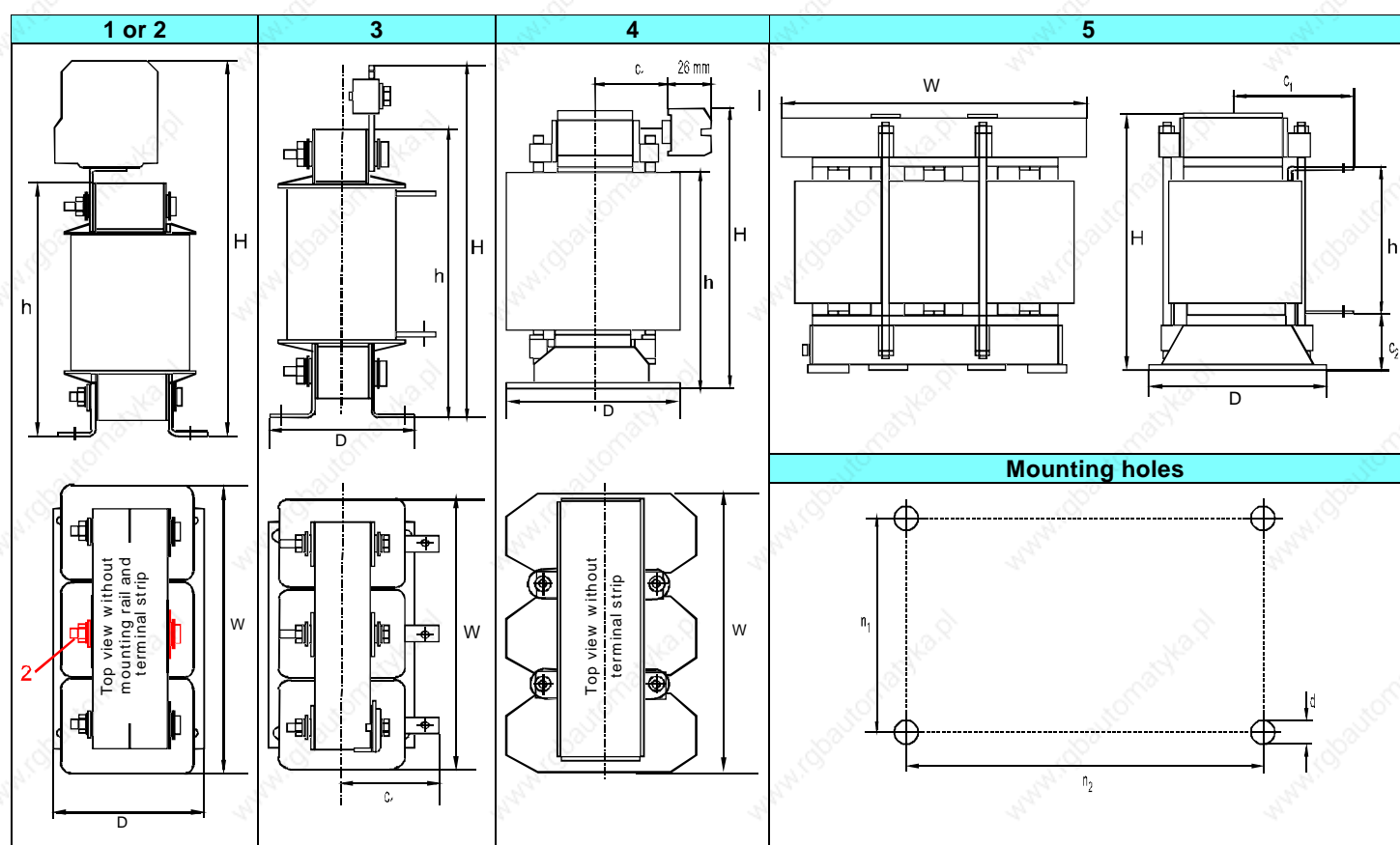

Output reactor	Drawing	H [mm] max.	h [mm] max.	W [mm] max.	D [mm] max.	c ₁ [mm] max.	n ₁ [mm] max.	n ₂ [mm] max.	c ₂ [mm] max.	d	Weight [kg]
4EP3601-3DB	approx. 1	145	125	123	70 (115)	--	49	90	--	M4	2.3
4EP3700-5DB	approx. 1	170	150	153	75 (118)	--	49	113	--	M5	3.2
4EP3700-6DB	approx. 5	158	--	153	75	70	49	113	--	M5	3.4
4EP3700-7DB	approx. 5	158	--	153	75	70	49	113	--	M5	3.7
6SE7016-1ES87-1FE0	2	186	133	150	82	--	64	113	--	M5	6.0
6SE7026-0HS87-1FE0	5	250	--	235	146	98	101	200	--	M8	30
6SE7028-2HS87-1FE0	5	280	--	264	155	101	18	224	--	M8	45
6SE7022-2FS87-1FE0	4	220	--	207	128	66	94.5	176.5	--	M6	25
6SE7023-4FS87-1FE0	5	220	114	197	104	72	70	176	49	M6	20
6SE7024-7FS87-1FE0	5	220	93	197	128	81	128	176	63	M6	25
Commutating reactor	Drawing	H [mm] max.	h [mm] max.	W [mm] max.	D [mm] max.	c ₁ [mm] max.	n ₁ [mm] max.	n ₂ [mm] max.	c ₂ [mm] max.	d	Weight [kg]
4EP36	1	160	108	120	64	--	49	90	--	M4	
4EP37	1	186	133	150	67	--	49	113	--	M5	
4EP38	3	163	133	150	82	--	64	113	--	M5	
4EP39	3	188	158	179	76	--	56	136	--	M6	
4EP40	3	188	158	179	96	--	76	136	--	M6	

MICRO MASTER

MIDI MASTER

Specification and quotation texts	A/2
Sales regions in Germany	A/3
European Siemens Companies and Representatives	A/5
Overseas Siemens Companies and Representatives	A/5
Conditions for supply and sale	A/6

MICRO MASTER (IP 21)
0.25 to 2.2 kW. 1-ph. 230 V AC.
0.25 to 3 kW. 1/3-ph. 230 V AC and
1.5 to 5.5 kW. 3-ph. 380 to 500 V AC

MICRO MASTER

MIDI MASTER

MIDI MASTER (IP 21 or IP 54)

5.5 to 22 kW (27 kW). 3-ph. 230 V AC.

7.5 to 37 kW (45 kW). 3-ph. 380 to 500 V AC und

7.5 to 37 kW (45 kW). 3-ph. 525 to 575 V AC

(higher output ↑ for square-law load torque characteristics)

Voltage-source DC link drive converters with constant DC link voltage. Units are ready-to-connect with IGBTs in the inverter for continuous and low power loss speed control of three-phase AC motors. Fully-digital, microprocessor-based open- and closed-loop control technology.

Manufactured in accordance with DIN VDE 0558, DIN VDE 0113, DIN VDE 0106, DIN VDE 0160 and DIN VDE 0875, UL and cUL listed.

Power section

Line-side converter as uncontrolled diode bridge circuit, DC link capacitors to smooth the DC link voltage, self-commutated motor-side converter as six-pulse IGBT inverter.

Switchgear and protective devices

Pre-charging circuit with pre-charging relay.

Open- and closed-loop control

Gating unit, closed-loop control and sequence control using microprocessor technology.

Operator control panel with membrane keypad

Keys to power-up and power-down the equipment, direction of rotation changeover, inching, parameterization, raise/lower.

Four-digit, 7-segment display to display the setpoint, actual values, parameter values and fault messages.

Plain text operator control panel OPM (option)

Keys as for the membrane keypad, illuminated LC display with 4x16 alphanumeric characters. CMOS memory for up to 31 parameters sets, parameter sets can also be individually or completely set, read and written via the USS bus. It can be used as main control device for a maximum of 31 drive converters via the USS bus.

Control terminal strip for external operator control

5 binary inputs for control commands, parameterizable, 24 V
2 binary relay outputs for checkback signals, parameterizable
1 analog input for setpoint input 0/2-10 V, 0/4-20 mA
1 analog input for PID controllers, 0-5 V, 0-20 mA
1 analog output for actual value outputs, 0/4-20 mA
Motor temperature sensor connection (PTC thermistor).

Automation interface

RS485 serial interface with USS protocol, bus-capable with up to 31 nodes with up to 19.2 kbit/s
Serial interface for PROFIBUS SINEC L2-DP with optional PROFIBUS module, max. 125 nodes with up to 1.5 mbit/s

Standard functions

- Open-loop frequency control with v/f characteristic for synchronous motors, reluctance motors and multi-motor drives
- Closed-loop field current control (FCC) with high efficiency for single-motor drives with induction motors
- 0-650 Hz output frequency with 0.01 Hz resolution
- Integrated PID controller for standard applications, for example, closed-loop pressure or temperature control
- RS485 serial interface with USS protocol
- Integrated, adjustable DC current brake
- Integrated, programmable sequence control to control an external holding brake
- Slip compensation for high speed stability, even without tachometer and closed-loop control
- Restart-on-the-fly circuit to switch to a motor which is still rotating
- Automatic restart after power failure or fault
- Flexible setpoint input via fixed frequencies, motorized potentiometer, inching setpoint, via analog output or serial interface
- Two, freely-programmable ramp-function generators (0.1s-650s) with adjustable rounding-off
- Up to 8 independent fixed frequencies
- Electrical isolation between the power section, open-loop control and closed-loop control
- Comprehensive protection for drive converter and motor (protection against overvoltage and undervoltage, ground faults, short-circuit, overtemperature, overload, stalling, additional PTC input for motor protection)
- Two-quadrant operation, i.e. motoring in both directions of rotation
- Integrated braking chopper for MICRO MASTER
- MICRO MASTER for 3-ph. 230 V AC can also be connected to single-phase supplies
- Integrated radio interference suppression filter for single-phase MICRO MASTER for Class A1 (EN55011)

Standard options

OPM plain text operator control panel, SIMOVIS PC program, OPMP PROFIBUS module
Radio interference suppression filter, brake resistor, braking unit for MIDI MASTER, output reactor, dV/dt output filter, commutating reactor.

Technical data

Rated supply voltage	V
Rated line frequency	Hz
Rated output current	A
Overload capability by 50% for 60 s to	A
Rated output current $M \sim n^2$, without overload	A
Rated output	kW
Rated output, $M \sim n^2$	kW
Cooling-medium temperature (max. 40°)	°C
Degree of protection (IP 21/IP 54)	
Dimensions (W x H x D)	mm
Weight	kg