

SIEMENS

SIMATIC

ET 200S distributed I/O IM151-1 HIGH FEATURE interface module (6ES7151-1BA02-0AB0)

Manual



The following supplement is part of this documentation:

No.	Product Information	Drawing number	Edition
1	LED display of the configuration and parameter assignment errors	A5E02478858-01	03/2009

Preface

Properties

1

Parameters

2

Functions

3

Interrupt, error, and system messages

4

Response times

5

Legal information

Warning notice system

This manual contains notices you have to observe in order to ensure your personal safety, as well as to prevent damage to property. The notices referring to your personal safety are highlighted in the manual by a safety alert symbol, notices referring only to property damage have no safety alert symbol. These notices shown below are graded according to the degree of danger.

⚠ DANGER
indicates that death or severe personal injury will result if proper precautions are not taken.
⚠ WARNING
indicates that death or severe personal injury may result if proper precautions are not taken.
⚠ CAUTION
with a safety alert symbol, indicates that minor personal injury can result if proper precautions are not taken.
CAUTION
without a safety alert symbol, indicates that property damage can result if proper precautions are not taken.
NOTICE
indicates that an unintended result or situation can occur if the corresponding information is not taken into account.

If more than one degree of danger is present, the warning notice representing the highest degree of danger will be used. A notice warning of injury to persons with a safety alert symbol may also include a warning relating to property damage.

Qualified Personnel

The device/system may only be set up and used in conjunction with this documentation. Commissioning and operation of a device/system may only be performed by **qualified personnel**. Within the context of the safety notes in this documentation qualified persons are defined as persons who are authorized to commission, ground and label devices, systems and circuits in accordance with established safety practices and standards.

Proper use of Siemens products

Note the following:

⚠ WARNING
Siemens products may only be used for the applications described in the catalog and in the relevant technical documentation. If products and components from other manufacturers are used, these must be recommended or approved by Siemens. Proper transport, storage, installation, assembly, commissioning, operation and maintenance are required to ensure that the products operate safely and without any problems. The permissible ambient conditions must be adhered to. The information in the relevant documentation must be observed.

Trademarks

All names identified by ® are registered trademarks of the Siemens AG. The remaining trademarks in this publication may be trademarks whose use by third parties for their own purposes could violate the rights of the owner.

Disclaimer of Liability

We have reviewed the contents of this publication to ensure consistency with the hardware and software described. Since variance cannot be precluded entirely, we cannot guarantee full consistency. However, the information in this publication is reviewed regularly and any necessary corrections are included in subsequent editions.

Preface

Preface

Purpose of the manual

This manual supplements the *ET 200S Distributed I/O System* Operating Instructions. General functions for the ET 200S are described in the *ET 200S Distributed I/O System* Operating Instructions.

The information in this document along with the operating instructions enables you to commission the ET 200S.

Basic knowledge requirements

To understand these operating instructions you should have general knowledge of automation engineering.

Scope of the manual

This manual applies to this ET 200S module. It describes the components that are valid at the time of publication.

Recycling and disposal

Thanks to the fact that it is low in contaminants, this ET 200S module is recyclable. For environmentally compliant recycling and disposal of your electronic waste, please contact a company certified for the disposal of electronic waste.

Additional support

If you have any questions relating to the products described in these operating instructions, and do not find the answers in this document, please contact your local Siemens representative.

<http://www.siemens.com/automation/partner>

The portal to our technical documentation for the various SIMATIC products and systems is available at:

<http://www.siemens.com/automation/simatic/portal>

The online catalog and ordering system are available at:

<http://www.siemens.com/automation/mall>

Training center

We offer courses to help you get started with the ET 200S and the SIMATIC S7 automation system. Please contact your regional training center or the central training center in D - 90327, Nuremberg, Germany.

Phone: +49 (911) 895-3200.

<http://www.siemens.com/sitrain>

Technical Support

You can reach technical support for all A&D projects

- using the support request web form:
<http://www.siemens.com/automation/support-request>
- Phone: + 49 180 5050 222
- Fax: + 49 180 5050 223

For more information about our technical support, refer to our Web site at

<http://www.siemens.de/automation/service>

Service & Support on the Internet

In addition to our documentation services, you can also make use of our comprehensive online knowledge base on the Internet.

<http://www.siemens.com/automation/service&support>

There you will find:

- Our Newsletter, which constantly provides you with the latest information about your products.
- The right documentation for you using our Service & Support search engine.
- The bulletin board, a worldwide knowledge exchange for users and experts.
- Your local contact for Automation & Drives in our contact database.
- Information about on-site services, repairs, spare parts. Lots more can be found on our "Services" pages.

Table of contents

	Preface	3
1	Properties	7
1.1	IM151-1 HIGH FEATURE interface module (6ES7151-1BA02-0AB0).....	7
2	Parameters	13
2.1	Parameters for the IM151-1 HIGH FEATURE interface module	13
2.2	Parameter description	14
2.2.1	DP interrupt mode	14
2.2.2	Bus length	14
2.2.3	Enable startup for set <> actual configuration	14
2.2.4	Option handling in general	14
2.2.5	Option handling: Slot 2 to 63.....	15
2.2.6	Diagnostic interrupt	15
2.2.7	Process interrupt.....	15
2.2.8	Insert/remove-module interrupt.....	15
2.2.9	Analog-value format.....	15
2.2.10	Interference frequency suppression	16
2.2.11	Reference junction slot	16
2.2.12	Reference junction input	16
2.2.13	Synchronize DP slave with equidistant DP cycle.....	16
2.2.14	Time Ti (read in process values).....	17
2.2.15	Time To (output process values)	17
3	Functions	19
3.1	Cycle synchronization	19
3.1.1	Basics.....	19
3.1.2	Assigning the parameters for cycle Synchronization on the PROFIBUS DP	22
3.1.3	Troubleshooting during isochronous mode on PROFIBUS DP	25
3.2	Option handling with RESERVE modules	26
3.2.1	Principle of operation of option handling with RESERVE modules	26
3.2.2	Prerequisites for option handling with RESERVE modules.....	27
3.2.3	Example for using RESERVE modules	28
3.2.4	Assigning parameters for option handling with RESERVE modules	29
3.2.5	Controlling and monitoring options with RESERVE modules.....	30
3.2.6	Troubleshooting for option handling with RESERVE modules	32
3.2.7	Address area for option handling and status byte with RESERVE modules.....	32
3.3	Option handling without RESERVE modules	34
3.3.1	Principle of operation of option handling without RESERVE modules	34
3.3.2	Prerequisites for option handling without RESERVE modules.....	35
3.3.3	Example for use without RESERVE modules.....	36
3.3.4	Configuring option handling without RESERVE modules.....	37
3.3.5	Controlling and monitoring options without RESERVE modules.....	38
3.4	Identification data	40

4	Interrupt, error, and system messages	43
4.1	LED displays on the interface module	43
4.2	Diagnostic messages of the electronic modules.....	45
4.3	Diagnostics with STEP 7	45
4.3.1	Reading out diagnostics.....	45
4.3.2	Structure of the slave diagnostics	47
4.3.3	Station statuses 1 to 3.....	48
4.3.4	Master PROFIBUS address	49
4.3.5	Identifier-related diagnostics	50
4.3.6	Module status.....	51
4.3.7	Channel-specific diagnostics.....	52
4.3.8	H status	53
4.3.9	Interrupts	54
4.3.10	Incorrect module configurations of ET 200S on the PROFIBUS DP	62
4.4	Evaluating the interrupts of the ET 200S	62
5	Response times	65
5.1	Overview	65
5.2	Response times for the ET 200S	65
5.3	Response time for digital input modules	66
5.4	Response time for digital output modules.....	67
5.5	Response time for analog input modules.....	67
5.6	Reaction times of analog output modules.....	68
5.7	Response times for a 4 IQ-SENSE electronic module	69
5.8	Response times for technology modules	69
	Index.....	71

Properties

1.1 IM151-1 HIGH FEATURE interface module (6ES7151-1BA02-0AB0)

Properties

The IM151-1 HIGH FEATURE interface module has the following features:

- It connects the ET 200S with PROFIBUS DP via the RS 485 interface.
- There is no restriction on the SIMATIC S7 for the maximum parameter length. It is normally 244 bits.
- The maximum address space is 244 bytes for inputs and 244 bytes for outputs.
- Operation as a DPV0 or DPV1 slave
- A maximum of 63 modules can be operated with the IM151-1 HIGH FEATURE.
- The maximum bus length at the backplane bus is 2 m.
- Supports option handling and the status byte for power modules.
- synchronizable with the DP cycle (cycle synchronization).
- The firmware can be updated via PROFIBUS DP using HW CONFIG.
- Safety-related I-slave-slave-communication via PROFIBUS DP. You can find the description of this function in the *S7 Distributed Safety Configuration and Programming* manual.
- Identification data
- Direct data exchange
- Operation as DPV1 slave on the Y switching
- Use of fail-safe modules

Installation constraints

- For every 2DO 24 to 230 V AC electronic module used, the number of connectable I/O modules in this station is reduced by one.
- The following modules cannot be used with the IM151-1 HIGH FEATURE:

Module	Up to order number	Up to product version
1COUNT 24V/100kHz	6ES7138-4DA02-0AB0	1
1COUNT 5V/500kHz	6ES7138-4DE00-0AB0	1
1SSI	6ES7138-4DB00-0AB0	3
1STEP 5V/204kHz	6ES7138-4DC00-0AB0	3
1SI serial interface module	6ES7138-4DF00-0AB0	1
Modbus/USS serial interface module	6ES7138-4DF01-0AB0	1
2AI U; HIGH FEATURE	6ES7134-4LB00-0AB0	1
2AI I 2/4DMU; HIGH FEATURE	6ES7134-4MB00-0AB0	1
2AO U; HIGH FEATURE	6ES7135-4LB00-0AB0	1

Terminal assignment

The following table shows the terminal assignment of the IM151-1 HIGH FEATURE interface module for the 24 VDC voltage supply and PROFIBUS DP:

Table 1- 1 Terminal assignment of the IM151-1 HIGH FEATURE interface module

View	Signal name	Name	
	1	-	
	2	-	
	3	RxD/TxD-P	Data line B
	4	RTS	Request To Send
	5	M5V2	Data reference potential (station)
	6	P5V2	Supply plus (station)
	7	-	-
	8	RxD/TxD-N	Data line A
	9		

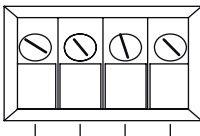
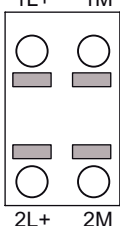
View	Signal name	Name
<p>Product version 1 1L+ 2L+ 1M 2M</p>  <p>Product release 2 or later 1L+ 1M 2L+ 2M</p> 	1L+	24 VDC
	2L+	24 VDC (for loop through)
	1M	Chassis ground
	2M	Chassis ground (for loop through)

Block diagram

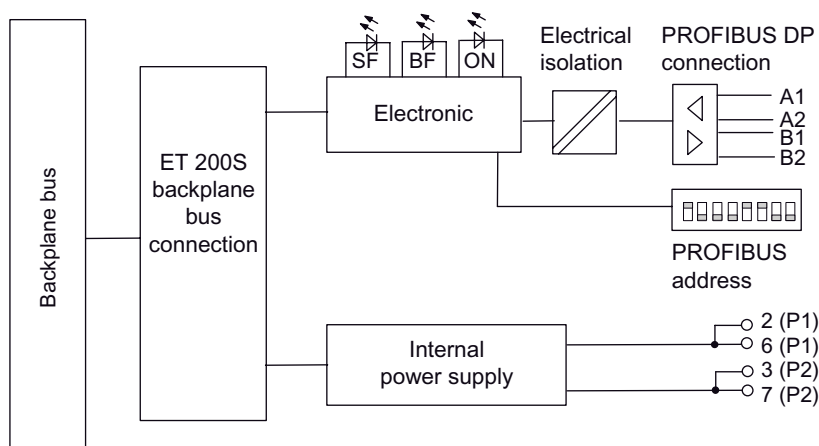

Figure 1-1 Block diagram for the IM151-1 HIGH FEATURE interface module

Technical data for the IM151-1 HIGH FEATURE interface module (6ES7151-1BA02-0AB0)

Dimensions and weight	
Dimension B (mm)	45
Weight	Approx. 150 g
Module-specific data	
Data transmission rate	9.6; 19.2; 45.45; 93.75; 187.5; 500 kBaud, 1.5; 3; 6; 12 Mbit/s
Bus protocol	PROFIBUS DP
Interface	RS 485
SYNC capability	yes
FREEZE capability	yes
Manufacturer ID	80E0 _H
Direct data exchange	yes
Cycle synchronization	Yes, from 1.5 Mbits/s
Parameter length	27 bytes 56 bytes, if cycle synchronization is active
Address space	244 bytes I/O
Option handling	
• With reserve module	yes
• Without reserve module	yes
I&M data	yes
Firmware update	via PROFIBUS DP with HW Config
Max. output current of the PROFIBUS DP interface (5, 6)	80 mA
Voltages, currents, potentials	
Rated supply voltage of the electronics (1L+)	24 VDC
• Incorrect polarity protection	yes
• Power failure bypass	Min. 20 ms
Galvanic isolation	
• Between the backplane bus and electronic components	No
• Between the PROFIBUS DP and electronic components	yes
• Between the supply voltage and electronic components	No
Permitted potential difference (to the rail)	75 VDC / 60 VAC
Insulation test voltage	500 VDC
Current consumption from rated supply voltage (1L+)	Approx. 200 mA
Power dissipation of the module	Typically 3.3 W

Status, interrupts, diagnostics	
Interrupts	yes
Diagnostic function	yes
<ul style="list-style-type: none"> Group error 	Red "SF" LED
<ul style="list-style-type: none"> PROFIBUS DP bus monitoring 	Red "BF" LED
<ul style="list-style-type: none"> Monitoring of the power supply voltage of the electronics 	Green "ON" LED

Updating the firmware for IM151-1 HIGH FEATURE

The IM151-1 HIGH FEATURE firmware can be updated using *STEP 7*V5.1, SP 3 or higher.

To update the firmware, you receive the *.UPD files containing the current firmware.

Requirements:

- The IM151-1 HIGH FEATURE in the station whose firmware is to be updated must be accessible online.
- The files with the current firmware version must be available in the file system of your programming device or PC.

Information regarding the method of procedure can be found in the *STEP 7* online help.

Note

Make sure to use the correct firmware version for the interface module in use during the update process. An interface module with an older order number cannot be updated with the firmware version for an interface module with a more recent order number and vice versa.

Configuration with more than 244 bytes of parameter data

For configurations with *STEP 7*V5.3 SP 3 and higher, it is possible to operate the IM151-1 HIGH FEATURE from 6ES7151-1BA01-0AB0 in DPV1 mode with more than 244 bytes of parameter data.

A configuration based on the GSD file does not offer this possibility.

Note

If the parameter length is greater than 244 bytes, an increase in the station startup time is to be expected.

Parameters

2.1 Parameters for the IM151-1 HIGH FEATURE interface module

Table 2- 1 Parameters for the IM151-1 HIGH FEATURE interface module

IM151-1 HIGH FEATURE	Value range	Default setting ⁵	Applicability
DP interrupt mode	DPV0/DPV1	DPV0	ET 200S
Bus length	≤ 1 m / > 1 m	≤ 1 m	ET 200S
Operation at set <> actual configuration ¹	disable/enable	disable	ET 200S
Diagnostic interrupt ³	disable/enable	disable	ET 200S
Process interrupt ³	disable/enable	disable	ET 200S
Remove/insert module interrupt ^{2,3}	disable/enable	disable	ET 200S
Identifier-related diagnostics	disable/enable	enable	ET 200S
Module status	disable/enable	enable	ET 200S
Channel-specific diagnostics	disable/enable	enable	ET 200S
Option handling in general	disable/enable	disable	ET 200S
Option handling	With/without reserve module	With reserve module	Module
Option handling: Slots 2 to 63	disable/enable	disable	Module
Analog-value format ⁴	SIMATIC S7/SIMATIC S5	S7	ET 200S
Interference frequency suppression	50 Hz/60 Hz	50 Hz	ET 200S
Reference junction slot	None /2 to 63	None	ET 200S
Reference junction input	RTD on channel 0/ RTD on channel 1	0	ET 200S
Synchronize DP slave with DP cycle	disable/enable	disable	ET 200S
Time T _i (read process values)	Minimum/Maximum	Standard value	ET 200S
Time T _o (output process values)	Minimum/Maximum	Standard value	ET 200S
¹ See also the "option handling" parameter. ² The default setting of the parameter in the GSD file is "disable". ³ Only parameterizable in DPV1 operation. ⁴ The parameter only exists when configuring using the GSD file. ⁵ The default settings apply to the default start-up (if no other parameters have been assigned by the DP master).			

2.2 Parameter description

2.2.1 DP interrupt mode

This parameter can be used to enable or disable ET 200S DPV1 operation. Data records and interrupts (can be assigned parameters) are supported by class 1 and class 2 services after DPV1 operation is enabled.

Requirements:

- The DP master must also support DPV1.

2.2.2 Bus length

≤ 1 m: The default setting for the maximum bus length is 1 m.

> 1 m: The bus length of the ET 200S is > 1 m and can be a maximum 2 m. This setting will increase the response time of the ET 200S.

2.2.3 Enable startup for set <> actual configuration

When this parameter is enabled, and

- Modules removed and inserted during operation will not lead to a ET 200S station failure.
- The actual configuration differs from the expected configuration, the ET 200S remains engaged in data transfer with the DP master.

When this parameter is disabled, and

- Modules removed and inserted during operation will lead to an ET 200S station failure.
- The actual configuration differs from the expected configuration, there is no data transfer between the DP master and the ET 200S.
Exception: option handling with RESERVE modules.

2.2.4 Option handling in general

These parameters can be used enable or disable the option handling for the entire ET 200S.

See also

Assigning parameters for option handling with RESERVE modules (Page 29)

Configuring option handling without RESERVE modules (Page 37)

2.2.5 Option handling: Slot 2 to 63

This parameter can be used to enable or disable checking the configuration.

- Slots 2 to 63 are enabled: Instead of the configured electronic module you can also insert a RESERVE module in the relevant slot without diagnostics being reported.
- Slots 2 to 63 are disabled: Only the configured module can be located on the relevant slot. RESERVE modules are treated as incorrect modules. Depending on the setting of the parameter "Operation at Preset <> Actual Configuration" the ET 200S will either terminate or continue exchanging data.

2.2.6 Diagnostic interrupt

This parameter can be used to enable or disable diagnostic interrupts. Diagnostic interrupts are supported

- on PROFIBUS DP, if the ET 200S is in DPV1 mode.
- and on PROFINET IO.

2.2.7 Process interrupt

This parameter can be used to enable or disable process interrupts. Process interrupts are supported:

- On PROFIBUS DP, if the ET 200S is in DPV1 mode.
- On PROFINET IO.

2.2.8 Insert/remove-module interrupt

This parameter can be used to enable or disable remove/insert module interrupts. Remove/insert module interrupts are supported

- On PROFIBUS DP, if the ET 200S is in DPV1 mode
- On PROFINET IO.

2.2.9 Analog-value format

You set the number format for all analog electronic modules here.

2.2.10 Interference frequency suppression

The frequency of your AC power system can interfere with the measured value especially when measuring in low voltage ranges and using thermocouple elements. Enter the line frequency for your system here (50 Hz or 60 Hz).

The interference frequency suppression parameter applies to all analog electronic modules. This parameter is also used to specify the integration and conversion time of the various modules. See the technical data for the analog electronic modules.

2.2.11 Reference junction slot

This parameter allows you to assign a slot (none, 2 to 63) with a channel for measuring the reference temperature (calculation of the compensation value).

Reference

For information on connecting thermocouples, refer to the *manuals* for the analog electronic modules.

2.2.12 Reference junction input

This parameter can be used to set the channel (0/1) for measuring the reference temperature (calculation of the compensation value) for the assigned slot.

Reference

For information on connecting thermocouples, refer to the *manuals* for the *analog electronic modules*.

2.2.13 Synchronize DP slave with equidistant DP cycle.

This parameter can be used to enable or disable cycle synchronization.

After enabling cycle synchronization the ET 200S I/O are synchronized with the global control frame of the master (as equidistance cycle).

2.2.14 Time T_i (read in process values)

This value can only be set if you have enabled the "Synchronize DP slave to DP cycle" parameter.

T_i is the time reserved for reading in the input data at the ET 200S. At the beginning of T_i , the input data is converted at the terminals and stored in a buffer via the backplane bus of the ET 200S. T_i ends at the beginning of the next equidistant DP cycle i.e., with the global control frame.

At this point the most recent and up-to-date input data must be available for read in on the PROFIBUS subnet. The T_i time must consider the processing and delay times in the ET 200S modules and backplane bus and is therefore dependent on the configuration with regard to modular slaves.

The T_i time can only be set between the minimum and maximum values within the specified grid. Normally, the default values should be accepted.

2.2.15 Time T_o (output process values)

This value can only be set if you have enabled the "Synchronize DP slave to DP cycle" parameter.

This value can only be set provided you have enabled the "Synchronize DP slave with DP cycle" parameter. The time T_o includes the following:

- Distribution of the output data via the PROFIBUS DP bus system to the slaves (= cyclic data-exchange master slave)
- Distribution of the output data to the modules via the backplane bus of the slave
- Conversion and transfer of the output data to the output terminals of the module

T_o starts with the arrival of the global control frame. As with T_i , the time can be set between the minimum and maximum values within the specified grid. Normally, you should accept the default values.

Functions

3.1 Cycle synchronization

3.1.1 Basics

Properties

Reproducible response times (i.e., of equal length) are achieved in SIMATIC with a constant DP bus cycle, synchronization of the user program on the DP bus cycle, and the isochronous transfer of I/O data to the I/O modules. The isochronous sections of the user program are processed synchronously with the DP bus cycle by means of synchronous cycle interrupts (OB 61 to OB 64). The I/O data are transferred at defined and constant (isochronous) intervals via the backplane bus of the DP slave to the I/O modules and switched through isochronously up to the "terminal".

In other words, isochronous operation results in the synchronization of all hitherto free-running single cycles. These include the user program in the CPU, the DP cycle on the PROFIBUS subnet and the cycle in the DP slave right up to the cycle in the I/O modules of the DP slaves.

The maximum jitter for the IM151-1 is 10 μ s. The jitter of the ET 200S I/O modules cannot be considered due to the existing diversity.

Requirements

- Cycle synchronization is possible with the IM151-1 HIGH FEATURE with modules which support cycle synchronization. You can see whether a module supports cycle synchronization in the device description or HW Config. Other modules can be used in the ET 200S setup, but they do not support cycle synchronization.
- The transmission rate of the PROFIBUS DP is at least 1.5 Mbps (shorter equidistance times can be achieved with higher transmission rates).
- The maximum constant bus cycle time is 32 ms.
- The constant bus cycle time master (class 1) must be a class 1 DP master. This means a programming device/PC cannot be a constant bus cycle time master.
- Only one DP master (class 1) may be active on the PROFIBUS DP during equidistant mode. Programming devices or PCs (class 2) can also be connected.
- The isochronous mode can only be activated on the ET 200S if the constant bus cycle is enabled on the DP master system.
- Isochronous operation (constant bus cycle time) of the ET 200S is not possible during removal or insertion of electronic modules.

In order to ensure that asynchronous results such as "Switch on power module" or "Read/Write data record" do not cause cycle violation, a sufficiently large gap between T_o and T_i must be provided, i.e. T_{dp} must be increased.

- In constant bus cycle time operation, the ET 200S requires a starting time of approx. 150 DP cycles to guarantee isochronous operation up to the terminals.
- The bus length must be less than 1 meter.

Note

Isochronous operation is only possible without interference frequency suppression and without smoothing.

Optimizing the constant bus cycle time

- Ensure equal input delay of all the digital input modules in the ET 200S station for cycle synchronization.
If the settings differ, the lowest input delay is used to calculate the DP cycle time. Changes at the inputs of modules with a higher input delay are recorded with a corresponding time offset.
This also applies to the digital output modules. Choose modules with the same conversion time TWA here.
- The shorter the input delays you set for the HIGH FEATURE digital input modules, the shorter the constant bus cycle times that can be achieved.
Hint: Set an input delay as close to 0.1 ms as possible for the HIGH FEATURE digital input modules.
- The processing time of the modules should be taken into account in the case of modules that support isochronous operation.
- The minimum constant bus cycle time depends on the number of modules in the ET 200S.
Hint: Always try to use 4-channel digital input HIGH FEATURE modules to reduce the number of modules required.
Shorter constant bus cycle times can be achieved by distributing the modules of an ET 200S (with a high module count) over two ET 200S stations.
- The constant bus cycle time is reduced if you increase the transmission rate.
Hint: Set the highest possible baud rate.
- Interface module 151-1 HIGH FEATURE, 6ES7151-1BA02-0AB0 and higher: An optimization of the periods for the constant bus cycle can be achieved through the correct plugging sequence of the electronic modules:
 - Plug the output modules with the longest processing time on the left in the ET 200S.
 - Plug the input modules with the longest processing time on the right in the ET 200S.The processing times (= TWE or TWA) can be found in the technical data for the module concerned.

Use of the analog input modules

We recommend that you always use the HIGH FEATURE modules (HF) instead of the older HIGH SPEED modules (HS) as analog input devices in an isochronous structure. You can achieve shorter response times with HIGH FEATURE modules.

HIGH FEATURE modules:

- 2AI 2/4WIRE HF: 6ES7 134-4MB02-0AB0
- 2AI U HF: 6ES7 134-4LB02-0AB0

If you do use HIGH SPEED modules and operate the IM151-1 isochronously, you have to activate the "isochronous mode" for the modules listed below in STEP7. This is the only method of ensuring reliable operation of these modules with the shorter cycle times of the IM151-1 (6ES7151-1BA02-0AB0) that can then be achieved.

HIGH-SPEED modules:

- 2AI U HS: 6ES7 134-4FB51-0AB0
- 2AI I 2WIRE HS: 6ES7 134-4GB51-0AB0
- 2AI I 4WIRE HS: 6ES7 134-4GB61-0AB0

Further information

For further information regarding cycle synchronization, please refer to the *STEP 7 Online Help* and the *Isochronous Mode* manual.

Overlapping of T_i and T_o with IM151-1 HIGH FEATURE (6ES7151-1BA02-0AB0 and higher)

A reduction of the system reaction time is attained with the overlapping of T_i and T_o , meaning that the time from the occurrence and detection of an event via the processing up to outputting of a response at the outputs is reduced.

This function is only possible with the interface modules IM151-1 HIGH FEATURE (6ES7151-1BA02-0AB0 and higher).

Preconditions for constant bus cycle time ≥ 0.5 ms

The following requirements must be fulfilled:

- Interface module IM151-1 HIGH FEATURE (6ES7151-1BA02-0AB0 and higher)
- *STEP 7 V5.4 SP1* and higher

3.1.2 Assigning the parameters for cycle Synchronization on the PROFIBUS DP

Procedure

1. CPU settings:
 "Object properties" of the CPU > Register "Cycle synchronization alarms"
 - CPU - Set cycle synchronization alarm
 - Select the DP master system being used
 - Select the desired sub-process image

Memory	Interrupts	Interrupts	Cyclic interrupts	Diagnostics/clock	Time-of-day interrupts
General information	Startup	Clocked interrupts	Cycle / clock memory	Retentivity	
OB 61:	Priority 25	DP master-systemno. 1 ▼	Partial process image(s) (e. g.: 1.4) 1	Time lag 3.000	ms
				Default	

Figure 3-1 Dialog box cycle synchronization alarms

2. DP master system settings:

DP master "Object properties" > "General" tab > "Properties" button > "Parameter" tab > "Properties" button > "Network settings" tab > "Options" button

- Activate constant bus cycle time on the DP master system
- Set the length of the constant bus DP cycle (max. 32 ms)
- Set "Times Ti and To identical for all slaves" (effects a synchronization of the I/O data of the various DP slaves)
- Times Ti and To can be set separately. Recommendation: Accept the standard settings for Ti and To.

The dialog box is titled 'Constant bus cycle time' and has three tabs: 'Constant bus cycle time', 'Network stations', and 'Cables'. The 'Constant bus cycle time' tab is selected.

Options in the dialog include:

- Activate equidistant bus cycle
- Optimize DP cycle (and, if nec. Ti, To): [Calculate again]
- Number of PGs/OPs/TDs etc. on the PROFIBUS: Configured: [0] Total: [0]
- Equidistant DP cycle: [8.000] ms (min = 6.000 ms; max. = 32.000 ms). Time base: [0.125] ms [Details ...]
- Slave synchronization:
 - Times Ti and To identical for all slaves (if not: Set in Properties -- Slaves)
 - Time Ti (read process values): [3.5000] ms (min = 3.4375 ms; max = 3.5625 ms). Time base: [0.0625] ms
 - Time Ti (read process values): [3.5000] ms (min = 0.8125 ms; max = 3.5625 ms). Time base: [0.0625] ms

Figure 3-2 Dialog box options

Note

With the "Calculate again" button you can calculate a value for the constant buy DP cycle from STEP 7 that takes into account the current PROFIBUS DP configuration. This value is then automatically entered in the "Equidistant DP cycle", "Time Ti (...)," and "Time To (...)" boxes.

3.1 Cycle synchronization

3. DP slave settings:

DP slave "Object properties" > "Cycle synchronization" tab

- Activate "Synchronize DP slave to equidistant DP cycle".
- Enter the times T_i and T_o (if "Times T_i and T_o identical for all slaves" has not been set on the DP master system). Recommendation: Accept the standard settings for T_i and T_o .
- Select the electronic modules to be synchronized and assign them in the "Addresses" tab to the sub-process image defined in the CPU. For further information, please refer to the *Isochronous Mode* Function Manual.

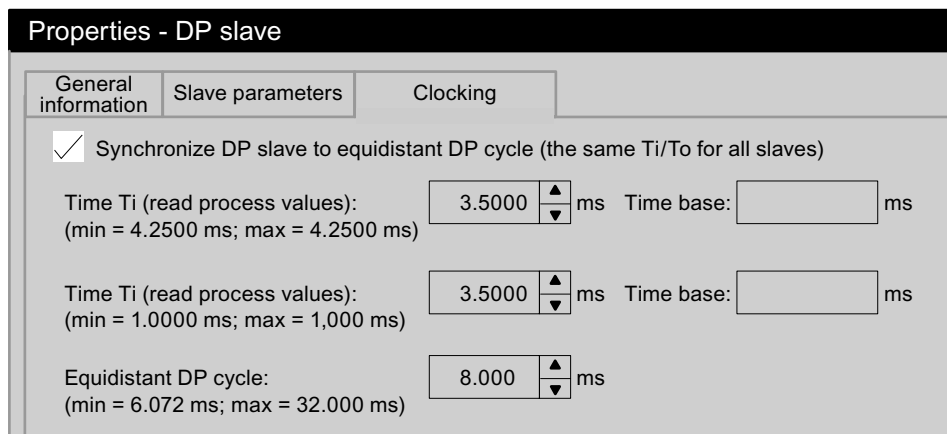

Figure 3-3 DP slave properties dialog box

Note

If you click on "Cycle synchronization" in the "Edit" menu, a configuration overview of the cycle-synchronized modules appears.

4. Create user program:

- Creating the OB 61.
- At the start of the OB 61, the SFC 126 must be called in order to update the sub-process image of the inputs.
- At the end of the OB 61, the SFC 127 must be called in order to update the sub-process image of the outputs.
- The sub-process image to be used is the sub-process image parameterized in the CPU ("Cycle synchronization alarms" tab).

Configure Ti and To overlap with IM151-1 HIGH FEATURE (6ES7151-1BA02-0AB0 and higher)

With IM 151-1 HIGH FEATURE in isochronous mode, you can also configure an overlap of Ti and To.

Parameter assignment with STEP 7:

Parameter assignment takes place as described above. In addition you can configure an overlap of Ti and To.

An Ti/To overlap is given if $Ti + To > Tdp$. STEP 7 checks the values you have entered for feasibility.

Further information

For further information about the isochronous mode please refer to the STEP 7 Online Help and the *Isochronous Mode* Function Manual.

You will find the Function Manual on the Internet at:

<http://support.automation.siemens.com>

Search for the entry with the ID number 15218045.

3.1.3 Troubleshooting during isochronous mode on PROFIBUS DP

Event	Cause	Action
Station failure of the ET 200S	Faulty cycle synchronization (more than 25 lost or violated cycles).	Check the parameter assignment.
The obtainable constant bus cycle times are too long.	The input delays of the HIGH FEATURE digital input modules are not optimally set.	Decrease the input delay of the HIGH FEATURE digital input modules.
No isochronous signal detection/output	Wrong sub-process image used. Negative RET_VAL in the case of SFCs 126/127	Check whether the same sub-process image was used in the OB 61 user program (or up to OB 64) when SFCs 126/127 are called and in the configuration of the DP master/DP slave.

3.2 Option handling with RESERVE modules

3.2.1 Principle of operation of option handling with RESERVE modules

Principle

With option handling with RESERVE modules, the configuration of ET 200S Slots 2 to 63 is checked. If a slot is enabled for option handling, the RESERVE module (option) can occupy this slot instead of the configured electronic module without triggering a diagnostic interrupt. If the slot is disabled, only the configured electronic module can occupy this slot. Any other module will trigger a diagnosis. You can also control the configuration of Slots 2 to 63 and monitor the configuration of Slots 1 to 63 using the control and feedback interface in the process input image (PII) and process output image (PIQ).

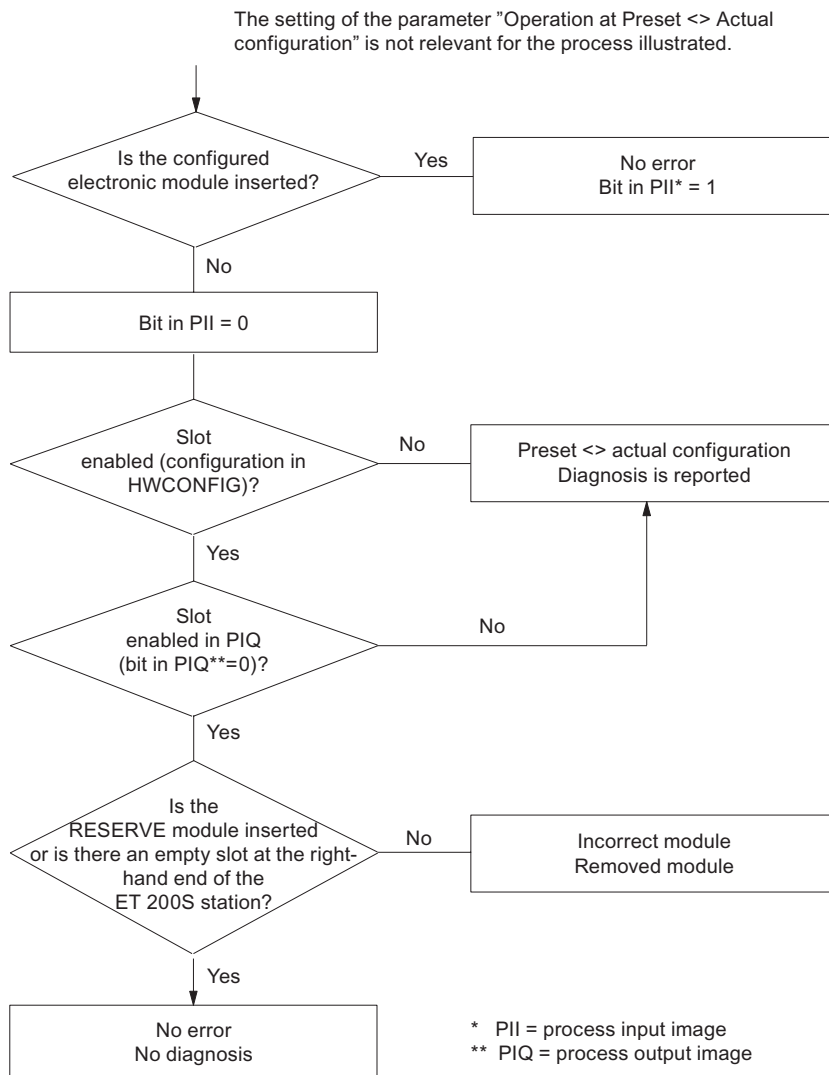

Figure 3-4 Principle of operation of option handling with RESERVE modules

3.2.2 Prerequisites for option handling with RESERVE modules

Requirements

For option handling with RESERVE modules you require:

- An interface module that supports option handling with a RESERVE module.
- A power module that supports option handling with a RESERVE module.
- RESERVE modules as replacements for future electronic modules.
- GSD file SI0380E0.GSx for the IM151-1 HIGH FEATURE, as of 10/2006 (V1.0), for configuration purposes.

Note

In *STEP 7*, you do not require a GSD file for option handling with the IM151-1 HIGH FEATURE in the case of *STEP 7* V5.3 SP 3 or higher.

You can find the options handling description in the STEP 7 Online Help.

Note

If the actual configuration of an ET 200S station does not match the preset configuration, a diagnostics report is generated if the check for the relevant slots is not enabled for option handling.

3.2.3 Example for using RESERVE modules

Configuration variants

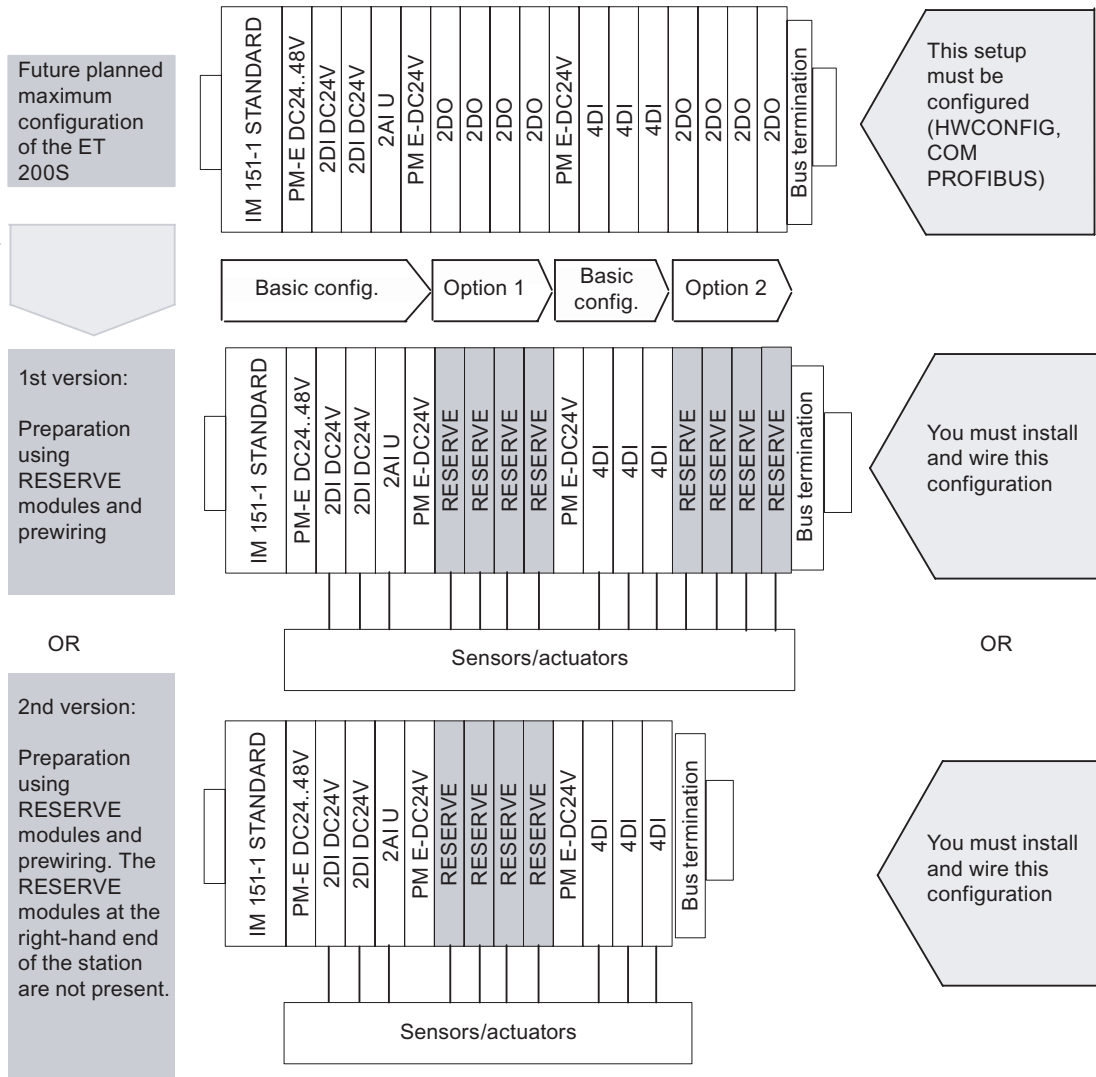

Figure 3-5 Example for using RESERVE modules

3.2.4 Assigning parameters for option handling with RESERVE modules

Introduction

In *STEP 7* or *COM PROFIBUS* you assign the parameters for the electronic modules which you want to use in future applications, e.g. 4DI H, on the RESERVE module slots (or the expansion modules on the right-hand end of the station):

- Drag the electronic module to the configuration table
- Assign the parameters

Procedure

1. Drag a PM-E 24..48 VDC or PM-E 24..48 VDC/24..230 VAC power module with one of the following entries into the configuration table:
 - ...O (option handling) or
 - ...SO (status byte + option handling)

Note

Entry of the power module with the ending ...O or ...SO can only be made **once** in the ET 200S configuration!

2. Assign parameters to the interface module as follows:

Interface module	Parameter	Setting	Description
IM151-1 STANDARD	Option handling, general	enable	Option handling is activated for the entire ET 200S.
<i>or</i> IM151-1 FO STANDARD	Option handling: Slots 2 to 63	Enable (all the slots where RESERVE modules can be located)	There are RESERVE modules or a configured electronic module on the slot. A diagnostic is not signaled.
<i>or</i> IM151-1 HIGH FEATURE	Option handling: With/without RESERVE modules	With RESERVE modules	Selects option handling with RESERVE modules

Note

If "Operation for set < > actual installation" is blocked for parameter assignment,

- the ET 200S does not start up if a module is missing or if an incorrect module is plugged in. The diagnostic "No module" or "Incorrect module" is signaled.
 - The ET 200S starts up if you enable option handling for the slot where a RESERVE module is plugged in. A diagnostic is not signaled.
-

Substitute values

If you have assigned an electronic module for the RESERVE module, the following substitute values are signaled:

- Digital input modules: 0
- Analog input modules: 7FFF_H
- Function module: 0

See also

Option handling in general (Page 14)

3.2.5 Controlling and monitoring options with RESERVE modules

Introduction

You can use the control interface (PIQ) and feedback interface (PII) to control and monitor options by means of the user program.

Recommendation: Before working with the ET 200S optional enhancements, check whether all the configured electronic modules are plugged in using the feedback interface (refer to the table below).

Note

SFCs 14/15 can be used to consistently access the control and feedback interface.

Principle

The control and feedback interface is located in the input and output process image of the PM-E 24..48 VDC or PM-E 24..48 VDC/24..230 VAC power module. It can only be accessed if entries ending in ...O or ...SO for that power module were selected in the configuration software.

One bit is available for each ET 200S electronic or RESERVE module slot.

- Control interface: Slot 2 to 63
- Feedback interface: Slot 1 to 63

	7	6	5	4	3	2	1	0
EB/AB x	7	6	5	4	3	2	1	*
EB/AB x+1	15	14	13	12	11	10	9	8
EB/AB x+2	23	22	21	20	19	18	17	16
EB/AB x+3	31	30	29	28	27	26	25	24
EB/AB x+4	39	38	37	36	35	34	33	32
EB/AB x+5	47	46	45	44	43	42	41	40
EB/AB x+6	55	54	53	52	51	50	49	48
EB/AB x+7	63	62	61	60	59	58	57	56

Figure 3-6 Control (PIQ) and feedback interface (PII)

(* not relevant)

Control interface PIQ (AB x to AB x+7):

You can use these bytes (8 bytes) to control the diagnostic behavior of the slots that you enabled for option handling in the HW Config.

Only the slot bits enabled at parameter assignment for option handling are evaluated. They are marked with "0".

Table 3- 1 Control interface

Slot	Value of the bit	Reaction
2 to 63	0	Parameter assignment for option handling applies. RESERVE modules are allowed: <ul style="list-style-type: none"> • The station is engaged in data exchange. • A diagnostic is not signaled. • The SF LED on the interface module is off.
	1	Parameter assignment for option handling is cancelled. RESERVE modules are not accepted on this slot: <ul style="list-style-type: none"> • The station is engaged in data exchange. • The diagnostic "Incorrect module" is signaled. • The SF LED on the interface module is on.

Feedback interface PII (EB x to EB x+7):

The feedback interface (8 bytes) tells you which module is actually located on which slot. All slots are reported. Even slots that were not enabled for option handling.

Table 3- 2 Feedback interface

Slot	Value of the bit	Reaction
0	0	Option handling is inactive
	1	Option handling is active
1 to 63	0	The RESERVE module, an incorrect module, or a removed module is on the slot.
	1	The configured module is on the slot.

3.2.6 Troubleshooting for option handling with RESERVE modules

Troubleshooting for option handling

Table 3- 3 Troubleshooting option handling

Event	Cause	Action
ET 200S does not start up; configuration error	There are multiple entries in the ET 200S configuration for power modules ending in ...O or ...SO.	Check and correct the configuration in HW Config.
	There are no entries of power modules ending in ...O or ...SO in the ET 200S configuration.	Use a power module entry ending in ...O or ...SO in HW Config.

3.2.7 Address area for option handling and status byte with RESERVE modules

Address area for option handling and status byte

You can control and monitor option handling and evaluate the status byte of the power module using the control (PIQ) and feedback (PII) interface.

The address range in the control (PIQ) and feedback interface (PII) depends on the configuration, i.e. the selection of the corresponding entry in the configuration software.

This table shows the PII feedback interface and the PIQ control interface for various entries.

Table 3- 4 PII feedback interface and PIQ control interface

In STEP 7/HW Config or COM PROFIBUS or other configuration software	Feedback interface PII		Control interface PIQ	
	Address	Description	Address	Description
Usual entry for the power module	---		---	
Ends in ...S	lBx	Status byte	---	
Ends in ...O	lBx	Option handling	OBx	Option handling
	... lBx+7		... OBx+7	
Ends in ...SO	EBx	Option handling	ABx	Option handling
	... EBx+7		... ABx+7	
	lBx+8	Status byte	OBx+8	Not applicable

Option handling in PIO/PII

	7	6	5	4	3	2	1	0
AB/EB x	7	6	5	4	3	2	1	*
AB/EB x+1	15	14	13	12	11	10	9	8
AB/EB x+2	23	22	21	20	19	18	17	16
AB/EB x+3	31	30	29	28	27	26	25	24
AB/EB x+4	39	38	37	36	35	34	33	32
AB/EB x+5	47	46	45	44	43	42	41	40
AB/EB x+6	55	54	53	52	51	50	49	48
AB/EB x+7	63	62	61	60	59	58	57	56

(*) Not applicable

Figure 3-7 Option handling in PIQ/PII

PIO: OB x to OB x+7		
Slot 2 to 63:	0	Parameter assignment for option handling applies. RESERVE modules are allowed: <ul style="list-style-type: none"> The station is engaged in data exchange. A diagnostic is not signaled. The SF LED on the interface module is off.
	1	Parameter assignment for option handling is canceled. RESERVE modules are not accepted on this slot: <ul style="list-style-type: none"> The station is engaged in data exchange. A diagnostic is not signaled. The SF LED on the interface module is off.
PII: IB x to IB x+7		
Slot 1 to 63:	0	The RESERVE module, an incorrect module, or a removed module is on the slot.
	1	The configured module is on the slot.

3.3 Option handling without RESERVE modules

3.3.1 Principle of operation of option handling without RESERVE modules

Principle

In the case of option handling without RESERVE modules, the configuration data are insufficient to compare the preset configuration with the actual configuration. In addition, information about the existing options is still required. This must be sent via the user data to the IM151-1. In order to be able to receive the user data, the IM151-1 initially goes formally into cyclic data exchange after the configuration data have been received. However, direct I/O access does not yet take place. Output data are rejected, the input data are zero. The IM151-1 only responds to the output data that you have to connect to a power module (O or SO). A preset-actual test isn't possible until this option information is available. Only after this can the I/O devices be operated.

Since the option information is stored retentively in the IM151-1, this intermediate state only exists during the first commissioning or reconfiguration/retrofitting.

Please note the following:

NOTICE

In this operating mode, the IM151-1 may not be operated as a subscriber (F-data exchange broadcast) on the PROFIBUS.
--

- Data record requests to option slots that do not exist induce a fault (80B0).
- If the IM151-1 is operated without configuration or without a CPU (DP master), it supplies the configuration as it exists. This is relevant for wiring test tools, since the actual slot numbers, without gaps from 1 to n, are used there for status/control.
- In isochronous operation, the designed configuration applies for the time calculation (Ti, To, Tdp).
- There are no limitations when "packing" digital modules. Theoretically, the module to which the byte address is assigned in the preset configuration can be missing in the structure.

Note

The configured slot numbers (slot numbers in data records, and for events such as diagnostics and interrupts) always apply for slot addressing.

3.3.2 Prerequisites for option handling without RESERVE modules

Prerequisites

For option handling without RESERVE modules you require:

- Interface module IM151-1 HIGH FEATURE (6ES7151-1BA02-0AB0 and higher)
- Power module PM E-24 ..48 VDC or PM E- 24..48 VDC/24 ..230 VAC
One of these power modules must be included in the configuration at least once.
- For configuring the GSD file SI0380E0.GSx as from 10/2006.

Note

You do not require a GSD file for option handling in *STEP 7* as from:

- STEP 7 V5.3 SP 3 with HSP0102

You can find the description for option handling in the STEP 7 Online Help.

3.3.3 Example for use without RESERVE modules

Configuration variants

Below is an example of the use of option handling without RESERVE modules.

Note: A "0" in the control interface means that this slot number is deactivated in the configuration and thus does not exist.

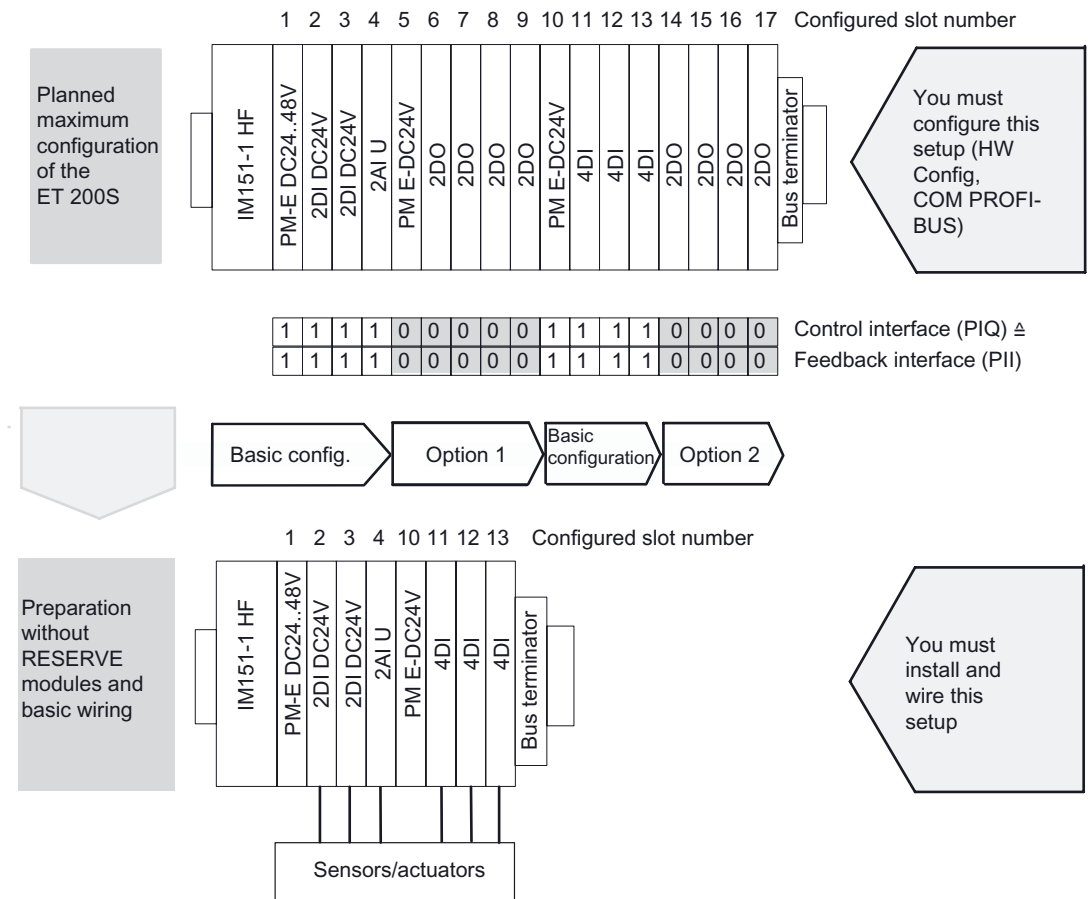

Figure 3-8 Example for use without RESERVE modules

3.3.4 Configuring option handling without RESERVE modules

Introduction

You configure option handling without RESERVE modules as described below.

Procedure

1. Drag a PM-E 24..48 VDC or PM-E 24..48 VDC/24..230 VAC power module with one of the following entries into the configuration table:
 - ...O (option handling) or
 - ...SO (status byte + option handling)

Note

You may only enter the power module with the ending ...O or ...SO **once** in the ET 200S configuration!

2. Assign parameters to the interface module as follows:

Interface module	Parameter	Setting	Description
IM151-1 HIGH FEATURE (6ES7151-1BA02-0AB0 and higher)	Option handling, general	Enable	Option handling is activated for the entire ET 200S.
	Option handling: With/without RESERVE modules	Without RESERVE modules	Selects option handling without RESERVE modules

Note

If "Operation for set < > actual installation" is blocked for parameter assignment, the ET 200S does not start up if a module is missing or if an incorrect module is plugged in. The diagnostic "No module" or "Incorrect module" is signaled.

If the IM151-1 does not start up in this state, the SF LED lights up at the IM151-1 and at the deactivated electronic module of the ET 200S.

Note

In the case of option handling without RESERVE modules, incorrect filling in of the control interface can result in too many plugged modules with a slot number greater than 63 are reported from the point of view of the interface module. Since there is only room for 63 modules in the diagnostics message (module status), the highest-value bit is set in the "Identifier-related diagnostics" in this case. This produces the following results:

- The SF LED on the IM lights up
 - Bit 3 in status byte 1 of the diagnostics message is set (external diagnosis exists)
 - The "Slot 64 faulty" error message is indicated in STEP7.
-

Behavior during the first start-up

In the case of option handling without RESERVE modules, the IM151-1 always goes into cyclic data exchange during the first start-up. However, the I/O device input/output is not activated until valid information about the options is available from the module. No fault is indicated externally in this state (BF LED does not light up). The input/output of the I/O devices is not active in this state. Evaluate the data of the feedback interface in order to assess this state.

Behavior during a warm restart

Valid information about the options is stored retentively in the IM151-1. During the warm restart, the IM151-1 goes into cyclic data exchange and the input/output of the I/O devices is activated immediately. If the configuration has changed since the last start-up (for example incorrect module plugged or information about options is incorrect), the input/output of the I/O devices is deactivated until the real configuration agrees again with the configured one.

See also

Option handling in general (Page 14)

3.3.5 Controlling and monitoring options without RESERVE modules

Introduction

You can use the control interface (PIQ) and feedback interface (PII) to control and monitor options by means of the user program.

Recommendation: Before working with the ET 200S optional enhancements, check whether all the required electronic modules are plugged in using the feedback interface (refer to the table below). The contents of the feedback interface have to agree with the specifications of the control interface.

Note

The use of SFCs 14/15 enables consistent access to the control and feedback interface.

Principle

The control and feedback interface is located in the input and output process image of the PM-E 24..48 VDC or PM-E 24..48 VDC/24..230 VAC power modules. It can only be accessed if entries ending in ...O or ...SO for that power module were selected in the configuration software.

One bit is available for each ET 200S electronic module slot:

- Control interface: Slots 1 to 63
- Feedback interface: Slots 1 to 63

	7	6	5	4	3	2	1	0
EB/AB x	7	6	5	4	3	2	1	0
EB/AB x+1	15	14	13	12	11	10	9	8
EB/AB x+2	23	22	21	20	19	18	17	16
EB/AB x+3	31	30	29	28	27	26	25	24
EB/AB x+4	39	38	37	36	35	34	33	32
EB/AB x+5	47	46	45	44	43	42	41	40
EB/AB x+6	55	54	53	52	51	50	49	48
EB/AB x+7	63	62	61	60	59	58	57	56

Figure 3-9 Control (PIQ) and feedback interface (PII)

Control interface PIQ (AB x to AB x+7):

You must inform the IM151-1 via the control interface about which modules actually exist and which slots have been left out. The IM151-1 cannot evaluate the configuration until it has received this information.

Table 3- 5 Control interface

Slot	Value of the bit	Reaction
0	0	Content of the bitspur is not relevant
	1	Bitspur is valid
1 to 63	0	Slot does not exist in the actual configuration
	1	Slot exists in the actual configuration

Feedback interface PII (EB x to EB x+7):

The feedback interface (8 bytes) tells you which module is actually located on which slot.

Table 3- 6 Feedback interface

Slot	Value of the bit	Reaction
0	0	Option handling is inactive
	1	Option handling is active
1 to 63	0	Slot belongs to an option that does not exist or the module status is not OK
	1	Slot exists and is OK

If the feedback result of the feedback interface is identical with the specification of the control interface, the configuration is correct.

Procedure

In order to start testing the options, set Bit0=1 in the first byte (AB x).

Proceed as follows in order to ensure the consistency of the 8 bytes:

- Write the first byte (AB x) last (for direct access with T PAB)
- or
- First write the complete information of the control interface in the first byte (AB x) with Bit0=0 and then set Bit0=1 in this byte in the subsequent OB1 cycle.

Alternatively you can use the SFC15 in order to achieve consistent transfer.

Note

Whenever any change in the 8 bytes of the control interface takes place, this information is stored and used, even if non-relevant bits were changed (bits outside the preset configuration).

3.4 Identification data

Definition

Identification data are data that are stored in a module for assisting the user in:

- Checking the system configuration
- Locating hardware modifications in a system
- Correcting errors in a system

Identification data enable modules to be uniquely identified online.

In *STEP 7*, the identification data are displayed in the "Module Information - IM 151" and "Properties - DP Slave" tabs (see *STEP 7* online help).

Reading of identification data

Users can directly access specific identification data by selecting **Read data record**. This requires a two-stage access:

1. Data record 248 contains a folder that holds the data records associated with the various indexes (see the table below.)

Table 3- 7 DS 248 structure for the ET 200S

List of contents	Length (bytes)	Coding (hex)
Header information		
ID of content directory	2	00 01
Index of content directory	2	00 00
Length of successive blocks in bytes	2	00 08
Number of blocks	2	00 05

List of contents	Length (bytes)	Coding (hex)
Block information for identification data		
SSL	2	F1 11
associated data record number	2	00 E7
Length of the data record	2	00 40
Index	2	00 01
SSL	2	F1 11
associated data record number	2	00 E8
Length of the data record	2	00 40
Index	2	00 02
SSL	2	F1 11
associated data record number	2	00 E9
Length of the data record	2	00 40
Index	2	00 03
SSL	2	F1 11
associated data record number	2	00 EA
Length of the data record	2	00 40
Index	2	00 04
8 bytes of block information for additional data record objects		
	Σ: 48	

2. The relevant index assigned to a particular section of the ID data is found in the associated data record number (see the ID data table below.)
- All data records which contain ID data have a length of 64 bytes.
 - The data record structure is based on the principle shown in the table below.

Table 3- 8 Basic structure of data records which contain ID data.

List of contents	Length (bytes)	Coding (hex)
Header information		
SSL	2	F1 11
Index	2	00 0x
Length of identification data	2	00 38
Number of blocks which contain ID data.	2	00 01
Identification data		
Index	2	00 0x
Identification data for the respective index (see table below)	54	

The identification data are assigned to the indices corresponding to the table below.

The data structure of data records 231 to 234 is compliant with the PROFIBUS Guideline - Order No. 3.502, Version 1.1, dated May 2003.

3.4 Identification data

Reading of identification data

Table 3- 9 Identification data

Identification data	Access	Default setting	Description
Identification data 0: Index 1 (Data record 231)			
MANUFACTURER_ID	read (2 Byte)	2A hex (= 42 dec)	The name of the manufacturer is stored here. (42 dec = SIEMENS AG)
ORDER_ID	Read (20 bytes)	Depends on the module	Order number of the module
SERIAL_NUMBER	Read (16 bytes)	Not relevant	
HARDWARE_REVISION	read (2 Byte)	Not relevant	
SOFTWARE_REVISION	Read (4 bytes)	Firmware version	This indicates the firmware version of the module.
REVISION_COUNTER	read (2 Byte)	-	Provides information on parameter modifications on the module.
PROFILE_ID	read (2 Byte)	F600 hex	Generic Device
PROFILE_SPECIFIC_TYPE	read (2 Byte)	0003 hex 0005 hex	On electronic modules on interface modules
IM_VERSION	read (2 Byte)	0101 hex	Provides information on the ID data version (0101 hex = version 1.1)
IM_SUPPORTED	read (2 Byte)	000E hex	Provides information on existing identification data (index 2 to 4)
Maintenance data 1: Index 2 (Data record 232)			
TAG_FUNCTION	Read/write (32 bytes)	-	Define a unique identifier for the module in this record.
TAG_LOCATION	Read/write (22 bytes)	-	Enter the installation location of the module here.
Maintenance data 2: Index 3 (data record 233)			
INSTALLATION_DATE	Read/write (16 bytes)	-	Enter the installation date of the module here.
RESERVED	Read/write (38 bytes)	-	Reserved
Maintenance data 3: Index 4 (data record 234)			
DESCRIPTOR	Read/write (54 bytes)	-	Enter a comment on the module here.

Interrupt, error, and system messages

4.1 LED displays on the interface module

Interface module

LED displays on the interface module:

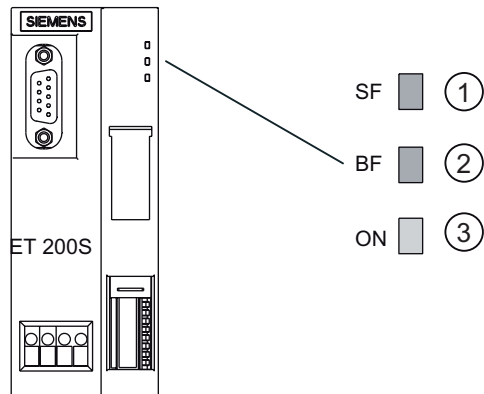

- ① Group error (red)
- ② Bus fault (red)
- ③ Supply voltage (green)

4.1 LED displays on the interface module

Status and error displays by means of LEDs on the IM151-1 HIGH FEATURE

The table below shows the status and error displays on the IM151-1 HIGH FEATURE module.

Table 4- 1 IM151-1 HIGH FEATURE status and error displays

Event (LEDs)			Cause	Remedy
SF	BF	ON		
off	off	off	There is no voltage at the interface module, or the interface module has a hardware defect.	Switch on the power supply voltage 24 VDC on the interface module.
*	*	On	There is voltage at the interface module.	---
*	Flashing	on	<p>The interface module is not configured or is configured incorrectly. No data exchange is taking place between the DP master and the interface module.</p> <p>Causes:</p> <ul style="list-style-type: none"> The PROFIBUS address is incorrect. Configuration error Parameter assignment error 	<ul style="list-style-type: none"> Check the interface module. Check the configuration and parameter assignment. Check the PROFIBUS address.
*	on	on	<p>Transmission rate detection, illegal PROFIBUS address, or bottom DIP switch (PROFIBUS address) not in the OFF position.</p> <p>Causes:</p> <ul style="list-style-type: none"> The response monitoring interval has elapsed. Bus communication to the interface module via PROFIBUS DP is interrupted. 	<p>Set a valid PROFIBUS address (1 to 125) on the interface module or check the bus configuration.</p> <ul style="list-style-type: none"> Check that the bus connector is correctly inserted. Check whether the connecting cable to the DP master has been disconnected. Switch the 24 V DC supply voltage on and off again at the interface module.
on	*	on	<p>The configured structure of the ET 200S does not match the actual structure of the ET 200S.</p>	<p>Check the structure of the ET 200S for missing or defective modules or whether an unconfigured module is inserted.</p> <p>Check the configuration (using COM PROFIBUS or STEP 7, for example) and correct the parameter assignment error.</p>
			<p>There is an error in an I/O module, or the interface module is defective.</p>	<p>Replace the interface module, or contact your Siemens representative.</p>
off	off	on	<p>Data exchange is taking place between the DP master and the ET 200S.</p> <p>The set configuration and actual configuration of the ET 200S match.</p>	---
* Not relevant				

4.2 Diagnostic messages of the electronic modules

Actions following a diagnostic message in DPV0 mode

The error is entered in the diagnostics frame in the channel-specific diagnostics:

- The SF LED on the interface module
- Several diagnostic messages can be output simultaneously.

Actions Following a Diagnostic Message in DPV1 mode

Each diagnostic message triggers the following actions:

- Diagnostics can be reported as diagnostic interrupts in DPV1 mode.
- After a diagnostic message is signaled, the message is:
 - Entered in the diagnostic frame as a diagnostic interrupt block (always limited to one interrupt)
 - written to the diagnostics buffer of the CPU
- The SF LED of the interface module lights up.
- OB 82 is called. If OB 82 is not available, the CPU goes into STOP.
- Acknowledgment of the diagnostic interrupt (thereafter a new interrupt is possible).

4.3 Diagnostics with STEP 7

4.3.1 Reading out diagnostics

Introduction

The slave diagnostics comply with IEC 61784-1:2002 Ed1 CP 3/1. Depending on the DP master, slave diagnostics can be read out with *STEP 7* for all DP slaves that comply with the standard.

Length of the diagnostics frame

- The maximum frame length for the ET 200S is as follows:
 - IM151-1 HIGH FEATURE (DPV0 mode): 64 bytes
 - IM151-1 HIGH FEATURE (DPV1 mode): 128 bytes
- The minimum frame length is
 - 6 bytes (identifier-related diagnostics, module status, and channel-specific diagnostics disabled via parameter assignment).

Options for reading out the diagnostics

The table below shows the options for reading out the diagnostics with *STEP 7* on PROFIBUS DP.

Table 4-2 Reading out the diagnostics with STEP7 on PROFIBUS DP

Automation system with DP master	Block or tab in <i>STEP 7</i>	Application	Reference
SIMATIC S7/M7	"DP Slave Diagnostics" tab	Slave diagnostics in plain text on the STEP 7 user interface	"Diagnosing hardware" in <i>STEP 7</i> online help
	SFC 13 "DP NRM_DG"	Reading slave diagnostics data (stored in the data area of the user program)	SFC see <i>Online Help in STEP 7</i>
	SFC 59 "RD_REC"	Reading out data records of the S7 diagnostics (store in the data area of the user program)	See the system and standard functions reference manual
	SFB 52 "RDREC"	Read data records from the DP slave	SFB see <i>STEP 7 online help</i> (system functions/-function blocks)
	SFB 54 "RALRM" ¹	Receiving interrupts from the interrupt OBs	SFB see <i>STEP 7 online help</i> (system functions/-function blocks)

¹ only for S7-400 from V3.0 and CPU 318 from V3.0

Example of reading out S7 diagnostics using SFC 13 "DP NRM_DG"

Here, you will find an example of how to use SFC 13 to read out the slave diagnostics for a DP slave in the STEP 7 user program.

For the purpose of this STEP 7 user program, the following is assumed:

- The diagnostic address of the ET 200S is 1022 (3FE_H).
- The slave diagnostics are to be stored in DB 82: Starting from address 0.0, length = 64 bytes.

STEP 7 user program

STL	Description
CALL SFC 13	
REQ :=TRUE	Read request
LADDR :=W#16#3FE	Diagnostic address of the ET 200S
RET_VAL :=MW0	RET_VAL of SFC 13
RECORD :=P#DB82.DBX 0.0 BYTE 64	Data record for the diagnostics in DB 82
BUSY :=M2.0	The read process runs through several OB 1 cycles

4.3.2 Structure of the slave diagnostics

Structure of the slave diagnostics

The figure below shows the structure of the slave diagnostics.

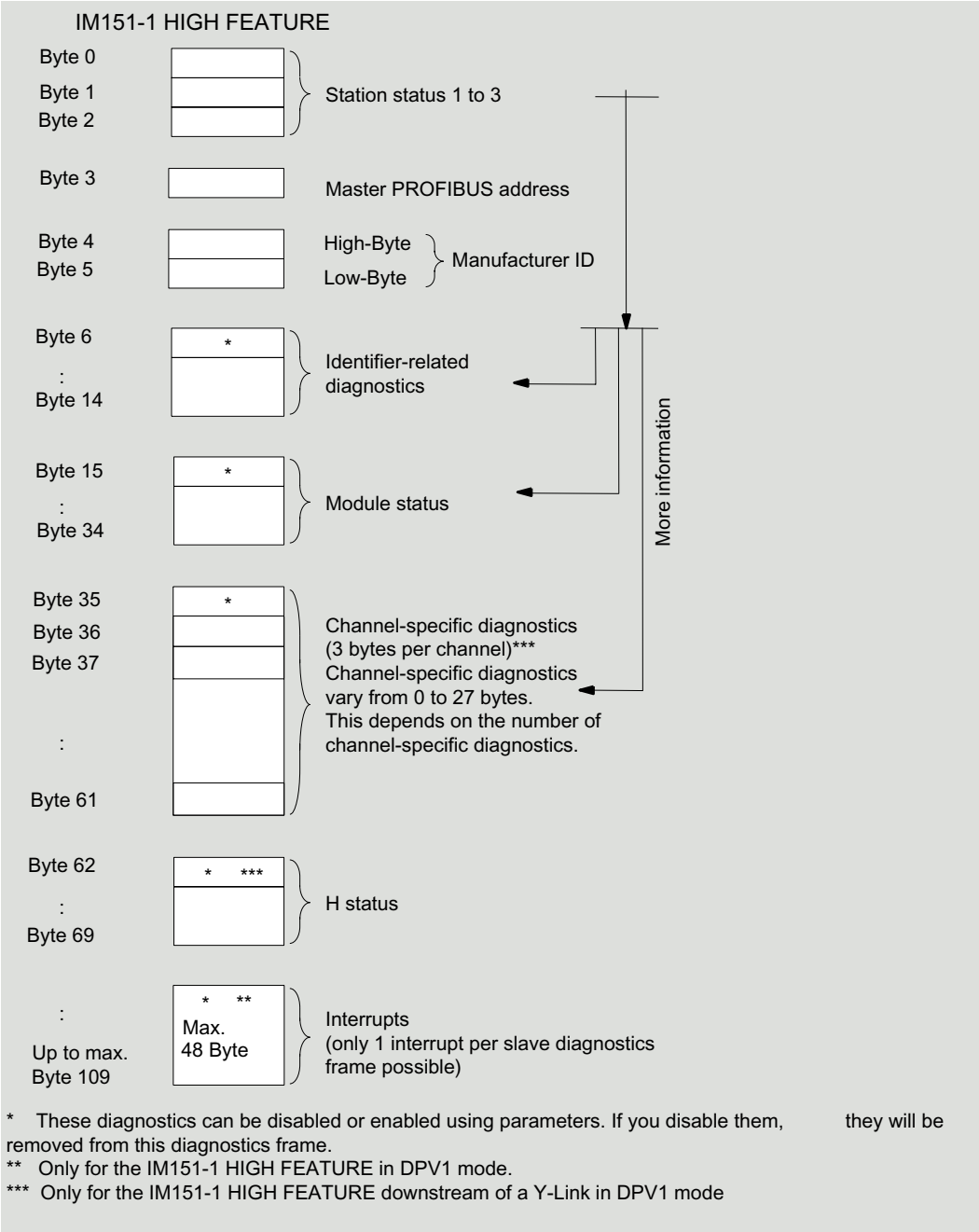

Figure 4-1 Structure of the slave diagnostics

Note

The length of the diagnostics frame varies:

- With the IM151-1 HIGH FEATURE (depending on the parameter assignment)
 - Between 6 and 62 bytes in DPV0 mode
 - Between 6 and 128 bytes in DPV1 mode

You can identify the length of the last received diagnostics frame in *STEP 7* by referring to the RET_VAL parameter of the SFC 13.

4.3.3 Station statuses 1 to 3

Definition

Station statuses 1 to 3 provide an overview of the status of a DP slave.

Structure of station status 1 (byte 0)

Table 4- 3 Structure of station status 1 (byte 0)

Bit	Meaning	Cause/Remedy
0	1: The DP slave cannot be accessed by the DP master.	<ul style="list-style-type: none"> • Is the correct PROFIBUS address set on the DP slave? • Is the bus connector plugged in? • Is the DP slave connected to the voltage supply? • Is the RS-485 repeater set correctly? • Has the DP slave been reset?
1	1: The DP slave is not yet ready to exchange data.	<ul style="list-style-type: none"> • Wait, the DP slave is currently starting up.
2	1: The configuration data transferred from the DP master to the DP slave does not match the slave configuration.	<ul style="list-style-type: none"> • Has the correct station type or the correct DP slave configuration been entered in the configuration software?
3	1: External diagnostics information is pending. (Group diagnostics display)	<ul style="list-style-type: none"> • Evaluate the ID-specific diagnostics information, the module status, and/or the channel-specific diagnostics information. As soon as all errors have been eliminated, bit 3 will be reset. The bit will be set again when there is a new diagnostics message in the bytes of the aforementioned diagnostics.
4	1: The required function is not supported by the DP slave (for example, changing the PROFIBUS address by means of software).	<ul style="list-style-type: none"> • Check the configuration.
5	1: The DP master cannot interpret the response of the DP slave.	<ul style="list-style-type: none"> • Check the bus configuration.

Bit	Meaning	Cause/Remedy
6	1: The DP slave type does not match the software configuration.	<ul style="list-style-type: none"> Has the correct station type been entered in the configuration software?
7	1: Parameters have been assigned to the DP slave by a different DP master (not the one that currently has access to the DP slave).	<ul style="list-style-type: none"> The bit is always 1, for example, if you access the DP slave with the programming device or another DP master. The PROFIBUS address of the DP master that assigned parameters to the DP slave is located in the "Master PROFIBUS address" diagnostics byte.

Structure of station status 2 (byte 1)

Table 4- 4 Structure of station status 2 (byte 1)

Bit	Meaning
0	1: The DP slave parameters need to be reassigned.
1	1: A diagnostics message is pending. The DP slave will not operate until the problem is eliminated (static diagnostics message).
2	1: The bit on the DP slave is always "1".
3	1: The watchdog is activated for this DP slave.
4	1: The DP slave has received the "FREEZE" control command ¹ .
5	1: The DP slave has received the "SYNC" control command ¹ .
6	0: Bit is always "0".
7	1: The DP slave is disabled, that is, it has been removed from the processing in progress.

¹ The bit is updated only if another diagnostics message changes also.

Structure of station status 3 (byte 2)

Table 4- 5 Structure of station status 3 (byte 2)

Bit	Meaning
0 to 6	0: Bits are always set to "0".
7	1: <ul style="list-style-type: none"> There are more diagnostics messages pending than the DP slave is able to store. The DP master cannot enter all the diagnostics messages sent by the DP slave in its diagnostics buffer (channel-specific diagnostics).

4.3.4 Master PROFIBUS address

Definition

The Master PROFIBUS address diagnostics byte contains the PROFIBUS address of the DP master:

- That assigned parameters to the DP slave
- That has read and write access to the DP slave

The master PROFIBUS address is located in byte 3 of the slave diagnostics.

4.3.5 Identifier-related diagnostics

Definition

The identifier-related diagnostics indicate whether or not modules of the ET 200S have errors/faults. Identifier-related diagnostics start at byte 6 and are 9 bytes long.

The identifier-related diagnostics for the ET 200S with the IM151-1 HIGH FEATURE are structured as follows:

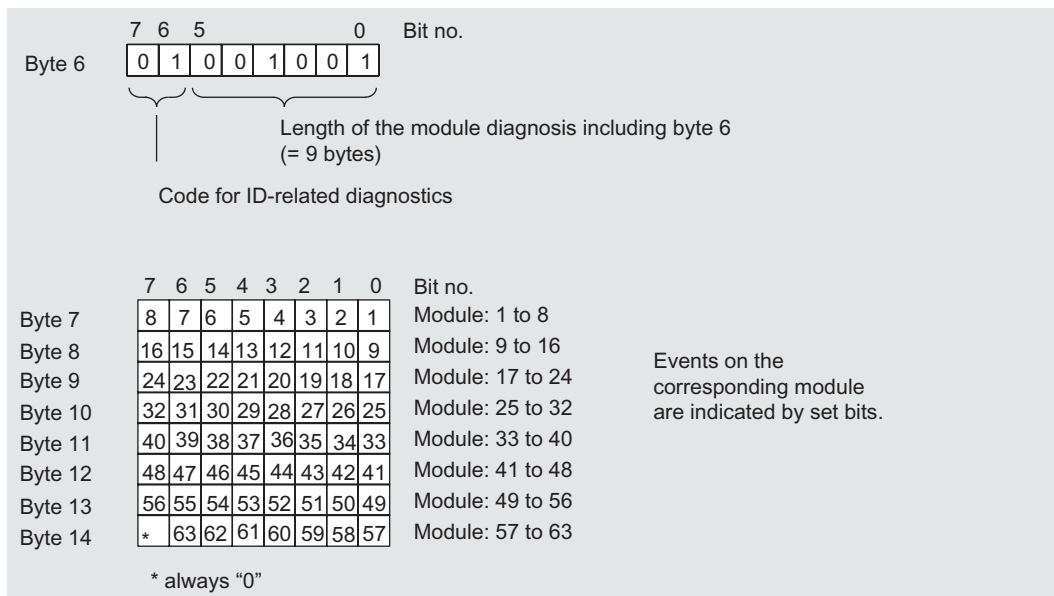

Figure 4-2 Structure of the identifier-related diagnostics for the ET 200S with IM151-1 HIGH FEATURE

4.3.6 Module status

Definition

The module status indicates the status of the configured modules and provides more information on the identifier-related diagnostics with respect to the configuration. The module status begins after the identifier-related diagnostics and comprises 20 bytes.

The module status for the ET 200S with the IM151-1 HIGH FEATURE is structured as follows:

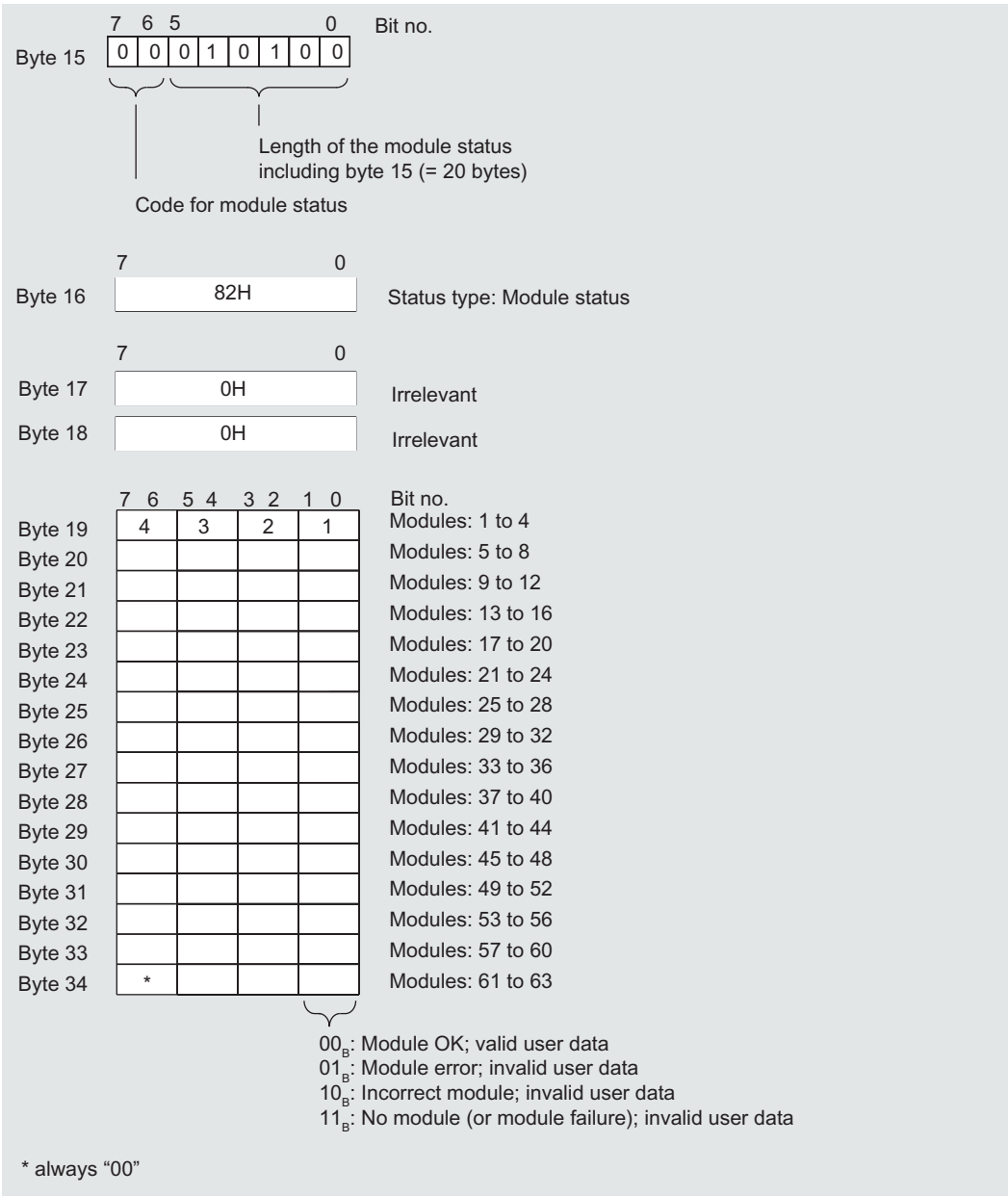

Figure 4-3 Structure of the module status for the ET 200S with the IM151-1 HIGH FEATURE

4.3.7 Channel-specific diagnostics

Definition

Channel-specific diagnostics provide information about channel errors in modules and details of the identifier-related diagnostics. The channel-specific diagnostics start after the module status (if parameters are preset accordingly). The maximum length is limited by the maximum total length of the slave diagnostics, i.e., 62 bytes in DPV0 mode or 128 bytes in DPV1 mode. Channel-specific diagnostics do not affect the module status.

Up to 9 channel-specific diagnostic messages are possible.

The channel-specific diagnostics for the ET 200S with the IM151-1 HIGH FEATURE are structured as follows:

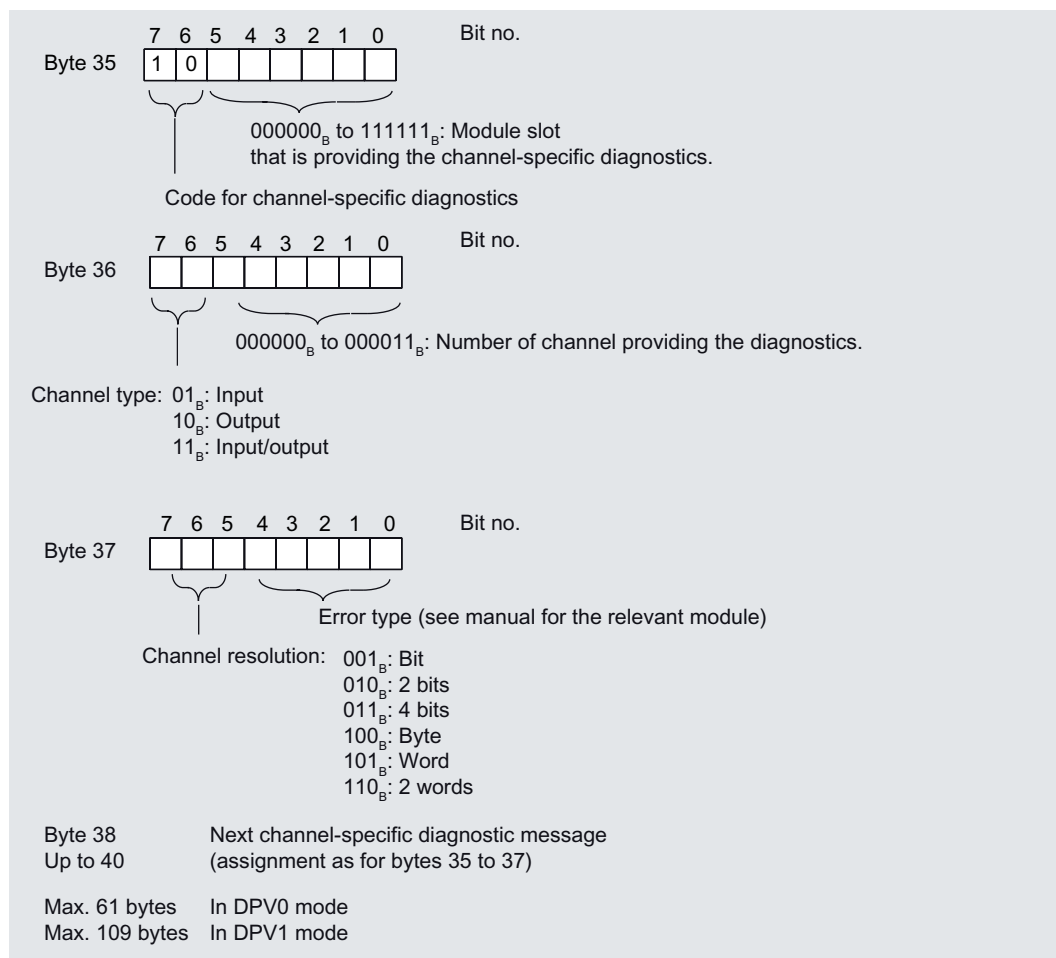

Figure 4-4 Structure of the channel-specific diagnostics for the ET 200S with the IM151-1 HIGH FEATURE;

Note

The module slot coding is contained in byte 35, bits 0 to 5. The following applies: Displayed number +1 $\hat{=}$ Slot of the module (0 $\hat{=}$ Slot 1; 1 $\hat{=}$ Slot 2; 3 $\hat{=}$ Slot 4, etc.)

In bits 6/7 of byte 36, 00_B is output if a power module reports channel-specific diagnostics.

4.3.8 H status

Requirements

The H status in the diagnostic frame supplies the IM151-1 HIGH FEATURE only when operated behind a Y link (e. g. IM 157) in DPV1 mode. This block can be passed over during the evaluation of the diagnostics frame. The configuration is described in the following section.

Structure of the H status

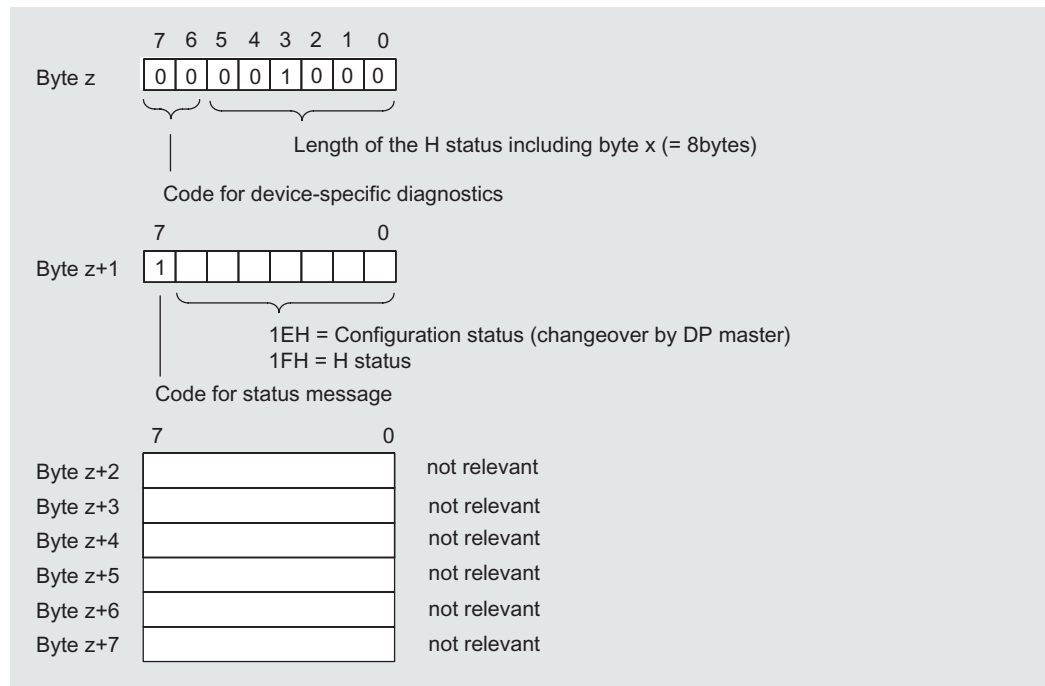

Figure 4-5 Structure of the H status of the IM151-1 HIGH FEATURE

4.3.9 Interrupts

Definition

The interrupt section of the slave diagnostic information indicates the interrupt type and the event that led to an interrupt being triggered. The interrupt section comprises of a maximum 48 bytes.

Position in the diagnostic frame

The interrupt section comes after the channel-specific diagnostics (only in DPV1 mode).

Example: If 3 channel-specific diagnostics are pending, then the interrupt section starts at byte 44.

Data record

The diagnostic data of a module can be up to 44 bytes in length and is located in data records 0 and 1:

- Data record 0 contains 4 bytes of diagnostic data describing the current status of an automation system. DS0 is part of the header information of OB 82 (local data bytes 8 to 11).
- Data record 1 contains the 4 bytes of diagnostic data that is also contained in data record 0 and, in addition, up to 40 bytes of module-specific diagnostic data.

DS0 and DS1 can be read out with SFC 59 "RD_REC."

List of Contents

The contents of the interrupt information depend on the interrupt type:

- In the case of diagnostic interrupts, diagnostic data record 1 (up to 44 bytes) is sent as the interrupt status information (starting from byte x+4).
- The status interruption for process interrupts is 4 bytes in length.

Structure of interrupts

Once configuration with *STEP 7* is completed the alarm data is evaluated and transferred to the relevant organization blocks (OBs).

The interrupt section for the ET 200S is structured as follows:

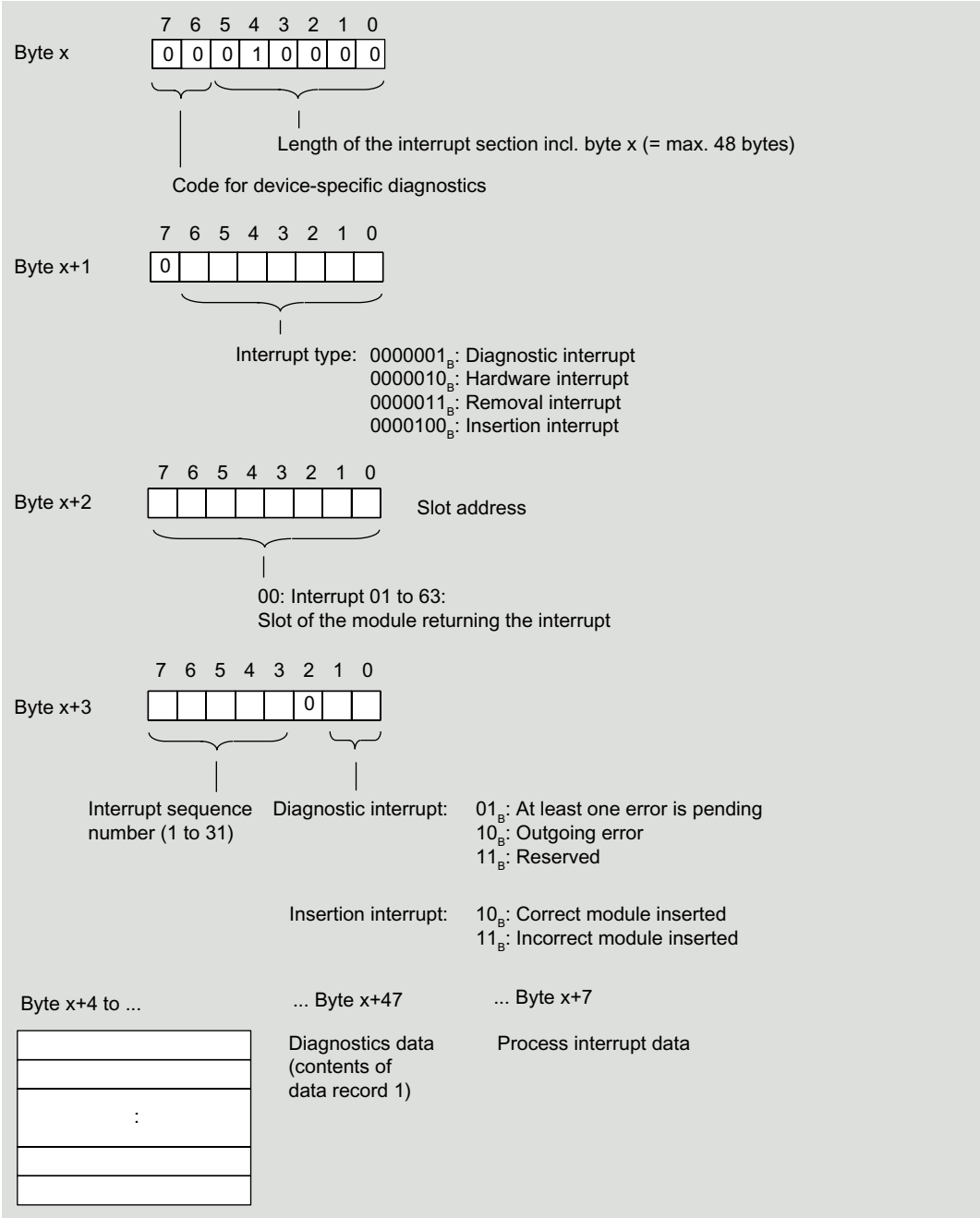

Figure 4-6 Structure of the interrupt status of the interrupt section

Diagnostic interrupt, byte x+4 to x+7

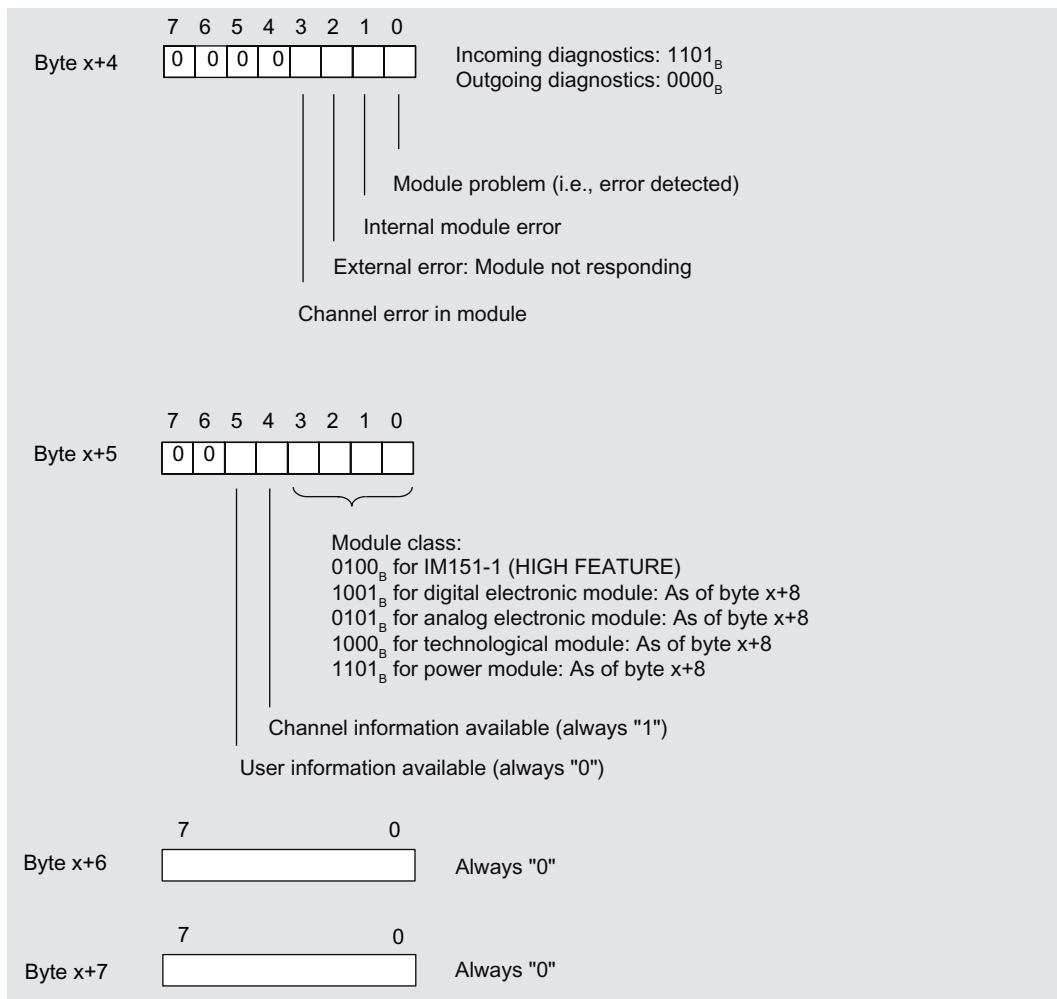

Figure 4-7 Structure of bytes x+4 to x+7 for diagnostic interrupt

Diagnostic interrupt from the modules, bytes x+8 to x+11

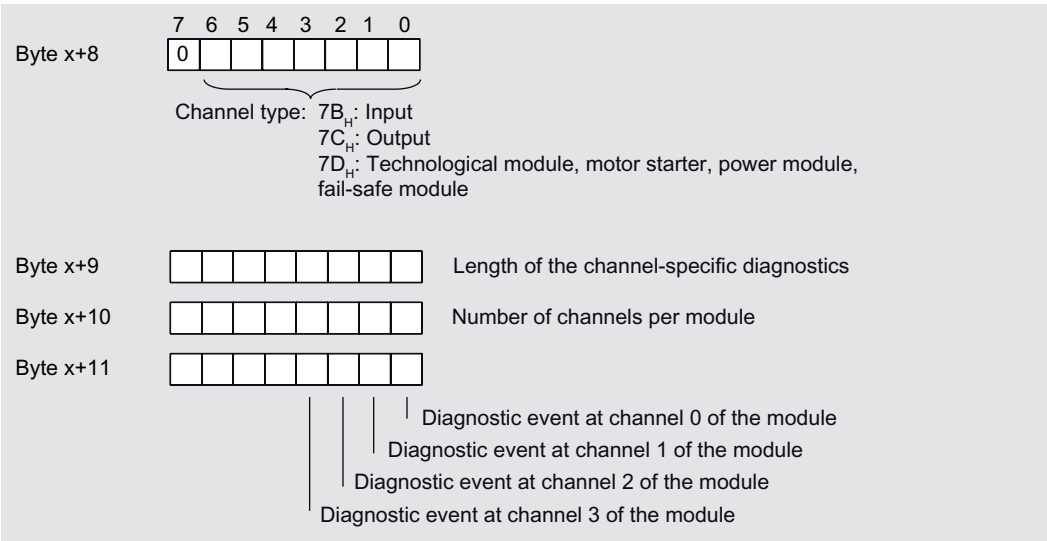

Figure 4-8 Structure of bytes x+8 to x+11 for the diagnostics frame

Diagnostic interrupt from the modules, bytes x+12 to x+15

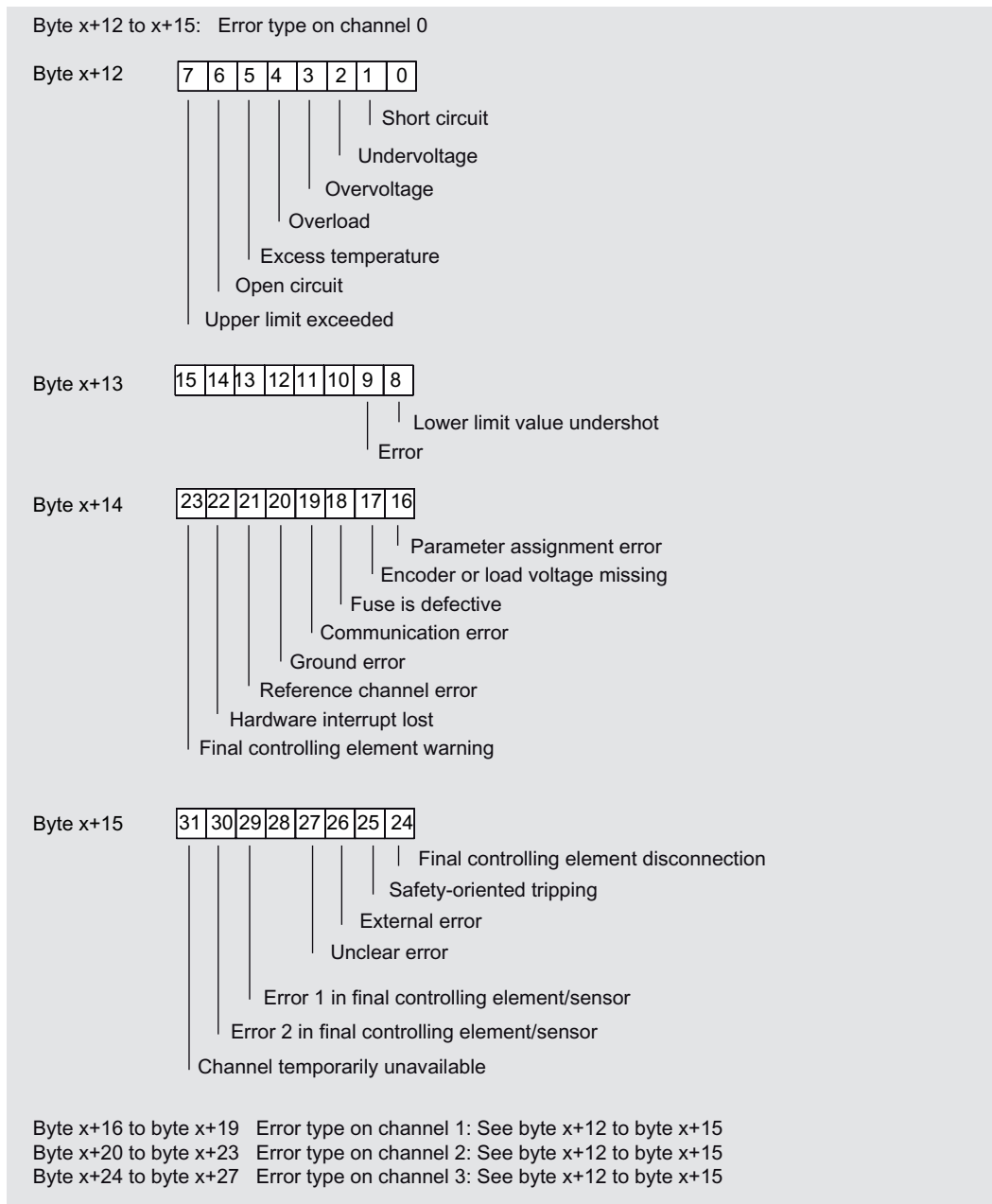

Figure 4-9 Structure of bytes x+12 to x+15 for the diagnostics frame

Example of a Diagnostic Interrupt

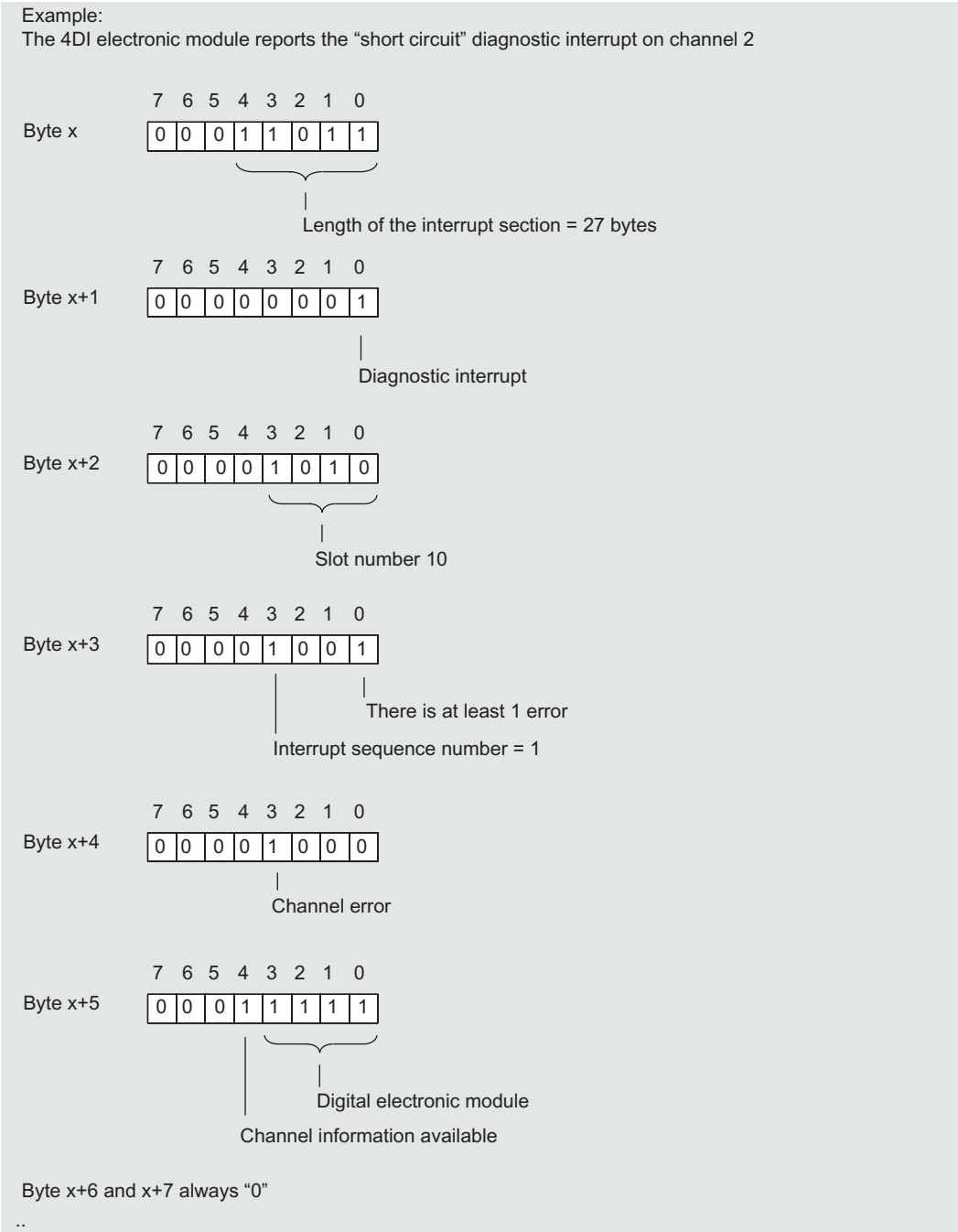

Figure 4-10 Example of a diagnostic interrupt (Part 1)

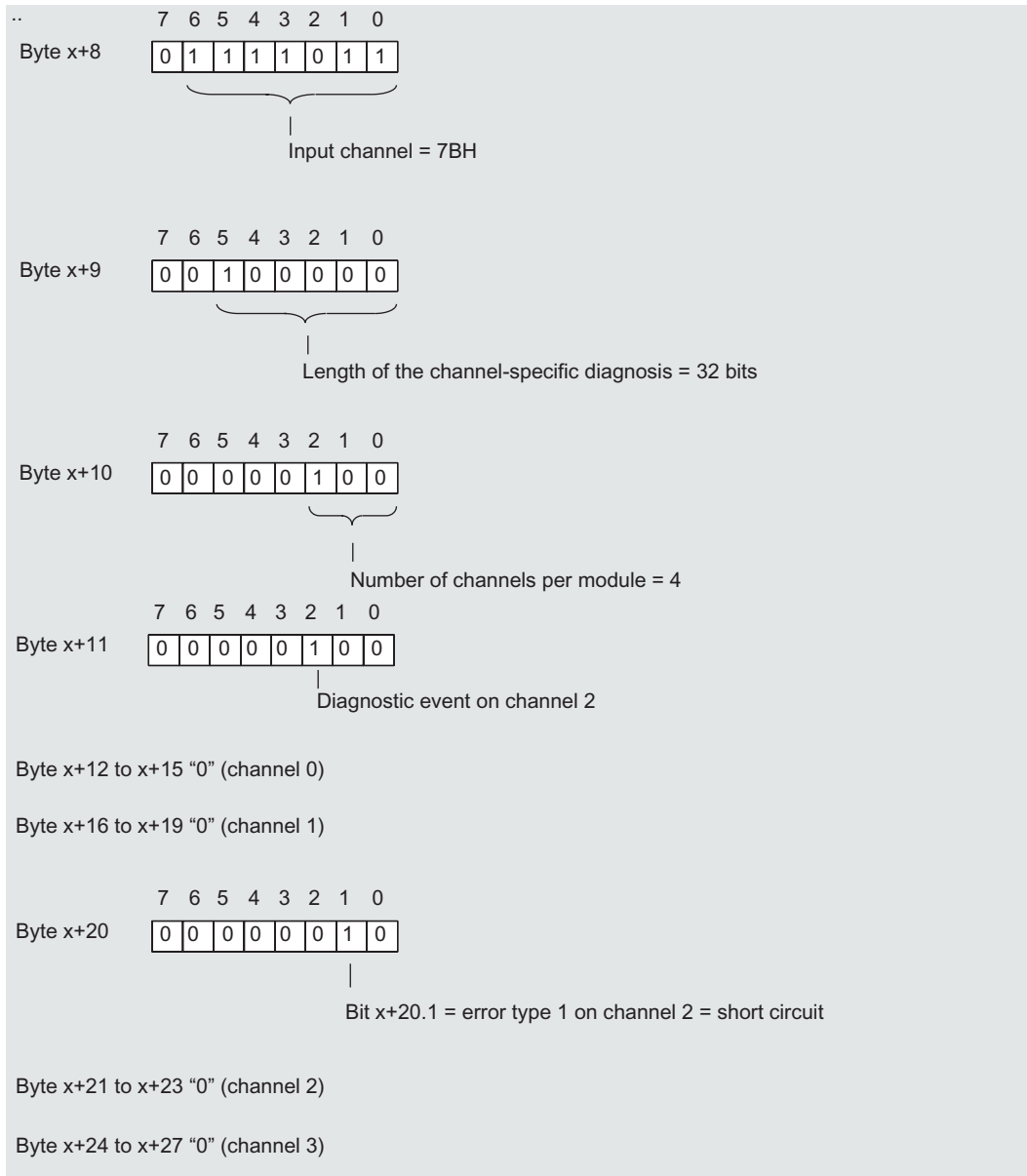

Figure 4-11 Example of a diagnostic interrupt (Part 2)

Process interrupt of digital input modules

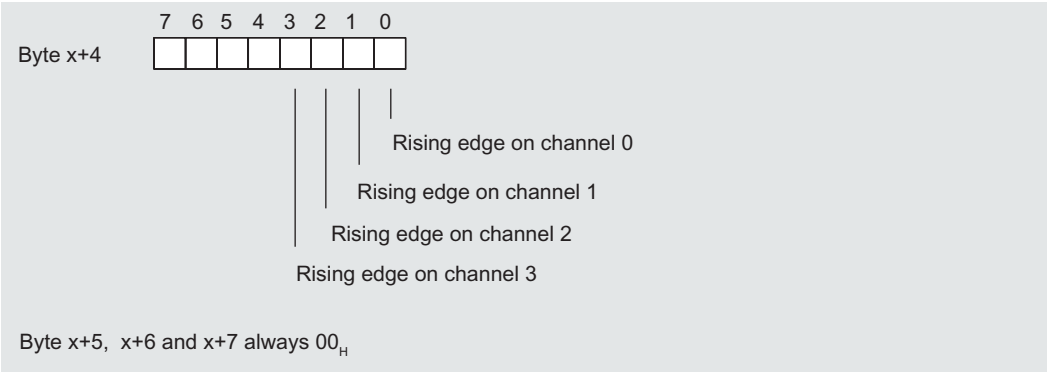

Figure 4-12 Structure as of Byte x+4 for process interrupt (digital input)

Process interrupt of analog input modules

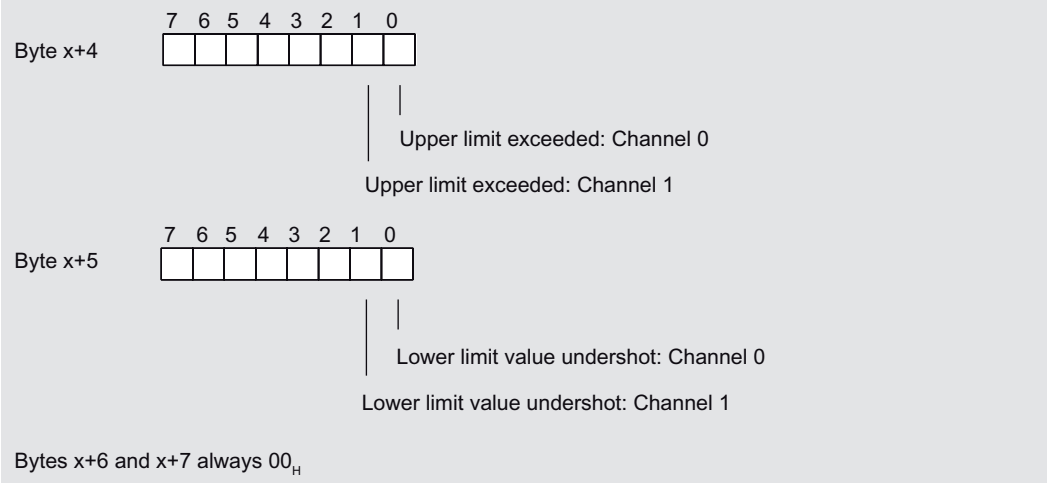

Figure 4-13 Structure as of Byte x+4 and Byte x+5 for process interrupt (analog input)

4.3.10 Incorrect module configurations of ET 200S on the PROFIBUS DP

Invalid module configuration states

The following invalid ET 200S module configuration states lead to an ET 200S station failure or prevent entry into data exchange. These responses occur regardless of whether the IM parameters "Operation at set <> actual configuration", "Replace modules during operation", and "Startup at set <> actual configuration" have been enabled.

- Two missing modules
- Terminating module missing
- Number of modules exceeds maximum configuration
- Backplane bus fault (for example, defective terminal module)

Note

The station will not start up if **one** module is missing (gap) and the ET 200S is switched on.

Diagnostics

You can identify any invalid module configuration states on the basis of the following diagnostics:

Identifier-related diagnostics	Module status
All 63 bits set	<ul style="list-style-type: none">• 01_B: "Module error; invalid user data" for all modules (slots) until the cause of the error is found• 11_B: "No module; invalid user data" once the cause of the error is found

4.4 Evaluating the interrupts of the ET 200S

Introduction

In the case of certain process states/errors, the DP slave saves one interrupt block for each process state or error containing relevant information in the diagnostic frame (DPV1 interrupt mechanism). Independent of this, the diagnostic status of the DP slave is maintained in the identifier-related diagnostics, the module status, and the channel-related diagnostics.

Interrupts in DPV0 mode

For DPV0 mode, no interrupts are defined in accordance with the PROFIBUS standard. Thus, interface modules do not trigger an interrupt in DPV0 mode.

Interrupts in DPV1 mode

The ET 200S supports the following interrupts:

- Diagnostic interrupts
- Process interrupts
- Insert/remove interrupts

Requirements: Interrupts are only supported when you run the ET 200S with the IM151-1 HIGH FEATURE interface module (in DPV1 mode).

In case of an interrupt, interrupt OBs are automatically executed in the CPU of the DP master (see information on program design in the *System Software for S7-300/S7-400 programming manual*).

Triggering of a diagnostic interrupt

When an incoming or outgoing event (e.g. wire break) is registered the module triggers a diagnostic interrupt: if "Enable: Diagnostic interrupt" is set.

The CPU interrupts processing of the user program and processes the OB 82 diagnostic block instead. The event that triggered the interrupt is entered in the OB 82 start information.

Evaluating hardware interrupts with *STEP 7*

When a process interrupt occurs the CPU interrupts the processing of the user program and processes the OB 40 interrupt block.

The module channel that triggered the process interrupt is entered in the start information of OB 40 in the OB 40_POINT_ADDR variable. The figures below present the assignment to the bits of the local data double word 8.

Process interrupts in electronic modules 2DI DC24V HF and 4DI DC24V HF:

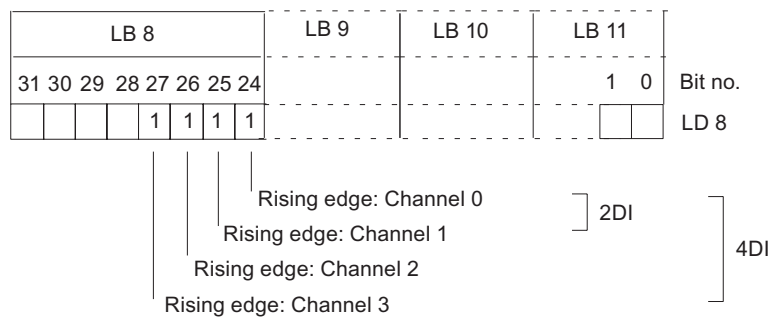

Figure 4-14 OB 40 start information: The event that triggered process interrupt for digital input modules

Process interrupts for 2AI U HS, 2AI I 2WIRE HS und 2AI I 4WIRE HS electronic modules:

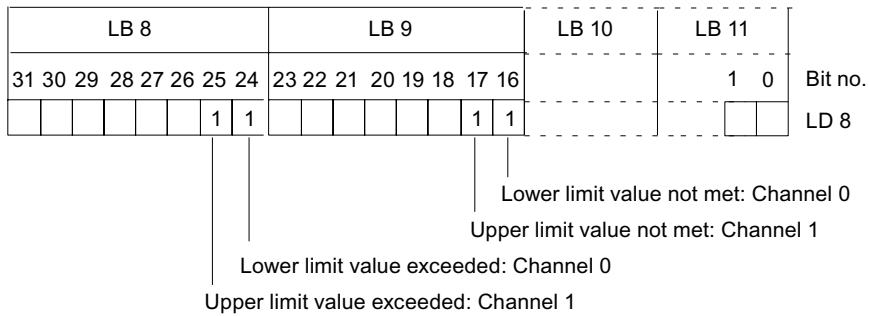

Figure 4-15 OB 40 start information: The event that triggered process interrupt for analog input modules

You will find a description of OB 40 in the *System and Standard Functions* reference manual.

Triggering of a swapping module interrupt

Insert/remove-module interrupts are supported in DPV1 mode. The CPU interrupts processing of the user program and processes the OB 83 diagnostic block instead. The event that triggered the interrupt is entered in the OB 83 start information.

"Process interrupt lost" Diagnostics

Modules with a controller use the "Process interrupt lost" diagnostics.

The "Process interrupt lost" diagnostics are not currently available for the 2DI 24 V DC High Feature and 4DI 24 V DC High Feature modules.

Note

Process interrupts should not be used for technological purposes (e.g. cyclical generation of process interrupts).

If more than approximately 90 process interrupts are generated per second, process interrupts may be lost.

Response times

5.1 Overview

The figure below shows the various response times between DP Master and ET 200S.

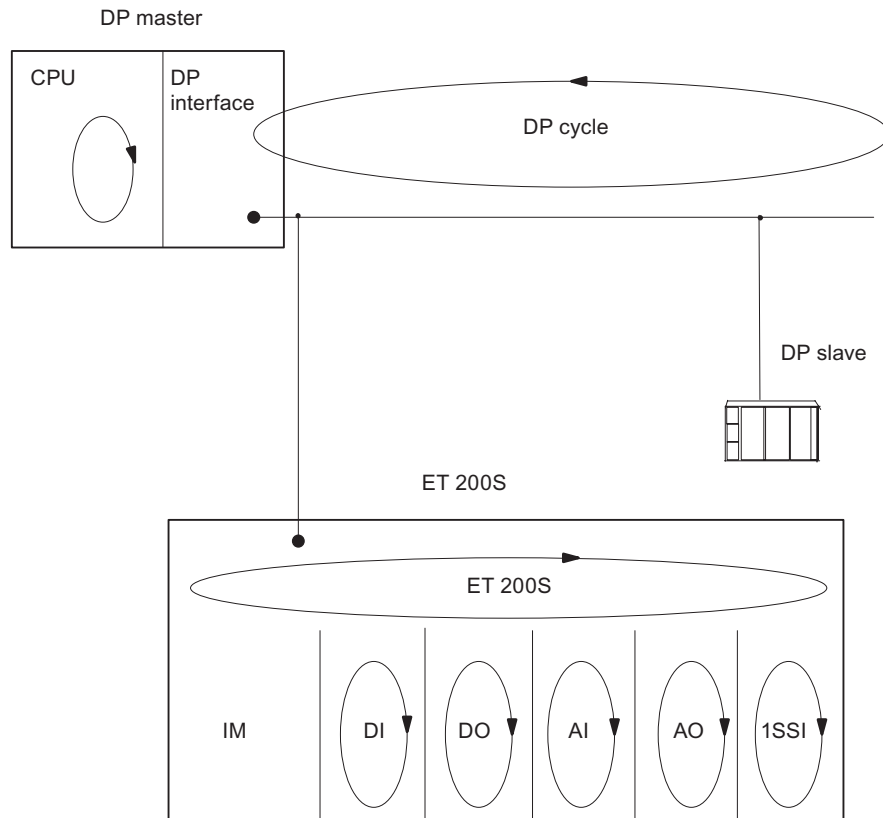

Figure 5-1 Response times between DP Master and ET 200S

5.2 Response times for the ET 200S

Calculating the response time with the IM151-1 HIGH FEATURE

The following equation enables you to make an approximate calculation of the ET 200S response time:

$$\text{Response time } [\mu\text{s}] \text{ (non-isochronous mode)} = 16 + m + 9 + b + 160$$

Explanation of the parameters:

- **m**: Sum total of all configured modules
- **b**: Sum total of all input and output bytes (without bit granular modules)

Example for calculating the ET 200S response time for the IM151-1 HIGH FEATURE (6ES7151-1BA02-0AB0), firmware V2.2 and higher

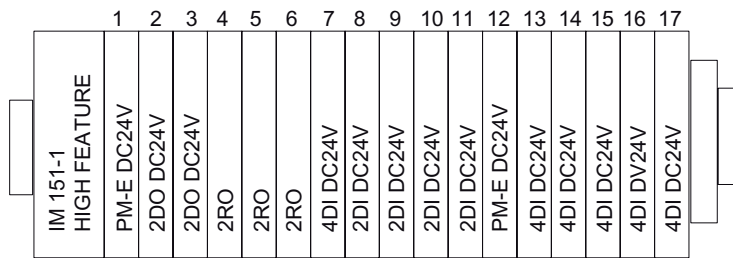

Figure 5-2 Example setup for calculating the ET 200S response time for the IM151-1 HIGH FEATURE

Calculation method:

$$m = 17; b = 0$$

$$\text{Response time } [\mu\text{s}] = 16 + m + 9 + b + 160$$

$$\text{Response time } [\mu\text{s}] = 16 + 17 + 9 + 0 + 160$$

$$\text{Response time } [\mu\text{s}] = \mathbf{432 \mu\text{s}}$$

5.3 Response time for digital input modules

Input delay

The reaction times of the digital input modules depend on the input delay.

Reference

Information on the input delays can be found in the technical data of the *manual* for the relevant digital electronic module.

5.4 Response time for digital output modules

Output delay

The response times correspond to the output delay.

Reference

Information on the output delays can be found in the technical data of the *manual* for the relevant digital electronic module.

5.5 Response time for analog input modules

Conversion time

The conversion time comprises the basic conversion time and the processing time for wire break check diagnostics.

In integrative conversion processes, the integration time is included directly in the conversion time.

Cycle time

The analog/digital conversion and the transfer of the digitized measured values to memory or to the backplane bus take place sequentially. In other words, the analog input channels are converted one after the other. The cycle time, that is, the time until an analog output value is converted again, is the sum of the conversion times of all the activated analog output channels of the analog input modules. You should deactivate unused analog input channels during parameter assignment in order to reduce the cycle time. The conversion and integration time for a deactivated channel is 0.

The following figure gives you an overview of what the cycle time for an n-channel analog input module comprises.

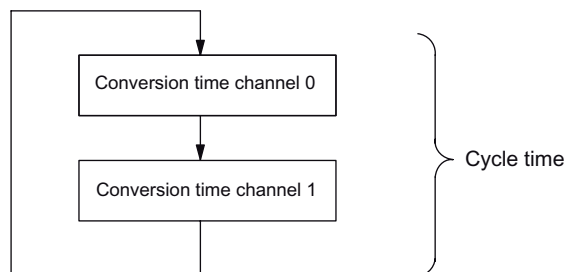

Figure 5-3 Cycle time of the analog input module

Reference

Information on the conversion times can be found in the technical data of the *manual* for the relevant analog electronic module.

5.6 Reaction times of analog output modules

Conversion time

The conversion time of the analog output channels comprises the time for the transfer of the digitized output values from internal memory and the digital/analog conversion.

Cycle time

The conversion of the analog output channels for the module takes place with a processing time and sequentially with a conversion time for channels 0 and 1.

The cycle time, i.e. the time until an analog output value is converted again, is the sum of the conversion times of all the activated analog output channels and of the processing time of the analog output module.

The following figure provides you with an overview of what makes up the cycle time for an analog output module.

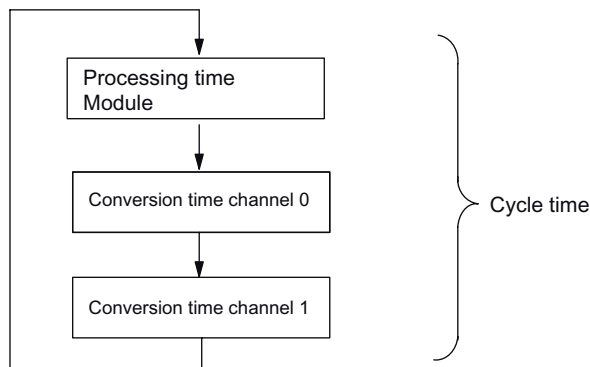

Figure 5-4 Cycle time of the analog output module

Settling time

The settling time (t_2 to t_3) i.e. the time from the application of the converted value until the specified value is obtained at the analog output - depends on the load. A distinction must be drawn between resistive, capacitive, and inductive loads.

Response time

The response time (t_1 to t_3) i.e., the time from the application of the digital output values in internal memory until the specified value is obtained at the analog output - is, in the most unfavorable case, the sum of the cycle time and the settling time. The most unfavorable case is when the analog channel is converted shortly before the transfer of a new output value and is not converted again until after the conversion of the other channels (cycle time).

This figure shows the response time of an analog output channel:

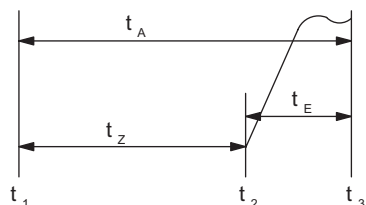

t_A	Response time
t_Z	Cycle time, corresponding to the processing time of the module and the conversion time of the channel
t_E	Settling time
t_1	new digital value applied
t_2	output value transferred and converted
t_3	specified output value obtained

Figure 5-5 Response time of an analog output channel

Reference

Information on the conversion times can be found in the technical data of the *manual* for the relevant analog electronic module.

5.7 Response times for a 4 IQ-SENSE electronic module

The response time of the 4 IQ-SENSE electronic module is specified as a cycle time in the Technical Data.

5.8 Response times for technology modules

The response times of the technology modules are specified as response time or update rate in the Technical Data. See *ET 200S Technological Functions Manual*.

Index

B

Basic knowledge requirements, 3
Block diagram, 9

C

Channel-specific diagnostics, 52
Configuration, 11
Control interface, 31, 39
Conversion time, 68
Cycle synchronization
 Parameter assignment, 22
 Parameter assignment for Ti/To overlap, 25
Cycle time, 67, 68

D

Definition
 Station status, 48
Diagnostics
 H status, 53
Disposal, 3

F

Feedback interface, 31, 39

H

H status, 53

I

Identification Data, 40
Identifier-related diagnostics, 50
IM151-1 HIGH FEATURE interface module
 Status and error displays, 44
Internet
 Service & Support, 4
Isochronous operation
 Overlapping of Ti and To, 21
 Prerequisites, 21

L

Length of the diagnostics frame, 45

M

Master PROFIBUS address, 49
Module status, 51

O

Option handling, 27
 Functional principle, 26
 parameter assignment, 29, 37
 Prerequisites, 35
Options, 46

P

Parameters, 13
PII, 31, 39
PIQ, 31, 39

R

Reading out diagnostics, 45, 46
Recycling, 3
RESERVE modules
 Use of, 28
Response time, 69
Response times, 65
 4 IQ-SENSE, 69
 analog input modules, 67
 analog output modules, 68
 digital input modules, 66
 digital output modules, 67
 Technological modules, 69

S

Scope
 Manual, 3
Service & Support, 4
Settling time, 68

SFC 13, 46
Slave diagnostics, 45, 47
Station status 1
 Structure, 48
Station status 2
 Structure, 49
Station status 3
 Structure, 49
Station statuses 1 to 3, 48
Status and error displays, 44
 IM151-1 HIGH FEATURE, 44
STEP 7 user program, 46
Structure, 47

T

Technical data, 10
Technical Support, 4
Terminal assignment, 8
Training center, 4

U

Updating firmware, 11

SIEMENS

SIMATIC

Distributed I/O

Product Information for the ET 200S IM 151-1 STANDARD, IM 151-1 HIGH FEATURE Manuals

Product Information

LED display of the configuration and parameter assignment errors

Properties

The configuration and parameter assignment errors of the ET 200S distributed I/O system are output at the interface module by means of the LEDs group error **SF** (red) and bus error **BF** (red).



Requirements

- The function is available for the following interface modules from the specified firmware version on:
 - IM151-1 STANDARD (6ES7 151-1AA05-0AB0): FW Version V2.2.3
 - IM151-1 HIGH FEATURE (6ES7 151-1BA02-0AB0): FW Version V2.2.2
- The current firmware can be downloaded from Service&Support on the Internet at:
<http://www.siemens.com/automation/service&support>

Mode of operation

The information about the cause of the problem is determined by means of the LED fault display. After an announcement by means of a flashing signal, the respective error type and after that the error location / error code are displayed.

The LED fault display of the configuration and parameter assignment errors

- Is activated both during POWER ON and during operation.
- Takes precedence over all other states that are displayed by the SF and BF LED.
- Remains activated until the cause of the problem has been eliminated.

After a change in the ET 200S configuration, a POWER-OFF / POWER ON may be required at the interface module.

Steps	Description
1	LEDs SF and BF flash 3x at 0.5 Hz Announcement of error type
2	LED BF flashes at 1 Hz Display of the error type (decimal)
3	LEDs SF and BF flash 3x at 2 Hz Announcement of the error location / error code
4	LED SF flashes at 1 Hz Display of the decade (decimal) of the error location / error code
5	LED BF flashes at 1 Hz Display of the unit position (decimal) of the error location / error code
6	Repetition of 1 - 5 until the cause of the problem has been eliminated.

Error display

Error type (BF)	Error location (SF/BF)	Cause of the problem	Measure
1	01 to 63 (slot)	<p>Communication interruption Displays the first slot at which no I/O module is recognized.</p> <ul style="list-style-type: none"> • Missing I/O module during POWER ON or several I/O modules are missing during operation. • Interruptions at the rear panel bus • Short-circuit at the rear panel bus ("01" is output as the slot) • Termination module missing If the termination module is missing, the number of inserted I/O modules + 1 is output (if there is no set configuration) 	Check the configuration of the ET 200S.
2	01 to 63 (slot)	<p>Termination module not recognized This error type is output if there is a set configuration and the slot at which an I/O module is no longer recognized is equal to (number of modules of the set configuration +1).</p>	Install the termination module.
3	01 to 63 (slot)	<p>I/O module The configured structure of the ET 200S does not match the actual structure of the ET 200S. The first slot that displays a configuration error (missing module, incorrect module module fault) is displayed. This error is only output if the parameter "Operation at preset <=> actual configuration" is locked.</p>	Check the structure or the configuration of the ET 200S, whether a module is missing or defective, or whether an unconfigured module has been inserted.

The following errors can only occur if you have configured the ET 200S at a master from a different supplier or by using the GSD file:

Error type (BF)	Error location, error code (SF/BF)	Cause of the problem	Measures
4	01	<p>Configuration error at the option handling Option handling has been configured but no power module was configured for options handling.</p>	Change the configuration.
	02 to 63 (slot)	<p>Option handling has been configured but more than one power module was configured for options handling. The slot of the second power module that has option handling is displayed.</p>	
5 ¹	01	<p>General parameter assignment error The number of module parameter blocks in the parameter assignment telegram does not agree with the number of identifiers in the configuration telegram.</p>	Correct the configuration.
	02	<p>The maximum address area (inputs and outputs) of the interface module has been exceeded.</p>	
	03	<p>Incorrect structure of the parameter assignment telegram.</p>	

¹ You prevent this error when configuration is carried out with STEP 7 and it is only possible if other configuration tools are used.