

SIEMENS

SINAMICS

SINAMICS G120 CU240B-2 and CU240E-2 Control Units

Compact Operating Instructions

Fundamental safety instructions	1
Scope of delivery	2
Installing	3
Commissioning	4
More information	5



Edition 04/2015

04/2015
A5E35792002B AA



Scan the QR code
for additional
information about
SINAMICS G120.



Legal information

Warning notice system

This manual contains notices you have to observe in order to ensure your personal safety, as well as to prevent damage to property. The notices referring to your personal safety are highlighted in the manual by a safety alert symbol, notices referring only to property damage have no safety alert symbol. These notices shown below are graded according to the degree of danger.

 DANGER
indicates that death or severe personal injury will result if proper precautions are not taken.
 WARNING
indicates that death or severe personal injury may result if proper precautions are not taken.
 CAUTION
indicates that minor personal injury can result if proper precautions are not taken.
NOTICE
indicates that property damage can result if proper precautions are not taken.

If more than one degree of danger is present, the warning notice representing the highest degree of danger will be used. A notice warning of injury to persons with a safety alert symbol may also include a warning relating to property damage.

Qualified Personnel

The product/system described in this documentation may be operated only by **personnel qualified** for the specific task in accordance with the relevant documentation, in particular its warning notices and safety instructions. Qualified personnel are those who, based on their training and experience, are capable of identifying risks and avoiding potential hazards when working with these products/systems.

Proper use of Siemens products

Note the following:

 WARNING
Siemens products may only be used for the applications described in the catalog and in the relevant technical documentation. If products and components from other manufacturers are used, these must be recommended or approved by Siemens. Proper transport, storage, installation, assembly, commissioning, operation and maintenance are required to ensure that the products operate safely and without any problems. The permissible ambient conditions must be complied with. The information in the relevant documentation must be observed.

Trademarks

All names identified by ® are registered trademarks of Siemens AG. The remaining trademarks in this publication may be trademarks whose use by third parties for their own purposes could violate the rights of the owner.

Disclaimer of Liability

We have reviewed the contents of this publication to ensure consistency with the hardware and software described. Since variance cannot be precluded entirely, we cannot guarantee full consistency. However, the information in this publication is reviewed regularly and any necessary corrections are included in subsequent editions.

Table of contents

1	Fundamental safety instructions	4
1.1	General safety instructions	4
1.2	Industrial security	5
2	Scope of delivery	6
3	Installing	7
3.1	Plugging the Control Unit onto the Power Module.....	7
3.2	Overview of the interfaces	8
3.3	Terminal strips on CU240B-2 Control Units.....	10
3.4	Terminal strips on CU240E-2 Control Units.....	13
4	Commissioning	18
4.1	Tools to commission the converter	18
4.2	Commissioning with BOP-2 operator panel.....	19
4.2.1	Basic commissioning with BOP-2	19
4.2.2	Standard Drive Control	21
4.2.3	Dynamic Drive Control	23
4.3	Connecting the inverter to the fieldbus	26
4.4	Frequently required parameters	28
5	More information	31
5.1	Manuals for your inverter	31
5.2	Product support.....	32

This manual describes how you install the CU240B-2 or CU240E-2 Control Unit of the SINAMICS G120 inverter and commission it.

What is the meaning of the symbols in the manual?



1 An operating instruction starts here.



This concludes the operating instruction.

1

Fundamental safety instructions

1.1 General safety instructions

 **WARNING**

Risk of death if the safety instructions and remaining risks are not carefully observed

If the safety instructions and residual risks are not observed in the associated hardware documentation, accidents involving severe injuries or death can occur.

- Observe the safety instructions given in the hardware documentation.
- Consider the residual risks for the risk evaluation.

 **WARNING**

Danger to life or malfunctions of the machine as a result of incorrect or changed parameterization

As a result of incorrect or changed parameterization, machines can malfunction, which in turn can lead to injuries or death.

- Protect the parameterization (parameter assignments) against unauthorized access.
- Respond to possible malfunctions by applying suitable measures (e.g. EMERGENCY STOP or EMERGENCY OFF).

1.2 Industrial security

Note

Industrial security

Siemens provides products and solutions with industrial security functions that support the secure operation of plants, solutions, machines, equipment and/or networks. They are important components in a holistic industrial security concept. With this in mind, Siemens' products and solutions undergo continuous development. Siemens recommends strongly that you regularly check for product updates.

For the secure operation of Siemens products and solutions, it is necessary to take suitable preventive action (e.g. cell protection concept) and integrate each component into a holistic, state-of-the-art industrial security concept. Third-party products that may be in use should also be considered. For more information about industrial security, visit Hotspot-Text (<http://www.siemens.com/industrialsecurity>).

To stay informed about product updates as they occur, sign up for a product-specific newsletter. For more information, visit Hotspot-Text (<http://support.automation.siemens.com>).

WARNING

Danger as a result of unsafe operating states resulting from software manipulation

Software manipulation (e.g. by viruses, Trojan horses, malware, worms) can cause unsafe operating states to develop in your installation which can result in death, severe injuries and/or material damage.

- Keep the software up to date.
You will find relevant information and newsletters at this address (<http://support.automation.siemens.com>).
- Incorporate the automation and drive components into a holistic, state-of-the-art industrial security concept for the installation or machine.
You will find further information at this address (<http://www.siemens.com/industrialsecurity>).
- Make sure that you include all installed products into the holistic industrial security concept.

2

Scope of delivery

The delivery comprises at least the following components:

- A CU240B-2 or a CU240E-2 control unit with firmware, which is ready to run. Options for upgrading and downgrading the firmware can be found on the Internet: Firmware (<http://support.automation.siemens.com/WW/news/en/67364620>).

The fieldbus interface of the Control Unit depends on the Article No. The Article No., the designation and the version of the hardware (e.g. 02) and firmware (e.g. 4.6) can be found on the rating plate ① of the Control Unit.

	Designation	Article number	Fieldbus
	CU240B-2	6SL3244-0BB00-1BA1	USS, Modbus RTU
	CU240B-2 DP	6SL3244-0BB00-1PA1	PROFIBUS DP
	CU240E-2	6SL3244-0BB12-1BA1	USS, Modbus RTU
	CU240E-2 F	6SL3244-0BB13-1BA1	
	CU240E-2 DP	6SL3244-0BB12-1PA1	PROFIBUS DP
	CU240E-2 DP-F	6SL3244-0BB13-1PA1	
	CU240E-2 PN	6SL3244-0BB12-1FA0	PROFINET IO, EtherNet/IP
CU240E-2 PN-F	6SL3244-0BB13-1FA0		

- Compact Operating Instructions in German and English
- The inverter contains open-source software (OSS). The OSS license terms are saved in the inverter.

Reading the OSS license terms

The inverter contains open-source software (OSS). OSS comprises open source text and satisfies special license terms. If you wish to read the license terms, you must transfer them from the inverter to a PC.

Procedure



To transfer the OSS license terms from the inverter to a PC, proceed as follows:

1. Switch off the inverter power supply.
2. Insert an empty memory card into the card slot of the inverter. See also Section: Overview of the interfaces (Page 8)
3. Switch on the inverter power supply.
4. When you have switched on the power supply, wait 30 seconds.
During this time, the inverter writes the "Read_OSS.ZIP" file onto the memory card.
5. Switch off the inverter power supply.
6. Withdraw the memory card from the inverter.
7. Use a card reader and load the file to a PC.



You have then transferred the OSS license terms from the inverter to a PC, and you can now read the license terms.

Installing

3.1 Plugging the Control Unit onto the Power Module

Permissible Power Modules

You may operate the Control Unit with the following Power Modules:

Power Module	✓ = operation with Power Module permissible, --- = not permissible	
	CU240B-2	CU240E-2
PM340 1AC	---	✓
PM230 IP20 and push-through	✓	✓
PM240	✓	✓
PM240-2	✓	✓
PM250	✓	✓
PM260	✓	✓

Plugging the Control Unit onto an IP20 Power Module FSA ... FSF



Procedure

Proceed as follows to plug the Control Unit onto a Power Module:

1. Locate the lugs at the rear of the Control Unit in the matching recesses of the Power Module.
2. Press the Control Unit onto the Power Module until you hear it latch into place.

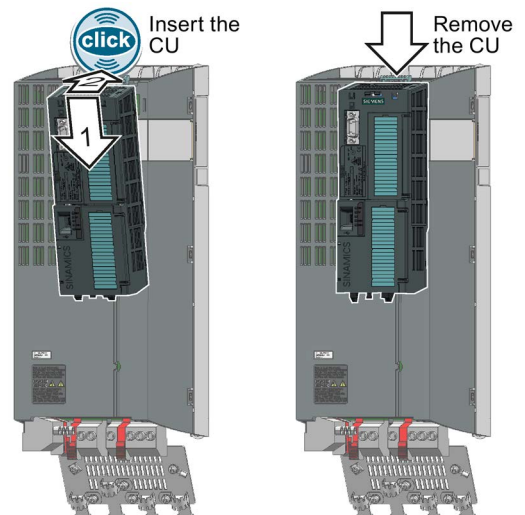

You have now plugged the Control Unit onto the Power Module.

To remove the Control Unit, press on the release button on the Power Module and withdraw the Control Unit.

3.2 Overview of the interfaces

Interfaces at the front of the Control Unit

To access the interfaces at the front of the Control Unit, you must lift the Operator Panel (if one is being used) and open the front doors.

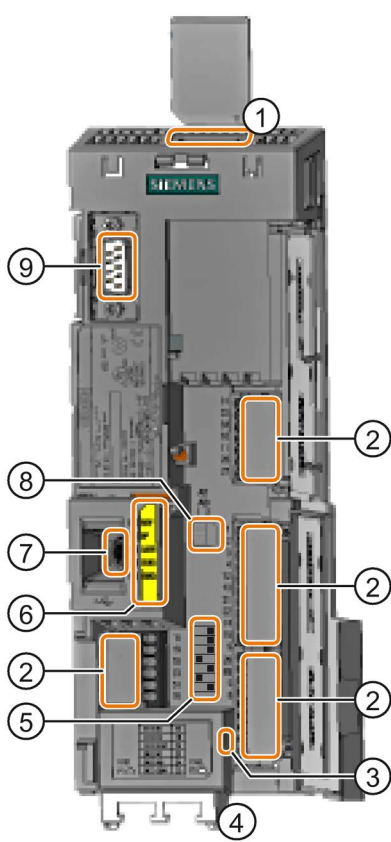

- ① Memory card slot
- ② Terminal strips
- ③ Depending on the fieldbus:
 - USS, Modbus: Bus termination
 - PROFIBUS, PROFINET, EtherNet/IP: No function
- ④ Fieldbus interfaces at the lower side
- ⑤ Selecting the fieldbus address
On all Control Units with the exception of CU240E-2 PN and CU240E-2 PN-F.

Bit 6 (64)	■
Bit 5 (32)	■
Bit 4 (16)	■
Bit 3 (8)	■
Bit 2 (4)	■
Bit 1 (2)	■
Bit 0 (1)	■
On	Off
- ⑥ Status LED

■	RDY
■	BF
■	SAFE
■	LNK1, only for PROFINET
■	LNK2, only for PROFINET
- ⑦ USB interface for connection to a PC
- ⑧ Switch for AI 0 and AI 1 ¹⁾ (U/I)

AI1	■
AI0	■
I	U

 - I 0/4 mA ... 20 mA
 - U -10/0 V ... 10 V
- ⑨ Connection to the operator panel

Table 3- 1 Number of inputs and outputs

	Digital inputs DI	Digital outputs DO	Analog inputs AI	Analog outputs AO	Safe inputs F-DI ¹⁾
CU240B-2, CU240B-2 DP	4	1	1	1	0
CU240E-2, CU240E-2 DP, CU240E-2 PN	6	3	2	2	1
CU240E-2 F, CU240E-2 DP-F, CU240E-2 PN-F	6	3	2	2	3

¹⁾ Every F-DI safe input used occupies two digital inputs DI

Table 3- 2 Permissible cable and wiring options

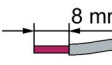
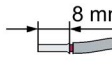
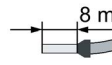
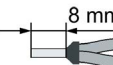
Solid or flexible conductors	Finely stranded conductor with non-insulated end sleeve	Finely stranded conductor with partially insulated end sleeve	Two finely stranded conductors with the same cross-section with partially insulated twin end sleeves
 0.5 ... 1.5 mm ²	 0.5 ... 1.0 mm ²	 0.5 mm ²	 2 * 0.5 mm ²

Wiring the terminal strip in compliance with EMC

- If you use shielded cables, then you must connect the shield to the mounting plate of the control cabinet or with the shield support of the inverter through a good electrical connection and a large surface area.
- Use the shield connection plate of the Control Unit as shield support and strain relief.

Table 3- 3 Article numbers

Shield connection kit 2 for the CU240B-2 and CU240E-2 Control Units with all fieldbus interfaces except for PROFINET.	6SL3264-1EA00-0HA0
Shield connection kit 3 for the CU230P-2 and CU240E-2 Control Units with PROFINET interface	6SL3264-1EA00-0HB0

Further information about EMC-compliant wiring is available on the Internet: EMC installation guideline (<http://support.automation.siemens.com/WW/view/en/60612658>)

Interfaces at the lower side of the CU240B-2 and CU240E-2 Control Units

RS485 plug for USS and Modbus RTU (X128)

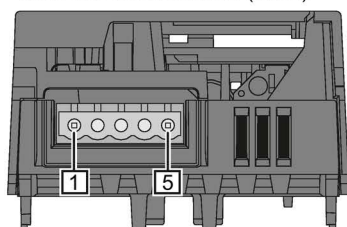

Pin

- 1 0 V, reference potential
- 2 RS485P, receive and transmit (+)
- 3 RS485N, receive and transmit (-)
- 4 Cable shield
- 5 Not connected

RJ45 connector socket for PROFINET IO (X150 P1, X150 P2)

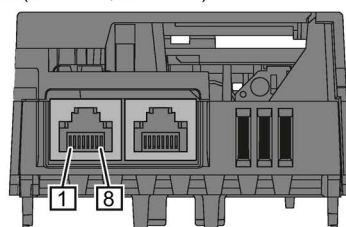

Pin

- 1 RX+, receive data +
- 2 RX-, receive data -
- 3 TX+, Transmit data +
- 4 Not assigned
- 5 Not assigned
- 6 TX-, transmit data -
- 7 Not assigned
- 8 Not assigned

SUB-D socket for PROFIBUS DP (X126)

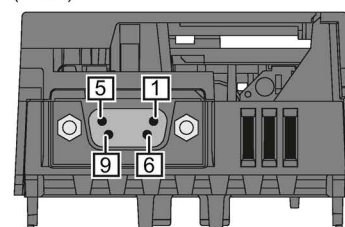

Pin

- 1 Shield, grounding connection
- 2 Not assigned
- 3 RxD/TxD-P, receive and transmit (B/B')
- 4 CNTR-P, control signal
- 5 DGND, reference potential for data (C/C')
- 6 VP, supply voltage
- 7 Not assigned
- 8 RxD/TxD-N, receive and transmit (A/A')
- 9 Not assigned

3.3 Terminal strips on CU240B-2 Control Units

Terminal strips with wiring example

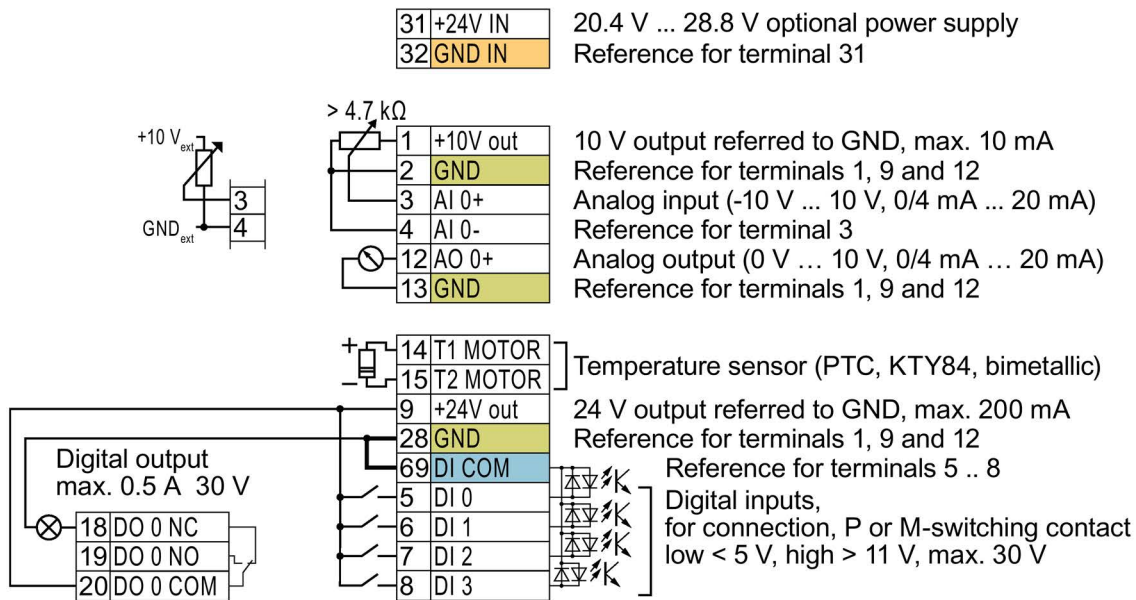

GND All terminals labelled with reference potential "GND" are connected internally in the inverter.

DI COM Reference potential "DI COM" is electrically isolated from "GND".

→ If, as shown above, the 24 V supply from terminal 9 is used to supply the digital inputs, then you must connect "GND" to "DI COM".

Terminals 31, 32 Reference potential "GND IN" is electrically isolated from "GND". When an optional 24 V power supply is connected at terminals 31, 32, even when the Power Module is disconnected from the line supply, the Control Unit remains in operation. The Control Unit thus maintains the fieldbus communication, for example.

GND IN

→ at terminals 31, 32, only connect a power supply that is in accordance with SELV (Safety Extra Low Voltage) or PELV (Protective Extra Low Voltage).

→ if you use a common external power supply for terminals 31, 32 and the digital inputs, you must connect "GND" to "GND IN".

Terminals 3, 4: You may use the internal 10V power supply or an external power supply for the analog input.

→ If you use the internal 10 V power supply, you must connect AI 0- to GND.

Figure 3-1 Wiring example of the digital inputs with the internal inverter 24 V power supply

Additional options for wiring the digital inputs

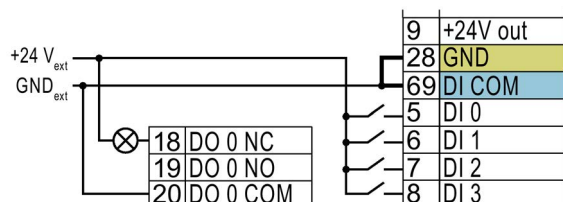

You must remove the jumper between terminals 28 and 69 if it is necessary to have electrical isolation between the external power supply and the internal inverter power supply.

Connecting P-switching contacts with an external power supply

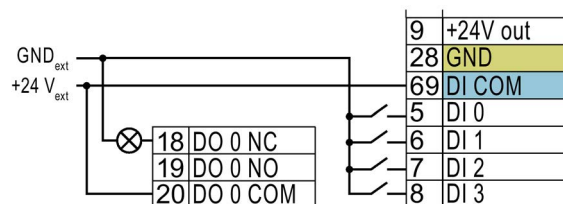

It is not permissible that terminals 28 and 69 are connected with one another.

Connecting M-switching contacts with an external power supply

Factory setting of the terminal strip on the CU240B-2

The factory setting of the terminals depends on whether the Control Unit has a PROFIBUS / PROFINET interface.

Control Units with USS interface

The fieldbus interface is not active.

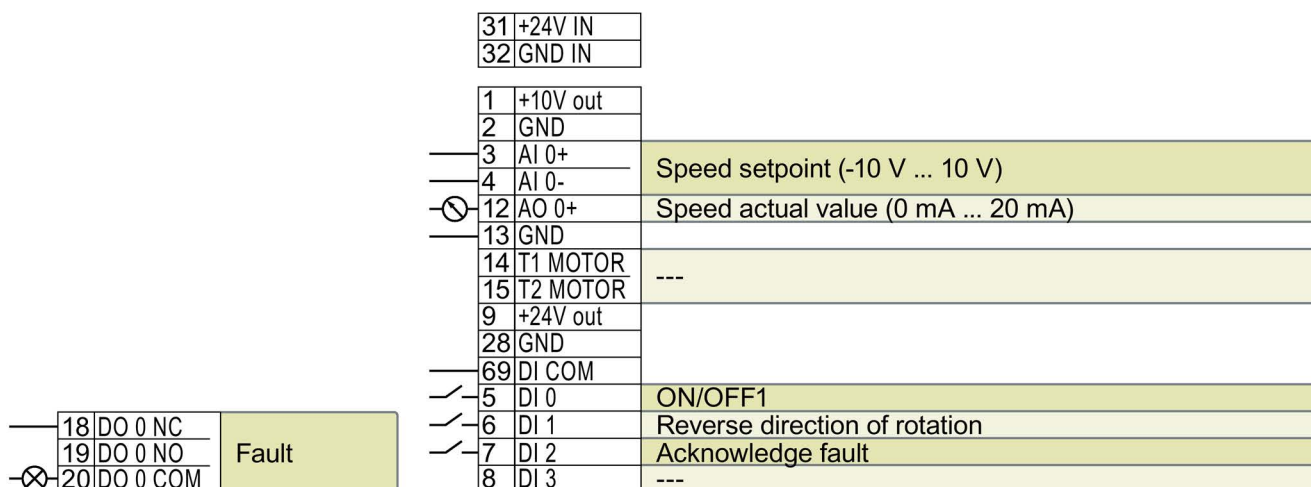

--- No function.

DO 0: p0730

AO 0: p0771[0]

DI x: r0722.x

AI 0: r0755[0]

Speed setpoint (main setpoint): p1070[0] = 755[0]

Figure 3-2 Factory settings of the CU240B-2 Control Unit

Control Units with PROFIBUS interface

The function of the fieldbus interface and digital inputs DI 0, DI 1 depends on DI 3.

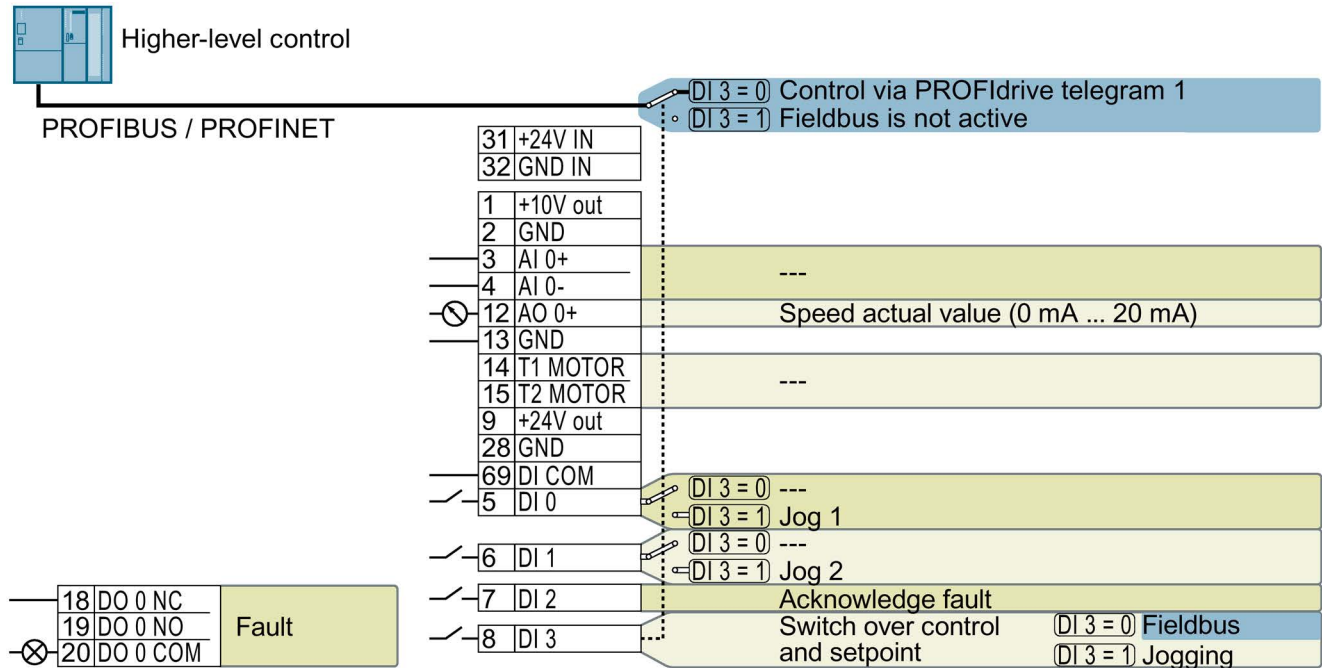

--- No function.

DO 0: p0730

AO 0: p0771[0]

DI x: r0722.x

Speed setpoint (main setpoint): p1070[0] = 2050[1]

Figure 3-3 Factory setting of the CU240B-2 DP and CU240B-2 PN Control Units

Changing the function of the terminals

The function of the terminals marked in color in the two figures above, can be set.

In order that you do not have to successively change terminal for terminal, several terminals can be jointly set using default settings ("p0015 Macro drive unit").

The terminal settings made in the factory described above correspond to the following default settings:

- Default setting 12 (p0015 = 12): "Standard I/O with analog setpoint"
- Default setting 7 (p0015 = 7): "Fieldbus with data set switchover"

Further default settings can be found in the Operating Instructions, see also: Manuals for your inverter (Page 31).

3.4 Terminal strips on CU240E-2 Control Units

Terminal strips with wiring example

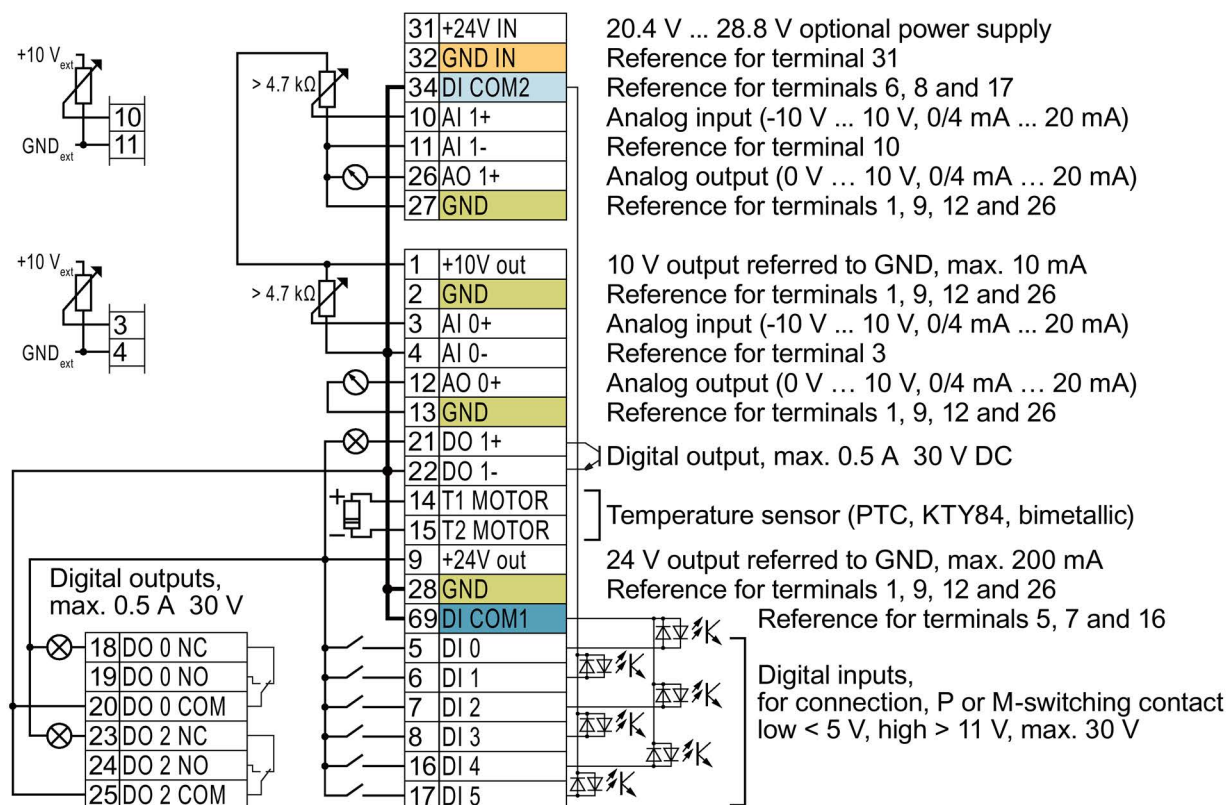

GND All terminals labelled with reference potential "GND" are connected internally in the inverter.

DI COM1 Reference potentials "DI COM1" and "DI COM2" are electrically isolated from "GND".

DI COM2 → If, as shown above, the 24 V supply from terminal 9 is used to supply the digital inputs, then you must connect "GND", "DI COM1" and "DI COM2" with one another.

Terminals 31, 32 Reference potential "GND IN" is electrically isolated from "GND". When an optional 24 V power supply is connected at terminals 31, 32, even when the Power Module is disconnected from the line supply, the Control Unit remains in operation. The Control Unit thus maintains the fieldbus communication, for example.

→ at terminals 31, 32, only connect a power supply that is in accordance with SELV (Safety Extra Low Voltage) or PELV (Protective Extra Low Voltage).

→ if you use a common external power supply for terminals 31, 32 and the digital inputs, you must connect "GND" to "GND IN".

Terminals 3, 4 and 10, 11: You may use the internal 10V power supply or an external power supply for the analog inputs.

→ If you use the internal 10 V power supply, you must connect AI 0- or AI 1- to GND.

Figure 3-4 Wiring example of the digital inputs with the internal inverter 24 V power supply

Additional options for wiring the digital inputs

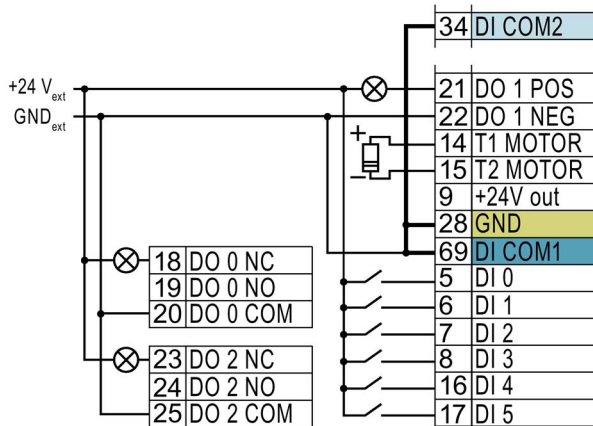

If you wish to connect the potential of an external power supply with the potential of the internal inverter power supply, then you must connect "GND" with terminals 34 and 69.

Connecting P-switching contacts with an external power supply

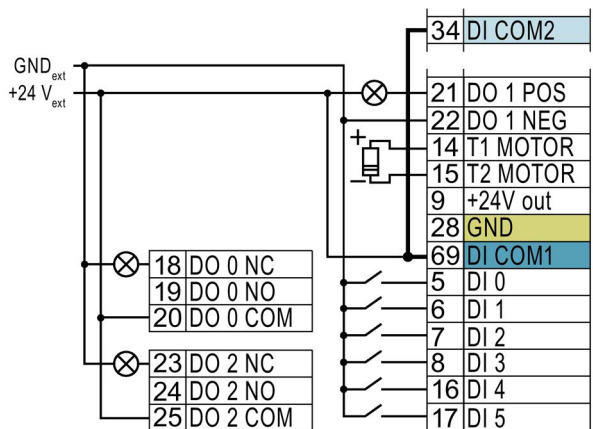

Connect terminals 69 and 34 with one another.

Connecting M-switching contacts with an external power supply

Factory setting of the terminal strip on the CU240E-2

The factory setting of the terminal strip depends on the Control Unit.

Control Units with USS interface

The fieldbus interface is not active.

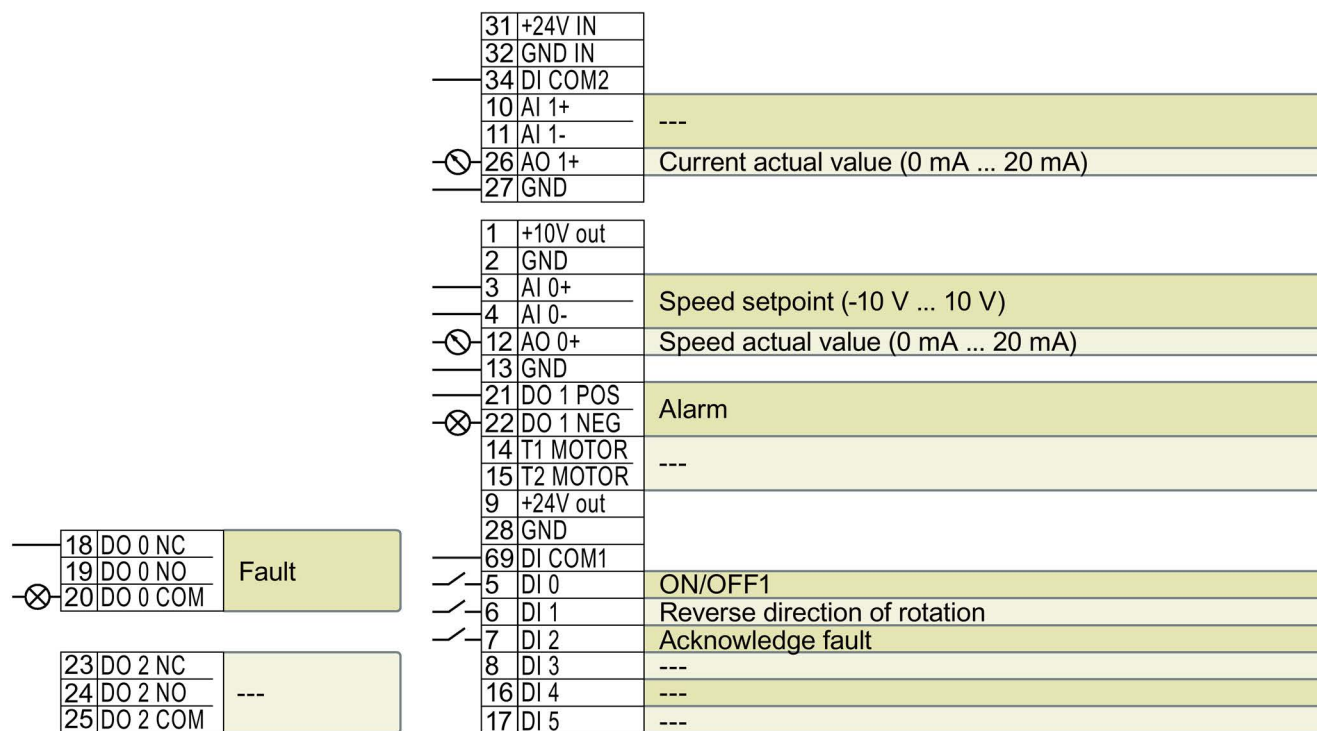

--- No function.

DO x: p073x

AO 0: p0771[0]

DI x: r0722.x

AI 0: r0755[0]

Speed setpoint (main setpoint): p1070[0] = 755[0]

Figure 3-5 Factory setting of the CU240E-2 and CU240E-2 F Control Units

Control Units with PROFIBUS or PROFINET interface

The function of the fieldbus interface and digital inputs DI 0, DI 1 depends on DI 3.

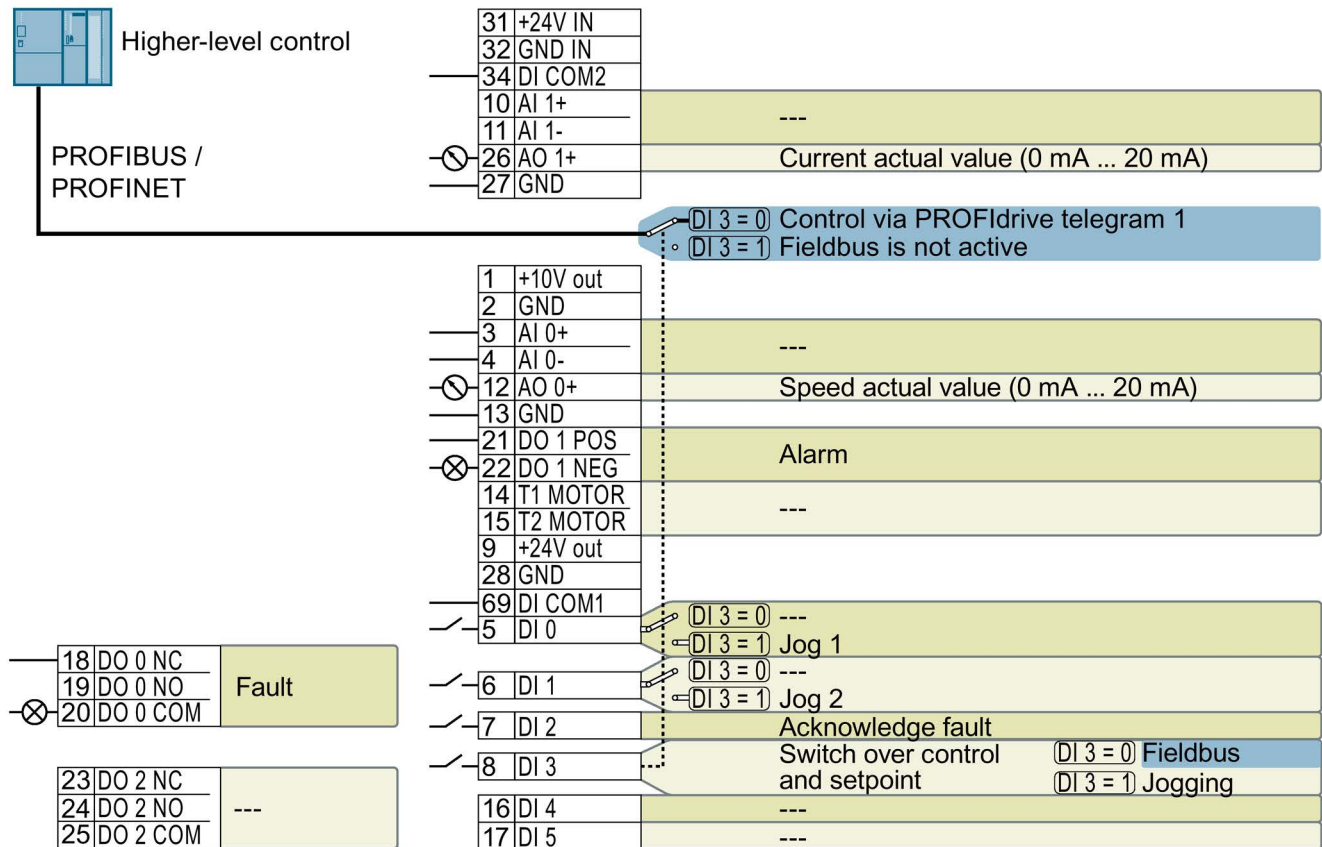

--- No function.

DO x: p073x

AO 0: p0771[0]

DI x: r0722.x

Speed setpoint (main setpoint): p1070[0] = 2050[1]

Figure 3-6 Factory setting of the CU240E-2 DP(-F) and CU240E-2 PN(-F) Control Units

Changing the function of the terminals

The function of the terminals marked in color in the two figures above, can be set.

In order that you do not have to successively change terminal for terminal, several terminals can be jointly set using default settings ("p0015 Macro drive unit").

The factory settings of the terminals for USS/Modbus and PROFIBUS/PROFINET described above correspond to the following default settings:



- p0015 = 12
 - Setting using the commissioning tools STARTER, Startdrive and the IOP operator panel: "Standard I/O with analog setpoint"
 - Setting using the BOP-2 operator panel: "Std ASP"
- p0015 = 7
 - Setting using STARTER, Startdrive and the IOP operator panel: "Fieldbus with data set switchover"
 - Setting using BOP-2: "FB cdS"

Further default settings can be found in the Operating Instructions, see also: Manuals for your inverter (Page 31).

4 Commissioning

4.1 Tools to commission the converter

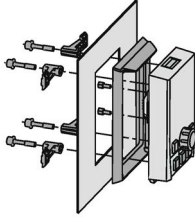
The following tools are used to commission, troubleshoot and control the inverter, as well as to backup and transfer the inverter settings.

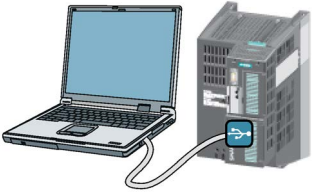
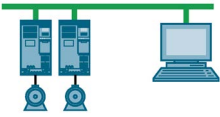
Operator panels		Article number
 <p>BOP-2 (Basic Operator Panel) - for snapping onto the inverter</p> <ul style="list-style-type: none"> Two-line display Guided basic commissioning 	 <p>Door mounting kit for IOP/BOP-2</p> <ul style="list-style-type: none"> For installation of the BOP-2 or IOP in a control cabinet door. Degree of protection with IOP: IP54 or UL Type 12 Degree of protection with BOP-2: IP55 	<p>BOP-2: 6SL3255-0AA00-4CA1</p> <p>IOP: 6SL3255-0AA00-4JA1</p> <p>Door mounting kit: 6SL3256-0AP00-0JA0</p>
 <p>IOP (Intelligent Operator Panel) - for snapping onto the inverter</p> <ul style="list-style-type: none"> Plain text display Menu-based operation and application wizards 		
 <p>For mobile use of the IOP: IOP handheld with power supply unit and rechargeable batteries as well as RS232 connection cable If you are using your own connection cable, carefully note the maximum permissible length of 5 m.</p>		6SL3255-0AA00-4HA0
PC tools		
  <p>You can access the inverter either via a USB connection or via PROFIBUS/PROFINET.</p>	<p>STARTER System requirements and download: STARTER (http://support.automation.siemens.com/WW/view/en/26233208) Help regarding operation: STARTER videos (http://www.automation.siemens.com/mcms/mc-drives/en/low-voltage-inverter/sinamics-g120/videos/Pages/videos.aspx)</p>	STARTER on DVD: 6SL3072-0AA00-0AG0
	<p>Startdrive System requirements and download: Startdrive (http://support.automation.siemens.com/WW/view/en/68034568) Help regarding operation: Startdrive tutorial (http://support.automation.siemens.com/WW/view/en/73598459)</p>	Startdrive on DVD: 6SL3072-4CA02-1XG0
	<p>SINAMICS PC Inverter Connection Kit 2 Contains the correct USB cable (3 m) to connect a PC to the inverter.</p>	6SL3255-0AA00-2CA0

4.2 Commissioning with BOP-2 operator panel

Plugging on an operator panel

- Procedure**
- ➔ 1 To plug an Operator Panel on the Control Unit, proceed as follows:
- 2
1. Locate the lower edge of the Operator Panel into the matching recess of the Control Unit.
 2. Press the Operator Panel onto the inverter until you hear the latching mechanism engage.
- You have plugged an operator panel onto the Control Unit.
- The operator panel is ready for operation when you connect the inverter to the power supply.

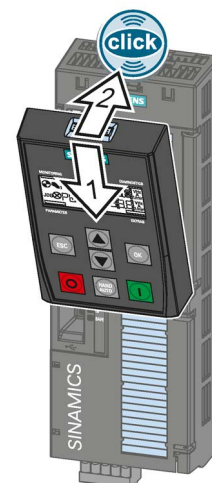

4.2.1 Basic commissioning with BOP-2





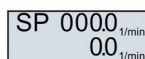



Carry out basic commissioning

Preconditions



- The power supply is switched on.
- The operator panel displays setpoints and actual values.

Procedure

- ➔ 1 Proceed as follows to carry out basic commissioning:
- 2
1.  Press the ESC key.
 2.  Press one of the arrow keys until the BOP-2 displays the "SETUP" menu.
 3.   In the "SETUP" menu, press the OK key to start basic commissioning.
 4.   If you wish to restore all of the parameters to the factory setting before the basic commissioning:
 - 4.1. Switch over the display using an arrow key: nO → YES
 - 4.2. Press the OK key.
 5.   When selecting an application class, the inverter assigns the appropriate default settings to the motor control:







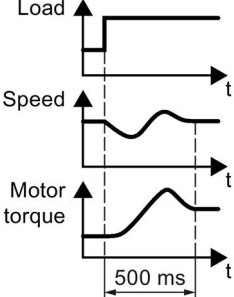
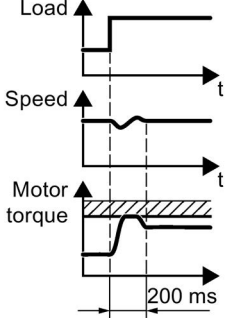



STANDARD	→ Standard Drive Control (Page 21)
DYNAMIC	→ Dynamic Drive Control (Page 23)
EXPERT	The approach is described in the operating instructions → Manuals for your inverter (Page 31)

Selecting a suitable application class

When selecting an application class, the inverter assigns the appropriate settings to the motor control.

Application class	Standard Drive Control	Dynamic Drive Control
Motors that can be operated	Induction motors	Induction and synchronous motors
Power Modules that can be operated	PM240, PM240-2, PM340	
Application examples	<ul style="list-style-type: none"> • Pumps, fans, and compressors with flow characteristic • Wet or dry blasting technology • Mills, mixers, kneaders, crushers, agitators • Horizontal conveyor technology (conveyor belts, roller conveyors, chain conveyors) • Basic spindles 	<ul style="list-style-type: none"> • Pumps and compressors with displacement machines • Rotary furnaces • Extruder • Centrifuge
Properties	<ul style="list-style-type: none"> • Typical correction time after a speed change: 100 ms ... 200 ms • Typical correction time after a load surge: 500 ms • Standard Drive Control is suitable for the following requirements: <ul style="list-style-type: none"> – Motor power ratings < 45 kW – Acceleration time 0 → rated speed (depending on the rated motor power): 1 s (0.1 kW) ... 10 s (45 kW) – Applications with increasing load torque without load surges • Standard Drive Control is insensitive with respect to inaccurate motor data settings 	<ul style="list-style-type: none"> • Typical correction time after a speed change: < 100 ms • Typical correction time after a load surge: 200 ms • Dynamic Drive Control controls and limits the motor torque • Torque accuracy that can be achieved: ± 5 % for 15 % ... 100 % of the rated speed • We recommend Dynamic Drive Control for the following applications: <ul style="list-style-type: none"> – Motor power ratings > 11 kW – For load surges of 10 % ... >100 % of the rated motor torque • Dynamic Drive Control is necessary for an acceleration time 0 → rated speed (dependent on the rated motor power): < 1 s (0.1 kW) ... < 10 s (250 kW). 
Max. output frequency	240 Hz	200 Hz
Torque control	Without torque control	Speed control with lower-level torque control
Commissioning	<ul style="list-style-type: none"> • Contrary to "Dynamic Drive Control" a speed controller does not have to be set • In comparison to "Configuration for experts": <ul style="list-style-type: none"> – Simplified commissioning using preassigned motor data – Reduced number of parameters 	<ul style="list-style-type: none"> • Reduced number of parameters when compared to "Configuration for experts"

4.2.2 Standard Drive Control

6.  Motor standard
 KW 50HZ IEC
 HP 60HZ NEMA
 KW 60HZ IEC 60 Hz
7.  Supply voltage for the inverter
8. Enter the motor data:
- 8.1.  Motor type
 Depending on the particular inverter, it is possible that the BOP-2 does not list all of the following motor types.
 INDUCT Third-party induction motor
 SYNC Third-party synchronous motor
 RELUCT Third-party reluctance motor
 1L... IND 1LE1, 1LG6, 1LA7, 1LA9 induction motors
 1LE1 IND 100 1LE1□9 with motor code on the rating plate
 1PH8 IND Induction motor
 1FP1 Reluctance motor
 1F... SYN 1FG1, 1FK7 synchronous motor, without encoder
- 8.2.  If you have selected a motor type > 100, then you must enter the motor code:
 With the correct motor code, the inverter assigns the motor data the following values.
 If you do not know the motor code, then you must set the motor code = 0, and enter the motor data from p0304 and onwards from the rating plate.
- 8.3.  87 Hz motor operation
 The BOP-2 only displays this step if you previously selected IEC as the motor standard (EUR/USA, P100 = KW 50HZ).
- 8.4.  Rated voltage
- 8.5.  Rated current
- 8.6.  Rated power
- 8.7.  Rated frequency
- 8.8.  Rated speed
- 8.9.  Motor cooling
 SELF Natural cooling
 FORCED Forced-air cooling
 LIQUID Liquid cooling
 NO FAN Without fan

9. TEC APPL
P501 

Select the application:

VEC STD Constant load: Typical applications include belt conveyor drives.

PUMP FAN Speed-dependent load: Typical applications include pumps and fans.

10. MAc PAr
P15 

Select the default setting for the interfaces of the inverter that is suitable for your application. The available default settings can be found in the operating instructions, see: Manuals for your inverter (Page 31).

11. MIN RPM
P1080 

Minimum and maximum motor speed

12. MAX RPM
P1082 

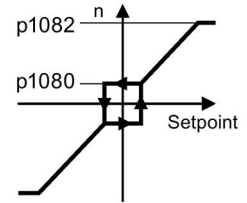



13. RAMP UP
P1120 

Motor ramp-up time

14. RAMP DWN
P1121 

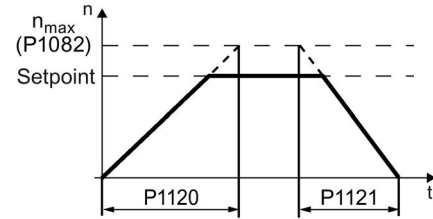
Motor ramp-down time



15. OFF3 RP
P1135 

Ramp-down time for the OFF3 command

16. FINISH 







Complete the basic commissioning:

16.1. Switch over the display using an arrow key: nO → YES

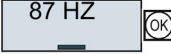

16.2. Press the OK key.

You have entered all of the data that is necessary for the basic commissioning of your inverter.



4.2.3 Dynamic Drive Control











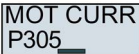

6.   Motor standard
 - KW 50HZ IEC
 - HP 60HZ NEMA
 - KW 60HZ IEC 60 Hz
7.   Supply voltage for the inverter
8. Enter the motor data:
 - 8.1.   Motor type

Depending on the particular inverter, it is possible that the BOP-2 does not list all of the following motor types.

INDUCT	Third-party induction motor
SYNC	Third-party synchronous motor
RELUCT	Third-party reluctance motor
1L... IND	1LE1, 1LG6, 1LA7, 1LA9 induction motors
1LE1 IND 100	1LE1□9 with motor code on the rating plate
1PH8 IND	Induction motor
1FP1	Reluctance motor
1F... SYN	1FG1, 1FK7 synchronous motor, without encoder
 - 8.2.   If you have selected a motor type > 100, then you must enter the motor code:

With the correct motor code, the inverter assigns the motor data the following values.

If you do not know the motor code, then you must set the motor code = 0, and enter the motor data from p0304 and onwards from the rating plate.
 - 8.3.   87 Hz motor operation

The BOP-2 only displays this step if you previously selected IEC as the motor standard (EUR/USA, P100 = KW 50HZ).
 - 8.4.   Rated voltage
 - 8.5.   Rated current
 - 8.6.   Rated power
 - 8.7.   Rated frequency
 - 8.8.   Rated speed
 - 8.9.   Motor cooling

SELF	Natural cooling
FORCED	Forced-air cooling
LIQUID	Liquid cooling
NO FAN	Without fan

9.

Select the application:

OP LOOP Recommended setting for standard applications.

CL LOOP Recommended setting for applications with short ramp-up and ramp-down times. This setting is not suitable for hoisting gear and cranes/lifting gear.

HVY LOAD Recommended setting for applications with a high break loose torque.

10.

Select the default setting for the interfaces of the inverter that is suitable for your application. The available default settings can be found in the operating instructions, see: Manuals for your inverter (Page 31).

11.

Minimum and maximum motor speed

12.

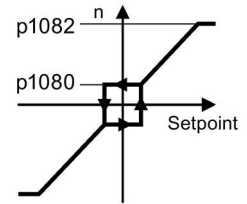

13.

Motor ramp-up time

14.

Motor ramp-down time

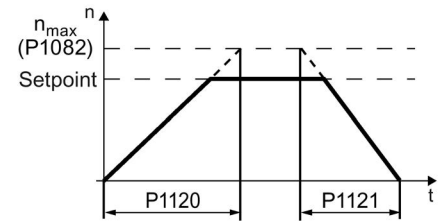

15.

Ramp-down time for the OFF3 command

16.

Motor data identification

Select the method which the inverter uses to measure the data of the connected motor:

OFF Motor data is not measured.

ST RT OP Recommended setting: Measure the motor data at standstill and with the motor rotating.

STILL OP Measure the motor data at standstill.

Select this setting if the motor cannot rotate freely – for example, if the traversing range is mechanically limited.

17.

Complete the basic commissioning:

17.1. Switch over the display using an arrow key: nO → YES

17.2. Press the OK key.

You have entered all of the data that is necessary for the basic commissioning of your inverter.

Identifying the motor data and optimizing the closed-loop control

The inverter has several techniques to automatically identify the motor data and optimize the speed control.

To start the motor data identification routine, you must switch-on the motor via the terminal strip, fieldbus or from the operator panel.

 WARNING
<p>Risk of death due to machine motion while motor data identification is active</p> <p>For the stationary measurement, the motor can make several rotations. The rotating measurement accelerates the motor up to its rated speed. Secure dangerous machine parts before starting motor data identification:</p> <ul style="list-style-type: none"> • Before switching on, ensure that nobody is working on the machine or located within its working area. • Secure the machine's work area against unintended access. • Lower hanging/suspended loads to the floor.

Preconditions

- In the basic commissioning, you have selected a motor data identification method, e.g. measuring the motor data at standstill

After basic commissioning has been completed, the inverter outputs alarm A07991.





	This is symbol in the BOP-2 indicates an active alarm.
---	--

- The motor has cooled down to the ambient temperature.
An excessively high motor temperature falsifies the motor data identification results.



Procedure when using the BOP-2 operator panel



To start the motor data identification, proceed as follows:

1.  ⇒  Press the HAND/AUTO key. The BOP-2 displays the symbol for manual operation.
 2.  Switch on the motor.
 3.  The motor data identification takes several seconds.
Wait until the inverter switches off the motor after motor data identification has been completed.
-  If you have also selected a rotating measurement in addition to the motor data identification, then the inverter again issues the alarm A07991.

4.3 Connecting the inverter to the fieldbus

4.  Switch the motor on again in order to optimize the rotating measurement.
5.  Wait until the inverter switches off the motor after completion of the optimization. The optimization time depends on the rated motor power: 20 s ... 2 min.
6.  Switch the inverter control from HAND to AUTO.

You have now completed motor data identification.

4.3 Connecting the inverter to the fieldbus

Where can I find instructions for the fieldbus connection of the inverter?

You can find instructions for the fieldbus connection on the Internet:

- Application examples (<http://support.automation.siemens.com/WW/view/en/60733299>)
- Operating instructions - inverter with Control Units CU2...: Manuals for the Control Unit (<http://support.automation.siemens.com/WW/view/en/30563628/133300>)
- Function Manual, Fieldbus Systems: Manuals for the Control Unit (<http://support.automation.siemens.com/WW/view/en/30563628/133300>)

Description files for fieldbuses

The description files are electronic device data sheets which contain all the required information of a higher-level controller. You can configure and operate the inverter on a fieldbus with the appropriate description file.

Description file	Download	Alternative to download
Generic Station Description (GSD) for PROFIBUS	Internet: http://support.automation.siemens.com/WW/view/en/23450835	GSD and GSDML are saved in the inverter. The inverter writes its GSD or GSDML to the memory card once you insert this card in the inverter and set p0804 = 12. You can then transfer the file to your programming device or PC using the memory card.
GSD Markup Language (GSDML) for PROFINET	Internet: http://support.automation.siemens.com/WW/view/en/26641490	
Electronic Data Sheet (EDS) for CANopen	Internet: http://support.automation.siemens.com/WW/view/en/48351511	---
EDS for Ethernet/IP	Internet: http://support.automation.siemens.com/WW/view/en/78026217	---

Examples for telegrams via PROFIBUS and PROFINET

Telegram 1:

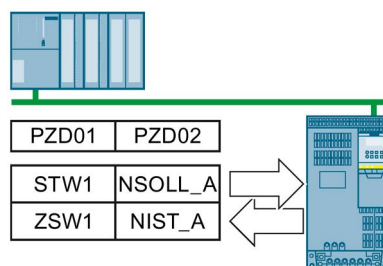

STW1 Control word 1
 ZSW1 Status word 1
 PZD01/02 Process data 16-bit
 NSOLL_A Speed setpoint
 NIST_A Speed actual value

Control word 1 (STW1), PZD receive word 1 (word: r2050[0], bits: r2090.00 ... r2090.15)

Bit	Meaning	Explanation
0	0 = OFF1	The motor brakes with the ramp-down time p1121 of the ramp-function generator. The inverter switches off the motor at standstill.
	0 → 1 = ON	The inverter goes into the "ready" state. If, in addition bit 3 = 1, then the inverter switches on the motor.
1	0 = OFF2	Switch off the motor immediately, the motor then coasts down to a standstill.
	1 = No OFF2	Precondition in order to be able to switch on the motor using bit 0 (ON command).
2	0 = Quick stop (OFF3)	The motor brakes with the OFF3 ramp-down time p1135 down to standstill.
	1 = No quick stop (OFF3)	Precondition in order to be able to switch on the motor using bit 0 (ON command).
3	0 = Inhibit operation	Switch off the motor immediately → motor coasts down to a standstill.
	1 = Enable operation	Precondition in order to be able to switch on the motor using bit 0 (ON command).
4	0 = Disable RFG	The inverter immediately sets its ramp-function generator output to 0.
	1 = Do not disable RFG	The ramp-function generator can be enabled.
5	0 = Stop RFG	The output of the ramp-function generator stops at the actual value.
	1 = Enable RFG	The output of the ramp-function generator follows the setpoint.
6	0 = Inhibit setpoint	The inverter brakes the motor with the ramp-down time p1121 of the ramp-function generator.
	1 = Enable setpoint	Motor accelerates with the ramp-up time p1120 to the setpoint.
7	0 → 1 = Acknowledge faults	Acknowledge fault. If the ON command is still active (bit 0 = 1), the inverter switches to "closing lockout" state.
8, 9	Reserved	
10	0 = No control via PLC	The inverter ignores the process data from the fieldbus.
	1 = Control via PLC	Control via fieldbus, the inverter accepts the process data from the fieldbus.
11	1 = Direction reversal	Invert setpoint in the inverter.
12	Not used	
13	1 = MOP up	Increase the setpoint saved in the motorized potentiometer.
14	1 = MOP down	Reduce the setpoint saved in the motorized potentiometer.
15	Reserved	Changes over between settings for different operation interfaces (command data sets).

4.4 Frequently required parameters

Status word 1 (ZSW1), PZD send word 1 (word: p2051[0], bits: p2080[0] ... p2080[15])

Bit	Meaning	Comments
0	1 = Ready to start	Power supply switched on; electronics initialized; pulses locked.
1	1 = Ready	Motor is switched on (ON/OFF1 = 1), no fault is active. With the command "Enable operation" (STW1.3), the inverter switches on the motor.
2	1 = Operation enabled	Motor follows setpoint. See control word 1, bit 3.
3	1 = Fault active	The inverter has a fault. Acknowledge fault using STW1.7.
4	1 = OFF2 inactive	Coast down to standstill is not active.
5	1 = OFF3 inactive	Quick stop is not active.
6	1 = Closing lockout active	It is only possible to switch on the motor after an OFF1 followed by ON.
7	1 = Alarm active	Motor remains switched on; no acknowledgement is necessary.
8	1 = Speed deviation within the tolerance range	Setpoint / actual value deviation within the tolerance range.
9	1 = Master control requested	The automation system is requested to accept the inverter control.
10	1 = Comparison speed reached or exceeded	Speed is greater than or equal to the corresponding maximum speed.
11	1 = torque limit reached	Comparison value for current or torque has been reached or exceeded.
12	1 = Holding brake open	Signal to open and close a motor holding brake.
13	0 = Alarm, motor overtemperature	--
14	1 = Motor rotates clockwise	Internal inverter actual value > 0
	0 = Motor rotates counter-clockwise	Internal inverter actual value < 0
15	0 = Alarm, inverter thermal overload	

4.4 Frequently required parameters

Parameter	Explanation	
p0015	Macro drive unit Set defaults for inputs and outputs via a macro.	
r0018	Control Unit firmware version	
p0096	Application class	0: Expert 1: Standard Drive Control 2: Dynamic Drive Control
p0100	IEC/NEMA mot stds	0: Europe 50 [Hz] 1: NEMA motor (60 Hz, US units) 2: NEMA motor (60 Hz, SI units)
p0304	Rated motor voltage [V]	
p0305	Rated motor current [A]	
p0307	Rated motor power [kW] or [hp]	
p0310	Rated motor frequency [Hz]	
p0311	Rated motor speed [rpm]	

Parameter	Explanation			
p0601	Motor temperature sensor type			
	Terminal 14	T1 motor (+)	0: No sensor (factory setting)	2: KTY84 (→ P0604)
	Terminal 15	T2 motor (-)	1: PTC (→ P0604)	4: Bimetal
p0625	Motor ambient temperature during commissioning [° C]			
p0640	Current limit [A]			
r0722	Digital inputs status			
	.0	Terminal 5	DI 0	Selection of the possible settings:
	.1	Terminal 6	DI 1	p0840 ON/OFF (OFF1) p0844 no coast down (OFF2) p0848 no quick stop (OFF3) p0855 unconditionally release holding brake p1020 fixed speed setpoint selection bit 0 p1021 fixed speed setpoint selection bit 1 p1022 fixed speed setpoint selection bit 2 p1023 fixed speed setpoint selection bit 3 p1035 motorized potentiometer raise setpoint p1036 motorized potentiometer lower setpoint p2103 acknowledge faults p1055 jog bit 0 p1056 jog bit 1
	.2	Terminal 7	DI 2	
	.3	Terminal 8	DI 3	
	.4	Terminal 16	DI 4	
	.5	Terminal 17	DI 5	
	.11	Terminal 3, 4	AI 0	
	.12	Terminal 10, 11	AI 1	
			p1110 inhibit negative direction p1111 inhibit positive direction p1113 setpoint inversion p1122 bypass ramp-function generator p1140 enable/inhibit ramp-function generator p1141 continue/freeze ramp-function generator p1142 enable/inhibit setpoint p1230 DC braking activation p2103 acknowledge faults p2106 external fault 1 p2112 external alarm 1 p2200 technology controller enable	
p0730	Signal source for terminal DO 0		Selection of the possible settings:	
	Terminals 19, 20 (NO contact) Terminals 18, 20 (NC contact)		52.0 ready for switching on 52.1 ready for operation	53.0 DC braking active 53.1 n_act > p2167 (n_off)
p0731	Signal source for terminal DO 1		52.2 operation enabled 52.3 fault present	53.2 n_act ≤ p1080 (n_min) 53.3 l_act > p2170
	Terminals 21, 22 (NO contact)		52.4 coast down active (OFF2)	53.4 n_act > p2155 53.5 n_act ≤ p2155
p0732	Signal source for terminal DO 2		52.5 quick stop active (OFF3) 52.7 alarm present	53.6 n_act ≥ n_set 53.10 technology controller output at lower limit
	Terminals 24, 25 (NO contact) Terminals 23, 25 (NC contact)		52.14 motor rotates forwards	53.11 technology controller output at upper limit
r0755	Analog inputs actual value [%]			
	[0]	Terminals 3, 4	AI 0	
	[1]	Terminals 10, 11	AI 1	
p0756	Analog input type			0: Unipolar voltage input (0 V ...+10 V) 1: Unipolar voltage input monitored (+2 V... +10 V) 2: Unipolar current input (0 mA ...+20 mA) 3: Unipolar current input monitored (+4 mA ...+20 mA) 4: Bipolar voltage input (-10 V...+10 V)
	[0]	AI 0		
	[1]	AI 1		
p0771	Analog outputs signal source			Selection of the possible settings:
	[0]	Terminals 12, 13	AO 0	
	[1]	Terminals 26, 27	AO 1	
				0: Analog output locked 21: Speed actual value 24: Output frequency smoothed 25: Output voltage smoothed 26: DC link voltage smoothed 27: Actual current value (smoothed absolute value)

4.4 Frequently required parameters

Parameter	Explanation	
p0776	Analog outputs, type	0: Current output (0 mA ... +20 mA) 1: Voltage output (0 V ... +10 V) 2: Current output (+4 mA ... +20 mA)
	[0]	AO 0
	[1]	AO 1
p0922	PROFIdrive telegram selection	
p1001	Fixed speed setpoint 1	
p1002	Fixed speed setpoint 2	
p1003	Fixed speed setpoint 3	
p1004	Fixed speed setpoint 4	
p1058	Jog 1 speed setpoint	
p1059	Jog 2 speed setpoint	
p1070	Main setpoint	Selection of the possible settings: 0: Main setpoint = 0 755[0]: Analog input 0 1024: Fixed setpoint 1050: Motorized potentiometer 2050[1]: PZD 2 from the fieldbus
p1080	Minimum speed [rpm]	
p1082	Maximum speed [rpm]	
p1120	Ramp-function generator ramp-up time [s]	
p1121	Ramp-function generator ramp-down time [s]	
p1300	Open-loop/closed-loop control operating mode	Selection of the possible settings: 0: U/f control with linear characteristic 1: U/f control with linear characteristic and FCC 2: U/f control with parabolic characteristic 20: Speed control (without encoder) 22: Torque control (without encoder)
p1310	Starting (voltage boost) permanent	
p1800	Pulse frequency setpoint	
p2030	Fieldbus interface protocol selection	The possible settings depend on the Control Unit: 0: No protocol 1: USS 2: Modbus RTU 3: PROFIBUS 4: CANopen 5: BacNet 7: PROFINET 8: P1 10: EtherNet/IP
r2050	Words received via fieldbus (16 bit) r2050[0]: PZD01 ... r2050[11]: PZD12	
p2051	Words sent via fieldbus (16 bit) p2051[0]: PZD01 ... p2051[16]: PZD17	
p2080	Binector-connector converter, status word 1 p2080[0]: Bit 0 ... p2080[15]: Bit 15	
r2090	PROFIdrive PZD1 receive bit-by-bit (control word 1) r2090.00: Bit 0 ... r2090.15: Bit 15	

More information

5.1 Manuals for your inverter



Documentation on DVD:

SINAMICS Manual Collection, Article number 6SL3097-4CA00-0YGO

Table 5- 1 Manuals for your inverter for download

Information depth	Manual	Contents	Available languages	Download
++	Compact Operating Instructions	(this manual)	English, German, Italian, French, Spanish, Chinese	Manuals for the Control Unit (http://support.automation.siemens.com/WW/view/en/30563628/133300)
+++	Operating instructions for the SINAMICS G120 inverter with a CU240B-2 and CU240E-2 Control Units	Installing, commissioning and operating the inverter. Setting the inverter functions. Technical data.		
+++	Fieldbus function manual for the SINAMICS G110M, G120, G120C and G120D inverters	Configuring fieldbuses.		
+++	Function Manual for Safety Integrated for the SINAMICS G110M, G120, G120C, G120D inverters and SIMATIC ET 200pro FC-2 converters	Configuring PROFI-safe. Installing, commissioning and operating fail-safe functions of the inverter.		
+++	List Manual for of the CU240B-2 and CU240E-2 Control Units	List of all parameters, alarms and faults of the inverter. Graphic function diagrams.		
+	Getting Started for the following SINAMICS G120 Power Modules: <ul style="list-style-type: none"> • PM230 IP20/PT • PM240, PM250 and PM260 • PM240-2 	Installing the Power Module.	English	Manuals for the Power Modules (http://support.automation.siemens.com/WW/view/en/30563173/133300)
+++	Hardware Installation Manual for the following SINAMICS G120 Power Modules: <ul style="list-style-type: none"> • PM230 IP20/PT • PM240 • PM240-2 • PM250 • PM260 	Installing Power Modules, reactors and filters. Technical data Maintenance	English, German	
+	Installation Instructions for reactors, filters and braking resistors	Installing components.	English	Manuals for the inverter accessories (http://support.automation.siemens.com/WW/view/en/30563173/133300)

5.2 Product support

Information depth	Manual	Contents	Available languages	Download
+++	Operating Instructions for the following Operator Panels: <ul style="list-style-type: none"> • BOP-2 • IOP 	Operating operator panels, installing door assembly kit for IOP.	English, German	
+++	Configuration Manual EMC installation guideline	EMC-compliant control cabinet design, potential equalization and cable routing	English, German, Italian, French, Spanish, Chinese	EMC installation guideline (http://support.automation.siemens.com/WW/view/en/60612658)
+++	Manual SINAMICS S110 Manual PM340 Power Module	Installing the PM340 Power Module. Technical data Maintenance	English, German, Italian, French, Spanish	S110 Manual (http://support.automation.siemens.com/WW/view/en/49086218)

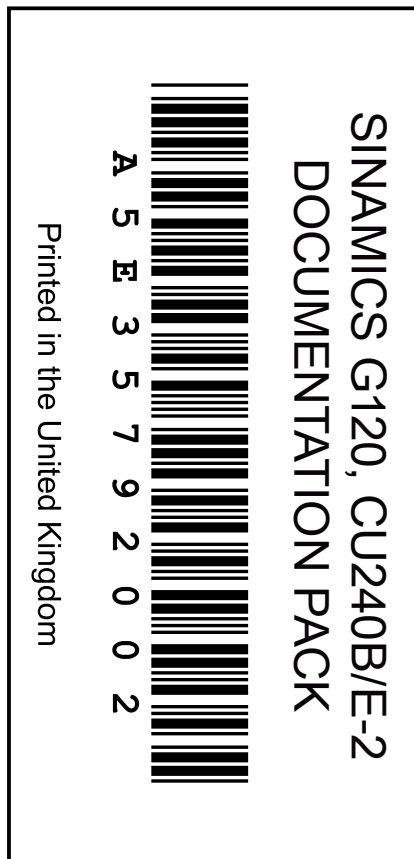

5.2 Product support

France	Germany	Italy	Spain	Great Britain
+33 (0) 821 801 122	+49 (0)911 895 7222	+39 (02) 24362000	+34 902 237 238	+44 161 446 5545
Other service telephone numbers: Product support (http://www.siemens.com/automation/service&support)				