

# SINAMICS G120

Control Units	CU240E	CU240S
	CU240S DP	CU240S DP-F
	CU240S PN	CU240S PN-F

Operating Instructions · 03/2009

## SINAMICS

Answers for industry.

**SIEMENS**



# SIEMENS

## SINAMICS

### SINAMICS G120 CU240S and CU240E Control Units, FW 3.2

#### Operating Instructions



<u>Introduction</u>	<b>1</b>
<u>Description</u>	<b>2</b>
<u>Connection</u>	<b>3</b>
<u>Commissioning</u>	<b>4</b>
<u>Functions</u>	<b>5</b>
<u>Servicing and maintenance</u>	<b>6</b>
<u>Messages and fault codes</u>	<b>7</b>
<u>Technical data</u>	<b>8</b>

Edition 03/2009, FW 3.2

## Legal information

### Warning notice system

This manual contains notices you have to observe in order to ensure your personal safety, as well as to prevent damage to property. The notices referring to your personal safety are highlighted in the manual by a safety alert symbol, notices referring only to property damage have no safety alert symbol. These notices shown below are graded according to the degree of danger.

 <b>DANGER</b>
indicates that death or severe personal injury <b>will</b> result if proper precautions are not taken.
 <b>WARNING</b>
indicates that death or severe personal injury <b>may</b> result if proper precautions are not taken.
 <b>CAUTION</b>
with a safety alert symbol, indicates that minor personal injury can result if proper precautions are not taken.
<b>CAUTION</b>
without a safety alert symbol, indicates that property damage can result if proper precautions are not taken.
<b>NOTICE</b>
indicates that an unintended result or situation can occur if the corresponding information is not taken into account.

If more than one degree of danger is present, the warning notice representing the highest degree of danger will be used. A notice warning of injury to persons with a safety alert symbol may also include a warning relating to property damage.

### Qualified Personnel

The device/system may only be set up and used in conjunction with this documentation. Commissioning and operation of a device/system may only be performed by **qualified personnel**. Within the context of the safety notes in this documentation qualified persons are defined as persons who are authorized to commission, ground and label devices, systems and circuits in accordance with established safety practices and standards.

### Proper use of Siemens products

Note the following:

 <b>WARNING</b>
Siemens products may only be used for the applications described in the catalog and in the relevant technical documentation. If products and components from other manufacturers are used, these must be recommended or approved by Siemens. Proper transport, storage, installation, assembly, commissioning, operation and maintenance are required to ensure that the products operate safely and without any problems. The permissible ambient conditions must be adhered to. The information in the relevant documentation must be observed.

### Trademarks

All names identified by ® are registered trademarks of the Siemens AG. The remaining trademarks in this publication may be trademarks whose use by third parties for their own purposes could violate the rights of the owner.

### Disclaimer of Liability

We have reviewed the contents of this publication to ensure consistency with the hardware and software described. Since variance cannot be precluded entirely, we cannot guarantee full consistency. However, the information in this publication is reviewed regularly and any necessary corrections are included in subsequent editions.

# Table of contents

<b>1</b>	<b>Introduction.....</b>	<b>9</b>
1.1	About this manual .....	9
1.2	Fast track commissioning .....	10
1.3	Adapting inverters to the application (parameterization for entry level personnel).....	11
1.3.1	General basics .....	11
1.3.2	Parameter .....	12
1.3.3	Parameters with follow-on parameterization.....	13
1.4	Frequently required parameters.....	14
1.5	Extended adaptation options (parameterization for advanced level personnel).....	16
1.5.1	BICO technology: basic principles .....	16
1.5.2	BICO technology: example .....	19
<b>2</b>	<b>Description.....</b>	<b>21</b>
2.1	Modularity of the converter system .....	21
2.2	Overview of Control Units .....	23
2.3	Overview of Power Modules .....	24
2.4	Reactors and filters .....	25
<b>3</b>	<b>Connection .....</b>	<b>27</b>
3.1	Procedure for installing the frequency inverter .....	27
3.2	Mounting reactors and filters.....	28
3.3	Mounting Power Modules .....	30
3.3.1	Dimensions, hole drilling templates, minimum clearances, tightening torques .....	31
3.3.2	Wiring Power Modules .....	36
3.3.3	EMC-compliant connection .....	39
3.4	Installing the Control Unit.....	41
3.4.1	Interfaces, connectors, switches, control terminals, LEDs on the CU .....	42
<b>4</b>	<b>Commissioning .....</b>	<b>45</b>
4.1	Initial coupling of the CU and PM - message F0395 .....	46
4.2	Restoring the factory settings .....	47
4.3	Preparing commissioning.....	48
4.4	Commissioning with factory settings.....	51
4.4.1	Wiring examples for the factory settings.....	52
4.4.2	Factory setting of the frequency inverter .....	54
4.4.3	Default terminal settings .....	56
4.5	Commissioning with STARTER .....	58
4.5.1	Creating a STARTER project.....	59
4.5.2	Establishing an online connection between the PC and converter (going "online") .....	64
4.5.3	Starting the general commissioning.....	65
4.5.4	Commissioning the application .....	70

4.6	Commissioning with the operator panel.....	71
4.6.1	Function of the Basic Operator Panel.....	71
4.6.2	BOP controls and displays.....	72
4.6.3	Parameterization with the BOP (two examples).....	73
4.6.4	Commissioning steps.....	74
4.6.5	Commissioning V/f control.....	74
4.7	Data backup with the operator panel and memory card.....	77
4.7.1	Saving and transferring data using the BOP.....	77
4.7.2	Saving and transferring data using the MMC.....	78
<b>5</b>	<b>Functions.....</b>	<b>81</b>
5.1	Overview of inverter functions.....	81
5.2	Inverter control.....	84
5.2.1	Frequency inverter control using digital inputs (two/three-wire control).....	84
5.2.2	Two-wire control, method 1.....	87
5.2.3	Two-wire control, method 2.....	88
5.2.4	Two-wire control, method 3.....	89
5.2.5	Three-wire control, method 1.....	90
5.2.6	Three-wire control, method 2.....	91
5.3	Command sources.....	93
5.3.1	Selecting command sources.....	93
5.3.2	Assigning functions to digital inputs.....	94
5.3.3	Controlling the motor via the fieldbus.....	95
5.4	Setpoint sources.....	96
5.4.1	Selecting frequency setpoint sources.....	96
5.4.2	Using analog inputs as a setpoint source.....	97
5.4.3	Using a motorized potentiometer as a setpoint source.....	99
5.4.4	Using the fixed frequency as a setpoint source.....	100
5.4.5	Running the motor in jog mode (JOG function).....	101
5.4.6	Specifying the motor speed via the fieldbus.....	102
5.5	Changing over the command data sets (manual, automatic).....	103
5.6	Setpoint preparation.....	106
5.6.1	Minimum frequency and maximum frequency.....	106
5.6.2	Parameterizing the ramp-function generator.....	107
5.7	Closed-loop control.....	109
5.7.1	V/f control.....	109
5.7.1.1	Typical applications for V/f control.....	109
5.7.1.2	V/f control with linear characteristic.....	110
5.7.1.3	V/f control with parabolic characteristic.....	111
5.7.1.4	Additional characteristics for the V/f control.....	111
5.7.2	Vector control.....	112
5.7.2.1	Typical applications for vector control.....	112
5.7.2.2	Commissioning vector control.....	113
5.7.2.3	Torque control.....	114
5.7.2.4	Using a speed encoder.....	115
5.8	Protection functions.....	118
5.8.1	Overtemperature protection for the frequency inverter and motor.....	118
5.8.2	Overcurrent protection.....	120
5.8.3	Limiting the maximum DC link voltage.....	121
5.8.4	Load torque monitoring (system protection).....	122

5.9	Evaluating the frequency inverter status.....	124
5.9.1	Assigning specific functions to digital outputs.....	124
5.9.2	Assigning certain functions to analog outputs .....	126
5.10	Technological functions .....	128
5.10.1	Braking functions of the frequency inverter .....	128
5.10.1.1	DC and compound braking .....	130
5.10.1.2	Dynamic braking .....	133
5.10.1.3	Regenerative braking.....	135
5.10.1.4	Parameterizing a motor holding brake.....	136
5.10.2	Automatic restart and flying restart .....	139
5.10.2.1	Flying restart: switching on the converter when the motor is running.....	139
5.10.2.2	"Automatic restart" function after power failure.....	141
5.10.3	Technology controller.....	145
5.10.4	Positioning down ramp.....	146
5.10.5	Logical and arithmetic functions using function blocks .....	147
5.10.6	Changing over drive data sets (several motors connected to a frequency inverter) .....	148
5.11	Operation in fieldbus systems.....	151
5.11.1	Communication interfaces .....	151
5.11.2	Communication via USS .....	151
5.11.2.1	User data range of the USS message frame.....	154
5.11.2.2	Data structure of the USS parameter channel.....	154
5.11.2.3	Timeouts and other errors.....	160
5.11.2.4	USS process data channel (PZD).....	160
5.11.3	Communication via PROFIBUS and PROFINET.....	161
5.11.3.1	Connect the frequency inverter to PROFIBUS .....	161
5.11.3.2	Example for configuring the inverter on PROFIBUS.....	162
5.11.3.3	Integrating a frequency inverter in PROFINET .....	172
5.11.3.4	Example for configuring the inverter on PROFINET .....	173
5.11.3.5	The PROFIdrive profile .....	176
5.11.3.6	STEP 7 program examples.....	188
5.12	Safety functions .....	195
5.12.1	Overview .....	195
5.12.2	Connecting-up the fail-safe inputs .....	198
5.12.3	Restoring safety-related parameters to the factory setting.....	200
5.12.4	Controlling the safety functions via PROFIsafe .....	201
5.12.5	Controlling the safety functions via digital inputs.....	201
5.12.6	Settings for the "STO" function .....	204
5.12.7	Settings of the SS1, SLS and SBC safety functions.....	206
5.12.8	Acceptance test and report.....	208
5.12.8.1	Documentation of the acceptance test .....	209
5.12.8.2	Function check of the acceptance test .....	210
5.12.8.3	Filling in the acceptance report.....	213
<b>6</b>	<b>Servicing and maintenance.....</b>	<b>215</b>
6.1	Behavior of the frequency inverter when replacing components.....	215
6.2	Replacing the Power Module.....	216
6.3	Replacing the Control Unit.....	217
6.4	Standard commissioning.....	218
<b>7</b>	<b>Messages and fault codes .....</b>	<b>219</b>
7.1	Status display using LEDs .....	220
7.2	Alarm and error messages.....	225

<b>8</b>	<b>Technical data .....</b>	<b>227</b>
8.1	Technical data, CU240S Control Unit .....	227
8.2	Technical data, CU240E Control Unit .....	228
8.3	General technical data, PM240 Power Modules .....	229
8.4	Power-dependent technical data, PM240 Power Modules .....	230
8.5	General technical data, PM250 Power Modules .....	233
8.6	Power-dependent technical data, PM250 Power Modules .....	234
8.7	General technical data, PM260 Power Modules .....	235
8.8	Power-dependent technical data, PM260 Power Modules .....	236
	<b>Index.....</b>	<b>237</b>



# Introduction

## 1.1 About this manual

### Who requires the operating instructions and why?

These operating instructions primarily address fitters, commissioning engineers and machine operators. The operating instructions describe the devices and device components and enable the target groups being addressed to install, connect-up, parameterize, and commission the inverters safely and in the correct manner.

### What is described in the operating instructions?

These operating instructions provide a summary of all of the information required to operate the inverter under normal, safe conditions.

The information provided in the operating instructions has been compiled in such a way that it is sufficient for all standard applications and enables drives to be commissioned as efficiently as possible. Where it appears useful, additional information for entry level personnel has been added.

The operating instructions also contain information about special applications. Since it is assumed that readers already have a sound technical knowledge of how to configure and parameterize these applications, the relevant information is summarized accordingly. This relates, e.g. to operation with fieldbus systems and safety-related applications.

### Additional information on SINAMICS G120

- **As download:** List Manual (<http://support.automation.siemens.com/WW/view/en/32465038>) CU240E and CU240S Control Units  
Among other things, the List manual includes
  - A detailed description of *all* of the parameters
  - Function diagrams of all of the inverter functions
  - A list of the fault messages and alarms
- **As download:** All of the operating instructions, manuals on SINAMICS G120 (<http://support.automation.siemens.com/WW/view/en/22339653/133300>)
- **On DVD:** SD Manual Collection - all manuals on low-voltage motors, geared motors and low-voltage inverters, 5 languages.
  - MLFB: 6SL3298-0CA00-0MG0 (supplied once)
  - MLFB: 6SL3298-0CA10-0MG0 (update service for 1 year; supplied 4 times)
- **As download:** Catalog D 11.1: SINAMICS G110 / G120 Inverter Chassis Units SINAMICS G120D Distributed Inverters. ([http://sd.nes.siemens.de/sales\\_2003/support/info/catalogues/html\\_76/index.html#Catalogs\\_Inverters](http://sd.nes.siemens.de/sales_2003/support/info/catalogues/html_76/index.html#Catalogs_Inverters))

The catalog includes ordering data as well as engineering and selection data.

## 1.2 Fast track commissioning

### Procedure when commissioning

1. Required components
  - Power Module, Control Unit; optional: Operator panel or PC connection kit
2. Installing the inverter -> Chapter 3.3 (Page 30)
  - Installing the Power Modules (minimum clearances, components) -> Chapter 3.3.1 (Page 31)
  - Connecting-up Power Modules (line supply connections, motor circuit ( $\Delta/Y$ ), EMC) -> Chapter 3.3.2 (Page 36) and Chapter 3.3.3 (Page 39)
  - Installing and connecting up the Control Unit (control terminals, user interfaces) -> Chapter 3.4.1 (Page 42)
3. Switching-on the line supply voltage and 24 V control voltage
4. Preparing commissioning
  - Information and data that you should obtain before commissioning -> Chapter 4.3 (Page 48)
  - If the components are not brand new, but are *used*: Restoring the factory settings -> Chapter 4.2 (Page 47)
5. Quick commissioning
  - When using the factory settings -> Chapter 4.4 (Page 51)
  - With STARTER (commissioning tool) -> Chapter 4.5 (Page 58)
  - With BOP (Basic Operator Panel)-> Chapter 4.6 (Page 71)
6. Storing data in a power-independent manner -> Chapter 4.7 (Page 77)
7. You can now switch-on the motor.

### Finely adjusting the inverter

With the commissioning procedure described above, your inverter is supplied with the basic functions and settings that are completely adequate for many applications.

Using the functions and parameters described in Chapter 5 (Page 81), if required, you can precisely adapt this closed-loop control structure of your inverter to your application.

## 1.3 Adapting inverters to the application (parameterization for entry level personnel)

### 1.3.1 General basics

#### **Parameterizable inverters transform standard motors into variable-speed drives**

Inverters are parameterized to adapt them to the motor being driven so that this can be optimally operated and protected. This is realized using one of the following operator units:

- Keyboard and display unit (Operator Panel) that is snapped onto the inverter.
- Software (STARTER commissioning tool) that allows the inverter to be parameterized and controlled from a PC.

Inverters are especially used to improve and expand the starting and speed response of motors.

#### **Many standard applications can function with the default parameters**

Although inverters can be parameterized for very specific applications, many standard applications can be configured by means of just a few parameters.

#### **Use the factory settings (where possible)**

For basic applications, commissioning can be carried out using just the factory settings (see Section "Commissioning with factory settings" (Page 51)).

#### **Use quick commissioning (for simple, standard applications)**

In the majority of standard applications, commissioning can be carried out by entering or changing just a few parameters during quick commissioning (see Section "Commissioning with Operator Panel" (Page 71)).

## 1.3.2 Parameter

### Parameter types

There are two types of parameters, adjustable and display parameters.

#### Adjustable parameters

Adjustable parameters are represented with four digits preceded by the letter "P". You can change the value of these parameters within a defined range.

**Example:**

P0305 is the parameter for the rated motor current in Amps. This parameter is set during commissioning. You can enter values between 0.01 and 10000.

#### Display parameters

Display parameters are represented with four digits preceded by the letter "r". You cannot change the value of these parameters.

**Example:**

r0027 is the parameter for the inverter output current. The inverter measures the current and writes the current value to the parameter. You can display the parameter value, e.g. using an analog output of the inverter.

### Change protection for write parameters

The process of changing parameter values is subject to certain conditions. If an attempt to change a parameter is rejected by the inverter, this can have a number of causes:

1. The inverter operating state does not allow you to change parameters.  
For example, certain parameters can only be changed when the inverter is in commissioning mode.
2. In some cases, you may not be able to change certain parameters due to automatic follow-on parameterization.  
Example: When P0701 = 1, the ON/OFF1 command is connected to digital input 0. As follow-on parameterization, P0840 (source of the ON/OFF1 command) is assigned value 722.0 (status of digital input 0). which means that P0840 can no longer be changed.
3. Parameter protection via P0927 has been activated.  
Example: P0927 = 1101 prevents parameters from being changed from the BOP.

For each parameter, the List Manual specifies whether and which conditions apply for changing the values.

### 1.3.3 Parameters with follow-on parameterization

When you change certain parameters, the system may automatically change other parameters accordingly. This makes it much easier to parameterize complex functions.

**Example: Parameter P0700 (command source)**

Parameter P0700 can be used to switch the command source from the fieldbus to digital inputs. When the value of P0700 is changed from 6 (command source "fieldbus") to 2 (command source "digital inputs"), other parameter values are changed automatically:

- New functions are assigned to the digital inputs (P0701 ... P0713)
- New functions are assigned to the digital outputs (P0731 ... P0733)
- Inverter control is interconnected with the signals from the digital inputs (P0800, P0801, P0840, etc.)

For more information about follow-on parameterization for P0700, see the List Manual.

## 1.4 Frequently required parameters

### Parameters that in many cases help

Table 1- 1 This is how you filter the parameter list to keep the number of displayed parameters transparent

Parameter	Description
P0003 =	<b>User access level</b> 1: Standard: Allows access to the most frequently used parameters (factory setting) 2: Extended: Extended access, e.g. to inverter I/O functions 3: Expert: To be used by experts
P0004 =	<b>Parameter filter</b> 0: All the parameters are displayed (factory setting). 2: Inverter 3: Motor - data of the motor and output filter are displayed 4: Speed encoder - parameters for the optional speed encoder are displayed

Table 1- 2 How to switch to commissioning mode or restore the factory setting

Parameter	Description
P0010 =	<b>Commissioning parameters</b> 0: Ready (factory setting) 1: Perform quick commissioning 30: Factory setting - initiate restore factory settings

Table 1- 3 How to determine the firmware version of the Control Unit

Parameter	Description
r0018	The firmware version is displayed:

Table 1- 4 This is how you reset the parameters to the factory setting

Parameter	Description
P0010 = 30	30: Factory setting - initiate restore factory settings
P0970 = 1	1: Resetting - restoring all parameters to the factory setting (Exception: Password-protected parameters of the safety functions are not reset!)

Table 1- 5 This is how you select the command source of the control signals (ON/OFF, reversing) of the inverter

Parameter	Description
P0700 =	0: Factory default setting 1: Operator Panel 2: Digital inputs (P0701 ... P0709); factory setting non-fieldbus-capable inverters 4: USS on RS 232 5: USS on RS 485 (not available for CU240S DP or CU240S DP-F) 6: Fieldbus (P2050 ... P2091); (factory setting for fieldbus-capable inverters)

Table 1- 6 This is how you select the setpoint source for the frequency

Parameters	Description
P1000 =	0: No main setpoint 1: MOP setpoint 2: Analog setpoint (factory setting for non-fieldbus-capable inverters) 3: Fixed frequency 4: USS at RS 232 5: USS on RS 485 6: Fieldbus (factory setting for fieldbus-capable inverters) 7: Analog setpoint 2

Table 1- 7 This is how you parameterize the up and down ramps

Parameters	Description
P1080 = ...	<b>Minimum frequency</b> 0.00 [Hz] factory setting
P1082 = ...	<b>Maximum frequency</b> 50.00 [Hz] factory setting
P1120 = ...	<b>Rampup time</b> 10.00 [s]
P1121 = ...	<b>Rampdown time</b> 10.00 [s]

Table 1- 8 This is how you set the closed-loop type

Parameters	Description
P1300 = 2	<b>Extended access</b>
P1300 = ...	0: V/f control with linear characteristic (factory setting) 1: V/f control with FCC 2: V/f control with parabolic characteristic 3: V/f control with programmable characteristic  20: Sensorless vector control 21: Vector control with encoder 22: Torque vector control without encoder

Table 1- 9 This is how you optimize the starting behavior of the V/f control for a high break loose torque and overload

Parameters	Description
P0003 = 2	<b>Extended access</b>
P1310 = ...	<b>Voltage boost to compensate resistive losses</b> The voltage boost is effective from standstill up to the rated speed. The voltage boost continually decreases with increasing speed. The maximum voltage boost is effective at speed zero and is in V: Rated motor current (P305) × stator resistance (P350) × P1310 /100.
P1311 = ...	<b>Voltage when accelerating</b> The voltage boost is effective from standstill up to the rated speed. The voltage boost is independent of the speed. The voltage boost in V is: Rated motor current (P305) × stator resistance (P350) × P1311 /100

## 1.5 Extended adaptation options (parameterization for advanced level personnel)

### 1.5.1 BICO technology: basic principles

#### Functional principle of BICO technology and inverter closed/open-loop control functions

The inverter software offers a range of open/closed-loop control functions, communication functions, as well as various diagnostics and operating functions. These functions are interconnected via internal signal paths and represent the default control structure.

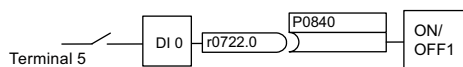

Figure 1-1 Example: Pre-assigned signal interconnection for digital input 0 of a non-bus-capable Control Unit

The functions can be parameterized and interconnected as required. The signal interconnection of the functions is realized, contrary to electric circuitry, not using cables, but in the software. The various functions use a range of inputs, outputs, and parameters.

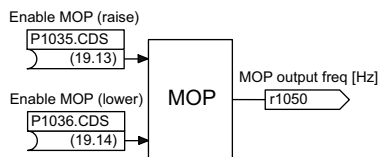

Figure 1-2 Example: MOP function (motorized potentiometer)

#### Binectors and connectors

Connectors and binectors are elements used to exchange signals between the individual functions. Connectors and binectors can be seen as "storage compartments":

- Connectors are used to store "analog" signals (e.g. speed setpoint)
- Binectors are used to store "digital" signals (e.g. 'MOP raise' command)

#### Definition of BICO technology

BICO technology describes the type of parameterization that can be used to disconnect all the internal signal interconnections between the functions or establish new connections. This is realized using **Binectors** and **Connectors**. Hence the name **BICO** technology. ( Binector Connector Technology)



## BICO parameters

You can use the BICO parameters to define the sources of the input signals of a function. This means that using BICO parameters you can define from which connectors and binectors a function reads-in its input signals. thereby enabling you to "interconnect" the functions stored in the devices in accordance with your requirements. Four different BICO parameter types are available:

- Binector inputs: BI
- Connector inputs: CI
- Binector outputs: BO
- Connector outputs: CO
- Binector/connector outputs: CO/BO

Binector/connector outputs (CO/BO) are parameters that combine more than one binector output in a single word (e.g. r0052 CO/BO: status word 1). Each bit in the word represents a digital (binary) signal. This feature reduces the number of parameters and makes it easier to set parameters by means of the serial interface (data transfer).

BICO parameters of type CO, BO, or CO/BO can be used more than once.

## BICO symbols, representation, and description

Table 1- 10 Binector symbols



Abbreviation and symbol	Description	Function
BI 	Binector input	
BO 	Binector output	

Table 1- 11 Connector symbols



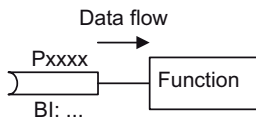

Abbreviation and symbol	Description	Function
CI 	Connector input	
CO 	Connector output	

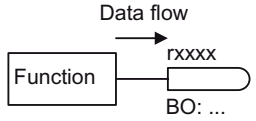
Table 1- 12 Connector and binector output symbols

Abbreviation and symbol	Description	Function
CO/BO 	Binector/connector output	

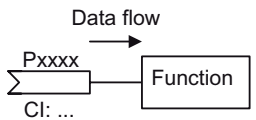
**When do you need to use BICO technology?**

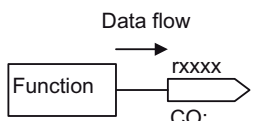
BICO technology allows you to adapt the inverter to a wide range of different requirements. This does not necessarily have to involve highly complex functions.

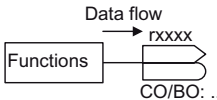
Example 1: Assign a different function to a digital input.

Example 2: Switch over the speed setpoint from the fixed frequency to the analog input.

**What precautions should you take when using BICO technology?**

Always apply caution when handling internal interconnections. Note which changes you make as you go along since the process of analyzing them later can be quite difficult.

The STARTER commissioning tool offers various screens that make it much easier for you to use BICO technology. The signals that you can interconnect are displayed in plain text, which means that you do not need any prior knowledge of BICO technology.

**What sources of information do you need to help you set parameters using BICO technology?**

- This manual is sufficient for simple signal interconnections, e.g. assigning a different significance to the to digital inputs.
- The parameter list in the List Manual is sufficient for signal interconnections that go beyond just simple ones.
- You can also refer to the function diagrams in the List Manual for complex signal interconnections.

## 1.5.2 BICO technology: example

### Example: Shifting a basic PLC functionality into the inverter

A conveyor system is to be configured in such a way that it can only start when two signals are present simultaneously. These could be the following signals, for example:

- The oil pump is running (the required pressure level is not reached, however, until after five seconds)
- The protective door is closed

The task is realized by inserting free blocks between the digital input 0 and the internal ON command for the motor and interconnecting them.

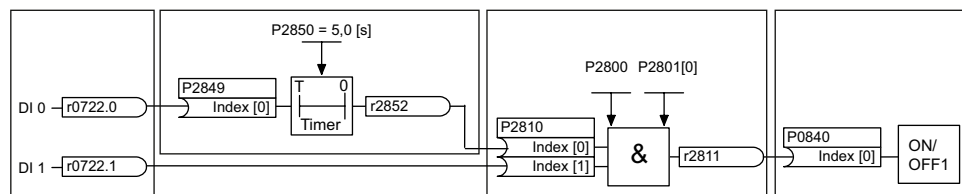

Figure 1-3 Example: Signal interconnection for interlock

Table 1- 13 Parameterizing an interlock

Parameter	Description
P0003 = 3	Enable expert access to parameters
P0700 = 2	Select the command source: Digital inputs
P0701 (e.g.) = 99	Enable/"open" digital input 0 (DI0) for BICO parameterization
P0702 (e.g.) = 99	Enable/"open" digital input 1 (DI1) for BICO parameterization
P2800 = 1	Group enable all freely-programmable function blocks (FFB)
P2801 [In000] = 1	Individual enable of the AND function block
P2802 [In000] = 1	Individual enable of the TIMER function block
P2850 = 5.0	Set the TIMER delay time: 5 seconds
P2849 = r0722.0	Connect the status of DI0 to the TIMER input r0722.0 = Parameter that displays the status of digital input 0.
P2810 [In000] = r2852	Connect the TIMER output to the 1st input of the AND
P2810 [In001] = r0722.1	Connect the status of DI1 to the 2nd AND input r0722.1 = Parameter that displays the status of digital input 1.
P0840 = r2811	Connect the AND output to the control command ON/OFF1

**Explanations of the example**

**Open the default signal interconnection for BICO parameterization**

The default setting P0701 = 1 indicates the following internal signal interconnection:

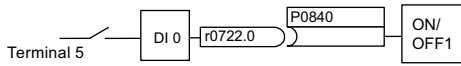

Figure 1-4 Default parameterization

The setting P0701 = 99 means that a pre-assigned signal interconnection is disconnected and therefore the connection opened for BICO parameterization.

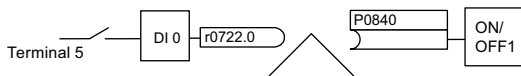

Figure 1-5 BICO parameterization

When P0701 = 99, the binector input of the ON/OFF1 function (P0840) is available for activation by a signal source other than r0722.0 (in this case r2852).

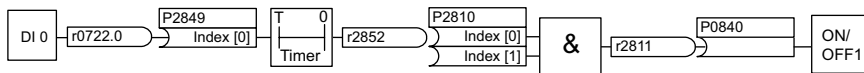

Figure 1-6 Interconnection after insertion of two functions

**Principle of connecting functions by means of BICO technology**

A connection between two functions comprises a connector/binector and a BICO parameter. Connections are always established with respect to the input of a particular function, which means that the output of an upstream function must always be assigned to the input of a downstream function. The assignment is always made by entering the number of the connector/binector from which the required input signals are read in a BICO parameter.

With this functional logic in mind, **where does the signal come from?**

## Description

### Overview of the SINAMICS G120 family of inverters

Thanks to their modular design, SINAMICS G120 inverters can be used in a wide range of applications with respect to functionality and power.

Each SINAMICS G120 inverter comprises a Control Unit and a Power Module. The power range extends from 0.37 kW to 250 kW.

The Basic Operator Panel (BOP) and the STARTER commissioning tool are available for commissioning.

A range of additional, application-specific components are also available (e.g. filters, reactors, braking resistors).

## 2.1 Modularity of the converter system

### Main components of the inverter



Each SINAMICS G120 inverter comprises a Control Unit and Power Module. In the SINAMICS G120 range, the Control Units can be combined with any Power Module.

- The Control Unit controls and monitors the Power Module and the connected motor in various control modes (which can be selected as required). It supports communication with local or central control as well as with monitoring devices.
- The Power Modules are available for motors with a power range of between 0.37 kW and 250 kW. IGBT technology and pulse-width modulation are used to ensure reliable and flexible motor operation.



**Supplementary components**

In addition to the main components, the following components are available for commissioning and parameterization:

	<p>Operator Panel (OP) for parameterization, diagnostics, and control as well as for copying drive parameters.</p>
	<p>MMC memory card for carrying out standard commissioning of more than one inverter and for external data backup.</p>
 <p style="text-align: center;">STARTER CD/DVD</p>	<p>PC connection kit and STARTER commissioning tool for prompted, PC-based commissioning.</p>
	<p>Filters and reactors</p> <ul style="list-style-type: none"> <li>• Line filters (classes A and B)</li> <li>• Line reactors</li> <li>• Braking resistors</li> <li>• Output reactors</li> <li>• Sine-wave filter</li> </ul>
	<p>Further options</p> <ul style="list-style-type: none"> <li>• Brake Relay</li> <li>• Safe Brake Relay</li> <li>• Adapter for DIN rail mounting</li> <li>• Shield connection kit</li> </ul>

## 2.2 Overview of Control Units

	Control Units with safety-relevant functions					
	Control Units with fieldbus interface					
	CU240E	CU240S	CU240S DP	CU240S PN	CU240S DP-F	CU240S PN-F
	Cost-effective variants Functionally identical with the CU240S however, no encoder connection, fewer I/Os	Control Unit CU240S for operation via terminals and USS via RS485	Control Unit CU240S additionally with PROFIBUS DP interface	Control Unit CU240S additionally with PROFINET interface	Control Unit CU240S additionally with PROFIBUS DP interface and safety-relevant functions via terminals or PROFIsafe	Control Unit CU240S additionally with PROFINET interface and safety-relevant functions via terminals or PROFIsafe

Figure 2-1 Control Unit variants

## 2.3 Overview of Power Modules



Figure 2-2 Power Module versions

A number of Power Module versions are available for different line supply voltages in a power range from between 0.37 kW and 250 kW. Depending on the Power Module used, the energy released in regenerative mode is either

- fed back to the supply system (Efficient Infeed Technology) or
- stored in the DC link and/or fed to an external braking resistor.

### Overview of the available Power Modules

Depending on the output, Power Modules are available with different frame sizes. The range of frame sizes extends from FSA to FSGX.

		FSA	FSB	FSC	FSD	FSE	FSF	FSGX
PM240 3-ph. 400V AC		0.37 kW ... 1.5 kW	2.2 kW ... 4kW	7.5 kW ... 15 kW	18.5 kW ... 30 kW	37 kW ... 45 kW	55 kW ... 132 kW	160 kW ... 250 kW
	With integr. Line filter, class A	○	●	●	●	●	● <sup>1)</sup>	● <sup>2)</sup>
	With integr. Braking chopper	●	●	●	●	●	●	● <sup>2)</sup>
PM250 3-ph. 400V AC		-	-	7.5 kW ... 15 kW	18.5 kW- 3 0 kW	37 kW ... 45 kW	55 kW ... 90 kW	-
	With integr. Line filter, class A			●	●	●	●	
	Capable of energy recovery			●	●	●	●	
PM260 3-ph. 690V AC		-	-	-	11 kW ... 18.5 kW	-	30 kW ... 55 kW	-
	With/without integr. Line filter, Class A				●		●	
	With integr. Sine-wave filter				●		●	
	Capable of energy recovery				●		●	

● = Feature available; ○ = Feature not available; ◐ = Feature available, modified;

1) PM240 Power Modules, 110 kW and higher, are only available without an integrated class A filter. Instead, an optional class A line filter for side mounting is available.

2) PM240 FSGX Power Module is only available without integrated components. Instead, optional line reactor, line filter, output reactor, sine-wave filter, braking chopper, braking resistor and Brake Relay are available.



## 2.4 Reactors and filters

### Overview

Depending on the Power Module, the following combinations with filters and reactors are permitted:

Power Module	Line-side components			Load-side components	
	Line reactor	Line filters class B	Braking resistor	Sine-wave filter	Output reactor
PM240	•	•	•	•	•
PM250	-	•	-	•	•
PM260	-	•	-	integrated	-



## Connection

### 3.1 Procedure for installing the frequency inverter

#### Prerequisites for installing the inverter

Check that the following prerequisites are fulfilled before you install the inverter:

- Are the components, tools and small parts required for installation available?
- Are the ambient conditions permissible? See: Technical data (Page 227)
- Have the cables and wires been routed in accordance with the applicable regulations? See: EMC-compliant connection (Page 39)
- Are the minimum distances from other equipment complied with? (Cooling sufficient?) See: Chapter: Dimensions, hole drilling templates, minimum clearances, tightening torques (Page 31)

#### Installation sequence

1. Install the Power Module (detailed instructions are provided in the Installation Manual for the Power Modules (<http://support.automation.siemens.com/WW/view/en/30563173/133300>))
  - Remove the terminal covers - where applicable
  - Connect motor cable and power cable
  - Terminate the shield over a large area, if necessary using a shield connection set
  - Refit the terminal covers
2. Mount the Control Unit
  - Open the terminal covers of the Control Unit
  - Connect the control lines to the terminals
  - Terminate the shield over a large area, if necessary using a shield connection set
  - Close the terminal covers again
3. Control Unit – for operation in a higher-level control – connect to the fieldbus
  - For PROFIBUS DP and CANopen connect it via the 9-pin sub D connector
  - For RS 485, connect it via the two-part bus connector
4. To commission the drive unit, either plug-in the operator control/display instrument (operator panel) or connect the inverter to the PC using the PC connection kit.

Installation has now been completed and you can begin commissioning.

### 3.2 Mounting reactors and filters

#### Mounting system components in a space-saving fashion for the inverters

Many system components for the inverters are designed as sub-chassis components, that is, the component is mounted on the baseplate and the inverter mounted above it to save space. Up to two base components can be mounted above one another.

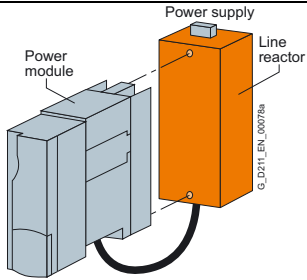
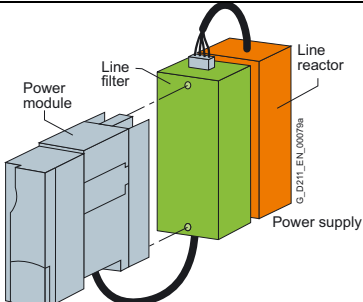
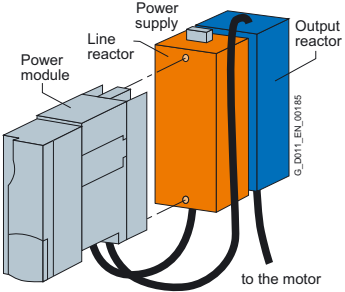
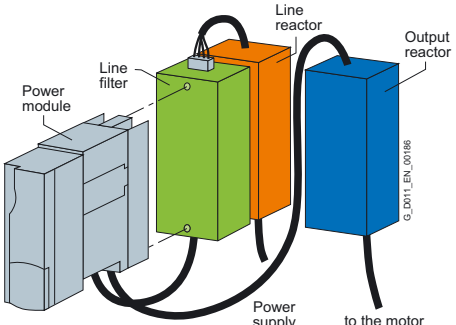
PM240	
	
<p>Basic layout of a PM240 Power Module with line reactor as base component</p>	<p>PM240 Power Module frame size FSA with line reactor and class A line filter</p>
<p>The line-side reactors are equipped with terminals while the reactors on the Power Module side are equipped with a prefabricated cable. In the final installation position, the mains terminals are at the top on frame sizes FSA to FSC, and at the bottom on frame sizes FSD to FSE.</p> <p>For frame size FSA, in addition to the line reactor, a class A line filter can be used. In this case, the mains connection is at the bottom.</p> <p>Power Modules of frame size FSB and higher are available with integrated class A line filters (an external class A line filter is not required in this case).</p>	
	
<p>PM240: frame size FSA with line reactor and output reactor</p>	<p>PM240 Power Modules: frame size FSA with line reactor, line filter, and output reactor</p>
<p>In installations containing more than two base-type system components (e.g. line filter + line reactor + output reactor), the components must be installed to the side of the Power Modules, whereby the line reactor and line filter are installed under the Power Module and the output reactor to the side.</p>	

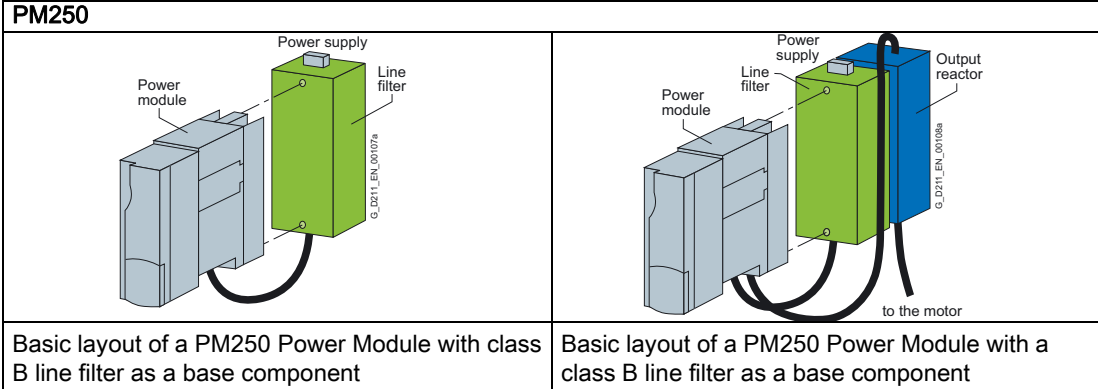

### 3.3 Mounting Power Modules

#### Options for installing the Power Module

Depending on the format, various options are available for installing inverters. This manual describes how to install inverters directly on the cabinet wall.

Installation options	Frame size						
	A	B	C	D	E	F	GX
Installation on standard rails	X	X	X	---	---	---	---
Mounting on a cabinet panel with shield connection kit	X	X	X	X	X	X	---
Installation directly on the cabinet wall	X	X	X	X	X	X	X

#### Installing Power Modules

Choose the best installation option for your application and install the Power Module in accordance with the instructions provided in this section.

#### NOTICE

##### Information about installation

The Power Module must not be installed horizontally.



Correct



Incorrect

Devices that could impede the flow of cooling air must not be installed in this area. Make sure that the ventilation openings for the cooling air for the inverter are not covered and that the flow of cooling air is not obstructed.

#### Installing additional components

Depending on the application, additional line reactors, filters, braking resistors, brake relays etc., may also be used.

Please observe the mounting and installation instructions supplied with these components!

### 3.3.1 Dimensions, hole drilling templates, minimum clearances, tightening torques

#### Overview of dimensions and hole drilling templates for the Power Modules

0.37 kW ... 1.5 kW	2,2 kW ... 4 kW	7,5 kW ... 15 kW
<b>Retaining type</b> <ul style="list-style-type: none"> <li>• 2 x M4 bolts</li> <li>• 2 x M4 nuts</li> <li>• 2 x M4 washers</li> </ul>	<b>Retaining type</b> <ul style="list-style-type: none"> <li>• 4 x M4 bolts</li> <li>• 4 x M4 nuts</li> <li>• 4 x M4 washers</li> </ul>	<b>Retaining type</b> <ul style="list-style-type: none"> <li>• 4 x M5 bolts</li> <li>• 4 x M5 nuts</li> <li>• 4 x M5 washers</li> </ul>
<b>Tightening torques</b> <ul style="list-style-type: none"> <li>• 2.5 Nm (22.1 lbf.in)</li> </ul>	<b>Tightening torques</b> <ul style="list-style-type: none"> <li>• 2.5 Nm (22.1 lbf.in)</li> </ul>	<b>Tightening torques</b> <ul style="list-style-type: none"> <li>• 2.5 Nm (22.1 lbf.in)</li> </ul>
<b>Distances from other devices</b> <ul style="list-style-type: none"> <li>• Lateral: 0 mm (0 inch) up to 40°C 30 mm (1.18 inch) from 40°C and higher</li> <li>• Top/bottom: 100 mm (3.93 inch)</li> </ul>	<b>Clearances to other devices</b> <ul style="list-style-type: none"> <li>• Lateral: 0 mm (0 inch) up to 40°C 40 mm (1.57 inch) from 40°C and higher</li> <li>• Top/bottom: 100 mm (3.93 inch)</li> </ul>	<b>Clearances to other devices</b> <ul style="list-style-type: none"> <li>• Lateral: 0 mm (0 inch) up to 40°C 50 mm (1.96 inch) from 40°C and higher</li> <li>• Top/bottom: 125 mm (4.92 inch)</li> </ul>
<b>Depth</b> <ul style="list-style-type: none"> <li>• Standalone: 145 mm (5.71 inch)</li> <li>• With CU240E: 187 mm (7.36 inch)</li> <li>• With CU240S: 208 mm (8.19 inch)</li> </ul>	<b>Depth</b> <ul style="list-style-type: none"> <li>• Standalone: 165 mm (6.50 inch)</li> <li>• With CU240E: 207 mm (8.15 inch)</li> <li>• With CU240S: 228 mm (8.98 inch)</li> </ul>	<b>Depth</b> <ul style="list-style-type: none"> <li>• Standalone: 185 mm (7.28 inch)</li> <li>• With CU240E: 227 mm (8.94 inch)</li> <li>• With CU240S: 248 mm (9.76 inch)</li> </ul>

3.3 Mounting Power Modules

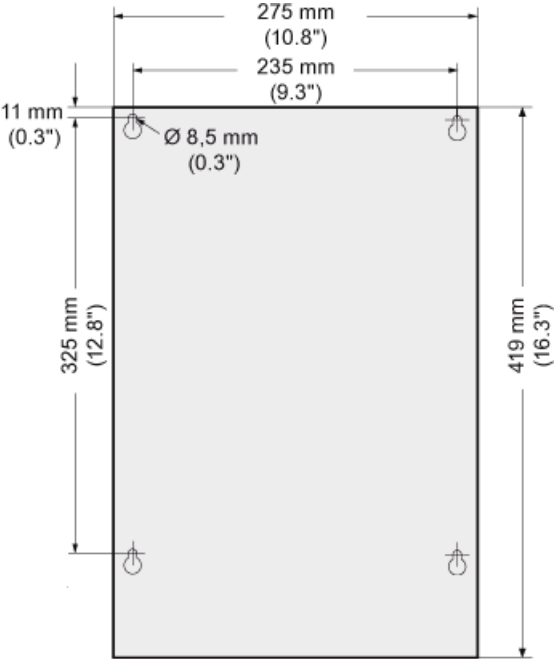
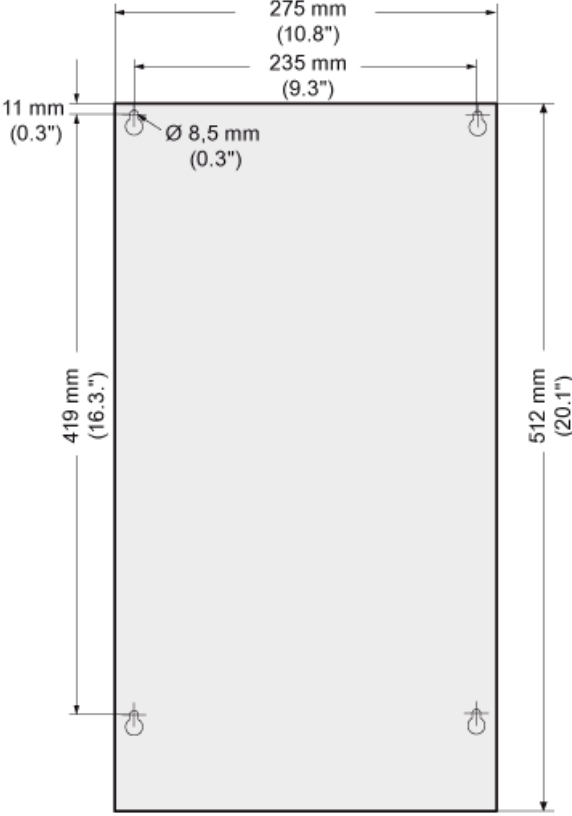
18.5 kW ... 30 kW without filter	18.5 kW ... 30 kW with filter for PM240 and PM250 11 kW ... 18 kW for PM260
	
Retaining type	<ul style="list-style-type: none"> <li>• 4 x M6 bolts</li> <li>• 4 x M6 nuts</li> <li>• 4 x M6 washers</li> </ul>
Tightening torques	<ul style="list-style-type: none"> <li>• 6 Nm (53 lbf.in)</li> </ul>
Clearances to other devices	<ul style="list-style-type: none"> <li>• Lateral: 0 mm (0 inch)</li> <li>• Top/bottom: 300 mm (11.81 inch)</li> </ul>
Depth	<ul style="list-style-type: none"> <li>• Standalone: 204 mm (8.03 inch)</li> <li>• With CU240E: 246 mm (9.68 inch)</li> <li>• With CU240S: 267 mm (10.51 inch)</li> </ul>



37 kW ... 45 kW without filter		37 kW ... 45 kW with filter	
Retaining type	<ul style="list-style-type: none"> <li>• 4 x M6 bolts</li> <li>• 4 x M6 nuts</li> <li>• 4 x M6 washers</li> </ul>		
Tightening torques	<ul style="list-style-type: none"> <li>• 6 Nm (53 lbf.in)</li> </ul>		
Clearances to other devices	<ul style="list-style-type: none"> <li>• Lateral: 0 mm (0 inch)</li> <li>• Top/bottom: 300 mm (11.81 inch)</li> </ul>		
Depth	<ul style="list-style-type: none"> <li>• Standalone: 204 mm (8.03 inch)</li> <li>• With CU240E: 246 mm (9.68 inch)</li> <li>• With CU240S: 267 mm (10.51 inch)</li> </ul>		

3.3 Mounting Power Modules

55 kW ... 132 kW without filter for PM240 and PM250 30 kW ... 55 kW for PM260	55 kW ... 90 kW with filter
Retaining type	<ul style="list-style-type: none"> <li>• 4 x M8 bolts</li> <li>• 4 x M8 nuts</li> <li>• 4 x M8 washers</li> </ul>
Tightening torques	<ul style="list-style-type: none"> <li>• 13 Nm (115 lbf.in)</li> </ul>
Clearances to other devices	<ul style="list-style-type: none"> <li>• Lateral: 0 mm (0 inch)</li> <li>• Top/bottom: 350 mm (13.77 inch)</li> </ul>
Depth	<ul style="list-style-type: none"> <li>• Standalone: 316 mm (12.44 inch)</li> <li>• With CU240E: 358 mm (14.09 inch)</li> <li>• With CU240S: 379 mm (14.92 inch)</li> </ul>

<b>160 kW ... 250 kW for PM240</b>	
Retaining type	<ul style="list-style-type: none"> <li>• 6 x M8 bolts</li> <li>• 6 x M8 nuts</li> <li>• 6 x M8 washers</li> </ul>
Tightening torques	<ul style="list-style-type: none"> <li>• 13 Nm (115 lbf.in)</li> </ul>
Clearances to other devices	<ul style="list-style-type: none"> <li>• Lateral: 0 mm (0 inch)</li> <li>• Top: 250 mm (9.84 inch)</li> <li>• Bottom: 150 mm (5.91 inch)</li> </ul>
Depth	<ul style="list-style-type: none"> <li>• 544 mm (21.4 inch)</li> </ul>

### 3.3.2 Wiring Power Modules

#### Prerequisites

Once the Power Module has been properly installed, the line and motor connections can now be established. The following warning information must be observed here.



<b>! WARNING</b>
<b>Line and motor connections</b>
The inverter must be grounded on the supply and motor side. If this is not carried out properly, this can lead to extremely hazardous conditions which, under certain circumstances, can result in death.
The device must be disconnected from the electrical power supply before any connections with the device are established or in any way altered.
The inverter terminals can carry hazardous voltages even after the inverter has been switched off. After disconnecting the line supply, wait at least 5 minutes until the drive unit has discharged itself. Only then, carry out any installation and mounting work.
When connecting the inverter to the line supply, ensure that the motor terminal box is closed.
Even if the LEDs or other indicators do not light up or remain inactive when a function is switched from ON to OFF, this does not necessarily mean that the unit has been switched off or is de-energized.
The short-circuit ratio of the power supply must be at least 100.
Make sure that the inverter is configured for the correct supply voltage (the inverter must not be connected to a higher supply voltage).
If a residual-current circuit breaker is installed on the supply side of the electronic devices to protect against direct or indirect contact, only type B is permissible. In all other cases, other protective measures must be implemented, such as creating a barrier between the electronic devices and the environment by means of double or reinforced insulation, or disconnecting them from the supply by means of a transformer.

<b>CAUTION</b>
<b>Supply and control cables</b>
The control cables must be laid separately from the supply cables to ensure that the system is not affected by inductive or capacitive interference.

---

#### Note

##### Electrical protective equipment

Make sure that suitable circuit breakers and/or fuses (with the prescribed rated currents) are installed between the supply system and inverter (see the technical specifications).

---

Connection example: Power Module PM240

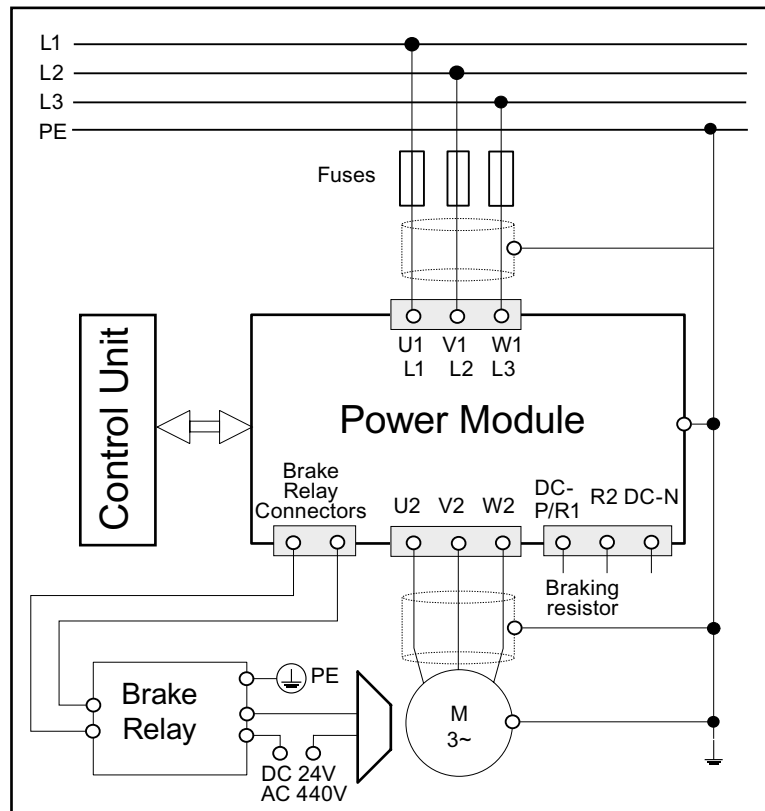

Figure 3-1 Connection diagram: PM240 Power Module with Brake Relay

Star connection and delta connection

With SIEMENS motors, you will see a diagram of both connection types on the inside of the terminal board cover:

- Star connection (Y)
- Delta connection ( $\Delta$ )

The motor rating plate provides information about the correct connection data:  
e.g.: 230/400V  $\Delta$ /Y means that for a 400V line supply, the motor is connected up in the Y connection.

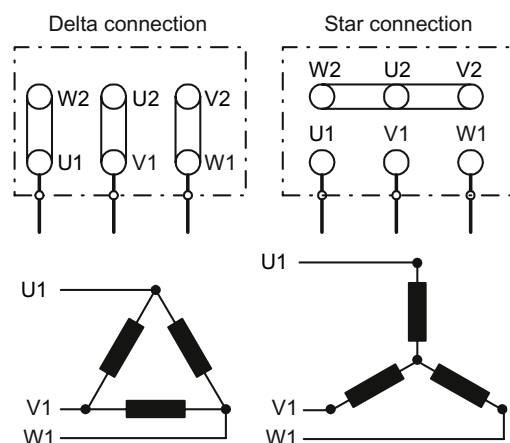

Connecting-up Power Modules

Line supply connection	Motor connection	Connect the braking resistor
<p>Connect the line supply to terminals U1/L1, V1/L2 and W1/L3.</p> <p>Connect the protective conductor of the line supply to terminal PE of the inverter.</p> <p>Power Modules without an integrated line filter can be connected to grounded (TN, TT) and non-grounded (IT) line supply systems. Power Modules with an integrated class A line filter are only suitable for TN supply systems.</p>	<p>Connect the motor at terminals U2, V2, and W2.</p> <p>Connect the protective conductor of the motor to the terminal <math>\perp</math> of the inverter.</p> <p>The following cable lengths are permissible:</p> <ul style="list-style-type: none"> <li>• Unshielded 100 m</li> <li>• Shielded, 50 m for inverters without filter 25 m for inverters with filter</li> </ul> <p>Additional information is provided in Catalog D11.1 for longer cable lengths</p>	<p>A braking resistor can be connecting at terminals DCP/R1 and R2.</p> <p>Do not ground the braking resistor at the inverter, but directly at your grounding bar.</p>

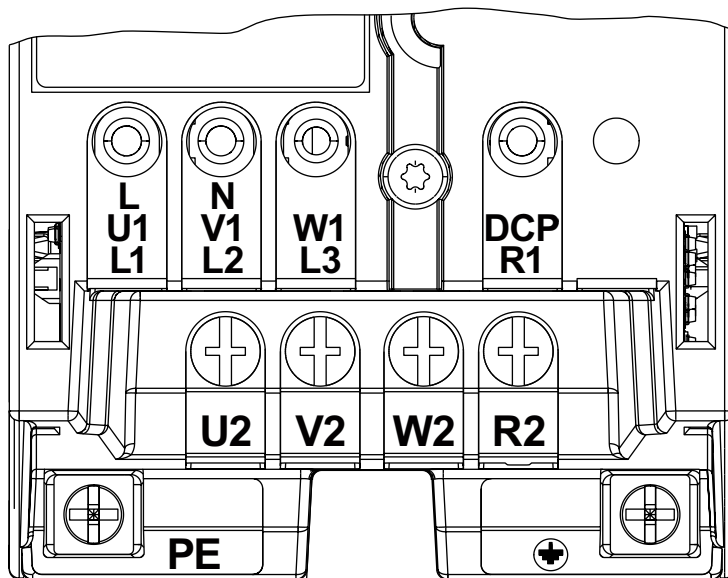

	FSA	FSB	FSC	FSD	FSE	FSF	FSGX
Power	0.37 kW ... 1.5 kW	2.2 kW ... 4 kW	7.5 kW ... 15 kW	18.5 kW ... 30 kW	37 kW ... 45 kW	55 kW ... 132 kW	160 kW ... 250 kW
Connection cross-section	1 mm <sup>2</sup> ... 2.5 mm <sup>2</sup>	1.5 mm <sup>2</sup> ... 6 mm <sup>2</sup>	4 mm <sup>2</sup> ... 10 mm <sup>2</sup>	10 mm <sup>2</sup> ... 35 mm <sup>2</sup>	10 mm <sup>2</sup> ... 35 mm <sup>2</sup>	35 mm <sup>2</sup> ... 120 mm <sup>2</sup>	95 mm <sup>2</sup> ... 2 x 240 mm <sup>2</sup>
Torque	1.1 Nm	1.5 Nm	2.25 Nm	6 Nm	6 Nm	13 Nm	14 Nm

### 3.3.3 EMC-compliant connection

#### EMC-compliant connection

The example diagram shows how shielding is implemented for frame size FSA using a shield connection kit. Corresponding shield connection kits are available for all Power Module frame sizes (you will find more information in Catalog D11.1).

The cable shields must be connected to the shield connection kit with the greatest possible surface area by means of the shield clips.

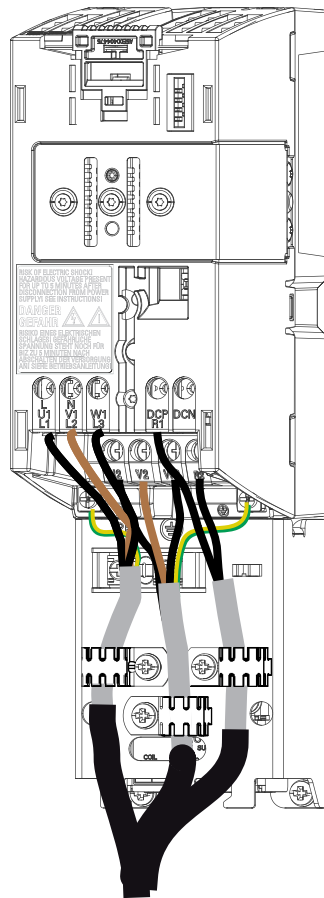

Figure 3-2 Shield connection kit FSA

---

#### Note

EMC-compliant shielding can also be implemented without this optional shield connection kit. In this case, you must ensure that the cable shields are connected to the ground potential with the greatest possible surface area.

---

### Avoiding electromagnetic disturbances

The inverters are designed for operation in industrial environments where high values of electromagnetic noise and disturbances are expected. Generally, correct installation guarantees safe, reliable and disturbance-free operation. If difficulties do arise, then please note the following guidelines.

#### Required measures

- Ensure that all of the devices in the cabinet are well-grounded using short grounding cables with high cross-sections, connected to a common grounding point or a grounding bar.
- Ensure that every control device (e.g. a PLC) connected to the inverter is connected to the same ground or the same grounding point as the inverter through a short cable with a large cross-section.
- Connect the return ground of the motors, which are controlled from the inverters, directly at the ground connection (PE) of the associated inverter.
- Flat cables are preferred as they have a lower impedance at higher frequencies.
- The cable ends must be cleanly terminated and it must be ensured that unshielded cables are as short as possible.
- The control cables must be routed separately from the supply cables. Power and control cables should cross at a 90° angle.
- If at all possible, use shielded cables to connect the control circuit.
- Ensure that the contactors in the cabinet have the necessary interference suppression components; either using an RC circuit for AC contactors or using "free-wheeling diodes" for DC contactors, whereby the noise suppression elements should be connected at the coils. Varistor suppressors are also effective. This is important if the contactors are controlled from the inverter relay.
- Use shielded cables for the motor connections, and ground the shielding at both ends using cable clamps.



## 3.4 Installing the Control Unit

### Locating the Control Unit on the power unit

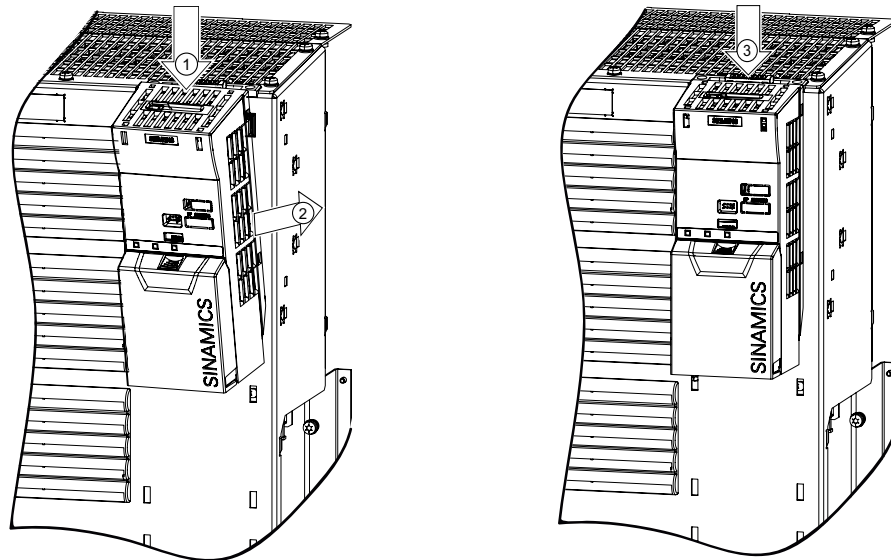

The Control Unit is simply snapped-on to a Power Module. This also establishes all of the electrical connections between the two components.

The Control Unit can be removed by pressing the release button ③.

### Removing the terminal cover

To access the control terminals, remove the cover as shown in the adjacent diagram.

- Maximum cable cross-section for control terminals, 2.5 mm<sup>2</sup>.
- Tightening torque, 0.25 Nm

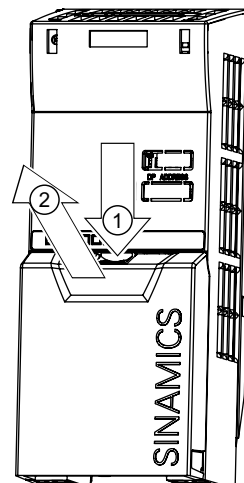

### 3.4.1 Interfaces, connectors, switches, control terminals, LEDs on the CU

#### Overview of the process and user interfaces

The following interfaces are provided on the Control Unit

- Terminals for the input and output signals
- Card slot to upload and download inverter settings
- Connector to communicate with higher-level controls
- DIP switches to configure the speed encoder, the analog inputs and, if required, to set the PROFIBUS address.
- LEDs for diagnostics

All of these interfaces are shown in the following diagram.

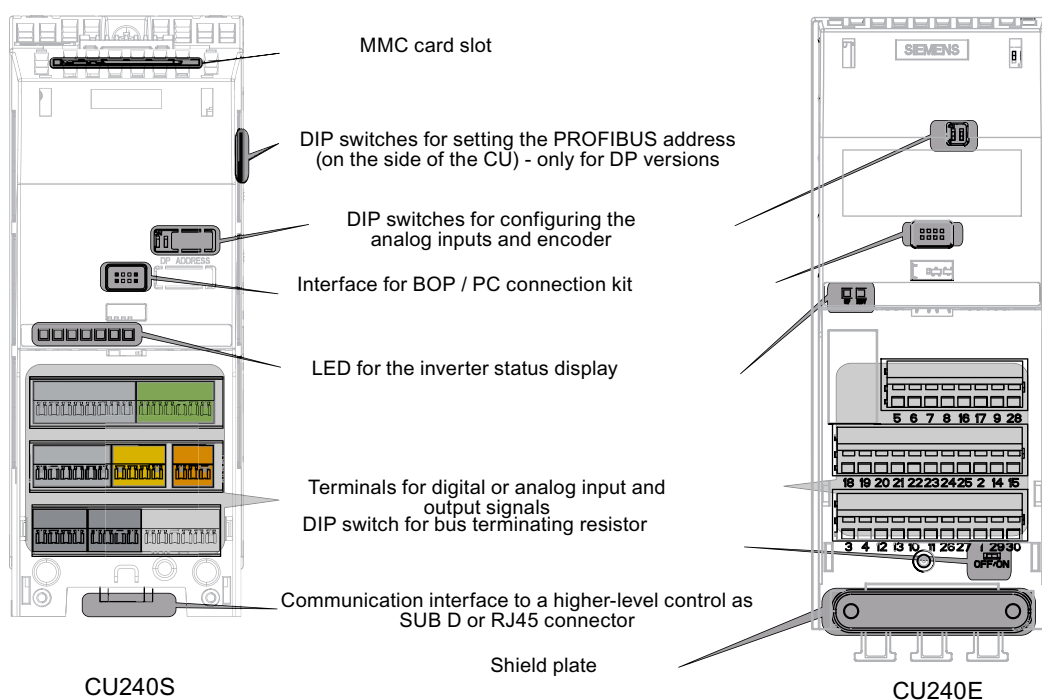
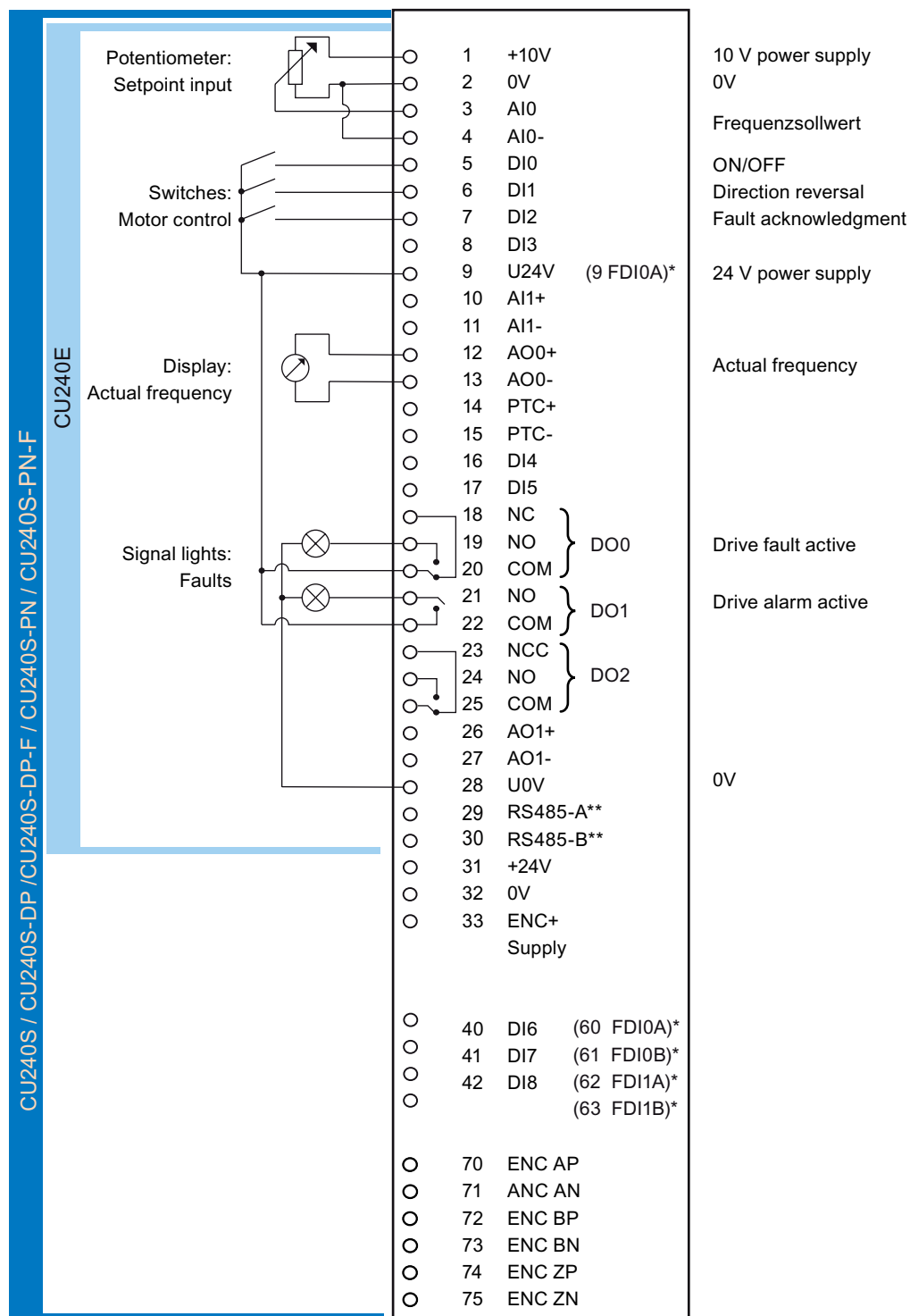

Figure 3-3 User interfaces of the CU240E/S



\* Terminals for fail-safe versions / \*\* only for CU240E

Figure 3-4 Block diagram, CU 240

### Arrangement and function of the terminals on the CU240S Control Unit

All Control Units are equipped with the same control terminals. However, depending on the CU version, the factory set activation for certain digital inputs and interfaces differ. (see the block diagram for CU240S/E and for CU240S-DP/CU240S-DPF/CU240S-PN/CU240S-PN-F).

Unlike the standard Control Units, the fail-safe Control Units CU240S DP-F and CU240S PN-F only have six digital inputs instead of nine. They are instead equipped with two fail-safe digital inputs. Fail-safe digital inputs are redundant and each have two terminals.

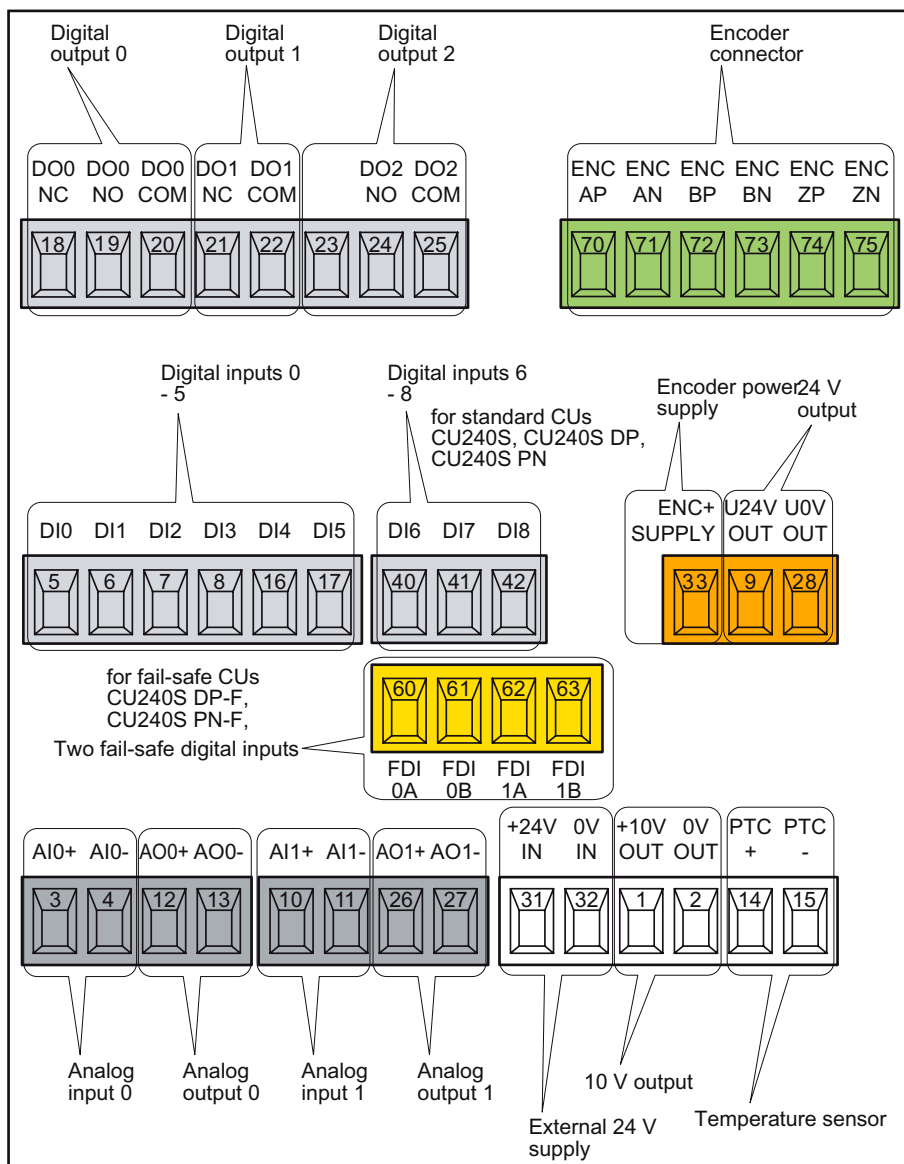

Figure 3-5 Terminal overview: CU240S-DP /-DP-F/ -PN /-PN-F

# Commissioning

## Alternative commissioning options

The functions of an inverter are activated and configured using parameters. Parameters can either be accessed from the operator control/display instrument (operator panel) or using the STARTER commissioning tool from the PC via the appropriate inverter interface.

Inverters can also be parameterized by saving the valid inverter parameter set on an MMC memory card or on the Operator Panel and then transferring it to a different inverter with the same configuration and function.

The commissioning scenarios listed below are described in the following sections:

- Commissioning, using the factory settings
- Commissioning using the STARTER commissioning tool
- Commissioning using the Operator Panel
- Data backup with the Operator Panel and MMC memory card

## Users can access the inverter parameters via the following interfaces

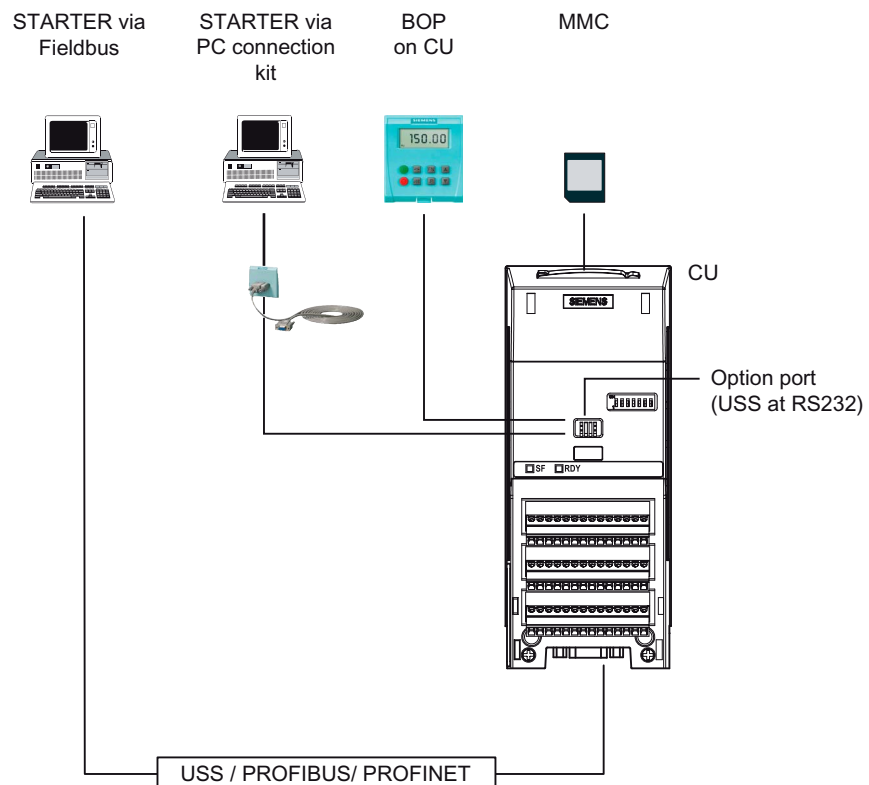

## 4.1 Initial coupling of the CU and PM - message F0395

### Description

Message "F0395" is displayed when Control Units or Power Modules are switched on for the first time or after they have been replaced.

Using this message F0395, the two inverter components - Control Unit and Power Module - are monitored to ensure that they are not replaced without the appropriate authorization. If you acknowledge this message, then you accept the responsibility that the parameter set on the Control Unit matches the Power Module and the hardware has been correctly connected, e.g. all of the output phases have been correctly connected.

### Acknowledging message F0395

Depending on which command source is set, you can acknowledge message F0395 in the following ways:

- If the command source is "BOP": press function key FN
- If the command source is 'Terminals' (P0700 = 2): digital input 2 (factory setting for the acknowledge command)
- If the command source is 'Fieldbus' (P0700 = 6): control word 1 (STW1 / bit 7)

Message F0395 is also acknowledged when 'Restoring the factory setting'.

## 4.2 Restoring the factory settings

### If nothing else works, restore the factory settings!

You can restore the factory setting using parameter P0970.

Table 4- 1 Restoring the factory settings

Parameter or procedure	Description
P0003 = 1	<b>User access level</b> 1: Standard
P0010 = 30	<b>Commissioning parameter</b> 30: Factory setting - initiate restore factory settings
P0970 = 1	<b>Restore factory settings</b> 1: Resetting - restoring parameters to the factory settings
BOP displays "BUSY"  STARTER displays progress bar	Once the factory settings have been restored, P0970 and P0010 are set to 0 and the BOP returns to the standard display.

---

#### Note

Data transfer is interrupted while the factory parameter settings are being restored.

The following parameters remain unchanged even after the factory settings have been restored:

- P0014 Storage mode
  - P0100 Europe / North America
  - Communication parameters
  - Power-Module-specific data
-

## 4.3 Preparing commissioning

### Prerequisites: before you start

Before you start parameterization, you should clarify the following issues about commissioning your application.

### Are the factory settings sufficient for your application?

To start, check which factory settings you can use and which settings you wish to change (see Section 'Commissioning with factory settings' (Page 51)). When doing so, you may find that you only need to change just a few parameters.

### Which motor are you using? [P0300]

- A synchronous or induction motor?

The SINAMICS inverters are preset in the factory for applications using 4-pole three-phase induction motors that correspond to the performance data of the inverter.

### Motor data / data on the motor rating plate

If you use the STARTER commissioning tool and a SIEMENS motor, you only have to specify the motor Order No. In all other cases, you must read-off the data from the motor rating plate and enter into the appropriate parameters.

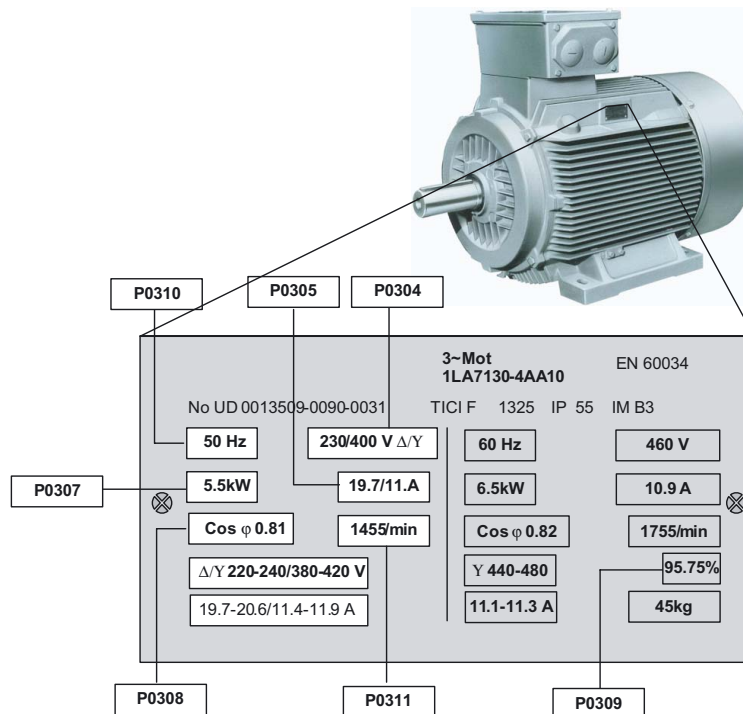



**NOTICE**

**Information about installation**

The rating plate data that you enter must correspond to the connection type of the motor (star connection [Y]/ delta connection [ $\Delta$ ]), i.e. for a delta motor connection, the delta rating plate data must be entered.

**In which region of the world is the motor used? - Motor standard [P0100]**

- Europe ICE: 50 Hz [kW] - factory setting
- North America NEMA: 60 Hz [hp] or 60 Hz [kW]

**Are you using an external speed encoder, and if yes, what is its resolution? [P0400]**

- Speed encoder type
- Number of encoder pulses (resolution) per revolution

**What is the prevailing temperature where the motor is operated? [P0625]**

- Motor ambient temperature [P0625], if it differs from the factory setting = 20° C.

**What control mode do you want to use for your application? [P1300]**

A distinction is made between V/f open-loop control and vector closed-loop control.

- The V/f open-loop control is the simplest operating mode for an inverter. For example, it is used for applications involving pumps, fans or motors with belt drives.
- For closed-loop vector control, the speed deviations between the setpoint and actual value are less than for V/f open-loop control; further, it is possible to specify a torque. It is suitable for applications such as winders, hoisting equipment or special conveyor drives.

### What command and setpoint sources are you using?

The command and setpoint sources that are available depend on the inverter. Depending on whether you use an inverter with or without fieldbus interface, with or without fail-safe functions, the default command and setpoint sources set in the factory differ.

- **Possible command sources [P0700]**
  - Operator Panel
  - Fieldbus (factory setting for bus-capable and fail-safe inverters)
  - Local digital inputs/switches (factory setting for non-bus-capable inverters)
- **Possible setpoint sources [P1000]**
  - Motorized potentiometer
  - Analog setpoint
  - Fixed frequency
  - Fieldbus

### Controlling motors via terminals

There are various methods to start, stop and reverse the direction of a motor. The various methods can be configured using parameter P0727.

The following two-wire control versions are available with the factory setting (P0727 = 0):

- Switching on and off with one control command and reversing with the second control command.
- Switching on and switching off a direction of rotation with each control command.

### Minimum/maximum frequency of the motor

The minimum and maximum frequency with which the motor operates or is limited regardless of the frequency setpoint.

- Minimum frequency [P1080] - factory setting 0 Hz
- Maximum frequency [P1082] - factory setting 50 Hz

### Ramp-up time and ramp-down time

The ramp-up and ramp-down time define the maximum motor acceleration when the speed setpoint changes. The ramp-up and ramp-down time is the interval between motor standstill and the maximum frequency, or between the maximum frequency and motor standstill.

- Ramp-up time [P1120] - factory setting 10 s
- Ramp-down time [P1121] - factory setting 10 s

## 4.4 Commissioning with factory settings

### Prerequisites for using the factory settings

In simple applications, commissioning can be carried out just using the factory settings. This section explains what prerequisites must be fulfilled for this purpose and how they are fulfilled.

1. The inverter and motor must match one another; compare the data on the motor rating plate with the technical data of the Power Module.
  - The rated inverter current must, as a minimum, be the same as the motor.
  - The motor power should match that of the inverter; motors can be operated in the power range from 25 % ... 100 % of the inverter power rating.
2. The digital and analog inputs must be connected in accordance with the wiring example. (See Section 'Wiring example (Page 52)')
3. You then have to "tell" the inverter the following,
  - the source of its commands:
    - from an operator panel,
    - from the digital inputs
    - from the fieldbus interface

You can change this *command source* using parameter P0700 if the factory setting is not appropriate for your application.

- where it gets its speed setpoint (setpoint source)
  - from an analog input (analog setpoint)
  - as fixed frequency from a digital input
  - from the fieldbus interface

You can change this *frequency setpoint source* using parameter P1000 if the factory setting is not appropriate for your application.

### 4.4.1 Wiring examples for the factory settings

#### Many applications function using the factory settings

To ensure that the factory setting can be used, you must wire the control terminals on your inverter as shown in the following examples.

#### Default settings for the control terminals on the CU240E

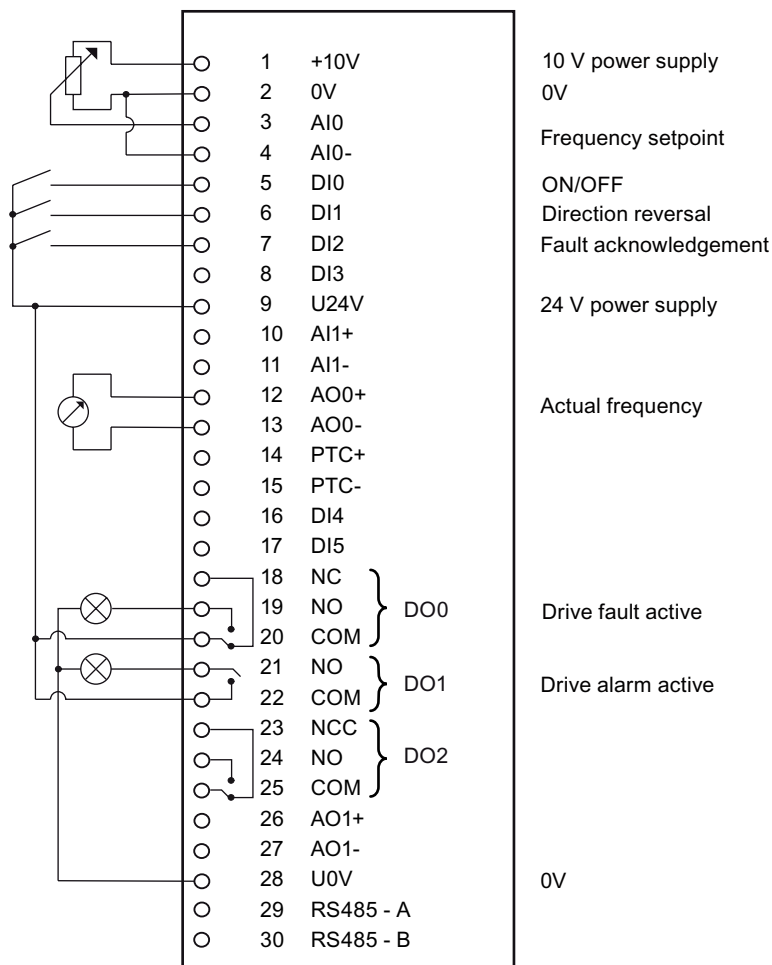
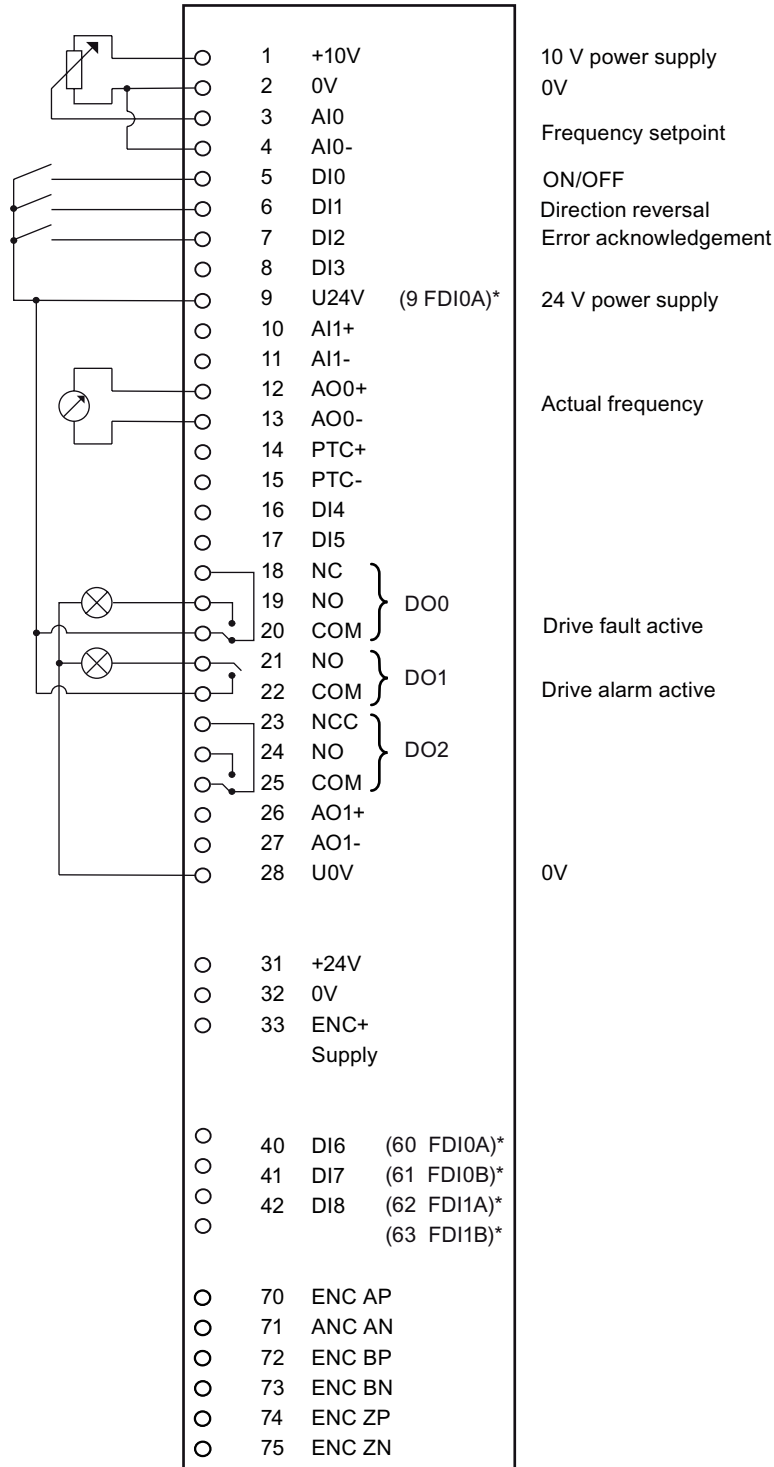

Figure 4-1 CU240E terminal overview: wiring example for using the factory settings

Default settings for the control terminals on the non-bus-capable CU240E



\* Failsafe versions in brackets

Figure 4-2 CU240S terminal overview: wiring example for using the factory settings

### 4.4.2 Factory setting of the frequency inverter

#### Default command and setpoint sources

Inverters used in automation solutions have the appropriate fieldbus interfaces. These inverters are preset in the factory so that the appropriate control and status signals can be exchanged via the fieldbus interface.

Inverters without a fieldbus interface are pre-set in the factory so that the digital and analog and input output signals are exchanged via terminals.

For instance, if you do not want to control an inverter equipped with a fieldbus interface via the fieldbus, but instead using switches and pushbuttons that are connected to the digital inputs, then you must change parameter P0700 as follows.

Table 4- 2 Command and setpoint sources

Parameters	Description
P0700 = 2 or 6	<b>Select the command source</b> 2: Digital inputs (P0701 ... P0709) (factory setting for CUs without fieldbus interface) 6: Fieldbus (P2050 ... P2091), (factory setting for CUs with fieldbus interface)
P1000 = 2 or 6	<b>Select the setpoint source</b> 2: Analog setpoint (factory setting for CUs without fieldbus interface) 6: Fieldbus (factory setting for CUs with fieldbus interface)

Table 4- 3 Factory settings of additional important parameters

Parameter	Factory setting	Meaning of the factory setting	Function	Access level
P0003	1	Access to the most frequently used parameters	Selecting the user access level	1
P0004	0	All parameters are displayed	Parameter filter: filters parameters in accordance with the functionality	1
P0010	0	Ready to be entered	Commissioning parameter	1
P0100	0	Europe [50 Hz]	Frequency of the regional supply network <ul style="list-style-type: none"> <li>• IEC, Europe</li> <li>• NEMA, North America</li> </ul>	1
P0300	1	Induction motor	Select the motor type (induction motors / synchronous motor)	2
P0304	400	[V]	Rated motor voltage (in accordance with the rating plate in V)	1
P0305	depends on the Power Module	[A]	Rated motor current (in accordance with the rating plate in A)	1
P0307	depends on the Power Module	[kW/hp]	Rated motor output (in accordance with the rating plate in kW/hp)	1
P0308	0	[cos phi]	Rated motor power factor (in accordance with the rating plate in cos 'phi') if P0100 = 1.2, then P0308 is irrelevant	1

Parameter	Factory setting	Meaning of the factory setting	Function	Access level
P0309	0	[%]	Rated motor efficiency (in accordance with the rating plate in %) if P0100 = 0, then P0309 is irrelevant	1
P0310	50	[Hz]	Rated motor frequency (in accordance with the rating plate in Hz)	1
P0311	1395	[rpm]	Rated motor speed (in accordance with the rating plate in rpm)	1
P0335	0	Non-ventilated: Shaft-mounted fan in the motor	Motor cooling (specify the motor cooling system)	2
P0625	20	[°C]	Ambient temperature of motor	3
P0640	200	[%]	Motor overload factor (entered in % referred to P0305)	2
P0700	2 or 6	2 for non-bus-capable CUs 6 for bus-capable CUs	Select the command source	1
P0727	0	DI0: On / off DI1: Direction reversal	Control response when the motor starts (start, stop, reverse)	3
P0970	0	Locked	Restore factory settings	1
P1000	2 or 6	2 for non-bus-capable CUs 6 for bus-capable CUs	Select the source of the frequency setpoint (setpoint input)	1
P1080	0	[Hz]	Minimum frequency	1
P1082	50	[Hz]	Maximum frequency	1
P1120	10	[s]	Ramp-up time	1
P1121	10	[s]	Ramp-down time	1
P1300	0	V/f control with linear characteristic	Control mode	2
P3900	0	No quick commissioning	Completes the quick commissioning	1

### 4.4.3 Default terminal settings

#### Factory settings of the process interfaces

Digital inputs				
Terminal	Abbreviation	Parameter	Factory setting	Meaning of the factory setting
5	DI0	P0701	1	ON/OFF1
6	DI1	P0702	12	Direction reversal
7	DI2	P0703	9	Fault acknowledgment
8	DI3	P0704	15	Fixed frequency selector bit 0 (direct) [P1001]
16	DI4	P0705	16	Fixed frequency selector bit 1 (direct) [P1002]
17	DI5	P0706	17	Fixed frequency selector bit 2 (direct) [P1003]
40	DI6	P0707	18	Fixed frequency selector bit 3 (direct) [P1004]
41	DI7	P0708	0	Digital input locked
42	DI8	P0709	0	Digital input locked

Digital inputs of the safety functions				
Terminal	Abbreviation	Parameter	Factory setting	Meaning of the factory setting
60	FDI0A	P9603	0	Digital inputs of the safety functions are locked
61	FDI0B			
62	FDI1A			
63	FDI1B			

Digital outputs (relay outputs)					
Terminal	Abbreviation	Parameters	Factory setting	Meaning of the factory setting	
18	NC	DO0	P0731	52.3	Drive fault active
19	NO				
20	COM				
21	NO	DO1	P0732	52.7	Drive alarm active
22	COM				
23	NC	DO2	P0733	0.0	Relay output is locked
24	NO				
25	COM				



Analog inputs					
Terminal	Abbreviation		Parameters	Factory setting	Meaning of the factory setting
3	AI0+	AI0	P0756 [0]	0	Set unipolar voltage input 0 V ... +10 V DC in addition to parameterizing DIP switch on CU housing.
4	AI0-				
10	AI1+	AI1	P0756 [1]	0	Set unipolar voltage input 0 V ... +10 V DC in addition to parameterizing DIP switch on CU housing.
11	AI1-				

Analog outputs					
Terminal	Abbreviation		Parameters	Factory setting	Meaning of the factory setting
12	AO0+	AO0	P0771[0]	21	Frequency on the inverter output; analog output 0 can be switched from current output to voltage output by means of P0776
13	AO0-				
26	AO1+	AO1	P0771[1]	21	Frequency on the inverter output; analog output 1 is current output only
27	AO1-				

Encoder interface (encoder)				
Terminal	Function	Parameter	Factory setting	Meaning of the factory setting
70	Channel A - non-inverting	P0400	0	Evaluation of the speed encoder is locked
71	Channel A - inverting			
72	Channel B - non-inverting			
73	Channel B - inverting			
74	Zero pulse - non-inverting			
75	Zero pulse - inverting			

PTC/KTY84 interface				
Terminal	Abbreviation	Parameters	Factory setting	Meaning of the factory setting
14	PTC+	P0601	0	Evaluation of the motor temperature sensor is locked
15	PTC-			

## 4.5 Commissioning with STARTER

### Prerequisites

The STARTER commissioning tool features a project Wizard that guides you step-by-step through the commissioning process. Configuring the inverter using the PC is significantly more user friendly and faster than commissioning using the operator panel.

The following is required to commission the inverter via the PC:

- A PC connection kit for connecting the inverter to a PC.  
Order no.: 6SL3255-0AA00-2AA1

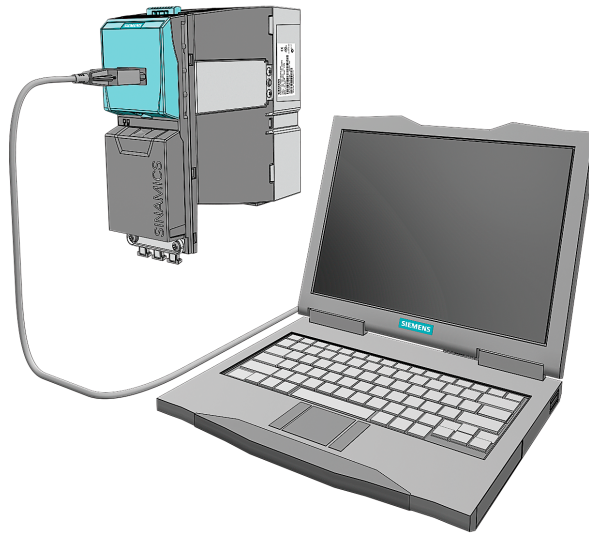

Figure 4-3 PC connection kit

- The installed STARTER software.  
(supplied with the PC connection kit). You can download the latest version from the Internet under the following address  
(<http://support.automation.siemens.com/WW/view/en/10804985/133100>):
- The motor must be connected to the inverter.

## 4.5.1 Creating a STARTER project

### Description

An inverter can be parameterized in a user-friendly fashion using the Project Wizard. The commissioning procedure described here follows the Project Wizard. The PC communicates with the inverter via the USS interface.

- Switch on the inverter supply voltage
- Launch the STARTER commissioning tool.
- Use the Project Wizard and click on the "Find drive units online ..."

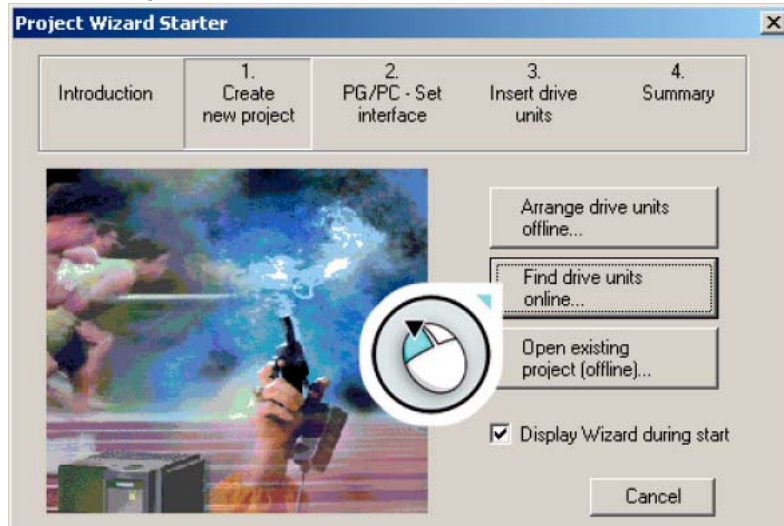

Figure 4-4 Start field

- In the screen that follows (not shown here), enter a meaningful name into your project, e.g. "Basic Commissioning" and click on "Continue". The following dialog box is displayed.

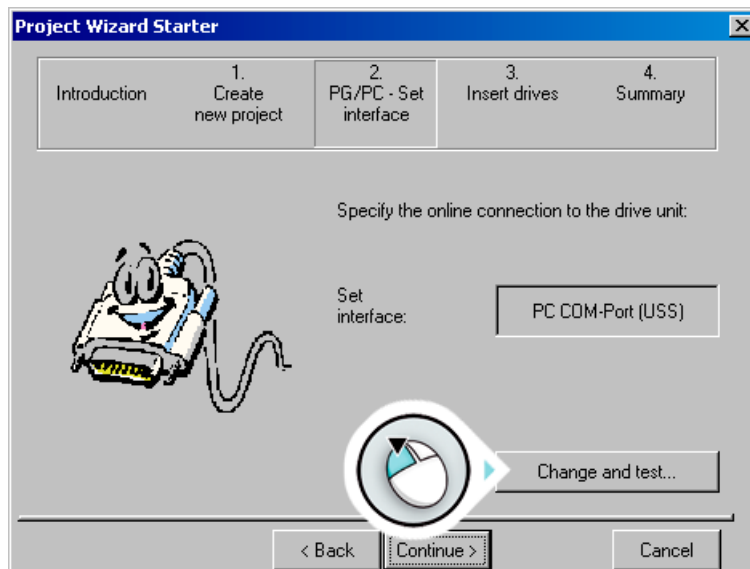

Figure 4-5 Setting the PC interface

- Click "Change and test..." to set up the PG/PC interface.

### PG/PC - Set interface

- Select "PC COM-Port (USS)" from the list and click on "Properties ..."

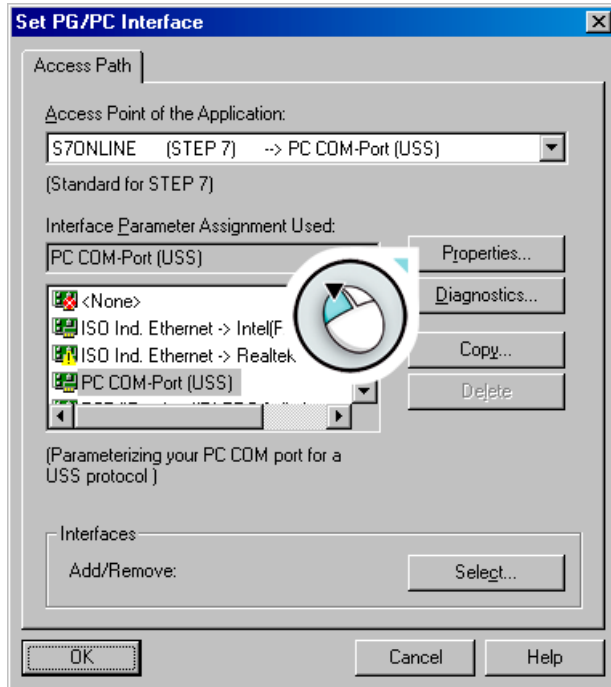

Figure 4-6 Setting the USS interface

- If "PC COM-Port (USS)" is not available, click on "Select ..." to install the "PC COM-Port (USS)" interface as shown in the "Install/Remove Interfaces" dialog box.

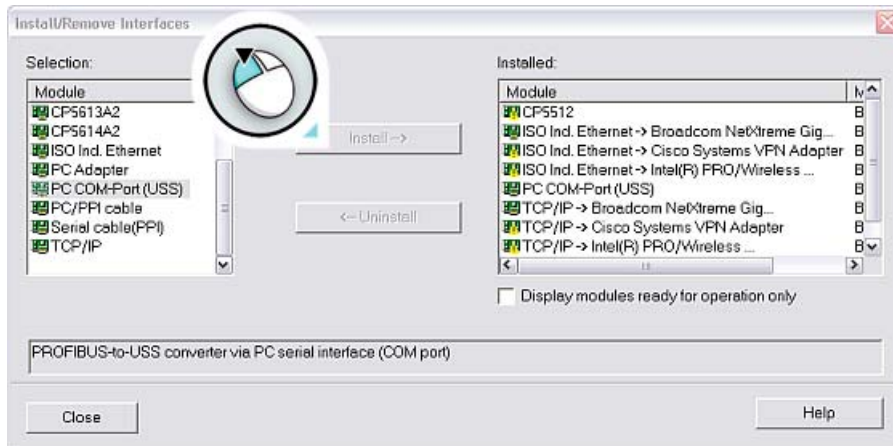

Figure 4-7 Installing the USS interface

- If you have installed the "PC COM-Port (USS)" interface, close the dialog box and now call up "Properties - PC COM-Port (USS)".

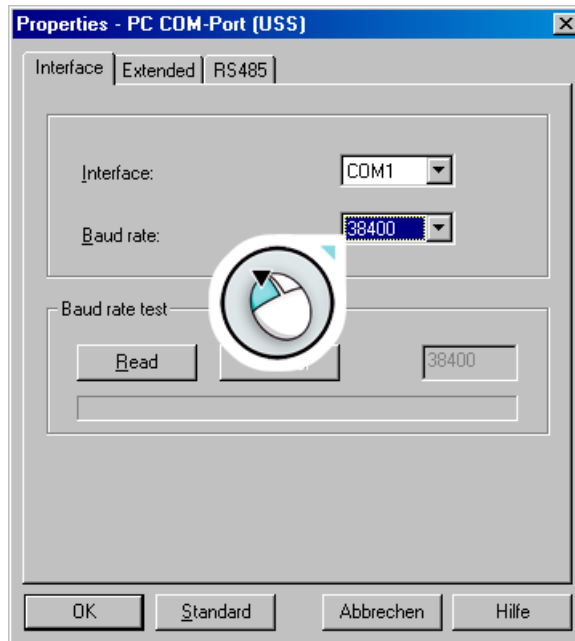

Figure 4-8 PC COM properties

- In this dialog box, you can set the COM interface (COM1, COM2, COM3) and baud rate (default: 38400).
- To determine the correct values of your interface, choose e.g. COM1, and then click on "Read".
- Under the "RS 485" tab, in addition, select the "Automatic mode". Using various baud rates in succession, the PC checks whether communications have been established to the inverter. This can take several minutes.
- If "???" is displayed in the Baud rate test field then the baud rate test was unsuccessful. and you should choose a different COM interface. In the case of the correct COM interface, a value is displayed. Enter this value into the "baud rate" selection field.

- When you click "OK", the "Set PG/PC Interface" dialog box is displayed again.



**Tip**

In the "Set PG/PC Interface" dialog box, you can view the stations that can be accessed via USS by choosing "Diagnostics...":

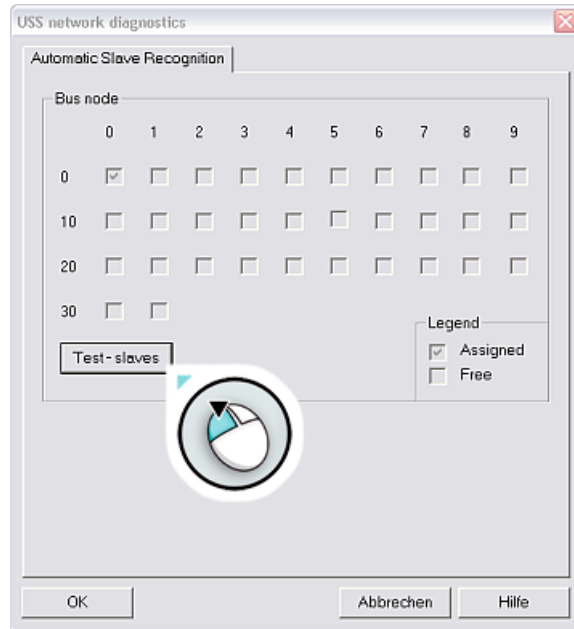

- When you choose "OK" again, this takes you back to the Project Wizard.
- By clicking on "Continue", a search is made for devices that are available online and you then come to the step "Insert drives".

## Insert drives

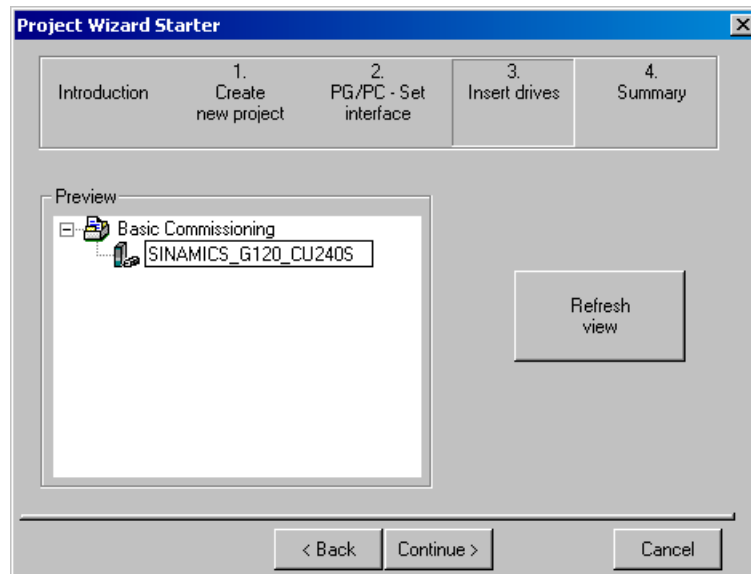

Figure 4-9 Insert drives

- In this dialog box, enter a name for your inverter, e.g. "SINAMICS\_G120\_CU240S" (no blanks or special characters).
- Click on "Next".
- Close the "Summary" dialog box by choosing "Finish".

### 4.5.2 Establishing an online connection between the PC and converter (going "online")

#### Description

With the procedure described above, the project has been created and your inverter is integrated into the project tree. However, there is no online connection.

- Click on  ("Connect to the target system"), in order to go online with the inverter.

The left-hand column in the dialog box below contains the online data that has been saved, while the right-hand column contains the offline data that has been saved.

- Click on "Load HW configuration to PG" to download the online data into your PC.

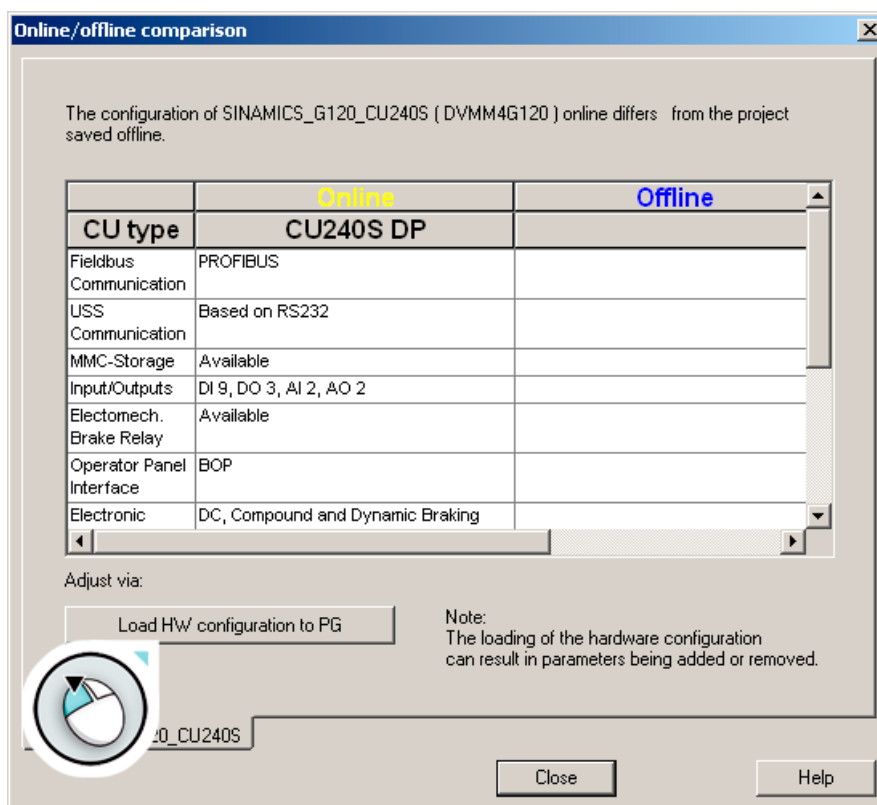

Figure 4-10 Inverters found online (using the SINAMICS G120 with Control Unit CU240S DP as example)

- To conclude your entry, choose "Close".
- The status display changes from the "Offline mode" with blue background into the "Online mode" with yellow background.



### 4.5.3 Starting the general commissioning

#### Description

- When the final dialog box in the "Going online" section is closed, the text "Offline mode" in the bottom right of the dialog box changes to "Online mode".

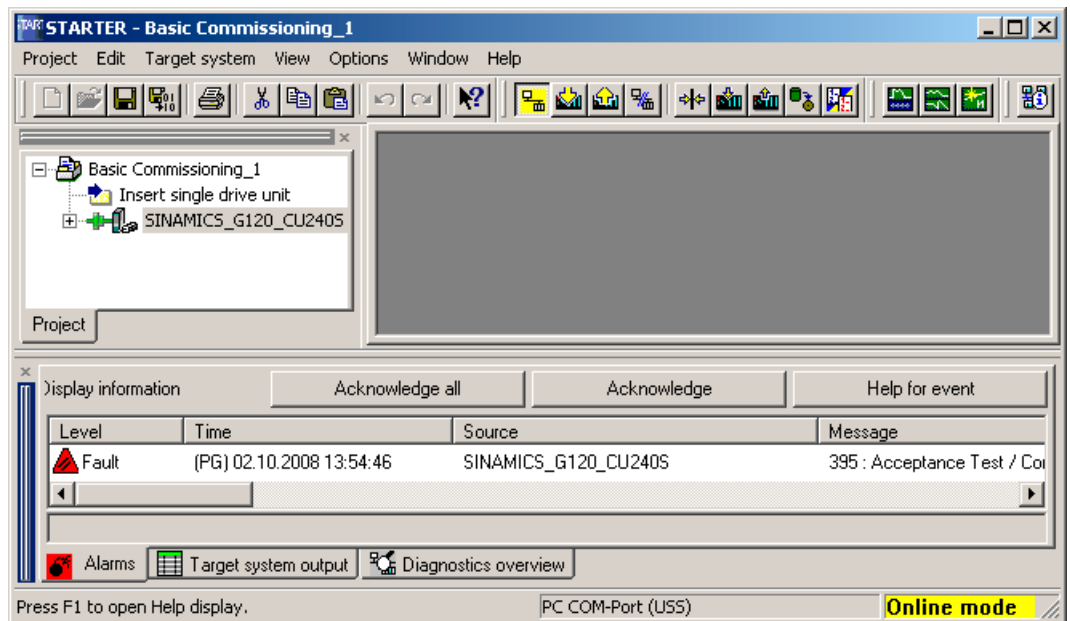

Figure 4-11 Going online with STARTER (example with SINAMICS G120)

- For modular inverters that comprise a Control Unit and Power Module, when first powered-up and after replacing a control unit or a Power Module, message F0395 is output. This message is intentional and does not indicate that the inverter is faulty. This message monitors the individual inverter components (CU and PM) against unauthorized replacement.
- Select and acknowledge message F0395 that is present as described in the Section "Initial coupling of the CU and PM".

#### Note

For information about the symbols used in STARTER, call up the online help. Press <Shift><F1> and choose the relevant symbol. For example:



- Open the drive unit (🖱️), by double clicking on the drive object (🖱️)
- Click on "Wizard ..." for the (basic) commissioning, and let the Wizard guide you.

### Carrying out commissioning

The Project Wizard navigates you step-by-step using pull-down menus through the basic settings for your application.

- You get to the next menu item by pressing, choose "Next".

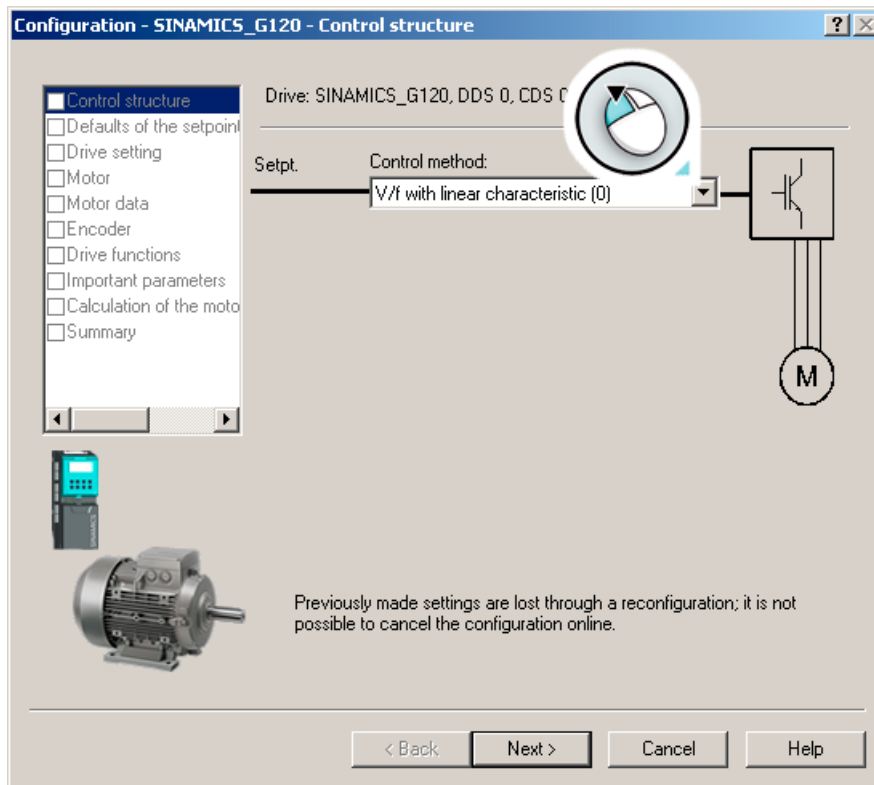

Figure 4-12 Start field: commissioning

- For the "Drive functions" menu item, we recommend that motor data identification: "Locked" should be selected.

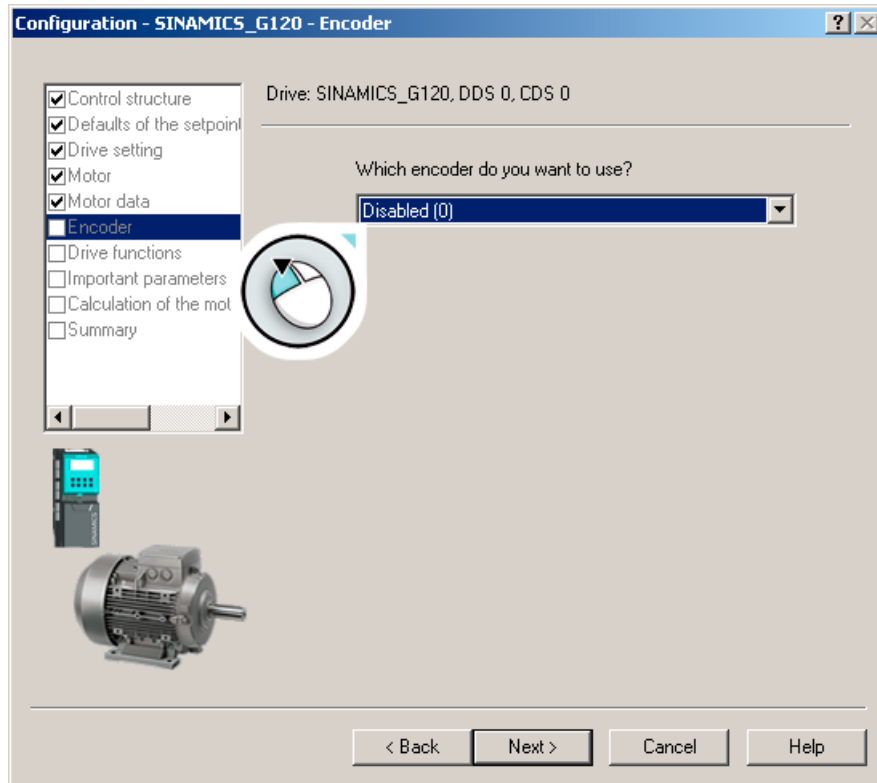

Figure 4-13 Deselecting motor data identification

---

### Note

#### Motor data identification

Motor data identification is only required for vector control - and it is described there.

---

- For the menu item "Calculation of the motor data", we recommend that you select "Restore factory settings and calculate motor data".

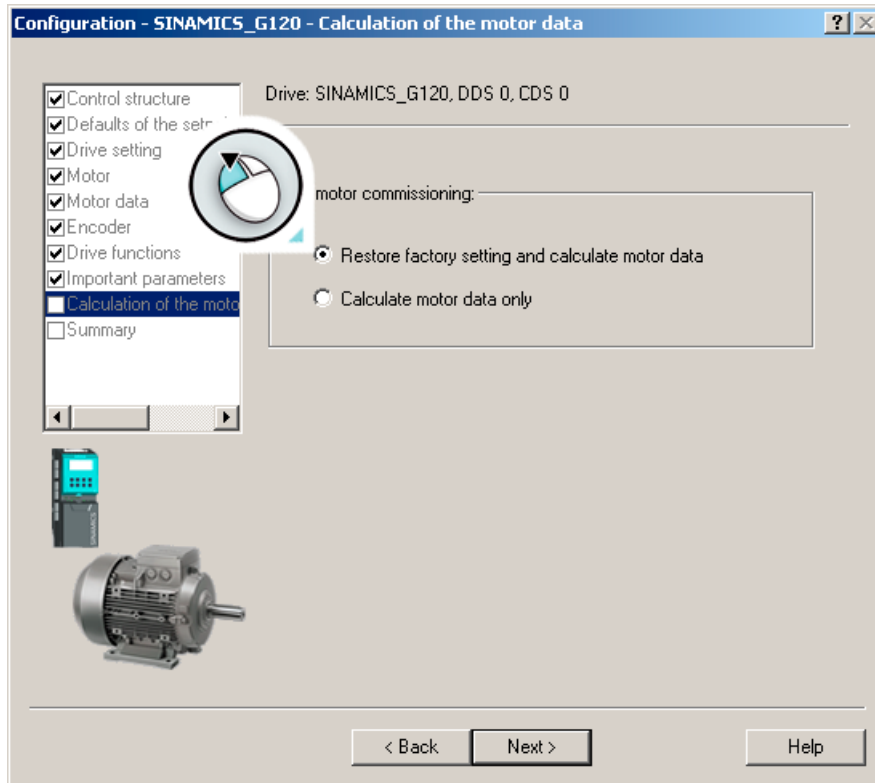

Figure 4-14 Calculating the motor data and restoring the factory setting

- The Project Wizard for the (first) commissioning is concluded with the following summary:

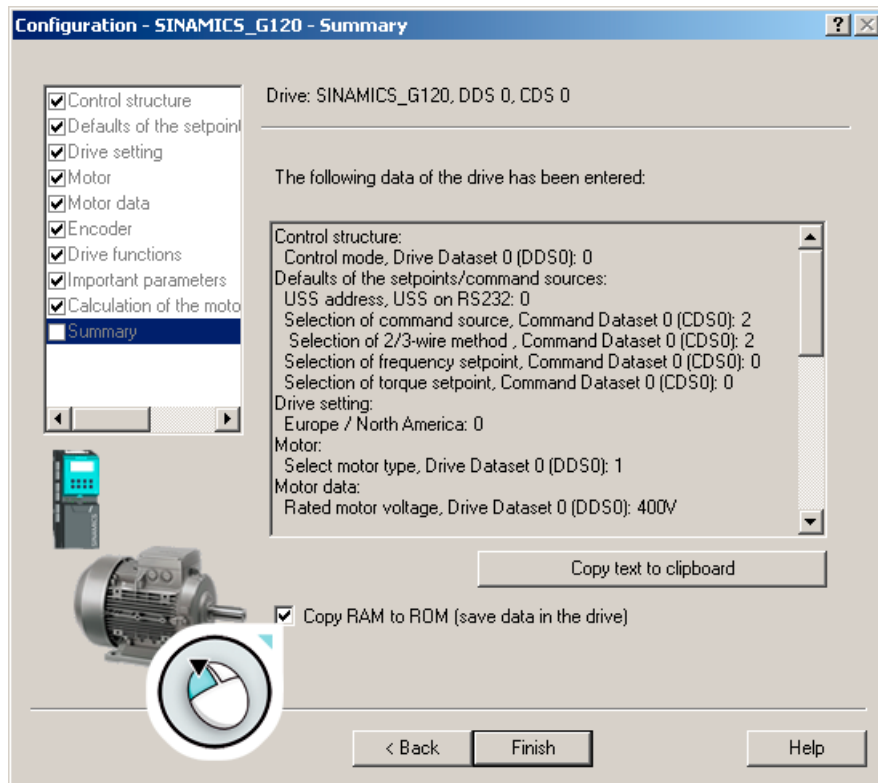



Figure 4-15 Completing commissioning

- Finally, choose "Finish".

### 4.5.4 Commissioning the application

#### Description

- You can now commission your application using the "Drive Navigator" screens or by using the functions available in the project tree.
- Save your settings so that they are protected against power failure (see below).
- Once you have commissioned your application, disconnect the online connection between the PC and inverter by clicking on .

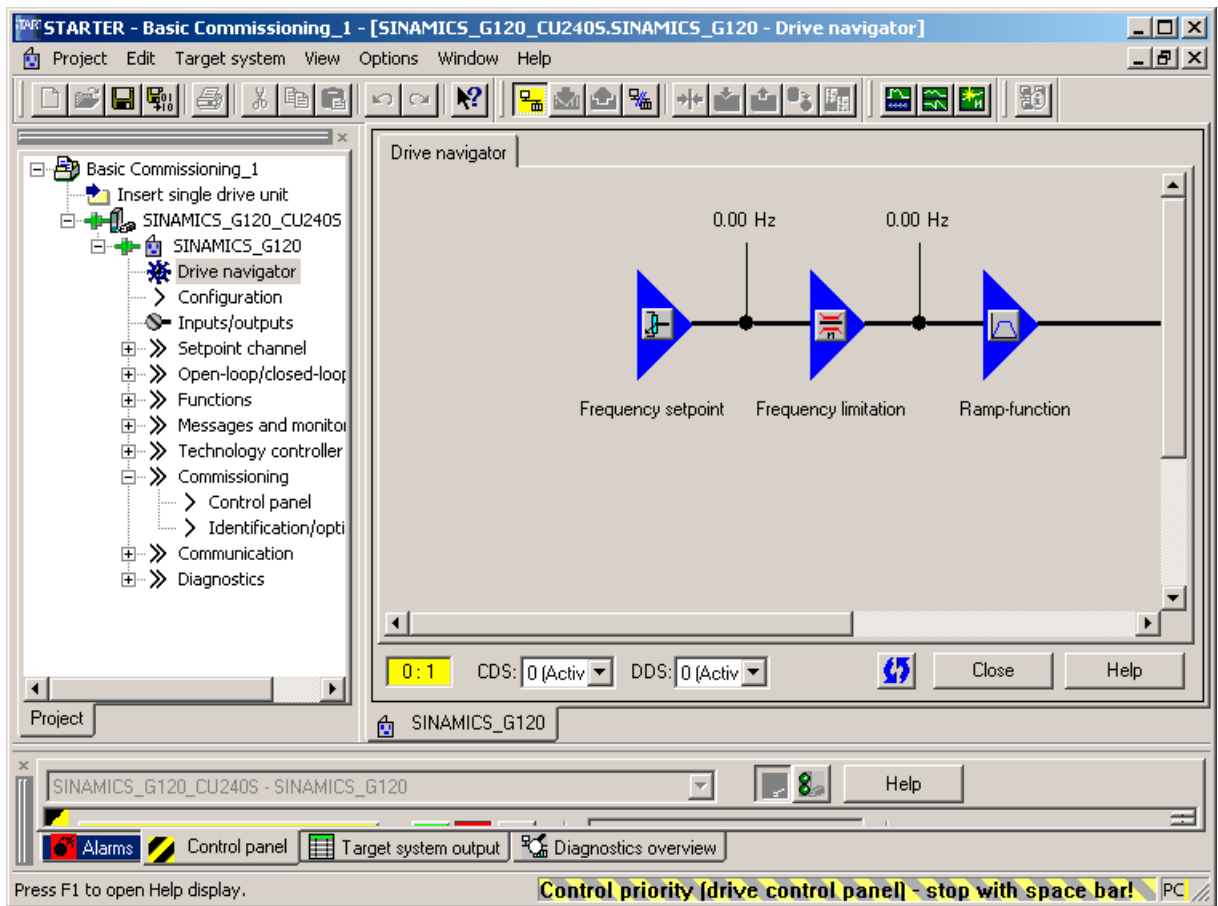

Figure 4-16 Application communication

#### Storing data in a power-independent manner

- In the project tree, select your SINAMICS project
- Double-click on "Drive Navigator".
- Select "Commissioning" in the working area
- In the dialog box, select "Save data in the drive (RAM to ROM)".

You can now disconnect the online connection with  "Disconnect from target system"

## 4.6 Commissioning with the operator panel

### 4.6.1 Function of the Basic Operator Panel

The Basic Operator Panel (BOP) offers various commissioning options and ways to save data and transfer data with the BOP (Page 77).

The Basic Operator Panel can be used to commission drives, monitor operation and set individual parameters. The keys can be used, for example, to set control signals and the speed setpoint. Parameter changes that are made using the BOP are saved so that they are protected against power failure.

#### The Basic Operator Panel for 'local' operation and how to attach it to the Control Unit

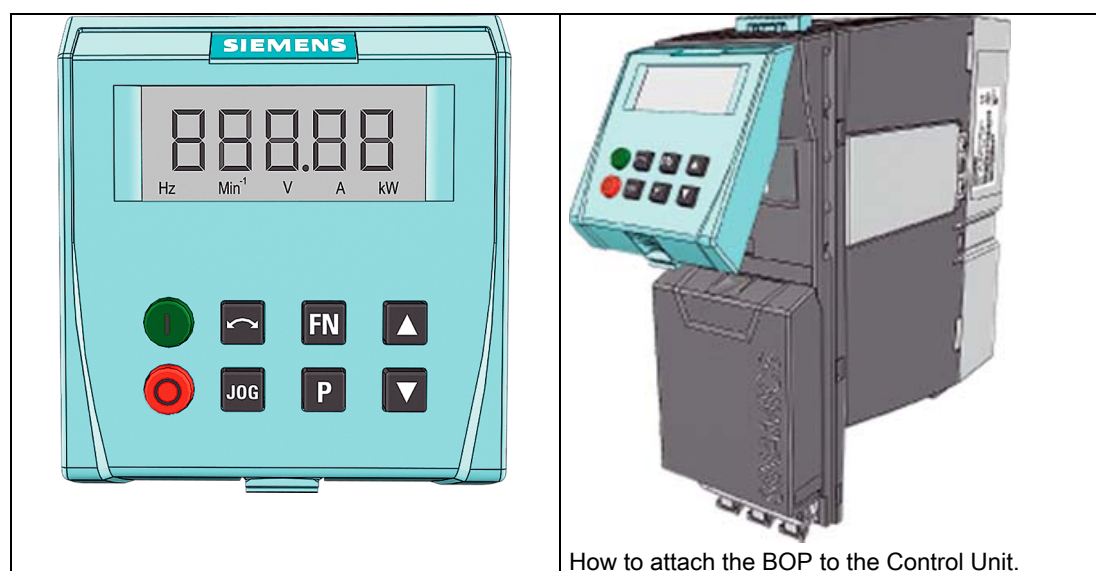

The Basic Operator Panel is an input and display instrument that allows you to operate inverters "locally". A BOP can be used for more than one inverter and is mounted directly on a Control Unit.







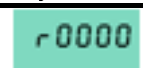

The BOP has 8 keys and a 2-line screen for displaying values and units:

- Line 1 shows a parameter number or value
- Line 2 shows the corresponding physical unit

### 4.6.2 BOP controls and displays

#### How to use the BOP

Table 4- 4 Operator controls of the Basic Operator Panel and its functions

Key	Function	Function / result
	Status LED	Shows parameter numbers, values, and physical units of measure.
	Parameter access	This button allows you to access the parameter list. r _ _ _ _ read-only parameters: for display only P _ _ _ _ write parameters: these can be changed
	Increase displayed values	This button allows you to scroll forwards in the parameter list;
	Decrease displayed values	This button allows you to scroll backwards in the parameter list.
	Function key	The function of this button varies depending on the data displayed:  If a parameter <b>number</b> is displayed and you press this button once briefly, you can return to the start of the parameter list r0000.  If a parameter <b>value</b> is displayed and you press this button once briefly, the cursor jumps to the next position (e.g. in a multi-digit number). This allows you to change a decimal number digit by digit, for example.  If an alarm or a fault <b>message</b> is displayed and you press this button once briefly, this acknowledges the message.
	Start motor	Press this button to start the motor.  In the factory setting, this button is not active: activate with P0700 = 1
	Stop motor	Press this button to stop the motor.  OFF2 is always activated: Press twice briefly or press once for longer: The motor coasts to a standstill.  In the factory setting, OFF1 is not active. To activate it, set P0700 = 1.
	Change direction of rotation	When you press this button, the direction of motor rotation is reversed (CW/CCW).  In the factory setting, this button is not active. To activate it, set P0700 = 1.
	Jog mode	Run the motor in jog mode. The motor rotates at a predefined speed for as long as this key is pressed (and kept down).  In the factory setting, this button is not active. To activate it, set P0700 = 1.



### 4.6.3 Parameterization with the BOP (two examples)

All of the parameter changes, which are made using the BOP, are saved so that they are protected against power failure.

#### Changing a parameter value using the BOP

The following description is an example of how to change any parameter using the BOP.

Table 4- 5 Change P0003 (set user access level "3")

	Step	Result displayed
1	Press <b>P</b> to access the parameters.	r0000
2	Press <b>▲</b> until P0003 is displayed.	P0003
3	Press <b>P</b> to display the parameter value.	1
4	Press <b>▲</b> or <b>▼</b> to set the required value (to 3).	3
5	Press <b>P</b> to confirm and save the value.	P0003
6	The user can now view all parameters in steps 1 to 3.	

#### Using the BOP to change parameters with more than one index

The next example shows how the value of an indexed parameter can be changed.

Table 4- 6 Change index parameter P0700 (set command source "BOP" under index 1)

	Step	Result displayed
1	Press <b>P</b> to access the parameters.	r0000
2	Press <b>▲</b> as often or as long as required until P0700 is displayed.	P0700
3	Press <b>P</b> : index "in000" is displayed.	in000
4	Press <b>▲</b> or <b>▼</b> to select index 1.	in001
5	Press <b>P</b> to display the value that is currently set.	0
6	Press <b>▲</b> or <b>▼</b> until the required value is displayed.	1
7	Press <b>P</b> to confirm and save the value.	P0700
8	Press <b>▼</b> until r0000 is displayed.	r0000
9	Press <b>P</b> to reset the display to the standard drive display (as defined by the customer).	

#### Note

When parameter values are being changed, the BOP sometimes displays the message "bUSY". This means that the inverter is currently processing a higher-priority task.

### 4.6.4 Commissioning steps

The following section provides a step-by-step guide to quick commissioning, which is sufficient for the majority of applications.

The first step in commissioning a drive train is to ensure that the inverter and motor are harmonized. This inverter-motor combination can then be adapted in line with the requirements of the drive machine

The inverter is adapted to the requirements of an application by parameterizing it. A corresponding parameter list with explanations is provided on the following pages.

### 4.6.5 Commissioning V/f control

Since the load characteristic can be set as required, V/f control is sufficient for many drive trains. A drive train that operates with *V/f control with a linear characteristic* can be set by entering the following parameters.

#### Parameter settings for V/f control

Table 4- 7 Setting the access level and parameter filter

Parameters	Description
P0003 = 1	<b>User access level</b> 1: Standard: Allows access to the most frequently used parameters (factory setting) 2: Extended: Allows extended access, e.g. to inverter I/O functions 3: Expert: To be used by experts
P0010 = 1	<b>Commissioning parameter filter</b> 0: Ready (factory setting) 1: Quick commissioning 30: Factory setting - initiate restore factory settings To parameterize the motor rating plate data, set P0010 = 1.

Table 4- 8 Data on the environmental conditions at the installation location

Parameters	Description
P0100 = 0	<b>Europe / North America (line frequency of region)</b> 0: Europe [kW], standard frequency 50 Hz (factory setting) 1: North America [hp], standard frequency: 60 Hz 2: North America [kW], standard frequency: 60 Hz
P0230 = 0	<b>Output filter</b> 0: No filter (factory setting)
P0233 = ...	<b>Filter inductance of the output filter used</b> 0.000 (factory setting)
P0234 = ...	<b>Filter capacitance of the output filter used</b> 0.000 (factory setting)

Table 4- 9 Motor data in accordance with the specifications on the motor rating plate

Parameters	Description
P0304 = ...	<b>Rated motor voltage</b> (enter value as specified on the motor rating plate in Volt) 400 [V] (factory setting)  The rating plate data entered must correspond to the motor connection type (star/delta) (i.e. with a delta motor connection, the delta rating plate data must be entered).
P0305 = ...	<b>Rated motor current</b> (enter value as specified on the motor rating plate in Ampere) 1 [A] (factory setting)
P0307 = ...	<b>Rated motor power</b> (enter value as specified on the motor rating plate in kW or hp) 0.37 [kW / hp] (factory setting)  If P0100 = 0 or 2, the data is specified in kW If P0100 = 1, the data is specified in hp.
P0308 = ...	<b>Rated motor power factor [cos phi]</b> 0.820 (factory setting)  This parameter is irrelevant when P0100 = 1 or 2.
P0310 = ...	<b>Rated motor frequency</b> (enter value as specified on the motor rating plate in Hz) 50.00 [Hz] (factory setting)  When this parameter is changed, the number of pole pairs for the motor is automatically recalculated.
P0311 = ...	<b>Rated motor speed</b> (enter value as specified on the motor rating plate in rpm) 1395 [U / min]

Table 4- 10 Specify command source and frequency setpoint source

Parameter	Description
P0700 = 2 or 6	<b>Select the command source</b> 0: Standard factory setting (restores the CU to the factory setting) 1: BOP (Basic Operator Panel keys) 2: Digital inputs (factory setting for 'stand-alone' CUs) 4: USS on RS 232 5: USS on RS 485 6: Fieldbus (factory setting for fieldbus-capable CUs)
P1000 = 2 or 6	<b>Select the setpoint source</b> 0: No main setpoint 1: MOP setpoint 2: Analog setpoint (factory setting for stand-alone CUs) 3: Fixed frequency 4: USS at RS 232 5: USS at RS 485 6: Fieldbus (factory setting for fieldbus-capable CUs) 7: Analog setpoint 2

Table 4- 11 Parameters that must be set in every application

Parameter	Description
P1080 = ...	<p><b>Minimum frequency</b> 0.00 [Hz] factory setting</p> <p>Enter the minimum frequency (in Hz) at which the motor runs independently of the frequency setpoint. The value set here applies to CW and CCW rotation.</p>
P1082 = ...	<p><b>Maximum frequency</b> 50.00 [Hz] factory setting</p> <p>Enter the maximum frequency (in Hz) to which the motor is restricted independently of the frequency setpoint. The value set here applies to CW and CCW rotation.</p>
P1120 = ...	<p><b>Rampup time</b> 10.00 [s]</p> <p>Enter the time (in seconds) in which the motor is to accelerate from standstill to the maximum frequency (P1082). If the ramp-up time is too short, alarm A0501 (current limit value) may be output or the inverter is shut down with fault F0001 (overcurrent).</p>
P1121 = ...	<p><b>Rampdown time</b> 10.00 [s]</p> <p>Enter the time (in seconds) during which the motor is to be decelerated (braked) from the maximum frequency (P1082) to standstill. If the ramp-down time is too short, alarm A0501 (current limit value) or A0502 (overvoltage limit value) may be output or the inverter is shut down with fault F0001 (overcurrent) or F0002 (overvoltage).</p>

Table 4- 12 End quick commissioning (= start internal motor data calculation)

Parameter	Description
P3900 = 1	<p><b>End quick commissioning</b></p> <p>0: No quick commissioning (factory setting)</p> <p>1: Quick commissioning incl. restoring factory settings</p> <ul style="list-style-type: none"> <li>- Calculate the motor data with the quick commissioning parameters</li> <li>- Restore the factory settings for the I/O</li> <li>- Restore the factory settings for all other parameters</li> </ul> <p>2: Quick commissioning incl. restoring the factory settings for the I/O.</p> <ul style="list-style-type: none"> <li>- Calculate the motor data with the modified quick commissioning parameters</li> <li>- Restore the factory settings for the I/O</li> <li>- All the other parameters remain unchanged</li> </ul> <p>3: Quick commissioning with motor data only</p> <ul style="list-style-type: none"> <li>- Calculate the motor data with the quick commissioning parameters</li> <li>- I/O settings remain unchanged</li> <li>- All the other parameters remain unchanged</li> </ul> <p>When P3900 = 1, 2, or 3, the value for P1082 is written to P2000.</p> <p>When quick commissioning is being completed, the message <b>"bUSY"</b> is displayed on the BOP. This means that the system is in the process of calculating the control data and saving the parameter values in the EEPROM.</p> <p>Once quick commissioning has been carried out, P3900 and P0010 are set to 0.</p> <p>When you press "FN" and "P" on the BOP, the actual frequency is displayed.</p>

## 4.7 Data backup with the operator panel and memory card

### 4.7.1 Saving and transferring data using the BOP

#### The operator panel as a medium to backup and transfer data

You can save a parameter set on the operator panel and transfer it to other inverters, e.g. to identically parameterize several devices or to transfer the settings after a device has been replaced.

#### Prerequisites for transferring data sets from the operator panel to a different inverter

The Control Unit to which the parameter set is transferred must be of the same type and have the same firmware release as the source Control Unit. (Same 'type' means: The same Order No.)

#### Saving the parameters on the operator panel (upload)

Table 4- 13 Transfer data from the inverter to the operator panel

Parameters	Description
P0003 = 3	3: Expert
P0010 = 30	30: Initiating parameter transfer
P0802 = 1	1: Transfer data <b>from the</b> EEPROM (of the inverter) to the operator panel
	<ul style="list-style-type: none"> <li>If the upload procedure is successful, P0010 and P0802 are set to 0 and the "RDY" LED lights up.</li> <li>If the download procedure is unsuccessful, F0055 or F0057 is displayed and the LED "SF" (red) lights up. In this case, make another attempt to transfer data.</li> </ul>

#### Transferring parameters from the operator panel into the inverter (download)

Table 4- 14 Transfer data from the operator panel to the inverter

Parameters	Description
P0003 = 3	3: Access level 3
P0010 = 30	30: Initiating parameter transfer
P0803 = 1	1: Transfer data <b>to the</b> EEPROM (of the inverter) from the operator panel
	<ul style="list-style-type: none"> <li>If the upload procedure is successful, P0010 and P0803 are set to 0 and the "RDY" LED lights up.</li> <li>If the download procedure is unsuccessful, F0055 or F0057 is displayed and the LED "SF" (red) lights up. In this case, make another attempt to transfer data.</li> </ul>

### 4.7.2 Saving and transferring data using the MMC

#### The MMC memory card as a medium for backing up and transferring data

You can save a parameter set on the memory card and transfer it to other inverters, e.g. to identically parameterize several devices or to transfer the settings after a device has been replaced.

#### Data backup

The MMC is a removable, non-volatile flash memory for the parameter set of an inverter and does not require a power supply. For instance, this can be used to transfer parameter settings to a new inverter after the previous one was replaced.

We recommend that memory card MMC (Order No.: 6SL3254-0AM00-0AA0) should be used.

#### Prerequisites for transferring data sets from the MMC to a different inverter

The Control Unit to which the parameter set is transferred must be of the same type and have the same firmware release as the source Control Unit. (Same 'type' means: The same Order No.)

#### Backup the parameters on the MMC memory card (upload)

Table 4- 15 Transferring data from the inverter to the memory card

Parameters	Description
Insert MMC	
A0564	When saving data, this alarm can be ignored. This alarm is only displayed if the value of parameter P8458 = 1 or 2 and means that the MMC was inserted while the device was in operation and an MMC was not inserted when the inverter was booted.
P0003 = 3	3: Expert
P0010 = 30	30: Initiating parameter transfer
P0802 = 2	2: Transfer data <b>from the</b> EEPROM (of the inverter) to the MMC. "RDY" LED flashes.
	<ul style="list-style-type: none"> <li>If the upload procedure is successful, P0010 and P0802 are set to 0 and the "RDY" LED lights up.</li> <li>If the download procedure is unsuccessful, F0061 or F0062 is displayed and the LED "SF" (red) lights up. In this case, make another attempt to transfer data.</li> </ul>
Remove the MMC	

#### Note

##### Time it takes to save the data

It can take several minutes to transfer data to the MMC memory card.

### Transferring the parameters from the MMC memory card into the inverter (download)

Table 4- 16 Transferring data from the memory card to the inverter

Parameters	Description
P0003 = 3	3: Expert
P0010 = 30	30: Initiating parameter transfer
P0803 = 2	2: Transfer data <b>to the</b> EEPROM (of the inverter) from the MMC. "RDY" LED flashes.
	<ul style="list-style-type: none"> <li>• If the upload procedure is successful, P0010 and P0803 are set to 0 and the "RDY" LED lights up.</li> <li>• If the download procedure is unsuccessful, F0061 or F0062 is displayed and the LED "SF" (red) lights up. In this case, make another attempt to transfer data.</li> </ul>





## Functions

### 5.1 Overview of inverter functions

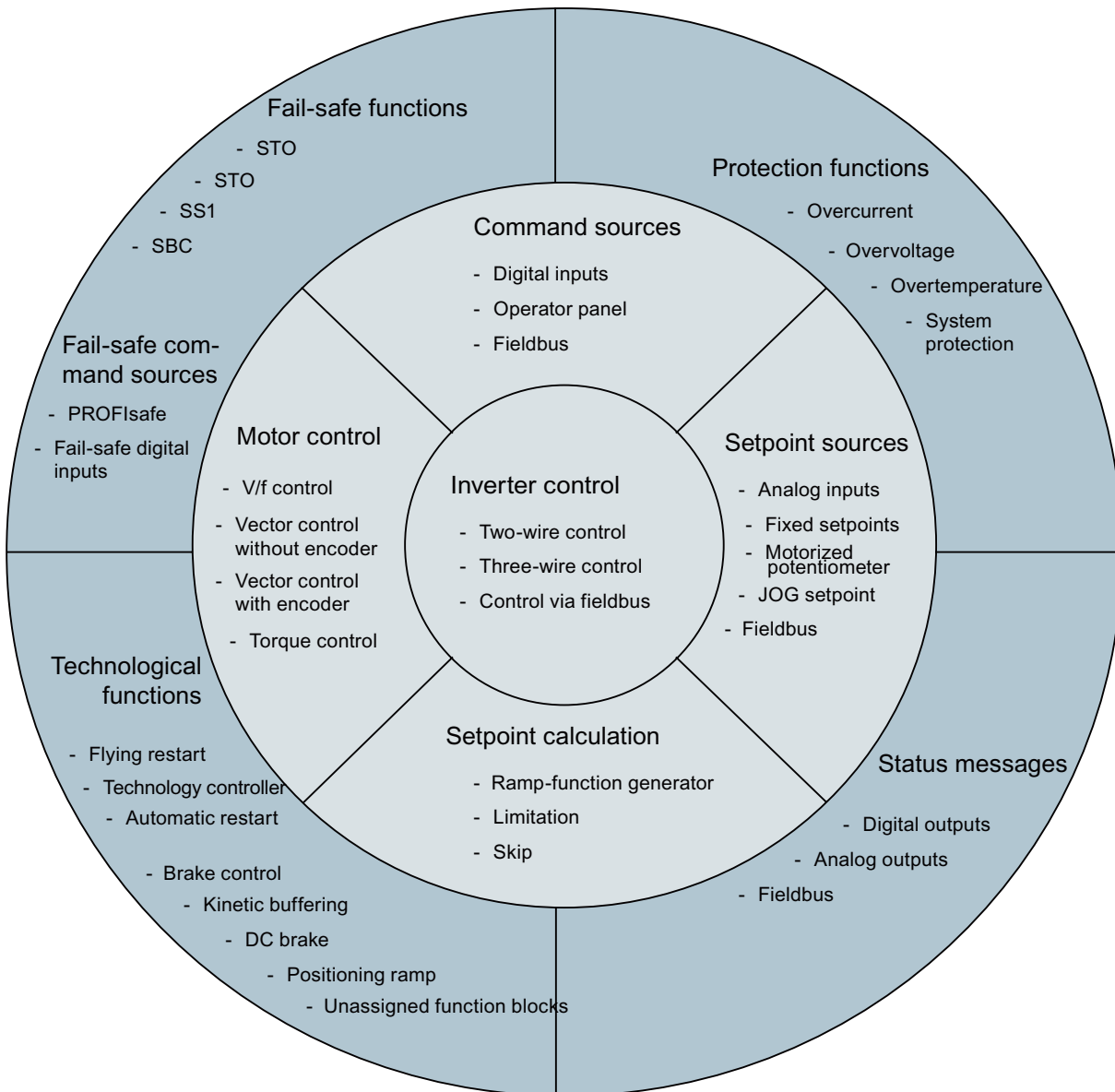
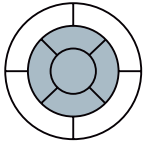
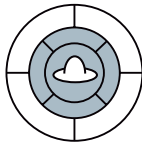

Figure 5-1 Overview of inverter functions

### Functions relevant to all applications



The functions that you require in each application are located at the center of the function overview above. The parameters of these functions are provided with a matching basic setting during quick commissioning so that in many cases, the motor can be operated without requiring additional parameterization.



**Inverter control** is responsible for all of the other inverter functions. Among other things, it defines how the inverter responds to external control signals.

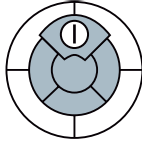

The **command source** defines from where the control signals are received to switch-on the motor, e.g. via digital inputs or a fieldbus.

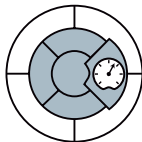

The **setpoint source** defines how the speed setpoint for the motor is entered, e.g. via an analog input or a fieldbus.

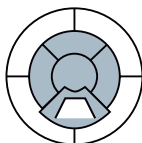

The **setpoint calculation** uses a ramp-function generator to prevent speed steps occurring and to limit the speed to a permissible maximum value.

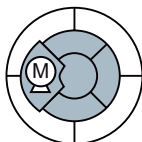

The **motor closed-loop control** ensures that the motor follows the speed setpoint.

### Functions required in special applications only

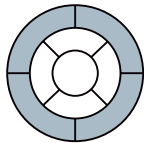

The functions, whose parameters you only have to adapt when actually required, are located at the outer edge of the function overview above.

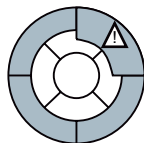

The **production functions** avoid overloads and operating states that could cause damage to the motor, inverter and driven load. The motor temperature monitoring is, e.g. set here.

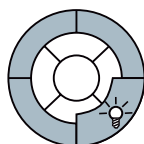

The **status messages** provide digital and analog signals at the digital outputs or via the fieldbus. Examples include the actual speed of the motor or fault message output by the inverter.

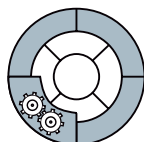

The **technological functions** allow you to activate a motor holding brake or implement a higher-level pressure or temperature control using the technology controller, for example.

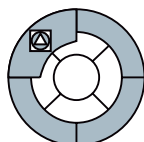

The **safety functions** are used for applications that must fulfill special requirements placed on the functional safety. These are only available for fail-safe inverters.

### Connection to a fieldbus



If you wish to operate the inverter on a fieldbus, then you must connect the following inverter functions with the fieldbus:

- Command sources
- Setpoint sources
- Status messages

A connection with a fieldbus can be established via software tools in the control systems. This manual includes descriptions of how you proceed for PROFIBUS and PROFINET with a SIMATIC control.

## 5.2 Inverter control

### 5.2.1 Frequency inverter control using digital inputs (two/three-wire control)

#### Configuring start, stop and direction of rotation reversal using digital inputs

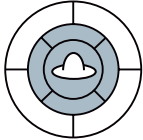

If the inverter is controlled using digital inputs, using parameter P0727, you can define how the motor responds when it is started, stopped, and the direction of rotation is changed (reversing).

Five different methods are available for controlling the motor. Three of the five control methods just require two control commands (two-wire control). The other two control methods require three control commands (three-wire control).

The wide range of setting options is especially intended to be able to emulate existing control methods on the plant or system side if the inverter has to be integrated into an existing application. The two most common methods use the factory setting (P0727 = 0) and are available as standard in SINAMICS inverters.

---

#### Note

When clockwise rotation is activated, the inverter generates a clockwise voltage characteristic at its output terminals. Whether the connected motor actually rotates clockwise depends on the wiring between the inverter and motor.

---

#### Factory setting for "start", "stop", and "direction reversal" control commands

In the factory setting (P0727 = 0), the motor is operated using two control commands. In this case, two versions are available

#### Further methods for "start", "stop", and "direction reversal" control commands

Parameter P0727 offers three additional methods for controlling the motor.

- Method 3 for controlling the motor is ideal for drives where the direction of rotation is manually changed, for instance, traction drives that are controlled from a master switch. It functions similarly to method 2. Method 3 differs from method 2 with respect to how the motor responds when both control commands are present at the same time, and that it also allows you to change the direction of rotation at any time.
- Two further methods are available for controlling motors, each of which use three control commands. With these methods, the motor is no longer controlled via the signal level only but also with the positive signal edges of certain commands.

Just the same as method 3 of the two-wire control, the first three-wire control method is especially suitable for drives where the direction of rotation is manually reversed.

Table 5- 1 Comparison of the methods for two-wire motor control

Control commands	Description
 <p style="text-align: center;">Motor rotating CW    Motor stops    Motor rotating CCW    Motor stops</p>	
<b>Two-wire control, method 1 (P0727=0)</b>	
	<p>1. Control command: Switch the motor on or off</p> <p>2. Control command: Reverses the motor direction of rotation</p>
<p><b>Two-wire control, method 2 (P0727=0)</b>                  If CW and CCW rotation are selected simultaneously, the signal that was issued first has priority. The second signal is ignored.                  The motor cannot be reversed as long as it is still rotating.</p>	
	<p>1. Control command: Switch on or switch off the motor CW rotation</p> <p>2. Control command: Switch on or switch off the motor CCW rotation</p>
<p><b>Two-wire control, method 3 (P0727=1)</b>                  When CW and CCW are simultaneously selected, the motor is stopped.                  Reversing is possible at any time.</p>	
	<p>1. Control command: Switch on or switch off the motor CW rotation</p> <p>2. Control command: Switch on or switch off the motor CCW rotation</p>

Table 5-2 Comparison of the methods for three-wire motor control

<b>Control commands</b> 	<b>Explanation</b>
<b>Three-wire control, method 1 (P0727 = 2)</b>	
	<ol style="list-style-type: none"> <li>1. Control command: Enable the motor so that it can be switched on or switched off</li> <li>2. Control command: Switch on the motor CW rotation</li> <li>3. Control command: Switch on motor CCW rotation</li> </ol>
<b>Three-wire control, method 2 (P0727 = 3)</b>	
	<ol style="list-style-type: none"> <li>1. Control command: Enable the motor so that it can be switched on or switched off</li> <li>2. Control command: Switch the motor on or off</li> <li>3. Control command: Enter CW or CCW rotation of the motor</li> </ol>

A detailed description of all of the methods to control a motor can be found in the following sections.

## 5.2.2 Two-wire control, method 1

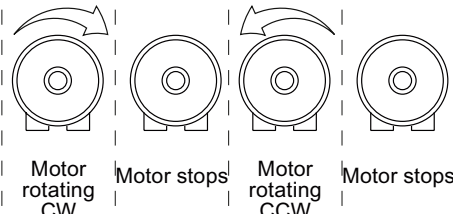
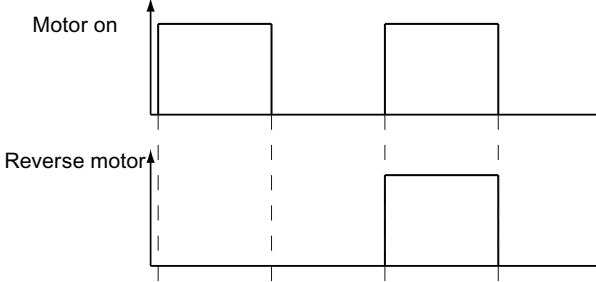
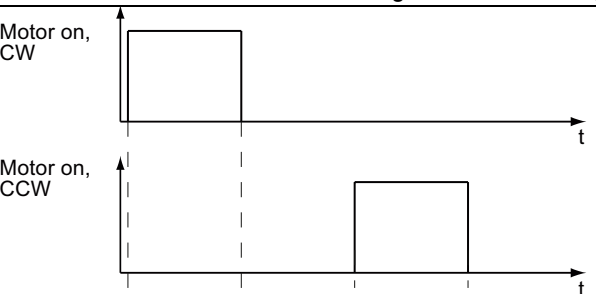
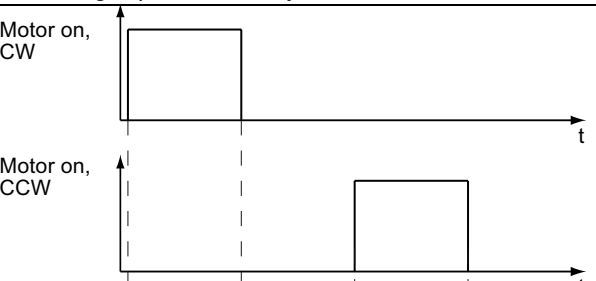
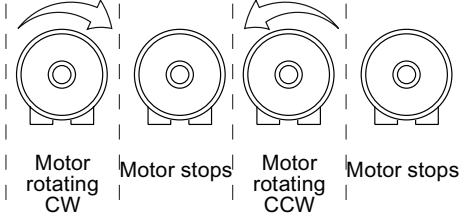
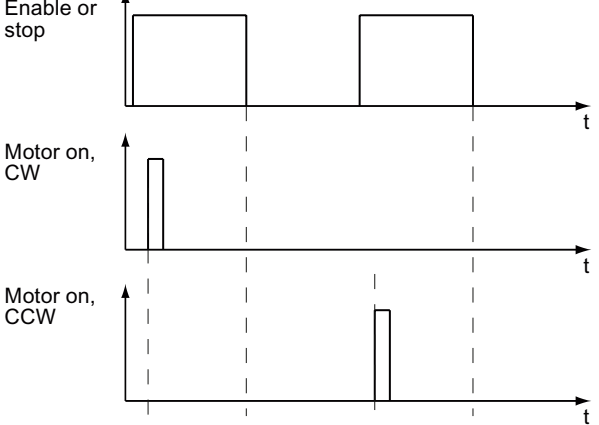
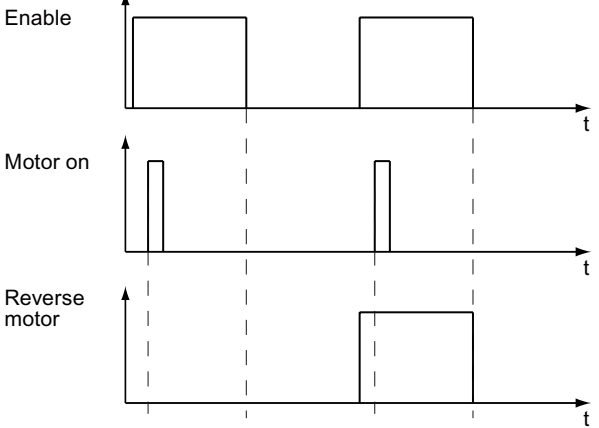
### Function description

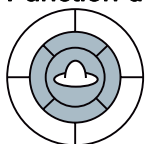

This control method uses two control commands as permanent signals.

One control command starts/stops the motor, while the other control command changes the direction of rotation.

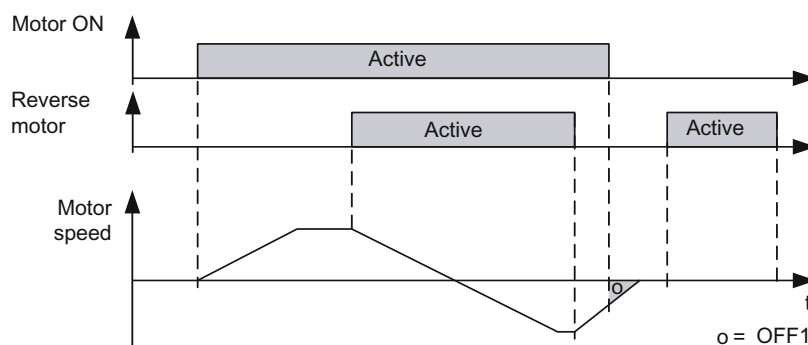

Figure 5-2 Two-wire control using digital inputs, method 1

Table 5- 3 Function table

Motor ON	Reverse motor	Function
0	0	OFF1: The motor decelerates to a standstill
0	1	OFF1: The motor decelerates to a standstill
1	0	The motor accelerates to the setpoint
1	1	The motor accelerates to the inverted setpoint

Table 5- 4 Parameterizing the function

Parameter	Description
P0700 = 2	Controls the motor using the digital inputs of the inverter
P0727 = 0	Two-wire control, method 1 or 2
P0701 = 1	<b>The motor is power-up with digital input 0</b> Further options: The motor can be powered-up with any other digital input, e.g. with digital input 3 via P0704 = 1
P0702 = 12	<b>The motor is reversed with digital input 1</b> Further options: The motor can be reversed with any other digital input, e.g. with digital input 3 via P0704 = 12

### 5.2.3 Two-wire control, method 2

#### Function description

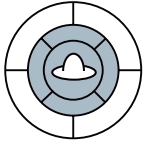

This control method uses two control commands as permanent signals.

CW and CCW rotation of the motor is started and stopped with one control command each. To change the direction, the drive must first decelerate to 0 Hz with OFF1 before the direction reversal signal is accepted.

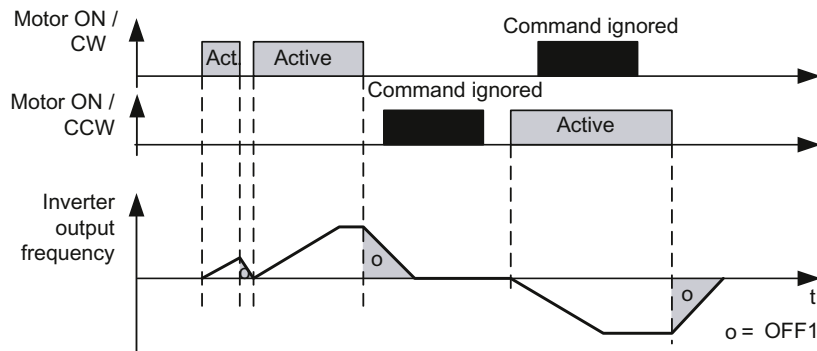

Figure 5-3 Two-wire control using digital inputs, method 2

Table 5-5 Function table

Motor ON / CW	Motor ON / CCW	Function
0	0	OFF1: The motor decelerates to a standstill
0	1	The motor accelerates to the inverted setpoint
1	0	The motor accelerates to the setpoint
1	1	The first active signal has priority; the second signal is ignored.

Table 5-6 Parameterizing the function

Parameter	Description
P0700 = 2	Controls the motor using the digital inputs of the inverter
P0727 = 0	Two-wire control, method 1 or 2
P0701 = 1	<b>CW rotation is activated with digital input 0</b> Further options: CW rotation can be activated with any other digital input, e.g. with digital input 3 via P0704 = 1
P0702 = 2	<b>CCW rotation is activated with digital input 1</b> Further options: CCW rotation can be activated with any other digital input, e.g. with digital input 3 via P0704 = 2



## 5.2.4 Two-wire control, method 3

### Function description

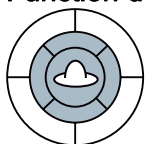

This control method uses two control commands as permanent signals.

Like method 2, CW and CCW rotation can be started/stopped by one control command each. In contrast to method 2, however, the control commands can be switched at any time regardless of the setpoint, output frequency, and direction of rotation. The motor does not have to coast to 0 Hz either before a control command is executed.

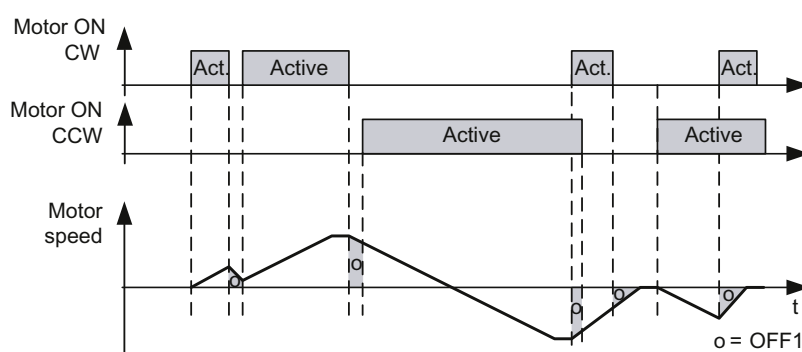

Figure 5-4 Two-wire control using digital inputs, method 3

Table 5- 7 Function table

Motor ON / CW	Motor ON / CCW	Function
0	0	OFF1: The motor decelerates to a standstill
0	1	The motor accelerates to the inverted setpoint
1	0	The motor accelerates to the setpoint
1	1	OFF1: The motor decelerates to a standstill

Table 5- 8 Parameterizing the function

Parameter	Description
P0700 = 2	Controls the motor using the digital inputs of the inverter
P0727 = 1	Two-wire control, method 3
P0701 = 1	<b>CW rotation is activated with digital input 0</b> Further options: CW rotation can be activated with any other digital input, e.g. with digital input 3 via P0704 = 1
P0702 = 2	<b>CCW rotation is activated with digital input 1</b> Further options: CCW rotation can be activated with any other digital input, e.g. with digital input 3 via P0704 = 2

### 5.2.5 Three-wire control, method 1

#### Function description

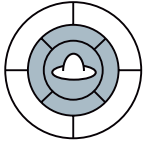

- The first control command is a permanent enable signal for starting the motor. When this enable signal is canceled, the motor stops.
- CW rotation is activated with the positive edge of the second control command.
- CCW rotation is activated with the positive edge of the third control command.

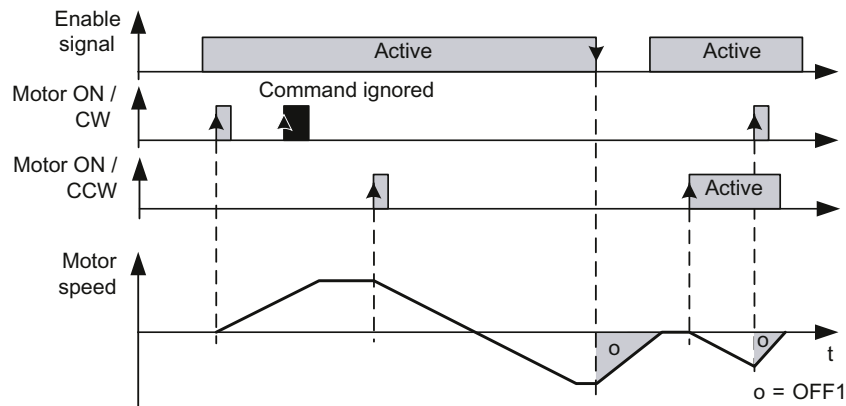

Figure 5-5 Three-wire control using digital inputs, method 1

Table 5-9 Function table

Enable signal	Motor ON / CW	Motor ON / CCW	Function
0	Not relevant	Not relevant	OFF1: The motor decelerates to a standstill
1	0→1	0	The motor accelerates to the setpoint
1	0	0→1	The motor accelerates to the inverted setpoint
1	0	0	No effect on the direction of rotation.
1	1	1	OFF1: The motor decelerates to a standstill

Table 5-10 Parameterizing the function

Parameter	Description
P0700 = 2	Controls the motor using the digital inputs of the inverter
P0727 = 2	Three-wire control, method 1
P0701 = 1	<b>The enable signal to power-up the motor is issued with digital input 0</b> Further options: The enable signal can be issued with any other digital input, e.g. with digital input 3 via P0704 = 1
P0702 = 2	<b>CW rotation is activated with digital input 1</b> Further options: CW rotation can be activated with any other digital input, e.g. with digital input 3 via P0704 = 2
P0703 = 12	<b>CCW rotation is activated with digital input 2</b> Further options: CCW rotation can be activated with any other digital input, e.g. with digital input 3 via P0704 = 12

## 5.2.6 Three-wire control, method 2

### Function description

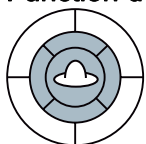

- The first control command is a permanent enable signal for starting the motor. When this enable signal is canceled, the motor stops.
- The motor is started with the positive edge of the second control command.
- The third control command defines the direction of rotation.

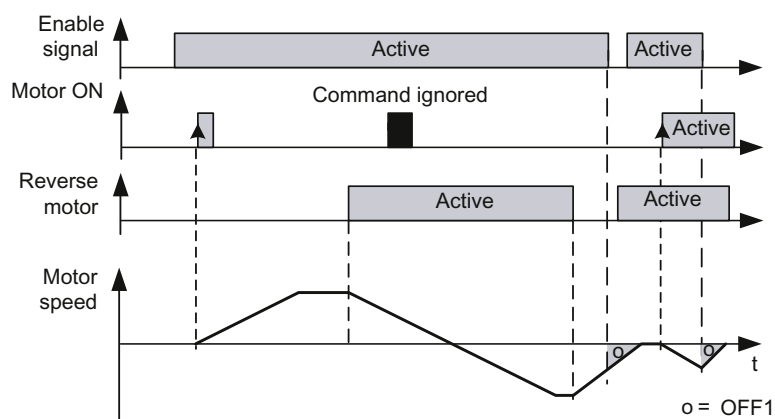

Figure 5-6 Three-wire control using digital inputs, method 2

Table 5- 11 Function table

Enable signal	Motor ON	Reverse motor	Function when motor is at a standstill	Function when motor is rotating
0	Not relevant	Not relevant	No effect	OFF1: The motor decelerates to a standstill
1	0→1	0	The motor accelerates to the setpoint	No effect
1	0→1	1	The motor accelerates to the inverted setpoint	No effect
1	0	1→0	No effect	The motor reverses to the setpoint.
1	0	0→1	No effect	The motor reverses to the inverted setpoint.

Table 5- 12 Parameterizing the function

Parameter	Description
P0700 = 3	Controls the motor using the digital inputs of the inverter
P0727 = 3	Three-wire control, method 2
P0701 = 2	<b>The enable signal to power-up the motor is issued with digital input 0</b> Further options: The enable signal can be issued with any other digital input, e.g. with digital input 3 via P0704 = 2
P0702 = 1	<b>The motor is started with digital input 1</b> Further options: The motor can be started with any other digital input, e.g. with digital input 3 via P0704 = 1
P0703 = 12	<b>The direction of the motor is reversed with digital input 2</b> Further options: The direction of the motor can be reversed with any other digital input, e.g. with digital input 3 via P0704 = 12

## 5.3 Command sources

### 5.3.1 Selecting command sources

#### Selecting the command source [P0700]

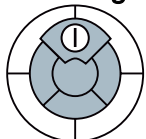

The motor is switched on/off via external inverter control commands. The following command sources can be used to specify these control commands:

- Operator control / display instrument (operator panel)
- Digital inputs
- Fieldbus

The command sources available depend on the inverter version.

- For inverters with a fieldbus interface, the 'fieldbus' (P0700 = 6) is pre-selected as the command source,
- For inverters without a fieldbus interface, the digital inputs (P0700 = 2) are pre-selected as command source.

Table 5- 13 Parameters, to select the source for the inverter control commands

Parameters	Description
P0700 = ...	0: Factory default setting 1: Operator panel 2: Digital inputs (P0701 ... P0709), factory setting for an inverter without fieldbus interface 4: USS at RS 232 5: USS at RS 485 (not available for all inverters) 6: Fieldbus (P2050 ... P02091), factory setting for inverters with fieldbus interface.

### 5.3.2 Assigning functions to digital inputs

#### Assigning control commands to digital inputs as command sources [P0701...P0709]

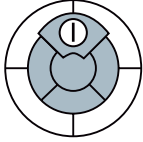

The digital inputs are pre-assigned with certain control commands in the factory. However, these digital inputs can be freely assigned to a control command. Depending on the Control Unit version, SINAMICS inverters are equipped with up to 9 digital inputs.

Table 5- 14 Factory setting of the digital inputs

Terminal no.: Digital input no.	Control command	Available in CU...
<b>Terminal 5:</b> Digital input 0 (DI0)	Switch motor on/off (ON/OFF1)	CU240E
<b>Terminal 6:</b> Digital input 1 (DI1)	Reverse direction of rotation	CU240S
<b>Terminal 7:</b> Digital input 2 (DI2)	Fault acknowledgment	CU240S DP
<b>Terminal 8:</b> Digital input 3 (DI3)	Selects fixed frequency 1	CU240S PN
<b>Terminal 16:</b> Digital input 4 (DI4)	Selects fixed frequency 2	CU240S DP-F
<b>Terminal 17:</b> Digital input 5 (DI5)	Selects fixed frequency 3	CU240S PN-F
<b>Terminal 40:</b> Digital input 6 (DI6)	Selects fixed frequency 4	CU240S
<b>Terminal 41:</b> Digital input 7 (DI7)	Locked	CU240S DP
<b>Terminal 42:</b> Digital input 8 (DI8)	Locked	CU240S PN

Table 5- 15 Changing the digital input settings

Terminal no.: Digital input no.	Parameter	Description
	P0003 = 2	Extended access to the parameters
<b>Terminal 5:</b> Digital input 0 (DI0)	P0701 = ...	Possible values for P0701 to P0709: 0: Digital input locked 1: Switch motor on/off (ON/OFF1) 2: Activate motor CW 3: Motor coasts to standstill (OFF2) 4: Rapid stop with ramp (OFF3) 9: Fault acknowledgement 10: Jog mode CW 11: Jog mode CCW 12: Change direction of rotation (reverse) 13: Increase frequency of motorized potentiometer 14: Increase frequency of motorized potentiometer 15: Select fixed frequencies (bit 0) 16: Select fixed frequencies (bit 1) 17: Select fixed frequencies (bit 2) 18: Select fixed frequencies (bit 3) 25: Enable signal for DC brake 27: Enable signal for PID technology controller 29: External fault 33: Disable additional frequency setpoint 99: The digital input can be freely used for the BICO technology
<b>Terminal 6:</b> Digital input 1 (DI1)	P0702 = ...	
<b>Terminal 7:</b> Digital input 2 (DI2)	P0703 = ...	
<b>Terminal 8:</b> Digital input 3 (DI3)	P0704 = ...	
<b>Terminal 16:</b> Digital input 4 (DI4)	P0705 = ...	
<b>Terminal 17:</b> Digital input 5 (DI5)	P0706 = ...	
<b>Terminal 40:</b> Digital input 6 (DI6)	P0707 = ...	
<b>Terminal 41:</b> Digital input 7 (DI7)	P0708 = ...	
<b>Terminal 42:</b> Digital input 8 (DI8)	P0709 = ...	

If you enable one of the digital inputs to be freely used for BICO technology (P701...P709 = 99), then you must interconnect this digital input to the required control command.

If value 99 is assigned to the digital input to define its function, this can only be reversed by restoring the factory setting.

### 5.3.3 Controlling the motor via the fieldbus

#### Control commands via the fieldbus

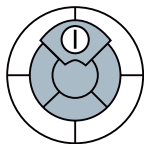

To control the motor via the fieldbus, the inverter must be connected to a higher-level control via the STARTER software tool. For more information, see Chapter "Operation in fieldbus systems".

## 5.4 Setpoint sources

### 5.4.1 Selecting frequency setpoint sources

#### Selecting the setpoint source [P1000]



The speed of the motor can be set via the frequency setpoint. The following sources can be used to specify the frequency setpoint:

- Analog inputs
- Fixed frequency via digital inputs
- Motorized potentiometer
- Fieldbuses

The frequency setpoint sources available depend on the inverter version.

- For inverters with a fieldbus interface, the 'fieldbus' (P0700 = 6) is pre-selected as the frequency setpoint source.
- For inverters without fieldbus interface, the analog input (P0700 = 2) is pre-selected as the frequency setpoint source.

Table 5- 16 Settings to select the possible frequency setpoint sources

Parameter	Description
P0003 = 1	Standard: Access to the most frequently used parameters
P1000 = ...	0: No main setpoint 1: MOP setpoint / motorized potentiometer (P1031 ... P1040) 2: Analog setpoint (P0756 ... P0762), factory setting for inverters without fieldbus interface 3: Fixed frequency (P1001 ... P1023) 4: USS on RS 232 6: Fieldbus (P2050 ... P2091), factory setting for inverters with fieldbus interface

#### Adding setpoints from different sources

You can add several setpoints via frequency setpoint source P1000. For more information, see the List Manual (P1000 in the parameter list and function diagram 5000).



## 5.4.2 Using analog inputs as a setpoint source

### Frequency setpoint via analog input [for P1000 = 2]

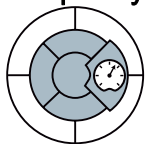

Analog setpoints are read-in via the corresponding analog inputs. The setting specifying whether the analog input is a voltage input (10 V) or current input (20 mA) must be made via P0756 and in addition using the DIP switches on the Control Unit housing.

#### Note

Only analog input 0 (AI0) can be used as a *bipolar* voltage input.

Depending on the AI type of the source, a suitable connection must be established.

Table 5- 17 Set and parameterize the analog input for use as setpoint source

Terminal No. and Significance	Parameters	Description
	Setting the DIP switch	OFF: Voltage input (factory setting) ON: Current input 
3 4	AI0+ AI0-	P0756 [0] Analog input 1
10 11	AI1+ AI1-	P0756 [1] Analog input 2
	P0756 = 0	<b>Analog input type (AI)</b> Defines the analog input type and enables analog input monitoring. 0: Unipolar voltage input (0 ... +10 V) (factory setting) 1: Unipolar voltage input with monitoring (0 ... +10 V) 2: Unipolar current input (0 mA ... 20 mA) 3: Unipolar current input with monitoring (0 ... 20 mA) 4: Bipolar voltage input (-10 ... +10 V)
	P0757 = 0	<b>Value x1 for AI scaling [V or mA]</b>
	P0758 = 0.0	<b>Value y1 of AI-scaling</b> This parameter shows the amount of x1 as a % of P2000 (reference frequency)
	P0759 = 10	<b>Value x2 for AI scaling [V or mA]</b>
	P0760 = 100	<b>Value y2 of AI-scaling</b> This parameter shows the amount of x2 as a % of P2000 (reference frequency)
	P0761 = 0	<b>Width of the AI dead zone</b>

Table 5- 18 Example: Scaling an analog input to 4 - 20 mA

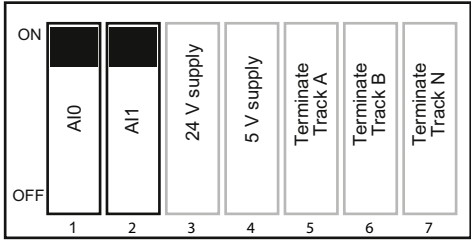
Terminal No. and Significance	Parameters	Description
	Setting the DIP switch	OFF: Voltage input (factory setting) ON: Current input 
3	AI0+	P0756 [0] Analog input 1
4	AI0-	
10	AI1+	P0756 [1] Analog input 2
11	AI1-	
	P0756 = 2	<b>Analog input type (AI)</b> 2: Unipolar current input (0 mA ...20 mA)
	P0757 = 4.0	<b>Value x1 of AI scaling [mA]</b>
	P0758 = 0.0	<b>Value y1 of AI scaling</b> This parameter shows the amount of x1 as a % of P2000 (reference frequency)
	P0759 = 20	<b>Value x2 of AI scaling [mA]</b>
	P0760 = 100	<b>Value y2 of AI-scaling</b> This parameter shows the amount of x2 as a % of P2000 (reference frequency)
	P761 = 4.0	<b>Width of the AI dead zone</b>

### 5.4.3 Using a motorized potentiometer as a setpoint source

#### Frequency setpoint via motorized potentiometer (MOP) (when P1000 = 1 -> P1031)

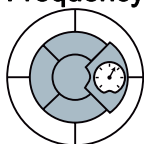

The 'motorized potentiometer' function simulates an electromechanical potentiometer for entering setpoints. The value of the motorized potentiometer (MOP) can be set by means of the "up" and "down" control commands.

Table 5- 19 Example: Implementing the motorized potentiometer using the Operator Panel keys

Parameter	Description
P0700 = 1	1: Operator panels; ON and OFF buttons as well as "up" and "down" keys
P1000 = 1	1: MOP setpoint
P1031 = 0	<b>Setpoint memory of the MOP</b> The last motorized potentiometer setpoint that was active prior to the OFF command or shutdown can be saved. 0: MOP setpoint is not saved (factory setting) 1: MOP setpoint is saved in P1040
P1032 = 1	<b>Disable opposite direction of the MOP</b> 0: Reverse direction of rotation is permitted 1: Reverse direction of rotation is locked (factory setting)
P1040 = 5	<b>Setpoint of the MOP</b> Determines the setpoint [Hz] of the motorized potentiometer (MOP). Factory setting 5 Hz
P2000 = 50	<b>Reference frequency (Hz);</b> An output value of the MOP of 100 % corresponds to the frequency setpoint from P2000. P2000 should be changed, if a maximum frequency greater than 50 Hz is required.

Table 5- 20 Example: Implementing a motorized potentiometer using digital inputs

Parameters	Description
P0700 = 2	2: Digital inputs P0701...P0709 (DI x ON/OFF1; DI y "up" and DI z "down")
P0701 = 1	1: ON/OFF1
P0702 = 13	13: MOP "up"
P0703 = 14	14: MOP "down"
P1000 = 1	1: MOP setpoint
P1031 = 0	<b>Setpoint memory of the MOP</b> The last motorized potentiometer setpoint that was active prior to the OFF command or shutdown can be saved. 0: MOP setpoint is not saved (factory setting) 1: MOP setpoint is saved in P1040
P1032 = 1	<b>Disable opposite direction of the MOP</b> 0: Reverse direction of rotation is permitted 1: Reverse direction of rotation is locked (factory setting)
P1040 = 5	<b>Setpoint of the MOP</b> Determines the setpoint [Hz] of the motorized potentiometer (MOP); factory setting, 5 Hz
P2000 = 50	<b>Reference frequency (Hz);</b> An output value of the MOP of 100 % corresponds to the frequency setpoint from P2000. P2000 should be changed, if a maximum frequency greater than 50 Hz is required.

### 5.4.4 Using the fixed frequency as a setpoint source

#### Frequency setpoint via fixed frequency (P1000 = 3)

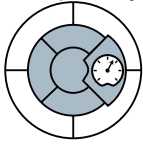

The fixed frequencies are defined using parameters P1001 to P1004 and can be assigned to the corresponding digital inputs using P1020 to P1023.

Table 5- 21 Parameters to directly select frequencies

Parameters	Description																																											
P1016 = 1	Fixed frequency mode, defines the procedure for selecting fixed frequencies. 1: Direct selection (factory setting) 2: Binary-coded selection	The fixed frequency can be selected using four digital inputs (factory setting: DI3 ... DI6) and combined (e.g. summed). The factory settings support the following additional combinations: <table border="1" style="margin-top: 10px;"> <thead> <tr> <th>Fixed Frequency selected via</th> <th>FF- Par</th> <th>FF [Hz]</th> </tr> </thead> <tbody> <tr> <td>DI3 (P1020 =722.3)</td> <td>P1001 (default = 0 Hz)</td> <td>0</td> </tr> <tr> <td>DI4 (P1021 =722.4)</td> <td>P1002 (default = 5 Hz)</td> <td>5</td> </tr> <tr> <td>DI5 (P1022 =722.5)</td> <td>P1003 (default = 10 Hz)</td> <td>10</td> </tr> <tr> <td>DI6 (P1023 =722.6)</td> <td>P1004 (default = 15 Hz)</td> <td>15</td> </tr> <tr> <td>DI3, DI4</td> <td>P1001+P1002</td> <td>5</td> </tr> <tr> <td>DI3, DI5</td> <td>P1001+P1003</td> <td>10</td> </tr> <tr> <td>DI3, DI6</td> <td>P1001+P1004</td> <td>15</td> </tr> <tr> <td>DI4, DI5</td> <td>P1002+P1003</td> <td>15</td> </tr> <tr> <td>DI5, DI6</td> <td>P1003+P1004</td> <td>25</td> </tr> <tr> <td>DI3, DI4, DI5</td> <td>P1001+P1002+P1003</td> <td>15</td> </tr> <tr> <td>DI3, DI4, DI6</td> <td>P1001+P1002+P1004</td> <td>20</td> </tr> <tr> <td>DI3, DI5, DI6</td> <td>P1001+P1003+P1004</td> <td>25</td> </tr> <tr> <td>DI3, DI4, DI5, DI6</td> <td>P1001+P1002+P1003+P1004</td> <td>30</td> </tr> </tbody> </table>	Fixed Frequency selected via	FF- Par	FF [Hz]	DI3 (P1020 =722.3)	P1001 (default = 0 Hz)	0	DI4 (P1021 =722.4)	P1002 (default = 5 Hz)	5	DI5 (P1022 =722.5)	P1003 (default = 10 Hz)	10	DI6 (P1023 =722.6)	P1004 (default = 15 Hz)	15	DI3, DI4	P1001+P1002	5	DI3, DI5	P1001+P1003	10	DI3, DI6	P1001+P1004	15	DI4, DI5	P1002+P1003	15	DI5, DI6	P1003+P1004	25	DI3, DI4, DI5	P1001+P1002+P1003	15	DI3, DI4, DI6	P1001+P1002+P1004	20	DI3, DI5, DI6	P1001+P1003+P1004	25	DI3, DI4, DI5, DI6	P1001+P1002+P1003+P1004	30
Fixed Frequency selected via	FF- Par		FF [Hz]																																									
DI3 (P1020 =722.3)	P1001 (default = 0 Hz)		0																																									
DI4 (P1021 =722.4)	P1002 (default = 5 Hz)		5																																									
DI5 (P1022 =722.5)	P1003 (default = 10 Hz)		10																																									
DI6 (P1023 =722.6)	P1004 (default = 15 Hz)		15																																									
DI3, DI4	P1001+P1002		5																																									
DI3, DI5	P1001+P1003		10																																									
DI3, DI6	P1001+P1004		15																																									
DI4, DI5	P1002+P1003		15																																									
DI5, DI6	P1003+P1004		25																																									
DI3, DI4, DI5	P1001+P1002+P1003	15																																										
DI3, DI4, DI6	P1001+P1002+P1004	20																																										
DI3, DI5, DI6	P1001+P1003+P1004	25																																										
DI3, DI4, DI5, DI6	P1001+P1002+P1003+P1004	30																																										
P1001 = 0	<b>Fixed frequency 1 (FF1)</b> (FF values in Hz)																																											
P1002 = 5	<b>Fixed frequency 2 ((FF2)</b>																																											
P1003 = 10	<b>Fixed frequency 3 (FF3)</b>																																											
P1004 = 15	<b>Fixed frequency 4 (FF4)</b>																																											
P1020 = 722.3	<b>FF1 selection</b> using DI3																																											
P1021 = 722.4	<b>FF2 selection</b> using DI4																																											
P1022 = 722.5	<b>FF3 selection</b> using DI5																																											
P1023 = 722.6	<b>FF4 selection</b> using DI6																																											

Additional information about binary coded selection of the fixed frequencies (P1016 = 2) is provided in function chart 3210 of the List Manual.

Table 5- 22 Example: Selecting 2 fixed frequencies using digital input 2 and digital input 3

Parameter	Description
P0003 = 3	Enable expert access to parameters
P0700 = 2	Selecting the command source: Digital inputs
P0701 = 1	ON/OFF1 (DI0) - factory setting
P0702 = 12	Direction reversal (DI1) - factory setting
P0703 = 99	Enable / 'open' digital input 2 (DI2)
P0704 = 99	Enable / 'open' digital input 3 (DI3)
P0705 = 99	Enable / 'open' digital input 4 (DI4)
P1001 = 4.00	Defines fixed frequency 1 (FF1) in [Hz]
P1002 = 8.00	Defines fixed frequency 2 (FF2) in [Hz]
P1020 = r0722.2	Connect fixed frequency 1(FF1) with the status of DI2. r0722.2 = Parameter, which displays the status of digital input 2.
P1021 = r0722.3	Connect fixed frequency 2(FF2) with the status of DI3. r0722.3 = Parameter, which displays the status of digital input 3.

## 5.4.5 Running the motor in jog mode (JOG function)

### Run motor in jog mode [JOG function]

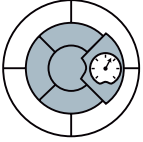

The JOG function enables you to carry out the following:

- Test the motor and inverter after commissioning to ensure that they function properly (the first traverse movement, direction of rotation etc.)
- Move a motor or motor load to a specific position
- Run a motor (e.g. following program interruption)

This function allows the motor to start up or rotate with a specific jog frequency. This function can normally be activated via the JOG button on the Basic Operator Panel,

When this function is enabled, the motor starts up ("ready for operation" status) when the JOG button is pressed and rotates at the set JOG frequency. When the button is released, the motor stops. This button has no effect when the motor is already running.

Table 5- 23 Example: Enabling the jog mode

Parameters	Description
P0003 = 2	2: Extended
P1057 = 1	<b>JOG enable</b> 0: JOG function locked 1: JOG function enabled (factory setting)
P1058 = 5	<b>JOG frequency CW</b> 0 Hz ... 650 Hz in JOG mode of motor in clockwise direction of rotation; 5 Hz (factory setting)
P1059 = 5	<b>JOG frequency CCW</b> 0 Hz ... 650 Hz in the motor JOG mode in the counter-clockwise direction; 5 Hz (factory setting)
P1060 = 10	<b>JOG ramp-up time</b> 0 s ... 650 s / 10 s (factory setting) Ramp-up time (in seconds) from 0 to maximum frequency (P1082). The ramp-up procedure in JOG mode is limited by P1058 or P1059.
P1061 = 10	<b>JOG ramp-down time</b> 0 s ... 650 s / 10 s (factory setting) The ramp-down time in seconds from the highest frequency (P1082) to 0.

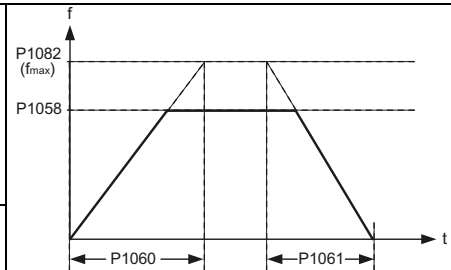

Using BICO technology, you can also assign the JOG function to other keys.

Table 5- 24 Parameter to assign the JOG function to another button

Parameters	Description
P0003 = 3	3: Expert
P1055 = ...	<b>Enable JOG CW</b> Possible sources: 722.x (digital inputs) / 19.8 (JOG key on the Operator Panel) / r2090.8 (serial interface)
P1056 = ...	<b>Enable JOG CCW</b> Possible sources: 722.x (digital inputs) / 19.8 (JOG key on the Operator Panel) / r2090.9 (serial interface)

### 5.4.6 Specifying the motor speed via the fieldbus

#### Specifying the motor speed via the fieldbus

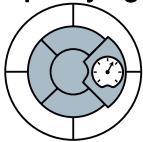

To specify the speed of the motor via the fieldbus, the inverter must be connected to a higher-level control via the STARTER software tool. For more information, see "Operation in fieldbus systems".

## 5.5 Changing over the command data sets (manual, automatic)

### Switching operating priority

In some applications, the inverter is operated from different locations.

Example: Switchover from the automatic mode into the manual mode

A central control can switch a motor on/off or change its speed either via a fieldbus or via local switches. A key-operated switch close to the motor can be used to switch the operating priority of the inverter from "control via fieldbus" to "local control".

### Command data set (CDS)

The inverter offers options to parameterize the settings for the command sources, setpoint sources and status messages (with the exception of analog outputs) in three different ways. The associated parameters are indexed (index 0, 1 or 2). When the inverter is operational, control commands select one of the three indices and therefore one of the three settings that has been saved. This means that as described in the example above, the master control of the inverter can be switched over.

All of the switchable parameters for command sources, setpoint sources and status messages with the same index is known as a "command data set".

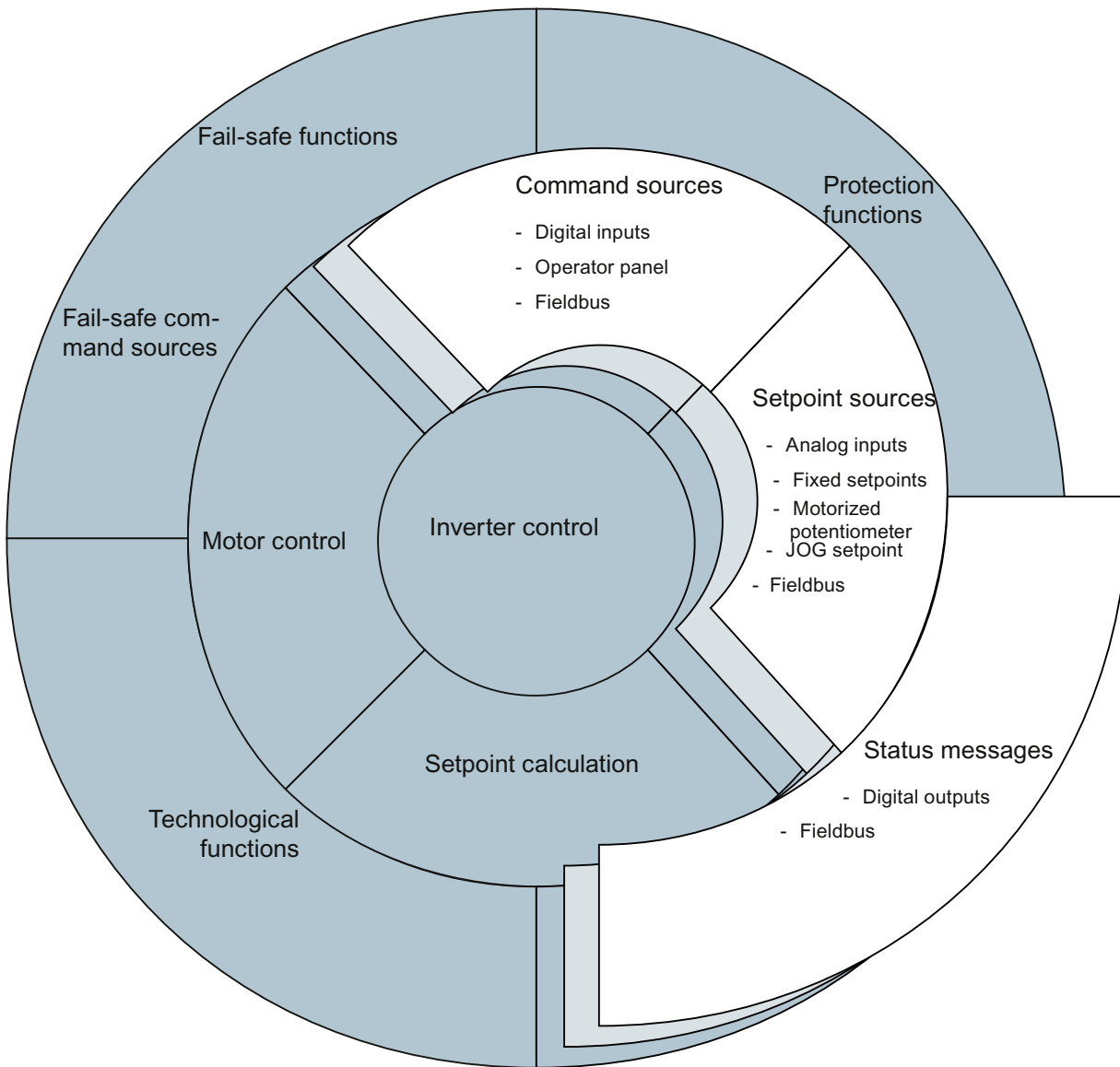

Figure 5-7 CDS switchover in the inverter

The command data sets are switched over using parameters P0810 and P0811. Parameters P0810 and P0811 are interlinked to control commands, e.g. the digital inputs of the inverter, using BICO technology.



5.5 Changing over the command data sets (manual, automatic)

Table 5- 25 Command data set changeover using parameters P0810 and P0811.

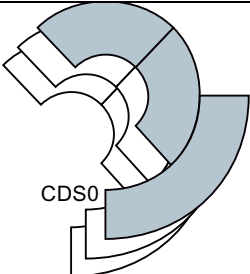
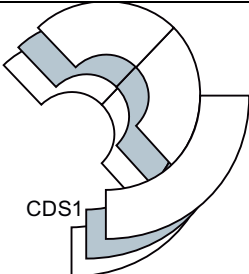
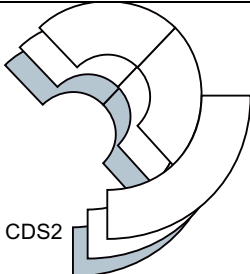
Status of P0810	0	1	0 or 1
Status of P0811	0	0	1
The CDS that is current active is gray.			
Selected parameter index	0	1	2
Examples	Fieldbus as setpoint source: The speed setpoint is specified via the fieldbus.	Analog input as setpoint source: The speed setpoint is specified via an analog input.	-
	Fieldbus as command source: The motor is switched on/off via the fieldbus.	Digital inputs as command source: The motor is switched on/off via digital inputs.	-

**Note**

Command data sets can be switched in the "ready for operation" and "operation" state. The switchover time is approx. 4 ms.

Table 5- 26 Parameters for switching the command data sets:

Parameter	Description
P0810 = ...	<b>1st control command for switching the command data sets</b> Example: When P0810 = 722.0, the system switches from command data set 0 to command data set 1 via digital input 0.
P0811 = ...	<b>2nd control command for switching the command data sets</b>
r0050	<b>Displaying the number of the CDS that is currently active</b>
<b>A copy function is available making it easier to commission more than one command data set:</b>	
P0809.0 = ...	<b>Number of the command data set to be copied (source)</b>
P0809.1 = ...	<b>Number of the command data set to which the data is to be copied (target)</b>
P0809.2 = 1	<b>Start copying</b>

For an overview of all the parameters that belong to the drive data sets and can be switched, see the List Manual.

## 5.6 Setpoint preparation

### Overview of setpoint calculation

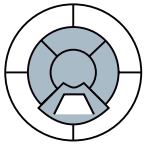

The setpoint calculation modifies the speed setpoint, e.g. it limits the setpoint to a maximum and minimum value and using the ramp-function generator prevents the motor from executing speed steps.

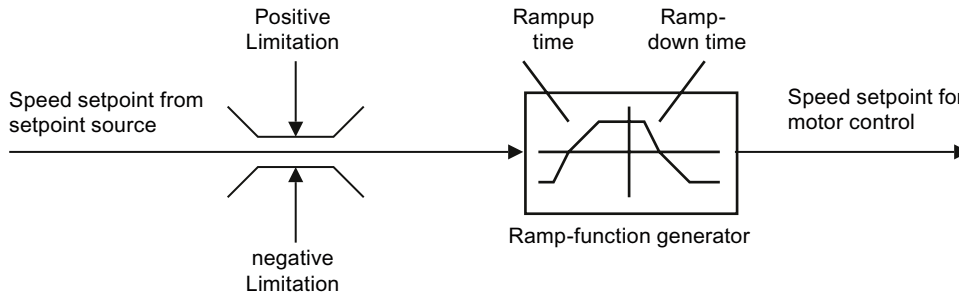

Figure 5-8 Setpoint calculation in the inverter

### 5.6.1 Minimum frequency and maximum frequency

#### Limiting the speed setpoint



The speed setpoint is limited by both the minimum and maximum frequency.

#### Minimum frequency

When the motor is switched on, it accelerates to the minimum frequency regardless of the frequency setpoint. The set parameter value applies to both directions of rotation. In addition to its limiting role, the minimum frequency can be used as a reference value for various monitoring functions (e.g. if a motor holding brake is engaged when the minimum frequency is reached).

#### Maximum frequency

The frequency setpoint is limited to the maximum frequency in both directions of rotation. A message is output if the maximum frequency is exceeded.

The maximum frequency also acts as an important reference value for various inverter functions (e.g. the ramp-function generator).

Table 5- 27 Parameters for minimum and maximum frequency

Parameter	Description
P1080 = ...	Minimum frequency
P1082 = ...	Maximum frequency

## 5.6.2 Parameterizing the ramp-function generator

### Parameterizing the ramp-function generator

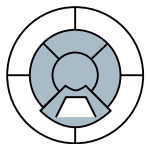

The ramp-function generator in the setpoint channel limits the speed of setpoint changes. This causes the motor to accelerate and decelerate more smoothly, thereby protecting the mechanical components of the driven machine.

### Ramp-up/down time

The ramp-up and ramp-down times of the ramp-function generator can be set independently of each other. The times that you select depend purely on the application in question and can range from just a few 100 ms (e.g. for belt conveyor drives) to several minutes (e.g. for centrifuges).

When the motor is switched on/off via ON/OFF1, the motor also accelerates/decelerates in accordance with the times set in the ramp-function generator.

Table 5- 28 Parameters for ramp-up time and ramp-down time

Parameters	Description
P1120 = ...	<b>Ramp-up time</b> Duration of acceleration (in seconds) from zero speed to the maximum frequency (P1082).
P1121 = ...	<b>Ramp-down time</b> Duration of deceleration (in seconds) from the maximum frequency (P1082) to standstill.

The quick-stop function (OFF3) has a separate ramp-down time, which is set with P1135.

### Note

If the ramp-up/down times are too short, the motor accelerates/decelerates with the maximum possible torque and the set times will be exceeded.

### Rounding

Acceleration can be "smoothed" further by means of rounding. The jerk occurring when the motor starts and when it begins to decelerate can be reduced independently of each other. Rounding can be used to lengthen the motor acceleration/deceleration times. The ramp-up/down time parameterized in the ramp-function generator is exceeded.

Rounding does not affect the ramp-down time in the event of a quick stop (OFF3).

Table 5- 29 Rounding parameters

Parameter	Description
P1130 = ...	<b>Initial rounding time for ramp up</b> (in seconds)
P1131 = ...	<b>Final rounding time for ramp up</b> (in seconds)
P1132 = ...	<b>Initial rounding time for ramp down</b> (in seconds)
P1133 = ...	<b>Final rounding time for ramp down</b> (in seconds)
P1134 = ...	<b>Rounding type</b>

For more information about this function, see the List Manual (function diagram 5300 and the parameter list).

## 5.7 Closed-loop control

### Overview

There are two different open-loop and closed-loop control techniques for inverters used with synchronous and induction motors.

- Closed-loop control with V/f-characteristic (called V/f control)
- Field-oriented control technology (called vector control)

### 5.7.1 V/f control

#### 5.7.1.1 Typical applications for V/f control

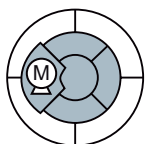

V/f control is perfectly suitable for almost any application in which the speed of induction motors is to be changed. Examples of typical applications for V/f control include:

- Pumps
- Fans
- Compressors
- Horizontal conveyors

#### Basic properties of V/f control

V/f control sets the voltage at the motor terminals on the basis of the specified speed setpoint. The relationship between the speed setpoint and stator voltage is calculated using characteristic curves. The inverter provides the two most important characteristics (linear and square-law). User-defined characteristic curves are also supported.

V/f control is not a high-precision method of controlling the speed of the motor. The speed setpoint and the speed of the motor shaft are always slightly different. The deviation depends on the motor load. If the connected motor is loaded with the rated torque, the motor speed is below the speed setpoint by the amount of the rated slip. If the load is driving the motor (i.e. the motor is operating as a generator), the motor speed is above the speed setpoint.

5.7.1.2 V/f control with linear characteristic

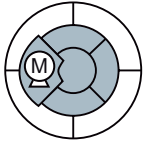

Table 5- 30 Setting the control type

Parameter	Description
P0003 = 2	<b>Extended access</b>
P1300 = 0	<b>Control type:</b> V/f control with linear characteristic

Optimizing the starting characteristics for a high break loose torque and brief overload

The inverter can provide a higher voltage in the lower speed range and when accelerating. Examples of applications where this is necessary, include:

- Utilizing the brief overload capability of the motor when accelerating
- Driven machines with a high breakaway torque
- Holding a load

Background information: The linear characteristic of the V/f control assumes an ideal motor without resistive losses. The resistive losses in the motor stator resistance and in the motor cable reduce the available torque and must not be neglected in all applications. These losses play a more significant role the smaller the motor and the lower the motor speed. The losses can be compensated by the V/f control by increasing the voltage at low speeds. (so-called 'boost parameters': P1310 and P1311)

**Note**

Only increase the voltage boost in small steps until satisfactory motor behavior is reached. Excessively high values in P1310 and P1311 can cause the motor to overheat and switch off (trip) the inverter due to overcurrent .

Table 5- 31 Optimizing the starting characteristics for a linear characteristic

Parameters	Description
P0003 = 2	<b>Extended access</b>
P1310 = ...	<b>Voltage boost to compensate resistive losses</b> The voltage boost is effective for all speeds below the rated speed and continually decreases as the speed increases. The maximum voltage boost is effective at zero speed and is in V: Rated motor current (P305) × stator resistance (P350) × P1310 /100
P1311 = ...	<b>Voltage boost when accelerating</b> The voltage boost is effective from standstill up to the rated speed. The voltage boost is independent of the speed. The voltage boost in V is: Rated motor current (P305) × stator resistance (P350) × P1311 /100

Additional information about this function is provided in the parameter list and in the function diagrams 6100 and 6200 in the List Manual.

### 5.7.1.3 V/f control with parabolic characteristic

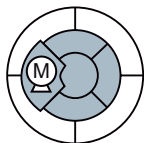

**Note**

V/f control with a parabolic characteristic must not be used in applications in which a high torque is required at low speeds.

Table 5- 32 Setting the control type

Parameter	Description
P0003 = 2	<b>Extended access</b>
P1300 = 2	<b>Control type:</b> V/f control with parabolic characteristic

### 5.7.1.4 Additional characteristics for the V/f control

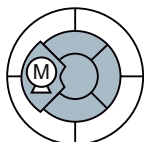

In addition to linear and square-law characteristics, there are the following additional versions of the V/f control that are suitable for special applications.

Table 5- 33 Further V/f control methods (P1300)

Parameter value	Application
P1300 = 1	<b>Linear V/f characteristic with Flux Current Control (FCC)</b> Voltage losses across the stator resistance are automatically compensated. This is particularly useful for small motors since they have a relatively high stator resistance. The prerequisite is that the value of the stator resistance in P350 is parameterized as accurately as possible.
P1300 = 3	<b>Freely adjustable V/f characteristic, which supports the torque behavior of synchronous motors (SIEMOSYN motors)</b>
P1300 = 5 P1300 = 6	<b>Linear V/f characteristic for textile applications</b> where it is important that the motor speed is kept constant under all circumstances. This setting has the following effects: <ol style="list-style-type: none"> <li>1. When the maximum current limit is reached, the stator voltage is reduced but not the speed.</li> <li>2. Slip compensation is locked.</li> </ol>
P1300 = 19	<b>V/f control without characteristic.</b> The interrelationship between the frequency and voltage is not calculated in the inverter, but is specified by the user. With BICO technology, P1330 defines the interface via which the voltage setpoint is entered (e.g. analog input → P1330 = 755).

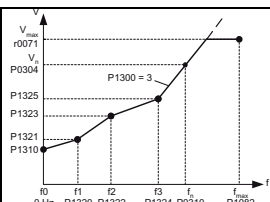

For more information about this function, see function diagrams 6100 and 6200 in the List Manual.

## 5.7.2 Vector control

### 5.7.2.1 Typical applications for vector control

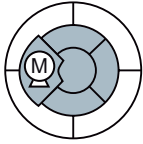

The vector control can be used to control (closed-loop) the speed and the torque of a motor.

Vector control is used in many cases without directly measuring the motor speed. This closed-loop control is known as sensorless vector control. The vector control is also used with a speed encoder in special applications.

### Vector control in comparison to V/f control

When compared to V/f control, vector control offers the following advantages:

- The speed is more stable for motor load changes
- Shorter accelerating times when the setpoint changes
- Acceleration and braking are possible with an adjustable maximum torque
- Improved protection of the motor and the driven machine as a result of the adjustable torque limiting
- The full torque is possible at standstill

### Vector control must not be used in the following cases:

- If the motor is too small in comparison to the inverter (the rated motor power may not be less than one quarter of the rated inverter power)
- If the maximum frequency is more than 200 Hz
- If several motors are connected to one inverter
- If a power contactor is used between the inverter and motor and is opened while the motor is powered-up

### Typical applications for vector control with and without speed encoder

Vector control is typically used for the following applications:

- Hoisting gear and vertical conveyor belts
- Winders
- Extruders



### 5.7.2.2 Commissioning vector control

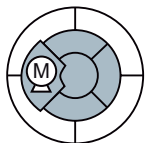

Vector control with and without speed encoder requires careful commissioning and therefore must only be performed by commissioning engineers that are experienced in handling this type of control.

#### Steps when commissioning the vector control

1. Carry out quick commissioning (P0010 = 1)  
In order to ensure that the vector control functions perfectly, it is absolutely imperative that the motor data is entered correctly
2. Run the motor data identification (P1900 = 2)  
The motor data identification must be carried out with the motor in the cold state. The motor data identification must be carried out after the quick commissioning as the quick commissioning supplies output data for the motor model and the motor data identification makes these even more precise
3. Carry out the automatic speed controller optimization (P1960 = 1)

Table 5- 34 The most important vector control parameters

Parameter	Description
P0003 = 2	<b>Extended access</b>
P1300 = 20	<b>Control type:</b> Vector control without speed encoder
P0300 ... P0360	<b>Motor data</b> are transferred from the motor rating plate during the quick commissioning and calculated with the motor data identification
P1442 ... P1496	<b>Speed controller parameters</b>
P1511 = ...	<b>Additional torque</b>
P1520 = ...	<b>Upper torque limit</b>
P1521 = ...	<b>Lower torque limit</b>
P1530 = ...	<b>Motoring power limit</b>
P1531 = ...	<b>Regenerative power limit</b>

For more information about this function, refer to the parameter list as well as the function diagrams 7000, 7500, 7700, 7800 and 7900 in the List Manual.

You will find additional information in the Internet (<http://support.automation.siemens.com/WW/view/en/7494205>):

5.7.2.3 Torque control

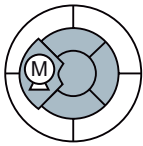

Torque control is part of the vector control and normally receives its setpoint from the speed controller output. By deactivating the speed controller and directly entering the torque setpoint, the closed-loop speed control becomes closed-loop torque control. The inverter then no longer controls the motor speed, but the torque that the motor generates.

Typical applications for torque control

The torque control is used in applications where the motor speed is specified by the connected driven load. Examples of such applications include:

- Load distribution between master and slave drives:  
The master drive is speed controlled, the slave drive is torque controlled
- Winding machines

Steps when commissioning the torque control

1. Carry out quick commissioning (P0010 = 1)  
In order to ensure that the torque control functions perfectly, it is absolutely imperative that the motor data is entered correctly.
2. Run the motor data identification (P1900 = 2)  
The motor data identification must be carried out with the motor in the cold state. The motor data identification must be carried out after the quick commissioning as the quick commissioning supplies output data for the motor model and the motor data identification makes these even more precise.

Table 5- 35 The most important torque control parameters

Parameter	Description
P0003 = 2	<b>Extended access</b>
P1300 = ...	<b>Control type:</b> 20: Vector control without speed encoder 21: Vector control with speed encoder 22: Torque-vector control without speed encoder 23: Torque-vector control with speed encoder
P0300 ... P0360	<b>Motor data</b> are transferred from the motor rating plate during the quick commissioning and calculated with the motor data identification
P1511 = ...	<b>Additional torque</b>
P1520 = ...	<b>Upper torque limit</b>
P1521 = ...	<b>Lower torque limit</b>
P1530 = ...	<b>Motoring power limit</b>
P1531 = ...	<b>Regenerative power limit</b>

Additional information about this function is provided in the parameter list and in the function diagrams 7200, 7700 and 7900 in the List Manual.

### 5.7.2.4 Using a speed encoder

#### Higher accuracy by using a speed encoder

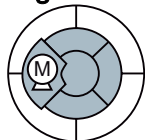

A speed encoder increases the accuracy of the speed and the torque of the vector control for speeds below approx. 10% of the rated motor frequency.

#### Commissioning the speed encoder

A speed encoder requires the following commissioning steps:

1. Connect the speed encoder (see below).
2. Set the encoder voltage using the DIP switches on the CU (see below).
3. Set the speed encoder parameters (see below).
4. Set the inverter to V/f control (P1300 = 0).
5. Power-up the motor with an average speed.
6. Compare parameters r0061 (speed encoder signal in Hz) and r0021 (calculated speed in Hz) regarding the sign and absolute value.
7. If the signs do not match, invert the speed encoder signal (P0410 = 1).
8. If the absolute value of the two values do not correspond, check P0408, the speed encoder wiring and the setting of the corresponding DIP switch.
9. Switch over to a control type with speed encoder: P1300 = 21 or P1300 = 23.

#### Connect the speed encoder

An encoder can only be connected to CU240S, CU240S DP, CU240S DP-F, CU240S PN or CU240S PN-F.

Only encoders with two pulse tracks A and B offset through 90° may be connected.

Table 5- 36 Terminals on the CU to connect the speed encoder

Terminal	Designation	Function
28	U0V OUT	Reference potential of the power supply voltage (terminal 9)
33	ENC+ SUPPLY	Supply voltage for the encoder
70	ENC AP	Pulse track A, non-inverting input
71	ENC AN	Pulse track A, inverting input
72	ENC BP	Pulse track B, non-inverting input
73	ENC BN	Pulse track B, inverting input
74	ENC ZP	Zero signal, non-inverting input
75	ENC ZN	Zero signal, inverting input

**CAUTION**  
 Use a shielded cable to connect the speed encoder. The shield must not be interrupted by terminal points between the encoder and inverter.

**Setting the encoder voltage**

The encoder voltage is set using the DIP switches at the front of the CU. If you use either a BOP or a PC Connection Kit, you must remove this module in order to be able to access the switches.

Table 5- 37 Encoder settings

Encoder type	Setting the DIP switches* at the front of the CU
No encoder	
TTL encoder ** Supply voltage: 5 V	
HTL encoder Supply voltage: 24 V	
<p>*) DIP switches 1 and 2 are of no significance when setting the encoder voltage</p> <p>**) When using standard TTL encoders, it is recommended that DIP switches 5, 6 and 7 are set to OFF. If TTL encoders with a differential circuit are being used, and if a long cable is required (more than 50 meters), then DIP switches 5, 6, and 7 can be set to ON.</p>	

**WARNING**  
 If DIP switch 3 is set to ON (24 V), a TTL encoder (voltage level 5 V) must not be connected to the inverter.

Table 5- 38 The most important speed encoder parameters

Parameter	Description
P0003 = 2	<b>Extended access</b>
P0400 = ...	<b>Selecting the encoder type</b> <ul style="list-style-type: none"> <li>• 0: Encoder signal is not evaluated</li> <li>• 2: Encoder with pulse tracks A and B without zero pulse</li> <li>• 12: Encoder with pulse tracks A, B and zero pulse</li> </ul>
P0408 = ...	<b>Number of encoder pulses per revolution</b>
P0410 = ...	<b>Reversing the internal sense of rotation</b> <ul style="list-style-type: none"> <li>• 0: The encoder signal is not influenced</li> <li>• 1: The encoder signal is inverted</li> </ul>
P0491 = ...	<b>Loss of speed response</b> (response when the speed signal is lost) <ul style="list-style-type: none"> <li>• 0: Motor is shut down with fault message F0090</li> <li>• 1: Alarm and switch to SLVC, if in SVC</li> </ul>
P0492 = ...	<b>Permissible speed difference</b> to monitor the encoder signal (F0090)
P0494 = ...	<b>Delay time of the loss of speed</b> (delayed response when the speed signal is lost)
P1300 = 21 or P1300 = 23	<b>Control type:</b> 21: Vector control with speed encoder 23: Torque-vector control with speed encoder

## 5.8 Protection functions

The frequency inverter offers protective functions against overtemperature and overcurrent for both the frequency inverter as well as the motor. Further, the frequency inverter protects itself against an excessively high DC link voltage when the motor is regenerating.

The load torque monitoring functions provide effective plant and system protection.

### 5.8.1 Overtemperature protection for the frequency inverter and motor

#### Temperature monitoring for the inverter (Power Module)

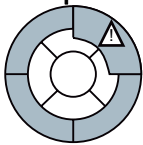

Parameter s	Description
P0003 = 3	<b>User access level</b> 3: Expert
P0290 = 2	<b>Temperature monitoring of the Power Module</b> This defines the response of the inverter to an <b>internal overtemperature</b> . 0: Reduce the output frequency 1: Shutdown (F0004) 2: Reduce pulse frequency and output frequency (factory setting) 3: Reduce pulse frequency, then shut down (F0004)
P0292	<b>Parameterizes the alarm threshold</b> for heatsink and module temperature monitoring (Power Module)

#### Temperature monitoring for the motor

Two options are available for implementing thermal motor protection:

- Temperature sensing in the motor with PTC sensor, KTY 84 sensor or ThermoClick sensor
- Temperature calculation without sensors by analyzing the rating plate data and ambient temperature of the motor. (Only possible in the 'vector control' mode)

## Temperature sensing using a temperature sensor

Table 5- 39 Parameters to sense the temperature using a temperature sensor

Parameters	Description
P0003 = 2	<b>User access level</b> 2: Extended
P0335 = 0	<b>Specify the motor cooling</b> 0: Self-ventilated* - with fan on the motor shaft (IC410* or IC411*) - (factory setting) 1: Forced ventilation* - with a separately driven fan (IC416*) 2: Self-ventilated* and inner cooling* (open-circuit air cooled) 3: Forced ventilated* and inner cooling* (open-circuit air cooled)
P0601 = 0	<b>Specify the motor temperature sensor</b> 0: No sensor (factory setting; → P0610) 1: PTC thermistor (→ P0604) 2: KTY84 (→ P0604) 4: ThermoClick sensor
P0604 = ...	<b>Motor overtemperature alarm threshold</b> (0°C ... 220°C, factory setting 130°C) Enter the alarm threshold for motor overtemperature protection. The shutdown temperature threshold (alarm threshold + 10 %) is the value at which either the inverter is shut down or $I_{max}$ is reduced (P0610).
P0610 = 2	<i>This parameter is only visible, if P0003 = 3!</i> <b>Response for motor overtemperature I<sup>2</sup>t</b> Defines the behavior as soon as the motor temperature reaches the alarm threshold. 0: No response, alarm only 1: Alarm and reduction of $I_{max}$ (reduces the output frequency) 2: Fault and shutdown (F0011) (factory setting)
P0640	<b>Motor overload factor</b> (entered in % referred to P0305: rated motor current)

\*You will find detailed information on classifying the cooling technique in EN 60034-6

## Temperature measurement without temperature sensor

This temperature calculation is only possible in the vector control mode (P1300 = 20/21/22/23) and functions by calculating a thermal motor model.

Table 5- 40 Parameter to sense the temperature without using a temperature sensor

Parameters	Description
P0621 = 1	<b>Motor temperature measurement after restarting</b> 0: No identification (factory setting) 1: Temperature measurement after the first "motor ON" 2: Temperature measurement after each "motor ON".
P0622 = ...	<b>Magnetization time of the motor for temperature measurement after starting</b> ( <i>set automatically as the result of motor data identification</i> )
P0625 = 20	<b>Ambient motor temperature</b> Enter the ambient motor temperature in °C at the instant that the motor data is acquired (factory setting: 20°C). The difference between the motor temperature and motor environment (P0625) must lie within a tolerance range of approx. ± 5 °C.

## 5.8.2 Overcurrent protection

### Method of operation

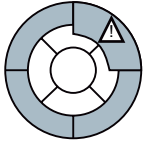

The maximum current controller ( $I_{max}$  controller) protects the motor and inverter against overload by limiting the output current. The  $I_{max}$  controller is only active with V/f control.

If an overload situation occurs, the speed and stator voltage of the motor are reduced until the current is within the permissible range. If the motor is in regenerative mode, i.e. it is being driven by the connected machine, the  $I_{max}$  controller increases the speed and stator voltage of the motor to reduce the current.

### Note

The inverter load is only reduced if the frequency is reduced with a lower load and at lower speeds (e.g. parabolic torque-speed characteristic of the motor load).

In the regenerative mode, the current only decreases if the torque decreases at a higher frequency.

### Settings

#### NOTICE

The factory setting of the  $I_{max}$  controller only needs to be changed in exceptional cases by appropriately trained personnel.

Table 5- 41  $I_{max}$  controller parameters

Parameter	Description
P0003 = 3	<b>User access level</b> 3: Expert
P0305 = ...	<b>Rated motor current</b>
P0640 = ...	<b>Maximum permissible motor overload referred to P0305 rated motor current</b>
P1340 = ...	<b>Proportional gain of controller for frequency reduction</b>
P1341 = ...	<b>Integral time of controller for frequency reduction</b>
P1345 = ...	<b>Proportional gain of controller for voltage reduction</b>
P1346 = ...	<b>Integral time of controller for voltage reduction</b>
r0056 bit13	<b>Status: <math>I_{max}</math> controller active</b>
r1343	<b>Frequency output of <math>I_{max}</math> controller</b> Shows the amount to which the I-max controller reduces the inverter output frequency.
r1344	<b>Voltage output of <math>I_{max}</math> controller</b> Shows the amount by which the I-max controller reduces the inverter output voltage.

For more information about this function, see function diagram 6100 in the List Manual.



### 5.8.3 Limiting the maximum DC link voltage

#### How does the motor generate overvoltage?

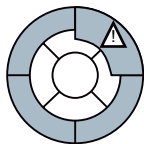

An induction motor can operate as a generator if it is driven by the connected load, In this case, the motor converts mechanical energy into electrical energy. The motor feeds the regenerative energy back to the inverter.

As a consequence, the DC link voltage is increased. The inverter can only reduce the increased DC link voltage if it is capable of regenerative feedback into the line supply or is equipped with a braking resistor.

Without being capable of regenerating into the line supply, only extremely low or brief regenerative loads – relative to the inverter power – are possible because the inverter may be damaged if the DC link voltage reaches critical levels. Before the voltage can reach critical levels, however, the inverter shuts down with the fault message "DC link overvoltage".

#### Protecting the motor and inverter against overvoltage

The  $V_{DCmax}$  controller prevents – as far as is technically possible – the DC link voltage from reaching critical levels.

The  $V_{DCmax}$  controller is not suitable for applications in which the motor is permanently in the regenerative mode, e.g. in hoisting gear or when large flywheel masses are subject to braking. For applications such as these, you must select an inverter that is equipped with a braking resistor or that can feed energy back into the line supply (e.g. PM250 and PM260)

Table 5- 42  $V_{DCmax}$  controller parameters

Parameter	Description
P0003 = 3	<b>User access level</b> 3: Expert
P1240 = ...	<b>Enables the <math>V_{DCmax}</math> controller</b> 1: Enables the $V_{DCmax}$ controller 3: Enables the $V_{DCmax}$ controller with kinetic buffering
r1242	<b>Shows the value of the DC link voltage above which the <math>V_{DCmax}</math> controller is active</b>
P1243 = ...	<b>Multiplier for the output of <math>V_{DCmax}</math> controller (scaling of the <math>V_{DCmax}</math> controller output)</b>
P1250 = ...	<b>Proportional gain of the <math>V_{DCmax}</math> controller</b>
P1251 = ...	<b>Integral time of the <math>V_{DCmax}</math> controller</b>
P1252 = ...	<b>Derivative time of the <math>V_{DCmax}</math> controller</b>
P1253 = ...	<b>Limits the output of the <math>V_{DCmax}</math> controller</b>
P1254 = ...	<b>Activates or deactivates automatic detection of the switch-on levels of the <math>V_{DCmax}</math> controller</b>

For more information about this function, see function diagram 4600 in the List Manual.

## 5.8.4 Load torque monitoring (system protection)

### Applications with load torque monitoring

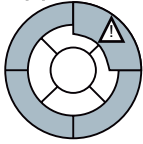

In many applications, it is advisable to monitor the motor torque:

- Applications in which the mechanical connection between the motor and load may be interrupted (e.g. if the drive belt in fan or conveyor belt systems tears).
- Applications that are to be protected against overload or locking (e.g. extruders or mixers).
- Applications in which no-load operation of the motor represents a critical situation (e.g. pumps).

### Load torque monitoring functions

The inverter monitors the torque of the motor in different ways:

1. No-load monitoring:  
The inverter generates a message if the motor torque is too low.
2. Lock protection:  
The inverter generates a message if the motor speed cannot match the speed setpoint despite maximum torque.
3. Stall protection:  
The inverter generates a message if the inverter control has lost the orientation of the motor.
4. Frequency-dependent torque monitoring:  
The inverter measures the current torque and compares it with a parameterized frequency/torque characteristic.

Table 5- 43 Parameterizing the monitoring functions

Parameter	Description
<b>No-load monitoring</b>	
P2179 = ...	<b>Current limit for no-load detection</b> If the inverter current is below this value, the message "no load" is output.
P2180 = ...	<b>Delay time for the "no load" message</b>
<b>Lock protection</b>	
P2177 = ...	<b>Delay time for the "motor locked" message</b>
<b>Stall protection</b>	
P2178 = ...	<b>Delay time for the "motor stalled" message</b>
P1745 = ...	<b>Deviation of the setpoint from the actual value of the motor flux as of which the "motor stalled" message is generated</b> This parameter is only evaluated as part of encoderless vector control.
<b>Frequency-dependent torque monitoring</b>	
P2181 = ...	<b>Enable signal for function</b>
P2182 = ...	<b>Frequency threshold 1</b>
P2183 = ...	<b>Frequency threshold 2</b>
P2184 = ...	<b>Frequency threshold 3</b>
P2185 = ...	<b>Upper torque threshold for frequency threshold 1</b>
P2186 = ...	<b>Lower torque threshold for frequency threshold 1</b>
P2187 = ...	<b>Upper torque threshold for frequency threshold 2</b>
P2188 = ...	<b>Lower torque threshold for frequency threshold 2</b>
P2189 = ...	<b>Upper torque threshold for frequency threshold 3</b>
P2190 = ...	<b>Lower torque threshold for frequency threshold 3</b>
P2192 = ...	<b>Delay time for the message "Leave torque monitoring tolerance band"</b>

For more information about these functions, see the List Manual (function diagrams 4110, 4130, and 4140 as well as the parameter list).

## 5.9 Evaluating the frequency inverter status

Frequency inverter states, such as alarms or faults or different actual value quantities of the frequency inverter can be displayed using digital and analog outputs. The pre-assignments (default settings) can be adapted to the particular plant or system requirements as explained in the following descriptions.

### 5.9.1 Assigning specific functions to digital outputs

#### Assigning specific functions to digital outputs

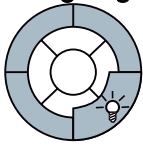

Three digital outputs are available that can be programmed to display different inverter states, e.g. faults, alarms, current limit value violations etc.

Table 5- 44 Factory setting of the digital outputs

Terminal No., significance			Function
18	NC	Digital output 0	Inverter fault active
19	NO		
20	COM		
21	NO	Digital output 1	Inverter alarm active
22	COM		
23	NC	Digital output 2	Digital output deactivated
24	NO		
25	COM		

Table 5- 45 Setting the functions of the digital outputs

Terminal No., significance			Parameter	Description
			P0003 = 2	Extended parameter access
18	NC	Digital output 0	P0731	Possible values and functions for P0731, P0732 and P0732: ValueFunction
19	NO			
20	COM			
21	NO	Digital output 1	P0732	0 Deactivate digital output 52.0 Drive ready 52.1 Drive ready for operation
22	COM			
23	NC	Digital output 2	P0733	52.2 Drive running 52.3 Drive fault active 52.4 OFF2 active 52.5 OFF3 active 52.6 Switching on inhibited 52.7 Drive alarm active 52.8 Setpoint/actual value deviation 52.9 PZD control 52.10 f_act >= P1082 (f_max) 52.11 Alarm: Motor current/torque limiting 52.12 Brake active 52.13 Motor overload 52.14 Motor CW rotation 52.15 Inverter overload 53.0 DC brake active 53.1 f_act < P2167 (f_off) 53.2f_act > P1080 (f_min) 53.3 Current actual value r0027 ≥ P2170 53.6 f_act ≥ setpoint (f_set)
24	NO			
25	COM			
			P0748	Inverting digital outputs Bit 0:Digital output 0 Bit 1:Digital output 1 Bit 2:Digital output 2

Further, the digital outputs can be interconnected with all binector outputs. A list of the binector outputs is provided in the List Manual.

## 5.9.2 Assigning certain functions to analog outputs

### Assigning specific functions to analog outputs

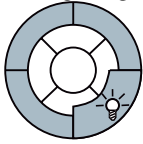

Two analog outputs are available, which can be parameterized to display a multitude of variables, e.g. the actual speed, the actual output voltage or the actual output current.

Table 5- 46 Factory setting of the analog outputs

Terminal No., significance			Function
12	AO0+	Analog input 0	Actual speed
13	AO0-		
26	AO1+	Analog input 1	Actual speed
27	AO1-		

Table 5- 47 Changing the functions of the analog outputs

Terminal No., significance			Parameter	Description
12	AO0+	Analog input 0	P0771 [Ind 0]	Possible values and functions for P0771, Ind 0 and Ind 1:  ValueFunction 21: CO actual frequency (factory setting; scaled corresponding to P2000) 24: CO actual output frequency (scaled corresponding to P2000) 25: CO actual output voltage (scaled corresponding to P2001) 26: CO actual value of the DC link voltage (scaled corresponding to P2001) 27: CO actual output current (scaled corresponding to P2002)
13	AO0-			
26	AO1+	Analog input 1	P0771 [Ind 1]	
27	AO1-			

The analog outputs can also be interconnected with all connector outputs. A list of the connector outputs is provided in the List Manual.

Table 5- 48 Additional analog output settings

Parameter	Description
P0775 = 0	<p><b>Permit absolute value</b></p> <p>Specifies whether or not the absolute value of the analog output is used. If enabled, this parameter will use the absolute value of the value to be output. If the original value was negative, the corresponding bit is set in r0785.</p>
P0776 = 0	<p><b>Analog output type</b></p> <p>Scaling of r0774.                      0: Current output (factory setting)                      1: Voltage output</p> <p><b>Note:</b> P0776 changes the scaling of r0774 (0 to 20 mA <math>\Leftrightarrow</math> 0 to 10 V). The scaling parameters P0778 and P0780 as well as the dead band are always entered with 0 to 20 mA. Analog output 0 can be switched as a voltage output between 0 and 10 V. Analog output 1 is a current output only. If it is to be used as a voltage output, it must be terminated with a 500 <math>\Omega</math> resistor.</p>
P0777 = 0.0	<p><b>Value x1 for analog output scaling</b></p> <p>Defines output characteristic x1 (in %). This parameter is the minimum analog value expressed as a percentage of P200x (depending on how P0771 is set).</p>
P0778 = 0	<p><b>Value y1 for analog output scaling</b></p> <p>This parameter is the value of x1 (in mA).</p>
P0779 = 100	<p><b>Value x2 for analog output scaling</b></p> <p>This defines x2 of the output characteristic as a percentage. This parameter is the maximum analog value expressed as a percentage of P200x (depending on how P0771 is set).</p>
P0780 = 20	<p><b>Value y2 for analog output scaling</b></p> <p>This parameter is the value of x2 (in mA).</p>
P0781 = 0	<p><b>Dead band width of the analog output</b></p> <p>This can be used to set the width of the dead band for the analog output (in mA).</p>

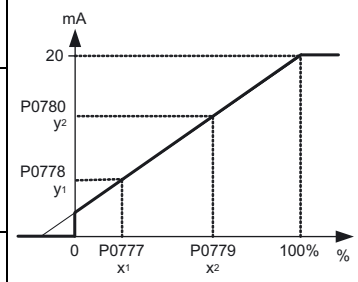

## 5.10 Technological functions

The inverter offers the following technological functions:

- Braking functions
- Automatic restart and flying restart
- Basic process control functions
- Positioning down ramp
- Logical and arithmetic functions using function blocks that can be freely interconnected

Please refer to the following sections for detailed descriptions.

### 5.10.1 Braking functions of the frequency inverter

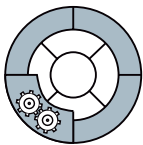

A differentiation is made between electrically braking and mechanically braking a motor:

- The motor is electrically braked by the inverter. An electrical braking is completely wear-free. Generally, a motor is switched off at standstill in order to save energy and so that the motor temperature is not unnecessarily increased.
- Mechanical brakes are generally motor holding brakes that are closed when the motor is at a standstill. Mechanical operating brakes, that are closed while the motor is rotating are subject to a high wear and are therefore often only used as an emergency brake.

#### Electrical braking and regenerative energy

If an induction motor electrically brakes the connected load and the kinetic energy that is released exceeds the mechanical and electrical losses, then it operates as a generator. In this case, the motor converts kinetic energy into electrical energy. Examples of typical applications, in which regenerative operation briefly occurs, include:

- Grinding disk drives
- Fans

For certain drive applications, the motor can operate in the regenerative mode for longer periods of time. Examples include:

- Centrifuges
- Cranes
- Conveyor belts with downward movement of load

#### Inverter braking methods

Depending on the particular application and the inverter type, there are different technologies to handle regenerative energy.

- The regenerative energy is converted into heat in the motor (DC and compound braking)
- The inverter converts the regenerative energy to heat using a braking resistor (dynamic braking)
- The inverter feeds the regenerative energy back into the line supply (regenerative braking)



### Different electrical braking methods for different applications

Table 5- 49 Braking methods and Power Modules depending on the application

Application examples	Electrical braking method	Power Modules that can be used
Pumps, fans, compressors, extruders, mixers	Not necessary	PM240, PM250, PM260
Fans, grinding machines, conveyor belts	DC braking, compound braking	PM240
Centrifuges, vertical conveyors, hoisting gear, cranes, winders	Dynamic braking	PM240
	Regenerative braking	PM250, PM260

### Braking methods depending on the drive inverter being used

Table 5- 50 Power Modules depending on the braking method

	SINAMICS G120 Power Module		
	PM240	PM250	PM260
DC and compound braking	X	---	---
Dynamic braking	X	---	---
Regenerative braking	---	X	X

### Advantages and disadvantages of the braking methods

- DC braking
  - *Advantage:* The motor is braked without the inverter having to convert the braking energy
  - *Disadvantages:* significant increase in the motor temperature; no defined braking characteristics; no constant braking torque; no braking torque at standstill; braking energy is lost as heat; does not function when the power fails
- Compound braking
  - *Advantage:* Defined braking characteristics, the motor is braked without the inverter having to convert any significant amount of braking energy
  - *Disadvantages:* no constant braking torque; excessive motor temperature rise; braking energy is dissipated as heat; does not function when the power fails

- Dynamic braking
  - *Advantages:* defined braking characteristics; no additional motor temperature increase; constant braking torque; in principle, also functions when the power fails
  - *Disadvantages:* A braking resistor is required; braking energy is lost as heat; the permissible load of the braking resistor must be taken into account
- Regenerative braking
  - *Advantages:* Constant braking torque; the regenerative energy is not converted into heat, but is regenerated into the line supply; can be used in all applications; continuous regenerative operation is possible - e.g. when lowering a crane load
  - *Disadvantage:* Does not function when power fails

5.10.1.1 DC and compound braking

Application areas for DC braking and compound braking

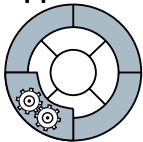

DC braking and compound braking are typically used for applications in which the motor is normally operated at a constant speed and is only braked down to standstill in longer time intervals, e.g. centrifuges, saws, grinding machines and conveyor belts.

Operating characteristics of DC braking

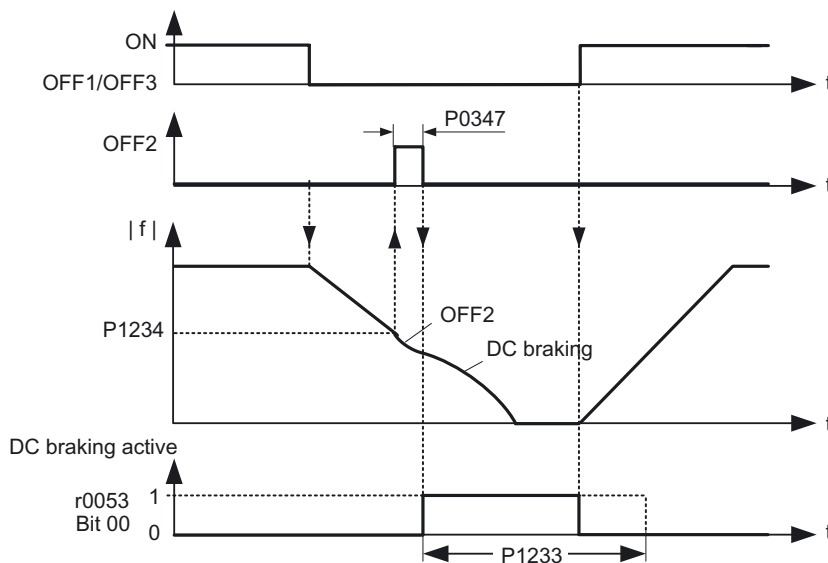



Figure 5-9 DC braking after an OFF1 or OFF3 command

DC braking after an OFF1 or OFF3 command has the following timing sequence:

1. Initially, the motor speed is reduced along the down ramp of the ramp-function generator until an adjustable speed threshold is reached.
2. Once the motor speed reaches this threshold, the inverter interrupts the braking operation using an internal OFF2 command until the motor is de-magnetized.
3. The inverter then starts the actual DC braking by allowing a DC current to flow through the motor. The magnitude and duration of the DC current can be set.

 <b>CAUTION</b>
For DC braking, the kinetic energy of the motor and motor load is partially converted into thermal energy. The motor can overheat if braking lasts too long or the drive must be braked too frequently.

### Parameterizing DC braking

Table 5- 51 Parameters to enable and set DC braking

Parameter s	Description
P003= 3	<b>User access level</b> 3: Expert
P1230	<b>Enabling DC braking using an external command</b> Enables DC braking via a signal that was used by an external source (BICO). The function remains active as long as the external signal is active.
P1232=	<b>Current, DC braking (entered as a %)</b> Defines the strength of the direct current in [%] with respect to the rated motor current (P0305)
P1233=	<b>Enable and duration of the DC braking for OFF1 or OFF3 command (entered in s)</b> Defines the duration of the DC braking in seconds after an OFF1 or OFF3 command. P1233 = 0 deactivates DC braking for an OFF1 and OFF3 command.
P1234=	<b>Starting frequency of DC braking (entered in Hz)</b> Sets the speed threshold for the start of DC braking.
P0347=	<b>Demagnetizing time of the motor</b> The inverter calculates this value from the motor data during commissioning. Only commissioning engineers, who have the appropriate experience, may change the parameter values. The inverter can trip due to an overcurrent during DC braking if the demagnetizing time is too short.

Operating characteristics of compound braking

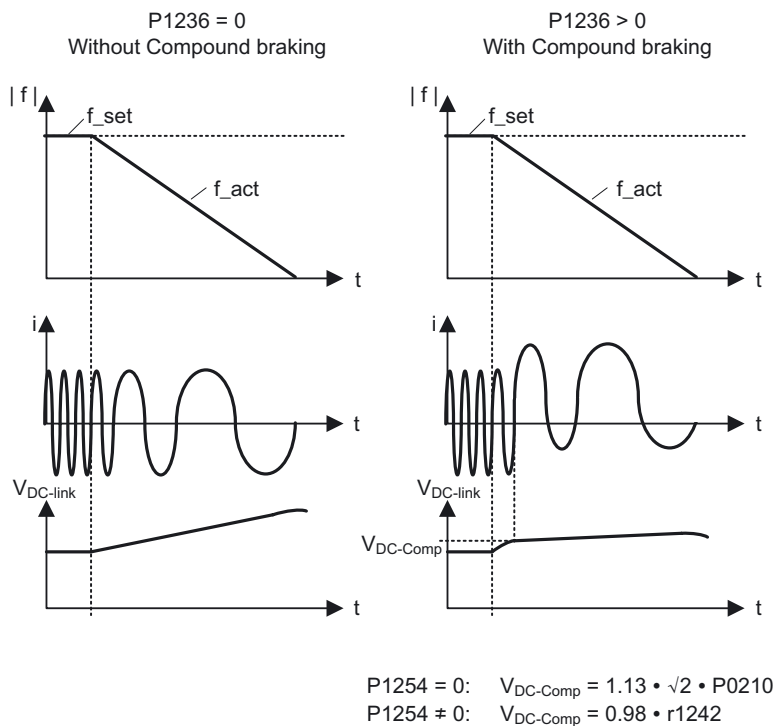

Figure 5-10 Compound braking

When the motor is in the regenerative mode, the inverter DC link voltage increases. Compound braking is active depending on the DC link voltage. From a DC link voltage threshold that can be set, the inverters adds a DC current component to the motor current. The DC current component brakes the motor, converts the regenerative energy of the motor into heat and prevents the DC link voltage from increasing too high.

**Note**

Compound braking is only active in conjunction with the V/f control.

Compound braking is deactivated, if:

- The "flying restart" function is active
- DC braking is active
- Vector control is selected

**CAUTION**

For compound braking, the kinetic energy of the motor and motor load is partially converted into thermal energy. The motor can overheat if braking lasts too long or the drive must be braked too frequently.

## Parameterizing compound braking

Table 5- 52 Parameters to enable and set compound braking

Parameter s	Description
P003=3	<b>User access level</b> 3: Expert
P1236=	<b>Compound braking (entered in %)</b> Parameter P1236 defines the DC current superimposed on the motor current after the DC link voltage threshold $V_{DC\ link\ comp}$ has been exceeded. P1236 = 0 Compound braking locked P1236 = 1 ... 250 Current level of the DC braking current as a % of the rated motor current (P0305)
P1254=	<b>Calculation type of the switch-in threshold <math>V_{DC\ link\ comp}</math> for compound braking</b> P1254 = 0 $V_{DC\ link\ comp}$ is a fixed value that only depends on the parameterized value of the line supply voltage (P0210). P1254 = 1 $V_{DC\ link\ comp}$ is continually calculated using internal algorithms. This allows the inverter reserves to be better utilized.

### 5.10.1.2 Dynamic braking

#### Dynamic braking applications

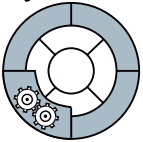

Dynamic braking is typically used in applications in which dynamic motor behavior is required at different speeds or continuous direction changes, e.g. for conveyor drives or hoisting gear.

An internal closed-loop chopper control (braking chopper) in the inverter, which can control an external braking resistor, is required for dynamic braking.

#### Operating characteristics of dynamic braking

Dynamic braking converts the regenerative energy, which is released when the motor brakes, into heat.

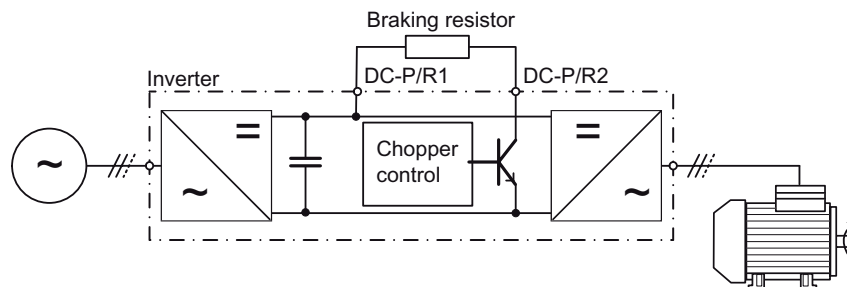



Figure 5-11 Dynamic braking with braking chopper in the inverter

The inverter controls the dynamic braking depending on the DC link voltage.

The temperature monitoring of the braking resistor should be evaluated. The inverter must be switched off if the braking resistor overheats.

 <b>WARNING</b>
<p>If a braking resistor that is unsuitable is used, a fire could break out and severely damage the inverter.</p> <p>The temperature of braking resistors increases during operation. For this reason, avoid coming into direct contact with braking resistors. Make sure that the devices are located at sufficient distances from each other and that proper ventilation is provided.</p>

### Parameterizing the dynamic braking

Table 5- 53 Parameters to enable and set dynamic braking

Parameter	Description
P0003 = 2	<b>Extended access</b>
P1240 = 0 or P1240 = 2	<b>Deactivate the <math>V_{DCmax}</math> controller</b>
P1237	<p><b>Enable signal and ON period of dynamic braking</b></p> <p>0: Dynamic braking is locked                      1: 5% ON period**                      2: 10% ON period                      3: 20% ON period                      4: 50% ON period                      5: 100% ON period</p> <p>The ON period set here is only effective if the braking resistor has reached its operating temperature. When required, a cold braking resistor is switched-in independent of this parameter</p> <p>** ) SIEMENS resistors are designed for 5% ON period</p>

### 5.10.1.3 Regenerative braking

#### Regenerative braking applications

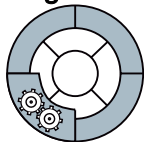

Regenerative braking is typically used in applications in which braking energy is generated either frequently or for longer periods of time, e.g. centrifuges, unwinders or cranes.

#### Operating characteristics of regenerative braking

The inverter can feed back up to 100% of its power (for HO base load) into the line supply.

#### Parameterizing regenerative braking

Table 5- 54 Parameters to set regenerative braking

Parameter s	Description
<b>Energy recovery option for V/f control (P1300 &lt; 20)</b>	
P640	<b>Motor overload factor</b> Setting the maximum regenerative power. If the regenerative power exceeds this value for longer than 5 s, the inverter shuts down with fault message F0028.
<b>Energy recovery option for vector control (P1300 ≥ 20)</b>	
P1531	<b>Regenerative power limit</b> If the regenerative power reaches this value, the motor can no longer follow its speed setpoint, i.e. the motor speed increases. If the regenerative power exceeds this value, the inverter shuts down with fault message F0028.

### 5.10.1.4 Parameterizing a motor holding brake

#### Motor holding brake applications

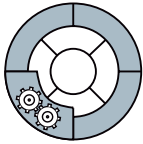

The motor holding brake prevents the motor turning when the inverter is switched-off. The inverter has internal logic to control a motor holding brake.

The motor holding brake control inside the inverter is suitable for the following typical applications:

- Pumps
- Fans
- Horizontal and vertical conveyors

#### Operating characteristics of the motor holding brake control after an OFF1 and OFF3 command

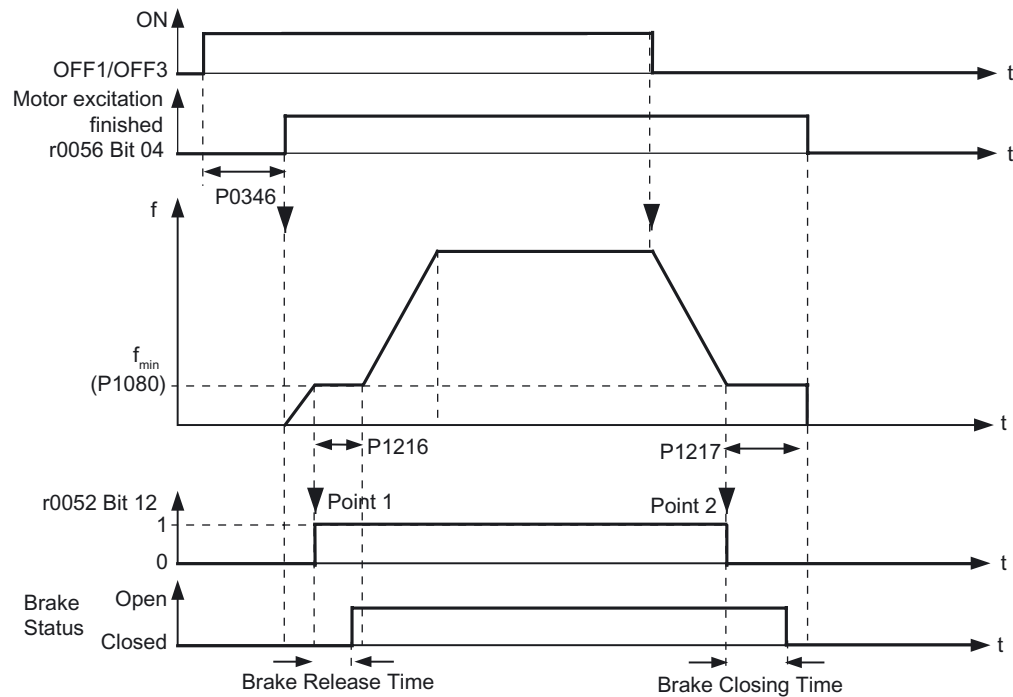

Figure 5-12 Function diagram of the motor holding brake control after an OFF1 or OFF3 command

#### Controlling the motor holding brake after an OFF2 or STO command

For the following signals, the brake closing time is not taken into account:

- OFF2 command, or
- For fail-safe applications, in addition, after "Safe Torque Off" (STO)

After these control commands, the signal to close the motor holding brake is immediately output independent of the motor speed.



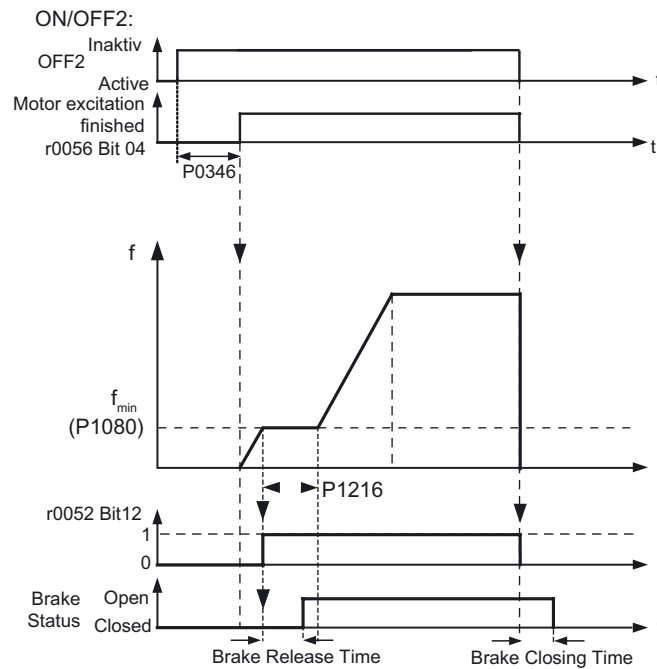

Figure 5-13 Function diagram, motor holding brake after an OFF2 command

### Commissioning the control logic of a motor holding brake

**! WARNING**

The following applications require special settings of the motor holding brake. In these cases, the motor holding brake control may only be commissioned by experienced personnel:

- All applications that involve moving and transporting people
- Hoisting gear
- Elevators
- Cranes

1. Before commissioning, secure any dangerous loads (e.g. loads on inclined conveyor belts)
2. Suppress the motor holding brake control, e.g. by disconnecting the control cables
3. When opening the motor holding brake, ensure that a torque is established that prevents the load from briefly dropping.
  - Check the magnetizing time P0346; the magnetizing time is pre-assigned when commissioning the system and must be greater than zero
  - For V/f operation (P1300 = 0 to 3), set the boost parameters P1310, P1311.

4. Parameterize the opening and closing times of the motor holding brake  
 It is extremely important that electromechanical braking is controlled with the correct timing (brake release time, brake closing time, release time) to protect the brakes against long-term damage. The exact values can be found in the technical data of the connected brake. Typical values:
  - Brake release times are between 35 ms and 500 ms
  - Brake closing times are between 15 ms and 300 ms
  - Release times are between 25 ms and 230 ms
5. Restore the motor holding brake control
  - The mechanical brake is connected to the inverter via the Brake Relay. Bit 12 "Brake active" of status signal r0052 controls the brake.
  - It is not sufficient to simply select status signal r0052 bit 12 in P0731 to P0733 (relay outputs). To activate the motor holding brake, parameter P1215 must be additionally set to 1.

When a motor with a built-in holding brake is commissioned, a "clicking" sound in the motor indicates that the brake has been properly released.

Table 5- 55 Control logic parameters of the motor holding brake

Parameters	Description
P0003 = 2	<b>Enables extended parameter access</b>
P1215 = ...	<b>Enable motor holding brake</b> 0 Motor holding brake locked (factory setting) 1 Motor holding brake enabled
P0731= 52.C	<b>BI: Function digital output 1</b> Note: To control the Brake Relay via the digital output, the following must apply, e.g. for digital output 1: P0731 = 52.C = 52.12
P0346 = ...	<b>Magnetizing time time</b> 0 ... 20 s, factory setting 1 s
P1080 = ...	<b>Minimum frequency</b> 0 ... 650 Hz, (0 Hz factory setting): minimum motor frequency, regardless of frequency setpoint
P1216 = ...	<b>Delay time for opening the brake</b> 0 ... 20 s, factory setting 0.1 s Note: P1216> brake release time + relay opening time
P1217 = ...	<b>Holding time after runout</b> 0 ... 20 s, factory setting 0.1 s Note: P1217> brake closing time + relay closing time
P1227 = ...	<b>Zero value detection monitoring time</b> 0 ... 300 s, factory setting 4 s
r0052.12	<b>"Brake active" status</b>

### Opening the motor holding brake via P1218

Using parameter P1218, you can force the brake to open, e.g. in order to be able to manually move a conveyor drive.

P1218 is ignored if the motor holding brake is closed because of an STO.

 <b>WARNING</b>
<p><b>Secure loads held by the brake!</b></p> <p>Since this procedure cancels the "Brake active" signal which, in turn, causes the brake to be forced open, the user must ensure that, even when the motor has been powered-down, all loads held by the brake are secured before the signal is canceled.</p>

Table 5- 56 Parameter to force open a motor holding brake

Parameter	Description
P0003 = 3	Enable expert access to parameters
P1218 = 1	Forcibly open the motor holding brake

## 5.10.2 Automatic restart and flying restart

### 5.10.2.1 Flying restart: switching on the converter when the motor is running

#### Description

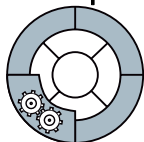

The "flying restart" function, which is activated by P1200, allows the inverter to be switched to a rotating motor. The function must be used whenever a motor may still be running. This could be:

- After a brief line interruption
- When an inverter is shut down but air currents cause a fan impeller to rotate (either CW or CCW)
- If the motor is driven by a load

This function is useful, therefore, with motors whose load exhibits a high moment of inertia since it can help prevent sudden loads in the mechanical components.

If this function is not used in such cases, this could cause the motor to shut down due to overcurrent (overcurrent fault F0001).

The "flying restart" function can be used to synchronize the inverter and motor frequency.

 <b>WARNING</b>
<p><b>Drive starts automatically</b></p> <p>When this function is enabled (P1200 &gt; 0), all those working with the system must be informed of the following:</p> <ul style="list-style-type: none"> <li>• The drive starts automatically.</li> <li>• Although the drive is at a standstill, it can be started by the search current.</li> </ul>

Input values

Table 5- 57 Main function parameters

Parameter	Description
P1200 = ...	<b>Flying restart</b> 0: locked (factory setting), 1 - 6 Active

Table 5- 58 Overview: the "flying restart" function

P1200	Flying restart active	Search direction
0	Flying restart locked (factory setting)	-
1	Flying restart always active	Search performed in both directions, startup in direction of setpoint
2	Flying restart active after: <ul style="list-style-type: none"> <li>• Power ON</li> <li>• Faults</li> <li>• OFF2</li> </ul>	Search performed in both directions, startup in direction of setpoint
3	Flying restart active after <ul style="list-style-type: none"> <li>• Faults</li> <li>• OFF2</li> </ul>	Search performed in both directions, startup in direction of setpoint
4	Flying restart always active	Search performed in direction of setpoint only
5	Flying restart is active after <ul style="list-style-type: none"> <li>• Power ON</li> <li>• Faults</li> <li>• OFF2</li> </ul>	Search performed in direction of setpoint only
6	Flying restart is active after <ul style="list-style-type: none"> <li>• Faults</li> <li>• OFF2</li> </ul>	Search performed in direction of setpoint only

Table 5- 59 Additional commissioning parameters

Parameter	Description
P1202 = ...	<b>Motor current: Flying restart</b> (entered in %): 10 % ... 200 %, factory setting 100 % Defines the search current with respect to the rated motor current (P0305) that is present when the "flying restart" function is used.
P1203 = ...	<b>Search rate/speed: Flying restart</b> (entered in %): 10 % ... 200 %, factory setting 100 % Sets the factor by which the output frequency changes during the flying restart to synchronize itself with the running motor.

---

**Note**

The higher the search rate (P1203), the longer the search time. A lower search rate shortens the search time.

The "flying restart" function decelerates the motor slightly. The smaller the drive torque, the more the drive is decelerated.

The "flying restart" function should not be activated for motors in group drives due to the different coasting characteristics of the individual motors.

---

### 5.10.2.2 "Automatic restart" function after power failure

#### Restart after a power failure and/or faults within a few seconds.

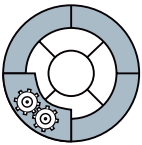

This automatic restart function is primarily used when the inverter is operated as a stand-alone device.

The "automatic restart" function is used to restart the drive automatically once the power has been restored following a power failure. All faults are acknowledged automatically and the drive is switched on again.

#### Line undervoltage or power failure

The term "line undervoltage" describes a situation in which the line voltage fails momentarily and is then restored. The power failure is so short that the 400V power supply of the inverter is briefly interrupted, but the electronics power supply is still maintained.

The term "power failure" describes a situation in which the power fails for a longer period, whereby the DC link collapses completely and the Control Unit of the inverter is in a zero-current state.

#### Important secondary condition

An ON command prior to the power failure and when the power returns is required for the "automatic restart" function. The ON command must be connected-up through a digital input. An ON command from a fieldbus is ignored.

Since the function is not restricted to line supply faults, it can also be used to automatically acknowledge faults and restart the motor after any tripping. To allow the drive to be switched to a motor shaft that is still rotating, the "flying restart" function must be activated via P1200.

 <b>WARNING</b>
<p>When the "automatic restart" function is active (P1210 &gt; 1), a motor can restart automatically once the power has been restored. This is particularly critical if it is incorrectly assumed that the motors have been shut down after a long power failure.</p> <p>For this reason, death, serious injury, or considerable material damage can occur if personnel enters the working area of motors in this condition.</p>

**Commissioning the automatic restart**

1. Parameterizing the automatic restart using P1210
2. Set the number of start attempts via P1211.
3. If, for an automatic restart, the inverter is to be connected to an already rotating motor, then the 'flying restart' function should also be activated using P1200.
4. Make sure that this functions properly.

**Parameterizing the automatic restart**

Table 5- 60 Parameterizing the automatic restart

Parameter s	
P1210 =	Automatic restart mode 0: Automatic restart locked 1: Fault acknowledgment after an ON command; P1211 locked (factory setting) 2: Automatic restart after a power failure; P1211 locked 3: Automatic restart after a line supply undervoltage or fault; P1211 enabled 4: Automatic restart after a line supply undervoltage; P1211 enabled 5: Automatic restart after a power failure and fault; P1211 locked 6: Automatic restart after a line supply undervoltage / failure or fault; P1211 locked
P1211 =	Number of automatic restart attempts [minimum 0 ... maximum 10] 3 (factory setting)
P1200 =	Flying restart (Page 139)

Table 5- 61 Principle of operation of the automatic restart

<p><b>P1210 = 0: Automatic restart locked</b> (this is a practical setting for a networked drive) After the line supply voltage returns, possible faults must be acknowledged. After this, the ON command must be switched-in again in order that the inverter starts.</p>
<p><b>P1210 = 1: Fault acknowledgment after ON command (P1211 locked)</b> After a power failure, the inverter automatically acknowledges all faults (it resets them), as soon as the line supply voltage returns.</p> <ul style="list-style-type: none"> <li>• Faults due to a line supply undervoltage are not automatically acknowledged.</li> <li>• The motor does not automatically start.</li> <li>• The motor only starts to rotate again if an ON command is issued again after the line supply voltage returns.</li> </ul>
<p><b>P1210 = 2: Automatic restart after power failure - no additional start attempts (P1211 locked)</b> After power failure, the inverter automatically acknowledges fault F0003 (resets it), as soon as the line supply voltage is available again; and automatically restarts.</p> <ul style="list-style-type: none"> <li>• All other faults are not automatically acknowledged.</li> <li>• Faults due to a line supply undervoltage are not automatically acknowledged.</li> <li>• Switching the ON command in the de-energized state only results in an automatic start if the inverter was in the "ready" state when the power failed.</li> </ul>
<p><b>P1210 = 3: Automatic restart after a line supply undervoltage or fault - with additional start attempts (P1211 enabled)</b> After a line supply undervoltage, the inverter automatically acknowledges all faults (resets them), as soon as the line supply voltage is again available; and automatically restarts.</p> <ul style="list-style-type: none"> <li>• This behavior is independent of the power failure or line supply undervoltage.</li> <li>• Switching the ON command in the de-energized state has no effect, if the inverter was "ready" before the power failure.</li> <li>• The number of start attempts can be set. (If the automatic restart is interrupted due to a new fault)</li> </ul>
<p><b>P1210 = 4: Automatic restart after a line supply undervoltage (P1211 enabled)</b> After power failure or a line supply undervoltage, the inverter automatically acknowledges fault F0003 (resets it), as soon as the line supply voltage is again available; and automatically starts.</p> <ul style="list-style-type: none"> <li>• All other faults are not automatically acknowledged.</li> <li>• An ON command in the de-energized state has no effect.</li> <li>• The number of start attempts can be set. (If the automatic restart is interrupted due to a new fault)</li> </ul>
<p><b>P1210 = 5: Automatic restart after power failure and fault (P1211 locked)</b> After a power failure, the inverter automatically acknowledges all faults (resets them), as soon as the line supply voltage is again available; and automatically starts.</p> <ul style="list-style-type: none"> <li>• Faults due to a line supply undervoltage are not automatically acknowledged.</li> <li>• Switching the ON command in the de-energized state always results in automatic restart. Possible faults are first automatically acknowledged.</li> </ul>
<p><b>P1210 = 6: Automatic restart after line supply undervoltage / power failure or fault (P1211 locked)</b> The inverter automatically acknowledges all faults (resets them), as soon as the line supply voltage is again available; and automatically starts.</p> <ul style="list-style-type: none"> <li>• This behavior is independent of the power failure or line supply undervoltage.</li> <li>• If the ON command is switched-on during the power failure, then an automatic start is always formed. Possible faults are first automatically acknowledged.</li> </ul>

**Automatic restart characteristics**

Table 5- 62 Overview of the automatic restart characteristics

P1210	ON command always active (continuously)				ON command in the de-energized state	
	Fault F0003 due to		All other faults		Inverter signals a fault Before power failure	Inverter ready Before power failure
	Power failure	Line supply undervoltage	Before power failure	in operation		
0	--*	--*	--*	--*	--*	--*
1	Fault acknowledgement	--*	Fault acknowledgement	--*	Fault acknowledgement	--*
2	Fault acknowledgement + restart	--*	--*	--*	--*	Restart
3	Fault acknowledgement + restart	Fault acknowledgement + restart	Fault acknowledgement + restart	Fault acknowledgement + restart	Fault acknowledgement + restart	--*
4	Fault acknowledgement + restart	Fault acknowledgement + restart	--*	--*	--*	--*
5	Fault acknowledgement + restart	--*	Fault acknowledgement + restart	--*	Fault acknowledgement + restart	Restart
6	Fault acknowledgement + restart	Fault acknowledgement + restart	Fault acknowledgement + restart	Fault acknowledgement + restart	Fault acknowledgement + restart	Restart

\*) -- = no action



### 5.10.3 Technology controller

#### Technology controller for processing higher-level control functions

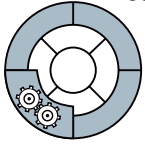

The technology controller supports all kinds of simple process control tasks. For example, it is used for controlling pressures, levels, or flow rates.

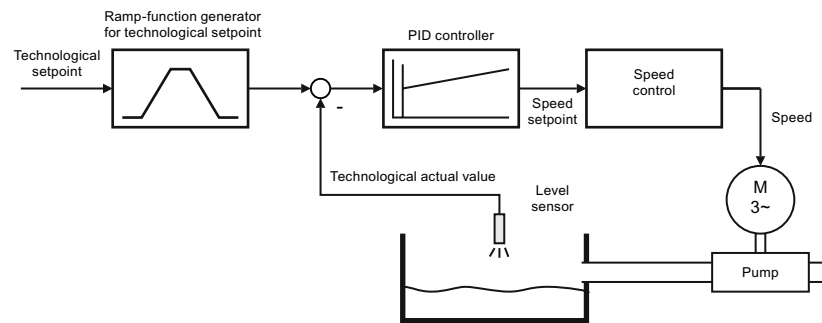

Figure 5-14 Example: technology controller as a level controller

The technology controller specifies the speed setpoint of the motor in such a way that the process variable to be controlled corresponds to its setpoint. The technology controller is designed as a PID controller, which makes it highly flexible.

The technology controller setpoint can be supplied via the same setpoint sources as those available for the speed setpoint. The technology controller is also equipped with its own motorized potentiometer and own fixed frequencies.

The setpoints, actual values, and control signals of the technology controller are defined by means of BICO technology.

Table 5- 63 Technology controller parameters

Parameter	Description
P2200 = ...	<b>Enable technology controller</b>
P2201 ... r2225	<b>Fixed frequencies</b>
P2231 ... P2248	<b>Motorized potentiometer</b>
P2251 ... r2294	<b>Technology controller parameters</b>

You will find more information about this function in the parameter list and in (function diagram 5100 of the List manual).

### 5.10.4 Positioning down ramp

#### A basic positioning function in the inverter

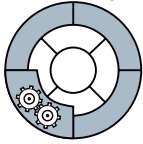

In certain applications, e.g. when a conveyor belt is brought to a standstill, the belt may have to travel a defined braking distance after it has been switched-off so that it always stops at the same position.

For a fixed ramp-down type, the number of revolutions that a motor requires to reach a standstill depends on the speed of the motor at the instant of the switch-off. Using the "positioning down ramp" function, the number of revolutions from the OFF1 command down to standstill can be defined independent of the speed.

The following diagram shows the principle signal characteristic of velocity ( $v$ ) and position ( $s$ ) of a linearly moved load, e.g. of a conveyor belt, that is stopped using the positioning down ramp. For a low velocity ( $v_2$ ) the down ramp is extended so that the load comes to a standstill at the same end position ( $s_0$ ) as for a higher velocity ( $v_1$ ).

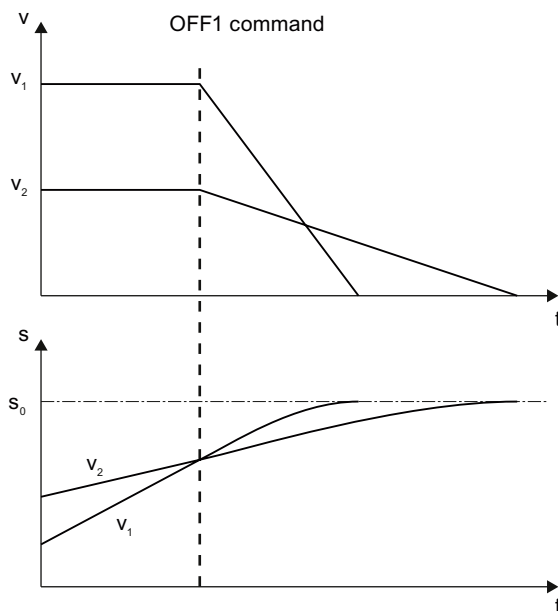

Figure 5-15 Velocity ( $v$ ) and position ( $s$ ) of a linearly moved load with the positioning down ramp

The accuracy of this basic positioning function is adequate for many applications. The accuracy is increased when using a speed encoder.

Table 5- 64 Parameters for the simple positioning function

Parameters	Description
P2480 = ...	<b>Control command for the positioning function</b> Example: When P2840 = 722.0, the positioning function is activated via digital input 0.
P2481 = ...	<b>Gear ratio = P2481/P2482</b>
P2482 = ...	
P2484 = ...	<b>Number of shaft revolutions at the gearbox output for one distance unit</b>
P2488 = ...	<b>Number of distance units until the end position</b>
P2487 = ...	<b>Additive compensation value for increasing accuracy</b>

For more information about this function, see the List Manual.

### 5.10.5 Logical and arithmetic functions using function blocks

#### Description

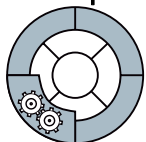

Additional signal interconnections in the inverter can be established by means of free function blocks. Every digital and analog signal available via BICO technology can be routed to the appropriate inputs of the free function blocks. The outputs of the free function blocks are also interconnected to other functions using BICO technology. Among others, the following unassigned function blocks are available:

- Time blocks
- Adders, subtracters, multipliers, dividers
- AND blocks, OR blocks, XOR blocks, NOT blocks
- Memory elements

#### Example: OR logic operation

You want to switch-on the motor via digital input 0 and also via digital input 1:

1. To do so, interconnect the status signals of digital inputs r722.0 and r722.1 with the inputs of a free OR block via BICO.
2. Now activate the OR block.
3. Finally, interconnect the OR block output with the internal ON command (P0840).

Table 5- 65 Parameters for using the free function blocks

Parameters	Description
P2800 = ...	<b>Enable FFBs</b> (General enable for all function blocks) 0: locked 1: enabled
P2801 = ... P2802 = ...	<b>Activate FFBs</b> (activation of the individual function blocks)
P2803 = ...	<b>Activate fast FFBs</b> (enable an 8ms time slice to calculate the activated, fast function blocks) 0: All function blocks are calculated with a 128 ms time grid 1: Some of the function blocks can be calculated with an 8 ms time grid.

#### Example: AND logic operation

An example of an AND logic operation, explained in detail, including the use of a time block is provided in the Chapter BICO technology (Page 19).

For more information about this function, see function diagrams 4800, 4810, 4820, and 4830 in the List Manual.

## 5.10.6 Changing over drive data sets (several motors connected to a frequency inverter)

### Switching motor control

In certain applications, the inverter parameters need to be switched.

Example: Operating different motors on one inverter

One inverter should operate one of two different motors. Depending on which motor is to run at any given time, the motor data and the ramp-function generator times for the different motors must be adjusted accordingly in the inverter.

### Drive data sets (DDS)

The inverter provides the possibility of parameterizing the following functions in up to three different ways:

- Setpoint sources  
(exceptions: Analog inputs and fieldbus)
- Setpoint calculation
- Motor control
- Motor and inverter protection
- Technological functions  
(Exception: Technology controller, brake control, automatic restart and unassigned function blocks)

The associated parameters are indexed (index 0, 1 or 2). Control commands select one of the three indices and therefore one of the three saved settings.

This means, that as described in the example above, you can switch over all of the settings of the inverter matching the particular motor.

All of the switchable parameters of the five functions mentioned above with the same index is known as a "command data set".

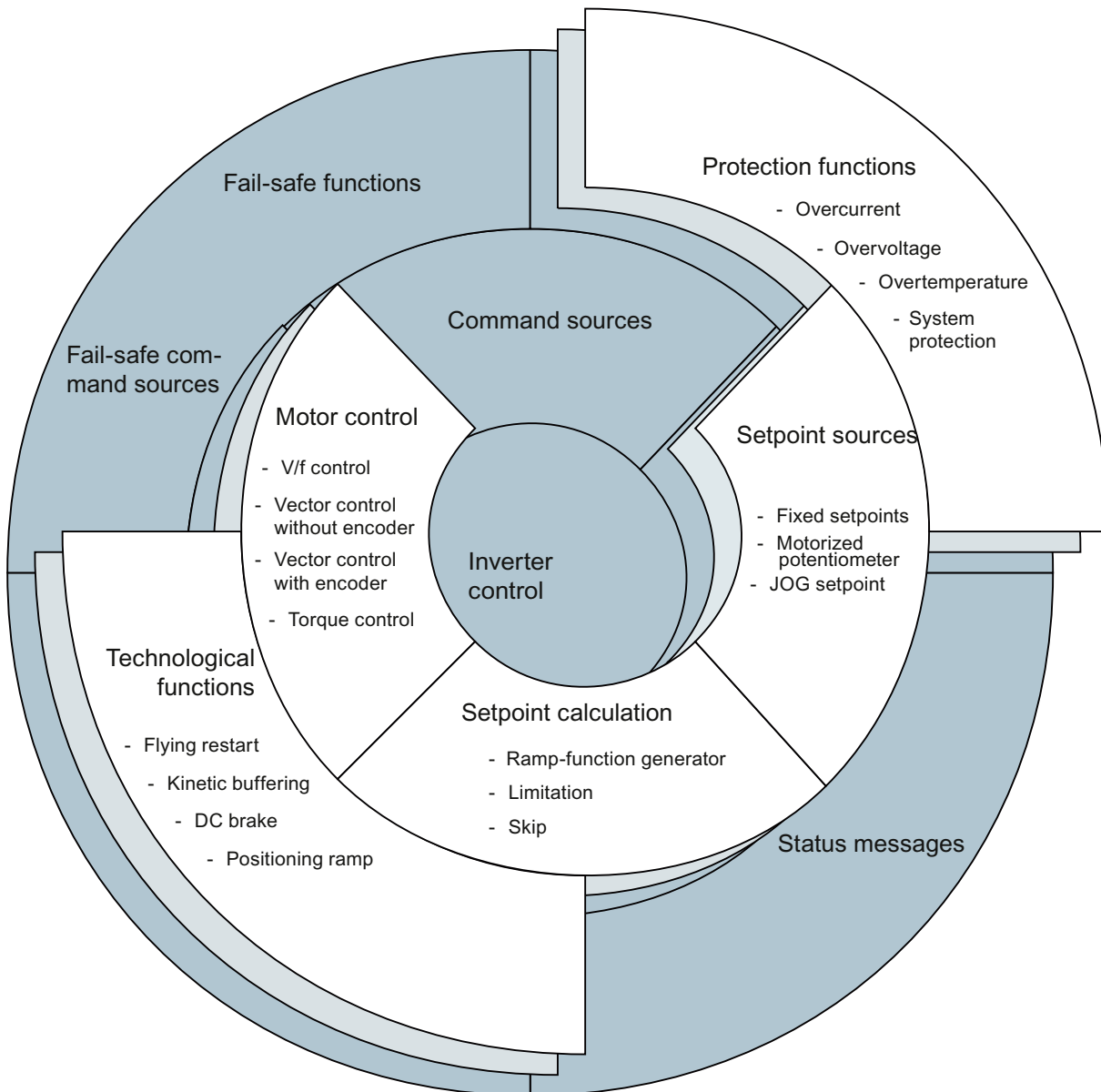

Figure 5-16 DDS switchover in the inverter

The drive data sets are switched over using parameters P0820 and P0821. Parameters P0820 and P0821 are interlinked to control commands, e.g. the digital inputs of the inverter, using BICO technology.

**Note**

Drive data sets can only be changed over in the "ready for operation" state. The switchover time is approx. 50 ms.

Exceptions: The ramp-function generator parameters, the ramp-down time for OFF3, and the speed controller gain can be switched during operation.

Table 5- 66 Parameters for switching the drive data sets:

Parameter	Description
P0820 = ...	<b>1st cntrol command for switching the drive data sets</b> Example: When P0820 = 722.0, the system switches from drive data set 0 to drive data set 1 via digital input 0
P0821 = ...	<b>2nd control command for switching the drive data sets</b>
r0051	<b>Displaying the number of the DDS that is currently active</b>
<b>A copy function is available making it easier to commission more than one drive data set:</b>	
P0819.0 = ...	<b>Number of the drive data set to be copied (source)</b>
P0819.1 = ...	<b>Number of the drive data to which the data is to be copied (target)</b>
P0819.2 = 1	<b>Start copying</b>

For an overview of all the parameters that belong to the drive data sets and can be switched, see the List Manual.

## 5.11 Operation in fieldbus systems

### 5.11.1 Communication interfaces

#### Fieldbus interfaces of the CU versions

The inverters are available in different versions for communication with higher-level controls with the subsequently listed fieldbus interfaces:

- **CU240E and CU240S** for USS via RS485
  - Control via PZD (process data channel)
  - Parameterizing using PKW (parameter channel)
- **CU240S DP and CU240S DP-F** for PROFIBUS DP
  - Control in cyclic operation using telegrams 1, 20, 350, 352 and 999
  - Control and parameterizing in cyclic operation using telegrams 353 and 354
  - Parameterizing via acyclic communication
- **CU240S DP and CU240S DP-F** for PROFINET
  - Control in cyclic operation using telegrams 1, 20, 350, 352 and 999
  - Control and parameterizing in cyclic operation using telegrams 353 and 354
  - Parameterizing via acyclic communication

### 5.11.2 Communication via USS

#### Universal serial interface (USS)

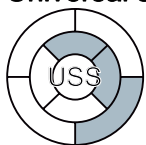

Using the USS protocol (protocol of the universal serial interface), users can set-up a serial data connection between a higher-level master system and several slave systems (RS 485 interface). Master systems include programmable logic controllers (e.g. SIMATIC S7-200) or PCs. The inverters are always slaves on the bus system.

The USS protocol allows you to implement automation tasks with cyclic telegram transfer (fixed telegram length required) and visualization tasks. In this case, variable telegram lengths are better since texts and parameter descriptions can be transferred in a single telegram without the data being subdivided.

#### USS bus topology via RS 485

Communication networks with up to 31 inverters (slaves) connected to a control can be established via the RS 485 interface. The topology must be configured as a line in which the first and last devices are terminated with terminating resistors.

**USS communication network via RS 485 with a CU240E**

The diagram shows the RS 485 terminals (29/30) and the DIP switches at the CU240E for the terminating resistor. The default position is OFF (no terminating resistor).

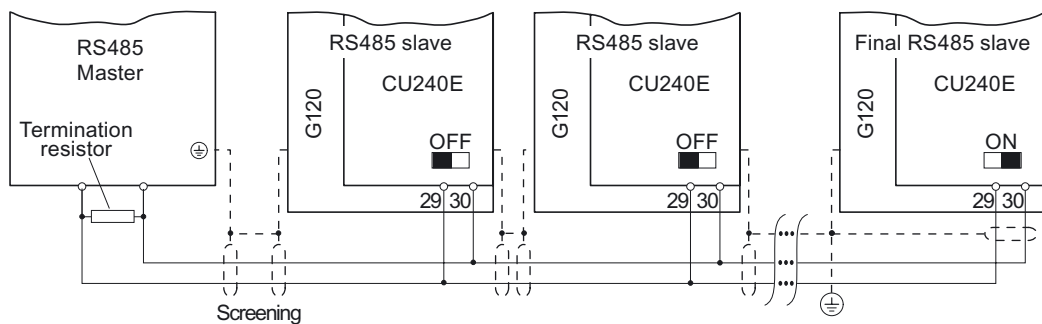
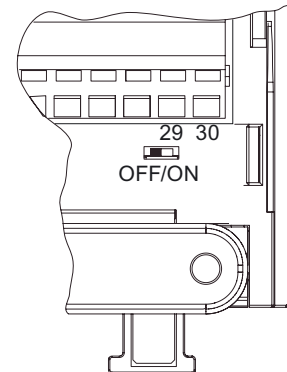

Figure 5-17 USS network via RS 485

**USS communication network via RS 485 with a CU240S**

The connection is established using the SUB D connector located on the lower side of the Control Unit.

The diagram shows the DIP switch for the terminating resistor at the CU240S. The default position is OFF (no terminating resistor).

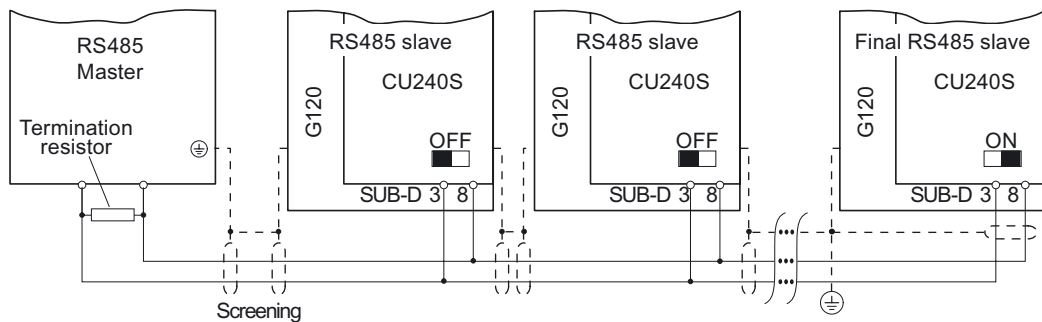
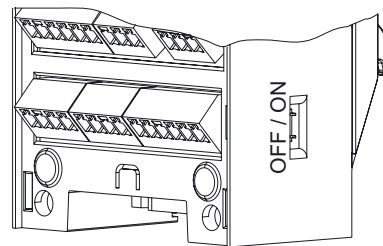



Figure 5-18 USS network via RS 485



 <b>CAUTION</b>
<p>A difference in the ground potential between the master and slaves in an RS 485 network can damage the inverter Control Unit. You must make absolutely sure that the master and slaves have the same ground potential.</p>

### SUB D connection on the CU 240S (pin assignment)

The CU240S Control Units are equipped with a 9-pole SUB D socket for connecting the inverter via an RS 485 interface. A standard 9-pole SUB D connector with a 180° cable outlet can be used for the USS connection via RS 485.

Table 5- 67 Contact assignment of the 9-pole SUB D socket

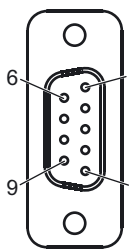
	Con tact	Designation	Description
	1	-	Unused
	2	-	Unused
	3	RS 485P	Receive and transmit signal (+)
	4	-	Unused
	5	0 V	Ground reference
	6	-	Unused
	7	-	Unused
	8	RS 485N	Receive and transmit signal (-)
	9	-	Unused
	X	Shield (housing)	Equipotential bonding

### Cable lengths and number of devices

Table 5- 68 Max. no of devices and cable length

Baud rate in bit/s	Max. no. of devices	Max. cable length
2.400 ... 93.750	32	1200 m
115.200 (max. baud rate)	30	1000 m

5.11.2.1 User data range of the USS message frame

Structure of the user data

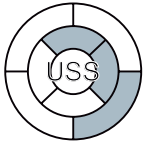

The user data range of the USS protocol is used to transfer application data. The process data is exchanged cyclically between the inverter and controller via the process data channel (PZD), while the parameter channel is used for transferring parameter values acyclically.

The following diagram shows the structure and sequence of parameter channel and process data (PZD).

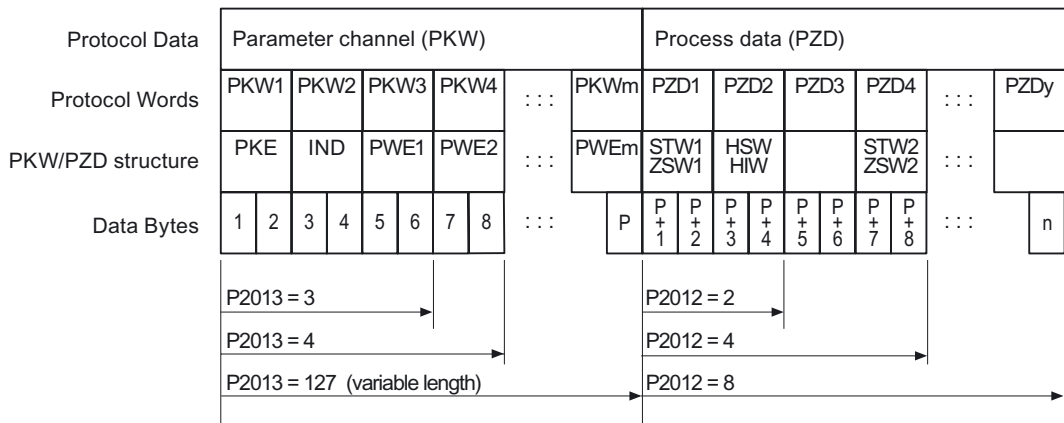

Figure 5-19 USS user data structure

The length of the parameter channel is defined via parameter P2013, while the length of the process data is defined via parameter P2012. If only parameter channel or only process data are required, the parameters of the channel not required can be set to zero ("only PKW " or "only PZD").

If both channels are required, they must be transferred together.

5.11.2.2 Data structure of the USS parameter channel

Description

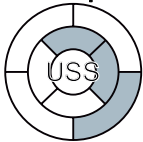

The parameter channel is used to monitor and/or change parameters in the inverter. Every time data is transferred, the parameter ID and associated parameter value are sent. The parameter channel can be set to a fixed length (3 or 4 data words) or variable length.

- The first data word always contains the parameter ID (PKE)
- The second data word contains the parameter index (IND)
- The third and fourth data word contain parameter values, text, and descriptions (PWE)

### Parameter ID (PKE) and parameter index (IND)

The parameter ID (PKE) is always a 16 bit value. In conjunction with the index (IND), it defines the parameter to be transferred.

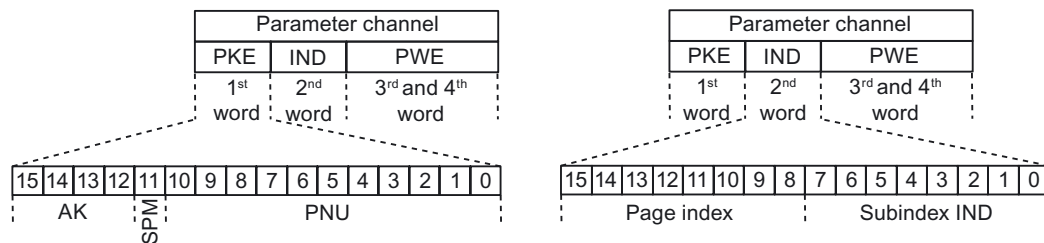

PKE structure

IND structure

- The parameter number is encoded in the lower 11 bits (PNU) of the PKE. Since the PNU can only contain values up to 2000, an offset must also be encoded for parameter numbers above 2000. The offset is set in the first word of the index (IND) as shown in the table below.
- Bit 11 (SPM) is reserved and is always 0.
- Bits 12 to 15 (AK) contain the request or response ID.

The meaning of the request ID for request telegrams (master → inverter) is explained in the following table.

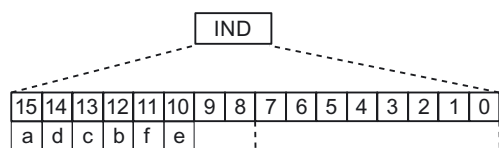

IND page index

Table 5- 69 Regulations for setting the PNU

Parameter range	Page index						Bit		Hex value	+ PNU
	a	b	c	d	f	e	9	8		
0000 ... 1999	0	0	0	0	0	0	0	0	0x00	0 – 7CF
2000 ... 3999	1	0	0	0	0	0	0	0	0x80	0 – 7CF
4000 ... 5999	0	0	0	1	0	0	0	0	0x10	0 – 7CF
6000 ... 7999	1	0	0	1	0	0	0	0	0x90	0 – 7CF
8000 ... 9999	0	0	1	0	0	0	0	0	0x20	0 – 7CF
...	...	...	...	...	...	...	...	...	...	...
32.000 ... 33.999	0	0	0	0	1	0	0	0	0x8	0 – 7CF
...	...	...	...	...	...	...	...	...	...	...
64.000 ... 65.999	1	1	1	1	0	1	0	0	0xF4	0 – 7CF

Table 5- 70 Coding example for a parameter number in PKE and IND for P7841, index 2

	PKE		IND	
decimal	xx	1841	144	2
hex	xx	731	90	02

The parameter index is encoded in the second word of the index (IND).

Example: Coding of a parameter number in PKE and IND for P2016, index 3

PKE	IND	PWE1	PWE2
xx   10	80   03		

The master and slave exchange data via the request ID and response ID (AK), a process that is to take place with the parameter specified in the PKE. The transfer status is communicated with the response ID.

Table 5- 71 Request ID (master → inverter)

Request ID	Description	Response ID	
		positive	negative
0	No request	0	7 / 8
1	Request parameter value	1 / 2	7 / 8
2	Change parameter value (word)	1	7 / 8
3	Change parameter value (double word)	2	7 / 8
4	Request descriptive element <sup>1)</sup>	3	7 / 8
6	Request parameter value (field) <sup>1)</sup>	4 / 5	7 / 8
7	Change parameter value (field, word) <sup>1)</sup>	4	7 / 8
8	Change parameter value (field, double word) <sup>1)</sup>	5	7 / 8
9	Request number of field elements	6	7 / 8
11	Change parameter value (field, double word) and save in EEPROM <sup>2)</sup>	5	7 / 8
12	Change parameter value (field, word) and save in EEPROM <sup>2)</sup>	4	7 / 8
13	Change parameter value (double word) and save in EEPROM	2	7 / 8
14	Change parameter value (word) and save in EEPROM	1	7 / 8

1) The required element of the parameter description is specified in IND (second word).  
 2) The required element of the indexed parameter is specified in IND (second word).

The meaning of the response ID for response telegrams (inverter → master) is explained in the following table. The request ID determines which response IDs are possible.

Table 5- 72 Response ID (inverter → master)

Response ID	Description
0	No response
1	Transfer parameter value (word)
2	Transfer parameter value (double word)
3	Transfer descriptive element <sup>1)</sup>
4	Transfer parameter value (field, word) <sup>2)</sup>
5	Transfer parameter value (field, double word) <sup>2)</sup>
6	Transfer number of field elements
7	Request cannot be processed, task cannot be executed (with fault number)
8	No master controller mode / no authorization to change parameters of the PARAMETER CHANNEL interface
1) The required element of the parameter description is specified in IND (second word). 2) The required element of the indexed parameter is specified in IND (second word).	

If the response ID is 7 (request cannot be processed), one of the fault numbers listed in the following table is stored in parameter value 2 (PWE2).

Table 5- 73 Fault numbers for the response "request cannot be processed"

No.	Description	Comments
0	Impermissible parameter number (PNU)	Parameter does not exist
1	Parameter value cannot be changed	The parameter can only be read
2	Minimum/maximum not reached or exceeded	–
3	Incorrect subindex	–
4	No field	An individual parameter was addressed with a field request and subindex > 0
5	Incorrect parameter type / incorrect data type	Word and double word mixed up
6	Set not permitted (reset only)	–
7	The descriptive element cannot be changed	Description can never be changed
11	Not in "master controller" mode	Change request without "master controller" mode (see P0927)
12	Keyword missing	–
17	Request cannot be processed due to the operating state	The current inverter operating state is not compatible with the request received.
101	Parameter number currently deactivated	Dependent on the operating state of the inverter
102	Channel width is insufficient	Communication channel is too small for response
104	Impermissible parameter value	The parameter only permits certain values.
106	Request not included / task not supported	After request ID 5, 10, 15
200/201	Modified minimum/maximum not reached or exceeded	The maximum or minimum can be limited further during operation.
204	The available access authorization does not cover parameter changes.	–

### Parameter value (PWE)

When communication takes place via the USS, the number of PWEs can vary. One PWE is required for 16 bit values. If 32 bit values are exchanged, two PWEs are required.

---

#### Note

U8 data types are transferred as U16, whereby the upper byte is zero. U8 fields, therefore, require one PWE for each index.

---

A parameter channel for 3 words is a typical data telegram for exchanging 16 bit data or alarm messages. The mode with a fixed word length of 3 is used when P2013 = 3.

A parameter channel for 4 words is a typical data telegram for exchanging 32 bit data variables and requires P2013 = 4.

A parameter channel allowing a flexible word length is used when P2013 = 127. The telegram length between the master and slave can have a different number of PWEs.

When the length of the parameter channel is fixed (p2013 = 3 or 4), the master must always transmit either 3 or 4 words in the parameter channel, otherwise the slave will not respond to the telegram. The response from the slave will also contain either 3 or 4 words. When the length is fixed, 4 should be used because 3 is insufficient for many parameters (i.e. double words). When the parameter channel is of a variable length (P2013 = 127), the master transmits only the amount of words required for the task in the parameter channel. The length of the response telegram is also restricted to the required size.

### Rules for processing requests/responses

- A request or a response can only be referred to one parameter.
- The master must constantly repeat a request until it receives a suitable response.
- The master recognizes the response to a request that it sent by:
  - Evaluating the response ID
  - Evaluating the parameter number (PNU)
  - Evaluating the parameter index IND, if required
  - Evaluating the parameter value PWE, if necessary.
- The complete request must be sent in a telegram. Request telegrams cannot be subdivided. The same applies to responses.
- If response telegrams contain parameter values, the drive always returns the current parameter value when it repeats response telegrams.

5.11.2.3 Timeouts and other errors

Process timeouts

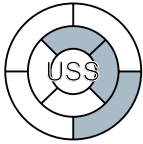

Parameter P2014 defines the permissible timeout in ms. Value zero prevents timeout monitoring. Parameter P2014 checks the cyclic update of bit 10 in control word 1.

If the USS is configured as a command source for the drive and P2014 is not zero, bit 10 of the received control word 1 is checked. If the bit is not set, an internal timeout counter is incremented. If the threshold defined in P2014 is reached, the drive sets a process timeout error.

Other errors

- P2025 = USS rejected
- P2026 = USS character frame error
- P2027 = USS overflow error
- P2028 = USS parity error
- P2029 = USS start not recognized
- P2030 = USS BCC error
- P2031 = USS length error

5.11.2.4 USS process data channel (PZD)

Description

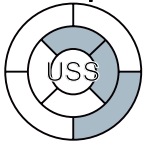

Process data (PZD) is exchanged continuously between the master and slave in this telegram range. Depending on the direction of transfer, the process data channel contains request data for the USS slave or response data to the USS master. The request contains control words and setpoints for the slaves, while the response contains status words and actual values for the master.

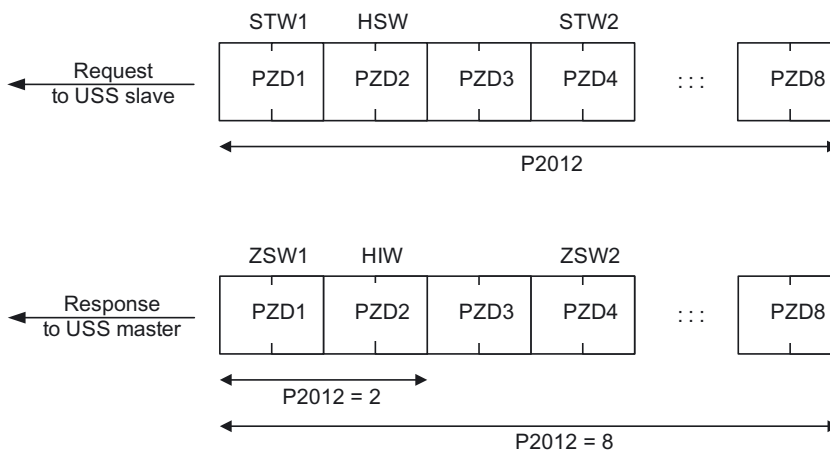

Figure 5-20 USS process data channel



The number of PZD words in a USS telegram is defined by parameter P2012. The first two words are:

- Control 1 (STW1) and main setpoint (HSW)
- Status word 1 (ZSW1) and main actual value (HIW)

If P2012 is greater than or the same as 4, the additional control word (STW2) is transferred as the fourth PZD word (default setting).

The sources of all the other PZDs are defined with parameter P2019 for an RS 485 interface and with P2016 for an RS 232 interface.

### 5.11.3 Communication via PROFIBUS and PROFINET

#### 5.11.3.1 Connect the frequency inverter to PROFIBUS

##### Assignment of the SUB-D connector to connect to the PROFIBUS-DP network



Control Units CU240S DP and CU240S DP-F of the inverter are equipped with a SUB D connection to connect to the PROFIBUS cable.

Table 5- 74 Contact assignment of the 9-pole SUB D connection

	Contact	Designation	Description	Area
	1	Shielding	Ground connection	
	2	U0V	Floating and reference point for user supply	
	3	RxD/TxD-P	Receive/transmit data P (B/B')	RS 485
	4	CNTR-P	Control signal	TTL
	5	DGND	Reference potential for PROFIBUS data (C/C')	
	6	VP	Plus pole for supply voltage	5 V ± 10 %
	7	U24V	Floating user supply +24 V at 100 mA	
	8	RxD/TxD-N	Receive/transmit data N (A/A')	RS 485
	9	-	Not assigned	
	Housing	Cable shield	Cable shield	

The SUB D connection is suitable for the SIMATIC RS 485 bus connector.

### Recommended PROFIBUS connectors

We recommend one of the following connectors for the PROFIBUS cable:

1. 6GK1500-0FC00
2. 6GK1500-0EA02

Both connectors are suitable for all SINAMICS G120 Control Units with respect to the angle of the outgoing cable.

---

#### Note

#### PROFIBUS communication when the 400 V supply for the inverter is switched off

If the inverter is only supplied via the 400 V line connection for the Power Module, the PROFIBUS connection for the Control Unit is interrupted as soon as the power supply is disconnected. To prevent this, the Control Unit must be connected to a separate 24 V power supply via terminals 31 (+24 V I<sub>n</sub>) and 32 (0 V I<sub>n</sub>).

---

### Permissible cable length / installing and shielding the PROFIBUS cable

You can find information about this under the following link:  
(<http://support.automation.siemens.com/WW/view/en/1971286>)

#### 5.11.3.2 Example for configuring the inverter on PROFIBUS

##### Task



A drive with a SINAMICS G120 inverter is to be controlled from a central SIMATIC controller via PROFIBUS, whereby the control signals and speed setpoint are to be transferred from an S7-300 CPU to the drive. In the other direction, the drive is to transfer its status messages and actual speed value to the central controller via PROFIBUS.

Using a suitable example, the following section provides step-by-step instructions explaining how to connect an inverter to a higher-level SIMATIC controller via PROFIBUS. To extend the PROFIBUS network to include additional inverters, simply repeat the relevant steps.

#### What prior knowledge is required?

In this example, it is assumed that readers know how to basically use an S7 control and the STEP 7 engineering tool and is not part of this description.

**Hardware components (example)**



Component	Type	Order no.	Qty
Central controller			
Power supply	PS307 2 A	6ES7307-1BA00-0AA0	1
S7 CPU	CPU 315-2DP	6ES7315-2AG10-0AB0	1
Memory card	MMC 2MB	6ES7953-8LL11-0AA0	1
DIN rail	DIN rail	6ES7390-1AE80-0AA0	1
PROFIBUS connector	PROFIBUS connector	6ES7972-0BB50-0XA0	1
PROFIBUS cable	PROFIBUS cable	6XV1830-3BH10	1
Drive			
SINAMICS G120 Control Unit	CU240S DP	6SL3244-0BA20-1PA0	1
SINAMICS G120 Power Module	PM240	6SL3224-0BE21-5UA0	1
Basic Operator Panel	BOP	6SL3255-0AA00-4BA1	1
Motor	Three-phase induction motor	1LA7060-4AB10	1
PROFIBUS connector	PROFIBUS connector	6GK1500-0FC00	1

**Note**

The description provided in this manual uses the hardware listed above. Other similar products not listed above can also be used.

**Software components**

Component	Type	Order no.	Qty
SIMATIC STEP 7	V5.3 + SP3	6ES7810-4CC07-0YA5	1
STARTER	V4.1 SP2 HF4	6SL3072-0AA00-0AG0	1
Drive ES Basic	V5.4	6SW1700-5JA00-4AA0	1

Drive ES Basic is the basic software of the engineering system, which combines the drive technology and Siemens controllers. The STEP 7 Manager user interface acts as a basis with which Drive ES Basic is used to integrate drives in the automation environment with respect to communication, configuration, and data storage.

**Setting the PROFIBUS address of the inverter**



Two DIP switch blocks are located on the Control Unit. The PROFIBUS address of the inverter is set using one of these. The DIP switch for the PROFIBUS address is, depending on the firmware release, either located on the front of the CU below the operator and display instrument (operator panel) or at the side of the CU.

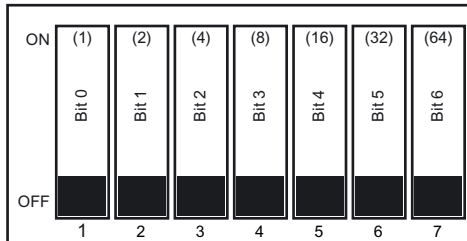

Figure 5-21 PROFIBUS DIP switches

Alternatively, the PROFIBUS address can be set via parameter P0918. The DIP switch setting has priority over P0918.

**CAUTION**

When the PROFIBUS address is changed, the Control Unit needs to be switched off and on again to activate the new address. This must be carried out by switching the power supply off and then on again, regardless of whether the interface is supplied by the power supply for the inverter or via its own 24 V power supply.

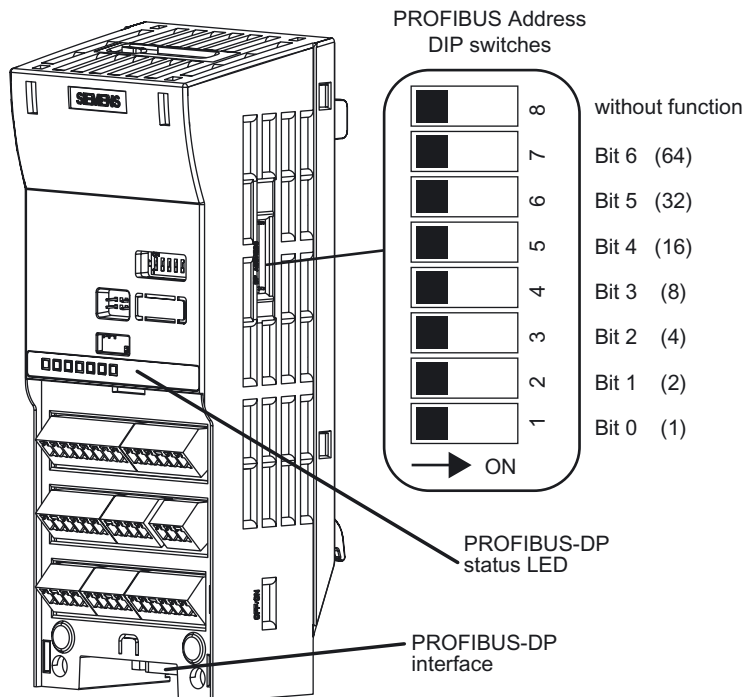

Figure 5-22 PROFIBUS interface, diagnostics, and address setting on the Control Unit

Set the DIP switch to address 10 (as shown in the following table).

Table 5- 75 Examples of setting the PROFIBUS address

DIP switch		1	2	3	4	5	6	7
Address = values added in this line		1	2	4	8	16	32	64
Example 1: Address = 117 = 1 + 4 + 16 + 32 + 64	OFF	<input type="checkbox"/>	<input checked="" type="checkbox"/>	<input type="checkbox"/>	<input checked="" type="checkbox"/>	<input type="checkbox"/>	<input type="checkbox"/>	<input type="checkbox"/>
	ON	<input checked="" type="checkbox"/>	<input type="checkbox"/>	<input checked="" type="checkbox"/>	<input type="checkbox"/>	<input checked="" type="checkbox"/>	<input checked="" type="checkbox"/>	<input checked="" type="checkbox"/>
Example 2: Address = 39 = 1 + 2 + 4 + 32	OFF	<input type="checkbox"/>	<input type="checkbox"/>	<input type="checkbox"/>	<input checked="" type="checkbox"/>	<input checked="" type="checkbox"/>	<input type="checkbox"/>	<input checked="" type="checkbox"/>
	ON	<input checked="" type="checkbox"/>	<input checked="" type="checkbox"/>	<input checked="" type="checkbox"/>	<input type="checkbox"/>	<input type="checkbox"/>	<input checked="" type="checkbox"/>	<input type="checkbox"/>

The valid address range is specified in the table below:

Table 5- 76 Valid PROFIBUS addresses

DIP switch settings	Significance
0	PROFIBUS address defined via P0918
1 ... 125	Valid PROFIBUS address
126, 127	Invalid PROFIBUS address

### Integrating the inverter into a higher-level SIMATIC control



Once you have set the PROFIBUS address of the inverter, all the remaining settings required for integrating it in the SIMATIC control are carried out in STEP 7 with HW Config.

### Creating a STEP 7 project

Create a new STEP 7 project and assign a project name (e.g. "G120\_in\_S7").

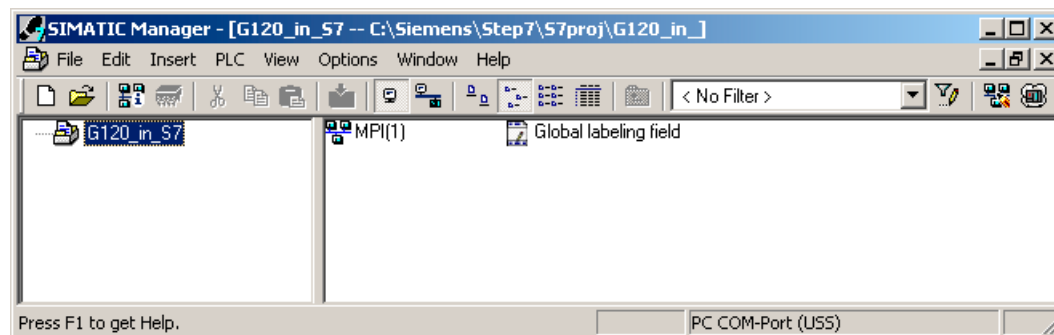

Figure 5-23 Create a new project in STEP 7

### Configuring SIMATIC 300 and creating the PROFIBUS network

Add an S7 300 CPU.

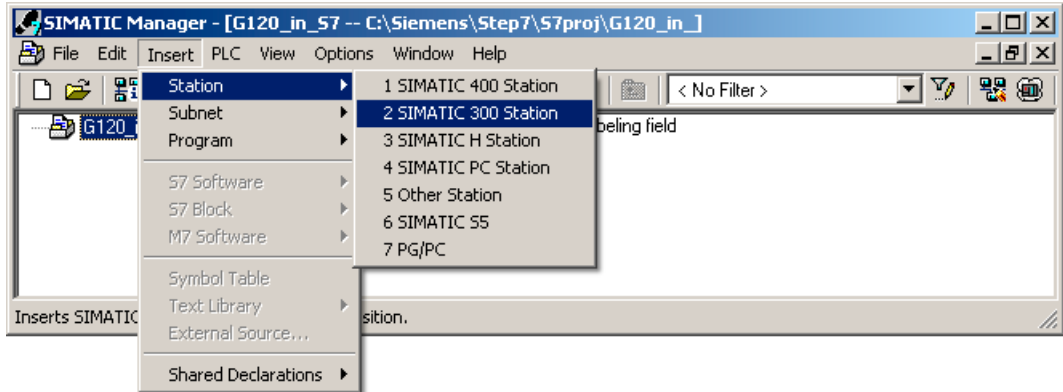

Figure 5-24 Add a SIMATIC 300 station

Open the hardware configuration (HW Config) in Step 7.

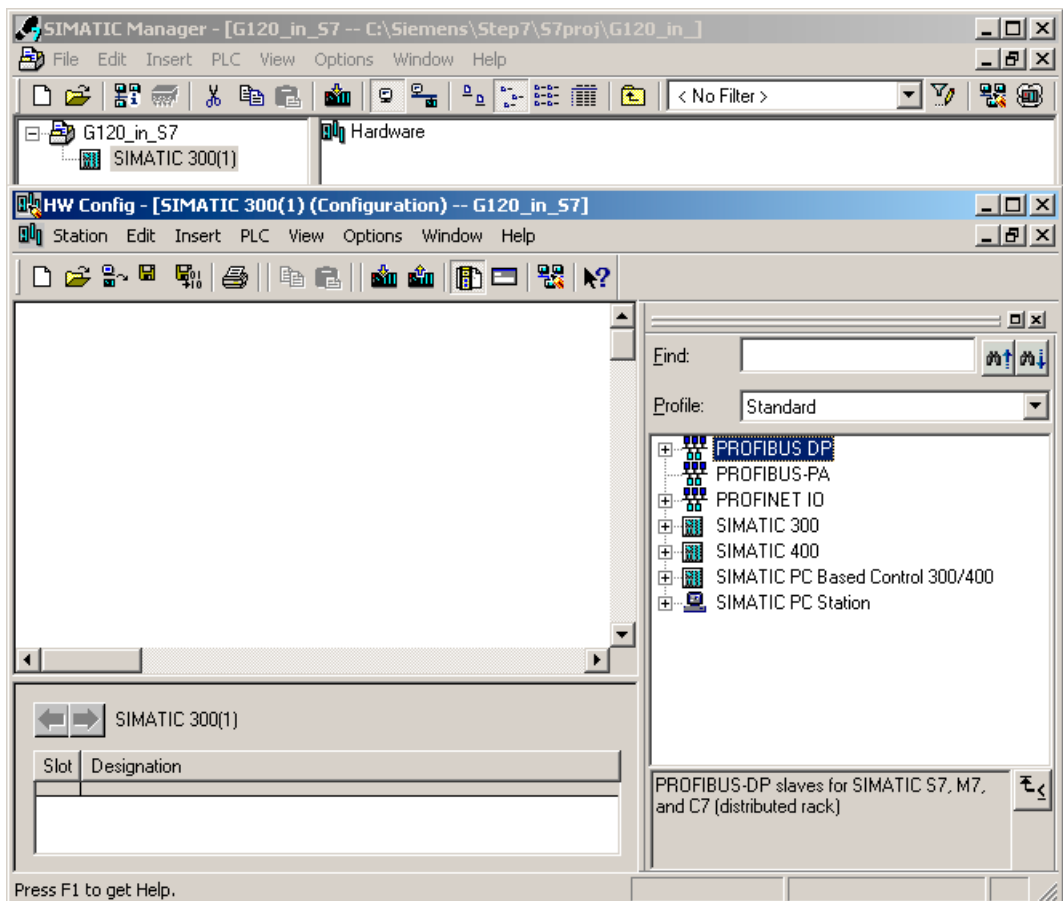

Figure 5-25 Open HW Config

Add an S7 300 subrack to your project by dragging and dropping it from the "SIMATIC 300" hardware catalog. Connect a power supply to slot 1 of the subrack and a CPU 315-2 DP to slot 2.

When you add the SIMATIC 300, a window is displayed in which you can define the network. Create a PROFIBUS DP network.

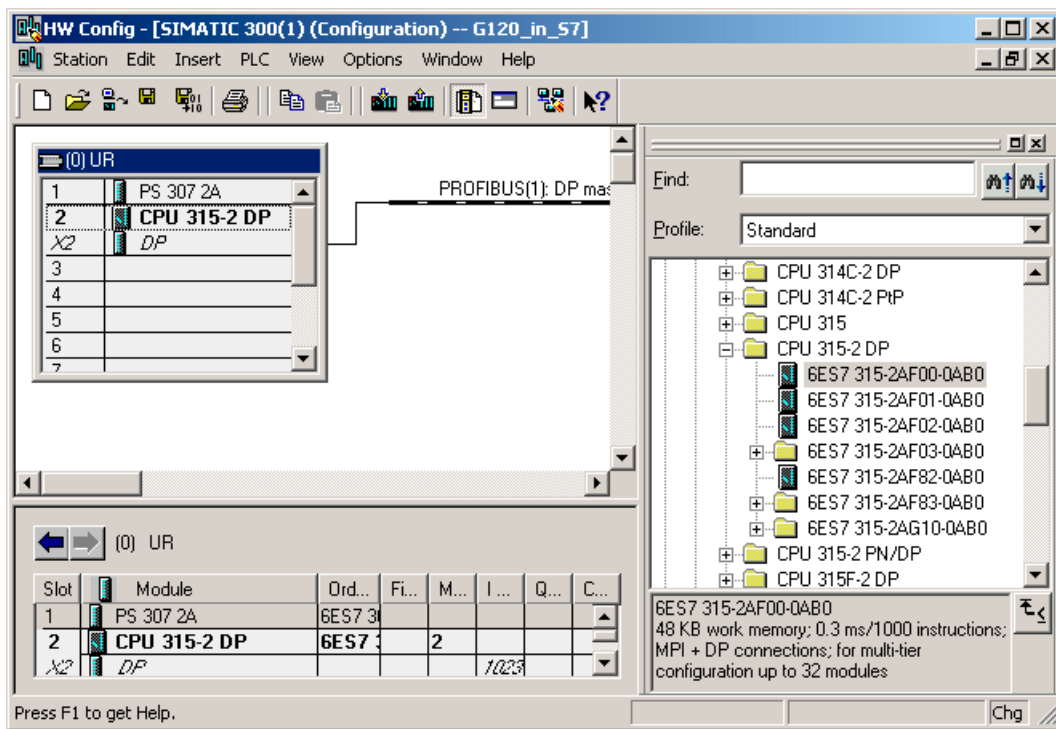

Figure 5-26 Add a SIMATIC 300 station with the PROFIBUS DP network

### Configuring the inverter and integrating it in the Profibus network



In STEP 7, the inverter can be connected to an S7 control in two ways:

1. Using the inverter GSD

The GSD is a standardized description file for a PROFIBUS slave. It is used by all controllers that are PROFIBUS masters.

2. Via the STEP 7 object manager

This somewhat more user-friendly method is only available for S7 controls and installed Drive\_ES\_Basic.

The following section describes how to configure the inverter using the GSD.

### Installing the GSD in STEP 7

The GSD of the SINAMICS inverters are available in the Internet.

It is integrated in STEP 7 via HW Config.

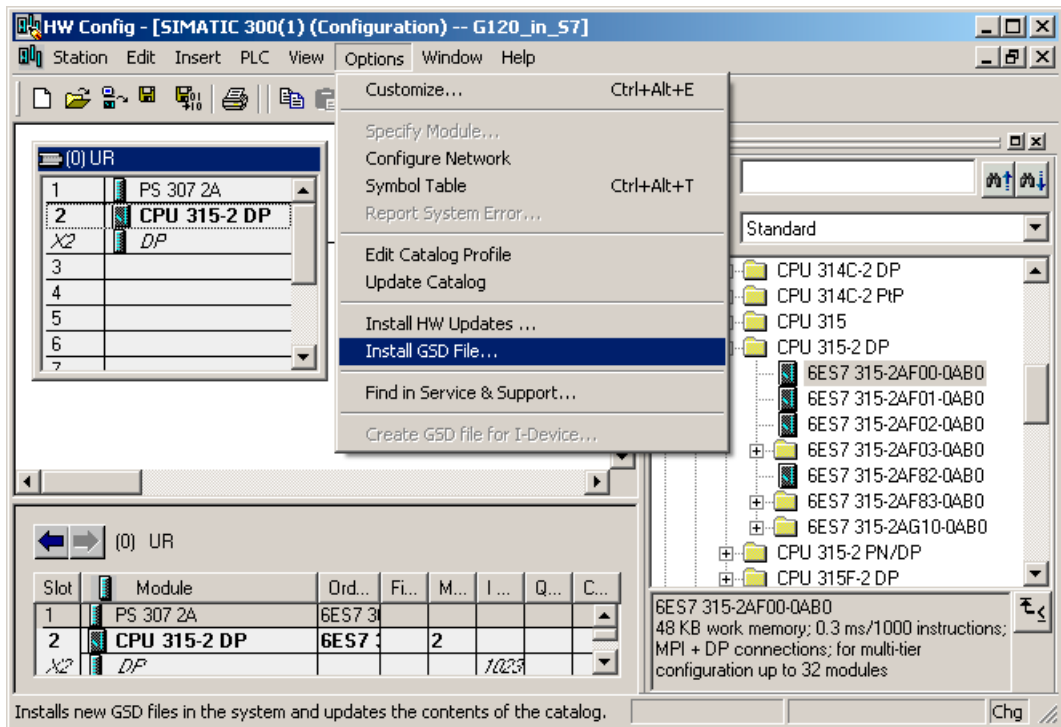

Figure 5-27 Install the GSD in STEP 7 with HW Config



Once the GSD has been installed, the inverter appears as an object under "PROFIBUS DP" in the HW Config product catalog.

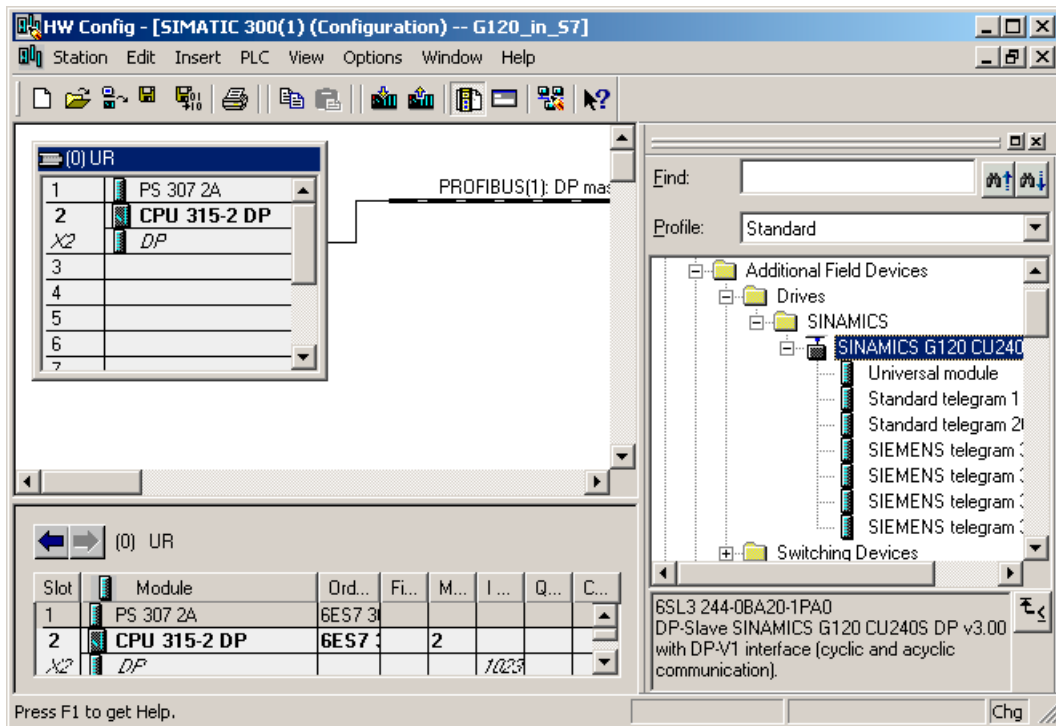

Figure 5-28 G120 in the HW Config product catalog

Drag and drop the inverter into the PROFIBUS network. Enter the PROFIBUS address set at the inverter in HW Config.

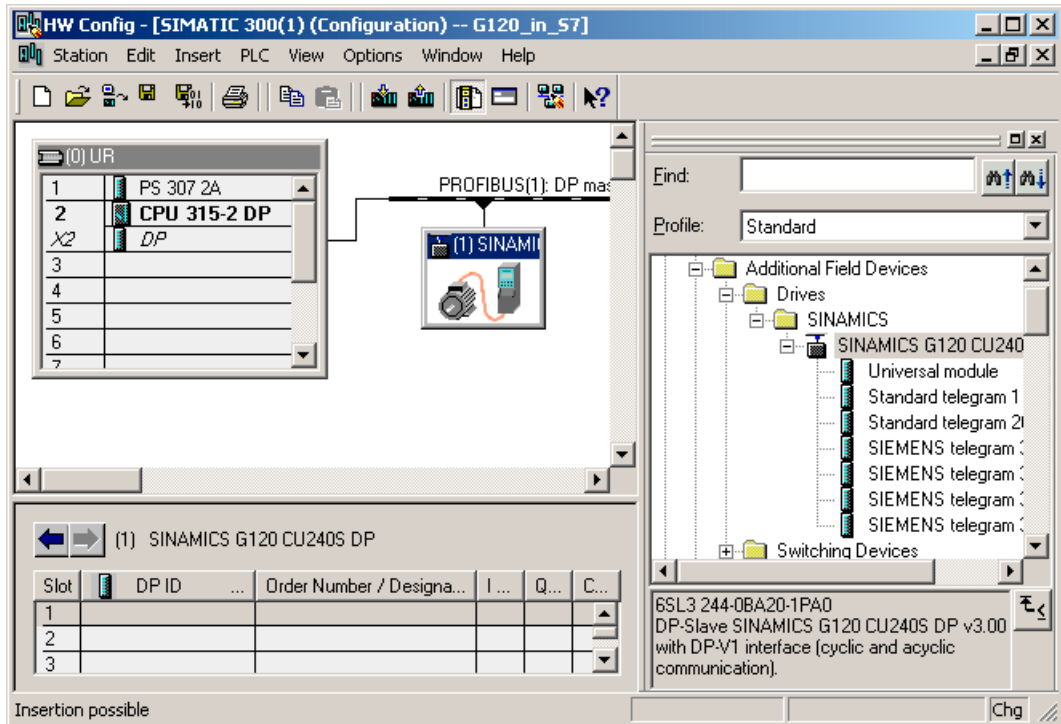

Figure 5-29 Connect G120 to the PROFIBUS network

The inverter object in the HW Config product catalog contains several telegram types. The telegram type defines which cyclic data (= process data (PZD)) is exchanged between the control and inverter. With standard telegram 1, for example, the inverter receives the process data for the speed setpoint and control word from the control and returns its actual speed value and status word in the process data.

Add the required telegram type to slot 1 of the inverter by dragging and dropping it from the HW catalog.

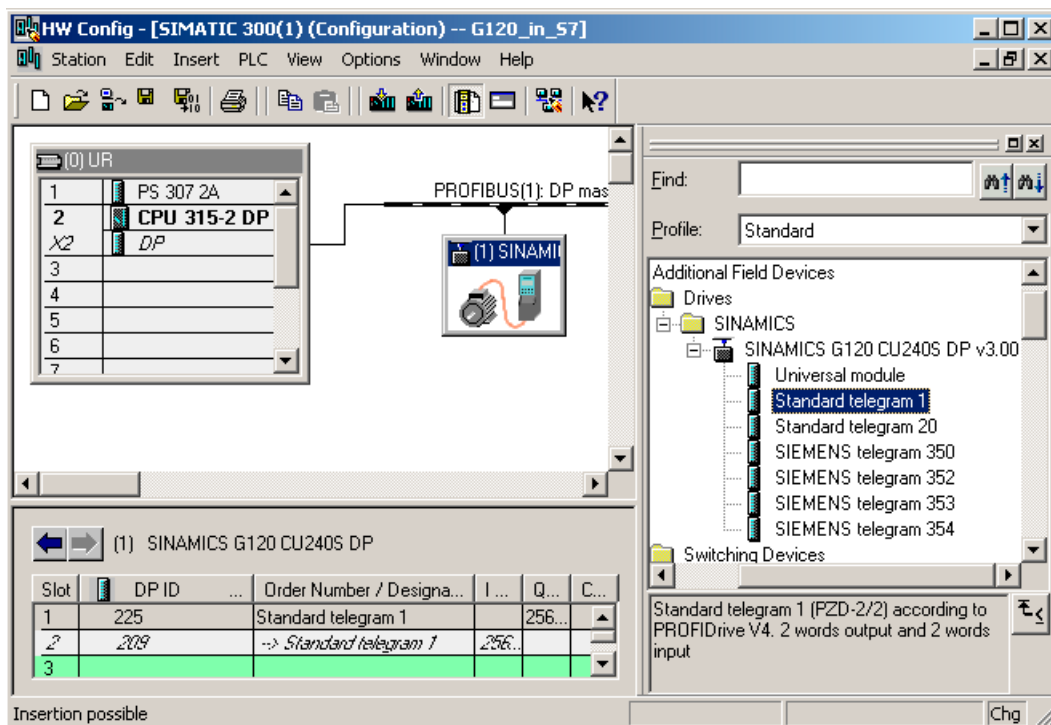

Figure 5-30 Define the telegram type of the SINAMICS G120 inverter in the control

STEP 7 automatically assigns the address range containing the process data for the inverter. Standard telegram 1 occupies four bytes of input data and four bytes of output data.

### Note

#### Defining the telegram type in the inverter

The telegram type setting in HW Config only applies to the controller side. In the inverter, the same telegram type must be set by means of STARTER or the BOP via parameter P0922.

### Final steps

- Save and compile the project in STEP 7.
- Establish an online connection between your PC and the S7 CPU and download the project data to the S7 CPU.

The inverter is now connected to the S7 CPU. The communications interface between the CPU and inverter is specified by the PROFIDrive profile. An example of how you can supply this interface with data can be found in this manual.

### 5.11.3.3 Integrating a frequency inverter in PROFINET

#### Assignment of the RJ45 connector to integrate an inverter into PROFINET



The CU240S PN and CU240S PN-F Control Units are equipped with an Ethernet switch for two connections in the form of RJ45 sockets. Connections with optical networks are established via switches, which are equipped with an electrical and optical port. The inverter is then connected to an electrical port.

Table 5- 77 Contact assignment of the RJ45 sockets

	Contact	Designation	Significance	Wire color
	1	TX+	Transmit data +	Yellow
	2	TX	Transmit data -	Orange
	3	RX+	Receive data +	White
	4	-		
	5	-		
	6	RX -	Receive data -	Blue

For product information about assembling the SIMATIC NET Industrial Ethernet FastConnect RF45 plug 180, see "Assembly Instructions for SIMATIC NET Industrial Ethernet FastConnect RJ45 Plug". The document is available for download in the Internet (<http://support.automation.siemens.com/WW/view/en/23175326/130000>):

#### Recommended PROFINET connectors

We recommend the following connector for the PROFINET cable:  
6GK1901-1BB10-2Ax0

#### Additional information on PROFINET

You can find information on PROFINET in the Internet (<http://support.automation.siemens.com/WW/view/en/19292127>):

### 5.11.3.4 Example for configuring the inverter on PROFINET

#### Differences between PROFIBUS and PROFINET

The procedure for operating the inverter on PROFINET differs only slightly from the previous description for PROFIBUS. The following section covers only the key differences between PROFIBUS and PROFINET.

#### Hardware components (example)



In comparison to PROFIBUS, the S7 CPU, the Control Unit of the inverter and the communication cable must be configured for PROFINET.

Component	Type	Order no.	Qty
Central controller			
Power supply	PS307 2 A	6ES7307-1BA00-0AA0	1
S7 CPU	CPU 315-2 PN/DP from V2.5 and higher	6ES7315-2EH13-0AB0	1
Memory card	MMC 2MB	6ES7953-8LL11-0AA0	1
DIN rail	DIN rail	6ES7390-1AE80-0AA0	1
PROFINET connector	PROFINET connector	6GK1901-1BB10-2Ax0	1
PROFINET cable	PROFINET cable	6XV1840-2AH10	1
Drive			
SINAMICS G120 Control Unit	CU240S PN	6SL3244-0BA20-1FA0	1
SINAMICS G120 Power Module	PM240	6SL3224-0BE21-5UA0	1
Basic Operator Panel	BOP	6SL3255-0AA00-4BA1	1
Motor	Three-phase induction motor	1LA7060-4AB10	1
PROFINET connector	PROFINET connector	6GK1901-1BB10-2Ax0	1

#### Note

The description provided in this manual uses the hardware listed above. Other similar products not listed above can also be used.

#### Software components

Component	Type	Order no.	Qty
SIMATIC STEP 7	V5.4 SP2	6ES7810-4CC07-0YA5	1
STARTER	V4.1 SP2 HF4	6SL3072-0AA00-0AG0	1
Drive ES Basic	V5.4	6SW1700-5JA00-4AA0	1

### Integrating the inverter into a higher-level SIMATIC control



All settings required for integrating the inverter in the SIMATIC controller are carried out in STEP 7 with HW Config.

### Creating the STEP 7 project and configuring SIMATIC 300

The procedure here is very similar to that described for PROFIBUS. The main differences are:

1. In the module catalog, choose a PROFINET-capable S7 controller (e.g. CPU 315-2 PN/DP).
2. Once you have added the SIMATIC 300, create a PROFINET network.

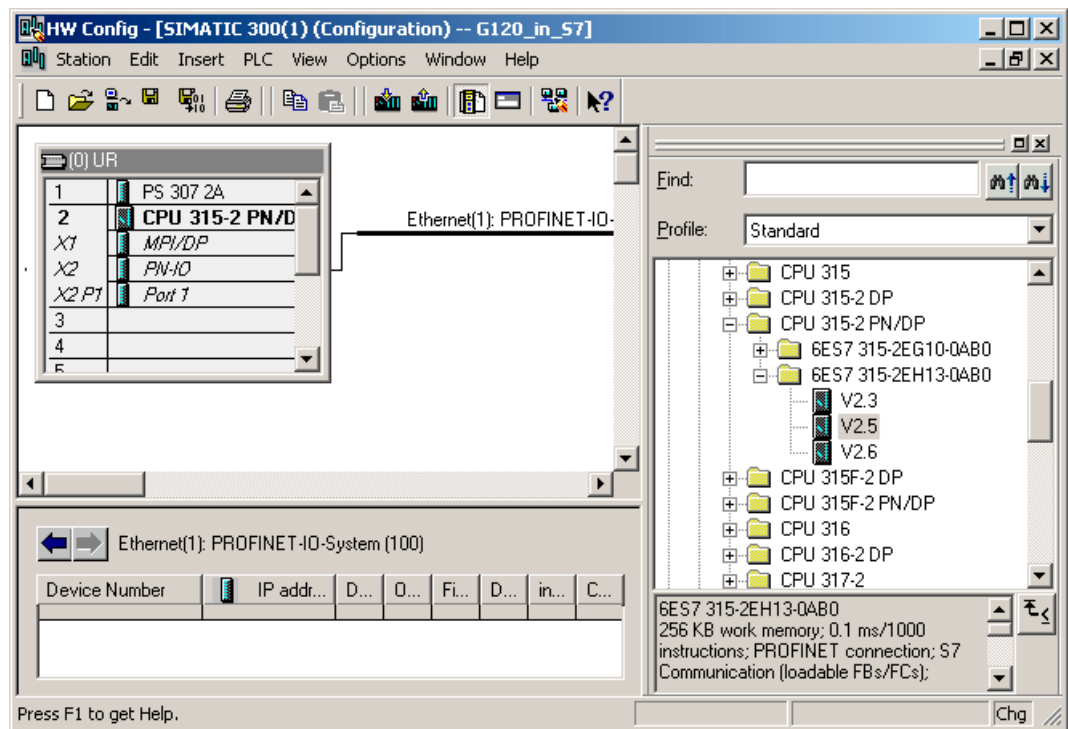

Figure 5-31 Add SIMATIC 300 station with the PROFINET network

### Configuring the inverter and integrating it into a PROFINET network



The inverter is integrated into the higher-level control with its GSDML via PROFINET. The GSDML of the SINAMICS inverters are available in the Internet. Once the GSDML has been installed (see "Communication via PROFIBUS"), the inverter appears as an object under "PROFINET IO" in the HW Config product catalog.

Drag and drop the inverter into the PROFINET network and then choose the standard telegram 1 as the telegram type.

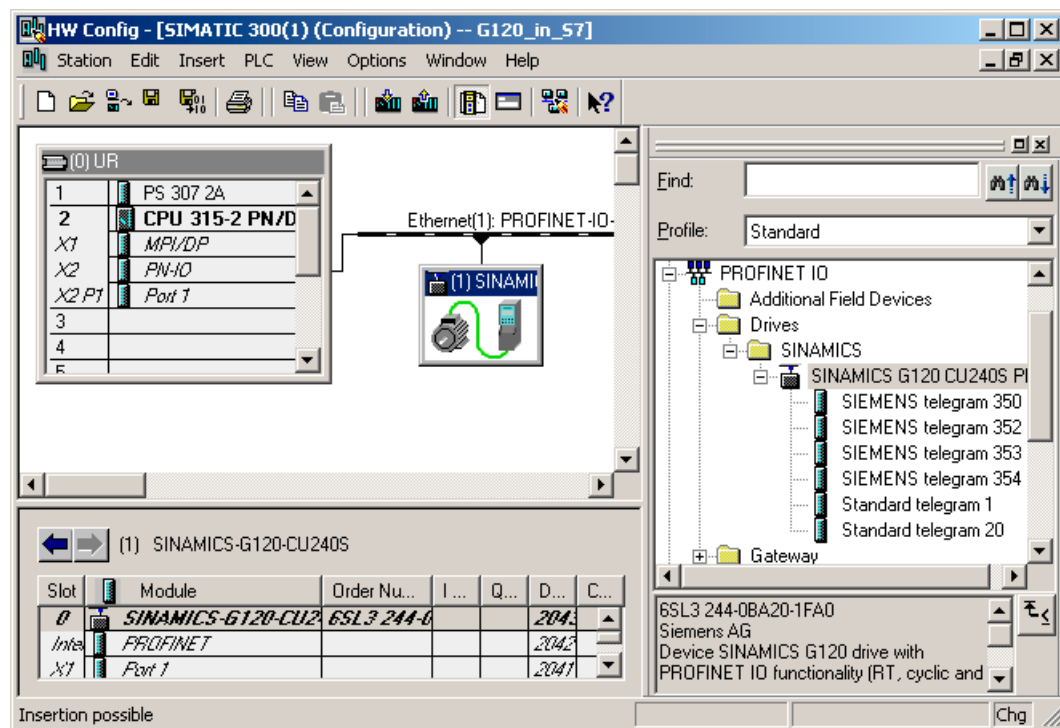

Figure 5-32 G120 with standard telegram 1 in STEP 7 on PROFINET

### Final steps

- Save and compile the project in STEP 7.
- Establish an online connection between your PC and the S7 CPU and download the project data to the S7 CPU.

The inverter is now connected to the S7 CPU. The communications interface between the CPU and inverter is specified by the PROFIdrive profile. An example of how you can supply this interface with data can be found in this manual.

5.11.3.5 The PROFIdrive profile

User data structure in the PROFIdrive profile

PROFIdrive as an inverter interface on PROFIBUS or PROFINET

The SINAMICS G120 inverters are controlled via the PROFIdrive profile, version 4.1. The PROFIdrive profile defines the user data structure with which a central control communicates with the inverter by means of cyclic or acyclic data transfer. The PROFIdrive profile is a cross-vendor standard.

Cyclic communication

Description



The PROFIdrive profile defines different telegram types. Telegrams contain the data packages for cyclic communication with a defined meaning and sequence. SINAMICS G120 inverters have the telegram types listed in the following table.

Table 5- 78 SINAMICS G120 telegram types

Telegram type	Parameter channel (PKW) parameter data	Process data (PZD) - control and status words, actual values							
		PZD01 STW1 ZSW1	PZD02 HSW HIW	PZD03	PZD04	PZD05	PZD06	PZD 07	PZD 08
<b>Telegram 1</b> speed control, 2 words	No	STW1	NSOLL_A	← The inverter receives this data from the control					
		ZSW1	NIST_A	⇒ The inverter sends this data to the control					
<b>Telegram 20</b> speed control, VIK/NAMUR 2 or 5 words	No	STW1	NSOLL_A						
		ZSW1	NIST_A_ GLATT	IAIST	MIST	PIST			
<b>Telegram 350</b> speed control, 4 words	No	STW1	NSOLL_A	M_LIM	STW2				
		ZSW1	NIST_A_ GLATT	IAIST_	ZSW2				
<b>Telegram 352</b> speed control, PCS7	No	STW1	NSOLL_A	PCS7 process data					
		ZSW1	NIST_A_ GLATT	IAIST	MIST	FAULT_ CODE	WARN_ CODE		
<b>Telegram 353</b> speed control, PKW 4/4 and PZD 2/2	Yes	STW1	NSOLL_A						
		ZSW1	NIST_A_ GLATT						
<b>Telegram 354</b> speed control, PKW 4/4 and PZD 6/6	Yes	STW1	NSOLL_A	PCS7 process data					
		ZSW1	NIST_A_ GLATT	IAIST	MIST	FAULT_ CODE	WARN_ CODE		



Telegram type	Parameter channel (PKW) parameter data	Process data (PZD) - control and status words, actual values							
		PZD01 STW1 ZSW1	PZD02 HSW HIW	PZD03	PZD04	PZD05	PZD06	PZD 07	PZD 08
Telegram 999 free interconnection via BICO	No	STW1	Telegram length on receipt is max. 8 words. The central configuration is user defined (e.g. HW Config (universal module in GSD))						
		ZSW1	Telegram length on transmission is max. 8 words. The central configuration is user defined (e.g. HW Config (universal module in GSD))						
STW1/2 ZSW1/2 NSOLL_A NIST_A_GLATT IA_IST MIST PIST M_LIM FAULT_CODE WARN_CODE		Control word 1/2 Status word 1/2 Speed or frequency setpoint Smoothed speed or actual frequency value Current output current Current torque Current active power Toque limit value Fault number Alarm number							

The following sections explain the content of this table in more detail.

Data structure of the parameter channel

Parameter channel



The parameter channel can be used to process and monitor process data (write/read) as described below. The parameter channel always comprises four words.

Parameter channel		
PKE	IND	PWE
1 <sup>st</sup> word	2 <sup>nd</sup> word	3 <sup>rd</sup> and 4 <sup>th</sup> word

Abbreviations: PKE : Parameter identifier  
 IND : Index  
 PWE: Parameter value

Figure 5-33 Structure of the parameter channel in the telegram structure

Parameter ID (PKE), first word

The parameter ID (PKE) is always a 16 bit value.

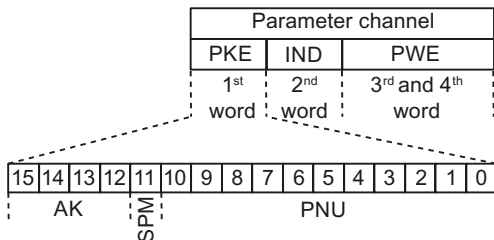

Figure 5-34 PKE structure

- Bits 0 to 10 (PNU) contain the rest of the parameter number (value range 1 to 61999). An offset must be added, which is defined by IND with the upper bits (acyclic) or the lower bits (cyclic) of the byte, for parameter numbers ≥ 2000.
- Bit 11 (SPM) is reserved and is always 0.
- Bits 12 to 15 (AK) contain the request or response ID.

The meaning of the request ID for request telegrams (master → inverter) is explained in the following table.

Table 5- 79 Request ID (master → inverter)

Request ID	Description	Response ID	
		positive	negative
0	No request	0	7 / 8
1	Request parameter value	1 / 2	↑
2	Change parameter value (word)	1	
3	Change parameter value (double word)	2	
4	Request descriptive element <sup>1)</sup>	3	
6	Request parameter value (field) <sup>1)</sup>	4 / 5	
7	Change parameter value (field, word) <sup>1)</sup>	4	
8	Change parameter value (field, double word) <sup>1)</sup>	5	
9	Request number of field elements	6	
11	Change parameter value (field, double word) and save in EEPROM <sup>2)</sup>	5	
12	Change parameter value (field, word) and save in EEPROM <sup>2)</sup>	4	
13	Change parameter value (double word) and save in EEPROM	2	↓
14	Change parameter value (word) and save in EEPROM	1	7 / 8
1) The required element of the parameter description is specified in IND (second word). 2) The required element of the indexed parameter is specified in IND (second word).			

The meaning of the response ID for response telegrams (inverter → master) is explained in the following table. The request ID determines which response identifiers are possible.

Table 5- 80 Response ID (inverter → master)

Response identifier	Description
0	No response
1	Transfer parameter value (word)
2	Transfer parameter value (double word)
3	Transfer descriptive element <sup>1)</sup>
4	Transfer parameter value (field, word) <sup>2)</sup>
5	Transfer parameter value (field, double word) <sup>2)</sup>
6	Transfer number of field elements
7	Request cannot be processed, task cannot be executed (with fault number)
8	No master controller mode / no authorization to change parameters of the PARAMETER CHANNEL interface
1) The required element of the parameter description is specified in IND (second word). 2) The required element of the indexed parameter is specified in IND (second word).	

If the response ID is 7 (request cannot be processed), one of the fault numbers listed in the following table is stored in parameter value 2 (PWE2).

Table 5- 81 Fault numbers for the response "request cannot be processed"

No.	Description	Comments
0	Impermissible parameter number (PNU)	Parameter does not exist
1	Parameter value cannot be changed	The parameter can only be read
2	Minimum/maximum not reached or exceeded	–
3	Incorrect subindex	–
4	No field	An individual parameter was addressed with a field request and subindex > 0
5	Incorrect parameter type / incorrect data type	Word and double word mixed up
6	Setting is not permitted (reset only)	–
7	The descriptive element cannot be changed	Description can never be changed
11	Not in the "master control" mode	Change request without "master controller" mode (see P0927)
12	Keyword missing	–
17	Request cannot be processed due to the operating state	The current inverter operating state is not compatible with the request received.
101	Parameter number currently deactivated	Dependent on the operating state of the inverter
102	Channel width is insufficient	Communication channel is too small for response
104	Impermissible parameter value	The parameter only permits certain values
106	Request not included / task not supported	After request ID 5, 10, 15
200/201	Changed minimum/maximum not reached or exceeded	The maximum or minimum can be limited further during operation.
204	The available access authorization does not cover parameter changes.	–

### Parameter index (IND), second word

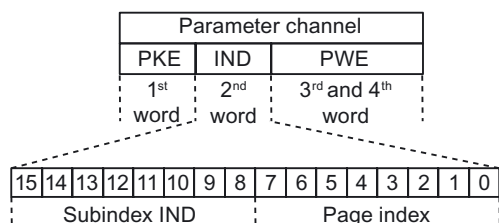

Figure 5-35 IND structure (cyclic)

- The field sub-index is an 8 bit value which, in cyclic data transfer mode, is transferred in the more-significant byte (bits 8 to 15) of the parameter index (IND).
- In this case, the least-significant byte (bits 0 to 7) in the parameter index selects the parameter page for additional parameters.

### Rules for the parameter range

The bit for selecting the parameter page functions as follows:

When it is set to 1, an offset of 2000 is applied in the inverter to the parameter number (PNU) transferred in the parameter channel request before the data is transferred.

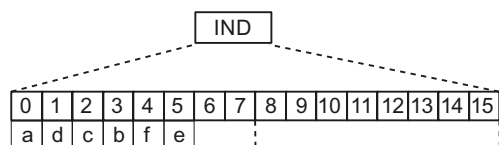

Figure 5-36 IND page index (cyclic)

Table 5- 82 Regulations for setting the PNU

Parameter range	Page index						Bit		Hex value	+ PNU
	a	d	c	b	f	e	9	8		
0000 ... 1999	0	0	0	0	0	0	0	0	0x00	0 – 7CF
2000 ... 3999	1	0	0	0	0	0	0	0	0x80	0 – 7CF
4000 ... 5999	0	0	0	1	0	0	0	0	0x10	0 – 7CF
6000 ... 7999	1	0	0	1	0	0	0	0	0x90	0 – 7CF
8000 ... 9999	0	0	1	0	0	0	0	0	0x20	0 – 7CF
...	...	...	...	...	...	...	...	...	...	...
32.000 ... 33.999	0	0	0	0	0	1	0	0	0x04	0 – 7CF
...	...	...	...	...	...	...	...	...	...	...
64.000 ... 65.999	0	0	0	0	1	0	0	0	0x08	0 – 7CF

Table 5- 83 Coding example for a parameter number in PKE and IND for P7841, index 2

	PKE		IND	
decimal	xx	1841	144	2
hex	xx	731	90	02

**Parameter value (PWE) 3rd and 4th word**

When data is transferred via PROFIBUS or PROFINET, the parameter value (PWE) is transferred as a double word (32 bit). Only one parameter value can be transferred in a single telegram.

A 32 bit parameter value includes PWE1 (high-order word, third word) and PWE2 (low-order word, fourth word).

A 16 bit parameter value is transferred in PWE2 (low-order word, fourth word). In this case, PWE1 (high-order word, third word) must be set to 0 in the PROFIBUS DP master / PROFINET I/O controller.

**Rules for processing requests/responses**

- A request or a response can only be referred to one parameter.
- The master must constantly repeat a request until it receives a suitable response.
- The master recognizes the response to a request that it sent by:
  - Evaluating the response ID
  - Evaluating the parameter number (PNU)
  - Evaluating the parameter index IND, if required
  - Evaluating the parameter value PWE, if necessary.
- The complete request must be sent in a telegram. Request telegrams cannot be subdivided. The same applies to responses.
- If response telegrams contain parameter values, the drive always returns the current parameter value when it repeats response telegrams.

## Control and status words

### Description



The control and status words fulfill the specifications of PROFIdrive profile version 4.1 for "speed control" mode.

### Control word 1 (STW1)

Control word 1 (bits 0 to 10 in accordance with PROFIdrive profile and VIK/NAMUR, bits 11 to 15 for SINAMICS G120 only).

Table 5- 84 Assignment of control word 1

Bit	Value	Significance	Comments
0	0	OFF1	Shutdown, deceleration on the RFG ramp, pulse inhibit when $f < f_{min}$ .
	1	ON	Switches the inverter to "ready for operation" mode. The direction of rotation must be specified via bit 11.
1	0	Coast to standstill (OFF2)	Immediate pulse inhibit, drive coasts to standstill.
	1	No coasting to standstill	All "coast to standstill" (OFF2) commands are canceled.
2	0	Quick stop (OFF3)	Quick stop: Shut down with the deceleration ramp that can be additionally set.
	1	No quick stop	All "quick stop" (OFF3) commands are canceled.
3	0	Disable operation	Control and inverter pulses are locked.
	1	Enable operation	Control and inverter pulses are enabled.
4	0	Reset ramp-function generator (RFG)	RFG output is set to 0 (quickest possible deceleration), inverter remains ON.
	1	Enable ramp-function generator (RFG)	
5	0	Inhibit ramp-function generator (RFG)	The setpoint currently provided by the ramp-function generator is "frozen".
	1	Enable ramp-function generator (RFG)	
6	0	Deactivate setpoint	The value selected at the ramp-function generator input is set to 0 (zero).
	1	Enable setpoint	The value selected at the ramp-function generator input is enabled.
7	1	Fault acknowledgment	Fault is acknowledged with a positive edge; the inverter then switches to "starting inhibit" mode.
8	0	JOG 1 OFF	Drive brakes along the ramp.
	1	JOG 1 ON	The drive ramps-up to the setpoint for the jog mode (direction of rotation: CW = clockwise).
9	0	JOG 2 OFF	Drive brakes along the ramp.
	1	JOG 2 ON	The drive ramps-up to the setpoint for the jog mode (direction of rotation: CCW = counter-clockwise).
10	0	No PLC control	Process data invalid, "sign of life" expected.
	1	PLC control	Control via interface; process data valid

5.11 Operation in fieldbus systems

Bit	Value	Significance	Comments
11	0	No setpoint inversion	Motor runs clockwise in response to a positive setpoint.
	1	Setpoint inversion	Motor runs counter-clockwise in response to a positive setpoint.
12		Not used	
13	1	Motorized potentiometer UP	
14	1	Motorized potentiometer LOWER	
15	1	Data set changeover	Dependent on protocol: with SINAMICS G120 inverters, you can switch between the command data sets (CDS) 0 and 1 in control word 1, bit 15 using the local/remote operation function. This triggers a data set changeover. Command data set 0 is active for local operation, while command data set 1 is active for remote operation. You can now set the application-specific parameters for command and target value sources in both command data sets.

**Default assignment of control word 2 (STW2)**

The settings for control word 2 are defaulted as follows. This can be changed by using BICO.

Table 5- 85 Default setting for control word 2 (not defined for VIK/NAMUR)

Bit	Value	Significance
0	1	Fixed frequency selection bit 0
1	1	Fixed frequency selection bit 1
2	1	Fixed frequency selection bit 2
3	1	Fixed frequency selection bit 3
4	–	Not used
5	–	Not used
6	–	Not used
7	–	Not used
8	1	Enable technology controller
9	1	Enable DC brake
10	–	Not used
11	1	Enable droop speed controller
12	1	Torque control
	0	Speed control
13	0	External fault 1
14	–	Not used
15	–	Not used



**Status word 1 (ZSW1)**

Status word 1 (bits 0 to 10 in accordance with PROFIdrive profile and VIK/NAMUR, bits 11 to 15 for SINAMICS G120 only).

Table 5- 86 Bit assignments for status word 1 (for all PROFIdrive and VIK/NAMUR telegram)

Bit	Value	Significance	Comments
0	1	Ready for switching on	Power supply switched on; electronics initialized; pulses locked.
	0	Not ready for switching on	--
1	1	Ready for operation	Inverter is switched on (ON command present), no active fault, inverter can start as soon as "enable operation" command is issued. See control word 1, bit 0.
	0	Not ready for operation	--
2	1	Operation enabled	Drive follows setpoint. See control word 1, bit 3.
	0	Operation locked	--
3	1	Fault present	Drive is faulty. The drive is faulty, which means that it is not in operation and switches to "starting inhibit" mode once the fault has been successfully rectified and acknowledged.
	0	No fault	--
4	1	"Coast to standstill" not activated	--
	0	"Coast to standstill" activated	"Coast to standstill" (OFF 2) command present.
5	1	"Quick stop" not activated	--
	0	Quick stop activated	"Quick stop" (OFF 3) command present.
6	1	Switch-on locked	The drive only switches to the ON state when the "No coast down" AND "No quick stop" commands (followed by "ON") are issued.
	0	Switch-on not locked	--
7	1	Alarm present	Drive still in operation; alarm in service/maintenance parameter; no acknowledgement; see alarm parameter r2110.
	0	No alarm	No alarm is present or the alarm has disappeared.
8	1	Speed deviation within tolerance range	Setpoint/actual value deviation within tolerance range.
	0	Speed deviation outside of tolerance range	--
9	1	Master control requested	The automation system is requested to assume control.
	0	No control requested	The master is not currently the master controller.
10	1	Maximum frequency reached or exceeded	Inverter output frequency is greater than or equal to the maximum frequency.
	0	Maximum frequency not reached	--
11	1	--	--
	0	Alarm: Motor current/torque limit reached	--
12	1	Motor holding brake active	Signal can be used to control a holding brake.
	0	--	--
13	1	--	Motor data displays overload status.
	0	Motor overload	--

5.11 Operation in fieldbus systems

Bit	Value	Significance	Comments
14	1	Clockwise rotation	--
	0	Counter-clockwise rotation	--
15	1	--	--
	0	Inverter overload	E.g. current or temperature

**Status word 2 (ZSW2)**

Status word 2 has the following default assignment. This can be changed by using BICO.

Table 5- 87 Default setting for status word 2 (not defined for VIK/NAMUR)

Bit	Value	Significance	Description
0	1	DC brake active	DC brake active
1	1	n_act < P2167	Inverter frequency < shutdown limit
2	1	n_act ≥ P1080	Actual frequency > minimum frequency
3	1	i_act ≥ P2170	Current ≥ limit value
4	1	n_act > P2155	Actual frequency > reference frequency
5	1	n_act ≤ P2155	Actual frequency < reference frequency
6	1	Speed setpoint reached	Actual frequency ≥ setpoint
7	1	DC link voltage < P2172	Voltage < threshold value
8	1	DC link voltage ≥ P2172	Voltage > threshold value
9	1	Speed ramp ended	--
10	1	Technology controller output ≤ P2292	PI frequency < threshold value
11	1	Technology controller output > P2291	PI saturation
12	1	Vdc_max controller	--
13	1	Kinetic buffering and flexible response	--
14	1	Not used	--
15	1	Not used	--

## Acyclic communication

### Overview of acyclic communication



The contents of the transferred data set corresponds to the structure of the acyclic parameter channel according to the PROFIdrive profile, Version 4.1 (<http://www.profibus.com/organization.html>).

The acyclic data transfer mode generally allows:

- The transfer of large volumes of user data (up to 240 bytes). A parameter request/response must fit into a data set (max. 240 bytes). The requests/responses are no longer distributed over several data sets.
- Transfer of complete fields or field parts or the complete parameter description.
- Transfer of different parameters in one access (multiple request).
- Reading of profile-specific parameters over an acyclic channel
- Acyclic data transfer in parallel with cyclic data transfer.

Only one parameter request is processed at a time (no pipelining). No spontaneous messages are transferred.

### Acyclic communication over PROFIBUS DP (DPV1)

The PROFIBUS DP expansions DPV1 comprise the definition of acyclic data exchange.

It supports concurrent access by other PROFIBUS masters (Class 2 master, e.g. commissioning tool).

#### Implementation of the extended PROFIBUS DP functions

Suitable channels are provided in the inverters of the SINAMICS G120 series for the different masters/different data transfer types:

- Acyclic data exchange with the same Class 1 master using the DPV1 functions READ and WRITE (with data set 47 (DS47)).
- Acyclic data exchange with the help of a SIEMENS startup tool (Class 2 master, e.g. STARTER). The startup tool can acyclically access parameters and process data in the inverter.
- Acyclic data exchange with a SIMATIC HMI (Human Machine Interface) (second Class 2 master). The SIMATIC HMI can acyclically access parameters in the inverter.
- Instead of a SIEMENS startup tool or a SIMATIC HMI, it is also possible for an external master (Class 2 master) as defined in the acyclic parameter channel according to the PROFIdrive profile, Version 4.1 (with DS47), to access the inverter.

### Acyclic communication over PROFINET (basic mode parameter access)

In the case of basic mode parameter access, the requests and responses are transferred acyclically using the mechanism "Acyclic data exchange" of the communication system.

It supports concurrent access by other PROFINET IO supervisors (e.g. startup tool).

#### Acyclic PROFINET functions

Suitable channels are provided in the inverters of the SINAMICS G120 series for the different communication devices/different data transfer types:

- Acyclic data exchange with IO controller uses the functions READ and WRITE (with 0xB02E).
- Acyclic data exchange with the help of a SIEMENS startup tool (IO supervisor, e.g. STARTER). The startup tool can acyclically access parameters and process data in the inverter.
- Acyclic data exchange with a SIMATIC HMI (Human Machine Interface) (second IO supervisor). The SIMATIC HMI can acyclically access parameters in the inverter.
- Instead of a SIEMENS startup tool or a SIMATIC HMI, it is also possible for an external IO supervisor as defined in the acyclic parameter channel according to the PROFIdrive profile, Version 4.1 (with 0xB02E), to access the inverter.

### 5.11.3.6 STEP 7 program examples

#### STEP 7 program example for cyclic communication

#### S7 program for controlling the inverter



The S7 program, which supplies data for cyclic communication between the inverter and the central control, can be used for PROFIBUS and PROFINET.

In the example provided below, communication between the control and inverter is handled via standard telegram 1. The control specifies control word 1 (STW1) and the speed setpoint, while the inverter responds with status word 1 (ZSW1) and its actual speed value.

**Network 1** : Create control word 1 and speed setpoint

STW1: 0x47E  
 Freq: 0x2500

L W#16#47E  
 T MW 1  
 L W#16#2500  
 T MW 3

**Network 2** : Acknowledge fault

Comment:

U E 0.6  
 = M 2.7

**Network 3** : Start and stop

Comment:

U E 0.0  
 = M 2.0

**Network 4** : Write process data

Comment:

L MW 1  
 T PAW 256  
 L MW 3  
 T PAW 258

Figure 5-37 Controlling the G120 via PROFIBUS or PROFINET

**Network 5** : Read process data

Comment:

L PEW 256  
 T MW 5  
 L PEW 258  
 T MW 7

Figure 5-38 Evaluating the status of G120 via PROFIBUS or PROFINET

**Information about the S7 program**

The hexadecimal numeric value 047E is written to control word 1. The bits in control word 1 are listed in the following table.

Table 5- 88 Assignment of the control bits in the inverter to the SIMATIC flags and inputs

HEX	BIN	Bit in STW1	Significance	Bit in MW1	Bit in MB1	Bit in MB2	Inputs	
E	0	0	ON/OFF1	8		0	E0.0	
	1	1	ON/OFF2	9		1		
	1	2	ON/OFF3	10		2		
	1	3	Operation enable	11		3		
7	1	4	Ramp-function generator enable	12		4		
	1	5	Start ramp-function generator	13		5		
	1	6	Setpoint enable	14		6		
	0	7	Acknowledge fault	15	7	E0.6		
4	0	8	Jog 1	0	0			
	0	9	Jog 2	1	1			
	1	10	PLC control	2	2			
	0	11	Setpoint inversion	3	3			
0	0	12	Irrelevant	4	4			
	0	13	Motorized potentiometer ↑	5	5			
	0	14	Motorized potentiometer ↓	6	6			
	0	15	Data set changeover	7	7			

In this example, inputs E0.0 and E0.6 are linked to the -bit ON/OFF1 or to the "acknowledge fault" bit of STW 1.

The hexadecimal numeric value 2500 specifies the setpoint frequency of the inverter. The maximum frequency is the hexadecimal value 4000.

The process data is written to logical address 256 of the inverter in the cyclic time slice of S7 (e.g. OB1) and read from logical address 256 of the inverter. The logical addresses for field bus communication were defined in HW Config.

**STEP 7 sample program for acyclic communication**

**Simple S7 program for parameterizing the inverter**



The S7 program, which supplies data for acyclic communication between the inverter and the central control is valid for PROFIBUS.

For PROFINET, instead of blocks SFC58 and SFC59, use blocks SFB52 and SFB53.

The number of simultaneous requests for acyclic communication is limited. More detailed information can be found in the Internet

(<http://support.automation.siemens.com/WW/view/en/15364459>):

OB1 : "Main Program Sweep (Cycle)"

Kommentar:

**Netzwerk 1** : Define Read or write

Kommentar:

```

// Read parameter
O{
  U    M    9.2
  UN   M    9.1
}
O{
  U    M    9.0
  UN   M    9.1
}
R    M    9.3

SPB  RD

// write parameter
O{
  U    M    9.3
  UN   M    9.0
}
O{
  U    M    9.1
  UN   M    9.0
}
R    M    9.2

SPB  WR
BEA

RD:  NOP  0
     CALL FC  1
     BEA

WR:  NOP  0
     CALL FC  3
    
```

Figure 5-39 STEP 7 program example for acyclic communication - OB1

Flags 9.0 to 9.3 specify whether parameters are read or written:

- M9.0: request to read parameters
- M9.1: request to write parameters
- M9.2: displays the read process
- M9.3: displays the write process

### FC1 to read parameters from the inverter

Inverter parameters are read via SFC 58 and SFC 59.

FC1 : PAR\_RD

Kommentar:

Netzwerk 1 : Parameters for reading

Kommentar:

```
      L    MB    62
      T    DB1.DBB  3
//-----
      L    MW    50
      T    DB1.DBW  6
      L    MB    58
      T    DB1.DBB  5
      L    MW    63
      T    DB1.DBW  8
//-----
      L    MW    52
      T    DB1.DBW 12
      L    MB    59
      T    DB1.DBB 11
      L    MW    65
      T    DB1.DBW 14
//-----
      L    MW    54
      T    DB1.DBW 18
      L    MB    60
      T    DB1.DBB 17
      L    MW    67
      T    DB1.DBW 20
//-----
      L    MW    56
      T    DB1.DBW 24
      L    MB    61
      T    DB1.DBB 23
      L    MW    69
      T    DB1.DBW 26
```



**Netzwerk 2 : Read request**

Kommentar:

```

CALL SFC 58
REQ :=M9.0
IOID :=B#16#54
LADDR :=W#16#170
RECNUM :=B#16#2F
RECORD :=P#DB1.DBX0.0 BYTE 28
RET_VAL:=MW10
BUSY :=M8.1

U M 8.1
R M 9.0
S M 9.2
    
```

**Netzwerk 3 : Read delay after sending the read request**

Kommentar:

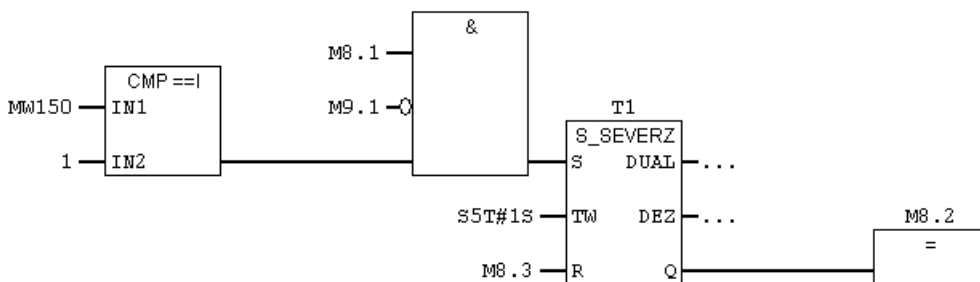

**Netzwerk 4 : Read request**

Kommentar:

```

CALL SFC 59
REQ :=M8.2
IOID :=B#16#54
LADDR :=W#16#170
RECNUM :=B#16#2F
RET_VAL:=MW12
BUSY :=M8.3
RECORD :=P#DB2.DBX0.0 BYTE 36

U M 8.3
R M 8.2
    
```

Figure 5-40 Function block for reading parameters

You first have to define how many parameters (MB62), which parameter numbers (MW50, MW52, etc.), and how many parameter indices (MW58, MB59, etc.) are read for each parameter number. The specifications are saved in DB1.

SFC 58 copies the specifications for the parameters to be read from DB1 and sends them to the inverter as a read request. No other read requests are permitted while this one is being processed.

Once the read request has been issued and a waiting time of one second has elapsed, the parameter values are copied from the inverter via SFC 59 and saved in DB2.

**FC3 to write parameters to the inverter**

FC3 : PAR\_WR

Kommentar:

**Netzwerk 1** : Parameter for writing

Kommentar:

```
L    MW    21
T    DB3.DBW    6
L    MW    23
T    DB3.DBW    8
L    MW    35
T    DB3.DBW   12
```

**Netzwerk 2** : Write request

Kommentar:

```
CALL SFC 58
REQ    :=M9.1
IOID   :=B#16#54
LADDR  :=W#16#170
RECNUM :=B#16#2F
RECORD :=P#DB3.DBX0.0 BYTE 14
RET_VAL:=MW10
BUSY   :=M8.1

U    M    8.1
R    M    9.1
S    M    9.3
```

Figure 5-41 Function block for writing parameters

You first have to define which value (MW35) is written to which parameter index (MW23) of which parameter (MW21). The specifications are saved in DB3.

SFC 58 copies the specifications for the parameters to be written from DB3 and sends them to the inverter. No other write requests are permitted while this one is being processed.

For more information about SFC 58 and SFC 59, consult the STEP 7 online help.

## 5.12 Safety functions

### 5.12.1 Overview

#### Functional safety

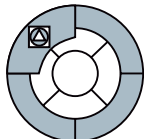

Machine components operated by electrical drives are intrinsically hazardous. If a drive is incorrectly used or acts in an unexpected manner in the event of a malfunction, not only can this damage the machine but it can also cause severe injury or death. Functional safety reduces this risk of accidents caused by machines to an acceptable residual risk.

#### Integrated safety functions in SINAMICS G120

The CU240S DP-F and CU240S PN-F Control Units feature a range of integrated safety functions, which are certified in accordance with Cat. 3 to EN 954-1 and SIL 2 to IEC 61508:

Table 5- 89 Integrated safety functions

Abbreviation	Description (DE/EN)	Function
STO	Sicher abgeschaltetes Moment Safe Torque Off	The motor is switched safely to zero torque.
SS1	Sicherer Stopp 1 Safe Stop 1	The motor is brought to a controlled standstill.
SLS	Sicher begrenzte Geschwindigkeit Safely Limited Speed	The speed of the motor is restricted in a controlled manner.
SBC	Sichere Bremsenansteuerung Safe Brake Control	The motor holding brake is safely controlled.

#### Basic prerequisites for using fail-safe functions

1. The machine risk assessment (e.g. in compliance with EN ISO 1050, "Safety of machinery - Risk assessment - Part 1: Principles") allows the use of inverter safety functions in accordance with SIL 2 or category 3.
2. The speed control of the inverter must function perfectly. Each fail-safe drive (drive = inverter + motor + brake + driven machine) must be set up in such a way that all operating procedures performed by the driven machine can be properly monitored and that the inverter operates below its limit values (for current, temperature, voltage, etc.). The performance and parameters of the inverter must be compatible with both the connected motor and the application in question.
3. Once the machine has been successfully commissioned, you must review the typical operating conditions and operate the machine close to the permissible limit values. The fail-safe drive must not malfunction under any circumstances.

### Permissible control modes for using fail-safe functions

When the above-mentioned conditions are fulfilled, the fail-safe functions can be used for both V/f control and vector control.

### Restrictions regarding SLS and SS1

 <b>CAUTION</b>
--

<p>Safety functions SS1 and SLS must not be used if the motor, after it has been switched-off, can still be accelerated by the mechanical elements of the connected machine component.</p> <p>Whether or not a mechanical brake is installed is irrelevant.</p>
---

Examples:

1. For the hoisting gear of a crane, the suspended load can accelerate the motor as soon as the motor is switched-off. In this case, safety functions SS1 and SLS are not permissible. Even if the mechanical brake of the hoisting gear is generally closed after the motor has been switched-off, this is of no significance when it comes to the fact that SS1 and SLS safety functions are prohibited in this application.
2. A horizontal conveyor is always braked to a standstill due to friction as soon as the motor is switched-off. In this case, safety functions SS1 and SLS can be used without any restriction.

## Examples of how the safety functions can be applied

Table 5- 90 Application examples for safety functions

Description of problem	Suitable safety function	Solution
When the EMERGENCY STOP button is pressed, a stationary motor must not start unintentionally.	STO	Control the inverter via terminals using an Emergency-Stop button.
A central EMERGENCY STOP button is designed to prevent more than one drive from starting unintentionally.	STO	Evaluate the Emergency-Stop button in a central control, control the inverter via PROFIsafe.
A short-circuit and cable break occurring when the motor holding brake is activated are to be signaled.	SBC	Connect the motor holding brake to the optional 'Safe Brake Module' of the inverter.
Having opened a protective door, the machine operator must enter the hazardous zone around a machine and run a conveyor belt at low speed.	SLS	Control the inverter via terminals using a button to move the conveyor belt.
When a protective door is opened, the motor must be stationary.	SS1	Activate the SS1 function in the inverter and enable the protective door as soon as the inverter signals back 'STO'.

### Controlling the safety functions

The safety functions in the inverter can be controlled via fail-safe digital inputs as well as over safe bus communication PROFIsafe via PROFIBUS or PROFINET in conjunction with a fail-safe CPU.

### Safe feedback signals from the inverter

When fail-safe functions are used, feedback is generally required as to whether or not the drive is in a safe state.

With the SLS function, for example, this is the case if the inverter has decelerated the motor to below the speed monitoring limit. This safe state is signaled by the inverter via fail-safe channels. On the basis of this, a higher-level controller can trigger further actions (e.g. enable a protective door).

Fail-safe feedback signals from the inverter are realized using PROFIsafe.

### Monitoring the safety functions -passivation:

A fail-safe inverter permanently monitors its hardware and software as well as the timing of the safety function as soon as it was activated. In the case of a fault, the inverter passivates itself:

- The inverter initiates an STO, i.e. the motor is safely switched into a no-torque condition
- The inverter signals a fault

In the List Manual, under the inverter fault message, you will find information and instructions as to what you must do in order to acknowledge the fault and to terminate the inverter passivation.

### 5.12.2 Connecting-up the fail-safe inputs

#### Connecting sensors to fail-safe inputs

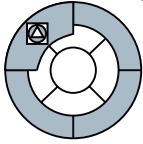

The fail-safe inputs of the inverter are designed for connecting electromechanical sensors with two NC contacts.

It is not possible to directly connect sensors with two NO contacts and antivalent contacts (1 NO contact and 1 NC contact).

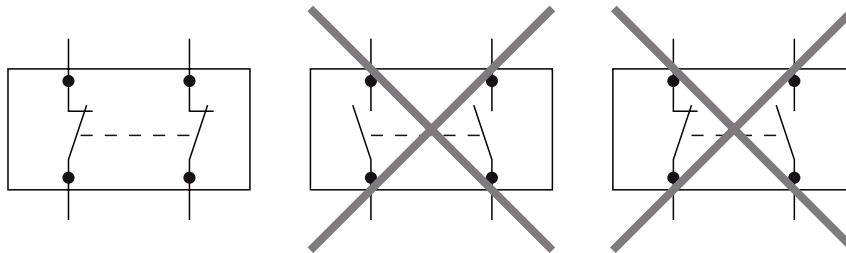

Figure 5-42 Sensors that can be connected to the fail-safe inputs

The following diagrams show the principle connection options for fail-safe inputs for the case that all of the components are mounted and installed inside a control cabinet.

- Connecting sensors with electromechanical contacts, e.g. Emergency Stop mushroom pushbuttons and end position switches
- Connecting electronic sensors, e.g. SIMATIC FS-400 light curtains
- Connecting safety relays, e.g. SIRIUS 3TK28.
- Connecting fail-safe outputs, e.g. SIMATIC F digital output modules

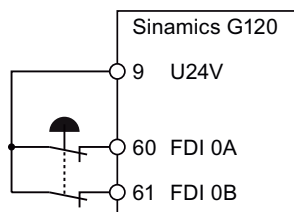

Figure 5-43 Connecting an electromechanical sensor

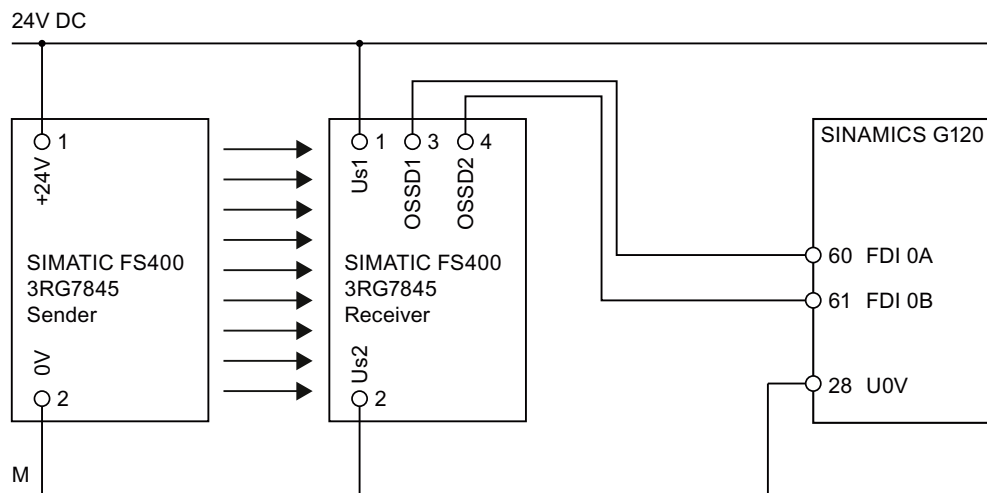

Figure 5-44 Connecting-up an electronic sensor inside a control cabinet

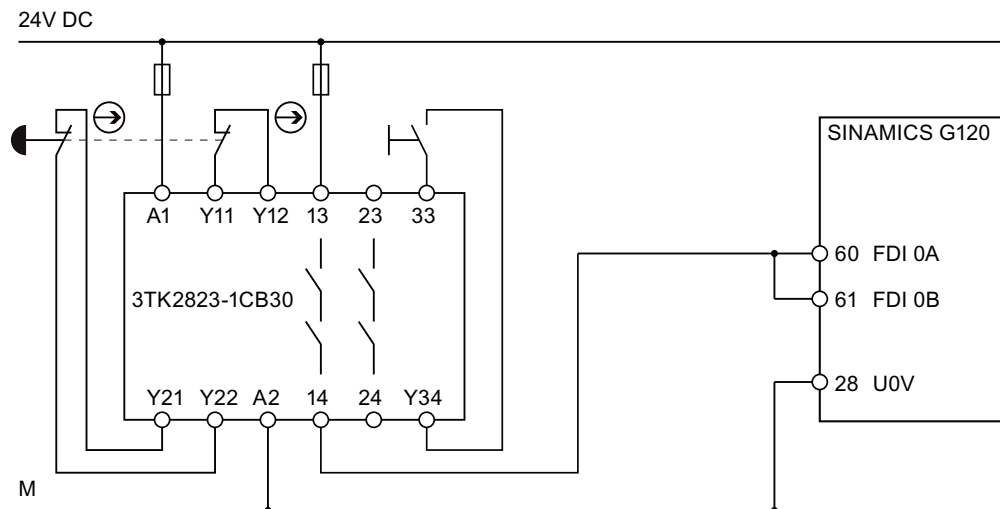

Figure 5-45 Connecting-up a safety relay in a control cabinet

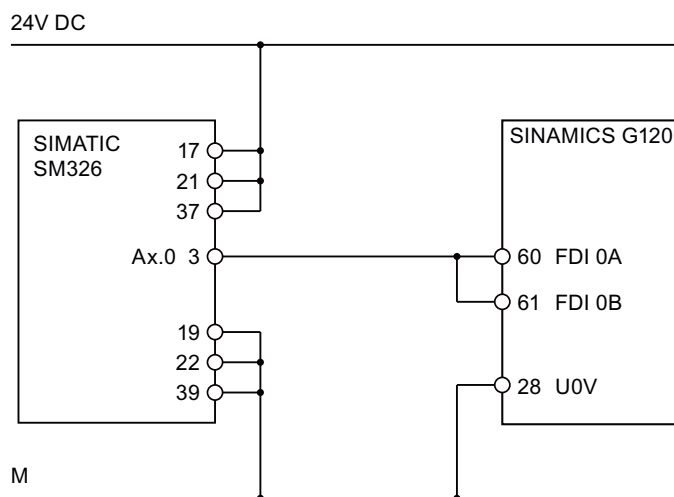
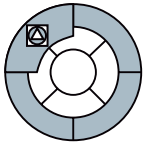

Figure 5-46 Connecting up an F digital output module in a control cabinet

Additional interconnection options are listed under  
(<http://support.automation.siemens.com/WW/view/en/27231237>):

### 5.12.3 Restoring safety-related parameters to the factory setting



Before starting to commission the safety functions, you should know whether the safety-relevant parameters of the inverter have already been changed. If you do not precisely know the setting of the safety-relevant parameters, then reset these parameters to the factory setting.

#### Which parameters are reset to the factory setting?

Resetting the safety-relevant parameters to the factory setting does not change the setting of the other parameters, e.g. the motor data or the significance of these terminals.

Restoring the factory setting sets all of the safety-relevant parameters back to their standard values. Exceptions:

- P9761 SI password input
- P9762 SI password change
- P9763 SI confirmation of password change

#### Procedure

1. Connect the PC and the inverter using the PC connection kit or via the fieldbus
2. Go online by clicking on the button  and call the screen of the safety functions by double clicking. The Safety Integrated menu is displayed in the main screen.

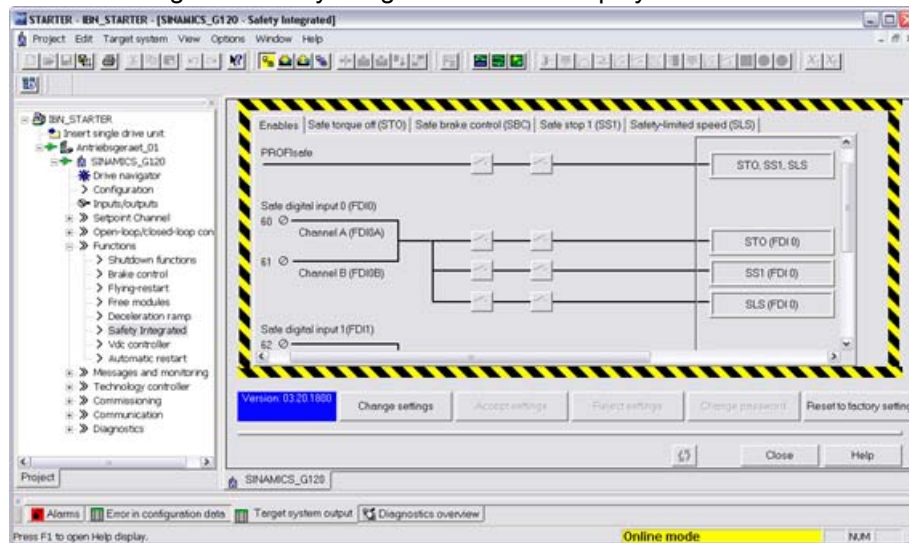

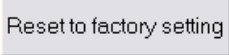
3. With the mouse, click on the button  at the lower edge of the screen.
4. Enter the safety password in the following screen and confirm with OK.

The safety-relevant parameters of the inverter have now been reset to the factory setting.



### 5.12.4 Controlling the safety functions via PROFIsafe

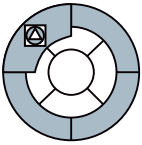

The safety functions can either be controlled via digital inputs or via the fieldbus i.e. PROFIBUS or PROFINET with the fail-safe PROFIsafe profile.

Examples for connecting an inverter to a fail-safe SIMATIC control via PROFIsafe is provided in the Internet under the following URL:

- PROFIBUS control of the safety functions (STO, SLS and SS1) of a SINAMICS G120 with an S7 300-F CPU (<http://support.automation.siemens.com/WW/view/en/24093625>)
- PROFINET control of the safety functions (STO, SLS and SS1) of a SINAMICS G120 with an S7 300-F CPU (<http://support.automation.siemens.com/WW/view/en/29585944>)

### 5.12.5 Controlling the safety functions via digital inputs

#### Activating fail-safe inputs

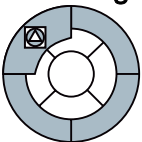

A fail-safe input of the inverter is activated by assigning it a safety function. This is described in the following using an example. The example shows the assignment of the fail-safe digital input FDI0 to the STO safety function using STARTER.

#### Procedure

1. Connect your PC to the inverter e.g. using the PC connection kit.
2. Launch the STARTER parameterization tool and go online.
3. In STARTER, call the screens with the fail-safe functions

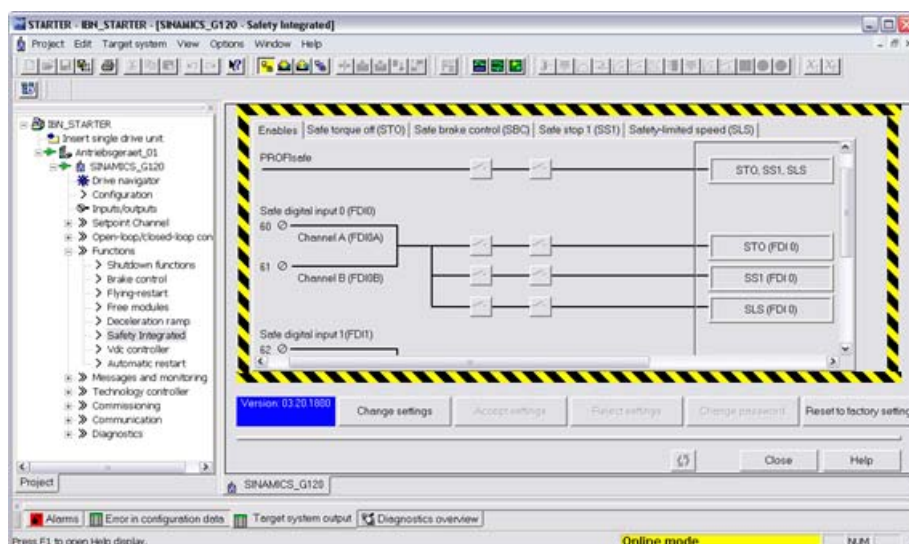

4. Select the "Enables" tab. None of the fail-safe inputs are activated in the factory setting, i.e. no input is assigned to a safety function

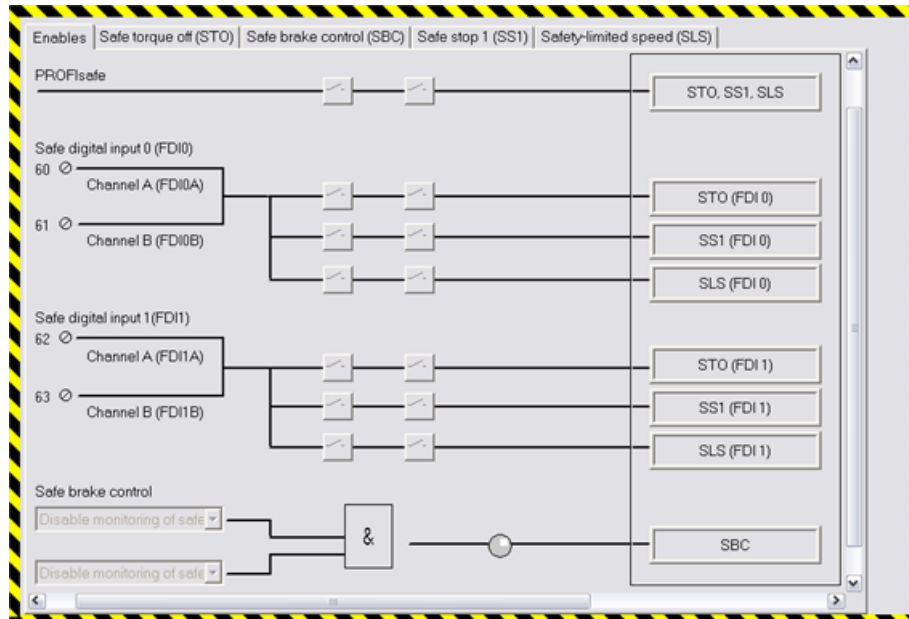

5. Click on the button

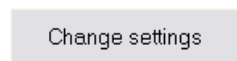

on the lower edge of the STARTER screen and enter the safety password. The default password is '12345'.

The inverter outputs alarm A1698 to signal that safety settings are currently being changed. Further, the following LEDs flash on the Control Unit: RDY, ES, STO, SS1, and SLS.

6. Assign the fail-safe digital input 0 (FDI0) to the STO function by clicking on the appropriate two switches.

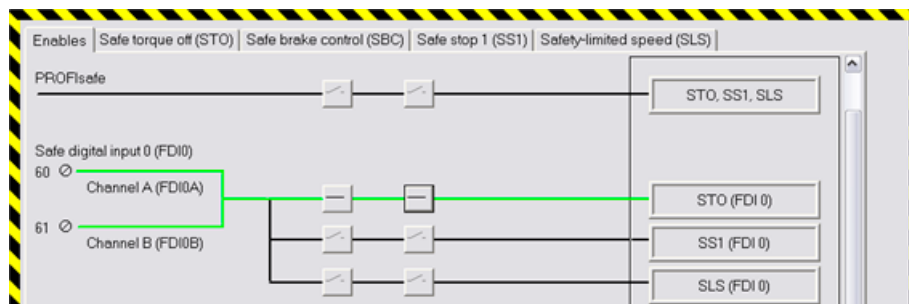

The required function is always selected on two channels, i.e. both switches should always be closed to activate. An activated fail-safe input is represented by a green line.

You can then make additional settings in the safety function screens or finalize the commissioning of the safety functions.

## Debouncing and filtering the signals from the fail-safe input

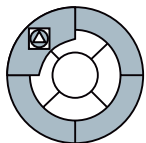

As soon as a fail-safe input has been assigned to a safety function, the inverter checks the consistency of the input signal. Consistent signals at both terminals always assume the same signal state (high or low).

### Reasons for inconsistent input signals

With electromechanical sensors (e.g. EMERGENCY STOP buttons or door switches), the contacts may bounce briefly at the moment switching takes place. The two sensor contacts never switch at exactly the same time either. As a result, the inverter responds with a fault and indicates signal inconsistencies.

To prevent this, the input signals in the inverter must be filtered.

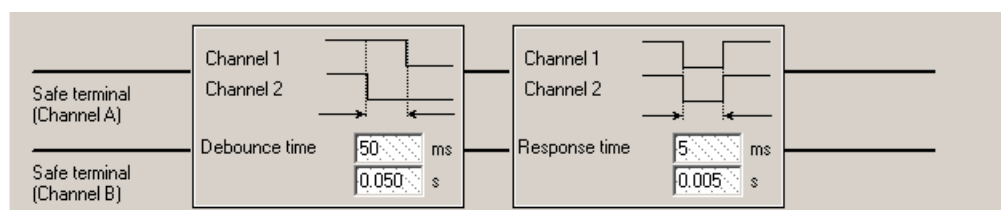

Figure 5-47 Debouncing and filtering the signals at the fail-safe inputs

### Setting the signal filters in the inverter

Set the debounce time (P9650 and P9850) to such a level that faults caused by contact bounce or signal faults cannot occur.

#### Note

Short response times are essential for ensuring the functional safety of machines. The filter times increase the time required by the inverter to respond to fail-safe signals. For this reason, do not set the filter times any longer than required.

### Transferring the safety-relevant parameters

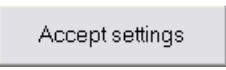
1. Click on the button  to accept all of the settings that you have made.
2. If the default password has not been changed, you are prompted to change it.
3. In the following dialog box, confirm the checksums of the safety-related parameters. This concludes the process of changing the safety settings.

### 5.12.6 Settings for the "STO" function

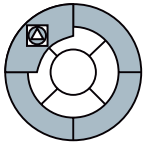

You can make two settings for the STO safety function.

#### Testing the shutdown paths

Shutdown paths are electronic circuits of the inverter used to disconnect a motor in a safety-relevant fashion. The shutdown paths must be checked regularly to ensure that the fail-safe inverter complies with certification requirements.

The shutdown paths are always checked after the inverter has been switched on. Further, the inverter always checks, in its factory setting, the shutdown paths if the STO function is de-selected.

The shutdown path test takes approximately three seconds. The motor cannot be switched on during the test. The inverter signals this status as 'switch on inhibit' in the status word (r0052, bit 6). A higher-level control must evaluate this bit to ensure that the inverter accepts the ON command.

#### Deactivating the shutdown path test after an ON command

For applications where the STO safety function is very frequently required, the delay caused by testing the shutdown paths can be disturbing. If you wish to avoid the waiting time after each STO request, deactivate the regular shutdown path test when exiting the STO function (P9601, bit 1 and P9801, bit 1).

1. Connect your PC to the inverter e.g. using the PC connection kit.
2. Launch the STARTER parameterization tool and go online.
3. In STARTER, call up the screens displaying the fail-safe functions.
4. Select the "Safe Torque Off (STO)" screen from the safety function screens

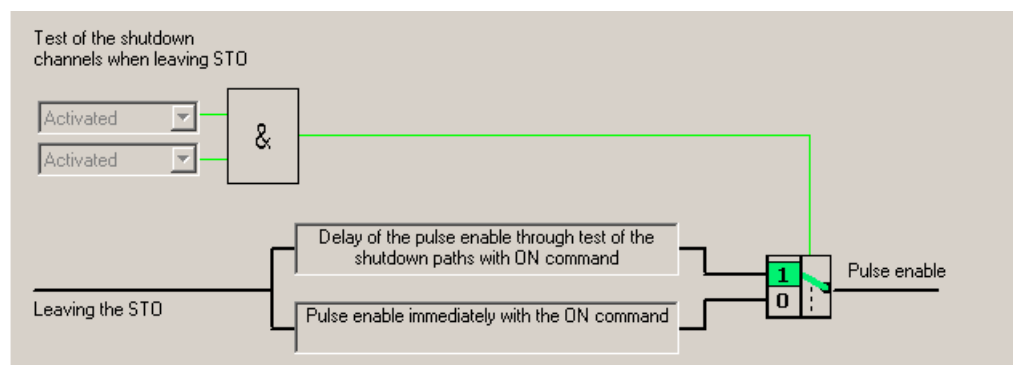

5. Click on the button

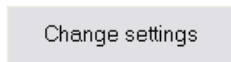

on the lower edge of the STARTER screen and enter the safety password. The default password is '12345'.

The inverter outputs alarm A1698 to signal that safety settings are currently being changed. Further, the following LEDs flash on the Control Unit: RDY, ES, STO, SS1 and SLS

6. Deactivate the regular shutdown path test when exiting the STO function.

### Test periods to monitor the shutdown paths

A timer monitors the execution of the shutdown path test. The monitoring time (P9659) can be extended up to a maximum of one year. When the timer has expired, this is signaled via status word r9772, bit 15. A higher-level controller must monitor this bit to ensure that the STO safety function is tested on a regular basis.

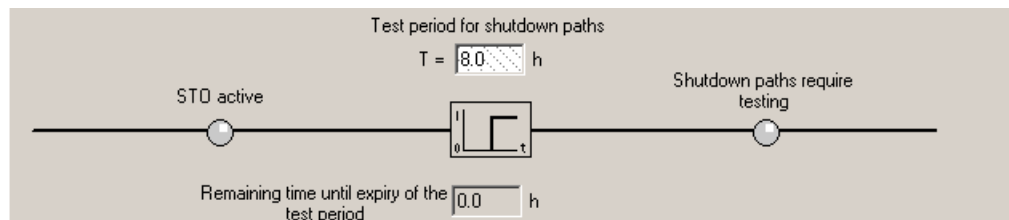

Figure 5-48 Test period for shutdown paths

---

#### Note

If you have deactivated the regular shutdown path test, before the test period expires, the inverter must be switched off once and switched-on again.

---

### Transferring the safety-relevant parameters

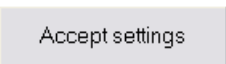
1. Click on the button  to accept all of the settings that you have made.
2. If the default password has not been changed, you are prompted to change it.
3. In the following dialog box, confirm the checksums of the safety-related parameters. This concludes the process of changing the safety settings.

### 5.12.7 Settings of the SS1, SLS and SBC safety functions

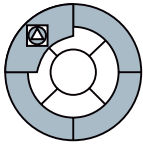

Always parameterize the fail-safe functions using the STARTER PC tool. Parameterizing fail-safe functions using the BOP is always very time consuming due to the fact that parameters must be set twice.

The safety functions are parameterized according to the following schematic:

1. Go online with STARTER, open the screen with the safety functions and click on the button

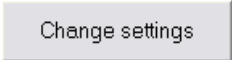

2. Enable the safety-related parameters by entering the correct password
3. Change the parameters of the safety function
4. Complete parameterization using the button

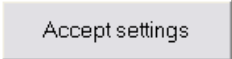

5. Confirm the checksums of the safety-related parameters

You will find a detailed description of the SS1, SLS and SBC functions in the Function Manual: (<http://support.automation.siemens.com/WW/view/en/31676845>)

#### Safety function SS1 (Safe Stop 1)

Table 5- 91 Safety-related parameters for SS1

Parameters	Description
P9603 = ... P9803 = ...	<b>Selecting the signal source of the safety functions</b>
P9680 = ... P9880 = ...	<b>Ramp deceleration</b> You will find a calculation formula for the ramp deceleration in the Function Manual
P9681 = ... P9881 = ...	<b>Ramp-down time of the braking ramp</b>
P9682 = ... P9882 = ...	<b>Minimum frequency for the standstill detection</b>
P9761 = ...	<b>Password for the safety functions</b>
P9799 = ... P9899 = ...	<b>Checksum of the safety-related parameters</b>
r9798 = ...	
r9898 = ...	

### Safety function SLS (Safely Limited Speed)

The SLS safety function can be operated in three different modes. Depending on the mode, the inverter behavior differs when the SLS safety function is activated.

Table 5- 92 Safety-related parameters for SLS

Parameters	Description
P9603 = ... P9803 = ...	<b>Selecting the signal source of the safety functions</b>
P9680 = ... P9880 = ...	<b>Ramp deceleration</b> You will find a calculation formula for the ramp deceleration in the Function Manual
P9681 = ... P9881 = ...	<b>Ramp-down time of the braking ramp</b>
P9690 = ... P9890 = ...	<b>Fixed setpoint for SLS</b>
P9691 = ... P9891 = ...	<b>Tolerance to monitor the velocity</b>
P9692 = ... P9892 = ...	<b>Mode of the SLS safety function</b>
P9761 = ...	<b>Password for the safety functions</b>
P9799 = ... P9899 = ... r9798 = ... r9898 = ...	<b>Checksum of the safety-related parameters</b>

### Safety function SBC (Safe Brake Control)

The SBC safety function is only possible in conjunction with the Safe Brake Relay.

Table 5- 93 Safety-related parameters for SBC

Parameters	Description
P9602 = ... P9802 = ...	<b>Enabling the SBC safety function</b>
P9761 = ...	<b>Password for the safety functions</b>
P9799 = ... P9899 = ... r9798 = ... r9898 = ...	<b>Checksum of the safety-related parameters</b>

### 5.12.8 Acceptance test and report

#### Acceptance test report for safety functions

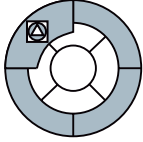

To verify safety-related parameters, an acceptance test must be performed after initial commissioning has been carried out and after the safety-related parameters have been changed. The acceptance test must be documented in the form of a report. The acceptance test reports are part of the machine documentation and must be archived accordingly.

The checksums (r9798 and r9898) ensure that subsequent changes to safety-related parameters can be identified.

#### What must be carried out when an acceptance test is performed for safety functions?

1. **Machine documentation**

Document the machine, including its fail-safe functions.

- Description of the machine and overview/block diagram
- Fail-safe functions for each drive
- Description of the fail-safe equipment

An empty document is provided as an example following this section.

2. **Function test**

Check each individual fail-safe function. An empty document is provided as an example following this section.

3. **Complete the report**

Document the commissioning period and sign the report.

- Check the parameters for fail-safe functions.
- Document the checksums.
- Provide evidence showing that the data has been backed up and archived.
- Sign the report.

An empty document is provided as an example following this section.

4. **Enclosures with the report**

Include records and printouts of measurements associated with the function test.

- Alarm reports
- Printouts of curve characteristics
- When required, you can create a list with all of the changed parameters of the inverter. Instructions on how to do this are available here:  
(<http://support.automation.siemens.com/WW/view/en/29319456>)



5.12.8.1 Documentation of the acceptance test

Overview

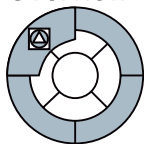

Acceptance test No.	
Date	
Person carrying out the test	

Table 5- 94 Description of the system and overview/block diagram

Designation	
Type	
Serial number	
Manufacturer	
End customer	
Block diagram/overview diagram of the machine	

Table 5- 95 Fail-safe functions for each drive

Drive No.	Firmware version	SI version	Fail-safe functions
	r0018 =	r9770 =	Example: STO

Table 5- 96 Description of the fail-safe equipment/devices

Drive No.	Description
	Examples: Wiring of STO terminals (protective door, Emergency-Off) grouping of STO terminals

5.12.8.2 Function check of the acceptance test

Description

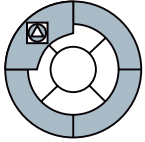

The function check must be carried out for each individual drive (under the assumption that the machine permits this).

Conducting the test

First commissioning	Please enter a check mark	
Standard commissioning		

Function check, "Safe Torque Off" (STO)

This check involves the following steps:

Table 5- 97 Function, "Safe Torque Off" (STO)

No.	Description	Status
1.	Initial state <ul style="list-style-type: none"> <li>The inverter signals "ready for switching on" (P0010 = 0)</li> <li>No safety faults and alarms</li> <li>r9772.0 = r9772.1 = 0 (STO deselected and inactive)</li> <li>P9659 = time intervals for the forced checking procedure correctly set</li> </ul>	
2.	Switch on the motor	
3.	Check whether the motor involved rotates	
4.	Select STO while the ON command is being issued	
5.	Check the following points: <ul style="list-style-type: none"> <li>The motor coasts down to a standstill</li> <li>The motor is braked and held by the mechanical brake if a brake is being used</li> <li>No safety fault</li> <li>r9772.0 = r9772.1 = 1 (STO selected and active), r9772.14 = 1, if safe brake control is active</li> </ul>	
6.	Deselect STO	
7.	Check the following points: <ul style="list-style-type: none"> <li>No safety fault</li> <li>r9772.0 = r9772.1 = 0 (STO deselected and inactive), r9772.14 = 0</li> </ul>	
8.	Check whether the motor involved is running. If yes, check the following points: <ul style="list-style-type: none"> <li>That the cabling between the Control Unit and Power Module is correct</li> <li>Correct assignment, drive No. - inverter - Power Module - motor</li> <li>That the hardware is operating correctly</li> <li>That the shutdown paths are correctly wired</li> <li>Correct STO terminal assignment at the Control Unit</li> <li>Correct parameterization of the STO function</li> <li>Routine for the forced checking procedure of the shutdown paths</li> </ul>	

### Function check, "Safe Stop 1" (SS1)

This check involves the following steps:

Table 5- 98 Function, "Safe Stop 1" (SS1)

No.	Description	Status
1.	Initial state <ul style="list-style-type: none"> <li>• The inverter signals "ready for switching on" (P0010 = 0)</li> <li>• No safety faults and alarms</li> <li>• r9772.0 = r9772.1 = 0 (STO deselected and inactive)</li> <li>• r9772.2 = r9772.3 = 0 (SS1 deselected and inactive)</li> </ul>	
2.	Switch on the motor	
3.	Check whether the motor involved rotates	
4.	Select SS1 while the ON command is being issued	
5.	Check the following points: <ul style="list-style-type: none"> <li>• The motor speed decelerates corresponding to the selected ramp time (if required, use a stopwatch)</li> <li>• The motor coasts down to a standstill after the parameterized minimum speed has been fallen below</li> <li>• The motor is braked and held by the mechanical brake if a brake is being used</li> <li>• No safety fault</li> <li>• r9772.1 = 1 (STO active)</li> <li>• r9772.2 = 1 (SS1 selected)</li> <li>• r9772.14 = 1, if the monitoring function of the safety-relevant brake is activated</li> </ul>	
6.	Cancel SS1	
7.	Check the following points: <ul style="list-style-type: none"> <li>• No safety fault</li> <li>• r9772.1 = 0 (STO inactive)</li> <li>• r9772.2 = 0 (SS1 deselected)</li> <li>• r9772.14 = 0</li> </ul>	
8.	Check whether the motor involved rotates. If yes, check the following points: <ul style="list-style-type: none"> <li>• The cabling between the Control Unit and Power Module is correct</li> <li>• Correct assignment, drive No. - inverter - Power Module - motor</li> <li>• The hardware can function correctly</li> <li>• Correct wiring of the shutdown paths</li> <li>• Correct STO terminal assignment at the Control Unit</li> <li>• Correct parameterization of the SS1 function</li> </ul>	

**Function check, "Safely Limited Speed" (SLS)**

This check involves the following steps:

Table 5- 99 Function, "Safely Limited Speed" (SLS)

No.	Description	Status
1.	Initial state <ul style="list-style-type: none"> <li>• The inverter signals "ready for switching on" (P0010 = 0)</li> <li>• No safety faults and alarms</li> <li>• r9772.4 = r9772.5 = 0 (SLS deselected and inactive)</li> </ul>	
2.	Switch on the motor. The motor speed must be higher than the parameterized safely limited speed, if the machine permits this	
3.	Check whether the motor involved rotates	
4.	Select SLS while the ON command is being issued	
5.	Check the following points: <ul style="list-style-type: none"> <li>• r9772.4 = 1 (SLS selected)</li> <li>• The motor response depends on the selected mode of the SLS function                             <ul style="list-style-type: none"> <li>– SLS mode 0 The drive speed decreases corresponding to the selected ramp time and then the inverter is subsequently passivated</li> <li>– SLS mode 1 The motor speed decelerates corresponding to the selected ramp time. The motor then rotates with the parameterized safely limited speed</li> <li>– SLS mode 2 The inverter is immediately passivated, the motor coasts down</li> <li>– SLS mode 3 The inverter is immediately passivated, the motor coasts down</li> </ul> </li> <li>• r9772.5 = 1 (SLS active)</li> </ul>	
6.	Deselect SLS	
7.	Check the following points: <ul style="list-style-type: none"> <li>• No safety fault</li> <li>• r9772.4 = r9772.5 = 0 (SLS deselected and inactive)</li> </ul>	
8.	Check whether the drive involved is running. If yes, check the following points: <ul style="list-style-type: none"> <li>• The cabling between the Control Unit and Power Module is correct</li> <li>• Correct assignment, drive No. - inverter - Power Module - motor</li> <li>• The hardware can function correctly</li> <li>• Correct wiring of the shutdown paths</li> <li>• Correct parameterization of the SLS function</li> </ul>	

### 5.12.8.3 Filling in the acceptance report

#### Parameters of the fail-safe functions

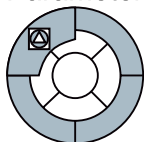

	Comparison value of the checksums checked?	
	Yes	No
Control Unit		

#### Checksums

Drive		Checksums of the Control Unit	
Name	Drive No.	r9798	r9898

#### Data backup/archiving

	Storage medium			Where is it kept
	Type	Designation	Date	
Parameter				
PLC program				
Circuit diagrams				

#### Signatures

##### Commissioning engineer

Confirms that the checks and test listed above have been correctly conducted.

Date	Designation	Company/Dept.	Signature

##### Machinery construction OEM

Confirms the correctness of the parameterization documented above.

Date	Designation	Company/Dept.	Signature



## Servicing and maintenance

### 6.1 Behavior of the frequency inverter when replacing components

#### Components should be replaced by the same type and the same version

To ensure maximum plant availability, the Control Unit and the Power Module can, when required, be replaced by a unit of the same type and the version without having to recommission the drive.

A memory card with a valid parameter set is required when replacing a Control Unit without having to re-commission it.

The details are described in the following sections.

---

#### Note

##### Valid parameter set

A valid parameter set is a parameter set that matches the type and software release of the Control Unit and that has been adapted to fit the particular application.

##### Message F0395

When switching-on the unit for the first time after replacing the Control Unit or Power Module, message F0395 is always displayed on the BOP (the SF on the CU lights up).

The message indicates that components were replaced. In this case, when switching-on the motor, check the direction of rotation and the response to control signals.

---

#### Replacing different components or version

If you replace different components (e.g. Profibus CU for Profinet CU) or components with different software releases, then the drive must always be re-commissioned.

#### Questions that can arise in conjunction with replacing components:

- How do I create a valid parameter set?  
When commissioning, you can create a valid parameter set either using the commissioning tool STARTER (Page 58) or using the operator panel (Page 71).
- Which options are available for saving a valid parameter set? You can save a valid parameter set either on the memory card (Page 77) or on the computer (Page 58) that you use for commissioning with STARTER.
- How do I load a valid parameter set into my inverter?  
From the memory card when the inverter is powered-up or by manually downloading a parameters set either from the memory card (Page 78) or from the PC (Page 58).

---

#### Note

##### Standard commissioning

As a result of the similarity in the procedure to replace components, the standard commissioning with memory card is also described in this chapter.

---

## 6.2 Replacing the Power Module

When required, the Power Module can be replaced by an identical module (the same type and the same version) without having to re-commission it.

If you replace a Power Module by one of the same type and the same format, however with a higher power rating, then re-parameterization is not absolutely necessary and you can acknowledge message F0395. However, this can have a negative impact on the open-loop / closed-loop control accuracy.

If you replace a Power Module by one with the same type and with a lower power rating, then then drive must be re-commissioned.

 <b>CAUTION</b>
--

Before you replace the Power Module, ensure that all of the parameter settings are saved in the EEPROM of the Control Unit (refer to P0014 or P0971).
---

### Replacing a Power Module

1. Switch-off the Power Module power supply and wait 5 minutes until the device has discharged itself.
2. Disconnect the Power Module connecting cable
3. Remove the Control Unit from the Power Module
4. Replace the Power Module
5. Mount the Control Unit onto the new Power Module
6. Connect the Power Module connecting cable
7. Switch-on the Power Module power supply again  
**Before switching-on the power supply again, ensure that the new Power Module is correctly installed and connected.**
8. Wait until the inverter has completely booted (RDY-LED and SF-LED are lit, BOP returns to the standard display)
9. Acknowledge message F0395 (SF-LED off)
10. When switching-on the motor, check the direction of rotation and the response to control signals.
11. For fail-safe inverters, also check the safety functions that have been set.



## 6.3 Replacing the Control Unit

Under the prerequisite that you have a memory card with a valid parameter set, when required, you can replace a Control Unit for another one of the same type and the same software version without having to re-commission the inverter.

To do so, proceed as follows:

### **Procedure when replacing a Control Unit**

1. Switch-off the inverter power supply and wait 5 minutes until the device has discharged itself.
2. Release the control cables from the Control Unit.
3. Remove the defective Control Unit from the Power Module.
4. Mount a new Control Unit on the Power Module.
5. Reconnect the control cables.
6. Insert a memory card with a valid parameter set into the new Control Unit.
7. Switch-on the inverter power supply again (the valid parameter set is then downloaded into the inverter from the memory card)
8. Wait until the inverter has completely booted (RDY-LED and SF-LED are lit, BOP returns to the standard display)
9. Remove the memory card and acknowledge message F0395 (SF-LED is dark)
10. When switching-on the motor, check the direction of rotation and the response to control signals.
11. For fail-safe inverters, also check the safety functions that have been set.

## **6.4 Standard commissioning**

### **Standard commissioning with a valid parameter set**

If you have a memory card with a valid parameter set, then you can also perform standard commissioning for several inverters.

#### **Prerequisites**

- Several inverters (Control Units and Power Modules of the same type) must be commissioned for the same application.
- A memory card with a valid parameter set is available.

#### **Procedure for standard commissioning**

1. Insert the memory card into the control unit of the first inverter.
2. Switch-on the inverter power supply (the valid parameter set is downloaded into the inverter from the memory card)
3. Wait until the inverter has completely booted (RDY-LED and SF-LED are lit, BOP returns to the standard display)
4. Remove the memory card and acknowledge message F0395 (SF-LED is dark)
5. Proceed with the next inverter

## Messages and fault codes

### Overview

The G120 inverter features the following diagnostic indicators:

- LEDs on the Control Unit  
For a detailed overview of LED statuses, see "LED status indicators" (below).
- Fault and alarm numbers
  - Alarms provide warning information. They do not trigger any response from the system and do not need to be acknowledged.
  - If a fault occurs, the inverter shuts down and the "SF" LED on the Control Unit lights up. The inverter cannot be switched on again until the fault has been rectified. Once the fault has been rectified, it must be acknowledged.

Alarm and fault numbers are displayed on the operator panel, STARTER, or a higher-level control system.

---

#### Note

A description of all of the alarms and faults as well as the associated counter-measures are provided in the STARTER online help or in the List Manual in Section "Faults and alarm messages".

---

## 7.1 Status display using LEDs

### LEDs on the inverter versions

Depending on their particular version, inverters are equipped with different LEDs to display operating states.

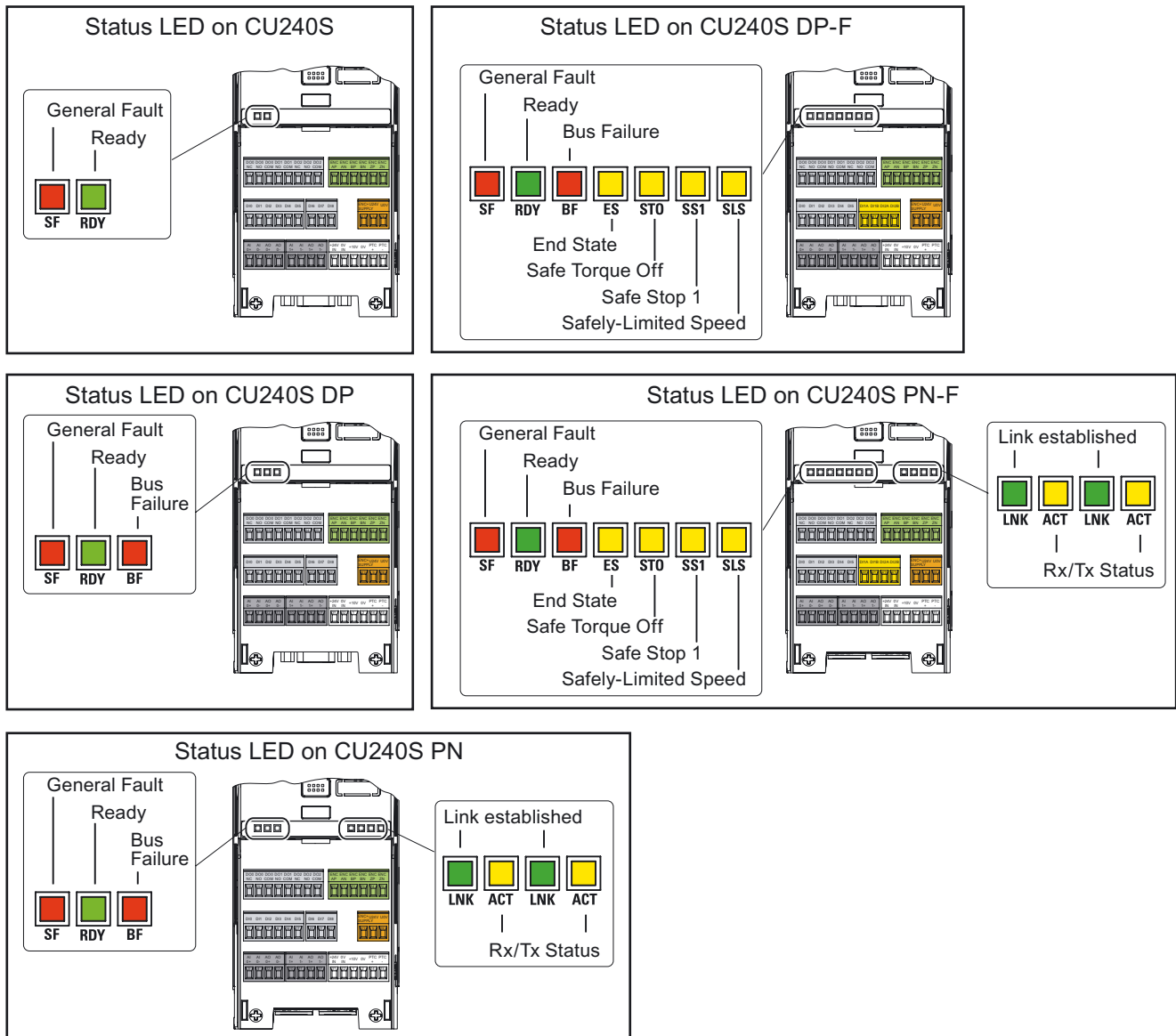

Figure 7-1 Status LED on the CU240S, CU240S DP, CU240S DP-F, CU240S PN

## Diagnostics via LEDs

### Note

"---" signals that the LED state (on, off or flashing) is not relevant for the corresponding state.

## LED status display for standard inverters

Table 7- 1 Status displays on the CU240S

LED displays		Possible operating and fault states
SF (red)	RDY (green)	
On / Off	Flashing	<ul style="list-style-type: none"> <li>• Commissioning</li> <li>• Restoring the factory setting</li> <li>• Parameter download</li> </ul>
On	Off	General fault
Off	On	Ready

Table 7- 2 Status displays on the CU240S DP

LED displays			Possible operating and fault states
SF (red)	RDY (green)	BF (red)	
On / Off	Flashing	---	<ul style="list-style-type: none"> <li>• Commissioning</li> <li>• Restoring the factory setting</li> <li>• Parameter download</li> </ul>
On	Off	---	General fault
On / Off	On / Off	Flashing	Bus failure (no data)
On / Off	On / Off	On	Bus failure (searching for baud rate)
Off	On	---	Ready

### Note

#### Control Unit with PROFIBUS DP interface – operation via terminals

If a Control Unit with a PROFIBUS DP interface is operated via terminals, in the standard setting the BF-LED indicates a fault (flashes). You can avoid this fault display by setting the fieldbus shutdown time in parameter P2040 to "0".

7.1 Status display using LEDs

Table 7-3 Status displays on the CU240S PN

LED displays					Possible operating and fault states
SF (red)	RDY (green)	BF (red)	LNK (green)	ACT (yellow)	
On / Off	Flashing	---	On / Off	On / Off	<ul style="list-style-type: none"> <li>Commissioning</li> <li>Restoring the factory setting</li> <li>Parameter download</li> </ul>
On	Off	---	On / Off	On / Off	General fault
On / Off	On / Off	Flashing	On	OFF	Bus failure (no data)
On / Off	On / Off	On	OFF	OFF	Bus failure (searching for baud rate)
On / Off	On / Off	OFF	On	On / Off	Connection established
On / Off	On / Off	On	OFF	OFF	No connection established
On / Off	On / Off	OFF	On	On	Data transfer active
Off	On	---	On / Off	On / Off	Ready

LED status display for fail-safe inverters - CU240S DP-F

Table 7-4 Display of the general states on the CU240S DP-F

LED displays							Possible operating and fault states
SF (red)	RDY (green)	BF (red)	ES (yellow)	STO (yellow)	SS1 (yellow)	SLS (yellow)	
On / Off	Flashing	---	On / Off	---	---	---	<ul style="list-style-type: none"> <li>Commissioning</li> <li>Restoring the factory setting</li> <li>Manual parameter download</li> </ul>
On / Off	Flashing	---	Flashing	Flashing	Flashing	Flashing	<ul style="list-style-type: none"> <li>Safety commissioning</li> <li>Resetting the safety parameters</li> </ul>
Flashing	Flashing	---	Flashing	Flashing	Flashing	Flashing	Parameter download from the memory card when switching-on
On	OFF	---	On / Off	---	---	---	General fault
OFF	On	---	On / Off	---	---	---	Ready

Table 7-5 Display of the communication states on the CU240S DP-F

LED displays			Possible operating and fault states
SF (red)	RDY (green)	BF (red)	
On / Off	On / Off	Flashing	Bus failure (no data)
On / Off	On / Off	On	Bus failure (searching for baud rate)

The "ES", "STO" and "SS1" LEDs have no significance for the communication status of the CU240S DP-F

Table 7-6 Display of the fail-safe states on the CU240S DP-F

LED displays						Possible operating and fault states
SF (red)	RDY (green)	ES (yellow)	STO (yellow)	SS1 (yellow)	SLS (yellow)	
On / Off	On	OFF	On	On / Off	On / Off	STO parameterized
On / Off	On	On	Flashing	---	---	<ul style="list-style-type: none"> <li>• STO initiated</li> <li>• STO reached</li> </ul>
On / Off	On	OFF	On / Off	On / Off	On	<ul style="list-style-type: none"> <li>• SLS parameterized</li> </ul>
On / Off	On	OFF	---	---	Flashing	<ul style="list-style-type: none"> <li>• SLS initiated</li> </ul>
On / Off	On	On	---	---	Flashing	<ul style="list-style-type: none"> <li>• SLS reached</li> </ul>
On / Off	On	OFF	On / Off	On	On / Off	<ul style="list-style-type: none"> <li>• SS1 parameterized</li> </ul>
On / Off	On	OFF	---	Flashing	---	<ul style="list-style-type: none"> <li>• SS1 initiated</li> </ul>
On / Off	On	On	---	Flashing	---	<ul style="list-style-type: none"> <li>• SS1 reached</li> </ul>
On	OFF	On	OFF	OFF	OFF	<ul style="list-style-type: none"> <li>• Passivation</li> </ul>

The "BF" LED has no significance for the fail-safe states of the CU240S DP-F.

### LED status display for fail-safe inverters - CU240S PN-F

Table 7-7 Display of the general states on the CU240S PN-F

LED displays						Possible operating and fault states
SF (red)	RDY (green)	ES (yellow)	STO (yellow)	SS1 (yellow)	SLS (yellow)	
On / Off	Flashing	On / Off	---	---	---	<ul style="list-style-type: none"> <li>• Commissioning</li> <li>• Restoring the factory setting</li> <li>• Manual parameter download</li> </ul>
On / Off	Flashing	Flashing	Flashing	Flashing	Flashing	<ul style="list-style-type: none"> <li>• Safety commissioning</li> <li>• Resetting the safety parameters</li> </ul>
Flashing	Flashing	Flashing	Flashing	Flashing	Flashing	Parameter download from the memory card when switching-on
On	OFF	On / Off	---	---	---	General fault
OFF	On	On / Off	---	---	---	Ready

The "BF", "LNK" and "ACT" LEDs have no significance for the general state of the CU240S PN-F

7.1 Status display using LEDs

Table 7- 8 Display of the communication states on the CU240S PN-F

LED displays					Possible operating and fault states
SF (red)	RDY (green)	BF (red)	LNK (green)	ACT (yellow)	
On / Off	On / Off	Flashing	On	OFF	Bus failure (no data)
On / Off	On / Off	On	OFF	OFF	Bus failure (searching for baud rate)
On	OFF	---	On / Off	On / Off	PROFIsafe failure
On / Off	On / Off	OFF	On	On / Off	Connection established
On / Off	On / Off	ON	OFF	OFF	No connection
On / Off	On / Off	OFF	On	On	Data transfer active

The "ES", "STO" and "SS1" LEDs have no significance for the communication status of the CU240S PN-F

Table 7- 9 Display of the fail-safe states on the CU240S PN-F

LED displays						Possible operating and fault states
SF (red)	RDY (green)	ES (yellow)	STO (yellow)	SS1 (yellow)	SLS (yellow)	
On / Off	On	OFF	On	On / Off	On / Off	STO parameterized
On / Off	On	On	Flashing	---	---	<ul style="list-style-type: none"> <li>• STO initiated</li> <li>• STO reached</li> </ul>
On / Off	On	OFF	On / Off	On / Off	On	SLS parameterized
On / Off	On	OFF	---	---	Flashing	SLS initiated
On / Off	On	On	---	---	Flashing	SLS reached
On / Off	On	OFF	On / Off	On	On / Off	SS1 parameterized
On / Off	On	OFF	---	Flashing	---	SS1 initiated
On / Off	On	On	---	Flashing	---	SS1 reached
On	OFF	On	OFF	OFF	OFF	Passivation

The "BF", "LNK" and "ACT" LEDs have no significance for the fail-safe states of the CU240S PN-F



## 7.2 Alarm and error messages

### Diagnostics via alarm and fault numbers

If an alarm or fault condition occurs, the OP displays the corresponding alarm or fault number.

- If an alarm is present, the inverter continues to operate.
- If a fault occurs, the inverter shuts down.

Table 7- 10 Alarm and fault numbers – cause and remedy

Alarm number	Significance	
A0700	Cause	The parameter or configuration settings made by the PROFIBUS master are invalid.
	Remedy	Correct the PROFIBUS configuration.
A0702	Cause	The connection to PROFIBUS is interrupted.
	Remedy	Check the connector, cable, and PROFIBUS master.
A0703	Cause	The PROFIBUS master is either not receiving any setpoints or is only receiving invalid setpoints (control word = 0).
	Remedy	Check the setpoints of the PROFIBUS master. Switch the SIMATIC CPU to "RUN".
A0704	Cause	At least one transmitter between two nodes is not yet active or has failed.
	Remedy	Activate the transmitter between the two nodes.
A0705	Cause	The inverter is not receiving any actual values.
	Remedy	None (the inverter is faulty).
A0706	Cause	PROFIBUS DP software error.
	Remedy	No diagnostics parameter r2041.
A0710	Cause	The inverter has detected an error with the PROFIBUS data connection.
	Remedy	The Control Unit data interface may be interrupted.
A0711	Cause	Invalid PROFIBUS parameter.
	Remedy	Check addresses P0918 and P2041.
F0070	Cause	No communication via PROFIBUS. Initiated by A0702, A0703, and A0704. The telegram downtime set in P2040 has elapsed. For details, see "Faults and Alarms" in the List Manual.
	Remedy	Check the connection between the data transfer devices and make sure that a valid control word is used.

### Reading fault codes

The following parameters must be taken into account during troubleshooting:

- Stored in parameter r0947 under its code number, e.g. F0003 = 3
- Associated fault value; stored in parameter r0949 (0 = no fault value)
- The time stamp of the fault is stored in r0948 and can be read
- The number of fault codes (P0952) is stored in r0947 and can be read

### Reading messages

The following parameters must be taken into account when alarms are processed:

- Stored in parameter r2110 under the code number; can be read, e.g. A0503 = 503. The value 0 indicates that no alarm is generated. The index allows you to access the two current alarms and the two previous alarms.

### General fault acknowledgement

You can use one of the following methods to reset the fault number:

- Press **FN** on the BOP.
- Factory settings: acknowledge via DI 2.
- Set bit 7 in control word 1 (r0054).
- Switch the inverter off and then on again.

(switch off the main power supply and the external 24 V supply for the Control Unit and switch it on again.)

### Faults that can only be acknowledged by switching the device off and then on again

- **F00051** Parameter EEPROM fault
- **F00052** Power Stack fault
- **F00061** Automatic download, memory card is not used
- **F00062** Automatic download, the contents of the memory card are invalid
- **F00063** Automatic download, the contents of the memory card are incompatible
- **F00064** The drive has attempted to download data automatically while ramping up.
- **F01601** System startup fault

---

#### Note

The drive cannot be operated until all active faults have been acknowledged. The procedure to delete F0395 is described in the Section "Coupling the CU and PM for the first time - Message F0395 (Page 46)" of this manual.

---

### Motor failure without fault code or alarm

If the motor does not start once the ON command has been issued:

- Check whether P0010 = 0.
- Check the inverter status via r0052.
- Check the command and setpoint source (P0700 and P1000).
- Check whether the motor data refers to the inverter data "load range" and "voltage".

## Technical data

### 8.1 Technical data, CU240S Control Unit

Technical data of the CU240S, CU240S DP, CU240S DP-F, CU240S PN and CU240S PN-F

Feature	Data
Operating voltage	Supply from the Power Module or an external 24 V DC supply (20.4 V to 28.8 V, 0.5 A) via control terminals 31 and 32
Heat loss	CU240S, CU240S DP: < 5.5 W CU24S PN < 13 W CU240S DP-F < 16 W CU24S PN-F < 17 W
Setpoint resolution	0.01 Hz
Digital inputs (dependent on the CU type)	6 or 9, isolated; PNP Low < 5 V, High > 10 V, maximum input voltage 30 V, current drain 5.5 mA
Analog inputs	2, with 10-bit resolution AI0: 0 V to 10 V, 0 mA to 20 mA and -10 V to +10 V AI1: 0 V to 10 V and 0 mA to 20 mA Both analog inputs can also be configured as digital inputs
Digital outputs	3 relay outputs, 30 V DC / max. 0.5 A for a resistive load
Analog outputs	2 AO0: 0 V to 10 V or 0 mA to 20 mA AO1: 0 mA to 20 mA
Encoder input	5 V or 24 V power supply is set using the DIP switch, max. 300 mA, CU240S PN-F max. 200 mA
Fail-safe inputs (dependent on the CU type)	2, two-channel, maximum input voltage 30 V, 5.5 mA
PFH	$5 \times 10E-8$ Valid for all safety functions STO, SS1, SLS and SBC
Dimensions (WxHxD)	73 mm x 178 mm x 55 mm
Weight	0.52 kg

## 8.2 Technical data, CU240E Control Unit

### CU240E

Feature	Data
Operating voltage	Supply from the Power Module
Heat loss	< 5.5 W
Setpoint resolution	0.01 Hz
Digital inputs	6, isolated; PNP/NPN switchable Low < 5 V, High > 10 V, maximum input voltage 30 V,
Analog inputs	2, with 10-bit resolution AI0: 0 V to 10 V, 0 mA to 20 mA and -10 V to +10 V AI1: 0 V to 10 V and 0 mA to 20 mA Both analog inputs can also be configured as digital inputs
Digital outputs	3 relay outputs, 30 V DC / max. 0.5 A for a resistive load
Analog outputs	2 AO0: 0 V to 10 V or 0 mA to 20 mA AO1: 0 mA to 20 mA
Dimensions (WxHxD)	73 mm x 195 mm x 30 mm
Weight	0.21 kg

## 8.3 General technical data, PM240 Power Modules

### PM240

Feature	Version	
Line operating voltage	3 AC 380 V ... 480 V $\pm$ 10%	The permissible line operating voltage depends on the installation altitude
Input frequency	47 Hz ... 63 Hz	
Power factor $\lambda$	0.7 ... 0.85	
Overload capability	The Power Module PM240 can either be operated with high overload (HO) or low overload (LO). In order to avoid overtemperature of the Power Module, after the overload, as a minimum its load must decrease back to the base load (HO base load or LO base load).	
	HO base load 0.37 kW ... 75 kW	150% overload for 57 s 200% overload for 3 s 100% HO base load for 240 s
	HO base load 90 kW ... 200 kW	136% overload for 57 s 160% overload for 3 s 100% HO base load for 240 s
	LO base load 7.5 kW ... 90 kW	110% overload for 57 s 150% overload for 3 s 100% LO base load for 240 s
	LO base load 110 kW ... 250 kW	110% overload for 59 s 150% overload for 1 s 100% LO base load for 240 s
Pulse frequency	4 kHz for 0.37 kW ... 75 kW (HO) 2 kHz for 90 kW ... 200 kW (HO)	The pulse frequency can be increased in 2 kHz steps. A higher pulse frequency reduces the permissible output current.
Possible braking methods	DC brake, compound brake, dynamic brake with integrated braking chopper	
Degree of protection	IP20	
Operating temperature	0.37 kW ... 110 kW (HO) -10 °C ... +50 °C (14 °F ... 122 °F)	Higher operating temperatures are possible when the rated power is reduced (derating)
	132 kW ... 200 kW (HO) -10 °C ... +40 °C (14 °F ... 104 °F)	
	(LO) -10 °C ... +40 °C (14 °F ... 104 °F)	
Bearing temperature	-40 °C ... +70 °C (-40 °F ... 158 °F)	
Relative humidity	< 95% RH - condensation not permissible	
Installation altitude	0.37 kW ... 110 kW (HO) Up to 1000 m (3300 ft) above sea level	Higher altitudes are possible when the rated power is reduced (derating)
	132 kW ... 200 kW (HO) Up to 2000 m (6500 ft) above sea level	
Standards	UL, cUL, CE, C-tick, SEMI F47 In order that the system is UL-compliant, UL-certified fuses, overload circuit-breakers or intrinsically safe motor protection devices must be used	

## 8.4 Power-dependent technical data, PM240 Power Modules

### General conditions

The input currents specified for the PM240 Power Modules is the technical data apply for a 400V line supply with  $U_k = 1\%$  referred to the frequency inverter power rating. When using a line reactor, the currents are reduced by a few percent.

Table 8- 1 PM240 Frame Size A

Order No.	6SL3224-0BE13-7UA0	6SL3224-0BE15-5UA0	6SL3224-0BE17-5UA0	6SL3224-0BE21-1UA0	6SL3224-0BE21-5UA0
Power rating for HO base load	0.37 kW / 0.5 PS	0.55 kW / 0.75 PS	0.75 kW / 1 PS	1.1 kW / 1.5 PS	1.5 kW / 2 PS
Input current for HO base load	1.6 A	2.0 A	2.5 A	3.8	4.8
Output current for HO base load	1.3 A	1.7 A	2.2 A	3.1	4.1
Fuse	10 A	10 A	10 A	10 A	10 A
Heat loss	0.097 kW	0.099 kW	0.102 kW	0.108	0.114
Cooling air requirement	4.8 l/s / 10 CFM	4.8 l/s / 10 CFM	4.8 l/s / 10 CFM	4.8 l/s / 10 CFM	4.8 l/s / 10 CFM
Cable cross-section for line and motor connections	1 ... 2.5 mm <sup>2</sup> / 18 ... 14 AWG	1 ... 2.5 mm <sup>2</sup> / 18 ... 14 AWG	1 ... 2.5 mm <sup>2</sup> / 18 ... 14 AWG	1 ... 2.5 mm <sup>2</sup> / 18 ... 14 AWG	1 ... 2.5 mm <sup>2</sup> / 18 ... 14 AWG
Weight	1.2 kg / 2.6 lb	1.2 kg / 2.6 lb	1.2 kg / 2.6 lb	1.2 kg / 2.6 lb	1.2 kg / 2.6 lb

Table 8- 2 PM240 Frame Size B and C

Order No., unfiltered	6SL3224-0BE22-2AA0	6SL3224-0BE23-0AA0	6SL3224-0BE24-0AA0	6SL3224-0BE25-5AA0	6SL3224-0BE27-5AA0	6SL3224-0BE31-1AA0
Order No., filtered	6SL3224-0BE22-2UA0	6SL3224-0BE23-0UA0	6SL3224-0BE24-0UA0	6SL3224-0BE25-5UA0	6SL3224-0BE27-5UA0	6SL3224-0BE31-1UA0
Power rating for HO base load	2.2 kW / 3 PS	3 kW / 4 PS	4 kW / 5 PS	5.5 kW / 7.5 PS	7.5 kW / 10 PS	11 kW / 15 PS
Input current for HO base load	7.6 A	10.2 A	13.4 A	16.7 A	23.7 A	32.7 A
Output current for HO base load	5.9 A	7.7 A	10.2 A	13.2 A	19 A	26 A
Input current for LO base load	7.6 A	10.2 A	13.4 A	21.9 A	31.5 A	39.4 A
Output current for LO base load	5.9 A	7.7 A	10.2 A	18 A	25 A	32 A
Fuse	16 A	16 A	16 A	20 A	32 A	35 A
Heat loss	0.139 KW	0.158 KW	0.183 KW	0.240 KW	0.297 KW	0.396 KW
Cooling air requirement	24 l/s / 50 CFM	24 l/s / 50 CFM	24 l/s / 50 CFM	55 l/s / 120 CFM	55 l/s / 120 CFM	55 l/s / 120 CFM
Cable cross-section for line and motor connections	1.5 ... 6 mm <sup>2</sup> / 16 ... 10 AWG	1.5 ... 6 mm <sup>2</sup> / 16 ... 10 AWG	1.5 ... 6 mm <sup>2</sup> / 16 ... 10 AWG	4 ... 10 mm <sup>2</sup> / 12 ... 8 AWG	4 ... 10 mm <sup>2</sup> / 12 ... 8 AWG	4 ... 10 mm <sup>2</sup> / 12 ... 8 AWG
Weight	4.3 kg / 9.5 lb	4.3 kg / 9.5 lb	4.3 kg / 9.5 lb	6.5 kg / 14 lb	6.5 kg / 14 lb	6.5 kg / 14 lb

Table 8- 3 PM240 Frame Size D and E

Order No., unfiltered	6SL3224-0BE31-5AA0	6SL3224-0BE31-8AA0	6SL3224-0BE32-2AA0	6SL3224-0BE33-0AA0	6SL3224-0BE33-7AA0
Order No., filtered	6SL3224-0BE31-5UA0	6SL3224-0BE31-8UA0	6SL3224-0BE32-2UA0	6SL3224-0BE33-0UA0	6SL3224-0BE33-7UA0
<b>Power rating for HO base load</b>	15 kW / 20 PS	18.5 kW / 25 PS	22 kW / 30 PS	30 kW / 40 PS	37 kW / 50 PS
<b>Input current for HO base load</b>	40 A	46 A	56 A	73 A	90 A
<b>Output current for HO base load</b>	32 A	38 A	45 A	60 A	75 A
<b>Input current for LO base load</b>	46 A	53 A	72 A	88 A	105 A
<b>Output current for LO base load</b>	38 A	45 A	60 A	75 A	90 A
<b>Fuse</b>	50 A	63 A	80 A	100 A	125 A
<b>Heat loss</b>	0.44 KW	0.55 KW	0.72 KW	1.04 KW	1.2 KW
<b>Cooling air requirement</b>	55 l/s / 120 CFM	55 l/s / 120 CFM	55 l/s / 120 CFM	110 l/s / 240 CFM	110 l/s / 240 CFM
<b>Cable cross-section for line and motor connections</b>	10 ... 35 mm <sup>2</sup> 7 ... 2 AWG	10 ... 35 mm <sup>2</sup> 7 ... 2 AWG	10 ... 35 mm <sup>2</sup> 7 ... 2 AWG	25 ... 35 mm <sup>2</sup> 3 ... 2 AWG	25 ... 35 mm <sup>2</sup> 3 ... 2 AWG
<b>Weight</b>	Filtered: 16 kg / 35 lb; unfiltered: 13 kg / 29 lb	Filtered: 16 kg / 35 lb; unfiltered: 13 kg / 29 lb	Filtered: 16 kg / 35 lb; unfiltered: 13 kg / 29 lb	Filtered: 23 kg / 51 lb; unfiltered: 16 kg / 35 lb	Filtered: 23 kg / 51 lb; unfiltered: 16 kg / 35 lb

Technical data

8.4 Power-dependent technical data, PM240 Power Modules

Table 8- 4 PM240 Frame Size F

Order No., unfiltered	6SL3224-0BE34-5AA0	6SL3224-0BE35-5AA0	6SL3224-0BE37-5AA0	6SL3224-0BE38-8UA0	6SL3224-0BE41-1UA0
Order No., filtered	6SL3224-0BE34-5UA0	6SL3224-0BE35-5UA0	6SL3224-0BE37-5UA0	-	-
Power rating for HO base load	45 kW / 60 PS	55 kW / 75 PS	75 kW / 100 PS	90 kW / 125 PS	110 kW / 150 PS
Input current for HO base load	108 A	132 A	169 A	205 A	235 A
Output current for HO base load	90 A	110 A	145 A	178 A	205 A
Input current for LO base load	129 A	168 A	204 A	234 A	284 A
Output current for LO base load	110 A	145 A	178 A	205 A	250 A
Fuse	160 A	200 A	250 A	250 A	315 A
Heat loss	1.5 KW	2.0 KW	2.4 KW	2.4 kW	2.5 kW
Cooling air requirement	150 l/s / 320 CFM	150 l/s / 320 CFM	150 l/s / 320 CFM	150 l/s / 320 CFM	150 l/s / 320 CFM
Cable cross-section for line and motor connections	35 ... 120 mm <sup>2</sup> 2 ... 4/0 AWG	35 ... 120 mm <sup>2</sup> 2 ... 4/0 AWG	35 ... 120 mm <sup>2</sup> 2 ... 4/0 AWG	35 ... 120 mm <sup>2</sup> 2 ... 4/0 AWG	35 ... 120 mm <sup>2</sup> 2 ... 4/0 AWG
Weight	Filtered: 52 kg / 115 lb; unfiltered: 36 kg / 80 lb	Filtered: 52 kg / 115 lb; unfiltered: 36 kg / 80 lb	Filtered: 52 kg / 115 lb; unfiltered: 36 kg / 80 lb	39 kg / 90 lb	39 kg / 90 lb

Table 8- 5 PM240 Frame Size G

Order No.	6SL3224-0BE41-3UA0	6SL3224-0BE41-6UA0	6SL3224-0BE42-0UA0
Power rating for HO base load	132 kW / 177 PS	160 kW / 215 PS	200 kW / 268 PS
Input current for HO base load	245 A	297 A	354 A
Output current for HO base load	250 A	302 A	370 A
Input current for LO base load	297 A	354 A	442 A
Output current for LO base load	302 A	370 A	477 A
Fuse	355 A	400 A	630 A
Heat loss	3.9 KW	4.4 KW	5.5 KW
Cooling air requirement	360 l/s / 760 CFM	360 l/s / 760 CFM	360 l/s / 760 CFM
Cable cross-section for line and motor connections	95 ... 240 mm <sup>2</sup> 3/0 ... 600 AWG	120 ... 240 mm <sup>2</sup> 4/0 ... 600 AWG	185 ... 240 mm <sup>2</sup> 6/0 ... 600 AWG
Weight	176 kg / 388 lb	176 kg / 388 lb	176 kg / 388 lb



## 8.5 General technical data, PM250 Power Modules

### PM250

Feature	Version	
Line operating voltage	3 AC 380 V ... 480 V $\pm$ 10%	The permissible line operating voltage depends on the installation altitude
Input frequency	47 Hz ... 63 Hz	
Power factor $\lambda$	0.9	
Overload capability	The Power Module PM250 can either be operated with high overload (HO) or low overload (LO). In order to avoid overtemperature of the Power Module, after the overload, as a minimum its load must decrease back to the base load (HO base load or LO base load).	
	HO base load 5.5 kW ... 75 kW	150% overload for 57 s 200% overload for 3 s 100% HO base load for 240 s
	LO base load 7.5 kW ... 90 kW	110% overload for 57 s 150% overload for 3 s 100% LO base load for 240 s
Pulse frequency	4 kHz	The pulse frequency can be increased in 2 kHz steps. A higher pulse frequency reduces the permissible output current.
Braking methods	Regenerative energy	
Degree of protection	IP20	
Operating temperature	HO base load -10 °C ... +50 °C (14 °F ... 122 °F)	Higher operating temperatures are possible when the rated power is reduced (derating)
	LO base load -10 °C ... +40 °C (14 °F ... 104 °F)	
Bearing temperature	-40 °C ... +70 °C (-40 °F ... 158 °F)	
Relative humidity	< 95% RH - condensation not permissible	
Installation altitude	Up to 1000 m (3300 ft) above sea level	Higher altitudes are possible when the rated power is reduced (derating)
Standards	UL, cUL, CE, C-tick, SEMI F47 In order that the system is UL-compliant, UL-certified fuses, overload circuit-breakers or intrinsically safe motor protection devices must be used	

## 8.6 Power-dependent technical data, PM250 Power Modules

### PM250 Power Module

Table 8- 6 PM250 Frame Size C and D

Order No.	6SL3225-0BE25-5AA0	6SL3225-0BE27-5AA0	6SL3225-0BE31-1AA0	6SL3225-0BE31-5AA0	6SL3225-0BE31-8AA0	6SL3225-0BE32-2AA0
Power rating for HO base load	5.5 kW 7.5 PS	7.5 kW 10.0 PS	11.0 kW 15 PS	15.0 kW 20 PS	18.5 kW 25 PS	22.0 kW 30 PS
Input current for HO base load	13.2 A	19.0 A	26.0 A	30.0 A	36.0 A	42.0 A
Output current for HO base load	13.2 A	19.0 A	26.0 A	32.0 A	38.0 A	45.0 A
Input current for LO base load	18.0 A	25.0 A	32.0 A	36.0 A	42.0 A	56.0 A
Output current for LO base load	18.0 A	25.0 A	32.0 A	38.0 A	45.0 A	60.0 A
Fuse	20 A	32 A	35 A	50 A	63 A	80 A
Heat loss	Available soon	Available soon	Available soon	0.44 kW	0.55 kW	0.72 kW
Cooling air requirement	38 l/s 0 CFM	38 l/s 80 CFM	38 l/s 80 CFM	22 l/s 46 CFM	22 l/s 46 CFM	39 l/s 82 CFM
Cable cross-section for line and motor connections	2.5 ... 10 mm <sup>2</sup> 14 ... 8 AWG	4 ... 10 mm <sup>2</sup> 12 ... 8 AWG	6 ... 10 mm <sup>2</sup> 10 ... 8 AWG	10 ... 35 mm <sup>2</sup> 7 ... 2 AWG	10 ... 35 mm <sup>2</sup> 7 ... 2 AWG	16 ... 35 mm <sup>2</sup> 5 ... 2 AWG
Weight	7.5 kg / 17 lb	7.5 kg / 17 lb	7.5 kg / 17 lb	15 kg / 33 lb	15 kg / 33 lb	16 kg / 35 lb

Table 8- 7 PM240 Frame Size E and F

Order No.	6SL3225-0BE33-0AA0	6SL3225-0BE33-7AA0	6SL3225-0BE34-5AA0	6SL3225-0BE35-5AA0	6SL3225-0BE37-5AA0
Power rating for HO base load	30.0 kW / 40 PS	37.0 kW / 50.0 PS	45.0 kW / 60 PS	55.0 kW / 75 PS	75 kW / 100 PS
Input current for HO base load	56 A	70 A	84 A	103 A	135 A
Output current for HO base load	60 A	75 A	90 A	110 A	145 A
Input current for LO base load	70 A	84 A	102 A	190 A	223 A
Output current for LO base load	75 A	90 A	110 A	145 A	178 A
Fuse	100 A	125 A	160 A	200 A	250 A
Heat loss	1 kW	1.3 kW	1.5 kW	2 kW	2.4 kW
Cooling air requirement	22 l/s / 46 CFM	39 l/s / 82 CFM	94 l/s / 200 CFM	94 l/s / 200 CFM	117 l/s / 250 CFM
Cable cross-section for line and motor connections	25 ... 35 mm <sup>2</sup> 3 ... 2 AWG	25 ... 35 mm <sup>2</sup> 3 ... 2 AWG	35 ... 150 mm <sup>2</sup> 2 ... - 5 AWG	70 ... 150 mm <sup>2</sup> - 2 ... - 5 AWG	95 ... 150 mm <sup>2</sup> - 3 ... - 5 AWG
Weight	21 kg / 46 lb	21 kg / 46 lb	51.0 kg / 112 lb	51.0 kg / 112 lb	51.0 kg / 112 lb

## 8.7 General technical data, PM260 Power Modules

### PM260

Feature	Version	
Line operating voltage	3 AC 660 V ... 690 V ± 10%	The permissible operating voltage depends on the installation altitude
		The power units can also be operated with a minimum voltage of 500 V – 10 %. In this case, the power is linearly reduced as required.
Input frequency	47 Hz ... 63 Hz	
Power factor λ	0.95	
Overload capability	The Power Module PM260 can either be operated with high overload (HO) or low overload (LO). In order to avoid overtemperature of the Power Module, after the overload, as a minimum its load must decrease back to the base load (HO base load or LO base load).	
	HO base load 7.5 kW ... 37 kW	150% overload for 57 s 200% overload for 3 s 100% HO base load for 240 s
	LO base load 11 kW ... 55 kW	110% overload for 57 s 140% overload for 3 s 100% LO base load for 240 s
Pulse frequency	16 kHz	
Braking methods	Regenerative energy	
Degree of protection	IP20	
Operating temperature	HO base load -10 °C ... +50 °C (14 °F ... 122 °F)	Higher operating temperatures are possible when the rated power is reduced
	LO base load -10 °C ... +40 °C (14 °F ... 104 °F)	
Bearing temperature	-40 °C ... +70 °C (-40 °F ... 158 °F)	
Relative humidity	< 95% RH - condensation not permissible	
Installation altitude	Up to 1000 m (3300 ft) above sea level	Higher altitudes are possible when the rated power is reduced
Standards	CE	

## 8.8 Power-dependent technical data, PM260 Power Modules

### PM260 Power Module

Table 8- 8 PM260 Frame Size D and F

Order No., unfiltered	6SL3225-0BH27-5UA0	6SL3225-0BH31-1UA0	6SL3225-0BH31-5UA0	6SL3225-0BH32-2UA0	6SL3225-0BH33-0UA0	6SL3225-0BH33-7UA0
Order No., filtered	6SL3225-0BH27-5AA0	6SL3225-0BH31-1AA0	6SL3225-0BH31-5AA0	6SL3225-0BH32-2AA0	6SL3225-0BH33-0AA0	6SL3225-0BH33-7AA0
<b>Power rating for HO base load</b>	7.5 kW 10 PS	11 kW 15 PS	15 kW 20 PS	22 kW 30 PS	30 kW 41 PS	37 kW 50 PS
<b>Input current for HO base load</b>	10 A	13 A	18 A	26 A	34 A	41 A
<b>Output current for HO base load</b>	10 A	14 A	19 A	26 A	35 A	42 A
<b>Input current for LO base load</b>	13 A	18 A	22 A	34 A	41 A	60 A
<b>Output current for LO base load</b>	14 A	19 A	23 A	35 A	42 A	62 A
<b>Fuse</b>	20 A	20 A	32 A	50 A	50 A	80 A
<b>Heat loss</b>	Available soon	Available soon	Available soon	Available soon	Available soon	Available soon
<b>Cooling air requirement</b>	22 l/s 47 CFM	22 l/s 47 CFM	39 l/s 83 CFM	94 l/s 199 CFM	94 l/s 199 CFM	117 l/s 248 CFM
<b>Cable cross-section for line and motor connections</b>	2,5 ... 16 mm <sup>2</sup> 14 ... 6 AWG	4 ... 16 mm <sup>2</sup> 12 ... 6 AWG	6 ... 16 mm <sup>2</sup> 10 ... 6 AWG	10 ... 35 mm <sup>2</sup> 8 ... 2 AWG	16 ... 35 mm <sup>2</sup> 6 ... 2 AWG	25 ... 35 mm <sup>2</sup> 4 ... 2 AWG
<b>Weight</b>	Unfiltered: 20 kg / 44 lb; filtered: 21 kg / 46 lb	Unfiltered: 20 kg / lb; filtered: 21 kg / 46 lb	Unfiltered: 20 kg / lb; filtered: 21 kg / 46 lb	Unfiltered: 46 kg / lb; filtered: 48 kg / lb	Unfiltered: 46 kg / 100 lb; filtered: 48 kg / 105 lb	Unfiltered: 46 kg / 100 lb; filtered: 48 kg / 105 lb

# Index

## A

- Access level, 76
- Adjustable parameters, 12
- Alarms, 219
- Ambient temperature, 51, 120
- Analog inputs, 58
- Analog outputs, 58
  - Functions of the, 127
- Automatic mode, 105
- Automatic restart, 142, 143, 144

## B

- Basic Operator Panel
  - Operator controls of the, 74
- Baud rates, 63
- BICO parameters, 17
- BICO technology, 16
- Binectors, 16
- Blocking protection, 123
- Boost parameter, 112
- BOP, 73
  - Operator controls of the, 74
- Braking
  - Regenerative, 135
- Braking methods, 130
- Braking resistor, 134
- Break loose torque, 15

## C

- CDS, 105
- Changing parameters using BOP, 75
- Clearances to other devices, 34, 35, 36, 37
- Closed-loop control type, 51
- COM interface, 62, 63
- Command Data Set, 105
- Command data set switchover, 106
- Command source, 52, 53, 77, 84
  - Default setting, 56
  - Selecting, 14
  - Selecting the, 95
- Commissioning, 67, 76
- Commissioning situations, 47
- Commissioning the application, 72

- Compound braking, 130, 131, 134
- Connect the braking resistor, 40
- Connectors, 16
- Control commands, 86
- Control Data Set, CDS, 105
- Control mode, 15
- Control terminal overview, 46
- Control terminals, 43, 46, 54, 55
- Control Units, 22, 24
- Control word, 180
- Control word 1, 180
- Control word 2, 181
- Controlling the motor, 52, 86
- Current input, 99
- Current output, 58, 127

## D

- Data backup, 47, 72, 79, 80
- Data transfer, 79, 80
- DC braking, 130, 131, 132
- DC link voltage, 122
- Default settings, 56
- Default terminal settings, 57
- Defining the telegram type, 170
- Delta connection ( $\Delta$ ), 39, 51
- Digital inputs, 57
  - Settings for the, 96
- Digital outputs, 58
  - Functions of the, 126
- DIP switch, 44, 153, 164
- Direction reversal, 86
- Display parameters, 13
- Distances from other devices, 33
- Down ramp, 15
- Download, 79, 81
- Drive Data Set, DDS, 149
- Drive Data Sets, 149
- Drive navigator, 72
- Dynamic braking, 131

## E

- Efficient Infeed Technology, 25
- Electromagnetic interference, 42
- EMC-compliant shielding, 41
- Encoder, 59

Encoder interface, 59  
Energy recovery option, 122, 136  
Enter clockwise or counter-clockwise rotation of the motor, 86  
Environmental conditions, 76

## F

F0395, 67  
Factory pre-assignment, 54, 55  
factory setting  
    Restoring the, 49  
Factory setting  
    Control commands, 86  
Factory settings, 56, 57  
Fault acknowledgment, 226  
Faults, 219  
FCC  
    Flux Current Control, 113  
F-digital output module, 197  
Filter, 27  
Firmware version, 14  
Flow control, 145  
Flying restart, 140, 141, 142  
Follow-on parameterization, 13  
Force the brake open, 139  
Frame sizes, 25  
Frame sizes, 25  
Function blocks  
    Unassigned, 147, 148  
functions  
    Technological, 85  
Functions  
    Overview, 83

## G

Going online, 65, 67  
GSD, 167  
GSDML, 173

## H

Hardware configuration, 165  
HTL encoder, 118  
HW Config, 165, 167, 172  
    Hardware configuration, 165

## I

I<sub>max</sub> controller, 120  
Implementation of the extended PROFIBUS DP functions, 184  
IND  
    Parameter index, 178  
Installation, 29, 32  
Installation options, 32  
Installing the Control Unit, 43  
Interfaces, 44, 47, 57  
Interlock, 19  
Inverter control, 84

## J

JOG function, 103  
Jog mode, 74, 103

## K

KTY 84 temperature sensor, 59, 119

## L

LEDs, 44  
Level control, 145  
Line filter, 27, 30  
Line reactor, 27, 30  
Line supply connection, 40  
Line supply faults, 143  
Line undervoltage, 142

## M

Manual mode, 105  
Maximum current controller, 120  
Maximum frequency, 15, 52, 78, 108  
Message F0395, 67  
Minimum frequency, 15, 52, 78, 108  
MMC, 22, 47, 80  
MMC memory card, 22, 47, 80  
MOP, 100  
Motor connection, 40  
Motor control, 84  
Motor data, 50, 77  
Motor data identification, 69, 114, 115  
Motor holding brake, 137, 138, 139  
Motor rating plate, 50  
Motor temperature sensor, 59, 120  
Motorized potentiometer, 100

**N**

No-load monitoring, 123

**O**

Online connection, 65  
 Operator panel, 22, 47  
 Output filter, 76  
 Output reactor, 27, 30  
 Overload, 15, 121  
 Overview of the functions, 83  
 Overvoltage, 122

**P**

Parameter assignment, 12, 76  
 Parameter channel, 176  
 Parameter filter, 76  
 Parameter set, 213  
 Parameter transfer, 79, 80, 81  
 Parameter types, 12  
 parameters  
   Important, 56  
 Passivation, 194  
 PC connection kit, 22, 60  
 PID controller, 146  
 PKE  
   Parameter ID, 176  
 PLC functionality, 18  
 Positioning function, 147  
 Power failure, 142  
 Power Module, 22, 25  
 Pre-assignment of the control terminals, 54, 55  
 Pressure control, 145  
 Process interfaces, 57  
 PROFIBUS, 171  
 PROFIBUS address, 163  
 PROFIBUS DP  
   Implementation of the extended functions, 184  
 PROFIdrive profile, 174  
 PROFINET, 171  
 Project Wizard, 60  
 Protection functions, 84  
 PTC temperature sensor, 59, 119  
 PTC/KTY 84, 59  
 PWE  
   Parameter value, 179

**Q**

Quick commissioning, 12, 78

**R**

Ramp-down time, 15, 52, 78, 109  
 Rampup time, 15, 52, 78, 109  
 Rating plate, 77  
 Reactors, 27  
 Regenerative braking, 131, 135  
 Regenerative energy, 129  
 Relay outputs, 58  
 Replacing the device, 79  
 Restore factory settings, 49  
 Restoring factory settings  
   of the safety-related parameters, 197  
 Restoring the factory setting, 14  
 Restoring the factory settings, 49  
 Rounding, 109

**S**

Safety functions, 85, 192, 193  
   Controlling the, 194  
 Safety relay, 196  
 SBC, 192, 193  
   Safe Brake Control, 192  
 Scaling, 99, 100  
   of the analog output, 128  
 Selecting the setpoint source, 15  
 Sensor  
   Electromechanical, 196  
   Electronic, 196  
 Setpoint calculation, 84, 108  
 Setpoint source, 52, 53, 77, 84  
   Default setting, 56  
 Setting up the PROFIBUS DP, 161  
 Setting-up the PG/PC interface, 61, 64  
 Shield connection kit, 41  
 Signal interconnection, 16, 19  
 SIMATIC, 162, 165, 172  
 Sine-wave filter, 27  
 SLS, 192, 193  
   Function test, 209  
   Safely Limited Speed, 192  
 Speed encoder, 51, 116  
 SS1, 192, 193  
   Safe Stop 1, 192  
 Stall protection, 123  
 Star connection (Y), 39, 51  
 STARTER, 47, 60

STARTER commissioning tool, 60  
STARTER software, 47  
Starting characteristics  
    Optimizing the, 112  
Status messages, 84  
Status word, 180  
Status word 1, 182  
Status word 2, 183  
STO, 192, 193, 199  
    Function test, 207  
    Safe Torque Off, 192  
Storing data in a power-independent manner, 72  
STW  
    Control word, 175  
STW1  
    Control word 1, 180  
STW2  
    Control word 2, 181  
Sub-chassis components, 30  
Sub-D connection, 154, 161  
System components, 30

## T

Technology controller, 145  
Telegram types, 169, 175  
Temperature monitoring, 119  
Terminal overview, CU240E, 54  
Terminal overview, CU240S, 55  
Terminating resistor, 153  
ThermoClick temperature sensor, 119  
Three-wire control, 86, 88  
Tightening torques, 33, 34, 35, 36, 37  
Torque monitoring  
    Frequency-dependent, 123  
TTL encoder, 117  
Two-wire control, 86, 87

## U

Universal serial interface (USS), 152  
Up ramp, 15  
Upload, 79, 80  
User access level, 76  
User interfaces, 44  
Using the factory settings, 53  
USS protocol, 152

## V

V/f control, 15, 76, 111, 114

V/f open-loop control, 51  
Vector control, 15, 51, 114  
    Automatic restart, 143  
    Sensorless, 113  
Vector control, 114  
Voltage boost, 15, 112  
voltage input  
    Unipolar, 58  
Voltage input, 99  
Voltage output, 58, 127

## W

Wizard, 60

## Z

ZSW  
    Status word, 175  
ZSW1  
    Status word 1, 182  
ZSW2  
    Status word 2, 183





Siemens AG  
Industry Sector  
P.O. Box 48 48  
90026 NUREMBERG  
GERMANY

Subject to change without prior notice  
© Siemens AG 2008

[www.siemens.com/automation](http://www.siemens.com/automation)