

SIEMENS

SINUMERIK 840D/810D/FM-NC

Operator's Guide

10.2000 Edition

SIEMENS

SINUMERIK 840D/810D/FM-NC

Operator's Guide

Valid for

<i>Control</i>	<i>Software version</i>
SINUMERIK 840D	6
SINUMERIK 840DE (export version)	6
SINUMERIK 810D	4
SINUMERIK 810DE (export version)	4
SINUMERIK FM-NC	3

10.00 Edition

Introduction	1
Operator components / Operating sequences	2
Sample operations	3
Machine	4
Parameters	5
Program	6
Services	7
Diagnosis	8
Installation	9
Maintenance	10
Appendix	A

SINUMERIK® Documentation

Printing history

Brief details of this edition and previous editions are listed below.

The status of each edition is shown by the code in the "Remarks" column.

Status code in the "Remarks" column:

A New documentation.

B Unrevised reprint with new Order No.

C Revised edition with new status.

If factual changes have been made on the page since the last edition, this is indicated by a new edition coding in the header on that page.

Edition	Order No.	Remarks
02.95	6FC5298-2AA00-0BP0	A
04.95	6FC5298-2AA00-0BP1	C
12.95	6FC5298-3AA00-0BP0	C
03.96	6FC5298-3AA00-0BP1	C
08.97	6FC5298-4AA00-0BP0	C
12.97	6FC5298-4AA00-0BP1	C
12.98	6FC5298-5AA00-0BP0	C
08.99	6FC5298-5AA00-0BP1	C
04.00	6FC5298-5AA00-0BP2	C
10.00	6FC5298-6AA00-0BP0	C

This manual is included in the documentation available on CD-ROM (**DOCONCD**)

Edition	Order No.	Remarks
10.00	6FC5298-6CA00-0BG0	C

Trademarks

SIMATIC®, SIMATIC HMI®, SIMATIC NET®, SIROTEC®, SINUMERIK® and SIMODRIVE® are registered trademarks of Siemens AG. The other designations in this publication may also be trademarks, the use of which by third parties may constitute copyright violation.

Further information is available on the Internet under:
<http://www.ad.siemens.de/sinumerik>

This publication was produced with WinWord V 8.0 and Designer V 7.0.

The reproduction, transmission or use of this document or its contents is not permitted without express written authority. Therefore we cannot guarantee that they are completely identical. Offenders will be liable for damages. All rights, including rights created by patent grant or registration of a utility model or design, are reserved.

© Siemens AG 1995–2000. All rights reserved.

Other functions not described in this documentation might be executable in the control. This does not, however, represent an obligation to supply such functions with a new control or when servicing.

We have checked that the contents of this document correspond to the hardware and software described. Nonetheless, differences might exist and therefore we cannot guarantee that they are completely identical. The information contained in this document is, however, reviewed regularly and any necessary changes will be included in the next edition. We welcome suggestions for improvement.

Subject to change without prior notice.

Introduction	1-21
1.1 The product SINUMERIK 840D/810D/FM-NC.....	1-22
1.2 Handling instructions	1-24
1.3 Switching the control ON and OFF	1-25
Operator Components / Operating Sequences	2-27
2.1 Operator panels	2-29
2.1.1 Operator panel OP 031	2-29
2.1.2 Operator panel OP 032	2-30
2.1.3 Slimline operator panel OP 032S	2-31
2.1.4 Full standard keyboard.....	2-32
2.2 Operator panel keys	2-33
2.3 Machine control panels.....	2-38
2.4 Keys of the machine control panel.....	2-39
2.4.1 EMERGENCY STOP	2-39
2.4.2 Operating modes and machine functions.....	2-39
2.4.3 Feed control	2-41
2.4.4 Spindle control.....	2-43
2.4.5 Keyswitch	2-44
2.4.6 Program control.....	2-46
2.5 Screen layout.....	2-48
2.5.1 Overview	2-48
2.5.2 Global machine status display.....	2-49
2.5.3 Channel status display	2-51
2.6 General operating sequences	2-53
2.6.1 Program overview and program selection.....	2-53
2.6.2 Changing the menu window	2-54
2.6.3 Selecting a directory/file	2-54
2.6.4 Editing entries/values	2-55
2.6.5 Confirming/canceling an input.....	2-57
2.6.6 Editing a part program in the ASCII editor.....	2-57
2.6.7 Switch channel over	2-64
2.6.8 m:n communication links.....	2-65
2.6.9 Pocket calculator function	2-71
2.7 Help	2-72
2.7.1 Overview: Help in Editor (SW 5 and higher)	2-74
2.7.2 Short help for program commands (SW5 and higher)	2-75
2.7.3 Extended help for program commands (SW5.2 and higher)	2-79
2.8 Job list (SW 5 and higher)	2-80

2.8.1	Description of syntax for job lists	2-82
2.8.2	Example of a job list for two-channel 1:1 links	2-86
2.8.3	Example of a job list for multi-channel m:n links	2-87
2.8.4	Sequence of operations "Executing joblist"	2-88
2.8.5	Renaming workpieces with job lists (SW 5.2 and higher)	2-89
2.8.6	Copying workpieces with job lists (SW 5.2 and higher).....	2-90
2.8.7	Archiving workpieces with job lists with m:n (SW 5.2 and higher).....	2-91
Operating Example		3-93
	Typical operating sequence	3-93
"Machine" Operating Area		4-95
4.1	Data structure of the numerical control.....	4-97
4.1.1	Operating modes and machine functions.....	4-98
4.1.2	Operating mode group and channels	4-100
4.1.3	Select operating mode, change operating mode.....	4-101
4.2	General functions and displays.....	4-103
4.2.1	Start/stop/cancel/continue part programs.....	4-103
4.2.2	Display program level	4-104
4.2.3	Switching between the machine/workpiece coordinate system (MCS/WCS).....	4-105
4.2.4	Displaying axis feedrates.....	4-107
4.2.5	Displaying G functions and transformations	4-107
4.2.6	Displaying auxiliary functions.....	4-108
4.2.7	Displaying spindles	4-109
4.2.8	Handwheel.....	4-110
4.2.9	Status of synchronized actions (NCU SW 4.2 and higher).....	4-111
4.2.10	Preset	4-113
4.2.11	Setting the actual value (SW 5 and higher)	4-114
4.2.12	Hiding axes (SW 4.4 and higher)	4-116
4.2.13	Inch/metric switchover (SW 5 and higher).....	4-117
4.2.14	Changing the coordinate system for actual value display (SW 5 and higher)	4-118
4.3	Reference point approach.....	4-119
4.4	Jog mode	4-122
4.4.1	Function and basic display	4-122
4.4.2	Traversing axes	4-125
4.4.3	Inc: Incremental dimension	4-126
4.4.4	Repos (repositioning)	4-127
4.4.5	SI (Safety Integrated): User confirmation	4-128
4.4.6	Scratching/determining zero offset (SW 4.4. and higher)	4-130
4.5	MDA mode	4-134
4.5.1	Function and basic display	4-134
4.5.2	Storing a program (MMC 100.2).....	4-136

4.5.3	Storing a program, file function (MMC 103)	4-137
4.5.4	Deleting a program	4-138
4.5.5	Teach In	4-138
4.6	Automatic mode.....	4-142
4.6.1	Function and basic display	4-142
4.6.2	Program overview	4-144
4.6.3	Execution via the V.24 interface (MMC 100.2).....	4-146
4.6.4	Loading and unloading the workpiece/part program (MMC 103)	4-147
4.6.5	Log: Loading list of programs (MMC 103)	4-148
4.6.6	Executing programs from the hard disk (MMC 103)	4-148
4.6.7	Accessing the external network drive from the MMC 103 (SW 5.2 and higher)	4-149
4.6.8	Program editing	4-151
4.6.9	Block search/setting the search destination	4-153
4.6.10	Fast external block search without calculation (MMC 103 only: SW 5.3 and higher)	4-156
4.6.11	Start of search in Program test mode, multi-channel (MMC 103 only: SW 5.3 and higher)	4-160
4.6.12	Overstore.....	4-162
4.6.13	Program control.....	4-164
4.6.14	DRF offset	4-167
"Parameters" Operating Area		5-169
5.1	Tool data.....	5-171
5.1.1	Structure of tool compensation	5-171
5.1.2	Tool types and tool parameters	5-172
5.2	Tool offset.....	5-187
5.2.1	Function and basic display of tool offset	5-187
5.2.2	New tool	5-188
5.2.3	Display tool	5-189
5.2.4	Tool search.....	5-191
5.2.5	Delete tool	5-192
5.2.6	New tool edge	5-193
5.2.7	Display tool edge	5-194
5.2.8	Find tool edge.....	5-194
5.2.9	Delete tool edge	5-194
5.2.10	Determine tool offsets	5-195
5.2.11	Tool offsets with D numbers only (flat D No.).....	5-196
5.2.12	Immediate activation of tool offset.....	5-196
5.3	Tool management.....	5-198
5.3.1	Basic functions of tool management	5-200
5.3.2	Display/change tool data	5-208
5.3.3	Loading.....	5-213

5.3.4	Unloading.....	5-218
5.3.5	Relocation.....	5-219
5.3.6	Tool master data in tool catalog (MMC 103)	5-221
5.3.7	Tool offset data in the tool cabinet (MMC 103).....	5-224
5.3.8	Job processing for tools.....	5-227
5.4	ShopMill Tool Management, MMC 100.2 (SW 5.3 and higher)	5-237
5.4.1	Functional scope	5-238
5.4.2	Selecting a tool list.....	5-239
5.4.3	Creating a new tool.....	5-240
5.4.4	Creating a tool offset for cutting edge 1/2.....	5-241
5.4.5	Changing tool name	5-242
5.4.6	Creating a duplo/replacement tool.....	5-242
5.4.7	Manual tools	5-242
5.4.8	Creating tool wear data.....	5-243
5.4.9	Tool monitoring.....	5-244
5.4.10	Magazine list.....	5-245
5.4.11	Delete tool.....	5-246
5.4.12	Changing the tool type.....	5-246
5.4.13	Loading a tool	5-247
5.4.14	Unloading a tool.....	5-248
5.4.15	Sorting tools in the tool list.....	5-249
5.5	R parameters (arithmetic parameters).....	5-250
5.5.1	Function.....	5-250
5.5.2	Editing/deleting/finding R parameters.....	5-250
5.6	Setting data.....	5-252
5.6.1	Working area limitation.....	5-252
5.6.2	Jog data.....	5-253
5.6.3	Spindle data.....	5-254
5.6.4	Dry run feedrate for DRY mode.....	5-255
5.6.5	Starting angle for thread cutting	5-256
5.6.6	Other types of setting data	5-257
5.6.7	Protection zones	5-258
5.7	Zero offset.....	5-259
5.7.1	Function.....	5-259
5.7.2	Changing the settable zero offset (G54 ...).....	5-261
5.7.3	Displaying other types of zero offset.....	5-263
5.7.4	Displaying active settable zero offsets.....	5-264
5.7.5	Displaying active programmable zero offsets.....	5-265
5.7.6	Displaying active external zero offsets	5-265
5.7.7	Displaying the sum of the active zero offsets	5-266
5.7.8	Activate zero offset and basic frame immediately	5-266
5.7.9	Global zero offset/frame (SW 5 and higher).....	5-267

5.7.10	Actual value display: Settable zero system, SZS (SW 5.2 and higher).....	5-272
5.8	User data/user variables (GUD, PUD, LUD)	5-273
5.8.1	General information.....	5-273
5.8.2	Changing/finding user data/user variables	5-274
5.9	Displaying system variables (SW 4.1 and higher)	5-276
5.9.1	Processing/creating variable views	5-277
5.9.2	Managing variable views	5-278
5.9.3	Logging system variables.....	5-279
"Program" Operating Area		6-283
6.1	Program types	6-285
6.1.1	Part program	6-285
6.1.2	Subroutine	6-285
6.1.3	Workpiece	6-285
6.1.4	Cycles.....	6-285
6.2	Storing programs	6-286
6.2.1	MMC 100.2.....	6-286
6.2.2	MMC 103.....	6-286
6.3	Program basic display	6-286
6.4	Editing programs	6-289
6.4.1	Text editor	6-289
6.4.2	Interactive programming (MMC 103)	6-289
6.4.3	Selective program protection: *RO* (MMC 103, SW 5 and higher)	6-289
6.4.4	Defining and activating user data (GUD, LUD)	6-291
6.5	User-defined contour programming (from SW 4.3 and SW 5).....	6-294
6.5.1	General.....	6-294
6.5.2	Programming a contour.....	6-295
6.5.3	Contour elements.....	6-298
6.5.4	Graphic representation of the contour.....	6-300
6.5.5	Input screen forms for parameterizing the contour elements.....	6-301
6.5.6	Help	6-304
6.5.7	Parameter description of straight line/circle contour elements	6-305
6.5.8	Examples of user-defined contour programming.....	6-306
6.6	Program simulation MMC 100.2.....	6-309
6.6.1	Rotation simulation.....	6-309
6.6.2	Milling simulation before machining (SW 5.2 and higher).....	6-311
6.6.3	Milling simulation during machining (SW 5.2 and higher)	6-312
6.7	Program simulation MMC 103.....	6-314
6.7.1	Simulation user interface.....	6-315
6.7.2	Simulation settings	6-325

6.7.3	Downtime settings	6-329
6.7.4	Display and colors	6-330
6.7.5	Section by section simulation (SW 5.2)	6-331
6.7.6	Simulation for orientable toolholder (SW 5.3).....	6-332
6.8	Simulation with external network drive (SW 5.2)	6-333
6.9	Program management	6-334
6.9.1	Overview	6-334
6.9.2	File types, blocks and directories	6-335
6.9.3	File handling	6-337
6.9.4	New workpiece/part program.....	6-340
6.9.5	Storing setup data (SW 5.2 and higher)	6-343
6.9.6	Selecting a program for execution.....	6-344
6.9.7	Loading/unloading a program (MMC 103).....	6-346
6.9.8	Storing a program	6-347
6.9.9	Enabling.....	6-348
6.9.10	Copying/inserting	6-348
6.9.11	Renaming	6-350
6.9.12	Deleting.....	6-351
6.9.13	Log (MMC 103).....	6-352
6.10	Memory info (MMC 100.2)	6-353
6.11	Accessing an external network drive/computer (from SW 5.2)	6-353
"Services" Operating Area		7-355
7.1	Function	7-357
7.2	Directory structure.....	7-357
7.2.1	NC active data	7-357
7.2.2	Hard disk (MMC 103)	7-358
7.2.3	Directories	7-359
7.2.4	Data selection.....	7-361
7.3	Formats for saving and importing data	7-365
7.3.1	Punched tape format	7-366
7.3.2	PC format	7-370
7.4	V.24 interface parameters	7-371
7.4.1	Interface parameters	7-374
7.5	MMC 100.2	7-378
7.5.1	Services basic display	7-378
7.5.2	Setting the interface.....	7-379
7.5.3	Reading in data via the V.24 interface.....	7-381
7.5.4	Storing data from the clipboard	7-383
7.5.5	Reading out data via the V.24 interface	7-384

7.5.6	Reading out PLC alarm texts and cycle texts.....	7-385
7.5.7	Series start-up.....	7-386
7.5.8	Error/transmission log.....	7-387
7.5.9	Importing/exporting ISO programs via V.24 (SW 5 and higher).....	7-389
7.5.10	Restoring the original state via NC card (SW 4.4 and higher).....	7-393
7.6	MMC 103.....	7-394
7.6.1	Services basic display.....	7-394
7.6.2	Setting the V.24 interface.....	7-397
7.6.3	Reading in data.....	7-398
7.6.4	Reading out data.....	7-400
7.6.5	Log.....	7-401
7.6.6	Defining and activating user data (GUD).....	7-403
7.6.7	Importing/exporting ISO programs (SW 5 and higher).....	7-406
7.7	Start-up functions (MMC 103).....	7-411
7.7.1	Series start-up.....	7-411
7.7.2	Restoring the original state via NC card (SW 4.4 and higher).....	7-413
7.7.3	Software update.....	7-414
7.8	Managing data (MMC 103).....	7-416
7.8.1	Creating a new file/directory.....	7-416
7.8.2	Loading/unloading.....	7-416
7.8.3	Copying/inserting.....	7-417
7.8.4	Deleting.....	7-418
7.8.5	Changing the properties of a file/drive/archive.....	7-419
"Diagnosis" Operating Area		8-421
8.1	Diagnosis basic display.....	8-422
8.2	Alarms/messages/alarm log.....	8-424
8.3	Service display.....	8-426
8.3.1	Service axis.....	8-426
8.3.2	Service drive.....	8-427
8.3.3	Service Safety Integrated (SW 5.2 and higher).....	8-428
8.3.4	Configuration data (SW 4.1 and higher, MMC 103).....	8-429
8.3.5	Communication error log.....	8-429
8.3.6	Version.....	8-430
8.4	PLC status.....	8-431
8.4.1	General.....	8-431
8.4.2	Changing/deleting values.....	8-432
8.5	Selecting/creating operand forms for PLC status.....	8-434
8.5.1	Reading in an operand (MMC 100.2).....	8-435
8.5.2	File functions (MMC 103).....	8-436

8.6	Displaying system resources (NC, MMC) (SW 4.1 and higher).....	8-437
"Start-up" Operating Area		9-439
9.1	Start-up basic display.....	9-440
9.2	Displaying machine data.....	9-443
9.2.1	Display options: Masking filters (SW 4 and higher).....	9-445
9.3	PLC.....	9-446
9.3.1	PLC status.....	9-447
9.3.2	Setting the date/time.....	9-447
9.4	MMC 103.....	9-448
9.4.1	Changing the MMC interface.....	9-448
9.4.2	System settings.....	9-450
9.5	Language selection.....	9-451
9.6	Password.....	9-452
Maintenance		10-453
10.1	Operating data.....	10-454
10.2	Cleaning.....	10-455
Appendix		A-457
A	Abbreviations.....	A-457
B	Terms.....	A-465
C	References.....	A-485
D	Index.....	A-497



MMC 100.2



MMC 103

Preface

Organization of documentation

SINUMERIK documentation is organized on 3 separate levels:

- General Documentation
- User Documentation
- Manufacturer/Service Documentation

Target group

This Manual is intended for machine-tool users. This publication provides detailed information that the user requires to operate the SINUMERIK 840D, SINUMERIK 810D or SINUMERIK FM-NC.

Standard functions

This Operator's Guide describes the functionality afforded by standard functions. Modifications and additions implemented by the machine-tool manufacturer are documented by the machine-tool manufacturer.

More detailed information about other publications relating to SINUMERIK 840D, 810D or SINUMERIK FM-NC and publications that apply to all SINUMERIK controls (e.g. Universal Interface, Measuring Cycles...) can be obtained from your local Siemens branch office.

Other functions not described in this documentation might be executable in the control. This does not, however, represent an obligation to supply such functions with a new control or when servicing.

Validity

Catalog NC 60 is the definitive document as regards the validity of functions
/VS/ Technical Information, Catalog NC 60.

Functions with the reference "SW 4 and higher" or "SW 5 and higher" are not available for the FM-NC control system.





MMC 100.2



MMC 103

Export version

The following functions are not available in the export version:

Function	FM-NC	810DE	840DE
5-axis machining package	–	–	–
Handling transformation package (5 axes)	–	–	–
Multi-axis interpolation (> 4 axes)	–	–	–
Helical interpolation 2D+6	–	–	–
Synchronized actions, stage 2	–	–	O ¹⁾
Measurements, stage 2	–	–	O ¹⁾
Adaptive control	–	O ¹⁾	O ¹⁾
Continuous dressing	–	O ¹⁾	O ¹⁾
Utilization of compile cycles (OEM)	–	–	–
Sag compensation, multi-dimensional	–	–	O ¹⁾

– Function not available

1) Restricted functionality

Further notes

The screen shots in this Operator's Guide are MMC 100.2 shots and identical in most cases to those of the MMC 103.



MMC 100.2



MMC 103

Structure of descriptions

All functions and operating options have been described according to the same internal structure as far as this is suitable and practicable. The various levels of information have been structured so that you can find the information you are looking for quickly.



1. Function

This theoretical section is primarily intended as learning material for the NC beginner. It provides important information that will help you to understand the principle of operating functions.

You should work through the manual at least once to get an idea of the scope of the functions and capability of your SINUMERIK control.



2. Operating sequence

This section provides a clear diagrammatic description of the sequence of key inputs required. If entries have to be made at individual stages of the sequence or if you require additional information, you will find this next to the key illustrations.



3. Further notes

For safety reasons, some of the functions are protected from access by unauthorized persons. The machine-tool manufacturer can influence or modify the described functions. Please follow the instructions of the machine-tool manufacturer.



MMC 100.2



MMC 103

Explanation of symbols

Function

Operating sequence

Further notes

Cross-references to other documentation or sections

Danger notes

Additional notes or background information

Ordering data option

Description of control with MMC 100.2 operator panel

Description of control with MMC 103 operator panel



MMC 100.2



MMC 103



MMC 100.2



MMC 103

**Notes**

The following special symbols and keywords have been used in this documentation:

This symbol appears in this documentation whenever it is necessary to draw your attention to an important item of information.



In this document, you will find the symbol depicted with a reference to an ordering code. Please note that the function described can operate only if the specified option is installed in the control.

Warnings

The following warnings with varying degrees of severity appear in this document.

**Danger**

Indicates an imminently hazardous situation which, if not avoided, **will** result in death or serious injury or in heavy damage to property.

**Warning**

Indicates a potentially hazardous situation which, if not avoided, **could** result in death or serious injury.

**Caution**

Used **with** the safety alert symbol indicates a potentially hazardous situation which, if not avoided, **may** result in minor or moderate injury.

Caution

Used **without** the safety alert symbol indicates a potentially hazardous situation which, if not avoided, **may** result in property damage.

Notice

Indicates a potential situation which, if not avoided, **may** result in an **undesirable** result or state.

**References**

This symbol appears whenever specific information can be found in other literature.

A complete list of available literature is included in the Appendix of this Operator's Guide.



MMC 100.2



MMC 103

Principle

Your SIEMENS 840D, 810D or FM-NC has been designed and constructed according to state-of-the-art technology and approved safety regulations and standards.

Additional equipment

The applications of SIEMENS controls can be expanded by adding special additional devices, equipment and expansions supplied by SIEMENS.

Personnel

Only **appropriately trained, authorized and reliable personnel** may be allowed to operate this equipment. No-one without the necessary training must be allowed to operate the control, even temporarily.

The **responsibilities** of the personnel employed to set up, operate and maintain the equipment must be clearly **defined** and **supervised**.

Procedure

Before the control is started up, the personnel who will work on the control system must become thoroughly acquainted with the Operator's Guide. It is also the duty of the equipment operator to **constantly monitor** the overall technical condition of the control (outwardly apparent defects or damage as well as changes in operating performance).



MMC 100.2



MMC 103

Service



Repairs must be carried out by personnel who are **specially trained and qualified** in the relevant technical subject according to the information supplied in the service and maintenance guide. All relevant safety regulations must be followed.

The following is deemed to be **improper usage** and **exempts the manufacturer from any liability**:

Any application deviating from the above points or usage extending beyond the given limits.

If the control is **not in a technically perfect condition** or is not operated under the necessary observance of safety and accident prevention regulations and according to instructions given in the relevant documentation.

If faults that might affect the safety of the equipment are not rectified **before** the control is started up.

Any **modification, bypassing** or **disabling** of items of equipment on the control that are required to ensure fault-free operation, unlimited use and active and passive safety.

Improper usage gives rise to **unforeseen danger** to:

- Life and limb of personnel,
- The control, machine or other assets of the owner and the user.



Rules for proper use

MMC 100.2



MMC 103

Introduction

1.1	The product SINUMERIK 840D/810D/FM-NC.....	1-22
1.2	Handling instructions	1-24
1.3	Switching the control ON and OFF	1-25

1.1 The product SINUMERIK 840D/810D/FM-NC



MMC 100.2



MMC 103

1.1 The product SINUMERIK 840D/810D/FM-NC

General information

SINUMERIK 840D, 810D and SINUMERIK FM-NC are CNC controls (Computerized Numerical Control) for machine tools.

You can implement the following basic functions (for a machine tool) via the operator panel of the CNC control:

- Development and adaptation of part programs,
- Execution of part programs,
- Manual control,
- Reading in and out part programs and data,
- Editing of data for programs,
- Display alarms and eliminate specifically,
- Editing of machine data,
- Establishment of communication links between 1 or more MMCs or 1 or more NCs (m:n, m MMC units and n NCK/PLC units).



MMC 100.2



MMC 103

Operating areas

Basic functions are grouped to form the following operating areas in the control (on gray background):

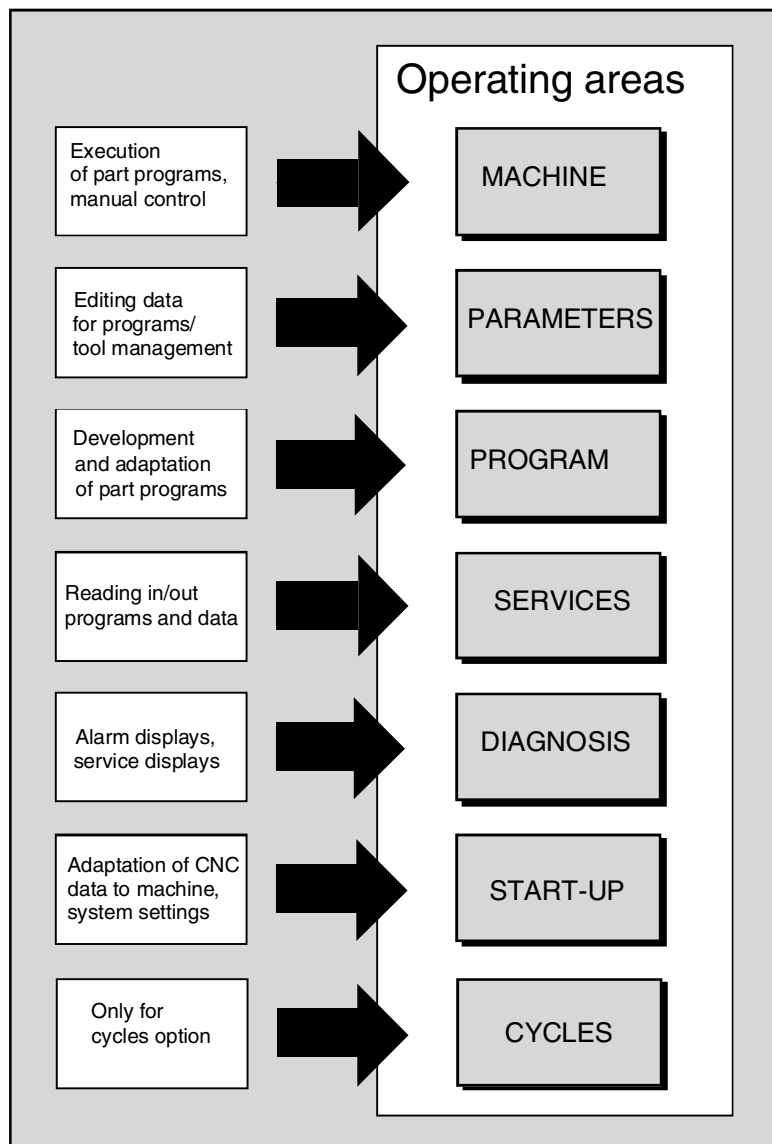

The user can call up all the functions via the user interface.

The user interface consists of:

- Display units, such as monitor, LEDs etc.
- Operator elements such as keys, switches, handwheels etc.

Read Chapter 2 "Operator Components" carefully before proceeding with further chapters.

All subsequent chapters are written on the assumption that you have done so!



1.2 Handling instructions



MMC 100.2



MMC 103

1.2 Handling instructions



Caution

The operator panel/machine control panel may only be opened by trained personnel for servicing purposes.



Danger

Never open the operator panel/machine control panel unless the power supply has been disconnected!

Failure to comply could result in fatal injury!



Warning

Electronic components inside the operator panel/machine control panel might be destroyed by electrostatic discharge if they are handled incorrectly.



Before operating any of the control elements on this operator panel:
Please first read the explanations supplied in this documentation!



MMC 100.2



MMC 103

1.3 Switching the control ON and OFF



Function

Switching the control ON

The control and the entire system can be switched on in different ways.



Machine manufacturer

Please follow the machine manufacturer's instructions!

After the control has been switched on, the "Reference point approach" display or another basic display programmed by the machine manufacturer will appear.

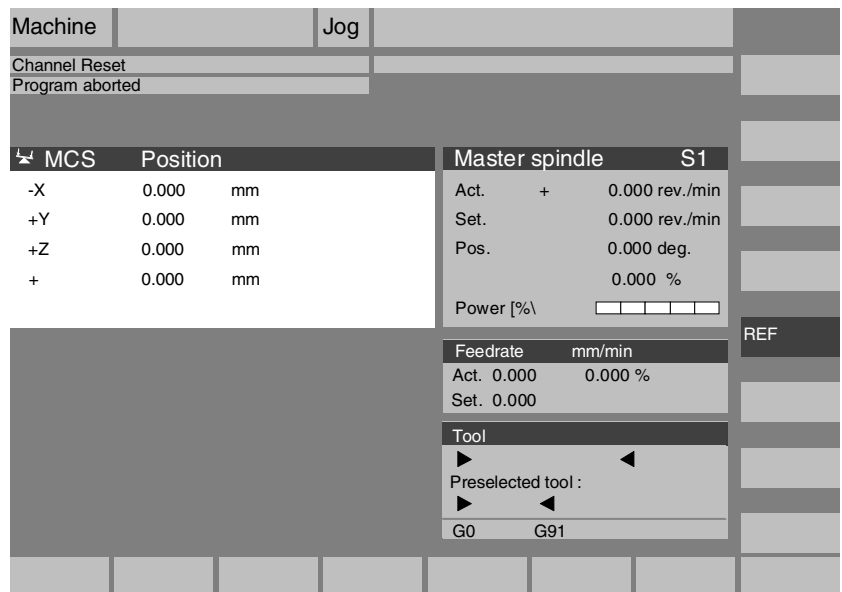

Switching the control OFF

Please follow the instructions for switching off the control or the entire system!



Machine manufacturer

Please follow the machine manufacturer's instructions!

1.3 Switching the control ON and OFF



MMC 100.2



MMC 103



Sequence of operations

When you press the "Area switchover" key, operating areas are displayed on the horizontal softkey bar and operating modes are displayed on the vertical softkey bar. You can use this key to go to the area menu bar from any location in the menu hierarchy if you wish to select another operating mode or a different operating area.

Machine				Jog				
Channel RESET						Auto		
Program aborted								
						MDA		
MCS	Position	Repos offset	Auxiliary Functions			JOG		
+ X	900.000 mm	0.000	M0			REPOS		
- Y	-156.000 mm	0.000	M0			REF		
+ Z	230.000 mm	0.000	M0					
			H0.000000					
			H0.000000					
			H0.000000					
			Feedrate mm/min					
			Act. 3000.000 0.0 %					
			Set. 3000.000					
			Tool					
			▶T0 D0◀					
			▶T0 D0◀					
			▶T0 D0◀					
			G1					
Machine	Param.	Services	Diagn.	Start-up				



By pressing the "Area switchover" key twice, you can toggle between the operating areas last selected, e.g. between the "Parameters" and "Machine" areas.

Operator Components / Operating Sequences

2.1	Operator panels	2-29
2.1.1	Operator panel OP 031	2-29
2.1.2	Operator panel OP 032	2-30
2.1.3	Slimline operator panel OP 032S	2-31
2.1.4	Full standard keyboard	2-32
2.2	Operator panel keys	2-33
2.3	Machine control panels	2-38
2.4	Keys of the machine control panel	2-39
2.4.1	EMERGENCY STOP	2-39
2.4.2	Operating modes and machine functions	2-39
2.4.3	Feed control	2-41
2.4.4	Spindle control	2-43
2.4.5	Keyswitch	2-44
2.4.6	Program control	2-46
2.5	Screen layout	2-48
2.5.1	Overview	2-48
2.5.2	Global machine status display	2-49
2.5.3	Channel status display	2-51
2.6	General operating sequences	2-53
2.6.1	Program overview and program selection	2-53
2.6.2	Changing the menu window	2-54
2.6.3	Selecting a directory/file	2-54
2.6.4	Editing entries/values	2-55
2.6.5	Confirming/canceling an input	2-57
2.6.6	Editing a part program in the ASCII editor	2-57
2.6.7	Switch channel over	2-64
2.6.8	m:n communication links	2-65
2.6.9	Pocket calculator function	2-71
2.7	Help	2-72
2.7.1	Overview: Help in Editor (SW 5 and higher)	2-74
2.7.2	Short help for program commands (SW5 and higher)	2-75
2.7.3	Extended help for program commands (SW5.2 and higher)	2-79
2.8	Job list (SW 5 and higher)	2-80
2.8.1	Description of syntax for job lists	2-82
2.8.2	Example of a job list for two-channel 1:1 links	2-86
2.8.3	Example of a job list for multi-channel m:n links	2-87
2.8.4	Sequence of operations "Executing joblist"	2-88
2.8.5	Renaming workpieces with job lists (SW 5.2 and higher)	2-89
2.8.6	Copying workpieces with job lists (SW 5.2 and higher)	2-90



2.8.7 Archiving workpieces with job lists with m:n (SW 5.2 and higher).....2-91



MMC 100.2



MMC 103

2.1 Operator panels

2.1.1 Operator panel OP 031

OP 031 operator panel with machine control panel

- A** Display
- B** Alphanumeric keypad
Editing/cursor keys
- C** Machine control panel

- 1** Machine area key
- 2** Recall (Return)
- 3** Softkey bar (horizontal)
- 4** ETC key
(menu expansion)
- 5** Area switchover key
- 6** Softkey bar (vertical)

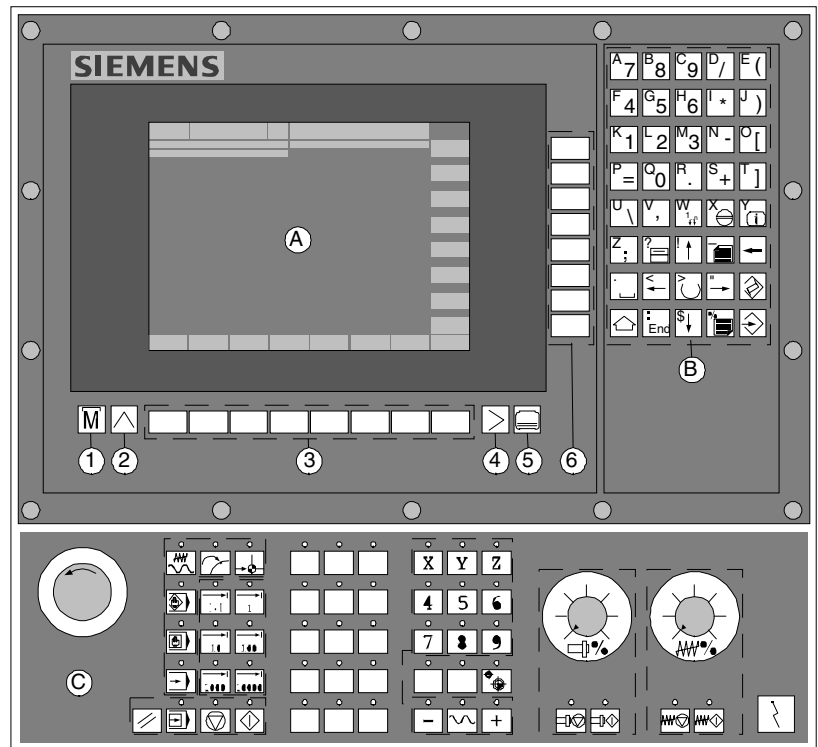

All keys are described in the following sections.



MMC 100.2

2.1.2 Operator panel OP 032

OP 032 operator panel with machine control panel and full CNC keyboard

- A Display
- B Numeric keypad
- C Editing/cursor keypad/control keys
- D Machine control panel
- E Alphanumeric keypad
- F Slot for PCMCIA adapter

- 1 Machine area key
- 2 Recall (Return)
- 3 Softkey bar (horizontal)
- 4 ETC key (menu expansion)
- 5 Area switchover key
- 6 Softkey bar (vertical)

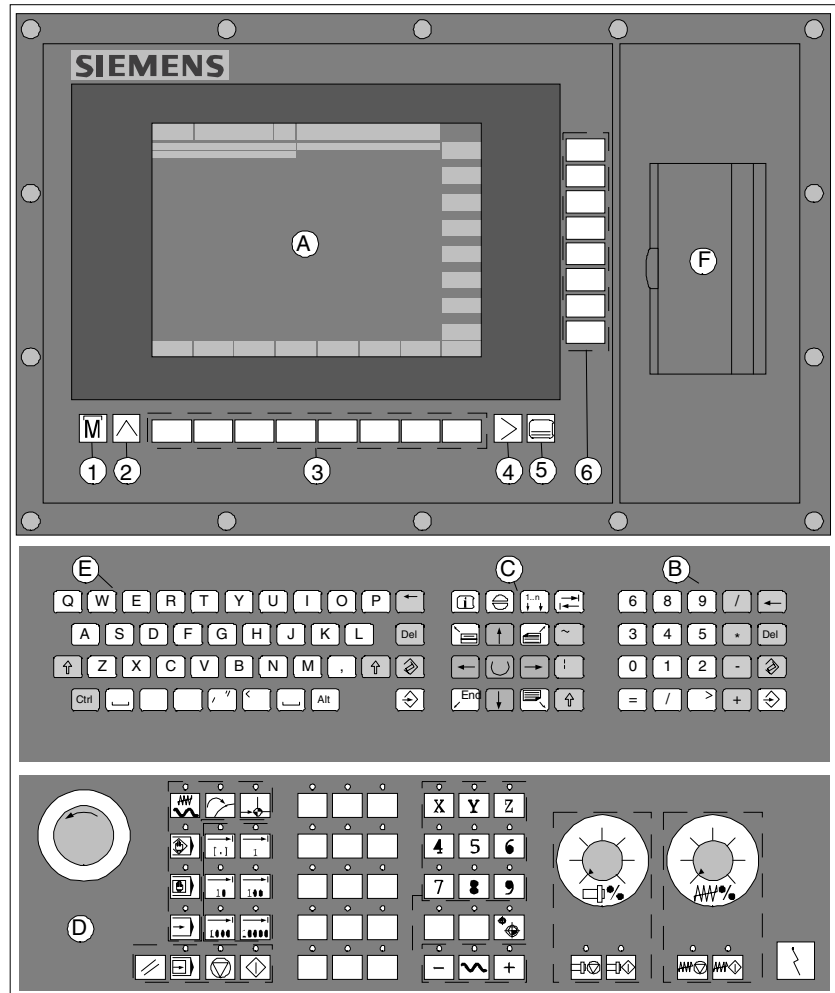



MMC 100.2



MMC 103

2.1.3 Slimline operator panel OP 032S

**Slimline operator panel
OP 032S for
MMC 100.2, 103**

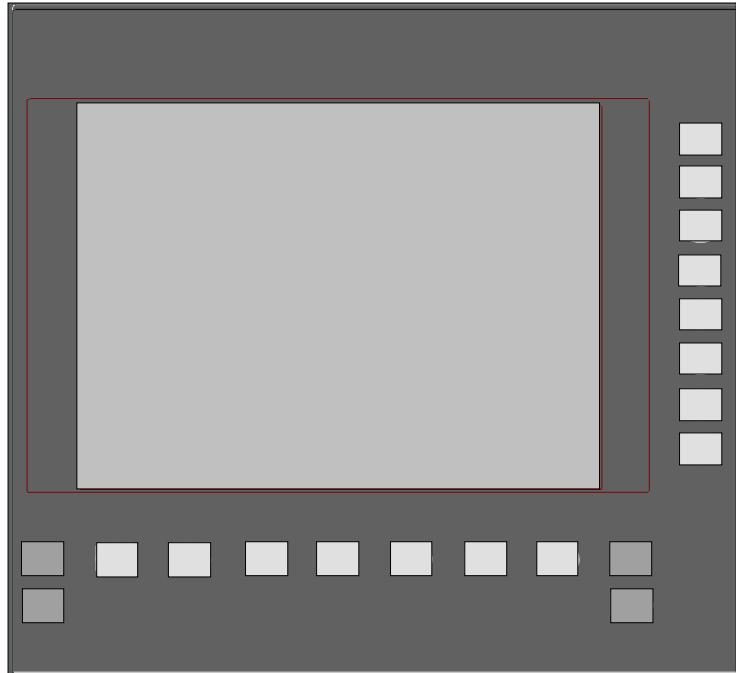

**with CNC keyboard
(QWERTY)
(example of key assignments)**

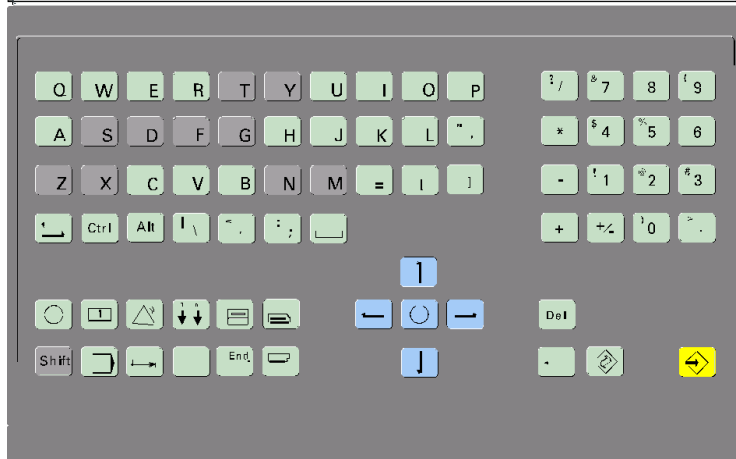

**and machine control
panel
(example of key assignments)**

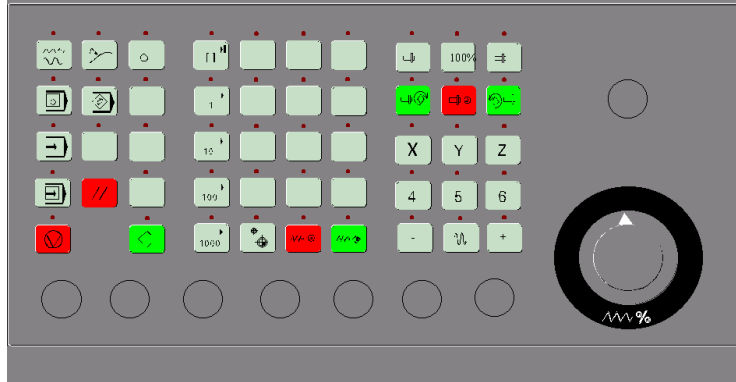

2.1 Operator panels



MMC 100.2



MMC 103

2.1.4 Full standard keyboard

A standard MF-2 full keyboard can be connected. However, a machine control panel is required additionally.

The special function keys of the operator keyboard can also be used with the full PC keyboard. The following table shows how the horizontal and vertical softkeys and special keys are mapped onto the PC keyboard keys:

Full PC keyboard	F1	F2	F3	F4	F5	F6	F7	F8	F9	F10	F11	F12
with SHIFT	Vertic soft. 1	Vertic soft. 2	Vertic soft. 3	Vertic soft. 4	Vertic soft. 5	Vertic soft. 6	Vertic soft. 7	Vertic soft. 8	>	M		
without SHIFT	Horiz soft. 1	Horiz soft. 2	Horiz soft. 3	Horiz soft. 4	Horiz soft. 5	Horiz soft. 6	Horiz soft. 7	Horiz soft. 8	^	☰	W _{↓↑}	Y
Full PC keyboard	5	Esc	Insert	Home	Page Up	Page Down	Enter	Tab				
without SHIFT	↻	X	☒	?	☰	☰	☒	:	End			

Caution

The full standard keyboard does not meet the requirements (EMC) of a SINUMERIK control. For this reason it can be used only for installation and service purposes.

Further notes

Since the English version of Windows 95 is used in the control, the keyboard language is English. A different keyboard language cannot be set.





MMC 100.2



MMC 103

2.2 Operator panel keys

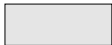

The elements of the operator panel keyboard and the symbols used to represent them in this manual are shown and explained below. The keys marked with an * correspond to the key symbols in US layout.

Softkeys

Keys to which functions are assigned by means of a menu bar displayed on the screen.

- It is possible to access further menu levels via the horizontal softkeys in any operating area. Each horizontal menu item has a vertical menu bar/softkey assignment.
- The vertical softkeys are assigned functions for the currently selected horizontal softkey.

A function is called up by pressing one of the vertical softkeys.

The assignments of the vertical softkey bar can change if further subsidiary functions are classified under a function.

Softkey (horizontal or vertical):

This key symbol indicates that you must have selected an operating area or a menu item or have already performed certain functions before you are able to execute the function described in the relevant section.

Machine area key

Direct branch to the "Machine" operating area.

Recall key

Return to the next higher menu. Recall closes a window.

Etc. key

Expansion of the softkey bar in the same menu.

2.2 Operator panel keys



MMC 100.2



MMC 103



Area switchover key

You can call the basic menu from any operating area by pressing this key. Pressing the key twice in succession changes from the current operating area to the previous one and back again.

The standard basic menu branches into the following operating areas:

1. Machine
2. Parameters
3. Program
4. Services
5. Diagnosis
6. Start-up

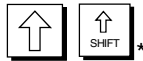

Shift key

Switches between functions on keys with double assignment.

On the OP031, this key can be configured as "single shift" and "permanent shift" (after being pressed twice), i.e. the characters arranged at the top of the keys are output when the key is pressed (with the exception of the cursor keys).

(See also /IAD/ or /IAC/, Installation and Start-Up Guide for 840D/810D, Section "MMC Start-Up")



Switch over channel

When several channels are in use, it is possible to switch between them (from channel 1 through 4).

When a "Channel menu" is configured, all existing communication links to other NCUs plus the associated channels are displayed on softkeys.

(See also Section "Switch over channel")



Alarm acknowledgment key

By pressing this key, you can acknowledge the alarm marked by this Cancel symbol.



Information key

Press this key to call explanatory text and information relating to the current operating status (e.g. interactive programming, diagnosis, PLC, alarms).

The letter "I" displayed in the dialog line indicates that information is available.



MMC 100.2



MMC 103



Window selection key

If several windows are displayed on the screen, it is possible to make the next window the active one using the window selection key (the active window has a thicker border).

Keyboard input e.g. the page keys, is possible only in the active window.



Cursor up



Page down

You "page" down by one display.

Within a part program you can "page" the display down (towards end of program) or up (towards beginning of program).

With the page keys you scroll the visible/displayed area of the window that is active. The scroll bar indicates which part of the program/document/... is selected.



Delete key (backspace)

Delete characters from right



Blank



Cursor LEFT



Selection key toggle key

- Selection key for values entered in input fields and selection lists that are marked by this key symbol.
- Activate or deactivate a field:

= active

= active

= not active

= not active

Multiple selection button
(you can select several options
or none)

Single selection button/option
(only one option can be active at
a time)



Cursor RIGHT

2.2 Operator panel keys



MMC 100.2



MMC 103

**Edit key/Undo key**

- Switchover to Edit mode in tables and input fields (in this case, Insert mode is set in the input field) or
- UNDO function for table elements and input fields (when you exit a field with the edit key, the value is not saved and the field is reset to the previous value = UNDO).
- **Pocket calculator mode on MMC 100.2**

**End of line key**

- This key moves the cursor to the end of the line in input fields (MMC 100.2 only) or to the end of the line on the displayed page in the editor.
- Rapid positioning of the cursor on a group of related input fields.
- MMC 103: Tab key

**Cursor DOWN****Page up**

You "page" up by one display. With the page keys you scroll the visible/displayed area of the window that is active. The scroll bar indicates which part of the program/document/... is selected.

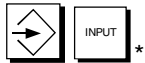
**Input key**

- Accepts an edited value
- Opens/closes a directory
- Opens file

**Additional keys on
OP 032 and OP 032S****Tab key**

The Tab key is not evaluated in connection with the MMC 100.2 interface.

**Ctrl key**

The Ctrl key is not evaluated in connection with the MMC 100.2 interface.

**Alt key**

The Alt key is not evaluated in connection with the MMC 100.2 interface.



MMC 100.2



MMC 103

Additional keys on OP 032S

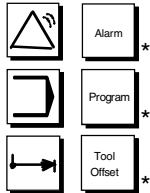

Additional key combinations

Shift key



The OP 032S has the following additional keys:

Reserved

The following additional key combinations are available on the OP 032S:

Key combination	Edition
Shift + =	+
Shift + [{
Shift +]	}
Shift + 8	*
Shift + 6	^

Switchover between functions on keys with double assignment or lower case shift.

Delete key

The setting in a parameterization field is deleted. The field remains blank.

2.3 Machine control panels

Standard turning machines/milling machines

Actions on the machine tool, for example traversing the axes or program start, can only be initiated via a machine control panel.

The machine tool can either be equipped with a standard machine control panel from SIEMENS (ordering data option) or with a specific machine control panel from the machine-tool manufacturer.

The following description applies to the 19" machine control panel supplied by SIEMENS. If you are using another machine control panel, please consult the operating instructions of the machine-tool manufacturer.

The standard machine control panel from SIEMENS is equipped with the following operator controls:

- 1 EMERGENCY STOP button
- 2 Operating modes (with machine functions)
- 3 JOG / Increment keys
- 4 Program control
- 5 Direction key with rapid traverse override
- 6 Spindle control
- 7 Feed control
- 8 Keyswitch

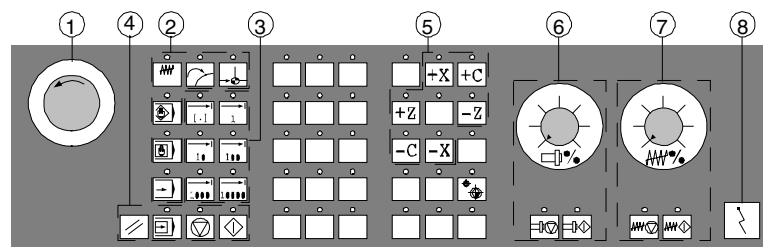

Machine control panel for turning machines

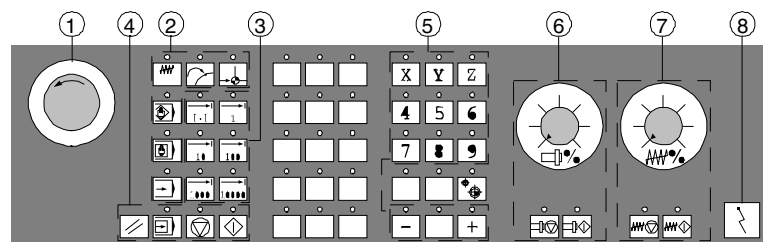

Machine control panel for milling machines

2.4 Keys of the machine control panel

2.4.1 EMERGENCY STOP

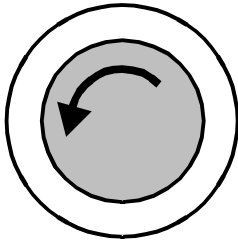

Emergency stop key

Press the red button in emergency situations, i.e.

1. If human life is in danger.
2. If there is a risk of damage to the machine or workpiece.

As a rule, emergency stop causes all drives to be stopped under control with the greatest possible braking torque.

For other responses when the emergency stop switch is operated:
Please consult the instructions of the machine-tool manufacturer!

2.4.2 Operating modes and machine functions



The keys marked with an * correspond to the key symbols in US layout.

If you press a "Mode key", the corresponding mode is selected if permissible, and all other modes and functions are deselected.

The active mode is signaled and confirmed by the associated LED which lights up.



Jog

Jogging

Axis jog mode implemented by:

- continuous motion of the axes using the direction keys or
- incremental motion of the axes using the direction keys or
- the handwheel.



MDI

Manual Data Input

Control of machine through execution of a block or a sequence of blocks. The blocks are entered via the operator panel.

2.4 Keys of the machine control panel



Automatic

Control of machine through automatic execution of programs.

Inc keys



You can activate the Inc functions in conjunction with the following modes:

- "Jog" mode
- "MDA/Teach In" mode

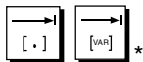

Inc Var

Incremental feed variable

Incremental traverse with variable increment size (see "Parameters" operating area, setting data).

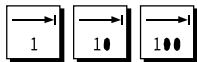

Inc

Incremental feed

Incremental traverse with preset increment size of 1, 10, 100, 1000, 10000 increments.

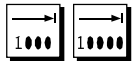

The way that the incremental value is evaluated depends on the setting in the machine data.

Machine functions



Teach In

Creation of programs in interactive mode with the machine in "MDA" mode.



REPOS

Reposition

Reposition, re-approach contour in "Jog" mode.



Ref point

Reference point approach

Approach the reference point (Ref) in "Jog" mode.

2.4.3 Feed control

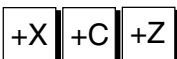
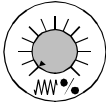

Feedrate rapid traverse override (feedrate override switch)

Control range:

0% to 120% of programmed feedrate.

In rapid traverse, the 100% value is not exceeded.

Settings:

0%, 1%, 2%, 4%, 6%, 8%, 10%, 20%, 30%, 40%, 50%, 60%, 70%, 75%, 80%, 85%, 90%, 95%, 100%, 105%, 110%, 115%, 120%

Feed stop

If you press the "Feed stop" key:

- execution of the current program is stopped,
- the axis drives are stopped in a controlled manner,
- the associated LED lights up as soon as feed stop has been accepted by the control and
- FST (=feed stop) is displayed in the header (channel status display).

Example:

- An error is detected while a block is being processed in "MDA" mode.
- The tool must be changed.

Feed start

If you press the "Feed start" key:

- the part program is continued at the current block position,
- the feedrate is accelerated to the value defined in the program and
- the associated LED lights up as soon as feed start has been accepted by the control.

Axis keys (for turning machines):

Press these keys to traverse the selected axis (X...Z) in a positive direction.

Press these keys to traverse the selected axis (X...Z) in a negative direction.

Axis keys (for milling machines):

You select the axis (X...9) to be traversed,

2.4 Keys of the machine control panel



press the "+" key to traverse in the positive direction or



press the "-" key to traverse in the negative direction.



Rapid traverse override

If you press this key together with key "+" or "-", the axis moves in rapid traverse mode.



Machine manufacturer

- The specified increments and control range apply to standard machines.
- Increments and control range can be modified by the machine tool manufacturer to suit specific applications.
- Feedrate/rapid traverse feedrate and the values for the feedrate override positions (if the feedrate override switch is also active for rapid traverse) are defined in the machine data (see the information supplied by the machine-tool manufacturer).



MCS/WCS

You can switch between the machine and workpiece coordinate systems in the Machine operating area using softkeys MCS/WCS or the corresponding key on the machine control panel.

2.4.4 Spindle control

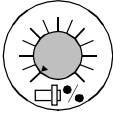

Spindle override (spindle speed override switch)

- The rotary switch with latch positions allows you to increase or decrease the programmed spindle speed "S" (equivalent to 100%).
- The set spindle speed value "S" is output as an absolute value and a percentage in the "Spindles" display (vertical softkey in basic display).

Control range:

50% to 120% of programmed spindle speed

Increment:

5% between latch positions



Spindle stop

When you press the "Spindle stop" key:

- the spindle is decelerated down to zero speed and
- the associated LED lights up as soon as "Spindle stop" is accepted by the control.

Example:

- to change a tool.
- to enter S, T, H, M functions during setup.



Spindle start

When you press the "Spindle start" key:

- the spindle speed is accelerated to the value defined in the program and
- the associated LED lights up as soon as "Spindle start" has been accepted by the control.

OP 032S

Press key "Spindle left" or "Spindle right" to start the spindle.

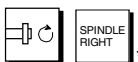

2.4 Keys of the machine control panel

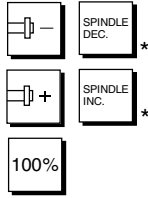

Press the key

- "Spindle dec." or "Spindle inc." to increase or decrease the programmed spindle speed (which corresponds to 100%),
- "100%" to set the programmed spindle speed.



Machine manufacturer

- The specified increment and the control range apply to standard machine data (MD). These MD can be changed by the machine-tool manufacturer to suit the application.
- The maximum spindle speed and the values for the spindle speed override position are defined in the machine data and setting data (see information supplied by the machine-tool manufacturer).

2.4.5 Keyswitch

SIEMENS keyswitch

The keyswitch on the SINUMERIK 840D, 810D and SINUMERIK FM/NC controls has 4 positions to which protection levels 4 to 7 are assigned.



Machine manufacturer

Functions can be assigned to keyswitch positions by the machine manufacturer. Using machine data it is also possible to set access to programs, data and functions to suit the user's requirements. The keyswitch has three different colored keys which can be removed in the specified positions:



Switch positions

Position 0
No key
Protection level 7

Lowest
access rights



Position 1
Key 1 **black**
Protection level 6



Position 2
Key 1 **green**
Protection level 5



Position 3
Key 1 **red**
Protection level 4

Highest
access rights



Changing access rights

The screen is not automatically updated after a change in access authorization (e.g. when the keyswitch position is changed), but only when the screen is next refreshed (e.g. on closing and opening a directory).

The currently valid access authorization is checked every time a function is executed.

Passwords

If the PLC is in the stop state, the input image of the machine control panel is not scanned. For this reason the keyswitch positions are not evaluated during start-up.

As an additional option for setting access authorization, it is possible to enter three passwords in the "Start-Up" operating area.

If the password is set, the keyswitch positions are irrelevant.

/IAD/, Installation and Start-Up Guide 840D or

/IAC/, Installation and Start-Up Guide 810D

2.4.6 Program control



NC Start

If you press the "NC Start" key, the selected part program (part program name is displayed in header) is started at the current block and the associated LED lights up.



NC Stop

If you press the "NC Stop" key, processing of the active part program is halted and the associated LED lights up.

After this, you can continue processing with NC start.



Single block

This function allows you to execute a part program block by block. You can activate the "Single block" function in "Automatic" and "MDA" modes. If single block is activated, the associated LED on the machine control panel lights up.

If single-block processing is active

- SBL 1, SBL 2 or SBL 3 (stop in cycle, SW 5 and higher) is displayed on the screen (in channel status display line),
- the text "Stop: Block ended in single block" is output in the channel operational message line (when program is interrupted),
- the current block of the part program is not processed until you press the "NC Start" key,
- processing is stopped after execution of one block,
- the following block can be executed by pressing the "NC Start" key again.

You can deselect the function by pressing the "Single block" key again.

This function is dependent on the settings under "Program control" in the Machine operating area.



Reset

When you press the "Reset" key:

- processing of the current part program is aborted,
- signals from the monitoring function are cleared (except for alarms signaling POWER ON, NC Start and Acknowledge alarm),
- the channel is switched to the "Reset" state, i.e.
 - the NC control remains synchronized with the machine,
 - the control is in the initial state and ready for another program run.

(See also /FB/, K1, Description of Functions Mode Group, Channel, Program Operation Mode)



MMC 100.2



MMC 103

2.5 Screen layout

2.5.1 Overview

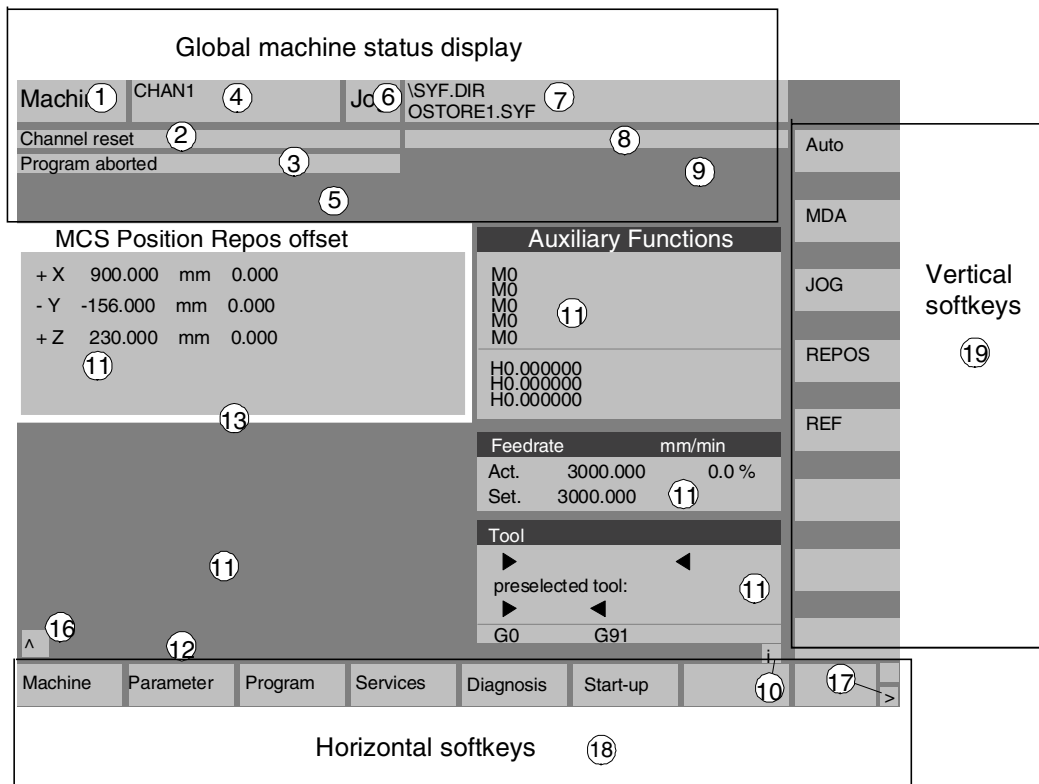

- 1 Operating areas
- 2 Channel status
- 3 Program status
- 4 Channel name
- 5 Alarm and message line
- 6 Operating mode
- 7 Program name of selected program
- 8 Channel operational messages
- 9 Channel status display
- 10 Additional explanatory text (Help) can be called
 - i Information can be displayed by means of the i key
 - ^ Recall: Return to higher-level menu
 - > Etc.: Extension of horizontal softkey bar within the same menu



MMC 100.2



MMC 103

11 Working windows, NC displays

The working windows (program editor) and NC displays (feedrate, tool) available in the selected operating area are displayed here.

12 Dialog line with operator prompts

Operator prompts (if available) relating to the selected function are displayed here.

13 Focus

The selected window is clearly identified by a special border.

The window header display is inverted. Inputs via the operator panel are active in this window.

16 Recall function, i.e. ^ key is active**17 ETC. function, i.e. > key is active****18 Horizontal softkeys****19 Vertical softkeys**

The softkey functions available in the selected operating area are displayed in the horizontal and vertical softkey menus (corresponding to F1 to F8 on the full keyboard).

2.5.2 Global machine status display

1 Operating areas	The currently selected operating area is displayed (Machine, Parameters, Program, Services, Diagnosis, Start-Up).
2 Channel status	The current channel status is displayed, <ul style="list-style-type: none"> - Channel reset - Channel interrupted - Channel active
3 Program status	The current status of the part program being executed is output <ul style="list-style-type: none"> - Program aborted - Program running - Program stopped
4 Channel name	Name of channel in which program is running.

2.5 Screen layout



MMC 100.2



MMC 103

5 Alarm and message line	- Alarms and messages or - information programmed with command MSG in the part program (if no alarms are active)
6 Operating mode display	The currently selected operating mode, i.e. Jog, MDA or AUTO (automatic) is displayed.
7 Program name	Press NC Start to execute this program.
8 Channel operational messages	<ol style="list-style-type: none"> 1 Stop: No NC ready 2 Stop: No mode group ready 3 Stop: Emergency Stop active 4 Stop: Alarm active with stop 5 Stop: M0/M1 active 6 Stop: Block ended in SBL mode 7 Stop: NC Stop active 8 Wait: Read-in enable missing 9 Wait: Feedrate enable missing 10 Wait: Dwell active 11 Wait: Aux. funct. ackn. missing 12 Wait: Axis enable missing 13 Wait: Exact stop not reached 14 Wait for positioning axis 15 Wait for spindle 16 Wait for other channel 17 Wait: Feedrate override to 0% 18 Stop: Error in NC block 19 Wait for NC blocks from external 20 Wait due to SYNACT instruction 21 Wait: Block search active 22 Wait: No spindle enable 23 Wait: Axis feedrate value is 0 24 Wait for tool change acknowledgement 25 Wait for gear stage change 26 Wait for position control 27 Wait for thread cut 28 Wait: 29 Wait for punching 30 Wait for safe operation 31 Stop; No channel ready (SW 4.1 and higher)



MMC 100.2



MMC 103

9 Channel status display

32 Stop; Oscillation active (SW 4.1 and higher)
 33 Stop; Axis replacement active (block change inhibited because axis replacement has been initiated) (SW 4.1 and higher)

Functions that have been activated are displayed (settable via "Program control").

2.5.3 Channel status display



SKP

Skip block

Only functions that have been activated are visible (settable via "Program control"). The channel status line is displayed irrespective of the selected menu.

Program blocks marked by a slash in front of the block number are ignored in the program run (e.g. "/N100...").

In SW 5 and higher, up to 8 program levels can be skipped (e.g. "/6N100 .."; the 7th program level is skipped).

References: /PG/, Programming Guide, Fundamentals, Chapter 2

DRY

Dry run feedrate

Traverse movements are performed with the feedrate value set in the setting data "Dry run feedrate". The dry run feedrate function replaces the programmed travel commands.

ROV

Rapid traverse override

The override switch for the feedrate also applies to the rapid traverse feedrate.

SBL1

Single block with stop after each machine function block

If this function is active, execution is interrupted after every block that triggers a function on the machine (calculation blocks are not affected).

SBL2

Single block with stop after each block

If this function is active, the part program blocks are executed as follows: Each block is decoded separately and execution is interrupted after every block.

SBL3

Stop in cycle

If this function is active, the part program blocks in the cycle are executed as follows: Each block is decoded separately and execution is interrupted after every block.

2.5 Screen layout



MMC 100.2



MMC 103

Part program blocks are

- Traversing blocks
- Switching functions and auxiliary functions
- Blocks generated by the control (e.g.: blocks inserted by tool radius compensation)
- Thread blocks after retraction
- Thread blocks with dry run feedrate

Thread blocks without dry run feedrate are an exception to this.

Here, execution is only interrupted at the end of the current thread block. SBL2 can only be selected in the Reset state.

Either SBL1 or SBL2 can be selected!

This function can be activated only in the "Single block" state.

**M01**

Programmed stop

When this function is active, processing of the program is stopped at every block in which miscellaneous function M01 is programmed. The message "*Stop: M00/M01 active*" is then displayed on the screen. You can restart the program run by pressing the NC Start key. If Programmed Stop is not active, then miscellaneous function M01 (from part program) is **ignored**.

DRF

DRF selection

When the "*DRF*" function is active, DRF offsets are applied.

PRT

Program test

In program test mode, setpoint outputs to the axes and spindles are disabled. The setpoint display "simulates" the traverse movements.

FST

Feed stop

The activated feed stop is displayed.

This function is not activated/deactivated under Program Control, but via the Feed Start/Feed Stop keys on the machine control panel.





MMC 100.2



MMC 103

2.6 General operating sequences



Keys

A range of keys and menus is provided in the various operating areas. The function of the keys and menus is the same in all operating areas.

Functions

The following section describes functions which you can select in several operating modes.

2.6.1 Program overview and program selection



Function

After selection of a workpiece or program overview, individual workpieces or programs can be enabled or disabled for execution.



Sequence of operations

"*AUTO*" is selected in the "*Machine*" operating area.
The appropriate channel is selected.
The channel is in reset state.
The workpiece/program to be selected is in the memory.

Program
overview

An overview of all workpiece directories/programs that exist is displayed.

Position the cursor on the desired workpiece/program.

Select the workpiece/program for execution:

Select
program

The name of the selected workpiece is displayed on the screen in field "Program name" at the top. The program is then loaded.

2.6 General operating sequences



MMC 100.2



MMC 103

2.6.2 Changing the menu window



If a screen comprises several windows, you can use the *"Window selection"* key to switch between the individual windows. You only need to do this if you wish to make inputs in the active window via the operator panel. The focus changes to the selected menu window (the header and border of the active window appear in a different display format).



Scroll in menu window:

If the contents of a window cover several screen pages, you can use the *"Page"* keys to scroll up or down through the information. A scroll bar indicates that the contents of the window extend beyond the visible display.



Position cursor in menu window:

You can position the cursor at the desired point in the menu window with the *"Direction keys"*.

2.6.3 Selecting a directory/file

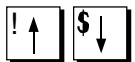

The *"Direction keys"* can be used to position the cursor on the desired directory/file.

If you enter a character on the alphanumeric keyboard, the cursor moves to the first name that begins with the character.



Open/close directory:

Press the *"Input"* key to open or close a directory.



Open file:

You can open a file with the *"Input"* key if you wish to edit it in the ASCII editor. The editor is opened automatically.



MMC 100.2



MMC 103

**Select file (MMC 103 only):**

This key is used to select a file. It is possible to select multiple files. The symbol appears next to the cursor bar when a file is selected.

**Select several files (MMC 103 only):**

In order to select a block of files, press the "Shift" and "Cursor down" keys simultaneously.



The first time you press the keys, the start of the block is selected. The subsequent files are selected continuously

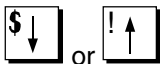

until you press "Cursor up" or "Cursor down" (without "Shift") key.



Deselects a selected file.



Cancels all selections.

2.6.4 Editing entries/values



If you wish to edit inputs/values, the corresponding key is always displayed automatically on the right of the input field. The following input fields are available:

1. Option buttons (single selection button/multiple selection button):

You can use the "Selection key" to activate or deactivate a selection field.

Multiple selection button
(you can select several options
or none)

Single selection button/option
button (only one option can be
active at a time)

= active

= active

= not active

= not active

2.6 General operating sequences



MMC 100.2



MMC 103

2. Input fields:

Position the cursor on the input field and start to type. When you begin typing, you automatically switch to Insert mode.



Always confirm your input with the *"Input"* key. The value is accepted.



If you explicitly wish to change an existing value, press the *"Edit"* key to switch to input mode.

Enter the value or word (e.g. file name, etc.) on the alphanumeric keypad.



In some fields it is possible to choose between several preset values by means of the *"Toggle"* key.

3. Selection list (MMC 103):

Selection lists show you a selected value from a list of possible values.



Press the *"Edit"* key to open a complete list of possible or existing values.



Position the cursor on the value of your choice using the *"Direction keys"*.



Always confirm your input with the *"Input"* key. The value is accepted.



With this key, you can switch to the next value in the selection list without displaying the entire list (e.g. to select from only a small number of values/settings).

- The editor only displays the characters that can be entered via the operator panel keyboard.
- **SW 5.2 and higher:** A part program opened in the editor cannot be started simultaneously in the NC (enable canceled), alarm (14014) is output. If the control is switched off while the editor is open, the enable might have to be set manually.





MMC 100.2



MMC 103

2.6.5 Confirming/canceling an input

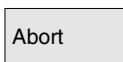

Confirm input:

Your inputs are accepted when you press softkey "OK". The selected function is executed. The window is closed, and you return to the call menu level.

Cancel input:

Your inputs are rejected if you select the "Abort" softkey. The selected function is aborted. The window is closed and you return to the menu level from which the window was called.

The response is the same on return from a function (vertical softkey bar).

The "Edit" key can also have an "Undo" function if you abandon the input/modification you have just entered. The cursor remains positioned in the currently selected field.

Switch from the horizontal menu level back to the call menu level.

2.6.6 Editing a part program in the ASCII editor



Function

The ASCII editor provides you with the following functions:

- Switch between insert and overwrite mode
- Mark, copy, delete block
- Paste block
- Position cursor/find text
- Save file (MMC 103)
- Generate contour (programming support: contour definition programming and user-defined contour programming)
- Configure cycle parameters (drilling, milling, turning)
- Start simulation
- Recompile (cycles, free contour programming)
- Renumber blocks
- Change settings

2.6 General operating sequences



MMC 100.2



MMC 103

- Open 2nd file (MMC 103)

The characters of blocks that can be edited are displayed in color.

Additional notes

A part program or sections of a part program can only be edited if the relevant blocks have not yet been executed (which might be more blocks than are displayed in the current block display, e.g. due to processing of blocks in the dynamic block buffer).

When a part program is selected and the relevant channel in the "Channel Reset" state, the program can be fully edited.

If you require the previous operating logic (up to SW 4.4) via the "Support" softkey, you can set this up using the file "cov.com", see /PGZ/ Programming Guide, Cycles.

MMC 103:

Please note the following differences in the ASCII editor:

- You can edit a program that has been loaded to the NC or a program stored on the hard disk. How programs are saved on the hard disk is determined by settings.
- The end of block character is displayed not as " L_F " but as "¶".

Sequence of operations

The following functions are fully enabled in the Program operating area but only partially in operating areas Machine and Services. In the Machine operating area, the ASCII editor is called via the program editor, in Services, by selecting a file in the file manager.



You have selected the file you wish to edit in the directory and pressed the Enter key, the vertical softkey bar changes. Your selected file is opened in the text editor.

Cursor block:

Use the "Direction keys" to position the cursor in the text.

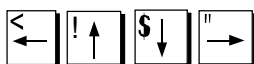



MMC 100.2



MMC 103



You can page up and down using the "Page" keys.

Press the "Delete" key to delete the character to the left of the cursor.

Press the "Input" key to end a block. The characters "LF" ("Line Feed") are automatically generated. The block you have just input will not be accepted until this has been done (MMC 100.2 only).

Vertical softkeys

Overwrite

The softkey toggles between insert and overwrite modes.

Mark (select) block

When you press this softkey, the vertical softkey bar changes.

The softkey marks the beginning of a block.

Now position the cursor at the end of the block.

The block is selected automatically.

The softkey copies the selected block into the buffer. The block remains in the buffer even after you have switched to another part program.

The selected block is deleted.

You cancel selection mode when you select "Mark block".

If the cursor is positioned on a line which was generated by a support function, the complete block is selected.

MMC 100.2 only:

A limit is applied to the block area which can be selected. When this limit is reached the following message is displayed in the dialog line: "Buffer limit for selection reached".

Paste block

The softkey pastes the cut or copied block from the buffer into the text in front of the cursor position.

Overwrite

Mark
block

Copy
block

Delete
block

Mark
block



Paste
block

2.6 General operating sequences



MMC 100.2



MMC 103

Find/
Go to ..

Start of
Program

End of
Program

Go to ..

Find

OK

Abort

Find
next or 

Replace or 

Replace
text global

Find/Go to...

The window "Find/Go to..." is opened.

You can select functions for positioning and searching via the vertical softkeys:

The following search methods are available:

- to the beginning of the part program (cursor on the first character in the program),
- the end of the part program (cursor on the last character in the program) and
- position on a particular line with "Go to..."
- or search for a particular character string with "Find".

"Go to...":

Enter the block number you are looking for.

- If the line being searched for contains an "N" or ":", you are taken to that line,
- If there is no block number, the cursor is positioned on the block with the specified number.

Press softkey "OK" or the "Input" key to position the cursor on the block number/line number of your choice.

The "Go to..." window is closed.

If you abort positioning, the process is stopped and the window closed.

"Find":

Enter the character string you wish to find.

The string you enter is sought downwards from the current cursor position, the find result appears as highlighted text.

You can start a new search by pressing softkey "Find next" or the "Input" key.

Enter the new text with the "Replace" softkey.

The text found is replaced by the "replacement text". The new text is replaced when you press "Input". Every time you press "Input", a new find and replace process is started.

Global text replacement (SW 5.2 and higher)

Enter the new text with the "Replace text global" softkey. The query asks you "Do you really want to replace all non write protected strings: ... globally with ... ?".

Note: This function can be protected with a password, see MMC Installation and Start-Up Guide, IM1 and IM3 Start-up Functions for MMC 100.2/103. MMC 100.2 and 103



MMC 100.2



MMC 103



Abort

Save file



Close editor

Contour

Generate contour

Accept contour

Contour

Contour 1-str. line

OK

The function "Replace text globally" is only available for files located on the hard disk (not in the NC memory).

If you abort Find + Replace, the process is stopped and the window closed. You are in "Edit mode" again".

Save file

Changes are saved in the file loaded in the editor.

Additional notes

Please note that the changes to programs stored in the NC memory take immediate effect.

MMC 103:

The save options for the control system can be altered in the "Settings" menu (e.g. save automatically, etc.).
(See "Start-up" section)

Close editor

When you select softkey "Close editor", a dialog box appears in which you must confirm whether or not to save the changes. The text editor is then closed and the current program overview is displayed again.

Horizontal softkeys

Free contour programming

Use the "Contour" and "Generate contour" softkeys to call up the free contour programming function.

The part program block is inserted in the part program with the appropriate parameters.

Contour definition programming

The softkeys "Contour" and "Contour 1-straight line" open the parameterization screen form for "Contour definition 1-straight line". There are also parameterization screen forms for the contour definitions "Contour 2-straight lines" and "Contour 3-straight lines".

The part program block is inserted in the part program with the appropriate parameters.

The input screen forms are described in /PGZ/ PG Cycles, Chapter 1.

2.6 General operating sequences



MMC 100.2



MMC 103

Drilling

Milling

Turning

OK

Simulation

Recom-
pilation

Cycle parameterization

The following functions are provided as programming support:

- Drilling, milling, turning (cycles)
- Contour (free contour programming)

You can call up the relevant cycle compilation via the vertical softkeys Drilling, Milling, Turning.

Enter the new values for the cycle parameters.

The part program block is inserted in the part program with the appropriate parameters.

Example:

```
CYCLE81 (110, 100, 2, 35)
/PGZ/, Programming Guide, Cycles
```

Simulation

MMC 100.2:

The Simulation function is selected.

When you press the "NC Start" button, graphic simulation is started (see Section "Simulate program").

MMC 103:

The simulation is called up (see /BA/, Operator's Guide Interactive Programming or, for SW 5, Chapter 6 "Program" Operating Area).

Softkey "Simulation" is displayed only if the simulation function can be called in the current operating situation.

Cycle recompilation

If program steps (cycle/contour) have already been parameterized but must be changed, you can display and edit the parameter values with their meanings.

Position the cursor in the text editor on the line with the program step (contour/cycle) whose parameters you wish to change.

A screen form containing the parameter settings for the selected cycle/contour appears on the screen.

Change the parameters.



MMC 100.2



MMC 103

OK

The part program block is automatically inserted in the part program with the new parameters.

Renumber

The block numbering in the program shown in the editor is executed again according to the values defined under the "Settings" softkey.

Settings

Editor settings

Settings (MMC 100.2 only)

In the "Editor settings" window you define whether the edited program is to be automatically enabled after it has been stored or enabled manually.

Setting contour prg.

The following settings are possible for contour programming:

- Last line
Each time you complete a program step in the contour programming you can insert a text in the last line (e.g. "End of contour").

Settings

Editor settings

Settings (MMC 103 only)

Define the following values in the window "Editor Settings":

- Horizontal scrolling ON/OFF
- Display hidden lines ON/OFF
- Time interval for Automatic Save
When you set Automatic Save, you can also set the time intervals at which text must be saved automatically (applicable only to files on hard disk). If the value $\neq 0$ is entered, the softkey "Save file" is not displayed. If the value 0 is entered, automatic save is not performed.
- Automatic numbering ON/OFF
A new block number is automatically inserted on every new line. If you wish to assign new block numbers to an existing program, use the "Renumber" function.
- Number of first block
- Incrementation of block numbers (e.g. 1, 2, 10)

Setting contour prg.

The following settings are possible for contour programming:

- Last line
Each time you complete a program step in the contour programming you can insert a text in the last line (e.g. "End of contour").

2.6 General operating sequences



MMC 100.2



MMC 103



Additional notes

- The coordinate system and the technology used are set in the machine data; see /IAM/ MMC Installation and Start-Up Guide
- On the MMC 103, edited programs are automatically enabled as soon as they are saved.

2.6.7 Switch channel over



It is possible to switch between channels when several are in use. Since individual channels may be assigned to different mode groups, a channel switchover command is also an implicit mode switchover command.

If the selected channel is linked to another NCU (m:n link), the MMC is also switched over implicitly to the relevant NCU.

When a "Channel menu" is configured, all existing communication links to other NCUs plus the associated channels are displayed on softkeys.

Channel states

The following three channel states can occur in each of the above modes:

1. Channel reset

The machine is in the initial state, e.g. after power-on or after end of program. The initial state is defined by the machine-tool manufacturer in the PLC program.

2. Channel active

A program has been started, the program is being executed or a reference point approach is in progress.

3. Channel interrupted

The current program or reference point approach has been interrupted.

In this context a program can be a main program, subprogram, cycle or a series of NC blocks.





MMC 100.2



MMC 103

There are 3 different switchover levels:

1. Switch to next channel  .
2. Switch over configured channel group/channels (1 NC).
3. Switch to another NC (with m:n link involving several NCs).

2.6.8 m:n communication links

General information

The term m:n link is used to indicate a configuration in which m MMC units and n NCU/PLC units are interconnected. This does not, however, mean that all possible links are actually active.

In this case, an MMC is linked to only one NC at any given point in time (cf. 1:1 link) and communicates only with this unit. With an m:n link, the link can also be switched over to another NC. Using the channel switchover key and channel menu, you can switch the MMC over to another link.

The Channel Menu function is an option and must be configured in the "NETNAMES.INI" file.

You can go to the channel menu by pressing the channel switchover key in any of the operating areas. When you do so, only the horizontal and vertical softkeys change.

Use the horizontal softkeys to select a channel group (max. 24), 8 links to channels on different NCUs can be set up in each channel group.

All current communication links and associated symbol names are listed in display "*Channel menu*".



Important

Only two links may be active simultaneously on one NCU.



MMC 100.2



MMC 103



Function

You can establish a link via the operator interface in any operating area between the MMC unit and other connected NCU/PLC units.

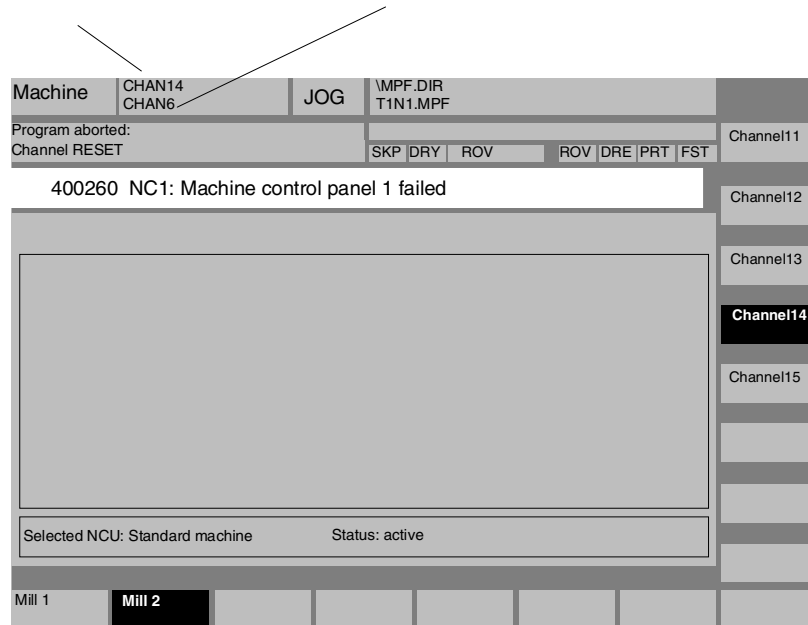

Press the channel switchover key. The current link can be identified by highlighted horizontal and vertical softkeys when the channel menu is active.

Switch channel over

It is possible to switch over to other channels by means of the softkeys in the vertical menu.

Switch group over

You can switch over to another group by selecting a softkey in the horizontal menu; the vertical softkeys now display the channels of the currently selected group. You can only switch over to another channel (and thus possibly to another NC) by selecting one of the vertical softkeys.



MMC 100.2



MMC 103

Switch NC over

You can switch over to another NC by selecting a channel which is not linked to the current NC on one of the vertical softkeys.

Additional notes

- Horizontal softkeys are assigned to vertical softkeys in the NETNAMES.INI file. The assignment merely represents an MMC-specific grouping characteristic.
- When you select a vertical softkey, you are selecting a channel and potentially an NC as well.
- Channels that are configured in the channel menu, but defined as a channel gap in the corresponding NC, will not be displayed.
- If an application (e.g. processing from external source) disables switchover to the selected NC, then only the channels of the current NC are displayed in the channel menu.
- Only the MPI link is available on SINUMERIK 810D systems.

Example: 2 MMCs and 1 NCU

Two MMCs (MMC 100.2 plus OP 030) are linked to one NCU. You can connect an additional programming device (PG) with start-up tool.

The configuration illustrated below makes it possible to install the following equipment on a large machine tool:

- A high-performance operator panel with MMC 100.2 on the front and
- an OP 030 operator panel near auxiliary machines or
- an OP 030 operator panel to the rear.

2.6 General operating sequences



MMC 100.2



MMC 103

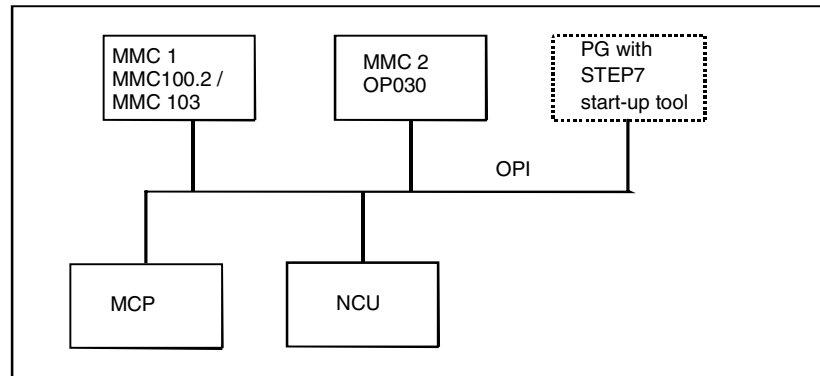

The following rules apply to the operation of two MMCs or OP 030 operator panels:

- The inputs on the MMC or OP 030 operator panels have the same priority as on the NCU.
- Each operator unit can display the screens selected on it, independently of the other operator unit.
- Spontaneous events such as alarms are displayed on both operator units.
- The protection level with the highest access rights according to the lowest activated protection level number applies to both operator panels.

The system does not perform any additional coordination of the operator units.



MMC 100.2



MMC 103

Example: 1 MMC and 3 NCUs

An MMC unit can be linked to several NCU/PLC units. The machine control panel MCP is assigned permanently to the NCU.

You can connect an additional programming device (PG) with start-up tool.

The configuration illustrated below allows several NCUs to be operated from one MMC, i.e.

- several autonomous machines with several NCUs or
- one large machine with several NCUs.

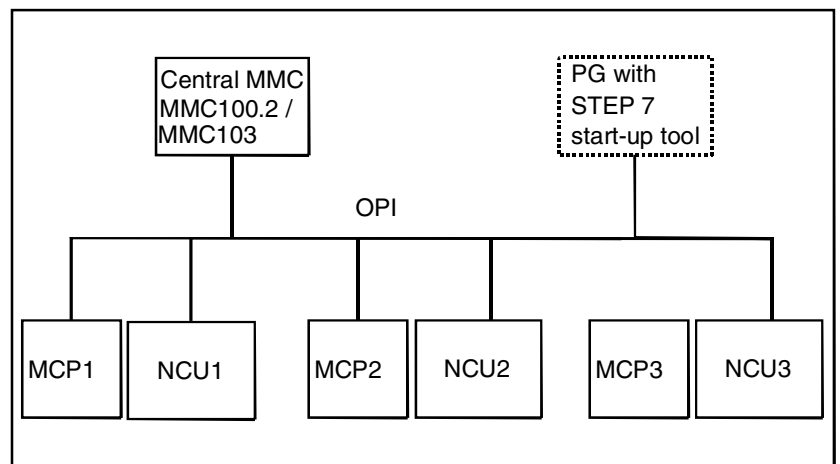

2.6 General operating sequences



MMC 100.2



MMC 103

The following rules apply to the operation of several NCUs from one MMC:

- The NCU to be operated is selected via the channel switchover key and the channel menu.
- The softkeys highlighted in the channel menu indicate the mode group/NC/channel to which the MMC is currently linked.
- **MMC 100.2/OP 030**
 - Only the alarms/messages of the NCU currently connected to the MMC are displayed.
 - No other applications (e.g. data back-up via V.24 interface) should be active on the link that will be interrupted when you switch over to another NCU. If an attempt is made to switch the connection, the system outputs an appropriate message.
 - The MMC is always in the default Start area (i.e. as if it had just been restarted cold) after it has been reconnected to another NCU.
- **MMC 103**

After setting up a link to another NCU, the operating area selected last is always available for this (as for the NCU whose link was separated).



MMC 100.2



MMC 103

2.6.9 Pocket calculator function



Precondition:

The cursor is positioned on an input field or input/output field.

With the Edit key (MMC 100.2)

or

Equal key (MMC 103, with SW 5 also MMC 100.2)

you can switch to **pocket calculator mode**.

If a fundamental operation of arithmetic sign (+, −, /, *), followed by a value (e.g. *13.5*) or expression (e.g. *sin(26.5)*) is entered in this mode and then the input key is pressed, the next value to be entered is calculated with the previous value.

If the input/output field is opened with the input or equals key, the editor is in insert mode; if the field is opened directly with a character, the editor is in write-over mode.

Inch-metric conversion (MMC 103)

In pocket calculator mode, you can convert numeric values from the metric to inch system by entering "I" and from the inch to metric system by entering "M".

Proceed as follows to convert values:

- Position the cursor on an input field which contains a numeric value or enter a value
- Press the equal key
- Enter the letter "I" (convert to inches) or "M" (convert to metric)
- Press the "input" key, the value is converted.

Help display (MMC 100.2)

When the pocket calculator mode is active, you can insert a help screen via the info key which describes operation of the input field editor.



MMC 103

2.7 Help



Function

Whenever the symbol "i" appears in the dialog line, this means that additional information can be called via the information key . A comment appears in the dialog line.

Analogous to the Windows Help, an MMC Help function is provided on the MMCs. If, for example, you have made an input error, you can select the MMC Help to access detailed information about the error that has just occurred, e.g. the Diagnostic Guide is displayed.

You can call MMC Help (MMC 103) automatically by pressing the "Information" key in operating area Diagnosis/Alarms.

Press the "Page down" or "Page up" softkey.
The screen contents are scrolled up or down.

Use the "Highlight fwd" or "Highlight back" softkeys to go to the entry of your choice.

Press the "Follow cross ref." softkey.

The entry you chose appears on the screen.

Press the "Back" softkey to return to the entry displayed beforehand.

Select and display an entry in MMC Help (MMC 103):

Press "Contents" softkey.

The current contents of MMC Help are displayed.

You exit the MMC Help and return to the previous menu.

Page
down

Page up

Highlight
backHighlight
fwd.Follow
cross ref.

Back

Contents

Exit
help



MMC 103

 Notepad

 OK

 MMC Help

Making notes on entries in MMC Help (MMC 103):

Press "*Notepad*" softkey.

You can paste comments about errors in this pad.

These inputs can neither be saved separately nor output via RS 232 C (V.24).

Press "*OK*" softkey.

Your comment is automatically assigned to the correct entry.

Context-independent Help call:

When you press the "*Area switchover key*" you are taken back to the basic menu and

when you then press the "*etc. key*"

you can call the function "*MMC Help*" directly (MMC 103).

Additional notes

The "*MMC Help*" tool is structured in a similar way to Windows Help. See the Windows TM manuals for detailed information on Windows Help.



MMC 103

2.7.1 Overview: Help in Editor (SW 5 and higher)



Function

The following help functions are provided as programming support with the editing of part programs in the editor via the *"information key"*:

- **Short help for programming commands**
configuring see /IAM/ HE1, Help in Editor.
 - Help in part program for instructions:
Display descriptive text (e.g. G9 "Exact stop - velocity reduction")
 - Display an overview of topics (e.g. "Preparatory functions", "Path commands", "Path travel behavior" etc.), to which instructions are assigned.
 - Display an overview of instructions with descriptive text
 - Search selectively in special screen forms on the basis of topic assignment or by entering a character string
 - Transfer the selected instruction to the Editor
- **Short help "Parameterization form" + extended help "pdf"**
Configurable parameterization forms from which you can jump to a particular page in the documentation (pdf file), parameterization forms for cycles, you jump to the Configuring Guide Cycles; for configuration see: /IAM/, BE1 Expanding the User Interface.
- **Short help for program commands + extended help "pdf"**.
From the context-sensitive help you can jump to the corresponding page in the documentation with the *"information key"*, e.g. jump to the Programming Guide, Fundamentals.



MMC 103

2.7.2 Short help for program commands (SW5 and higher)



Function

You can call up a help function to provide programming support with the editing of part programs via the *"information key"*.

This help function can assist in the following ways:

- Display instructions with descriptive text context-sensitively with reference to the cursor position (e.g. G9 "Exact stop - velocity reduction")
- Display an overview of topics (e.g. "Preparatory functions", "Path commands", "Path travel behavior" etc.), to which instructions are assigned.
- Display an overview of instructions with descriptive text
- Search selectively in special screen forms on the basis of topic assignment or by entering a character string
- Jump from the context-sensitive help via the *"information key"* onto the corresponding page of the documentation, e.g. jump to Programming Guide, Fundamentals
- Jump into an input screen form with softkey *"Input screen form"* in which, for example, a cycle is assigned new parameters.
- Transfer the selected instruction to the Editor

Notes

If the help function is being used by one editor, it is not available for use by other editors.

Sequence of operations

You call the help function in the editor with the *"information key"*.

Depending on the current context of the cursor:

- With standard context sensitivity (*"displayed if wording is identical"*), only the programmed instruction with descriptive text or
- with extended context sensitivity (*"displayed if initial wording is the same"*), additionally all instructions with the same initial wording or
- if there is no match, a full overview (see below) is displayed.



MMC 103

Help system - Overview (general)	
Instruction	Description
\$A	NC-unabhängiger aktueller Wert
\$AA	achs-spezifischer aktueller Wert
\$AC	kanal-spezifischer aktueller Wert
\$AN	NCK-globaler aktueller Wert
\$MA	achs-spezifisches Maschinendatum
\$MC	kanal-spezifisches Maschinendatum
\$MD	YSA/HSA-Maschinendatum
\$MM	Anzeige-Maschinendatum
\$MN	NCK-globales Maschinendatum
\$P	programmierter Wert
\$PI	Kreiskonstante PI
\$SA	achs-spezifisches Settingdatum
\$SC	kanal-spezifisches Settingdatum
\$SN	NCK-globales Settingdatum
\$TC	Werkzeugverwaltungdatum
\$VA	achs-spezifisches Servicedatum
*	Operator für Multiplikation
+	Operator für Addition
-	Operator für Subtraktion
:	Sprungmarkenende, Verkettungsoperator für FRAME-Vars bzw. Hauptsatz
<	Vergleichsoperator, kleiner

Transfer to editor

Exit help

General overview Headings Find Settings

Transfer to editor

If transfer is possible, the instruction selected in the overview is inserted directly in the part program with *"Transfer to editor"*.

If an instruction selected with context sensitivity active is different to the programmed instruction, the programmed instruction is overwritten.

If extended context sensitivity is not active or if a different selection is displayed with *"Find"*, *"Headings"* or *"General overview"*, the selected instruction text is inserted in the part program behind the instruction marked by the cursor.

Exit help

As an alternative to returning to the Editor by transferring an entry, this softkey can be selected to close the Help window and return to the part program writing screen.

Apart from context-sensitive help, it is also possible to search independently of context for instructions, descriptive texts or topics.

General overview

With *"General overview"* a full overview of the instructions and relevant descriptive text stored in the help system is displayed.

Headings

With *"Headings"* the stored headings are listed for which a functional grouping of the instructions can be displayed.

To select a heading, you can either use the cursor keys or enter the heading number in an input box.



MMC 103



Show heading

If a heading is selected and you press *"Input"* or the softkey *"Display heading"*, the instructions belonging to the selected heading are displayed.

Find

With the *softkey "Find"* you can define a search text in an input window, which you can search under

- *"Instruction text only"*
- *"Descriptive text only"*
- *"Instruction and descriptive texts"*.



Start search

No distinction is made between upper and lower case.

With *"Input"* or *"Start search"* a search is made using the defined search text in accordance with the instruction or descriptive part.

Any matching instructions or descriptions found during the search are displayed.



Settings

Notes for setting the help system in the editor

The editor help uses a standard text file (see /IAM/, "Installation and Start-up Guide MMC", Chapter "Help in editor"), which contains topics and instructions with descriptive text.

If you want to create an end user text file for the help in order to record your own instructions/topics, you can enter the path/name of the text file under softkey *"Settings"* in an input window as *"end user text file"*.

You can also change the context sensitivity under *"Settings"*.

You can choose between:

- *"Display with same initial wording"* (extended context sensitivity) and
- *"Display with identical wording"*

If, for example, in the option *"Display with same initial wording"* the cursor is located to the right of the instruction "G4", all instructions with the same initial wording, e.g. "G40, G41, G42" are also displayed.

With *"Display with identical wording"* the current instruction, e.g. "G4" is displayed.

The settings are activated by restarting the help system.



MMC 103



SW 5.2 and higher:

If you select the individual descriptions in the full overview with the cursor key, you can jump directly into the Programming Guide, for example, with the "info key", if the symbol for the info key is displayed on the bottom right part of the screen (see Fig. below).

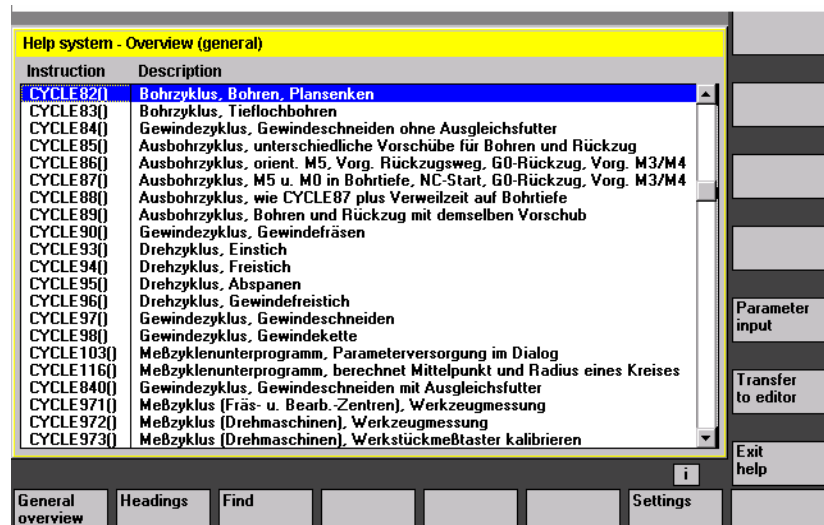

Parameter input

If "Parameter input" appears in the vertical softkey menu, you can assign parameters in an input screen for a particular instruction (e.g. a cycle).



MMC 103

2.7.3 Extended help for program commands (SW5.2 and higher)



Function

You can call up a help function (short help) to provide programming support for editing part programs via the *"information key"* in the program command editor.

If the short help is not sufficient, you can also open the Programming Guide (pdf file) by pressing the *"information key"* again. The command you are looking for is highlighted in the document.



Sequence of operations

Precondition:

The cursor is positioned on a programming command (e.g. G01).



You can call up the help function (short help) in the editor with the *"information key"*.



Press the *"information key"* once more to open the Programming Guide (pdf file) with the Adobe Acrobat Reader.

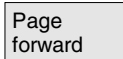

or

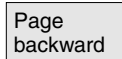

You can page through the document with the softkeys "Page forward" and "Page backward",

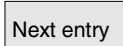

you jump to the next hit in the document with "Next entry".



Where there are cross references to other documents you can jump to a particular point in that document with this softkey.

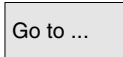

You can search for any words in the document with the search function "Go to ...".

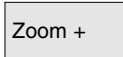

or

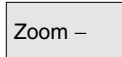

With the softkeys "Zoom +" and "Zoom -" you can increase or decrease the zoom factor in the document view,

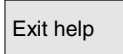

with "Exit help" you return to the editor.



MMC 103

2.8 Job list (SW 5 and higher)



Function

With SW 5 and higher, it is possible to create a job list (loading list) for each workpiece.

This list contains instructions which prepare the following for the execution of part programs (in several channels if necessary):

- Parallel setup (LOAD/COPY) i.e.:
Load or copy main programs and subprograms and associated data such as
 - initialization programs (INI)
 - R parameters (RPA),
 - user data (GUD),
 - zero offsets (UFR),
 - tool/magazine data (TOA/TMA),
 - setting data (SEA),
 - protection zones (PRO) and
 - sag/angularity (CEC)

from the hard disk of the MMC to the main memory of the NC

- Preparations for NC Start (SELECT), i.e.:
Selection of programs in various channels and start preparations for execution
- Parallel cleanup (reversed LOAD/COPY) i.e.:
Unload main programs and subprograms and the associated data from the main memory of the NC onto the hard disk of the MMC
- Backup (in preparation for the next software version)

Notes

Parallel setup, preparations for NC Start, parallel cleanup and backup can also be executed from the PLC.



MMC 103

The job list is executed if the workpiece contains a job list of the same name.

The instructions of the job list are activated (see diagram) on

- ① Parallel setup with "Load" (LOAD/COPY)
- ② "Selection" (LOAD/COPY/SELECT)
- ③ "NC Start" (Program is executed and SELECT is activated)
- ④ Parallel clearing with "Unload" (reversed LOAD/COPY)
- ④ "Back up" (being prepared for the next software version)

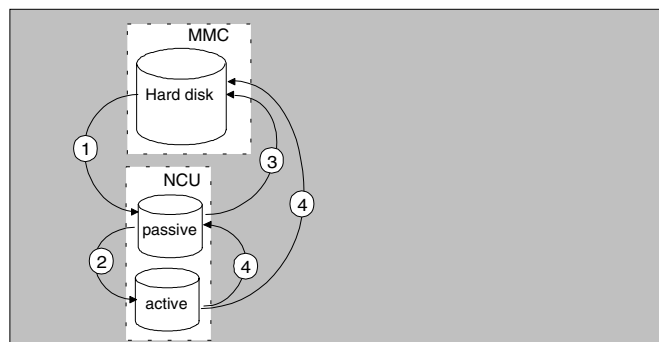

Creating file "Workpiece.JOB" (e.g. SHAFT.JOB)

There are various methods by which job lists can be created:

- While creating a workpiece directory with the function "New", generate a standard job list as a file in this workpiece. The job list syntax is included as a comment in this standard job list. To do that, check the field "Create templates for joblist" under "Start-up/MMC/System settings/Templates".

With this method, the file is automatically assigned the name of the relevant workpiece directory `workpiece.JOB` (e.g. `SHAFT.JOB`).

- Creating joblists with different names in an existing workpiece directory with the function "New".
- Job lists can be inserted in an existing workpiece directory.

The job list can be modified with the Editor.

Notes

You can create your own templates for job lists or standard part programs/subprograms in the directory `\Templates\Manufacturer` or `\Templates\User`. The data manager always searches the User directory first, then the Manufacturer directory, and finally the Siemens directory.



New



2.8 Job list (SW 5 and higher)



MMC 103

It is recommended that you name the template `_templ_`. `_templ_` is replaced by the workpiece name when you create a new workpiece. For example, if `_templ_.job` or `_templ_.mpf` is found, it is renamed `SHAFT.JOB` or `SHAFT.MPF` in the workpiece `SHAFT.WPD`. If the templates are to be language-dependent, the language abbreviation must be appended with an underscore prefix to the end of the template name. When you create a new workpiece, the template with the abbreviation of the current language is used. The abbreviation is removed when the file is copied (e.g. `_templ__gr.job` becomes `SHAFT.JOB`). Templates without a language abbreviation are always copied. The template is always selected when the workpiece is created, i.e. the language cannot be changed subsequently.

2.8.1 Description of syntax for job lists



Explanation

The job list syntax consists of 3 instructions

- Load instruction `LOAD`
- Select instruction `SELECT`
- Copy instruction `COPY` (for m:n link only)

Notes

As regards the job list commands, a distinction must be made between an m:n network and a 1:1 link between the MMC and NCs. It is advisable to use the instruction `LOAD` for a 1:1 link and `COPY` for an m:n link, at least for global programs and, in particular, cycles used in several NCUs.

Comment

All terms placed inside "brackets" or ";" are comments and are ignored when the joblist is processed.



MMC 103



Description of syntax

LOAD [source]

The LOAD instruction loads one or several files from the MMC to the NC main memory, deleting the source file on the MMC. In other words, the files are stored only once.

This instruction is recommended for a 1:1 link.

[source] is [path]/[name]

The path/name defines the relevant path within the file tree of the data manager.

Wildcards (e.g. *) may also be used in the name.

Examples:

LOAD *

(load all files from workpiece directory of job list)

LOAD /MPF.DIR/*

(load all files from one directory, e.g. in this example, all files from part programs (MPF.DIR))

LOAD PART1.MPF

(load one file, e.g. PART1.MPF, from the workpiece directory currently selected in the job list)

LOAD /SPF.DIR/PART1.SPF

(load one file from a directory, in this case from subprogram directory SPF.DIR)

SELECT [source] [destination] [DISK]

The SELECT instruction selects a program for execution.

The selected program must be loaded to the main memory of the NC. It can then be started with NC-START.

If programs on the hard disk of the MMC103 must be executed, then the command must include vocabulary word DISK.

[source]

is the name of the main program which is selected for execution in a specific channel in the NCK.



MMC 103

[destination]

A channel must be specified as the destination.

CH=

Channel number (for a 1:1 link only);

or

with NETNAMES:INI: Channel name (channels are unambiguously distributed across all NCs);

or

NC name, channel number

Example:

CH=2

(2 is the channel number)

CH=Station5

(Station5, corresponds to channel name from NETNAMES.INI)

CH=ncu_b,1

(ncu_b corresponds to NCU name from NETNAMES.INI
1 is the local channel number of this NCU)

[DISK]

can be optionally specified for program execution from hard disk.

Examples:

SELECT PART12 CH=CHANNEL22

SELECT PART12 CH=NCU_2,2

(PART2 is selected in the 2nd channel of NCU_2)

SELECT /shaft1.wpd/side1.mpf CH=2 DISK

(Part program SIDE1.MPF of workpiece SHAFT1.WPD
is executed from the hard disk in the 2nd channel)

COPY [source] [destination]

The COPY instruction copies one or several files from the MMC to an NC main memory. The original files remain stored on the MMC.

The COPY instruction is executed only if the relevant file does not yet exist at the destination or if it has a different time stamp.

This instruction is recommended for an m:n link.



MMC 103

If this type of file needs to be modified, it must always be edited on the NC. If the file has been distributed more than once via the joblist, and you want the changes to be active in all NCs, you must first unload that file, then edit it, and finally redistribute it via the joblist.

[source] is [path]/[name]

[destination] is the NCU/channel address:

The destination can be specified using one of the three address categories. It must be noted that only the logical names from NETNAMES.INI are taken into account.

NC= Name of NCU

Without NETNAMES.INI, the only option in this case is to specify the NC name with NC=.

CG= Name of the channel group, i.e. copy in every channel of this group (therefore in all NCs to which the channels are assigned).

Parameter CG can be specified only if a channel menu is configured.

CH= Name of channel

Channel names are only assigned uniquely across NCs when a channel menu is configured.

If no destination is specified, the source is copied to the NC currently linked to the MMC. If * is entered as the target, the source is distributed to all the NCs configured in NETNAMES.INI.

Examples:

COPY * *

(copies all files from the workpiece of the joblist to all NCs that are configured in NETNAMES.INI)

COPY PART12.MPF NC=NCU_2

(copies a file from the workpiece of the joblist into the NC "NCU_2")

COPY /SPF.DIR/PART1.* CG=MILL2

(copies all files with a name from a directory e.g. PART1.* from subroutines (SPF.DIR) into a channel group, i.e. to all NCs to which channels of this group are assigned).



MMC 103

```
COPY /MPF.DIR/* CH=CHANNEL22
```

(copies all files from a directory, e.g. all from part programs (MPF.DIR) to the NC which is assigned to this channel.)

2.8.2 Example of a job list for two-channel 1:1 links



Example

If only channel1 and channel2 on NCU1 (1:1 link) were involved in machining of the workpiece, then the most suitable job list structure would be as follows:

```
LOAD /MPF.DIR/Gen.MPF  
LOAD /WCS.DIR/Part1.WPD/WpdGen.MPF
```

```
LOAD /WCS.DIR/Part1.WPD/ Channel1.MPF  
LOAD /WCS.DIR/Part1.WPD/ Channel1.INI  
LOAD /WCS.DIR/Part1.WPD/ K12.MPF
```

```
LOAD /WCS.DIR/Part1.WPD/ Channel2.MPF  
LOAD /WCS.DIR/Part1.WPD/ Channel2.INI  
LOAD /WCS.DIR/Part1.WPD/ K22.MPF
```

```
SELECT /WCS.DIR/Part1.WPD/Channel1.MPF CH=1  
SELECT /WCS.DIR/Part1.WPD/Channel2.MPF CH=2
```

The destination is not specified for loading in a 1:1 link, the current NC is the default.



MMC 103

2.8.3 Example of a job list for multi-channel m:n links



Example

MMC1 to two NCs
 NCU1 with channel1 and channel2
 NCU2 with channel3

Part1.JOB:

COPY /MPF.DIR/Gen.MPF NC=NCU1 (or CH=CHANNEL1)

COPY /WCS.DIR/Part1.WPD/WpdGen.MPF NC=NCU1
 (or CH=CHANNEL1)

COPY /WCS.DIR/Part1.WPD/Channel1.MPF NC=NCU1
 (or CH=CHANNEL1)

COPY /WCS.DIR/Part1.WPD/Channel1.INI NC=NCU1
 (or CH=CHANNEL1)

COPY /WCS.DIR/Part1.WPD/K12.MPF NC=NCU1
 (or CH=CHANNEL1)

COPY /WCS.DIR/Part1.WPD/Channel2.MPF NC=NCU1
 (or CH=CHANNEL2)

COPY /WCS.DIR/Part1.WPD/Channel2.INI NC=NCU1
 (or CH=CHANNEL2)

COPY /WCS.DIR/Part1.WPD/K22.MPF NC=NCU1
 (or CH=CHANNEL2)

COPY /MPF.DIR/Gen.MPF NC=NCU2 (or CH=CHANNEL3)

COPY /WCS.DIR/Part1.WPD/WpdGen.MPF NC=NCU2
 (or CH=CHANNEL3)

COPY /WCS.DIR/Part1.WPD/Channel3.MPF NC=NCU2
 (or CH=CHANNEL3)

COPY /WCS.DIR/Part1.WPD/Channel3.INI NC=NCU2
 (or CH=CHANNEL3)

COPY /WCS.DIR/Part1.WPD/K32.MPF NC=NCU2
 (or CH=CHANNEL3)

SELECT /WCS.DIR/Part1.WPD/Channel1.MPF CH=CHANNEL1

SELECT /WCS.DIR/Part1.WPD/Channel2.MPF CH=CHANNEL2

SELECT /WCS.DIR/Part1.WPD/Channel3.MPF CH=CHANNEL3



MMC 103

2.8.4 Sequence of operations "Executing joblist"



Manage
data

Load

Select

Unload



Load

e.g. press the softkey *"Manage data"* under *"Services"*.

The horizontal and vertical softkey bars change.

Position the cursor on the correct workpiece directory.

Then execute functions

- *"Load"*
- *"Select"*
- *"Unload"*.

If a job list named `workpiece.JOB` is stored in a workpiece directory, then the functions are executed for that job list.

However, the functions can be executed directly on the job list, e.g. if the directory contains job lists that are named differently from the workpiece.

Additional notes

"Load" joblist

"Load" means that all the prepared joblist instructions are executed.

The data are distributed from [Source] to [Target], to the target NCs with the instruction `LOAD` or `COPY`. The workpiece is then marked as "loaded".

`SELECT` instructions are ignored.

If the workpiece/job list is loaded, then the log window displays a list of the files to be distributed.

The log window can be displayed in the event of an error. Loading of the job list can then be aborted if necessary.

Marking of files on user interface

If the file is stored only on the hard disk of the MMC, then it is marked as "not loaded".

If the file is only located in the RAM of the NC, it is marked as loaded with an "X".

If the file is located both in the MMC and in the NC, the identifier "X" is only removed when the files are no longer identical.

If the files have different time stamps or are of different lengths, the identifier is "!X!".



MMC 103

Select

"Selection" joblist

If you select a joblist or workpiece with joblist, all instructions of the joblist are executed.

LOAD instructions are executed if the files are still stored on the MMC. COPY instructions are executed only if the files are not stored on the NC or if the file copy on the NC has a different time stamp to the MMC copy. If the time stamps are different, the system inquires whether the file must be overwritten.

SELECT instructions are executed.

Unload

"Unload" joblist

"Unload" means that the instructions of the joblist are "undone", the instructions in the joblist are executed in reverse order, e.g.:

Data which have been loaded to a destination NC with a LOAD instruction are unloaded from [destination] to [source] into the source directory on the MMC.

Data that have been copied to a destination NC with COPY are erased at the [destination], provided they have the same time stamp as the original. If the NC file copy has been modified, a query box appears, asking whether the NC version must be transferred to the MMC.

With "Unload" only files are transferred from the passive file system of the NC. If, for example, modifications have been made to the active data in parameters, these must be saved beforehand.

2.8.5 Renaming workpieces with job lists (SW 5.2 and higher)

Function

When you rename a workpiece directory, all the workpiece files under that directory that have the same name as the directory are renamed. If a job list with the name of the directory exists, the instructions in that job list are also renamed.

Comment lines remain unchanged.

2.8 Job list (SW 5 and higher)



MMC 103



Example:

Workpiece directory A . WPD renamed to B . WPD:

All files with the name A . XXX are renamed to B . XXX, i.e. the extension is not altered.

If a job list called A . JOB exists it is renamed to B . JOB.

If this job list contains instructions of file A . XXX located in this workpiece directory, then that file is also renamed to B . XXX.

Example:

If job list A . JOB contains an instruction

```
LOAD/WKS . DIR/A . WPD/A . MPF
```

it is renamed to

```
LOAD/WKS . DIR/B . WPD/B . MPF
```

However, if a job list contains the instruction

```
LOAD/MPF . DIR/A . MPF or
```

```
LOAD/WKS . DIR/X . WPD/A . MPF
```

the files are not renamed.

Sequence of operations

The softkey "*Manage programs*" in operating area "*Program*" must be pressed (MMC 103).

Place the cursor on the workpiece directory that you want to rename.

The "*Rename*" dialog window opens.

Enter the new name.



Manage
programs



Rename

2.8.6 Copying workpieces with job lists (SW 5.2 and higher)



Function

If the files of a workpiece directory are copied to a new directory, all the files with the same directory name are renamed to the new workpiece directory name.



MMC 103

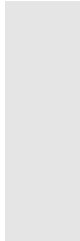

If a job list with the name of the directory exists, the instructions in that job list are also renamed.

See also section "*Renaming*".

This function applies to operating area "*Program*" only.

When you copy under "*Services*", the names remain unchanged.



Manage
programs



Copy

Insert

OK

Sequence of operations

The softkey "*Manage programs*" in operating area "*Program*" must be pressed (MMC 103).

Position the cursor on the file that you want to copy and press the softkey "*Copy*".

The file is marked as the source for copying.

Press the softkey "*Insert*", enter a new name, if necessary, and confirm with "OK".

2.8.7 Archiving workpieces with job lists with m:n (SW 5.2 and higher)

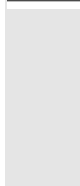

Function

When archiving workpieces that contain job lists of the same name, in the case of m:n you are asked whether the job lists to be unloaded are to be executed. You can terminate the action with "*Cancel*", otherwise all job lists are executed and archiving is then started.



Data
from

Sequence of operations

In the "*Services*" operating area press the "*Data from*" softkey.

The "*Programs/Data*" file tree is displayed.

The vertical softkey bar changes.

Please refer to Chapter "Reading out data" in operating area "*Services*" for additional operating sequences.

2.8 Job list (SW 5 and higher)

MMC 103



MMC 100.2



MMC 103

Operating Example

Typical operating sequence

To provide support for entry-level users or an orientation guide for others, this section uses a typical operating sequence (from control system power-up to back-up of a user-generated part program) to explain how the functions described can be located.

	Step	Described in Section
Setup	• Switch on machine	1.3
	• Reference point approach	4.3
	• Clamp workpiece/blank	
	• Select tools	
	• Define workpiece zero for coordinate inputs	
	• Enter tool offsets	5.2.2
	• Calculate speeds and feedrates	4.2.4
	• Define a reference point (scratching)	4.4.6
Enter/test a program	• Create a part program or read one in via an external data interface	6.4 7.5.3/7.6.3
	• Select a part program	4.6.2
	• Test a program (without a tool) <ul style="list-style-type: none"> • Start a part program (e.g. in single block) • Edit part program using program editing function or diagnostics guide/help 	4.2.1 4.6.10 4.6.7/2.6.6 8.2
	• Optimize a part program	4.2
Machine a workpiece	• Insert tool and execute machining program	4.2.1
Save a program	• Save a part program <ul style="list-style-type: none"> • to hard disk • Read out via V.24 interface 	6.8.7 6.6.6 7.5.5/7.6.4



MMC 100.2



MMC 103

"Machine" Operating Area

4.1	Data structure of the numerical control	4-97
4.1.1	Operating modes and machine functions.....	4-98
4.1.2	Operating mode group and channels.....	4-100
4.1.3	Select operating mode, change operating mode	4-101
4.2	General functions and displays.....	4-103
4.2.1	Start/stop/cancel/continue part programs	4-103
4.2.2	Display program level.....	4-104
4.2.3	Switching between the machine/workpiece coordinate system (MCS/WCS)	4-105
4.2.4	Displaying axis feedrates	4-107
4.2.5	Displaying G functions and transformations.....	4-107
4.2.6	Displaying auxiliary functions	4-108
4.2.7	Displaying spindles.....	4-109
4.2.8	Handwheel	4-110
4.2.9	Status of synchronized actions (NCU SW 4.2 and higher)	4-111
4.2.10	Preset.....	4-113
4.2.11	Setting the actual value (SW 5 and higher).....	4-114
4.2.12	Hiding axes (SW 4.4 and higher)	4-116
4.2.13	Inch/metric switchover (SW 5 and higher)	4-117
4.2.14	Changing the coordinate system for actual value display (SW 5 and higher).....	4-118
4.3	Reference point approach	4-119
4.4	Jog mode.....	4-122
4.4.1	Function and basic display	4-122
4.4.2	Traversing axes.....	4-125
4.4.3	Inc: Incremental dimension	4-126
4.4.4	Repos (repositioning)	4-127
4.4.5	SI (Safety Integrated): User confirmation.....	4-128
4.4.6	Scratching/determining zero offset (SW 4.4. and higher)	4-130
4.5	MDA mode.....	4-134
4.5.1	Function and basic display	4-134
4.5.2	Storing a program (MMC 100.2)	4-136
4.5.3	Storing a program, file function (MMC 103)	4-137
4.5.4	Deleting a program.....	4-138
4.5.5	Teach In	4-138
4.6	Automatic mode.....	4-142
4.6.1	Function and basic display	4-142
4.6.2	Program overview	4-144
4.6.3	Execution via the V.24 interface (MMC 100.2).....	4-146

4.6.4	Loading and unloading the workpiece/part program (MMC 103)	4-147
4.6.5	Log: Loading list of programs (MMC 103)	4-148
4.6.6	Executing programs from the hard disk (MMC 103)	4-148
4.6.7	Accessing the external network drive from the MMC 103 (SW 5.2 and higher).....	4-149
4.6.8	Program editing	4-151
4.6.9	Block search/setting the search destination	4-153
4.6.10	Fast external block search without calculation (MMC 103 only: SW 5.3 and higher)	4-156
4.6.11	Start of search in Program test mode, multi-channel (MMC 103 only: SW 5.3 and higher)	4-160
4.6.12	Overstore	4-162
4.6.13	Program control	4-164
4.6.14	DRF offset	4-167

4.1 Data structure of the numerical control



MMC 100.2



MMC 103

4.1 Data structure of the numerical control



Function

- NC with part program memory
- Part programs are processed in different channels (one program per channel).

MMC 100.2

The data are always stored in the NC and changed directly in the NC.

MMC 103

A hard disk is also available. Softkeys "Load" – "Unload" are used to transfer data to the NC from hard disk or vice versa.

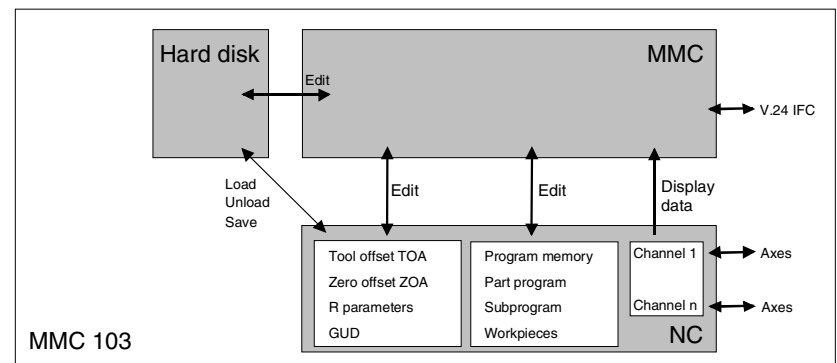
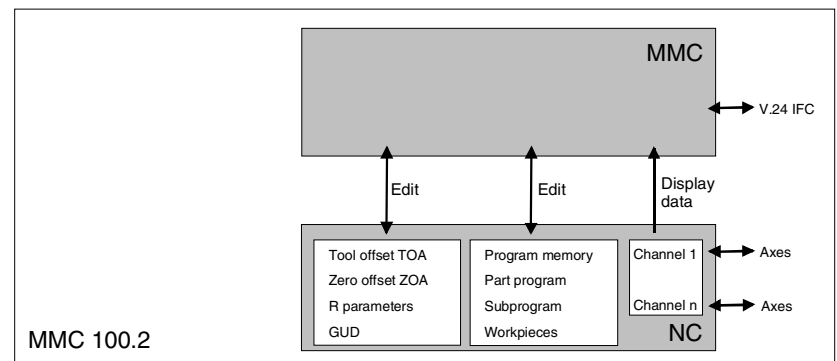

Data in the NC memory are retained when the control power supply is switched off. Only one copy exists of programs that are loaded from the hard disk to the NC memory. The program memory in the NC is limited (see memory display).

4.1 Data structure of the numerical control



MMC 100.2



MMC 103

4.1.1 Operating modes and machine functions



Function

The Machine operating area contains all the functions and control variables that trigger actions on the machine tool or detect its status. There are three different modes in this area:

- **Jog:** Jog is the mode required for manual operation and setting up of the machine. The setup functions provided are "Reference point approach", "Repositioning", "Handwheel" or "Traverse in preset increments" and "Redefine control zero" (preset).
- **MDA:** Semi-automatic operation
Part programs can be set up and processed block by block in this mode. The tested blocks can then be stored in the part program. In Teach In mode, positions can be traversed and stored to generate motion sequences which are then stored in the MDA program.
- **Automatic:** Fully automatic operation
Part programs are executed fully automatically in Automatic mode, i.e. they are selected, started, corrected, selectively manipulated (e.g. single block) and processed.

Select machine



or

You can switch to the "*Machine*" area at any time from any of the other operating areas simply by pressing the "*Machine area*" key.



When you switch on the control, it is usually in the operating area "*Machine*" in operating mode "*Jog*". (Please consult the machine manufacturer's documentation!)



Machine manufacturer

The state after power-up can be configured and might therefore deviate from the default.



MMC 100.2



MMC 103

Machine functions



In operating mode "*Jog*" you can select the following machine functions via the machine control panel or softkeys in the basic menu:

Inc (traverse in preset increments)



Repos (reposition at a defined position)



Ref (reference point approach to coordinate machine and control zero points)



In "*MDA*" mode, it is possible to select "*Teach In*" (storage of motion sequences in a part program through position approach) by pressing the MCP key.

Preparation for production

To start actual production some preparatory measures must be taken:

1. Load the tools and workpiece,
2. traverse the tools and the workpiece to the starting position defined in the setup plan,
3. load the part program into the memory of the control,
4. check and enter the zero offsets,
5. check and enter the tool offsets.

4.1 Data structure of the numerical control



MMC 100.2



MMC 103

4.1.2 Operating mode group and channels



Function

Every channel behaves like an independent NC in which a maximum of one part program can be processed.

- Control with one channel:
Only one mode group exists.
- Control with several channels:
Channels can be joined to form several mode groups.

Example:

Control with 4 channels, where machining is carried out in 2 channels and 2 other channels are used to control the transport of the new workpieces.

Mode group1	Channel 1 (machining)
	Channel 2 (transport)
Mode group2	Channel 3 (machining)
	Channel 4 (transport)

Technologically related channels can be combined to form a mode group.

Axes and spindles of the same mode group can be controlled by one or more channels.

An operating mode group is either in operating mode "*Automatic*", "*Jog*" or "*MDA*", i.e. several channels of an operating mode group can never assume different operating modes.



MMC 100.2



MMC 103

4.1.3 Select operating mode, change operating mode



Function

The defined modes for operating a SINUMERIK control system are Jog, MDA and Automatic. They are selected via the MCP or by means of softkeys.

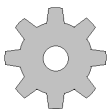

Machine manufacturer

Whether the requested mode can be accessed and the manner in which it is accessed can be configured machine-specifically in the PLC program.

Mode change

Not all mode changes are permitted.

An error message is output if a mode change request is rejected by the system. The error message will indicate the error cause and possibly the remedy.



Operating sequence

Selection of mode

The selected mode is displayed in the mode field on the screen.

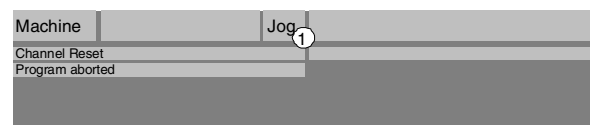

1 = operating mode

To select the modes:

- Jog
- MDA
- Automatic

press one of the keys shown on the left on the machine control panel
or

the corresponding vertical softkey that you can access via the
"Area switchover key".

- JOG



JOG

4.1 Data structure of the numerical control



MMC 100.2



MMC 103

MDA
AUTO

- MDA
- Automatic

When a mode is selected, the LED next to the selection key on the MCP lights up. The same status is signaled in the mode field on the screen.

Further notes

The basic display of the selected mode appears on the screen.

If a mode change is not possible, please contact your installation engineer, the machine-tool manufacturer or our service personnel.

In many cases, a mode change is enabled only for trained personnel for the purpose of safety. To provide this type of protection, the control system offers a facility for disabling or enabling mode changes.

/FB/, K1, Description of Functions



MMC 100.2



MMC 103

4.2 General functions and displays

4.2.1 Start/stop/cancel/continue part programs



Precondition:



Function

The following section describes how to start and stop part programs and to resume them after they have been aborted.

Operating sequence

"*AUTO*" mode is selected in the "*Machine*" operating area.

No alarms are pending.
The program is selected.
Feedrate enable is active.
Spindle enable is set.

Start part program:

The part program is started and executed.

Stop/abort part program:

The program run is interrupted, but can be restarted with "*NC Start*".

The current program is aborted.

Resume part program:

After interrupting the program with "*NC Stop*" you can retract the tool from the contour in "*Jog*" mode. The control saves the coordinates of the point of interruption. The distances traversed are displayed.

Repositioning:

Select the "*Machine*" operating area.

Select "*Jog*" mode.

Press the "*Repos*" key to reposition the tool on the contour.

4.2 General functions and displays



MMC 100.2



MMC 103

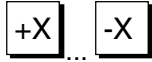

Turning machine:

Press the "+" or "-" key.

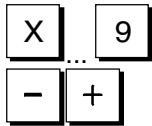

Milling machine:

Select the axis to be traversed and

then press the "+" or "-" key.

Traverse the axes to the point of interruption.

4.2.2 Display program level



Function

If subprograms are called while a part program is running, the block numbers for the main program and subprograms together with their pass number (P) can be displayed.



Operating sequence

"AUTO" mode is selected in the "Machine" operating area.

When you press softkey "Program level", the window headed "Program level" appears instead of the "Current block" window. The softkey labeling changes to "Current block".



Current
block

During execution of a part program, the block numbers for the main program and subprograms, together with their pass number (P), are displayed in the "Program level" window. The main level is always visible, a nesting depth of up to 12 can be displayed.

When you press softkey "Current block", the "Current block" window containing the program blocks of the current part program is displayed again.



MMC 100.2



MMC 103

4.2.3 Switching between the machine/workpiece coordinate system (MCS/WCS)



Function

The display can be toggled between the machine and workpiece coordinate systems by means of special key "MCS/WCS" on the MCP or via softkeys (depending on MCP model and user program). The actual position display for the distance-to-go and the corresponding axes change.

Machine axes

Machine axes are axes that actually exist on the machine and have been parameterized during installation.

Geometry axes and special axes

These are the axes programmed in the part program. Geometry axes and special axes are offset by the selected zero offset relative to the machine axes.

Three is the maximum number of Cartesian geometry axes.

MCS

The machine coordinate system (MCS) refers to the coordinates of the machine axes, i.e. all machine axes are displayed in the machine coordinate system.

MCS position	Repos offset
X	
Y	
Z	

WCS

An offset (e.g. zero offset, rotation) can be used to set up a relationship, e.g. with the workpiece clamp. This relationship defines the position of the workpiece coordinate system (WCS) in relation to the machine coordinate system. The workpiece is always represented in a Cartesian coordinate system.

All geometry axes and special axes are displayed in the workpiece coordinate system.

WCS position	Repos offset
X1	
Y1	
Z1	



MMC 100.2



MMC 103



Machine manufacturer (SW 5 and higher)

Machine data are used to define whether the programmed frames are to be calculated when displaying the WCS (settable zero system display). Please consult the documentation provided by the machine-tool manufacturer!



Operating sequence

"Jog" mode is selected in the "Machine" operating area.

Act. val.
MCS

The actual values of the machine axes and their positions are displayed.

The softkey label changes to "Act. val. WCS".

The machine coordinate system is set up using all physically existent machine axes. Reference points, tool and pallet change points are defined in the MCS.

Act. val.
WCS

When you select softkey "Act. val. WCS", the geometry and auxiliary axes plus their positions appear in the "Position" window.

The softkey label changes to "Act. val. MCS".

The workpiece coordinate system is assigned to a specific workpiece. Settings in the NC program refer to the WCS.



- You can also toggle between the workpiece and machine coordinate systems by pressing the "MCS/WCS" key on the MCP.
- The number of places displayed after the decimal point and units of measure can be set in machine data.

/PG/, Programming Guide, Fundamentals



MMC 100.2



MMC 103

4.2.4 Displaying axis feedrates



Axis
feedrate

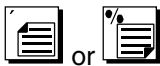

Function

In operating mode *"Jog"* or *"MDA"* or *"AUTO"*, you can display the current feedrate, residual path information and the associated override data.

Operating sequence

"Jog" mode is selected in the *"Machine"* operating area.

Press the *"Axis feedrate"* softkey:

- When *"MCS"* is selected, the feed window containing the current feedrates, distance-to-go information and associated override is displayed.
- When *"WCS"* is selected, the feed window for the axes involved in interpolation, the current feedrate and the distance-to-go information with path override as well as the current feedrate and distance-to-go information with single-axis override for axes not involved in interpolation is displayed.

You can use the *"Page"* keys to display other axes if required.

4.2.5 Displaying G functions and transformations



G funct.+
transform.

Function

Active G functions and transformations in the currently active channel can be displayed.

Operating sequence

"AUTO"/"MDA"/"Jog" mode is selected in the *"Machine"* operating area.

The *"G functions + transformations"* window containing active G functions and transformations is output on the screen.

4.2 General functions and displays



MMC 100.2



MMC 103



Using the "Page" keys you can scroll up and down to display other G functions.



Further notes

Every G group has a fixed location.

The group number (no.) and the current G function of the G groups are displayed only if a G function is active.

4.2.6 Displaying auxiliary functions



Function

Auxiliary functions active in the selected channel can be displayed.



Operating sequence

"AUTO"/"MDA"/"Jog" mode is selected in the "Machine" operating area.

Auxiliary functions

The "Auxiliary functions" window appears on the screen. Up to 5 M functions and 3 H functions can be displayed.



MMC 100.2



MMC 103

4.2.7 Displaying spindles



or



Function

The current spindle values (actual speed, setpoint speed, position on oriented spindle stop and spindle override) can be displayed.

Operating sequence

"*AUTO*"/"*MDA*"/"*Jog*" mode is selected in the "Machine" operating area.

The "*Spindle*" window appears on the screen.

The window contains the spindle setpoint and actual value, position, setting of spindle override switch and spindle output.

Using the "*Page*" keys you can scroll up and down to display other spindles if any are configured.

Further notes

- The "*Spindle*" window is displayed only if at least one spindle is configured.
- If a master spindle is available it is displayed automatically in the spindle window (SW 5.3 or higher), even if it is not meant to be the first spindle.



MMC 100.2



MMC 103

4.2.8 Handwheel



Function

Using the *"Handwheel"* function, you can assign an axis to the handwheels and activate them.



Operating sequence

"Jog" mode is selected in the *"Machine"* operating area.

The *"Handwheel"* window appears on the screen.

Position the cursor on the handwheel of your choice (1–3).



An axis identifier is suggested in the *"Axis"* field. You can select all the other axes by means of the *"Toggle key"*. The settings are accepted immediately and an axis is assigned to each handwheel (1–3).



Each time you press the *"Toggle button"* on the *"Active"* field you activate or deactivate enabling of the handwheel in question. The settings become active immediately.

When you turn the handwheel, the assigned axis traverses by the number of increments that have been set for it (Inc keys).

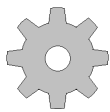

Machine manufacturers

The machine-tool manufacturer is responsible for the design of handwheels. Operation may therefore differ from the explanation above.

Please consult the documentation provided by the machine-tool manufacturer!



MMC 103

4.2.9 Status of synchronized actions (NCU SW 4.2 and higher)



Function

Status information (such as "enabled", "disabled", etc.) can be displayed here to support start-up of synchronized actions.

References: /PGA/, Programming Guide Advanced, Chapter "Synchronized Actions"



Operating sequence

"*AUTO*"/"*MDA*"/"*Jog*" mode is selected in the "*Machine*" operating area.



Press the *ETC* key followed by

the "*Synchroniz. actions*" softkey.

The display "Status of synchronized actions" appears,

Synchroniz.
actions

Status of synchronized actions		
Current block		
N100 X100		
N200 X200		
N300 X0		
Programmed synchronized actions	Status	Block no. SPF
N100 lds=1	enabled	N111
N129 lds=2	disabled	
N100 ID=3		
N1000	enabled	

containing the following:

- Column "**Current block**":
Current section of selected part program:
Preceding, current and following block
- Column "**Programmed synchronized actions**":
The programmed synchronized actions are listed block by block with block number
(static/modal actions are listed together with the number of the synchronized action)



MMC 103

- Column "**Status**"
 - " " (no information given)
the condition is checked in interpolation cycles.
 - "disabled"
LOCK was set from the PLC for the synchronized action
 - "active"
The action is currently running. If the instruction part of a programmed synchronized action starts a subroutine/cycle, the current block number of the cycle is additionally displayed in column "Block number SPF".



Search in
program

A window opens

in which you must enter the system variable/synchronized action of your choice.

The control system searches the current or an additionally specified program for synchronized actions which match the current block and synchronized action numbers.

If the control finds matching program blocks, the associated condition and instruction parts are output with the other basic display data.



Press RECALL to return to the "Automatic" basic display.



MMC 100.2



MMC 103

4.2.10 Preset



Preset



Function

The *"Preset"* function can be used to redefine the control zero in the machine coordinate system.

Preset values are applied to machine axes.

Axes do not move when *"Preset"* is active.

Further notes

A new position value is entered for the current axis positions.

Machine manufacturer

Please follow the machine manufacturer's instructions.

Operating sequence

"Jog" mode is selected in the *"Machine"* operating area.

The *"Preset"* window appears on the screen.

Enter the new actual value, which must in future correspond to the current axis position, for each individual axis. By doing so, you are redefining the control zero in the MCS. When the control zero is redefined, the tool change point, for example, also changes.

Danger

After the actual value has been reset, none of the protection zones or software limit switches are operative! Only after another reference point approach are the protection zones and software limit switches active again.

4.2 General functions and displays



MMC 100.2



MMC 103



Further notes

Machine manufacturer

The "Preset" function can be disabled by means of protection levels (keyswitch position).

4.2.11 Setting the actual value (SW 5 and higher)



Function

The "Set actual value" function is now available via display MD 9422 PRESET_MODE as a functional alternative to the existing "Preset" function. The "Set actual value" function can be used only if the control system is operating in the workpiece coordinate system.

- MD 9422 = 1 "Preset" (default) or
- MD 9422 = 2 "Set actual value" or
- MD 9422 = 0 Neither

The functions are stored under the same softkey.

Machine manufacturer

Please follow the machine manufacturer's instructions.

For configuring references, please see

/IAD/ 840D Installation and Start-Up Guide, Section "MMC"

Set actual value assigns the 1st base offset, rough.

This function sets the workpiece coordinate system to a defined actual coordinate. The resultant offset between the old actual value and the newly entered WCS actual value is computed in the first basic offset.

Operating sequence

Precondition:

The function is available only when G500 (MD 20100 bits 14 and bit 0 = 1) and the WCS are active.



MMC 100.2



MMC 103

Set actual
value

1

9



Reset

The new setpoint position of the axes in the workpiece coordinate system can be entered using "Set actual value" in the actual value window. When you transfer a value to the system by pressing "Input", the deviation from the current actual value is entered in the basic offset. The new actual value is displayed in the "Position" column.

WCS	Position	
X	20.000	mm
Y	10.000	mm
Z	120.0	mm
U	0.000	grd
V	0.000	mm

You can undo the complete offset entered up to this point by pressing the "Reset" softkey.

Further notes

- The offsets for setting the actual value are entered in G500 (first basic offset).
- The first basic offset is assigned as soon as actual value setting is used. This also applies to the variable \$P_UIFR[0].
- If other zero offsets apart from G500 are active, the "Set actual value" function is rejected.
- Use of the function actual value setting for the tool axis is only sensible when tool offset is active.



MMC 100.2



MMC 103

4.2.12 Hiding axes (SW 4.4 and higher)



Function

MD 20098 DISPLAY_AXIS can be set to hide axes in the Machine area.

All axes are displayed with the default setting.

MD 20098 is described in
/IAD/ 840D Installation and Start-Up Guide, Chapter 13

Axes can be hidden in the following windows in the Machine area:

- Small axis window (5 axes, machine default setting)
- Wide axis window (5 axes with feedrate and override)
- Large axis window (8 axes, large font)

It is possible to set separately for the view in the machine or workpiece coordinate system whether or not the axis must be displayed:

MD 20098 DISPLAY_AXIS

- Bits 0–15 Display/hide geometry axes (WCS) and
- Bits 16–31 Display/hide machine axes (MCS).

Special cases

- **Reference point approach and Safety Integrated**

Machine data MD 20098 DISPLAY_AXIS is not evaluated in the displays for referencing mode, i.e. in the "axis reference point" and "acknowledge safe position" displays. All machine axes are always displayed.

- **Handwheel selection**

The possible axes for making selections for handwheel assignment are selected with bit 19 of data MD 20098 DISPLAY_AXIS for machine axes and with bit 3 for geometry axes.

- **Preset, basic offset and scratching**

The possible axes for display are selected with bit 18 of data MD 20098 DISPLAY_AXIS for machine axes and with bit 2 for geometry axes.



MMC 100.2



MMC 103

4.2.13 Inch/metric switchover (SW 5 and higher)



Function

The control system can operate with the inch or the metric system of measurement. In SW 5 and higher, you can switch between the inch and metric systems of measurement in the "Machine" operating area. The control converts the values accordingly.



Machine manufacturers

The switchover is only possible if:

- The corresponding machine data have been set.
- All channels are in the Reset state.
- Axes are not traversing with JOG, DRF or PLC control.
- Constant grinding wheel peripheral speed (GWPS) is not active.

The display resolution for the inch system of measurement is defined by machine data.



Actions such as part program start or mode change are disabled for the duration of the switchover.



Operating sequence

"AUTO"/"MDA"/"Jog" mode is selected in the "Machine" operating area.

Press the *ETC* key followed by

the softkey "*Switch to metric*".



Switch to
metric

When the system of measurement is changed, all length-related parameters are automatically converted to the new system of measurement from the perspective of the operator.

If the switchover cannot be performed, this is indicated by a message in the user interface.

References: /FB/, G2 Section "Metric/inch system of units"



MMC 100.2



MMC 103

4.2.14 Changing the coordinate system for actual value display (SW 5 and higher)



Function

Via the MD you can define whether the actual values are to be displayed

- without programmed offset = WCS or
- including programmed offsets = SZS (settable zero offset system).

Example:

Program	WCS display	SZS display
....		
N110 X100	100	100
N120 X0	0	0
N130 \$P_PFRAME=CTTRANS(X,10)	0	0
N140 X100	100	110
N150 ...		



Machine manufacturers

Actual value display settings:

See machine manufacturer's specifications



MMC 100.2



MMC 103

4.3 Reference point approach



Function

The "Ref" function ensures that the control and machine are synchronized after power on.

Before a reference point approach can be carried out, the axes must be located at positions (if necessary, traversed to these positions using the axis keys/handwheels) from where the machine reference point can be approached without collision.

If reference point approach is called from a part program all axes can be traversed simultaneously.



Reference point approach can only be performed by machine axes. The actual value display does not match the real position of the axes when the control is switched on.



Caution

- If the axes are not safely positioned, you must traverse them to safe positions in "Jog" or "MDA" mode.
- You must follow the axis motions directly on the machine!
- Ignore the actual value display until the axes have been referenced!
- The software limit switches are not active!



Operating sequence

"Jog" or "MDA" is selected in the "Machine" operating area. The channel for reference point approach is selected.

The "Ref" machine function is selected.

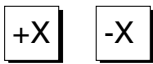

Turning machine:

Press the "Axis keys".



Milling machine:

Select the axis to be traversed and



MMC 100.2



MMC 103

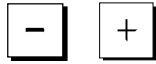

then press the "+" or "-" key.

The selected axis moves to the reference point. The direction and sequence is defined by the machine-tool manufacturer in the PLC program.

If you have pressed the wrong direction key, the action is not accepted and the axes do not move.

The display shows the reference point value.

No symbol is displayed for axes that are not referred to a reference point.

- This symbol appears for axes which must be referenced.
- This symbol is displayed next to the axis as soon as it has reached the reference point.



The axis, once started, can be stopped before it reaches the reference point.



Turning machine:

Press the "Axis keys".



Milling machine:

Select the axis to be traversed and



then press the "+" or "-" key.

The selected axis moves to the reference point.

Caution

The machine is synchronized as soon as the reference point is reached. The actual value display is set to the reference point value. The display is the difference between the machine zero and the slide reference point. From now on path limits, such as software limit switches, are active.

You can end the function by selecting another operating mode ("Jog", "MDA" or "Automatic").





MMC 100.2



MMC 103

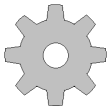

- All axes of a mode group can approach the reference point simultaneously (depending on the PLC program of the machine-tool manufacturer).
- The feedrate override is active.

Machine manufacturers

Your machine manufacturer will instruct you how to select axes if you intend to enter more than nine.

Further notes

The sequence in which axes must be referenced can be defined by the machine-tool manufacturer.

The NC cannot be started in automatic mode until all axes with a defined reference point (see machine data MD) have actually reached this point.



MMC 100.2



MMC 103

4.4 Jog mode

4.4.1 Function and basic display



Function

You can perform the following tasks in Manual mode:

1. Synchronize the measuring system of the control with the machine (reference point approach).
2. Set up the machine, i.e. you can trigger manually-controlled motions on the machine using the appropriate keys and handwheels on the machine control panel.
3. Trigger manually-controlled motions on the machine using the appropriate keys and handwheels on the machine control panel while the part program is interrupted.



The following basic display "Jog" is displayed when you press the "Area switchover key" and the "JOG" key.

The "Jog" basic display contains values relating to position, feedrate, spindle and tool.

Machine		Jog					
Channel reset						G. fct. + transf.	
Program aborted							
						Display aux. funct.	
	MCS	Position	Repos offset	Master spindle S1		Spindles	
	-X	90.646 mm	0.000	Act. +	0.000 rpm		
	+Y	113.385 mm	0.000	Set	0.000 rpm		
	+Z	109.131 mm	0.000	Pos	0.000 deg.	Axis feedrate	
	+V	0.000 mm	0.000	Power [%]	<input type="text"/>		
				Feedrate mm/min		Zoom Act. val.	
				Act.	7000.000	0.000%	
				Set	7000.000		
				Tool		Act. val. WCS	
				Preselected tool:			
				G0	G91		
Preset		Scratch		Handwheel		INC	



MMC 100.2



MMC 103

Explanation of the basic display Jog



Motion symbol (MMC 100.2 only) in actual value window: The axes are still moving, i.e. they are not within the exact stop window.



WCS

+

X2*

Y2*

Z2*

Displays the addresses of the existing axes with the machine axis identifier (MCS) or with the geometric axis identifier (WCS).

(see also Section "Toggling between Machine/Workpiece Coordinate Systems (MCS/WCS)")



Machine manufacturer (SW 5 and higher)

Machine data are used to define whether the programmed frames are to be calculated when displaying the WCS (settable zero system display). Please consult the documentation provided by the machine-tool manufacturer!

- If the axis identifier can only be displayed in an abbreviated form it is replaced by the character *.
- If you traverse an axis in the positive (+) or negative (–) direction, a plus or minus sign is shown in the relevant field.
The axis is in position if neither + nor – is displayed in the position display.

Position

0.0

0.1

–0.1

1.1

0.0

The actual position of each configured axis in the MCS or WCS is displayed in these fields.

The sign is only displayed for negative values.

Repos. offset

0.0

0.1

–0.1

1.1

0.0

If the axes are traversed in the "Program interrupted" status in "Jog" mode, the path traversed by every axis with respect to the point of interruption is displayed in the Repos offset.



MMC 100.2



MMC 103

Spindle
rpm

Spindle window (if spindle is available)

Displays the set and actual value of the spindle speed, the position of

the spindle, the position of the spindle override switch,  and the spindle power.

Nibbling

The spindle window is replaced by a nibble window if the "Nibbling" technology option is set.

The active function, if any, appears at the top left in the window header:

- PON Punching ON
- SON Nibbling ON
- SPOF Punching/Nibbling OFF

Feedrate
mm/min

Feedrate window

Display of the setpoint and actual value of the feedrate as well as the

position of the feedrate override switch  (in %). The actual setpoint to be traversed is dependent on the override switch.

With SW 5.3 and higher: The value of the rapid traverse override is displayed when G00 (rapid traverse movement) is programmed.

Tool

Tool window

Display of active tool offset (e.g. D1), tool currently in use (T no.), preselected tool (on milling machines) plus currently active motion commands (e.g. G01, SPLINE, ...) or tool radius compensation not active (e.g. G40).

The following values are displayed:

- "Path segment" and "Number of strokes" are displayed in reverse video if you have used "Length of path segment" or "Number of path segments" when programming automatic block segmentation.
- The "Delay time" is not displayed unless you have programmed "Punching with delay time".

Zoom
act. val.

Increases the size of the actual-value display.



MMC 100.2



MMC 103

4.4.2 Traversing axes

Traversing speed

The initial settings for traversing velocity and feed mode are stored in setting data for JOG mode.

Traversing velocities are defined by the machine-tool manufacturer.

The default setting for the feedrate is mm/min.

See operating area "Parameters/Setting data/Jog data"



Operating sequence

"Jog" mode is selected in the "Machine" operating area.

Traverse axes

Using the "Inc" (increment) function, manually traverse the selected axis in preset increments in the appropriate direction by pressing an "Axis key" repeatedly:



- [.] Variable increment can be set via softkey "Inc" (see Subsection 3.2.5).

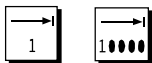

- [1], [10], ..., [10000] fixed increment

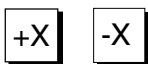

Turning machine:

Press the "Axis keys".

If necessary, set the speed with the override selector.



If you press "Rapid traverse override" at the same time, you can traverse the axis in rapid traverse mode.

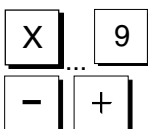

Milling machine:

Select the axis to be traversed and

then press the "+" or "-" key.

Feedrate and rapid traverse override switches can be operative.



MMC 100.2



MMC 103



One or several axes can be selected at the same time (depending on PLC program).



Further notes

- After you have switched on the control, you can move axes into the limit range of the machine since their reference points have not yet been approached. In doing so, you may activate emergency limit switches.
- The software limit switches and the working area limitation are not yet operative!
- Feedrate enable must be set (FST must not light up in the channel status display field).

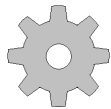

Machine manufacturers

If it is not meaningful to traverse several axes simultaneously, the machine-tool manufacturer must provide an interlock in the PLC program.

4.4.3 Inc: Incremental dimension



Function

The *"Inc"* (Increment) function can be used to enter a settable increment value for Inc variable traversing.



Operating sequence

"Jog" mode is selected in the *"Machine"* operating area.

The *"Increment"* window appears on the screen.

Enter the desired increment size.

INC



MMC 100.2



MMC 103



Press this key in manual mode together with the "Axis key" to traverse the axis in increments of the size set above in the appropriate direction (see also Section "Traversing axes").

Increment keys with preset increment sizes are temporarily inoperative.

4.4.4 Repos (repositioning)



Function

After a program interruption in automatic mode (e.g. to take a measurement on the workpiece or to compensate tool wear values or after tool breakage), you can retract the tool manually from the contour after selecting "Jog" mode. In such cases, the control stores the coordinates of the point of interruption and displays the path distances traversed by the axes in "Jog" mode as a "Repos" offset (Repos = repositioning) in the actual value window.

"Repos" offsets can be displayed in the machine coordinate system (MCS) or workpiece coordinate system (WCS).



Operating sequence

"Jog" mode is selected in the "Machine" operating area.

The axes have been moved away from the point of interruption.

Select machine function "Repos".

Turning machine:

Press the "Axis keys".

Milling machine:

Select the axis to be traversed and

then press the "+" or "-" key.

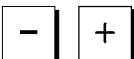
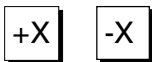

4.4 Jog mode



MMC 100.2



MMC 103



It is not possible to overtravel the point of interruption.
The feedrate override switch is active.

**Warning**

The rapid traverse override switch is active.
Non-compensated Repos offsets are compensated with programmed feedrate and linear interpolation on switchover to Automatic mode and selection of NC start.

4.4.5 SI (Safety Integrated): User confirmation

**Function**

If the option "user enabling" is installed on the NC, you must enable or disable the function depending on the keyswitch position in operating mode "*Approach reference point*".



User enabling can only be granted if keyswitch position 3 or higher is selected for the keyswitch position.

The displayed values are always referred to the machine coordinate system (MCS).

**Operating sequence**

"Jog Ref" mode is selected in the "*Machine*" operating area.
The channel to be referenced is already selected.

User
confirmation

Press softkey "*User confirmation*".

The "*Confirm machine positions*" window is opened.

The machine axes in the MCS are displayed, together with the current position and a checkbox for activating/deactivating the user confirmation.

**MMC 103 only:**

Machine axes that do not need to be referenced are displayed in reverse video with their current position, but without a checkbox.

Position the cursor on the desired machine axis.



MMC 100.2



MMC 103



Activate or deactivate user agreement for the selected machine axis by means of the *"Toggle key"*.



Check whether the axis is referenced. If not, error message *"Please reference axis first"* is output. User agreement cannot be activated for the axis until it has been referenced.



Further notes

The function user enabling is only provided if user enabling is required for at least one axis of the channel.

For more detailed information please consult the /FBSI/, SINUMERIK Safety Integrated, Description of Functions.



MMC 100.2



MMC 103

4.4.6 Scratching/determining zero offset (SW 4.4. and higher)



Function

You can determine the zero offset by "scratching" the workpiece, taking an (active) tool and, if necessary, the basic offset into account. A window is displayed for the "scratching" function, which is operated differently on the MMC 103 and MMC 100.2:



MMC 103

Scratch

Operating sequence

1. Press softkey "Scratch":

- The active plane is selected (G17).
- The active ZO is selected. If no ZO is currently active, then the first ZO (G54) is selected.
- The active tool is selected. No tool is displayed if none is active (message).

Machine			Jog	\MPF.DIR MAGKONE.MPF		
Channel Reset						
Program aborted						
WCS Position Repos offset						
X	90.646	mm	0.000			Base ZO
Y	113.385	mm	0.000			
Z	109.131	mm	0.000			
A	0.000	mm	0.000			
B						
Scratch						
Plane	G17	T number	5			
Zero offset	G54	Tool edge	1			
Axis	Offset	Set position	Geo. +	Wear	Base	
X	0.000		+ R	0.000	mm	
Y	0.000	0.000	+ R	0.000 +	0.000 mm	Abort
Z	0.000		- L1	0.000 -	0.000 mm	
A	0.000				mm	
B	0.000				mm	OK

Meanings of columns in the "Scratch" window:

- "Offset": Current value of offset to be determined. The coarse offset is displayed; the fine offset is taken into account and remains valid.
- "Set position": Input of subsequent setpoint position for scratched edge.
- "Geo + Wear": Selection fields for tool offsets (geometry + wear)
- "Base": Display of effective tool base dimension



MMC 100.2



MMC 103

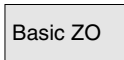
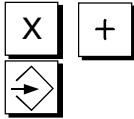

2. Use the cursor to select the first axis to be moved in the "Scratch" display.
Selected axes are automatically marked in parallel in the actual value window.
3. Move the axis up to the workpiece, enter the chosen setpoint position (e.g. "0") and press the "Input" key; the offset is then calculated.
Repeat the process for other axes.
4. Press "OK" to transfer all values to the selected ZO. The offset is always calculated in relation to the current workpiece coordinate system (WCS).
5. Press the softkey "Basic ZO" to select the values for the basic frame (G500 is automatically displayed in the "Zero offset" field) or enter G500 in the field "Zero offset".
6. To ensure that allowance is made in the tool geometry (or the tool base dimension), position the cursor in the "Geometry + Wear" column on the axis to be altered and press the "Toggle key" to define how the tool offset must be included in the calculation.

Example 1:

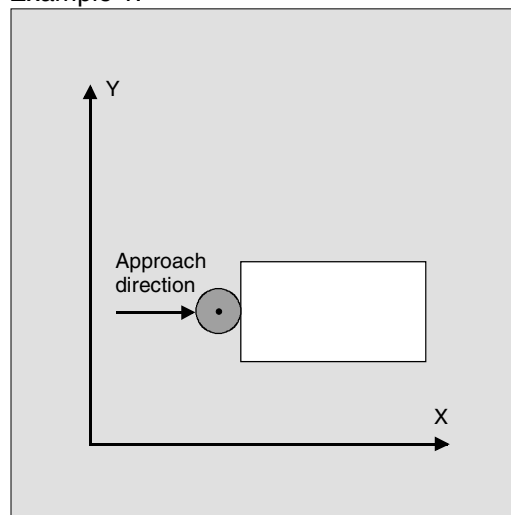

Set "+R" with toggle key.



MMC 100.2



MMC 103

Example 2:

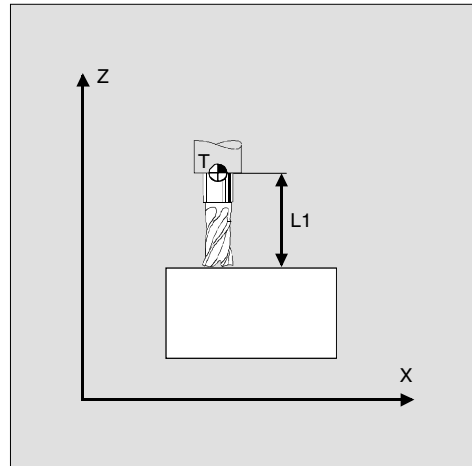

Set "-L1" with toggle key.



There are three different variants depending on the system configuration:

- Tool selection with D No. only (flat D No.)
- Without tool management
- With tool management

Correspondingly, the "scratching" screen displays

- only the tool edge (D No.O),
- T number and tool edge and
- tool name and Duplo number.



MMC 100.2

(SW 5.1 and higher)

Operating sequence

The operating sequence for the MMC 100.2 corresponds to that of the MMC 103 (see above) with the following exceptions:

Step 1: MMC 100.2 does not select G54 when G500 (basic offset) is active, but G500. It is still only possible to switch through the standard frames G500, G54 ...G57 for the frame.

The softkey "Basic ZO" (see fig.) is therefore unnecessary and no longer available.

Step 2: The selected axis is not marked in the actual value window. MMC 100.2 distinguishes between geometry and auxiliary axes. The first three locations are reserved for geometry axes. If a geometry axis is missing, an empty line is displayed. The two remaining locations are reserved for auxiliary axes. Only the first two auxiliary axes behind the geometry axes can be selected.

The geometry axis display still depends on whether the display MD 9421: MM_MA_AXES_SHOW_GEO_FIRST has been set to 1.



MMC 100.2



MMC 103

If this is not the case, the geometry axes must be defined as the first axes in the channel.

Step 5: Softkey "Basic ZO" does not exist (see Step 1).

Further notes

- The function "scratching" is not available if the following setting data are $\neq 0$:
 - \$SC_MIRROR_TOOL_LENGTH
 - \$SC_MIRROR_TOOL_WEAR
 - \$SC_WEAR_SIGN_CUTPOS
 - \$SC_WEAR_SIGN
 - \$SC_TOOL_LENGTH_CONST
 - \$SC_TOOL_LENGTH_TYPE
- When a basic offset is active and contains rotation or mirroring, the "scratching" function cannot be used for G54 to G599.
- Any rotation, mirroring or scale modification included in the offset to be measured remains valid.
- **MMC 100.2:**
 - If a rotation/mirroring/scale modification action is active for the selected frame, the calculation is acknowledged with an error.
 - If a rotation/mirroring/scale modification action is active for a frame that is not selected, it is ignored.



MMC 100.2



MMC 103

4.5 MDA mode

4.5.1 Function and basic display

In "MDA" (Manual Data Automatic) mode, you can write part programs block by block and execute them. You can transfer the required motions as single part program blocks to the control using the operator panel.

The control processes the entered program blocks when you press the "NC Start" key.

Caution

The same safety interlocks must be applied as used in fully automatic operation. The same preconditions must be fulfilled as for fully automatic operation.

The automatic functions (traverse blocks) are active in "MDA" mode.

The functions associated with "Jog" are active in submode "Teach In" and can be accessed via an MCP key. You can therefore create and store a program in the input and manual modes by alternating between "MDA" and "Teach In".

You can use the editor to edit the program blocks in the MDA window. You can view blocks that have already been processed by paging upwards.

Blocks that have already been executed can only be edited in the Reset state.

Further blocks can be added with "Input".

Blocks can be input and executed only with the channel in the "Channel Reset" or "Channel interrupted" state.

The program generated in MDA mode can be stored

- MMC 100.2: in the clipboard
- MMC 103: in the part programs directory (MPF.DIR).



Teach In



MMC 103

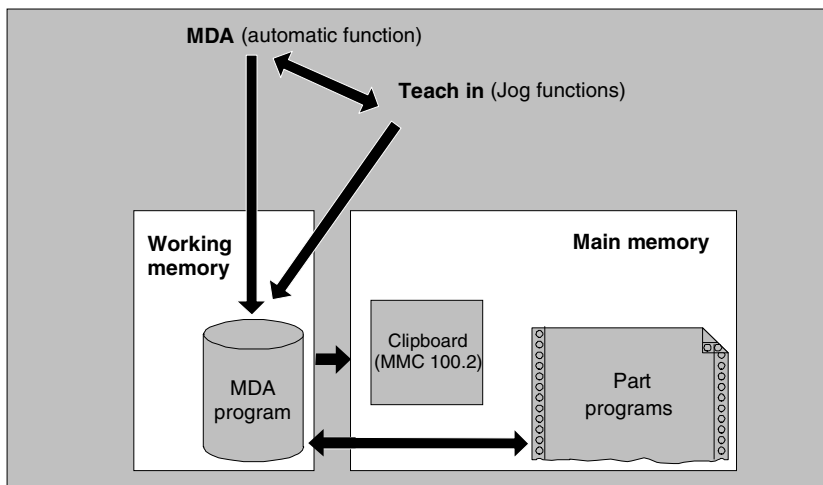

Basic display (MMC 103) "MDA" contains position, feedrate, spindle and tool data as well as the contents of the MDA buffer.

Machine	CHAN1	MDA	SYF.DIR OSTORE1.SYF	
Channel active				G fct. + transf.
Program running				
MCS	Position	Dist.-to-go	Master spindle S1	Auxiliary func.
-X	90.301 mm	9.699	Act. + 0.000 rpm	Spindles
+Y	80.081 mm	9.919	Set 0.000 rpm	
+Z	0.000 mm	0.000	Pos 0.000 deg.	Axis feedrate
+V	0.000 mm	0.000	Power [%] <input type="checkbox"/>	
MDA program			Feedrate mm/min	Program sequence
N51 Y0 H55=99 ↵			Act. 7000.000 0.000 %	
Y120 F7000 ↵			Set 7000.000	Zoom act. val.
↵			Tool	Act. val. WCS
			Preselected tool:	
			G0 G91	Delete MDA buffer
		Program control	Handwheel	Editor function
				MDA file fct.

Explanation of "MDA" basic display

Analogous to the Jog basic display, the actual value window, spindle window, feedrate window and tool window are output.

Store MDA program

Softkey "Store MDA program" copies the MDA program to the clipboard.



MMC 100.2



MMC 103

Editor
functions

MDA
file fct.

Delete
MDA prog.

MMC 103 only:

Press this softkey to access vertical softkeys providing editing functions:

Overwrite, Mark, Copy, Paste, Delete, Find, Find Next, Position.

You can save the MDA buffer contents or copy a part program to the MDA buffer for editing in MDA or Teach In.

Vertical softkeys

Like the Jog basic display, the MDA display also contains softkeys "*G fct. + transf.*", "*Auxiliary funct.*" and "*Spindle*" (if spindle is configured).

The contents of the MDA program in the NC are erased.

4.5.2 Storing a program (MMC 100.2)

Store MDA
program

Function

A program written in MDA can be stored temporarily in the clipboard and, as a permanent solution,

- incorporated as a program or
- read out to an external device via the V.24 interface.

The system will ask you to enter a name for the file to be saved to the MDA buffer.

The program is saved/stored as a part program (MPF) under the name you have entered in the clipboard.



MMC 103

4.5.3 Storing a program, file function (MMC 103)



Function

You can use the MDA file function to

- save the contents of the MDA program to a file or
- read a part program to the MDA buffer to modify it in MDA or Teach In mode.



Operating sequence

"MDA" mode is selected in the "Machine" operating area.

The program overview of "Part programs" is opened, a dialog window also appears.

The new file is then displayed in the program overview.

MDA
file fct.

The program overview of part programs is displayed. From the list of programs select the one that you wish to copy to the MDA buffer with "Read in MDA". This can now be modified accordingly.

Read in
MDA

The system will ask you to enter a name for the file to be saved to the MDA buffer.

The program is saved/stored as a part program (MPF) under the name you have entered in the Part Programs directory.

Store MDA
program



MMC 100.2



MMC 103

4.5.4 Deleting a program



Function

Programs written in MDA mode and stored in the clipboard are deleted by a mode switchover (e.g. to MDA Jog)
or
by softkey "Delete MDA buffer".

4.5.5 Teach In



Function

With the function "*Teach In*" part programs (main programs and subroutines) for motion sequences or simple workpieces can be created, modified and executed by approaching and then storing positions in combination with the function "*MDA*".

There are two possible methods of writing programs with "*Teach In*" and "*MDA*":

1. Manual positioning.
2. Manual input of coordinates and additional information.



Both entry of blocks (input, delete, insert) and automatic insertion by manual approach of positions are possible only at points that have not yet been executed.



MMC 103

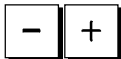

1. Manual positioning

Operating sequence

"MDA" mode is selected in the "Machine" operating area.

Submode "Teach In" is selected.

After selection of the function the cursor is located in the first blank line of the "Teach-In program" window.

Turning machine:

Press the "Axis keys".

Milling machine:

Select the axis to be traversed

and then press key "+" or "-".

The axis name and the path being traversed are displayed continuously on the screen in the "Teach In program" window.

The axis name and axis positions are transferred to the MDA program as values referred to the workpiece coordinate system.

Save position values:

- MMC 100.2:
The positioning values of the axes can be edited in the buffer until the block in question is stored with the key "NC start".

When you use the "Save block" function for the first time you will be asked to enter the name of the teach program.

The teach program is now set for the duration of the MDA/Teach in procedure.

After "Jog" or "AUTO" mode has been selected, a new Teach program can be set.

Additional functions:

Place the cursor at the desired position in the "Buffer" window.



MMC 100.2



MMC 103

Enter the additional functions (e.g. feedrates, miscellaneous functions, etc.) in the program (if permitted).

- MMC 103:
Position values are stored automatically (SW 4.1 and later).
Using MDA file functions, you can store the MDA program in the "Part programs" directory (MPF.DIR).

Delete/insert block:

Position the cursor at the desired point.

Delete
block

- MMC 100.2:
The block is automatically deleted.

Insert
block

The block stored in the delete memory is automatically inserted in front of the line in which the cursor is located.

- MMC 103:
You can use the editing functions of the vertical softkeys to overwrite, select, copy, paste, delete, find, find next, and position program blocks (SW 4.1 and later).



When you switch to "MDA" mode and press "NC Start", the corresponding traversing motions and additional function entries are executed as program blocks. While the program is being processed, the blocks traversed by the NC are displayed in the "Current block" window.

2. Manual input of coordinates

Operating sequence

"MDA" mode is selected in the "Machine" operating area.

Save position values/additional functions:

Transfer the coordinates of the traversing positions plus any additional functions (preparatory functions, auxiliary functions, etc.) in the program by entering them in the "MDA program" window.



MMC 103



Further notes

- Any change to the zero offset will cause the axis to carry out compensatory movements when you press NC Start.
- In the case of G64, the end point response will differ when the part program is executed in "Automatic" mode.
- All the G functions can be used.



MMC 100.2



MMC 103

4.6 Automatic mode

4.6.1 Function and basic display

Preconditions

You can execute part programs fully automatically in "Automatic" mode, i.e. this mode is normally used for machining parts.

The following conditions must be fulfilled before you can execute part programs:

- You have synchronized the measuring system of the control with the machine (reference point approach).
- You have already loaded the part program to be executed to the control system.
- You have checked the required offset values or entered them, i.e. zero offsets or tool offsets.
- The requisite safety interlocks are already active.

The "Automatic" basic display contains values relating to position, feedrate, spindle and tool as well as the block currently being processed or program pointer.

Machine	Auto	WKS.DIR\TEST.MPF	
Channel reset			G. fct. + transf.
Program aborted			
MCS Position.	Dist.-to-go	Master spindle	S1
-X 53.761 mm	-25.761	Act. + 0.000 rpm	Auxiliary func.
+Y 30.000 mm	0.000	Set 0.000 rpm	Spindles
+Z 112.704 mm	-112.704	Pos 0.000 deg.	Axis feedrate
+ 0.000 mm	0.000	Power [%] <input type="text"/>	Program blocks
Current block TEST.MPF		Feedrate mm/min	Zoom act. val.
N51 Y0 H55=99		Act. 7000.000 0.000 %	Act. val. WCS
Y120 F7000		Set 7000.000	Program level
		Tool	Program overview
		Preselected tool:	
		G0 G91	
Over-store	DRF offset	Program control	Block search
		Handwheel	Correct program

Explanation of basic display

Like the Jog display, the Automatic display contains actual value, spindle window, feedrate and tool windows.

If G0 is detected by the NC during processing of a part program, the current value of the rapid traverse override is displayed in the "Feedrate" window (SW 5.3 and later).





MMC 103

Program
overview

Horizontal softkeys

The workpiece or program overview is displayed. In this area it is possible to select programs for execution.

MMC 103 only:

The memory space available on the hard disk and in the NCU is displayed in the footer.

Current
block

Vertical softkeys

The "*Current block*" window is also displayed.

The current block is highlighted while the program is running.

The name of the program to which the blocks on the screen belong is output in the window header.

Program
level

When you press softkey "*Program level*", the window headed "*Program level*" appears instead of the "*Current block*" window.

The program nesting depth (P = number of passes) is displayed.

Program
level

or

Current
block

In program operation it is possible to toggle between the "*Program level*" and "*Current block*" displays.

Program
blocks

Seven program blocks of the current program are displayed together with the current position in the part program.

Unlike with function "Current block", the program created by the programmer is displayed.

Further notes

The other softkeys are described in the sections below.

4.6 Automatic mode



MMC 100.2



MMC 103

4.6.2 Program overview

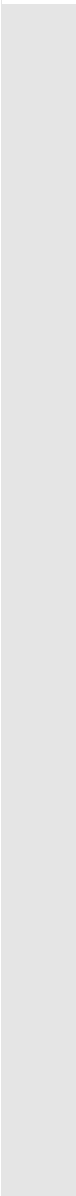
Select
program

Workpiece

Part
programsSub-
programsStandard
cyclesUser
cycles**Function**

After selection of a workpiece or program overview, individual workpieces or programs can be enabled or disabled for execution.

Operating sequence

"*AUTO*" is selected in the "*Machine*" operating area.

The appropriate channel is selected.

The channel is in reset state.

The workpiece/program to be selected is in the memory.

An overview of all workpiece directories/programs that exist is displayed.

Position the cursor on the desired workpiece/program.

Select the workpiece/program for execution:

The name of the selected workpiece is displayed on the screen in field "Program name" at the top. The program is then loaded.

Explanation of other softkeys:

All programs of a particular type are displayed via the horizontal softkeys:

Display of all workpiece directories

Display of all existing part programs

Display of all existing subroutines

Display of all existing standard cycles

Display of all existing user cycles



MMC 103

Clipboard

Display of files stored in the clipboard (MMC 100.2 only)

Execution
from ext.

You can activate the following functions by means of the vertical softkeys:

MMC 100.2:

Programs can be read from an external source (e.g. PC) into the control via the V.24 (RS-232-C) interface and executed there. (see Section "Execution via the V.24 interface" in this chapter).

Proc. from
hard disk

MMC 103:

If a program requires more memory to run than can be supplied by the NC, then it can be loaded step-by-step from the hard disk (see subsection "Processing from hard disk" in this Section).

Change
enable

The selected workpiece/program is enabled (X) or disabled (no "X"). Only now can you select a program or workpiece.

4.6 Automatic mode



MMC 100.2



MMC 103

4.6.3 Execution via the V.24 interface (MMC 100.2)

**Function**

A function is provided that allows you to transfer programs to the NC via the V.24 interface for immediate processing. The buffer size available for the temporary storage of part program blocks in the NC depends on the capacity of the NC memory and how it is allocated (machine data).

**Operating sequence**

The "Machine" operating area is selected.

The "Program overview" is open.
The vertical softkey bar changes.

Program
overview

Execution
from ext.

Press softkey "Execution from ext."

The program can now be transferred. Execution begins after NC Start.



Alternatively, you can start the program in the "Services" operating area.

You can alter the transfer parameters in the "Services" operating area.
The transmission is recorded in a log in this area.



The name appears as a selected program if the program is transmitted from the external device as a punched tape archive.



Press the "NC Start" key.

The executed blocks appear in the current block window.



MMC 103

4.6.4 Loading and unloading the workpiece/part program (MMC 103)



Program
overview

Load

Enable

Unload



Function

Workpieces and part programs can be stored in the NC memory ("*Load*") and erased from this memory again ("*Unload*") after they have been executed.

In this way, it is possible to prevent the NC memory from becoming unnecessarily overloaded because programs that are no longer required can be erased immediately.

Operating sequence

The "*Machine*" operating area is selected.

The "*Program overview*" is open.
The vertical softkey bar changes.

Position the cursor in the directory tree on the workpiece/part program that you wish to load.

The selected workpiece/part program is loaded from the hard disk into the memory of the NC.

It is erased from the hard disk.

If the enable command (X) is set, the workpiece can be machined.

The highlighted workpiece/part program is loaded from the NC memory to the hard disk.
The workpiece/program is erased from the NC memory.

Further notes

Workpieces/part programs that have been loaded to the NC memory are marked with ("X") in the "Loaded" column in the workpiece/program overview.

4.6 Automatic mode



MMC 100.2



MMC 103

4.6.5 Log: Loading list of programs (MMC 103)

**Function**

If you are working with the hard disk of an MMC 103, a facility is available that allows you to view the following log data:

- Job list:
Display of loaded or unloaded programs
- Error list:
Display of previously loaded programs if errors have occurred during loading.

**Operating sequence**

The "Machine" operating area is selected.

The "Program overview" is open.

The softkey bars change.

Select softkey "Log".

The "Job log for program overview" is opened.



Program
overview



Log

4.6.6 Executing programs from the hard disk (MMC 103)

**Function**

If a program requires more memory than the NC can provide for execution, then it can be loaded continuously from the hard disk.

**Operating sequence**

The "Machine" operating area is selected.

The "Program overview" is open.

The vertical softkey bar changes. Select the program you wish to execute with the cursor (enable (x) must be set).



Program
overview



MMC 103

Execution
f. hard disk

The highlighted program is loaded continuously to the NC memory during execution.



Press "NC Start".



The program remains stored on the hard disk while the "Execution from hard disk" function is in progress.

External
programs

The "External programs" window is opened.

The "Status" field indicates what percentage of the program has been loaded from the hard disk.



Further notes

Programs which are loaded step-by-step from the hard disk are marked with "Ext." in the program overview.

On Reset or end of program (M36, M17) "Ext." is automatically deselected.

4.6.7 Accessing the external network drive from the MMC 103 (SW 5.2 and higher)



Function

You can link your control to external network drives or other computers by means of the SINDNC software. This makes it possible, for example, to execute part programs from other computers.

Precondition:

- The SINDNC software is installed.
- The computer or drive which you want to link up to is accessible/enabled.
- A connection to the computer/drive has been established.
- The softkeys for selecting the drive/computer link have been configured in the machine data, see /IAM/ MMC, Installation and Start-Up Guide, IM3, Chapter 2 Data Transmission



MMC 103

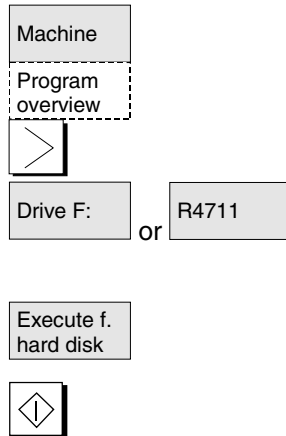

Operating sequence

You can access the softkeys (configured) for the external drive or computer in the Machine operating area via the softkey "Program overview" and the "Etc." key. Horizontal softkeys 1 to 4 are reserved for this. The vertical softkey bar changes.

When you press a softkey, e.g. "Drive F:" or "R4711" the Explorer appears on the screen with the data of the external drive, e.g. "Drive F" or of computer "R4711".

Select the program that you want to execute with the cursor and then press the softkey "Execute from hard disk".

The program starts when you press "NC Start".

Further notes

- If the drive/computer is not connected or enabled, the message "No data available" is displayed.
- Only files with the ID MPF or SPF for external execution can be selected.
- DOS naming conventions must be used for the files and paths: Max. 8 characters for the name, 3 characters for the extension).
- A template of the same name is stored in the NC in the part program directory for processing the programs. If naming conflicts arise, program selection is refused with an error message.

Program call from the part program: EXTCALL

It is possible to access files on network drives from a part program using the command EXTCALL.

The programmer can define the source directory in the part program with \$SC_EXT_PROG_PATH and the file name for the subroutine to be loaded with the command EXTCALL; see /PG/ Programming Guide Advanced, Chapter 2.

The following constraints apply for EXTCALL calls:

- Only files with the extension SPF can be called with EXTCALL on a network drive.
- DOS naming conventions must be used for the files and paths: A max. of 8 characters for the name, 3 characters for the extension.
- A program is found on a network drive with the command EXTCALL if



MMC 103

- The search path refers to the network drive or a directory in it with \$SC_EXT_PROG_PATH. The program must be stored directly on that level, no subdirectories are searched.
- The program is defined directly in the EXTCALL call with a qualified path which can also point to a subdirectory of the network drive and is also located there.
- The search path is not delimited with \$SC_EXT_PROG_PATH.

4.6.8 Program editing



Function

As soon as a syntax error in the part program is detected by the control, program processing is interrupted and the syntax error is displayed in the alarm line.

You can switch to the program editor and monitor the program run in a full-screen display. If an error occurs (Stop state), you can edit the program in the program editor (SW 4 and later, MMC 103).



Operating sequence

"Auto" is selected in the "Machine" operating area.

It is not possible to overtravel the point of interruption. The feedrate override switch is active.

The program status is "Stopped" or "Reset".

The correction editor is displayed with this softkey, the softkey bars change, the softkey "Edit" is marked.

If an error occurs, the faulty block is highlighted and can be corrected.

Correct
program



MMC 103



Using editor functions "Overwrite", "Highlight block", "Insert block", "Go To..." and "Find...", you can edit the program in the correction block editor.

You can toggle between program levels using these softkeys. Press "Level -" to view the program in which the faulty routine is called. You can return to the program to be edited by pressing "Level +".

After you have edited out the error, you can continue the program run by pressing "NC Start".

- NC Stop state:
Only program lines that have not yet been executed can be edited.
- Reset state:
All program lines can be edited.

Note:

You cannot use the "Correct program" function if you are running a program from the hard disk.

Further notes

If the error cannot be corrected in the "Channel aborted" state, an appropriate message is displayed when the "Correct block" softkey is pressed.

In this case, program execution must be aborted with "NC Reset". The part program can then be edited under Programming.



MMC 103

4.6.9 Block search/setting the search destination



Function

The block search function allows you to run the part program forward until you reach the block you require. Three types of search are available:

1. With calculation on contour:

During block searches with calculation, the same calculations are performed as in normal program mode. The complete destination block is then executed analogously to normal program execution.

2. With calculation at block end point:

During block searches with calculation, the same calculations are performed as in normal program mode. The interpolation mode valid in the destination block is then applied to approach its end point or the next programmed position.

3. Without calculation:

No calculations are performed during the block search. The values stored in the control remain the same as they were before the block search.

4. External block search without calculation (SW 5.3 and later).

In menus "Search position" and "Search pointer" you can start a block search for programs using softkey "External without calculation". These programs are then processed by an external unit.

You can define the search destination

- by direct positioning or
- indirectly by entering a block number, a label, a program name or any character string.



MMC 103



Block
search

Calculate
contour



Calc. block
end point

without
calculation



Operating sequence

"*AUTO*" is selected in the "*Machine*" operating area.

The channel is in the reset state.

The program in which the block search is to be performed is selected.

Calls up the "*Search position*" function.

Position the cursor on the destination block.

The block search is started when you press one of the following three softkeys:

Block search start with calculation on contour

- When you press "*NC Start*", a compensatory axis motion is initiated between the current actual position and the new position determined by the block search.
- The current position is defined by the program status (all axis positions, active auxiliary functions) at the beginning of the selected block, i.e. after a block search the control stops at the final position of the NC block before the target of the search.

Block search start with calculation at block end point (SW 4.3 and later)

Block search start without calculation

- If the destination block is found this block becomes the current block. MMC announces "Target of search found" and displays the target block in the current block display.
- Action blocks (e.g. collection of auxiliary functions) are output after NC Start.
- Alarm 10208 is output to indicate that operator interventions such as Overstore or Mode Change after JOG are permissible.
- When you press NC start the program is started and the process resumes at this destination block.

Block search can be aborted with Reset.



MMC 103

Search
position

Program
level +

or

Program
level -

Search
pointer

0 ... 5

A ... Z

Define search destination in program editor:

The current selected program level is displayed.

Position the cursor bar on a destination block of your choice in the part program.

You can toggle between program levels using these softkeys if necessary.

Defining the search destination in the search pointer:

Once the softkey "search pointer" has been pressed, a screen form with the program pointer is displayed.

It contains input fields for program name, search type (block number, text, ...) and search destination (content). The cursor is positioned in the input field for the "search type".

You must enter your selected search type for the search destination in input field "Type".

Information about the available search types is displayed in the dialog line.

The following search types can be entered:

Search type (= jump to ...)	Value in search type field
End of program	0
Block number	1
Jump label	2
Any character string	3
Program name	4
Line number	5

Different search types can be specified for different program levels.

You can enter your chosen search destination (according to search type) in the "Search destination" field.



MMC 103

0 ... 9

Interrupt.
point

You can enter the corresponding number of program passes in the "P" field (pass counter).

Preset search destination to last program interruption point:

The search pointer is assigned the data of the last program interruption point.

4.6.10 Fast external block search without calculation (MMC 103 only: SW 5.3 and higher)



Function

The block search function allows you to run the part program forward until you reach the block you require.

You can use the "External without calc." softkey in the "Search position" and "Search pointer" menus to start a fast block search in programs that are processed by an external device (local hard disk or network drive).

You can define the search destination

- by positioning the cursor bar directly on the target block or
- by specifying a block number or a line number.

Block search sequence:

Only programs and program parts required to reach the next specified search destination and subsequent program processing are transferred to the NC. This behavior applies to the function

- "Processing from external source" and
- when execution of EXTCALL statements.

Example:

The following search destinations are entered in the Block search menu:

<i>Search destination 1</i>	"Level1": MAIN1.MPF	"Line": 8
<i>Search destination 2</i>	"Level2": SUBPRG2.SPF	"Line": 4000
<i>Search destination 3</i>	"Level3": SUBPRG3.SPF	"Line": 2300



MMC 103

Programs

MAIN1.MPF

```

1      G90
2      X100 Y200 F2000
3      EXTCALL SUBPRG1
4      X200 Y400
5      EXTCALL SUBPRG2
6      EXTCALL SUBPRG3
7      X0 Y0

```

*Search
destination 1*

```

8      EXTCALL SUBPRG2
9      X50
10     M30

```

SUBPRG2.SPF

```

1      X200 Y300
2      X400 Y500
3      EXTCALL SUBPRG3

```

*Search
destination 2*

```

4000  EXTCALL SUBPRG3
.
.
5000  M17

```

SUBPRG3.SPF

```

1      X20 Y50
2

```

*Search
destination 3*

```

2300  X100 Y450
.
.
5000  M17

```

A distinction is made the following two cases for block search:

1. The main program MAIN1.MPF is in the NC, the subroutines SUBPRG1.SPF to SUBPRG3.SPF are processed externally.
2. The main program MAIN1.MPF and the subroutines SUBPRG1.SPF to SUBPRG3.SPF are processed externally.



MMC 103

Case 1

- Search destination 1: The NC does not consider the EXTCALL calls in lines 3, 5, and 6 of the main program MAIN1.MPF and jumps to the search destination Line 8.
- Search destination 2: The NC jumps to the search destination Line 4000 of the external subroutine SUBPRG2.SPF; the previous statements are not considered.
- Search destination 3: The NC jumps to the search destination Line 2300 of the external subroutine SUBPRG3.SPF; the previous statements are not considered, the search stops.

The program is started on NC Start; the G and M functions accumulated in the main program are taken into account and the subroutine SUBPRG3.SPF processed starting at the destination line.

Case 2

- Search destination 1: The NC jumps to the line 8 of the search destination.
- Search destination 2: see above.
- Search destination 3: see above.

On NC Start, the subroutine SUBPRG3.SPF is started and processed starting at the destination line.

Further notes

The function only works properly if the search pointer is assigned via interrupt point. Then, you can modify the search destination in the search screen form for the search pointer (e.g. change the line number or delete a level). Expanding the search destinations by another program does not work for the block search. However, the search pointer can be defined freely for a search destination in the first program level.

Operating sequence

"AUTO" is selected in the "Machine" operating area.

The channel is in the reset state.

The program in which the block search is to be performed is selected.

Switches to the "Search position" dialog.

Program
control



MMC 103

Search
position

Program
level +

or

Program
level -

without
calculation

Search
pointer

without
calculation

Define search destination in program editor:

The current selected program level is displayed.

Searching via the "Search position" is only possible for the programs loaded in the NC, not for programs processed from the hard disk.

Position the cursor bar on a destination block of your choice in the part program.

If an interrupt point is present in the NC, you can switch between the program levels.

Start of search without calculation for external programs.

Defining the search destination in the search pointer:

Once the softkey "search pointer" has been pressed, a screen form with the program pointer is displayed.

It contains input fields for program name, search type (block number, text, ...) and search target (content). The cursor is positioned in the input field for the "search type".

Type 1 (block number) and Type 5 (line number) are possible types for the search destinations.

Start of search without calculation for external programs.



MMC 103

4.6.11 Start of search in Program test mode, multi-channel (MMC 103 only: SW 5.3 and higher)



Function

The NC is operated in Program test mode for this search, so that interactions between channel and synchronous actions and among several channels are possible within an NCU.

The "Block search in Program test mode" enables a program advance up to the desired point of the part program with the following functions: During "Block search in Program test mode", all auxiliary functions of the NC are output to the PLC and the part program commands for channel coordination (WAITE, WAITM, WAITMC, Replace axis, Write variables, etc.) are carried out by the NC.

- This means that the PLC is updated during this block search and
- machining operations that involve several channels are processed correctly within the block search.

You can select the function via the "Prog.test Contour" softkey in the "Search position" and "Search pointer" menus.

You can define the search destination

- by positioning the cursor bar directly on the destination line
or
- using the input fields "Program name", "Search type" and "Search destination".

Further notes

The function "Block search in program test mode" requires NC SW 6 or higher.



MMC 103

Block
searchSearch
positionProgram
level +

or

Program
level -Calculate
contourSearch
pointer

Operating sequence

Precondition:

- "AUTO" is selected as operating mode.
- The channels have the status Reset.
- The program in which the block search is to be performed is selected.

The channel in which the destination block is searched for or the program pointer set is the destination channel. Other channels are started according to the setting in the "machine.ini" file.

Switches to the "Search position" dialog.

Define search destination in program editor:

The current selected program level is displayed.

Position the cursor bar on a destination block of your choice in the part program.

You can toggle between program levels using these softkeys if necessary.

Start of search in Program test mode.

A dialog message appears as soon as all the channels involved in the current search have exited program test mode. This message indicates that Repos offsets may, depending on the particular part program, have been produced in the channels involved during the block search and will be retracted the by the NC through interpolation the next it starts. You must acknowledge this message.

The repositioning offsets that occur may be traversed manually in JOB mode before continuing program processing with the "NC Start" key at the program position reached in the block search.

Defining the search destination in the search pointer:

Once the softkey "Search pointer" has been pressed, a screen form with the program pointer is displayed.

It contains input fields for program name, search type (block number, text, ...) and search target (content). The cursor is positioned in the input field for the "Search type".



MMC 103

Prog. test
contour

Start of search in Program test mode.

A dialog message appears as soon as all the channels involved in the current search have exited program test mode, see "Search destination in program editor mode" above.

Any repositioning offsets (in the individual channels) can be retracted in sequence via manually controlled traversing movements in JOG mode, before program processing is continued via NC Start at the point in the program reached by the block search.

4.6.12 Overstore



Overstore



Function

In "AUTO" mode you can overstore technological parameters (auxiliary functions, all programmable instructions ...) in the working memory of the NC. You can also enter and execute any NC block.

Operating sequence

"AUTO" is selected in the "Machine" operating area.

Overstore with single block:

The program automatically stops at the next block boundary.

The "Overstore" window is opened.

In this window you can now enter the NC blocks that are to be processed.

The blocks you have entered are executed and displayed in the "Current block" window.

The "Overstore" window and associated softkeys are not displayed again until the control switches to the "Channel interrupted", "NC Stop" or "NC Reset" state.

More blocks can be added to the overstore buffer when these blocks have been processed.



MMC 100.2



MMC 103

**Note:**

After "*Overstore*" a subroutine with the content REPOSA is executed. The program is displayed for the operator.

Overstore without single block:

The basic menu for "*AUTO*" mode is selected.

Stop the program by pressing "*NC Stop*".

The "*Overstore*" window is opened.

In this window you can now enter the NC blocks that are to be processed.

The blocks you have entered are executed, the "*Current block*" window is opened and the softkeys disappear. The "*Overstore*" window and associated softkeys are not displayed again until the control switches to the "*Channel interrupted*", "*NC Stop*" or "*NC Reset*" state.

More blocks can be added (to the overstore buffer) when these blocks have been processed.

Further notes

- You can close the window and exit the Overstore function by pressing the "*Recall*" key. You have now exited the Overstore function.
- You cannot change operating modes until you have deselected "*Overstore*" with the "*Recall*" key.
- The program that was selected before Overstore is now resumed in "*AUTO*" mode when you press "*NC Start*" again.
- Overstore does not alter the programs stored in the part program memory.

4.6 Automatic mode



MMC 100.2



MMC 103

4.6.13 Program control

**Function**

You can use this function to change a program sequence in "AUTO" and "MDA" modes. The following program control functions can be activated or deactivated:

- SKP Skip block; up to 8 skip blocks
(1 for MMC 100.2) may be activated in SW 5 and later
- DRY Dry run feedrate
- ROV Rapid traverse override
- SBL1 Single block with stop after machine function blocks
- SBL2 Single block with stop after every block
- SBL3 Stop in cycle (SW 5 and higher, MMC 103)
- M01 Programmed stop
- DRF DRF selection
- PRT Program test
 - Show all blocks in current block display
 - Display only traversing blocks in current block display

DRY

The feedrate entered in setting data "Dry run feedrate" is applied in the program instead of the programmed feedrate when the "Dry run feedrate" function (program control) is selected in "Automatic" mode. See description in Section "Channel status display".

The display is dependent on the machine data of the operator panel in which access authorization can be set.

References: /FB/, A2, Various Interface Signals, Chapter 4, and /FB/ K1, Mode Groups, Channels, Program Operation



MMC 100.2



MMC 103

SKP:

Activating skip levels
(MMC 103:
SW 5 and higher
MMC 100.2:
SW 5.2 and higher)

Blocks that cannot be executed, can be skipped (8 levels for MMC 103, 1 for MMC 100.2). Blocks which are to be skipped are marked with an oblique "/" in front of the block number. The skip levels in the part program are specified by "/0" to "/7". You can activate/deactivate skip levels in the following window:

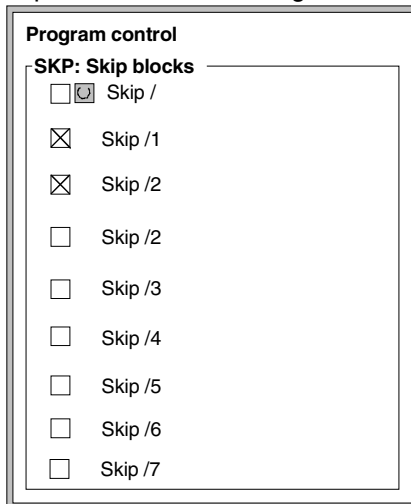

The levels to be skipped can only be changed when the control is in the Stop/Reset state.



Display of activated skip levels
(MMC 103 only:
SW 5.3 and higher)

If several skip levels are activated, the program control screen can be used to determine

- which level is selected but not yet activated,
- which level is selected and activated,
- which level is deselected and activated,
- which level is deselected and not activated.

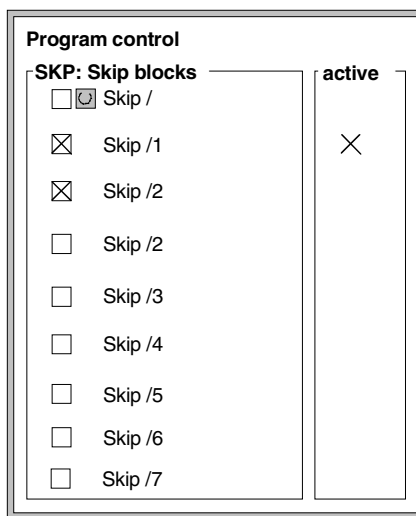



MMC 100.2



MMC 103

You can select this screen using the vertical softkey "Skip blocks", if more than 1 skip level has been set via MD.

Machine manufacturers

Activating the function "Display activated skip levels": see manufacturer's specification.

References: /FB1/ K1: BAG, Channel, Program Mode., Chapter 2

Operating sequence

"*AUTO*" or "*MDA*" mode is selected in the "*Machine*" operating area.

The "*Program control*" window appears on the screen.

Place the cursor at the required position.

Every time you press the "*Toggle key*", you activate or deactivate the selected function.

Program
control



Display of active skip levels
(MMC 103:
SW 5.3 and higher)

Skip
blocks

If the function is not active, the previous screen appears with the "General" softkey selected.

If the function is activated, the additional softkey "Skip blocks" is available in the Program control menu.

If the number of skip levels to be displayed is greater than 1, you can use the vertical softkey "Skip blocks" to select the skip levels.

You can use the "SKP: skip blocks" area to activate individual levels; the "active" area shows whether these levels have also been activated by the PLC.

Further notes

The entries influence the channel status display (see Section 2.3).

The channel status display is output irrespective of the selected menu.



MMC 100.2



MMC 103

4.6.14 DRF offset



Switching on and off

Alter DRF

Function

The DRF (differential resolver function) offset allows you to apply an additional incremental zero offset (DRF offset) via a handwheel. It is active in the workpiece coordinate system for geometry axes and special axes. With this function it is possible, for example, to correct tool wear within a programmed block.

The DRF offset can be switched on and off for specific channels by means of the *"Program control"* function.

It remains stored until

- Power ON for all axes
- DRFOF (deselection of DRF via part program)
- PRESETON (alteration of actual value by means of Preset)

You can alter the DRF offset by traversing the appropriate machine axis using the handwheel (the actual value display does not change).

Operating sequence

"Auto" is selected in the *"Machine"* operating area.

The standard axis assignment is defined.

Enter the handwheel of your choice or select via the MCP.

Enter the increment size of your choice or select via the MCP.

The window *"DRF offset"* is displayed.

Traverse the required axes using the handwheel.

Using the same operating sequence, you can also return the DRF offset to the value *"0"*.



or



4.6 Automatic mode

MMC 100.2



MMC 103



MMC 100.2



MMC 103

"Parameters" Operating Area

5.1	Tool data.....	5-171
5.1.1	Structure of tool compensation	5-171
5.1.2	Tool types and tool parameters.....	5-172
5.2	Tool offset.....	5-187
5.2.1	Function and basic display of tool offset	5-187
5.2.2	New tool	5-188
5.2.3	Display tool	5-189
5.2.4	Tool search.....	5-191
5.2.5	Delete tool	5-192
5.2.6	New tool edge	5-193
5.2.7	Display tool edge.....	5-194
5.2.8	Find tool edge.....	5-194
5.2.9	Delete tool edge	5-194
5.2.10	Determine tool offsets	5-195
5.2.11	Tool offsets with D numbers only (flat D No.).....	5-196
5.2.12	Immediate activation of tool offset.....	5-196
5.3	Tool management.....	5-198
5.3.1	Basic functions of tool management	5-200
5.3.2	Display/change tool data	5-208
5.3.3	Loading.....	5-213
5.3.4	Unloading	5-218
5.3.5	Relocation	5-219
5.3.6	Tool master data in tool catalog (MMC 103)	5-221
5.3.7	Tool offset data in the tool cabinet (MMC 103)	5-224
5.3.8	Job processing for tools	5-227
5.4	ShopMill Tool Management, MMC 100.2 (SW 5.3 and higher).....	5-237
5.4.1	Functional scope	5-238
5.4.2	Selecting a tool list	5-239
5.4.3	Creating a new tool	5-240
5.4.4	Creating a tool offset for cutting edge 1/2	5-241
5.4.5	Changing tool name	5-242
5.4.6	Creating a duplo/replacement tool	5-242
5.4.7	Manual tools	5-242
5.4.8	Creating tool wear data	5-243
5.4.9	Tool monitoring.....	5-244
5.4.10	Magazine list.....	5-245
5.4.11	Delete tool	5-246
5.4.12	Changing the tool type.....	5-246
5.4.13	Loading a tool.....	5-247

5.4.14	Unloading a tool.....	5-248
5.4.15	Sorting tools in the tool list.....	5-249
5.5	R parameters (arithmetic parameters).....	5-250
5.5.1	Function.....	5-250
5.5.2	Editing/deleting/finding R parameters.....	5-250
5.6	Setting data.....	5-252
5.6.1	Working area limitation.....	5-252
5.6.2	Jog data.....	5-253
5.6.3	Spindle data.....	5-254
5.6.4	Dry run feedrate for DRY mode.....	5-255
5.6.5	Starting angle for thread cutting.....	5-256
5.6.6	Other types of setting data.....	5-257
5.6.7	Protection zones.....	5-258
5.7	Zero offset.....	5-259
5.7.1	Function.....	5-259
5.7.2	Changing the settable zero offset (G54 ...)......	5-261
5.7.3	Displaying other types of zero offset.....	5-263
5.7.4	Displaying active settable zero offsets.....	5-264
5.7.5	Displaying active programmable zero offsets.....	5-265
5.7.6	Displaying active external zero offsets.....	5-265
5.7.7	Displaying the sum of the active zero offsets.....	5-266
5.7.8	Activate zero offset and basic frame immediately.....	5-266
5.7.9	Global zero offset/frame (SW 5 and higher).....	5-267
5.7.10	Actual value display: Settable zero system, SZS (SW 5.2 and higher).....	5-272
5.8	User data/user variables (GUD, PUD, LUD).....	5-273
5.8.1	General information.....	5-273
5.8.2	Changing/finding user data/user variables.....	5-274
5.9	Displaying system variables (SW 4.1 and higher).....	5-276
5.9.1	Processing/creating variable views.....	5-277
5.9.2	Managing variable views.....	5-278
5.9.3	Logging system variables.....	5-279



MMC 100.2



MMC 103

5.1 Tool data

5.1.1 Structure of tool compensation

	<p>A tool is selected in the program by means of the T function. Numbers T0 to T32000 can be assigned to tools. Each tool can have up to 9 cutting edges: D1–D9. D1 to D9 activates the tool offset of a cutting edge for the active tool.</p> <p>The tool length compensation is applied with the first traversing motion (linear or polynomial interpolation) of the axis.</p> <p>A tool radius compensation is activated by programming of G41/42 in the active plane (G17, 18, 19) and in a program block with G0 or G1.</p>
	<p>Tool wear</p> <p>Allowances for changes in the active tool shape can be made in the tool length (tool parameters 12–14) and tool radius (tool parameters 15–20).</p>
	<p>Tool offset with D numbers only (SW 4 and higher)</p> <p>Tool management is implemented outside the NCK, T numbers are irrelevant. This option can be activated via MD 18102 MM_TYPE_OF_CUTTING_EDGE. (value = 1 = absolute direct D programming, value = 2 = relative indirect D programming).</p> <p>The D number range increases to 1–32000. A D number can be assigned only once for each tool, i.e. each D number represents precisely one tool offset data record.</p>
	<p>i 12 cutting edges (MMC 103 SW 5 and higher NCU 57x SW 5 and higher)</p> <p>Each tool can have up to 12 cutting edges: D1–D12.</p>



MMC 100.2



MMC 103

5.1 Tool data

5.1.2 Tool types and tool parameters

Entries

T no. Number of the tool

D no. Number of the cutting edge

Every data field (offset memory) that can be called with a D number contains not only the geometric information for the tool but also further entries, i.e. the tool type (drill, milling cutter, turning tools with cutting edge position etc.).

Tool types

Tool type classification:

- **Group with type 1xy (milling cutters):**

- 100 Cutter acc. to CLDATA
- 110 Ballhead cutter
- 120 End mill (without corner rounding)
- 121 End mill (with corner rounding)
- 130 Angle head cutter (without corner rounding)
- 131 Angle head cutter (with corner rounding)
- 140 Facing tool
- 145 Thread cutter
- 150 Side mill
- 155 Bevelled cutter

Required offset values for a milling cutter

Entries in tool parameters										
DP1	1xy									
DP3	Length 1									
DP6	Radius									
Wear values according to requirement		<table border="1"> <thead> <tr> <th colspan="2">Effect</th> </tr> </thead> <tbody> <tr> <td>G17:</td> <td>Length 1 in Z Radius in X/Y</td> </tr> <tr> <td>G18:</td> <td>Length 1 in Y Radius in Z/X</td> </tr> <tr> <td>G19:</td> <td>Length1 in X Radius in Y/Z</td> </tr> </tbody> </table>	Effect		G17:	Length 1 in Z Radius in X/Y	G18:	Length 1 in Y Radius in Z/X	G19:	Length1 in X Radius in Y/Z
Effect										
G17:	Length 1 in Z Radius in X/Y									
G18:	Length 1 in Y Radius in Z/X									
G19:	Length1 in X Radius in Y/Z									
Other values must be set to zero		F: Toolholder reference point								



MMC 100.2



MMC 103

Milling tool with adapter

Entries in tool parameters										
DP1	1xy									
DP3	Length 1 -Geometry									
DP6	Radius -Geometry									
DP21	Length -Adapter									
Wear values according to requirements		<table border="1"> <tr> <th colspan="2">Effect</th> </tr> <tr> <td>G17:</td> <td>Length 1 in Z Radius in X/Y</td> </tr> <tr> <td>G18:</td> <td>Length 1 in Y Radius in Z/X</td> </tr> <tr> <td>G19:</td> <td>Length 1 in X Radius in Y/Z</td> </tr> </table>	Effect		G17:	Length 1 in Z Radius in X/Y	G18:	Length 1 in Y Radius in Z/X	G19:	Length 1 in X Radius in Y/Z
Effect										
G17:	Length 1 in Z Radius in X/Y									
G18:	Length 1 in Y Radius in Z/X									
G19:	Length 1 in X Radius in Y/Z									
Other values must be set to zero		<p>F: Adapter reference point (when tool is inserted = toolholder reference point)</p> <p>F': Toolholder reference point</p>								

• **Group with type 2xy (drills):**

- 200 Twist drill
- 205 Solid drill
- 210 Boring bar
- 220 Center drill
- 230 Countersink
- 231 Counterbore
- 240 Tap, regular
- 241 Tap, fine
- 242 Tap, Whitworth
- 250 Reamer

Required offset values for a drill

Entries in tool parameters										
DP1	2xy									
DP3	Length 1									
Wear values according to requirements		<table border="1"> <tr> <th colspan="2">Effect</th> </tr> <tr> <td>G17:</td> <td>Length 1 in Z</td> </tr> <tr> <td>G18:</td> <td>Length 1 in Y</td> </tr> <tr> <td>G19:</td> <td>Length 1 in X</td> </tr> </table>	Effect		G17:	Length 1 in Z	G18:	Length 1 in Y	G19:	Length 1 in X
Effect										
G17:	Length 1 in Z									
G18:	Length 1 in Y									
G19:	Length 1 in X									
Other values must be set to zero		<p>F: Toolholder reference point</p>								



MMC 100.2



MMC 103

- **Group type 4xy (grinding tools):**
 - 400 Surface grinding wheel
 - 401 Surface grinding wheel with monitoring
 - 403 Surface grinding wheel with monitoring without base dimension for grinding wheel peripheral speed
 - 410 Facing wheel
 - 411 Facing wheel with monitoring
 - 413 Facing wheel with monitoring without base dimension for grinding wheel peripheral speed
 - 490 Dresser

Required offset values for a surface grinding wheel

<p>Entries in tool parameters</p> <table border="1" style="border-collapse: collapse; width: 100%;"> <tr> <td>STC_DP1</td> <td>403</td> </tr> <tr> <td>STC_DP3</td> <td>Length 1</td> </tr> <tr> <td>STC_DP4</td> <td>Length 2</td> </tr> <tr> <td>STC_DP6</td> <td>Radius</td> </tr> </table>	STC_DP1	403	STC_DP3	Length 1	STC_DP4	Length 2	STC_DP6	Radius	<p>e.g. G18: Z/X plane</p> <p>F: Toolholder reference point</p> <table border="1" style="border-collapse: collapse; width: 100%;"> <thead> <tr> <th colspan="2">Effect</th> </tr> </thead> <tbody> <tr> <td>G17:</td> <td>Length 1 in Y Length 2 in X Radius in X/Y</td> </tr> <tr> <td>G18:</td> <td>Length 1 in X Length 2 in Z Radius in Z/X</td> </tr> <tr> <td>G19:</td> <td>Length 1 in Z Length 2 in Y Radius in Y/Z</td> </tr> </tbody> </table>	Effect		G17:	Length 1 in Y Length 2 in X Radius in X/Y	G18:	Length 1 in X Length 2 in Z Radius in Z/X	G19:	Length 1 in Z Length 2 in Y Radius in Y/Z
STC_DP1	403																
STC_DP3	Length 1																
STC_DP4	Length 2																
STC_DP6	Radius																
Effect																	
G17:	Length 1 in Y Length 2 in X Radius in X/Y																
G18:	Length 1 in X Length 2 in Z Radius in Z/X																
G19:	Length 1 in Z Length 2 in Y Radius in Y/Z																
<p>Wear values according to requirements</p> <p>Other values must be set to zero</p>																	



MMC 100.2



MMC 103

Required offset values for inclined grinding wheel with implicit monitoring selection

Entries in tool parameters		STC_TPG1	Spindle number
		STC_TPG2	Chaining rule
STC_DP1	403	STC_TPG3	Minimum wheel radius
STC_DP3	Length 1	STC_TPG4	Minimum wheel width
STC_DP4	Length 2	STC_TPG5	Current wheel width
STC_DP6	Radius	STC_TPG6	Maximum speed
Wear values according to requirement		STC_TPG7	Max. surface speed
		STC_TPG8	Angle of the inclined wheel
		STC_TPG9	Parameter no. for radius calculation
Other values must be set to zero		F: Toolholder reference point	
Effect			
G17:	Length 1 in Y Length 2 in X Radius in X/Y		
G18:	Length 1 in X Length 2 in Z Radius in Z/X		
G19:	Length 1 in Z Length 2 in Y Radius in Y/Z		

Required offset values for inclined grinding wheel with implicit monitoring selection

Entries in tool parameters		STC_TPG1	Spindle number
		STC_TPG2	Chaining rule
STC_DP1	403	STC_TPG3	Minimum wheel radius
STC_DP3	Length 1	STC_TPG4	Minimum wheel width
STC_DP4	Length 2	STC_TPG5	Current wheel width
STC_DP6	Radius	STC_TPG6	Maximum speed
Wear values according to requirement		STC_TPG7	Max. surface speed
		STC_TPG8	Angle of the inclined wheel
		STC_TPG9	Parameter no. for radius calculation
Other values must be set to zero		F: Toolholder reference point	
Effect			
G17:	Length 1 in Y Length 2 in X Radius in X/Y		
G18:	Length 1 in X Length 2 in Z Radius in Z/X		
G19:	Length 1 in Z Length 2 in Y Radius in Y/Z		



MMC 100.2



MMC 103

Required offset values for a surface grinding wheel without basic dimension for grinding wheel surface speed

Entries in tool parameters		STC_TPG1	Spindle number	
STC_DP1		403	STC_TPG2	Chaining rule
STC_DP3	Length 1	STC_TPG3	Minimum wheel radius	
STC_DP4	Length 2	STC_TPG4	Minimum wheel width	
STC_DP6	Radius	STC_TPG5	Current wheel width	
STC_DP21	L1 base	STC_TPG6	Maximum speed	
STC_DP22	L2 base	STC_TPG7	Max. surface speed	
Wear values according to requirement		STC_TPG8	Angle of the inclined wheel	
Other values must be set to zero		STC_TPG9	Parameter no. for radius calculation	
Effect		F: Toolholder reference point		
G17:	Length 1 in Y Length 2 in X Radius in X/Y			
G18:	Length 1 in X Length 2 in Z Radius in Z/X			
G19:	Length 1 in Z Length 2 in Y Radius in Y/Z			

Required offset values for a facing wheel with monitoring parameters

Entries in tool parameters		STC_TPG1	Spindle number	
STC_DP1		403	STC_TPG2	Chaining rule
STC_DP3	Length 1	STC_TPG3	Minimum wheel radius	
STC_DP4	Length 2	STC_TPG4	Minimum wheel width	
STC_DP6	Radius	STC_TPG5	Current wheel width	
Wear values according to requirement		STC_TPG6	Maximum speed	
Other values must be set to zero		STC_TPG7	Max. surface speed	
Effect		STC_TPG8	Angle of the inclined wheel	
		STC_TPG9	Parameter no. for radius calculation	
Effect		F: Toolholder reference point		
G17:	Length 1 in Y Length 2 in X Radius in X/Y			
G18:	Length 1 in X Length 2 in Z Radius in Z/X			
G19:	Length 1 in Z Length 2 in Y Radius in Y/Z			



MMC 100.2



MMC 103

Assignment of tool-specific Parameter

Parameters	Meaning	Data type
Tool-specific parameters		
\$TC_TPG1	Spindle number	Integer
\$TC_TPG2	Chaining rule	Integer
\$TC_TPG3	Minimum wheel radius	Real
\$TC_TPG4	Minimum wheel width	Real
\$TC_TPG5	Current wheel width	Real
\$TC_TPG6	Maximum speed	Real
\$TC_TPG7	Maximum surface speed	Real
\$TC_TPG8	Angle of the inclined wheel	Real
\$TC_TPG9	Param. no. for radius calc.	Integer
Additional parameters		
\$TC_TPC1	Angle of the inclined wheel	Real
to		
\$TC_TPC10		Real



MMC 100.2



MMC 103

Required offset values for a turning tool with tool radius compensation

• **Group type 5xy (turning tools):**

- 500 Roughing tool
- 510 Finishing tool
- 520 Recessing tool
- 530 Parting tool
- 540 Threading tool

Required offset values for a turning tool with tool radius compensation

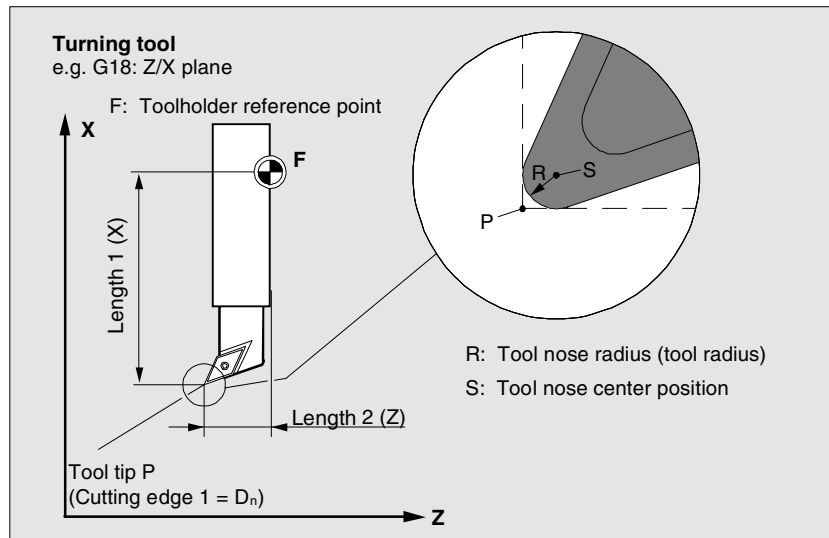

Tool parameter DP2 defines the tool nose position. Any value between 1 and 9 can be entered.

X Tool nose position DP2

Note:
Length 1, length 2 refer to point P for edge positions 1–8; but in case of 9 to S ($S = P$)

Entries in tool parameters		Wear values according to requirements	Other values must be set to zero	Effect	
DP1	5xy				
DP2	1...9	G18:	Length 1 in X Length 2 in Z		
DP3	Length 1	G19:	Length 1 in Z Length 2 in Y		
DP4	Length 2				
DP6	Radius				



MMC 100.2



MMC 103

Required offset values for slotting saw

• **Group type 700 (slotting saw)**

Entries in tool parameters		
DP3 Length 1 - Base		
DP4 DP3 Length 2 - Base		
DP6 Diameter - Geometry		
DP7 Zero width - Geometry		
DP8 Projection - Geometry		
Wear values according to requirements	Effect	
Other values must be set to zero	G17: Semi-diameter (L1) in Z Projection in (L2) Y Saw blade in (R) X/Y	Plane selection 1st-2nd axis (X-Y)
	G17: Semi-diameter (L1) in Y Projection in (L2) X Saw blade in (R) Z/X	Plane selection 1st-3rd axis (X-Z)
	G17: Semi-diameter (L1) in Z Projection in (L2) Z Saw blade in (R) Y/Z	Plane selection 2nd-3rd axis (Y-Z)
$L1 = DP3 + DP6/2$ $L2 = DP4 + DP7/2 - DP8$ $R = DP7/2$		

The offset data (TOA data) you can enter for tool type 700 "slotting saw" are as follows:

	Geometry	Wear	Base	
Tool length compensation				
Length 1	\$TC_DP3	\$TC_DP12	\$TC_DP21	mm
Length 2	\$TC_DP4	\$TC_DP13	\$TC_DP22	mm
Length 3	\$TC_DP5	\$TC_DP14	\$TC_DP23	mm
Radius offset				
Diameter	\$TC_DP6	\$TC_DP15		mm
Slot width b	\$TC_DP7	\$TC_DP16		mm
Projection k	\$TC_DP8	\$TC_DP17		mm

5.1 Tool data



MMC 100.2



MMC 103

Calculating the tool parameters

Types 1xy (milling cutters), 2xy (drills) and 5xy (turning tools) are calculated according to the same scheme.

For the geometric values (e.g. length 1 or radius), there are several entry components. These are added to form a resulting quantity (e.g. total length 1, total radius) that then applies.

Tool parameter number (P)	Meaning	Comment
1	Tool type	For overview see list
2	Cutting edge position	For turning tools only
Geometry		Tool length compensation
3	Length 1	Calculation according to type and plane
4	Length 2	
5	Length 3	
Geometry		Radius
6	Radius	Does not apply to drills
7	Reserved	
8	Reserved	
9	Reserved	
10	Reserved	
11	Reserved	
Wear		Length and radius compensation
12	Length 1	
13	Length 2	
14	Length 3	
15	Radius	
16	Reserved	
17	Reserved	
18	Reserved	
19	Reserved	
20	Reserved	



MMC 100.2



MMC 103

Base dim./adapter	Length compensations	
21	Length 1	
22	Length 2	
23	Length 3	
Technology		
24	Clearance angle	For turning tools
25	Clearance angle	

Offsets that are not required must be set to zero
(= default when the offset memory is set up).

The individual values of the offset memory (P1 to P25) can be read and written by the program via system variables.



The tool offsets can be entered not only via the operator panel but also via the data input interface.

Calculation of tool base dimensions for two-dimensional millhead

Entries in tool parameters DP1 5xy DP3 Length 1 - Geometry DP6 Radius - Geometry DP21 Length 1 - Base DP22 Length 2 - Base DP23 Length 3 - Base			
	Effect		
	G17:	Length 1 in Z Length 2 in Y Length 3 in X Radius in Y/Z	
	G18:	Length 1 in Y Length 2 in X Length 3 in Z Radius in X/Y	
Wear values according to requirements Other values must be set to zero	G19:	Length 1 in X Length 2 in Z Length 3 in Y Radius in Z/X	



MMC 100.2



MMC 103

Calculation of tool base dimensions for three-dimensional millhead:

Entries in tool parameters			
DP1	5xy		
DP3	Length 1 - Geometry		
DP6	Radius - Geometry		
DP21	Length 1 - Base		
DP22	Length 2 - Base		
DP23	Length 3 - Base		
Wear values according to requirements	Effect		
	G17:	Length 1 in Z Length 2 in Y Length 3 in X Radius in Y/Z	
	G18:	Length 1 in Y Length 2 in X Length 3 in Z Radius in X/Y	
	G19:	Length 1 in X Length 2 in Z Length 3 in Y Radius in Z/X	
Other values must be set to zero			

Required length compensation values for turning tools:

Entries in tool parameters			
DP1	5xy		
DP3	Length 1		
DP4	Length 2		
Wear values according to requirements	Effect		
	G17:	Length 1 in Y Length 2 in X	F: Toolholder reference point
	G18:	Length 1 in X Length 2 in Z	
	G19:	Length 1 in Z Length 2 in Y	
Other values must be set to zero			



MMC 100.2



MMC 103

Turning tool with several cutting edges – length compensation:

Entries in tool parameters		Grooving tool e.g. G18: Z/X plane
DP1	5xy	
DP3	Length 1	
DP4	Length 2	
DP1		Effect G17: Length 1 in Y Length 2 in X G18: Length 1 in X Length 2 in Z G19: Length 1 in Z Length 2 in Y
DP3	Length 1	
DP4	Length 2	
Wear values according to requirements		F: Toolholder reference point
Other values must be set to zero		

Calculation of tool base dimensions for turning machine:

Entries in tool parameters		Turning tool e.g. G18 Z/X plane
DP1	5xy	
DP3	Length 1-Geometry	
DP4	Length 2-Geometry	
DP21		Effect G17: Length 1 in Y Length 2 in X G18: Length 1 in X Length 2 in Z G19: Length 1 in Z Length 2 in Y
DP22	Length 2 - Base	
Wear values according to requirements		F': Tool base reference point F: Toolholder reference point
Other values must be set to zero		

5.1 Tool data



MMC 100.2



MMC 103

Tool type 4xy (grinding tools) is calculated separately.

For the geometric values (e.g. length or radius), there are several entry components.

Parameters	Grinding wheel, comp. left	Grinding wheel, comp. right	Dresser left	Dresser right
Tool-specific parameters				
\$TC_DP1	Tool type	$*(2^0=1)$	Tool type	Tool type
\$TC_DP2	Cutting edge position	Cutting edge position	Cutting edge position	Cutting edge position
Geometry tool length compensation				
\$TC_DP3	Length 1	$*(2^2=4)$	Length 1	Length 1
\$TC_DP4	Length 2	$*(2^3=8)$	Length 2	Length 2
\$TC_DP5	Length 3	$*(2^4=16)$	Length 3	Length 3
\$TC_DP6	Radius	Radius	Radius	Radius
\$TC_DP7 to \$TC_DP11	Reserved	Reserved	Reserved	Reserved
Wear tool length compensation				
\$TC_DP12	Length 1	$*(2^{11}=2048)$	Length 1	Length 1
\$TC_DP13	Length 2	$*(2^{12}=4096)$	Length 2	Length 2
\$TC_DP14	Length 3	$*(2^{13}=8192)$	Length 3	Length 3
\$TC_DP15	Radius	Radius	Radius	Radius
\$TC_DP16 to \$TC_DP20	Reserved	Reserved	Reserved	Reserved
Tool base dimensions/adapter dimension tool length compensation				
\$TC_DP21	Base length 1	$*(2^{20}=1048576)$	Base length 1	Base length 1
\$TC_DP22	Base length 2	$*(2^{21}=2097152)$	Base length 2	Base length 2
\$TC_DP23	Base length 3	$*(2^{22}=4194304)$	Base length 3	Base length 3



MMC 100.2



MMC 103

Technology				
\$TC_DP24	Reserved	Reserved	Reserved	Reserved
\$TC_DP25	Reserved	Reserved	Reserved	Reserved
Additional parameters				
\$TC_DPC1				
to				
\$TC_DPC10				

* Value of the chaining parameter if the compensation parameters is to be chained.

Parameter no. for radius calculation \$TC_TPG9

With this parameter it is possible to define which offset value is used for grinding wheel surface speed, tool monitoring and centerless grinding. The value always refers to cutting edge D1.

\$TC_TPG9 = 3	Length 1 (geometry + wear + base, depending on tool type)
\$TC_TPG9 = 4	Length 2 (geometry + wear + base, depending on tool type)
\$TC_TPG9 = 5	Length 3 (geometry + wear + base, depending on tool type)
\$TC_TPG9 = 6	Radius

*: The tool parameter of cutting edge 2 is chained to the parameter of cutting edge 1 (see tool-specific grinding data \$TC_TPG2, chain rule). Here, typical chains are shown and the associated place value is specified in brackets.

Spindle number \$TC_TPG1

This parameter contains the number of the spindle to which the monitoring data and GWPS refer.

Chain rule \$TC_TPG2

This parameter defines which tool parameters of the right wheel edge (D2) and left wheel edge (D1) must be chained (see TOA data). If the value of one of the chained parameters is changed, it is then automatically included in the chained parameter.

With an inclined grinding wheel it is important that the minimum grinding wheel radius be specified in the Cartesian coordinate system. The length compensations always specify the distances between the tool holder reference point and the tool tip in Cartesian coordinates.

5.1 Tool data



MMC 100.2



MMC 103

The monitoring data apply both to the left and to the right cutting edge of the grinding wheel.

The tool lengths are not compensated automatically if the angle changes.

With inclined axis machines, the same angle must be used for the inclined axis and the inclined grinding wheel.

Offsets that are not required must be assigned the value 0 (= default when the offset memory is set up).

The tool offsets can be entered via the operator panel but also via the data input interface.

For programming offset data see /PG/, Programming Guide, Fundamentals





MMC 100.2



MMC 103

5.2 Tool offset

5.2.1 Function and basic display of tool offset

Tool offset data consist of data which describe the geometry, wear, identification, tool type and the assignment to parameter numbers. The unit used for the dimensions of the tool are displayed. The input field is highlighted.

Parameter	CHAN1	AUTO	MPF.DIR TEST.MPF	
Channel active				T No. +
Program running				T No. -
Tool offset data				D No. +
T number	1	D number	1	D No. -
Tool type	100	No. of c. edges	1	D No. +
C. edge pos.	1			D No. -
Tool length comp.		Geometry	Wear	Base
Length 1	:		0.000	0.000 mm
Length 2	:	0.000	0.000	0.000 mm
Length 3	:	0.000	0.000	0.000 mm
Radius comp.				mm
Radius	:	0.000	0.000	
DP7,18.res	:	0.000	0.000	
DPR,17.res	:	0.000	0.000	
DP9,18.res	:	0.000	0.000	
DP10,19.res	:	0.000	0.000	
DP11,20.res	:	0.000	0.000	
Length compensation				
Clear angle	:	0.000	Deg.	
DP25.res	:	0.000		
Tool offset	R para- meters	Setting data	Zero offset	User data
				Determine compens...

Every offset number contains up to 25 parameters depending on the tool type.

The number of parameters shown in the window is that for the tool type.

Tool wear: Fine compensation (SW 4.3 and higher)

If you have the authorization level set in MD 9202:

USER_CLASS_TOA_WEAR or higher, you can alter the values for tool fine compensation incrementally. The difference between the old and new values must not exceed the limit stored in MD 9450: WRITE_TOA_FINE_LIMIT.

The maximum number of offset parameters (T and D numbers) can be set by means of machine data.



5.2 Tool offset



MMC 103

Tool
offset

R para-
meters

Setting
data

Zero
offset

User
data

Determine
compens...

T No.
+

T No.
-

D No.
+

D No.
-

Delete...

Go to...

Overview

New...

Horizontal softkeys

You can select different data types with the horizontal softkeys:

Selection of *"Tool offset"* menu

Selection of *"R parameters"* menu

Selection of *"Setting data"* menu

Selection of *"Zero offset"* menu

Selection of *"User data"* menu

Support in determining tool offsets. This softkey is not required if the tool management function is available.

Vertical softkeys

The vertical softkeys support data input:

Selection of the next tool

Selection of the previous tool

Selection of next higher offset number (cutting edge)

Selection of next lower offset number (cutting edge)

Deletion of a tool or cutting edge

Find any tool or the active tool

List of all available tools

New cutting edge or a new tool

5.2.2 New tool



Function

If you create a new tool, the relevant tool types are automatically preselected as input support when you select the tool group.



MMC 103

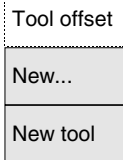

Abort

OK

OK + new tool

OK + new cutting edge

Operating sequence

The *"Tool offset"* window is displayed automatically.

Select softkey *"New tool"*.

The *"New tool"* window appears on the screen.

As soon as you enter the first characters in the string for the tool group, for example

- 5xy turning tools,
all available tool types in the 5xy group are automatically displayed for you to select, i.e.,
- 500 Roughing tool
- 510 Finishing tool
- 520 Recessing tool
- 530 Parting tool
- 540 Threading tool.

Enter the digits for your selections via the alphanumeric keypad or select them from the displayed list.

No new tool is set up.

A new tool is set up.
The window is closed.

Sets up another tool.
The window remains open so that you can set up other new tools.

Sets up another cutting edge for the tool you have just set up.
The window remains open.

5.2.3 Display tool



Function

You can select tools that you have set up and access their tool compensation data.



MMC 103



Tool offset



T No.
+

T No.
-



Operating sequence

The "Tool offset" window is displayed automatically.

If the "Parameter" area has already been selected, the window and the last tool selected when the area was exited are displayed.

The tool offset data of the current tool are displayed immediately. If no tool has yet been selected, the data of the first tool are shown together with its first D number.

If no tools are available in the area, a message is output.

Select the set up tools.

Further notes

Input of the geometry and wear data of the tool can be disabled using the keyswitch.



MMC 103

5.2.4 Tool search



Tool offset

Overview
OK

Go to...

Preselect
T/D No. or Active
T/D No.
OK

Function

There are two methods by which you can find tools and view their tool offset data.

- Overview
- Go to

Operating sequence

Find tool by selecting softkey **"Overview"**:

The *"Tool offset"* window is displayed automatically.

The *"Overview"* softkey displays a list of all existing tools.

Position the cursor on the tool you wish to find and confirm your request by pressing softkey *"OK"*.

The new tool is selected and displayed in the *"Tool offset"* window.

Find tool by selecting softkey **"Go to"**:

Softkey *"Go to..."* opens a window in which you can enter the T or D number you wish to find or in which you can select the preselected or active tool using the vertical softkeys.

The tool to be found is positioned by OK. Its tool offsets are then displayed.



MMC 103

5.2.5 Delete tool



Tool offset
data

T No. +/-
D No. +/-

Delete

Delete
tool

Function

The tool is deleted together with all its cutting edges and the tool list updated accordingly.

Operating sequence

The *"Tool offset data"* window is displayed automatically.

Scroll the screen contents until you reach the tool to be deleted.

The vertical softkey bar changes when softkey *"Delete"* is selected.

Select softkey *"Delete tool"*.

The tool and all its edges are deleted. The tool offsets of the tool number preceding the deleted tool are displayed.



MMC 103

5.2.6 New tool edge

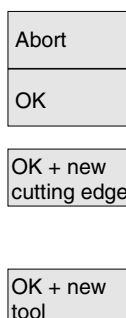

Function

To help you to select a new tool edge, the associated tool types are displayed automatically when you select a tool group.

Operating sequence

The *"Tool offset"* window is displayed automatically.

Press softkeys *"New ..."* and *"New edge"*.

The window *"New edge"* is displayed.

As soon as you enter the first characters in the string for the tool group, for example

- 5xx turning tools

all available tool types in the 5xx group are automatically displayed for you to select, i.e.,

- 500 Roughing tool
- 510 Finishing tool
- 520 Recessing tool
- 530 Parting tool
- 540 Threading tool.

MMC 103:

The possible tool point directions are displayed automatically for some tool types (e.g. for special tools, turning tools, grinding tools, etc.).

Enter the appropriate digit on the alphanumeric keyboard.

Creation of a new cutting edge is aborted.

A new cutting edge is set up.

A new cutting edge is set up.

Another new cutting edge can be set up.

A new cutting edge is set up.

Another new tool can be set up.



MMC 103

5.2.7 Display tool edge



Tool offset

T No.

+

D No.

+

Function

You can select and modify the edges of tools that you have set up.

The "Tool offsets" window is selected.

Select a tool of your choice and a cutting edge.

5.2.8 Find tool edge



Overview

Go to...

Function

You can use one of two search methods:

- Overview: List of existing tools with their edges is displayed.
- Go to: Opens a window in which you can enter the T or D number you wish to find or you can use softkeys to select the "Preselected T/D No." or the "Active T/D No."

5.2.9 Delete tool edge



Delete

Delete
edge

Function

You can delete one or several edges of a tool. The tool list is updated automatically.

Select the edge of a tool, press softkey *"Delete"* and then softkey *"Delete edge"*.

The displayed cutting edge is deleted and the preceding edge values displayed (on MMC 100.2, SW 4.3 and later).



MMC 103

5.2.10 Determine tool offsets



Function

The "Determine tool offsets" function allows you to change the reference values of different axes and then to calculate them.

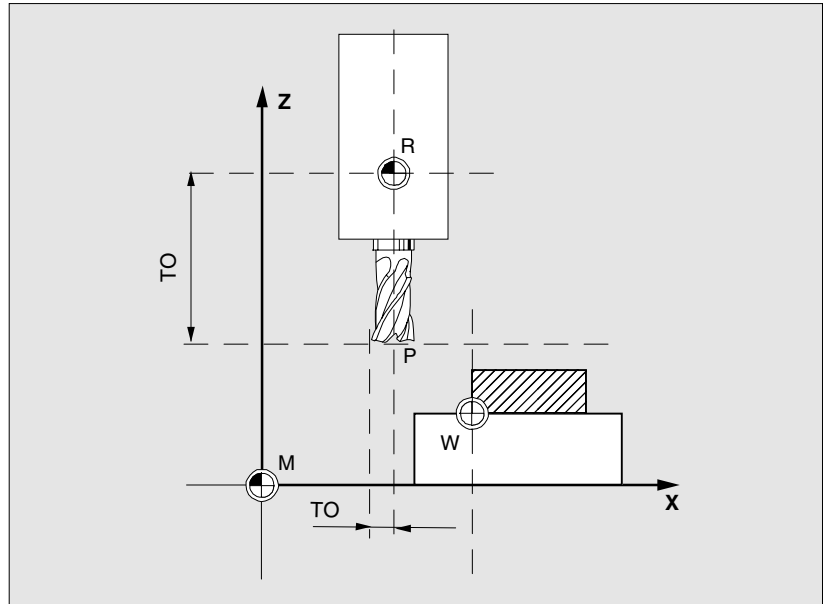

- TO** Tool offset, absolute dimension
- R** Tool mounting point
- M** Machine zero
- W** Workpiece zero

Operating sequence

The "Tool offset" window is displayed automatically.

Position the cursor on the tool parameter you wish to change.
The "Absolute dimension" window opens.

Use the "Toggle key" to select the appropriate axis. Alter the reference value if necessary using the numeric keypad.

When you press softkey "OK", the current position and corresponding reference value for the selected tool parameter are calculated.

The following equation applies:

Position – reference value = input value

The window is closed.



Tool offset
data

Determine
compens...



OK



MMC 103

Calculate



Position – reference value is entered in the input field. The window remains open.

If "Jog" mode is selected, it is also possible to change the position by traversing the axes.

The control automatically calculates the value from the reference value and the new position.

5.2.11 Tool offsets with D numbers only (flat D No.)



Function

Machine data MD 18102 MM_TYPE_OF_CUTTING_EDGE can be set such that tools are selected solely via the D number. A D number can be assigned only once per tool, i.e. each D number represents exactly one offset data record.

Parameter	CHAN1	AUTO	MPF.DIR TEST.MPF
Channel active			
Program running			
⊞			
Tool offset data			
T number	1	D number	1
Tool type	100	No. of c. edges	1
C. edge pos.	1		
Tool length comp.		Geometry	Wear
Length 1	:		0.000
Length 2	:	0.000	0.000
Length 3	:	0.000	0.000
Radius comp.		Base	
Radius	:	0.000	0.000
DP7.10.res	:	0.000	0.000
DP8.17.res	:	0.000	0.000
DP9.18.res	:	0.000	0.000
DP10.19.res	:	0.000	0.000
DP11.20.res	:	0.000	0.000
Length compensation		mm	
Clear angle	:	0.000	Deg.
DP25.res	:	0.000	
Tool offset	R parameters	Setting data	Zero offset
			User data
			System variables
			Determine compens...

/FB/, Description of Functions, Basic Machine, W1 Tool Compensation

5.2.12 Immediate activation of tool offset



Function

Machine data MD 9440: ACTIVATE_SEL_USER_DATA can be set to ensure that the active tool offset is activated as soon as the part program is in the "Reset" or "Stop" state.



MMC 103



Further notes

If the function is used in the Reset state, machine data \$MC_RESET_MODE_MASK must be set such that the tool offset is not reset on a Reset.

/FB/, Description of Functions, Fundamentals, K2 Axes, Coordinate Systems...

Caution

The offset is applied after NC Start of the Reset in response to the next programmed axis motion in the part program.



MMC 100.2



MMC 103

5.3 Tool management

5.3 Tool management

The tool management system is organized by means of various configurable lists which show different views of the tools used.

Magazine list

In the "*Magazine list*", the tools of a magazine are displayed in order of ascending magazine location numbers.

You can find, display and, in the majority of cases, modify the data. A function is also provided for checking the D numbers and subsequently activating tools.



This list is mainly used to load and unload tools during setup, and to move tools between magazines.

Tool list

In the "*Tool list*", the tools are displayed in the order of ascending T numbers.



You use this list if you are working with small tool magazines and know the exact location of each tool in each of the magazines.

Working offset list

(MMC 103; SW 5 and higher) The cutting edges of active replacement tools are displayed in the "*Working offset list*". They are sorted in order of ascending D numbers.

You can search (according to D number/DL number), display and modify the data.



Use this list to modify and monitor sum offsets (location-dependent offsets), quantities and cutting edge parameters during the machining process. You can configure up to three different views for the working offset list.



MMC 100.2



MMC 103

Tool catalog and tool cabinet (MMC 103 only)

The **tool catalog** contains only *"ideal"* tools. *"Ideal"* tools are characterized by the relevant tool *"master data"* (i.e. with ideal tool dimensions, no wear, etc.). An *"ideal"* tool is uniquely defined by its *"tool name"*.

The **tool cabinet** contains only *"real"* tools. *"Real"* tools (i.e. real tool dimensions, with wear, etc) are characterized by the relevant tool *"offset data"*. A *"real"* tool is uniquely defined by its *"tool name"* and the associated *"Duplo number"*. It is the *"Duplo number"* that assigns actual data to a *"real"* tool.

MMC 100.2

The tool management of the MMC 100.2 control includes only a subset of the MMC 103 functionality.

The following restrictions apply:

- No tool cabinet
- No tool catalog
- It is not possible to sort tool and offset data according to user-specific criteria and call them up via softkey.
- No working offset list



If a connection to a host computer exists, a message is automatically output to this host computer when a tool is loaded (but not relocated), unloaded or deleted, and the corresponding data block is transferred. The data are then still available on the host computer even after the tool has been deleted.

Tool management
ShopMill
(SW 5.3 and higher)

As an alternative to standard tool management, with MMC 100.2 you can use the ShopMill tool management. It uses workshop-compatible tool management for milling. You can select it via an MD.



Machine manufacturers

Please refer to the information supplied by your machine manufacturer to see which functions are included in your tool management.
see /FBW/ Description of Functions Tool Management or
/FBSP Description of Functions ShopMill



MMC 100.2



MMC 103

5.3.1 Basic functions of tool management

The tool management system offers various tools for selection. You can assign geometric and technological data to the tool types in order to set up your master tool data. Several versions of each tool can exist. You can assign the actual data of the tool used (particular tool data) to these versions.

Tool
managemt.

You start the tool management from the operating area "Parameters" by pressing the softkey.

The machine manufacturer configures which list is to be displayed when the tool management system is called up. In the example shown, the "Magazine list" is displayed.

Important

The structure of the table is **freely** programmable (configured by the machine manufacturer).

The **example** shows only one possible case:

Parameter	CHAN1	AUTO	MPF.DIR LEER.MPF													
Channel RESET																
Program aborted		ROV	FST													
Magazine list 1																
Magazin: <input type="text" value="2 - Kette20"/> Plätze: <input type="text" value="20"/> AVB: <input type="text" value="0"/>																
Pl	P.P	PTP	WerkzeugID	Dupl	TNr	PTT	W	W	W	W	PV	WTyp	xGeo-L1	xGeo-L2		
1	-	1	newRack860	1	1	1	-	F	G	M	V	-	0	900	11.0000	11.0000
2	-	F	Wzg1	1	76	1	-	F	-	-	-	-	0	900	0.0000	0.0000
3	-	F	1										0			
4	-	-	1										0			
5	-	-	Wzg2	1	85	1	-	F	-	-	E	-	0	900	0.0000	0.0000
6	-	F	Wzg3	1	7	1	-	F	-	-	-	-	0	900	0.0000	0.0000
7	-	F	1										0			
8	-	F	1										0			
9	-	F	1										0			
10	-	F	1										0			
11	-	F	1										0			
12	-	F	1										0			
13	-	F	1										0			
14	-	F	1										0			





MMC 100.2



MMC 103

Location (PI)	Location number
Location state (P)	Location state (one column is provided for each state) e.g. F = location free D = location disabled
PTP	Type assigned to the location
ToolID	Name of the tool
Dupl	Number of replacement tool
TNo	Internal T numbers which may be needed for reloading tool data.
PTT	Type of location assigned to the tool
W (8x)	Tool status (one column is provided for each status) No display = Replacement tool A = Active tool F = Tool enabled G = Tool disabled M = Measured tool V = Warning limit reached W = Tool is being changed P = Fixed-location-coded tool E = Tool was in use
PV	Wear group assigned to the tool.
Tool type	Tool type Only some of the tool offsets are enabled for input, depending on the tool type. All other tool types are preset to a value of 0.
Geo - L1 ... Radius ...	Tool offsets such as length, radius, wear, monitoring data, etc.



MMC 100.2



MMC 103

Magazine list

Horizontal softkeys

The first or most recently displayed magazine is shown in the "Magazine list" together with all the tools which have been loaded. You can access the next magazine by pressing the corresponding vertical softkey.

Tool list

All tools which are stored as a set of data on the NC are displayed (irrespective of whether they have been assigned to a magazine location).

Load

A magazine location is assigned to the tool.

Unload

The tool is deleted from the current magazine location.

Relocate

The tool is moved from the current magazine location to another location.

Working offset list

The cutting edges of active replacement tools are displayed. They are sorted in order of ascending D numbers.



Further softkeys are displayed when you press the "ETC" key on the **MMC 103**:

Tool catalog

You can create new tool master data ("*ideal*" tools) and modify the existing data.

Tool cabinet

You can create new tool offset data and tool operating data ("*real*" tools) and modify the existing data.

Transformation

This softkey allows you to display the tool data as transformed data (adapter data are calculated) or non-transformed data.



Special situation:

This conversion feature is only available in the magazine list display. The data are always displayed as non-transformed data in the tool list and as transformed data in the working offset list.

If you display transformed data and want to create a new tool in the magazine list (loading mode), the transformed data display is activated exclusively for input of this data block.



MMC 100.2



MMC 103

(Names assigned by user)

Magazine list 1

Magazine list 2

Magazine list 3

Tool data

Activate D check



Vertical softkeys (magazine list), MMC 103 only

Selection of user-specific display windows (if configured), e.g.

- General data
- Geometry data
- Wear data

You can display and edit the complete data of a tool.

Call up the start screen for updating the tool data. You can display and normally also modify all the data of the tool, its cutting edges and its working offsets in this screen and subsidiary screens. The vertical softkey bar changes.

The exact procedure is described under "Displaying/modifying tool data" (on page 208 ff).

Two functions are implemented with this softkey:

- Verify unique D number assignment
Duplication can occur when assigning D numbers to the cutting edges of the individual tools. This function checks all numbers within the current magazine or all allocated D numbers within a TO unit (configured by parameter).
- Activating the tools
If unique D numbers were assigned, a wear group is activated. A tool is subsequently activated from each replacement tool group in the TOA of the current channel. Allowance is made for the active wear group.

Only automatically accessible magazines are considered for processing. Any previously active tools are disabled by the activation of tools, especially if the wear group is changed.



MMC 100.2



MMC 103

Buffer
locations

Display and skip the buffer window in the magazine list. The display shows spindles, grippers, etc., i.e. locations which can accommodate tools but which are not magazine locations. If no buffers are defined, this key has no function.

Search and
position

The "Find tool/location" window appears.

- Search
 - Tool:
Enter the tool name and Duplo number and start the search with OK.
The cursor is positioned on the tool found.
 - Location:
Enter the magazine and location number and start the search with OK.
The cursor is positioned on the tool found.
- Position
Select softkey "*Position*",
tool/location is moved to loading point. If there is more than one possible loading point, a window is opened. You can select the correct one with the cursor.

Next
magazine

The locations of the next magazine are displayed in the magazine list.

You can only scroll forwards. When you reach the last magazine, the display returns to the first magazine.





MMC 100.2



MMC 103

(Names assigned by user)

Tool list 1

Tool list 2

Tool list 3

Tool details

Tool from CC

Tool in cabinet

Delete tool

Tool in cabinet

Data on CC

Abort

OK

Vertical softkeys (tool list)

Selection of a table structure configured by the user (if configured), e.g.:

- General data
- Geometry data
- Wear data

You can display and edit the complete data of a tool (as in the magazine list).

The tool data are read from a code carrier and entered in the tool list (you can then edit the data).

Select the tool in the tool cabinet.

The tool data are read from there and entered in the tool list.

In SW 5.1 and higher, a list display appears for which you can parameterize a filter for the tool number, duplo number and tool type. The list displays all the tools that fulfill the filter criteria. You can select the tool you require from the list.

The selected tool is removed from the list. Use the vertical softkeys to determine whether to save the tool data.

The data are copied into the tool cabinet. The tool can be loaded later with the same data.

If a code carrier is installed, the tool data are stored on the carrier. The tool can then be loaded later with the same data.

The operation is canceled. The tool is not removed from the list.

The tool is deleted from the list. The tool data are no longer available.

5.3 Tool management



MMC 100.2



MMC 103

New tool

Each time you press this softkey, a tool is created **immediately**. The screen form for entering the tool data (tool details) and the associated softkey bar (same as tool details) appear. The values are initialized with the default settings (configured in the INI file) and can be modified here (e.g. you can change the name of the tool).

Use the vertical softkey bar to display the tables for cutting edge data and offsets with the default settings. If necessary, enter any changes in the individual views.

<<

Terminates input of the tool data and switches to the tool list display. The new tool appears in the table and is available for loading.

Once you have set up a new tool, the cursor automatically jumps to the line containing the new tool when you return to the tool list. This gives you feedback about your operation.

Note

The data you enter are always updated immediately (without prompting). You can change the properties of the new tool by pressing the *"Tool details"* softkey.

It is not possible to modify the data directly in the table.

You can only change the name and type of a tool by selecting New-Add, not via Tool details.

To change a name, you have to create a new tool and delete the old one.



MMC 100.2



MMC 103

(Names assigned by user)

W offset
list 1

W offset
list 2

W offset
list 3

Tool data

Find
D number

Current
D number

Vertical softkeys (working offset list)

Selection of a table structure configured by the user (if configured), e.g.:

- General data
- Geometry data
- Wear data

You can display and edit the complete data of a tool (as in the magazine list).

Find an entry with a specific D -number/DL -number.

- Enter the D -number and DL number you want to find in the search window.
- Confirm with "OK". If a matching entry is found, the cursor jumps to the corresponding line. If you have not specified a DL number, the cursor is positioned on the first line of the matching tool.

The D number of the current tool is determined and displayed.



MMC 100.2



MMC 103

5.3.2 Display/change tool data



Tool man-
agement

Magazine
list

Tool list

Working
offset list

Tool
details

Function

You can view and edit the tool data of the tool selected in the lists.

You can edit the following cutting edge data:

- Offset values
- Monitoring data
- User data

Operating sequence

Select softkey "*Tool management*".

The list configured by the machine manufacturer appears (e.g. the magazine list). The horizontal and vertical softkey bars change.

Select the appropriate list via softkey:

- "*Magazine list*"
- "*Tool list*"
- "*Working offset list*"

Position the cursor bar on the appropriate tool. The tool is selected.

Select softkey "*Tool details*".

The input screen form for "*Tool details*" appears.

The vertical softkey bar changes again.

The following functions are available:

- Create new cutting edges
- Modify cutting edge data
- Modify monitoring data
- Modify location-dependent offsets (DL numbers)
- Delete cutting edges



MMC 100.2



MMC 103

You can modify the following data in the input screen form:

- Type of location
- Tool location coding
- Monitoring type
- Status (available, disabled, measured, etc.)
- Tool user data (OEM_Tx; x = 1...10)
- D numbers
- Tool name (SW 5.2 and higher)
- Duplo number (SW 5.2 and higher)
- Tool type, in magazine list and tool list only (SW 5.2 and higher)

**Note**

The tool data Name, Duplo number and Type can only be changed in SW 5.2 and higher if the option has been enabled by the machine manufacturer. If the option is not activated you cannot make any changes. These data are permanently defined when a new tool is created.

New edge

New cutting edges are created for the displayed tool. A cutting edge number to which no D number has yet been assigned is automatically selected in the table.

When you have allocated a D number, the value is displayed in red (the cutting edge has not yet been created). Select "Cutting data" in the vertical softkey bar. The selected cutting edge is created. Default values are assigned to the cutting edge data and the corresponding table is displayed. Enter any necessary changes.



You can use the "Cutting edge +" and "Cutting edge –" keys to display and, if necessary, edit the data of the other cutting edges. The data are updated immediately.

Press the "<<" softkey to return to the Tool details input screen form. The new cutting edge is defined. The display color changes.



MMC 100.2



MMC 103

Edit the tool data

Cutting edge data

Further notes

If nine cutting edges have already been defined for the tool, you must delete one of the cutting edges (via softkey) before you can create a new one.

A new cutting edge can be added to a tool at any time (even if the tool is already located in the magazine). Select "New cutting edge" and enter the cutting edge data.

The softkeys "Cutting edge data", "Monitoring data" and "Location-dependent offsets" display tables for editing the data. You can move freely between the individual tables. The name, Duplo number and type of tool and all defined cutting edges (#1...#9) are displayed.

Use the softkeys "Cutting edge +" and "Cutting edge –" to change between the cutting edges. Press the "<<" softkey to return to the Tool details input screen form.

Note

When you edit the data, the new data is saved immediately. The "<<" softkey only changes the display.

The cutting edge data and tool offsets of the currently selected cutting edge are displayed and can be edited.

You can edit the following data:

- Cutting edge user data (OEM_Sx; x = 1...10)
- Tool offsets
 - Geometry
 - Wear
 - Basic offset
 - Tool point direction (for turning tools)
 - Tool clearance angle (for turning tools)

You can define the value of Length1, Length2, Length3 and Radius1 for every parameter.



MMC 100.2



MMC 103

Monitoring
data

The monitoring data of the currently selected cutting edge are displayed and can be edited.

When you have selected a cutting edge, define the actual value, setpoint and prewarning limit monitoring data for the following parameters:

- Quantity
- Service life
- Wear

Loc-dep.
offsets

The tool offsets (identical to the cutting edge data table) and the location-dependent offsets of the currently selected cutting edge are displayed and can be edited.

You can change the following settings:

- You can define the value of Length1, Length2, Length3 and Radius1 for every parameter.
- Up to six location-dependent offsets (DL1...DL6) are possible (according to the machine manufacturer's configuration).
- Setup values and wear values can be defined for each offset.

Edge +

In the individual tables, this softkey displays the data/offsets of the **next** cutting edge for editing.

Edge –

The data/offsets of the **previous** cutting edge are displayed and can be edited.

Delete
edge

In the table, select the cutting edge you want to delete (by positioning the cursor).

The cutting edge is deleted when you activate the softkey.

Notice! There is no separate prompt.

The D number is removed from the table and can be reallocated.

<<

Terminates input of the tool data and returns to the table displayed previously.

5.3 Tool management



MMC 100.2



MMC 103

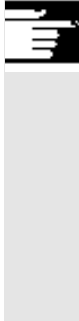

Note

You can enter individual tool data directly in the list, provided you have the necessary access authorization and the data are displayed in the list (the list structure is configurable).

Select the value to be edited and enter the required data. The system automatically switches to edit mode.



MMC 100.2



MMC 103

5.3.3 Loading



Function

You can load a tool in one of the following ways:

- You can enter the individual tool data directly in the list.
- You can import tool data from existing tools.

You can load a tool from the *"Magazine list"* or the *"Tool list"*.

- **Loading a tool from the *"Magazine list"***

To edit tool data directly in the list, you must first find a suitable empty location for the tool (use the softkeys). You can then enter the data directly in the list.

You can also load all existing tools into the magazine.

You load the associated tool data:

- from the master data catalog
- from the tool cabinet
- from the code carrier (if one exists) or
- from the host computer (if one is connected).

In this case, the system automatically tries to find a suitable empty location for the selected tool.

- **Loading a tool from the *"Tool list"***

You can load magazines whose data are already stored in the TO memory.

The magazine location is selected either by searching for an empty location or by entering a magazine number and location number in the corresponding columns of the list.



MMC 100.2



MMC 103

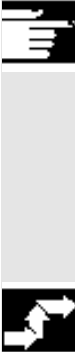

Tool management

Magazine list

Load

Manual entry of data (with search for empty location)

Further notes

With SW 5.1 and higher, you can parameterize a filter for loading tools into the lists. A list display appears for which you can parameterize a filter for the tool number, duplo number and tool type. The list then displays the tools in the tool cabinet that meet the filter criteria. By selecting it from the list, you accept the tool.

Operating sequence (loading from the "Magazine list ")

Select softkey "*Tool management*".

The "*Magazine list*" is displayed.

The horizontal and vertical softkey bars change.

The "*Magazine list*" is selected.

The appropriate magazine is selected.

Select the "*Load*" softkey.

The vertical softkey bar changes again.

If you want to enter data directly in the table, you must first find a suitable empty location in the magazine.

There are four methods by which you can find an empty location for different tool sizes in combination with location types:

1. Directly in the magazine list ("Manually").
2. Via a user-defined location
e.g. "oversize" (name configured by machine manufacturer)
3. Via the "Find empty location" softkey
4. Via the "To loading point" softkey

Further notes

With SW 5.1 and higher, values are checked for validity when you enter a tool type in the lists. Only known tool types are permitted.

Searching directly in the magazine list

Position the cursor on the location of your choice in the magazine list.



MMC 100.2



MMC 103

normal

large

oversize

normal and
heavyFind empty
locationTo loading
point

Tool details

Search via user-defined location (example)

The assignment of the softkeys is configured by the machine manufacturer.

- "normal" (name configured by machine manufacturer)
- "large" (name configured by machine manufacturer)
- "oversize" (name configured by machine manufacturer)
- "normal and heavy" (name configured by machine manufacturer)

The system searches for a suitable empty location.

The cursor bar is automatically positioned on the magazine location found in the *"Magazine list"*.

Search via the "Find empty location" softkey

Enter the *"Tool size"* and *"Location type"* in the dialog box.

If more than one loading point is configured, select the desired loading point from a query window.

The system searches for a suitable empty location.

The cursor bar is automatically positioned on the magazine location found in the *"Magazine list"*.

Search via the "To loading point" softkey

You have found an empty location in front of the current loading point.

When you press *"To loading point"* the cursor is automatically positioned at this location.

Enter data

If the desired empty location is found after a search operation, the system switches to edit mode and the softkey bar changes. When you search for an empty location manually, the system switches to edit mode as soon as you start entering the data on the keyboard.

You can use the *"Tool details"* display to edit the data of the tool to be loaded (if necessary).

If the tool has not yet been created, it is created automatically when you call up the input screen form.



MMC 100.2



MMC 103

Abort

Load/input mode is canceled.

A tool created via *"Tool details"* or *"Start"* is deleted. You can search for another empty location.

Start

The loading operation is initiated. If the tool has not yet been created, it is created automatically.



If data are still missing for loading, the input screen form for the tool details appears. The missing data are initialized with default values and can be edited if necessary. Start the loading operation again afterwards.

Importing tool data

In addition to direct data entry, there are various ways of importing and loading tool data belonging to tools which have already been defined:

Data from
CC

1. Read the data in from a code carrier (if one is installed)

Data from
host

2. Read the data in from a host computer (if one is installed)

Tool from
cabinet

3. Select the "Tool from cabinet" menu (MMC 103 only).

Select the tool in the tool cabinet. The tool data are read from there.

If not all of the softkeys are visible, change the display by pressing the appropriate key on the operator panel.

When you have defined the source for loading, the system automatically tries to find a suitable empty location for the tool to be imported. The vertical softkey bar changes.

If no location is found, an error message is displayed.

Tool
details

You can use the *"Tool details"* display to edit the data of the tool to be loaded (if necessary).

If the tool has not yet been created, it is created automatically when you call up the input screen form.

Abort

Load/input mode is canceled.

A tool created via *"Tool details"* or *"Start"* is deleted. You can search for another empty location.



MMC 100.2



MMC 103

Start

The loading operation is initiated. If the tool has not yet been created, it is created automatically.



"Load directly to spindle" is possible if the cursor is positioned on the spindle buffer location.



Operating sequence (loading from the "Tool list")

Tool list

The "Tool list" is selected.
The appropriate tool is selected.

Load

Select the "Load" softkey.
The vertical softkey bar changes.

Find empty location

Search for an empty location for a tool which has already been created or enter the desired location and magazine number in the list.

The location found is entered under the magazine/location number.

Abort

The loading operation is not initiated.
The basic display appears.

Start

The loading operation is initiated.



MMC 100.2



MMC 103

5.3.4 Unloading



Tool man-
agement

Magazine
list

Tool list

Unload

Tool in
cabinet

(MMC 103 only)

Data on
CC

(MMC 103 only)

Function

This function allows you to unload a selected tool and to save its data.

Operating sequence

Select softkey *"Tool management"*.

The *"Magazine list"* is displayed.

The horizontal and vertical softkey bars change.

You can unload a tool from the "Magazine list" or the "Tool list".

The operating sequence is the same for both methods.

Select the appropriate list via softkey:

- *"Magazine list"*

A tool is to be physically removed from a magazine location. You can configure whether the corresponding NC block is also removed from the TO memory.

Select the magazine and the tool to be unloaded (select the tool with the cursor).

or

- *"Tool list"*

The NC block is to be unloaded from the memory. Select the tool to be unloaded (select the tool with the cursor).

Select softkey *"Unload"*.

The vertical softkey bar changes.

The tool data of the selected tool are stored in the tool cabinet on the hard disk. This allows you to load the tool with the same data again at a later point.

If a code carrier is installed, the tool data are automatically stored there. This allows you to load the tool with the same data again at a later point.



MMC 100.2



MMC 103

From
magazine



The selected tool is unloaded.

The corresponding line is deleted from the magazine list.

The entries in the magazine number and location number columns are removed from the tool list.

"Unload directly from spindle" is possible only if the buffer is selected and the cursor is positioned on the location of the spindle.

To quit the display **without** unloading the tool, select another display in the vertical softkey bar **before** activating "Start".

Delete
tool



The tool data of the selected tool are deleted from the TO memory. If the tool is in a magazine location, it is unloaded and deleted.

If a host computer is connected, the data are transferred to the host computer each time a tool is deleted or unloaded.

5.3.5 Relocation



Function

This function allows you to move a selected tool from one location to another.



Operating sequence

Select softkey *"Tool management"*.

The *"Magazine list"* is displayed.

The horizontal and vertical softkey bars change.

Tool man-
agement

You can relocate a tool from the magazine list or the tool list. The operating sequence is the same for both methods.



MMC 100.2



MMC 103

Magazine
list

Tool list

Relocate

Abort

Start

Select the appropriate list via softkey:

- *"Magazine list"*
Select the magazine and the tool to be relocated (position the cursor on the magazine location containing the tool).
- or
- *"Tool list"*
Select the tool to be relocated (position the cursor on the tool).
A tool must already have been loaded (entry in the magazine number and location number columns).

When you select the "Relocate" key, the "Relocate tool" window opens.

There are 2 methods by which you can select the new location for the tool:

- Enter the magazine and location numbers in the "Relocate tool" window.
- or
- Select softkey "Find empty location" and select the desired data in the window.

The tool is not relocated.

The tool is relocated to the new empty location.

Use magazine number 9998 to move a tool to or from a spindle location.





MMC 103

5.3.6 Tool master data in tool catalog (MMC 103)



Advantage

Function

You can create tool master data in the tool catalog. A set of data can be created for every tool in use.

Master data which apply to the tool, regardless of which cutting edge you use, do not have to be entered again for every new tool you create, but can be copied from the tool catalog (in the tool cabinet) for each tool you use.



Ideal tools

The **tool catalog** contains only "ideal" tools. "Ideal" tools are characterized by the relevant tool "master data" (i.e. with ideal tool dimensions, no wear, etc.). An "ideal" tool is uniquely defined by its "Tool name".



Tool management

Operating sequence

Select softkey "Tool management".
The horizontal and vertical softkey bars change.



The horizontal softkey bar is expanded.

Tool catalog

Select softkey "Tool catalog".
The vertical softkey bar changes again. The tool details of the tool catalog are displayed.

You can use the list fields to display the available standard tools and tools which have already been defined or to create new tools.

Creating tool data

Proceed as follows to create the tool data:

- Select the desired technology in the appropriate list field (e.g. drilling tools, milling tools).
- Define the tool type in the second list field (e.g. twist drill).



MMC 103

New

- Activate this softkey to create a new tool.
You can edit the field for the tool name.
- Enter a tool name.
- In the open window *"Tool details"*, define the tool properties (in *"Tool size"* you define the total number of tool half-locations occupied by the tool).

Abort

- Select "Abort" to discard the settings.
The tool is not created.

OK

- Save your data with OK.
The new tool is created.

Displaying/changing tool data

In addition to the tool master data already defined, you can enter default settings in the tool catalog for all the other tool data (e.g. cutting edge data, user data). You can change this data later.

Duplo number 0 is allocated to the tool.

Tools in the tool catalog are used as a basis for real tools. It is recommended to define only data actually required in that exact form for several real tools. This helps to minimize the amount of changes required later.

Tool data are displayed and edited as follows:

- Tool offset data (cutting edge data)
The tool offset data window is displayed. The data of the first cutting edge are listed in a table. The vertical softkey bar changes. Enter the required settings.

The following functions are available for editing the cutting edge data:

Edge +

The cutting edge data of the next defined cutting edge are displayed in a table.



Offsets



MMC 103

Edge –

The data of the previous cutting edge are listed.

New

A new cutting edge is created for the tool.

Delete

The current cutting edge and all the data defined for the cutting edge are deleted after a prompt.

Abort

Select "Abort" to discard the changes.
No new cutting edge is created.

OK

Save the cutting edge data with "OK".
A new cutting edge is created (if defined).

Cutting edge
user data

- Cutting edge user data (if configured)
Switches to the input screen form "*Cutting edge user data*".
Up to 10 user-specific cutting edge data are displayed here.
Enter the required settings in the table.

Tool user
data

- Tool user data (if configured)
Switches to the input screen form "*Tool user data*".
Up to 10 user-specific tool data are displayed here.
Enter the required settings in the table.

Additional functions

Copy

The following functions are also available in the tool catalog:

The data of the tool are copied and a new tool is created with identical data. You are prompted to enter a name for the new tool.

Delete

The currently selected tool is deleted after a prompt. All data of the tool are lost.



MMC 103



Further notes

The "Tool offset data", "Cutting edge user data" and "Tool user data" softkeys are always displayed when you edit the tool details. This allows you to move between the individual tables as required.

The tool data for tools of the catalog can be edited at any time.

5.3.7 Tool offset data in the tool cabinet (MMC 103)



Function

You can create tool offset data in the tool cabinet. A set of data can be created for every tool in use.

The "ideal" master data defined in the tool catalog can be copied to the tool cabinet.

Advantage

Tools which have already been used can be stored in the tool cabinet before they are unloaded from the magazine. The current data, such as the remaining tool life, remain stored and can be accessed again the next time the tool is loaded.

You can also enter the tool data of tools which you plan to use in future (like the tools in a real tool cabinet).

Real tools

The **tool cabinet** contains only "real" tools.

"Real" tools (i.e. real tool dimensions, with wear, etc) are characterized by the relevant tool "offset data".

A "real" tool is uniquely defined by its "tool name" and the associated "Duplo number". It is the "Duplo number" that assigns actual data to a "real" tool.



Tool management

Operating sequence

Select softkey "Tool management".

The horizontal and vertical softkey bars change.



MMC 103



The horizontal softkey bar is expanded.

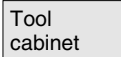

Select softkey "*Tool cabinet*".

The vertical softkey bar changes again.

Create tool offset data

In order to add a tool to the tool cabinet, it must first be created in the tool catalog.

You create a real tool by defining a new Duplo number in the tool cabinet.

Proceed as follows:

- Select the desired technology, tool type and tool successively in the appropriate list fields.
- Define the Duplo number.
The tool master data are loaded into the tool cabinet. The editing functions are available.
- Use the vertical softkeys to make all the necessary changes to the cutting edge data and user data.
- Select "Abort" to discard the settings.
The tool is not created.
- Select "OK" to save the changes.
The tool is created with the current offset data.

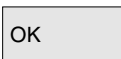
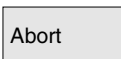

The defined tool data can be edited at any time. You can overwrite the data for the current tool or allocate a new Duplo number to create a replacement tool.

Displaying/changing tool data

The vertical softkeys can be used to display and edit the data for tools already stored in the cabinet:



- Tool offset data (cutting edge data)
Enter the required offset values. The design of the vertical softkeys is identical to the tool catalog softkeys (see previous section under offsets).



MMC 103

Cutting edge
user dataTool user
data

Abort

OK

Additional functions

Delete



A new cutting edge can be added to a tool at any time (even if the tool is already located in the magazine).

- Cutting edge user data (if configured)
Up to 10 user-specific cutting edge data are displayed here. Enter the required settings in the table.
- Tool user data (if configured)
Up to 10 user-specific tool data are displayed here. Enter the required settings in the table.
- Select "Abort" to discard the changes.
The data retain their old values.
- Select "OK" to save the changes.
The data are updated.

The "*Delete*" function is also available in the tool cabinet. It is not possible to copy or create a new ideal tool here (only in the tool catalog).

The currently selected tool is deleted from the tool cabinet after a prompt.

All data of the tool with this Duplo number are lost. The master data in the tool catalog are not affected (tool with Duplo number 0).

Further notes

The "Tool offset data", "Cutting edge user data" and "Tool user data" softkeys are always displayed when you edit the tool details. This allows you to move between the individual tables as required.

A tool entered in the cabinet can be loaded to a magazine location via softkey "Tool from cabinet".



MMC 103

5.3.8 Job processing for tools



Area of application

Application

Function

The new function "Job processing for tools" (batch) enables the operator to

- load and unload, delete and store tools in the cabinet in one common job for several tools
- to monitor the progress of execution
- utilize the "Reactivate tools" function.

Parameterizable filters are used to select the tools. These enable you to create a snapshot of the tool data inventory of the NC containing all tools with the properties specified in the filter definition, e.g. all tools with particular tool status bits set, with a particular tool type, with a certain length, with particular OEM data, etc.

The search is carried out exclusively in the NC.

(this is done by using the OPI block "TF" ("Parameterization, return parameter of `_N_TMGETT`, `_N_TSEARC`") and the PI service "`_N_TSEARC`" ("Complex search via search screen forms").)

Job processing for tools can be initiated via the operator interface and monitored there. Loading, unloading and reactivation can take place in the background, even if the associated interface is not active.

Filter definition and some of the interface settings are carried out in the INI file for tool management.

The machine operator can use the "Job processing for tools" function to load, unload and reactivate sets of tools according to pre-defined filter criteria.

The function is available within the tool management.

The parameters and other settings for the filter criteria and made in the `paramtm.ini` file without a separate operator interface.



MMC 103

Functional description

Operator interface:

The "Job processing for tools" function is selected via the horizontal softkey "Filter lists" from the basic states if the magazine and tool lists in the tool management.

The "Job processing for tools" recognizes three states, which are represented by different screens:

1. Filter selection
2. Displays the hit list, tool selection and start of job processing in 2 screens: Load job list and standard job list.
3. Job processing

Each TOA (data area for tool offsets) has a separate state. You can exit the "Filter lists" in these states and display different tool management screens for switch to other operating areas.

The next time you press the horizontal "Filter lists" softkey, the screen for the noted state is displayed.

The 2nd state "Hit list" stores the hit list and the tool selection as a snapshot.

The 3rd state "Job execution" stores the data for the selected tools and the job type. You can exit the "Filter lists" during job processing. After returning to the "Filter lists", the new status of job processing is displayed. The status of the job as a whole and the states of the individual job elements are visible.

Paramtm.ini

You can set the user rights for the softkeys involved in the paramtm.ini file (section [ACCESSLEVEL], entries "SKB...").

The filter lists are parameterized in the paramtm.ini file in the section [BatchTools].

Country-specific sections are parameterized in the "language\patm_*.ini" file in the section [BatchTools]; "*" stands for the 2 letters of the country code.

Where "Parametrization" or "INI file" is mentioned in this description, these terms refer to the specified sections in the above files.

All parameterizable texts are defined via the country-specific language mechanism, which is not described further in the course of this description.



MMC 103



Precondition

Filter selection

Operating sequence

Select the tool management

Softkey "Filter lists"

Parameter	REV1	MDA	\SYF.DIR OSTORE1.SYF	
Channel reset				Prewarn. or disabled
Program aborted			ROV	Disabled
Job processing of tools				All loaded
Selection of a filter for snapshot:				All unloaded
The following filters are available:				Load ID
- Prewarn. or disabled: Prewarning limit reached or disabled				Unload ID
- Disabled: Disabled tools				
- All loaded: Unloading list for all loaded tools				
- All unloaded: Loading list for all unloaded tools				
- Load ID: Loading list for all tools with load ID				
- Unload ID: Unloading list for all tools with unload ID				
				Magazine selection
Active compens.	Tool list		Magazine list	Filter lists

The screen has a maximum of 6 filters which can be selected per softkey. The filter definitions (the criteria which the tools must satisfy), the header texts and softkey descriptions are set in the INI file, entries:

`n_FindCondition`,

`n_FindResultHeadlineText`,

`n_FindSoftkeyText` where "n" = 1 to 6.

Vertical softkeys

Starts determining the tools that match the criteria in the NC and jumps to a 2nd screen that displays the hit list. The filter produces a snapshot of the data. These data are **not** updated later.

Filter 1– 6



MMC 103

Magazine selection

You can use the filter definition to specify whether the filter always applies to the whole TOA or is restricted only to single magazines (INI file, entry `n_FindLimitedToCurMagazine`).

You can use the "Magazine selection" sofkey to select a particular magazine or "All magazines" for a restrictable filter.

When you switch from a magazine list to the filter lists and no current filter or job processing is active in the TOA (you access the first screen "Filter selection"), the current magazine in the magazine list is taken as the preset value for restrictable filters.

If the situation is the same when coming from the tool list, the preset value is "All magazines".

**Hit list
in the "Load point" and
"standard list" screens**

This screen has 2 variants, which can be set for each filter in the INI file, entry `n_ResultListType`.

- Load point with the functions "Load" and "Reactivate"
- Standard list with the functions "Reactivate", "Unload", "Delete", "In cabinet".

When filtering has started in screen 1 "Filter selection", the tools found in screen 2 "Hit list" are displayed in a list with one line per tool.

The data are a **snapshot** created at the time of filtering; it is **not updated later** when the data in the NC change.



MMC 103

Selection of tools



No tool is selected for job processing at the outset. By positioning the cursor and pressing the toggle key, you can toggle the tool selection for job processing. To change the tool selection for job processing, you can use the softkeys "Select all" and "Deselect".

The cursor position and the selection for job processing is displayed by coloring the lines and displaying the lines and symbols in the 2nd column of the hit list.

The color settings and reference to the bitmap file (resident in the mmc2 program directory) can be modified in the INI file; you can store variants of the bitmap files that have been changed in the user directory.

(INI file, entries:

```
ResultColors,
BatchFilterElBUnTUnBitmap,
BatchFilterElBUnTSeBitmap,
BatchFilterElBSeTUnBitmap,
BatchFilterElBSeTSeBitmap,
BatchRunElWaitingBitmap,
BatchRunElInWorkBitmap,
BatchRunElOKBitmap, BatchRunElErrorBitmap)
```

In the standard setting, a tool selected for job processing is displayed with a checkbox ticked off ( and ). The color for "Cursor" and for "Selected for job processing" is identical and corresponds to the general selection display.

5.3 Tool management



MMC 103

Several columns in the list can be affected by the entries in the INI file:

- The tool status bits, header text status bit text to be displayed (entries:
ResultToolStatusColumnsEnable,
ResultToolStatusColumnsHeaderText,
ResultToolStatusColumnsListText)
- Width of the tool ID column (entry:
ResultDisplayedNumberOfToolnameCharacters)
- Additional column: OPI pattern, header, column width (entries:
n_FindResultAddColumnBtss,
n_FindResultAddColumnText,
n_FindResultAddColumnDisplayedNumberOfCharacters)

When the tools have been selected fully, you can start the job function per softkey.

Start of Job processing

"Load"

Parameter	REV1	MDA	\SYF.DIR OSTORE1.SYF
Channel reset			
Program aborted		ROV	
Job processing of tools			
Loading list for all unloaded tools			
Tools: 45, selected: 6.			
No.	Sel.	Tool id.	Duplo Mag Loc APD MWU OI
31	<input type="checkbox"/>	Test31	1 0 0
32	<input type="checkbox"/>	Test32	1 0 0
33	<input checked="" type="checkbox"/>	Test33	1 0 0
34	<input checked="" type="checkbox"/>	Test34	1 0 0
35	<input type="checkbox"/>	Test35	1 0 0
36	<input checked="" type="checkbox"/>	Test36	1 0 0
37	<input checked="" type="checkbox"/>	Test37	1 0 0
38	<input type="checkbox"/>	Test38	1 0 0
39	<input type="checkbox"/>	Test39	1 0 0
40	<input type="checkbox"/>	Test40	1 0 0
41	<input checked="" type="checkbox"/>	Test41	1 0 0
42	<input checked="" type="checkbox"/>	Test42	1 0 0
43	<input type="checkbox"/>	Test43	1 0 0
44	<input type="checkbox"/>	Test44	1 0 0

Active compens. | Tool list | Magazine list | Filter lists

Select all

Vertical softkeys

All tools in the hit list are selected for job processing.



MMC 103

Cancel selection

Loading

Reactivation

The selection for job processing is canceled for all tools in the hit list..

"Loading" is initiated for the selected tools. You are prompted to enter the destination magazine and and the load point in a dialog box.

"Reactivation" is initiated for the selected tools. On "Reactivation" of a tool, the actual monitoring values and the wear are reset. You can use the INI file (entry *n_ReactivatePositioningMode*) to specify (for each filter) whether reactivation is carried out "always", "never", or "on request" with magazine positioning. Depending on the setting, the dialog box prompts for positioning and the load point as appropriate to the setting.

"Unload"

Parameter	REV1	MDA	\SYF.DIR OSTORE1.SYF										
Channel reset													
Program aborted		ROV											
Job processing of tools													
Unloading list for all loaded tools													
Tools: 25, selected: 4.													
No.	Sel.	Tool id.	Duplo	Mag	Loc	A	P	D	M	W	U	O	I
12	<input type="checkbox"/>	Test12	1	2	12								
13	<input type="checkbox"/>	Test13	1	2	13								
14	<input type="checkbox"/>	Test14	1	2	14								
15	<input type="checkbox"/>	Test15	1	2	15								
16	<input type="checkbox"/>	Test16	1	2	16								
17	<input checked="" type="checkbox"/>	Test17	1	2	17								
18	<input type="checkbox"/>	Test18	1	2	18								
19	<input type="checkbox"/>	Test19	1	2	19								
20	<input checked="" type="checkbox"/>	Test20	1	2	20								
21	<input checked="" type="checkbox"/>	Test21	1	2	21								
22	<input checked="" type="checkbox"/>	Test22	1	2	22								
23	<input type="checkbox"/>	Test23	1	2	23								
24	<input type="checkbox"/>	Test24	1	2	24								
25	<input type="checkbox"/>	Test25	1	2	25								

Active compens. Tool list Magazine list Filter lists



MMC 103

Delete

"Delete" is initiated for the selected tools. Loaded tools are unloaded prior to deletion. You are prompted to specify the unloading point in a dialog box.

Unload

"Unload" is initiated for the selected tools. The tools are not deleted. You are prompted to specify the unloading point in a dialog box.

In the cabinet

Job processing is initiated "In the cabinet" for the selected tools. This function is similar to the "Delete" function; in addition, the tool data are saved in the tool cabinet database. Loaded tools are unloaded before saved and delete. You are prompted for the unloading point in this case.

Update filter

The current filter and its magazine settings are used again and a new hit list produced. The tool selection for job processing canceled completely.

Recall "∧"

The current number of hits is discarded and the 1st screen "Filter selection" is displayed.

If job processing has been started and the necessary entries made, the display switches to the 3rd screen "Job execution".

Job execution

The screen shows the information relating to the job execution as a whole and with respect to the individual tools. The operator may halt, continue or cancel job processing and monitor the results during and after job processing.

Each tool is represented by a separate line in the list. The status of the tool is represented by the symbol in the 2nd column. The references to icon bitmaps are contained in the INI file,

Entries:

BatchRunElWaitingBitmap,

BatchRunElInWorkBitmap,

BatchRunElOKBitmap,

BatchRunElErrorBitmap.

The icons may be changed.



MMC 103

The following states are displayed:

- "waiting to be machined": green surface,
- "current tool in job processing": yellow/blue arrow,
- "completed without errors": green field ticked off,
- "completed with error(s)": red field with "X",

The status of the tool on which the cursor is placed is displayed in the form of a text, for example any errors, load destination.

The state of the current tool in job processing is displayed in the message line.

If the operator does not move the cursor for a few seconds, the cursor is automatically placed on the current tool for job processing when the next processing step has been completed.

Parameter	REV1	MDA	\SYF.DIR DSTORE1.SYF									
Channel reset												
Program aborted		ROV		Continue								
Job processing of tools												
Unloading list for all loaded tools												
Tools: 6, complete: 3, error: 0. Job in progress												
Unload												
No.	Sta.	Tool id.	Duplo	Mag	Loc	A	P	D	M	U	O	I
1		Test14	1	2	14							
2		Test15	1	2	15							
3	▶	Test16	1	2	16							
4	✓	Test17	1	2	17							
5	✓	Test18	1	2	18							
6	✓	Test19	1	2	19							
No.: 3, Test16-1, Unload, waits for NC ...												
No.: 3, Test16-1, Unload, waits for NC ...												
Active compens.	Tool list			Magazine list								Filter lists



MMC 103

Hold

Vertical softkeys

Job processing is halted. Processing of the active element up to this point is either completed or canceled depending on the status and type of job.

This softkey can only be used while job processing is halted.

Continue

Any job processing that has been halted is continued.

This softkey can only be used while job processing is halted.

Abort

Any job processing that is halted is canceled. Non-completed jobs are discarded and you are returned to the "Filter selection" screen.

This softkey can only be used while job processing is halted.

OK

All information relating to detail jobs are discarded and you are returned to the "Filter selection" screen:

This softkey can only be used when all detail jobs have been completed, irrespective of whether errors occurred or not.

The detail jobs for the individual tools are carried out in a similar manner for the NC as the relevant load and unload processes.

Job processing continues running in the background when you switch from your operator interface to other tool management screens or to other operating areas.



MMC 100.2

5.4 ShopMill Tool Management, MMC 100.2 (SW 5.3 and higher)



Tool list



Function

ShopMill tool management allows workshop-compatible tool management of milling machines.

The following lists are available to you for this function:

- Tool list
- Tool wear list
- Magazine list

Enter the tools and their offsets in the tool list/tool wear list, the magazine list shows you which magazine locations are disabled or not disabled.

All tools and their offset data that are stored in the NC as tool data records are displayed in the tool list irrespective of whether those tools are assigned to a magazine location. The tool list contains standard tools types to which geometric and technological data can be assigned.

Loading/unloading

A tool is loaded onto a magazine location.

It is unloaded from the magazine.

Sorting

The tools can be sorted according to magazine location, name, and type in the tool list and tool wear list.

Machine manufacturers

The softkeys "Load", "Unload" can be hidden by an entry in the MD, see /FBW/ Description of Functions Tool Management or /FBSP Description of Functions ShopMill

Manual tools

Manual tools only exist in the tool list, not in the magazine. They must be placed in the spindle by hand.



MMC 100.2

Tool wear list

This list specifies which wear data (length and radius/diameter) are to be taken into account. The following types of monitoring can also be defined for a tool:

- Monitoring of the effective operating time (tool life)
- Monitoring of the number of tool changes
- Additional information about tool status (disable tool, tool to fixed location, tool too large)

Tool location coding

In the MD you can define whether all tools are fixed or variable location coded.

- With fixed location coding, the tool is permanently assigned to a magazine location. This version can be used for machines with a disk-type magazine.
- With variable location coding, a tool can also be conveyed to a magazine location other than the original location. This version can be used for machines with a chain magazine. In the tool wear screen form on the user interface, you can set individual tools to fixed location coded.

Magazine list

The magazine locations are listed with their tools, magazine locations are indicated as disabled/not disabled, and the properties assigned to the active tool (e.g. oversize) are displayed in the magazine list.

5.4.1 Functional scope



Tool types

Function

ShopMill tool management supports the following tool types, tool parameters and magazine parameters:

- 120 End mill
- 200 Twist drill
- 220 Center drill
- 710 3D probe
- 711 Edge probe
- 110 Cylindrical die sinker
- 111 Ballhead cutter
- 121 End mill with corner rounding
- 155 Bevelled cutter
- 156 Bevel cutter with fillet
- 157 Conical die sinker



MMC 100.2

Tool parameters

- Magazine location/magazine number
- Tool type
- Tool name
- Duplo number
- Geometry length 1
- Geometry radius
- Wear length 1
- Wear radius
- Type of tool life monitoring
- Service life
- Quantity
- Tool status: Tool disabled
- Tool status: Oversized tool (right and left half location)
- Tool status: Tool to fixed location
- Fillet radius
- Angle for conical milling tools

Magazine parameters

- Magazine location disabled

5.4.2 Selecting a tool list



Selection with softkey

Operating sequence



When you call up the "Parameter" operating area for the first time, the menu Tool list is displayed. Otherwise you can call it via softkey.



MMC 100.2

5.4.3 Creating a new tool



Function

You create new tools in the tool list. A selection of tool types is displayed for this purpose. The tool type determines which geometry data are necessary and how they are calculated. The following common tool types are available:

	CUTTER
	DRILL
	CENTERDRILL
	DIEMILL_CYL
	BALL_END_MILL
	MILL_CORN.RAD.
	MILL_TAPER
	MILL_TAPER_CRAD
	DIEMILL_TAPER
	EDGE_FINDER
	3D_PROBE



Operating sequence

Selection with softkey

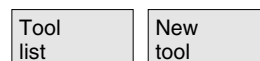

Select the tool location of your choice with the cursor keys

and activate the tool type of your choice via the softkey

The new tool is created.

3D tools

In the case of 3D tools, you must define parameters in addition to the geometry data in the tool list.

Type	Name	Additional parameters
110	Cylindrical die sinker	-
111	Ballhead cutter	Fillet radius
121	End mill with corner rounding	Fillet radius
155	Bevelled cutter	Angle for conical milling tools
156	Bevel cutter with fillet	Fillet radius, angle of conic. tools
157	Conical die sinker	Angle for conical milling tools



MMC 100.2

Details

Press the softkey "Details" and enter the fillet radius and angle for the conical milling tools.

5.4.4 Creating a tool offset for cutting edge 1/2

With ShopMill tool management, you can assign tools with 2 cutting edges, e.g. a pilot-sinking tool to different tool offset sets (one for each cutting edge).

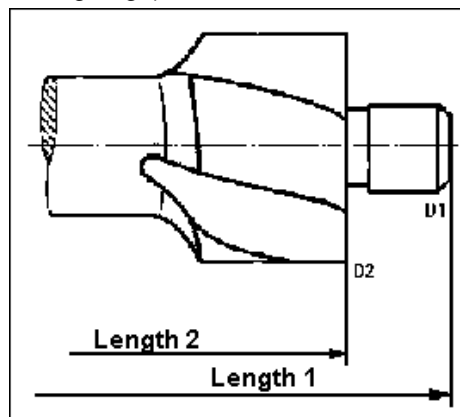

All tool parameters that describe a tool are stored under tool offset for cutting edge 1 (D1) or 2 (D2).

These are

- tool type (identical for cutting edge 1 and 2)
- geometry values (length, radius, angle), and
- wear values (length, radius).

In the case of ISO programs (e.g. ISO dialect 1) you must enter an H number. This corresponds to a particular tool offset set.

When you create a new tool, the tool offset set is automatically active for cutting edge 1.



Tool offset for 2nd cutting edge

Selection with softkey

In order to create tool offsets for a tool with a 2nd cutting edge, press softkey "2nd cutting edge":

2nd cutting edge

A list without the offset values for the 2nd cutting edge is displayed. When you enter values, the tool offsets of the selected tool are created for the 2nd cutting edge.



MMC 100.2

5.4.5 Changing tool name

A tool that has just been created in the tool list is automatically assigned the name of the selected tool group. You can change this name as often as you want to

- a tool name, e.g. "Face_mill_120mm" or
- a tool number, e.g. "1".

The tool name must not exceed 17 characters in length. The name can contain letters (except special characters), digits, underscores "_", periods ".", and slashes "/".

5.4.6 Creating a duplo/replacement tool

The duplo/replacement tool is a tool that can be used for the same machining operations as a tool that already exists (e.g. for use after a tool breakage).

When you create a replacement tool, you must use the same name as is used for a comparable tool.



Confirm the name with the "input" key and the duplo number of the replacement tool is automatically incremented by 1.

The sequence of replacement with a replacement tool is determined by the duplo number **DP**.

5.4.7 Manual tools

Manual tools are tools that are required during machining and which exist in the tool list but not in the tool magazine. These manual tools must be inserted and removed from the spindle by hand.



Machine manufacturers

Please follow the machine manufacturer's instructions!



MMC 100.2

5.4.8 Creating tool wear data

Selection with softkey

Tool wear

Tools									
Tool wear									
Loc	Typ	Tool name	DP	1st cutting edge	Δ Length	Δs	T	Op.life	Qty.
1	⌀	DRILL10	1	0.000	0.000				
1	▨	CUTTER40	1	0.000	0.000				
2	⌀	DRILL10	1	0.000	0.000				
3	▨	CUTTER18	1	0.000	0.000				
4									
5	▨	CUTTER36	1	0.000	0.000				
6	▨	CUTTER32	1	0.000	0.000				
7	⌀	DRILL18	1	0.000	0.000				
8	▨	CUTTER25	1	0.000	0.000				2nd cutt. edge
9	▨	CUTTER20	1	0.000	0.000				
10	⊥	CENTERDRILL	1	0.000	0.000				sort >
11	⌀	DRILL30	1	0.000	0.000				

Example of a tool wear list with variable location allocation

Allowances for lengths and radii

In the tool wear list you enter the delta values for length (Δ length), and radius (Δ radius)/diameter ($\Delta\varnothing$) for the tool.

Where a:

- positive delta value is the allowance (for later finishing),
- the negative delta value is the undersize (wear)

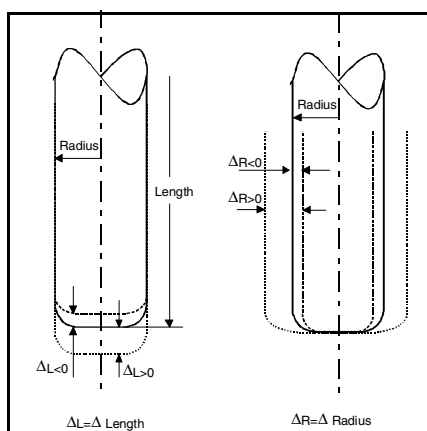

Allowances/undersizes for a corner radius mill

The offset values entered under "Tool list" and "Tool wear" are automatically activated when a tool is called and placed in the spindle.



MMC 100.2

5.4.9 Tool monitoring

In the tool wear list you can assign each tool the following tool monitoring and properties.

- Service life
- Quantity
- Other tool properties
 - Disable tool
 - Tool to fixed location
 - Tool oversized

Further notes

The tool monitoring functions are activated via machine data. Please follow the machine manufacturer's instructions!

Selection with softkey

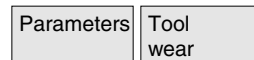

Tool life T

The tool life monitoring refers to the tool cutting edge (D1 or D2) currently in use and only if tool monitoring has been activated for it. The time is expressed in a one-minute timebase and can be entered as such.

If the remaining tool life = 0, the tool is disabled. It is no longer used after the next tool change.

If a tool is programmed again as the result of a tool change operation, the tool life length is checked. If it has expired, a replacement tool is inserted if available.

Number of workpieces C

Under this parameter you define how often a tool can be used in the spindle. If the number of replacements (number of pieces) is zero, the tool is disabled.



You activate the monitoring you require with the "Alternative" key via parameter **T/C**. You enter the values you require in the relevant input field.

Other tool properties

You can assign the following properties to a tool:

- G: Disable tool, e.g. if the tool cutting edge is worn.



MMC 100.2



- U: Tool oversized, i.e. in the case of an oversized tool, the adjacent magazine locations (left and right of the magazine location) are each half disabled.
- P: Tool in fixed location, i.e. a tool is permanently assigned to a magazine location (fixed location coded).

Using the cursor keys you select the function you want and activate it with the softkey "Alternative".

5.4.10 Magazine list

Selection with softkey

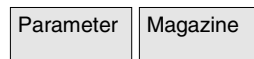

TOOLS					
Magazine					Inhibit magazine loc.
Loc	Typ	Tool identifier	DP	Locatn disabl	Workp. status
0		DRILL10	1	■	P
1		CUTTER40	1	■	■
2		DRILL10	1	■	■
3		CUTTER18	1	■	■
4				■	
5		CUTTER36	1	■	■
6		CUTTER32	1	■	■
7		DRILL18	1	■	■
8		CUTTER25	1	■	■
9		CUTTER20	1	■	■
10		CENTERDRILL	1	■	■
11		DRILL30	1	■	■

Example of a magazine with variable assignment

Disable magazine location

Magazine locations can be reserved or disabled for specific tools, e.g. in the case of an oversized tool.



Selecting the required magazine location.



Toggle in column "Disable location" with the softkey "Alternative" until a "G" (= disabled) appears in the field in question. The location is now disabled. A tool can no longer be loaded into this magazine location.



MMC 100.2

Tool status

In the column "Tool status", you can see which properties have been assigned to the active tool:

- G: Tool is disabled
- U: Tool oversized
- P: Tool at a fixed location

5.4.11 Delete tool



Function

Tools can be deleted from the tool list.



Operating sequence

Select the tool of your choice.



Press the softkey "Delete tool" and confirm with "Delete". The tool data of the selected tool are deleted, the magazine location in which the deleted tool was located is enabled.

5.4.12 Changing the tool type



Function

In the tool list you can change a tool type into another tool type.



Operating sequence

Select the tool of your choice. The cursor is positioned on input field "Type".



You can switch to the tool type you want with the Alternative key. The input fields for the new tool type are displayed.



MMC 100.2

5.4.13 Loading a tool



Precondition



Selection with softkey

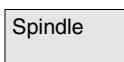

Function

You can load a tool directly into the spindle or to a free location in the magazine from the tool list.

Operating sequence

The machine data for the tool management is set with load/unload.

Further notes

Please follow the machine manufacturer's instructions!

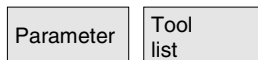

The "Tool list" menu is displayed.

Select the tool of your choice.

Press the "Load" softkey.

A window called "Empty location" appears with the location number of the first empty magazine location.

You can now enter a new location number

or

Load the tool directly into the spindle.

The loading operation is initiated.

The tool is loaded directly into the specified magazine location.

The load operation is canceled.



MMC 100.2

5.4.14 Unloading a tool

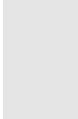

Precondition



Selection with softkey



Function

On unloading the tool is removed from the magazine and entered in a storage location in the tool list. The tool offset data set is retained. The unloaded tool has no location number in its storage location.

Operating sequence

The machine data for the tool management is set with load/unload.

Further notes

Please follow the machine manufacturer's instructions!

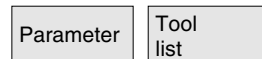

The "Tool list" menu is displayed.

Select the tool of your choice.

Press the "Unload" softkey.

The tool is removed from the magazine and placed in the storage location.



MMC 100.2

5.4.15 Sorting tools in the tool list



Function

The tools can be sorted according to magazine location, tool name (alphabetical), or tool type in the tool list. When you sort according to magazine assignment, the empty locations in the magazine are also displayed.



Selection with softkey

Operating sequence

Tool list Sort > or

Tool wear Sort >

acc. to magazine or acc. to name or acc. to type



MMC 100.2



MMC 103

5.5 R parameters (arithmetic parameters)

5.5.1 Function



Function

Parameters are read and written by programs.
In this operating area, parameters can be altered manually.

5.5.2 Editing/deleting/finding R parameters



Function

The number of channel-specific R parameters is defined in a machine data.

Range:

R0–R999 (dependent on machine data).

There are no gaps in the numbering within the range.



Sequence of operations

The "*R parameters*" window appears.

The channel-specific parameters are displayed.
The vertical softkey bars change.

You can page up and down using the "*Page*" keys.

Change parameters:

Position the cursor bar on the appropriate input field and enter the new values.

R para-
meters





MMC 100.2



MMC 103

Delete
area

Delete all

Abort

OK

Find



Delete parameters:

Displays a marker in which the Rx to Ry parameter range to be deleted must be entered.

The entire R parameter range is deleted, i.e. all values are reset to "0" (MMC 103).

Inputs are discarded.

Deletes the entered R parameter range.

Find parameters:

An input window for a parameter number appears when you press the "Find" softkey.

Enter the R parameter number you wish to find via the numeric keypad.

When you press the "Input key", the cursor is automatically positioned on this parameter if it exists.

Further notes

Input and deletion of parameters can be disabled via the keyswitch.



MMC 100.2



MMC 103

5.6 Setting data

5.6.1 Working area limitation



Function

The *"Working area limitation"* function can be used to limit the range within which a tool can traverse in all channel axes. This is a way of creating prohibited zones in a working area, in other words zones which the tool in question cannot enter.



Sequence of operations

Select softkey *"Setting data"*.

The vertical softkey bars change.

Setting
data

Working
area limitat.

Select softkey *"Working area limitation"*.

The *"Working area limitation"* window opens.

Alter working area limitation:

Position the cursor on the desired field.

Enter the new values on the numeric keypad.

The upper or lower limit of the protection zone changes according to your input.



Activate the relevant working area limitation using the *"Toggle key"*.



In *"MDA"* and *"Automatic"* modes, the working area limitation is not activated according to setting data within the current NC program until a *"WALIMON"* command is set.



Additional notes

The *"Working area limitation"* function can be disabled by means of the keyswitch.



MMC 100.2



MMC 103

5.6.2 Jog data



G function

Function

The feedrates must be specified in the unit determined by the G function.

G94 Feedrate in mm (inch)/min

G95 Rotational feedrate in mm (inch)/rev

Jog feedrate

Feedrate value in Jog mode

Jog continuous

- Continuous-trigger mode: The axis moves as long as the key is pressed.
- Momentary-trigger mode: The axis begins to move when the key is pressed once and continues until:
 - The key is pressed again
 - NC stop
 - Reset
 - SW/HW limit switch.

Variable increment

Increment value for Jog variable increment

Jog spindle speed

The following data are displayed only if a spindle is configured:
Spindle speed in Jog mode

Spindle

Jog data for the master spindle:

- Spindle no.: Name of master spindle
- Direction of rotation: Direction of rotation of the master spindle
- Spindle speed: Speed of the master spindle in Jog mode



Setting data

Jog data

Sequence of operations

Select softkey "*Setting data*".
The vertical softkey bars change.

Select softkey "*Jog data*".
The "*Jog data*" window is opened.

5.6 Setting data



MMC 100.2



MMC 103



Change jog data:

Position the cursor bar on the appropriate input field and enter a new value or

use the *"Toggle"* key to select a new value.

Additional notes

The limit values for the maximum and minimum permissible values are defined in the machine data.

5.6.3 Spindle data



Max./min.

Function

The value entered for the spindle speed in the fields max./min. must be within the limit values defined in the machine data.

Programmed

Programmable upper speed limit (G96) for constant cutting speed.



Setting
data

Sequence of operations

Select softkey *"Setting data"*.

The vertical softkey bars change.

Spindle
data

Select softkey *"Spindle data"*.

The *"Spindle data – limitation"* window opens.

Change spindle data:

Position the cursor bar on the appropriate input field and enter a new value or

use the *"Toggle"* key to select a new value.





MMC 100.2



MMC 103



Additional notes

- The limit values for the maximum and minimum permissible values are defined in the machine data.
- The "Spindle data" function is displayed only if a spindle is configured.

5.6.4 Dry run feedrate for DRY mode



Function

The feedrate entered here is used in the active program instead of the programmed feedrate when the function "Dry run feedrate" (program control) is selected in "Automatic" mode.



Setting
data

Feedrate
DRY

Sequence of operations

Select softkey "Setting data".
The vertical softkey bars change.

Select softkey "Feedrate DRY".
The "Dry run feedrate" window is opened.

Change the dry run feedrate:
Enter a new value.



MMC 100.2



MMC 103

5.6 Setting data

5.6.5 Starting angle for thread cutting



Function

For thread cutting, a starting position for the master spindle is displayed as the starting angle. A multiple thread can be cut by changing the angle when the thread cutting operation is repeated.

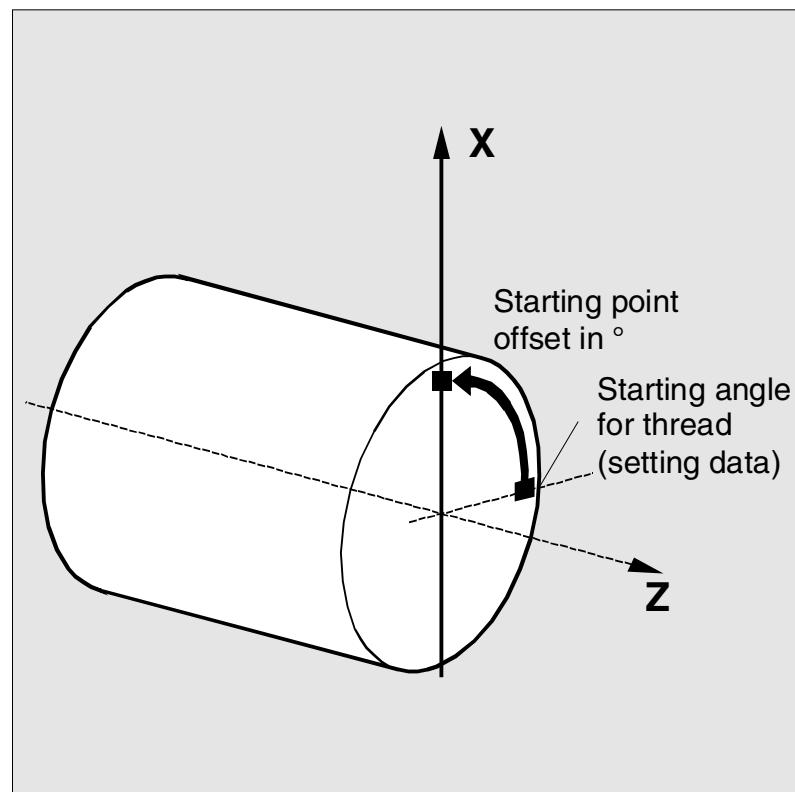

Sequence of operations

Select softkey "*Setting data*".
The vertical softkey bars change.

Change starting angle:

Select softkey "*Starting angle*".
The "*Starting angle for thread*" window opens.

Enter a new value.

Setting
data

Starting
angle



MMC 100.2



MMC 103

5.6.6 Other types of setting data



Function

All the setting data in the control are displayed in tabular form sorted according to general (i.e. NCK-specific), channel-specific and axis-specific setting data. The table contains both the setting data on the vertical softkeys such as working area limitation, Jog data etc., as well as special setting data such as software cam, oscillation, compensation etc.



Sequence of operations

Select softkey "*Setting data*".
The vertical softkey bars change.

Setting data

Display setting data:

Select softkey "*Misc.*".
The horizontal and vertical softkey bars change.

Misc.

Select the type:

- The "*General SD (\$SN_)*" window opens.
- The "*Channel-specific SD (\$SC_)*" window opens.
- The "*Axis-specific SD (\$SA_)*" window opens.

General SD

Channel-specific SD

Axis-specific SD

The current setting data of the corresponding type \$SN_, \$SC_ or \$SA_ are displayed.



You can page up and down using the "*Page*" keys.

Find

Find setting data:

Enter the setting data you wish to find in the "*Find*" window (initial ID is sufficient).

Find next

If several setting data have the same initial identifier, you can display other setting data by selecting softkey "*Find next*".

5.6 Setting data



MMC 100.2



MMC 103

Change setting data:

Position the cursor bar on the appropriate input field and enter a new value.

Additional notes

Data can be edited or not depending on the active access protection level.

5.6.7 Protection zones



Function

The "*Protection zones*" function allows you to protect various elements on the machine, your equipment or the machined workpiece against incorrect axis motions. You can view up to 10 programmed protection zones in levels G17, G18 and G19.

For further information about protection zones, please refer to /PGA/, Programming Guide, Advanced

Sequence of operations

Select softkey "*Setting data*".

The vertical softkey bars change.

Select softkey "*Protection zones*".

The "*Working area limitations and protection zones*" window opens.

The vertical softkey bar changes again.

Select softkey "*Protection zone +*" or "*Protection zone -*".

Up to 10 protection zones are displayed in succession.

Select the plane in which the relevant protection zone is located:

- Plane G17 (X,Y; infeed direction Z)
- Plane G18 (Z,X; infeed direction Y)
- Plane G19 (Y,Z; infeed direction X)

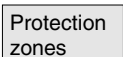
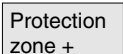
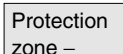



MMC 100.2



MMC 103

5.7 Zero offset

5.7.1 Function

Machine/ tool zero

The actual values are referred to the machine zero after a reference point approach. The machining program of the workpiece refers to the workpiece zero.

Machine zero and workpiece zero need not be identical. Depending on the type of workpiece and the way it is clamped, the distance between the machine zero and workpiece zero can vary. In part program processing this is compensated for by the zero offset.

Zero offset on a milling machine

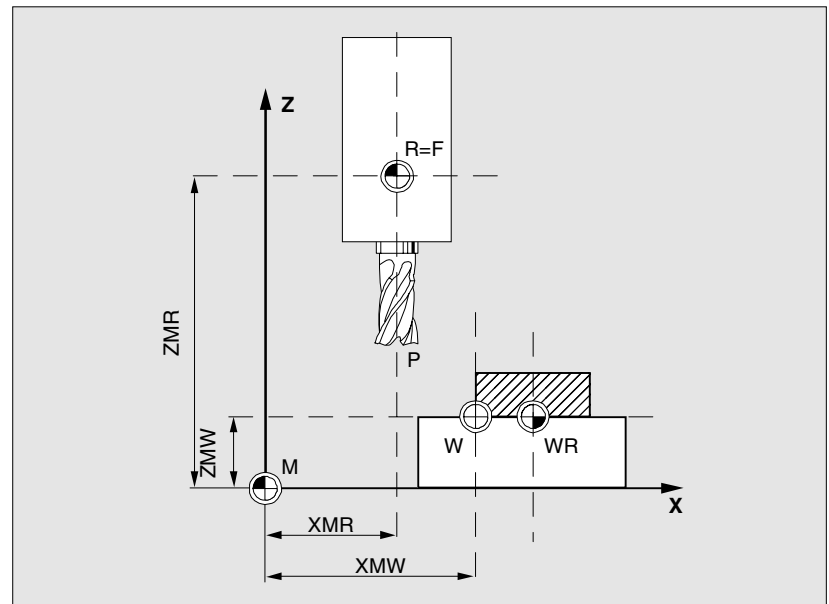

P	Tool setting point
W	Workpiece zero
F	Slide reference point
XMR, ZMR	Reference point coordinates
XMW, ZMW	Zero offset
M	Machine zero
R	Machine reference point
WR	Workpiece reference point

Effective ZO

The zero offset effective in an axis

`$P_ACTFRAME= . .` is calculated from the **sum** of the following zero offsets:



MMC 100.2



MMC 103

Settable ZO

You can activate a settable zero offset in the program you have called with G54 to G57 and other G functions or with $\$P_IFRAME=...$

Basic zero offset (basic frame): displayed like a settable ZO.

Programmable ZO

You can use the programmable zero offset $\$P_PFRAME=...$ to program an additional zero offset for geometry and special axes in the part program you have called.

The values of the programmed zero offsets are deleted with end of program or reset.

External ZO

In addition to all the offsets which define the position of the workpiece zero, an external zero offset can be overlaid by means of the handwheel (DRF offset) or from the PLC.

DRF offset

Differential Resolver Function: An NC function which generates an incremental zero offset in AUTOMATIC mode in conjunction with an electronic handwheel.

Frame

Frame is the conventional term for a geometrical expression that describes an arithmetic rule, such as translation or rotation. Frames are used to describe the position of a destination coordinate system by specifying coordinates or angles starting from the current workpiece coordinate system.

Possible frames

- Basic frame (basic offset)
- Settable frames (G54...G599)
- Programmable frames

References: /PG/, Programming Guide Advanced

Frame components

Frame components

A frame can consist of the following arithmetic rules:

- Zero offset, TRANS, ATRANS
- Rotation, ROT, AROT
- Scale, SCALE, ASCALE
- Mirror, MIRROR, AMIRROR

In the part program, all zero offsets can be deselected non-modally with G53.





MMC 100.2



MMC 103

5.7.2 Changing the settable zero offset (G54 ...)



\$P_UIFR []

Coarse offset

Fine offset (SW 4.3 and higher)

Basic frame (SW 4.3 and higher)



Rotation

Scale

Mirroring



Zero offset

Function

This identifier can be used to alter a settable zero offset in the program.

The value of the coarse offset is defined for the relevant axis.

MD 9451 WRITE_ZOA_FINE_LIMIT is programmed to set data limits (absolute) for the fine zero point offset. The fine offset is displayed in the "Settable zero offset" display.
Activation of ZO via MD MM_FRAME_FINE_TRANS.

The basic zero offset is displayed in the same way as a settable ZO and can be modified via softkey "Basic ZO" in the "ZO overview screen".

Machine manufacturers

The basic zero offset is activated by MD.

The value of the rotation around the respective geometry axis (e.g. X, Y, Z) can be entered.
Rotation can only be programmed around geometry axes.

The scale factor can be defined for the respective axis.

Mirroring of the relevant axis around the coordinate zero can be activated and deactivated.

Sequence of operations

Select softkey "Zero offset".
The vertical softkey bars change.
The "Settable zero offsets" window opens.



MMC 100.2



MMC 103

ZO +

or

ZO -

Selected
ZOAccept
position

Go to

9



Save

Reject

Determine
ZO

You can scroll through the settable zero offsets with ZO+/ZO-, the next identifier (e.g. G55) in each case being displayed on the softkey.

The softkey "Selected ZO" switches the display to the selected settable zero offset selected in the NC.

If no settable zero offset is selected in the NC, a corresponding dialog text indicating this state is displayed.

Softkey "Accept position" is displayed only if an axis position can be entered in the input field. This position is transferred to the control when you select "Accept position".

You can choose a zero offset selectively by entering its name or selecting it in the overview of zero offsets.

Change value

Select the zero offset you wish to change and position the cursor on the element to be modified (e.g. offset) and overwrite the existing value with a new value or

Use the "Toggle key" (with mirroring) to select a new value.

The zero offsets are saved, i.e. transferred to the NC.

Altered values are reset to their original settings.

If you exit the display "Settable zero offset" without storing the displayed values after they have been changed, a dialog box asks you what to do with the changes.

Determine settable zero offsets:

The "Measuring devices" window is opened.

In the "Measuring devices" window, enter the tool in the "T No." field and the cutting edge in the "D No." field.



MMC 100.2



MMC 103



Use the "Toggle" key to select

- the relevant length parameter (1, 2, 3) and direction (+, -, without),
- the inclusion and direction of radius 1 (+, -, without) and
- the inclusion and direction of a freely definable offset 1 (+, -, without).

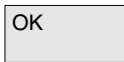

Calculate settable zero offset:

The zero offset parameter selected is calculated taking account of the associated axis positions and the constellation set in the "Measuring devices" window.



Additional notes

Entry can be disabled with the keyswitch.

5.7.3 Displaying other types of zero offset



Function

In the overview, all existing settable zero offsets are listed. The number of possible zero offsets is defined by a machine data. The first settable zero offsets G54 to G57 are permanently assigned the identifiers \$P_UIFR[1] to \$P_UIFR[4].



Sequence of operations

Operate the softkeys "Zero offset" and "Go to".
The window headed "Please select G identifier" is opened.



Select zero offsets:

There are two methods by which you can select a zero offset:

- Enter the offset identifier or
- position the cursor bar on the relevant zero offset and press the "Enter" key.



MMC 100.2



MMC 103

Settable
ZO

Display other zero offsets:

The overview of settable zero offsets appears on the screen (see Section "*Settable zero offset*").

Active
settable ZO

The values of active settable zero offsets are displayed (see Section "*Active values of settable zero offset*").

Active
progr. ZO

The values of the activated programmable zero offsets are displayed.

Sum of
active ZO

The sum value of the active zero offsets for each axis is displayed.

External
ZO

This lists the overview of external offsets.

5.7.4 Displaying active settable zero offsets



Function

The active settable zero offsets (selected from part program or MDA) can be displayed.

Values cannot be edited in this display.



Sequence of operations

Zero offset

Go to...

Select softkeys "*Zero offset*" and "*Go to ...*".
The vertical softkey bars change.

Active
settable ZO

The "*Active settable ZO*" window opens.
You can alter these values if necessary.



/PGA, Programming Guide, Advanced



MMC 100.2



MMC 103

5.7.5 Displaying active programmable zero offsets



Zero offset

Go to...

Active
progr. ZO

Function

The active, selected programmable zero offsets (from part program or MDA) can be displayed.

Values cannot be edited in this display.

Sequence of operations

Select softkeys "Zero offset" and "Go to ...".

The vertical softkey bars change.

The "Active progr. ZO" window opens.

5.7.6 Displaying active external zero offsets



Zero offset

Go to...

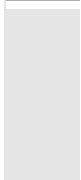
External
ZO

Function

The active, external zero offsets can be displayed.

Values cannot be edited in this display.

Sequence of operations

Select softkeys "Zero offset" and "Go to ...".

The vertical softkey bars change.

The "External ZO" window is opened.

Additional notes

The 2nd basic offset is recommended as an external zero offset (PLC offset) if the functionality of the standard external zero offset is not sufficient.

The frame components are available if the 2nd basic offset is used as the external zero offset.



MMC 100.2



MMC 103

5.7.7 Displaying the sum of the active zero offsets



Function

The sum of the active zero offsets from part program can be displayed.

Values cannot be edited in this display.



Zero offset

Go to...

Sequence of operations

Select softkeys "Zero offset" and "Go to ...".

The vertical softkey bars change.

Sum of
ZO

The "Sum of ZO" window is opened.

The sum of zero offsets is calculated in the following way:

$Sum\ ZO = active\ settable\ ZO + active\ programmable\ ZO$



The values can be changed only in the "Settable zero offsets" menu.
(see Section "Settable zero offsets" menu)

5.7.8 Activate zero offset and basic frame immediately



Function

Machine data MD \$MM_ACTIVATE_SEL_USER_DATA can be set to ensure that the zero offset and basic frame are made immediately effective when the part program is in the "Reset" state. This also occurs if the part program was first switched to JOG status.

If the channel is in the "Reset" state, active zero offset and basic frame are not activated until the part program is continued.



Additional notes

If the function is used in the Reset state,

MD \$MC_RESET_MODE_MASK must be set in such a way that settable zero offset and basic frame cannot be reset on Reset.



MMC 100.2



MMC 103



Machine manufacturers

See machine manufacturer's specifications

/FB/ K2: Axes, Coordinate Systems, Frames

Danger

The compensation is performed the next time the part program is started.

5.7.9 Global zero offset/frame (SW 5 and higher)



Function

In addition to the settable, programmable and external zero offsets, up to eight **global** zero offsets/frames (basic ZO) can be defined in SW 5 and higher. This allows offsets, scales and mirrors to be defined simultaneously for all channel and machine axes.

The global zero offsets (NCU-global frames) apply uniformly to **all** channels. They can be read and written from all channels. The activation is performed in the relevant channel.

Basic ZO (total basic frame)

In addition, eight channel-specific basic zero offsets can be defined in each channel. The global and channel-specific frames are combined to produce a total basic frame (basic ZO).

Machine manufacturers

Recommendation:

Use the 3rd basic offset onwards for your own applications. The 1st and 2nd basic offsets are reserved for setting the actual value and the external zero offset.

With global frames, no geometrical relationship exists between the axes. You cannot therefore perform rotations and you cannot program geometry axis identifiers.





MMC 103

In SW 5 and higher, the settable zero offset and the basic zero offset are represented in **one** table. You can edit the values in this table. You can switch between the values of the individual axes.

For **all** zero offsets, you can display either the defined offsets (coarse and fine) or the specified rotations, scales and mirrors for each value.



References

/FB/ K2: Axes, Coordinate Systems, Frames



Sequence of operations

The following softkeys are available for the zero offsets in the horizontal softkey bar:

Zero offset

All defined global and channel-specific basic zero offsets are displayed in a table.

The vertical softkey bars change.

Active ZO
+ offset

An overview of all active offsets, rotations and scale changes is displayed. These can result from zero offsets, transformations or tool offsets.

The vertical softkey bars change.



MMC 103

Zero offset

Axes +

Axes -

Offsets

Rotation
scl, mirr

Basic ZO

Settable
ZO

Displaying and editing zero offsets

Select softkey "Zero offset".

The vertical softkey bars change.

The display switches to the defined zero offsets of the next axis.

The display switches to the defined zero offsets of the previous axis.

You can use these softkeys to change the display mode of the currently displayed zero offsets.

The display shows:

- either the absolute offsets (coarse and fine) with reference to the coordinate axes
- or a list of individual values, split into components for rotation, scale and mirror.

You can select and, if necessary, change the individual values of the zero offsets in both display modes.

All defined basic zero offsets (global and channel-specific) are displayed in a table.

The display mode can be changed by softkey (see above).

You can edit the values directly in the table.

Rotations are not possible with global frames, since no geometrical relationship exists between the axes in this case.

All defined settable zero offsets are displayed in a table and can be edited if necessary (select and edit).

Further notes

- Changes to the zero offsets are updated immediately on input. The entries no longer have to be confirmed separately.
- If not all zero offsets are displayed in the tables, you can scroll through the table with the corresponding keys.



MMC 103

Active ZO +
offset

Axes +

Axes -

Offsets

Rotation
scl, mirrChange
active ZO

Display and edit active zero offset

Select horizontal softkey "*Active ZO + offset*".
The vertical softkey bars change.

Displays the active zero offset of the next axis.

Displays the active zero offset of the previous axis.

You can use these softkeys to change the display mode of the currently displayed zero offsets.

A table of currently active zero offsets and the offsets of the selected axis are displayed. You can select and, if necessary, change the individual values in the table.

The following values are displayed:

- Global basic ZO; coarse and fine (if defined)
- Channel-specific basic ZO; coarse and fine (if defined)
- Settable ZO; coarse and fine (G57)
- Programmable ZO; G58 (TRANS), G59 (ATRANS)
- T number and D number of active tool
- G17 (geometry, wear, base).



MMC 103

Overview

An overview shows all values of the active zero offset and offsets (no changes possible) including a selection of tool data (T number, D number, etc.). The basic zero offset and the settable zero offset are displayed as the sum.

Parameter	CHAN1	AUTO	MPF.DIR	TEST.MPF	
Channel active					Axis +
Program running					
					Axis -
Übersicht der aktiven Nullpunktverschiebungen und Korrekturen					
	Achse Istwert[MKS] Istwert[ENS]	X1 [mm] 000.000 000.000	Y1 [mm] 000.000 000.000	Z1 [mm] 000.000 000.000	
Überlagerte Bewegung		0.000	0.000	0.000	
DRF-Verschiebungen		0.000	0.000	0.000	
Externe NV		100.000	100.000	0.000	
Summe NV	grob	399.000	100.000	000.000	Change active ZO
	fein	1.000	0.000	0.000	
	Drehung [Grad]	0.000	0.000	0.000	
	Maßstab Spiegeln	1.000	1.000	1.000	
Akt. Werkzeug	T-Nr.	34	D-Nr. 2	Ebene G17	Overview
	Längen	100.000	100.000	000.000	
	Radius	0.000	0.000		
Istwert [WKS]		500.000	400.000	200.000	
		X	Y	Z	
Tool offset	R Parameter	Setting data	Zero offset	User data	Active ZO + offset

The following values are displayed:

- Actual value of MCS and settable zero system
- Superimposed movements
- DRF offsets
- External zero offsets
- Sum of the zero offsets, calculated from the basic, settable and programmable zero offsets
(corresponds to the table "Change active ...")
- Data of the active tool (T number, D number with reference to the plane G17, lengths, radius)
- WCS actual value.

5.7 Zero offset



MMC 103

Further notes

The active zero offset must be changed only when the NC program is stopped. Changes are updated immediately. The zero offset values in the display are updated cyclically.

In SW 5 and higher, the *"Accept position"* function is no longer available (values for zero offsets can be accepted using the function *"Scratching"*).

5.7.10 Actual value display: Settable zero system, SZS (SW 5.2 and higher)



Function

You can make a setting in the MD to define whether

- the position of the workpiece coordinate system, WCS (= programmed position, corresponds to default setting) or
- the tool holder position of the active tool relative to workpiece zero (settable zero offset system)

is to be displayed in the actual value display.

For configuration see

/IAM/ IM3: Installation/start-up functions MMC 103, Section Zero offset



MMC 100.2



MMC 103

5.8 User data/user variables (GUD, PUD, LUD)

5.8.1 General information



Function

User data (UD) can be defined by means of a variety of variables:

- GUD – global variables which are valid in all programs.
- LUD – local variables which are valid only in the program or subroutine in which they have been defined.

- **SW4.4 and higher** (MMC 103 only):

PUD – program-global variables.

Local variables (LUD) defined in the main program are turned into program-global variables (PUD) by a setting in a machine data.

PUD variables are valid on all subroutine levels, where they can also be written and read.

SW 4.3 and earlier

Global user data (GUD) should be defined as part of the system start-up process, as they require re-initialization of the control system.

SW 4.4 and higher (MMC 103 only):

The definition of user data (GUD) can be created for MMC 103 in operating area Services without reinitialization.

Please note:

- Definition files stored on the hard disk are not active.
- Definition files stored in the NC are always active.

The user memory must be configured to a large enough size before the GUD definition file is loaded to the control.

All relevant machine data have the GUD string in their names.

The display of global user data (GUD) can be locked by means of the keyswitch or a password.



5.8 User data/user variables (GUD, PUD, LUD)



MMC 100.2



MMC 103

5.8.2 Changing/finding user data/user variables



User
data

Global
user data

Channel-
spec. u.d.

Local
user data

Program
user data



GUD +

GUD -

GUD:

Sequence of operations

Press softkey *"User data"*.

The *"Global user data"* window is displayed.

The vertical softkey bar changes.

You can toggle between windows

- *"Global user data"* (GUD),
- *"Channel-specific user data"* and

SW 4.3 and earlier:

- *"Local user data"* (LUD).

The name and the value of the current user data are displayed in each case.

SW 4.4 and later:

- *"Program user data"*

Program-global variables (PUD) and local variables (LUD) are displayed.

You can scroll up and down in the list using the *"Page keys"*.

Edit user data

Position the cursor on the user data that you wish to edit and enter a new value or

select a new value using the *"Toggle key"*.

New values are automatically accepted.

Find user data

Press softkeys *"GUD +"* and *"GUD -"* to scroll through user data from GUD 1 to GUD 9.

The *"Select global user data"* window is opened. The following values may be selected:

- 1 = SGUD (Siemens)
- 2 = MGUD (machine manufacturer)
- 3 = UGUD (machine user)
- 4 ... 9 = GD4 ... GD9 (others, e.g. grinding cycles, etc.)



MMC 100.2



MMC 103

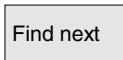
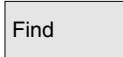

The selected data are displayed in the "Global user data" window.

Select softkey "Find".

Dialog window "Find user data" appears on the screen.

The data name or a character string within the name can be entered as the search target.

The cursor must be positioned on the user data to be found.

The next user data with the initial identifier searched for is displayed.

User data of types `AXIS` and `FRAME` are not displayed.

Only those local user data that still exist in the execution chain of the control are displayed.

The list of local user data for the display window is updated every time "NC Stop" is actuated. The data values are updated continuously. Before global user data definitions can be made operative in the control, it may be necessary to set machine data.

Additional notes

A description of how to define and activate user data can be found

- in Chapter "Program" Operating Area for the MMC 100.2 and
- in Chapter "Services" Operating Area for the MMC 103.



MMC 103

5.9 Displaying system variables (SW 4.1 and higher)



Function

System variables can be used for a wide range of different functions (e.g. as variables or in synchronized actions).

- View variables in a defined display (e.g. as a value or graphic characteristic) or
 - Manage views of variables
 - Display variables of a view
 - Define views of variables
- Generate a log of the response of variables during a program run
 - Define logs
 - Start a log
 - Manage a log
 - Display a log



Sequence of operations

The "System variable display" appears.

System
variable

Views of system variables		View 1
Actual values		View 2
\$AA_IW[1]	10000.144	View 3
\$AA_IW[2]	20089.000	View 4
Calculation parameters		More views
\$R[0]	100.0	Edit view
		Select view
		Variable log

Edit
view

This softkey opens a window in which views can be created or edited.

Select
view

With "Select view" a dialog is started in which the user can select individual views or a file with several views.

5.9 Displaying system variables (SW 4.1 and higher)



MMC 103

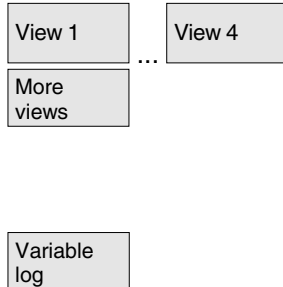

The names of the views of a file are assigned to the vertical softkeys "View 1" to "additional views". If a file contains more than five views, you can press softkey "More views" to select the views stored in the file in blocks of four.

The display "Logging system variables" is selected with the softkey "Variable log".

5.9.1 Processing/creating variable views



Function

You can compile your own views of variables. The display of variables can be edited with respect to

- layout (e.g. 2 columns) and
- properties (e.g. name, input limits).



Sequence of operations

The softkey "Edit view" changes to edit mode.

With "Insert variable", a dialog box is opened in which the required system variable can be selected from a list with the cursor and the "Edit" key. The full name of the variable appears in the info line.

It is included in a new line or column in the view with the "Input" key. The variable is inserted after the cursor position.

Confirm your input with OK.

By selecting softkey "Insert user variable", it is possible to access any existing user data by the same method.

The softkey "Properties" opens a dialog box in which the text displayed with a variable can be altered.

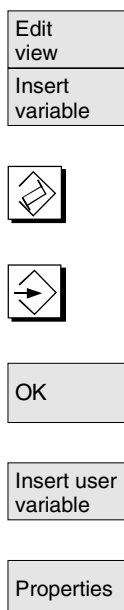

5.9 Displaying system variables (SW 4.1 and higher)



MMC 103

The following properties can be altered:

- Name
- Set another variable
- Display method (display or input)
- Display type
- No. of places after decimal point
- Input limits
- Text size (character size)
- Text alignment (left, right) and positioning (from left/from top)
- Width of input/output field

When 0 is entered, the field is automatically set to the relevant default.



Delete
variable

Delete
all

You can display additional information about the variables (variable description) by pressing the "info key".

If you want to remove a system or user variable from a view, select it and press the softkey "Delete variable".

You can delete the entire contents of the display with "Delete all", which does not affect a stored view on which the screen contents are based.

5.9.2 Managing variable views



Function

The views you create are stored and managed in file form.



Edit
view

Manage
views

Create
file

File
contents

Delete
file

Sequence of operations

With the softkeys "*Edit view*" and "*Manage views*" you here can open a window in which files and views can be

- created
- displayed and
- deleted.

5.9 Displaying system variables (SW 4.1 and higher)



MMC 103

File contents

Display view

New view

Delete view

Save view

The softkey "*File contents*" takes you to another window in which the views of the previously selected file are displayed. With the softkey "*Display view*" you exit the dialog box and the previously selected view in display "*Views of system variables*" is displayed.

These softkeys also enable you to create views,

delete views and

save the currently displayed view under a selected name.

5.9.3 Logging system variables



Function

When variables are used in synchronized actions, it may be necessary to evaluate and log the status of actions in the interpolation cycle. This is done by writing the values selected for a log definition to a log file of defined size in the specified cycle.

Recording of synchronized action variables can be limited to the event with identification number 1.

This event records variables in the IPO cycle or multiples thereof.

- A maximum of 6 variable contents can be recorded simultaneously in the log file.
- Size for memory depth: Values between 3 and 50 KB.

The MMC interprets the contents of the log file and displays them in graphic form.



System variable

Variable log

Sequence of operations

The display "*View of system variables*" appears.

The softkey "*Variable log*" opens the screen with the heading "*Logging system variables*".

5.9 Displaying system variables (SW 4.1 and higher)



MMC 103

Insert
variable

The softkey "*Insert variable*" opens a dialog box in which the system variable to be recorded can be selected.

OK

The variable name in the higher level window in the current recording list appears behind "OK".

If the list already contains 6 entries, the entry on which the cursor is positioned is overwritten.

Initial.
log

Whenever you create a log, you must first initialize the logging function in the NC by pressing the button "Initial. log".

You are informed when initialization is complete in the bottom left-hand corner of the display with the message "Logging initialized - You can now start".

Start log

or

$\$A_PROTO=1$

You can start logging by pressing the button "Start log" or with the system variable $\$A_PROTO=1$ in the part program.

Stop
log

or

$\$A_PROTO=0$

You stop logging by pressing the button "Stop log" or with the system variable $\$A_PROTO=0$.

When you have stopped logging, the log memory is automatically transferred to a file.

Manage
log

The button "*Manage log*" calls up a dialog box in which you can

- save a new log to a file or
- reselect a log that is already saved.

Graphic
log

With the button "*Graphic log*" you call up a window in which the changeover time of the variables are displayed as a curve.

Measuring times are output along the horizontal axis and the variable contents along the vertical axis. A graphic log window may contain several curves, the appropriate variable name is displayed at the top left of each curve.

5.9 Displaying system variables (SW 4.1 and higher)



MMC 103

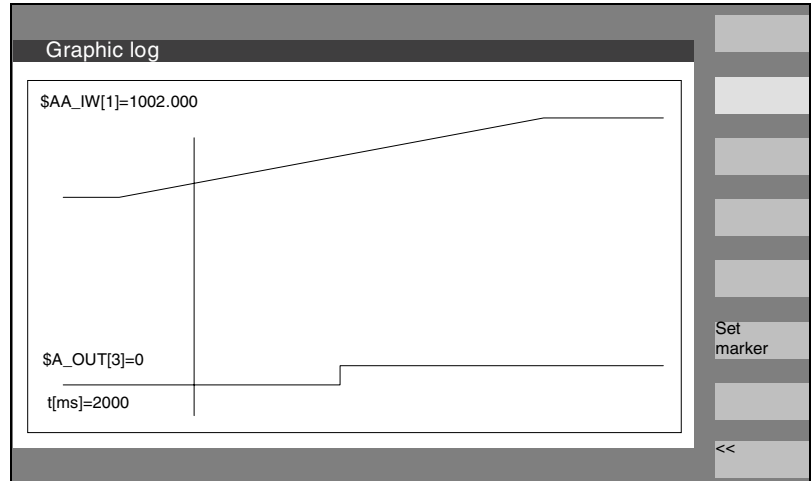

Set
marker

Display "Graphic log" provides you with a zoom function in which a section that you have already selected can be expanded to cover the entire display surface.

With the softkey "Set marker" a vertical cursor line appears which is moved with the cursor left and cursor right keys.

The softkey text then changes from "Set marker" to "Set marker2" and from "Set marker2" to "Expand".

Variable values marked by the cursor line are displayed on the left of the display.

You do not need to normalize the display in any way, normalization values are calculated automatically. The characteristic is automatically normalized to values between minimum and maximum. Binary signals are represented in expanded form.

5.9 Displaying system variables (SW 4.1 and higher)

MMC 103

"Program" Operating Area

6.1	Program types	6-285
6.1.1	Part program	6-285
6.1.2	Subroutine	6-285
6.1.3	Workpiece	6-285
6.1.4	Cycles.....	6-285
6.2	Storing programs	6-286
6.2.1	MMC 100.2.....	6-286
6.2.2	MMC 103.....	6-286
6.3	Program basic display	6-286
6.4	Editing programs	6-289
6.4.1	Text editor	6-289
6.4.2	Interactive programming (MMC 103)	6-289
6.4.3	Selective program protection: *RO* (MMC 103, SW 5 and higher)	6-289
6.4.4	Defining and activating user data (GUD, LUD)	6-291
6.5	User-defined contour programming (SW 4.3 and SW 5)	6-294
6.5.1	General.....	6-294
6.5.2	Programming a contour.....	6-295
6.5.3	Contour elements	6-298
6.5.4	Graphic representation of the contour.....	6-300
6.5.5	Input screen forms for parameterizing the contour elements.....	6-301
6.5.6	Help	6-304
6.5.7	Parameter description of straight line/circle contour elements	6-305
6.5.8	Examples of user-defined contour programming.....	6-306
6.6	Program simulation MMC 100.2.....	6-309
6.6.1	Rotation simulation.....	6-309
6.6.2	Milling simulation before machining (SW 5.2 and higher).....	6-311
6.6.3	Milling simulation during machining (SW 5.2 and higher)	6-312
6.7	Program simulation MMC 103.....	6-314
6.7.1	Simulation user interface.....	6-315
6.7.2	Simulation settings	6-325
6.7.3	Downtime settings	6-329
6.7.4	Display and colors	6-330
6.7.5	Section by section simulation (SW 5.2).....	6-331
6.7.6	Simulation for orientable toolholder (SW 5.3)	6-332
6.8	Simulation with external network drive (SW 5.2).....	6-333
6.9	Program management.....	6-334
6.9.1	Overview	6-334
6.9.2	File types, blocks and directories	6-335

6.9.3	File handling	6-337
6.9.4	New workpiece/part program.....	6-340
6.9.5	Storing setup data (SW 5.2 and higher)	6-343
6.9.6	Selecting a program for execution.....	6-344
6.9.7	Loading/unloading a program (MMC 103).....	6-346
6.9.8	Storing a program.....	6-347
6.9.9	Enabling.....	6-348
6.9.10	Copying/inserting	6-348
6.9.11	Renaming	6-350
6.9.12	Deleting.....	6-351
6.9.13	Log (MMC 103).....	6-352
6.10	Memory info (MMC 100.2)	6-353
6.11	Accessing an external network drive/computer (SW 5.2 and higher).....	6-353



MMC 100.2



MMC 103

6.1 Program types

6.1.1 Part program



A part program consists of a sequence of instructions to the NC control. In its entirety, this sequence affects the production of a specific workpiece or a particular machining process on a given blank.

6.1.2 Subroutine

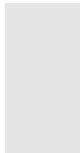

A subprogram is a sequence of instructions in a part program which can be called repeatedly with different defining parameters. Cycles are a type of subprogram.

6.1.3 Workpiece

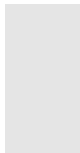

1. A workpiece is a part to be produced/machined by the machine tool or
2. a directory in which programs and other data are stored.

6.1.4 Cycles

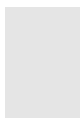

Cycles are subprograms for the execution of a recurring machining process on the workpiece.



MMC 100.2



MMC 103

6.2 Storing programs

6.2.1 MMC 100.2

Programs are saved in the NC memory. The size of this memory is dependent on settings made during start-up.
(See Chapter 5 under "Memory Info")

6.2.2 MMC 103

Programs can be saved in the NC memory or on hard disk. The currently available memory space is displayed in the dialog line.

6.3 Program basic display

The Program basic display contains a complete overview of all workpiece and program directories.

Program	Mda		
Channel reset			Interactive programm.
Program aborted			
			New
Workpiece overview			
Name	Type	Date	Enable
HUGO	WPD	01.06.96	x
WCS	WPD	01.06.96	
WCS	WPD	01.06.96	
			Load
			Unload
			Simulation
			Manage programs
			Select
Press INPUT key for program overview			
Free memory: <input type="text"/> Hard disk: <input type="text"/> New: <input type="text"/>			
Work-pieces	Part programs	Sub-programs	User cycles
			Clip-board
			Log



MMC 100.2



MMC 103

Part
programs

Sub-
programs

Standard
cycles

User
cycles

Clipboard

Log

Memory
info



System
files



Horizontal softkeys

An overview of all part programs (main programs) stored in the selected directory is displayed.

An overview of all subprograms stored in the selected directory is displayed.

Subprograms are processed in the same way as described for "*Process main programs*".

MMC 100.2

The standard cycles appear on the screen when you press softkey "*Standard cycles*".

Select softkey "*User cycles*" to display a list of the user cycles that you have added.

By pressing softkey "*Clipboard*" you can display a list of the programs/data stored in the clipboard.

The log contains error messages relating to errors that may occur during "Copy", "Rename", "Load", etc. (MMC 103 only).

MMC 100.2

This softkey displays the total free/assigned memory.

MMC 103

The currently available memory space is displayed in the dialog line.

MMC 100.2 (SW 4.2 and higher)

You can access the following softkeys by pressing the ETC. key:
System files (e.g. GUD_DEF), definition files (e.g. DEF_DIR),
operating data (e.g. SYF_DIR).

Machine manufacturers

These softkeys can be disabled in display machine data.



MMC 100.2



MMC 103

New

Copy

Insert

Delete

Rename

Change
enableProgram
selection

Back

Interactive
programm.

New

Load

Unload

Simulation

Manage
programs

Vertical softkeys

MMC 100.2:

Creates a new file for a workpiece/part program.

Copies the contents of a file to a clipboard.

Inserts the file from the clipboard.

Deletes a file (workpiece/part program).

Overwrites the file name/type of a workpiece/part program.

Sets/resets the enable for a workpiece/part program.
Enable must be set to allow execution/selection of a workpiece/part program.

Selects a workpiece/part program for execution in the currently active channel.

When you branch to a workpiece, softkey "Back" automatically appears to allow you to return to the workpiece overview.

MMC 103:

Calls the "Interactive programming" function.
See /BA/, Operator's Guide Interactive Programming

Creates a new file for a workpiece/part program.

The highlighted program (or programs) is (are) loaded from the hard disk to the NC memory.

The highlighted program is unloaded from the NC memory to the hard disk.

With the function "Simulation" you can display axis movements graphically and follow the results of machining as they are executed on the screen.

With the softkey "Manage programs" you can manage the functions "New", "Copy", "Insert", "Delete", "Rename" and "Enable".



MMC 100.2



MMC 103

 Selection

 <<

When you branch to a workpiece, softkey "<<" automatically appears to allow you to return to the main menu.

6.4 Editing programs

6.4.1 Text editor



Chapter 2, "General operating sequences"

- The editor only displays the characters that can be entered via the operator panel keyboard.
- **SW 5.2 and higher:** A part program opened in the editor cannot be started simultaneously in the NC (enable canceled), alarm (14014) is output. If the control is switched off while the editor is open, the enable might have to be set manually.

6.4.2 Interactive programming (MMC 103)



See /BA/, Operator's Guide Interactive Programming

6.4.3 Selective program protection: *RO* (MMC 103, SW 5 and higher)



Function

Certain machine-specific code lines can be protected against modification (writing) in programs that have been created with program templates.

A "Read Only" identifier is inserted as a comment (";*RO*") at the end of these machine-specific code blocks. The ASCII Editor identifies these blocks, displays them in "Read Only" text colors (gray text) and rejects any attempt to modify them.



MMC 100.2



MMC 103

6.4 Editing programs

```

Editor          \MPF.DIR\HARR.MPF          1
Test-Programm
;Nr 1
;141197
N100 g01 x50 f200
lab1:
N120 g01 x100 f500      ;*RO*
N130 x10                ;*RO*
N140x20                 ;*RO*
N150 x40                ;*RO*
gotob lab1
;Test 14.11.97
N200 g01 x200
N210 x150
N220 x40
N230 x200
  
```

Identification by the system of a "Read Only" program area can be activated or deactivated by entering line AEDITOR.INI in the file. The default setting is "deactivated".

Irrespective of the above setting, the user can identify protected machine-specific program sections by the "Read Only" identifier (";*RO*").

Any attempt to edit a program section protected by a "Read Only" identifier is rejected with the message "Block cannot be written".

Further notes

When creating a program template, remember to position the "Read Only" identifier directly at the end of the block.



MMC 100.2



MMC 103

6.4.4 Defining and activating user data (GUD, LUD)



Function

1. Back up block `_N_INITIAL_INI` via V.24 or hard disk (MMC 103).
2. Create a definition file for user data:
 - MMC 100.2: On external PC (up to **SW 4.3**)
 - For MMC 103 in operating area "Services" (SW 4.4 and higher) or
For MMC 100.2 in operating area "Program" (SW 5.2 and higher)

Behavior with **SW 4.4 and higher**

If you edit a definition file in the NC, a query box asking whether you want the definitions to be activated is displayed when you exit the Editor.

Example:

"Do you want to activate the definitions from file GUD7.DEF?"

"OK" → A query appears asking you whether you want to save the data currently active.

"Do you want to keep the previous definition data?"

"OK" → The GUD blocks of the definition file to be edited are saved, the new definitions are activated and the saved data are imported again.

"Abort" → The new definitions are activated, the old ones are lost.

"Abort" → The changes to the definition file are rejected, the associated data block is not altered.

Unload

If a definition file is unloaded, the associated data block is deleted after confirmation via a query box.

Load

If a definition file is loaded, a query box appears asking whether you wish to activate the file and/or retain the data. If you do not select activation, then the file will not be loaded.



MMC 100.2



MMC 103



If the cursor is located in a loaded definition file, the softkey labeling changes from "Load" to "Activate" to activate the definitions. If you select "Activate", you are again asked whether you want to save the data.

Data are saved only in the case of variable definition files, but not with macros.

- Predefined file names are used:
 - `_N_SGUD_DEF` (global Siemens data),
 - `_N_MGUD_DEF` (global machine manufacturer data),
 - `_N_UGUD_DEF` (global user data)
 - `_N_GD1_DEF` to `_N_GD9_DEF` (other global data, e.g. grinding cycles, etc.).
- Files with these names can contain definitions of GUD variables. The same rules apply to these as to LUD variable definitions.

3. Load definition file to control system main memory via the V.24 interface.

The control system always creates a directory named `_N_DEF_DIR`. This name is entered in the header of the GUD definition file as a path.

Example:

```
_N_SGUD_DEF
$PATH=/_N_DEF_DIR
DEF NCK REAL NCKVAR
DEF CHAN INT CHANVAR
M17
```



MMC 100.2



MMC 103

4. Activate definition file.

- **SW 4.3** and earlier

If the file has been loaded correctly, block `_N_INITIAL_INI` must then be copied back into the control system via the "Data in" function in the Services area.

- **SW 4.4** and higher (MMC 103)

The definition file is activated when it is loaded to the NC ("Activate" softkey).

5. Data backup

The modified GUD data contents are saved when block `_N_INITIAL_INI` is read out via "Data out" in the Services operating area. These data can only be reloaded into the control if it has first been ensured that the required definition files are in the control.

Definition and creation of user data

see /PGA/, Programming Guide, Advanced.





MMC 100.2



MMC 103

6.5 User-defined contour programming (from SW 4.3 and SW 5)

6.5.1 General



Function

User-defined contour programming is a support tool for the editor. The contour programming function enables you to create simple or complex contours.

An integrated contour calculator calculates any missing parameters for you, provided that they can be computed from other parameters. You can concatenate contour elements (up to 50 on the MMC 100.2).

Contour transition elements "radius" and "chamfer" are also provided to help you chain contour elements.

The programmed contours are transferred to the edited part program.

The following are contour elements:

- Start point
- Straight line (planar, longitudinal, inclined)
- Circular arc

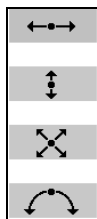

Further notes

1. This function is available for
 - MMC 100.2 SW 4.3 and higher
 - MMC 103 SW 5 and higher.
2. The valid geometry axes in the first channel are determined and used in the part program.
3. The contour editor uses the last programmed axis position when called, without allowing for previously valid G functions (MMC 103 only).
4. **SW 5.1 and earlier:** If user-defined texts are entered with the contour editor, the contour editor generates the identifier "GPNOP" at the end of the block and then inserts the user-defined text and the instruction "define gpnop as" in the program header for syntax reasons (MMC 103 only).
SW 5.2 and higher: The identifier "GPNOP" and the DEFINE instruction in the program header have been discontinued.



MMC 100.2



MMC 103

5. MMC 100.2:

As from **SW 5.3**, contour elements of the contour chain are represented by symbols (no longer by letters). In the MD you can define whether the softkeys for selecting the contour elements are to be displayed as

- as text (as before) or
 - as symbols,
- see /IAM/ IM1, Chapter 4.

6.5.2 Programming a contour



New contour

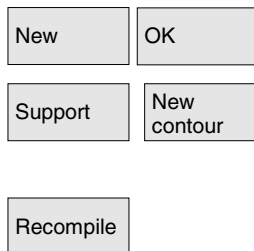

Define the starting point

Sequence of operations

Use softkeys "Workpiece" and "Part program" in the Program operating area to select an existing program or select softkey "New" to open a new part program, then enter a name and confirm with "OK". You are now back in the ASCII editor.

You can open the contour editor with the softkey "Support" and "New contour" (MMC 100.2).

You can edit an existing contour by selecting softkey "Recompile", making sure that the cursor of the Editor is positioned inside the relevant contour.

Notice

When you recompile, only those contour elements are generated that were created with free contour definition programming, and only those texts are recompiled that were appended via the input field "Free text input". Any changes you made directly in the program text are lost. However, you can insert and edit user-defined afterwards, which will not be lost.

The input screen form for the contour **start point** is displayed.

When entering a contour, begin at a position which you know and enter it as the starting point.

The default tool axis (defined in the machine data) can be changed for machines with more than two axes. The associated starting point axes are adapted automatically.



MMC 100.2



MMC 103

Accept
element

Select softkey "Accept element" to store the starting point. You can add the next element by selecting the appropriate softkey:

SW 5.3 and higher

The approach movement to the starting point can be changed from G0 (rapid traverse movement) to G1 (linear interpolation) via the new field "Approach starting point". You can define a specific feedrate for G1 via the field "Free text input",
e.g. G95 F0,3.

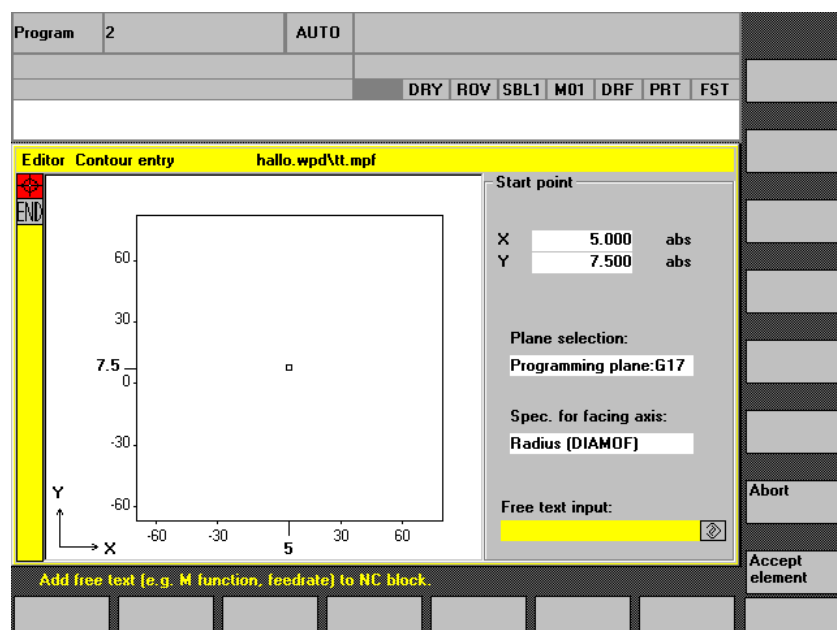

Alternative

Position the cursor on the "Facing axis dimension" field and click on the field using softkey "Alternative" (or with the "Selection" key) repeatedly until the dimension you require is displayed.

1 ... 0

Enter the values for the starting point.

Accept
element

The values you have entered are accepted when you select "Accept element", you can add the next element by selecting the appropriate softkey.

User-defined contour programming

Beginning at the starting point, enter the first contour element, e.g. a straight line. Input all the data specified on the workshop drawing: Length of straight lines, end position, transition to following element, angle of pitch, etc.

All
parameters

Select softkey "All parameters" to display a selection list of all the parameters for the contour element.



MMC 100.2



MMC 103

Horizontal
lineVertical
lineAny
line

Arc



Contour transition elements

Abort

Delete
value

If you leave any parameter input fields blank, the control assumes that you do not know the right values and attempts to calculate them from the settings of other parameters.

The contour is always machined in the programmed direction. As soon as you have entered an element, the input focus is moved to the contour chain on the left of the graphic display. The input focus has a yellow border. You can navigate within the contour chain using the cursor keys.

You can select an existing contour element with "INPUT". A new contour element is inserted after the cursor when you select one of the contour elements on the horizontal softkey menu, the input focus is then switched to the parameter input on the right of the graphic display. You can navigate around the contour chain again after selecting "Accept element" or "Abort". The following contour elements (example for turning: G18) are available for the definition of contours:

Straight line in horizontal direction. Enter the end point of the straight line (incremental/absolute can be selected with softkey "Alternative"), program the transition to the following element and then press softkey "Accept element".

Straight line in X direction.

Oblique line in X/Z direction. Enter the end point of the line as a coordinate or angle.

Arc with any direction of rotation

A transition element can be used whenever there is a point of intersection between two neighboring elements which can be calculated from the input values.

You can choose between a radius **RD** and a chamfer **FS** to be inserted as the transition between any two contour elements. The transition element is always added at the end of a contour element. You select transition elements in the parameter input screen form for the relevant contour element.

When you select "Abort", the contour element values are discarded and you return to the basic display. The input focus switches back to the contour chain.

The values for the element are deleted.



MMC 100.2



MMC 103

Parameters on gray background

These parameters have been calculated by the control system. You cannot alter them.

When the programmed parameter input fields (white background) are altered, the control calculates new data, which are then immediately displayed again in the input screen form.

Input value is already calculated

With some contours, the control system may already have calculated an input value from other settings.

Problems may then arise if the control-calculated value does not tally with the workshop drawing. In this case, you must delete the settings from which the control has automatically calculated the input value. You can then enter the setting exactly from the workshop drawing.

Settings

The technology (turning/milling) and the position of the coordinate system is read from the machine data. You can see the selected configuration with "Settings".

Free text input (MMC103)

Under "Free text input" you can enter a comment that is inserted in the program at the end of the contour (e.g. specifying the technology).

6.5.3 Contour elements



Contour chain

Function

The elements of the contour are displayed symbolically in the sequence in which they were programmed in a contour chain next to the graphic window.

Contour element	Abbrev.	Symbol	Meaning
Start point	SP		Starting point of contour
Straight line to the left	SL		Straight lines in 90° grid
Right	SR		
Left/right	LR		
Above	SU		

6.5 User-defined contour programming (from SW 4.3 and SW 5)



MMC 100.2



MMC 103

Below	SD		
Above/below	SUD		
Straight line, any	SA		Straight line with any pitch
Arc to the left	CL		Circle
Right	CR		
Contour termination	END	END	End of contour

Color of symbols

The different display colors of symbols provide information about their status:

MMC 100.2

Foreground	Background	Meaning
-	Black	Cursor on a new element
White	Black	Cursor on current element
Black	White	Normal (undefined) element
White	Black	Element currently detached (residual model)

MMC 103

Foreground	Background	Meaning
Black	Red	Cursor on a new element
Black	Green	Cursor on current element
White	Green	Normal (undefined) element
Black	Green	Element currently detached (residual model)



MMC 100.2



MMC 103

6.5.4 Graphic representation of the contour



Function

The graphics window displays the progress of the contour chain as you are parameterizing the contour elements.

The element you have selected is displayed in orange or red (MMC 103) in the graphics window.

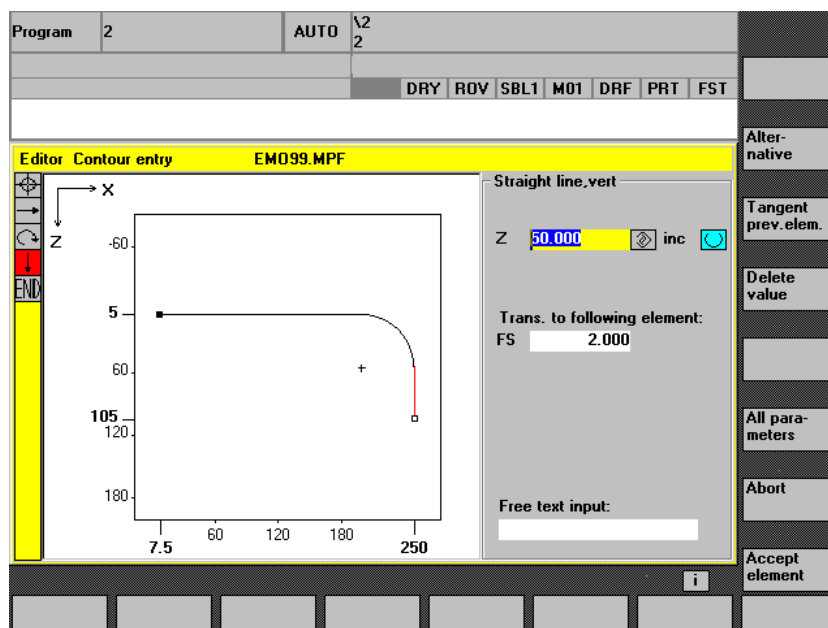

The created contour element can be displayed in various line types and colors depending on its status:

MMC 100.2	MMC 103	Meaning
Black	Black	Programmed contour
Orange	Red	Current contour element
Yellow	Green	Alternative element
Black solid line	Black solid line	Element is fully defined
Dotted line	Light blue line	Element is partially defined
Dashed line	Dashed green line	Alternative element

The current status of the contour is displayed insofar as it can be interpreted by the control on the basis of parameter inputs. If the contour is still not displayed in the programming graphic, further values still need to be entered. Check the contour elements you have already programmed. You may have forgotten to enter all the data you know.

6.5 User-defined contour programming (from SW 4.3 and SW 5)



MMC 100.2



MMC 103



The scale of the coordinate system is automatically matched to the changes in the overall contour.

The position of the coordinate system is displayed in the graphics window.

6.5.5 Input screen forms for parameterizing the contour elements



Function

Input screen forms are handled in principle according to the same procedure already described for handling contour elements STRAIGHT LINE, CONE and CIRCLE.

To help you to program a contour, the following softkeys are also available:

Tangent to previous element

Tangent
prev. elem.

With the softkey "Tangent to preceding element", angle α_2 is assigned the default value 0. The contour element has a tangential transition to the preceding element. The resets the angle to the preceding element (α_2) to 0 degrees.

Displaying additional parameters

All
parameters

If your drawing contains further data (dimensions) for a contour element, select softkey "All parameters" to extend the range of input options for the element.

Alternative

Softkey "Alternative" is displayed only in cases where the cursor is positioned on an input field with several selectable settings.

Selecting a dialog

Select
dialog

Select
dialog

Accept
dialog

Some constellations of parameters can produce several different contour characteristics. In such cases, you will be asked to select a dialog. By clicking the softkey "Select dialog", you can display the available selection options in the graphic display area.

Select softkey "Select dialog" to make the correct selection (solid line) and confirm your choice with softkey "Accept dialog".



MMC 100.2



MMC 103

Changing a dialog selection

Change selection

Select dialog

Accept dialog

If you have already chosen a dialog and want to change it, you must first select the contour element for which the dialog was required. Both alternatives are displayed again when you select softkey "Change selection".

You can select another dialog.

If the selection has become unnecessary as a result of other input values, you will no longer be requested to select a dialog!

Clearing a parameter input field

Delete value

You can delete the value in the selected parameter input field with the DEL key (MMC 103 only) or softkey "Delete value".

Saving a contour element

Accept element

If you have entered the available data for a contour element or selected the desired contour by means of softkey "Select dialog", select softkey "Accept element" to store the contour element and return to the basic display.

You can then program the next contour element.

Adding a contour element

Accept element

Use the cursor keys to select the element in front of the end marker. Use the softkeys to select the contour element of your choice and enter the values you know in the input screen form for that element. Confirm your inputs with softkey "Accept element".

Selecting a contour element



Position the cursor on the desired contour element in the contour chain, and select it with the "Input" key.

The parameters for the selected element will then be displayed. The name of the element appears at the top of the parameterization window.

If the contour element can be represented geometrically, it is highlighted accordingly in the display area, i.e. the color of the contour element changes from black to orange or to red (MMC 103).

Changing a contour element



Using the cursor keys, you can select a programmed contour element in the contour chain. The "Input" key displays the parameter input fields. These can now be altered.

Inserting a contour element

Use the cursor keys to select the contour element **behind** which you wish to insert another element.

6.5 User-defined contour programming (from SW 4.3 and SW 5)



MMC 100.2



MMC 103

Accept
element

Then select the contour element to be inserted from the softkey menu. After you have parameterized the new element, confirm the insert operation by selecting softkey "Accept element". Depending on the new state of the contour, the contour elements below are updated automatically or when the cursor arrow is played on them.

Deleting a contour element

Delete
element

Use the arrow keys to select the element you wish to delete. The selected contour symbol and associated contour element in the programming graphic are highlighted in red. Then press the softkey "Delete element" and confirm the query.

Undoing an input

Abort

By selecting softkey "Abort" you return to the basic display, **without** transferring the last edited values to the system.

Further notes

The NC code generated by the contour programming in the part program must never be altered manually. Otherwise recompilation is no longer possible.

Exception: Insertion of block numbers and skippable blocks.



MMC 100.2



MMC 103

6.5.6 Help



Function

When you enter parameters you can call up a help screen with the Info key which graphically represents the parameters you are entering. The help screen that appears depends on the cursor position in the parameter display.

The help screen covers up the display graphic.

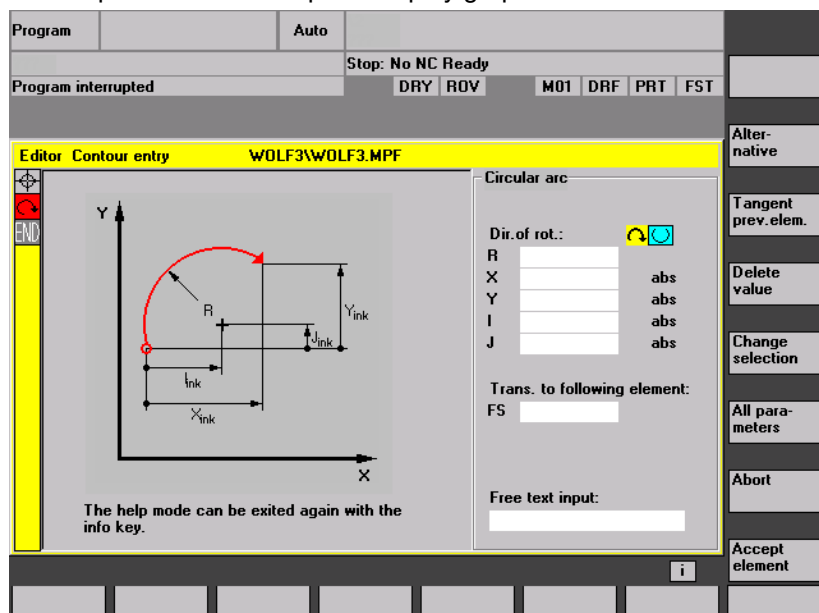

If you press the Info key again the help screen is closed and the display graphic is activated again. The help screens displayed correspond to the selected coordinate system. The axis names are derived from the current geometry axis names.

Help screens are displayed for the following entries:

- Start point
- Straight vertical line
- Straight vertical line, angle entry field
- Straight horizontal line
- Straight horizontal line, angle entry field
- Straight line, any
- Straight line any, angle entry field
- Circle
- Circle, angle entry field
- Radius/chamfer



MMC 100.2



MMC 103

6.5.7 Parameter description of straight line/circle contour elements

Parameter	Contour element "Straight line"	Unit
X absolute	Absolute end position in X direction	mm
X incremental	Incremental end position in X direction	mm
Y absolute	Absolute end position in Y direction	
Y incremental	Incremental end position in Y direction	
L	Length of line	mm
$\alpha 1$	Pitch angle referred to X axis	Degree
$\alpha 2$	Angle to preceding element; tangential transition: $\alpha 2=0$	Degree
Transition to following element	Transition element to next contour is a chamfer (FS) Transition element to next contour is a radius (R) FS=0 or R=0 means no transition element.	mm mm

Parameter	Contour element "Circle"	Unit
X absolute	Absolute end position in X direction	mm
X incremental	Incremental end position in X direction	mm
Y absolute	Absolute end position in Y direction	
Y incremental	Incremental end position in Y direction	
$\alpha 1$	Starting angle referred to X axis	Degree
$\alpha 2$	Angle to preceding element; tangential transition: $\alpha 2=0$	Degree
$\beta 1$	End angle referred to X axis	Degree
$\beta 2$	Arc angle of circle	Degree
Direction of rotation	In clockwise or counter-clockwise direction	
R	Radius of circle	mm
I	Position of arc center point in X direction (abs. or incr.)	mm
J	Position of arc center point in Y direction (abs. or incr.)	mm
Transition to following element	Transition element to next contour is a chamfer (FS) Transition element to next contour is a radius (R) FS=0 or R=0 means no transition element.	mm mm



Machine manufacturers

The names of the identifiers (X or Y ...) are defined in the machine data where they can also be changed.



MMC 100.2



MMC 103

6.5.8 Examples of user-defined contour programming



Example 1

Starting point: X=5.67 abs., Y=0 abs., machining plane G17

The contour is programmed in a counter-clockwise direction.

Workpiece drawing of contour

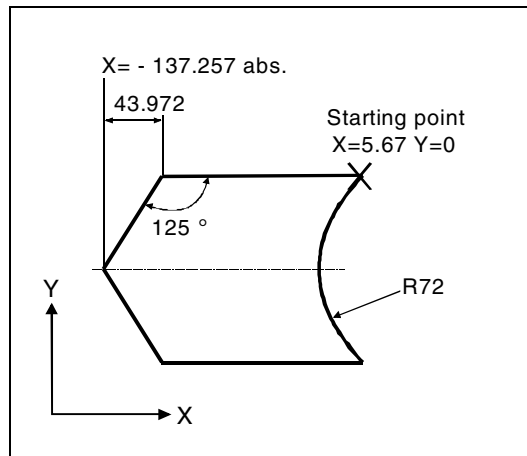

Element	Softkey	Parameter	Remarks
1	←●→	All parameters, $\alpha_1=180$ degrees	Observe angles in help screen!
2	↖↗↘↙	X=-43.972 inc, all parameters X=-137.257 abs $\alpha_1=-125$ degrees	Definition of coordinates in X in "abs" and in "inc" Observe angles in help screen!
3	↖↗↘↙	X=43.972 inc $\alpha_1=-55$ degrees	Definition of coordinates in X in "inc" Observe angles in help screen!
4	←●→	X=5.67 abs	
5	↻	CW direction of rotation, R=72, X=5.67 abs., Y=0 abs., Make a dialog selection	

6.5 User-defined contour programming (from SW 4.3 and SW 5)



MMC 100.2



MMC 103



Example 2

Workpiece drawing of contour

Starting point: X=0 abs., Y=0 abs., machining plane G17

The contour is programmed in the clockwise direction with dialog selection.

For this contour it is advisable to display all parameters via the softkey "All parameters".

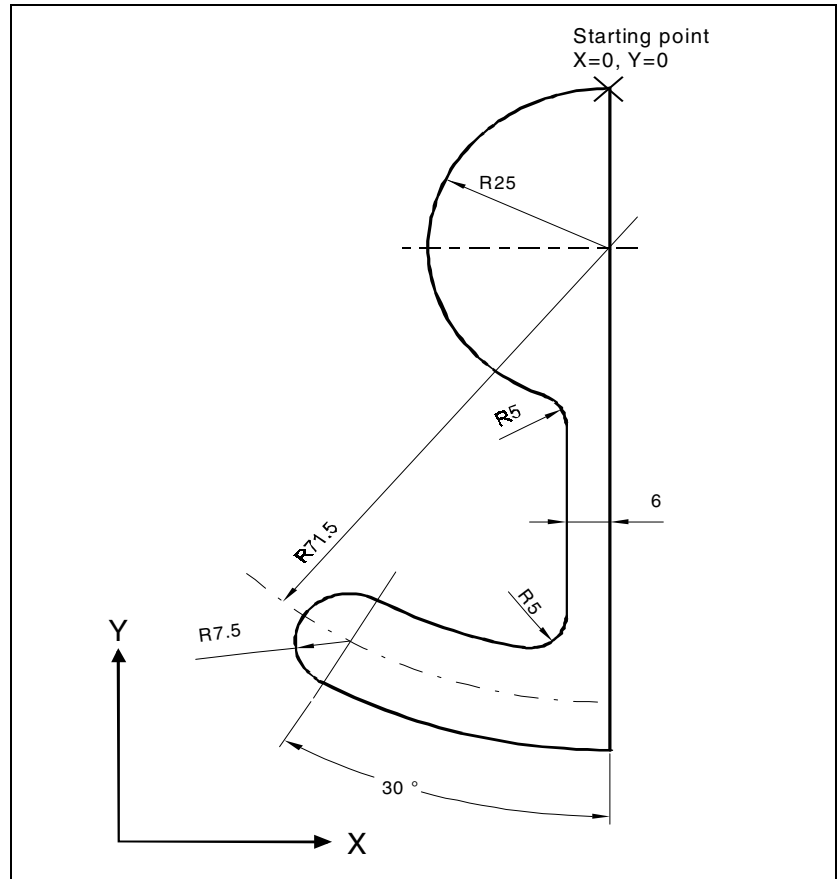

Element	Softkey	Parameter	Remarks
1		Y=-104 abs.	
2		Direction of rotation right, R=79, l=0 abs., Make dialog selection, all parameters, $\beta_2=30$ degrees	
3		CW direction of rotation, tangent to preced. R=7.5, all parameters, $\beta_2=180$ degrees	
4		Direction of rotation left, R=64, X=-6 abs., l=0 abs., Make dialog selection, make dialog selection Transition to following element: R=5	
5		All parameters, $\alpha_1=90$ degrees, Transition to following element: R=5	Observe angles in help screen!
6		Direction of rotation right, R=25, X=0 abs., Y=0 abs. l=0 abs Make dialog selection, make dialog selection.	



MMC 100.2



MMC 103

**Example 3**

Starting point: X=0 abs., Y=5.7 abs., machining plane G17

The contour is programmed in a clockwise direction.

Workpiece drawing of contour

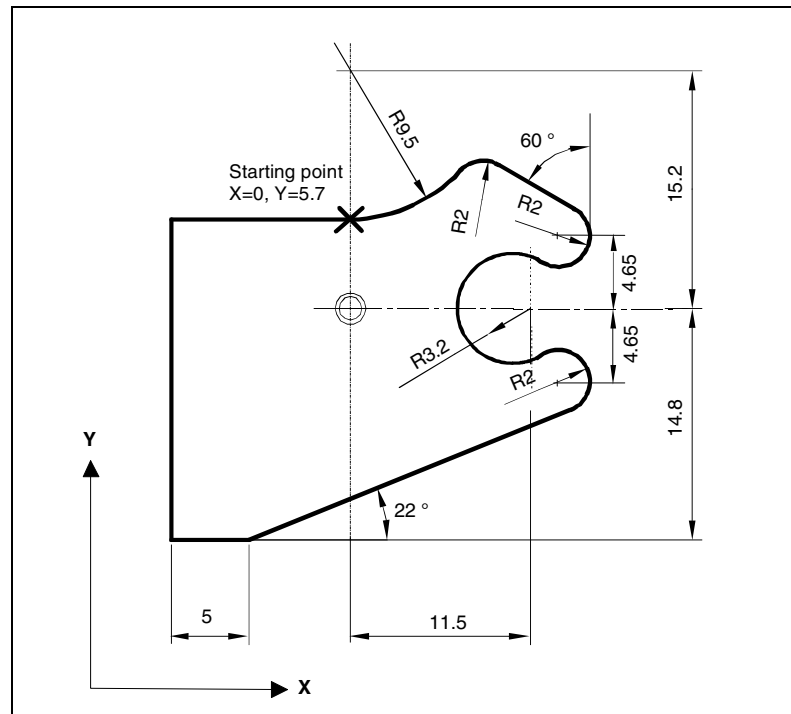

Element	Softkey	Parameter	Remarks
1		Direction of rotation left, R=9.5, I=0 abs., make dialog selection, Transition to following element: R=2	
2		$\alpha_1 = -30$ degrees	Observe angles in help screen!
3		CW direction of rotation, tangent to preced. R=2, J=4.65 abs.	
4		CCW direction of rotation, tangent to preced. R=3.2, I=11.5 abs., J=0 abs., make dialog selection, make dialog selection	
5		CW direction of rotation, tangent to preced. R=2, J=-4.65 abs., make dialog selection	
6		Tangent to previous element $\alpha_1 = -158$ degrees, Y=-14.8 abs., $\alpha_2 = 0$ degrees	Observe angles in help screen!
7		All parameters, L=5, make dialog selection	
8		Y=5.7 abs.	
9		X=0 abs.	



MMC 100.2

6.6 Program simulation MMC 100.2

6.6.1 Rotation simulation



Function

The "Simulation" function operates in conjunction with turning technology.

With the "Simulation" function you can

- represent axis motions in graphic displays and
- trace the machining result on the screen as the workpiece is actually machined.

By activating Simulation, you can execute a contour on the screen in graphic form with or without machine axis motions (can be disabled by the PLC).

Display elements

The colors in the graphic display area signify the following:

- **Red** = Traversing path in feed mode
- **Green** = Traversing path in rapid traverse
- **Yellow** = Cross-hair, polymarker (cutting edge), symmetry axis of workpiece

Cross-hair

Using the cross-hair, you can

- select the zoom center point and
- set measuring points (for window).

Cutting edge

The position of the cutting edge corresponds to the definitions in menu "Tool compensation" under softkey "Tool".

The tool path in the program block you are currently editing is simulated. The cutting edge is represented by a polymarker. The starting point of the polymarker corresponds to the starting point of the machine tool axes.

Coordinate system

The alignment of axes (coordinate system) is defined in machine data.



Machine manufacturers

Please note information supplied by machine tool manufacturer!

The display machine data are described in:

/FB/ K1, Mode Group, Program Operation Mode, Chapter 4



MMC 100.2



Simulation

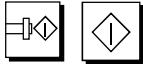

Auto-zoom

To origin

Display all

Zoom +

Zoom -

Delete window

Cursor fine

or

Cursor coarse

Close



Sequence of operations

You can select the function "Simulation" in the operating area Program.

Simulation is started by pressing the keys "Spindle start" and "NC start" on the machine control panel.

The following softkey functions are provided:

This softkey sets the size of the viewport showing the traversing movements.

You return to the initial display (size of the viewport when you select simulation). The viewport can be defined by the machine manufacturer in the machine data.

Optimizes the window for simulation purposes.

The contents of the screen are displayed in a larger or smaller resolution when you press softkeys "ZOOM+" or "ZOOM-". Using the cursor keys, you can move the cross-hair to the selected center point of the window display.

The current screen contents are deleted.

You can alter the increments of the cursor key movements with softkey "Cursor fine".

- Softkey is selected:
Cursor moves in "fine" increments.
- Softkey is not selected:
Cursor moves in "coarse" increments.

Select softkey "Close" to end the simulation.

Simulation is also aborted when you press one of the horizontal softkeys.



MMC 100.2

6.6.2 Milling simulation before machining (SW 5.2 and higher)



Simulation graphic

Function

In automatic mode you can display your program graphically in the "Program test" function before machining, without traversing the machine axes.

The simulation graphic shows a representation of a workpiece being machined by a cylindrical tool. You can select different views via softkey, e.g.

- Plan view
- Representation in three planes
- 3D representation (volume model)

Status displays

The status displays in the simulation graphic contain information

- the actual axis coordinates and
- the block currently being processed.



Option

This function is an option and is only available with a color display. Milling simulation is only possible in the 1st channel.



Precondition

Sequence of operations

- You select the program in automatic mode "Auto".
- In the Machine operating area under "Program control", the functions "Dry run feedrate" and "Program testing" (the machine is not moved while the program is run) are selected. If the function "Dry run feedrate" is active, the programmed feedrate is replaced by a dry run feedrate defined in the machine data.
- Tool T0: Tool displayed in the graphic.
- Tool not equal to T0: A corresponding tool edge must be selected.

Press the area switchover key and

the softkey "3D graphics".

The program is started.

You can follow program execution on the screen.

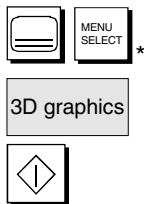



MMC 100.2

6.6 Program simulation MMC 100.2

6.6.3 Milling simulation during machining (SW 5.2 and higher)



Function

The current machining operation on the machine tool is simulated on the monitor of the control at the same time.



Option

This function is an option and is only available with a color display. Milling simulation is only possible in the 1st channel.



Sequence of operations

Precondition:



Graphic



See previous section

Press the area switchover key and the softkey "Graphic".

The program is started.

You can follow program execution on the screen.

You can start simulation at any time during the machining operation. Simulation is closed when you exit the graphic.

If you switch to another operating area, the current content of the graphic simulation is deleted.



Blank definition via input form

Details

Settings

Alternative

You can open the window Blank definition via the softkeys "Details" and "Settings".

You can enter values for corner point 1 (front top left) and corner point 2 (back bottom left) of the blank (cube).

With the softkey "Alternative" you can display/hide the view of the blank. If the view of the blank is disabled, the traversing paths are represented by broken-line graphics.

Blank definition via NC program (SW 5.3 and higher)

As an alternative, you can define a blank in the NC program to be simulated.

Syntax:

```
WRTPR("<String>")
```

The following statements can be used in the "String":

- Rectangle: BLOCK(p1x, p1y, p1z, p2x, p2y, p2z)



MMC 100.2

The positions correspond to the axis values of corner P1 (front top left) and P2 (back bottom right) of the rectangular blank.

P1x = X value of corner P1
 p1y = Y value of corner P1
 p1z = Z value of corner P1
 p2x = X value of corner P2
 p2y = Y value of corner P2
 p2z = Z value of corner P2

- Moving/rotating the graphic

FRAME (pv1, pv2, pv3, pd1, pd2, pd3)

pv1 = Moving the first axis
 pv2 = Moving the second axis
 pv3 = Moving the third axis
 pd1 = Rotating around the first axis
 pd2 = Rotating around the second axis
 pd3 = Rotating around the third axis

- Switching off the graphic: END ()
- Restoring the unmachined blank: CLEAN ()

Example

```
...
; DEFINITION of the blank
N100 WRTPR ("BLOCK(0,0,0,80,100,-30) ")
N110 ...
...
;DELETING the blank
N1000 WRTPR ("CLEAN() ")
...
```



MMC 103

6.7 Program simulation MMC 103



Function

SW 4 and earlier See /BA/, Operator's Guide, Interactive Programming, Simulation

SW 5 and later **Simulation of drilling/milling and complete turning operations**

Simulation selection The graphical simulation is implemented as a self-contained process. In addition to dialog programming selection under "Display mode", simulation in operating area "Program" can be selected directly from the program overview, after selection of a part program, or from the ASCII editor, after a part program has been opened.

Start-up Special measures (see Simulation supplement in /IAD/ Installation and Start-Up Guide 840D, Section MMC, Section about simulation) are available for optimizing the start-up phase and basic behavior of the graphic processing simulation at various points. Various operational modes also allow the user to modify the selection and response time and the memory behavior of the simulation with the aid of a settings screen form.

Cross-reference See also Description of Functions /FB/ D2, Interactive Programming

Technology versions

- Drilling/milling
- Complete turning operations
- Workpiece-specific assignment through local "dpwp.ini" file

Superimposing principle In SW 5.1 and higher, the simulation results of several part programs in succession (*e.g. for multilateral machining during milling, internal/external machining during turning, multi-slide machining, etc.*) can be superimposed on an overall display of the same blank (*see machining list in Channel/Spindle softkey*). The finished part results from the sequential interaction of all the simulated part programs. **The direct simulation of several part programs (simultaneously) is not possible.**

The scope of the part program currently selected (*displayed in the header of the simulation window*) is shown in the status line at the bottom of the simulation window (*channel, spindle, active tool, sequence pointer*).



MMC 103

ASCII editor interface

After deliberate interruptions (*simulation STOP* or *Single-block* in the main simulation menu) or on alarms, you can use the "Correct program" softkey to open the program in the editor at the point of interruption. For interruptions within protected subprograms (e.g. *cycles*), the program pointer is positioned at the line with the corresponding subprogram call.

If changes are made in the editor, simulation is returned to the last active section (*intermediate model if available*).

Additional notes

1. The integrity of the simulation data (*programs, subroutines, tool data, etc.*) is assured by **systematic time-stamp evaluation**.
2. **NC language labels** (e.g. **WAITE2: WAITM...**) ..., programmed to identify particular points in the program, **can be inserted in the simulation graphic as path labels**. You can simultaneously initiate generation of intermediate models at these points in the program (*see Managing "Settings/display and colors... \path markers"*).

6.7.1 Simulation user interface

Basic horizontal menu

Menu tree

. . . after a simulation start-up or alarm status

Match data

With the correct password (*can be set in ..\MMC2 or USER\dpsim.ini USER=n*), you can match the active simulation data (*tool data, machine data, cycles*) with the corresponding "NC active data".

⇒ See menu "Data comparison"

Time evaluation

Tabular evaluation at freely definable sections of the machining times calculated and estimated for the current simulation session (*see Chapter "Setting down times"*)

Correct program

Activate the ASCII editor from the current simulation interruption status (*cursor position synchronized with graphic, user interface: standard ASCII editor subset*)

⇒ Return to simulation with "Close editor"

Channel/spindle

Program-specific channel and spindle assignments (*activate processing list in combination with the overlay principle*)

⇒ See menu "Channel/spindle"



MMC 103

Vertical main menu



or



Simulation START or simulation STOP

(program-by-program in conjunction with the machining list)

RESET simulation

(program-by-program in conjunction with the machining list)

SINGLE BLOCK simulation mode on/off

(status display in header SBL1 or SBL2)

Milling



or

Turning



Technology-specific workpiece views

Milling: Plan view

Turning: External view, frontal

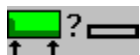

or

Milling: *Default* plan view
and front view

Turning: Full section, frontal

(free selection under "Details...")

or

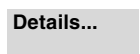
Milling: 3D view
or wire-frame modelTurning: *Default* half-section, frontal
front and wire-frame model
*(free selection under
"Details...")*Select status-dependent (*active view, alarm status*) detail menus

or

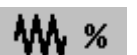

- Select user and vendor-specific setting menus
(..in RESET or STOP mode)

..or

(.. in RUN state)

- Show current simulation override bar
(% setting options:
- Increment of 10 with "+" or "-" key
- Increment of 50 with "Cursor right" or "Cursor left"
- Max/Min value with "Cursor up" or "Cursor down".
- Standard value 100 with "toggle" key)

Notes



1. On simulation START and program change, any 3D view currently displayed is automatically deselected and replaced by a technology-specific default view.
2. If you repeat machining simulation START after end of program M2/M30 of the last program to be simulated, the simulation channels are usually RESET and the simulation graphic reset if no machining list has been activated with softkey "Channel/Spindle".



MMC 103

3. If the machining list under "Channel/spindle" is activated, the overlay principle takes effect for the listed programs, where global reset in combination with a simulation START is only activated after a query on the last M2/M30.
4. New selection or reselection of one of the listed workpiece views is implicitly linked to automatic screen size adjustment.

Menu "Details...." standard horizontal . . . assuming 2 window views with no alarm status:

⇒ "Top view and front view" as default for milling

⇒ "Half section and wire-frame model" as default for turning.

Milling

Plan
view

or

Turning

External
view

With 2 window views only:

Free selection of basic view type in the window  activated with (*milling and turning*)

Front
view

or

Half-
section

ditto

Side
view

or

Full
section

ditto

Wire
model

or

Wire
model

ditto

End
face

ditto

Peripheral
surface

ditto



MMC 103

Menu "Details...." standard vertical

. . . assuming one of the active views with no alarm status:

- ⇒ "Top view" or "top view and front view" for milling
- ⇒ "Wire-frame model" (*3D without tool data*) for milling
- ⇒ All views for turning

Tool paths
on/off

or

Tool paths
on/off

Activate/deactivate representation of the tool center point path.
Deactivation also deletes any tool paths from the current model that have already been stored (*default setting: tool paths on*).



With 2 window views only: Select active window
(*also possible with "TAB" or "END" key*)

View from
front...

Conditionally with 2 window views:

"from front..." depending on type of view active (*horizontal selection*)
same meaning as "from above..." or "from left..."

View from
rear...

Conditionally with 2 window views:

"from behind..." depending on type of view active (*horizontal selection*)
same meaning as "from below..." or "from right..."

Automatic
screen size

Automatic screen size adjustment,

applies to the window activated with  in two-window views
(*also possible with "ENTER" or "INPUT" key*)

Zoom...

Show window pane border in active window
(*size can be altered with "+" - and "-" keys, position can be altered with cursor keys.*)

<<

Return to main simulation menu



MMC 103

Menu "Details..." 3D vertical



. . . assuming from the following active view, with no alarm status:

- ⇒ "3D view" (*3D with tool data*) for milling
- ⇒ Not effective for turning

Standard 3D view, orientation top/front



3D view, orientation top/left
(*Standard rotated clockwise through 90°*)



3D view, orientation top/right
(*Standard rotated counterclockwise through 90°*)



Standard 3D view, orientation bottom/front
(*Standard flipped upwards*)

Automatic screen size

Automatic resizing
(*also possible with "ENTER" or "INPUT" key*)

Zoom...

Show window pane border in active window
(*size can be altered with "+"- und "-" keys, position with "cursor" keys*)

<<

Return to main simulation menu



MMC 103

Menu "Details..." Alarms vertical



... assuming an alarm status during simulation, independent of the view currently active

Reset POWER ON alarms of simulation. The simulation is terminated and loaded again.



Reset RESET alarms of simulation. The simulation interpreter is reset. The simulation can be started again.



Reset CANCEL alarms of simulation. The simulation can be continued.

Close simulation

The simulation process is terminated. A load operation is necessary before the simulation is selected again.

Details view...

Display the menu bar "Details..." (*standard or 3D*) for the active workpiece view from alarm status. The simulation alarms remain active.



Return to main simulation menu

Additional notes

1. Simulation alarms are only messages of the simulation interpreter and have no direct association with the current NCK machining status on the machine tool.
2. If more than one simulation alarm is pending, you can show or hide the complete alarm list with the "toggle" key. You can select an alarm with the cursor keys.
3. If you press the information key "i" the online help with an explanation of the selected alarm is displayed.
4. Program sequences which cannot be interpreted in simulation contexts only and only then trigger an alarm (*e.g. in user cycles because the relevant PLC data and signals are not available in the simulation interpreter*), **must be jumped conditionally** in the corresponding NC program **with evaluation of system variable \$P_SIM during the simulation** (*..IF \$P_SIM GOTOF label*). The components relevant to simulation (*e.g. tool change position and M switching functions for tool change in tool change cycles, etc.*) cannot be skipped, they must be executed.



MMC 103

Menu "Settings..."**vertical**

. . . only accessible from the RESET or STOP state (e.g. *single block mode*) of simulation

⇒ Settable parameters: See Section "Simulation settings"

Load standard

Load vendor-specific default settings

(Source: *DH\DP.DIR\SIM.DIR\simini_m.com* for milling version
DH\DP.DIR\SIM.DIR\simini_t.com for turning version)

Options on/off

or

Options on/off

Display/hide optional setting parameters in the current window
(Initial setting: *options off*)

Change standard

With the correct password (*can be set in ..\MMC2 or USER\dpsim.ini SETUP=n*) it is possible to modify the manufacturer-specific default setting values

Downtime settings

With the correct password (*can be set in ..\MMC2 or USER\dpsim.ini USER=n*) it is possible to set the required time recording for downtimes and define estimated downtimes for the NC functions T, S, M and H selectively.

⇒ Settable parameters: See Section "Setting downtimes"

Display and colors

With the correct password (*can be set in ..\MMC2 or USER\dpsim.ini USER=n*) it is possible to modify the predefined display and color properties active in simulation.

⇒ Settable parameters: See Section "Display and colors"

Abort

Return to main simulation menu The old settings before the setting screen was selected are retained.

OK

Return to main simulation menu The modified settings are saved and activated immediately (*Destination: Workpiece or program-specific "dpwp.ini" or "for "Change standard" ..\DH\DP.DIR\SIM.DIR\simini_m.com or simini_t.com"*).



MMC 103

Additional notes

SW 5.1 and higher incorporate changes to manufacturer-specific standard setting values (*..in files "simini_m.com" or "simini_t.com"*) and in files "dpmwp.ini" or "dptwp.ini" in `..\USER\` directory as difference parameters (*delta values for "dpwp.ini" templates in ..\MMC2\ directory*) and are therefore included in all **new workpieces**.

Menu "Data comparison" vertical

Match tools

... if the correct password has been entered (operator), accessible from the RESET or STOP state of simulation via the horizontal softkey bar.

Assuming the presence of an NCK component, an automatic alignment of the NCK and simulation tool data is performed.
(Source: `..\INC-active data\TO_INI.INI` Destination: `DH\DP.DIR\SIM.DIR\..`)

Match mach. data

Assuming the presence of an NCK component, an automatic alignment of the NCK and simulation initialization data is performed.
(Source: `..\INC-active data\INITIAL.INI` Destination: `DH\DP.DIR\SIM.DIR\..`)

Match cycles

The cycles which have already been loaded into the simulation are replaced by cycles with more recent time stamps.
(Source: `NCK or MMC ..\CST.DIR` and `..\CUS.DIR`)

<<

Return to main simulation menu

Additional notes

1. If a data alignment has not yet taken place (*and the NCK component is installed*), a request is automatically issued in the form of a message when the simulation is initialized. The user is automatically informed of modifications to tool data.
2. The working cycles are loaded from the part program **once on the first call** and remain active for all subsequent simulation sessions.
3. With the softkey "Compare cycles" you can load updated cycles with a new timestamp in the simulation. Cycles with access protection are always reloaded, irrespective of the timestamp. A realignment is only necessary after changes have been made to the cycles.



MMC 103

Menu "Channel/spindle" vertical

... from simulation RESET or STOP status only

can be called up via the horizontal softkey bar

The form shows the **current machining list** of selected part programs in the current simulation session. The following parameters control the simulation sequence:

- ⇒ **Sequence:** Simulation sequence
- ⇒ **Program name:** Program identifier
- ⇒ **Channel:** Processing channel in the SIMNCK interpreter
- ⇒ **Spindle:** Location where named program takes effect:
 - ⇒ Milling: Currently not used
 - ⇒ Turning: On the main spindle, on the counterspindle, can be altered using NC keywords
- ⇒ **Skip:** The named program is ignored in the current session

Setting channels

Calls manufacturer-specific channel settings (*if password in ..\MMC2 and USER\dpsim.ini USER=n has been set*):

- Milling: Constant machine arrangement
- Turning: Machine arrangement in front or or behind turning center.

Setting spindles

Calls manufacturer-specific spindle settings (*if password in ..\MMC2 and USER\dpsim.ini USER=n has been set*):

- Milling: Currently not used
- Turning: Defines longitudinal offset for main spindle and counterspindle, longitudinal mirroring on/off, NC keyword definitions for spindle switchover.

Copy

Copy selected line of machining list into buffer.

Paste

Paste the line which has been copied/cut out of the machining list from the clipboard at the position of the selected line (*the selected line is pushed back one line*).



MMC 103

Delete

Delete the selected line from the machining list

Abort

Return to main simulation menu: Modifications to the current machining list are not saved

OK

Return to main simulation menu: Modifications to the current machining list are saved and activated with the information displayed

Additional notes

1. **To activate the machining list after a workpiece selection, it must be selected explicitly at least once with the softkey "Channel/spindle".** The list is displayed implicitly every time a program is subsequently selected from the same workpiece directory and can be added to as required. It only makes sense to define a simulation sequence using the machining list "Channel/spindle" provided if the overlay principle for part machining is used (*..i.e. when the simulation result of several part programs in succession is to be viewed at a single blank*). You must then pay special attention to the messages along the bottom of the screen form. For example, lines for which an intermediate model has already been generated contain special status displays. By selecting such a line in the machining list you can place the simulation directly on the associated intermediate model again.
2. If individual programs are simulated, the machining list default produces the correct simulation sequence even if menu item "Channel/spindle" is not selected (*and therefore without applying the overlay principle*).
3. With the correct password you can define manufacturer-specific default setting values with "Change default" under menu items "Channel settings" and "Spindle settings", which then apply **globally for all new workpieces**.
(applicable password for "Change default" can be set in ..\MMC2 or USER\dpsim.ini SETUP=n).



MMC 103

6.7.2 Simulation settings

Basic "Settings..."

Basic setting parameters are displayed immediately when the settings screen is called, without further intervention.

Optional setting parameters can also be displayed with softkey "Options on/off", if required.

- **Blank**

- Milling: without model, cuboid, cylinder

- Turning: without model, cylinder

- Display range for "Without model"

- Blank dimensions cube for "Cube"

- Blank dimensions cylinder for "Cylinder"

- ⇒ Turning: Additional active winding diameter for peripheral representation (*default: external diameter*)

- **Active view**

- Milling: X-Y, Z-X, Y-Z (*for "Cube" and "Without model" only*)

- Turning: predefined, always Z-X

- **Program control**

- Take skip blocks and/or programmed STOP into account

- Single block mode: STOP after each machine function (*SBL1*) or after each block (*SBL2*)

- Display all blocks or only traversing blocks

- **Tool data (*source*)**

- NC active data (*provided NCK component is available*)

- MMC data (*local TOA data, global SPF file, data from graphic DP tool catalog, tool data match from DH\DP.DIR\SIM.DIR\TO_INI.INI*)

- Default tool (*for milling/drilling only, with tool diameter from optional "Settings..." / default values*)

- Without tool data (*broken-line graphics with offset D0*)



MMC 103

Additional notes

1. In order to reduce the input effort when the blank type is repeatedly changed, the blank dimensions and the display area are compared internally when the settings are saved.
2. **A suitable image of the NC-active data NITIAL.INI and TO_INI.INI under DH\DP.DIR\SIM.DIR is required for simulation with the option "Tool monitoring".** Default settings for the tool management are taken from the supplementary tool data `..\mmc2\dp\sim\to_addon.ini`. Tools which are not loaded in the active magazine image (...from `TO_INI.INI`) can therefore be called during simulation if necessary .
3. In simulation "without tool data", using standard cycles results in the representation of the final contour derived from the available cycle parameters.
4. Simulation "without model" and/or "without tool data" both limits the required graphic memory and increases the simulation speed.

Optional "settings..."

- **Depths for color classification**
 - Depth range across which the available VGA system colors for displaying depth information are distributed
(*default range = blank thickness.*
The rounding inaccuracy in defining depth of color is 10^{-3} units)
- **Default values**
 - Tool diameter: Tool diameter used for milling simulation with default tool (end mill/drill) (*only if option tool management is not active!*).
 - IPO mm or inch: Approximation precision of simulation interpolator in mm or inches depends on actual measuring system.
 - F override %: Default setting of simulation feedrate



MMC 103

- **Display options**

- Actual position: Display hide actual value of simulated channel axes (*Note: TRANS, ROT, SCALE and MIRROR are not taken into account in the actual value display*).
- NC block: Activate/deactivate display of current NC block
- Machining time: Activate/deactivate display of the calculated machining time in the header of the basic simulation window
($T = \text{calculated machining time (from the programmed feedrates)}$
 $\Sigma = \text{machining time} + \text{sum of all estimated down times}$).

- **Simulation mode**

- Always reload tools
 - * In position "on" (*default setting*), all the necessary tool data are reloaded on each program change.
 - * In position "off", tool data are only reloaded if required, if the timestamp is altered (*with automatic query*). Otherwise, the existing tool environment is not changed.
- Save tool path
 - * In position "on" (*default setting*), all the tool paths in the simulation sequence are visualized and stored temporarily in the model for future manipulations (zoom, move etc.).
 - * In position "off", the resulting tool paths are visualized once and not stored temporarily in the model. When the display is subsequently manipulated in such a manner as to cause a screen refresh, the tool paths are lost.
- Block-by-block processing
 - * In position "on", discontinuous path processing, but largely accelerated (reduced number of IPO interpolation points, for example, only at block end points on straight lines).
 - * In position "off" (*default setting*), largely continuous path processing (constant distance between interpolation points depending on the IPO setting).



MMC 103

- Waiting for dwell times
 - * In position "on", program instructions with dwell times cause real dwell times in the simulation.
 - * In position "off" (*default setting*), the dwell is suppressed in the simulation and the dwell times are only taken into account in time calculations.

Additional notes

1. Changes to the blank dimensions in the infeed axis (*min or max*) are automatically traced in the depths for color separation (*min or max*).
2. High values for the interpolator approximation accuracy cause increased distortion of the geometry representation (*e.g. in details and rounded sections*), but also reduce the amount of graphics memory required and increase the speed of the simulation.
3. Recommended setting for group "simulation mode":
 - ... in production
 - Always reload tool "off" and store tool path "off"
 - Block by block preparation "on" and wait with dwell times "off"
 - ... in program mode (*default setting*)
 - Always reload tool "on" and store tool path "on"
 - Block by block preparation "off" and wait with dwell times "off"
 - ... for training
 - Always reload tool "on" and store tool path "on"
 - Block by block preparation "off" and wait with dwell times "on"
4. The following settings are recommended for demonstrations with endless program loops (accelerated execution of simulation with reduced demands on the graphic memory):
 - Always reload tool "off" and store toolpath "off"
 - Block by block preparation "off" and wait for dwell times "off"

and additionally:

- Blank "without model" (*graphic memory not used!*)



MMC 103

- possibly "without tool data", if representation of the tool center path (*broken-line graphics*) is sufficient. If the blank model is active ("*cube*", "*cylinder*"), reduced graphic memory capacity might result, which, depending on the complexity of the part and model resolution set, could exhaust the graphic memory.

6.7.3 Downtime settings

Time recording mode

Setting time recording mode for downtimes:

- **OFF** (*default setting*).
Central time recording does not include fixed downtimes or the processing of information for tabular "Time evaluation".
- **For whole programs**
Central time recording includes the elements listed in "Inclusion on" in downtime consideration. The tabular "Time evaluation" (*see horizontal softkeys*) is processed once per program in each case with M30, for example.
- **For program sections with labels**
Effect as for "whole programs", only that processing of the tabular "time evaluation" is also performed when freely definable program labels occur or in combination with the path markers displayed in the simulation graphic (*Managing "../display and colors.../path markers"*).

Inclusion

ON/OFF

Enabling and setting of fixed downtimes for:

- **Tool change**
– Definition of a fixed downtime for tool change commands
- **Spindles**
Definition of one fixed downtime for main spindle instructions and one for secondary spindle instructions
- **M functions**
– Multiple definitions of *M identification & fixed downtime*
- **H functions**
– Multiple definitions of *H identification & fixed downtime*

ON/OFF

ON/OFF

ON/OFF



MMC 100.2



MMC 103

Additional notes

With the correct password it is possible to define other manufacturer-specific default setting values with "Change default" under menu item "Downtime settings". They apply **globally for all new workpieces**. (applicable password for "Change default" can be set in ..\MMC2 or USER\dpsim.ini SETUP=n).

6.7.4 Display and colors

General attributes

Setting the general properties of the simulation graphics:

- **Rapid traverse broken line,**
Alternatively, rapid traverse as an unbroken line, as used for feedrate
- **Scale in the window margin,**
alternatively, as a scale along the coordinate axes.
- **Path label management,**
Offers various possibilities for displaying **program labels** which are have been inserted freely to identify specific points in the NC program (*watch label syntax*), **as path labels** at the corresponding point in the simulation graphics and then storing the associated graphic model in the buffer.
Program labels can also be used to mark program sections which can then be included by the central time recording facility (*see.. \Downtime settings\Time recording mode\In sections with labels*).

General colors

- **VGA color palette**
In addition to the standard VGA colors, the color elements *black* with special background properties and *transparent* to hide graphic elements are available in the color palette.
- Color selection option for **blank, axis intersection, tool holder and tool edge**.



MMC 100.2



MMC 103

- Color palettes for tool path**
 - Two freely definable color palettes are available for tool paths for differentiating between **feedrate and rapid traverse movements**.
 - In each color palette it is possible to differentiate between different **basic tool types** (*without tools, drilling tools, milling tools, turning tools, threading tools, special tools*), to allow differentiation for path visualization.
- Channel assignment of color palettes**
 - **One of the two** tool type specific color palettes can be freely assigned to each of the required simulation channels.
- Depths for color classification**
 - In the case of milling/drilling, the available colors are assigned to the defined **cutting depth range**.
 - The required cutting depth range (*default value: blank thickness*) is defined under
`..\Settings\Optional settings\Depths for color classification`

Additional notes

With the correct password you can define manufacturer-specific default setting values with "Change default" under menu item "Display and colors...", which then apply **globally for all new workpieces**. (applicable password for "Change default" can be set in `..\MMC2` or `USER\dpsim.ini SETUP=n`).

With the function block search you can start simulation in specific program blocks.

6.7.5 Section by section simulation (SW 5.2)

A procedure in which first the individual sections of a program are optimized one after the other without collision consideration is the preferred method for testing part programs graphically.

Section by section simulation allows the user to go to the individual section of the program via reference points (using block search).

The reference points are defined by path markers (program labels).



MMC 100.2



MMC 103

6.7 Program simulation MMC 103

Precondition:

- In order to manage path markers (program labels, e.g. MARKER1), they must be programmed at the required position in the program.
- With the setting "Manage path markers" (settings -> Display/Colors -> Manage path markers) you can decide whether
 - the path markers are to be displayed in the graphic and/or
 - the associated intermediate model is to be saved.

Intermediate stages of the simulation model can be stored next to the path markers, allowing synchronized resumption of simulation without resetting the graphic that already exists.

You can skip any sections that are already optimized.

Block search:

In the menu "Block search" you can select the path marker you wish to jump to.

Additional notes

- The data loaded during the simulation session (user programs, cycles, standard cycles, basic data such as initial.ini, DEF files) can be displayed in the menu below menu "Data comparison".
- You can now also load the machining list in menu "Channel/spindle" directly from the current workpiece with the softkey "Program selection" or from a JOB list.

6.7.6 Simulation for orientable toolholder (SW 5.3)



Function

You can process part programs for orientable toolholders using the simulation function. The following boundary conditions must be observed:

- The simulation distinguishes whether a toolholder Y has been activated for a tool x.
- Changes in the active toolholder are not detected. This is why the simulation uses the toolholder kinematic set initially for a tool y.
- Changes made after first activation (TCARR=x) are not considered.

6.8 Simulation with external network drive (SW 5.2)



MMC 100.2



MMC 103

- To use several toolholder kinematics for one tool y, create several identical tools with different toolholder settings.

6.8 Simulation with external network drive (SW 5.2)

With the SINDNC software, you can link your control to external network drives or other computers and use this facility for program simulation. It is possible to access files on network drives from a part program using the command EXTCALL.

- With EXTCALL, the drives in the network are also searched for subroutines (SPF only) if the program is called without a path. Subdirectories are not searched. The program will also be found if the search range is defined with the variable `$SC_EXT_PROG_PATH` or if a path to a file in the network – even in a subdirectory – has been defined.
- Programs in the network drives (with the extension MPF and SPF) can be simulated.
 - If write access is set for a network drive, file DPWP.INI is created and the current directory is treated like a workpiece.
 - If write access has not been set, a DPWP.INI is created for each network drive in the TEMP directory of the MMC irrespective of the current directory. In this case, the simulation settings are lost when the directory on the drive is changed.



MMC 100.2



MMC 103

6.9 Program management

6.9.1 Overview

To allow you to handle data and programs flexibly, you can organize, store and display them according to different criteria.

The MMC 100.2 stores data/programs in the NC memory.

MMC 103:

With an MMC 103, there are two memory areas, i.e.

- NC memory (main memory and program memory) containing the active system and user programs as well as all part programs for immediate execution and
- Hard disk

Programs can be exchanged with the program memory and hard disk. Part programs may be stored either in the program memory of the NC or on the hard disk, but they are always executed from the program memory.

The "Load" and "Unload" functions are used to load or unload programs to or from the program memory.

Program management

Programs and files are stored in different directories:

- Subprograms
- Part programs
- Workpieces
- Definitions
- Comments
- Standard cycles
- User cycles



MMC 100.2



MMC 103

The following diagram shows an example of directory contents:

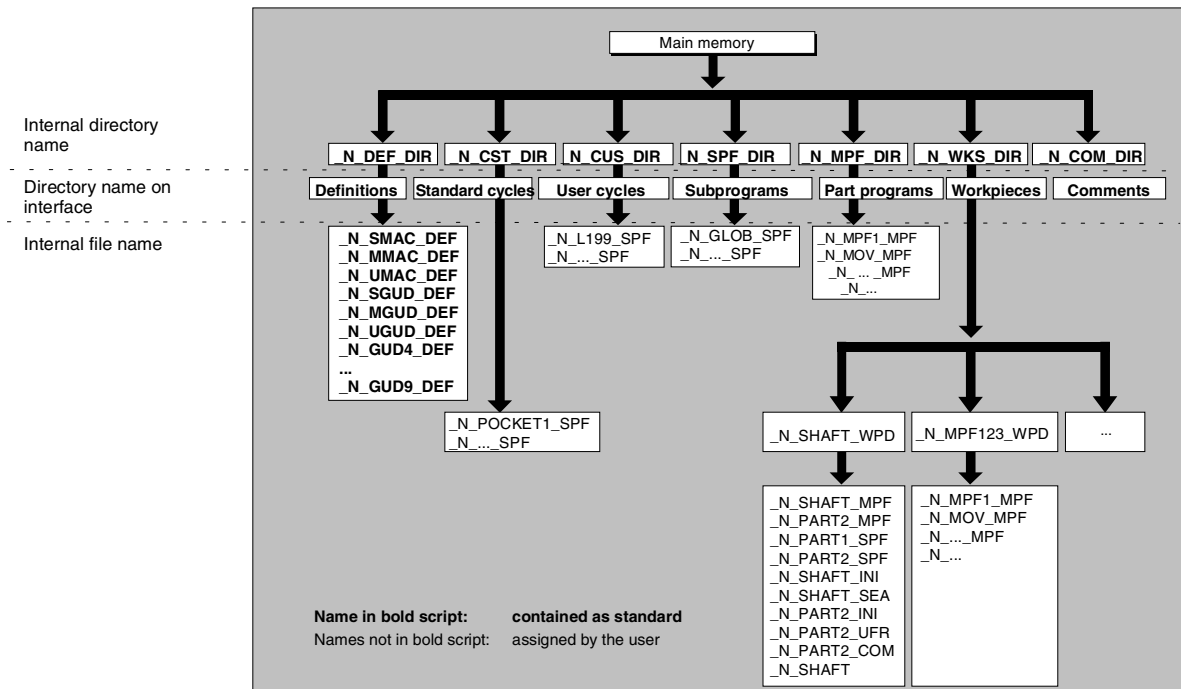

6.9.2 File types, blocks and directories

File types

File types can be identified by the file name extension (e.g. .MPF).

<i>name</i> .MPF	Main program
<i>name</i> .SPF	Subroutine
<i>name</i> .TEA	Machine data
<i>name</i> .SEA	Setting data
<i>name</i> .TOA	Tool offsets
<i>name</i> .UFR	Zero offsets/frame
<i>name</i> .INI	Initialization file
<i>name</i> .COM	Comment
<i>name</i> .DEF	Definition of global user data and macros

Block (FM NC only)

All files required for programming and program execution are known as blocks.

Program block (FM NC only)

Program modules contain the main programs and subprograms of part programs.



MMC 100.2



MMC 103

Data block (FM NC only)

NC data unit: Data blocks contain data definitions for global user data. The data can be initialized directly on definition.

Initialization block

Initialization blocks contain the default settings for data. The initial block is an ".ini" file. It contains values for initializing, for example, machine, user and system data, etc.

Macro block

Macro blocks are used to program one or more instructions with a single new name. Macro definitions are stored in the following files in directory *Definitions*:

- `_N_SMAC_DEF` Siemens macro definitions
- `_N_MMAC_DEF` Machine manufacturer macro definitions
- `_N_UMAC_DEF` User macro definitions

Reserved definition names for macros

The following macro definitions can be stored as standard:

<code>_N_SMAC_DEF</code>	Macro definitions (Siemens)
<code>_N_MMAC_DEF</code>	Macro definitions (machine manufacturer)
<code>_N_UMAC_DEF</code>	Macro definitions (user)
<code>_N_SGUD_DEF</code>	Definitions for global data (Siemens)
<code>_N_MGUD_DEF</code>	Definitions for global data (machine manufacturer)
<code>_N_UGUD_DEF</code>	Definitions for global data (user)

Directory types

In addition to files, some directories may also have extensions:

<code>name.DIR</code>	General directory which contains program and data blocks, workpiece directories and other directories with extension <code>DIR</code> .
<code>name.WPD</code>	Workpiece directories which contain program and data blocks that belong to a workpiece. (It must not contain another directory with the extension <code>DIR</code> or <code>WPD</code> .)
<code>name.CLP</code>	Clipboard directory: Files and directories of <u>any</u> type may be stored in here.

Workpiece directory

Workpiece directories (with extension `.WPD`) are set up in directory `WCS.DIR`.

A workpiece directory contains all the files that are required to machine a certain workpiece.

These can be main programs, subprograms, any initialization programs and comment files.



MMC 100.2



MMC 103

Example:

Creation of a workpiece directory `SHAFT.WPD` that contains the following files:

<code>SHAFT.MPF</code>	Main program
<code>PART2.MPF</code>	Main program
<code>PART1.SPF</code>	Subprogram
<code>PART2.SPF</code>	Subroutine
<code>SHAFT.INI</code>	General initialization program of data for the workpiece
<code>SHAFT.SEA</code>	Initialization program setting data
<code>PART2.INI</code>	General initialization program of data for program PART2
<code>PART2.UFR</code>	Initialization program for frame data for program part 2
<code>SHAFT.COM</code>	Comment file

6.9.3 File handling**Assigning values to data**

A series of modules/data is permanently installed in the control during start-up.



The structure and handling of these files is described in the Installation Guide.

Reading out data

You can save files via interfaces to external devices (PG diskette) (see Chapter *"Services" Operating Area*).

When saving files in punched tape/ASCII format, the entire path from which the file was saved is entered in the backup file.

The source path is specified in the second line:

File `SHAFT.MPF` was saved from the workpiece directory (`WCS.DIR`) under workpiece `SHAFT.WPD`.

Example:

```
%_N_SHAFT_MPF
; $PATH=/_N_WCS_DIR/_N_SHAFT_WPD
N10 G0 X... Z...
M2
```

The internal name of the file directories is e.g. `_N_WCS_DIR`.

For a complete backup of all data in a directory, the identifier `COMPLETE` is used for saving.



MMC 100.2



MMC 103

6.9 Program management

Reading in data

The complete backup of all data from all directories (INITIAL over all areas) is saved in the INI file `_N_INITIAL_INI`.

When you read in a file (see Chapter *Operating Area Services*) the path entered when you saved the file is used. The system tries to read the file in to the directory from which it was saved. If the path is missing, then files with file type `SPF` are stored in `/SPF.DIR`, files with extension `.INI` in the active working memory and all other files in `/MPF.DIR`. Files are immediately effective after import.

Activating data

Data can be activated/edited by loading files (see Chapter *"Services" Operating Area*) into the working memory. The exact time of activation depends on the type of data activated in the file.
(see References: `/LIS/`, Lists)

For example, machine data can take effect (depending on type) either

1. immediately or
2. on "RESET" or
3. on "NC Start" or
4. on "POWER ON" – when the control is switched on.

Selecting a workpiece

You can select a workpiece that you wish to machine in a channel (see Chapter *Operating Area "Machine"*).

If a main program of the same name exists in the workpiece directory, it is automatically selected for execution. If you choose workpiece `SHAFT.WPD`, then main program `SHAFT.MPF` is automatically selected.

If an `.INI` file of the same name exists, it is executed immediately (i.e. it is loaded into the working memory of the NC). Main programs with other names must be selected explicitly.

If a control has several channels, programs can be selected for processing and started from one part program for another channel.

Example:

The workpiece directory
`/WCS.DIR/SHAFT.WPD`
contains files
`SHAFT.SPF` and `SHAFT.MPF`.



MMC 100.2



MMC 103

Selection

When you select workpiece directory `SHAFT.WPD` you implicitly select program `SHAFT.MPF`.

SW5 and later (MMC 103 only):

If a `.JOB` file with the same name is stored in the workpiece directory, then it is executed immediately.

See also Chapter "Joblist (SW5 and higher)" and "Sequence of operations "Executing joblist"".

Find path for program call

If the call path for a subprogram (or an initialization file) is not explicitly specified in the part program, a fixed search strategy is applied to find the called program.

Case 1:

When a subprogram is called by

name with specification of the file type ("identifier" or "extension"), e.g. `SHAFT1.MPF`,

the system searches through directories in the following order:

- | | |
|---|---|
| 1. Current directory / <i>name.type</i> | Workpiece/standard directory <code>MPF.DIR</code> |
| 2. <code>/SPF.DIR / name.typ</code> | Global subroutines |
| 3. <code>/CUS.DIR / name.typ</code> | User cycles |
| <code>/CST.DIR / name.typ</code> | Standard cycles |

Case 2:

When a subprogram is called by

name without specification of the file type ("Identifier" or "Extension"),

e.g. `SHAFT1`,

the system searches through directories in the following order:

- | | |
|--|---|
| 1. Current directory / <i>name</i> | Workpiece/standard directory <code>MPF.DIR</code> |
| 2. Current directory / <i>name.SPF</i> | |
| 3. Current directory / <i>name.MPF</i> | |
| 4. <code>/SPF.DIR / name.SPF</code> | Subroutines |
| 5. <code>/CUS.DIR / name.SPF</code> | User cycles |
| 6. <code>/CST.DIR / name.SPF</code> | Standard cycles |

`/PGA, Programming Guide, Advanced`





MMC 100.2



MMC 103

6.9 Program management

6.9.4 New workpiece/part program



Selecting a workpiece/part program

The following subsection describes how you can select workpieces and part programs in a directory. A selected file can then be called and edited in the text editor.



Sequence of operations

Select workpiece/part program:

- Workpieces
- Part programs
- Subprograms
- Standard cycles (MMC 100.2)
- User cycles
- Clipboard

Workpieces

Part programs

Subprograms

Standard cycles

User cycles

Clipboard



Position the cursor in the directory on the desired file.

For each file, the file name, file type, length, date of creation/last change are displayed.

You can change the properties of the file display (see Section "Startup", "Settings" menu)



Call a part program:

Use the cursor to select a program in the program overview and press the "Input" key.

The text editor is displayed with the file you have selected.

You can now edit the part program.



Open a workpiece:

The workpiece directory is opened and the programs it contains displayed on the screen.



MMC 100.2



MMC 103



Workpieces

New



Create workpiece directory

You can set up various types of files such as main programs, initialization files, tool offsets, etc. in the new workpiece directory.

Sequence of operations

The current overview of all workpiece directories appears on the screen.

Input window "New" is opened.

The cursor is located in the input field for the name of the new workpiece directory.

Enter the name of the new directory on the alphanumeric keyboard.

A new directory is set up in the workpiece overview.

The system immediately requests the name of the first part program and the Editor or Interactive Programming function is opened.

SW 5 and later (MMC 103 only):

You can create your own templates for job lists or standard part programs/subprograms with the name of the workpiece in the workpiece directory.

For more detailed information, see Chapter "Joblist (SW 5 and higher)" under "Creating the file "Workpiece.JOB" (e.g. SHAFT.JOB)".



MMC 100.2



MMC 103



New



Set up programs/data in a workpiece directory

This section explains how you can set up a new file for a part program or workpiece.

Sequence of operations

The current overview of the workpiece directories stored on the NC appears.

Position the cursor on the required workpiece and open it.

You obtain an overview of the data and programs that have already been set up under the workpiece directory. If no data exist, an empty program overview is displayed.

A dialog box appears when you select softkey "New".

Enter the new file name.

You can also enter the corresponding file type using the "Toggle key". Some of the possible file types are listed below:

File type	Meaning
.MPF	Main program (Main Program File)
.SPF	Subroutine (Sub Program File)
.TOA	Tool offset (Tool Offset Active)
.UFR	Zero offset (User Frame)
.TEA	NC machine data (Testing Data Active)
.SEA	Addresses with assigned values (Setting Data Active)
.COM	Comment file
.INI	Initialization data
.GUD	User data (global)
.LUD	User data (local)
.EEC	Spindle pitch/encoder error compensation
.QEC	Quadrant error compensation
.CEC	Sag/angularity compensation
.TOP	Tool plan (for SINTDI)
.TCM	Tool plan, unformatted (for SINTDI)
.JOB	Job list
.RPA	R parameter
.TMA	Magazine data
.PRO	Protection zones



MMC 100.2



MMC 103

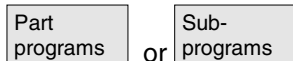

Number of workpieces (MMC 103)

Creating part programs in part program/subprogram directory:

You can set up main programs and subprograms by opening directories "*Part programs*" and "*Subprograms*".

Select softkey "*New*" to display a dialog window in which you can enter the names of the new main programs and subprograms.

The matching file type is automatically assigned in this case.

You can manage up to 310 workpieces/programs/files in each directory on the MMC 103.

6.9.5 Storing setup data (SW 5.2 and higher)



Function

With the softkey "*Storing setup data*", you can store all the active data belonging to a particular workpiece located in the RAM of the NC.

The data are stored for each channel under the same name under a workpiece.

Additional notes

"*Storing setup data*" can be disabled by the manufacturer using the protection levels.



Sequence of operations

The current overview of all workpiece directories appears on the screen.

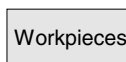

Place the cursor on the workpiece directory or workpiece in which you want to store the workpiece-specific data.

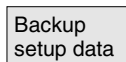

The input window "*Store workpiece data*" is opened when you select "*Save setup data*".

In this input window you can select the workpiece data that you wish to back up.

E.g. you can select the following data types:

- R parameters (RPA)
- Zero offset (UFR)



MMC 100.2



MMC 103

- Setting data (SEA)
- ...

If a job list exists, it is used as the basis for the backup procedure.

With the softkey "Save", you store the workpiece data of the selected data types into the relevant workpiece directory.

If a job list exists in this workpiece directory, the data for all the channels involved in the workpiece are automatically backed up. For this, the main program selected at the beginning is searched for each channel in the job list. The data are then backed up according to the data types selected under its name.

With the softkey "Load standard" you can load the default settings for input window "Store workpiece data".

Note:

Default settings are always supplied by SIEMENS.

If you want to define your own defaults in the input window, press this softkey.

6.9.6 Selecting a program for execution



Function

Workpieces and part programs must be selected for machining/execution before you press the NC Start key.



Sequence of operations

Select a program:

Use the cursor keys to select a program in the

program overview, e.g. part programs, and

then press softkey "Selection".

The program name is displayed in the "Program name" window at the top right.

You can start the part program by pressing "NC Start".





MMC 100.2



MMC 103

Workpieces



Selection



Select a workpiece:

A workpiece directory can be selected for machining in the currently active channel.

Use the cursor keys to select the workpiece

in the workpiece overview and then

press softkey "Selection".

- If this directory contains a main program of the same name, then this is automatically selected for the machining operation (e.g. when workpiece `SHAFT.WPD` is picked, main program `SHAFT.MPF` is automatically selected).

The program name is output along with workpiece information in the "Program name" window at the top right.

You can start the part program you have selected by pressing the "NC Start" key.

- If an INI file of the same name exists, it will be executed immediately you select the part program (e.g. `SHAFT.INI`).
- **SW 5 and higher (MMC 103 only):**
Machine data 11280 `$MN_WPD_INI_MODE` controls which programs are executed in a workpiece directory.

Machine manufacturers

See machine manufacturer's specifications

Preconditions:

- a main program (MPF) in the workpiece directory is selected
- "NC Start" has been pressed

`$MN_WPD_INI_MODE=0:`

The INI file with the same name as the selected workpiece is executed.

E.g. if `SHAFT1.MPF` is selected, `SHAFT1.INI` is executed with "NC Start".

(the response is the same as in previous versions)

`$MN_WPD_INI_MODE=1:`

All files with the same name as the selected main program and extensions `INI`, `SEA`, `GUD`, `RPA`, `UFR`, `PRO`, `TOA`, `TMA` and `CEC` are executed in the specified order.

6.9 Program management



MMC 100.2



MMC 103

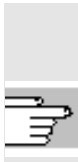

- The main programs stored in a workpiece directory can be selected and processed by several channels.

For further information, please see
/IAD/, 840D Installation and Start-Up Guide, Chapter MMC

6.9.7 Loading/unloading a program (MMC 103)



Function

Programs can be stored in the NC memory ("*Load*") and then erased from it again ("*Unload*") after execution. This prevents the NC memory from being overloaded unnecessarily.



Sequence of operations

Position the cursor on the program to be loaded.



Load

The highlighted program is loaded from the hard disk to the NC memory.



The selected program is deleted on the hard disk.

SW 5 and later:

See also Chapter "Joblist (SW5 and higher)".

Change
enable

If enable is set "(X)", the program can be executed.

Unload

The highlighted program is unloaded from the NC memory to the hard disk.



The selected program is deleted in the NC memory.



Additional notes

Programs which have been loaded to the NC memory are automatically marked with an "(X)" (in the "Loaded" column) in the program overview.

If the file is located both in the MMC and in the NC, the identifier "X" is only removed when the files are no longer identical.



MMC 100.2



MMC 103

If the files have different time stamps or are of different lengths, the identifier is "!X!".

SW 5.2 and higher:

If you want to "load/unload" a workpiece directory and a job list with the name of the directory exists in the job list, that job list is executed.

If a job list does not exist, all the files in that directory are loaded/unloaded (RAM of NC might overflow!).

6.9.8 Storing a program



Save
file



Function

You can save the changes in a program that you have unloaded with the function "Save file".

Sequence of operations

Changes are saved in the file loaded in the editor.

Additional notes

Please note that the changes to programs stored in the NC memory take immediate effect.

MMC 103:

The save options for the control system can be altered in the "Settings" menu (e.g. save automatically, etc.).
(See Chapter "Start-up")



MMC 100.2



MMC 103

6.9.9 Enabling



Function

The program overview indicates whether a workpiece or part program is enabled.

If a program is enabled, it may be executed (e.g. because it has already been tested) by the control after you select softkey *"Program selection"* and the *"NC Start"* key.

If you set up a new program, it is automatically enabled.



Sequence of operations

To set the enable for a program or abort it, position the cursor on the desired workpiece or part program in the program overview.

Select softkey *"Change enable"*.

A cross indicating *"Enable issued"* appears behind the workpiece or part program.

(X) Enable issued (program may be executed)

() Not enabled (program must not be executed)

Change
enable

Additional notes

- The system checks whether a program may be executed when the program is called (after selection via operator input or from part program). If an enable is required it must have been set previously. (See also Chapter 6 *"Changing properties of file/directory/archive"*)

6.9.10 Copying/inserting



Function

This subsection explains how files can be copied.



Sequence of operations

The softkey *"Manage programs"* must be pressed (MMC 103).

Manage
programs



MMC 100.2



MMC 103



Copy



Insert



OK



Position the cursor on the file that you want to copy and press the softkey "Copy".

The file is marked as the source for copying.

Press the softkey "Insert", enter a new name and confirm with "OK".

When you insert a workpiece directory, you can also change the file type with the "Toggle key". The file types are matched automatically in the global part program and in the global subprogram directory.

Additional notes

- Only files can be stored in a workpiece directory but not other workpiece directories.
- If the target specified is incorrect an error message is output.
- If a workpiece directory is copied, all the files that it contains are copied at the same time.

SW 5.2 and later:

- If the files of a workpiece directory are copied to a new directory, all the files with the same directory name are renamed to the new workpiece directory name.
- If a job list with the name of the directory exists, the instructions in that job list are also renamed.

This function applies to operating area "Program" only.

When you copy under "Services", the names remain unchanged.

See also section "Renaming".

- When you **copy to diskette** the full file names are stored on the diskette.



MMC 100.2



MMC 103

6.9.11 Renaming



Manage programs



Rename



Function

As regards files, you can alter their name as well as the associated file type.

Sequence of operations

The softkey "Manage programs" must be pressed (MMC 103).

Position the cursor on the file you want to rename.

The "Rename" dialog window opens.

Enter the new name.

When you rename a workpiece, you can also change the file type with the "Toggle key".

File types are matched automatically in the part program and subprogram directories.

SW 5.2 and later:

There are two ways of renaming files:

- Renaming the workpiece directory
- Renaming a directory in the workpiece directory

Renaming a workpiece directory:

When you rename a workpiece directory, all the workpiece files under that directory that have the same name as the directory are renamed.

If a job list with the name of the directory exists, the instructions in that job list are also renamed.

Comment lines remain unchanged.

Example:

Workpiece directory A.WPD renamed to B.WPD:

All files with the name A.XXX are renamed to B.XXX, i.e. the extension is not altered.

If a job list called A.JOB exists, it is renamed to B.JOB.

If this job list contains instructions of file A.XXX located in this workpiece directory, then that file is also renamed to B.XXX.



MMC 100.2



MMC 103

Example:

If job list A . JOB contains an instruction

```
LOAD/WCS . DIR/A . WPD/A . MPF
```

it is renamed to

```
LOAD/WCS . DIR/B . WPD/B . MPF
```

However, if a job list contains the instruction

```
LOAD/MPF . DIR/A . MPF or
```

```
LOAD/WCS . DIR/X . WPD/A . MPF
```

the files are not renamed.

Renaming a directory in the workpiece directory

If you rename the files in the workpiece directory, all files with the same name but a different extension are renamed.

Exception: If a job list of the same name exists in the directory, then this one is not renamed.

6.9.12 Deleting

Manage
programs



Delete

Function

This section explains how you can delete workpieces or files.

Sequence of operations

The softkey "Manage programs" must be pressed (MMC 103).

Position the cursor on the workpiece or the file you want to delete.

Delete several files:

If you wish to select several files, position the cursor on the first file, press the "Select" key and then position the cursor on the last file. The files you have selected are highlighted.

The prompt "Do you really want to delete the file?" appears.



MMC 100.2



MMC 103

 OK

Confirm your input.

Additional notes

- You can only delete programs that are not currently running.
- If you want to delete a workpiece directory, make sure that none of the programs it contains is currently selected.
- If a workpiece directory is deleted, all the files that it contains are deleted at the same time.

6.9.13 Log (MMC 103)



Function

If you are working on the hard disk of the MMC 103, the following data are included in the log:

- Name of program currently being executed (for "Processing from external source")
- Names of previously executed programs
- Prompts, e.g. *"Do you really want to delete job?"*
- Error list: Names of previously executed programs in which an error occurred.



 Log

Select softkey *"Log"*.

The *"Job log for programs"* window opens.

Depending on the status of the current program run, the following functions can be executed by means of the vertical softkeys (e.g. when prompt *"Really delete?"* is displayed in the *"Query"* window):

 Yes

All

No

Stop

- The program currently being executed is deleted.
- All programs in the current job list are deleted.
- The program currently being executed is not deleted.
- The program currently being executed is aborted.



MMC 100.2



MMC 103

6.10 Memory info (MMC 100.2)



Function

You can call a display showing the total available NC memory space.



Sequence of operations

The entire free/assigned NC memory is displayed in KB.



Additional notes

On the MMC 103, the total available memory space is displayed permanently in the dialog line.

6.11 Accessing an external network drive/computer (from SW 5.2)



Function

With the SINDNC software, you can link your control to external network drives or other computers.

Precondition:

- The SINDNC software is installed.
- The computer or drive which you want to link up to is accessible/enabled.
- A connection to the computer/drive has been established.
- The softkeys for selecting the drive/computer link have been configured by making entries in the file "MM.INI", see /IAM/ Installation and Start-Up Guide MMC



Sequence of operations

You can access the softkeys for the external drive or computer in the Program operating area via the "Etc." key. Horizontal softkeys 1 to 4 are reserved for this.

When you press a softkey, e.g. "Drive F:" or "R4711" the Explorer appears on the screen with the data of the external drive, e.g. "Drive F" or of computer "R4711".



MMC 100.2



MMC 103

You can perform the following operations (in addition to paging) via the vertical softkeys in the Program operating area:

- Copying/inserting files (no directories) from network drives to the data management. You can change the type in accordance with the target directory.
- Copying/inserting files (no directories) from the data management or a network drive to other network drives. The files are set up on the network drive using DOS naming conventions. The file name used in the data management (source) is maintained.
- Deleting files (no directories) on the network drives
- Simulation
- Editing files (find/go to, mark block, change) if write access to the drive is enabled.
- Files on the network drives can be simulated. This applies to files with the identifier MPF or SPF.

Additional notes

- If the drive/computer is not connected or enabled, the message "No data available" is displayed.
- Multiple selection is not possible on network drives.
- A root directory can only be selected as the destination for copying to a network drive if "." is displayed.
- In the Machine operating area, only files with an MMC-compatible name can be selected for "Exec. f. harddisk" (i.e. up to 27 characters, no special characters, no blanks).
- In operating area Program, the functions Copy, Insert, and Delete can only be applied to files **without** blanks in their name.
- The file name is displayed as it would be in the Windows Explorer with a long file name, but only up to 25 characters are displayed.
- Multiple selection in the file manager of the Program operating area is not possible.

"Services" Operating Area

7.1	Function	7-357
7.2	Directory structure	7-357
7.2.1	NC active data	7-357
7.2.2	Hard disk (MMC 103)	7-358
7.2.3	Directories	7-359
7.2.4	Data selection.....	7-361
7.3	Formats for saving and importing data.....	7-365
7.3.1	Punched tape format.....	7-366
7.3.2	PC format	7-370
7.4	V.24 interface parameters	7-371
7.4.1	Interface parameters	7-374
7.5	MMC 100.2	7-378
7.5.1	Services basic display	7-378
7.5.2	Setting the interface	7-379
7.5.3	Reading in data via the V.24 interface	7-381
7.5.4	Storing data from the clipboard	7-383
7.5.5	Reading out data via the V.24 interface	7-384
7.5.6	Reading out PLC alarm texts and cycle texts.....	7-385
7.5.7	Series start-up.....	7-386
7.5.8	Error/transmission log	7-387
7.5.9	Importing/exporting ISO programs via V.24 (SW 5 and higher).....	7-389
7.5.10	Restoring the original state via NC card (SW 4.4 and higher)	7-393
7.6	MMC 103	7-394
7.6.1	Services basic display	7-394
7.6.2	Setting the V.24 interface	7-397
7.6.3	Reading in data	7-398
7.6.4	Reading out data	7-400
7.6.5	Log	7-401
7.6.6	Defining and activating user data (GUD).....	7-403
7.6.7	Importing/exporting ISO programs (SW 5 and higher).....	7-406
7.7	Start-up functions (MMC 103)	7-411
7.7.1	Series start-up.....	7-411
7.7.2	Restoring the original state via NC card (SW 4.4 and higher)	7-413
7.7.3	Software update	7-414
7.8	Managing data (MMC 103)	7-416
7.8.1	Creating a new file/directory	7-416

7.8.2	Loading/unloading	7-416
7.8.3	Copying/inserting	7-417
7.8.4	Deleting.....	7-418
7.8.5	Changing the properties of a file/drive/archive	7-419



MMC 100.2



MMC 103

7.1 Function



The "Services" Operating Area provides the following functions:

- Read data in/out
- Manage data
- Series start-up

7.2 Directory structure

All files are organized in a directory structure.

MMC 100.2:

Files in the NC memory, sorted according to keywords.

MMC 103:

Files in the NC memory and on the hard disk, sorted in "file trees" in directories.

The names of the directories are the same as the keywords on the MMC 100.2.

7.2.1 NC active data

MMC 103:

The NC memory contains data (e.g. R parameters, tool offsets, machine data) that are not stored there in file format.

The directory "*NC Active data*" is provided in the file manager to allow the user to access these data and store them on the hard disk in file format.

This directory contains an overview of data that can be copied from the NC memory.

If the operator wishes to save data in files on the hard disk, they can set up the same directory structure under a directory of any name for "*NC data*" (.MDN).

Via "Copy/paste" any active data can be fetched from the NC and stored in files on the hard disk.

7.2 Directory structure



MMC 100.2



MMC 103



NC-active data cannot be unloaded.

MMC 100.2:

NC-active data can be displayed and selected in the "Read data out" menu. They can be transferred, e.g. to a PC, via the V.24 interface.

7.2.2 Hard disk (MMC 103)

General information

In addition to the NC working memory, SINUMERIK controls with MMC 103 are provided with a hard disk. It is thus possible to store all data or programs which are not required in the NC on the hard disk.

All data are displayed in a single file tree on the user interface. In the "Services" operating area, all files on the hard disk and in the NC memory can be:

- transferred to and from diskette via two V.24 interfaces,
- managed (new, load, unload, copy, delete, rename),
- saved for a series start-up (NC, PLC and MMC data) and
- loaded to the NC memory (programs and files).

Interfaces

The parameters of the two V.24 interfaces are also set in the "Services" operating area. The device-specific interface parameters and the communication protocol can be defined and stored separately for each V.24 interface.

Additional notes

The end of block character is displayed not as "LF" but as "¶".

System queries

The system behavior when copying/creating data (e.g. overwrite existing files or query first) can be configured for all operating areas.



MMC 100.2



MMC 103

Display

The file tree display can be modified by the user:

- Display of file properties
- Number of displayed directories



Data management limits:

Each directory can contain a maximum of 310 entries (workpieces/part programs).

7.2.3 Directories

The following directories contain special files:

1. Clipboard:

Files and directories of any type may be created/stored in the clipboard.

They can also be selected for processing here.

MMC 103 only:

The clipboard is a directory on the hard disk, where files, which cannot be included in the copy target directory, are stored. This may be the case, for example, if their file type is unknown, or is not permitted in the copy target directory.

2. Archive:

MMC 103:

If you wish to save several files, you can store them in an archive file (.ARC). Archive files are generated in a special format:

- Punched tape format
- PC format

(see also Sections "Punched tape" and "PC format")

The source path of files stored in an archive file is also saved in the archive, allowing the packed file to be transferred back to the same directory from which it was copied when the archive file is unpacked again.

Series start-up archives are also stored in this directory.

MMC 100.2:

Files must be stored on an external computer, e.g. by means of the PCIN data transfer program.



MMC 100.2



MMC 103



3. Workpiece:

All files (tool programs, tool data) needed to machine a workpiece can be stored in the "Workpieces" (.WPD) directory.

Like a part program, a workpiece can be selected in the NC for machining.

When a workpiece is selected for machining, an INI file (if available) of the same name as the workpiece is loaded to the NC and the main part program with the same name as the workpiece is automatically selected.

If there is no part program/MPF with the same name, an error message is issued and the previously selected part program remains active.

If there is no INI file with the same name (e.g. to activate tool_data), then other initialization blocks can be executed.

Example:

SHAFT.WPD	is selected
SHAFT.MPF	is displayed as the selected program in the status area
SHAFT.INI	is loaded to the working area of the NC and then processed



MMC 100.2



MMC 103

7.2.4 Data selection

You can read the following selection of file types in or out via the V.24 interface:

File type	Meaning
.MPF	Part program (Main Program File)
.SPF	Subprogram (Sub Program File)
.TOA	Tool offset (Tool Offset Active)
.UFR	Zero offset (User Frame)
.TEA	NC machine data (Testing Data Active)
.RPA	R parameters with assigned values (R Parameter Active)
.SEA	Addresses with assigned values (Setting Data Active)
.COM	Comment file
.INI	Initialization data
.GUD	User data (global)
.LUD	User data (local)
.WPD	Workpiece directory
.SYF	System files
.OPT	Options
.BOT	Boot files for 611D
.DIR	Directory
.DEF	Definition data
.CEC	Sag/angularity
.QEC	Quadrant error compensation
.EEC	Measuring system error compensation

7.2 Directory structure



MMC 100.2



MMC 103

**Additional file types on
MMC 103**

File type	Meaning
.AWB	Display description, user display
.CST	Display list
.ARC	Archive file. It contains any amount of back-up files and can be stored only in the "Archives" directory in readable punched tape/ASCII format or in non-readable PC/binary format.
.KLB	Configurable list display
.SUP	Setup parameters from circularity test
.SUD	Setup diagram from circularity test
.MCC	Torque control loop parameters
.DAC	D/A conversion configuration data
.FGC	Function generator configuration data
.MSC	Speed control loop parameters
.PLC	PLC operand screen
.BMP	Bit map for interactive programming tools
.DSC	Geometry processor macro description
.MAC	Geometry processor macro code
.LDB	Technology memory list structure
.MDB	Technology memory data
.CTC	Conversion specification for tool management
.WMF	Windows Metafile: Exchange format (for tool management)



MMC 100.2



MMC 103

Keywords/directories in the hierarchical file structure

The different files are made available for transfer under the following keywords (MMC 100.2) or directories (MMC 103):

- Data (general)
 - Option data
 - Machine data (all, NC MD, channel MD, axis MD)
 - Setting data
 - Tool offsets
 - Zero offsets
 - Global user data
 - R parameters
- Start-up data
 - NCK data
 - PLC data
- Compensation data
 - Leadscrew/encoder error
 - Quadrant error
 - Beam sag/angularity
- Display machine data
- Workpieces
- Global part programs
- Global subprograms
- User cycles
- Standard cycles
- Comment data
- Definitions
- Feed drives
- Main spindle drives
- OEM data
- System data
 - ASUB1
 - ASUB2
 - IBN
 - OSTORE1
 - OSTORE2
 - Versions
- Logbook
- Communications error log

If your control includes additional directories, these can be found in the file tree.

7.2 Directory structure



MMC 100.2



MMC 103



Services

Data
selection



User

Maintenance

Default
settings



OK

Abort

Data selection

The *"Data selection"* function allows you to select the directories that you wish to see displayed in the file tree.

The directories can be selected for two different access levels:

- User
- Maintenance

Sequence of operations

The *"Services"* operating area is selected.

Press softkey *"Data selection"*.

The *"Data selection for display"* window is opened.

The vertical softkey bar changes.

You can page through the window using the *"Page"* keys.

You can toggle between the settings

- User
- Maintenance
- Default settings

The softkey *"Standard values"* assigns default values to the settings *"User"* or *"Maintenance"*. These are suitable defaults that are supplied in the software.

Select, for example, the *"User"* setting. Position the cursor on an additional directory.

Mark the directory of your choice and press softkey *"OK"*.

A reset command by means of softkey *"Abort"* for the selected access level resets the data selection.



MMC 100.2



MMC 103



Additional notes

The file tree displays files that the operator may view on the basis of his or her access rights.

7.3 Formats for saving and importing data

Path name

The path name is automatically entered when files are saved (archived).

The path is named in the first line of a file:

```
;$PATH=/_N_WCS_DIR/_N_SHAFT_WPD
```

When the file is re-imported into the control, it is stored in this path. If no path name is specified, then files with identifier `.SPF` are stored in `SPF.DIR` (subprograms), files with extension `.INI` in the working memory and all other files in `MPF.DIR` (part programs).

Example of file with path name:

```
%_N_SHAFT_MPF
;$PATH=/_N_WCS_DIR/_N_SHAFT_WPD
N10 G0 X... Z...
...
M2
```

NC-active data

A backup of an entire directory of NC active data is saved in a single file whose name starts with

COMPLETE....

All NC-active data, with the exception of compensation data, are saved in file `INITIAL.INI`.

Using commands

- COMPLETE or
- INITIAL

you can set up an `INI` file:

`INITIAL.INI` that includes all areas (see also Section "Directory structure").

/IAD/, Installation & Start-up Guide



Formats

Files can be stored in two different formats in archive files:

- a) Punched tape/ASCII format
- b) PC/binary format

7.3 Formats for saving and importing data



MMC 100.2



MMC 103



- With the "Data out" function, files are **always** stored in an archive file with one of the formats named below.
- Files can be stored **without** format conversion only when the "Manage/copy data" function is used.

7.3.1 Punched tape format

1. Only files with displayable characters, i.e. files set up in the text editor, can be saved in this format. Binary data are excluded.
2. Files in punched tape format can be edited with the text editor.
3. Files can be set up externally in punched tape format provided that they are formatted in compliance with the format specified below.
4. If a file is set up manually, it must begin with %<name>, "%" must be typed in the first column of the first line. An archive in punched tape format may contain several files, each of which must begin with %<name>.

The structure of archive files in punched tape format is as follows:

```

<Leader>                                ;can be included
%1st file name
;$PATH=1st path name                    ;can be included
1st block                               NL ;contents of file 1
2nd block                               NL
...                                     NL
last block                               NL

%2nd file name
;$PATH=2nd path name                    ;can be included
1st block                               NL ;contents of file 2
...                                     NL
last block                               NL
...                                     ;contents of file n
last block                               NL

<Trailer>                               ;can be included

```



MMC 100.2



MMC 103

<Leader>

Information of any type (characters with ANSI values < ANSI value 32 (blank)) which is not part of the useful data on the punched tape. They might be positioned at the beginning of the tape so that it can be inserted into the punched tape reader.



When the archive file is read, a check is made to determine whether it was saved with a leader. If it was, then it is read in again with a leader.

NL

Character for block end/new line; ANSI value 10 (0x0A)

%

Identifier positioned in front of a file name. The identifier must be positioned in the first column of the relevant line (at beginning of block).

File names

1. File names can include the characters 0...9, A...Z, a...z or _ and must not be more than 24 characters long.
2. File names must have an identifier of 3 characters (_xx).
3. Files in punched tape format can be set up externally or edited with an editor. The file name of a file stored internally in the NC memory starts with "_N_".
A file in punched tape format begins with %<name>, "%" must appear in the first column of the first line.

Examples:

```
%_N_SHAFT123_MPF = part program SHAFT123 or
%Flange3_MPF     = part program Flange3
```

;\$PATH=

Path statement; identifier in front of a path name. The path statement must always be programmed as the next block after the file name. The ";" character in the path statement must be positioned in the first column of the relevant line (at beginning of block).

7.3 Formats for saving and importing data



MMC 100.2



MMC 103

Path names

1. Path names end in `_DIR` (directories) or `_WPD` (workpieces).
2. Path names may contain the characters `0...9`, `A...Z`, `a...z` or `_`.
3. Paths must be specified absolutely (starting with `"/`). The separator for the directory hierarchy is `"/`.
4. A path in punched type format begins with `;$PATH=<pathname>` in the first column of the program.
Path names in punched tape format start with `_N_` and end in `_DIR` (any directory) or `_WPD` (workpieces directory).

Example:

```
;$PATH=/_N_WKS_DIR/_N_PIVOT_WPD
Workpiece directory PIVOT in directory Workpieces
```



The data listed after the file name/path name belong to the file with the name specified after `"%"` in the directory specified after `;$PATH="`.

<Trailer>

Any information (characters with ANSI values < ANSI value 32 (blank) and not equal to ANSI value 10 (0x0A)) which is not part of the useful tape data.

Search strategy when no path is named

If no path is named in the punched tape format, the specified file name must be interpreted when the file is read into the control so that the file can be stored at a suitable position in the file tree.

Files are stored in the file tree according to the following strategy:

File name in tape format	Converted internal file name	Interpreted internal path	Stored in directory
<code>%*_INI</code>	<code>_N_*_INI</code>	<code>/_N_NC_ACT_DIR</code>	NC-active data
<code>_%N*_XXX</code>	<code>_N*_XXX</code>	<code>/_N_XXX_DIR</code>	XXX /_N_NC_DIR
<code>%MPFn</code>	<code>_N_MPFn_MPF</code>	<code>/_N_MPF_DIR</code>	Part programs
<code>%SPFn</code>	<code>_N_SPFn_SPF</code>	<code>/_N_SPF_DIR</code>	Subprograms
<code>%Ln</code>	<code>_N_SPFn_MPF</code>	<code>/_N_SPF_DIR</code>	Subprograms
<code>%*</code>	<code>_N*_MPF</code>	<code>/_N_CLIP_DIR</code>	Clipboard

* = any file name

n = any program number (e.g. MPF123)



MMC 100.2



MMC 103



Examples

- The search strategy is applied only if no path has been named. Paths detected using the search strategy are otherwise overwritten by the " ; \$PATH=" statement.
- Spaces in the name are ignored.

1. *.MPF files

- PC format:

Part program

%MPF123

Directory: Part program

(/_N_MPF_DIR)

- Punched tape format:

Part program

;%_N_MPF_MPF

Directory: Part program

; \$PATH=/_N_MPF_DIR

2. *.INI files

- PC format:

Part program

%COMPLETE_TEA_INI

Directory: NC-active data

(/_N_NC_ACT_DIR)

- Punched tape format:

Part program

;%_N_COMPLETE_TEA_INI

Directory: NC-active data

; \$PATH=/_N_NC_ACT_DIR

3. Part programs with name which cannot be assigned

- PC format:

Part program

%HUGO

Directory: Clipboard

(/_N_CLIP_DIR)

- Punched tape format:

Part program

;%_N_HUGO_MPF

Directory: Clipboard

; \$PATH=/_N_CLIP_DIR



MMC 100.2



MMC 103

7.3.2 PC format

Files which contain non-displayable characters/binary format can only be saved in PC format.

- Some file types such as ARC, BOT, AWB, TRC, BIN, BMP, ... can be saved **only** in PC format.

The PC format contains a header in which a checksum specifying the useful contents is entered. This sum is checked when the file is re-imported to ensure that all file contents have been transferred correctly.

References: /IAD/, Start-Up, Section "*Line checksum*"

- A PC format may also include commands such as NC RESET, PLC_STOP (not on MMC 100.2) or PLC_MEMORYRESET (not on MMC 100.2). For this reason, start-up and update archives are always stored in PC format.
- If you save files in PC format and then edit them with a text editor, you will not be able to re-import them again. The file cannot be edited or else the checksum will no longer be correct.
- Start-up and update data must always be saved in PC format.





MMC 100.2



MMC 103

7.4 V.24 interface parameters

Protocol

As soon as the V.24 transmission starts, detailed messages indicating the current transmission status are output in the dialog line of SERVICES. These messages are:

"Wait for CTS signal"
 "Wait for DSR signal"
 "Wait for Xon character"
 "Data transfer active"

The following protocols are supported for transmission via the V.24:

- XON/XOFF and RTS/CTS,
- Software Flow Control and Hardware Flow Control

XON/XOFF

It is possible to set the two modes on the user interface for V.24 transmissions, i.e. Wait for Xon for data receive and Send Xon for data transmission. The default setting is H11 or H13.

Input: By selection in display "Interface" with the cursor keys and the "Input" key.

One possible way of controlling transfer is to use control characters XON (DC1, DEVICE CONTROL 1) and XOFF (DC3). If the buffer of the peripheral device is full, it sends XOFF and XON as soon as it can receive data again (= default).

RTS/CTS

The RTS signal (Request to Send) controls the send mode of the data transmission equipment:

Active: Data can be transmitted.

Passive: The CTS signal (Clear to Send) is the acknowledgment signal for RTS and confirms that the data transmission equipment is ready to send.

7.4 V.24 interface parameters



MMC 100.2



MMC 103

Baud rate

Input: By selection in display "Interface" under "baud rate" with the selection key

300 baud
600 baud
1200 baud
2400 baud
4800 baud
9600 baud (default)
19200 baud

:

115200 baud (MMC 103)

With SW 4.3 and later, a baud rate of up to 115 kbaud (MMC 103) can be set. A baud rate of >19200 baud can be set depending on the connected device, cable length and electrical environmental conditions.

Data bits

Number of data bits for asynchronous transmission.

Input: By selection in display "Interface" under "Data bits"

- 7 data bits
- 8 data bits (default)

Parity

Parity bits are used to detect errors:

The parity bits are added to the coded characters to make the number of places set to "1" an odd number (odd parity) or an even number (even parity).

Input: Selected in the "Interface" display under "Parity"

- No parity (= default)
- Even parity
- Odd parity

Stop bits

Number of stop bits for asynchronous transmission.

Input: Selected in the "Interface" display under "Stop bits"

- 1 Stop bit (= default)
- 2 Stop bits



MMC 100.2



MMC 103

Special functions

The following special functions are also provided. These can be activated in the "Interface" display.

A checkbox with a cross in it means: special function active.

Overwrite with confirmation only

- Active: On reading in a check is made to determine whether the file already exists in the NC.
- Inactive: Existing files are overwritten without confirmation.

Block end with CR LF

- Active: For output in punched tape format, characters CR (Carriage Return, hexadecimal OD) are inserted after every line feed (LF).
- Inactive: No insertion of CR characters.
(On MMC 103: Archive format)

Stop on end of transmission character

- Active: Text mode: The end of transmission character is active.
- Inactive: Binary mode: The end of transmission character is not evaluated.
Default value for end of transmission character is hexadecimal 1A.

Evaluate DSR signal (not on MMC 103)

- Active: Transmission is interrupted if the DSR signal is missing (connection 6 of connector X6).
- Inactive: The DSR signal has no effect.

Leader and trailer

- Active: Skip leader on input, output 120x0(hex) on output (feed before and after data).
- Inactive: Both leader and trailer are read in.
No 0(hex) leader on output.
Read-in is automatically recognized on all MMCs

7.4 V.24 interface parameters



MMC 100.2



MMC 103

Punched tape format:

- Inactive: Output of archives in SINUMERIK 840D archive format.
- Active: Output of programs according to DIN 66025 e.g. SINUMERIK 840D programs: Program starts with %<filename>, %MPF<xxx> or %SPF<xxx>.

Time monitoring

- Active: Transmission is aborted after 5 seconds in the case of transmission errors or end of transmission (without end of transmission character). This function is controlled by a timer that is activated with the first character and reset every time a character is transmitted.
- Inactive: Transmission is not aborted.

The time monitoring function can be set on the MMC 103.



7.4.1 Interface parameters

Parameters for serial printer

Default setting: V.24 printer

A printer with a serial interface must be connected with the appropriate cable (line check on CTS).

Device type	RTS-CTS	Start with XON
Baud rate	9600	Start of program with LF
Stop bits	1	X End of block with CR LF
Parity	None	X Stop with end of transmission character
Data bits	8	Evaluate DSR signal
XON	11 (H)	Leader and trailer
XOFF	13 (H)	X Punched tape format
End of transmission	0C (FormFeed)	Time-out



MMC 100.2



MMC 103

Parameters for archiving with PG/PC

Default setting: V.24 PG/PC

Device type	RTS-CTS	Start with XON
Baud rate	9600	Start of program with LF
Stop bits	1	End of block with CR LF
Parity	None	Stop with end of transmission character
Data bits	8	X Evaluate DSR signal
XON	11 (H)	Leader and trailer
XOFF	13 (H)	Punched tape format
End of transmission	1A	X Time-out

This setting allows files in SINUMERIK 840D PC format to be archived and imported.

"Stop with end of transmission character" must not be selected for transmission of MSD and FDD files.

With ASCII data, other settings are possible. These must agree with those of the PG programming unit. Cable 6FX 2002-1AA01 is intended for this.

7.4 V.24 interface parameters



MMC 100.2



MMC 103

Parameters for DIN programs

Default setting: V.24 user

Device type	RTS-CTS	Start with XON
Baud rate	9600	Start of program with LF
Stop bits	1	X End of block with CR LF
Parity	None	X Stop with end of transmission character
Data bits	8	X Evaluate DSR signal
XON	11	Leader and trailer
XOFF	13	X Punched tape format
End of transmission	1A	Time-out

With this setting, programs are read in conforming to DIN (beginning with %).

Punched tape input/output

The *"With leader and trailer"* checkbox must be activated for tape readers and punches.

If the punched tape reader is controlled by CTS, the *"Stop with end of transmission character"* checkbox must also be activated.

The tape reader can be stopped if necessary to allow the tape to be inserted. This is done by pressing *"Data in"*, *"V.24"* and *"V.24 STOP"* (not on MMC 100.2).

Device type	RTS-CTS	Start with XON
Baud rate	9600	Start of program with LF
Stop bits	2	End of block with CR LF
Parity	None	X Stop with end of transmission character
Data bits	8	X Evaluate DSR signal
XON	00	Leader and trailer
XOFF	00	X Punched tape format
End of transmission	00	X Time-out



MMC 100.2



MMC 103

Reading in binary data (FDD, MSD)

Device type	RTS-CTS	Start with XON
Baud rate	9600	Start of program with LF
Stop bits	1	End of block with CR LF
Parity	None	Stop with end of transmission character
Data bits	8	Evaluate DSR signal
XON		Leader and trailer
XOFF		Punched tape format
End of transmission	00	Time-out



MMC 100.2

7.5 MMC 100.2

7.5.1 Services basic display

All transferable data/programs are output in the "Services" basic display.

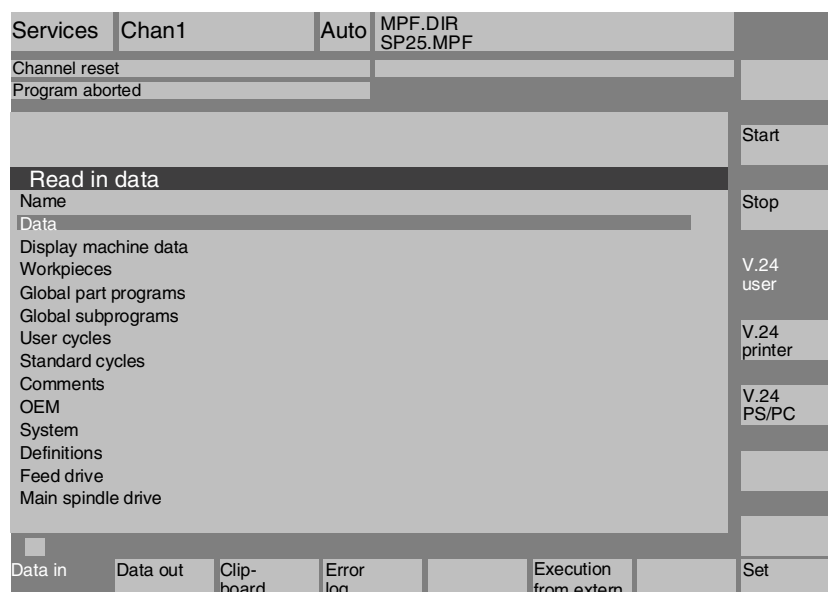

Horizontal softkeys

Read in data

The "Read in data" menu is opened.

Read out data

The "Read out data" menu is opened.

Clipboard

The "Clipboard" menu is opened.

Error log

You obtain information about the data transmission which has taken place.

Execution from extern

Step-by-step loading and execution of external programs can be initiated in this screen.

Set

The interface parameters of the currently selected interface can be changed.



MMC 100.2

Start

Stop

V.24
user

V.24
printer

V.24
PG/PC



Vertical softkeys

Data read-out is started.

The data output operation is aborted.

You can select the V.24 interface via

- V.24 user
- V.24 printer
- V.24 PG/PC.

The following applies in the "Services" operating area:

- Changes resulting from data transmissions are accepted and stored. Any modifications are thus retained when the NC powers up again.
- The selected window is closed. The next data tree display is displayed in the selected view.

7.5.2 Setting the interface



Function

You can output files to an external data storage device or read them in from there via the V.24 interface. The V.24 interface and your data backup device must be compatible. The control provides you with an input screen form for this purpose in which you can define the specific data for your device.

You have the option of selecting three different V.24 interface parameter sets:

1. V.24 user
2. V.24 printer
3. V.24 PG/PC



MMC 100.2



 Services

 V.24
user

 V.24
printer

 V.24
PG/PC

 Set

 Save
setting

Sequence of operations

The "Services" operating area is selected.

Select one of the three softkeys for the V.24 interface. The softkey remains marked so that you can see what you have selected.

- V.24 user
- V.24 printer
- V.24 PG/PC

Press softkey "Set" if you wish to alter the interface parameters for the currently selected interface (softkey is highlighted). The name of the interface to be set up is displayed in the title.

Position the cursor on the input fields and enter the required values.

The values of parameters "Device type", "Baud rate", "Stop bits", "Parity" and "Data bits" are selected with the "Toggle key" by switching through the fields.

You can also activate and deactivate special functions using the "Toggle key".

Close the parameter setting display by pressing the "Save setting" softkey.

The data for the interface are stored with the values you have entered.

(See also Section "Interface parameters")



MMC 100.2

7.5.3 Reading in data via the V.24 interface



Services

Data in

V.24
user

V.24
PG/PC



Back

Start

Function

It is possible to read data into a particular directory or into the clipboard via the V.24 interface.

Sequence of operations

The "Services" operating area is selected.
The interface for your data unit is set correctly.

When you press softkey "Data In", the currently selected V.24 interface parameter settings are stored.

Via the vertical softkey bar select the interface:

- V.24 user
- V.24 PG/PC

Position the cursor on the desired directory in the directory tree.

You can return to the main directory overview by pressing softkey "Back".

When you press softkey "Start", data are read in and stored in the specified path.

Path/workpiece from archive file

To archive files using the "Data out" function, the directory paths from which the files were read are stored with the other data in archiving format.

The stored paths are interpreted on import and the files are copied back to the directories from which they were backed up (NC default MPF.DIR).

In punched tape format, the ;\$path= statement is applied.

Path/workpiece from archive file

Irrespective of the archived path name, all files are stored in the directory selected beforehand with the "Direction keys".



MMC 100.2

OK

Stop

Start

Read into clipboard

All archived data are stored in the clipboard regardless of the archive path name.

The data are read in. The message *"Transmission in progress"* is displayed.

The display shows *"Path/workpiece"*, *"File"* and the number of transmitted *"bytes"*.

You can interrupt data import at any time by pressing the *"Stop"* key.

If you press softkey *"Start"* again, the data import recommences from the beginning.

Additional notes

- The control system cannot call specific data for import.
- If you have selected the *"Overwrite and confirm"* option, existing files are overwritten after your confirmation. On rejection, reading in continues with the next file.
- Only data that have an extension which is known to the system can be read in.
- When importing with the setting "without file end character" or "without timeout", transmission must be stopped with the STOP softkey.
- Transmission is not complete until the window "V.24 (RS 232C running)" is closed.
- If a program is overwritten when data are read in, the NC deletes the program at the beginning of the transmission operation and inserts the program again when all data have been transferred.

The BOOT files/initialization file `INITIAL.INI` produce the basic setting of the machine.

- The *"Path from workpiece/archive"* box must be checked for the V.24 interface before the Start command is given.
This applies both to data in archive format and in punched tape format.
- An *"NC Reset"* must then be carried out to make the machine data operative.

Reading in machine data



MMC 100.2

7.5.4 Storing data from the clipboard



Services

Clipboard



Copy and
paste

OK



Back

Function

You can store data from the clipboard in a new directory, copy or delete them.

Sequence of operations

The *"Services"* operating area is selected.

Data have been read into the *"Clipboard"* directory via the *"Data in"* interface.

Press softkey *"Clipboard"*.

The vertical softkey bar changes.

The cursor is positioned on a file in the *"Clipboard"* window. The selected window is active.

Select source:

Position the cursor on the file that you wish to place in the data structure of the control.

Position the cursor in the top window by selecting the *"Window selection"* key. The top window is then active.

Select target:

Position the cursor on the target directory in which you wish to place the file you have just located.

A confirmation window is displayed.

If you wish to retain the file name stored in the clipboard, confirm by pressing softkey *"OK"*.

If you want to use another file name, enter the new name and terminate your input by pressing softkey *"OK"*. The file is copied into the target directory and is not deleted from the clipboard.

Go back to the directory overview by pressing softkey *"Back"*.



MMC 100.2

Delete

Delete

You can only delete data from the clipboard with the *"Delete"* key.

Files stored in the clipboard are not automatically deleted when placed in the data structure.

You must yourself ensure that the clipboard is cleared so that it does not take up too much memory space unnecessarily.

7.5.5 Reading out data via the V.24 interface



Function

You can read data out of the control system via the V.24 interface to a device (e.g. PC) connected to the interface.



Sequence of operations

Services

The *"Services"* operating area is selected.
The interface for your data unit is set correctly.

Data out

The *"Data out"* window is opened.

 V.24
user

Via the vertical softkey bar select the interface:

- V.24 user
- V.24 PG/PC
- V.24 printer

 V.24
PG/PC

 V.24
printer

Position the cursor on the desired directory in the directory tree.

Back

You can return to the main directory overview by pressing softkey *"Back"*.



MMC 100.2

Start

The data are read out. The message *"Transmission in progress"* is displayed.

The display shows *"Path/workpiece"*, *"File"* and the number of transmitted *"Bytes"*.

Stop

You can interrupt data export at any time by pressing the *"Stop"* key.

Start

If you press softkey *"Start"* again, the data export recommences from the beginning.

7.5.6 Reading out PLC alarm texts and cycle texts



Function

You can read out PLC alarm texts and cycle texts.



Sequence of operations

Services

The *"Services"* operating area is selected.

Data out

The *"Data out"* window is opened.

You can choose any of the following texts from "Texts":

- PLC alarm texts (user)
- PLC alarm texts (standard)
- Standard cycles
- User cycles



MMC 100.2

7.5.7 Series start-up



Services

Manage
data

Start



Function

This function allows you to archive or read in a selection of PLC, NC and MMC data for the purpose of performing a series start-up.

Sequence of operations

The "Services" operating area is selected.

Press softkey "Manage data" (MMC 103 only).

Select directory "Start-up data" in the "Read data out" window. Press the Input key to branch to sub-directories in which you can select, for example, NC data or PLC modules.

Reading series start-up archive:

Start reading in the archive.

A dialog box is displayed in which you must confirm imports with OK in order to avoid mistakenly deleting all NC data. This dialog box must also be confirmed with OK.

Additional notes

Once you have completed a series start-up, do not forget to perform a power ON/Reset on the NC.



MMC 100.2

7.5.8 Error/transmission log



Function

A log listing data that have been imported and exported can be output in the Services operating area.

The log contains

1. For files to be output
 - the file name including path specification and
 - an error acknowledgment.
2. For files to be input
 - the file name and the first line which usually contains the path name ;\$PATH= . . . and
 - an error acknowledgment.

Transmission messages

The following messages may appear during transmission:

"OK"

Transmission has been terminated correctly.

"ERR EOF"

The end-of-text character has been received but the archive file is not complete.

"Time Out"

Transmission terminated by time-out.

Archive: Not completely transmitted, last file not stored.

Punched tape: Completeness cannot be checked, last file stored.

"User Abort"

Transmission terminated with *"Stop"* key.

Archive: Not completely transmitted, last file not stored.

Punched tape: Completeness cannot be checked, last file stored.

"Error Com 1"

Error at COM1 port

overrun buffer: Overflow at input buffer

overrun: Overflow at COM1 port

parity error: Parity error or

frame error: Frame error (data/stop bits/data transfer rate)

broken line/no DSR: DSR signal missing (wire break)

or BREAK (interruption) was received.



MMC 100.2

"NC/PLC Err or xxyzzzz"	<p>Error message from NC:</p> <p>xxyy Error code and error class signaled by the NC</p> <p>zzzz MMC-internal error number</p> <p>The NC cause of error is logged together with a short single-line text.</p>
"Error DATA"	<p>Data errors:</p> <ol style="list-style-type: none"> 1. File read in with leader/without leader or 2. Files sent in punched tape format without file name (PCIN).
"Error File Name"	The file name or path does not follow the naming conventions of the NC, e.g. special characters in the name or no 3-character extension.
"Tape format illegal"	Drive data (binary-coded data) can only be saved in 840D archive format (punched tape format not active).
"Tape format required"	Output of logs in punched tape format only.
"Rem CREG"	Reset register X39: Indication that the V.24 interface has been reinitialized.



Services

Error
log

Sequence of operations

The "Services" operating area is selected.

You can display information about the data transfer operation by pressing softkey "Error log".



MMC 100.2

7.5.9 Importing/exporting ISO programs via V.24 (SW 5 and higher)



Function

ISO programs can be imported and exported to and from the MMC 100.2 in punched tape format.

Additional notes

In SW 5.1 and later, you can import and export programs from the FANUC 0 control system.

The punched tape format for ISO programs (ISO punched tape format) is different from the Siemens MMC punched tape format.

The first line of a punched tape in ISO format must have the following format: %<Title>LF or %<Title>CRLF,

The title can be omitted and blanks can be skipped. The title may not start with one of the following characters:

0...9, a...z, A...Z or _.

No title is generated when a punched tape is generated in ISO format.

Siemens program headers are introduced by %<Name> and path
;PATH=<Path> in the next block.

ISO program headers are recognized from O<xxxxx (Title)> or
:<xxxxx (Title)> without path in the next block.

x stands for a number between 0 and 9. Between one and four digits can be specified, leading zeros can be omitted.

During export, ISO program headers are only tagged with O<...> and not with :<...>.

Import



The procedure for importing a punched tape in ISO format is the same as the procedure used to import a regular punched tape archive in the "Services" operating area with "Data in". During the import, the system detects automatically whether the archive to be imported is stored in binary/PC, punched tape or ISO punched tape format.



MMC 100.2

Imported ISO programs are stored as main programs on the NC. The setting for the import directory must be made each time a program is imported in area "Services" → "Data in" → "Start". If "Path from workpiece/archive" is selected, ISO programs are stored in the selected directory (e.g. workpiece xxx) or in the default NC directory (MPF.DIR); DIN programs are stored in accordance with their specified path.

ISO punched tape with two ISO programs:

```
%  
O1026 (HYDRAULICBLOCK)  
N20 G00 G80 G90 G40 G17  
N40 (NC-SPOTDRILL) T01 M06  
N50 G55 G43 Z20. H01 S1000 F100 M03  
N55 X10. Y-8. M08 T02  
(...)  
N690 Y-43.  
N700 G80 Z35.  
N710 T00 M66  
N715 G53 Y0. Z0.  
N720 M30  
:1127 (ANGLE)  
N10 (2. SPEEDRANGE)  
N20 G00 G80 G90 G40 G17  
N120 (TWDRILL 11) T01 M06  
N130 G55 G43 Z20. H01 S2300 F460 M03  
(...)  
N180 Y-72.  
N190 G80 Z35.  
N195 T00 M66  
N200 G53 Y0. Z0.  
N210 M30  
%
```



MMC 100.2

Export

Services

Data out

This punched tape generates two programs when imported: `_N_1026_MPF` and `_N_1127_MPF`; the title after the program number is retained:

```
Program _N_1026_MPF:
(HYDRAULICBLOCK)
N20 G00 G80 G90 G40 G17
N40 (NC-SPOTDRILL) T01 M06
( . . . )
N710 T00 M66
N715 G53 Y0. Z0.
N720 M30
```

```
Program _N_1127_MPF:
(ANGLE)
N10 (2. SPEEDRANGE)
N20 G00 G80 G90 G40 G17
( . . . )
N200 G53 Y0. Z0.
N210 M30
```

The procedure for generating a punched tape in ISO format is the same as the procedure used to generate a regular punched tape archive in the "Services" operating area with "Data out". The current output format determines whether the archive is created in binary/PC, punched tape or ISO punched tape format.

The output format can be modified in the "Services" operating area with "Set".

A toggle field offers the options punched tape format, punched tape format/ISO or binary format (PC format).

- If both ISO programs and Siemens programs are selected for the creation of an ISO punched tape archive, an ISO punched tape is generated without an alarm or message output; the punched tape contains Siemens program headers in addition to the ISO program headers.

If a Siemens program is followed by an ISO program, a `%<LF>` or `%<CR><LF>` is inserted in front of the ISO program header, depending on the output format, because the character string `O<four digits>` or `:<four digits>` in DIN code cannot be assigned uniquely to a new program.

These "hybrid" ISO punched tape archives can be imported to the MMC again, although the `%` character would abort any attempt to import the archives into third-party control systems (because the `%` character indicates the end of the punched tape in ISO format).



MMC 100.2

```

%
% _N_TEST1_MPF
; $PATH=/_N_WCS_DIR/_N_TEST_WPD
N40 G01 X150 Y150 Z150 F6000
N50 G90 G0 X0 Y0 Z0 G53
; ...
N500 G02 z100 x50 k-50 i0
N510 z50 x100 k0 i50
M30 ;Transition from Siemens prog. to Siemens prog.
% _N_TEST2_MPF
; $PATH=/_N_WCS_DIR/_N_TEST_WPD
N40 G01 X150 Y150 Z150 F6000
; ...
M30 ;Transition from Siemens prog. to ISO prog.
%
O1127 (ANGLE)
N10 (2. SPEEDRANGE)
N20 G00 G80 G90 G40 G17
(...)
N200 G53 Y0. Z0.
N210 M30
%
```

- If both ISO programs and Siemens programs are selected for the creation of a Siemens punched tape archive, a conventional punched tape is generated which contains only Siemens program headers, i.e. the ISO programs contain Siemens program headers.

```

% _N_TEST1_MPF
; $PATH=/_N_WCS_DIR/_N_TEST_WPD
N40 G01 X150 Y150 Z150 F6000
N50 G90 G0 X0 Y0 Z0 G53
; ...
N500 G02 z100 x50 k-50 i0
N510 z50 x100 k0 i50
M30 ;Transition from Siemens prog. to Siemens prog.
% _N_TEST2_MPF
; $PATH=/_N_WCS_DIR/_N_TEST_WPD
N40 G01 X150 Y150 Z150 F6000
; ...
M30 ;Transition from Siemens prog. to ISO prog.
% _N_1127_MPF
; $PATH=/_N_WCS_DIR/_N_TEST_WPD
(ANGLE)
N10 (2. SPEEDRANGE)
N20 G00 G80 G90 G40 G17
(...)
N200 G53 Y0. Z0.
N210 M30
```

- The difference is irrelevant for archives in binary format.



MMC 100.2



Additional notes

Binary files cannot be output in ISO punched tape format.

7.5.10 Restoring the original state via NC card (SW 4.4 and higher)



Function

The free memory on the NC card (PCMCIA card) can be used to store a start-up archive.

The archive can be copied onto the NC card by means of SINUCOPY-FFS (on an external programming device/PC).

The series start-up archive can be stored directly on the NC card from the MMC with the name "Original" (see Series start-up – creating a file).

SW 5.2 and higher:



Sequence of operations

Precondition:

The start-up archive named `_N_ORIGINAL_ARC` is already stored on the NC card (in directory `_N_NC_CARD_DIR_N_ARC_DIR`).



Original state

Select the "Key etc" in the Services basic display and then softkey *"Original state"*.

When you press the softkey, the log window appears with a query "Series start-up active: Perform series start-up?" After confirmation, the data are imported.



Caution

All user-specific NC data (and PLC data depending on contents) will be deleted and replaced by the data from the archive.



Additional notes

Users with access authorization to level 3 and later can access this softkey. It is displayed only if archive `_N_ORIGINAL_ARC` is stored on the NC card.



MMC 103

7.6 MMC 103

7.6.1 Services basic display

All programs/data stored on the hard disk or in the NC memory are listed in the "Services" basic display.

Services	CHAN1	AUTO								
Program stopped:										
Channel active			SKP	DAY	ROV	SBL2	MO1	DRF	PRT	FST
Programs/Data										
	Name	Type	Length	Data	Enable					
	Diagnostics	DIR		10.04.95	X					
	Data_management	DIR		10.04.95	X					
	Interactive_programming	DIR		10.04.95	X					
	DP_user_displays	DIR		10.04.95	X					
	DP_tools	DIR		10.04.95	X					
	GP_macros	DIR		10.04.95	X					
	DP_help	DIR		10.04.95	X					
	DP_basic_info	DIR		10.04.95	X					
	Technology_memory	DIR		10.04.95	X					
	MSD_data	DIR		10.04.95	X					
	MBDDE_alarm_texts	DIR		10.04.95	X					
	Part_programs	DIR		10.04.95	X					
	NC_data	MDN		10.04.95	X					
	OEM_data	DIR		10.04.95	X					
	Subroutines	DIR		10.04.95	X					
	System	DIR		10.04.95	X					
Free memory:			Hard disk:	355.565.568	NCU:	2				
EXIT										
Data in	Data out	Manage data	Log	Data selection	Interface					

Explanation of basic display

Display of the current file tree

Name

The following file attributes can be displayed for each file (depending on the default setting):

Directory name/file name

Files with a maximum name length of 25 characters can be managed on the MMC.

If the files are transferred to external systems (V.24, diskette), the name is truncated to 8 characters. Long names are lost.

When such files are reloaded, it is necessary to rename them.

Files that are stored in an archive file are re-assigned their full name when they are re-imported.

Type

Specifies the file type which matches the file identifier.

Length

File length in bytes (directory length is not displayed)



MMC 103

Date	Date of creation or date of last modification to file
Enable	<p>Enable (=selection/right to execute) activated "X" or not activated " "</p> <p>When you set up a program, you may not necessarily be able to process it immediately with an NC start (e.g. if it is not ready or requires testing).</p> <p>To indicate that a program is ready for NC Start, it is possible to enable or disable the program.</p> <p>The current state of a file is indicated by an "X" in the "Enable" column (= enable activated).</p>
Access rights	<p>There are also 5 access rights for each file:</p> <ul style="list-style-type: none"> • Read corresponds to level 5 • Write corresponds to level 3 • Execute corresponds to level 7 • Show corresponds to level 2 • Delete corresponds to level 1 <p>The access right for each file is indicated in the file tree.</p> <p>Not every operator should be able to edit data and programs on the control. Access levels are therefore defined for each file. They range from level 0 (SIEMENS password) to level 7 (keyswitch 0).</p> <p>A description of how to set the access rights is given in Chapter "Properties".</p>
Loaded	<p>To execute a program in the NC (through NC Start), it must be loaded into the NC main memory. To ensure that the memory does not become overloaded, however, related programs and data can be loaded explicitly (from the hard disk to the NC memory) and unloaded again (from NC memory back to hard disk).</p> <p>The current status of a file is indicated by an "X" in a column after the file name: File loaded, file can be selected and executed with an NC Start.</p>

Notice: Data may only be loaded for programs for which an enable has been set!





MMC 103

Data in

Horizontal softkeys

Read in archives/files

- V.24
- PG
- Diskette (if diskette drive is installed)
- Archive from (directory "Archive" on the hard disk)

Data out

Read out archives/files

- V.24
- PG
- Diskette (if diskette drive is installed)
- Archive to (directory "archive" on the hard disk)

Series
start-up

You can archive data for a series start-up. The softkey is password-protected.

Manage
data

Files/directories can be created, loaded, saved, deleted or copied and their attributes can be changed.

Log

Current actions, errors and any prompts are displayed in the job list. Prompts must be acknowledged. The "*Job log for PG*" lists, for example, errors that have occurred in data transmission from/to the PG.

Data
selection

Under softkey "*Data selection*", you can choose the directories that you wish to have displayed in the "*Services*" basic display.

Interface

You can set the interface parameters for the COM1 and COM2 interfaces under this softkey (see also Section "*Interface parameters*").

Vertical softkeys

The vertical softkeys allow you to select the source area (for data import) or the target area (for data export). The yellow title in the window indicates the area.



MMC 103

V.24

PG

Diskette

Archives

NC card

- V.24
- PG
- Diskette
- "Archives" directory on the hard disk
- "Archives" directory on NC card (SW 5 and later)

7.6.2 Setting the V.24 interface



Function

You can output files to an external device or read them in from there via the V.24 interface of the SINUMERIK 840D/810D/FM-NC. The V.24 interface and your device must be compatible. The control provides you with an input screen form for this purpose in which you can define the specific data for your device.

You can set separate parameter settings for each V.24 interface:

1. V.24
2. PG/PC



MMC 103



Interface

V.24

PG

Default
settings

Sequence of operations

Select softkey "*Interface*".

The vertical softkey bar changes.

Select the interface you want to be parameterized:

- V.24 (default setting)
- PG/PC

The default settings for "*V.24 interface*" or "*PG interface*" are accepted depending on which of the interfaces is currently selected for parameterization.

For interface parameter settings, see also Section "Interface parameters" or Section "Examples of interface parameter settings".

7.6.3 Reading in data



Function

Reading in archives and files: The following are possible source areas

- A device connected to the V.24 interface (e.g. PC)
- A programming device
- A diskette drive
- Archive (i.e. the "*Archives*" directory) in the directory tree (even if it is not displayed under "Data selection").
- The NC card (if a flash file system is formatted on the NC card - available with **SW 5** and later)
- When archives are read in, their format (punched tape/PC format) is recognized automatically.
- SW 5.2 and higher: Data with longer file names (> 8 + 3 characters) can be read in from diskette.



MMC 103



Data in

V.24

PG

Diskette

Archives

NC card

Start

Sequence of operations

The *"Programs/Data"* file tree is displayed.
The vertical softkey bar changes.

Mark the file into which you wish to read the archive.
Select the source area (see title in window):

- V.24 interface
Interface is made ready to receive.
- the programming device
- Diskette drive: Shows the contents of the diskette. Select the archive you wish to import.
- Opens the "Archives" directory on the hard disk. Select the archive you wish to import.
- The contents of the archives directory on the NC card are displayed (SW 4.4 and higher).
Select the archive you wish to import.

Users with access authorization to level 3 and later can access this softkey. It is displayed only if archive `_N_ORIGINAL_ARC` is stored on the NC card.

When importing data from diskette/archive, press the softkey "Start", otherwise the control is ready to receive immediately.

The data transfer is initiated. The vertical softkey bar changes to its initial settings. The softkey at the source also changes to *"Stop"*. You can cancel transmission by pressing the softkey in question (e.g. "PG") again.



MMC 103

7.6.4 Reading out data



Function

Creating archives:

With the "Data out" function, the source area (see title in window) for data transmission is the displayed directory tree.

Possible target areas are:

- A device (such as PC) connected to the V.24 interface,
- A diskette drive,
- "Archives" directory on hard disk.
- Free memory areas on the NC card (SW 5 and higher)

Sequence of operations

The "Programs/Data" file tree is displayed.

The vertical softkey bar changes.

You have marked the data that you wish to save/archive.

Select the target area (see title in window):

- V.24 interface (MMC)
The system prompts you to start the data receiving device.
- V.24 interface (programming device)
The system prompts you to start the data receiving device.
- Diskette drive: The diskette contents are displayed.
Enter the name of the new archive file.
- The contents of the "Archives" directory on the hard disk are displayed.
Enter the name of the new archive file.
- The contents of the archives directory on the NC card are displayed (SW 5 and higher).
Enter the name of the new archive file.

When exporting data from diskette/archive, press the softkey "Start", otherwise the control is ready to receive immediately.

The data transfer is initiated. The vertical softkey bar changes. The softkey labeling of the target area changes to "Stop". To abort data transmission, press the relevant softkey again.



Data out

V.24

PG

Diskette

Archives

NC card

Start



MMC 103



Additional notes

Archives to be stored on diskette need **not** fit complete on a single diskette. Distribution of the archive over several diskettes is supported.

The two V.24 interfaces (V.24 and PG) cannot be active simultaneously.

Note:

SW 5.2 and higher:

When archiving workpieces that contain job lists of the same name, in the case of m:n you are asked whether the job lists to be unloaded are to be executed. You can terminate the action with *"Cancel"*, otherwise all joblists are executed and archiving is then started.

7.6.5 Log



Services

Log

Manage data

V.24

PG

Function

You can use the log function to view a job log, e.g. for "Manage data".

Sequence of operations

The *"Services"* operating area is selected.

The *"Log"* window is opened. The source or target of the job is displayed in the header.

The vertical softkey bar changes.

Jobs are assigned to the vertical softkeys, i.e. jobs for

- "Manage data"
- V.24 interface
- the programming device



MMC 103

Diskette

- Diskette drive

You can switch between windows with these softkeys.

The softkey label displays "...Stop" if a job is not running. You can abort a job in progress by pressing the "Stop" softkey again.

A message line is displayed in the "Error list" field to indicate whether or not errors have occurred during data transmission.

In the case of queries, the prompt "*Please acknowledge query in log window*" appears in the dialog line.

Confirm the prompt with one of the vertical softkeys:

- Do not confirm
- Confirm all
- Confirm
- Change name/type
- Abort complete job

No

Yes all

Yes

Name/type

Stop

Delete
log

The currently displayed log is deleted.

The log window is closed on the last log.



MMC 103

7.6.6 Defining and activating user data (GUD)



Function

1. Back up block `_N_INITIAL_INI` via V.24 or hard disk (MMC 103).
2. Create a definition file for user data:
 - MMC 100.2: On external PC (up to **SW 4.3**)
 - in operating area "Services" for the MMC 103 (**SW 4.4** and higher)

Behavior with **SW 4.4 and higher**

If you edit a definition file in the NC, a query box asking whether you want the definitions to be activated is displayed when you exit the Editor.

Example:

"Do you want to activate the definitions from file GUD7.DEF?"

"OK" → A query appears asking you whether you want to save the data currently active.

"Do you want to keep the previous definition data?"

"OK" → The GUD blocks of the definition file to be edited are saved, the new definitions are activated and the saved data are imported again.

"Abort" → The new definitions are activated, the old ones are lost.

"Abort" → The changes to the definition file are rejected, the associated data block is not altered.

Unload

If a definition file is unloaded, the associated data block is deleted after confirmation via a query box.

Load

If a definition file is loaded, a query box appears asking whether you wish to activate the file and/or retain the data. If you do not select activation, then the file will not be loaded.



MMC 103

If the cursor is located in a loaded definition file, the softkey labeling changes from "Load" to "Activate" to activate the definitions. If you select "Activate", you are again asked whether you want to save the data.

Data are saved only in the case of variable definition files, but not with macros.

Further notes (MMC 103)

If there is insufficient memory space available to activate the definition file, then the file must be unloaded. After the memory size has been adjusted, the file must be loaded from the NC to the MMC and back again to the NC. The files are then activated.

Predefined file names are used:

- `_N_SGUD_DEF` (global Siemens data),
- `_N_MGUD_DEF` (global machine manufacturer data),
- `_N_UGUD_DEF` (global user data)
- `_N_GD1_DEF` to `_N_GD9_DEF` (other global data, e.g. grinding cycles, etc.).

Files with these names can contain definitions of GUD variables. The same rules apply to these as to LUD variable definitions.

3. Load definition file to control system main memory via the V.24.

The control system always creates a directory named `_N_DEF_DIR`. This name is entered in the header of the GUD definition file as a path.

Example:

```
_N_SGUD_DEF
$PATH=/_N_DEF_DIR
DEF NCK REAL NCKVAR
DEF CHAN INT CHANVAR
M17
```



MMC 103

4. Activate definition file.

- **SW 4.3** and earlier

If the file has been loaded correctly, block `_N_INITIAL_INI` must then be copied back into the control system via the "Data in" function in the Services area.

- **SW 4.4** and higher

The definition file is activated when it is loaded into the NC ("Activate" softkey).

5. Data backup

The modified GUD data contents are saved when block `_N_INITIAL_INI` is read out via "Data out" in the Services operating area. These data can only be reloaded into the control if it has first been ensured that the required definition files are in the control.

Definition and creation of user data

See /PGA/, Programming Guide, Advanced.





MMC 103

7.6.7 Importing/exporting ISO programs (SW 5 and higher)



Function

ISO programs can be imported and exported to and from the MMC 103 in punched tape format.

Additional notes

In SW 5.1 and later, you can import and export programs from the FANUC 0 control system.

The punched tape format for ISO programs (ISO punched tape format) is different from the Siemens MMC punched tape format.

The first line of a punched tape in ISO format must have the following format: %<Title>LF or %<Title>CRLF,

The title can be omitted and blanks can be skipped. The title may not start with one of the following characters:

0...9, a...z, A...Z or _.

No title is generated when a punched tape is generated in ISO format.

Siemens program headers are introduced by %<Name> and path ; PATH=<Path> in the next block.

ISO program headers are recognized from O<xxxx (Title)> or :<xxxx (Title)> without path in the next block.

x stands for a number between 0 and 9. Between one and four digits can be specified, leading zeros can be omitted.

During export, ISO program headers are only tagged with O<...> and not with :<...>.

Import

Services

Data in

The procedure for importing a punched tape in ISO format is the same as the procedure used to import a regular punched tape archive in the "Services" operating area with "Data in". During the import, the system detects automatically whether the archive to be imported is stored in binary/PC, punched tape or ISO punched tape format.

ISO programs which have been imported (e.g. O1234 or :1234) are stored in the NC either as main programs (e.g. _N_1234_MPF) or under a workpiece name defined by the machine manufacturer.



MMC 103

ISO punched tape with two ISO programs:

```
%
O1026 (HYDRAULICBLOCK)
N20 G00 G80 G90 G40 G17
N40 (NC-SPOTDRILL) T01 M06
N50 G55 G43 Z20. H01 S1000 F100 M03
N55 X10. Y-8. M08 T02
(...)
N690 Y-43.
N700 G80 Z35.
N710 T00 M66
N715 G53 Y0. Z0.
N720 M30
:1127 (ANGLE)
N10 (2. SPEEDRANGE)
N20 G00 G80 G90 G40 G17
N120 (TWD RILL 11) T01 M06
N130 G55 G43 Z20. H01 S2300 F460 M03
(...)
N180 Y-72.
N190 G80 Z35.
N195 T00 M66
N200 G53 Y0. Z0.
N210 M30
%
```

This punched tape generates two programs when imported:
_N_1026_MPF and _N_1127_MPF; the title after the program number
 is retained:

```
Program _N_1026_MPF:
(HYDRAULICBLOCK)
N20 G00 G80 G90 G40 G17
N40 (NC-SPOTDRILL) T01 M06
(...)
N710 T00 M66
N715 G53 Y0. Z0.
N720 M30
```

```
Program _N_1127_MPF:
(ANGLE)
N10 (2. SPEEDRANGE)
N20 G00 G80 G90 G40 G17
(...)
N200 G53 Y0. Z0.
N210 M30
```

Export

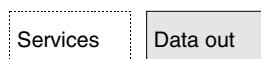

The procedure for generating an archive in ISO format is the same as the procedure used to generate a Siemens punched tape archive in the "Services" operating area with "Data out". The current output format determines whether the archive is created in binary/PC, punched tape or ISO punched tape format.



MMC 103

The output format can be changed in the "Services" operating area with "Interface" -> "V.24"/"PG" -> "Archive format" and for diskette or archive with "Data out" -> "Diskette"/"Archive" -> "Archive format in the target list box".

You can choose between the following formats:

- Binary (PC)
- Punched tape with LF only
- Punched tape with CR + LF
- Punched tape/ISO with LF only
- Punched tape/ISO with CR + LF

All programs with names in the format `_N_XXXX_MPF` for NC files or `XXXX.MPF` for MMC103 data management files (x is a digit between 0 and 9) are treated as ISO programs when creating an archive in ISO punched tape mode. Between one and four digits can be specified.

The file DINO.INI can be used to define the output directories for part programs in ISO format.

See /IAM/, Installation and Start-Up Guide MMC, Start-up Functions for the MMC (IM1).

- If both ISO programs and Siemens programs are selected for the creation of an ISO punched tape archive, an ISO punched tape is generated without an alarm or message output; the punched tape contains Siemens program headers in addition to the ISO program headers.

If a Siemens program is followed by an ISO program, a `%<LF>` or `%<CR><LF>` is inserted in front of the ISO program header, depending on the output format, because the character string `O<four digits>` or `:<four digits>` in DIN code cannot be assigned uniquely to a new program.

These "hybrid" ISO punched tape archives can be imported to the MMC again, although the % character would abort any attempt to import the archives into third-party control systems (because the % character indicates the end of the punched tape in ISO format).



MMC 103

```

%
%_N_TEST1_MPF
;$PATH=/_N_WCS_DIR/_N_TEST_WPD
N40 G01 X150 Y150 Z150 F6000
N50 G90 G0 X0 Y0 Z0 G53
; ...
N500 G02 z100 x50 k-50 i0
N510 z50 x100 k0 i50
M30 ;Transition from Siemens prog. to Siemens
prog.
%_N_TEST2_MPF
;$PATH=/_N_WCS_DIR/_N_TEST_WPD
N40 G01 X150 Y150 Z150 F6000
; ...
M30 ;Transition from Siemens prog. to ISO prog.
%
O1127 (ANGLE)
N10 (2ND SPEEDRANGE)
N20 G00 G80 G90 G40 G17
(...)
N200 G53 Y0. Z0.
N210 M30
%

```

- If both ISO programs and Siemens programs are selected for the creation of a Siemens punched tape archive, a conventional punched tape is generated which contains only Siemens program headers, i.e. the ISO programs contain Siemens program headers.



MMC 103

```

%_N_TEST1_MPF
;$PATH=/_N_WCS_DIR/_N_TEST_WPD
N40 G01 X150 Y150 Z150 F6000
N50 G90 G0 X0 Y0 Z0 G53
; ...
N500 G02 z100 x50 k-50 i0
N510 z50 x100 k0 i50
M30 ;Transition from Siemens prog. to Siemens prog.
%_N_TEST2_MPF
;$PATH=/_N_WCS_DIR/_N_TEST_WPD
N40 G01 X150 Y150 Z150 F6000
; ...
M30 ;Transition from Siemens prog. to ISO prog.
%_N_1127_MPF
;$PATH=/_N_WCS_DIR/_N_TEST_WPD
(ANGLE)
N10 (2ND SPEEDRANGE)
N20 G00 G80 G90 G40 G17
(...)
N200 G53 Y0. Z0.
N210 M30

```

- The difference is irrelevant for archives in binary format.

Additional notes

Binary files cannot be output in ISO punched tape format.



MMC 103

7.7 Start-up functions (MMC 103)

7.7.1 Series start-up



Function

"Series start-up" means to establish the same initial data status on several control systems.

With this function you can archive/read in a selection of PLC, NC and MMC data for a series start-up at a later stage.

Compensation data can be saved at the same time if necessary. The drive data are saved as binary data which cannot be modified.



Sequence of operations

Precondition: The password, e.g. with access level 3 (user) is set.

Series
start-up

Press softkey "*Series start-up*".

The vertical softkey bar changes.

The "*Create archive for series start-up*" window opens.

Create series start-up file:

You can select which data you wish to save as the archive contents:

- MMC
- NC
- PLC

The suggested archive name depends on the selected area (MMC, NC, PLC) and can be changed if necessary.

MMC data
selection

If you have selected the "*MMC*" area, you can select the data you wish to archive by pressing softkey "*MMC data selection*". The directories selected in this area are saved to directory \USER as standard. Directories \ADD_ON and \OEM can be saved additionally under "Additional products", either completely ("Complete") or just files regie.ini and re_*.ini ("Configuration").



MMC 103

V24
PG
Diskette ...
Archives
NC card

Read start-up archive

V24
PG
Diskette ...
Archives ...
NC card

Start

Make start-up archive

The archiving operation commences when you select the target device.

Archive data to:

- The device connected to the V.24 interface
- Programming device/PC
- Diskette drive
- "Archives" directory on hard disk
- "Archives" directory on the NC card (SW 5 and later)

Softkey labeling changes to "... Stop". The series start-up archive is created.

Toggle between functions "Create series start-up archive" and "Read start-up archive".

Reading series start-up archive:

The read-in operation commences when you select the source device connected to the V.24 interface. The data can be read via:

- The device connected to the V.24 interface
- A programming device
- The diskette drive
- The "Archives" directory on hard disk
- The archives directory on NC card (SW 5 and later)

Select an archive file under softkeys "Diskette", "Archives" and "NC card".

Start reading in the archive. The softkey label changes to "Stop".

Switchover from "Read" to "Make".



MMC 103

7.7.2 Restoring the original state via NC card (SW 4.4 and higher)



SW 5 and higher



Original
state



Function

The free memory on the NC card (PCMCIA card) can be used to store a start-up archive.

The archive can be copied onto the NC card by means of SINUCOPY-FFS (on an external programming device/PC).

In SW 5 and higher, the series start-up archive can be stored on the NC card from the MMC with the name "Original" (see Series start-up – creating a file).

Sequence of operations

Precondition:

The start-up archive named `_N_ORIGINAL_ARC` is already stored on the NC card (in directory `_N_NC_CARD_DIR_N_ARC_DIR`).

Please read machine manufacturer's instructions

Select the "Key etc" in the Services basic display and then softkey "*Original state*".

When you press the softkey, the log window appears with a query "Series start-up active": Execute series start-up?" Confirm to import the data.

Caution

All user-specific NC data (and PLC data depending on contents) will be deleted and replaced by the data from the archive.

Users with access authorization to level 3 and later can access this softkey. It is displayed only if archive `_N_ORIGINAL_ARC` is stored on the NC card.



MMC 103

7.7.3 Software update



Upgrade

V.24

PG

Diskette ...

Archives ...

Function

This function supports updating of the NC system software. For this purpose, you can create an update archive. This contains all NC data (like a series start-up archive) including compensation data. Software updates are carried out according to the same principle as series start-ups. The main difference is that drive data are saved and re-imported in ASCII format with software updates (thus allowing these data to be altered if necessary). Another major difference to the series start-up operation is that an update is always performed for the same machine, i.e. it makes sense to import compensation data as well.

For further information, please see Installation and Start-Up Guide for 840D or 810D.

Sequence of operations

Press softkey "Upgrade".

The vertical softkey bar changes.

The "Create update archive" window opens.

The NC data are preset as archive contents.

You can enter any archive name of your choice.

The archiving operation commences when you select the target device.

Data can be archived to

- the device connected to the V.24 interface
- the programming device
- the diskette drive
- "Archives" directory on hard disk



MMC 103

NC card

- The contents of the archives directory on the NC card are displayed (only available with SW 5 and later).
Enter the name of the new archive file.

Softkey labeling changes to "... Stop". The update archive is set up.

Read in update archive:

The read-in operation commences when you select the source device connected to the V.24 interface. The data can be read via:

- The device connected to the V.24 interface
- A programming device
- The diskette drive
- The "Archives" directory on hard disk
- The archives directory on NC card (SW 5 and later)

Select an archive file under softkeys "Diskette", "Archives" and "NC card".

V24

PG

Diskette ...

Archives ...

NC card

Start

Start reading in the archive. The softkey label changes to "Stop".



MMC 103

7.8 Managing data (MMC 103)

7.8.1 Creating a new file/directory



Manage
data

New

End

OK

Sequence of operations

Select softkey "*Manage data*".

The horizontal and vertical softkey bars change.

The "*New*" window appears.

Enter a new file name.

If the preassigned file type does not match, use the "*End*" key to switch between input field "*Name*" and "*File type*".

Select the new file type.

The new directory/file is set up in the directory overview.

7.8.2 Loading/unloading



Manage
data

Load

Unload

Sequence of operations

Select softkey "*Manage data*".

The horizontal and vertical softkey bars change.

Position the cursor on the desired file.

The selected file is deleted from the hard disk and loaded to the NC memory. In the display the entry "X" = loaded is added to the file.

SW 5 and higher:

See also Chapter "Job list (SW 5 and higher)".

The selected file is deleted from the NC memory and loaded to the hard disk. In the display, the entry " " = not loaded is added to the file.



MMC 103

SW 5.2 and higher:

If you want to *"load/unload"* a workpiece directory and a job list with the name of the directory exists in the job list, that job list is executed.

If a job list does not exist, all the files in that directory are loaded/unloaded (RAM of NC might overflow!).

7.8.3 Copying/inserting



Function

You can copy

1. a single file,
2. several files or
3. an entire directory.



Sequence of operations

Select softkey *"Manage data"*.

The horizontal and vertical softkey bars change.

Select the source files that you wish to copy.

A second window for the target directory (see title in window) is opened.

If available, select the target device via the vertical softkeys.

The contents of *"Programs/data"* are displayed.

The contents of the *"Clipboard"* directory are displayed.

If a diskette drive is installed, you can copy to or from diskette. The diskette contents are displayed.

Select a target directory.

Manage
data



Copy

Programs/
data

Clipboard

Diskette



MMC 103

 Paste

The source files are copied to the target directory you have selected.



SW 5.2 and higher:

With this copying action in operating area "Services" the names remain unchanged.

See also *Chapter "Copy/Insert"* in operating area "Program".

7.8.4 Deleting



File
Directory

Function

You can delete a single file or a group of files (multiple selection).
You can delete a directory and all its contents.



The system settings relating to deletion determine whether a prompt appears before files/directories/data are finally deleted (see also Section "Start-up" operating area).



 Manage
data

Sequence of operations

Select softkey "Manage data".

The horizontal and vertical softkey bars change.

Position the cursor on the desired file.

 Delete

A query window appears.

 OK

You can delete the highlighted file by pressing "OK".



SW 5 and higher:

Archives stored on the NC card can be deleted by selecting "NC card" under "Manage data".



MMC 103

7.8.5 Changing the properties of a file/directory/archive

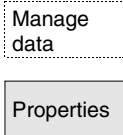

Function

This function allows you to view the contents of a file (or directory) as well as other information, to view file/directory properties and to change some properties.

In this window, you can

- rename a file,
- convert a file to another file type,
- change the access rights to the file/directory and
- view the contents of readable files.

The contents of text files are displayed.

You can change access levels only if you have the appropriate access rights to do so.

Sequence of operations

Select softkey "*Manage data*".

The horizontal and vertical softkey bars change.

The "*Properties*" window is opened.

Enter the changes you wish to make, e.g. rename the file or change the file type.

Renaming a file

Place the cursor on the file name and press the "*Edit key*" (displayed next to the type list), enter the new file name.

SW 5.2 and higher:

There are two ways of renaming files:

- Renaming the workpiece directory
- Renaming a directory in the workpiece directory

Renaming a workpiece directory:

When you rename a workpiece directory, all the workpiece files under that directory that have the same name as the directory are renamed. If a job list with the name of the directory exists, the instructions in that job list are also renamed.

Comment lines remain unchanged.

Example:

Workpiece directory A . WPD renamed to B . WPD:

All files with the name A . XXX are renamed to B . XXX, i.e. the extension is not altered.



MMC 103

If a job list called A . JOB exists it is renamed to B . JOB.

If this job list contains instructions of file A . XXX located in this workpiece directory, then that file is also renamed to B . XXX.

Example:

If job list A . JOB contains an instruction

```
LOAD/WCS . DIR/A . WPD/A . MPF
```

it is renamed to

```
LOAD/WCS . DIR/B . WPD/B . MPF
```

However, if a job list contains the instruction

```
LOAD/MPF . DIR/A . MPF
```

```
LOAD/WCS . DIR/X . WPD/A . MPF
```

the files are not renamed.

Renaming a directory in the workpiece directory

If you rename the files in the workpiece directory, all files with the same name but a different extension are renamed.

Exception: If a job list of the same name exists in the directory, then this one is not renamed.

Changing the file type

Use the *"Edit"* key (displayed next to the type bar) to show the list of file types to which the file may be converted.

Only the file types are displayed which are permissible in the directory where the file is located.

Use the *"Direction"* keys to display the new file type.

Confirm your selection with the *"Input"* key (displayed next to the file type you have selected).

The file is assigned the new file type.



OK

Additional notes

- No check is made to determine whether or not the file contents may be stored under the new file type!
- The contents of a file are **not** altered when the file type is converted.
- All data types may be stored in the *"Clipboard"* directory.

"Diagnosis" Operating Area

8.1	Diagnosis basic display	8-422
8.2	Alarms/messages/alarm log	8-424
8.3	Service display	8-426
8.3.1	Service axis	8-426
8.3.2	Service drive	8-427
8.3.3	Service Safety Integrated (SW 5.2 and higher)	8-428
8.3.4	Configuration data (SW 4.1 and higher, MMC 103)	8-429
8.3.5	Communication error log	8-429
8.3.6	Version	8-430
8.4	PLC status	8-431
8.4.1	General	8-431
8.4.2	Changing/deleting values	8-432
8.5	Selecting/creating operand forms for PLC status	8-434
8.5.1	Reading in an operand (MMC 100.2)	8-435
8.5.2	File functions (MMC 103)	8-436
8.6	Displaying system resources (NC, MMC) (SW 4.1 and higher)	8-437

8.1 Diagnosis basic display



MMC 100.2



MMC 103

8.1 Diagnosis basic display

A display headed "Alarms" appears when you select the operating area "Diagnosis".

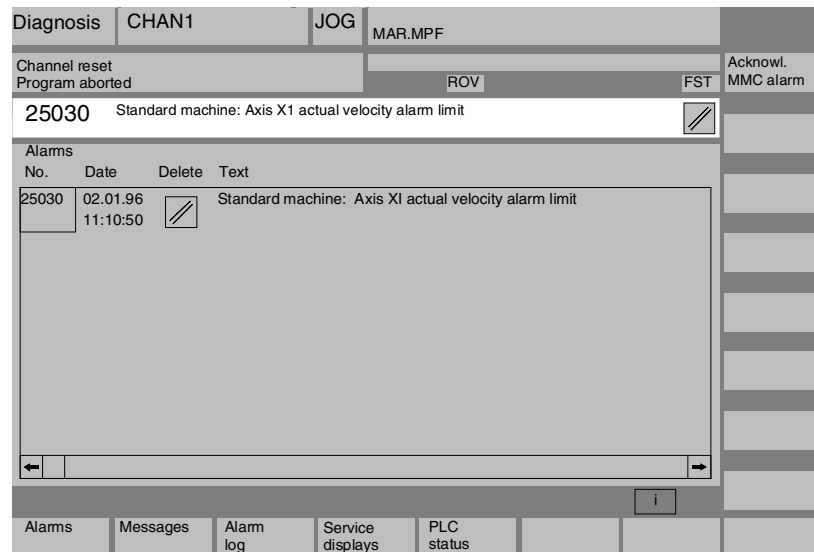
Basic display for
MMC 103

Explanation of display

Number

The alarm number is output under "*Number*". The alarms are output in chronological order.

Date

The date and time at which the alarm occurred is displayed with the date, in hours, min, sec, 1/100 sec (MMC 100.2 only).

Clear criterion

The symbol denoting the alarm abort key is displayed for every alarm.

Text

The alarm text is displayed under "*Text*".



MMC 100.2



MMC 103

Alarms

Messages

Alarm
logService
displaysPLC
statusRemote
diagnosisAcknowl.
MMC alarm

Horizontal softkeys

All active alarms are displayed in the "Alarm overview" display.

An overview of active messages is displayed.

MMC 103 only:

The alarm log of alarms and messages that have occurred is displayed. The log also includes alarms that have already been reset. Default setting for alarm buffer: 150 alarms/messages

You can view updated information about axes and drives installed in your system under softkey "Service displays".

Information on the current status of the PLC memory locations.

MMC 103 only, with SW 5 also MMC 100.2:

The control can be operated externally over a remote connection (e.g. modem) (option).

For more information about remote diagnostics please refer to /FB/ F3, Remote Diagnostics.

Vertical softkeys, MMC 103 only:

MMC alarms (alarm number 120...) that have occurred can be acknowledged.



MMC 100.2



MMC 103

8.2 Alarms/messages/alarm log



Function

You can display a list of alarms and messages and acknowledge them.



Operating sequence

Alarms:

The alarm overview displays all active alarms with alarm numbers, date, clearance criteria and descriptions.

Clear the alarm by pressing the key that is displayed as a symbol:

Switch device off and on again (*main switch*)

or NCK POWER ON

Press "*Reset*" key.

Press "*Acknowledge alarm*" key.

Alarm is cleared by "*NC Start*".

Alarm is cleared with the "*Recall*" key.

Messages:

- PLC operational messages that do not have to be acknowledged (as standard) (configurable).

Alarm log:

A log containing the alarms and messages that have so far occurred is displayed. 150 alarms/messages can be logged as standard (MMC 103 only).

The alarms cannot be acknowledged here.

It also contains the alarms that have already been acknowledged.

This symbol means "*Alarm is still active*".

The alarm is updated (static display).

Alarms



Messages

Alarm log



Display new



MMC 100.2



MMC 103

Acknowledgment symbol changed (SW 5.2 and higher)

The acknowledgment symbols have been changed for the MMC and PLC alarms:

MMC alarms:



PLC alarms:



Safety alarms S:



Safety alarms SQ:



The SQ alarms are cleared with softkey "Acknowledge SQ alarm". The S alarms are display alarms, they do not have to be cleared. The way S and SQ alarms are displayed depends on the settings in the files "MMC.INI" and "MBDDE.INI".

You can determine which acknowledgment symbol is to be displayed for the PLC alarms by an entry in the INI file "DG.INI".

The following symbols are available:

PLC alarms:



or



Activation of the symbols is described in /IAM/ IM3, Installation/Start-Up MMC 103



MMC 100.2



MMC 103

8.3 Service display

8.3.1 Service axis



Function

The information in the "Service Axis" display is used to

- check the setpoint branch (e.g. position setpoint, speed setpoint, spindle speed setpoint prog.)
- check the actual-value branch (e.g. position actual value, measuring system 1/2, actual speed value), optimize the position control of the axis (e.g. following error, control difference, servo gain factor)
- check the entire control loop of the axis (e.g. through position setpoint/actual-value comparison and speed setpoint/actual-value comparison)
- check hardware faults (e.g. encoder check: If the axis is moved mechanically, then the position actual value must change)
- set and check axis monitoring functions

References: /FB/, Description of Functions D1, Diagnostics Tools



Service displays

Service axis



Axis +

Axis -

Partial view

Operating sequence

Select the menu headed "Service displays".

The horizontal softkey bars change.

The "Service axis" window displays information about the machine axis together with axis name and axis number.

You can page up and down with the "Page keys".

The service values of the next (+) and the previous (-) axis are displayed.

MMC 103 only:

You can display a selection of important axis data by pressing the "Partial view" key.



MMC 100.2



MMC 103

Overall
view

MMC 103 only:

Return to display of all axis data.

8.3.2 Service drive

Service
displays

Service
drive



Drive
+

Drive
-

Function

The information contained in the "Service drive" display is used to

- check the status of the enable and control signals (e.g. pulse enable, drive enable, motor selection, setpoint parameter set)
check the status of the FDD/MSD operating modes (e.g. setup mode, parking axis)
- display temperature warnings
check the current setpoint/actual-value display (e.g. position actual-value measuring system 1/2, speed setpoint, speed actual value)
- check the drive status
- display the current ramp-up phase
- display a group error message (message status class 1)
display the status messages of the drive (e.g. threshold torque not reached, actual speed = set speed)

References: /FB/, Description of Functions D1, Diagnostics Tools

Operating sequence

Select the menu headed "Service displays".

The horizontal softkey bars change.

The "Service drive" window displays information about the axis drive together with axis name and number.

You can page up and down with the "Page keys".

The service values of the next (+) and the previous (-) drive are displayed.



MMC 103

8.3.3 Service Safety Integrated (SW 5.2 and higher)



Function

In the display "*Service SI*", the data for the function Safety Integrated of the axis currently selected on the MMC 103 are displayed:

- Stop F diagnostics Drive
- Safe actual position Axis
- Safe actual position Drive
- Positional deviation Axis/Drive
- Actual speed limit
- Actual speed limit
- Actual speed difference
- Maximum speed difference
- Safe input signals Axis
- Safe input signals Drive
- Safe output signals Axis
- Safe output signals Drive
- KDV (data cross-checking) level
- KDV status
- KDV control word
- SPL ramp-up status

You can page to the next axis.

If no data are displayed, the Safety Integrated function has not been enabled.

References: /FBSI/, Description of Functions Safety Integrated



Service displays

Service SI



Drive +

Drive -

Operating sequence

Select the menu headed "*Service displays*".

The horizontal softkey bars change.

The "*Service SI*" window displays information about Safety Integrated data together with axis name and axis number.

You can page up and down with the "*Page keys*".

The service values of the next (+) and the previous (-) drive are displayed.



MMC 100.2



MMC 103

8.3.4 Configuration data (SW 4.1 and higher, MMC 103)



Function

The configuration data for a machine can be collected in a file and read or printed out.

The configuration file CONFIGURATION_DATA is created in the "Services" operating area for this purpose.



Config.
data

Operating sequence

Press softkey "*Config. data*".

The system collects the configuration data and writes them to a file. The path and name of the file are output in the info line.

You can now read or print out this file.



Further notes

Configuration data can be output in the "Services" operating area.

8.3.5 Communication error log



Function

Errors that occur during communication between the MMC and NCK/PLC are registered in a communication error log.

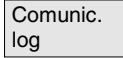
You can display this log by pressing the  key.



The error log file is principally used by the control manufacturer (Siemens) as a diagnostic tool for communication errors.

The communication error log file can be read out in the "*Services*" operating area via the V.24 interface (MMC 100.2 only).



MMC 100.2



MMC 103

8.3.6 Version



Function

The version data of the installed system software are output in the Version display.

MMC 100.2 only:

Version data can be read out in the "Services" operating area (directory system file `_N_SYF_DIR/_N_VERSION_SYF`) (via V.24 interface).



Operating sequence

Service displays

Version

NCU version

MMC version

Press softkey "Service displays".

The horizontal softkey bars change.

Open the "Version" window in the "Service displays" menu.

Two softkeys are displayed:

for the version data of the NCU and

for the version data of the MMC.

Use the "Page" keys to scroll up and down.





MMC 100.2



MMC 103

8.4 PLC status

8.4.1 General



Function

You can obtain information about the current states of the following memory locations of the PLC and change them if necessary:

Inputs:	Input bit (Ex), input byte (EBx) Input word (Ewx), input double word (Edx)
Outputs:	Output bit (Ax), output byte (Abx) Output word (Awx), output double word (Adx)
Bit memories:	Memory bit (Mx), memory byte (MBx) Memory word (MWx), memory double word (MDx)
Timers:	Time (Tx)
Counters:	Counter (Cx)
Data:	Data block (DBx), data bit (DBxx), data byte (DBBx), data word (DBWx), data double word (DBDx)
Format:	B = binary H = hexadecimal D = decimal G = floating comma (for doublewords)

Operand	Example	Read	Write	Format	Value	Range
Inputs		yes	yes			0–127
	I 2.0			B	0	
	IB 2			B	0101 1010	
				H	5A	
				D	90	
Outputs		yes	yes			0–127
	Q20.1			B	1	
	QB 20			B	1101 0110	
				H	D6	
				D	214	
Bit memories		yes	yes			0–255
	M 60.7			B	1	
	MB 60			B	1101 0110	
	MW 60			H	B8	
				D	180	
Timers	T20	yes	no			0–31
				B		
				H		
				D		



MMC 100.2



MMC 103

Operand	Example	Read	Write	Format	Value	Range
Counters	C20	yes	yes	B H D		0–31
Data block		yes	yes			0–255
Data byte	DB3.DBB9			H D B	A 10 000 0000 0000 1010	0–255

A maximum of 10 operands can be displayed at the same time on the MMC 100.2.

You can page up and down with the "Page" keys on the MMC 103.



8.4.2 Changing/deleting values



Function

The values of operands can be changed.



Operating sequence

The "Diagnosis" operating area is selected.

Press softkey "PLC status".

The first operand screen form appears.

The vertical softkey bar changes.

Cyclic updating of the values is interrupted.

You can increase or decrease the address of the operand by 1 place at a time.

Softkey assignment on MMC 103 only:

A selection window appears.

You can preset the format fields to "B" (binary), "H" (hexadecimal), "D" (decimal) or "None".

Change the operand, the format or the value.

Diagnosis

PLC
status

Change

Operand
+

Operand
–

Default
format...



MMC 100.2

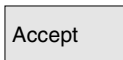
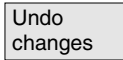
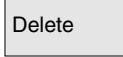

MMC 103

**Delete:**

The entries for the selected operand (formats and values) are deleted. A query window is opened.

Undo changes:

Cyclic updating is continued; the entered values are not transferred to the PLC.

Accept:

The entered values are transferred to the PLC. Cyclic updating is continued.

Further notes

Press the *"Information key"*.

A description of the permissible input syntax for the PLC status display is overlaid.



MMC 100.2



MMC 103

8.5 Selecting/creating operand forms for PLC status



Function

You can save the operands entered in the "PLC status" window to a file or read in a back-up list of operands.



Operating sequence

Diagnosis or Start-up

PLC

File functions

Delete

Save

Load

Error log

The operating area "*Start-up*" is selected.

Select softkey "*PLC*".

The horizontal and vertical softkey bars change.

Select softkey "*File functions*".

The vertical softkey bars change.

Enter the name of the file in which you wish to save the operands.
You can select existing back-up files from a list.

All the following functions refer to the file name entered:

The selected operand back-up file is deleted.

The selected operands are saved to the specified file.

The selected operand file is loaded to the "PLC status" window for processing.

If errors occur during transfer of the machine data, these are entered in an error log.

8.5 Selecting/creating operand forms for PLC status



MMC 100.2



MMC 103



Editor

The error log is transfer-specific, i.e. it is cleared before each new transfer.

The ASCII editor is called with the selected file.
You can now edit the operand back-up file.

8.5.1 Reading in an operand (MMC 100.2)



Function

The values in the PLC status are automatically discarded when the system is restarted cold (after POWER ON).

As a way of optimizing the entry of operands and formats in the PLC status, you can read in operand screen forms from DOS files (one file for each screen form).

These screen forms are generated in a special syntax in ASCII format.

Naming conventions for DOS files:

name.plc	<i>name</i> is a screen form name of max. 8 characters
----------	---

Content of the DOS file:

[\\comment]	e.g. // screen form for PLC test
Operand/format	DB0.DBB0/B
[operand/format]	DB1.DBW0/H
.	.
.	.
[operand/format]	T100-D

You can enter as many comments and operand/format lines as you wish. The PLC status map imposes restrictions, however, and with the MMC 100.2 only the first 10 operand/format lines are read in.



Diagnosis

PLC status

Operating sequence

The "Diagnosis" operating area is selected.

Press softkey "PLC status".

The first operand screen form appears.

The vertical softkey bar changes.



MMC 100.2



MMC 103

8.5 Selecting/creating operand forms for PLC status

Press softkey *"Read in operands"*.

Position the cursor on the appropriate screen form.

Press softkey *"Read in operands"* again.

The screen form you selected is imported into the PLC status display.

8.5.2 File functions (MMC 103)



Function

You can use the file functions to handle the operand screen forms.



Operating sequence

The *"Diagnosis"* operating area is selected.

Press softkey *"PLC status"*.

The first operand screen form appears.

The vertical softkey bar changes.

Select softkey *"File functions"*.

The *"File functions"* window opens.

Enter the file name of the desired operand screen form

or

position the cursor on the desired operand screen form in the list.

The selected operand screen form is deleted.

The current contents of the PLC status are saved in the selected operand screen form.

The contents of the selected operand screen form are loaded to the PLC status.



Further notes

The operand screen forms are ASCII files.

8.6 Displaying system resources (NC, MMC) (SW 4.1 and higher)



MMC 100.2



MMC 103

8.6 Displaying system resources (NC, MMC) (SW 4.1 and higher)



Function

For the NC and MMC (MMC 100.2 only) areas you can display the system resources (utilization display) currently being used:

Net and gross runtimes of

- position controller,
- interpolator and
- preprocessing.

Operating sequence

The "Diagnosis" operating area is selected.

Press softkey "System resources".

The display "NC utilization" is displayed.

The following minimum/maximum total data for the servo, IPO cycle and preprocessing are displayed:

- Net runtime in ms
- Gross runtime in ms
- Level of the IPO buffer in percent (SW 5.2 and higher)
- Total capacity utilization in percent (SW 5.2 and higher)

The display update can be halted with the softkey "Stop", the displayed values are updated again with the softkey "Start".

Press softkey "MMC" (MMC 100.2 only).

The window "MMC utilization" is opened.

The following data are displayed:

- Free memory
- Main memory
- EMS
- HighMem
- Heap
- RAM disk
- Hard disk
- Flash banks

8.6 Displaying system resources (NC, MMC) (SW 4.1 and higher)

MMC 100.2



MMC 103

"Start-up" Operating Area

9.1	Start-up basic display	9-440
9.2	Displaying machine data.....	9-443
9.2.1	Display options: Masking filters (SW 4 and higher).....	9-445
9.3	PLC.....	9-446
9.3.1	PLC status.....	9-447
9.3.2	Setting the date/time	9-447
9.4	MMC 103	9-448
9.4.1	Changing the MMC interface.....	9-448
9.4.2	System settings.....	9-450
9.5	Language selection.....	9-451
9.6	Password.....	9-452

9.1 Start-up basic display



MMC 100.2



MMC 103

9.1 Start-up basic display



Danger

Changes in the "Start-up" operating area have a major impact on the machine. Incorrect parameterization can endanger human life and cause damage to the machine.



Access to certain menus in the "Start-up" operating area can be protected by keyswitch or password.

This Chapter describes functions which the machine operator can perform on the basis of his or her access rights.



For information about start-up with respect to

- System personnel
- Machine manufacturers
- Service personnel
- Machine users (setup engineers).

please refer to

/IAD/, Installation and Start-Up Guide, SINUMERIK 840D

/IAC/, Installation and Start-Up Guide, SINUMERIK 810D

/IAF/, Installation and Start-Up Guide, SINUMERIK FM-NC.

9.1 Start-up basic display



MMC 100.2



MMC 103

MMC

You can enter the basic settings for the operator panel (e.g. color settings) (not on MMC 100.2).

LCD
brighter

LCD
darker

Vertical softkeys

Monochrome display only:

You can adjust the brightness and contrast of the screen.

You can define the boot settings in display machine data \$MM LCD CONTRAST. This display appears with each Power On boot.

Subsequent softkey-initiated changes affect the settings in the display machine data (not on MMC 100.2).

Change
language

You can use two languages in parallel.

When you press softkey "*Change language*", screen texts are displayed in the other of the two languages.



MMC 100.2 only:

If the language of your choice is not loaded on the MMC 100.2, "?" symbols are output instead. When you press softkey "*Change language*" again, screen texts are displayed in the other of the two languages.

NCK
Reset

You can press this softkey to initiate NCK power ON/Reset.

Password...

Softkey assignment on MMC 103 only:

You can set, modify or delete a password. This softkey appears only if you have been granted appropriate access rights.



MMC 100.2



MMC 103

9.2 Displaying machine data



Danger

Changes in the machine data have a considerable influence on the machine. Incorrect parameterization can endanger human life and cause damage to the machine.



Access to the Machine data operating area can be controlled by keyswitch or password.



Function

Machine data are organized in the following areas:

- 1 General machine data (\$MN)
- 2 Channel-specific machine data (\$MC)
- 3 Axis-specific machine data (\$MA)
- 4 Feed drive machine data (\$MD)
- 5 Main spindle drive machine data (\$MD)
- 6 Display machine data (\$MM)

A separate list display in which you can view and change machine data is provided for each of these areas.

The following information about the machine data is displayed from left to right:

- Machine data number
- Machine data name (without area identifier \$MN, \$MC, \$MA, \$MD, \$MM) , possibly with field index.
- Value of machine data
- Machine data unit
- Activation

If the machine data do not use units, no units are displayed.

If data are not available, the "#" symbol is displayed instead of the value.

If the value ends in an "H", it is a hexadecimal value.

Areas





MMC 100.2



MMC 103

The physical units of machine data are displayed on the right-hand side of the input field.

Examples:

m/s**2	m/s ² (meters/second squared): Acceleration
U/s**3	rev/s ³ (revolution/second to power of 3): Change in rate of acceleration for rotating axis
kg/m**2	kg/m ² (kilogram/meters squared): Moment of inertia
mH	mH (millihenry): Inductance
Nm	Nm (Newton meters): Torque
us	μs (microseconds): Time
uA	μA (microamperes): Unit of electric current
uVs	μVs (microvolt-seconds): Magnetic flux
userdef	User-defined: The unit is defined by the user.

The abbreviation in the right-hand column indicates the activation criterion for a machine data:

- so = active immediately
- cf = after confirmation via softkey "*Set MD active*"
- re = Reset
- po = POWER ON (NCK Power-On/Reset)

/IAD/, IAC/ or /IAF/, Installation and Start-Up Guide for 840D, 810D or FM-NC

Sequence of operations

The "*Start-up*" operating area is selected.

Press softkey "*Machine data*".

The horizontal and vertical softkey bars change.

You can select a machine data range, e.g. "General MD".







MMC 100.2



MMC 103

9.2.1 Display options: Masking filters (SW 4 and higher)



Function

The purpose of masking filters is to selectively reduce the number of displayed machine data. For this function, all machine data in areas

- General machine data
- Channel-specific machine data
- Axis-specific machine data
- Drive machine data

are assigned to specific groups (e.g. configuration data, etc.).

The following rules apply:

1. Each area has its own group organization.
2. Each group corresponds to one bit in the filter word ("spare" bit in previous SW)
3. Each area has a maximum of 13 groups (group 14 is reserved for Expert mode (see below), bit 15 is reserved for expansions).

Display machine data do not have any group organization.

Filter criteria

The following table shows the criteria for displaying machine data in the order in which they are evaluated:

Criterion	Check
1. Access rights	If the level of access authorization is not sufficient, the MD is not displayed. Otherwise criterion 2 is checked.
2. Masking filter active	The MD is always displayed when the filter is not active. Otherwise criterion 3 is checked.
3. Expert mode	The MD is not displayed if the expert mode bit is set and expert mode is not selected. Otherwise criterion 4 is checked.
4. Groups	If at least one group bit is both set and selected in the masking filter, criterion 6 is checked. Otherwise criterion 5 is checked.
5. All others	If none of the group bits is set and "All others" is selected in the masking filter, then criterion 6 is checked. If none of the group bits is set and "All others" is not selected in the masking filter, then the MD is not displayed.



MMC 100.2



MMC 103

6. Index from to

If the index check is selected and the index of an array is within the chosen range, then the MD is displayed.

If the index check is selected and the index of an array is not within the chosen range, then the MD is not displayed.

If the index check is not selected, then the MD is displayed (not on MMC 100.2).

Initialization

When you open a machine data window, the filter setting that matches the area is automatically updated.

Storing filter settings

Filter settings are stored for specific areas in file C:\MMC2\IB.INI.

Sequence of operations

The "Start-up" operating area is selected.

Press softkey "Machine data".

The horizontal and vertical softkey bars change.

Select the softkey "Display options", a list of all the ranges that can be displayed/hidden appears.



Start-up

Machine data

Display options

External programs (SW 5.2 and higher):

You can display/hide external programs via the field "N12 external programs".

9.3 PLC



- You can only change PLC operands if you know the correct password.
- The procedure for handling PLC operands is described in subsection "PLC" in Chapter 8, "Diagnosis" Operating Area.



Danger

Changes in the states of PLC memory locations have a major impact on the machine. Incorrect parameterization can endanger human life and cause damage to the machine.



MMC 100.2



MMC 103

9.3.1 PLC status



See Chapter 8, "PLC Status".

9.3.2 Setting the date/time



Start-up

PLC

Set
date/clock

Accept



Function

You can change the date and time of the PLC and synchronize the date and time of the PLC and MMC (MMC 100.2: SW 5.3 and higher).

Sequence of operations

The "Start-up" operating area is selected.

Select softkey "PLC".

The horizontal and vertical softkey bars change.

Press the softkey "Set date/clock", the window "Set date/clock" is displayed.

Enter the correct values in the input fields.

The date and time on the MMC are transferred to the PLC.

You can check the synchronization in the output field "Current" (MMC 100.2: SW 5.3 and higher).

You can switch cyclic synchronization of the time on/off and set the synchronization duration.

See /IAM/ IM1: Installation and Start-Up Guide MMC 100.2.

The set values are retained when the control is next powered up.



MMC 103

9.4 MMC 103

9.4.1 Changing the MMC interface



Function

You can make individual settings on your MMC and store them.



Sequence of operations

The *"Start-up"* operating area is selected.

Start-up

MMC

Press softkey *"MMC"*.

The horizontal and vertical softkey bars change.

Colors

The *"Colors"* setting menu is opened.

You can either define the color scheme of your user interface yourself

- User
- or activate default settings:
- VGA
 - VGA positive
 - Monochrome
 - Monochrome positive.

Save

The current color settings are saved.

Language

If more than 2 languages (German, English) are installed, you can select the default language for NC power-up.



MMC 103

Operator panel

You can make the following settings in the "Operator panel interface parameters" menu:

- Link
 - 1:1 (1NC and 1 MMC) or
 - m:n (1/several NCs and 1/several MMCs)
- Baud rate ("Bus")
 - MCP (1.5 Mbit/s)
 - MPI (187.5 Mbit/s)
- Highest bus address (15–31 available)
- Network address
 - MMC address (own address linked to bus)
 - NCK address (address used to establish communication link)
 - PLC address

NCK and PLC addresses can be changed only if you are using a 1:1 link. With m:n links, addresses are transferred from the "netnames.ini" file.

Editor

This key opens the ASCII editor in which files can be edited at DOS level. You can select existing drives via vertical softkeys.

DOS SHELL

You automatically switch to the DOS shell.



Enter the "Exit" command to go back to the "Colors" menu.

Bus node

List of addresses of active nodes that can be activated with "Update".

System settings

This softkey provides access to settings for inquiry windows, file tree display and screen representation of the Machine, Program and Services operating areas.

Select printer

This softkey will function only if a printer is installed under Windows 95. It can be used to print displays and data from the Start-up operating area.

You select the printer on which you wish to print data/displays (default setting: Output as bitmap file)

For further information, please see

/FBA/ Description of Functions, Drive Function).



MMC 103

9.4.2 System settings



Display

Function

You can alter the file tree display, the control response with respect to confirmation requests as well as the symbols used in input fields.

You can set the file tree display for the Services, Machine and Program operating areas.

The following columns can be selected:

- Type (extension)
- Loaded
- Length
- Access protection
- Date
- Time
- Enable
- Max. display levels (branch to directory trees, a max. of 7)
- Max. name length (a max. of 25 characters)

Your settings are automatically displayed in the "Forecast" window.



System queries

Request confirmation before

- Deletion of data/programs,
- Deletion of directories,
- File overwrite.

Symbols

Here you can define whether keys must be represented as symbols or as text in MMC displays.

Example: Operator panel in US layout ,

e. g. the selection key as a symbol (), as text .



Start-up

MMC

Sequence of operations

The "Start-up" operating area is selected.

Select softkey "MMC".

The horizontal and vertical softkey bars change.



MMC 103

File
display

The "Settings for file display" window is opened.

Inquiry

The "Settings for inquiries" window is opened.

You can specify whether or not an inquiry window should be displayed after certain commands, e.g. Delete.

Symbols

The "Representation of keys in displays..." window is opened.



Position the cursor on the desired point and perform the settings.

Save

Transfers your settings to system.

9.5 Language selection

Start-up

The "Start-up" operating area is selected.

Language

SW 5.2 and earlier:

When more than two languages are installed, you can select a language in this menu

- which is loaded during power-up and
- selected as the alternative language if required.

Change
Language

SW 5.3 and later:

The softkey for selecting the language is now called "Change Language" and offers the languages German, English, French, Italian and Spanish.

When more than two languages are installed, you can select a language in this menu

- which is loaded during power-up and
- toggled as required



MMC 100.2



MMC 103

9.6 Password



Function

The control has a protection level system for enabling data areas. This system uses protection levels 0 to 7,

- 0 is the highest level and
- 7 the lowest.

Access to protection levels

- 0 to 3 is controlled by means of passwords and
- 4 to 7 by means of keyswitch settings.

The operator has access to information that is available on the level (and the levels below) to which he or she has access rights. Machine data are all assigned protection levels which vary depending on the nature of the data.

Protection level	Access controlled by	Range
0	Password	Siemens
1	Password	Machine manufacturer
2	Password	Start-up/service engineer
3	Password	End user
4	Keyswitch setting 3	Programming/set-up engineer
5	Keyswitch setting 2	Qualified operator
6	Keyswitch setting 1	Trained operator
7	Keyswitch setting 0	Job-trained operator

Personnel can edit data such as cycles and machine data depending on the level of authorization they have been granted.

You can alter the set password using the Password function.

If one of the above passwords is set, the keyswitch position is ignored.



Maintenance

10.1 Operating data	10-454
10.2 Cleaning.....	10-455

10.1 Operating data



MMC 100.2



MMC 103

10.1 Operating data

Operating data

	Value
Air humidity, humidity class to DIN 40040	F
Air pressure	860 to 1080 hPa
Shock protection, Protection class to DIN VDE 0160	I
Degree of protection according to DIN 40050	
• Front of operator panel	IP 54
• Back of operator panel	IP 00
• Front of machine control panel	IP 54
• Back of machine control panel	IP 00

You will find the comprehensive operating data in the documentation /BH/ Operator Components Manual and in the relevant information sheets.





MMC 100.2



MMC 103

10.2 Cleaning

Cleaning agents

The front of the monitor and the surface of the operator panel can be cleaned. For dirt that is relatively easy to remove, standard household washing-up liquid, or an industrial cleaner (such as "Special Swipe") can be used. These cleaners will also remove dirt containing graphite.

Cleansing agents which contain one or more of the following ingredients can be used for a short period of time:

- Diluted mineral acids
- Bases
- Organic hydrocarbons
- Detergent solutions

Plastic material used

The plastic material used on the front of the SINUMERIK 840D and SINUMERIK FM-NC is suitable for applications on machine tools.

This is resistant to

1. Greases, oils, mineral oils
2. Bases and lyes
3. Detergent solutions and
4. Alcohol

Solvents such as chlorinate hydrocarbons, benzene, esters and ethers should be avoided!

10.2 Cleaning

MMC 100.2



MMC 103



MMC 100.2



MMC 103

Appendix

A Abbreviations

A-spline	The Akima spline progresses tangentially through the programmed interpolation points (3rd degree polynomial).
AS	Automation System
ASCII	American Standard Code for Information Interchange
ASIC	Application-Specific Integrated Circuit
ASUB	Asynchronous subprogram
AuxF	Auxiliary Function
AV	Production Planning
BA	Operating mode
BAG	Mode group
BB	Ready
BCD	Binary Coded Decimals
BCS	Basic Coordinate System
BIN	Binary files
BIOS	Basic Input Output System
BOT	Boot Files: for SIMODRIVE 611 D
C1 ... C4	Channel 1 to Channel 4
CAD	Computer-Aided Design
CAM	Computer-Aided Manufacturing
CNC	Computerized Numerical Control



MMC 100.2



MMC 103

COM	Communication
COR	Coordinate Rotation
CP	Communications Processor
CPU	Central Processing Unit
CR	Carriage Return
CRC	Cutter Radius Compensation
CRT	Cathode Ray Tube
CSB	Central Service Board: PLC module
CSF	Control System Flowchart
CTS	Clear To Send: (serial data interfaces)
CUTOM	Cutter radius compensation (tool radius compensation)
DAC	Digital-to-Analog Converter
DB	Data Block in the PLC
DBB	Data Block Byte in the PLC
DBW	Data Block Word in the PLC
DBX	Data Block Bit in the PLC
DC	Direct Control: The rotary axis is moved along the shortest path to the absolute position within one revolution.
DCD	Carrier Detect
DDE	Dynamic Data Exchange
DIN	Deutsche Industrie Norm (German Industry Standard)
DIO	Data Input/Output: Data transfer display



MMC 100.2



MMC 103

DIR	Directory
DLL	Dynamic Link Library
DOE	Data Communications Equipment
DOS	Disk Operating System
DPM	Dual-Port Memory
DPR	Dual-Port RAM
DRAM	Dynamic Random Access Memory
DRF	Differential Resolver Function
DRY	Dry Run
DSB	Decoding Single Block
DTE	Data Terminal Equipment
DW	Data Word
EIA Code	Special tape format: Number of perforations per character is always odd
ENC	Encoder actual-value sensor
EPROM	Erasable Programmable Read Only Memory
FB	Function block
FC	Function Call: Function block in PLC
FDB	Product Database
FDD	Feed Drive
FEPROM	Flash EPROM Read/write memory



MMC 100.2



MMC 103

FIFO	First In First Out: Memory which operates without address specification from which data are read in the same order as they are stored.
FIPO	Fine Interpolator
FPU	Floating Point Unit
FRA	Frame Block
FRAME	Data block (frame)
FST	Feed Stop
GUD	Global User Data
HD	Hard Disk
HEX	Abbreviation for hexadecimal
HHU	Hand-Held Unit
HMI	Human-Machine Interface
HMI	Human Machine Interface: SINUMERIK operator functionality for operation, programming and simulation. HMI has the same meaning as MMC.
HMS	High-Resolution Measuring System
HW	Hardware
I	Input
I/O	Input/output
I/RF	Infeed/Regenerative Feedback Unit (power supply) of SIMODRIVE 611(D)
IBN	Start-Up
IC (GD)	Implicit Communication (Global Data)



MMC 100.2



MMC 103

IF	Drive module pulse enable
IKA	Interpolative Compensation
IM	Interface Module
IMR	Interface Module Receive
IMS	Interface Module Send
INC	Increment
INI	Initializing Data
IPO	Interpolator
IS	Interface signal
ISO Code	Special tape code, number of perforations per character is always even
JOG	Jog mode Setup mode
KUE	Transmission ratio
KV	Servo gain factor
LAD	Ladder diagram (programming method for PLC)
LEC	Leadscrew Error Compensation
LF	Line Feed
LMS	Position Measuring System
LR	Position controller
LUD	Local User Data
MCP	Machine Control Panel
MCS	Machine Coordinate System



MMC 100.2



MMC 103

MD	Machine Data
MDA	Manual Data Automatic: Manual input
MLFB	Machine-readable product designation (= Order No.)
MMC	Man Machine Communication: SINUMERIK operator functionality for operation, programming and simulation. MMC has the same meaning as HMI.
MPF	Main Program File: NC part program
MPI	Multi Point Interface
MSD	Main Spindle Drive
NC	Numerical Control
NCK	Numerical Control Kernel (with block preparation, traversing range, etc.)
NCU	Numerical Control Unit: Hardware unit of the NCK
NURBS	Non-Uniform Rational B-Spline
O	Output
OB	Organization Block in PLC
OEM	Original Equipment Manufacturer
OI	Operator Interface
OP	Operator Panel
OPI	Operator Panel Interface
OPT	Options
PCIN	Name of the software for data communication with the control
PCMCIA	Personal Computer Memory Card International Association: Memory card standardization



MMC 100.2



MMC 103

PG	Programming Device
PLC	Programmable Logic Control
RAM	Random Access Memory (read-write memory)
REF	Reference point approach function
REPOS	Reposition function
RISC	Reduced Instruction Set Computer: Processor type with small instruction set and high-speed instruction throughput
ROV	Rapid Override
RPA	R Parameter Active Memory area in NCK for R parameter numbers
RPY	Roll Pitch Yaw: Type of rotation of a coordinate system
RTS	Request To Send (serial data interfaces)
SBL	Single Block
SD	Setting Data
SEA	Setting Data Active: (file identifier for setting data)
SK	Softkey
SKP	Skip block
SM	Stepper Motor
SPF	Sub Program File
SRAM	Static RAM (battery-backed)
SSI	Serial Synchronous Interface
STL	Statement list
SW	Software



MMC 100.2



MMC 103

SW limit switch	Software limit switch
SYF	System Files
T	Tool
TC	Tool Change
TEA	Testing Data Active: Identifier for machine data
TLC	Tool Length Compensation
TNRC	Tool Nose Radius Compensation
TO	Tool Offset
TOA	Tool Offset Active: Identifier (data type) for tool offsets
TRANSMIT	Transform Milling into Turning: Coordinate conversion on turning machines for milling operations
TRC	Tool Radius Compensation
UFR	User Frame: Zero offset
V.24	RS-232-C, defines transmission of serial data between DTE and DCE devices
WCS	Workpiece Coordinate System
WDP	Work Piece Directory
WOP	Workshop-Oriented Programming
ZO	Zero Offset
ZOA	Zero Offset Active: Identifier (file type) for zero offset data
μC	Micro Controller



MMC 100.2



MMC 103

B Terms

Important terms are listed below in alphabetical order, accompanied by explanations. Cross-references to other entries in this glossary are indicated by the symbol ->.

A

A-spline

The Alcima spline progresses tangentially through the programmed nodes (3rd degree polynomial).

Absolute dimension

A destination for an axis movement is defined by a dimension that refers to the origin of the currently active coordinate system. See also -> incremental dimension.

Acceleration with jerk limitation

To obtain the optimum acceleration gradient for the machine while at the same time minimizing mechanical wear and tear, the machining program offers a choice between instantaneous acceleration and continuous (smooth) acceleration.

Access rights

Programs and other files are protected by a 7-level system of access restrictions:

- Three password levels for system manufacturer, machine-tool manufacturer and user, and
- Four keyswitch positions that can be analyzed by the PLC (depending on keyswitch HW).

Alarms

All -> messages and alarms are displayed on the control panel in plain-text form and accompanied by date and time and the symbol for the appropriate deletion criterion. Alarms and messages are displayed separately.

Analog I/O module

Analog input/output modules are signal transducers for analog process signals.

Analog input modules convert analog measured signals into digital values that can be processed in the CPU.

Analog output modules convert digital values into analog manipulated variables.



MMC 100.2



MMC 103

Approach machine fixed-point

Approach to a predefined -> machine fixed point.

Archiving

Exporting files and/or directories to an **external** storage device.

Asynchronous subprogram

Part program that can be triggered asynchronously to (irrespective of) the current program status by means of an interrupt signal (e.g. "high-speed NC input" signal).

Automatic

Control operating mode (block-sequential operation to DIN): Operating mode of NC systems in which a -> part program is selected and then processed without interruption.

Auxiliary functions

Auxiliary functions can be used to pass -> parameters to the -> PLC in the -> part program, triggering reactions there which are defined by the machine manufacturer.

Axes

CNC axes are categorized by their functional scope as follows:

- Axes: Interpolative path axes
- Auxiliary axes: Non-interpolative infeed and positioning axes with axis-specific feedrates. Auxiliary axes do not participate in workpiece machining as such and include tool feeders, tool magazines, etc.

Axis address

See -> axis identifier

Axis identifier

In compliance with DIN 66217, axes are identified as X, Y, Z for a right-handed rectangular Cartesian -> coordinate system rotating in the clockwise direction.

Rotary axes rotating around X, Y and Z are assigned the identifiers A, B and C. Additional axes, which are parallel to those specified, can be identified by other letters.

Axis name

See -> axis identifier



MMC 100.2



MMC 103

B**B spline**

The programmed B spline positions are not intermediate points but simply "checkpoints". Instead of passing directly through these checkpoints, the curve merely passes in their vicinity (1st, 2nd or 3rd degree polynomials).

Base axis

Axis whose setpoint or actual value is employed in calculating a compensatory value.

Basic Coordinate System

Cartesian system of coordinates, mapped onto the machine coordinate system by transformation.

In the -> part program, the programmer uses the axis names of the basic coordinate system. The basic coordinate system exists in parallel to the machine coordinate system when no -> transformation is active. The difference between the systems relates only to the axis identifiers.

Blank

The unmachined workpiece.

Block

All files required for programming and program execution are known as blocks.

A section of a -> part program terminated with a line feed is also called a block. There are two types of block, i.e. -> main blocks and -> subblocks.

Block search

For testing part programs and after an interruption in machining, the block search function can be used to select a point in the part program at which machining must be started or resumed.

Boot

Loading of the system program after Power ON.



MMC 100.2



MMC 103

C**C axis**

Axis about which the tool spindle describes a controlled rotational and positioning movement.

Channel

A channel can execute a -> part program independently of other channels. A channel has exclusive control over the axes and spindles assigned to it. Part program sequences on different channels can be coordinated by -> synchronization.

Channel structure

On account of the channel structure, it is possible to execute the -> programs of the individual channels simultaneously and asynchronously. See also - machining channel.

Circular interpolation

The -> tool is required to travel in a circle between defined points on the contour with a specified feed while machining the workpiece.

CNC

-> NC

COM

Numerical control component for the implementation and coordination of communication.

Compensation axis

Axis having a setpoint or actual value modified by a compensation value.

Compensation table

Table of intermediate (interpolation) points. This table supplies the compensation values of the compensation axis for selected positions of the base axis.

Compensation value

Difference between the axis position measured by the position sensor and the desired, programmed axis position.

Continuous-path mode

The purpose of continuous-path control mode is to prevent excessive deceleration of -> path axes at part program block limits and to ensure the smoothest possible transition to the next block.



MMC 100.2



MMC 103

Contour	Outline of a -> workpiece
Contour monitoring	The following error is monitored within a definable tolerance bandwidth as a measure of contour precision. The following error might violate permissible limits, for example, on account of drive overload. In this case, an alarm is output and the axes are stopped.
Coordinate system	See -> machine coordinate system, -> workpiece coordinate system
CPU	Central processing unit of a -> programmable logic controller
Cycle	Subprogram for execution of a recurring machining process on the -> workpiece.
Cycles support	The cycles available can be viewed in a list called through the " <i>Cycles support</i> " menu in the " <i>Program</i> " operating area. Once a cycle is selected, the parameters required to assign values are displayed in plain-text form. See also -> standard cycles.
D	
D number	Number for the tool offset memory
Data block	<ol style="list-style-type: none"> 1. Data unit of the -> PLC, accessible by -> HIGHSTEP programs. 2. Data unit of the -> NC: Data blocks contain data definitions for global user data. The data can be initialized directly on definition.
Data transfer program PCIN	PCIN is a routine for sending and receiving CNC user data via the serial interface. Typical data include part programs, tool compensation data, etc. The PCIN program is executable under MS-DOS on industry-standard PCs.
Data word	A data unit, two bytes in size, within a -> data block.
Dimensions in metric and inch systems	In the machining program, position and lead/pitch values can be entered in inches. The control is set to a base system irrespective of the programmable unit of measure (G70/G71).
DRF	Differential Resolver Function: An NC function which generates an incremental zero offset in AUTOMATIC mode in conjunction with an electronic handwheel.



MMC 100.2



MMC 103

Drift compensation

When the CNC axes are in the constant motion phase, automatic drift compensation is implemented in the analog speed control. (SINUMERIK FM-NC).

Drive

- SINUMERIK FM-NC has an analog ± 10 V interface to the SIMODRIVE 611A converter system.
- The SINUMERIK 840D control system is connected to the SIMODRIVE 611D converter system by a high-speed digital parallel bus.

E**Editor**

The editor allows programs/texts/program blocks to be created, modified, extended, chained and inserted.

Electronic handwheel

Electronic handwheels are used to traverse selected axes simultaneously under manual control. The handwheel clicks are analyzed by the increment analyzer.

Exact stop

When an exact stop is programmed, a position specified in the block is approached accurately and, where appropriate, very slowly. In order to reduce the approach time, -> exact stop limits are defined for rapid traverse and feed.

Exact stop limit

When all path axes reach their exact stop limits, the control responds as if it had reached its destination point precisely. The -> part program carries on execution with the next block.

F**Feedrate override**

The current feedrate setting entered via the control panel or by the PLC is overlaid on the programmed feedrate (0-200 %). The feedrate can also be corrected by a programmable percentage factor (1-200 %) in the machining program.

File type

Possible types of files include part programs, zero offsets, R parameters, etc.



MMC 100.2



MMC 103

Finished-part contour

Contour of the finished workpiece. See also -> Blank.

Fixed-point approach

Machine tools can execute defined approaches to fixed points such as tool-change points, loading points, pallet-change points, etc. The coordinates of these points are stored in the control. The control traverses the axes in question in -> rapid traverse if possible.

Focus

Border (bold frame) which identifies windows that can be edited.

Frame

A frame is a calculation rule that translates one Cartesian coordinate system into another Cartesian coordinate system. A frame contains the components -> zero offset, -> rotation, -> scaling, -> mirroring.

G**Geometry**

Description of a -> workpiece in the -> workpiece coordinate system.

Geometry axis

Geometry axes are used to describe a 2- or 3-dimensional area in the workpiece coordinate system.

H**High-level language CNC**

The high-level language supports: -> user variables, -> predefined user variables, -> system variables, -> indirect programming, -> computation and angle functions, -> comparisons and logical gating, -> program jumps and program branches, -> program coordination (SINUMERIK 840D), -> macro programming.

High-speed digital inputs/outputs

Digital inputs can be used, for example, to start high-speed CNC program routines (interrupt routines). The digital CNC outputs can be used to trigger high-speed, program-driven switching functions (SINUMERIK 840D).

HIGHSTEP

Combination of the programming features for the -> PLC in the S7-300/S7-400 range.



MMC 100.2



MMC 103

I

I/O module

I/O modules establish the link between the CPU and the process. I/O modules are:

- ->Digital input/output modules
- ->Analog input/output modules
- ->Simulator modules

Identifier

In accordance with DIN 66025, identifiers (names) for variables (calculation variables, system variables, user variables), subprograms, vocabulary words and words can contain several address letters. These letters have the same meaning as the words in the block syntax. Identifiers must be unique. The same identifier may not be used for different objects.

Inch system of measurement

System of measurement in which distances are measured in inches and fractions of inches.

Incremental dimension

A destination for axis traverse is defined by a distance to be covered and a direction referenced to a point already reached.

See also -> absolute dimension.

Length of the traversing path given by the number of increments. The number of increments can be stored as -> setting data or selected using the corresponding keys 10, 100, 10 000.

Initialization file

Initialization files are special -> program blocks. They contain value assignments that must be implemented before program execution commences.

Initialization files are used primarily to initialize predefined data or global user data.

An initialization file can be created for each -> workpiece. In it, the various variable value instructions which apply exclusively to one workpiece can be stored.

Interpolative compensation

Interpolative compensation provides a means of compensative for leadscrew errors and measuring system errors resulting from the production process (LEC, MSEC).

Interpolator

Logical unit of the -> NCK which determines intermediate values of the movements to be traversed by the individual axes on the basis of destination positions specified in the part program.



MMC 100.2



MMC 103

J**Jog**

Control mode (setup): The machine can be set up in Jog mode. Individual axes and spindles can be jogged by means of manually operated momentary-contact switches. Other functions in the Jog mode are
-> reference point approach, -> Repos and -> Preset (act actual value).

K**Keyswitch**

1. **S7-300**: The keyswitch is the operating mode selector switch of the -> CPU. The keyswitch is locked and its setting cannot be changed once the key has been removed.
2. **840D/FM-NC**: The keyswitch on the -> machine control panel has 4 positions, each of which is assigned certain functions by the operating system of the control. The keyswitch has three keys of different colors; a key can be removed when in the designated position.

Keywords

Words of a defined notation and having a defined meaning in the programming language for -> part programs.

 $K_{\dot{u}}$

Transmission ratio

 K_v

Servo gain factor, control variable of a control loop

L**Languages**

The user interface and system messages and alarms are available in five system languages (on disk):

English, French, German, Italian and Spanish.

Any **two** of the above languages are installed and selectable in the control (operating area Start-up).

Leadscrew error compensation

Compensation for the mechanical inaccuracies of a leadscrew participating in the feed. The control uses stored deviation values for the compensation.

Limit speed

Maximum/minimum (spindle) speed: The maximum speed of a spindle can be limited by values defined in the machine data, the -> PLC or -> setting data.



MMC 100.2



MMC 103

Linear axis	The linear axis is an axis which, in contrast to a rotary axis, describes a straight line.
Linear interpolation	The tool is required to travel to the destination point along a straight line while machining the workpiece.
Look Ahead	The Look Ahead function is a means of optimizing the machiningspeed by looking ahead over a parameterizable number of traversing blocks.
M	
Machine axes	Axes which physically exist in the machine tool.
Machine control panel	An operator panel on a -> machine tool with operating elements such as keys, rotary switches, etc. and indicators such as LEDs. It is used for direct control of the machine tool via the PLC.
Machine coordinate system	The machine coordinate system (MCS) refers to the coordinates of the machine axes, i.e. all machine axes and auxiliary axes are displayed in the machine coordinate system.
Machine fixed point	A point uniquely defined by the machine tool, for example, the reference point.
Machine zero	A fixed point on the machine tool which can be referenced by all derived measuring systems.
Machining channel	A channel structure provides a means of reducing non-productive times by paralleling operations. For example, a loader can execute its movements during a machining operation. In this respect, a channel ranks as an autonomous CNC complete with decoding, block preparation and interpolation.
Macro programming	A collection of instructions under a common identifier. The identifier in the program represents the quantity of collected instructions.
Main block	A block prefixed by ":" containing all the parameters required to start execution of a -> part program.
Main memory	The working memory is a RAM in the -> CPU which the processor accesses as it executes the user program.



MMC 100.2



MMC 103

Main program

A -> part program identified by a number or a name in which further main programs, subprograms or -> cycles can be called.

MDA

Control operating mode: Manual Data Automatic. In the MDA mode, individual program blocks or block sequences can be entered without reference to a main program or routine. They can then be executed immediately with the NC start key.

Messages

All messages programmed in the part program and -> alarms detected by the system are displayed on the control panel in plain-text form with date and time and the appropriate symbol for the deletion criterion. Alarms and messages are displayed separately.

Metric measuring system

Standardized system of units: The units of measure for length, for example, are mm (millimeter) and m (meter).

Mirroring

Mirroring exchanges the leading signs of the coordinate values of a contour in relation to an axis. Mirroring can be performed simultaneously in relation to several axes.

Mode group (BAG)

Technologically related axes and spindles can be combined in a mode group. Axes/spindles of the same mode group can be controlled by one or more -> channels. The same -> mode is always assigned to the channels of a mode group.

Multipoint Interface (MPI)

The multipoint interface (MPI) is a 9-pin D-Sub port. A parameterizable number of devices can be connected to a multipoint interface for the purpose of communicating with one another:

- Programming devices
- MMI systems
- Other automation systems

The "Multipoint Interface MPI" parameter block of the CPU contains the -> parameters which define the properties of the MPI.

N**NC**

Numerical Control: NC control incorporates all the components of the machine tool control system: -> NCK, -> PLC, -> MMC, -> COM.

Note: CNC (computerized numerical control) is a more accurate term for the SINUMERIK 840D and FM-NC controls. computerized numerical control.



MMC 100.2



MMC 103

NCK	Numeric Control Kernel: Component of the NC control which executes -> part programs and essentially coordinates the movements on the machine.
Node number	The node number is the address of a -> CPU or the -> programming device or some other intelligent I/O module for communication via a -> network. The node number is assigned to the CPU or the programming device by the S7 tool -> "S7 configuration".
NRK	Numeric Robotic Kernel (operating system of the -> NCK)
NURBS	Within the NC, motion control and path interpolation are based on NURBS (Non-Uniform Rational B-Splines). This is available as a uniform procedure for all interpolation activities of the control (SINUMERIK 840D).
O	
OEM	The manufacturers of machine tools who prefer to generate their own user interfaces or incorporate customized, technology-related functions in the control have plenty of scope to do so (OEM applications) with the SINUMERIK 840D.
Offset memory	Data area in the control used to store the tool offset data.
Operating area	The basic functions of the control are organized in separate operating areas.
Operating mode	An operating concept on a SINUMERIK control. The modes -> Jog, -> MDA and -> Automatic are defined.
Oriented spindle stop	Stops the workpiece spindle at a specified orientation angle, e.g. to perform an additional machining operation at a specific position.
Oriented tool retractions	RETTOOL: If machining is interrupted (e.g. by tool breakage), a program command can be issued that causes the tool to be retracted a defined distance and at a specific orientation angle.
Override	Manual or programmable control feature which enables the operator to overlay programmed feedrates or speeds to adapt them to a specific workpiece or material.



MMC 100.2



MMC 103

P**Parameter**

1. **S7-300:** This system has 2 types of parameter:

- Parameter of a STEP 7 statement
A parameter of a STEP 7 statement is the address of the operand to be processed or a constant.
- Parameter of a -> parameter block
A parameter of a parameter block determines the behavior of a module.

2. **840D/FM-NC:**

- Computation parameter, can be set any number of times or interrogated by the programmer for any purpose in the part program.

Part program

A sequence of instructions to the NC control which combine to produce a specific -> workpiece by performing machining operations on a -> blank. Also refers to a specific machining operation on a given -> blank.

Path axis

Path axes are all the machining axes of the -> channel which controlled by the -> interpolator such that they start, stop, accelerate and reach their end points simultaneously.

Path feed

Path feed is applied to -> path axes. It is the geometric sum of feeds of the participating -> geometry axes.

Path speed

The maximum programmable path speed depends on the input resolution. If the resolution is 0.1 mm, for example, the maximum programmable path speed is 1000 mm/min.

PLC

Programmable Logic Control: -> Speicherprogrammierbare Steuerung. A component of the -> NC control. A control which can be programmed to control the logic on a machine tool.

PLC programmable controller

- SINUMERIK FM-NC: The PLC user memory of the CPU 314 is used to store the PLC application program and the user data together with the PLC basic program. The S7-CPU 314 has a user memory of 24 KB for this purpose.
- SINUMERIK 840D: The PLC user memory is used to store the PLC application program and the user data together with the PLC basic memory. The PLC user memory can be expanded to 96 KB through the insertion of expansion modules.



MMC 100.2



MMC 103

Polar coordinates	A coordinate system which defines the position of a point on a plane in terms of its distance from the origin and the angle formed by the radius vector with a defined axis.
Positioning axis	An axis which performs an auxiliary movement on a machine tool (e.g. tool magazine, pallet transport). Positioning axes are axes that do not interpolate with the -> path axes.
Preset	The Preset function is a means of redefining the control zero in the machine coordinate system. Preset does not trigger movement of the axes. Instead, a new position value is entered for the current axis positions.
Program control	This function can be used in the Automatic and MDA modes to control program execution (e.g. through selection of a block to be skipped).
Programmable frames	Programmable -> frames can be used to define new coordinate system starting points dynamically during execution of the part program. Two types of definition are used, i.e. "absolute" which uses a new frame and "additive" which uses a reference to an existing starting point.
Programmable working area limitation	Limitation of the movement area of the tool within programmed limits..
Programming key	Characters and character sequences which have a defined meaning the programming language for -> part programs (see Programming Guide).
Programming language CNC	The CNC programming language is based on DIN 66025 with high-level language extensions. The CNC programming language and -> high-level language extensions support the definition of macros (sequenced statements).
Protection zone	Three-dimensional zone within the -> working area and which the tool tip is not allowed to enter.



MMC 100.2



MMC 103

Q**Quadrant error compensation**

Quadrant error compensation is a means of largely eliminating contour errors at quadrant transitions caused by the variation in friction at guideways. Quadrant error compensation is parameterized by means of a circularity test.

R**R parameter**

Arithmetic parameter. The programmer of the -> part program can assign or request the values of the R parameter as required.

Rapid lift from contour

If an interrupt is received, the CNC machining program can trigger a movement which permits the tool to lift rapidly away from the workpiece contour currently being machined. The angle of retraction and the distance can also be parameterized. The rapid lift from contour can be followed by an interrupt routine (SINUMERIK FM-NC, 840D).

Rapid traverse

Highest speed of an axis, used, for example, to bring the tool from an idle position to the -> workpiece contour or retract it from the workpiece contour.

Reference point

A point on the machine tool to which the measurement system of the -> machine axes refers.

Reference point approach

If the system of position measuring employed is not based on absolute-value encoders, the control must perform a reference point approach in order to ensure that the measured values supplied by the measuring system coincide with the machine coordinate values.

REPOS

1. Reapproach to contour, triggered by operator
The Repos function provides a means of returning the tool to the interrupt position with the aid of the direction keys.
2. Program-driven return to contour
A number of repositioning strategies driven by program commands are available: Reposition at interrupt point, reposition at start of block, reposition at end of block, reposition at a point on the path between beginning of block and interruption.



MMC 100.2



MMC 103

Rigid tapping

This function is used to tap holes without the use of a compensating chuck. Through interpolative traversal of the spindle as a rotary axis and the drill axis, threads are tapped precisely to the final drilling depth, for example, in blind tapped holes (precondition: spindle is operating in axis mode).

Rotary axis

Rotary axes cause the tool or workpiece to rotate to a specified angle position.

Rotary axis, continuously turning

The range of motion of a rotary axis can be limited to an angle less than 360 degrees or defined as continuous in both directions, depending on the application. Continuously turning rotary axes are used, for example, for eccentric machining operations, grinding and winding.

Rotation

Component of a -> frame which defines a rotation of the coordinate system through a specific angle.

Rounding axis

Rounding axes cause the workpiece or tool to rotate to an angle position described on a graduated grid. When the grid position has been reached, the axis is "in position".

S**S7 Configuration**

S7 Configuration is a tool for parameterizing modules. S7 Configuration is used to set a variety of
-> parameter blocks of the -> CPU and the I/O modules in the ->
-> programming device. These parameters are uploaded to the CPU.

S7-300 bus

The S7-300 bus is a serial data bus via which modules communicate and receive their supply voltage. The connections between the modules are established by means of -> bus connectors.

Safety functions

The control incorporates monitors which are active at all times and which are designed to detect malfunctions in the -> CNC, the programmable controller (-> PLC) and the machine at an early stage in order to minimize the risk of damage to the tool, workpiece or machine. If a malfunction occurs, machining is interrupted and the drives are stopped. The cause of the malfunction is logged and an alarm is issued. At the same time, the PLC is notified that a CNC alarm has been triggered.

Scaling

Component of a -> frame which causes axis-specific alterations in the scale.



MMC 100.2



MMC 103

Setting data	Data which provide the NC with information on the properties of the machine tool in a way defined by the software.
Softkey	A key whose name appears on an area of the screen. The choice of softkeys displayed is adapted dynamically to the operating situation. Freely assignable function keys (softkeys) are assigned to functions defined in the software.
Software limit switch	Software limit switches define the limits of the travel range of an axis and prevent the slide contacting the hardware limit switches. Two pairs of values can be assigned per axis and activated separately via the -> PLC.
Spindles	The spindle functionality is a two-level structure: <ol style="list-style-type: none"> 1. Spindles: Speed-controlled or position-controlled spindle drives, analog ± 10 V (SINUMERIK FM-NC) digital (SINUMERIK 840D) 2. Auxiliary spindles: Speed-controlled spindle drives "auxiliary spindle" function package, e.g. for powered tools.
Spline interpolation	Spline interpolation is a method by which the control can construct a smooth curve from a limited number of intermediate points defined on a target contour.
Standard cycles	Standard cycles are provided for frequently recurring machining processes: <ul style="list-style-type: none"> • for drilling and milling • for turning (SINUMERIK FM-NC) The cycles available can be viewed in a list called through the " <i>Cycles support</i> " menu in the " <i>Program</i> " operating area. Once the desired machining cycle has been selected, the parameters required for value assignment are displayed in plain text and values can be entered.
Subblock	Block introduced by "N" and containing information for a step, e.g. the definition of a position.
Subprogram	Sequence of statements in a -> part program that can be called repeatedly with differing initial parameters. -> Cycles are a type of subprogram.
Synchronization	Instructions in -> part programs for coordination of the operations in different -> channels at specific machining points.



MMC 100.2



MMC 103

Synchronized actions

1. Auxiliary function output
When machining is in progress, technological functions (-> auxiliary functions) can be output to the PLC from within the CNC program. These auxiliary programs are used, for example, to control auxiliaries for the machine tool such as center sleeves, grippers, chucks, etc.
2. High-speed auxiliary function output
For time-critical switching functions, the acknowledgement times for the -> auxiliary functions can be minimized and unnecessary stops in the machining process avoided.

Synchronized axes

Synchronized axes require the same time for their travel as -> geometry axes for their path travel.

System variable

A variable which exists although it has not been programmed by the programmer of the -> part program. It is defined by the data type and the variable name, which is prefixed with \$.
See also -> user-defined variable.

T**Teach In**

Teach In is a means of creating or correcting part programs. The individual program blocks are keyed in via the keyboard and executed immediately. Positions approached via the diction keys or handwheels can also be stored. Additional specifications such as G functions, feedrates and M functions can be entered in the same block.

Text editor

-> Editor

Tool

Component used to machine workpieces, e.g. turning tool, milling tool, drill, LASER beam ...

Tool nose radius compensation

When a contour is programmed, it is assumed that the tool is pointed. Since this is not always the case in practice, the curvature radius of the tool used is specified so that the control can make allowance for it. The curvature center point is guided along an equal distance to the contour at an offset corresponding to the curvature radius.

Tool offset

A tool is selected by programming a **T function** (5 decades, integer) in the block. Up to nine tool edges (D addresses) can be assigned to each T number. The number of tools to be managed by the control is defined in parameterization.



MMC 100.2



MMC 103

Tool radius compensation

Direct programming of a \rightarrow workpiece radius requires the control to be able to travel a path equidistant to the programmed contour, taking the radius of the tool used into account (G41/G42).

Transformation

Programming in the Cartesian coordinate system, execution in a non-Cartesian coordinate system (e.g. with machine axes as rotary axes).

Travel range

The maximum permissible travel range for linear axes is ± 9 decades. The absolute value depends on the selected precision for input and position control and the unit of measurement (inch or metric system of measurement).

U**User program**

User programs for S7-300 PLCs are written in the STEP 7 programming language. The user program is modular in structure and consists of individual blocks.

The basic types of block are as follows:

Code blocks: These contain the STEP 7 commands.

Data blocks: These contain constants and variables for the STEP 7 program.

User-defined variable

Users can define variables in the part program or the data block for their own use (global user data). A definition contains a data type specification and the variable name. See also \rightarrow system variable.

V**Variable definition**

A variable definition includes the specification of a data type and a variable name. The variable name can be used to address the value of the variable.

Velocity control

In order to achieve an acceptable travel velocity in movements which call for very small adjustments of position in a block, the control can use \rightarrow lookahead and thus analyze a number of blocks in advance.

W**Working area**

Three-dimensional zone into which the tool tip can be moved on account of the physical design of the machine tool.
See also \rightarrow protection zone.



MMC 100.2



MMC 103

Working area limitation

Working area limitation is a means of restricting axis movements over and above the restrictions imposed by limit switches. A pair of values delimiting the protected zone can be defined for each axis.

Workpiece

1. Part to be produced/machined by the machine tool or
2. A directory containing programs and other data. Workpieces are stored in directories.

Workpiece contour

Setpoint contour of the -> workpiece to be created/machined.

Workpiece coordinate system

The datum of the workpiece coordinate system is the -> workpiece zero. If the workpiece coordinate system is used for programming, dimensions and directions are referenced to this system.

Workpiece zero

The workpiece zero is the datum for the -> workpiece coordinate system. It is defined by distances from the machine zero.

X**Y****Z****Zero offset**

Specification of a new reference point for a coordinate system by means of a reference to an existing zero and a -> frame.

1. Settable

SINUMERIK FM-NC: Four independent zero offsets can be selected per CNC axis.

SINUMERIK 840D: A parameterizable number of zero offsets is available for each CNC axis. Each of the zero offsets can be selected by G functions and selection is exclusive.

2. External

All offsets which define the position of the workpiece zero can be overlaid with an external zero offset

- defined by handwheel (DRF offset) or
- defined by the PLC.

3. Programmable

Zero offsets can be programmed for all path and positioning axes by means of the TRANS instruction.



MMC 100.2



MMC 103

User Documentation

/AUE/	<p>SINUMERIK 840D/810D/FM-NC AutoTurn Graphic Programming System (07.99 Edition) Part 2: Setup Order No.: 6FC5 298-4AA50-0BP2</p>
/AUK/	<p>SINUMERIK 840D/810D/FM-NC Short Guide AutoTurn Operation (07.99 Edition) Order No.: 6FC5 298-4AA30-0BP2</p>
/AUP/	<p>SINUMERIK 840D/810D/FM-NC AutoTurn Graphic Programming System (07.99 Edition) Operator's Guide Part 1: Programming Order No.: 6FC5 298-4AA40-0BP2</p>
/BA/	<p>SINUMERIK 840D/840Di/810D/FM-NC Operator's Guide (10.00 Edition) Order No.: 6FC5 298-6AA00-0BP0</p> <ul style="list-style-type: none"> • Operator's Guide • Operator's Guide with HMI Advanced
/BAE/	<p>SINUMERIK 840D/810D/FM-NC Operator's Guide Unit operator Panel (04.96 Edition) Order No.: 6FC5 298-3AA60-0BP1</p>
/BAH/	<p>SINUMERIK 840D/840Di/810D Operator's Guide HT 6 (PHG new) (06.00 Edition) Order No.: 6FC5 298-0AD60-0BP0</p>
/BAK/	<p>SINUMERIK 840D/840Di/810D/FM-NC Short Guide Operation (10.00 Edition) Order No.: 6FC5 298-6AA10-0BP0</p>
/BAM/	<p>SINUMERIK 810D/840D Operator's Guide ManualTurn (02.00 Edition) Order No.: 6FC5 298-5AD00-0BP0</p>



MMC 100.2



MMC 103

/BAS/	SINUMERIK 840D/810D Operator's Guide ShopMill Order No.: 6FC5 298-5AD10-0BP1	(08.00 Edition)
/KAS/	SINUMERIK 840D/810D Short Guide ShopMill Order No.: 6FC5 298-2AD30-0BP0	(01.98 Edition)
/BAP/	SINUMERIK 840D/840Di/810D Operator's Guide Handheld Programmer Order No.: 6FC5 298-5AD20-0BP1	(04.00 Edition)
/BNM/	SINUMERIK 840D/840Di/810D/FM-NC User Guide Measuring Cycles Order No.: 6FC5 298-5AA70-0BP2	(06.00 Edition)
/DA/	SINUMERIK 840D/840Di/810D/FM-NC Diagnostic Guide Order No.: 6FC5 298-6AA20-0AP0	(10.00 Edition)
/PG/	SINUMERIK 840D/840Di/810D/FM-NC Programing Guide, Fundamentals Order No.: 6FC5 298-6AB00-0BP0	(10.00 Edition)
/PGA/	SINUMERIK 840D/840Di/810D/FM-NC Programming Guide Advanced Order No.: 6FC5 298-6AB10-0BP0	(10.00 Edition)
/PGK/	SINUMERIK 840D/840Di/810D/FM-NC Short Description, Programming Order No.: 6FC5 298-6AB30-0BP0	(10.00 Edition)
/PGZ/	SINUMERIK 840D/840Di/810D/FM-NC Programming Guide Cycles Order No.: 6FC5 298-6AB40-0BP0	(10.00 Edition)
/PI/	PCIN 4.4 Software for Data Transfer to/from MMC Module Order No.: 6FX2 060-4AA00-4XB0 (de., en., fr.); order from: WK Fürth	
SYI	SINUMERIK 840Di System overview Order No.: 6FC5298-5AE40-0BP0	(10.00 Edition)



MMC 100.2



MMC 103

Manufacturer/Service Documentation**a) Lists**

/LIS/ SINUMERIK 840D/840Di/810D/FM-NC
SIMODRIVE 611D
Lists (10.00 Edition)
Order No.: 6FC5 297-6AB70-0BP0

b) Hardware

/BH/ SINUMERIK 840D/840Di/810D/FM-NC
Operator Components Manual (HW) (10.00 Edition)
Order No.: 6FC5 297-6AA50-0BP0

/BHA/ SIMODRIVE **Sensor**
Absolute Encoder with Profibus-DP
User Guide (HW) (02.99 Edition)
Order No.: 6SN1 197-0AB10-0YP1

/EMV/ SINUMERIK, SIROTEC, SIMODRIVE
EMC Directive (06.99 Edition)
Planning Guide (HW)
Order No.: 6FC5 297-0AD30-0BP1

/PHC/ SINUMERIK 810D
Manual Configuring (HW) (10.00 Edition)
Order No.: 6FC5 297-4AD10-0BP0

/PHD/ SINUMERIK 840D
NCU 571.2-573.2 Configuring Manual (HW) (10.00 Edition)
Order No.: 6FC5 297-6AC10-0BP0

/PHF/ SINUMERIK FM-NC
NCU 570 Configuring Manual (HW) (04.96 Edition)
Order No.: 6FC5 297-3AC00-0BP0

/PMH/ SIMODRIVE **Sensor**
Measuring System for Main Spindle Drives
Configuring Installation Guide, SIMAG-H (HW) (05.99 Edition)
Order No.: 6SN1197-0AB30-0BP0



MMC 100.2



MMC 103

c) Software**/FB1/**

SINUMERIK 840D/840Di/810D/FM-NC

Description of Functions, Basic Machine (Part 1) (10.00 Edition)

(the various sections are listed below)

Order No.: 6FC5 297-6AC20-0BP0

- A2 Various Interface Signals
- A3 Axis Monitoring, Protection Zones
- B1 Continuous Path Mode, Exact Stop and Look Ahead
- B2 Acceleration
- D1 Diagnostic Tools
- D2 Interactive Programming
- F1 Travel to Fixed Stop
- G2 Velocities, Setpoint/Actual Value Systems, Closed-Loop Control
- H2 Output of Auxiliary Functions to PLC
- K1 Mode Group, Channels, Program Operation
- K2 Coordinate systems, axis types, axis configurations, actual-value system for workpiece, zero offset external
- K4 Communication
- N2 EMERGENCY STOP
- P1 Transverse Axes
- P3 Basic PLC Program
- R1 Reference Point Approach
- S1 Spindles
- V1 Feeds
- W1 Tool Compensation

/FB2/

SINUMERIK 840D/840Di/810D(CCU2)/FM-NC

Description of Functions, Extended Functions (Part 2) (10.00 Edition)

including FM-NC: Turning, Stepping Motor

(the various sections are listed below)

Order No.: 6FC5 297-6AC30-0BP0

- A4 Digital and Analog NCK I/Os
- B3 Several Operator Panels and NCUs
- B4 Operation via PC/PG
- F3 Remote Diagnostics
- H1 Jog with/without Handwheel
- K3 Compensations
- K5 Mode Groups, Channels, Axis Exchange
- L1 FM-NC Local Bus
- M1 Kinematic Transformation
- M5 Measurements



MMC 100.2



MMC 103

- N3 Software Cams, Position Switching Signals
- N4 Punching and Nibbling
- P2 Positioning Axes
- P5 Oscillation
- R2 Rotary Axes
- S3 Synchronous Spindles
- S5 Synchronized Actions (SW 3 and earlier)
- S6 Stepping Motors
- S7 Memory Configuration
- T1 Indexing Axes
- W3 Tool Change
- W4 Grinding

/FB3/

SINUMERIK 840D/840Di/810D(CCU2)/FM-NC

Description of Functions, Special Functions (Part 3) (10.00 Edition)

(the various sections are listed below)

Order No.: 6FC5 297-6AC80-0BP0

- F2 3 to 5 Axis Transformation
- G1 Gantry Axes
- G3 Cycle Times
- K6 Contour Tunnel Monitoring
- M3 Coupled Motion and Master/Slave Couplings
- S8 Constant Workpiece Speed for Centerless Grinding
- T3 Tangential Control
- V2 Preprocessing
- W5 3D Tool Radius Compensation
- TE1 Clearance Control
- TE2 Analog Axis
- TE3 Master/Slave for Drives
- TE4 Transformation Handling
- TE5 Setpoint Exchange
- TE6 MCS Coupling

/FBA/

SIMODRIVE 611D/SINUMERIK 840D/810D

Description of Functions, Drive Functions (10.00 Edition)

(the various sections are listed below)

Order No.: 6SN1 197-0AA80-0BP6

- DB1 Operational Messages/Alarm Reactions
- DD1 Diagnostic Functions
- DD2 Speed Control Loop
- DE1 Extended Drive Functions



MMC 100.2



MMC 103

DF1 Enables
 DG1 Encoder Parameterization
 DM1 Calculation of Motor/Power Section Parameters and
 Controller Data
 DS1 Current Control Loop
 DÜ1 Monitors/Limitations

/FBAN/ SINUMERIK 840D/SIMODRIVE 611 DIGITAL
 Description of Functions
ANA MODULE (02.00 Edition)
 Order No.: 6SN1 197-0AB80-0BP0

/FBD/ SINUMERIK 840D
 Description of Functions **Digitizing** (07.99 Edition)
 Order No.: 6FC5 297-4AC50-0BP0

DI1 Installation
 DI2 Scanning with Tactile Sensors (scancad scan)
 DI3 Scanning with Lasers (scancad laser)
 DI4 Milling Program Generation (scancad mill)

/FBDN/ CAM Integration DNC NT-2000
 Description of Functions
System for NC Data Management and Data Distribution (05.00 Edition)
 Order No.: 6FC5 297-6AE50-0BP0

/FBFA/ SINUMERIK 840D/840Di/810D
 Description of Functions
ISO Dialects for SINUMERIK (10.00 Edition)
 Order No.: 6FC5 297-6AE10-0BP0

/FBHLA/ SINUMERIK 840D/SIMODRIVE 611 digital
 Description of Functions
HLA Module (08.99 Edition)
 Order No.: 6SN1 197-0AB60-0BP1

/FBMA/ SINUMERIK 840D/810D
 Description of Functions **ManualTurn** (02.00 Edition)
 Order No.: 6FC5 297-5AD50-0BP0



MMC 100.2



MMC 103

/FBO/	SINUMERIK 840D/810D/FM-NC Description of Functions Configuring the User Interface OP 030 (03.96 Edition) (the various sections are listed below) Order No.: 6FC5 297-3AC40-0BP0
	BA Operator's Guide
	EU Development Environment (Configuring Package)
	PS Online only: Configuring Syntax (Configuring Package)
	PSE Introduction to Configuring of Operator Interface IK Screen Kit: Software Update and Configuration
/FBP/	SINUMERIK 840D Description of Functions C-PLC Programming (03.96 Edition) Order No.: 6FC5 297-3AB60-0BP0
/FBR/	SINUMERIK 840D/810D Description of Functions Computer Link SINCOM (02.00 Edition) Order No.: 6FC5 297-5AD60-0BP0
	NFL Interface to Host Computer
	NPL Interface to PLC/NCK
/FBSI/	SINUMERIK 840D / SIMODRIVE Description of Functions SINUMERIK Safety Integrated (05.00 Edition) Order No.: 6FC5 297-5AB80-0BP1
/FBSP/	SINUMERIK 840D/810D Description of Functions ShopMill (08.00 Edition) Order No.: 6FC5 297-5AD80-0BP1
/FBST/	SIMATIC FM STEPDRIVE/SIMOSTEP
	Description of Functions (11.98 Edition) Order No.: 6SN1 197-0AA70-0YP3
/FBSY/	SINUMERIK 840D/840Di/810D(CCU2) Description of Functions Synchronized Actions (10.00 Edition) for Wood, Glass, Ceramics and Presses Order No.: 6FC5 297-6AD40-0BP0



MMC 100.2



MMC 103

/FBTD/	<p>SINUMERIK 840D/810D Description of Functions Tool Data Information System SINTDI with Online Help (04.99 Edition) Order No.: 6FC5 297-5AE00-0BP0</p>
/FBU/	<p>SIMODRIVE 611 universal Description of Functions (05.00 Edition) Control Components for Speed Control and Positioning Order No.: 6SN1 197-0AB20-0BP3</p>
/FBW/	<p>SINUMERIK 840D/840Di/810D Description of Functions Tool Management (07.00 Edition) Order No.: 6FC5 297-5AC60-0BP2</p>
/HBI/	<p>SINUMERIK 840Di Manual (06.00 Edition) Order No.: 6FC5 297-5EA60-0BP0</p>
/IK/	<p>SINUMERIK 840D/810D/FM-NC Screen Kit MMC 100/Unit Operator Panel (06.96 Edition) Description of Functions: Software Update and Configuration Order No.: 6FC5 297-3EA10-0BP1</p>
/KBU/	<p>SIMODRIVE 611 universal Short Description (05.00 Edition) Control Components for Speed Control Order No.: 6SN1 197-0AB40-0BP3</p>
/PJLM/	<p>SIMODRIVE Planning Guide Linear motors (05.00 Edition) (on request) ALL ALL General Information about Linear Motors 1FN1 1FN1 Three-Phase AC Linear Motor 1FN3 1FN3 Three-Phase AC Linear Motor CON Connections Order No.: 6SN1 197-0AB70-0BP1</p>
/PJM/	<p>SIMODRIVE Planning Guide Motors Transistor PWM Inverters for AC Feed Drives and AC Main Spindle Drives (09.00 Edition) Order No.: 6SN1 197-0AA20-0BP4</p>



MMC 100.2



MMC 103

/PJMS/	<p>SIMODRIVE Configuration Guide 1FE1 Synchronized Integrated Motors Transistor PWM Inverters for AC Main Spindle Drives (03.00 Edition) Order No.: (on request)</p>
/PJU/	<p>SIMODRIVE 611-A/611-D Planning Guide Interverts (08.98 Edition) Transistor PWM Inverters for AC Feed Drives and AC Main Spindle Drives Order No.: 6SN1 197-0AA00-0BP4</p>
/POS1/	<p>SIMODRIVE POSMO A (02.00 Edition) User Guide Distributed Positioning Motor on PROFIBUS DP, Order No.: 6SN2 197-0AA00-0BP1</p>
/POS2/	<p>SIMODRIVE POSMO A (12.98 Edition) Installation Instructions (enclosed with POSMO A) Order No.: 462 008 0815 00</p>
/POS3/	<p>SIMODRIVE POSMO SI/CD/CA (01.01 Edition) User Guide Distributed Servo Drive Technology Order No.: 6SN2 197-0AA20-0BP0</p>
/S7H/	<p>SIMATIC S7-300 Manual: Assembly, CPU Data (HW) (10.98 Edition) Reference Manual: Module Data Order No.: 6ES7 398-8AA03-8AA0</p>
/S7HT/	<p>SIMATIC S7-300 Manual: STEP 7, Fundamentals, V. 3.1 (03.97 Edition) Order No.: 6ES7 810-4CA02-8AA0</p>
/S7HR/	<p>SIMATIC S7-300 Manual (03.97 Edition) STEP 7, Reference Manuals, V. 3.1 Order No.: 6ES7 810-4CA02-8AR0</p>
/S7S/	<p>SIMATIC S7-300 FM 353Servo Drive Positioning Module for Stepper Drives (04.97 Edition) Order in conjunction with Configuring Package</p>



MMC 100.2



MMC 103

/S7L/	SIMATIC S7-300 FM 354 Multi-Axis Module for Servo Drives Order in conjunction with Configuring Package	(04.97 Edition)
/S7M/	SIMATIC S7-300 FM 357 Multi-Axis Module for Servo and Stepper Drives Order in conjunction with Configuring Package	(10.99 Edition)
/SHM/	SIMODRIVE 611 Manual Single-Axis Positioning for MCU 172A Order No.: 6SN 1197-4MA00-0BP0	(01.98 Edition)
/SP/	SIMODRIVE 611-A/611-D, SimoPro 3.1 Program for Configuring Machine-Tool Drives Order No.: 6SC6 111-6PC00-0AA Order from: WK Fürth	
d) Start-up		
/IAA/	SIMODRIVE 611A Installation and Start-Up Guide Order No.: 6SN 1197-0AA60-0BP6	(09.00 Edition)
/IAC/	SINUMERIK 810D Installation and Start-Up Guide (including description of SIMODRIVE 611D start-up software) Order No.: 6FC5 297-4AD20-0BP0	(10.00 Edition)
/IAD/	SINUMERIK 840D/SIMODRIVE 611D Installation and Start-Up Guide (including description of SIMODRIVE 611D start-up software) Order No.: 6FC5 297-6AB10-0BP0	(10.00 Edition)
/IAF/	SINUMERIK FM-NC Installation and Start-Up Guide Order No.: 6FC5 297-3AB00-0BP0	(04.96 Edition)



MMC 100.2



MMC 103

/IAM/

SINUMERIK 840D/840Di/810D

Start-Up Guide HMI/MMC

(10.00 Edition)

Order No.: 6FC5 297-6AE20-0BP0

IM1	Start-up functions for MMC 100.2
IM3	Start-up functions for MMC 103
IM4	Start-up functions for HMI Advanced (PCU 50)
HE1	Online Help
BE1	Supplement operator interface



MMC 100.2



MMC 103

D Index

3

3D tools 5-240

A

Access rights 2-45
 Acknowledgment symbol changed 8-425
 Activate basic frame immediately 5-266
 Activating data 6-338
 Activating skip levels 4-165
 Alarm acknowledgment key 2-34
 Alarm messages 8-424
 Alphanumeric keypad 2-29
 Alt key 2-36
 Angle for conical milling tool 5-241
 Area switchover key 2-29, 2-34
 Arithmetic parameters 5-250
 Assigning values to data 6-337
 Automatic 2-40, 4-142
 Program overview 4-144
 Axis feedrates 4-107

B

Baud rate 7-372
 Blank 2-35
 Block 6-335
 Block search 4-153
 Block search without calculation
 External 4-153
 Block search without calculation, external
 Fast 4-156

C

Calculation of tool parameters 5-180
 Cancel input 2-57

Chain rule 5-185
 Changing the coordinate system
 for actual value display 4-118
 Changing the menu window 2-54
 Changing the MMC interface 9-448
 Changing the operand value 8-432
 Changing the tool type 5-246
 Changing/finding user data 5-274
 Channel
 Active 2-64
 Interrupted 2-64
 Reset 2-64
 Switchover 2-64
 Channel states 2-64
 Channel status display 2-51
 Channels 4-100
 Cleaning 10-455
 Communication error log 8-429
 Configuration data 8-429
 Confirm 2-57
 Contour
 Graphic representation 6-300
 Symbolic representation 6-298
 Contour 2-straight lines
 blueprint programming 2-61
 Contour 3-straight lines
 blueprint programming 2-61
 Contour definition 1-straight line
 blueprint programming 2-61
 Contour definition programming 2-61, 6-294
 Contour element
 Add 6-302
 Selection 6-302
 Contour elements
 Input screen forms for parameterization 6-301
 COPY 2-84
 Copying 6-348
 Create workpiece directory 6-341



MMC 100.2



MMC 103

Creating a new directory 7-416
Creating a new file 7-416
Ctrl key 2-36
Cursor 2-35
Cycle parameterization 2-62
Cycle recompilation 2-62
Cycles 6-285

D

Data bits 7-372
Data block 6-336
Data selection 7-364
Data structure 4-97
Defining and activating user data 6-291
Defining and activating user data 7-403
Defining user data 5-273
Delete key 2-37
Delete key (backspace) 2-35
Deleting 6-351
Deleting a program 4-138
Deleting the operand value 8-432
Determine tool offsets 5-195
Diagnosis 8-421
 Basic display 8-422
Directories 7-359
Directory structure 7-357
Directory types 6-336
Disabling a magazine location 5-245
Display 2-29
Display options 9-445
Display program level 4-104
Displaying auxiliary functions 4-108
Displaying G functions 4-107
Displaying machine data 9-443
Displaying spindles 4-109
Displaying system resources 8-437
Displaying transformations 4-107
Downtime settings
 MMC 103 6-329
DRF 2-52
DRF offset 4-167
DRY 2-51
Dry run feedrate 5-255

Duplo/replacement tool
 Tool management 5-242

E

Edit key 2-36
Editing a part program 2-57
Editing values 2-55
Editing/cursor keypad 2-29
Emergency stop key 2-39
Enabling 6-348
End of line key 2-36
Executing joblist 2-88
Expansion key 2-33
Extended help for program commands 2-79
External block search without calculation 4-153
External network drive 6-353
External programs 9-446

F

Fast external block search without calculation
 4-156
Feed control 2-41
Feedrate override 2-41
File
 Changing its properties 7-419
 Copy 7-417
 Copying 6-348
 Delete 6-351, 7-418
 Insert 7-417
 Inserting 6-348
 Load 7-416
 Renaming 6-350
 Unload 7-416
File functions 8-436
File handling 6-337
File names 7-367
File types 6-335, 7-361
Fillet radius 5-241
Find 2-60
Find path for program call 6-339
Find/Go to 2-60
Fixed location 5-245



MMC 100.2



MMC 103

Flat D numbers 5-171

Free contour programming 2-61

FST 2-52

Full standard keyboard 2-32

G

Geometry axes 4-105

Global machine status display 2-49

Go to 2-60

GUD 5-273

H

Handwheel 4-110

Hard disk 4-148, 7-358

Help 2-72

Help function 2-74

Help in editor 2-74, 2-75, 2-79

Help in Editor

Overview 2-74

Help with free contour programming 6-304

Hiding axes 4-116

Hierarchical file structure 7-363

HMI A-460

I

Immediate activation of tool offset 5-196

Inc

Incremental dimension 4-126

Inc keys 2-40

Inch/metric switchover (SW 5 and higher) 4-117

Inch-metric conversion 2-71

Incremental 2-40

Incremental value 2-40

Information key 2-75, 2-79

Information key 2-34

Initialization block 6-336

Initialization program

User data

Defining 5-273

Input key 2-36

Interface parameters 7-371, 7-374

Interfaces 7-358

ISO program (MMC 103)

Import 7-406

ISO program (MMC100.2) 7-389

Export 7-391

Import 7-389

ISO program (MMC103) 7-406

Export 7-407

ISO punched tape format 7-389, 7-406

J

Job list 2-80

Job list syntax 2-82

Jog 2-39, 4-122

Basic display 4-123

Jog continuous 5-253

Jog data 5-253

Jog feedrate 5-253

Jog spindle speed 5-253

K

Key combinations 2-37

Keyswitch 2-44

L

Language selection 9-451

Length allowance 5-243

LOAD 2-83

Load standard 6-344

Loading 5-213, 6-346

From magazine list 5-217

From magazine list 5-214

Loading list 4-148

Log 6-352

M

m:n communication links 2-65

M01 2-52

MAC

Changing/finding user data 5-274



MMC 100.2



MMC 103

Machine area key 2-33
Machine axes 4-105
Machine control panel keys 2-39
Machine control panels 2-38
Machine functions 2-40, 4-99
Machine Operating Area 4-95
Machine zero 5-259
Macro block 6-336
Magazine 5-245
Magazine list 5-245
Maintenance 10-453
Manual tools 5-242
Mark (select) block 2-59
Masking filters 9-445
MCS 4-105
MCS 2-42
MCS/WCS switchover 4-105
MDA 4-134
MDI 2-39
Memory info 6-353
MF-2 keyboard 2-32
MMC A-462
MMC 100.2 7-378
 Basic display 7-378
 Error log 7-387
 Reading in data 7-381
 Reading out data 7-384
 Series start-up 7-386
 Setting the interface 7-379
 Storing data 7-383
 Transmission log 7-387
MMC 103 7-394
 Basic display 7-394
 Log 7-401
 Reading in data 7-398
 Reading out data 7-400
 Series start-up 7-411
 Setting the interface 7-397
 Software update 7-414
Mode group selection 4-101
Multi-channel search
 In Program test mode 4-160

N

NC active data 7-357
NC card
 Delete data on ... (SW 5 and higher) 7-418
 Export data to ... (SW 5 and higher) 7-400
 Import data from ... (SW 4.4 and higher) 7-399
 Restoring the original state ...
 (SW 5 and higher) 7-393, 7-413
 Series start-up from ...
 (SW 5 and higher) 7-412
 Upgrade from ... (SW 5 and higher) 7-415
NC Start 2-46
NC Stop 2-46
Network drive 6-353
New part program 6-340
New tool 5-188
New tool edge 5-193
New workpiece 6-340
Number of workpieces 5-244

O

Operand forms 8-434
Operating areas 1-23
Operating data 10-454
Operating example 3-93
Operating mode group 4-100
Operating modes 2-39, 4-98
Operating sequences, general 2-53
Operator components 2-27
Operator panel keys 2-33
Operator panel OP 031 2-29
Operator panel OP 032 2-30
Operator panels 2-29
Orientable toolholder
 Simulation 6-332
Overstore 4-162
Overwrite 2-59

P

Page down 2-35
Page up 2-36
Parameter 5-169



MMC 100.2



MMC 103

Parameter no. for radius calculation 5-185

Parity 7-372

Part program 6-285

Cancel 4-103

Continue 4-103

Load, unload 4-147

Select 6-340

Start 4-103

Stop 4-103

Password 2-45, 9-452

Path name 7-365

PC format 7-370

PLC 9-446

PLC status 8-431

Pocket calculator 2-88

Pocket calculator function 2-71

Preset 4-113

Program

Basic display 6-286

Program 6-283

Edit 6-289

Enabling 6-348

Execution 6-344

Loading 6-346

Management 6-334

Simulation 6-309

Store 6-286

Storing 6-347

Unloading 6-346

Program

Simulate, MMC103 6-314

Program block 6-335

Program control 2-46, 4-164

Program editing 4-151

Program overview 2-53

Program protection

Selective 6-289

Program selection 2-53

Program types 6-285

Programs

External 9-446

Protection levels 2-44

Protection zones 5-258

PRT 2-52

Punched tape format 7-366

R

R parameters 5-250

Change 5-250

Delete 5-251

Find 5-251

Radius allowance 5-243

Rapid traverse overlay 2-42

Rapid traverse override 2-41

Rapid traverse override display for G0 4-142

Reading in an operand 8-435

Reading in data 6-338

Reading out cycle texts 7-385

Reading out data 6-337

Reading out PLC alarm texts 7-385

Recall key 2-33

Ref point 2-40

Reference point approach 4-119

Renaming 6-350

Replace

Globally 2-60

Replacement tool 5-242

Repos 2-40, 4-127

Reserved block names 6-336

Reset 2-47

Restoring the original state 7-393, 7-413

ROV 2-51

S

Safety Integrated 4-128

Save file 2-61

SBL1 2-51

SBL2 2-51

Scratching 4-130

Search destination 4-153

SELECT 2-83

Selecting 6-344

Selecting a directory 2-54

Selecting a file 2-54

Selecting a workpiece 6-338

Selection key 2-35



MMC 100.2



MMC 103

- Service axis 8-426
 - Service display 8-426
 - Service drive 8-427
 - Service Drive 8-428
 - Setting data 5-252
 - Change 5-258
 - Display 5-257
 - Find 5-257
 - Other types 5-257
 - Setting defaults 6-344
 - Setting the actual value 4-114
 - Setting the date 9-447
 - Setting the time 9-447
 - Settings (MMC 100.2) 2-63
 - Settings (MMC 103 only) 2-63
 - Shift key 2-34
 - ShopMill
 - Tool management 5-199, 5-237
 - ShopMill Tool Management
 - MMC 100.2 5-237
 - Short help for program commands 2-75
 - Simulation 2-62
 - Orientable toolholder 6-332
 - Simulation graphic 6-311
 - Simulation of complete turning operations 6-314
 - Simulation of drilling/milling 6-314
 - Simulation settings
 - MMC 103 6-325
 - Simulation user interface
 - MMC 103 6-315
 - Single block 2-46
 - SINUMERIK 840D/810D/FM-NC 1-22
 - SKP 2-51
 - Slimline operator panel OP 032S 2-31
 - Softkey 2-33
 - Software version 8-430
 - Special axes 4-105
 - Special functions 7-373
 - Spindle control 2-43
 - Spindle data 5-254
 - Spindle number 5-185
 - Spindle override 2-43
 - Start of search in Program test mode
 - Multi-channel 4-160
 - Starting angle for thread cutting 5-256
 - Start-up
 - Basic display 9-440
 - Start-up 9-439
 - Status display 6-311
 - Stop bits 7-372
 - Storing 6-347
 - Setup data 6-343
 - Storing a program (MMC 100.2) 4-136
 - Storing a program (MMC 103) 4-137
 - Storing setup data 6-343
 - Subroutine 6-285
 - Switch over channel 2-34
 - Switching the control OFF 1-25
 - Switching the control ON 1-25
 - Synchronous actions
 - Status 4-111
 - System settings 9-450
 - System variable
 - Display 5-276
 - System variables
 - Logging 5-279
- ## T
- Tab key 2-36
 - Teach In 2-40, 4-134, 4-138
 - Tool
 - Create 5-188
 - Create new 5-240
 - Delete 5-192, 5-246
 - Disable 5-244
 - Display 5-189
 - Loading 5-247
 - Oversized 5-245
 - Relocation 5-219
 - Search 5-191
 - Sorting 5-249
 - Unloading 5-248
 - Tool cabinet 5-224
 - Tool catalog 5-221
 - Tool compensation
 - Structure 5-171



MMC 100.2



MMC 103

- Tool data 5-171
 - Change 5-222, 5-225
 - Create 5-221
 - Display 5-222, 5-225
 - Display/change 5-208
 - Tool edge
 - Create 5-193
 - Delete 5-194
 - Display 5-194
 - Search 5-194
 - Tool life 5-244
 - Tool list
 - Select 5-239
 - Tool management 5-198, 5-237
 - Tool management ShopMill 5-199
 - Tool management, Basic display 5-200
 - Tool monitoring 5-244
 - Tool name 5-242
 - Tool offset 5-187
 - Tool offset data
 - Create 5-225
 - Tool offset set for cutting edge 5-241
 - Tool offsets with D numbers 5-196
 - Tool parameters 5-172
 - Tool status 5-246
 - Tool type
 - Drill 5-173
 - Grinding tools 5-174
 - Milling tool 5-172
 - Slotting saw 5-179
 - Turning tools 5-178
 - Tool types 5-172
 - Tool wear data 5-243
 - Tool zero 5-259
 - Tool-specific parameters 5-177
 - Traversing axes 4-125
 - Traversing speed 4-125
- U**
- Undo key 2-36
- Unloading 5-218
 - User data 5-273
 - User interface 2-48
 - User-defined contour programming 2-61
 - Utilization display 8-437
- V**
- V.24 interface 4-146
 - Variable increment 5-253
 - Variable views
 - Creating 5-277
 - Manage 5-278
 - Processing 5-277
- W**
- WCS 2-42, 4-105
 - Window selection key 2-35
 - Working area limitation 5-252
 - Workpiece 6-285
 - Enabling 6-348
 - Execution 6-344
 - Load, unload 4-147
 - Select 6-340
 - Workpiece directory 6-336
 - Workpieces
 - MMC 103 6-343
 - Number 6-343
- Z**
- Zero offset 5-259
 - Activate immediately 5-266
 - Active external 5-265
 - Active programmable 5-265
 - Active settable 5-264
 - Settable 5-261
 - Zero offsets
 - Other 5-263
 - Sum of active 5-266



MMC 100.2



MMC 103

To
 SIEMENS AG
 A&D MC BMS
 P.O. Box 3180
 D-91050 Erlangen, Germany
 (Tel. 0180 / 525 - 8008 / 5009 [Hotline]
 Fax +49 9131 / 98 - 1145
 email: motioncontrol.docu@erlf.siemens.de)

From	Suggestions
Name	Corrections
Company/Dept.	For publication:
Address	SINUMERIK 840D/810D/FM-NC
Telephone:	User Documentation
Telefax: /	Operator's Guide
Telefax: /	Order No.: 6FC5298-6AA00-0BP0
	Edition: 10.00
	Should you come across any printing errors when reading this publication, please notify us on this sheet. Suggestions for improvements are also welcome.

Suggestions and/or corrections

Overview of SINUMERIK 840D/840Di/810D/FM-NC Documentation (10.00)

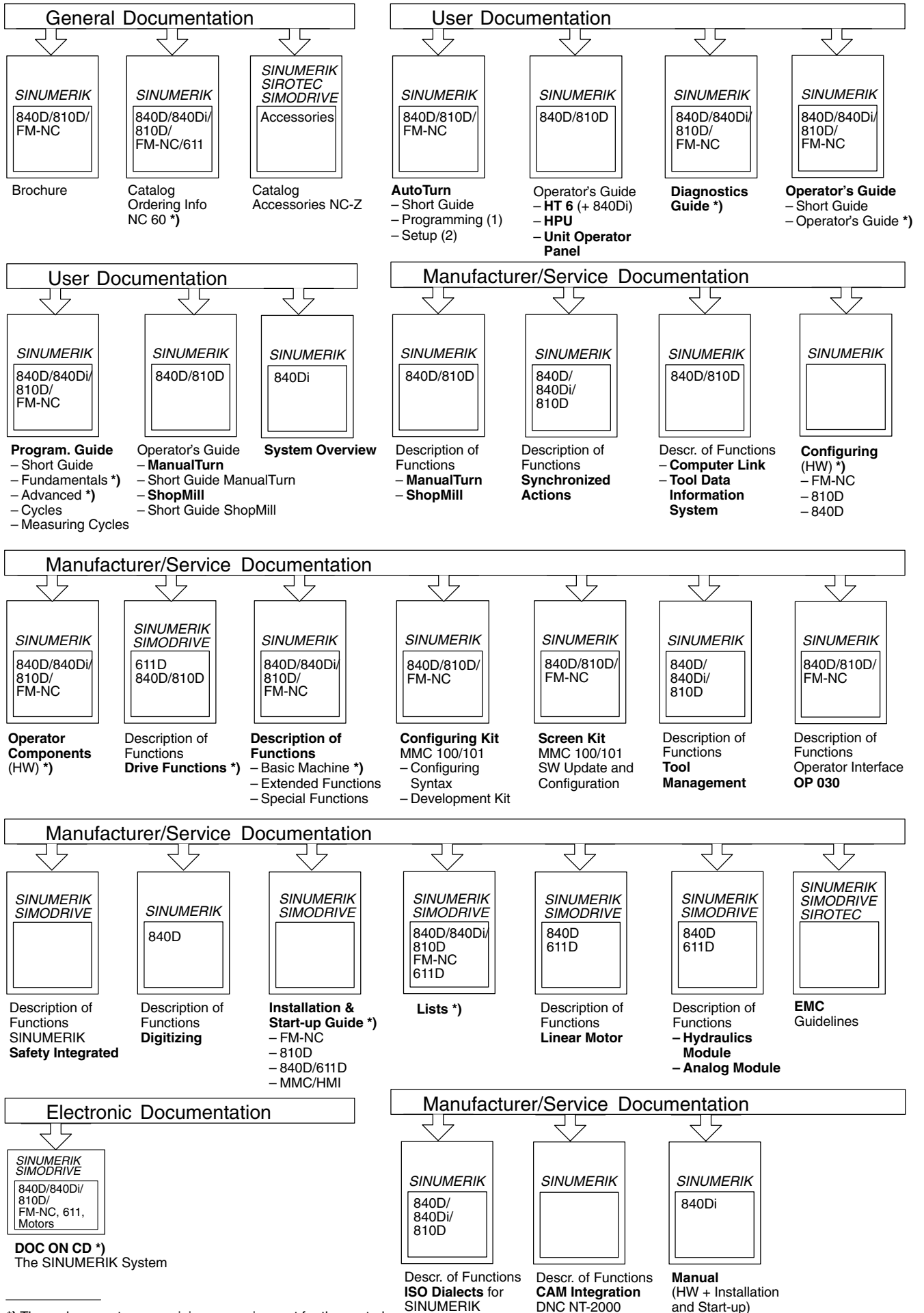

*) These documents are a minimum requirement for the control