

**SYSMAC
CPM1A**

Programmable Controllers

OPERATION MANUAL

OMRON

CPM1A Programmable Controllers

Operation Manual

Revised October 2007

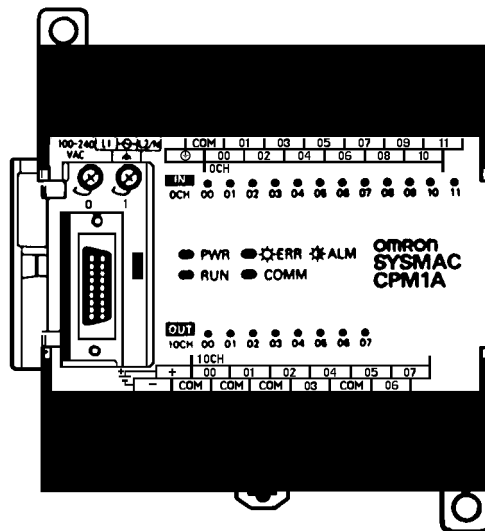



Notice:

OMRON products are manufactured for use according to proper procedures by a qualified operator and only for the purposes described in this manual.

The following conventions are used to indicate and classify precautions in this manual. Always heed the information provided with them. Failure to heed precautions can result in injury to people or damage to property.

 **DANGER** Indicates an imminently hazardous situation which, if not avoided, will result in death or serious injury. Additionally, there may be severe property damage.

 **WARNING** Indicates a potentially hazardous situation which, if not avoided, could result in death or serious injury. Additionally, there may be severe property damage.

 **Caution** Indicates a potentially hazardous situation which, if not avoided, may result in minor or moderate injury, or property damage.

OMRON Product References

All OMRON products are capitalized in this manual. The word “Unit” is also capitalized when it refers to an OMRON product, regardless of whether or not it appears in the proper name of the product.

The abbreviation “Ch,” which appears in some displays and on some OMRON products, often means “word” and is abbreviated “Wd” in documentation in this sense.

The abbreviation “PC” means Programmable Controller and is not used as an abbreviation for anything else.

Visual Aids

The following headings appear in the left column of the manual to help you locate different types of information.

Note Indicates information of particular interest for efficient and convenient operation of the product.

1, 2, 3... 1. Indicates lists of one sort or another, such as procedures, checklists, etc.

© OMRON, 1997

All rights reserved. No part of this publication may be reproduced, stored in a retrieval system, or transmitted, in any form, or by any means, mechanical, electronic, photocopying, recording, or otherwise, without the prior written permission of OMRON.

No patent liability is assumed with respect to the use of the information contained herein. Moreover, because OMRON is constantly striving to improve its high-quality products, the information contained in this manual is subject to change without notice. Every precaution has been taken in the preparation of this manual. Nevertheless, OMRON assumes no responsibility for errors or omissions. Neither is any liability assumed for damages resulting from the use of the information contained in this publication.

TABLE OF CONTENTS

PRECAUTIONS	xv
1 Intended Audience	xvi
2 General Precautions	xvi
3 Safety Precautions	xvi
4 Operating Environment Precautions	xvii
5 Application Precautions	xviii
6 EC Directives	xxi
7 Revised Specifications	xxiii
SECTION 1	
Introduction	1
1-1 CPM1A Features and Functions	2
1-2 System Configuration	10
SECTION 2	
Unit Specifications and Components	21
2-1 Specifications	22
2-2 Unit Components	31
SECTION 3	
Installation and Wiring	41
3-1 Design Precautions	42
3-2 Selecting an Installation Site	43
3-3 Installing the CPM1A	45
3-4 Wiring and Connections	50
SECTION 4	
Using Peripheral Devices	77
4-1 Support Software Capabilities	78
4-2 Using a Programming Console	84
4-3 Programming Console Operations	90
4-4 Programming Example	112
SECTION 5	
Test Runs and Error Processing	119
5-1 Initial System Checks and Test Run Procedure	120
5-2 The CPM1A Cycle	122
5-3 Self-diagnosis Functions	123
5-4 Programming Console Operation Errors	125
5-5 Programming Errors	125
5-6 Troubleshooting Flowcharts	127
5-7 Maintenance Inspections	135
5-8 Handling Precautions	136
SECTION 6	
Expansion Memory Unit	137
6-1 Overview	138
6-2 Specifications and Nomenclature	139
6-3 Handling	140

TABLE OF CONTENTS

Appendices

A Standard Models	147
B Dimensions	151

Glossary	159
-----------------------	------------

Index	175
--------------------	------------

Revision History	179
-------------------------------	------------

About this Manual:

The CPM1A is a compact, high-speed Programmable Controller (PC) designed for control operations in systems requiring from 10 to 100 I/O points per PC. There are two manuals describing the setup and operation of the CPM1A: the *CPM1A Operation Manual* (this manual) and the *CPM1/CPM1A/CPM2A/CPM2C/SRM1(-V2) Programming Manual (W353)*.

This manual describes the system configuration and installation of the CPM1A and provides a basic explanation of operating procedures for the Programming Consoles. It also introduces the capabilities of the SYSMAC Support Software (SSS). Read this manual first to acquaint yourself with the CPM1A.

The *CPM1/CPM1A/CPM2A/CPM2C/SRM1(-V2) Programming Manual (W353)* provides detailed descriptions of the CPM1A's programming functions. The *SYSMAC Support Software Operation Manuals: Basics and C-series PCs (W247 and W248)* provide descriptions of SSS operations for the CPM1A and other SYSMAC C-series PCs. The *SYSMAC-CPT Support Software Quick Start Guide (W332)* and *User Manual (W333)* provide descriptions of ladder diagram operations in the Windows environment. The *WS02-CXPC1-E-V72 CX-Programmer Ver. 7.2 Operation Manual (W446)* and the *WS02-CXPC1-E-V7 CX-Programmer Ver. 7.2 Operation Manual: Function Blocks/Structured Text (W447)* provide details of operations for the WS02-CXPC1-E CX-Programmer. The *CompoBus/S Operation Manual (W266)* provides CompoBus/S communications specifications and describes CompoBus/S application methods.

Please read this manual carefully and be sure you understand the information provide before attempting to install and operate the CPM1A.

Section 1 gives a brief overview of the steps involved in developing of a CPM1A System, describes the possible system configurations, and describes the CPM1A's special features and functions.

Section 2 provides the technical specifications of the Units that go together to create a CPM1A PC and describes the main components of the Units.

Section 3 describes how to install and wire a CPM1A PC.

Section 4 describes SSS capabilities, how to connect the Programming Console, and how to perform the various Programming Console operations.

Section 5 describes how to perform a test run and how to diagnose and correct the hardware and software errors that can occur during PC operation.

Section 6 describes how to use the CPM1-EMU01-V1 Expansion Memory Unit. Follow the handling precautions and procedures to properly use the Unit.

Appendix A provides tables of CPM1A Units and related products.

Appendix B provides the dimensions of CPM1A Units.



WARNING

Failure to read and understand the information provided in this manual may result in personal injury or death, damage to the product, or product failure. Please read each section in its entirety and be sure you understand the information provided in the section and related sections before attempting any of the procedures or operations given.

Read and Understand this Manual

Please read and understand this manual before using the product. Please consult your OMRON representative if you have any questions or comments.

Warranty and Limitations of Liability

WARRANTY

OMRON's exclusive warranty is that the products are free from defects in materials and workmanship for a period of one year (or other period if specified) from date of sale by OMRON.

OMRON MAKES NO WARRANTY OR REPRESENTATION, EXPRESS OR IMPLIED, REGARDING NON-INFRINGEMENT, MERCHANTABILITY, OR FITNESS FOR PARTICULAR PURPOSE OF THE PRODUCTS. ANY BUYER OR USER ACKNOWLEDGES THAT THE BUYER OR USER ALONE HAS DETERMINED THAT THE PRODUCTS WILL SUITABLY MEET THE REQUIREMENTS OF THEIR INTENDED USE. OMRON DISCLAIMS ALL OTHER WARRANTIES, EXPRESS OR IMPLIED.

LIMITATIONS OF LIABILITY

OMRON SHALL NOT BE RESPONSIBLE FOR SPECIAL, INDIRECT, OR CONSEQUENTIAL DAMAGES, LOSS OF PROFITS OR COMMERCIAL LOSS IN ANY WAY CONNECTED WITH THE PRODUCTS, WHETHER SUCH CLAIM IS BASED ON CONTRACT, WARRANTY, NEGLIGENCE, OR STRICT LIABILITY.

In no event shall the responsibility of OMRON for any act exceed the individual price of the product on which liability is asserted.

IN NO EVENT SHALL OMRON BE RESPONSIBLE FOR WARRANTY, REPAIR, OR OTHER CLAIMS REGARDING THE PRODUCTS UNLESS OMRON'S ANALYSIS CONFIRMS THAT THE PRODUCTS WERE PROPERLY HANDLED, STORED, INSTALLED, AND MAINTAINED AND NOT SUBJECT TO CONTAMINATION, ABUSE, MISUSE, OR INAPPROPRIATE MODIFICATION OR REPAIR.

Application Considerations

SUITABILITY FOR USE

OMRON shall not be responsible for conformity with any standards, codes, or regulations that apply to the combination of products in the customer's application or use of the products.

At the customer's request, OMRON will provide applicable third party certification documents identifying ratings and limitations of use that apply to the products. This information by itself is not sufficient for a complete determination of the suitability of the products in combination with the end product, machine, system, or other application or use.

The following are some examples of applications for which particular attention must be given. This is not intended to be an exhaustive list of all possible uses of the products, nor is it intended to imply that the uses listed may be suitable for the products:

- Outdoor use, uses involving potential chemical contamination or electrical interference, or conditions or uses not described in this manual.
- Nuclear energy control systems, combustion systems, railroad systems, aviation systems, medical equipment, amusement machines, vehicles, safety equipment, and installations subject to separate industry or government regulations.
- Systems, machines, and equipment that could present a risk to life or property.

Please know and observe all prohibitions of use applicable to the products.

NEVER USE THE PRODUCTS FOR AN APPLICATION INVOLVING SERIOUS RISK TO LIFE OR PROPERTY WITHOUT ENSURING THAT THE SYSTEM AS A WHOLE HAS BEEN DESIGNED TO ADDRESS THE RISKS, AND THAT THE OMRON PRODUCTS ARE PROPERLY RATED AND INSTALLED FOR THE INTENDED USE WITHIN THE OVERALL EQUIPMENT OR SYSTEM.

PROGRAMMABLE PRODUCTS

OMRON shall not be responsible for the user's programming of a programmable product, or any consequence thereof.

Disclaimers

CHANGE IN SPECIFICATIONS

Product specifications and accessories may be changed at any time based on improvements and other reasons.

It is our practice to change model numbers when published ratings or features are changed, or when significant construction changes are made. However, some specifications of the products may be changed without any notice. When in doubt, special model numbers may be assigned to fix or establish key specifications for your application on your request. Please consult with your OMRON representative at any time to confirm actual specifications of purchased products.

DIMENSIONS AND WEIGHTS

Dimensions and weights are nominal and are not to be used for manufacturing purposes, even when tolerances are shown.

PERFORMANCE DATA

Performance data given in this manual is provided as a guide for the user in determining suitability and does not constitute a warranty. It may represent the result of OMRON's test conditions, and the users must correlate it to actual application requirements. Actual performance is subject to the OMRON Warranty and Limitations of Liability.

ERRORS AND OMISSIONS

The information in this manual has been carefully checked and is believed to be accurate; however, no responsibility is assumed for clerical, typographical, or proofreading errors, or omissions.

PRECAUTIONS

This section provides general precautions for using the Programmable Controller (PC) and related devices.

The information contained in this section is important for the safe and reliable application of the Programmable Controller. You must read this section and understand the information contained before attempting to set up or operate a PC system.

1 Intended Audience	xvi
2 General Precautions	xvi
3 Safety Precautions	xvi
4 Operating Environment Precautions	xvii
5 Application Precautions	xviii
6 EC Directives	xxi
7 Revised Specifications	xxiii

1 Intended Audience

This manual is intended for the following personnel, who must also have knowledge of electrical systems (an electrical engineer or the equivalent).

- Personnel in charge of installing FA systems.
- Personnel in charge of designing FA systems.
- Personnel in charge of managing FA systems and facilities.

2 General Precautions

The user must operate the product according to the performance specifications described in the operation manuals.

Before using the product under conditions which are not described in the manual or applying the product to nuclear control systems, railroad systems, aviation systems, vehicles, combustion systems, medical equipment, amusement machines, safety equipment, and other systems, machines, and equipment that may have a serious influence on lives and property if used improperly, consult your OMRON representative.

Make sure that the ratings and performance characteristics of the product are sufficient for the systems, machines, and equipment, and be sure to provide the systems, machines, and equipment with double safety mechanisms.

This manual provides information for programming and operating the Unit. Be sure to read this manual before attempting to use the Unit and keep this manual close at hand for reference during operation.

 **WARNING** It is extremely important that a PC and all PC Units be used for the specified purpose and under the specified conditions, especially in applications that can directly or indirectly affect human life. You must consult with your OMRON representative before applying a PC System to the above-mentioned applications.

3 Safety Precautions

 **WARNING** Do not attempt to take any Unit apart while the power is being supplied. Doing so may result in electric shock.

 **WARNING** Do not touch any of the terminals or terminal blocks while the power is being supplied. Doing so may result in electric shock.

 **WARNING** Do not attempt to disassemble, repair, or modify any Units. Any attempt to do so may result in malfunction, fire, or electric shock.

 **WARNING** Provide safety measures in external circuits (i.e., not in the Programmable Controller), including the following items, in order to ensure safety in the system if an abnormality occurs due to malfunction of the PC or another external factor affecting the PC operation. Not doing so may result in serious accidents.

- Emergency stop circuits, interlock circuits, limit circuits, and similar safety measures must be provided in external control circuits.
- The PC will turn OFF all outputs when its self-diagnosis function detects any error or when a severe failure alarm (FALS) instruction is executed. As a countermeasure for such errors, external safety measures must be provided to ensure safety in the system.

- The PC outputs may remain ON or OFF due to deposition or burning of the output relays or destruction of the output transistors. As a countermeasure for such problems, external safety measures must be provided to ensure safety in the system.
- When the 24-VDC output (service power supply to the PC) is overloaded or short-circuited, the voltage may drop and result in the outputs being turned OFF. As a countermeasure for such problems, external safety measures must be provided to ensure safety in the system.

⚠ WARNING When transferring programs to other nodes, or when making changes to I/O memory, confirm the safety of the destination node before transfer. Not doing so may result in injury.

⚠ Caution Execute online edit only after confirming that no adverse effects will be caused by extending the cycle time. Otherwise, the input signals may not be readable.

⚠ Caution Tighten the screws on the terminal block of the AC Power Supply Unit to the torque specified in the operation manual. The loose screws may result in burning or malfunction.

⚠ Caution When connecting a personal computer or other peripheral device to the CPM1A, either ground the 0 V side of the CPM1A or do not ground at all. Depending on the method of grounding, the 24-V power supply may short-circuit; do not ground the 24-V side as shown in the following diagram.

Example: Connections where 24-V Power Supply Will Short-circuit

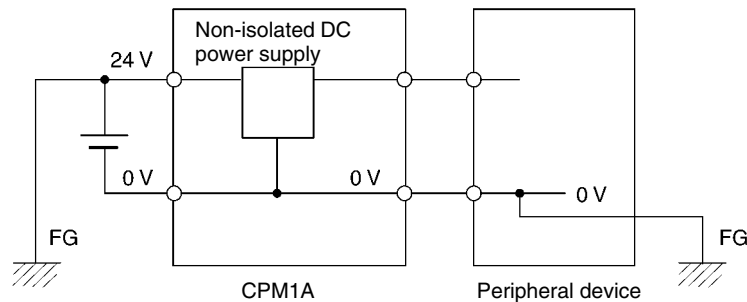

4 Operating Environment Precautions

⚠ Caution Do not operate the control system in the following places:

- Locations subject to direct sunlight.
- Locations subject to temperatures or humidity outside the range specified in the specifications.
- Locations subject to condensation as the result of severe changes in temperature.
- Locations subject to corrosive or flammable gases.
- Locations subject to dust (especially iron dust) or salts.
- Locations subject to exposure to water, oil, or chemicals.
- Locations subject to shock or vibration.

⚠ Caution Take appropriate and sufficient countermeasures when installing systems in the following locations:

- Locations subject to static electricity or other forms of noise.
- Locations subject to strong electromagnetic fields.
- Locations subject to possible exposure to radioactivity.
- Locations close to power supplies.

 **Caution** The operating environment of the PC System can have a large effect on the longevity and reliability of the system. Improper operating environments can lead to malfunction, failure, and other unforeseeable problems with the PC System. Be sure that the operating environment is within the specified conditions at installation and remains within the specified conditions during the life of the system.

5 Application Precautions

Observe the following precautions when using the PC System.

 **WARNING** Always heed these precautions. Failure to abide by the following precautions could lead to serious or possibly fatal injury.

- Always connect to a ground of 100 Ω or less when installing the Units. Not connecting to a ground of 100 Ω or less may result in electric shock.
- Always turn off the power supply to the PC before attempting any of the following. Not turning off the power supply may result in malfunction or electric shock.
 - Mounting or dismounting I/O Units, CPU Units, or any other Units.
 - Assembling the Units.
 - Connecting or wiring the cables.
 - Connecting or disconnecting the connectors.

 **Caution** Failure to abide by the following precautions could lead to faulty operation of the PC or the system, or could damage the PC or PC Units. Always heed these precautions.

- Fail-safe measures must be taken by the customer to ensure safety in the event of incorrect, missing, or abnormal signals caused by broken signal lines, momentary power interruptions, or other causes.
- Construct a control circuit so that power supply for the I/O circuits does not come ON before power supply for the Unit. If power supply for the I/O circuits comes ON before power supply for the Unit, normal operation may be temporarily interrupted.
- If the operating mode is changed from RUN or MONITOR mode to PROGRAM mode, with the IOM Hold Bit ON, the output will hold the most recent status. In such a case, ensure that the external load does not exceed specifications. (If operation is stopped because of an operation error (including FALS instructions), the values in the internal memory of the CPU Unit will be saved, but the outputs will all turn OFF.)
- Always use the power supply voltage specified in the operation manuals. An incorrect voltage may result in malfunction or burning.
- Take appropriate measures to ensure that the specified power with the rated voltage and frequency is supplied. Be particularly careful in places where the power supply is unstable. An incorrect power supply may result in malfunction.
- Install external breakers and take other safety measures against short-circuiting in external wiring. Insufficient safety measures against short-circuiting may result in burning.

- Do not apply voltages to the Input Units in excess of the rated input voltage. Excess voltages may result in burning.
- Do not apply voltages or connect loads to the Output Units in excess of the maximum switching capacity. Excess voltage or loads may result in burning.
- Disconnect the functional ground terminal when performing withstand voltage tests. Not disconnecting the functional ground terminal may result in burning.
- Install the Unit properly as specified in the operation manual. Improper installation of the Unit may result in malfunction.
- Be sure that all the mounting screws, terminal screws, and cable connector screws are tightened to the torque specified in the relevant manuals. Incorrect tightening torque may result in malfunction.
- With version-1 CPU Units, leave the label attached wiring in order to prevent wiring cuttings from entering in the Unit.
- With pre-version-1 CPU Units, be sure to attach the supplied labels when wiring in order to prevent wiring cuttings from entering in the Unit.
- Remove the label after the completion of wiring to ensure proper heat dissipation. Leaving the label attached may result in malfunction.
- Use crimp terminals for wiring. Do not connect bare stranded wires directly to terminals. Connection of bare stranded wires may result in burning.
- Double-check all the wiring before turning on the power supply. Incorrect wiring may result in burning.
- Be sure that the terminal blocks, expansion cables, and other items with locking devices are properly locked into place. Improper locking may result in malfunction.
- Check the user program for proper execution before actually running it on the Unit. Not checking the program may result in an unexpected operation.
- Confirm that no adverse effect will occur in the system before attempting any of the following. Not doing so may result in an unexpected operation.
 - Changing the operating mode of the PC.
 - Force-setting/force-resetting any bit in memory.
 - Changing the present value of any word or any set value in memory.
- Resume operation only after transferring to the new CPU Unit the contents of the DM and HR Areas required for resuming operation. Not doing so may result in an unexpected operation.
- Do not pull on the cables or bend the cables beyond their natural limit. Doing either of these may break the cables.
- Do not place objects on top of the cables. Doing so may break the cables.
- When replacing parts, be sure to confirm that the rating of a new part is correct. Not doing so may result in malfunction or burning.
- Before touching the Unit, be sure to first touch a grounded metallic object in order to discharge any static built-up. Not doing so may result in malfunction or damage.
- Do not touch the Expansion I/O Unit Connecting Cable while the power is being supplied in order to prevent any malfunction due to static electricity.
- When using a thermocouple-input type Temperature Sensor Unit, observe the following precautions:
 - Do not remove the cold junction compensator attached at the time of delivery. If the cold junction compensator is removed the Unit will not be able to measure temperatures correctly.
 - Each of the input circuits is calibrated with the cold junction compensator attached to the Unit. If the Unit is used with the cold junction compensator from other Units, the Unit will not be able to measure temperatures correctly.

- Do not touch the cold junction compensator. Doing so may result in incorrect temperature measurement.

! Caution Always clear memory before beginning to program the CPM1A. Although memory is cleared before the CPU Unit is shipped (except for bits with specific functions), AR 1314, which turns ON when the internal capacitor cannot back up memory, may have turned ON during shipment.

! Caution If the CPM1A will be turned off for periods exceeding the data backup period of the internal capacitor, design the system so that it will not be influenced if data in the DM, HR, and CNT areas is cleared when power is turned off.

! Caution Either switch the CPM1A to RUN or MONITOR mode, or turn off and on power to the CPM1A after changing from a Programming Device any data that is backed up in flash memory. This data includes the user program, read-only DM area (DM 6144 to DM 6599), and the PC Setup (DM 6600 to DM 6655).

- The user program and memory area data in the CPM1A are backed up either by an internal capacitor or in flash memory as shown in the following table.

Backup method	Data
Internal capacitor	Read/write DM area (DM 0000 to DM 0999, DM 1022, and DM 1023) Error log area (DM 1000 to DM 1021) HR area (HR 00 to HR 19) Counter area (CNT 000 to CNT 127)
Flash memory	User program Read-only DM area (DM 6144 to DM 6599) PC Setup (DM 6600 to DM 6655)

- Note**
1. The IR, TR, LR, and timer areas are not normally backed up when power is turned off and all contents will be cleared the next time power is turned on. (The PC Setup setting in DM 6601 can be used to back up this data. Refer to details on the PC Setup later in this manual for details.)
 2. The bits in the AR and SR areas have special functions and are set according to these functions when power is turned on.
- The capacitor backup time depends on the ambient temperature, as shown in the following graph. The backup time, however, assumes that the capacitor is fully charged, which requires that power be supplied to the CPU Unit continuously for at least 15 minutes.

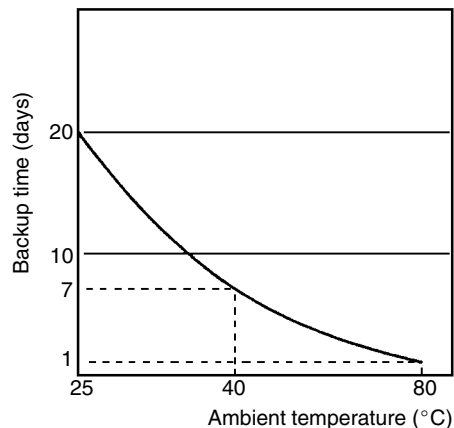

If the power remains off for a period exceeding the data backup period, AR 1314 will turn ON to indicate that the capacitor can no longer back up data and the data backed up by the capacitor will be cleared. AR 1314 will remain ON unless it is turned OFF using I/O monitor operations, using memory clear operations, or from the user program.

If desired, the PC Setup setting in DM 6604 can be set to create a fatal error and thus stop the system when AR 1314 goes ON.

- The data stored in flash memory will not be lost even if power remains off for a period exceeding the data backup period, because the data stored in flash memory will be read to the CPU Unit when the CPM1A is turned on.
- If the power is turned off without changing the mode from PROGRAM mode to RUN or MONITOR mode after having made changes in the data that is backed up in flash memory, the changes will not be written to flash memory. If the power is then left off for more than 20 days (at 25°C), the changes (i.e., the contents of the RAM) will be erased and the data values will become undefined.

6 EC Directives

6-1 Applicable Directives

- EMC Directives
- Low Voltage Directive

6-2 Concepts

EMC Directives

OMRON devices that comply with EC Directives also conform to the related EMC standards so that they can be more easily built into other devices or the overall machine. The actual products have been checked for conformity to EMC standards (see the following note). Whether the products conform to the standards in the system used by the customer, however, must be checked by the customer.

EMC-related performance of the OMRON devices that comply with EC Directives will vary depending on the configuration, wiring, and other conditions of the equipment or control panel on which the OMRON devices are installed. The customer must, therefore, perform the final check to confirm that devices and the overall machine conform to EMC standards.

Note Applicable EMC (Electromagnetic Compatibility) standards are as follows:

EMS (Electromagnetic Susceptibility): EN61131-2
 EMI (Electromagnetic Interference): EN61000-6-4
 (Radiated emission: 10-m regulations)

Low Voltage Directive

Always ensure that devices operating at voltages of 50 to 1,000 VAC or 75 to 1,500 VDC meet the required safety standards for the PC (EN61131-2).

6-3 Conformance to EC Directives

All CPM1A CPU Units with model numbers ending in “-V1” conform to EC directives.

The following restrictions apply to CPM1A CPU Units with model numbers not ending in “-V1.”

- Relay Output Units and Transistor Output Units of CPU Units with DC power supplies conform to EC Directives. Relay Output Units, however, conform to EC Directives only when the output load power supply is outside the ranges specified for the Low Voltage Directive (less than 75 VDC or less than 50 VAC).
- Relay Output Units and Transistor Output Units of CPM1A CPU Units with AC power supplies do not conform to EC Directives.

All Expansion I/O Units except for the CPM1A-20EDR conform to EC Directives.

To ensure that the machine or device in which the CPM1A PC is used complies with EC Directives, the PC must be installed as follows:

- 1, 2, 3... 1. The CPM1A PC must be installed within a control panel.
2. Reinforced insulation or double insulation must be used for the DC power supplies used for the PC and I/O power supplies.
3. CPM1A PCs complying with EC Directives also conform to the Common Emission Standard (EN61000-6-4). Radiated emission characteristics (10-m regulations) may vary depending on the configuration of the control panel used, other devices connected to the control panel, wiring, and other conditions. You must therefore confirm that the overall machine or equipment complies with EC Directives.

6-4 Relay Output Noise Reduction Methods

All CPM1A CPU Units with model numbers ending in “-V1” conform to the Common Emission Standards (EN61000-6-4) of the EMC Directives.

For CPM1A CPU Units with model numbers not ending in “-V1,” Relay Output Units and Transistor Output Units of CPU Units with DC power supplies conform to the Common Emission Standards (EN61000-6-4) of the EMC Directives. Relay Output Units, however, conform to the Common Emission Standards (EN61000-6-4) only when the output load power supply is outside the ranges specified for the Low Voltage Directive (less than 75 VDC or less than 50 VAC).

When a Unit is built into another device, however, it may not satisfy these standards due to noise generated by relay output switching. In such a case, a noise filter must be connected to the load side or other appropriate countermeasures must be provided external to the PC.

Countermeasures taken to satisfy the standards vary depending on the devices on the load side, wiring, configuration of machines, etc. Following are examples of countermeasures for reducing the generated noise.

Countermeasures

Refer to EN50081-2 for more details.

Countermeasures are not required if the frequency of load switching for the whole system including the PC is less than 5 times per minute.

Countermeasures are required if the frequency of load switching for the whole system including the PC is more than 5 times per minute.

Countermeasure Examples

When switching an inductive load, connect a surge protector, diodes, etc., in parallel with the load or contact. For detailed circuit examples, refer to the relevant parts of this manual.

6-5 CPM1A-MAD01 Conformance to EMC Directives

Immunity testing conditions when using the current I/O of the CPM1A-MAD01 are as follows.

- Total accuracy: +10%/-1%
- Insert the following core in each line as shown below.

Recommended core: 2643-002402

Manufacturer: Fair Rite Products Corp.

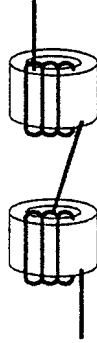

7 Revised Specifications

The following table shows the changes that have been made in product specifications beginning with lots produced in January 1998 (December 1997 for some models).

Item	Previous specifications	New specifications	Relevant pages
Input indicator operation when an error occurs	The input indicators will maintain the current status and will not change with the status of the input signal when a memory error, no END instruction error, or system error occurs.	The input indicators will change with the status of the input signal when a memory error, no END instruction error, or system error occurs.	Item 8., <i>Input Indicators</i> , on page 33.
Memory holding operation of built-in capacitor	If the power remains OFF for a period exceeding the data backup period, the capacitor will not be able to back up data and the status of the data backed up by the capacitor (Read/write DM area, Error log area, HR area, and Counter area) will become unstable.	If the power remains OFF for a period exceeding the data backup period, AR 1314 will turn ON to indicate that the capacitor can no longer back up data and the data backed up by the capacitor (Read/write DM area, Error log area, HR area, and Counter area) will be cleared. The PC Setup setting in DM 6604 can be set to create a fatal error and thus stop the system when AR 1314 goes ON.	Pages xviii to xx under 5 <i>Application Precautions</i> . Page 24 under 2-1-2 <i>Characteristics</i> . See also information on the PC Setup in the <i>CPM1/CPM1A/CPM2A/CPM2C/SRM1(-V2) Programmable Controllers Programming Manual (W353)</i> .

Item	Previous specifications	New specifications	Relevant pages
Online editing and changing set values from the SSS	If unsupported addresses are set in the program for operands or for set values for timers or counters from the SSS during online editing, the values will be accepted, but a memory error will occur in MONITOR or RUN mode.	If unsupported addresses are set in the program for operands or for set values for timers or counters from the SSS during online editing, error messages will be displayed and the values will not be accepted.	4-1-2 CPM1A Restrictions and Precautions
Communications parameters for the peripheral port	Communications are not possible if unsupported settings are made for the peripheral port's communications parameters.	Communications are possible using the following parameters if unsupported settings are made for the peripheral port's communications parameters. Mode: Host Link Standard format 1 start bit 7-bit data Even parity 2 stop bits 9,600 bps baud Transmission delay: None Unit number: 0	See information on the PC Setup in the CPM1/CPM1A/CPM2A/CPM2C/SRM1(-V2) Programmable Controllers Programming Manual (W353).

The following specifications have changed in products manufactured since October 2000.

Item	Previous specifications	New specifications	Relevant pages
Support for UM Area allocation function	The UM Area allocation function is not supported. As a result, a memory error will be displayed if the I/O comment area is set (although no actual memory error has occurred).	CX-Programmer can be used to set the I/O comment area in the CPU Unit, and I/O comments can be set together with programs.	See information on UM Area allocation in the WS02-CXPC1-EV3 CX-Programmer Operation Manual (W414) and the WS02-CXPC1-E-V4 CX-Programmer Operation Manual (W425).

The following table shows the changes that have been made in product specifications beginning with the introduction of version-1 Units in May 2001 (April 2001 for some models).

Item	New specifications (V1 models)	
EC Directives	All products with model numbers ending in "-V1" conform to EC Directives.	
Model numbers	"-V1" was added to the end of the model numbers.	
External appearance	The arrangement of input, output, and operation indicators was changed. The shape of the I/O connector was changed.	
Output specifications	Relay outputs	The mechanical life of output relays was increased from 10 to 20 million operations.
	Transistor outputs	The fuse was eliminated for both sourcing and sinking outputs.
Terminal blocks	The functional earth terminal was eliminated (i.e., converted to an NC terminal) on CPU Units with AC power supplies.	
External dimensions	The depth of CPU Units with AC power supplies was decreased from 85 mm to 70 mm.	

In this manual, version-1 CPU Units are referred to as V1 CPU Units and the previous CPU Units are referred to as pre-V1 CPU Units.

Unless otherwise specified, "CPM1A" refers to both V1 and pre-V1 CPU Units.

SECTION 1

Introduction

This section describes the CPM1A's special features and functions and shows the possible system configurations. Refer to the *Programming Manual* (W353) for details on programming actual operation.

1-1	CPM1A Features and Functions	2
1-1-1	CPM1A Features	2
1-1-2	I/O Terminal and IR Bit Allocation	5
1-1-3	CPM1A Functions	5
1-2	System Configuration	10
1-2-1	CPU Unit and Expansion I/O Unit Configuration	10
1-2-2	CPU Unit and Expansion Unit	12
1-2-3	Host Link Communications	14
1-2-4	One-to-one PC Link Communications	16
1-2-5	One-to-one NT Link Communications	17
1-2-6	CompoBus/S I/O Link Connections	17
1-2-7	DeviceNet I/O Link Connections	18
1-2-8	Peripheral Device Connections	18

1-1 CPM1A Features and Functions

1-1-1 CPM1A Features

One-piece Construction

The CPM1A CPU Units feature a one-piece construction including 10, 20, 30, or 40 built-in I/O terminals. The following three model groups are available: relay output models, sinking transistor output models, and sourcing transistor output models.

CPU Units with 10 I/O Points

CPM1A-10CD□-□-V1 CPM1A-10CD□-□

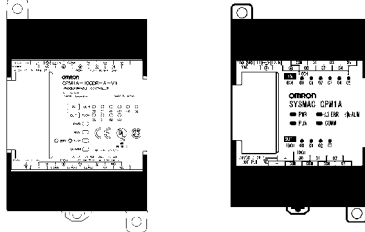

CPU Units with 20 I/O Points

CPM1A-20CD□-□-V1 CPM1A-20CD□-□

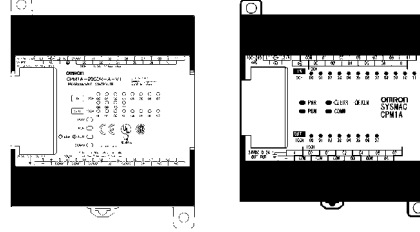

CPU Units with 30 I/O Points

CPM1A-30CD□-□-V1 CPM1A-30CD□-□

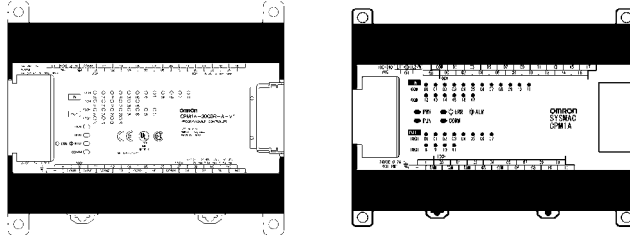

CPU Units with 40 I/O Points

CPM1A-40CD□-□-V1 CPM1A-40CD□-□

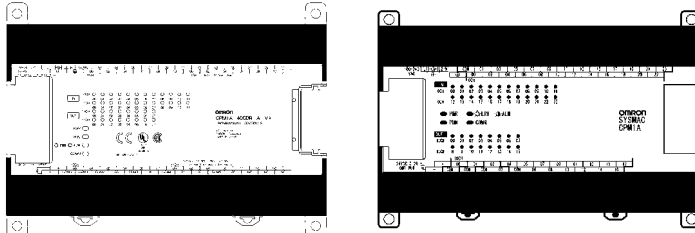

Extra I/O Capacity

Up to three Expansion I/O Units can be connected to a CPM1A-30CD□-□(-V1) or CPM1A-40CD□-□(-V1) CPU Unit to add an extra 8 or 20 I/O points for each, for a maximum of up to 100 I/O points.

Input Filter Function

The CPM1A is equipped with a filter function to prevent incorrect operation caused by chatter or noise in the input signal. The user can select an input time constant of 1 ms, 2 ms, 4 ms, 8 ms, 16 ms, 32 ms, 64 ms, or 128 ms.

Low-maintenance Design

Flash memory provides memory backup without a battery.

Input Interrupts

The CPM1A-10CD□-□(-V1) CPU Units can handle 2 interrupt inputs; the CPM1A-20CD□-□(-V1), CPM1A-30CD□-□(-V1), and CPM1A-40CD□-□(-V1) CPU Units can handle 4 interrupt inputs. In addition to normal input interrupts, the CPM1A has a counter mode that counts high-speed input signals and triggers interrupts at fixed count multiples.

Quick-response Inputs

Quick-response inputs can detect input signals with a pulse width as short as 0.2 ms regardless of their timing during the PC cycle. Quick-response inputs and interrupt inputs use the same input terminals.

- Interval Timer** CPM1A PCs have a high-speed interval timer which can be set from 0.5 ms to 319,968 ms. The timer can be set to trigger a single interrupt (one-shot mode) or repeat scheduled interrupts (scheduled interrupt mode).
- High-speed Counter** CPM1A PCs have a high-speed counter that can be used in incremental mode or up/down mode. The high-speed counter can be combined with input interrupts to perform target value control or zone comparison control that isn't affected by the PC's cycle time.
- Pulse Output Function** The CPM1A transistor output models have an output function capable of outputting a pulse of 20 Hz to 2 kHz (single-phase output).
- Analog Setting Function** The CPM1A PCs have 2 analog volume controls that can be used to make manual analog settings.
- Analog I/O Units** Up to 3 Analog I/O Units can be connected to provide analog inputs and outputs. Each Unit provides 2 analog inputs and 1 analog output, so a maximum of 6 analog inputs and 3 analog outputs can be achieved by connecting 3 Analog I/O Units.

Unit	Analog inputs	Analog outputs
CPM1A-MAD01	Signal range: 0 to 10 V, 1 to 5 V, or 4 to 20 mA, Resolution of 1/256 The open-circuit detection function can be used with the 1 to 5 VDC and 4 to 20 mA settings.	Signal range: 0 to 10 V, -10 to 10 V, or 4 to 20 mA, Resolution of 1/256
CPM1A-MAD11	Signal range: 0 to 5 V, 0 to 10 V, 1 to 5 V, -10 to 10 V, 0 to 20 mA, or 4 to 20 mA, Resolution of 1/6,000 The open-circuit detection function can be used with the 1 to 5 VDC and 4 to 20 mA settings.	Signal range: 0 to 10 V, 1 to 5 V, -10 to 10 V, 0 to 20 mA, or 4 to 20 mA, Resolution of 1/6,000

Temperature Sensor Units A Temperature Sensor Unit can be connected to provide up to 6 inputs for temperature input from sensors, such as thermocouples or platinum resistance thermometers.

Temperature Sensor Unit Functions

Thermocouple input (CPM1A-TS001/002; 2/4 input points):

- K: -200° to 1,300°C (-300° to 2,300°F)
0.0° to 500.0°C (0.0° to 900.0°F)
- J: -100° to 850°C (-100° to 1,500°F)
0.0° to 400.0°C (0.0° to 750.0°F)

Platinum resistance thermometer input (CPM1A-TS101/102; 2/4 input points):

- Pt100: -200.0° to 650.0°C (-300.0° to 1,200.0°F)
- JPt100: -200.0° to 650.0°C (-300.0° to 1,200.0°F)

Host Link Communications The CPM1A PCs are compatible with the Host Link, which allows communications with personal computers. The CPM1A using the Host Link can also communicate with Programmable Terminal using host link commands.

An RS-232C Adapter is used for 1:1 communications and an RS-422 Adapter is used for 1:N communications.

One-to-one PC Link A data link can be created with a data area in another CPM1A, CQM1, CPM1, SRM1 or C200HS or C200HX/HG/HE PC. An RS-232C Adapter is used to make the 1:1 connection.

NT Link Communications High-speed operations can be achieved by providing a direct access by connecting the CPM1A to the OMRON Programmable Terminal through the NT Link Interface. An RS-232C Adapter is used for this connection.

CompoBus/S I/O Link Units Up to 3 CompoBus/S I/O Link Units can be connected to make the CPM1A a Slave Device in a CompoBus/S Network. The I/O Link Unit has 8 input bits (internal) and 8 output bits (internal).

The CompoBus/S Network provides distributed CPU control based on a “PC + compact PC” configuration, which is an improvement on the earlier distributed I/O control based on a “PC + remote I/O” configuration. The distributed CPU control makes equipment modular, so designs can be standardized, special needs can be addressed, and modules can be replaced easily in the event of a breakdown.

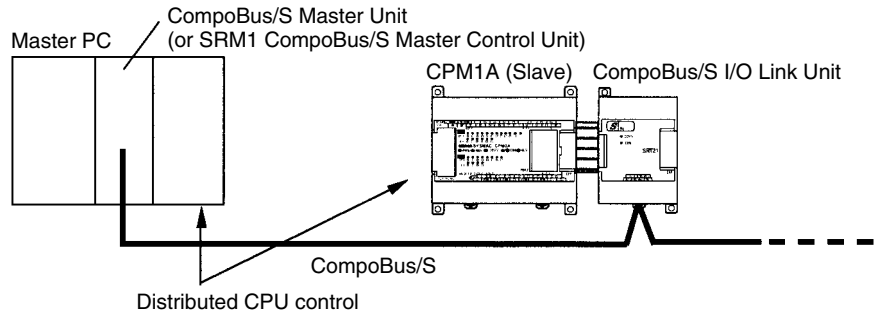

DeviceNet I/O Link Units

DeviceNet I/O Link Units can be connected to enable using the CPM1A as a DeviceNet slave. Up to 32 internal input and 32 internal outputs points are supported for each Unit, and up to 3 Units can be connected. DeviceNet application allows networks to be constructed including devices from other manufacturers.

Standard Peripheral Devices

The CPM1A uses the same Programming Consoles and SYSMAC Support Software (SSS) as the C200H/HS, C200HX/HG/HE, CPM1, SRM1, and CQM1 PCs.

Programming is Possible Using the PT

Programming operation is possible through the PT screen by using an OMRON PT that has a built-in Programming Console function.

Expansion Memory Unit

The CPM1-EMU01-V1 Expansion Memory Unit is a program loader for small-size or micro PLCs. Using the CPM1-EMU01-V1, simple on-site transfer of user programs and data memory is possible with PLCs.

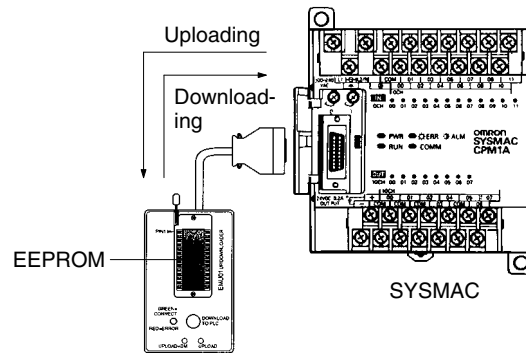

1-1-2 I/O Terminal and IR Bit Allocation

The following table shows which IR bits are allocated to the I/O terminals on the CPM1A's CPU Units and Expansion I/O Unit.

CPU Units

No. of I/O terminals on the CPU Unit		10		20		30		40	
Power supply		AC	DC	AC	DC	AC	DC	AC	DC
Model No.	Relay outputs	CPM1A-10CDR-A(-V1)	CPM1A-10CDR-D(-V1)	CPM1A-20CDR-A(-V1)	CPM1A-20CDR-D(-V1)	CPM1A-30CDR-A(-V1)	CPM1A-30CDR-D(-V1)	CPM1A-40CDR-A(-V1)	CPM1A-40CDR-D(-V1)
	Sinking transistor outputs	CPM1A-10CDT-A(-V1)	CPM1A-10CDT-D(-V1)	CPM1A-20CDT-A(-V1)	CPM1A-20CDT-D(-V1)	CPM1A-30CDT-A(-V1)	CPM1A-30CDT-D(-V1)	CPM1A-40CDT-A(-V1)	CPM1A-40CDT-D(-V1)
	Sourcing transistor outputs	CPM1A-10CDT1-A(-V1)	CPM1A-10CDT1-D(-V1)	CPM1A-20CDT1-A(-V1)	CPM1A-20CDT1-D(-V1)	CPM1A-30CDT1-A(-V1)	CPM1A-30CDT1-D(-V1)	CPM1A-40CDT1-A(-V1)	CPM1A-40CDT1-D(-V1)
CPU Unit terminals	Inputs	6 points: 00000 to 00005		12 points: 00000 to 00011		18 points: 00000 to 00011 00100 to 00105		24 points: 00000 to 00011 00100 to 00111	
	Outputs	4 points: 01000 to 01003		8 points: 01000 to 01007		12 points: 01000 to 01007 01100 to 01103		16 points: 01000 to 01007 01100 to 01107	

Expansion I/O Units

Unit	I/O	Relay output	Transistor output	
			Sinking outputs	Sourcing outputs
20 I/O points	12 inputs 8 outputs	CPM1A-20EDR CPM1A-20EDR1	CPM1A-20EDT	CPM1A-20EDT1
8 inputs	8 inputs	CPM1A-8ED		
8 outputs	8 outputs	CPM1A-8ER	CPM1A-8ET	CPM1A-8ET1

1-1-3 CPM1A Functions

Analog Setting Function

CPM1A PCs have 2 variable-resistor adjustment knobs used to control analog timer and counter settings manually. When one of the adjustments is turned, the content of the corresponding IR word is set automatically between 0 and 200 (BCD).

Turn the adjustment knob with a Phillips screwdriver.

Analogue adjustment 0
Analogue adjustment 1

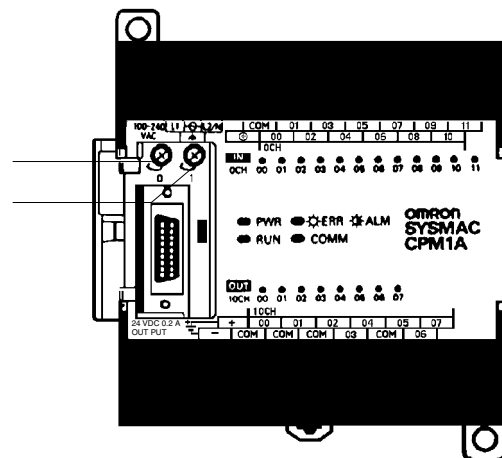

The following table shows which IR words are allocated to the analog adjustments on the CPM1A's CPU Unit.

Control	Corresponding IR word	Setting range (BCD)
Analog adjustment 0	IR 250	0000 to 0200
Analog adjustment 1	IR 251	

Input Filter Function

The input time constant for the CPM1A's external inputs can be set to 1, 2, 4, 8, 16, 32, 64, or 128 ms. Increasing the input time constant can reduce the effects of chatter or noise in the input signal.

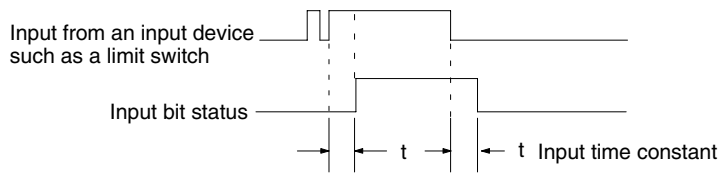

With the CPM1A, actual response time for each set input time constant for word 000 is different from that for word 001 or later.

Set value	Word 000	Word 001 or later
1 ms	1 to 1.5 ms	0.1 to 0.3 ms
2 ms	2 to 2.5 ms	0.7 to 1.5 ms
4 ms	4 to 4.5 ms	1.5 to 2.5 ms
8 ms	8 to 8.5 ms	3 to 4.5 ms
16 ms	16 to 16.5 ms	6 to 9 ms
32 ms	32 to 32.5 ms	12 to 18 ms
64 ms	64 to 64.5 ms	24 to 35 ms
128 ms	128 to 128.5 ms	50 to 70 ms

The input response time of the CPM1A is obtained with the following:

$$2 \text{ ms max. (hardware performance)} + \text{input time constant (see above table)} + \text{cycle time}$$

Input Interrupts

The CPM1A-10CDR-□(-V1)/10CDT-D(-V1)/10CDT1-D(-V1) PCs have 2 interrupt input terminals and the CPM1A-20CDR-□(-V1)/20CDT-D(-V1)/20CDT1-D(-V1), CPM1A-30CDR-□(-V1)/30CDT-D/30CDT1-D(-V1), and CPM1A-40CDR-□(-V1)/40CDT-D(-V1)/40CDT1-D(-V1) PCs have 4 interrupt input terminals. There are two modes for input interrupts: input interrupt mode and counter mode.

- 1, 2, 3...**
1. When an interrupt occurs in Input Interrupt Mode, the main program is interrupted and the interrupt program is executed immediately, regardless of the cycle time.
 2. In Counter Mode, external input signals are counted at high speed (up to 1 kHz) and an interrupt is generated each time the count reaches the set value. When an interrupt occurs, the main program is interrupted and the interrupt program is executed. The set value can be set from 0 to 65,535.

The following diagram shows the program execution when an interrupt occurs.

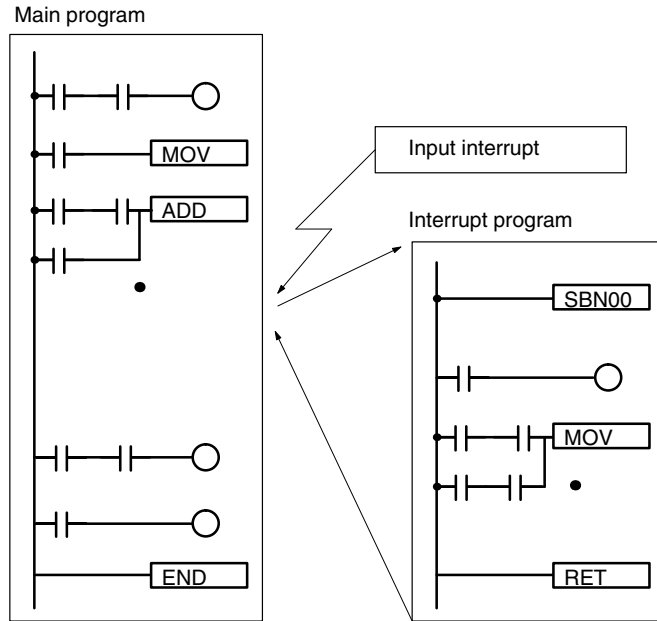

PC model	Input bits	Response time
CPM1A-10CDR-□(-V1)/ 10CDT-D(-V1)/10CDT1-D(-V1)	IR 00003 to IR 00004	0.3 ms (1 kHz in Counter Mode)
CPM1A-20CDR-□(-V1)/ 20CDT-D(-V1)/20CDT1-D(-V1)/ 30CDR-□(-V1)/30CDT-D(-V1)/ 30CDT1-D(-V1)/40CDR-□(-V1)/ 40CDT-D(-V1)/40CDT1-D(-V1)	IR 00003 to IR 00006	

Note When not using as interrupt input terminals, the input bits IR 00003 to IR 00006 can be used as normal input terminals.

Caution Although IORF(97) can be used in interrupt subroutines, you must be careful of the interval between IORF(97) executions. If IORF(97) is executed too frequently, a fatal system error may occur (FALS 9F), stopping operation. The interval between executions of IORF(97) should be at least 1.3 ms + total execution time of the interrupt subroutine.

Quick-response Inputs

The CPM1A-10CDR-□(-V1)/10CDT-D(-V1)/10CDT1-D(-V1) PCs have 2 quick-response input terminals and the CPM1A-20CDR-□(-V1)/20CDT-D/20CDT1-D(-V1), CPM1A-30CDR-□(-V1)/30CDT-D(-V1)/30CDT1-D(-V1) and CPM1A-40CDR-□(-V1)/40CDT-D(-V1)/40CDT1-D(-V1) PCs have 4 quick-response input terminals. (The same terminals are used for quick-response inputs and interrupt inputs.)

Quick-response inputs have an internal buffer, so input signals shorter than one cycle can be detected.

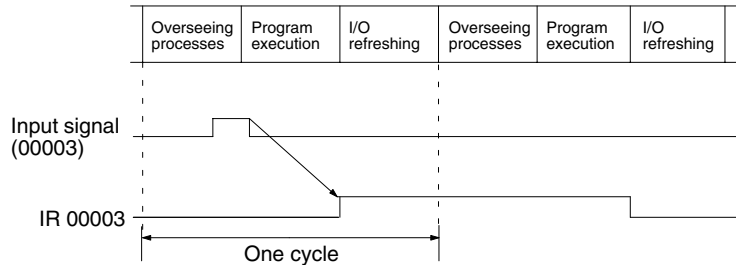

PC model	Input bits	Min. input pulse width
CPM1A-10CDR-□(-V1)/10CDT-D(-V1)/10CDT1-D(-V1)	IR 00003 to IR 00004	0.2 ms
CPM1A-20CDR-□(-V1)/20CDT-D(-V1)/20CDT1-D(-V1)/30CDR-□(-V1)/30CDT-D(-V1)/30CDT1-D(-V1)/40CDR-□(-V1)/40CDT-D(-V1)/40CDT1-D(-V1)	IR 00003 to IR 00006	

Interval Timer Function (Scheduled Interrupts)

CPM1A PCs are equipped with an interval timer which can be set from 0.5 ms to 319,968 ms in units of 0.1 ms. The timer can be set to trigger a single interrupt (one-shot mode) or to trigger scheduled interrupts (scheduled interrupt mode).

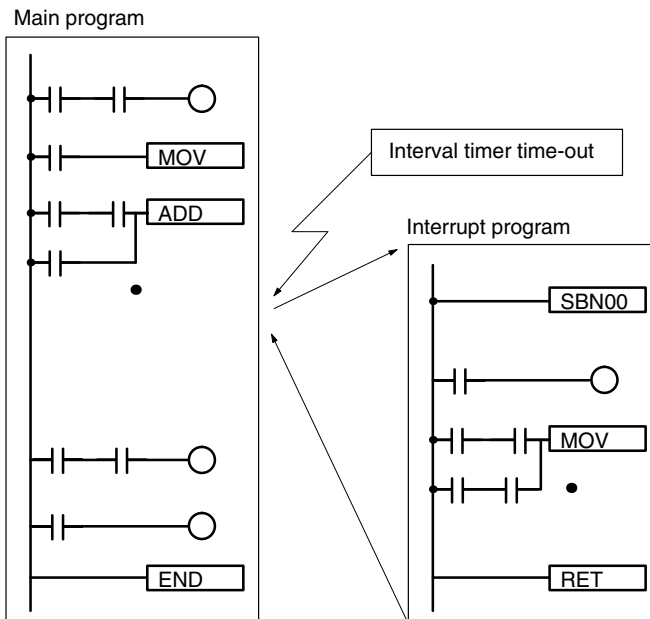

Mode	Function
One-shot	Generates a single interrupt the first time that the timer times out.
Scheduled interrupt	Generates an interrupt each time that the timer times out.

Pulse Output Function

Since the CPM1A with transistor output has a pulse output function capable of outputting a pulse of 20 Hz to 2kHz (single-phase output), a stepping motor can be controlled by the CPU Unit alone.

The pulse output can be set to either the continuous mode, under which the output can be stopped by an instruction, or the single mode, under which the output can be stopped by the preset pulse rate (1 to 16,777,215).

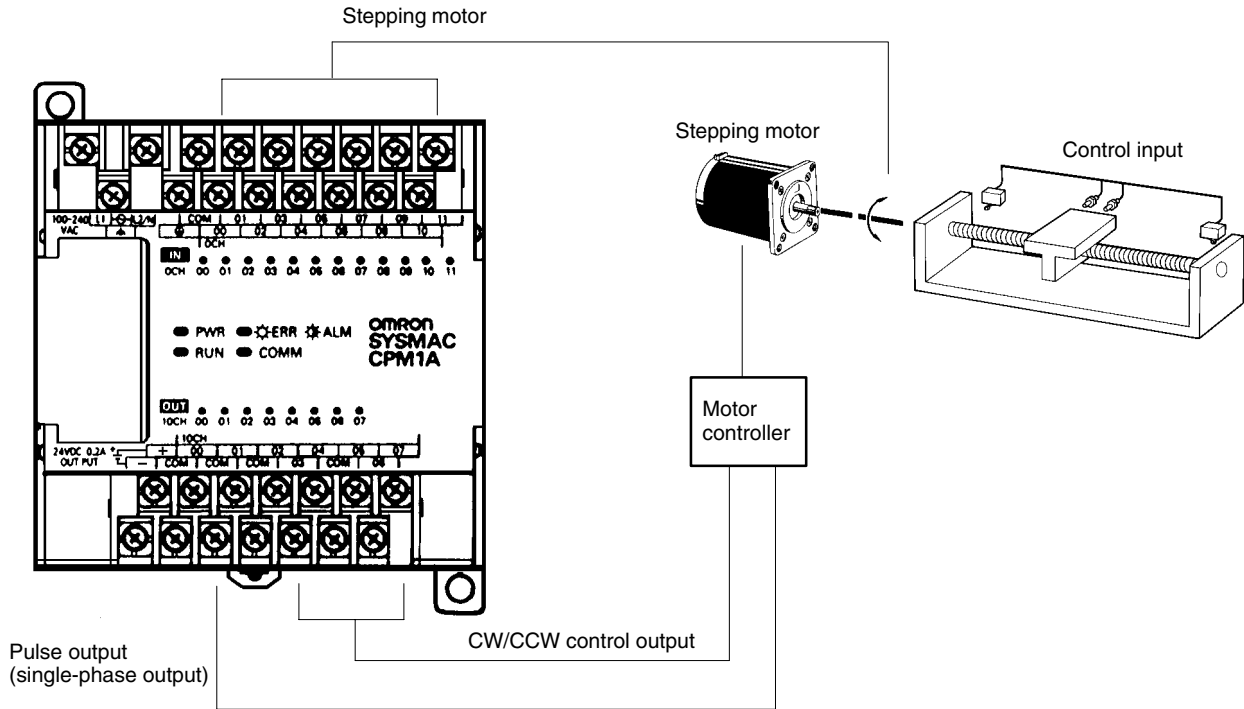

High-speed Counter

CPM1A PCs have a high-speed counter that can be used in incremental mode or up/down mode. The high-speed counter can be combined with input interrupts to perform target value control or zone comparison control that isn't affected by the PC's cycle time.

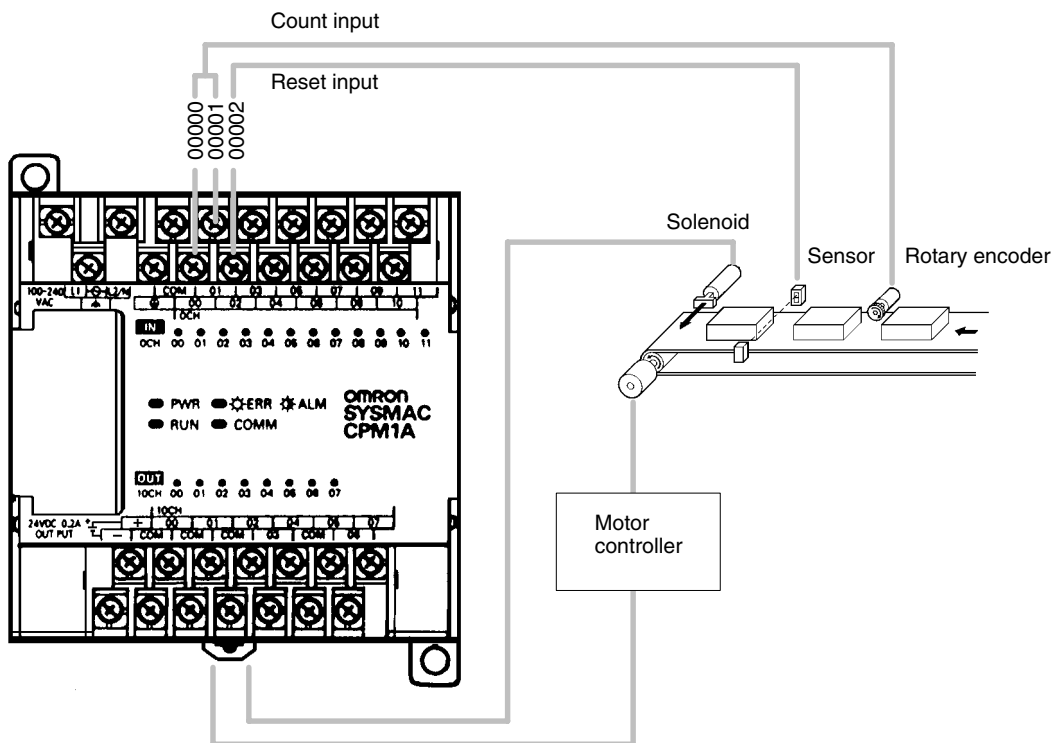

Mode	Input functions	Input method	Count frequency	Count range	Control methods
Up/Down	00000: A-phase input 00001: B-phase input 00002: Z-phase input	Phase-difference, 4x inputs	2.5 kHz	-32767 to 32767	Target value control: Up to 16 target values and interrupt subroutine numbers can be registered.
Incremental	00000: Count input 00001: See note. 00002: Reset input	Individual inputs	5.0 kHz	0 to 65535	Zone comparison control: Up to 8 sets of upper limit values, lower limit values, and interrupt subroutine numbers can be registered.

Note In incremental mode, this input (00001) can be used as a regular input.

1-2 System Configuration

1-2-1 CPU Unit and Expansion I/O Unit Configuration

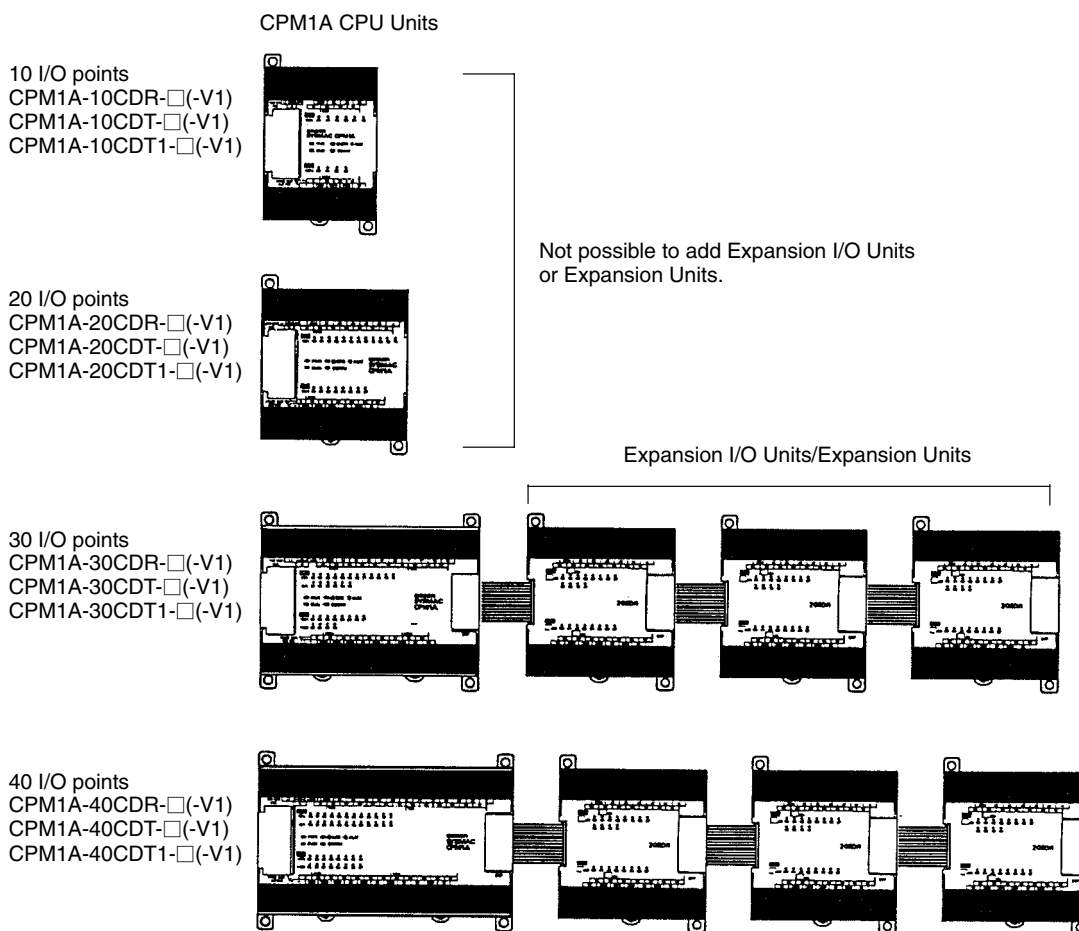

V1 CPM1A CPU Units

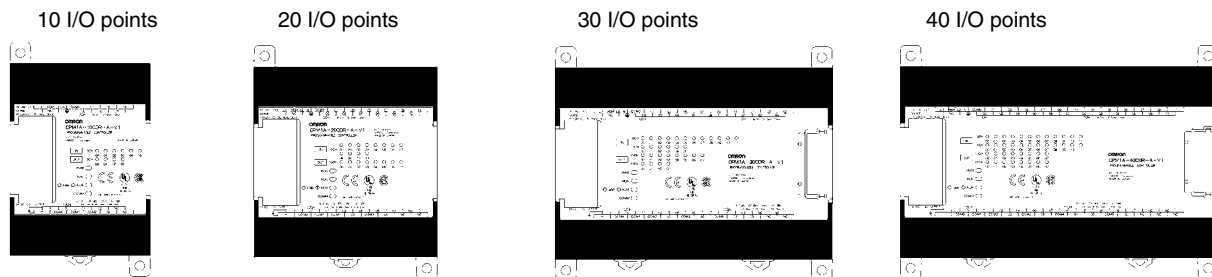

Number of I/O terminals	Inputs	Outputs	Power supply	Model number		
				Relay outputs	Transistor outputs	
					Sinking outputs	Sourcing outputs
10	6 points	4 points	AC	CPM1A-10CDR-A-V1	CPM1A-10CDT-A-V1	CPM1A-10CDT1-A-V1
			DC	CPM1A-10CDR-D-V1	CPM1A-10CDT-D-V1	CPM1A-10CDT1-D-V1
20	12 points	8 points	AC	CPM1A-20CDR-A-V1	CPM1A-20CDT-A-V1	CPM1A-20CDT1-A-V1
			DC	CPM1A-20CDR-D-V1	CPM1A-20CDT-D-V1	CPM1A-20CDT1-D-V1
30	18 points	12 points	AC	CPM1A-30CDR-A-V1	CPM1A-30CDT-A-V1	CPM1A-30CDT1-A-V1
			DC	CPM1A-30CDR-D-V1	CPM1A-30CDT-D-V1	CPM1A-30CDT1-D-V1
40	24 points	16 points	AC	CPM1A-40CDR-A-V1	CPM1A-40CDT-A-V1	CPM1A-40CDT1-A-V1
			DC	CPM1A-40CDR-D-V1	CPM1A-40CDT-D-V1	CPM1A-40CDT1-D-V1

Pre-V1 CPM1A CPU Units

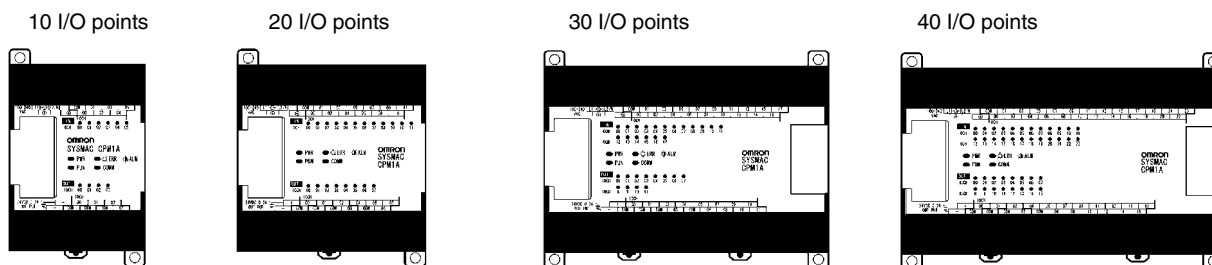

Number of I/O terminals	Inputs	Outputs	Power supply	Model number		
				Relay outputs	Transistor outputs	
					Sinking outputs	Sourcing outputs
10	6 points	4 points	AC	CPM1A-10CDR-A	CPM1A-10CDT-A	CPM1A-10CDT1-A
			DC	CPM1A-10CDR-D	CPM1A-10CDT-D	CPM1A-10CDT1-D
20	12 points	8 points	AC	CPM1A-20CDR-A	CPM1A-20CDT-A	CPM1A-20CDT1-A
			DC	CPM1A-20CDR-D	CPM1A-20CDT-D	CPM1A-20CDT1-D
30	18 points	12 points	AC	CPM1A-30CDR-A	CPM1A-30CDT-A	CPM1A-30CDT1-A
			DC	CPM1A-30CDR-D	CPM1A-30CDT-D	CPM1A-30CDT1-D
40	24 points	16 points	AC	CPM1A-40CDR-A	CPM1A-40CDT-A	CPM1A-40CDT1-A
			DC	CPM1A-40CDR-D	CPM1A-40CDT-D	CPM1A-40CDT1-D

1-2-2 CPU Unit and Expansion Unit

Up to 3 Expansion I/O Units or Expansion Units can be connected to a CPU Unit with 30 or 40 I/O points.

There are three types of Expansion Units available: Analog I/O Units, Temperature Sensor Units, the CompoBus/S I/O Link Unit, and the DeviceNet I/O Link Unit.

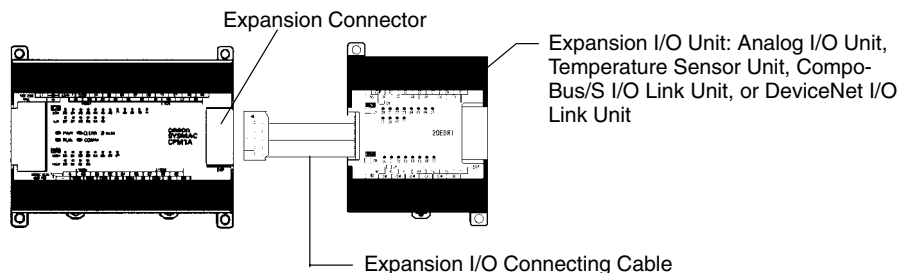

A PC with 100 I/O points (the maximum) can be assembled by connecting three Expansion I/O Units.

$$\text{CPM1A-40CD} \square \square \times 1 \text{ Unit} + \text{CPM1A-20EDR1} \times 3 \text{ Units} = 60 \text{ inputs, } 40 \text{ outputs}$$

(24 inputs, 16 outputs)

A PC with 6 analog inputs and 3 analog outputs (the maximum) can be assembled by connecting three Analog I/O Units.

A PC with up to 6 temperature inputs for input from thermocouples or platinum resistance thermometers can be assembled by connecting Temperature Sensor Units.

CompoBus/S I/O Link Units (Slave Units) can be connected to a CPU Unit. I/O data (8 inputs and 8 outputs) is transferred between the CPU Unit and the area allocated to the CompoBus/S Slave. (The I/O data exchanged with the Slave is internal data; there are no external input or output terminals.)

Up to three DeviceNet I/O Link Units can be connected to a CPU Unit. Each DeviceNet I/O Link Unit enables using the CPM1A as a DeviceNet slave with 32 input and 32 output points.

Note Different types of Expansion Units can be connected at the same time. For example, an Expansion I/O Unit, Analog I/O Unit, and CompoBus/S I/O Link Unit, or an Expansion I/O Unit, Analog I/O Unit, and Temperature Sensor Unit can be connected to the CPU Unit.

Expansion I/O Units

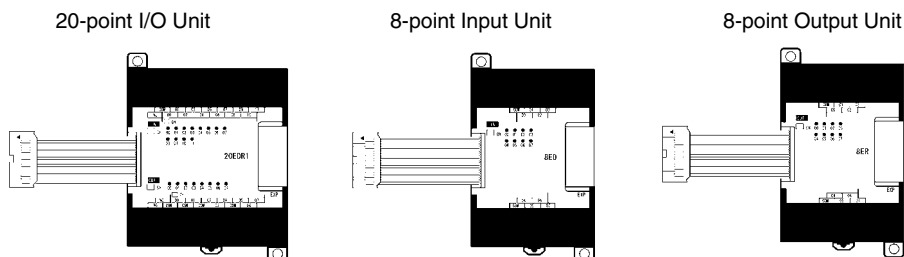

Unit	Max. number of Units	Inputs	Outputs	Model
20 I/O points 12 inputs 8 outputs	3 Units max. (See note.)	24 VDC	Relays	CPM1A-20EDR1
		24 VDC	Sinking transistors	CPM1A-20EDT
		24 VDC	Sourcing transistors	CPM1A-20EDT1
		24 VDC	---	CPM1A-8ED
		---	Relays	CPM1A-8ER
		---	Sinking Transistors	CPM1A-8ET
		---	Sourcing Transistors	CPM1A-8ET1
8 inputs				
8 outputs				

Expansion Units

CPM1A-MAD01
Analog I/O Unit

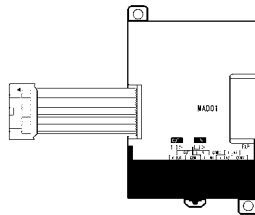

CPM1A-MAD11
Analog I/O Unit

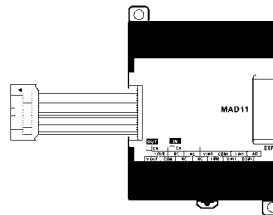

Temperature Sensor Unit

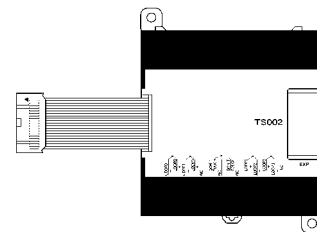

CompoBus/S I/O
Link Unit

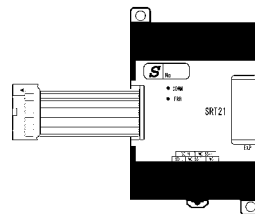

DeviceNet I/O
Link Unit

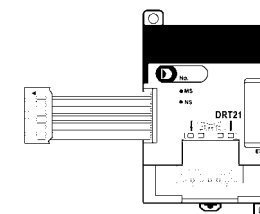

Unit		Max. number of Units	Inputs	Outputs	Model
Analog I/O Unit 2 analog inputs (2 words) 1 analog output (1 word)		3 Units max. (See note.)	2 analog inputs	1 analog output	CPM1A-MAD01
					CPM1A-MAD11
Temperature Sensor Unit	Thermocouple inputs	3 Units max. (See note.)	2 inputs (K, J)	---	CPM1A-TS001
		1 Unit max.	4 inputs (K, J)		CPM1A-TS002
	Platinum resistance thermometer inputs	3 Units max. (See note.)	2 inputs (Pt100, JPt100)		CPM1A-TS101
		1 Unit max.	4 inputs (Pt100, JPt100)		CPM1A-TS102
CompoBus/S I/O Link Unit 8 inputs and 8 outputs		3 Units max. (See note.)	8 bits (Inputs from the Master.)	8 bits (Outputs to the Master.)	CPM1A-SRT21
DeviceNet I/O Link Unit 32 inputs and 32 outputs		3 Units max. (See note.)	32 bits (Inputs from the Master.)	32 bits (Outputs to the Master.)	CPM1A-DRT21

Note Only one CPM1A-TS002/TS102 Temperature Sensor Unit can be connected to the CPU Unit. If a CPM1A-TS002/102 is connected to the CPU Unit, only one additional Expansion Unit (other than a CPM1A-TS002/102) or one Expansion I/O Unit can be connected to the CPU Unit.

1-2-3 Host Link Communications

Host Link communications which allows up to 32 OMRON PCs to be controlled from a host computer. The computer-PC connections can be made connectors such as RS-232C and RS-422 Adapters.

One-to-one Communications The following diagram shows the possible methods for a 1:1 connection between a CPM1A and an IBM PC/AT or compatible computer.

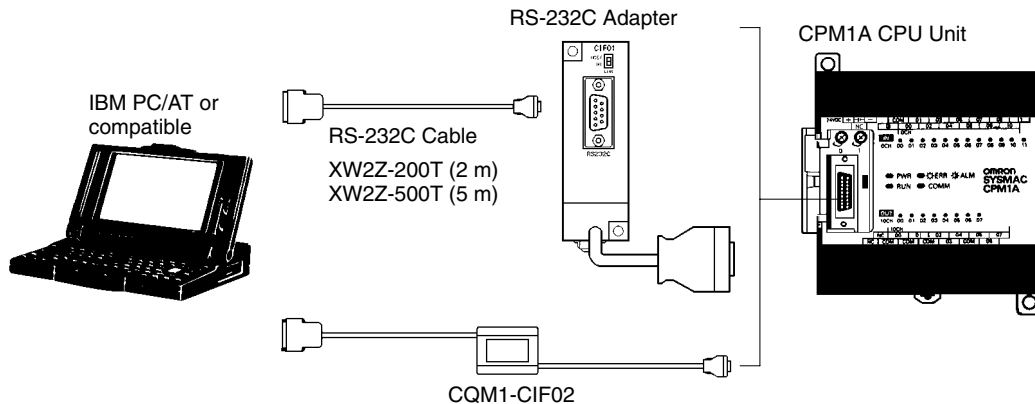

Connecting to a Programmable Terminal

The following diagram shows the possible methods for a connection between a CPM1A PC and an OMRON Programmable Terminal (a operator interface device).

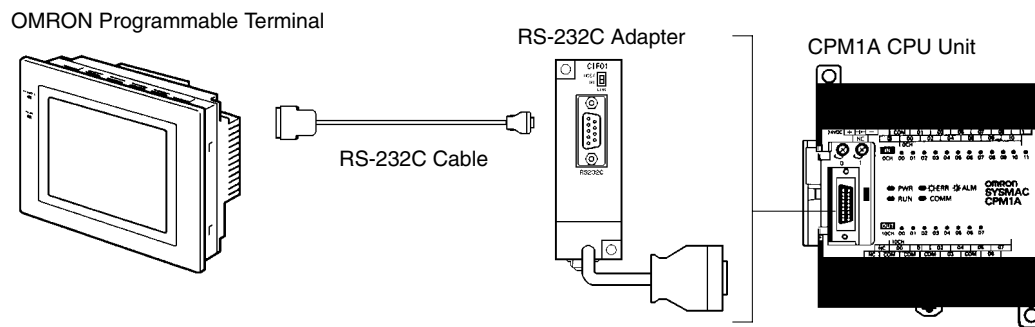

One-to-N Communications The following diagram shows how to connect up to 32 CPM1A PCs to an IBM PC/AT or compatible computer.

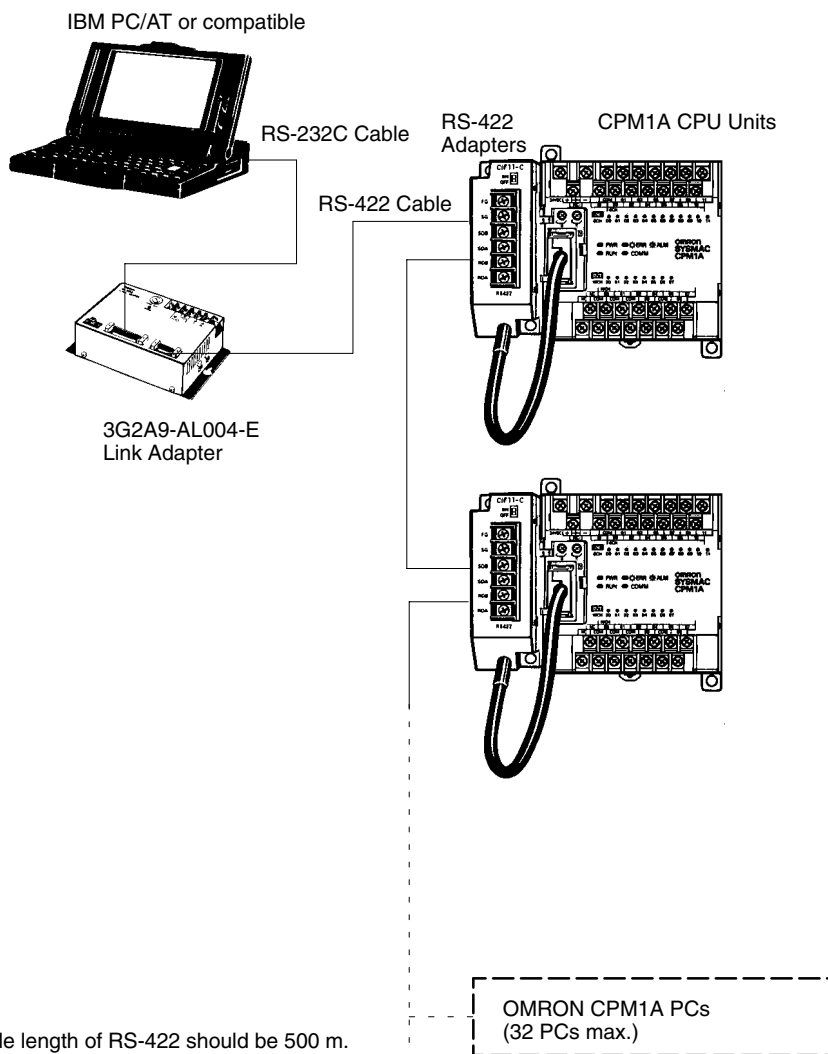

Adapters and Cables

The following table lists some of the Adapters and Cables used in Host Link communications.

Name	Usage	Model number
RS-232C Adapter	Converts to peripheral port-level communications.	CPM1-CIF01
RS-422 Adapter		CPM1-CIF11
Connecting Cables	Used to connect IBM PC/AT or compatible computers. (Cable length: 3.3 m)	CQM1-CIF02
Link Adapter	Converts between the RS-232C and RS-422 formats.	3G2A9-AL004-E

1-2-4 One-to-one PC Link Communications

A data link can be created with a data area in another CPM1A, CQM1, CPM1, CPM2A, CPM2C, SRM1(-V2) or C200HS PC or a C200HX/HG/HE PC. An RS-232C Adapter must be used to make the 1:1 connection.

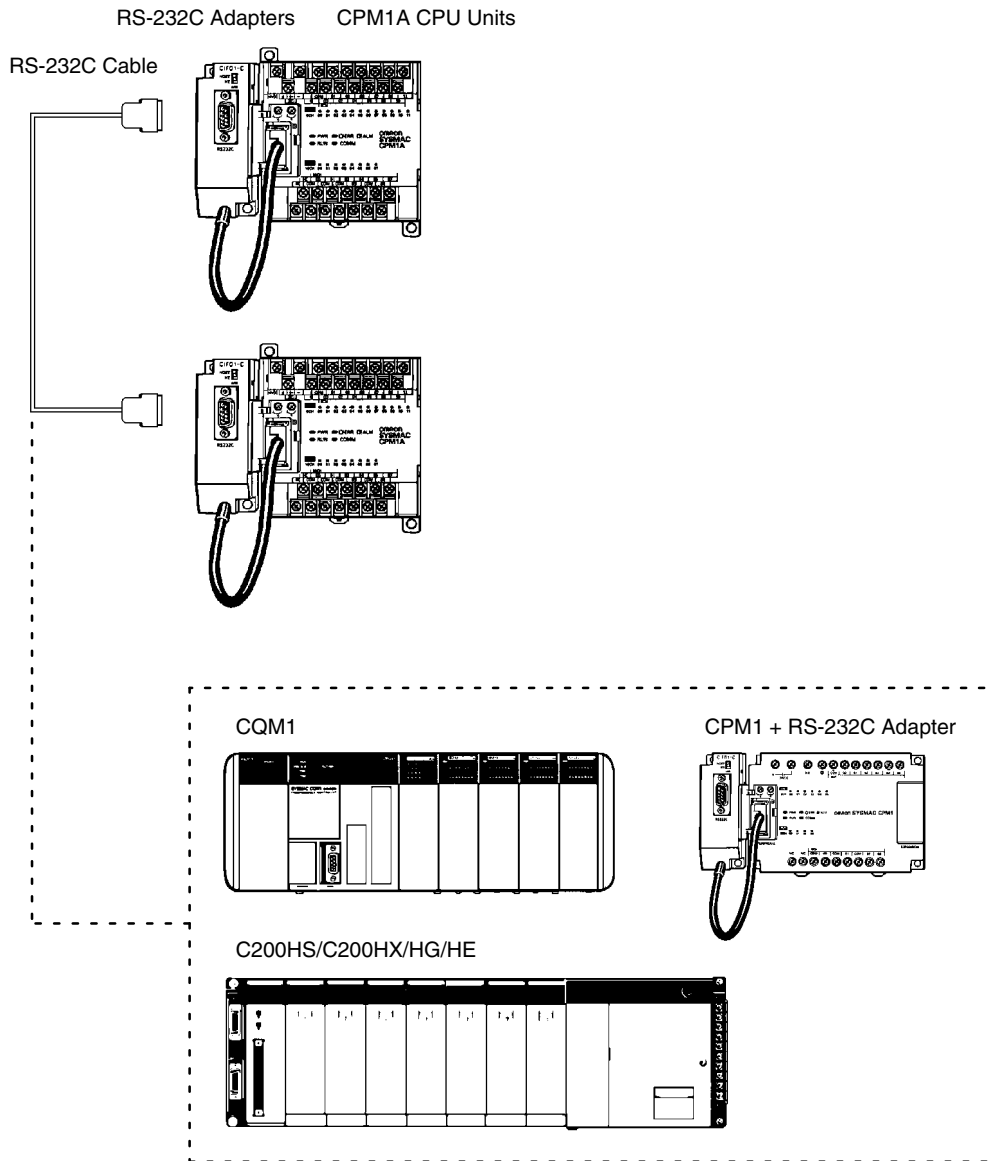

Name	Usage	Model number
RS-232C Adapter	Converts to the Peripheral Port format.	CPM1-CIF01

1-2-5 One-to-one NT Link Communications

Using the NT Link, the CPM1A PC can be connected to the Programmable Terminal (NT Link Interface) through an RS-232C Adapter.

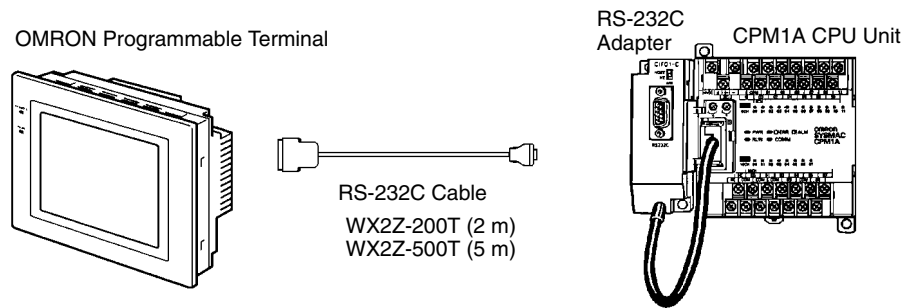

Name	Usage	Model number
RS-232C Adapter	Converts to peripheral port-level communications.	CPM1-CIF01

1-2-6 CompoBus/S I/O Link Connections

A CompoBus/S I/O Link can be used to create an I/O link (remote I/O) of 8 input points and 8 output points with a CompoBus/S Master Unit or SRM1 PC. The connection is made through a CompoBus/S I/O Link Unit.

From the standpoint of the CPM1A CPU Unit, the area allocated to the CompoBus/S I/O Link Unit can be treated just like the area allocated to an Expansion I/O Unit. The difference is that the bits are not actual I/O points, but I/O bits in the Master Unit.

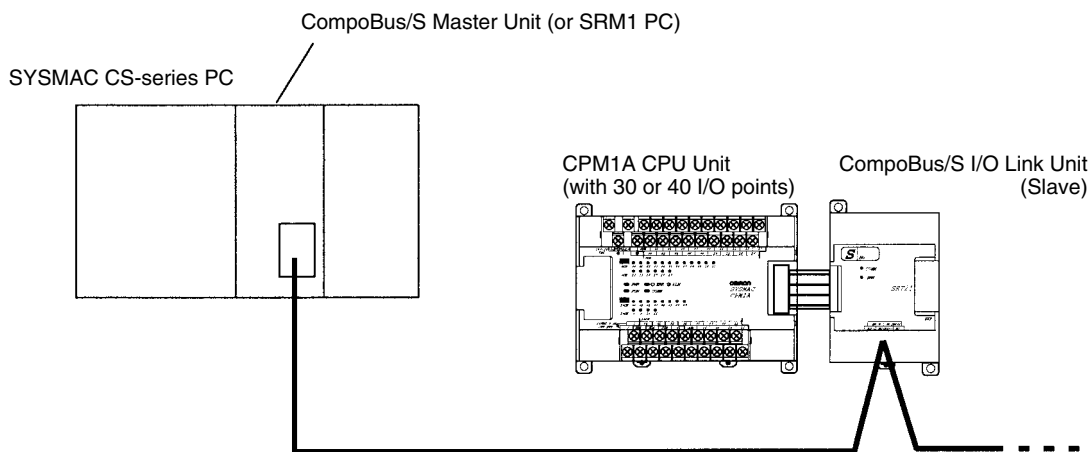

Cables

Use special flat cable, VCTF 2-core cable, or VCTF 4-core cable. Do not combine different types of cable in the same system.

Name	Specifications
Flat cable	4-core flat cable, 0.75 mm ²
VCTF cable	2-core x 0.75 mm ² , 4-core x 0.75 mm ² (JIS C3306)

1-2-7 DeviceNet I/O Link Connections

A DeviceNet I/O Link Unit can be used to create an I/O link (remote I/O) of 32 input points and 32 output points with a DeviceNet master, i.e., the CPM1A operates as a DeviceNet slave. From the standpoint of the CPM1A CPU Unit, the area allocated to the DeviceNet I/O Link Unit can be treated just like the area allocated to an Expansion I/O Unit. The difference is that the bits are not actual I/O points, but I/O bits in the DeviceNet master.

Up to three DeviceNet I/O Link Units can be connected, for a maximum DeviceNet I/O link capacity of 192 I/O points (96 inputs and 96 outputs).

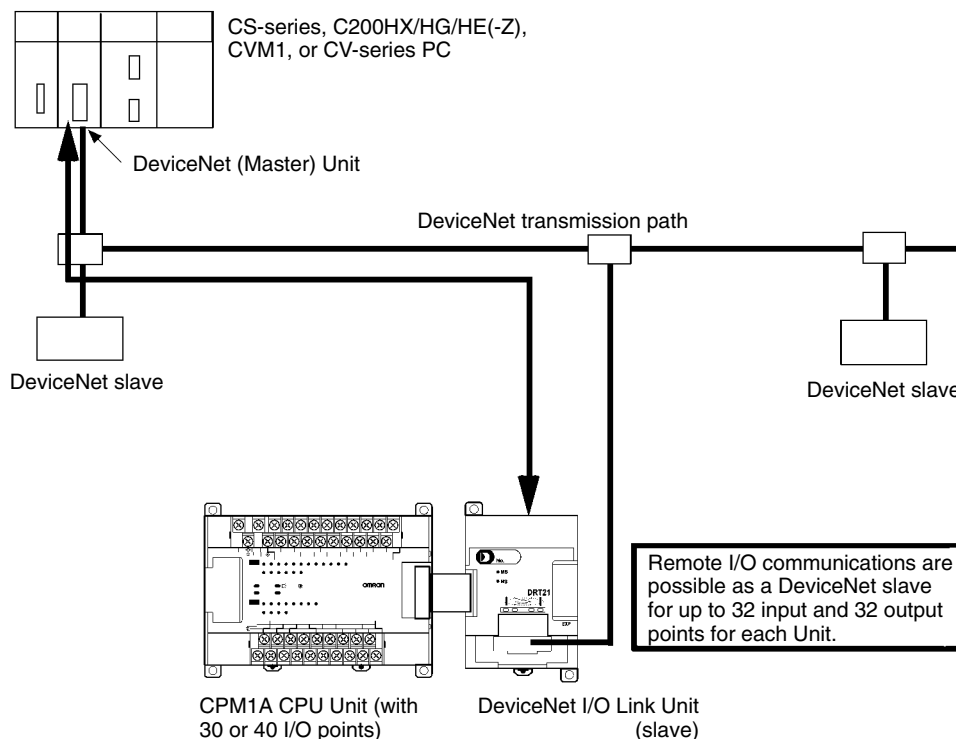

1-2-8 Peripheral Device Connections

CPM1A programs can be created or edited with a Programming Console or a personal computer running SYSMAC Support Software (SSS).

Programming Consoles

A CQM1-PRO01-E or C200H-PRO27-E Programming Console can be connected to the CPM1A as shown in the following diagram.

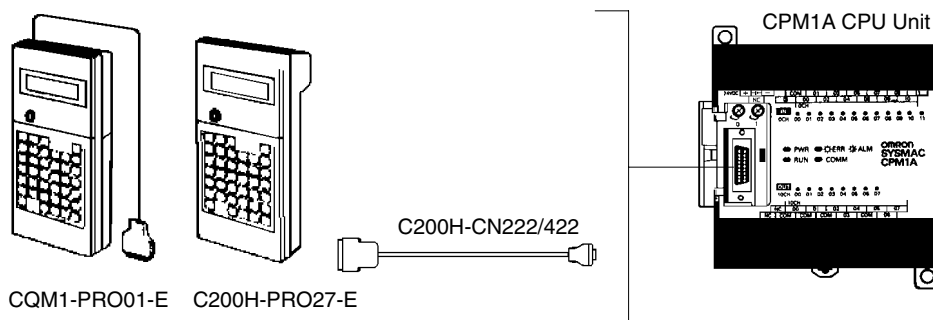

Name		Model number
CQM1 Programming Console (The Connecting Cable is included.)		CQM1-PRO01-E
C200H/HS and C200HX/HG/HE Programming Console		C200H-PRO27-E
C200H-series Connecting Cables	Cable length: 2 m	C200H-CN222
	Cable length: 4 m	C200H-CN422

SYSMAC Support Software and SYSMAC-CPT Support Software

An IBM PC/AT or compatible personal computer running SSS or the SYSMAC-CPT Support Software can be connected to the CPM1A as shown in the following diagram. Refer to 3-4-7 *Host Link Connections* for a diagram showing the standard wiring for the RS-232C cable.

Any version of the Support Software may be used. Refer to 4-1 *Support Software Capabilities* for further details on installing and using Support Software.

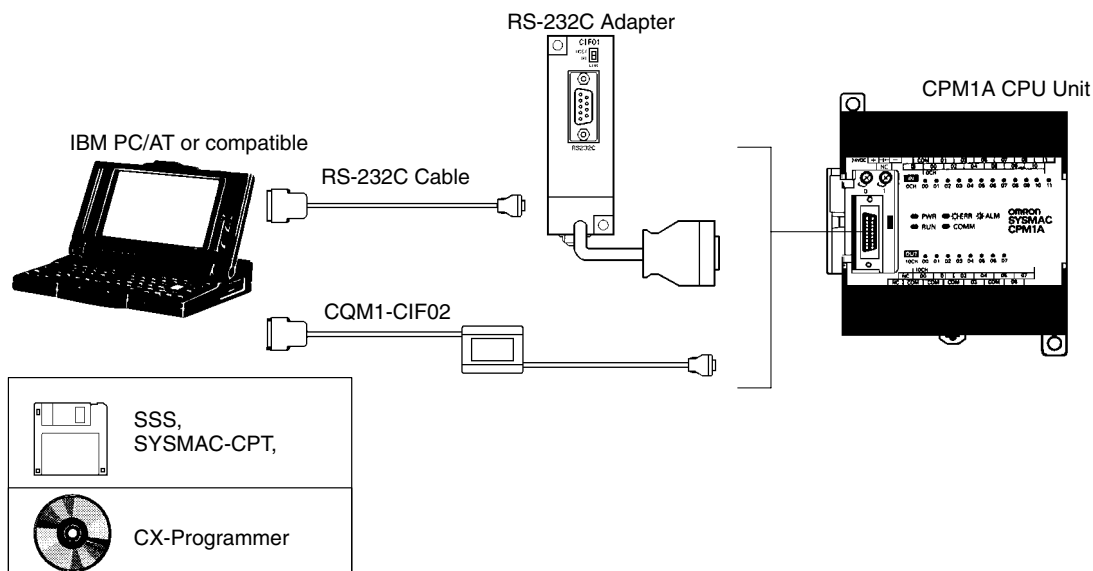

Name	Usage	Model number
RS-232C Adapter	Converts to Peripheral Port format level communications.	CPM1-CIF01
Connecting Cable	Used to connect IBM PC/AT or compatible computers. (Length: 3.3 m)	CQM1-CIF02
SYSMAC Support Software	For IBM PC/AT or compatible computers (3.5" disks, 2HD)	C500-ZL3AT1-E
SYSMAC-CPT Support Software	For IBM PC/AT or compatible computers (3.5" disks (2HD) and CDROM)	WS01-CPTB1-E
CX-Programmer	For Windows 95 or 98 computers (CDROM), version 1.2 or higher	WS02-CXPC1-E

SECTION 2

Unit Specifications and Components

This section provides the technical specifications of the Units that go together to create a CPM1A PC and describes the main components of the Units.

2-1	Specifications	22
2-1-1	General Specifications	22
2-1-2	Characteristics	23
2-1-3	I/O Specifications	25
2-1-4	Communications Adapter Specifications	30
2-2	Unit Components	31
2-2-1	CPU Unit Components	31
2-2-2	Expansion I/O Unit Components	33
2-2-3	Analog I/O Unit Components	35
2-2-4	Temperature Sensor Unit Components	36
2-2-5	CompoBus/S I/O Link Unit Components	37
2-2-6	DeviceNet I/O Link Unit Components	38
2-2-7	Communications Adapter Components	40

2-1 Specifications

2-1-1 General Specifications

Item		CPM1A-10CDR-□(-V1) CPM1A-10CDT-□(-V1) CPM1A-10CDT1-□(-V1)	CPM1A-20CDR-□(-V1) CPM1A-20CDT-□(-V1) CPM1A-20CDT1-□(-V1)	CPM1A-30CDR-□(-V1) CPM1A-30CDT-□(-V1) CPM1A-30CDT1-□(-V1)	CPM1A-40CDR-□(-V1) CPM1A-40CDT-□(-V1) CPM1A-40CDT1-□(-V1)
Supply voltage	AC type	100 to 240 VAC, 50/60 Hz			
	DC type	24 VDC			
Operating voltage range	AC type	85 to 264 VAC			
	DC type	20.4 to 26.4 VDC			
Power consumption	AC type	30 VA max.		60 VA max.	
	DC type	6 W max.		20 W max.	
Inrush current		30 A max.		38 A max.	
External power supply (AC type only) (See note 1.)	Supply voltage	24 VDC			
	Output capacity	200 mA (See note 2.)		300 mA	
Insulation resistance		20 MΩ min. (at 500 VDC) between the external AC terminals and protective earth terminals			
Dielectric strength		2,300 VAC 50/60 Hz for 1 min between the external AC and protective earth terminals, leakage current: 10 mA max.			
Noise immunity		Conforms to IEC6100-4-4; 2 kV (power lines)			
Vibration resistance		10 to 57 Hz, 0.075-mm amplitude, 57 to 150 Hz, acceleration: 9.8 m/s ² in X, Y, and Z directions for 80 minutes each (Time coefficient; 8 minutes × coefficient factor 10 = total time 80 minutes)			
Shock resistance		147 m/s ² three times each in X, Y, and Z directions			
Ambient temperature		Operating: 0° to 55°C Storage: -20° to 75°C			
Humidity		10% to 90% (with no condensation)			
Atmosphere		Must be free from corrosive gas			
Terminal screw size		M3			
Grounding		Less than 100 Ω			
Power interrupt time		AC type: 10 ms min. DC type: 2 ms min. (A power interruption occurs if power falls below 85% of the rated voltage for longer than the power interrupt time.)			
CPU Unit weight	AC type	400 g max.	500 g max.	600 g max.	700 g max.
	DC type	300 g max.	400 g max.	500 g max.	600 g max.
Expansion I/O Unit weight		Units with 20 I/O points: 300 g max. Units with 8 output points: 250 g max. Units with 8 input points: 200 g max.			
Expansion Unit weight		Analog I/O Unit: 150 g max. Temperature Sensor Units: 250 g max. CompoBus/S I/O Link Unit: 200 g max. DeviceNet I/O Link Unit: 200 g max.			

- Note**
1. Use the external power supply as the service power supply of input devices. The power supply cannot be used for driving output devices.
 2. If there is an overcurrent or short on the external power supply, the voltage of the external power supply will drop and the PC will stop operation.

2-1-2 Characteristics

Item		CPM1A-10CDR-□(-V1) CPM1A-10CDT-□(-V1) CPM1A-10CDT1-□(-V1)	CPM1A-20CDR-□(-V1) CPM1A-20CDT-□(-V1) CPM1A-20CDT1-□(-V1)	CPM1A-30CDR-□(-V1) CPM1A-30CDT-□(-V1) CPM1A-30CDT1-□(-V1)	CPM1A-40CDR-□(-V1) CPM1A-40CDT-□(-V1) CPM1A-40CDT1-□(-V1)
Control method		Stored program method			
I/O control method		Cyclic scan with direct output; immediate refresh processing			
Programming language		Ladder diagram			
Instruction length		1 step per instruction, 1 to 5 words per instruction			
Types of instructions		Basic instructions: 14 Special instructions: 77 types, 135 instructions			
Execution time		Basic instructions: 0.72 to 16.2 μs Special instructions: 16.3 μs (MOV instruction)			
Program capacity		2,048 words			
Max. I/O capacity	CPU Unit only	10 points	20 points	30 points	40 points
	With Expansion I/O Units	---	---	50, 70, or 90 points	60, 80, or 100 points
Input bits		00000 to 00915		Words not used for input or output bits can be used for work bits.	
Output bits		01000 to 01915			
Work bits		512 bits: 20000 to 23115 (Words IR 200 to IR 231)			
Special bits (SR area)		384 bits: 23200 to 25515 (Words IR 232 to IR 255)			
Temporary bits (TR area)		8 bits (TR0 to TR7)			
Holding bits (HR area)		320 bits: HR 0000 to HR 1915 (Words HR 00 to HR 19)			
Auxiliary bits (AR area)		256 bits: AR 0000 to AR 1515 (Words AR 00 to AR 15)			
Link bits (LR area)		256 bits: LR 0000 to LR 1515 (Words LR 00 to LR 15)			
Timers/Counters		128 timers/counters (TIM/CNT 000 to TIM/CNT 127) 100-ms timers: TIM 000 to TIM 127 10-ms timers (high-speed counter): TIM 000 to TIM 127 (see note 1) (the timer numbers used are the same as for the 100-ms timers) Decrementing counters and reversible counters			
Data memory		Read/Write: 1,024 words (DM 0000 to DM 1023) Read-only: 512 words (DM 6144 to DM 6655)			
Interrupt processing (see note 2)		External interrupts: 2		External interrupts: 4	
Interval timer interrupts		1 (0.5 to 319,968 ms in Scheduled Interrupt Mode or Single Interrupt Mode)			
Memory protection		HR and read/write DM area contents; and counter values maintained during power interruptions.			
Memory backup		Flash memory: The program, read-only DM area, and PC Setup area are backed up without a battery. Capacitor backup: The read/write DM area, error log area, HR area, and counter values are backed up by a capacitor for 20 days at 25°C. The capacitor backup time depends on the ambient temperature. See the graph on the following page for details.			
Self-diagnostic functions		CPU Unit failure (watchdog timer), I/O bus error, and memory failure			
Program checks		No END instruction, programming errors (continuously checked during operation)			
High-speed counter		One high-speed counter: 5 kHz single-phase or 2.5 kHz two-phase (linear count method) Increment mode: 0 to 65,535 (16 bits) Up/Down mode: -32,767 to 32,767 (16 bits)			
Quick-response inputs		The same inputs are used for quick-response inputs and external interrupt inputs. (Min. input pulse width: 0.2 ms)			

Item	CPM1A-10CDR-□(-V1) CPM1A-10CDT-□(-V1) CPM1A-10CDT1-□(-V1)	CPM1A-20CDR-□(-V1) CPM1A-20CDT-□(-V1) CPM1A-20CDT1-□(-V1)	CPM1A-30CDR-□(-V1) CPM1A-30CDT-□(-V1) CPM1A-30CDT1-□(-V1)	CPM1A-40CDR-□(-V1) CPM1A-40CDT-□(-V1) CPM1A-40CDT1-□(-V1)
Pulse output	One point, 20 Hz to 2 kHz (single-phase output) Can preset the pulse rate (1 to 16,777,215).			
Input time constant	Can be set to 1 ms, 2 ms, 4 ms, 8 ms, 16 ms, 32 ms, 64 ms, or 128 ms.			
Analog controls	2 controls, setting range: 0 to 200 BCD			

- Note**
1. Use TIM 000 to TIM 003 when creating a timer using the high-speed timer instruction to perform interrupt processing.
 2. The input interrupt response time is 0.3 ms max.

Memory Backup

The user program and memory area data in the CPM1A are backed up either by an internal capacitor or in flash memory as shown in the following table.

Backup method	Data
Internal capacitor	Read/write DM area (DM 0000 to DM 0999, DM 1022, and DM 1023) Error log area (DM 1000 to DM 1021) HR area (HR 00 to HR 19) Counter area (CNT 000 to CNT 127)
Flash memory	User program Read-only DM area (DM 6144 to DM 6599) PC Setup (DM 6600 to DM 6655)

- Note**
1. The IR, TR, LR, and timer areas are not normally backed up when power is turned off and all contents will be cleared the next time power is turned on. (The PC Setup setting in DM 6601 can be used to back up this data. Refer to details on the PC Setup later in this manual for details.)
 2. The bits in the AR and SR areas have special functions and are set according to these functions when power is turned on.

The capacitor backup time depends on the ambient temperature, as shown in the following graph. The backup time, however, assumes that the capacitor is fully charged, which requires that power be supplied to the CPU Unit continuously for at least 15 minutes.

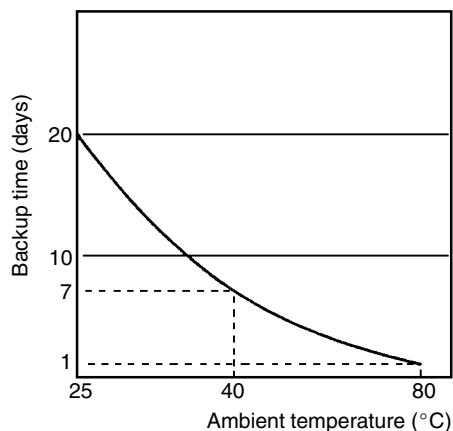

If the power remains off for a period exceeding the data backup period, AR 1314 will turn ON to indicate that the capacitor can no longer back up data and the data backed up by the capacitor will be cleared. AR 1314 will remain ON unless it is turned OFF using I/O monitor operations, using memory clear operations, or from the user program.

If desired, the PC Setup setting in DM 6604 can be set to create a fatal error and thus stop the system when AR 1314 goes ON.

The data stored in flash memory will not be lost even if power remains off for a period exceeding the data backup period, because the data stored in flash memory will be read to the CPU Unit when the CPM1A is turned on.

If the power is turned off without changing the mode from PROGRAM mode to RUN or MONITOR mode after having made changes in the data that is backed up in flash memory, the changes will not be written to flash memory. If the power is then left off for more than 20 days (at 25°C), the changes (i.e., the contents of the RAM) will be erased and the data values will become undefined.

Either switch the CPM1A to RUN or MONITOR mode, or turn off and on power to the CPM1A after changing from a Programming Device any data that is backed up in flash memory. This data includes the user program, read-only DM area (DM 6144 to DM 6599), and the PC Setup (DM 6600 to DM 6655).

2-1-3 I/O Specifications

CPU Unit Input Specifications

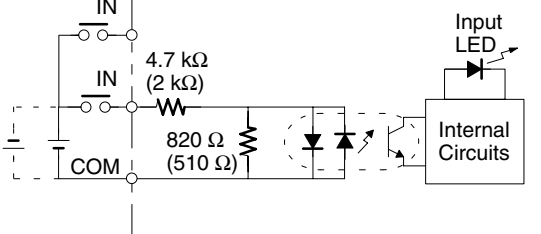
Item	Specification
Input voltage	24 VDC +10%/−15%
Input impedance	IN00000 to IN00002: 2 kΩ; other inputs: 4.7 kΩ
Input current	IN00000 to IN00002: 12 mA typical; other inputs: 5 mA typical
ON voltage	14.4 VDC min.
OFF voltage	5.0 VDC max.
ON delay	1 to 128 ms max. Default: 8 ms (see note.)
OFF delay	1 to 128 ms max. Default: 8 ms (see note.)
Circuit configuration	

Note Figures in parentheses are for IN00000 to IN00002.

Note Using the PC Setup, 1, 2, 4, 8, 16, 32, 64, or 128 ms can be selected. When IN00000 through IN00002 are used as high-speed counter inputs, the delays are as shown in the following table.

Input	Increment mode	Differential phase mode
IN00000 (A-phase)	5 kHz	2.5 kHz
IN00001 (B-phase)	Normal input	
IN00002 (Z-phase)	ON: 100 μs min.; OFF delay: 500 μs min.	

The minimum delay is as follows.

Increment Mode (5 kHz Max.)

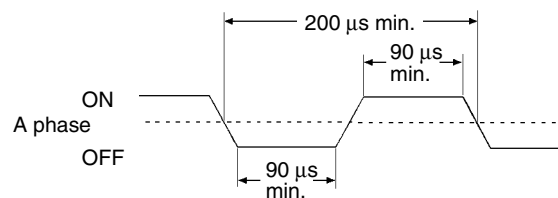

Differential Phase Mode (2.5 kHz Max.) IN00000 (A phase), IN00001 (B phase)

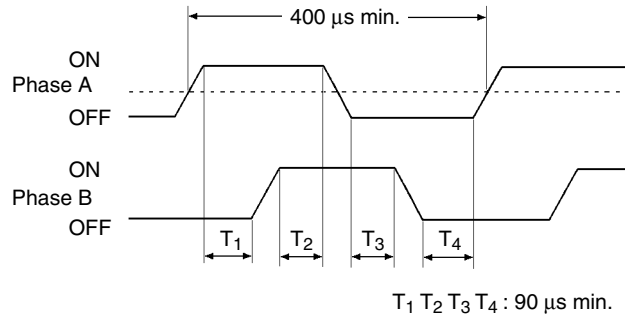

IN00002 (Z phase)

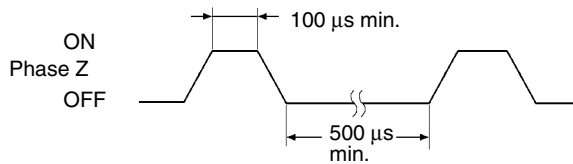

When IN00003 through IN00006 are used as interrupt inputs, the delay is 0.3 ms max. The delay is measured from the time that the input goes ON until the interrupt subroutine is executed.

Expansion I/O Unit Input Specifications

Item	Specification
Input voltage	24 VDC $+10\%/ -15\%$
Input impedance	4.7 k Ω
Input current	5 mA typical
ON voltage	14.4 VDC min.
OFF voltage	5.0 VDC max.
ON delay	1 to 128 ms max. Default: 8 ms (see note.)
OFF delay	1 to 128 ms max. Default: 8 ms (see note.)
Circuit configuration	

Note Using the PC Setup, 1, 2, 4, 8, 16, 32, 64, or 128 ms can be selected.

Caution Do not apply voltage in excess of the rated voltage to the input terminal. It may result in damage to the product or fire.

CPU Unit and Expansion I/O Unit Output Specifications

Relay Outputs

Item	Specification
Max. switching capacity	2 A, 250 VAC ($\cos\phi = 1$) 2 A, 24 VDC (4 A/common)
Min. switching capacity	10 mA, 5 VDC
Service life of relay	Electrical: 150,000 operations (resistive load, 24 VDC) 100,000 operations (inductive load, 220 VAC, $\cos\phi=0.4$) Mechanical for pre-V1 Units: 10,000,000 operations Mechanical for V1 Units: 20,000,000 operations
ON delay	15 ms max.
OFF delay	15 ms max.
Circuit configuration	<p>Maximum 250 VAC: 2 A 24 VDC: 2 A</p>

- Note**
1. The service life of relay output contacts shown in the table assumes the worst conditions. The following graph shows the results of OMRON's service life tests at a switching rate of 1,800 times/hour.
 2. The CPM1A-20EDR Expansion I/O Unit with Relay Outputs does not conform to the EC Directives. Use the CPM1A-20EDR1 or CPM1A-8ER Expansion I/O Unit, which has the CE marking, when conformance to EC Directives is required.

Pre-V1 Units

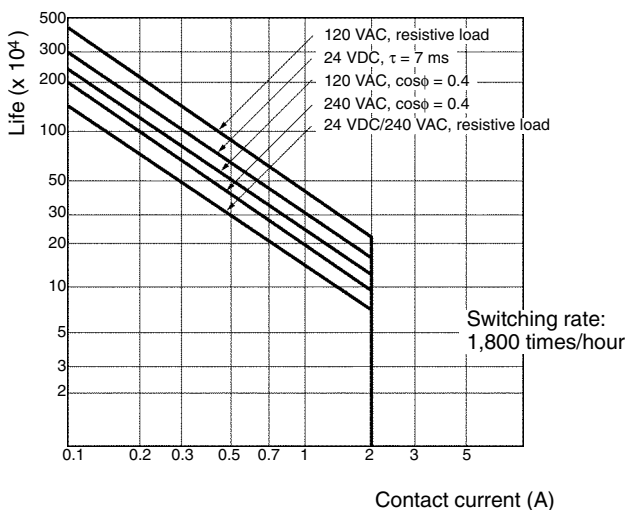

V1 Units

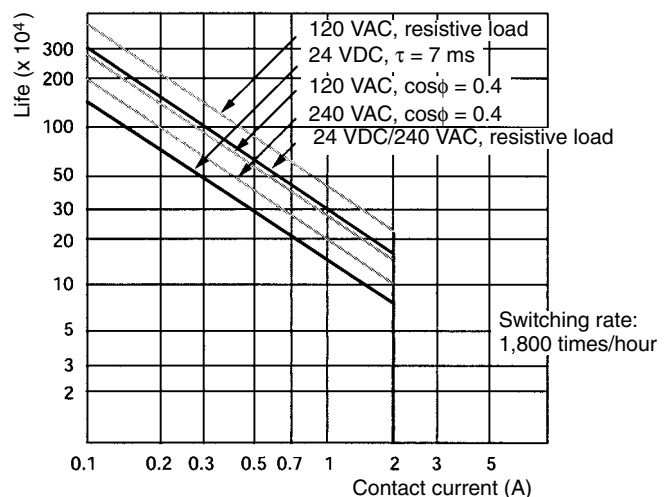

Transistor Outputs (Sinking)

Item	Specification					
	CPM1A-10CDT-□(-V1)	CPM1A-20CDT-□(-V1)	CPM1A-30CDT-□(-V1)	CPM1A-40CDT-□(-V1)	CPM1A-20EDT	CPM1A-8ET
Max. switching capacity	24 VDC +10%/−15%, 0.3 A/point (see note)					4.5 to 30 VDC 0.2 A (See note 2.) 0.3 A (See note 3.)
	0.9 A/Unit	0.9 A/common 1.8 A/Unit	0.9 A/common 2.7 A/Unit	0.9 A/common 3.6 A/Unit	0.9 A/common 1.8 A/Unit	
Leakage current	0.1 mA max.					
Residual voltage	1.5 V max.					
ON delay	0.1 ms max.					
OFF delay	OUT01000/01001: 0.2 ms max. (load current: 100 to 300 mA) 0.5 ms max. (load current: 5 to 100 mA) Other than OUT01000/01001: 1 ms max. (load current: 5 to 300 mA)				1 ms max. (24 VDC +10%/−5%, 5 to 300 mA)	
Fuse	V1 CPU Units: No fuse Expansion I/O Units and Pre-V1 CPU Units 1.25 A/common (cannot be replaced by the user)					
Circuit configuration						

Note When using the OUT01000 or OUT01001 as a pulse output, connect dummy resistors as required to set the load current to 0.1 to 0.2 A. If the load current is below 0.1 A, the ON-to-OFF response time will become longer and high-speed pulse will not be output. On the other hand, if the load current is above 0.2 A, the transistor may generate heat and components may be damaged.

Transistor Outputs (Sourcing)

Item	Specification					
	CPM1A-10CDT1-□(-V1)	CPM1A-20CDT1-□(-V1)	CPM1A-30CDT1-□(-V1)	CPM1A-40CDT1-□(-V1)	CPM1A-20EDT1	CPM1A-8ET1
Max. switching capacity	24 VDC $+10\%/-15\%$, 0.3 A/point (See note.)					4.5 to 30 VDC 0.2 A (See note 2.) 0.3 A (See note 3.)
	0.9 A/Unit	0.9 A/common 1.8 A/Unit	0.9 A/common 2.7 A/Unit	0.9 A/common 3.6 A/Unit	0.9 A/common 1.8 A/Unit	
Leakage current	0.1 mA max.					
Residual voltage	1.5 V max.					
ON delay	0.1 ms max.					
OFF delay	OUT01000/01001: 0.2 ms max. (load current: 100 to 300 mA) 0.5 ms max. (load current: 5 to 100 mA) Other than OUT01000/01001: 1 ms max. (load current: 5 to 300 mA)				1 ms max. (24 VDC $+10\%/-5\%$, 5 to 300 mA)	
Fuse	V1 CPU Units: No fuse Expansion I/O Units and Pre-V1 CPU Units 1.25 A/common (cannot be replaced by the user)					
Circuit configuration						

Note When using the OUT01000 or OUT01001 as a pulse output, connect dummy resistors as required to set the load current to 0.1 to 0.2 A. If the load current is below 0.1 A, the ON-to-OFF response time will become longer and high-speed pulse will not be output. On the other hand, if the load current is above 0.2 A, the transistor may generate heat and components may be damaged.

Caution Do not apply voltage in excess of the maximum switching capacity to an output terminal. It may result in damage to the product or fire.

2-1-4 Communications Adapter Specifications

RS-232C Adapter Specifications

Item	Specification
Function	Converts between the CMOS format (PC CPU Unit side) and the RS-232C format (peripheral device side).
Insulation	The RS-232C (peripheral device side) is isolated by a DC/DC convertor and photocoupler.
Power supply	Power is supplied from the PC CPU Unit.
Power consumption	0.3 A max.
Baud rate	38,400 bps max.
Transmission distance	Total length: 15 m max.
Vibration resistance	10 to 57 Hz: 0.075-mm amplitude 57 to 150 Hz: 9.8 m/s ² acceleration in X, Y, and Z directions for 80 minutes each (Time coefficient; 8 minutes × coefficient factor 10 = total time 80 minutes)
Shock resistance	147 m/s ² three times each in X, Y, and Z directions
Ambient temperature	Operating: 0° to 55°C Storage: -20° to 75°C
Humidity	10% to 90% (with no condensation)
Atmosphere	Must be free from corrosive gas
Weight	200 g max.

RS-422 Adapter Specifications

Item	Specification
Function	Converts between the CMOS format (PC CPU Unit side) and the RS-422 format (peripheral device side).
Insulation	The RS-422 (peripheral device side) is isolated by a DC/DC convertor and photocoupler.
Power supply	Power is supplied from the PC CPU Unit.
Power consumption	0.3 A max.
Baud rate	38,400 bps max.
Transmission distance	Total length: 500 m max.
Vibration resistance	10 to 57 Hz: 0.075-mm amplitude 57 to 150 Hz: 9.8 m/s ² acceleration in X, Y, and Z directions for 80 minutes each (Time coefficient; 8 minutes × coefficient factor 10 = total time 80 minutes)
Shock resistance	147 m/s ² three times each in X, Y, and Z directions
Ambient temperature	Operating: 0° to 55°C Storage: -20° to 75°C
Humidity	10% to 90% (with no condensation)
Atmosphere	Must be free from corrosive gas
Weight	200 g max.

2-2 Unit Components

2-2-1 CPU Unit Components

CPU Units with 10 I/O Terminals

CPM1A-10CDR-□-V1/10CDT-□-V1/10CDT1-□-V1

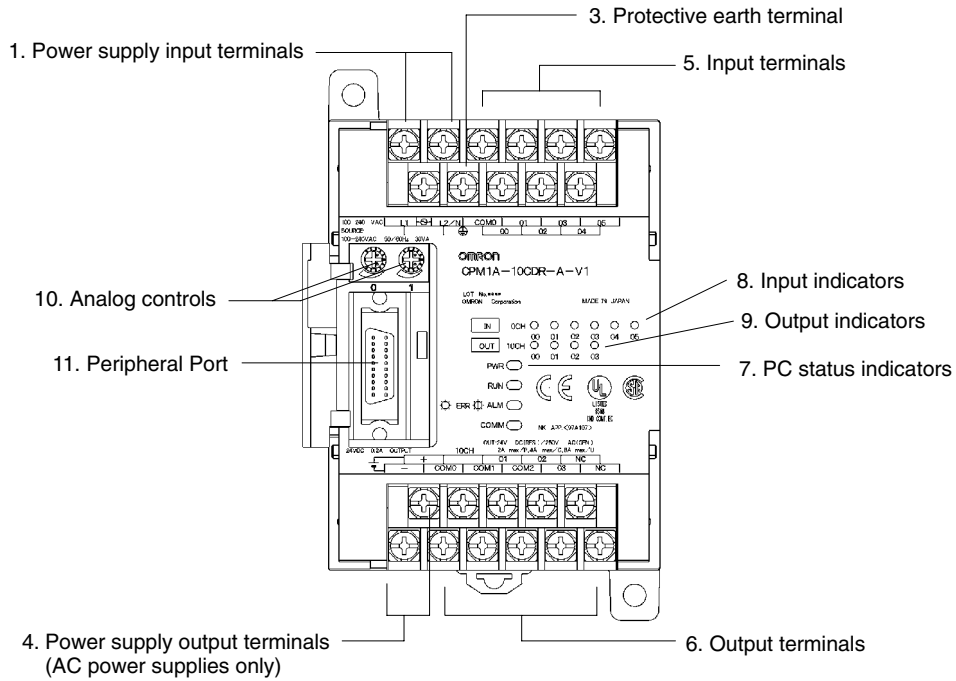

CPM1A-10CDR-□/10CDT-□/10CDT1-□

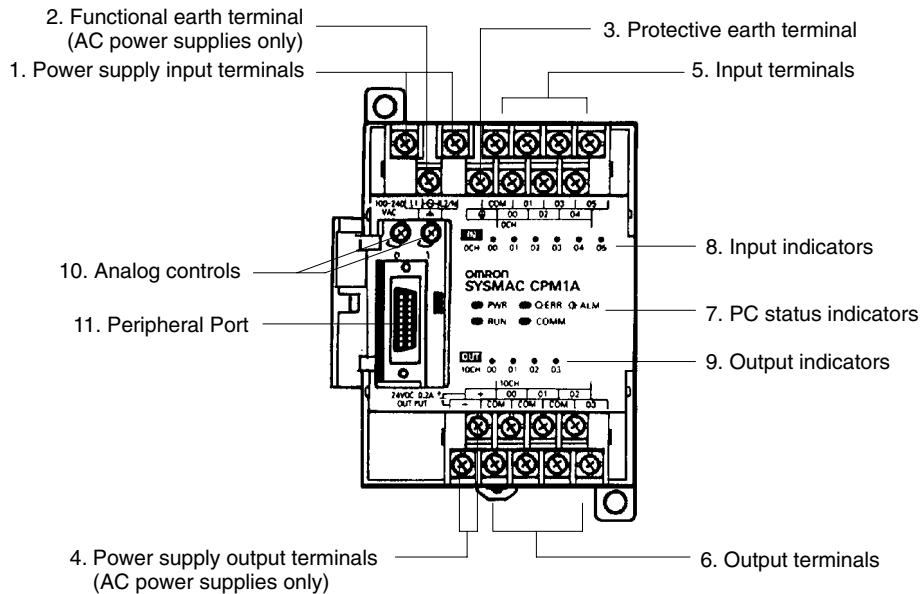

CPU Units with 20 I/O Terminals

CPM1A-20CDR-□-V1/20CDT-□-V1/20CDT1-□-V1

CPM1A-20CDR-□/20CDT-□/20CDT1-□

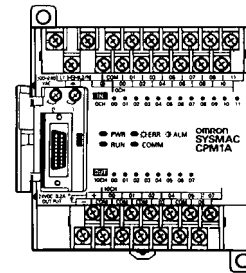
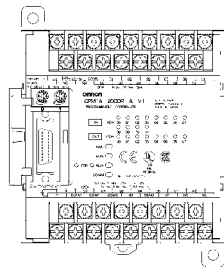

CPU Units with 30 I/O Terminals

CPM1A-30CDR-□-V1/30CDT-□-V1/30CDT1-□-V1

CPM1A-30CDR-□/30CDT-□/30CDT1-□

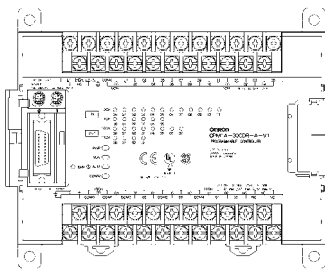

12. Expansion I/O Unit connector

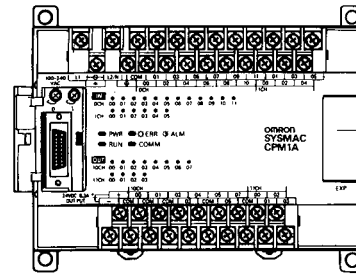

12. Expansion I/O Unit connector

CPU Units with 40 I/O Terminals

CPM1A-40CDR-□-V1/40CDT-□-V1/40CDT1-□-V1

CPM1A-40CDR-□/40CDT-□/40CDT1-□

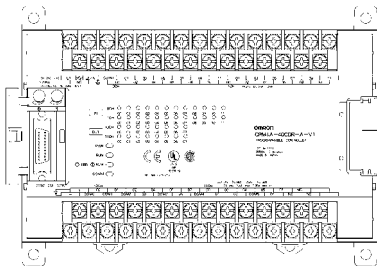

12. Expansion I/O Unit connector

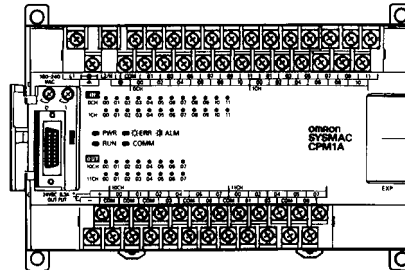

12. Expansion I/O Unit connector

CPU Unit Component Descriptions

1, 2, 3...

1. Power Supply Input Terminals
Connect the power supply (100 to 240 VAC or 24 VDC) to these terminals.
2. Functional Earth Terminal (⏏) (Pre-V1 CPU Units only)
Be sure to ground this terminal (AC-type PCs only) to enhance immunity to noise and reduce the risk of electric shock.
3. Protective Earth Terminal (⏏)
Be sure to ground this terminal to reduce the risk of electric shock.
4. Power Supply Output Terminals
CPM1A PCs are equipped with these 24-VDC power output terminals to supply power to input devices. (AC-type PCs only.)
5. Input Terminals
Connect the Unit to external input devices.
6. Output Terminals
Connect the Unit to external output devices.

7. PC Status Indicators

These indicators show the operating status of the PC, as shown in the following table.

Indicator	Status	Meaning
PWR (green)	ON	Power is being supplied to the PC.
	OFF	Power isn't being supplied to the PC.
RUN (green)	ON	The PC is operating in RUN or MONITOR mode.
	OFF	The PC is in PROGRAM mode or a fatal error has occurred.
ERR/ALARM (red)	ON	A fatal error has occurred. (PC operation stops.)
	Flashing	A non-fatal error has occurred. (PC operation continues.)
	OFF	Indicates normal operation.
COMM (orange)	ON	Data is being transferred via the Peripheral Port.
	OFF	Data isn't being transferred via the Peripheral Port.

8. Input Indicators

These indicators are lit when the corresponding input terminal is ON. When a fatal error occurs, the input indicators change as follows:

Fatal error	Input indicators
CPU Unit error or I/O bus error	Turn OFF.
Memory error, no END instruction error, or system error	The indicators will change with the status of the input signal, but input status will not be updated in memory.

9. Output Indicators

These indicators are lit when the corresponding output terminal is ON.

10. Analog Controls

Setting these controls sets the contents of IR 250 and IR 251 from 0 to 200.

11. Peripheral Port

Connects the PC to a Peripheral Device, RS-232C Adapter, or RS-422 Adapter.

12. Expansion I/O Unit Connector

Connects the PC's CPU Unit to an Expansion I/O Unit to add another 12 input points and 8 output points. Up to 3 Expansion I/O Units can be connected.

2-2-2 Expansion I/O Unit Components

Expansion I/O Unit with 20 I/O Terminals

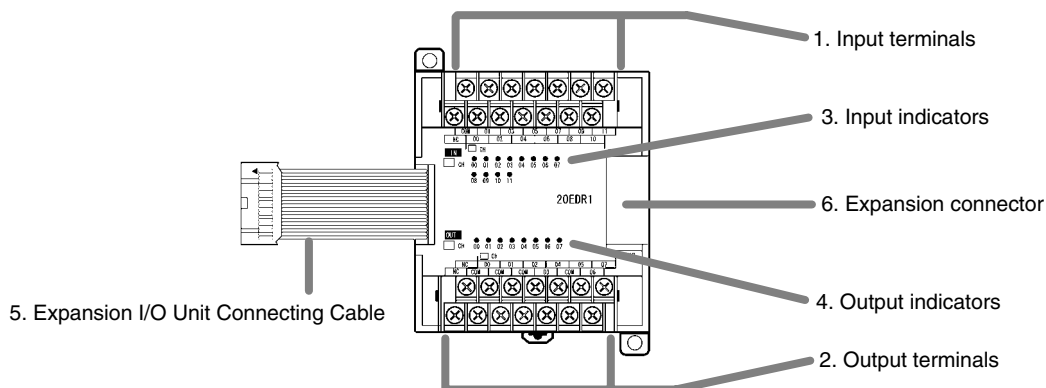

Expansion I/O Unit with 8 Input Terminals

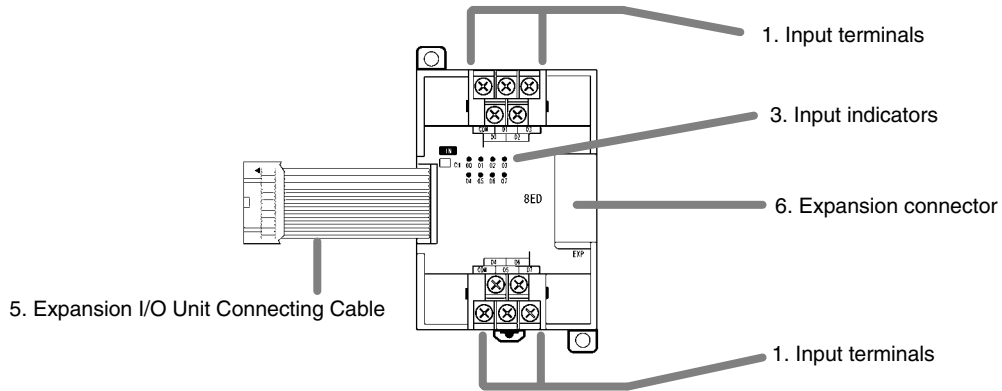

Expansion I/O Unit with 8 Output Terminals

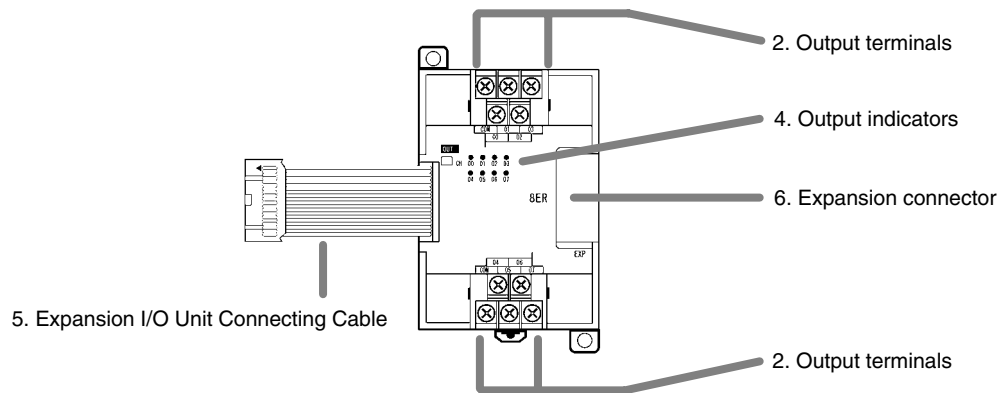

- 1, 2, 3...** 1. Input Terminals
Connects the Unit to external input devices.
- 2. Output Terminals
Connects the Unit to external output devices.
- 3. Input Indicators
The input indicators are lit when the corresponding input terminal is ON.
- 4. Output Indicators
The output indicators are lit when the corresponding output terminal is ON.
- 5. Expansion I/O Unit Connecting Cable
Connects the Expansion I/O Unit to the Expansion Connector on the PC's CPU Unit or another Expansion Unit.

! Caution Do not touch the Expansion I/O Unit Connecting Cable while the power is being supplied in order to prevent any malfunction due to static electricity.

- 6. Expansion Connector
Connects to another Expansion Unit (Expansion I/O Unit, Analog I/O Unit, or CompoBus/S I/O Link Unit). Up to 3 Expansion Units can be connected to a CPU Unit.

2-2-3 Analog I/O Unit Components

CPM1A-MAD01

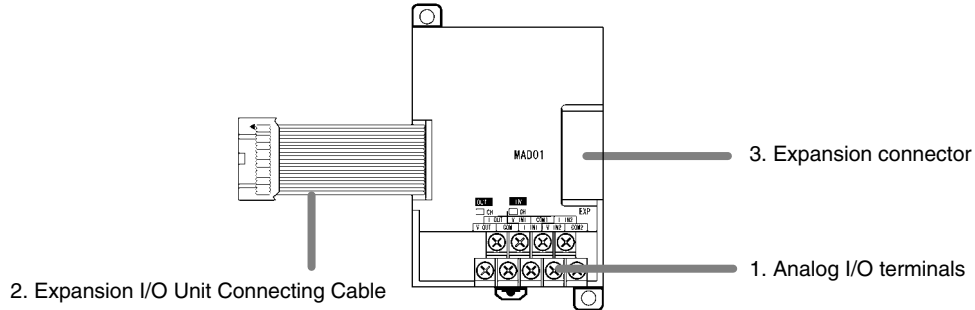

1, 2, 3... 1. Analog I/O Terminals

Connects the Unit to analog input devices and analog output devices.

2. Expansion I/O Unit Connecting Cable

Connects the Analog I/O Unit to the Expansion Connector on the PC's CPU Unit or another Expansion Unit. The cable is connected to the Analog I/O Unit and cannot be removed.



Caution Do not touch the Expansion I/O Unit Connecting Cable while the power is being supplied in order to prevent any malfunction due to static electricity.

3. Expansion Connector

Connects to another Expansion Unit (Expansion I/O Unit, Analog I/O Unit, or CompoBus/S I/O Link Unit). Up to 3 Expansion Units can be connected to a CPU Unit.

CPM1A-MAD11

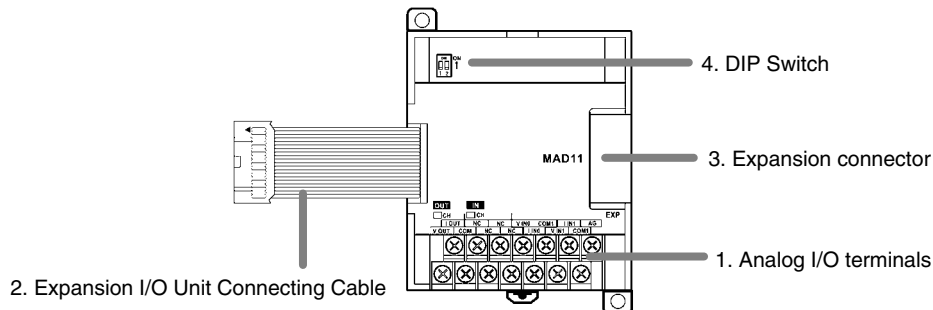

1, 2, 3... 1. Analog I/O Terminals

Connects the Unit to analog input devices and analog output devices.

2. Expansion I/O Unit Connecting Cable

Connects the Analog I/O Unit to the Expansion Connector on the PC's CPU Unit or another Expansion Unit. The cable is connected to the Analog I/O Unit and cannot be removed.



Caution Do not touch the Expansion I/O Unit Connecting Cable while the power is being supplied in order to prevent any malfunction due to static electricity.

3. Expansion Connector

Connects to another Expansion Unit (Expansion I/O Unit, Analog I/O Unit, or CompoBus/S I/O Link Unit). Up to 3 Expansion Units can be connected to a CPU Unit.

- 4. DIP Switch
Used to set averaging processing.

2-2-4 Temperature Sensor Unit Components

The following Temperature Sensor Units are available: CPM1A-TS001, CPM1A-TS002, CPM1A-TS101, and CPM1A-TS102.

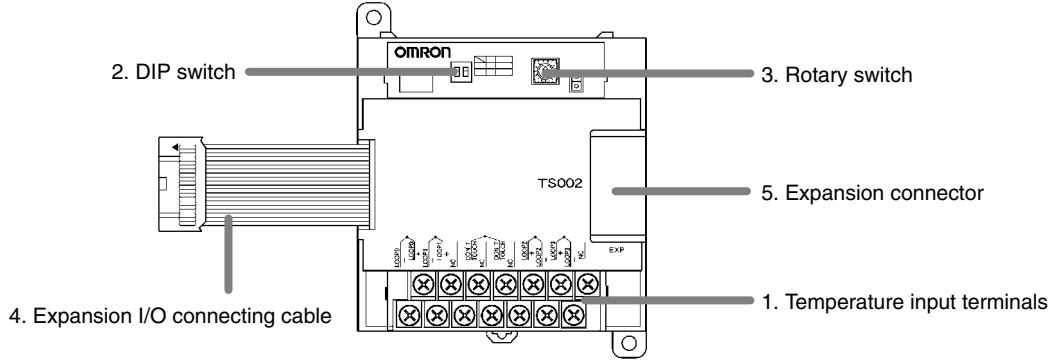

- 1, 2, 3...**
- 1. Temperature Input Terminals
Connect to a thermocouple or a platinum resistance thermometer.
 - 2. DIP Switch
Sets the temperature unit (°C or °F), and the number of decimal places used.

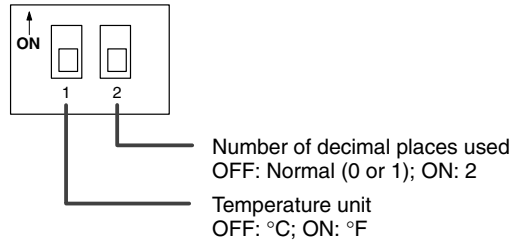

- 3. Rotary Switch
Sets the temperature range. Set the range in accordance with the specifications of the temperature sensor used.

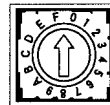

CPM1A-TS001/002

Set value	Thermocouple	Range (°C)	Range (°F)
0	K	-200 to 1,300	-300 to 2,300
1		0.0 to 500.0	0.0 to 900.0
2	J	-100 to 850	-100 to 1,500
3		0.0 to 400.0	0.0 to 750.0
4 to F	---	Setting not possible	

CPM1A-TS101/102

Set value	Platinum resistance thermometer	Range (°C)	Range (°F)
0	Pt100	-200.0 to 650.0	-300.0 to 1,200.0
1	JPt100	-200.0 to 650.0	-300.0 to 1,200.0
2 to F	---	Setting not possible	

4. Expansion I/O Connecting Cable

Connects the Temperature Sensor Unit to the expansion connector on the PC's CPU Unit, an Expansion I/O Unit, or another Expansion Unit. The cable is connected to the Temperature Sensor Unit and cannot be removed.

Caution Do not touch the expansion I/O connecting cable while the power is being supplied in order to prevent any malfunction due to static electricity.

5. Expansion Connector

Connects to an additional Expansion I/O Unit or another Expansion Unit.

2-2-5 CompoBus/S I/O Link Unit Components

The following CompoBus/S I/O Link Unit is available: CPM1A-SRT21.

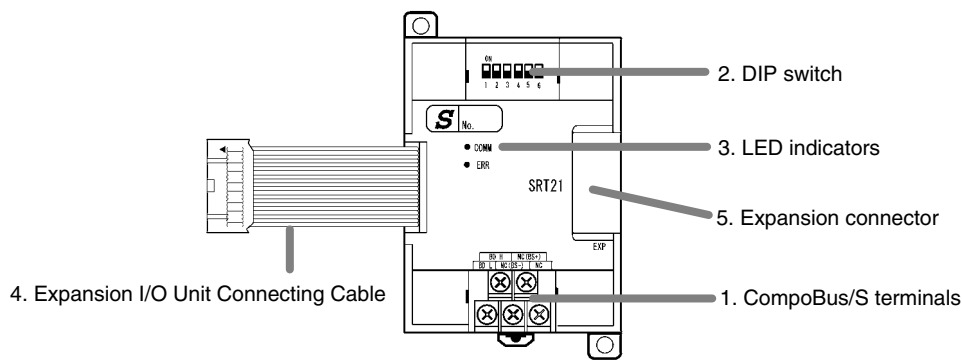

1, 2, 3... 1. CompoBus/S Terminals

Include the CompoBus/S communications data high/low terminal, communications power supply +/- terminals, and NC terminals. Power is supplied to the Unit internally, so the power supply terminals can be used as relay terminals.

2. DIP Switch

The DIP switch sets the Unit's node address, sets the communications mode, and determines whether or not the outputs will be cleared in the event of a communications error.

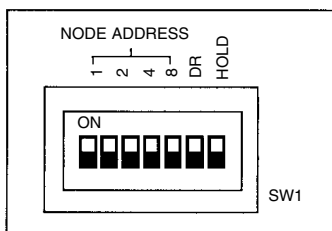

Pin(s)	Function			
1 to 4 (labeled 1, 2, 4, and 8)	These pins set the Unit's node address using the DIP switch pins as binary digits. (1 = ON)			
	0: 0000	1: 0001	2: 0010	3: 0011
	4: 0100	5: 0101	6: 0110	7: 0111
	8: 1000	9: 1001	10: 1010	11: 1011
	12: 1100	13: 1101	14: 1110	15: 1111
DR	ON: Long-distance Communications Mode OFF: High-speed Communications Mode (See note.)			
HOLD	ON: Retain outputs when a communications error occurs. OFF: Clear outputs when a communications error occurs.			

Note The Long-distance Communications Mode can be used only when connected to one of the following Master Units: C200HW-SRM21-V1, CQM1-SRM21-V1, or SRM1-C0□-V2.

3. LED Indicators

These indicators show the status of CompoBus/S communications.

Indicator	Status	Meaning
COMM (yellow)	ON	Communications in progress.
	OFF	Communications error or stopped.
ERR (red)	ON	A communications error has occurred.
	OFF	Indicates normal or no communications.

4. Expansion I/O Unit Connecting Cable

Connects the CompoBus/S I/O Link Unit to the Expansion Connector on the PC's CPU Unit or another Expansion Unit.

Caution Do not touch the Expansion I/O Unit Connecting Cable while the power is being supplied in order to prevent any malfunction due to static electricity.

5. Expansion Connector

Connects to another Expansion Unit (Expansion I/O Unit, Analog I/O Unit, or CompoBus/S I/O Link Unit). Up to 3 Expansion Units can be connected to a CPU Unit.

2-2-6 DeviceNet I/O Link Unit Components

The following DeviceNet I/O Link Unit is available: CPM1A-DRT21.

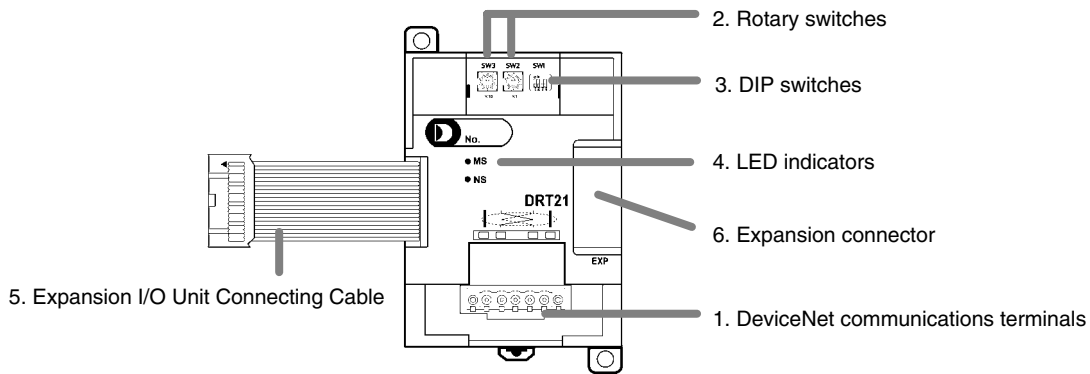

- 1, 2, 3...**
- 1. DeviceNet Communications Terminals**
Connect these terminals to the DeviceNet transmission path. Use either the enclosed connector or another connector for wiring.
 - 2. Rotary Switches (SW2 and SW3)**
The rotary switches are used to set the DeviceNet node address of the Unit between 00 and 64. (Do not set values 64 to 99.)

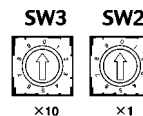

3. DIP Switch (SW1)

The DIP switch sets the baud rate and determines whether or not the outputs will be cleared in the event of a communications error.



Baud Rate Setting

Pin 1	Pin 2	DeviceNet baud rate	Max. transmission path length (reference value)
OFF	OFF	125 kbps	500 m max.
ON	OFF	250 kbps	250 m max.
OFF	ON	500 kbps	100 m max.
ON	ON	Do not set.	

Output Hold Setting

Pin 4	Output treatment for communications errors
OFF	Clear outputs when a communications error occurs.
ON	Retain outputs when a communications error occurs.

4. LED Indicators

Indicator	Color	Status	Definition	Meaning
MS	Green	ON	Device Operational	Normal operating status.
		Flashing	Device in Standby	Reading switch settings.
	Red	ON	Unrecoverable Fault	Unit hardware error: Watchdog timer error
		Flashing	Minor Fault	Switch settings incorrect, etc.
	---	OFF	No Power	Power isn't being supplied, waiting for initial processing, or Unit is being reset.
NS	Green	ON	On-line, Connected.	Network is operating normally (communications established)
		Flashing	On-line, Not Connected	Network is operating normally, but communications are not yet established.
	Red	ON	Fatal Communications Error	A fatal communications error has occurred. Network communications are not possible. Check for a node address duplication or Bus Off error.
		Flashing	Non-fatal communications error	Communications timeout or communications error for some of the slaves.
	---	OFF	Not Powered/ Not On-Line	Checking for node address duplication on the master, switch settings are incorrect, or the power supply is OFF.

5. Expansion I/O Unit Connecting Cable

Connects the DeviceNet I/O Link Unit to the Expansion Connector on the PC's CPU Unit or another Expansion Unit. This cable cannot be removed.



Caution Do not touch the Expansion I/O Unit Connecting Cable while the power is being supplied in order to prevent any malfunction due to static electricity.

6. Expansion Connector

Connects to another Expansion Unit or Expansion I/O Unit

2-2-7 Communications Adapter Components

CPM1-CIF01 RS-232C Adapter

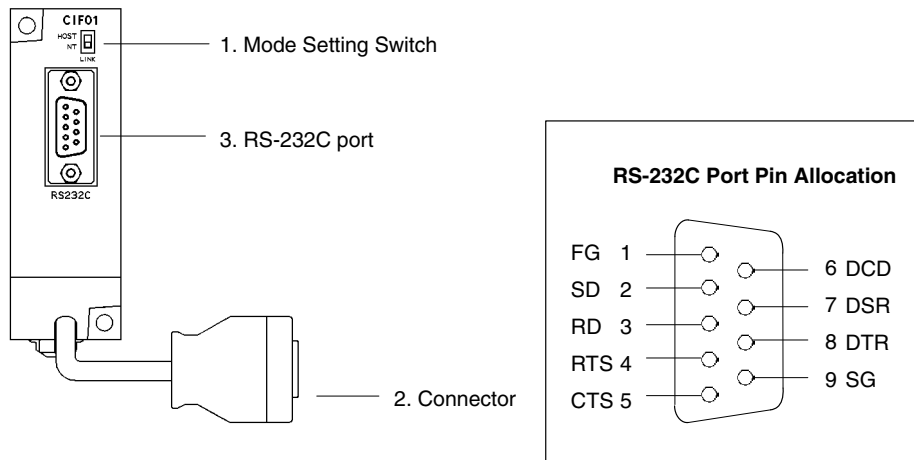

- 1, 2, 3...**
1. Mode Setting Switch
Set this switch to “HOST” when using a Host Link system to connect to a personal computer. Set this switch to “NT” when connecting to a Programmable Terminal or PC for 1:1 PC Link.
 2. Connector
Connects to the CPU Unit’s Peripheral Port.
 3. RS-232C Port
Connects to the RS-232C cable from the other device such as a personal computer, Peripheral Device, or Programmable Terminal.

CPM1-CIF11 RS-422 Adapter

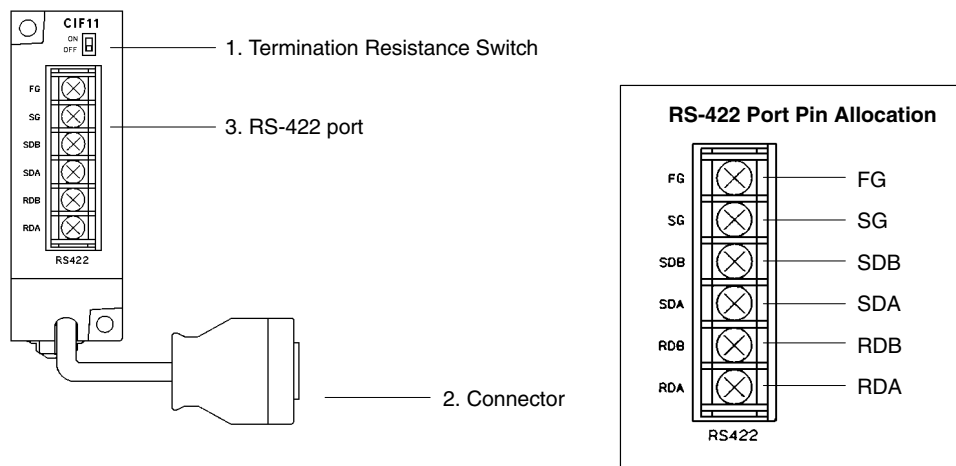

- 1, 2, 3...**
1. Termination Resistance Switch
Set the termination resistance switch to “ON” (upper side) for the Link Adapters on both ends of the Host Link system and for the RS-422 Adapter.
 2. Connector
Connects to the CPU Unit’s Peripheral Port.
 3. RS-422 Port
Connects to the Host Link network.

SECTION 3

Installation and Wiring

This section provides information on installing and wiring a CPM1A PC. Be sure to follow the directions and precautions in this section when installing the CPM1A in a panel or cabinet, wiring the power supply, or wiring I/O.

3-1	Design Precautions	42
3-1-1	Power Supply Wiring	42
3-1-2	Interlock and Limit Circuits	42
3-1-3	Power Supply Voltage	42
3-1-4	CPM1A Power Interruptions	42
3-2	Selecting an Installation Site	43
3-2-1	Installation Site Conditions	43
3-2-2	Panel/Cabinet Installation	44
3-3	Installing the CPM1A	45
3-3-1	CPM1A Orientation	45
3-3-2	CPM1A Installation	45
3-3-3	Connecting an Expansion I/O Unit	47
3-4	Wiring and Connections	50
3-4-1	General Precautions for Wiring	50
3-4-2	Ground Wiring	51
3-4-3	Power Supply Wiring	52
3-4-4	Input Wiring	55
3-4-5	Output Wiring	61
3-4-6	Peripheral Device Connection	69
3-4-7	Host Link Connections	69
3-4-8	One-to-one PC Link Connections	72
3-4-9	One-to-one NT Link Connections	73
3-4-10	CompoBus/S I/O Link Unit Connections	74
3-4-11	DeviceNet I/O Link Unit Connections	75

3-1 Design Precautions

Observe the following precautions when designing a system incorporating a CPM1A PC.

3-1-1 Power Supply Wiring

Separate the power supply wiring from the control system, CPM1A system, and DC I/O system wiring. Separate the control circuits that supply power to the main Unit from the main circuits using dedicated circuit protectors and fuses.

3-1-2 Interlock and Limit Circuits

! WARNING Emergency stop circuits, interlock circuits, limit circuits, and similar safety measures must be provided in external control circuits (i.e., not in the Programmable Controller) to ensure safety in the system if an abnormality occurs due to malfunction of the PC or another external factor affecting the PC operation. Not providing proper safety measures may result in serious accidents.

Construct an external interlock circuit if CPM1A outputs are used to perform reciprocal operations such as controlling the forward and reverse operation of a motor or if incorrect PC operation could cause accidents or mechanical damage. Also, construct an external limit circuit to prevent run-away movement in systems such as position control.

The following diagram shows an example of an interlock circuit.

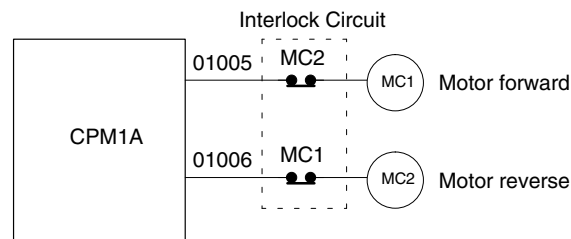

In the interlock circuit above, MC1 and MC2 can't be ON at the same time even if CPM1A outputs 01005 and 01006 are both ON (an incorrect PC operation).

3-1-3 Power Supply Voltage

! Caution Use the power supply voltages indicated in *Section 2 Unit Specifications and Components*. Failure to adhere to the specifications may result in fire. In places where power supply conditions are poor, take steps to ensure that power is supplied at the rated voltage. Be sure to adhere to safety precautions, such as providing breakers to prevent short circuits in external wiring. When conducting any of the following operations, turn OFF the power to the PC. Electric shock, product damage and malfunction may result.

- Connecting or disconnecting Expansion I/O Units and CPU Units.
- Assembling Units
- Connecting cables and wiring.

3-1-4 CPM1A Power Interruptions

Supply Voltage Drop

When the supply voltage falls below 85% of the rated value, the PC will stop and the outputs will go OFF.

Momentary Power Failure Detection

A momentary power failure lasting less than 10 ms with an AC power supply and 2 ms with a DC power supply is not detected and the CPU Unit continues to operate.

A momentary power failure lasting longer than 10 ms with an AC power supply and 2 ms with a DC power supply may or may not be detected in an uncertain area.

When a momentary power failure is detected, the CPU Unit stops operating and the output goes OFF.

Automatic Restart

When the supply voltage recovers to a value higher than 85% of the rated value, operations resumes automatically.



Note The CPM1A may repeat stop/start operations if the supply voltage of less than 85% of the rated value gradually goes up or down. If this affects the equipment, etc., provide a protection circuit which shuts off the output if the supply voltage is not above the rated value.

Time Up to the Start of Operation

The time from when the power supply is turned on to when the operation starts varies depending on the operation conditions such as power supply voltage, configuration, ambient temperature, etc. The minimum time is approximately 300 ms.

3-2 Selecting an Installation Site

The CPM1A is resistant to harsh conditions and highly reliable, but installing the PC in a favorable site will maximize its reliability and operating lifetime.

 **Caution** Be sure to install the CPM1A correctly, as outlined in this manual. Failure to do so may result in Unit malfunction.

3-2-1 Installation Site Conditions

Note Do not install the CPM1A under any of the following conditions.

- Locations subject to direct sunlight.
- Locations subject to a temperature below 0°C or over 55°C.
- Locations subject to a humidity below 10% or over 90%.
- Locations subject to condensation as the result of severe changes in temperature.
- Locations subject to corrosive or flammable gases.
- Locations subject to dust (especially iron dust) or salts.
- Locations subject to shock or vibration.
- Locations subject to exposure to water, oil, or chemicals.

Be sure that the conditions at the installation site conform to the CPM1A's general specifications. Refer to 2-1-1 *General Specifications* for details.

Note Provide proper shielding when installing in the following locations:

- Locations subject to static electricity or other sources of noise.
- Locations subject to strong electromagnetic fields.
- Locations subject to possible exposure to radiation.
- Locations near to power supply lines.

3-2-2 Panel/Cabinet Installation

Consider PC operation, maintenance, and surrounding conditions when installing the CPM1A in a panel or cabinet.

Overheating

The operating temperature range for the CPM1A is 0°C to 55°C. Be sure that there is adequate ventilation for cooling.

- Allow enough space for air circulation.
- Do not install the CPM1A above equipment that generates a large amount of heat, such as heaters, transformers, or large resistors.
- Install a cooling fan or system when the ambient temperature exceeds 55°C.

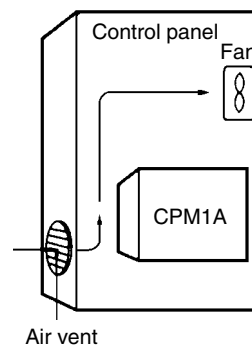

Electrical Noise

Power lines and high-voltage equipment can cause electrical noise in the PC.

- Do not install the CPM1A in a panel or cabinet with high-voltage equipment.
- Allow at least 200 mm between the CPM1A and nearby power lines.

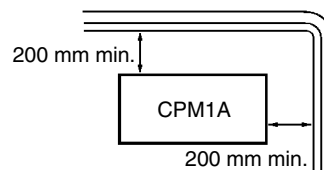

Accessibility

Ensure that the CPM1A can be accessed for normal operation and maintenance.

- Provide a clear path to the CPM1A for operation and maintenance. High-voltage equipment or power lines could be dangerous if they are in the way during routine operations.
- The PC will be easiest to access if the panel or cabinet is installed about 3 to 5 feet off of the floor.

3-3 Installing the CPM1A

3-3-1 CPM1A Orientation

The CPM1A must be installed in the position shown below to ensure adequate cooling.

Correct

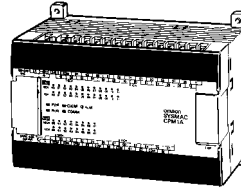

Do not install the CPM1A in either of the following positions.

Incorrect

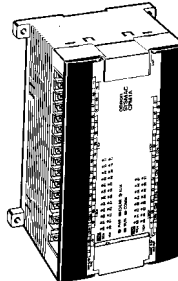

Incorrect

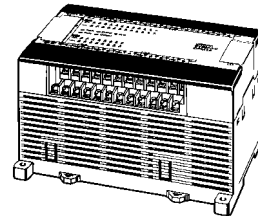

3-3-2 CPM1A Installation

The CPM1A can be installed on a horizontal surface or on a DIN track.

Surface Installation

Use the following pattern when installing a CPM1A on a horizontal surface.

**CPM1A-10CDR-□(-V1)/10CDT-□(-V1)/10CDT1-□(-V1) and
CPM1A-20CDR-□(-V1)/20CDT-□(-V1)/20CDT1-□(-V1)**

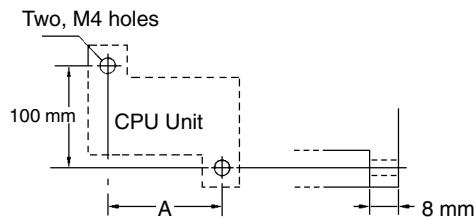

Use M4 dia. x 15 screws.

The width (A) between the mounting holes depends on the CPM1A model.

Model number	Width (A)
CPM1A-10CDR-□(-V1)/10CDT-□(-V1)/10CDT1-□(-V1) CPU Unit	56 mm
CPM1A-20CDR-□(-V1)/20CDT-□(-V1)/20CDT1-□(-V1) CPU Unit	76 mm

Allow 10 to 15 mm between the Units when installing a Communications Adapter next to the CPU Unit, as shown below.

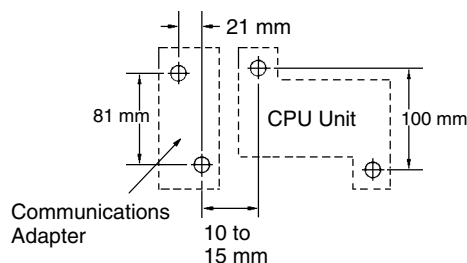

**CPM1A-30CDR-□(-V1)/30CDT-□(-V1)/30CDT1-□(-V1) and
CPM1A-40CDR-□(-V1)/40CDT-□(-V1)/40CDT1-□(-V1)**

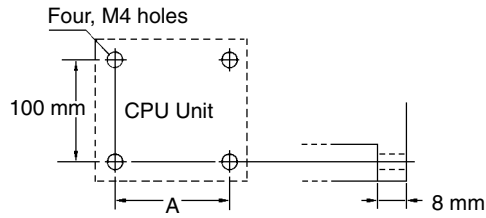

Use M4 dia. x 15 screws.

The width (A) between the mounting holes depends on the CPM1A model.

Model number		Width (A)
CPM1A-30CDR-□(-V1)/30CDT-□(-V1)/30CDT1-□(-V1) CPU Units		120 mm
CPM1A-40CDR-□(-V1)/40CDT-□(-V1)/40CDT1-□(-V1) CPU Units		140 mm
Expansion I/O Units	CPM1A-20ED□	76 mm
	CPM1A-8E□	56 mm
Analog I/O Unit	CPM1A-MAD01	56 mm
	CPM1A-MAD11	76 mm
CompoBus/S I/O Link Unit		56 mm
DeviceNet I/O Link Unit		56 mm
RS-232C Adapter		21 mm
RS-422 Adapter		21 mm
Temperature Sensor Unit		76 mm

Allow 10 to 15 mm between the Units when installing an Expansion Unit, Expansion I/O Unit, or Communications Adapter next to the CPU Unit, as shown below.

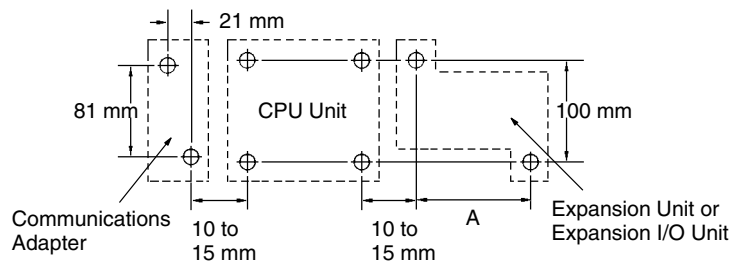

DIN Track Installation

The CPM1A can be installed on a 35-mm DIN Track.

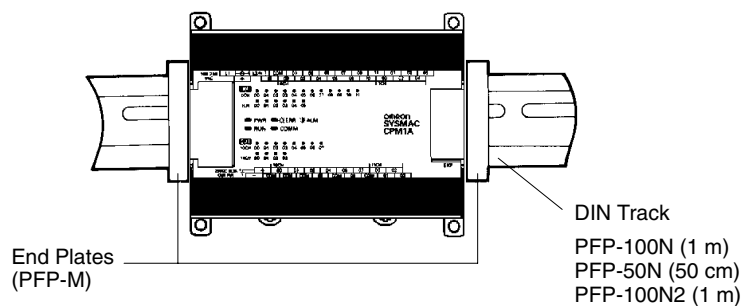

Installation

Lower the CPM1A so that the notch on the back of the PC catches the top of the DIN Track. Push the PC forward until the lock snaps into place.

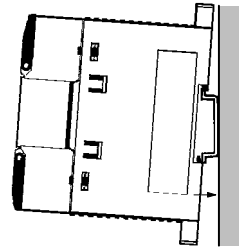

Removal

Pry the lock down with a standard screwdriver and pivot the PC upward to remove it.

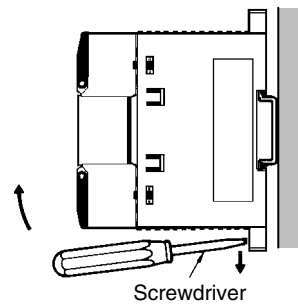

3-3-3 Connecting an Expansion I/O Unit

Up to 3 Expansion I/O Units can be connected to the CPM1A-30CDR-□(-V1)/30CDT-□(-V1)/30CDT1-□(-V1) and CPM1A-40CDR-□(-V1)/40CDT-□(-V1)/40CDT1-□(-V1) CPU Units. Use the following procedure when connecting an Expansion I/O Unit.

V1 Units

- 1, 2, 3... 1. Remove the cover from the CPU Unit's Expansion I/O Unit Connector. Insert a flat-blade screwdriver into the slot on the cover and press down lightly on the handle of the screwdriver to remove it from the case.

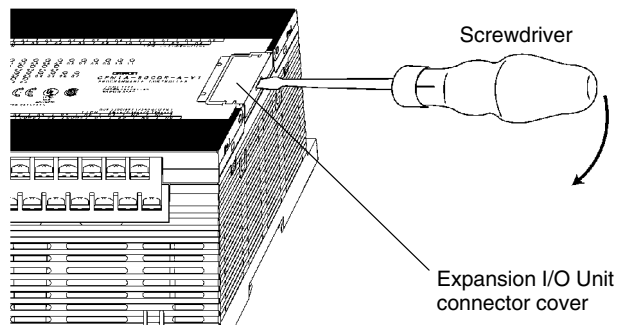

2. Insert the Expansion I/O Unit's Connecting Cable into the CPU Unit's Expansion I/O Unit Connector.

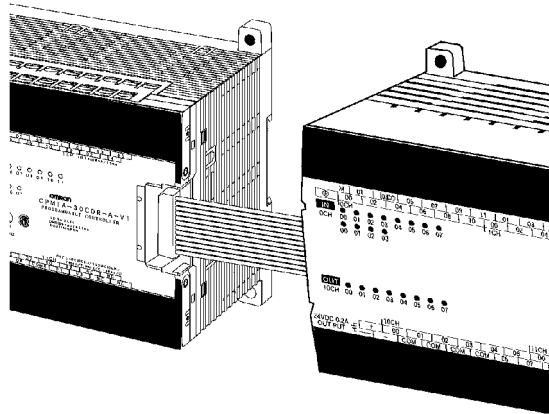

3. Attach the cover to the CPU Unit's Expansion I/O Unit Connector by inserting the two pins on the inside of the cover into the holes on the case and pressing downward lightly and evenly.

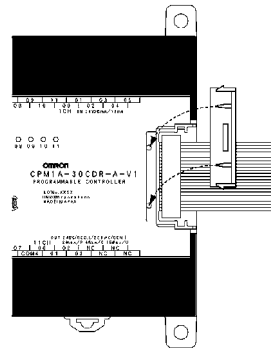

4. When the pins are part way into the holes, press down on points (a) and (b) in the following diagram alternately and firmly until the cover is securely in place.

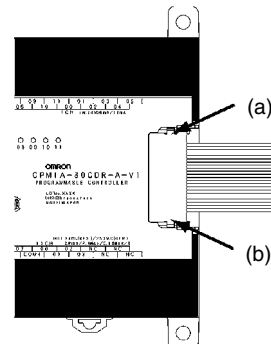

Pre-V1 Units

- 1, 2, 3... 1. Remove the cover from the CPU Unit's or the Expansion I/O Unit's Expansion I/O Unit Connector. Use a flat-blade screwdriver to remove the cover from the Expansion I/O Connector.

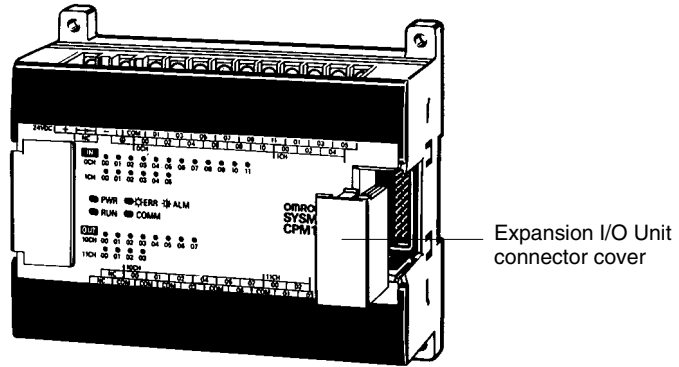

2. Insert the Expansion I/O Unit's Connecting Cable into the CPU Unit's or the Expansion I/O Unit's Expansion I/O Unit Connector.

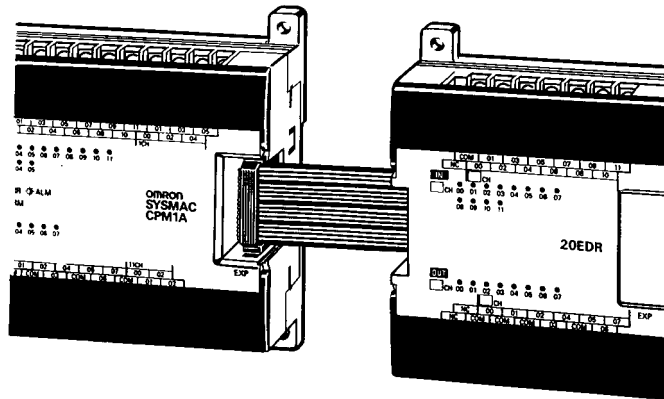

3. Replace the cover on the CPU Unit's or the Expansion I/O Unit's Expansion I/O Unit Connector.

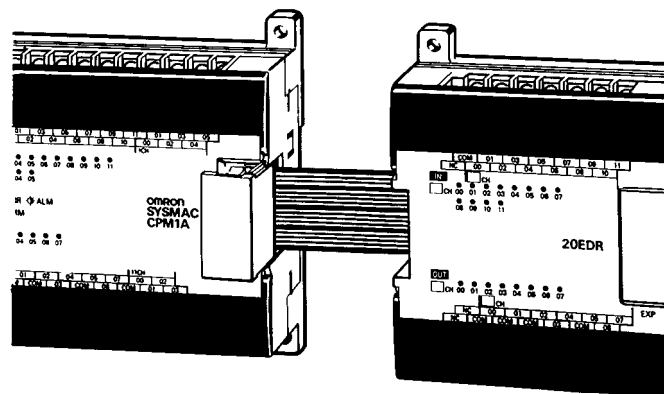

3-4 Wiring and Connections

This section provides basic information on wiring the Power Supply Unit and Expansion I/O Units, and on connecting Peripheral Devices.

3-4-1 General Precautions for Wiring

Caution With pre-V1 Units, attach the dustproof label provided before wiring. With V1 Units, leave the dustproof label in place while wiring. If scraps of wire get inside the Unit, malfunction will result. After completing wiring be sure to remove the label to avoid overheating.

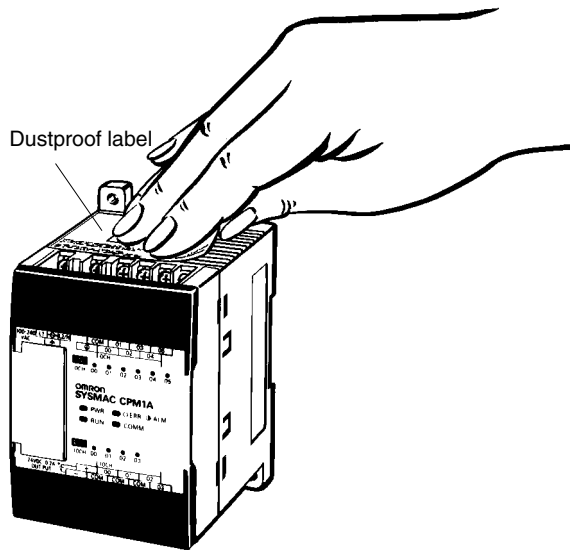

I/O Line Noise

Do not run CPM1A I/O lines in the same duct or conduit as power lines.

Hanging Ducts

Leave at least 300 mm between the power cables and the I/O or control wiring, as shown in the following diagram.

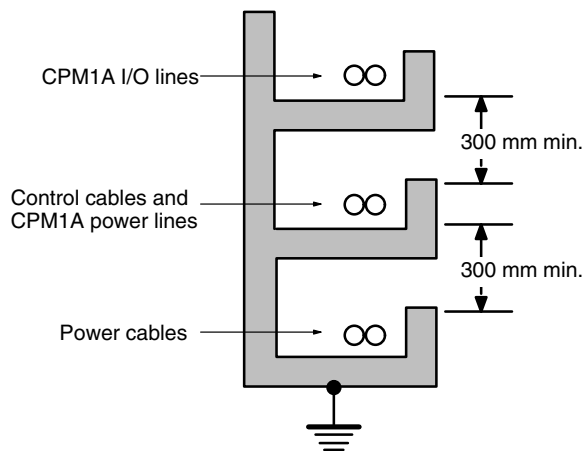

Floor Ducts

Leave at least 200 mm between the wiring and the top of the duct, as shown in the following diagram.

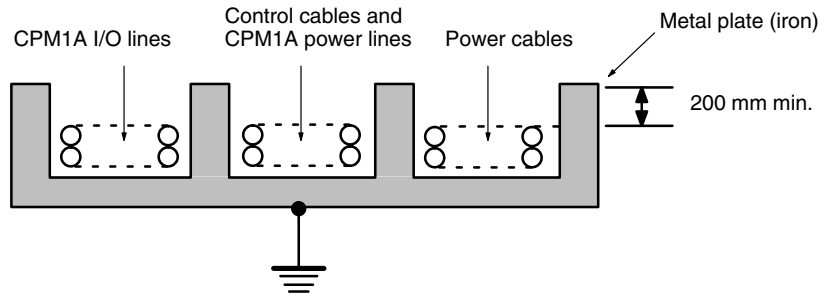

Conduits

Separate the CPM1A I/O lines, power and control lines, and power cables, as shown in the following diagram.

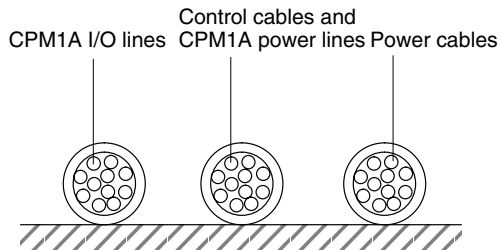

3-4-2 Ground Wiring

Grounding

Be sure to ground the earth terminal to less than 100 Ω in order to protect against electric shock and incorrect operation from electrical noise. Be sure to use a wire of at least 1.25 mm² for grounding.

⚠ WARNING During installation, be sure to ground to 100 Ω max in order to protect against electric shock.

Units with AC Power

V1 Units

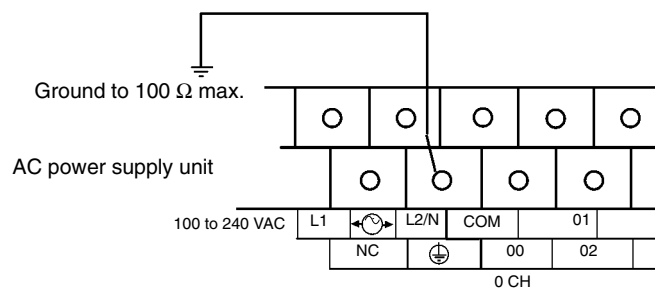

Pre-V1 Units

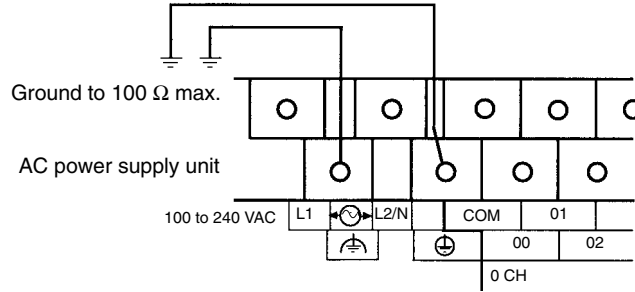

Note Disconnect the functional earth terminal before conducting withstand voltage test on pre-V1 Units.

Units with DC Power

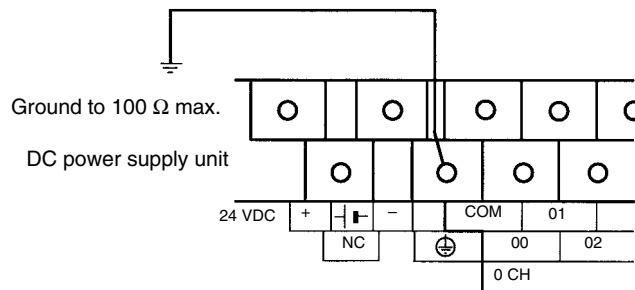

Note The NC terminal is not used.

Caution Disconnect the functional earth terminal when performing withstand voltage tests. Not disconnecting the functional earth terminal may result in burning.

Crimp Connectors

Caution Always use crimp connectors for the CPM1A's power lines and I/O lines or else use a solid wire (instead of a stranded wire). Do not connect bare stranded wires directly to terminals. Bare stranded wires connected directly to the terminal can cause a fire.

Use M3 terminal screws and tighten the screws securely (0.5 N • m).

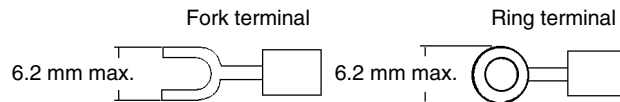

The recommended wire size for solid wires is 0.4 to 1.2 mm (AWG26 to AWG18).

3-4-3 Power Supply Wiring

100- to 240-VAC Power Supply

Wire a separate circuit for the CPM1A's power supply circuit so that there isn't a voltage drop from the inrush current that flows when other equipment is turned on.

When several CPM1A PCs are being used, it is recommended to wire the PCs on separate circuits to prevent a voltage drop from the inrush current or incorrect operation of the circuit breaker.

Use twisted power supply wires to prevent noise from the power supply lines. Adding a 1:1 isolating transformer reduces electrical noise even further.

Considering the possibility of voltage drops and the allowable current, be sure to use thick power lines.

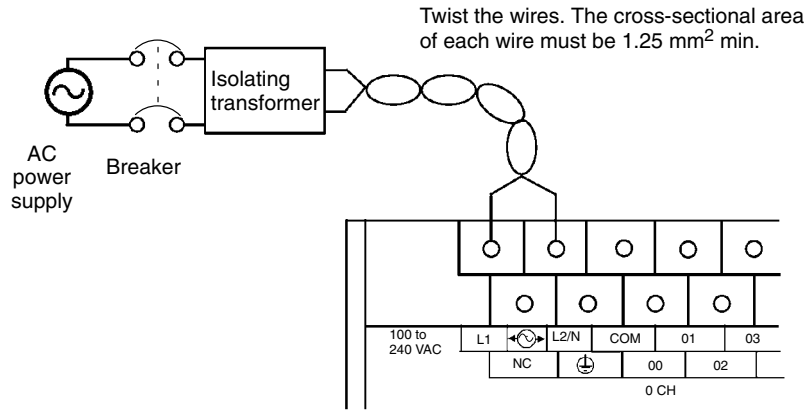

- Note**
1. Before connecting the power supply, make sure that the CPU Unit requires an AC power supply and not a DC power supply. The CPU Unit's internal circuitry will be damaged if AC power is mistakenly supplied to a CPU Unit that requires a DC power supply.
 2. The power supply input terminals are at the top of the CPU Unit; the terminals at the bottom of the CPU Unit output 24-VDC power for external devices. The CPU Unit's internal circuitry will be damaged if AC power is mistakenly supplied to a CPU Unit's power supply output terminals.

Crimp Connectors

Caution Always use crimp connectors for the CPM1A's power lines. Do not connect bare stranded wires directly to terminals. Bare stranded wires connected directly to the terminal can cause a fire.

Use M3 terminal screws.

Connect a crimp connector with a ring terminal to each terminal screw.

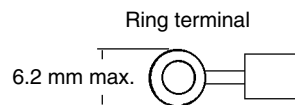

Caution Tighten the terminal block screws of the AC Power Supply to the torque of 0.5 N • m. Loose screws may result in burning or malfunction.

24-VDC Power Supply

Use a DC power supply with sufficient capacity and low ripple. For a DC power supply used for the transistor output, use a power supply with double insulation or reinforced insulation to conform to the EC Directives (Low-voltage Directives). The NC terminal is not used.

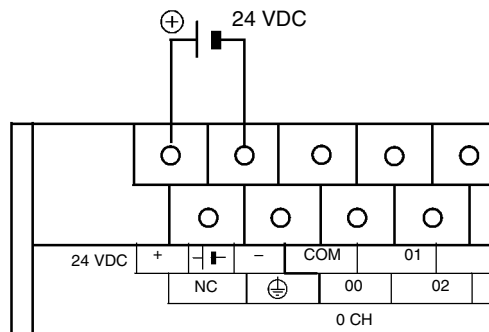

Caution Do not perform a withstand voltage test on a CPU Unit with a DC power supply. The test might damage the PC's internal components.

- Note**
1. Do not conduct a withstand voltage test for the power supply section of the CPU Unit with a DC power supply. Doing so may damage internal elements.
 2. Reinforced insulation or double insulation must be used for a DC power supply to conform to the EC Directives (Low Voltage Directive).

Crimp Connectors

Caution Always use crimp connectors for the CPM1A's power lines and I/O lines or else use a solid wire (instead of a stranded wire). Do not connect bare stranded wires directly to terminals. Bare stranded wires connected directly to the terminal can cause a fire.

Use M3 terminal screws and tighten the screws securely (0.5 N • m).

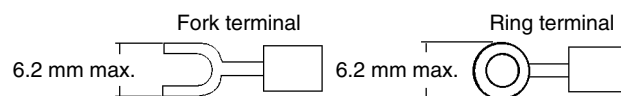

The recommended wire size for solid wires is 0.4 to 1.2 mm (AWG26 to AWG18).

3-4-4 Input Wiring

Wire the inputs to the CPM1A's CPU Unit and Expansion I/O Unit as shown in the following diagrams. Use crimp connectors or solid wire (not stranded wire) to connect to the PC. Do not apply voltages exceeding the rated input voltage to the input terminals. The power supply output terminals can be used with AC-type CPU Units.

Input Configuration

The following diagrams show the input configurations.

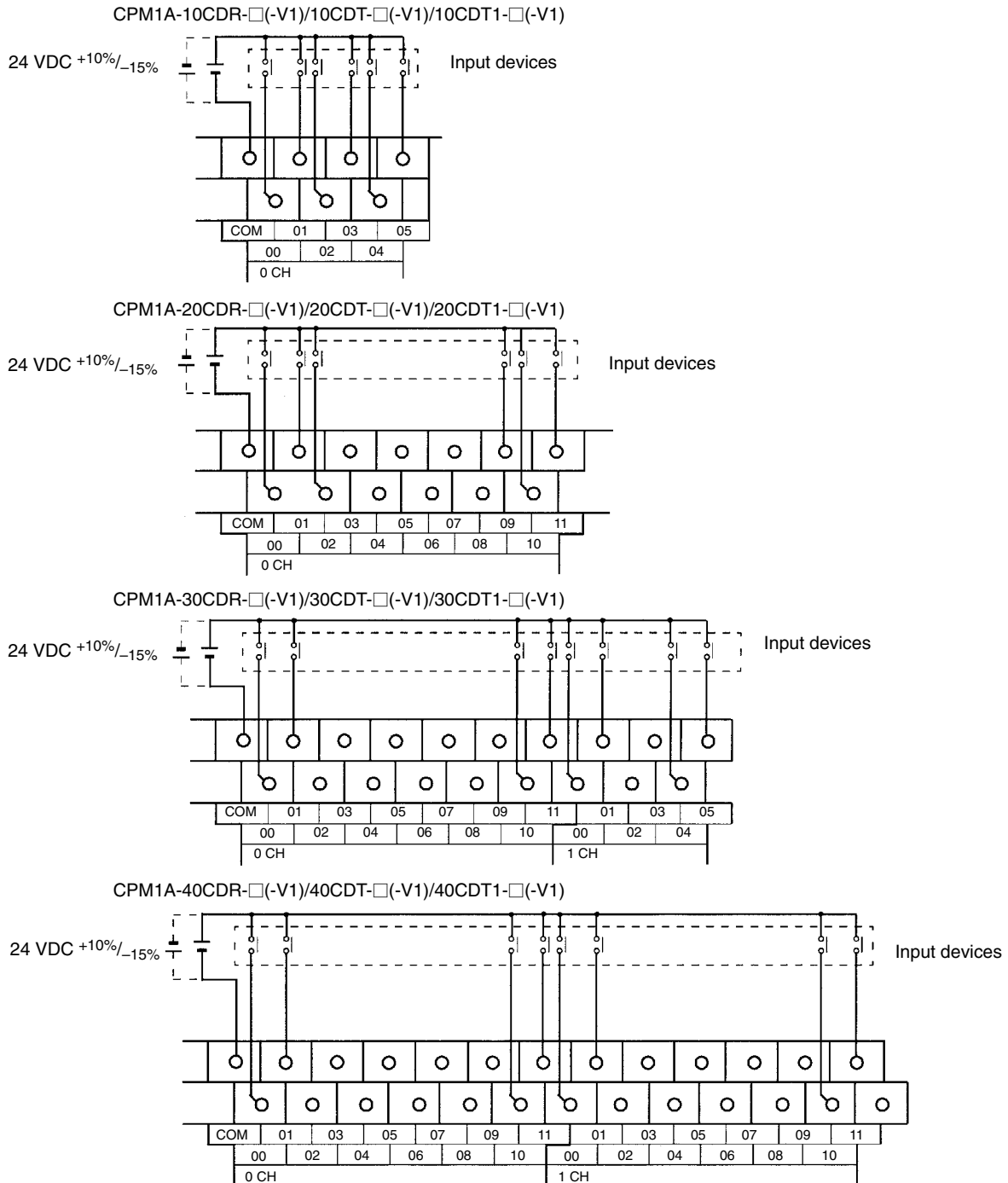

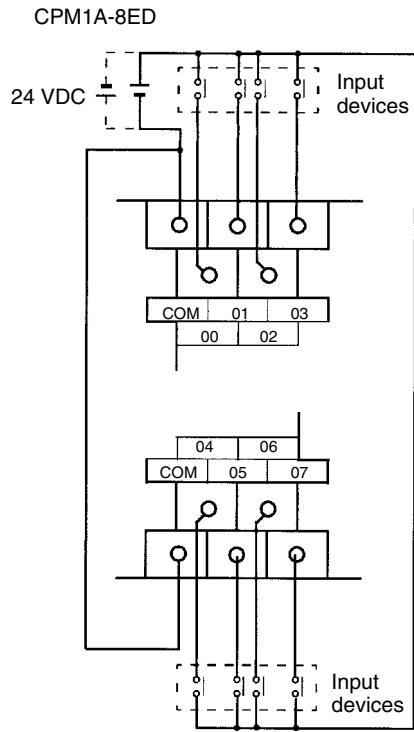

Note Although the COM terminals are internally connected, be sure to wire them externally as well.

CPM1A-20EDR/20EDR1/EDT/EDT1

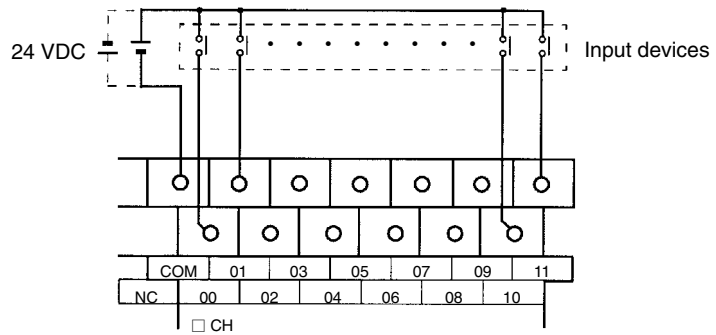

Input Wiring Example

An AC-type CPU Unit is shown. DC-type CPU Units don't have power supply outputs.

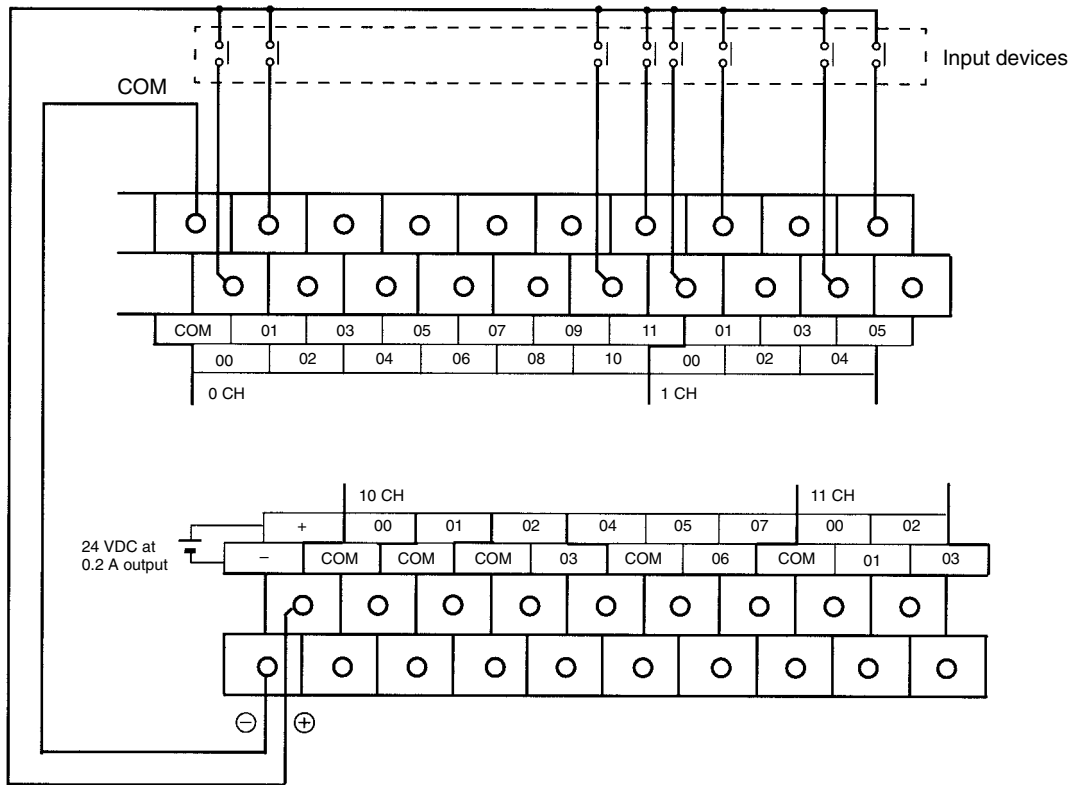

External power supply:
 24 VDC at 200 mA/10-point and 20-point I/O type CPU Units
 24 VDC at 300 mA/30-point and 40-point I/O type CPU Units
 (Applicable to CPU Units with a power supply of 100 to 240 VAC.)

⚠ WARNING When the 24-VDC output (service power supply to the PC) is overloaded or short-circuited, the voltage may drop and result in the outputs being turned OFF. External safety measures must be provided to ensure safety in the system. Not providing proper safety measures may result in serious accidents.

Input Devices

The following table shows how to connect various input devices.

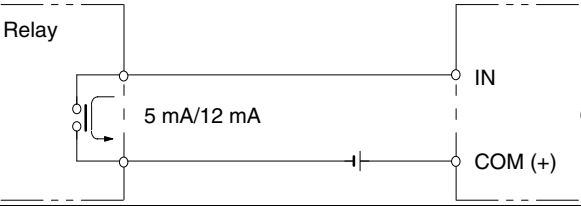
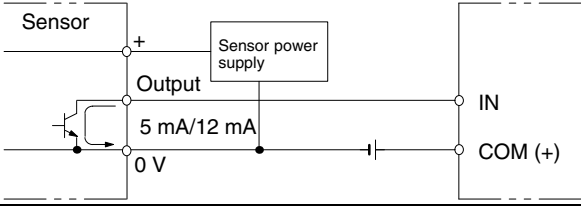
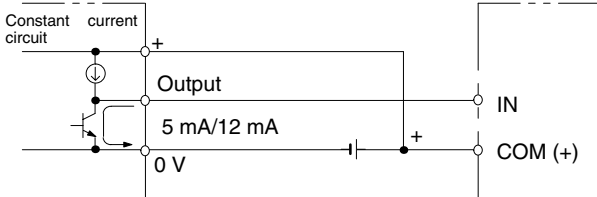
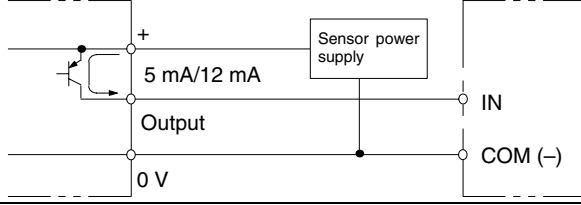
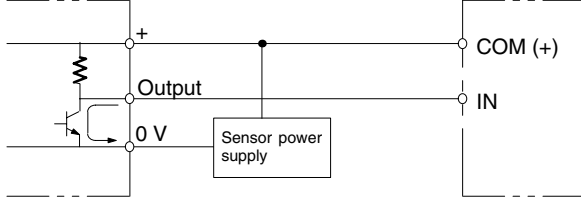
Device	Circuit diagram
Relay output	
NPN open collector	
NPN current output	<p data-bbox="1034 642 1326 688">Use the same power supply for the input and sensor.</p> 
PNP current output	
Voltage output	

Leakage Current (24 VDC)

A leakage current can cause false inputs when using 2-wire sensors (proximity switches or photoelectric switches) or limit switches with LEDs.

False inputs won't occur if the leakage current is less than 1.0 mA (2.5 mA for IN00000 to IN00002), but if the leakage current exceeds these values, insert a bleeder resistor in the circuit to reduce the input impedance, as shown in the following diagram.

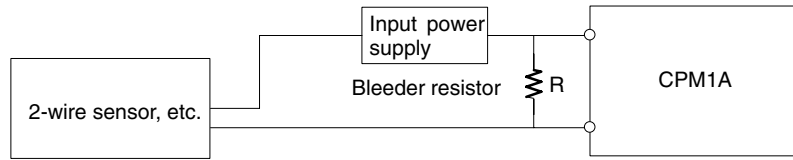

I: Device's leakage current (mA)
 R: Bleeder resistance (kΩ)
 W: Bleeder resistor's power rating (W)
 L_C: CPM1A's input impedance (kΩ)
 I_C: CPM1A's input current (mA)
 E_C: CPM1A's OFF voltage (V) = 5.0 V

$$R = \frac{L_C \times 5.0}{I \times L_C - 5.0} \text{ k}\Omega \text{ max.} \quad W = \frac{2.3}{R} \text{ W min.}$$

The equations above were derived from the following equations:

$$I \times \frac{R \times \frac{\text{Input voltage (24)}}{\text{Input Current (I}_C)}}{R + \frac{\text{Input voltage (24)}}{\text{Input Current (I}_C)}} \leq \text{OFF voltage (E}_C : 5.0)$$

$$W \geq \frac{\text{Input voltage (24)}}{R} \times \text{Input voltage (24)} \times \text{tolerance (4)}$$

Refer to 2-1-3 I/O Specifications for details on the values L_C, I_C, and E_C. The input impedance, input current, and OFF voltage may vary depending on the input being used. (IN00000 through IN00002 have different values.)

Sensor Surge Current

If a sensor power supply is turned ON when the PC is ON and ready to receive inputs, surge current from the sensor may result in an incorrect input. To prevent improper operation, use the following type of programming in the ladder program to delay accepting inputs from a sensor from when the sensor is turned ON until the sensor reaches stable operation.

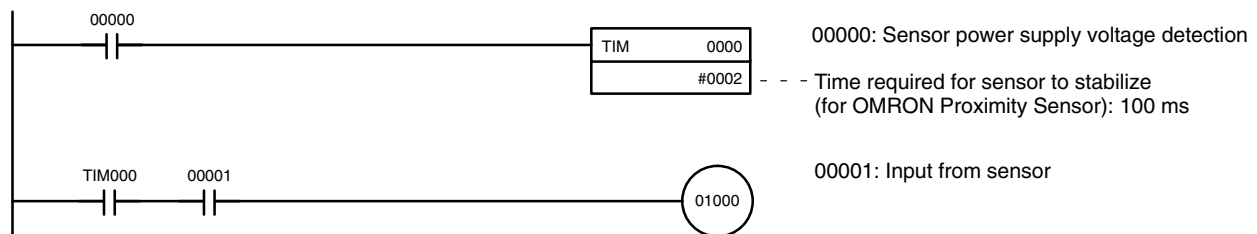

Note The SV of TIM 000 can be set to #0001 (0.1 s) to achieve a delay time of 100 ms, but the timer accuracy is 0 to 0.1 s, meaning that the timer's Completion Flag may turn ON immediately after the timer input. The SV must thus be set to #0002 (0.2 s) or higher to allow for timer accuracy.

Inductive Loads

When connecting an inductive load to an input, connect a diode in parallel with the load. The diode should satisfy the following requirements:

- 1, 2, 3... 1. Peak reverse-breakdown voltage must be at least 3 times the load voltage.

2. Average rectified current must be 1 A.

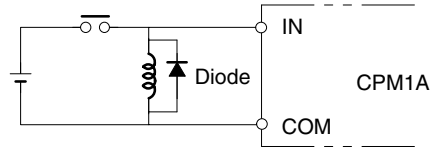

Crimp Connectors



Caution

Always use crimp connectors for the CPM1A's power lines and I/O lines or else use a solid wire (instead of a stranded wire). Do not connect bare stranded wires directly to terminals. Bare stranded wires connected directly to the terminal can cause a fire.

Use M3 terminal screws and tighten the screws securely (0.5 N • m).

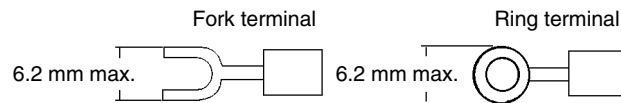

The recommended wire size for solid wires is 0.4 to 1.2 mm (AWG26 to AWG18).

3-4-5 Output Wiring

Relay Output Wiring

Wire the outputs to the CPM1A's CPU Unit and Expansion I/O Unit as shown in the following diagrams. Use crimp connectors or solid wire (not stranded wire) to connect to the PC. The power supply output terminals can be used with AC-type CPU Units.

- Always use solid wire or attach crimp connectors if a stranded wire is used.
- Do not connect loads or apply voltages exceeding the maximum switching capacity to the output terminals.
- Don't exceed the output capacity or the maximum common current. Refer to *2-1-3 I/O Specifications* for details.
- Each common terminal is separated from one another for each group of output terminals.

Item	Specification
Output capacity	2 A (250 VAC or 24 VDC)
Max. common capacity	4 A/common

 **WARNING** The PC outputs may remain ON or OFF due to deposition or burning of the output relays or destruction of the output transistors. External safety measures must be provided to ensure safety in the system. Not providing proper safety measures may result in serious accidents.

Output Configurations

CPM1A-10CDR-□(-V1)

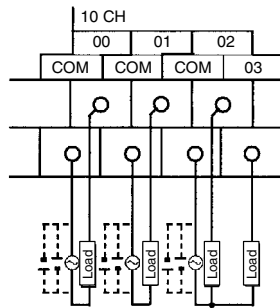

CPM1A-20CDR-□(-V1)/CPM1A-20EDR/20EDR1

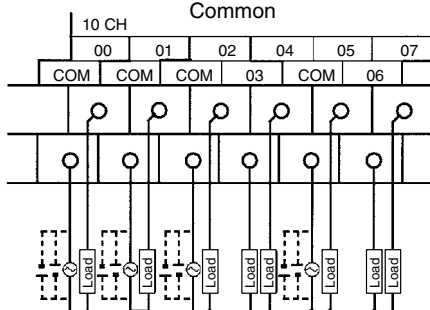

CPM1A-30CDR-□(-V1)

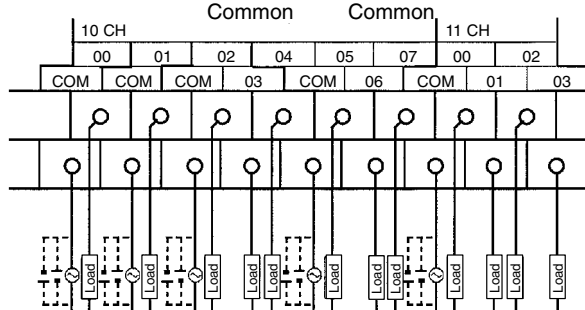

CPM1A-40CDR-□(-V1)

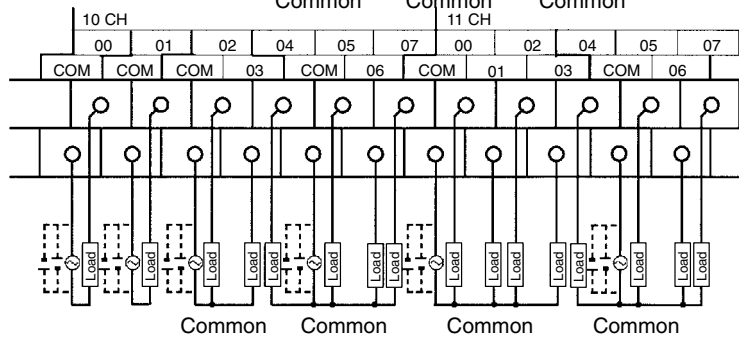

CPM1A-8ER

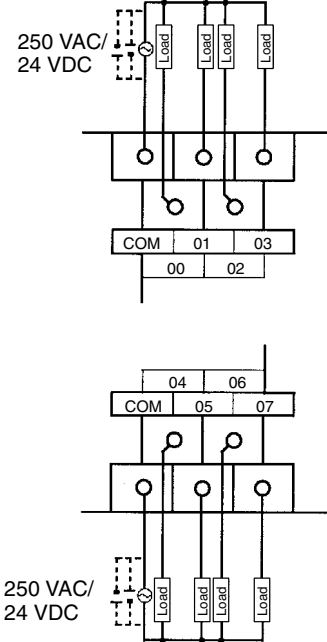

Transistor Output Wiring (Sinking Outputs)

Wire the outputs to the CPM1A's CPU Unit and Expansion I/O Unit as shown in the following diagrams.

- Always use solid wire or attach crimp connectors if a stranded wire is used.
- Don't exceed the output capacity or the maximum common current. Refer to 2-1-3 I/O Specifications for details.

Item	Specification
Output capacity	300 mA (24 VDC)
Max. common capacity	0.9 A/common

Output Configurations

CPM1A-10CDT-□(-V1)

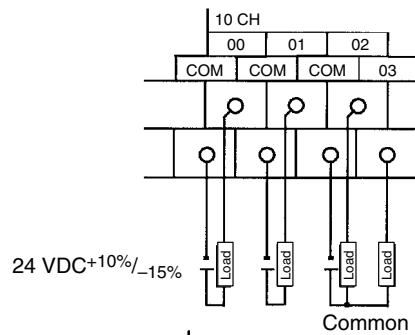

CPM1A-20CDT-□(-V1)/CPM1A-20EDT

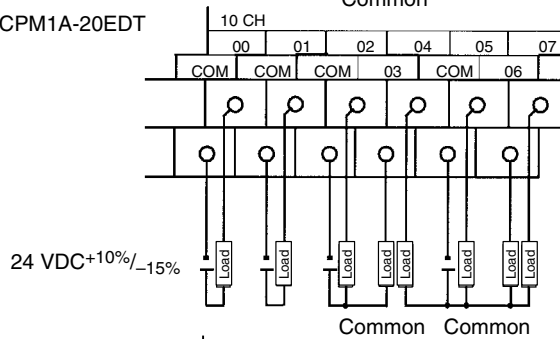

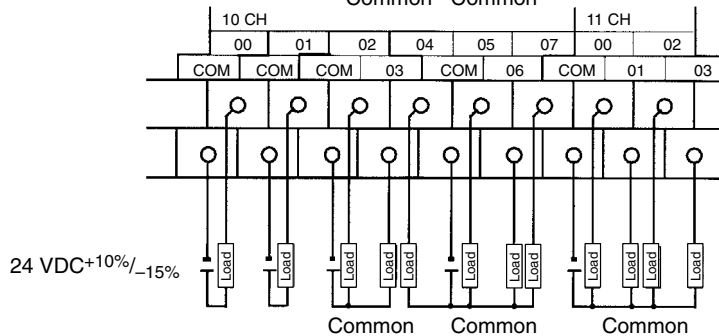

CPM1A-30CDT-□(-V1)

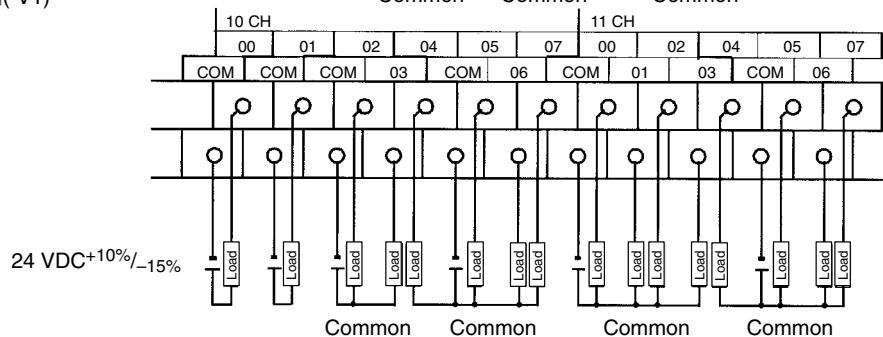

CPM1A-40CDT-□(-V1)

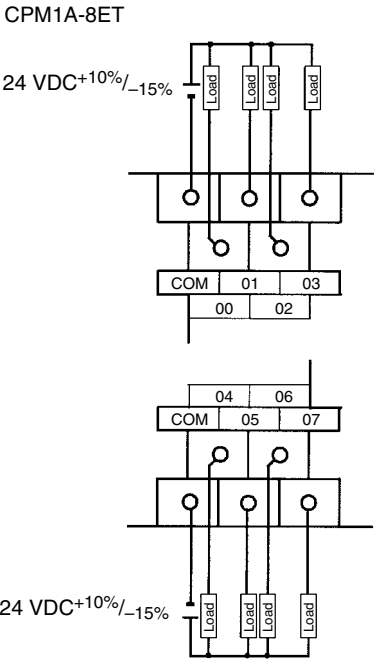



 **Caution** Double-check the polarity of the power supply for the load before turning it on.

Transistor Output Wiring (Sourcing Outputs)

Wire the outputs to the CPM1A's CPU Unit and Expansion I/O Unit as shown in the following diagrams.

- Always use solid wire or attach crimp connectors if a stranded wire is used.
- Don't exceed the output capacity or the maximum common current. Refer to 2-1-3 I/O Specifications for details.

Item	Specification
Output capacity	300 mA (24 VDC)
Max. common capacity	0.9 A/common

Output Configurations

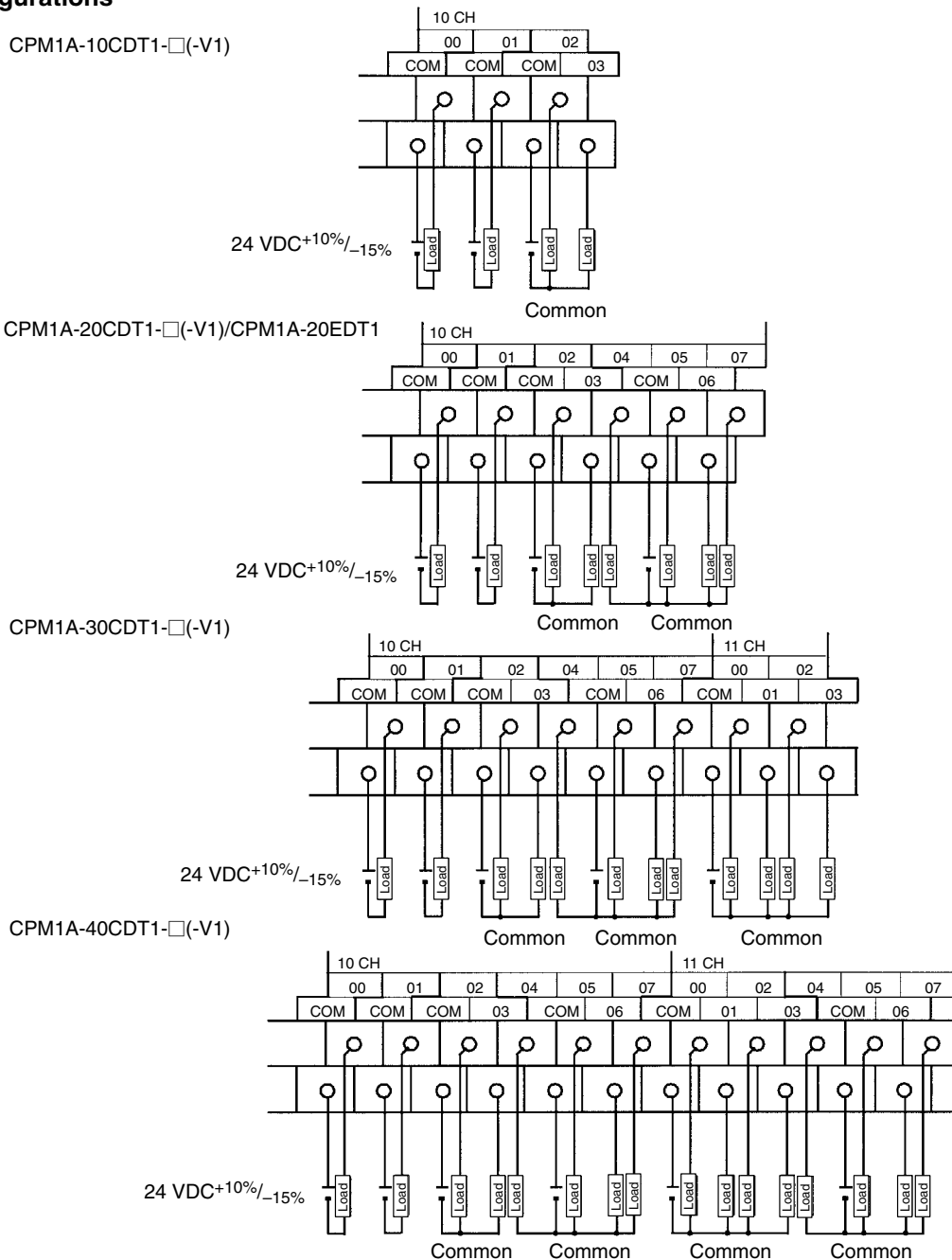

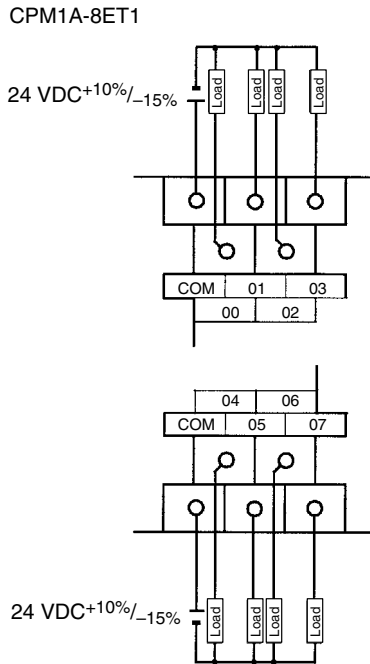

Caution Double-check the polarity of the power supply for the load before turning it on.

Output Wiring Precautions Observe the following precautions to protect the PC's internal components.

Output Short Protection

The output or internal circuitry might be damaged when the load connected to an output is short-circuited, so it is recommended to install a protective fuse (0.5 to 1.0 A) in each output circuit.

Polarity of Power Supply for the Load

Double-check the polarity of the DC power supply for the load before wiring the transistor output. If the polarity of the power supply is reversely connected, the load will malfunction and internal components may be damaged.

Inductive Loads

When connecting an inductive load to an input, connect a surge protector or diode in parallel with the load.

The surge protector's components should have the following ratings:

Relay Output

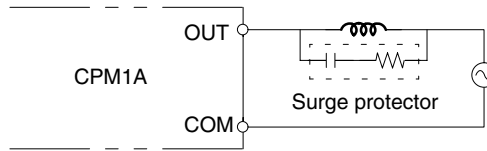

Relay Output Transistor Output (Sinking Output)

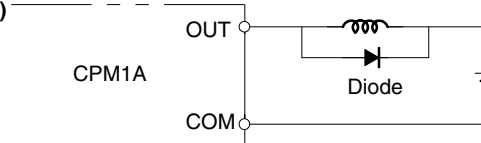

Relay Output Transistor Output (Sourcing Output)

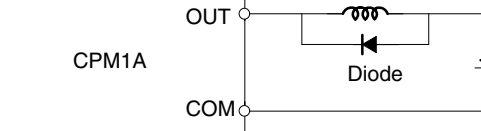

The diode should satisfy the following requirements:

- Peak reverse-breakdown voltage must be at least 3 times the load voltage.
- Average rectified current must be 1 A.

Inrush Current Considerations

When switching a load with a high inrush current in the CPM1A relay output or transistor output model, such as an incandescent lamp, suppress the inrush current as shown below.

Countermeasure 1

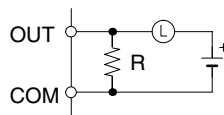

Providing a dark current of approx. one-third of the rated value through an incandescent lamp

Countermeasure 2

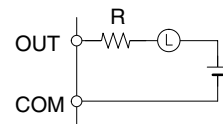

Providing a limiting resistor

Fuse Insertion

The CPM1A with transistor output may burn if the load is short-circuited, therefore, insert a protective fuse in series to the load.

Crimp Connectors



Caution Always use crimp connectors for the CPM1A's power lines and I/O lines or else use a solid wire (instead of a stranded wire). Do not connect bare stranded wires directly to terminals. Bare stranded wires connected directly to the terminal can cause a fire.

Use M3 terminal screws and tighten the screws securely (0.5 N • m).

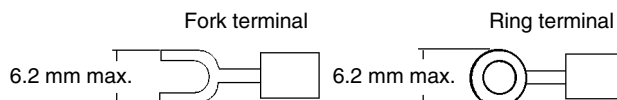

The recommended wire size for solid wires is 0.4 to 1.2 mm (AWG26 to AWG18).

3-4-6 Peripheral Device Connection

The CPM1A CPU Unit can be connected to a C200H-PRO27-E Programming Console with a standard C200H-CN222 (2 m) or C200H-CN422 (4 m) Connecting Cable. The CPM1A CPU Unit can be also connected to a CQM1-PRO01-E. The CQM1-PRO01-E is provided with a 2-m Connecting Cable.

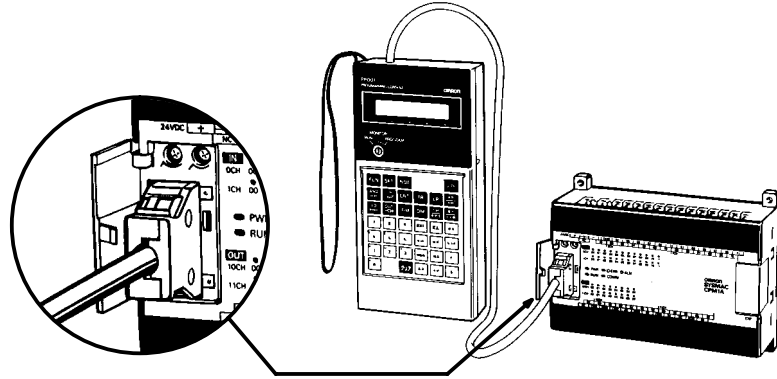

3-4-7 Host Link Connections

Host Link is a command/response communications system in which commands are transmitted from the host computer and corresponding responses are returned from the destination PCs. Host Link commands can be used to read/write data in PC data areas and read/write PC settings.

One-to-one Host Link Connection

The CPM1A CPU Unit can be connected to an IBM PC/AT compatible computer or a Programmable Terminal with an RS-232C Adapter, as shown in the following diagram.

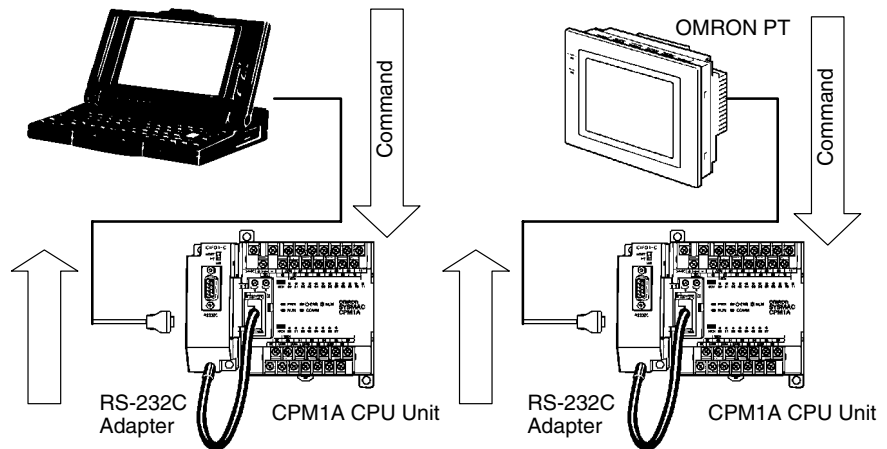

The following diagram shows the wiring in the RS-232C cable used to connect a CPM1A to a host computer or Programmable Terminal.

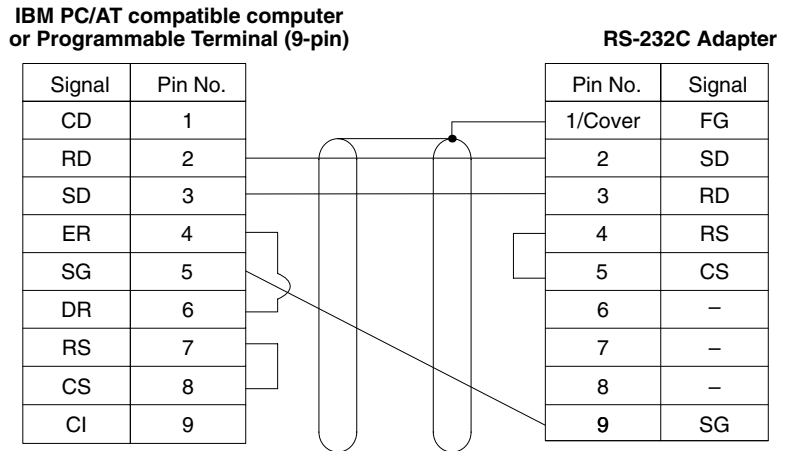

The type of connector used will vary depending on the PT. Check the PT manual to ensure the correct connector is used.

Note When the CPM1A is connected to a host computer or OMRON PT, set the RS-232C Adapter's mode setting switch to "HOST."

One-to-N Host Link Connection

Up to 32 CPU Units can be connected to an IBM PC/AT compatible computer with a 3G2A9-AL004-E Link Adapter and RS-422 Adapters, as shown in the following diagram.

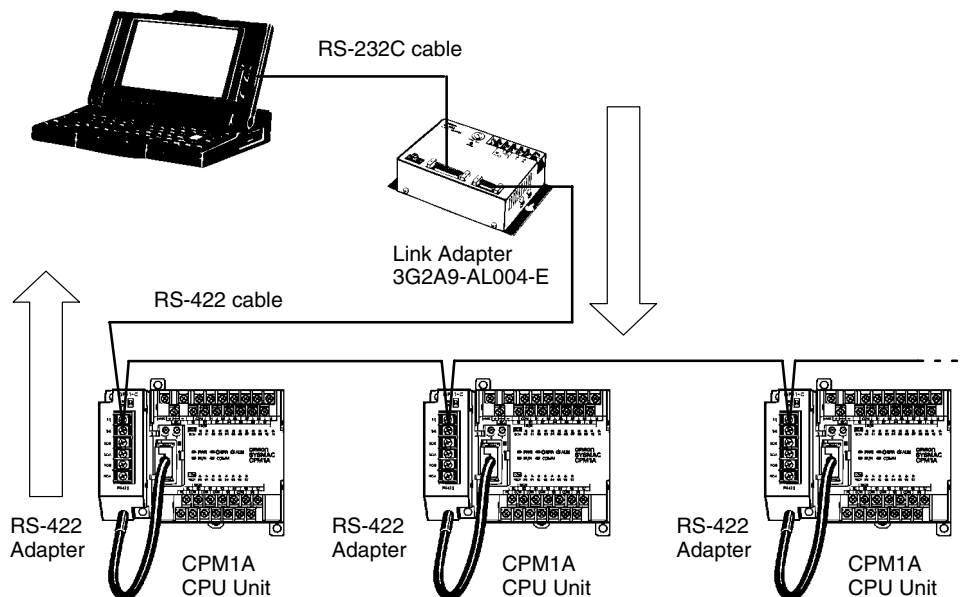

The following diagram shows the wiring in the RS-422 cables used to connect CPM1A PCs to a 3G2A9-AL004-E Link Adapter. In both the Link Adapter/RS-422 Adapter connections and the RS-422 Adapter/RS-422 Adapter connections, connect the SG, RDA, RDB, SDA, and SDB terminals to the same terminals in the other Adapter.

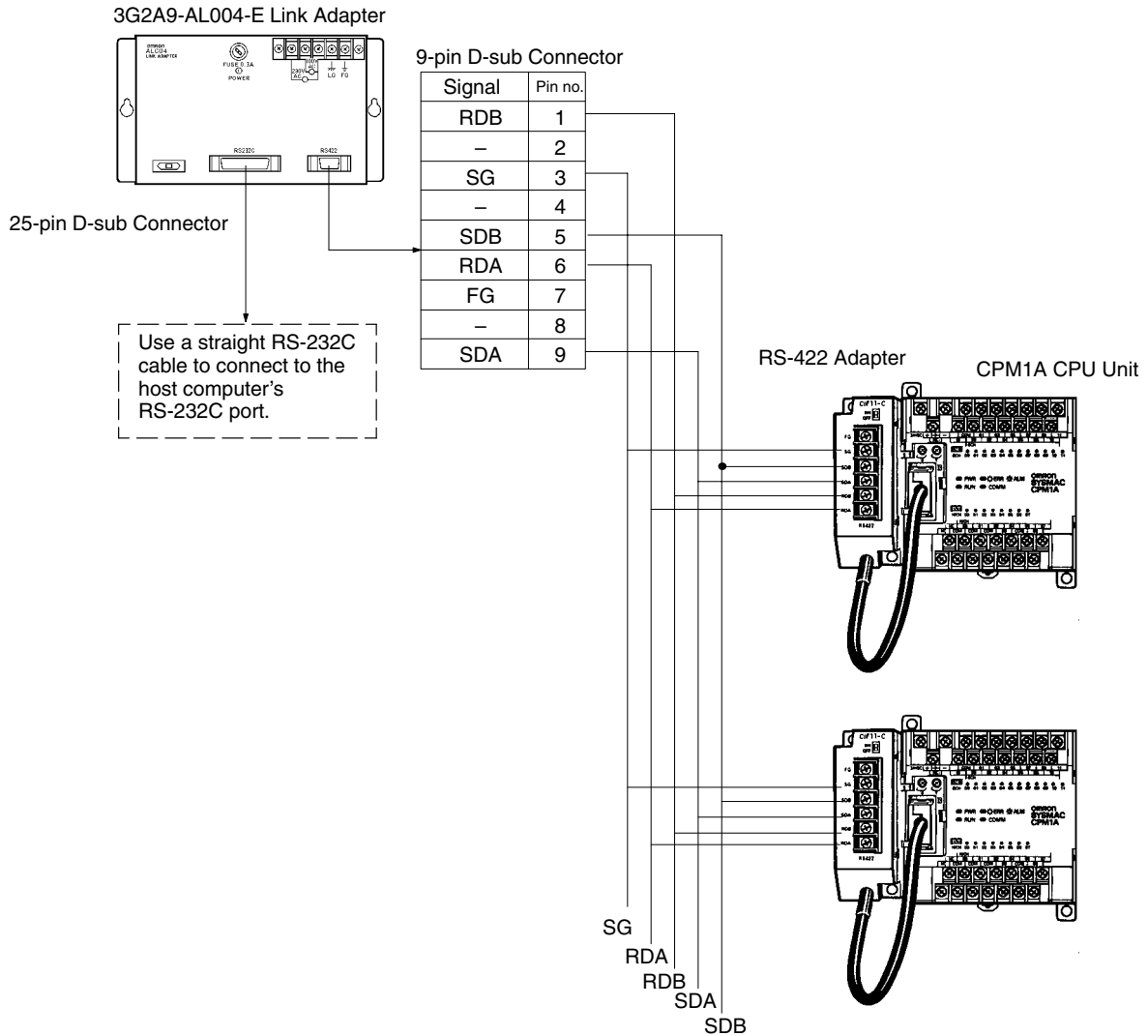

- Note**
1. The maximum length of the RS-422 cable should be 500 m.
 2. Set the termination resistance switch to "ON" (upper side) for Adapters on both ends of the Host Link system.

Always use crimp connectors when wiring the RS-422 Adapters. Use M3 terminal screws and tighten the screws securely to the torque of 0.5 N • m.

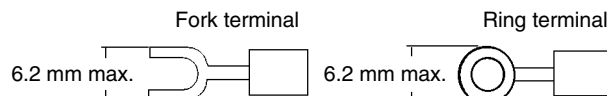

3-4-8 One-to-one PC Link Connections

A CPM1A can be linked to a CPM1A, CQM1, CPM1, CPM2A, CPM2C, SRM1(-V2), C200HS or C200HX/HG/HE PC through an RS-232C Adapter. One PC acts as the Master and the other as the Slave to link up to 256 bits in the LR area (LR 0000 to LR 1515).

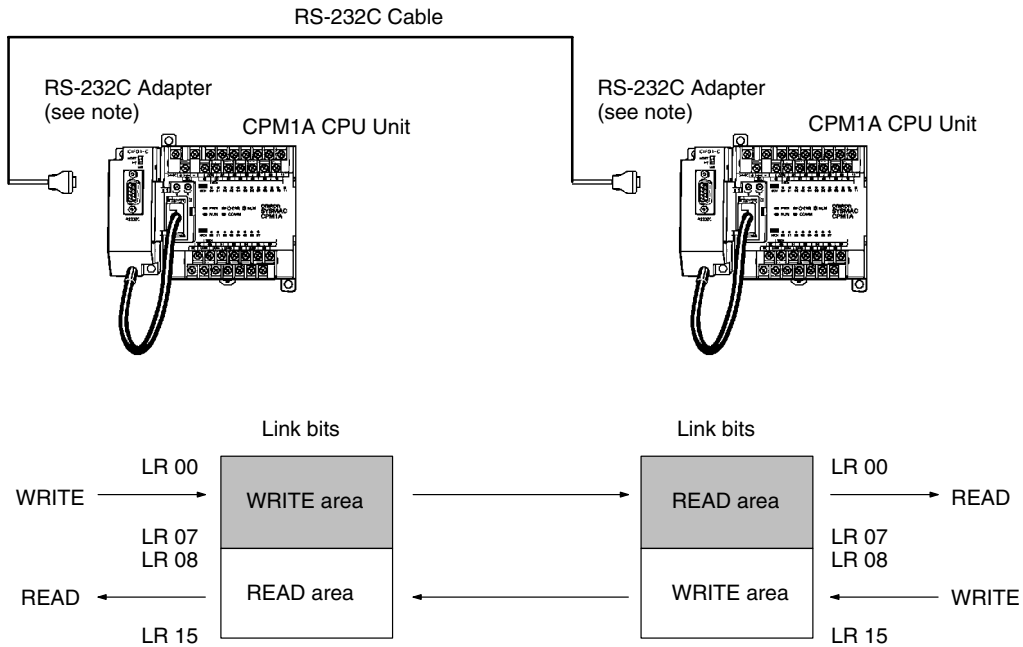

Note One-to-one PC connections can only be used when the RS-232C Adapter (CPM1-CIF01) is connected.

Set the DIP switch of the RS-232C Adapter (CPM1-CIF01) to the NT (bottom) side.

The following diagram shows the wiring in the RS-232C cable used to connect a CPM1A to another PC.

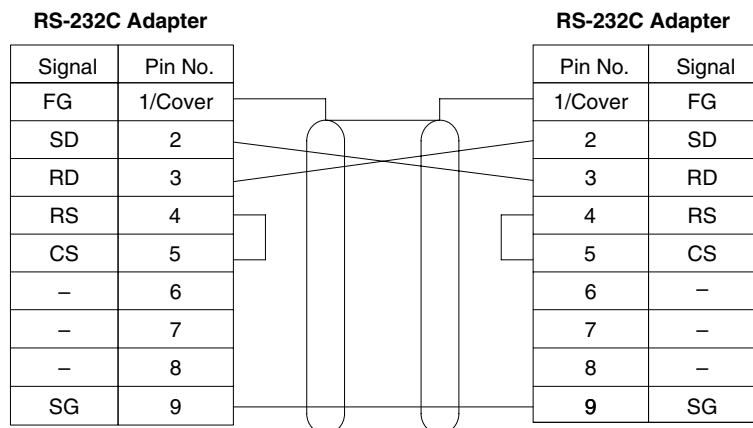

3-4-9 One-to-one NT Link Connections

High-speed communications can be achieved by providing a direct access through the use of the 1:1 NT Link between the CPM1A and Programmable Terminal.

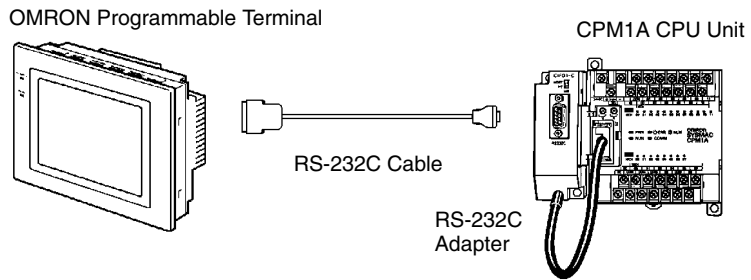

Note The 1:1 NT Link can only be used when the RS-232C Adapter (CPM1-CIF01) is connected.

Set the DIP switch of the RS-232C Adapter (CPM1-CIF01) to the NT (bottom) side.

The following diagram shows the wiring in the RS-232C cable used to connect a CPM1A to a Programmable Terminal.

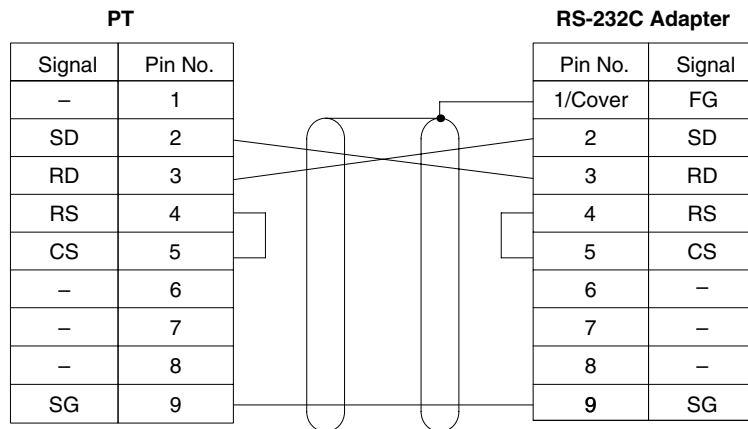

3-4-10 CompoBus/S I/O Link Unit Connections

A CompoBus/S I/O Link Unit can be used to create an I/O link (remote I/O) of 8 input points and 8 output points with a CompoBus/S Master Unit or SRM1 PC. The connection is made through a CompoBus/S I/O Link Unit.

From the standpoint of the CPM1A CPU Unit, the area allocated to the CompoBus/S I/O Link Unit can be treated just like the area allocated to an Expansion I/O Unit. The difference is that the bits are not actual I/O points, but I/O bits in the Master Unit.

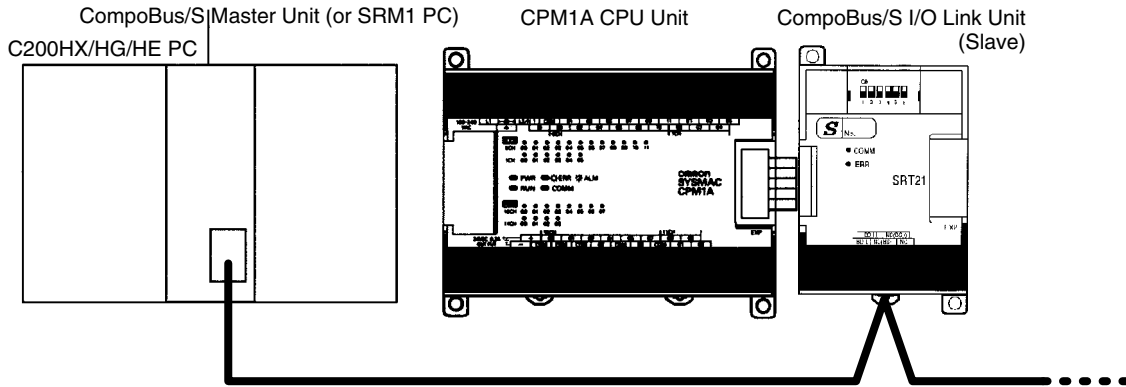

Cables

Use special flat cable or VCTF cable to connect the nodes in the CompoBus/S I/O Link. (Special flat cables and VCTF cables cannot be combined in the same system.)

Name	Specifications
Flat cable	4-core flat cable, 0.75 mm ²
VCTF cable	2-core x 0.75 mm ²

3-4-11 DeviceNet I/O Link Unit Connections

A DeviceNet I/O Link Unit can be used to create an I/O link (remote I/O) of 32 input points and 32 output points with a DeviceNet master, i.e., the CPM1A operates as a DeviceNet slave.

Up to three DeviceNet I/O Link Units can be connected, for a maximum DeviceNet I/O link capacity of 192 I/O points (96 inputs and 96 outputs). The DeviceNet I/O Link Unit can be connected only to 30-point or 40-point CPU Units.

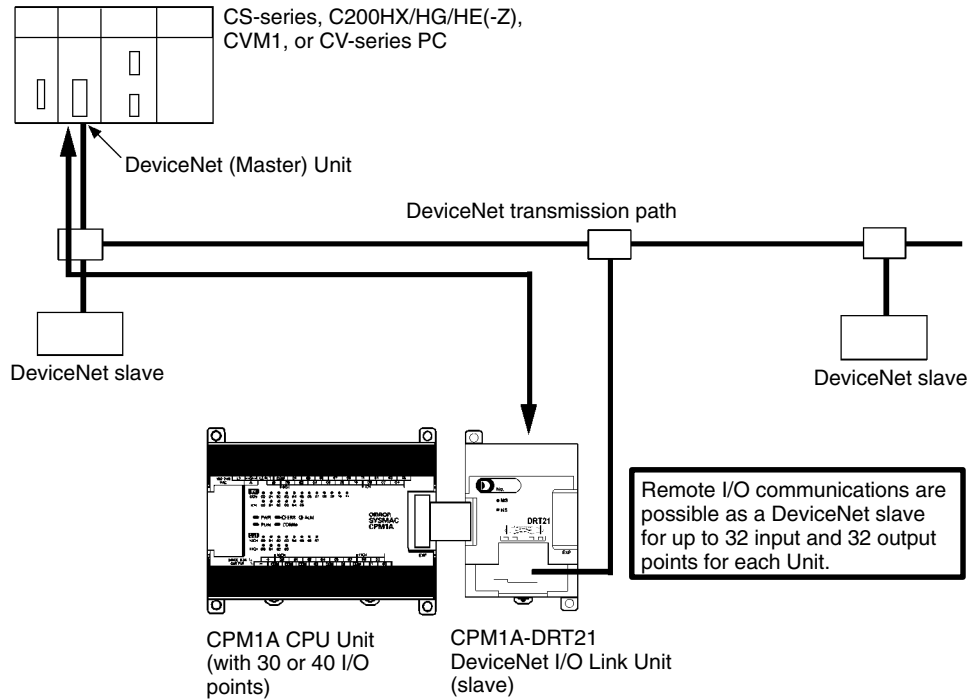

Note The current consumption for communications for the DeviceNet I/O Link Unit is 30 mA.

Network Connection

Connect the DeviceNet I/O Link Unit to the DeviceNet transmission path as shown in the following diagram.

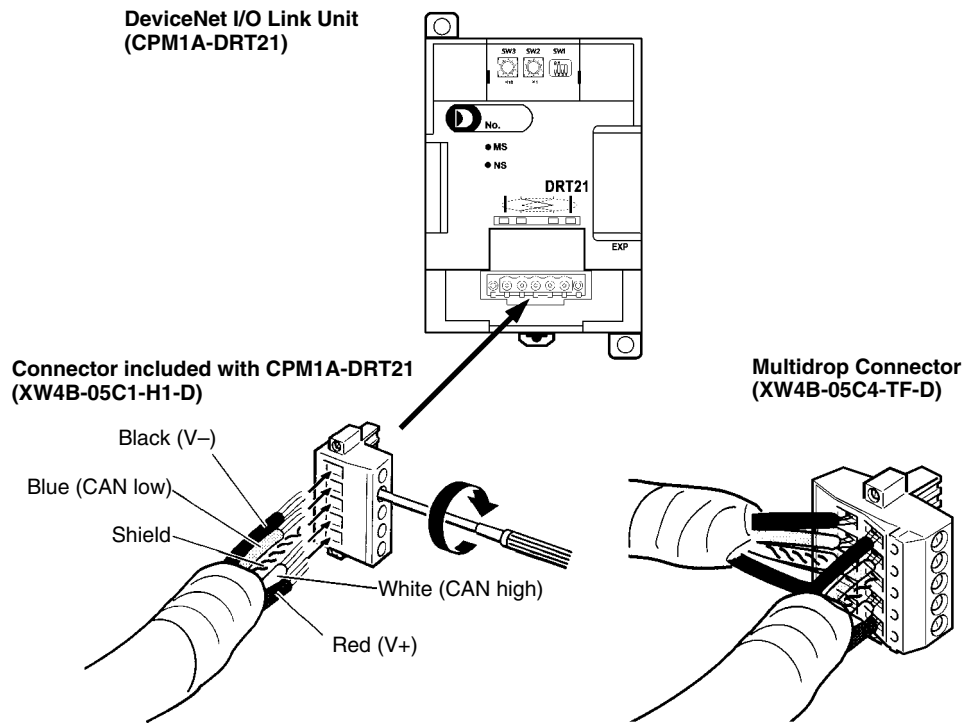

DeviceNet Connectors

Use the following DeviceNet connectors.

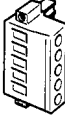
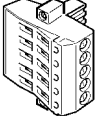
Model number	XW4B-05C1-H1-D	XW4B-05C4-TF-D
Specifications	OMRON, with set screws, included with the CQM1A-DRT21	OMRON, multidrop connector (See note.)
Appearance		

Note Use the XW4B-05C4-TF-D for multidrop wiring of thick cables.

The OMRON XW4Z-00C Screwdriver is available for tightening the line set screws.

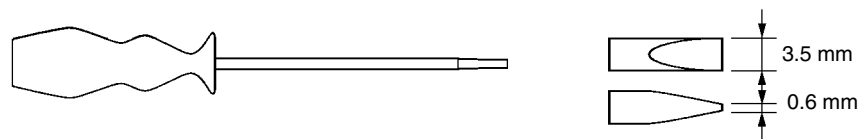

SECTION 4

Using Peripheral Devices

This section outlines the operations possible with the SYSMAC Support Software (SSS) and the Programming Consoles. Actual SSS operating procedures are provided in the *SSS Operation Manuals: Basics* and *C-series PCs*. Programming Console connection and operating procedures are provided in this section.

4-1	Support Software Capabilities	78
4-1-1	SSS System Setup	78
4-1-2	CPM1A Restrictions and Precautions	78
4-1-3	Offline Operations	79
4-1-4	Online Operations	82
4-1-5	Offline and Online Operations	83
4-2	Using a Programming Console	84
4-2-1	Compatible Programming Consoles	84
4-2-2	Changing the CPM1A's Mode with the Mode Switch	86
4-2-3	Connecting the Programming Console	87
4-2-4	Preparation for Operation	88
4-2-5	Entering the Password	88
4-3	Programming Console Operations	90
4-3-1	Overview	90
4-3-2	Clearing Memory	91
4-3-3	Clearing Memory Completely	92
4-3-4	Reading UM Allocation Information	92
4-3-5	Reading/Clearing Error Messages	92
4-3-6	Buzzer Operation	93
4-3-7	Setting and Reading a Program Memory Address and Monitoring I/O Bit Status	94
4-3-8	Entering or Editing Programs	95
4-3-9	Instruction Search	98
4-3-10	Bit Operand Search	98
4-3-11	Inserting and Deleting Instructions	99
4-3-12	Checking the Program	100
4-3-13	Bit, Digit, Word Monitor	101
4-3-14	Differentiation Monitor	103
4-3-15	Binary Monitor	103
4-3-16	Three-word Monitor	104
4-3-17	Signed Decimal Monitor	105
4-3-18	Unsigned Decimal Monitor	105
4-3-19	Three-word Data Modification	106
4-3-20	Changing Timer, Counter SV	106
4-3-21	Hexadecimal, BCD Data Modification	107
4-3-22	Binary Data Modification	108
4-3-23	Signed Decimal Data Modification	109
4-3-24	Unsigned Decimal Data Modification	110
4-3-25	Force Set, Reset	110
4-3-26	Clear Force Set/Reset	111
4-3-27	Hex-ASCII Display Change	111
4-3-28	Displaying the Cycle Time	112
4-4	Programming Example	112
4-4-1	Preparatory Operations	112
4-4-2	Example Program	114
4-4-3	Programming Procedures	115
4-4-4	Checking the Program	118
4-4-5	Test Run in MONITOR Mode	118

4-1 Support Software Capabilities

The SSS is a complete programming and control package designed for C-series and CVM1 PCs. It provides not only programming capabilities, but also advanced debugging, monitoring, and program/data management. The following tables provide only a brief introduction to the capabilities of the SSS. For further information and actual operating procedures, please refer to the *SYSMAC Support Software Operation Manuals: Basics and C-series*.

CPM1A programming can be performed with any version of the SSS.

In addition, the SYSMAC-CPT can be used for programming the CPM1A. Refer to the *SYSMAC-CPT Support Software Quick Start Guide (W332)* and *User Manual (W333)* for operation procedures. When programming the CPM1A using the SYSMAC-CPT, be sure to set the “PC model” on the Support Software to “CPM1 (CPM1A).”

Operations for the WS02-CXPC1-E CX-Programmer are provided in the *WS02-CXPC1-EV3 CX-Programmer Operation Manual (W414)* and the *WS02-CXPC1-E-V4 CX-Programmer Operation Manual (W425)*.

4-1-1 SSS System Setup

Set the PC Model to “CQM1” and the PC Interface to “PERIPHERAL.” Follow the directions in the SSS operating manuals for other System Setup settings.

PC Model

If the CPM1A PC doesn't appear as an option in the SSS's System Setup, set the PC Model to “CQM1.” The CPM1A is compatible with the CQM1.

PC Interface

Set the PC Interface to the Peripheral Device Port by selecting “PERIPHERAL” from the submenu. After selecting the Peripheral Device Port, set the communications baud rate to 9,600 baud.

4-1-2 CPM1A Restrictions and Precautions

When programming the CPM1A, set the PC Model on the SSS to “CQM1.” Heed the following restrictions when programming the CPM1A.

Programming Check

Since the data area of the CQM1 is larger than that of the CPM1A, some parts of the area cannot be checked as the CPM1A PC. Pay careful attention to the usable data area when programming.

Note If a program that contains addresses not supported by the CPM1A are transferred to the CPM1A, a memory error will occur when operation is begun and AR 1308 will turn ON. Refer to the *Programming Manual (W353)* for differences in memory areas.

Memory Usage

Since the memory of the the CQM1 is larger than that of the CPM1A, the displayed available memory capacity is larger than the actual available memory capacity. Pay careful attention to the actual available memory capacity when programming.

Expansion Instructions

When a program is transferred after changing the assignment of function codes for the 18 expansion instructions, a message to “Turn on the DIP switch of the PC and execute again” is displayed. Change the assignment of the function codes for the expansion instructions to the default settings before programming.

The default settings for the CQM1 are as shown in the following table.

Function code	Mnemonic	Function code	Mnemonic
17	ASFT	64	SPED
18	TKY	65	PULS
19	MCMP	66	SCL
47	RXD	67	BCNT
48	TXD	68	BCMP
60	CMPL	69	STIM
61	INI	87	DSW
62	PRV	88	7SEG
63	CTBL	89	INT

Online Editing

If unsupported addresses are set in the program for operands or set values, error messages will be displayed and the values will not be accepted.

4-1-3 Offline Operations

The following operations are possible when not connected online to the PC.

Group	Name	Description
Programming	Connect line	Draws a line between two ladder diagram objects.
	Save program	Writes all or part of the user program developed in the system work area to the data disk.
	Retrieve program	Retrieves all or part of the user program stored on a data disk to the system work area.
	Change display	Specifies the display modes for the user program.
	Search	Searches for instructions including specified operands. An address from which the search is to be started can be specified
	I/O comment	Creates I/O comments corresponding to bit addresses in the Ladder With Comments mode. In addition, reads (searches) and edits the program for comments.
	Instr comment	Creates and edits instruction comments for output instructions in the Ladder With Comments mode. (C-series PCs only)
	Block comment	Creates, reads (searches), and edits block comment in the Ladder With Comments mode.
	Edit ladder	Edits ladder diagrams using the following: <ul style="list-style-type: none"> • Moving specified instruction blocks • Copying specified instruction blocks • Deleting specified instruction blocks
	Edit comments	Displays I/O comments simultaneously to write, edit, and search for specified comments.
	Retrieve comments	Retrieves comments from the program stored on a data disk. The I/O comments are read to the system work area. Instruction comments (C-series PCs only) and block comments are copied to the currently displayed program.
	Memory usage	Displays the used capacity of the user program memory, the number of comments used, and the available capacity of the internal memory.
	Clear memory	Clears the user program memory. The starting address for clearing can be specified. The comment memory can also be cleared.
Check program	Checks whether the user program contains syntax errors. The check can be performed in three levels.	

Group	Name	Description
DM (data memory)	Go To Page	Displays the contents of the data memory in the system work area in pages (units of 160 words). The data can be altered with this function. (C-series PCs only)
	Copy	Copies the contents of the DM area of the system work area (data memory information).
	Fill	Writes the same data to more than one data word in the system work area data memory area.
	Print	Prints a specified range of DM words.
	Hex \longleftrightarrow ASCII	Specifies the display mode for the data memory contents when the work disk data memory contents are to be altered. The display mode can be hexadecimal or ASCII.
	Save DM Data	Writes the contents of a specified range of system work area data memory to the data disk.
	Retrieve DM Data	Retrieves the saved data disk data memory to the system work area DM area.
I/O Table	Write I/O Table	Edits the I/O table in the system work area.
	Check I/O Table	Checks the contents of the I/O table in the system work area.
	Save I/O Table	Writes the I/O table in the system work area to a data disk.
	Retrieve I/O Table	Retrieves the I/O table data stored on a data disk to the system work area.
	Print I/O Table	Prints an I/O table list. (C-series PCs only)

Group	Name	Description
Utility	Data Area Lists	Displays lists (such as used areas and cross-references) in accordance with the contents of the user program in the system work area.
	Change Addresses	Globally changes bit and word addresses in the user program in the system work area.
	Print Lists	Prints lists, ladder diagrams, and mnemonics in accordance with the contents of the user program in the system work area.
	EPROM/Memory Card	Writes, reads, and compares the user program between the PROM Writer/Memory Card and system work area.
	Program Conversion	C500 → C2000H: Converts C500-family programs to C2000H programs. C2000H → CVM1: Converts C2000H-family programs to CVM1 programs
	Create Library File	Creates a library on a floppy disk or hard disk for use as an LSS data disk.
	Time Chart Monitor	Accesses the time chart monitor data produced online. (C-series PCs only)
	Instruction Trace	Accesses the instruction trace data produced online. (C-series PCs only)
	Data trace	Accesses the data trace data produced online.
	Set Instructions	Used to assign instructions to function codes in the instructions table and to save and retrieve instructions tables to and from data disk files. (C-series PCs only)
	Retrieve/Save Instr	Used to save and retrieve expansion instruction sets to and from data disk files. (C-series PCs only)
	PC Setup	Used to set the PC operating parameters in the PC Setup and to save and retrieve PC Setups to and from data disk files.
	Allocate UM	Used to allocate parts of the user memory area for used as a Fixed DM Area and/or I/O Comment Area. (C-series PCs only)
	Network Support Table	Used to edit data link tables and routing tables for the SYSMAC NET and SYSMAC LINK Systems.
File Management	Directory	Displays a file list. Wildcard names can be used to display only desired files.
	Copy File	Copies files on the same floppy disk or between different disks.
	Change File Name	Changes the name of a specified file.
	Delete File	Deletes a specified file.
	LSS File Management	Used to change between LSS-style data files and DOS-style data files.

4-1-4 Online Operations

The following operations are possible when connected online to the PC.

Group	Name	Description
Monitoring	Monitor Data	Uses the lower one third of the screen as a monitor area where bits, words, DM contents, and TIM/CNT SV/PV are monitored, forced-set/reset, and changed.
	Transfer Program	Transfers and compares the user program between the computer and PC.
	Change Display	C-series PCs Ladder W/Comments Ladder CVM1 PCs Ladder Ladder (2 rows of comments) Ladder (4 rows of comments)
	Online Edit	Simultaneously edits the PC program and the program in the system work area.
	Read Cycle Time	Reads and displays the scan time of the PC.
	Clear Area	Clears the PC data areas such as HR, CNT, AR, and DM (to zero).
	Search	Searches for instructions (including specified operands).
	I/O Comments	Searches for I/O comments.
	Block Comments	Searches for block comments.
	Memory Usage	Displays used program memory area, the number of comments used, and the available capacity of the internal memory.
	DM	Transfer PC → Computer
Transfer Computer → PC		Writes system work area DM data to the PC. (C-series PCs only)
Transfer Verify		Compares DM data between the system work area and PC. (C-series PCs only)
Monitor		Used to monitor DM area contents in the PC. (C-series PCs only)
Go To Page		Reads a specified page from the DM list of the DM area in the system work area or PC. (C-series PCs only)
I/O Table	Transfer I/O Table	Transfers and compares the I/O table data between the computer and PC.
	Create I/O Table	Registers into the PC the I/O Units mounted on the PC and then assigns the words to the Units.
	Verify I/O Table	Compares the I/O table registered in the PC against the I/O Units actually mounted on the PC.
Utility	File Memory/ Memory Card	Displays a file memory list; transfers the file memory contents between the PC and computer or the PC and File Memory Unit; clears the file memory; saves or retrieves the file memory contents to or from a floppy disk; and edits file memory contents
	Time Chart Monitor	Used to execute time chart monitoring and to display, save, or retrieve results. (C-series PCs only)
	Instruction Trace	Used to execute instruction traces and used to display, save, or retrieve results. (C-series PCs only)
	Data Trace	Used to execute data traces and used to display, save, or retrieve results.
	Debug	Used to display the execution status of the specified program section. (C-series PCs only)
	Display/Set Clock	Used to read and set the internal clock in the PC. (CQM1, C200HS, or CVM1 only)
	Transfer Instr	Used to transfer expansion instruction set from the PC to the SSS. (C-series PCs only)
	PC Setup	Changes the PC Setup in the PC and in the system work area and used to transfer the PC Setup between the PC the disk (save/retrieve).
	Network Support Tables	C-series PCs: Used to input data link tables for SYSMAC NET. CVM1 PCs: Used to transfer data link tables and routing tables between Link Units, the PC, and the SSS and to compare these tables. Also used to start and start data links.

4-1-5 Offline and Online Operations

The following operations are possible either online or offline from the PC.

Group	Name	Description
System Setup (see note)	PC model	Specifies the model of PC that is being programmed or that is connected to the computer.
	PC Interface	C-series PCs: Specifies whether communications with the PC are performed through a SYSMAC NET Link Unit, peripheral interface, or a Host Link (RS-232C) interface and the computer port (COM1 or COM2) to use. When a Host Link Unit is used, it also specifies the port number and baud rate. CVM1 PCs: Used to specify the communications protocol for communications with the PC, i.e., peripheral or Host Link (RS-232C) interface. The baud rate, PC unit number, parity, data length, and number of stop bits are designated.
	Network address	Specifies the network address, node number, and data code type of the SYSMAC NET Link Unit communicating with the SSS on the SYSMAC NET System. The address determines the PC to be connected to for online operations. With CVM1 PCs this setting is also used to specify the PC being communicated with through networks when connected via a peripheral or Host Link interface.
	I/O table – UM transfer	Specifies whether the I/O table and data link tables are transferred to the user program area when the user program is transferred between the computer and PC or PROM Writer. (C-series PCs only)
	EPROM interface	Specifies the baud rate and port number of the PROM Writer connected to the computer. (C-series PCs only)
	Printer model	Specifies the printer model.
	Data disk drive	Specifies the data disk drive.
	OutBit Comment Type	Specifies whether I/O comments or instruction comments are displayed at the TIM/CNT, DIFU/DIFD, KEEP, and STEP/SNXT comment display positions. (C-series PCs only)
	Exit to DOS	Terminates SSS operation and returns to DOS.

Note When the SSS is operating in online mode, the only functions available on the System Setup Menu are “I/O table – UM transfer,” “Data disk drive,” and “Exit to DOS.”

4-2 Using a Programming Console

This section provides information on connecting and using a Programming Console. Refer to 5-4 *Programming Console Operation Errors* for details on errors that might occur during Programming Console operations.

4-2-1 Compatible Programming Consoles

There are two Programming Consoles that can be used with the CPM1A: The CQM1-PRO01-E and the C200H-PRO27-E. The key functions for these Programming Consoles are identical.

Press and release the Shift Key to input a letter shown in the upper-left corner of the key or the upper function of a key that has two functions. For example, the CQM1-PRO01-E's AR/HR Key can specify either the AR or HR Area; press and release the Shift Key and then press the AR/HR Key to specify the AR Area.

CQM1-PRO01-E

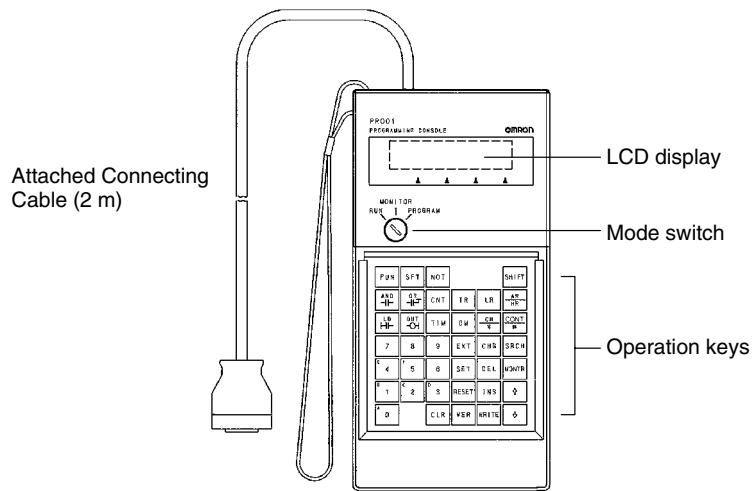



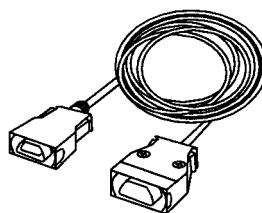
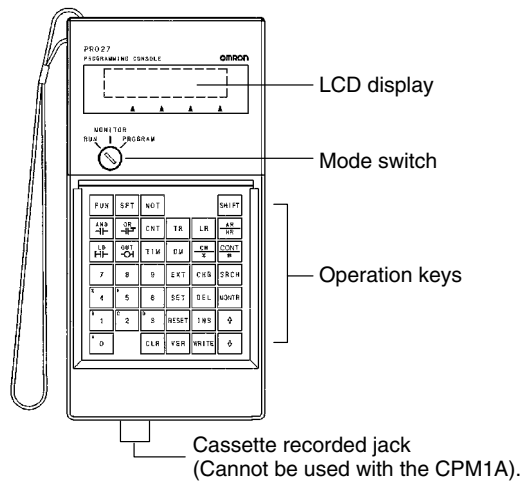



C200H-PRO27-E



Connecting Cables
C200H-CN222 (2 m)
C200H-CN422 (4 m)

Different Keys

The following keys are labeled differently on the CQM1-PRO01-E and the C200H-PRO27-E, but the operation of the keys in each pair is identical.

CQM1-PRO01-E Keys	C200H-PRO27-E Keys
	
	
	

Note To specify the AR area, use SHIFT and HR Keys for the C200H-PRO27-E and use SHIFT and AR/HR Keys for the CQM1-PRO01-E.

A shift symbol will be displayed in the upper-right corner of the screen when the Shift Key is pressed. The shift input can be cleared by pressing the Shift Key again.

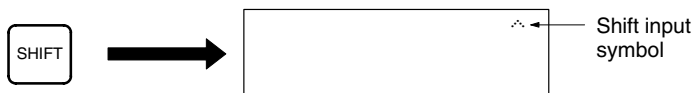

Mode Switch

The mode switch controls the CPM1A's operating mode. The key can be removed when the switch is set to RUN or MONITOR but it cannot be removed when the switch is set to PROGRAM.

Contrast Control

The display contrast can be adjusted with the control on the right side of the Programming Console.

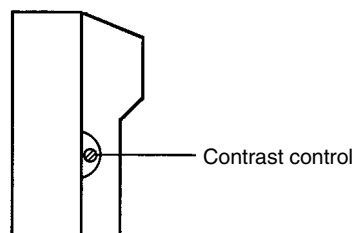

Buzzer Volume

The C200H-PRO27-E's buzzer volume can be adjusted with the lever on the right side of the Programming Console. The CQM1-PRO01-E's buzzer volume cannot be adjusted.

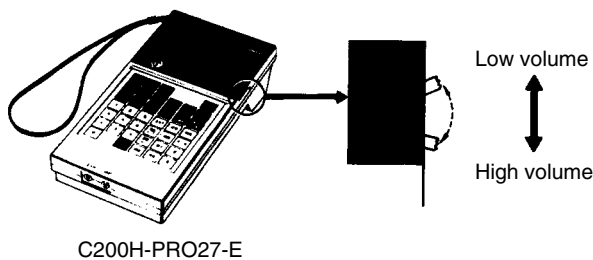

Note The buzzer volume can be turned on and off with a key operation. See 4-3-6 *Buzzer Operation* for details.

4-2-2 Changing the CPM1A's Mode with the Mode Switch

Once the Programming Console has been connected, its mode switch can be used to change the CPM1A's operating mode. The mode display (<PROGRAM>, <MONITOR>, or <RUN>) will appear on the Programming Console screen.

- No key operations can be performed while the mode display is displayed on the Programming Console screen. Press CLR to clear the display so that key operations can be performed.
- If the SHIFT Key is pressed while the mode switch is turned, the original display will remain on the Programming Console's screen and the mode display won't appear.
- The CPM1A will enter RUN mode automatically if a Programming Console isn't connected when the CPM1A is turned on.

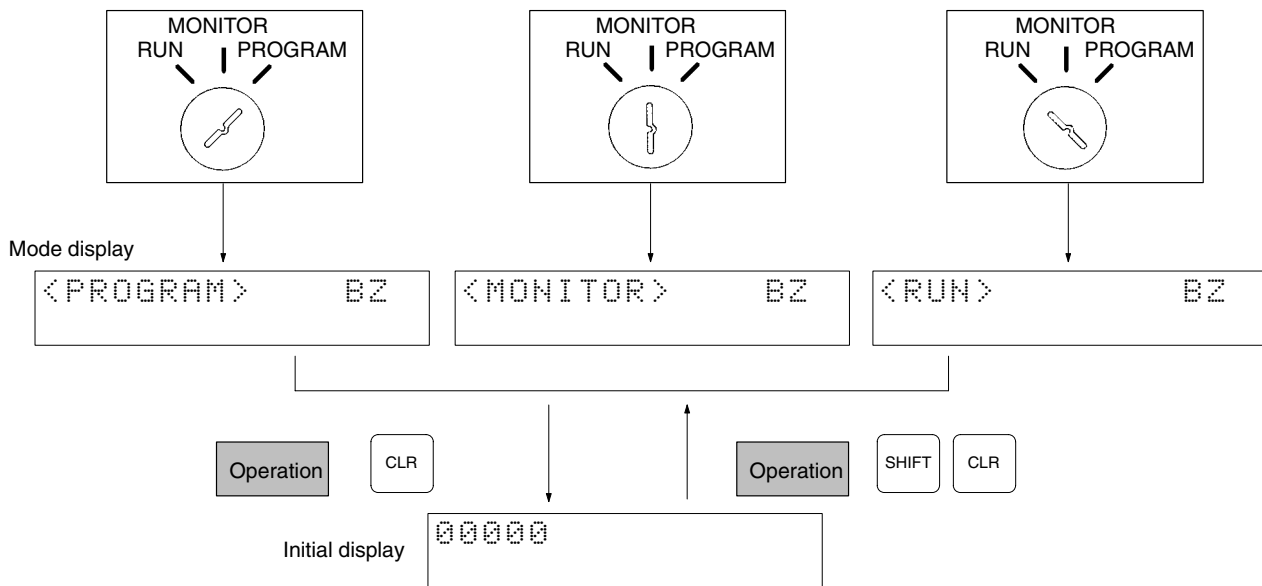

Operating Modes

PROGRAM Mode

The CPM1A program isn't executed in PROGRAM mode. Use PROGRAM mode to create and edit the program, clear memory, or check the program for errors.

MONITOR Mode

The CPM1A program is executed in MONITOR mode and I/O is refreshed just as it is in RUN mode. Use MONITOR mode to test system operations, such as monitoring CPM1A operating status, force-setting and resetting I/O bits, changing the SV/PV of timers and counters, changing word data, and online editing.

RUN Mode

This is the CPM1A's normal operating mode. The CPM1A's operating status can be monitored from a Programming Device, but bits can't be force-set/force-reset and the SV/PV of timers and counters can't be changed.

Caution Check the system thoroughly before changing the operating mode of the PC to prevent any accidents that might occur when the program is first started.

Caution Never change the mode while pressing any of the keys.

Startup Operating Mode

The operating mode of the CPM1A when the power is turned ON depends upon the PC Setup setting in DM 6600 and the Programming Console's mode switch setting if the Programming Console is connected.

PC Setup setting (DM 6600)	Programming Console connected	Programming Console not connected
0000	The startup mode determined by the mode switch setting.	RUN mode if no Programming Device is connected. PROGRAM mode if another Programming Device is connected.
0100	The startup mode is the same as the operating mode before power was interrupted.	
0200	PROGRAM mode	
0201	MONITOR mode	
0202	RUN mode	

Note The default setting is 0000. If a Programming Console is not connected, the PC will automatically enter RUN mode. Be sure that it is safe for the PC to operate before turning on the PC without a Programming Console connected.

4-2-3 Connecting the Programming Console

Connect the Programming Console's connecting cable to the CPM1A's peripheral port, as shown below.

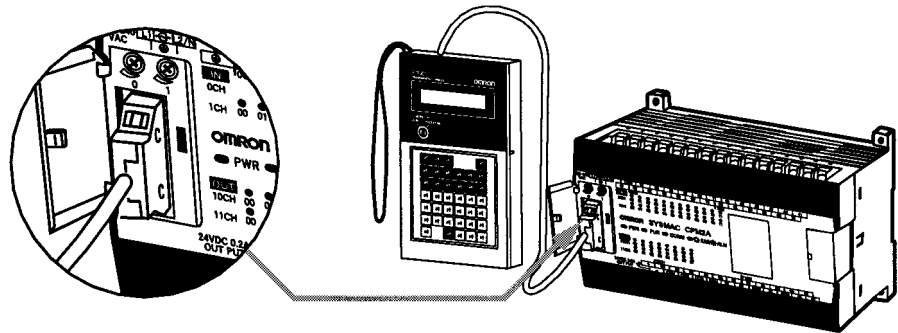

Panel Installation

The C200H-PRO27-E Programming Console can be installed in a control panel as shown in the following diagram. (The C200H-ATT01 Mounting Bracket is sold separately.)

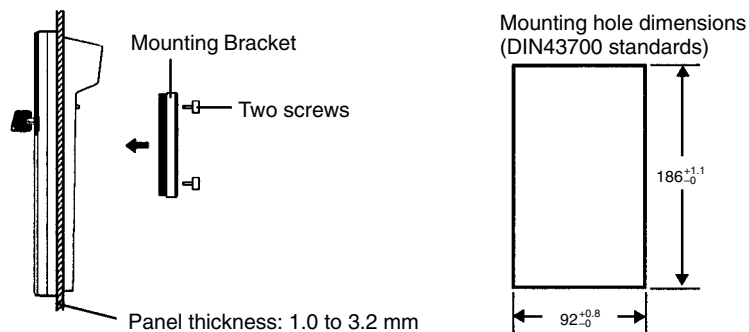

Allow at least 80 mm for the cable connector above the Programming Console.

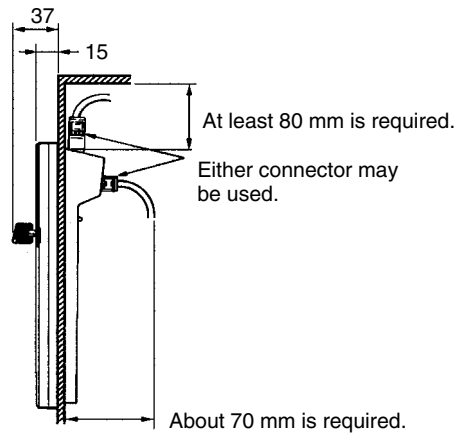

4-2-4 Preparation for Operation

This section describes the procedures required to begin Programming Console operation when using the Programming Console for the first time.

! Caution Always confirm that the Programming Console is in PROGRAM mode when turning ON the PC with a Programming Console connected unless another mode is desired for a specific purpose. If the Programming Console is in RUN mode when PC power is turned ON, any program in Program Memory will be executed, possibly causing a PC-controlled system to begin operation.

The following sequence of operations must be performed before beginning initial program input.

- 1, 2, 3...**
1. Be sure that the PC is OFF.
 2. Connect the Programming Console to the CPU Unit's peripheral port. See *4-2-3 Connecting the Programming Console* for details. (The CPU Unit's Communications Switch setting has no effect on communications with the Programming Console.)
 3. Set the mode switch to PROGRAM mode.
 4. Turn ON the PC.
 5. Enter the password. See *4-2-5 Entering the Password* for details.
 6. Clear (All Clear) the PC's memory. See *4-3-2 Clearing Memory* for details.
 7. Read and clear all errors and messages. See *4-3-5 Reading/Clearing Error Messages* for details.
 8. Start programming.

4-2-5 Entering the Password

To gain access to the PC's programming functions, you must first enter the password. The password prevents unauthorized access to the program.

The PC prompts you for a password when PC power is turned on or, if PC power is already on, after the Programming Console has been connected to the PC. To gain access to the system when the "Password!" message appears, press CLR and then MONTR. Then press CLR to clear the display.

If the Programming Console is connected to the PC when PC power is already on, the first display below will indicate the mode the PC was in before the Programming Console was connected. **Ensure that the PC is in PROGRAM mode before you enter the password.** When the password is entered, the PC will shift to the mode set on the mode switch, causing PC operation to begin if the mode is set to RUN or MONITOR with the mode switch after entering the password.



Indicates the mode set by the mode selector switch.

4-3 Programming Console Operations

4-3-1 Overview

The following table lists the programming and monitoring operations that can be performed from a Programming Console. Refer to the rest of this section for details on operational procedures.

Name	Function	Page
Clearing memory	Clears all or part of the Program Memory and any data areas that are not read-only, as well as the contents of the Programming Console's memory.	91
Clearing memory completely	Clears all of memory, including the user program, PC Setup, all data areas, and the I/O comment area (set with version 2.0 or later of CX-Programmer).	92
Reading UM allocation information	Reads the I/O comment area and user program area capacities when an I/O comment area has been set with version 2.0 or later of CX-Programmer.	92
Reading/clearing error messages	Displays and clears error messages and displays MESSAGE instruction messages.	92
Buzzer operation	Turns ON and OFF the buzzer that sounds when Programming Console keys are pressed.	93
Setting a program memory address	Sets the specified program memory address when reading, writing, inserting and deleting programs.	94
Reading a program memory address/monitoring bit status	Reads the contents of the Program Memory. Displays the status of the currently displayed bit in PROGRAM and MONITOR modes.	94
Instruction search	Finds occurrences of the specified instruction in the program.	98
Bit operand search	Finds occurrences of the specified operand bit in the program.	98
Inserting and deleting instructions	Inserts or deletes instructions from the program.	99
Entering or editing programs	Overwrites the contents of the current Program Memory to either input a program for the first time or to change a program that already exists.	95
Checking the program	Checks for programming errors and displays the program address and error when errors are found.	100
Bit, digit, word monitor	Monitors the status of up to 16 bits and words, although only 3 can be shown on the display at one time.	101
Multiple address monitor	Monitors the status of up to 6 bits and words simultaneously.	102
Differentiation monitor	Monitors ON-to-OFF or OFF-to-ON changes in the status of a particular bit.	103
Binary monitor	Monitors the ON/OFF status of any word's 16 bits.	103
Three-word monitor	Monitors the status of three consecutive words.	104
Signed decimal monitor	Converts the contents of the specified word from signed hexadecimal (two's complement format) to signed decimal for display.	105
Unsigned decimal monitor	Converts hexadecimal data in a word to unsigned decimal for display.	105
Three-word data modification	Changes the contents of one or more of the 3 consecutive words displayed in the Three-word Monitor operation.	106
Changing timer, counter SV 1	Changes the SV of a timer or counter.	106
Changing timer, counter SV 2	Makes fine adjustment changes to the SV of the timer or counter.	107
Hexadecimal, BCD data modification	Changes the BCD or hexadecimal value of a word being monitored.	107
Binary data modification	Changes the status of a word's bits when the word is being monitored.	108
Signed decimal data modification	Changes the decimal value of a word being monitored as signed decimal data within a range of -32,768 to 32,767. The contents of the specified word are converted automatically to signed hexadecimal (two's complement format.)	109
Unsigned decimal data modification	Changes the decimal value of a word being monitored as unsigned decimal data within a range of 0 to 65,535. A change to hexadecimal data is made automatically.	110
Force set/reset	Forces bits ON (force set) or OFF (force reset.)	110
Clear force set/reset	Restores the status of all bits which have been force set of reset.	111

Name	Function	Page
Hex-ASCII display change	Converts word data displays back and forth between 4-digit hexadecimal data and ASCII.	111
Displaying the cycle time	Displays the current average cycle time (scan time.)	112

4-3-2 Clearing Memory

This operation is used to clear all or part of the Program Memory and data areas, as well as the contents of the Programming Console's memory. This operation is possible in PROGRAM mode only.

RUN	MONITOR	PROGRAM
No	No	OK

Before beginning to program for the first time or when installing a new program, clear all areas.

All Clear

The following procedure is used to clear memory completely, including the program, all data areas, counter PVs, Data Memory, and the PC Setup (DM 6600 to DM 6655).

- 1, 2, 3... 1. Press the CLR Key to bring up the initial display.
2. Press the SET, NOT and then the RESET Key to begin the operation.

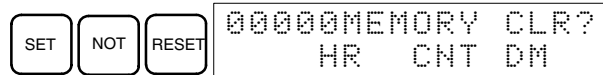

3. Press the MONTR Key to clear memory.

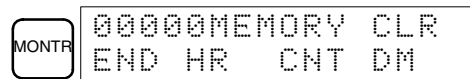

Caution The PC Setup (DM 6600 through DM 6655) will be cleared when this operation is performed.

Partial Clear

It is possible to retain the data in specified areas or part of the Program Memory. To retain the data in the HR, TC, or DM Areas, press the appropriate key after pressing SET, NOT, and RESET. Any data area that still appears on the display will be cleared when the MONTR Key is pressed.

The HR Key is used to specify both the AR and HR Areas, the CNT Key is used to specify the entire timer/counter area, and the DM Key is used to specify the DM Area.

It is also possible to retain a portion of the Program Memory from the first memory address to a specified address. After designating the data areas to be retained, specify the first Program Memory address to be cleared. For example, input 030 to leave addresses 000 to 029 untouched, but to clear addresses from 030 to the end of Program Memory.

As an example, follow the procedure below to retain the timer/counter area and Program Memory addresses 000 through 122:

- 1, 2, 3... 1. Press the CLR Key to bring up the initial display.
2. Press the SET, NOT, and then the RESET Key to begin the operation.
3. Press the CNT Key to remove the timer/counter area from the data areas shown on the display. (Counter PVs will not be cleared.)

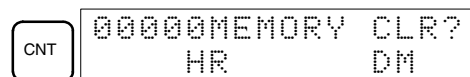

4. Press 123 to specify 123 as the starting program address.

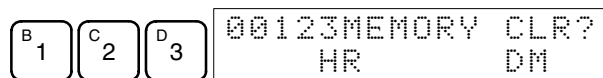

5. Press the MONTR Key to clear the specified regions of memory.

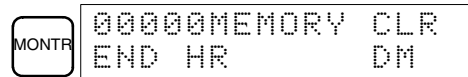

4-3-3 Clearing Memory Completely

This operation is used to clear all of memory, including the user program, PC Setup, all data areas, and the I/O comment area (set with version 2.0 or later of CX-Programmer).

RUN	MONITOR	PROGRAM
No	No	OK

The I/O comment function was supported for the CPM1A starting from version 2.0 of CX-Programmer. This operation must be used to delete the I/O comment area. The contents of the I/O comment area will be deleted and the area size will be returned to the default value of 2.0 Kwords.

Key Sequence

Follow the procedure below to clear memory completely.

- 1, 2, 3... 1. Press the CLEAR, SET, NOT, RESET, and then the EXT Key to begin the operation.



2. Press the MONTR Key to clear memory completely.

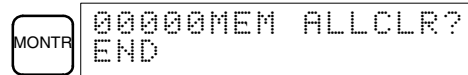

This operation must be used when it is necessary to clear the program and I/O comment area. There are no other Programming Console operation that can be used to clear the I/O comment area.

4-3-4 Reading UM Allocation Information

This operation is used to read the I/O comment area and ladder program area capacities when an I/O comment area has been set with version 2.0 or later of CX-Programmer.

RUN	MONITOR	PROGRAM
OK	OK	OK

Refer to the *CX-Programmer User Manual* (version 2.0 or later) for information on changing the size of the I/O comment area.

Key Sequence

Press the CLR, FUN and then the VER Key to display the I/O comment area and ladder program area capacities.

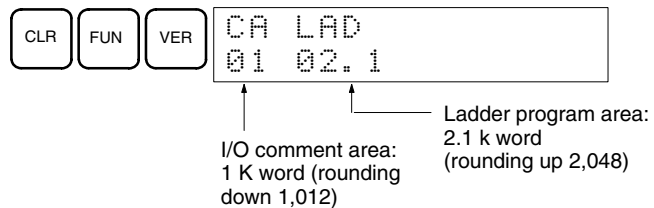

4-3-5 Reading/Clearing Error Messages

This operation is used to display and clear error messages. It is possible to display and clear non-fatal errors and MESSAGE instruction messages in any mode, but fatal errors can be cleared in PROGRAM mode only.

RUN	MONITOR	PROGRAM
OK	OK	OK

Before inputting a new program, any error messages recorded in memory should be cleared. It is assumed here that the causes of any of the errors for which error messages appear have already been taken care of. If the buzzer sounds when an attempt is made to clear an error message, eliminate the cause of the error, and then clear the error message. (Refer to *Section 5 Test Runs and Error Processing* for troubleshooting information.)

Key Sequence

Follow the procedure below to display and clear messages.

- 1, 2, 3...**
1. Press the CLR Key to bring up the initial display.
 2. Press the FUN and then the MONTR Key to begin the operation. If there are no messages, the following display will appear:

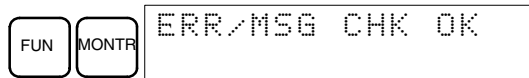

If there are messages, the most serious message will be displayed when the MONTR Key is pressed. Pressing MONTR again will clear the present message and display the next most serious error message. Continue pressing MONTR until all messages have been cleared. These are some examples of error messages:

A memory error:

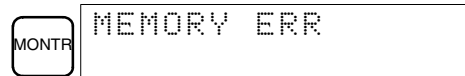

A system error:

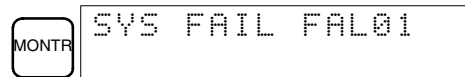

A message (displayed with MSG(46)):

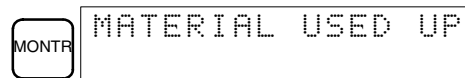

All messages cleared:

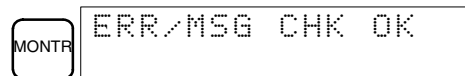

4-3-6 Buzzer Operation

This operation is used to turn ON and OFF the buzzer that sounds when Programming Console keys are pressed. This buzzer will also sound whenever an error occurs during PC operation. Buzzer operation for errors is not affected by this setting.

This operation is possible in any mode.

RUN	MONITOR	PROGRAM
OK	OK	OK

Key Sequence

Follow the procedure below to turn the key-input buzzer on and off.

- 1, 2, 3...**
1. Press the CLR, SHIFT, and then the CLR Key to bring up the mode display. In this case the PC is in PROGRAM mode and the buzzer is ON.

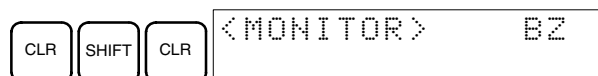

2. Press the SHIFT and then the 1 Key to turn off the buzzer.

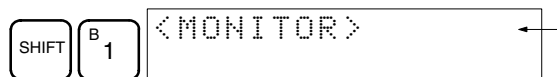

The buzzer will not sound when "BZ" is not displayed.

3. Press the SHIFT and then the 1 Key again to turn the buzzer back ON.



4-3-7 Setting and Reading a Program Memory Address and Monitoring I/O Bit Status

This operation is used to display the specified program memory address and is possible in any mode. In the RUN or MONITOR mode, the I/O bit status of bits in the program will be displayed.

RUN	MONITOR	PROGRAM
OK	OK	OK

When inputting a program for the first time, it is generally written to Program Memory starting from address 000. Because this address appears when the display is cleared, it is not necessary to specify it.

When inputting a program starting from other than 000 or to read or modify a program that already exists in memory, the desired address must be designated.

- 1, 2, 3...**
1. Press the CLR Key to bring up the initial display.
 2. Input the desired address. It is not necessary to input leading zeroes.

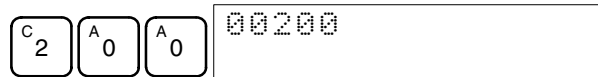

3. Press the Down Arrow Key.

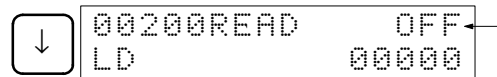

In the RUN or MONITOR mode, ON/OFF status of the bit will be displayed.

Note The ON/OFF status of any displayed bit will be shown if the PC is in RUN or MONITOR mode.

4. Press the Up and Down Arrow Keys to scroll through the program.

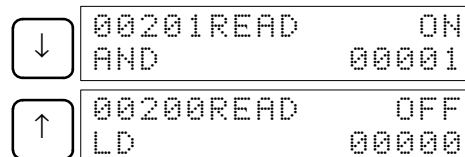

Pressing the MONTR Key will change to the I/O monitor display. Bits can be force-set or force-reset from the I/O monitor display. Press the CLR Key to return to I/O bit status monitoring of the initial address.

4-3-8 Entering or Editing Programs

This operation is used enter or edit programs. It is possible in PROGRAM mode only.

RUN	MONITOR	PROGRAM
No	No	OK

The same procedure is used to either input a program for the first time or to change a program that already exists. In either case, the current contents of Program Memory is overwritten.

The program shown in the following diagram will be entered to demonstrate this operation.

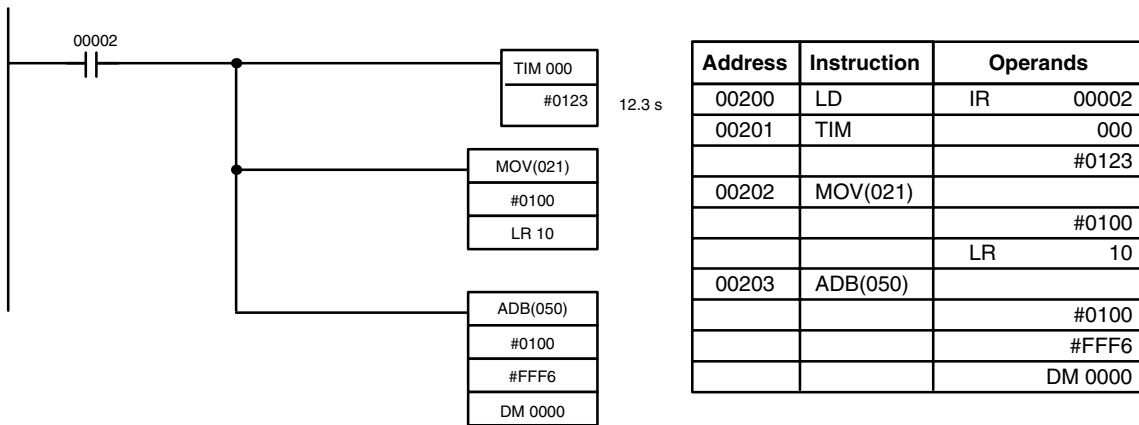

- 1, 2, 3...**
1. Press the CLR Key to bring up the initial display.
 2. Specify the address where the program will begin.
 3. Input the address where the program will begin and press the Down Arrow Key. It is not necessary to input leading zeroes.

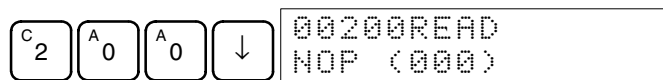

4. Input the first instruction and operand.

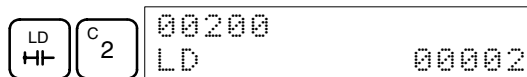

5. Press the WRITE Key to write the instruction to Program Memory. The next program address will be displayed.

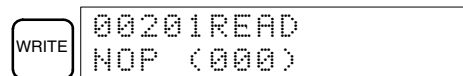

If a mistake was made inputting the instruction, press the Up Arrow Key to return to the previous program address and input the instruction again. The mistaken instruction will be overwritten

To specify the Completion Flag for a timer or counter, press the LD, AND, OR, or NOT Key followed by the TIM or CNT Key, and then input the timer/counter number last.

6. Input the second instruction and operand. (In this case it isn't necessary to enter the timer number, because it's 000.) Press the WRITE Key to write the instruction to Program Memory.

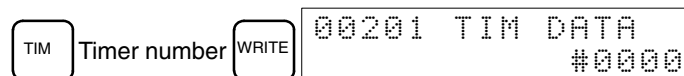

- Input the second operand (123 to specify 12.3 seconds) and press the WRITE Key. The next program address will be displayed.



If a mistake was made inputting the operand, press the Up Arrow Key to return to display the mistaken operand and input the operand again.

- Note**
- Counters are input in the same basic way as timers except the CNT Key is pressed instead of the TIM Key.
 - Timer and counter SVs are input in BCD, so it isn't necessary to press the CONT/# Key.

- Input the third instruction (MOVE) and its operands. First input the instruction by pressing the FUN Key and then the function code (21 in this case).

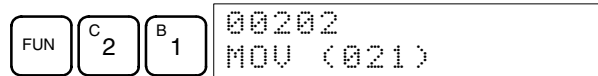

To input the differentiated version of an instruction, press the NOT Key after the function code (FUN 2 1 NOT). The "@" symbol will be displayed next to differentiated instructions. Press the NOT Key again to change back the instruction back to a non-differentiated instruction. The "@" symbol will disappear.

To change an instruction after it has been entered, simply scroll through the program until the desired instruction is displayed and press the NOT Key. The "@" symbol should be displayed next to the instruction.

- Press the WRITE Key to write the instruction to Program Memory. The input display for the first operand will be displayed.

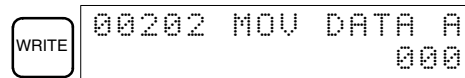

• Writing Hexadecimal, BCD Constant

- Input the first operand.

The operands of MOV(21) are normally word addresses, but a constant can be input by pressing the CONT/# Key first. When the CONT/# Key is pressed, the display will change to "#0000," indicating that a constant can be entered.

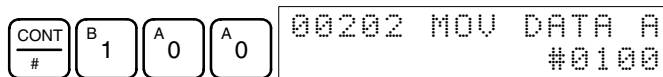

Press the WRITE Key to write the instruction to Program Memory. The input display for the second operand will appear.

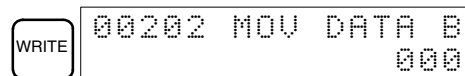

• Writing a Word Address

- Input the second operand.

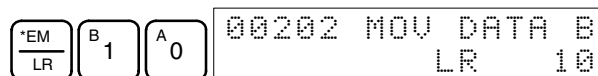

Press the WRITE Key to write the instruction to Program Memory. The next program address will be displayed.

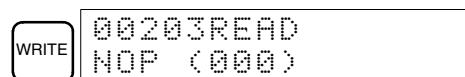

- Note** When the default display value is "000", a word address can be input immediately without pressing the Shift and CH/# Keys.

12. Input the next instruction (ADB).



Press the WRITE Key to write the instruction to Program Memory.

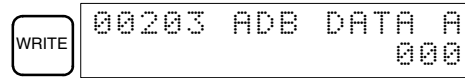

• Writing an Unsigned Decimal Number

13. The first operand is input as an unsigned integer.

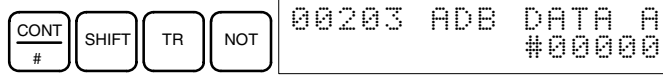

Input the value of the operand from 0 to 65535.

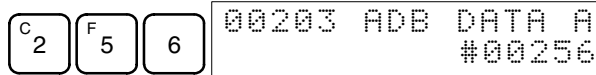

Note If an erroneous input is made, press the CLR Key to restore the status prior to the input. Then enter the correct input.

14. Restore the hexadecimal display.

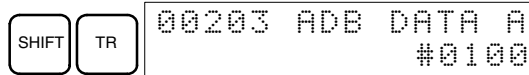

Note If an input is made outside of the permissible range, a buzzer will sound and the hexadecimal display will not be displayed.

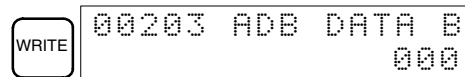

15. The second operand is input as a signed integer.

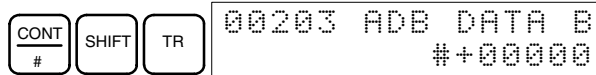

Input the value of the operand from -32,768 to 32,767. Use the SET Key to input a positive number, and use the RESET Key to input a negative number.

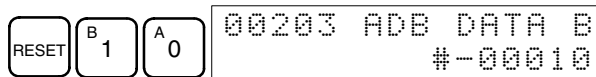

Note If an erroneous input is made, press the CLR Key to restore the status prior to the input. Then enter the correct input.

16. Restore the hexadecimal display.

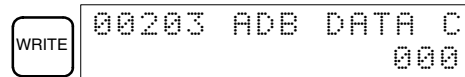
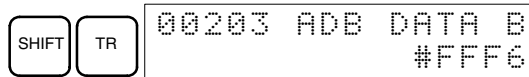

• Writing a Word Address (DM 0000)

17. Input the final operand and then press the WRITE Key. (It isn't necessary to input leading zeroes.)

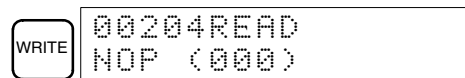
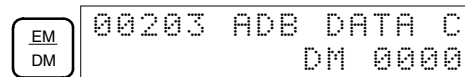

4-3-9 Instruction Search

This operation is used to find occurrences of the specified instruction in the program and is possible in any mode.

RUN	MONITOR	PROGRAM
OK	OK	OK

The ON/OFF status of any displayed bit will be shown if the PC is in RUN or MONITOR mode.

- 1, 2, 3...
1. Press the CLR Key to bring up the initial display.
 2. Input the address from which the search will begin and press the Down Arrow Key. It is not necessary to input leading zeroes.

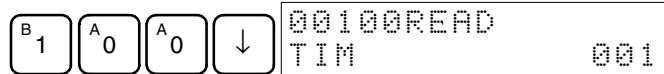

3. Input the instruction to be found and press the SRCH Key. In this case, the search is for OUT 01000.

In this case, the next OUT 01000 instruction is at address 200, as shown below.



4. Press the Down Arrow Key to display the instruction's operands or press the SRCH Key to search for the next occurrence of the instruction.
5. The search will continue until an END instruction or the end of Program Memory is reached. In this case, an END instruction was reached at address 397.

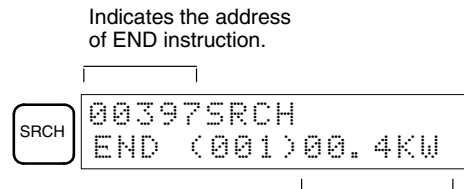

Indicates the address of END instruction.

Indicates the amount used by the user program in units of 0.1 Kwords.

4-3-10 Bit Operand Search

This operation is used to find occurrences of the specified operand bit in the program and is possible in any mode.

RUN	MONITOR	PROGRAM
OK	OK	OK

The ON/OFF status of any displayed bit will be shown if the PC is in RUN or MONITOR mode.

- 1, 2, 3...
1. Press the CLR Key to bring up the initial display.
 2. Input the operand address. It is not necessary to input leading zeroes.

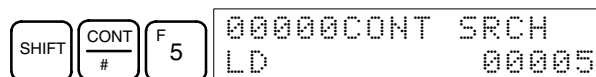

3. Press the SRCH Key to begin the search.

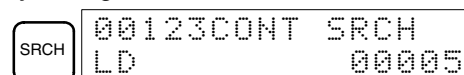

4. Press the SRCH Key to search for the next occurrence of the operand bit.

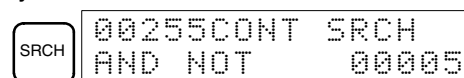

- The search will continue until an END instruction or the end of Program Memory is reached. In this case, an END instruction was reached.

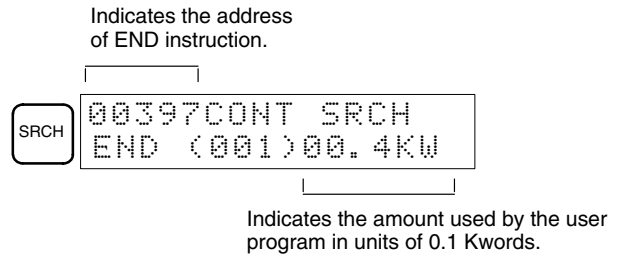

4-3-11 Inserting and Deleting Instructions

This operation is used to insert or delete instructions from the program. It is possible in PROGRAM mode only.

RUN	MONITOR	PROGRAM
No	No	OK

To demonstrate this operation, an IR 00105 NO condition will be inserted at program address 00206 and an IR 00103 NO condition deleted from address 00205, as shown in the following diagram.

Original Program

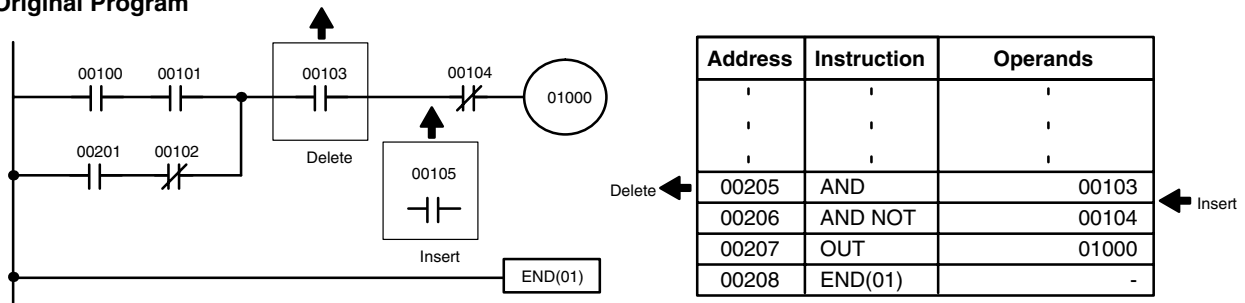

Insertion

Follow the procedure below to insert the IR 00105 NO condition at address 00206.

- 1, 2, 3... 1. Press the CLR Key to bring up the initial display.
2. Input the address where the NO condition will be inserted and press the Down Arrow Key. It is not necessary to input leading zeroes.

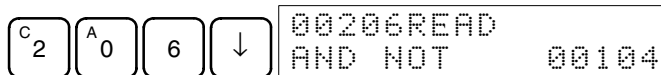

3. Input the new instruction and press the INS Key.



4. Press the Down Arrow Key to insert the new instruction.

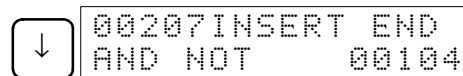

Note For instructions that require more operands (such as set values), input the operands and then press the WRITE Key.

Deletion

Follow the procedure below to delete the IR 00103 NO condition at address 00205.

- 1, 2, 3... 1. Press the CLR Key to bring up the initial display.
2. Input the address where the NO condition will be deleted and press the Down Arrow Key. It is not necessary to input leading zeroes.

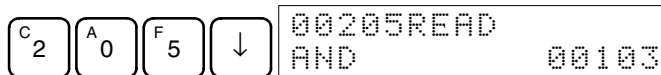

3. Press the DEL Key.

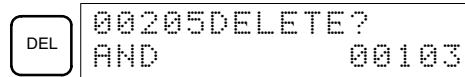

4. Press the Up Arrow Key to delete the specified instruction.

If the instruction has more operands, the operands will be deleted automatically with the instruction.



After completing the insertion and deletion procedures, use the Up and Down Arrow Keys to scroll through the program and verify that it has been changed correctly, as shown in the following diagram.

Corrected Program

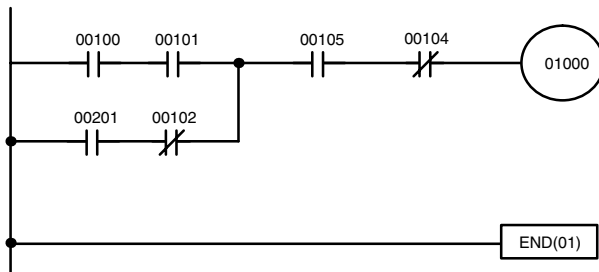

Address	Instruction	Operands
00205	AND	00105
00206	AND NOT	00104
00207	OUT	01000
00208	END(01)	-

4-3-12 Checking the Program

This operation checks for programming errors and displays the program address and error when errors are found. It is possible in PROGRAM mode only.

RUN	MONITOR	PROGRAM
No	No	OK

1, 2, 3...

1. Press the CLR Key to bring up the initial display.
2. Press the SRCH Key. An input prompt will appear requesting the desired check level.



3. Input the desired check level (0, 1, or 2). The program check will begin when the check level is input, and the first error found will be displayed.

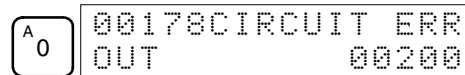

Note Refer to 5-5 Programming Errors for details on check levels and the errors that may be detected when the program is checked.

4. Press the SRCH Key to continue the search. The next error will be displayed. Continue pressing the SRCH Key to continue the search.

The search will continue until an END instruction or the end of Program Memory is reached. A display like this will appear if the end of Program Memory is reached:

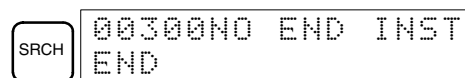

A display like this will appear if an END instruction is reached:

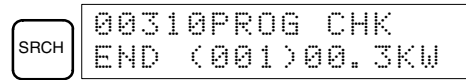

No more errors exist if the END instruction is displayed.

If errors are displayed, edit the program to correct the errors and check the program again. Continue checking the program by pressing the SRCH Key again until all errors have been corrected.

4-3-13 Bit, Digit, Word Monitor

This operation is used to monitor the status of up to 16 bits and words, although only 3 can be shown on the display at any one time. Operation is possible in any mode.

RUN	MONITOR	PROGRAM
OK	OK	OK

Program Read then Monitor

When a program address is being displayed, the status of the bit or word in that address can be monitored by pressing the MONTR Key.

1, 2, 3...

1. Press the CLR Key to bring up the initial display.
2. Input the desired program address and press the Down Arrow Key.

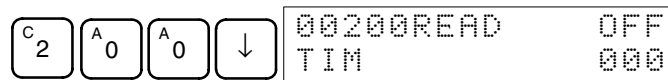

3. Press the MONTR Key to begin monitoring.

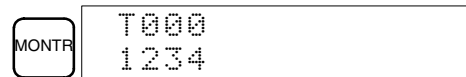

If the status of a bit is being monitored, that bit's status can be changed using the Force Set/Reset operation. Refer to 4-3-25 Force Set, Reset for details.

If the status of a word is being monitored, that word's value can be changed using the Hexadecimal/BCD Data Modification operation. Refer to 4-3-21 Hexadecimal, BCD Data Modification, 4-3-22 Binary Data Modification, 4-3-23 Signed Decimal Data Modification, and 4-3-24 Unsigned Decimal Data Modification for details.

4. Press the CLR Key to end monitoring.

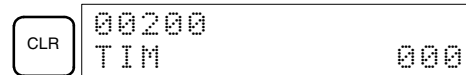

Bit Monitor

Follow the procedure below to monitor the status of a particular bit.

1, 2, 3...

1. Press the CLR Key to bring up the initial display.
2. Input the bit address of the desired bit and press the MONTR Key.

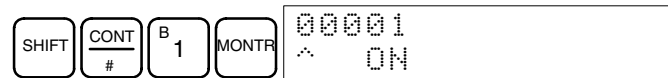

The Up or Down Arrow Key can be pressed to display the status of the previous or next bit.

The displayed bit's status can be changed using the Force Set/Reset operation. Refer to Refer to 4-3-25 Force Set, Reset for details.

3. Press the CLR Key to end monitoring.

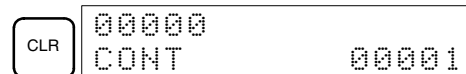

Word Monitor

Follow the procedure below to monitor the status of a particular word.

1, 2, 3...

1. Press the CLR Key to bring up the initial display.

2. Input the word address of the desired word.

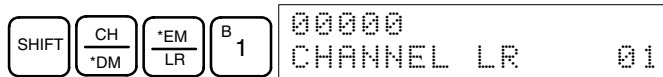

3. Press the MONTR Key to begin monitoring.



The Up or Down Arrow Key can be pressed to display the status of the previous or next word.

The displayed word's status can be changed using the Hexadecimal/BCD Data Modification operation. Refer to Refer to 4-3-21 Hexadecimal, BCD Data Modification, 4-3-22 Binary Data Modification, 4-3-23 Signed Decimal Data Modification, and 4-3-24 Unsigned Decimal Data Modification for details.

4. Press the CLR Key to end monitoring.

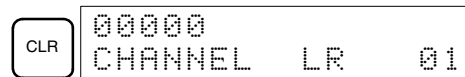

Note The operating mode can be changed without altering the current monitor display by holding down the SHIFT Key and then changing the operating mode.

Multiple Address Monitoring

The status of up to six bits and words can be monitored simultaneously, although only three can be shown on the display at any one time.

1, 2, 3...

1. Press the CLR Key to bring up the initial display.
2. Input the address of the first bit or word and press the MONTR Key.

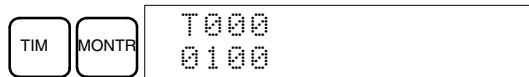

3. Repeat step 2 up to 6 times to display the next addresses to be monitored.

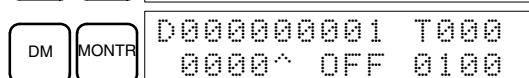
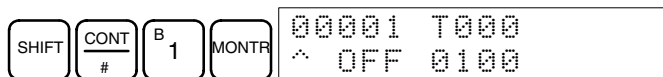

If 4 or more bits and words are being monitored, the bits and words that do not appear on the display can be displayed by pressing the MONTR Key. If the MONTR Key is pressed alone, the display will shift to the right.

If more than six bits and/or words are input, monitoring of the bit or word input first will be canceled.

4. Press the CLR Key to stop monitoring the leftmost bit or word and clear it from the display.

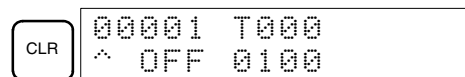

5. Press the SHIFT and CLR Keys to end monitoring altogether.

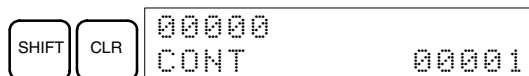

Note Press the SHIFT Key, CLR Key, and then CLR Key again to return to the initial Programming Console display with the multiple address monitoring state unchanged. Press the SHIFT Key and then the MONTR Key from the initial display to return to the multiple address monitoring state. The monitoring states can be retained for 6 bits and words.

The operating mode can be changed without altering the current monitor display by holding down the SHIFT Key and then changing the operating mode.

4-3-14 Differentiation Monitor

This operation is used to monitor the up (OFF-to-ON) or down (ON-to-OFF) differentiation status of a particular bit. When detected, the up or down differentiation will be displayed and the buzzer will sound. It is possible in any mode.

RUN	MONITOR	PROGRAM
OK	OK	OK

- 1, 2, 3... 1. Monitor the status of the desired bit according to the procedure described in 4-3-13 Bit, Digit, Word Monitor. If 2 or more bits are being monitored, the desired bit should be leftmost on the display.

In this case the differentiation status of LR 00 will be monitored.

```
L0000000001H0000
^ OFF^ OFF^ OFF
```

2. To specify up-differentiation monitoring, press the SHIFT and then the Up Arrow Key. The symbols "U@" will appear.

SHIFT ↑ L0000000001H0000
U@OFF^ OFF^ OFF

Indicates waiting for the bit to turn ON.

To specify down-differentiation monitoring, press the SHIFT and then the Down Arrow Key. The symbols "D@" will appear.

SHIFT ↓ L0000000001H0000
D@OFF^ OFF^ OFF

3. The buzzer will sound when the specified bit goes from off to on (for up-differentiation) or from on to off (for down-differentiation).

```
L0000000001H0000
^ ON^ OFF^ OFF
```

Note The buzzer will not sound if it has been turned off.

4. Press the CLR Key to end differentiation monitoring and return to the normal monitoring display.

CLR L0000000001H0000
^ OFF^ OFF^ OFF

4-3-15 Binary Monitor

This operation is used to monitor the ON/OFF status of any word's 16 bits. It is possible in any mode.

RUN	MONITOR	PROGRAM
OK	OK	OK

- 1, 2, 3... 1. Monitor the status of the desired word according to the procedure described in 4-3-13 Bit, Digit, Word Monitor. The desired word should be leftmost on the display if 2 or more words are being monitored.

```
c010
0000
```

(Word monitor)

2. Press the SHIFT and then the MONTR Key to begin binary monitoring. The ON/OFF status of the selected word's 16 bits will be shown along the bottom of the display. A 1 indicates a bit is on, and a 0 indicates it is off.

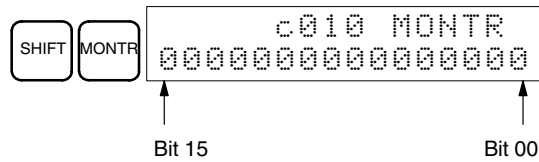

The status of force-set bits is indicated by "S," and the status of a force-reset bits is indicated by "R," as shown below.

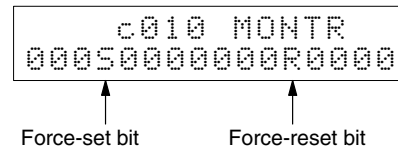

- Note**
- a) The status of displayed bits can be changed at this point. Refer to 4-3-22 Binary Data Modification for details.
 - b) The Up or Down Arrow Key can be pressed to display the status of the previous or next word's bits.

3. Press the CLR Key to end binary monitoring and return to the normal monitoring display.

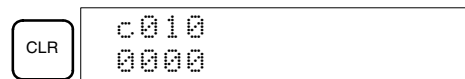

4-3-16 Three-word Monitor

This operation is used to monitor the status of three consecutive words. It is possible in any mode.

RUN	MONITOR	PROGRAM
OK	OK	OK

- 1, 2, 3... 1. Monitor the status of the first of the three words according to the procedure described in 4-3-13 Bit, Digit, Word Monitor.
If 2 or more words are being monitored, the desired first word should be left-most on the display.



(Word monitor)

2. Press the EXT Key to begin 3-word monitoring. The status of the selected word and the next two words will be displayed, as shown below. In this case, DM 0000 was selected.

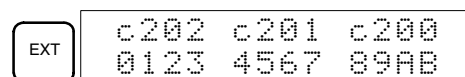

The Up and Down Arrow Keys can be used to shift one address up or down. The status of the displayed words can be changed at this point. Refer to 4-3-19 Three-word Data Modification.

The display can be changed to display ASCII text, which is useful when three consecutive words containing an ASCII message are displayed. Refer to 4-3-27 Hex-ASCII Display Change.

- Press the CLR Key to end 3-word monitoring and return to the normal monitoring display. The rightmost word on the 3-word monitor display will be monitored.

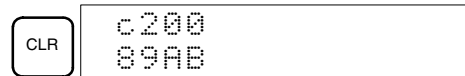

Note The operating mode can be changed without altering the current monitor display by holding down the SHIFT Key and then changing the operating mode.

4-3-17 Signed Decimal Monitor

This operation converts the contents of the displayed word from signed hexadecimal (two's complement format) to signed decimal for display. The operation can be executed while using I/O monitoring, multiple address monitoring or 3-word monitoring.

RUN	MONITOR	PROGRAM
OK	OK	OK

- Monitor the word that is to be used for decimal monitor with sign. During multiple address monitoring, the leftmost word will be converted.

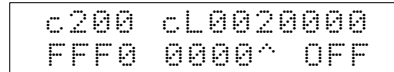

(Multiple address monitor)

- Press the SHIFT and TR Keys to display the leftmost word as signed decimal.

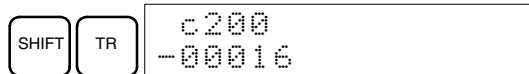

At this point, the contents of the displayed word can be changed with a signed-decimal input. Refer to 4-3-23 *Signed Decimal Data Modification*.

- Press the CLR Key or the SHIFT and TR Keys to end the unsigned decimal display and return to normal monitoring.

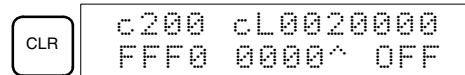

4-3-18 Unsigned Decimal Monitor

This operation is used to convert hexadecimal data in a word to unsigned decimal for display. The operation can be executed while using I/O monitoring, multiple address monitoring or 3-word monitoring.

RUN	MONITOR	PROGRAM
OK	OK	OK

- Monitor the word that is to be used for decimal monitor without sign. During multiple address monitoring, the leftmost word will be converted.

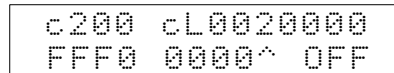

Multiple address monitoring

- Press the SHIFT Key, TR Key, and then NOT Key to display the leftmost word as unsigned decimal.

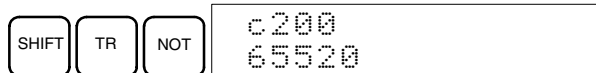

At this point, the contents of the displayed word can be changed with an unsigned-decimal input. Refer to 4-3-24 *Unsigned Decimal Data Modification*.

- Press the CLR Key or the SHIFT and TR Keys to end the unsigned decimal display and return to normal monitoring.



4-3-19 Three-word Data Modification

This operation is used to change the contents of one or more of the 3 consecutive words displayed in the Three-word Monitor operation. It is possible in MONITOR or PROGRAM mode only.

RUN	MONITOR	PROGRAM
No	OK	OK

Caution Before changing the contents of I/O memory, be sure that the changes will not cause equipment to operate unexpectedly or dangerously. In particular, take care when changing the status of output bits. The PC continues to refresh I/O bits even if the PC is in PROGRAM mode, so devices connected to output points on the CPU Unit or Expansion I/O Units may operate unexpectedly.

- 1, 2, 3... 1. Monitor the status of the desired words according to the procedure described 4-3-16 *Three-word Monitor*.

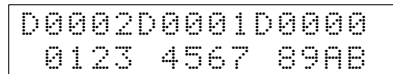

(Three-word monitor)

2. Press the CHG Key to begin 3-word data modification. The cursor will appear next to the contents of the leftmost word.

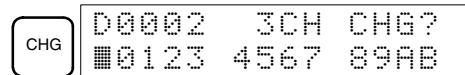

3. Input the new value for the leftmost word on the display and press the CHG Key if more changes will be made.
(Input the new value and press the WRITE Key to write the changes in memory if no more changes will be made.)

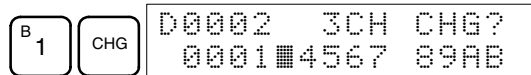

4. Input the new value for the middle word on the display and press the CHG Key if the rightmost word will be changed. Input the new value and press the WRITE Key to write the changes in memory if the rightmost word will not be changed. (In this case, it will not.)

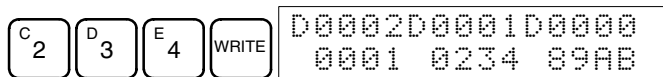

Note If the CLR Key is pressed before the WRITE Key, the operation will be cancelled and the 3-word monitor display will return without any changes in data memory.

4-3-20 Changing Timer, Counter SV

There are two operations that can be used to change the SV of a timer or counter. They are possible in MONITOR or PROGRAM mode only. In MONITOR mode, the SV can be changed while the program is being executed.

RUN	MONITOR	PROGRAM
No	OK	OK

The timer or counter SV can be changed either by inputting a new value or by incrementing or decrementing the current SV.

Inputting a New SV Constant

This operation can be used to input a new SV constant, as well as to change an SV from a constant to a word address designation and vice versa. The following examples show how to input a new SV constant and how to change the SV from a constant to an address.

- 1, 2, 3... 1. Press the CLR Key to bring up the initial display.
2. Display the desired timer or counter.

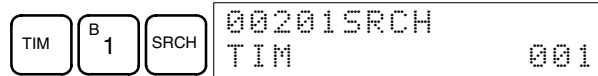

3. Press the Down Arrow Key and then the CHG Key.

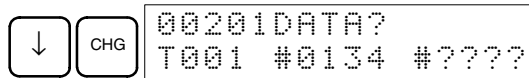

4. At this point a new SV constant can be input or the SV constant can be changed to a word address designation

- a) To input a new SV constant, input the constant and press the WRITE Key.

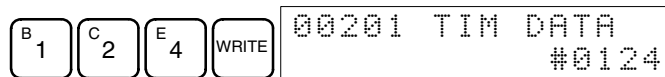

- b) To change to a word address designation, input the word address and press the WRITE Key.



Incrementing and Decrementing a Constant

This operation can be used to increment and decrement an SV constant. It is possible only when the SV has been entered as a constant.

- 1, 2, 3... 1. Press the CLR Key to bring up the initial display.
2. Display the desired timer or counter.

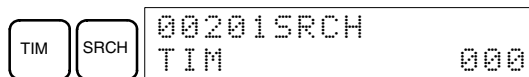

3. Press the Down Arrow, CHG, and then the EXT Key.

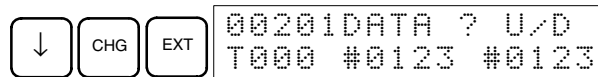

The constant on the left is the old SV and the constant on the right will become the new SV constant in step 5.

4. Press the Up Arrow Key to decrement and the Down Arrow Keys to increment the constant on the right. (In this case the SV is incremented once.)

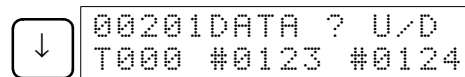

5. Press the CLR Key twice to change the timer's SV to the new value.

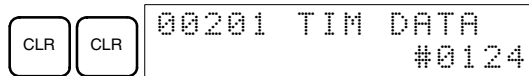

4-3-21 Hexadecimal, BCD Data Modification

This operation is used to change contents of a memory address or the present value of a timer/counter being monitored using the procedure described in 4-3-13 Bit, Digit, Word Monitor. It is possible in MONITOR or PROGRAM mode only.

RUN	MONITOR	PROGRAM
No	OK	OK

Words SR 253 to SR 255 cannot be changed.

! Caution Before changing the contents of I/O memory, be sure that the changes will not cause equipment to operate unexpectedly or dangerously. In particular, take care when changing the status of output bits. The PC continues to refresh I/O bits even if the PC is in PROGRAM mode, so devices connected to output points on the CPU Unit or Expansion I/O Units may operate unexpectedly.

- 1, 2, 3...**
1. Monitor the status of the desired word according to the procedure described in 4-3-13 *Bit, Digit, Word Monitor*. If two or more words are being monitored, the desired word should be leftmost on the display.



2. Press the CHG Key to begin hexadecimal, BCD data modification.

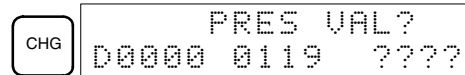

3. Input the new PV and press the WRITE Key to change the PV. The operation will end and the normal monitoring display will return when the WRITE Key is pressed.

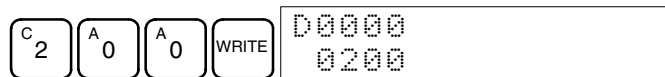

4-3-22 Binary Data Modification

This operation is used to change the status of a word's bits when the word is monitored using the procedure described in 4-3-15 *Binary Monitor*. It is possible in MONITOR or PROGRAM mode only.

RUN	MONITOR	PROGRAM
No	OK	OK

Bits SR 25300 to SR 25507 and timer/counter flags cannot be changed.

! Caution Before changing the contents of I/O memory, be sure that the changes will not cause equipment to operate unexpectedly or dangerously. In particular, take care when changing the status of output bits. The PC continues to refresh I/O bits even if the PC is in PROGRAM mode, so devices connected to output points on the CPU Unit or Expansion I/O Units may operate unexpectedly.

- 1, 2, 3...**
1. Monitor the status of the desired word according to the procedure described 4-3-15 *Binary Monitor*.

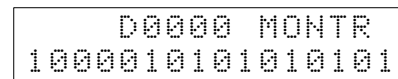

(Binary monitor)

2. Press the CHG Key to begin binary data modification.

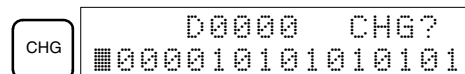

A flashing cursor will appear over bit 15. The cursor indicates which bit can be changed.

3. Three sets of keys are used to move the cursor and change bit status:
 - a) Use the Up and Down Arrow Keys to move the cursor to the left and right.

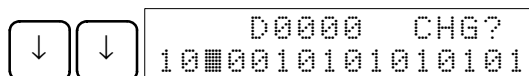

- b) Use the 1 and 0 Keys to change a bit's status to on or off. The cursor will move one bit to the right after one of these keys is pressed.

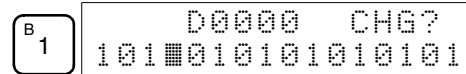

- c) Use the SHIFT and SET and SHIFT and RESET Keys to force-set or force-reset a bit's status. The cursor will move one bit to the right after one of these keys is pressed. The NOT Key will clear force-set or force-reset status.

Note Bits in the DM Area cannot be force-set or force-reset.

- Press the WRITE Key to write the changes in memory and return to the binary monitor.

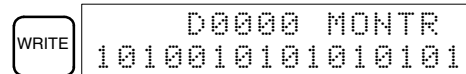

4-3-23 Signed Decimal Data Modification

This operation is used to change the decimal value of a word being monitored as signed decimal data, within a range of -32,768 to 32,767. The contents of the specified word are converted automatically to signed hexadecimal (two's complement format).

Words SR 253 to SR 255 cannot be changed.

RUN	MONITOR	PROGRAM
No	OK	OK

Caution Before changing the contents of I/O memory, be sure that the changes will not cause equipment to operate unexpectedly or dangerously. In particular, take care when changing the status of output bits. The PC continues to refresh I/O bits even if the PC is in PROGRAM mode, so devices connected to output points on the CPU Unit or Expansion I/O Units may operate unexpectedly.

- Monitor (signed decimal) the status of the word for which the present value is to be changed.



(Signed decimal monitor)

- Press the CHG Key to begin decimal data modification.



- Input the new PV and press the WRITE Key to change the PV. The operation will end and the signed-decimal monitoring display will return when the WRITE Key is pressed.

The PV can be set within a range of -32,768 and 32,767. Use the SET Key to input a positive number, and use the RESET Key to input a negative number.



If an erroneous input has been made, press the CLR Key to restore the status prior to the input. Then enter the correct input.

The buzzer will sound if a value outside the specified range is input, allowing no writing.

4-3-24 Unsigned Decimal Data Modification

This operation is used to change the decimal value of a word being monitored as unsigned decimal data, within a range of 0 to 65,535. A change into hexadecimal data is made automatically.

Words SR 253 to SR 255 cannot be changed.

RUN	MONITOR	PROGRAM
No	OK	OK

Caution Before changing the contents of I/O memory, be sure that the changes will not cause equipment to operate unexpectedly or dangerously. In particular, take care when changing the status of output bits. The PC continues to refresh I/O bits even if the PC is in PROGRAM mode, so devices connected to output points on the CPU Unit or Expansion I/O Units may operate unexpectedly.

- 1, 2, 3...** 1. Monitor (unsigned decimal) the status of the word for which the present value is to be changed.

(Unsigned decimal monitor)

2. Press the CHG Key to begin decimal data modification.

3. Input the new PV and press the WRITE Key to change the PV. The operation will end and the decimal-without-sign monitoring display will return when the WRITE Key is pressed.

The PV can be set within a range of 0 to 65,535.

If an erroneous input has been made, press the CLR Key to restore the status prior to the input. Then enter the correct input.

The buzzer will sound if a value outside the specified range is input, allowing no writing.

4-3-25 Force Set, Reset

This operation is used to force bits ON (force set) or OFF (force reset) and is useful when debugging the program or checking output wiring. It is possible in MONITOR or PROGRAM mode only.

RUN	MONITOR	PROGRAM
No	OK	OK

Caution Before changing the contents of I/O memory, be sure that the changes will not cause equipment to operate unexpectedly or dangerously. In particular, take care when changing the status of output bits. The PC continues to refresh I/O bits even if the PC is in PROGRAM mode, so devices connected to output points on the CPU Unit or Expansion I/O Units may operate unexpectedly.

- 1, 2, 3...** 1. Monitor the status of the desired bit according to the procedure described in 4-3-13 Bit, Digit, Word Monitor. If two or more words are being monitored, the desired bit should be leftmost on the display.

(Multiple address monitor)

2. Press the SET Key to force the bit ON or press the RESET Key to force the bit OFF.

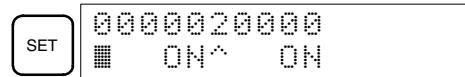

The cursor in the lower left corner of the display indicates that the force set/reset is in progress. Bit status will remain ON or OFF only as long as the key is held down; the original status will return one cycle after the key is released.

3. Press the SHIFT and SET Keys or SHIFT and RESET Keys to maintain the status of the bit after the key is released. In this case, the force-set status is indicated by an “S” and the force-reset status is indicated by an “R.”

To return the bit to its original status, press the NOT Key or perform the Clear Force Set/Reset operation. Refer to 4-3-26 Clear Force Set/Reset for details.

Forced status will also be cleared in the following cases:

- a) When the PC’s operating mode is changed (although the forced status will not be cleared when the mode is changed between PROGRAM and MONITOR if SR 25211 is ON)
- b) When the PC stops because a fatal error occurred
- c) When the PC stops because of a power interruption
- d) When the Clear Force Set/Reset Operation is performed

4-3-26 Clear Force Set/Reset

This operation is used to restore the status of all bits which have been force set or reset. It is possible in MONITOR or PROGRAM mode only.

RUN	MONITOR	PROGRAM
No	OK	OK



Caution

Before changing the contents of I/O memory, be sure that the changes will not cause equipment to operate unexpectedly or dangerously. In particular, take care when changing the status of output bits. The PC continues to refresh I/O bits even if the PC is in PROGRAM mode, so devices connected to output points on the CPU Unit or Expansion I/O Units may operate unexpectedly.

1, 2, 3...

1. Press the CLR Key to bring up the initial display.
2. Press the SET and then the RESET Key. A confirmation message will appear.

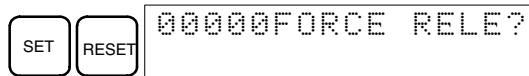

Note If you mistakenly press the wrong key, press CLR and start again from the beginning.

3. Press the NOT Key to clear the force-set/reset status of bits in all data areas.

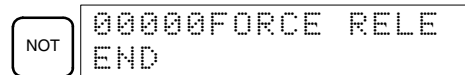

4-3-27 Hex-ASCII Display Change

This operation is used to convert word data displays back and forth between 4-digit hexadecimal data and ASCII. It is possible in any mode.

The displayed PV of the timer or counter cannot be changed.

RUN	MONITOR	PROGRAM
OK	OK	OK

- 1, 2, 3... 1. Monitor the status of the desired word(s) according to the procedure described in 4-3-13 Bit, Digit, Word Monitor. While the multiple addresses are being monitored, the leftmost word is subject to change.

```
D00000D00001
 4142 3031
```

(Multiple address monitor)

2. Press the TR Key to switch to ASCII display. The display will toggle between hexadecimal and ASCII displays each time the TR Key is pressed.

TR

```
D00000 D00001
"AB" 3031
```

TR

```
D00000D00001
 4142 3031
```

- Note**
1. A message contained in three words can be displayed by using ASCII display in combination with the 3-word monitor operation.
 2. The Hexadecimal, BCD Data Modification Operation can be used while displaying ASCII data. Input values in 4-digit hexadecimal.

4-3-28 Displaying the Cycle Time

This operation is used to display the current average cycle time (scan time). It is possible only in RUN or MONITOR mode while the program is being executed.

RUN	MONITOR	PROGRAM
OK	OK	No

- 1, 2, 3... 1. Press the CLR Key to bring up the initial display.
2. Press the MONTR Key to display the cycle time.

MONTR

```
000000SCAN TIME
          012.1MS
```

"MS" in the display indicates the unit "ms" for the cycle time.

There might be differences in displayed values when the MONTR Key is pressed repeatedly. These differences are caused by changing execution conditions.

4-4 Programming Example

This section demonstrates all of the steps needed to write a program with the Programming Console.

4-4-1 Preparatory Operations

Use the following procedure when writing a program to the CPM1A for the first time.

- 1, 2, 3... 1. Set the Programming Console's mode switch to PROGRAM mode and turn on the CPM1A's power supply. The password input display will appear on the Programming Console.



```
<PROGRAM>
PASSWORD!
```

2. Enter the password by pressing the CLR and then the MONTR Key.

CLR MONTR

```
<PROGRAM> BZ
```

3. Clear the CPM1A's memory by pressing the CLR, SET, NOT, RESET, and then the MONTR Key. Press the CLR Key several times if memory errors are displayed.

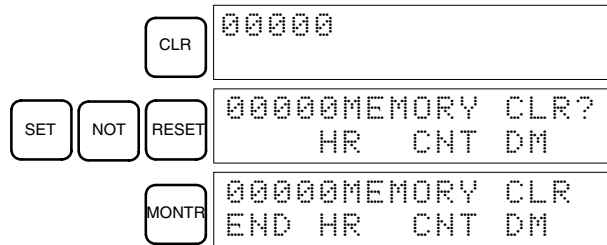

4. Display and clear error messages by pressing the CLR, FUN, and then the MONTR Key. Continue pressing the MONTR Key until all error messages have been cleared.

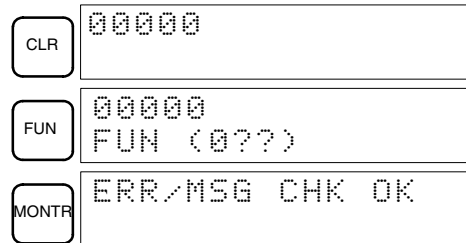

5. Press the CLR Key to bring up the initial programming display (program address 00000). The new program can be written at this point.

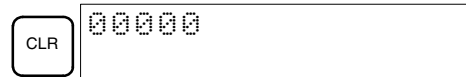

Caution Check the system thoroughly before starting or stopping the CPM1A to prevent any accidents that might occur when the program is first started.

4-4-2 Example Program

The following ladder program will be used to demonstrate how to write a program with the Programming Console. This program makes output IR 01000 flicker ON/OFF (one second ON, one second OFF) ten times after input IR 00000 is turned ON.

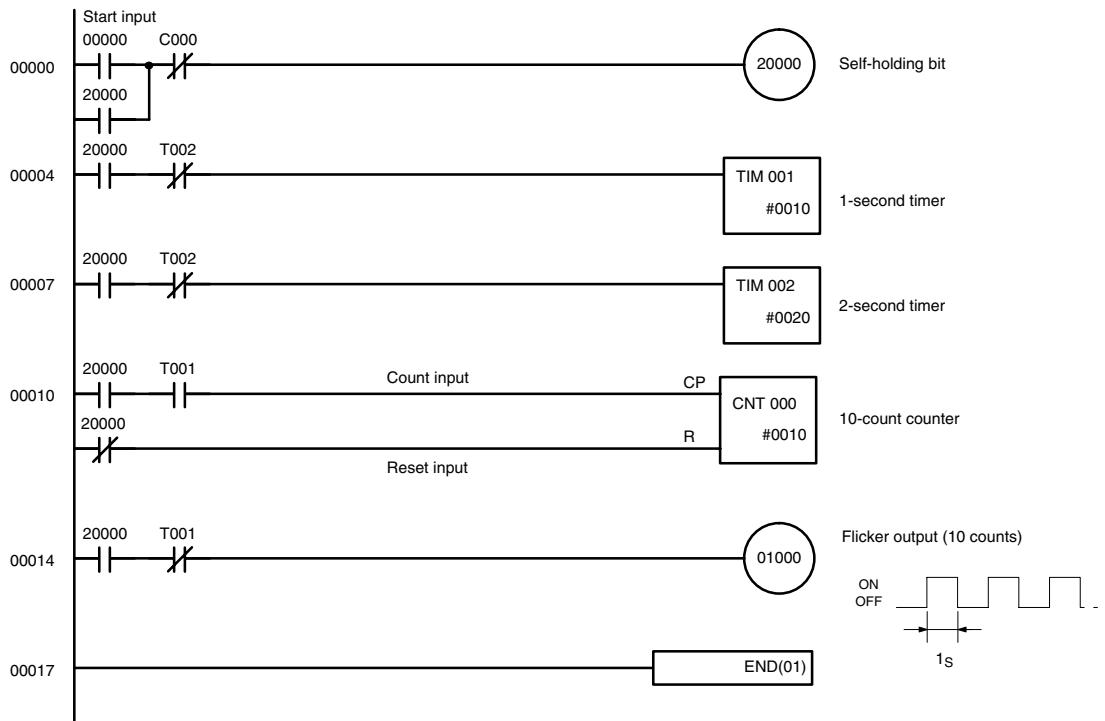

The mnemonic list for the example program is shown in the following table. The steps required to enter this program from a Programming Console are described in 4-4-3 Programming Procedures.

Address	Instruction	Data	Programming example procedures in 4-4-3 Programming Procedures
00000	LD	00000	(1) Self-holding bit
00001	OR	20000	
00002	AND NOT	CNT 000	
00003	OUT	20000	
00004	LD	20000	(2) 1-second timer
00005	AND NOT	TIM 002	
00006	TIM	001 # 0010	
00007	LD	20000	(3) 2-second timer
00008	AND NOT	TIM 002	
00009	TIM	002 # 0020	
00010	LD	20000	
00011	AND	TIM 001	
00012	LD NOT	20000	
00013	CNT	000 # 0010	
00014	LD	20000	(5) Flicker output (10 counts)
00015	AND NOT	TIM 001	
00016	OUT	01000	
00017	END (01)	---	(6) END(01) instruction

4-4-3 Programming Procedures

The example program will be written to the CPM1A according to the mnemonic list in 4-4-2 Example Program. The procedure is performed beginning with the initial display. (Clear the memory before entering a new program.)

Note If an error occurs while inputting the program, refer to 5-4 Programming Console Operation Errors for details on correcting the error. Refer to the relevant Support Software Operation Manual for details on errors that appear when operating the SSS or SYSMAC-CPT Support Software.

(1) Inputting the Self-holding Bit

- 1, 2, 3... 1. Input the normally open condition IR 00000.
(It isn't necessary to input leading zeroes.)

LD H	00000	LD	00000
WRITE	00001READ	NOP	(000)

2. Input the OR condition IR 20000.

OR H	C 2	A 0	A 0	A 0	A 0	00001	OR	20000
WRITE	00002READ	NOP	(000)					

3. Input the normally closed AND condition C000.
(It isn't necessary to input leading zeroes.)

AND H	NOT	CNT	00002	AND NOT	CNT	000
WRITE	00003READ	NOP	(000)			

4. Input the OUT instruction IR 20000.

OUT	C 2	A 0	A 0	A 0	A 0	00003	OUT	20000
WRITE	00004READ	NOP	(000)					

(2) Inputting the One-second Timer

- 1, 2, 3... 1. Input the normally open condition IR 20000.

LD H	C 2	A 0	A 0	A 0	A 0	00004	LD	20000
WRITE	00005READ	NOP	(000)					

2. Input the normally closed AND condition T002.
(It isn't necessary to input leading zeroes.)

AND H	NOT	TIM	C 2	00005	AND NOT	TIM	002
WRITE	00006READ	NOP	(000)				

3. Input the 1-second timer T001.

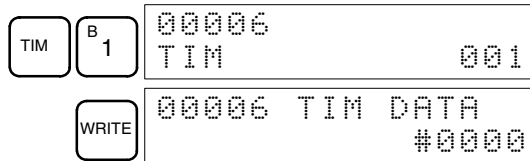

4. Input the SV for T001 (#0010 = 1.0 s).

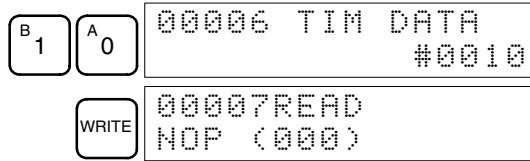

(3) Inputting the Two-second Timer

The following key operations are used to input the 2-second timer.

1, 2, 3...

1. Input the normally open condition IR 20000.

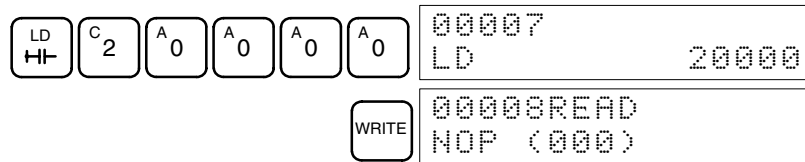

2. Input the normally closed AND condition T002.
(It isn't necessary to input leading zeroes.)

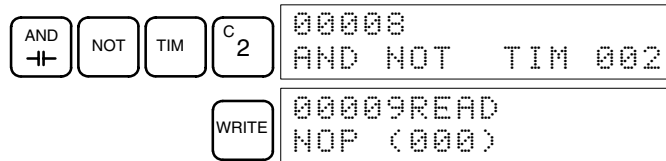

3. Input the 2-second timer T002.

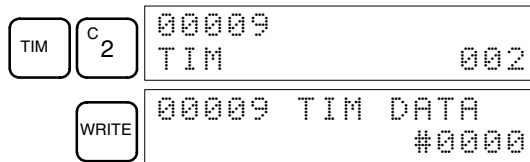

4. Input the SV for T002 (#0020 = 2.0 s).

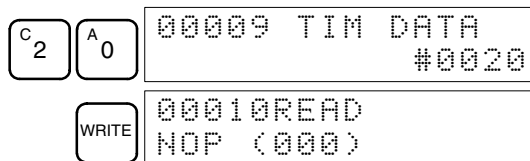

(4) Inputting the 10-count Counter

The following key operations are used to input the 10-count counter.

1, 2, 3...

1. Input the normally open condition IR 20000.

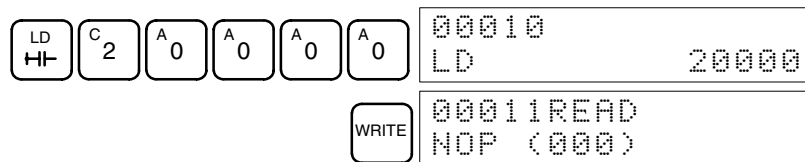

2. Input the normally open AND condition T001.
(It isn't necessary to input leading zeroes.)

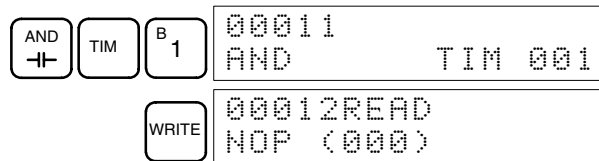

3. Input the normally closed condition IR 20000.

LD		NOT	C 2	A 0	A 0	A 0	A 0	00012	LD NOT	20000
WRITE										
00013READ										
NOP (000)										

4. Input the counter 000.

CNT	A 0	00013	CNT	000
WRITE				
00013 CNT DATA				
#0000				

5. Input the SV for counter 000 (#0010 = 10 counts).

B 1	A 0	00013 CNT DATA	#0010
WRITE			
00014READ			
NOP (000)			

(5) Inputting the Flicker Output

1, 2, 3... 1. Input the normally open condition IR 20000.

LD		C 2	A 0	A 0	A 0	A 0	000014	LD	20000	
WRITE										
00015READ										
NOP (000)										

2. Input the normally closed AND condition T001.
(It isn't necessary to input leading zeroes.)

AND		NOT	TIM	B 1	00015	AND NOT TIM 001
WRITE						
00016READ						
NOP (000)						

3. Input the OUT instruction IR 01000.
(It isn't necessary to input leading zeroes.)

OUT	B 1	A 0	A 0	A 0	00016	OUT	01000
WRITE							
00017READ							
NOP (000)							

(6) Inputting the END(001) Instruction

Input END(01). (The display shows three digits in the function code, but only the last two digits are input for CPM1A PCs.)

FUN	00017	FUN (0??)	
A 0	B 1	00017	END (001)
WRITE			
00018READ			
NOP (000)			

4-4-4 Checking the Program

Check the program syntax in PROGRAM mode to make sure that the program has been input correctly.

- 1, 2, 3... 1. Press the CLR Key to bring up the initial display.



2. Press the SRCH Key. An input prompt will appear requesting the desired check level.

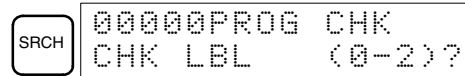

3. Input the desired check level (0, 1, or 2). The program check will begin when the check level is input, and the first error found will be displayed. If no errors are found, the following display will appear.

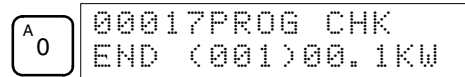

Note Refer to 5-5 Programming Errors for details on check levels and the programming errors that may be displayed during a program check.

4. Press the SRCH Key to continue the search. The next error will be displayed. Continue pressing the SRCH Key to continue the search. The search will continue until an END(01) instruction or the end of Program Memory is reached.

If errors are displayed, edit the program to correct the errors and check the program again. Continue checking the program until all errors have been corrected.

4-4-5 Test Run in MONITOR Mode

Switch the CPM1A in MONITOR mode and check the operation of the program.

- 1, 2, 3... 1. Set the Programming Console's mode switch to MONITOR mode.

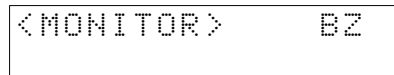
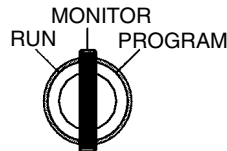

2. Press the CLR Key to bring up the initial display.

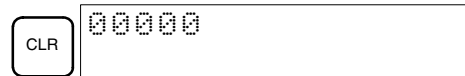

3. Force-set the start input bit (IR 00000) from the Programming Console to start the program.

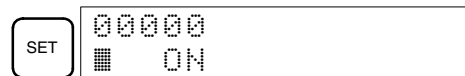
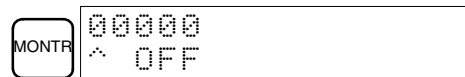
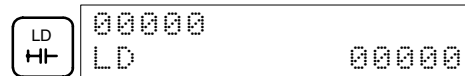

The cursor in the lower left corner of the display indicates that the force set is in progress. The bit will remain ON as long as the Set Key is held down.

4. The output indicator for output IR 01000 will flash ten times if the program is operating correctly. The indicator should go OFF after ten one-second flashes.

There is a mistake in the program if the output indicator doesn't flash. In this case, check the program and force set/reset bits to check operation.

SECTION 5

Test Runs and Error Processing

This section describes procedures for test runs of CPM1A operation, self-diagnosis functions, and error processing to identify and correct the hardware and software errors that can occur during PC operation.

5-1	Initial System Checks and Test Run Procedure	120
5-1-1	Initial System Checks	120
5-1-2	CPM1A Test Run Procedure	120
5-1-3	Flash Memory Precautions	121
5-2	The CPM1A Cycle	122
5-3	Self-diagnosis Functions	123
5-3-1	Non-fatal Errors	123
5-3-2	Fatal Errors	123
5-3-3	Identifying Errors	124
5-3-4	User-defined Errors	124
5-4	Programming Console Operation Errors	125
5-5	Programming Errors	125
5-6	Troubleshooting Flowcharts	127
5-7	Maintenance Inspections	135
5-8	Handling Precautions	136

5-1 Initial System Checks and Test Run Procedure

5-1-1 Initial System Checks

Note Check the following items after setting up and wiring the CPM1A. Be sure to check the wiring and connections before performing a test run.

Item	Points to check
Power supply and I/O connections	Is the wiring correct? Are the terminals securely tightened? Are there any shorts between crimp connectors or wires? Refer to <i>3-4 Wiring and Connections</i> for details.
Connecting cables	Are the cables all connected correctly and locked? Refer to <i>3-4 Wiring and Connections</i> for details.
Dustproof label	Has the dustproof label been removed?

- Note**
1. Always clear memory before beginning to program the CPM1A. Although memory is cleared before the CPU Unit is shipped (except for bits with specific functions), AR 1314, which turns ON when the internal capacitor cannot back up memory, may have turned ON during shipment.
 2. If the CPM1A will be turned off for periods exceeding the data backup period of the internal capacitor, design the system so that it will not be influenced if data in the DM, HR, and CNT areas is cleared when power is turned off.
 3. Either switch the CPM1A to RUN or MONITOR mode, or turn off and on power to the CPM1A after changing from a Programming Device any data that is backed up in flash memory. This data includes the user program, read-only DM area (DM 6144 to DM 6599), and the PC Setup (DM 6600 to DM 6655).

5-1-2 CPM1A Test Run Procedure

- 1, 2, 3...**
1. Power Supply Application
 - a) Check the CPM1A's power supply voltage and terminal connections.
 - b) Check the I/O devices' power supply voltage and terminal connections.
 - c) Turn on the power supply and check that the "PWR" indicator lights.
 - d) Use a Peripheral Device to set the CPM1A to PROGRAM mode.
 2. I/O Wiring Checks
 - a) With the CPM1A in PROGRAM mode, check the output wiring by turning on the output bits with the force set and force reset operations.
Refer to *4-3-25 Force Set, Reset* for details.
 - b) Check the input wiring with the CPM1A's input indicators or a Peripheral Device's monitor operations.
 3. Test Run
 - a) Use a Peripheral Device to set the CPM1A to RUN or MONITOR mode and check that the "RUN" indicator lights.
 - b) Check the sequence of operation with the force set/reset operations, etc.
 4. Debugging
Correct any programming errors that are detected.
 5. Saving the Program
 - a) Use a Peripheral Device to write the program to a backup floppy disk.
 - b) Print out a hard copy of the program with a printer.

Note Refer to *Section 4 Using Peripheral Devices* for details on SYSMAC Support Software or Programming Console operations.

5-1-3 Flash Memory Precautions

Observe the following precautions to protect the flash memory and ensure proper operation.

- 1, 2, 3...**
1. If the power is turned off without changing the mode after having made changes in the read-only DM area (DM 6144 through DM 6599), or PC Setup (DM 6600 through DM 6655), the contents of changes will not be written to flash memory. Therefore, if the power is turned off for more than 20 days (at 25°C), contents of changes (contents of the RAM) will disappear and the data values will become undefined values. For details, refer to *2-1-2 Characteristics*.
The changes can be saved by switching the CPM1A to RUN or MONITOR mode or turning on the CPM1A soon after the changes are made.
 2. When the CPM1A is operated for the first time after changing the program, the read-only DM area (DM 6144 through DM 6599) or PC Setup (DM 6600 through DM 6655) will take about 600 ms longer than usual. Be sure to take this one-time startup delay into account.
 3. If one of the following three operations is performed in MONITOR or RUN mode, the CPM1A will extend the cycle time for up to 600 ms and interrupts will be disabled while the program or PC Setup is being overwritten.
 - Program changes with the online edit operation
 - Changes to the read-only DM area (DM 6144 through DM 6599)
 - Changes to the PC Setup (DM 6600 through DM 6655)A "SCAN TIME OVER" error won't occur during these operations. The CPM1A's I/O response times may be affected when the online edit operation is being performed.

5-2 The CPM1A Cycle

The overall flow of CPM1A operation is as shown in the following flowchart. The CPM1A is initialized internally when the power is turned on. If no errors are detected, the overseeing processes, program execution, I/O refreshing, and Peripheral Device servicing are executed consecutively (cyclically). The average cycle time can be monitor from a Peripheral Device.

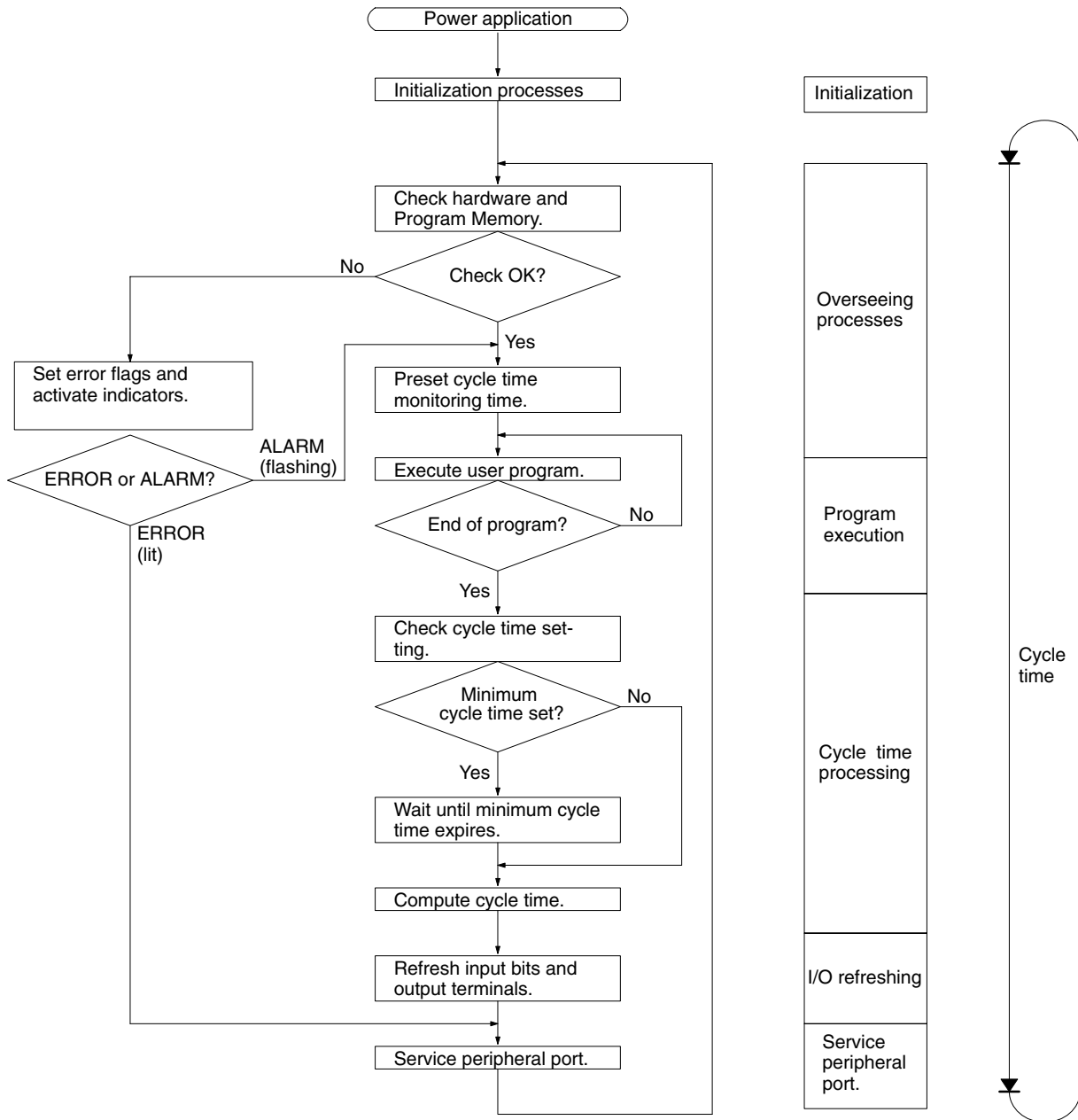

Note Initialization processes include clearing the IR, SR, and AR areas, presetting system timers, and checking I/O Units.

5-3 Self-diagnosis Functions

The CPM1A is equipped with a variety of self-diagnosis functions to help identify and correct errors that might occur and reduce down time.

PC errors are divided into 2 categories based on the severity of the errors. Fatal errors are more serious errors which stop CPM1A operation. Non-fatal errors are less serious and don't stop CPM1A operation.

5-3-1 Non-fatal Errors

PC operation and program execution will continue after one or more of these errors have occurred. Although PC operation will continue, the cause of the error should be corrected and the error cleared as soon as possible.

When one of these errors occurs, the POWER and RUN indicators will remain lit and the ERR/ALM indicator will flash.

Message	FAL No.	Meaning and appropriate response
SYS FAIL FAL** (** is 01 to 99 or 9B.)	01 to 99	An FAL(06) instruction has been executed in the program. Check the FAL number to determine conditions that would cause execution, correct the cause, and clear the error.
	9B	An error has been detected in the PC Setup. Check flags AR 1300 to AR 1302, and correct as directed. AR 1300 ON: An incorrect setting was detected in the PC Setup (DM 6600 to DM 6614) when power was turned on. Correct the settings in PROGRAM Mode and turn on the power again. AR 1301 ON: An incorrect setting was detected in the PC Setup (DM 6615 to DM 6644) when switching to RUN Mode. Correct the settings in PROGRAM Mode and switch to RUN Mode again. AR 1302 ON: An incorrect setting was detected in the PC Setup (DM 6645 to DM 6655) during operation. Correct the settings and clear the error.
SCAN TIME OVER	F8	Watchdog timer has exceeded 100 ms. (SR 25309 will be ON.) This indicates that the program cycle time is longer than recommended. Reduce cycle time if possible. (The CPM1A can be set so that this error won't be detected.)
Communication Errors (no message)	None	If an error occurs in communications through the peripheral port, the COMM indicator will be off. Check the connecting cables and restart. Check the error flags in AR 0812 ON.

5-3-2 Fatal Errors

PC operation and program execution will stop and all outputs from the PC will be turned OFF when any of these errors have occurred. CPM1A operation can't be restarted until the PC is turned off and then on again or a Peripheral Device is used to switch the PC to PROGRAM mode and clear the fatal error.

All CPU Unit indicators will be OFF for the power interruption error. For all other fatal operating errors, the POWER and ERR/ALM indicators will be lit. The RUN indicator will be OFF.

 **WARNING** The PC will turn OFF all outputs when its self-diagnosis function detects any error or when a severe failure alarm (FALS) instruction is executed. External safety measures must be provided to ensure safety in the system. Not providing proper safety measures may result in serious accidents.

Message	FALS No.	Meaning and appropriate response
Power interruption (no message)	None	Power has been interrupted for at least 10 ms (2 ms for DC power types.) Check power supply voltage and power lines. Try to power-up again.
MEMORY ERR	F1	AR 1308 ON: An unspecified bit area exists in the user program. Check the program and correct errors.
		AR 1309 ON: An error has occurred in reading or writing flash memory. Replace the CPU Unit.
		AR 1310 ON: A checksum error has occurred in read-only DM (DM 6144 to DM 6599). Check and correct the settings in the read-only DM area.
		AR 1311 ON: A checksum error has occurred in the PC Setup. Initialize all of the PC Setup and reinput.
		AR 1312 ON: A checksum error has occurred in the program. Check the program and correct any errors detected.
		AR 1314 ON: The internal capacitor can no longer back up data. Clear the error and check/correct the contents of the data areas backed up by the capacitor.
NO END INST	F0	END(01) is not written in the program. Write END(01) at the end of the program.
I/O BUS ERR	C0	An error has occurred during data transfer between the CPU Unit and Expansion I/O Unit. Check the Expansion I/O Unit's connecting cable.
I/O UNIT OVER	E1	Too many I/O Units have been connected. Check the I/O Unit configuration.
SYS FAIL FALS** (** is 01 to 99 or 9F.)	01 to 99	A FALS(07) instruction has been executed in the program. Check the FALS number to determine the conditions that caused execution, correct the cause, and clear the error.
	9F	The cycle time has exceeded the FALS 9F Cycle Time Monitoring Time (DM 6618). Check the cycle time and adjust the Cycle Time Monitoring Time if necessary.

5-3-3 Identifying Errors

PC errors can be identified from error messages displayed on the Programming Console, error flags in the SR or AR areas, and the error code in SR 25300 to SR 25307.

Error Messages

Error messages generated by the self-diagnosis function can be read from a Programming Console or host computer running SYSMAC Support Software.

Error Flags

When the self-diagnosis function detects a hardware error, it will turn on the corresponding error flags in the SR and AR areas.

Error Code

When an error is detected by the self-diagnosis function, the corresponding error code is written to SR 25300 to SR 25307. (The error code is a 2-digit hexadecimal code.)

5-3-4 User-defined Errors

There are three instructions that the user can use to define his own errors or messages. FAL(06) causes a non-fatal error, FAL(07) causes a fatal error, and MSG(46) sends a message to the Programming Console or host computer connected to the PC.

FAILURE ALARM – FAL(06)

FAL(06) is an instruction that causes a non-fatal error. The following will occur when an FAL(06) instruction is executed:

- 1, 2, 3... 1. The ERR/ALM indicator on the CPU Unit will flash. PC operation will continue.
2. The instruction's 2-digit BCD FAL number (01 to 99) will be written to SR 25300 to SR 25307.

The FAL numbers can be set arbitrarily to indicate particular conditions. The same number cannot be used as both an FAL number and an FALS number.

To clear an FAL error, correct the cause of the error and then execute FAL 00 or clear the error using the Programming Console.

SEVERE FAILURE ALARM – FALS(07) FALS(07) is an instruction that causes a fatal error. The following will occur when an FALS(07) instruction is executed:

- 1, 2, 3...**
1. Program execution will be stopped and outputs will be turned OFF.
 2. The ERR/ALM indicator on the CPU Unit will be lit.
 3. The instruction's 2-digit BCD FALS number (01 to 99) will be written to SR 25300 to SR 25307.
 4. The FALS number and time of occurrence will be recorded in the PC's error log area if a Memory Cassette with a clock (RTC) is used.

The FALS numbers can be set arbitrarily to indicate particular conditions. The same number cannot be used as both an FAL number and an FALS number.

To clear an FALS error, switch the PC to PROGRAM Mode, correct the cause of the error, and then clear the error using the Programming Console.

MESSAGE – MSG(46) MSG(46) is used to display a message on the Programming Console. The message, which can be up to 16 characters long, is displayed when the instruction's execution condition is ON.

5-4 Programming Console Operation Errors

The following error messages may appear when performing operations on the Programming Console. Correct the error as indicated and continue with the operation. Refer to the *SYSMAC Support Software Operation Manuals: Basics* and *C-series PCs* for errors that may appear when operating the SSS.

Message	Meaning and appropriate response
REPL ROM	An attempt was made to write to write-protected memory. Set bits 00 to 03 of DM 6602 to "0."
PROG OVER	The instruction at the last address in memory is not NOP(00). Erase all unnecessary instructions at the end of the program.
ADDR OVER	An address was set that is larger than the highest memory address in Program Memory. Input a smaller address.
SETDATA ERR	FALS 00 has been input, and "00" cannot be input. Reinput the data.
I/O NO. ERR	A data area address has been designated that exceeds the limit of the data area, e.g., an address is too large. Confirm the requirements for the instruction and re-enter the address.

5-5 Programming Errors

These errors in program syntax will be detected when the program is checked using the Program Check operation.

Three levels of program checking are available. The desired level must be designated to indicate the type of errors that are to be detected. The following table provides the error types, displays, and explanations of all syntax errors. Check level 0 checks for type A, B, and C errors; check level 1, for type A and B errors; and check level 2, for type A errors only.

Type	Message	Meaning and appropriate response
A	?????	The program has been damaged, creating a non-existent function code. Re-enter the program.
	CIRCUIT ERR	The number of logic blocks and logic block instructions does not agree, i.e., either LD or LD NOT has been used to start a logic block whose execution condition has not been used by another instruction, or a logic block instruction has been used that does not have the required number of logic blocks. Check your program.
	OPERAND ERR	A constant entered for the instruction is not within defined values. Change the constant so that it lies within the proper range.
	NO END INSTR	There is no END(01) in the program. Write END(01) at the final address in the program.
	LOCN ERR	An instruction is in the wrong place in the program. Check instruction requirements and correct the program.
	JME UNDEFD	A JME(05) instruction is missing for a JMP(04) instruction. Correct the jump number or insert the proper JME(05) instruction.
	DUPL	The same jump number or subroutine number has been used twice. Correct the program so that the same number is only used once for each.
	SBN UNDEFD	The SBS(91) instruction has been programmed for a subroutine number that does not exist. Correct the subroutine number or program the required subroutine.
B	STEP ERR	STEP(08) with a section number and STEP(08) without a section number have been used incorrectly. Check STEP(08) programming requirements and correct the program.
	IL-ILC ERR	IL(02) and ILC(03) are not used in pairs. Correct the program so that each IL(02) has a unique ILC(03). Although this error message will appear if more than one IL(02) is used with the same ILC(03), the program will executed as written. Make sure your program is written as desired before proceeding.
	JMP-JME ERR	JMP(04) and JME(05) are not used in pairs. Make sure your program is written as desired before proceeding.
C	SBN-RET ERR	If the displayed address is that of SBN(92), two different subroutines have been defined with the same subroutine number. Change one of the subroutine numbers or delete one of the subroutines. If the displayed address is that of RET(93), RET(93) has not been used properly. Check requirements for RET(93) and correct the program.
	COIL DUPL	The same bit is being controlled (i.e., turned ON and/or OFF) by more than one instruction (e.g., OUT, OUT NOT, DIFU(13), DIFD(14), KEEP(11), SFT(10)). Although this is allowed for certain instructions, check instruction requirements to confirm that the program is correct or rewrite the program so that each bit is controlled by only one instruction.
	JMP UNDEFD	JME(05) has been used with no JMP(04) with the same jump number. Add a JMP(04) with the same number or delete the JME(05) that is not being used.
	SBS UNDEFD	A subroutine exists that is not called by SBS(91). Program a subroutine call in the proper place, or delete the subroutine if it is not required.

5-6 Troubleshooting Flowcharts

Use the following flowcharts to troubleshoot errors that occur during operation.

Main Check

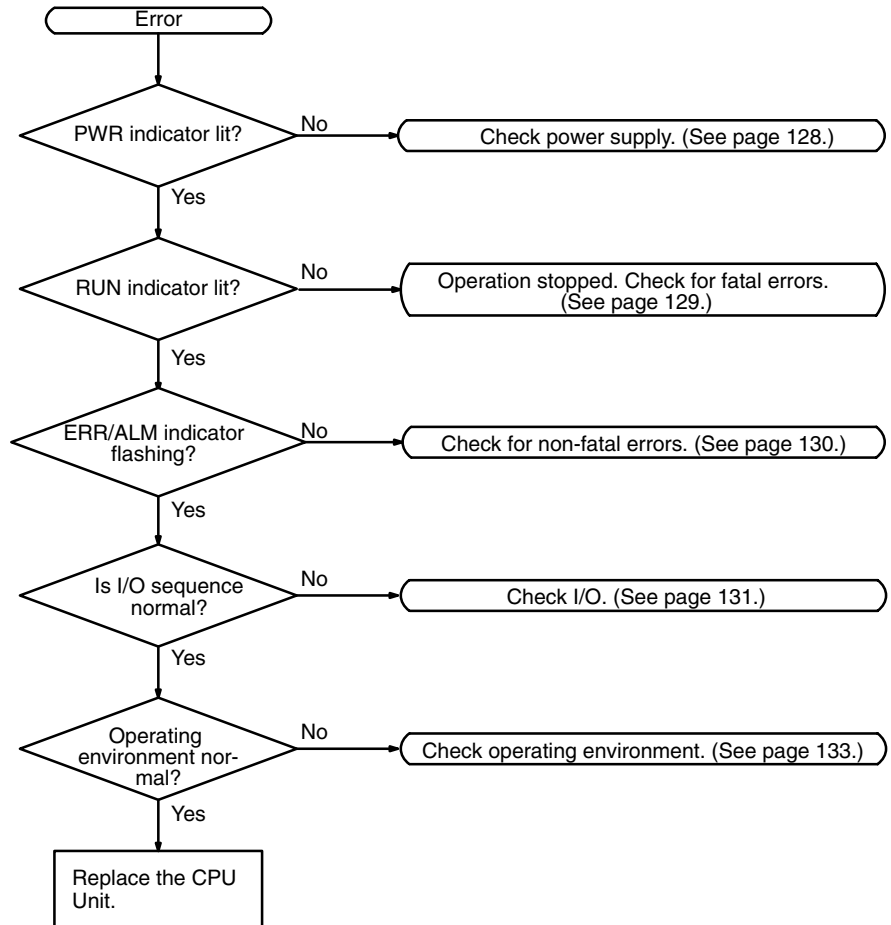

Power Supply Check

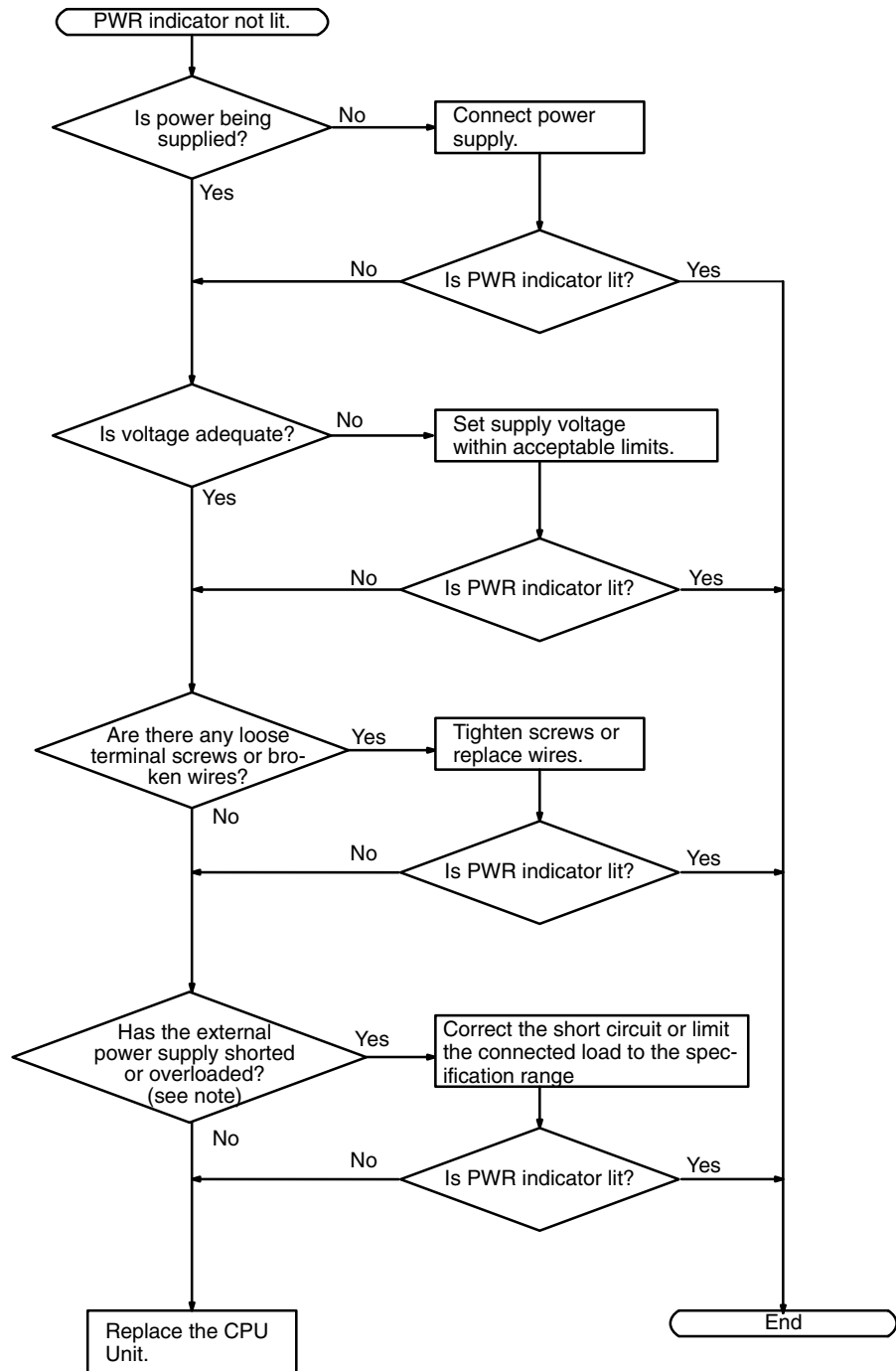

Note The PWR indicator will go out when there is a short circuit in the external power supply or an overload, only in the CPM1A-10CDR-□ and CPM1A-20CDR-□ CPU Units. In CPM1A-30CDR-□ and CPM1A-40CDR-□ CPU Units, when there is a short circuit or a overload, the external power supply voltage will drop but the PWR indicator will remain lit.

Fatal Error Check

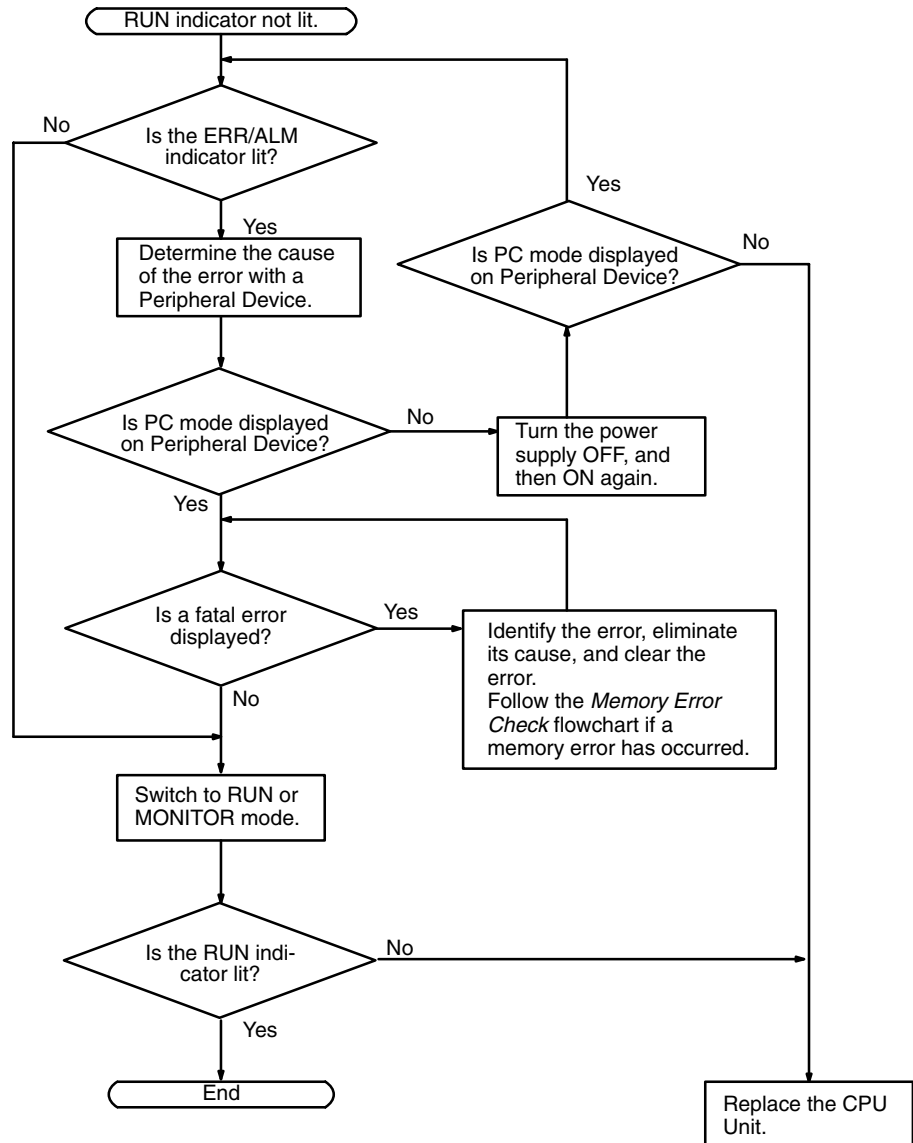

Non-fatal Error Check

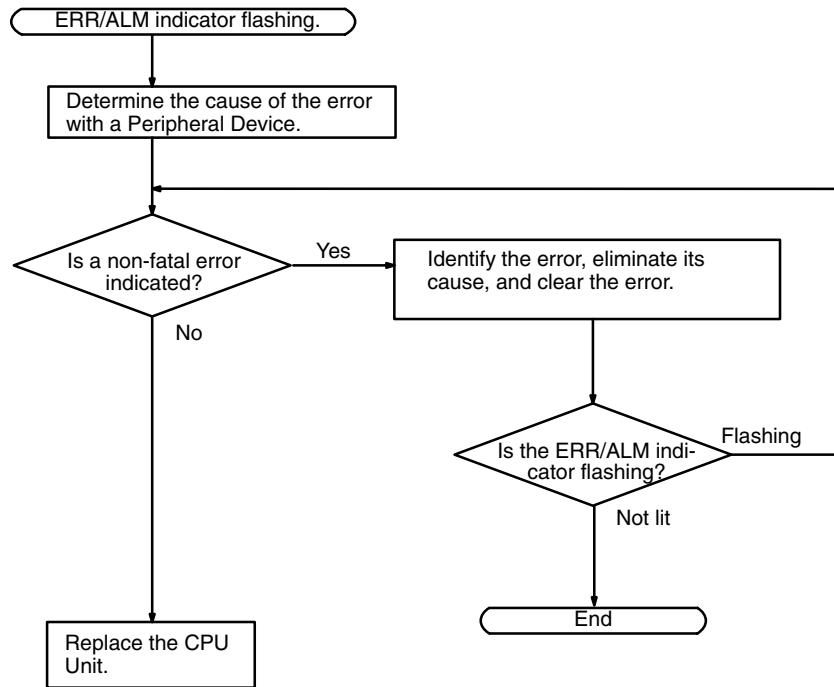

I/O Check

The I/O check flowchart is based on the following ladder diagram section.

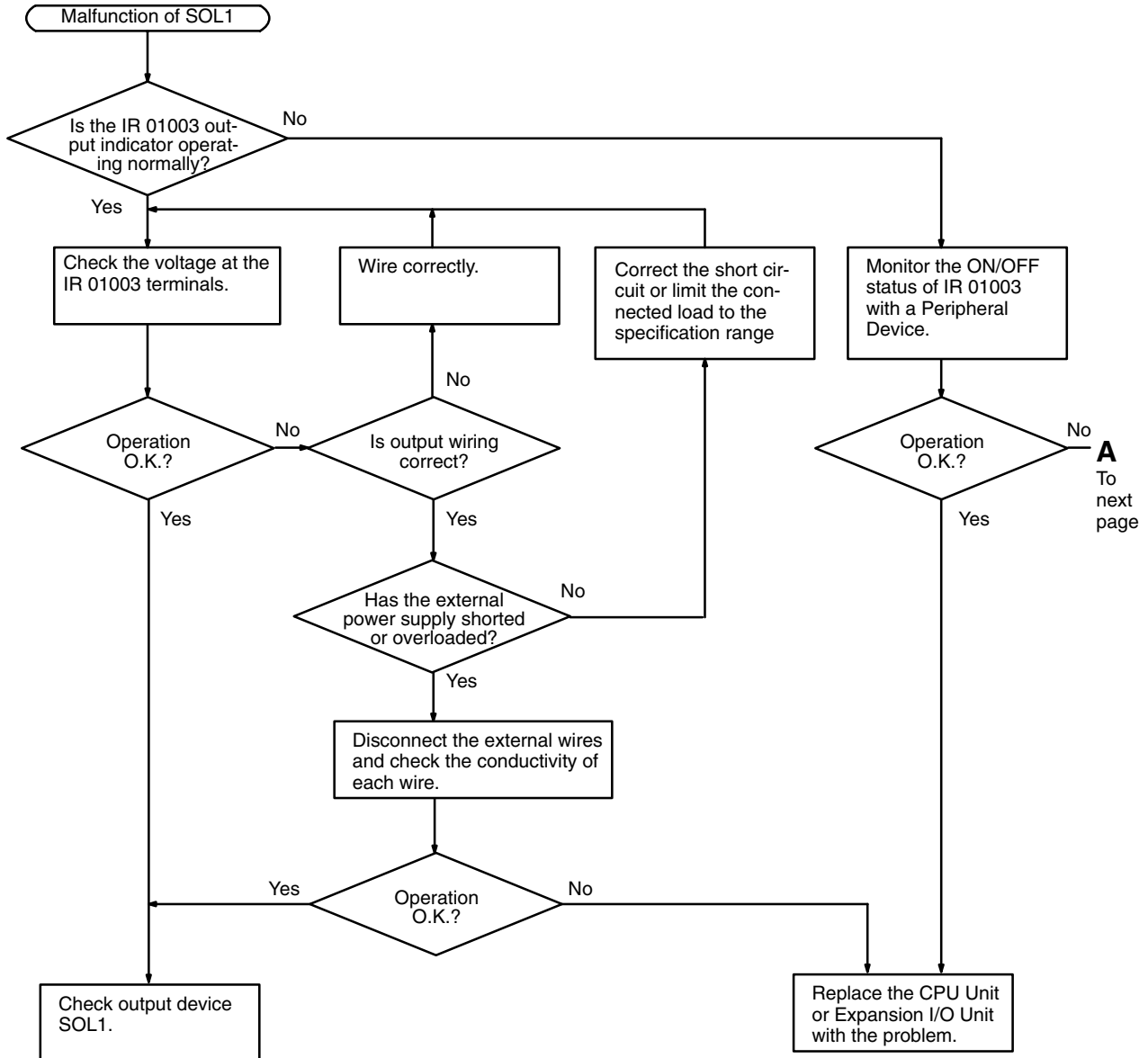
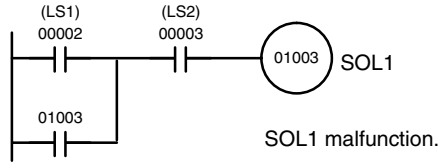

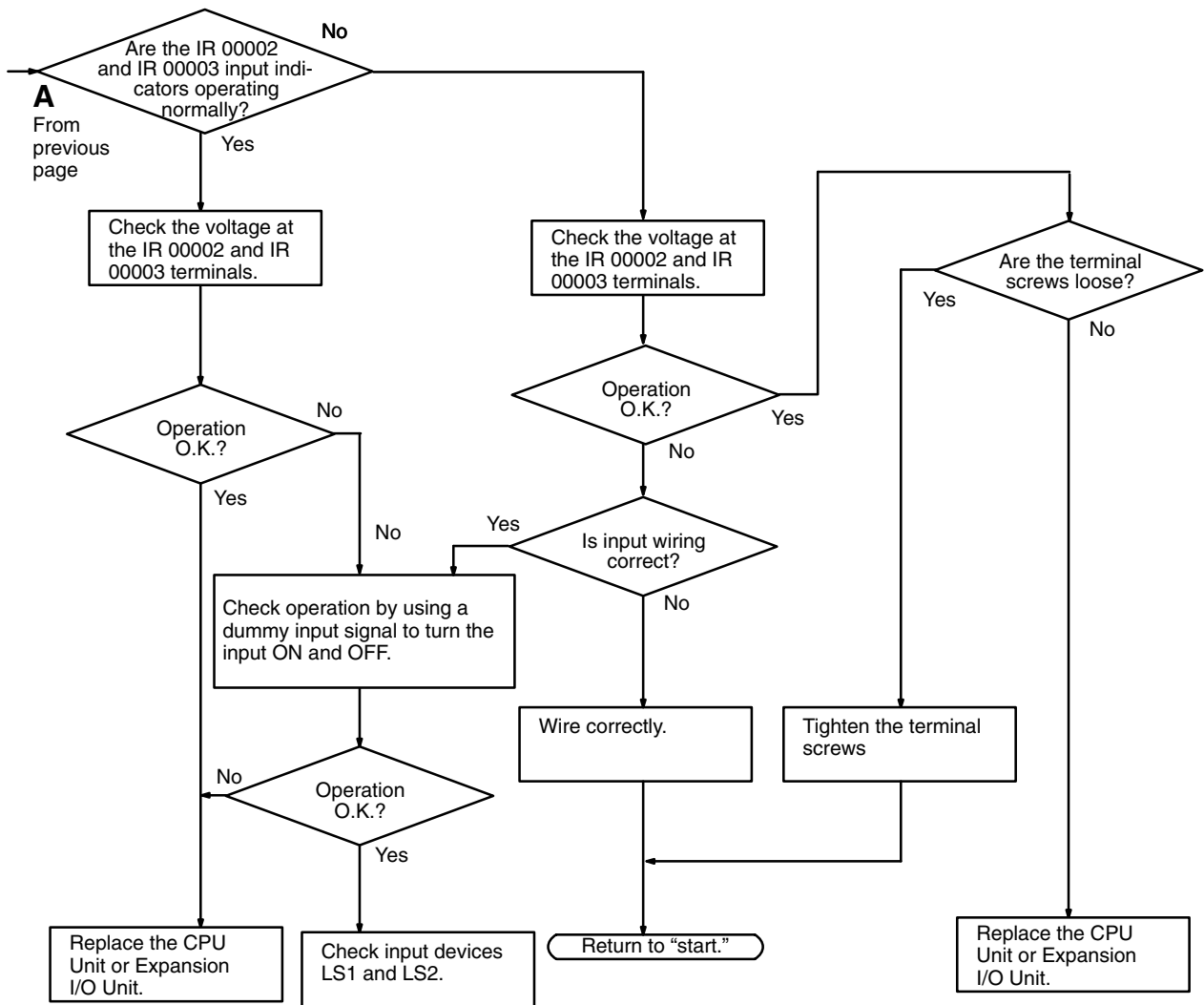

Environmental Conditions Check

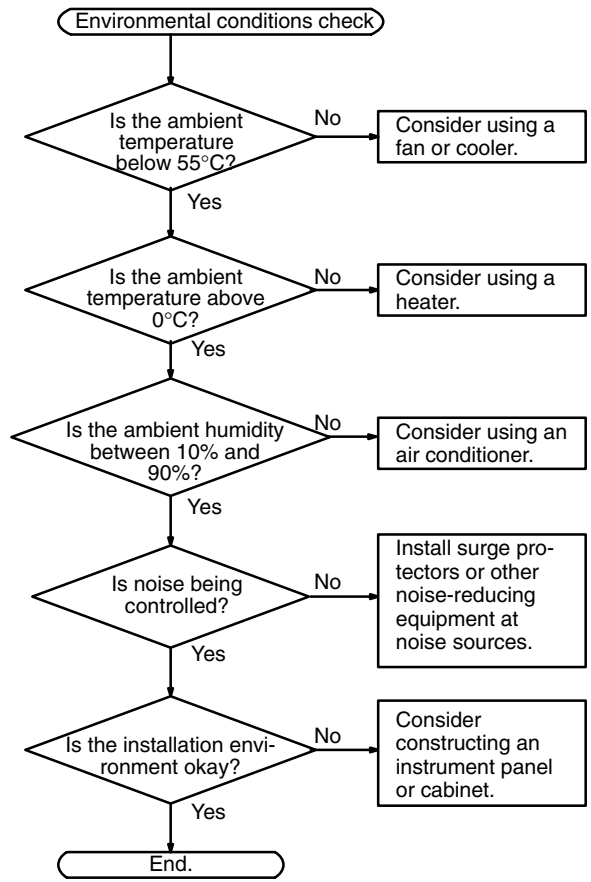

Memory Error Check

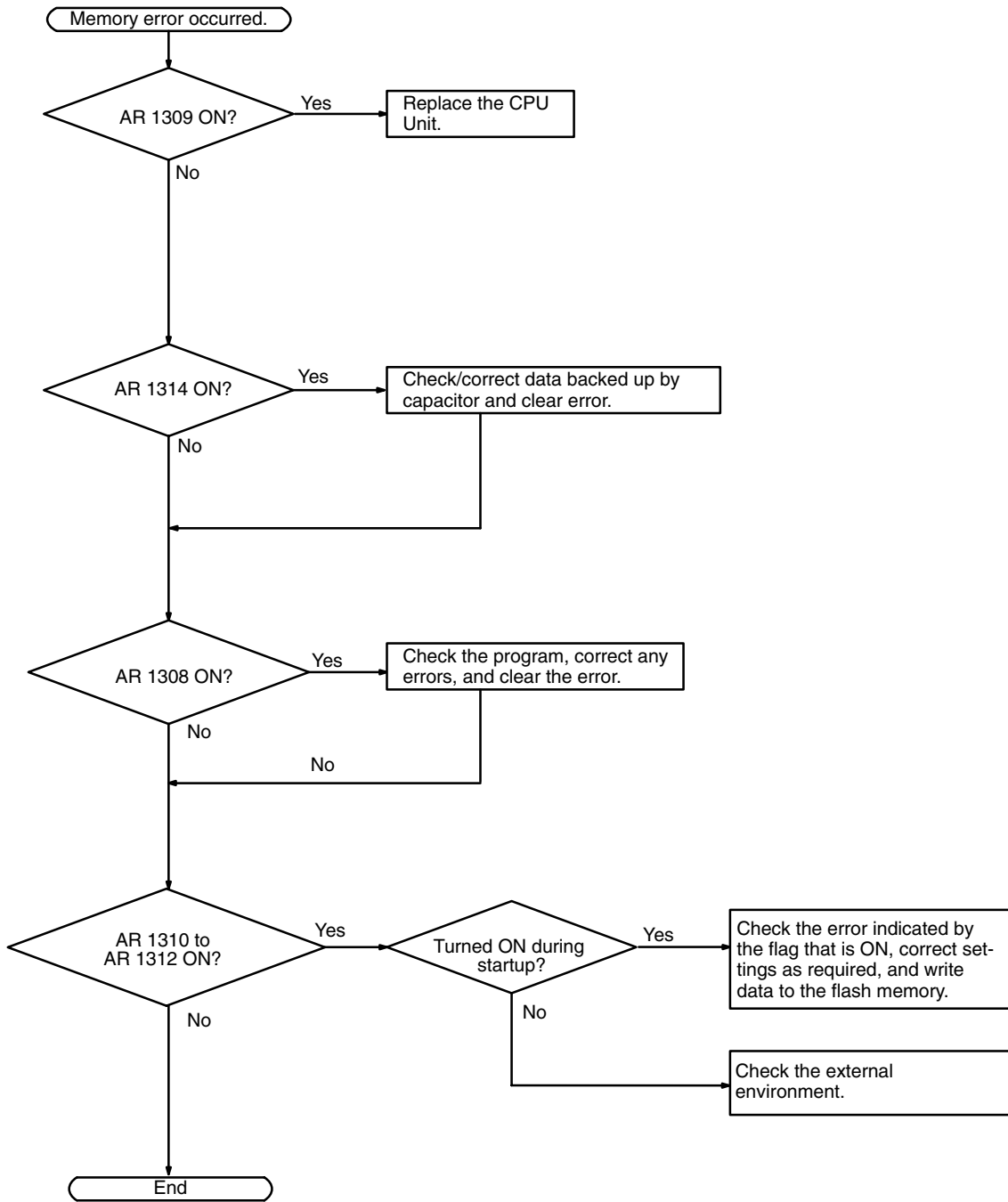

5-7 Maintenance Inspections

In order that your SYSMAC system operates in optimum condition, be sure to carry out daily or periodical inspections.

Inspection Items

The main system components of a SYSMAC system are semiconductors, and it contains few components with limited lifetimes. Environmental conditions, however, can lead to electrical element deterioration, making regular maintenance necessary.

The standard period for maintenance checks is 6 months to 1 year, but depending on the environment checks may need to be more regular.

If the criteria are not met, adjust to within the specified ranges.

Inspection items	Details	Criteria	Remarks
Power supply	Determine whether the voltage fluctuation is within the standard at the power supply terminal.	Within the voltage variation range (See note 2.)	Tester
Environmental conditions	Is the ambient temperature inside the panel appropriate?	0 to 55°C	Thermometer
	Is the ambient humidity inside the panel appropriate?	10% to 90% with no condensation	Hydroscope
	Has dirt or dust collected?	None	Visual inspection
I/O power supply	Is the voltage fluctuation measured at the I/O terminal within the standard range?	Each I/O must conform to the specifications	Tester
Installation status	Are all units securely installed?	Nothing is loose	Positive screwdriver
	Are all connection cables and connectors inserted completely and locked?	Nothing is loose	Visual inspection
	Are any of the external wiring screws loose?	Nothing is loose	Positive screwdriver
	Are any of the external wiring cables frayed?	No external abnormalities	Visual inspection
Product service life	Contact output relay	Electrical: Resistance load: 300,000 operations Inductive load: 100,000 operations Mechanical: 20,000,000 operations (See note 1.)	

Note 1. Mechanical life is 20,000,000 operations for V1 Units and 10,000,000 operations for pre-V1 Units.

2. Power supply voltage variation range.

Power supply	Allowable voltage fluctuation range
100 to 120 VAC	85 to 132 VAC
200 to 240 VAC	170 to 264 VAC
24 VDC	20.4 to 26.4 VDC

5-8 Handling Precautions

- Turn the power OFF before replacing the Unit.

Note Before restarting operation, transfer the contents of the DM and HR areas to the CPU Unit that was changed and then start operation.

- If a Unit is found to be faulty and is replaced, check the Unit again to ensure there is no error.
- When returning a faulty Unit for repair, make a detailed note of the Unit's malfunction and take it together with the Unit to your nearest OMRON office or sales representative.
- If a contact is not good, put some industrial alcohol on a clean cotton cloth and wipe the surface. After doing this, install the Unit.

Necessary Tools for Inspection

Standard Tools

- Screwdrivers (Philips and flat-blade)
- Voltage tester or digital voltage meter
- Industrial alcohol and a cotton cloth

Measurement Devices

- Synchroscope
- Cathode-ray oscilloscope
- Thermometer, hydroscope

Note Do not take apart, repair or remodel the PC in any way.

SECTION 6

Expansion Memory Unit

This section describes how to use the CPM1-EMU01-V1 Expansion Memory Unit. Follow the handling precautions and procedures to properly use the Unit.

6-1	Overview	138
6-1-1	Memory Areas	138
6-1-2	Precautions	138
6-2	Specifications and Nomenclature	139
6-2-1	Specifications	139
6-2-2	Nomenclature	139
6-3	Handling	140
6-3-1	Mounting/Removing EEPROM	140
6-3-2	PC Connections	141
6-3-3	Uploading Programs	142
6-3-4	Downloading Programs	143

6-1 Overview

The CPM1-EMU01-V1 Expansion Memory Unit is a program loader for small-size or micro PCs. Using the CPM1-EMU01-V1, simple on-site transfer of user programs and data memory between PCs is possible.

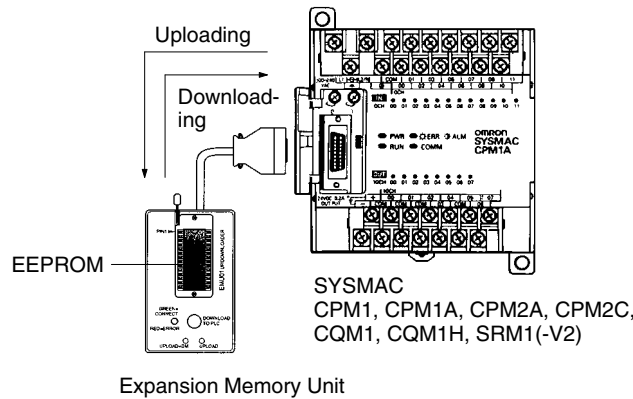

Note The “PLC” in the “DOWNLOAD TO PLC” Button indicates PCs (Programmable Controllers).

6-1-1 Memory Areas

The memory areas that are uploaded or downloaded vary with the button used as shown in the following table.

Button	UPLOAD + DM	UPLOAD	DOWNLOAD TO PLC
Ladder program and expansion instructions	Read from PC to EEPROM.	Read from PC to EEPROM.	All contents of EEPROM written to PC.
DM 6144 to 6655		Not affected.	

Note For details on program size, DM area, and the availability of expansion instructions, refer to the relevant PC manual.

6-1-2 Precautions

- Do not attempt to use the CPM1-EMU01-V1 for any applications other than those described here. Doing so may result in malfunction.
- Do not attempt to upload or download data between different types of PC. Doing so may result in malfunction.
- Do not download when the PC is in RUN or MONITOR mode. If downloading is performed when the PC is running, it will automatically switch to PROGRAM mode and operation will stop.
- Do not attempt to disassemble, repair, or modify the CPM1-EMU01-V1. Any attempt to do so may result in malfunction, fire, or electric shock.
- After downloading has been completed, be sure to confirm the user program, data, and expansion instruction information. Not doing so may result in faulty operation.
- Before touching the EEPROM or the CPM1-EMU01-V1, first touch a grounded metallic object to discharge any static build-up. Not doing so may result in malfunction or damage.

6-2 Specifications and Nomenclature

6-2-1 Specifications

Item	Specifications
Supported PCs	CPM1, CPM1A, CPM2A, CPM2C, SRM1 (-V2), CQM1, CQM1H
Read/Write memory areas	User program: 15.2 Kwords max. Data memory: DM 6144 to DM 6655 (Read-only DM and PC Setup) Expansion instructions: 18 instructions
Connector	Connector compatible with CPM1, CPM1A, CPM2A, SRM1 (-V2), and CQM1 PCs. For CPM2C and CQM1H PCs, connect via CS1W-CN114 or CPM2C-CN111 Connecting Cable.
Communications setting	1 start bit, 7 data bits, even parity, 2 stop bits, 9,600 bps
EEPROM (See note 1.)	256-Kbit EEPROM ATMEL: AT28C256-15PC OMRON: EEROM-JD
Current consumption	129 mA max.
Dimensions	Main body (not including cables or connectors): 57 × 92 × 38 mm (W × H × D)
Weight	200 g max. (not including EEPROM)

- Note**
1. The EEPROM must be purchased separately.
 2. For general specifications, refer to the relevant PC manual.

6-2-2 Nomenclature

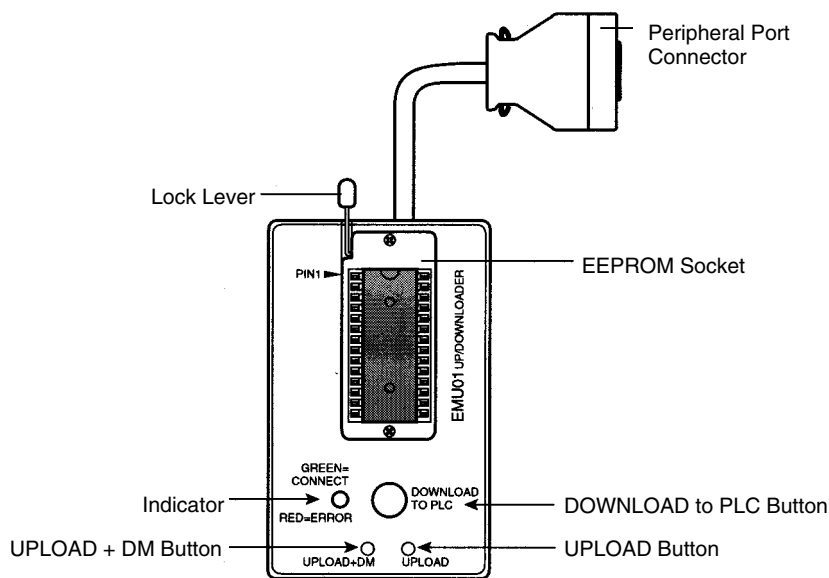

Lock Lever

For mounting and removing EEPROM.

DOWNLOAD TO PLC Button

Writes all EEPROM data (ladder programs, data memory etc.) to the PC.

UPLOAD + DM Button

Reads PC user program and contents of DM 6144 to DM 6655 to EEPROM.

UPLOAD Button

Reads only PC user program to EEPROM.

- Note** The "PLC" in the "DOWNLOAD TO PLC" Button indicates PCs (Programmable Controllers).

LED Indicator

CONNECT (green)	ERR (red)	Meaning
OFF	OFF	Not connected to PC (power supply OFF).
ON	OFF	Connected to a recognized PC.
Blinking	OFF	Uploading/downloading data.
ON	Blinking	Host link communications error, retry by user.
OFF	ON	PC model and EEPROM data not compatible.
OFF	Blinking	One of the following errors has occurred: An unrecognized PC is connected. An EEPROM error (EEPROM not present, EEPROM defect, or no program to download) or checksum error.

6-3 Handling

6-3-1 Mounting/Removing EEPROM

 **Caution** Do not mount or remove the EEPROM with the CPM1-EMU01-V1 connected to the PC. Doing so may damage the EEPROM.

Mounting EEPROM

- 1, 2, 3...
1. Lift up the lock lever.
 2. Straighten the pins on the EEPROM, line up with the socket and lower into the socket, as shown in the following diagram. If the EEPROM is loose, place it in the center of the socket.

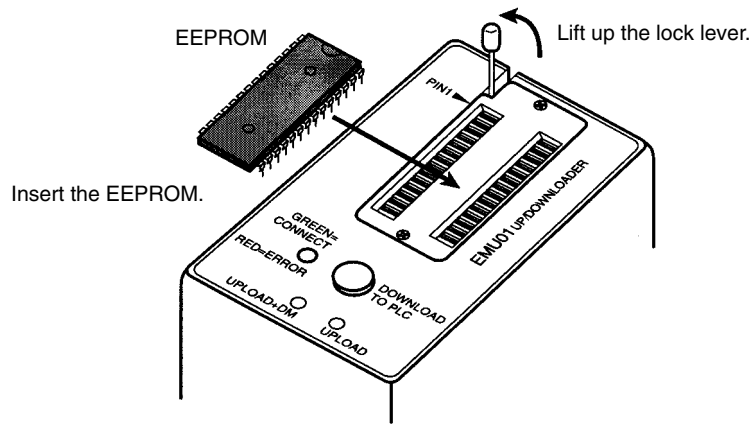

3. Gently hold down the EEPROM and pull down the lock lever.

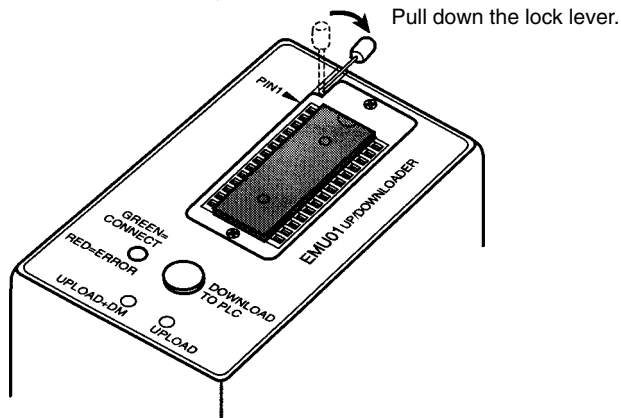

Removing EEPROM

Lift up the lock lever and detach the EEPROM.

6-3-2 PC Connections

Caution Mount the EEPROM to the CPM1-EMU01-V1 before connecting the CPM1-EMU01-V1 to the PC.

Caution Do not disconnect the CPM1-EMU01-V1 from the PC when the indicator is blinking green.

CPM1, CPM1A, CPM2A, CQM1, and SRM1 (-V2) PCs

When connecting to the CPM1, CPM1A, CPM2A, CQM1 or SRM1 (-V2), insert the connector into the peripheral port making sure that the connector is oriented correctly.

- Insert the connector until it securely locks into place.
- Connections are not possible to the RS-232C port or any other port.

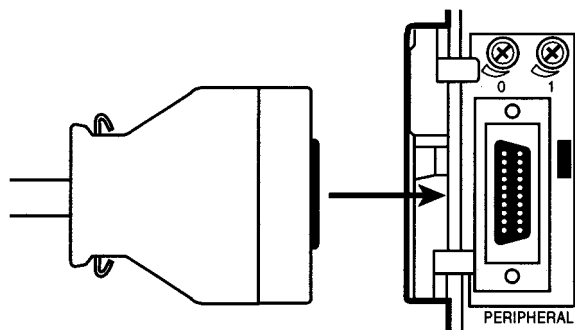

Connection to CPM2A

CPM2C and CQM1H PCs

When connecting to the CPM2C or CQM1H, connect to the peripheral port via the CPM2C-CN111 or CS1W-CN114 Connecting Cable. Also, set the pins on the CPU Unit's DIP switch as follows:

CPM2C	Pin 1: ON (see note)
	Pin 2: ON
CQM1H	Pin 5: ON (see note)
	Pin 7: ON

Note If pin 1 on the CPM2C or pin 5 on the CQM1H is OFF, connection is still possible if the peripheral port is set to the defaults.

Peripheral Port Communications Settings

The peripheral port must be set to the default communications settings shown below.

- Start bit: 1
- Data bits: 7
- Stop bits: 2
- Parity: Even
- Baud rate: 9,600 bps

Disconnecting

Press the levers on the top and bottom of the connector inwards to unlock the connector and pull out as shown in the following diagram.

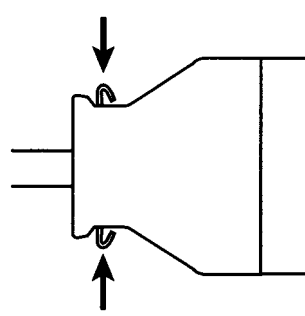

Note Do not attempt to remove the connector by pulling the cable.

6-3-3 Uploading Programs

Ladder programs and the contents of data memory can be uploaded to the EEPROM using the following procedure. The buttons used will determine whether the contents of data memory are uploaded or not.

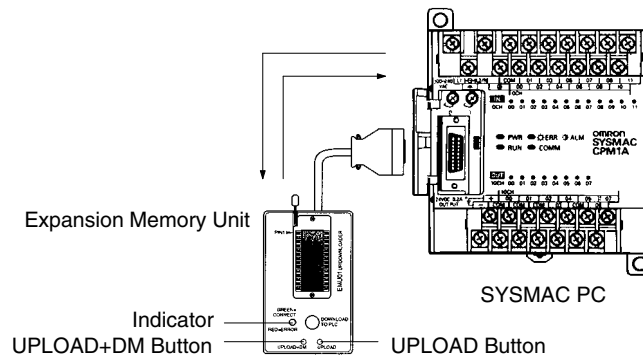

Button	UPLOAD + DM	UPLOAD
Ladder program and expansion instructions	Read from PC to EEPROM.	Read from PC to EEPROM.
DM6144 to 6655		Not affected.

Note Use a Phillips screwdriver or other tool with a diameter of 3.0 mm max. and a blade length of 10 mm min. to press the upload button.

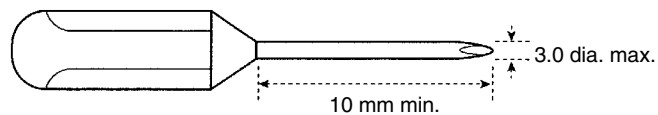

Uploading is possible even if the PC is in RUN or MONITOR mode.

Operation Procedure

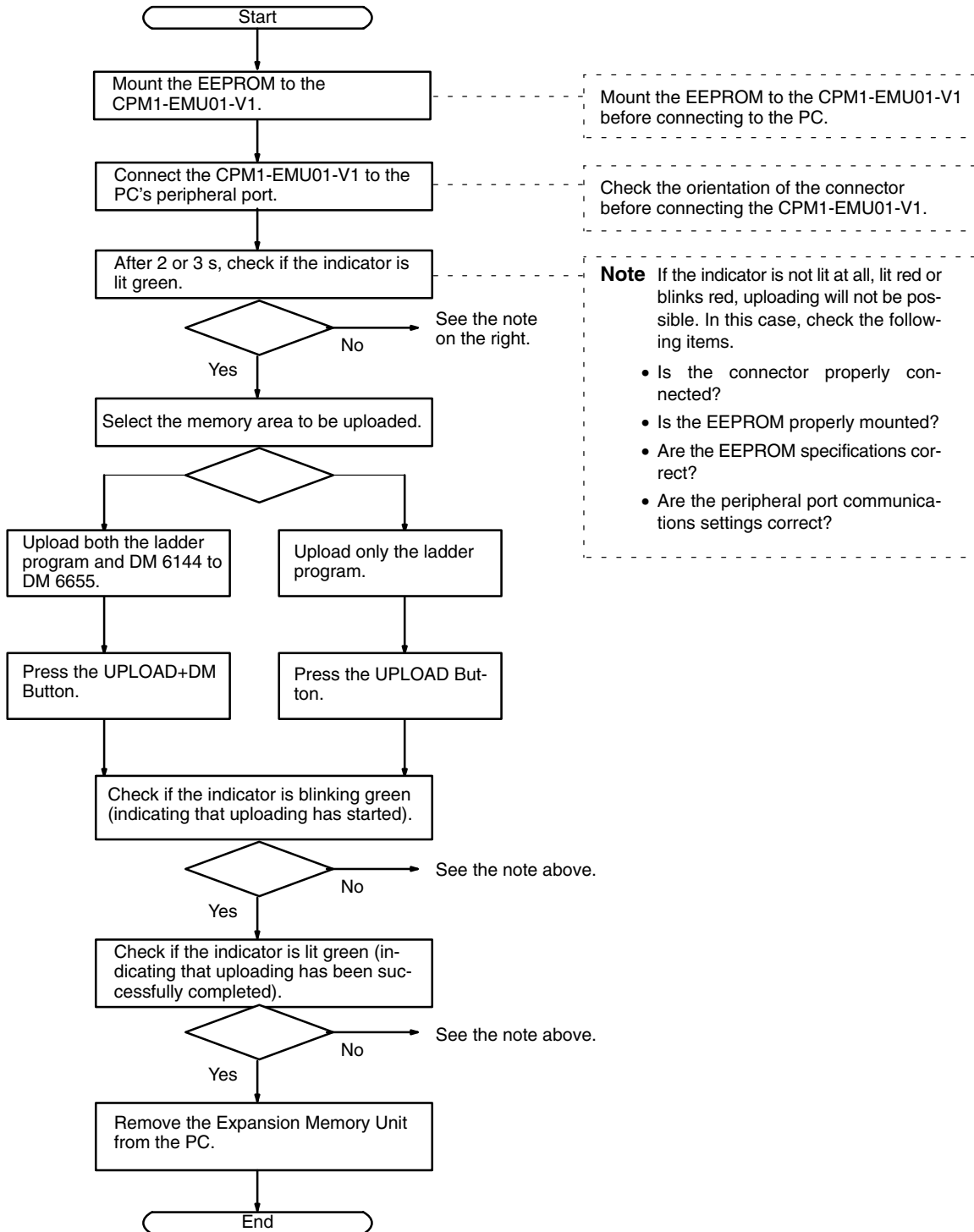

6-3-4 Downloading Programs

Ladder programs and the contents of data memory can be downloaded from the EEPROM to the PC using the procedure given below. When downloading, note the following points.

Caution  If the PC is in RUN or MONITOR mode when downloading is started, it will automatically switch to PROGRAM mode and operation will stop. Confirm that no adverse effects will occur to the system before downloading. Not doing so may result in unexpected operation.

- Note**
1. If the PC is in RUN or MONITOR mode, switch the PC mode to PROGRAM mode.
 2. Confirm that the program or other data to be downloaded to the PC is compatible with the PC before downloading.
 3. For the CQM1 or CQM1H, when downloading programs that use user-assigned function codes for expansion instructions, be sure that pin 4 on the CPU Unit's DIP switch is ON. If these programs are downloaded while the pin is OFF, the assignments for the expansion instructions will return to their default settings.
 4. After downloading has been completed, be sure to confirm the user program, data, and expansion instructions.
 5. When the DOWNLOAD TO PLC Button is pressed, all EEPROM data (ladder programs, data memory etc.) is written to the PC.

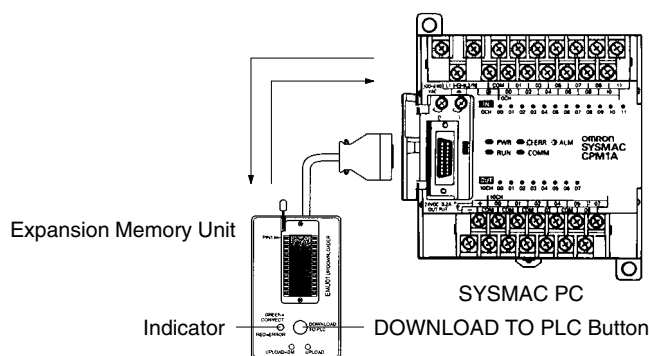

Operation Procedure

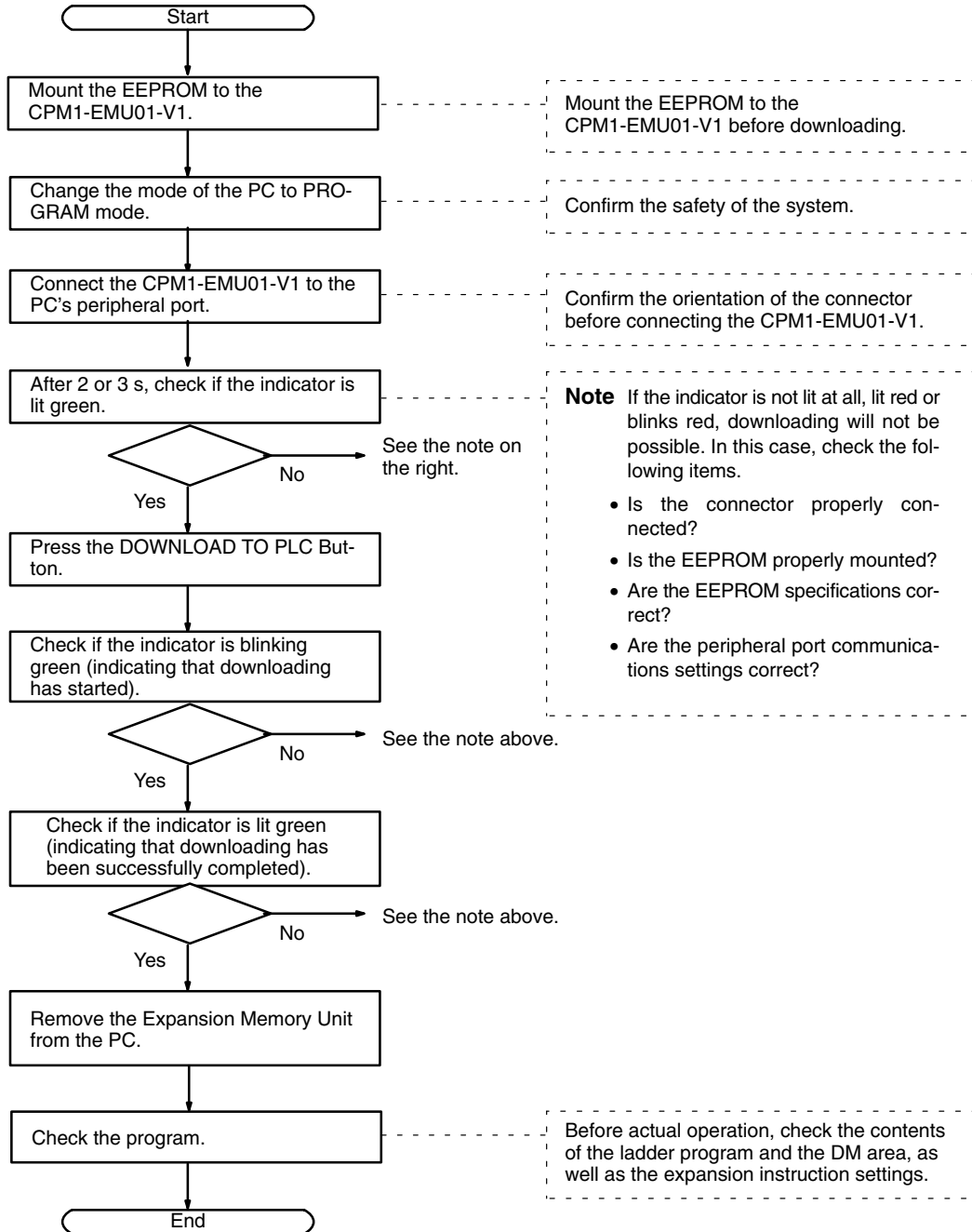



Appendix A

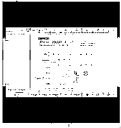
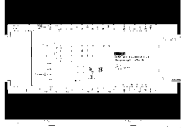

Standard Models

CPU Units

V1 Units

Description	Input points	Output points	Power supply	Model number		
				Relay outputs	Transistor outputs	
					Sinking	Sourcing
CPU Units with 10 I/O points 	6 points	4 points	AC	CPM1A-10CDR-A-V1	CPM1A-10CDT-A-V1	CPM1A-10CDT1-A-V1
			DC	CPM1A-10CDR-D-V1	CPM1A-10CDT-D-V1	CPM1A-10CDT1-D-V1
CPU Units with 20 I/O points 	12 points	8 points	AC	CPM1A-20CDR-A-V1	CPM1A-20CDT-A-V1	CPM1A-20CDT1-A-V1
			DC	CPM1A-20CDR-D-V1	CPM1A-20CDT-D-V1	CPM1A-20CDT1-D-V1
CPU Units with 30 I/O points 	18 points	12 points	AC	CPM1A-30CDR-A-V1	CPM1A-30CDT-A-V1	CPM1A-30CDT1-A-V1
			DC	CPM1A-30CDR-D-V1	CPM1A-30CDT-D-V1	CPM1A-30CDT1-D-V1
CPU Units with 40 I/O points 	24 points	16 points	AC	CPM1A-40CDR-A-V1	CPM1A-40CDT-A-V1	CPM1A-40CDT1-A-V1
			DC	CPM1A-40CDR-D-V1	CPM1A-40CDT-D-V1	CPM1A-40CDT1-D-V1

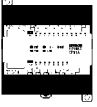
Pre-V1 Units

Description	Input points	Output points	Power supply	Model number		
				Relay outputs	Transistor outputs	
					Sinking	Sourcing
CPU Units with 10 I/O points 	6 points	4 points	AC	CPM1A-10CDR-A	CPM1A-10CDT-A	CPM1A-10CDT1-A
			DC	CPM1A-10CDR-D	CPM1A-10CDT-D	CPM1A-10CDT1-D
CPU Units with 20 I/O points 	12 points	8 points	AC	CPM1A-20CDR-A	CPM1A-20CDT-A	CPM1A-20CDT1-A
			DC	CPM1A-20CDR-D	CPM1A-20CDT-D	CPM1A-20CDT1-D
CPU Units with 30 I/O points 	18 points	12 points	AC	CPM1A-30CDR-A	CPM1A-30CDT-A	CPM1A-30CDT1-A
			DC	CPM1A-30CDR-D	CPM1A-30CDT-D	CPM1A-30CDT1-D
CPU Units with 40 I/O points 	24 points	16 points	AC	CPM1A-40CDR-A	CPM1A-40CDT-A	CPM1A-40CDT1-A
			DC	CPM1A-40CDR-D	CPM1A-40CDT-D	CPM1A-40CDT1-D

Expansion I/O Units

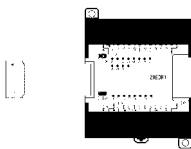
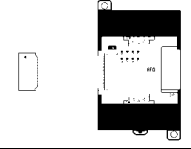
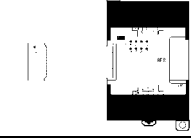
Description	Input points	Output points	Model number		
			Relay output	Transistor output	
				Sinking	Sourcing
Expansion I/O Unit with 20 I/O points 	12 points	8 points	CPM1A-20EDR CPM1A-20EDR1	CPM1A-20EDT	CPM1A-20EDT1
Expansion I/O Unit with 8 input points 	8 points	---	CPM1A-8ED (no outputs)		
Expansion I/O Unit with 8 output points 	---	8 points	CPM1A-8ER	CPM1A-8ET	CPM1A-8ET1

Expansion Units

Analog I/O Unit

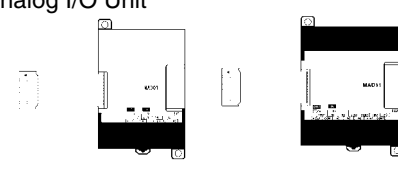
Description	Specifications	Model number
Analog I/O Unit 	2 analog inputs and 1 analog output Input signal ranges: 0 to 10 V, 1 to 5 V, or 4 to 20 mA Output signal ranges: 0 to 10 V, -10 to 10 V, or 4 to 20 mA, Resolution of 1/256	CPM1A-MAD01
	Input signal ranges: 0 to 5 V, 0 to 10 V, 1 to 5 V, -10 to 10 V, 0 to 20 mA, or 4 to 20 mA Output signal ranges: 0 to 10 V, 1 to 5 V, -10 to 10 V, 0 to 20 mA, or 4 to 20 mA Resolution of 1/6,000	CPM1A-MAD11

Temperature Sensor Units

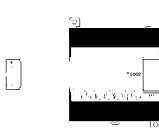
Description	Specifications	Model number
Temperature Sensor Unit 	2 thermocouple inputs: K, J	CPM1A-TS001
	4 thermocouple inputs: K, J	CPM1A-TS002
	2 platinum resistance thermometer inputs: Pt100 (100 Ω), JPt100 (100 Ω)	CPM1A-TS101
	4 platinum resistance thermometer inputs: Pt100 (100 Ω), JPt100 (100 Ω)	CPM1A-TS102

CompoBus/S I/O Link Unit

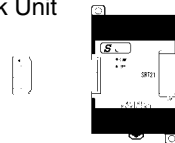
Description	Specifications	Model number
CompoBus/S I/O Link Unit 	Operates as a CompoBus/S slave and provides 8 inputs and 8 outputs to the CPM1A or CPM2A PC.	CPM1A-SRT21

DeviceNet I/O Link Unit

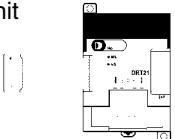



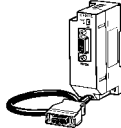
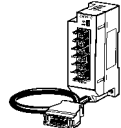

Description	Specifications	Model number
DeviceNet I/O Link Unit 	Operates as a DeviceNet slave and is allocated 32 input points and 32 output points.	CPM1A-DRT21

Communications Adapters

Description	Output points	Model number
RS-232C Adapter 	Converts data communications between the peripheral port and RS-232C devices.	CPM1-CIF01
RS-422 Adapter 	Converts data communications between the peripheral port and RS-422 devices.	CPM1-CIF11

The CPM1-CIF01/CIF11 are used with the CPM1A, CPM1 and SRM1 only. Do not use them with a C200HS PC or other PC.

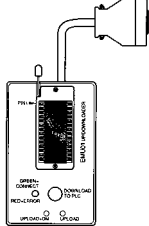
Peripheral Devices

Name	Appearance	Model Number	Specifications
Programming Console		CQM1-PRO01-E	2-m Connecting Cable attached
		C200H-PRO27-E	Hand-held, w/backlight; requires a C200H-CN222 or C200H-CN422 Connecting Cable, see below.
	C200H-CN222	Connects the C200H-PRO27-E to a peripheral port.	2-m cable
	C200H-CN422		4-m cable
CX-Programmer		WS02-CXPC1-E	For MS-Windows 95/98 (CD-ROM)
SYSMAC Support Software		C500-ZL3AT1-E	3.5", 2HD for IBM PC/AT compatible
SYSMAC-CPT		WS01-CPTB1-E	For IBM PC/AT or compatible computers (3.5" disks (2HD) and CDROM)
Expansion Memory Unit		CPM1-EMU01-V1	Uploads the ladder program and DM 6144 to DM 6655 from the PC to the EEPROM and downloads the ladder program and DM 6144 to DM 6655 from the EEPROM to the PC.
EEPROM		EEROM-JD	256 K bit

Appendix B Dimensions

All dimensions are in millimeters.

CPM1A-10CDR-□-V1/10CDT-□-V1/10CDT1-□-V1 CPU Unit

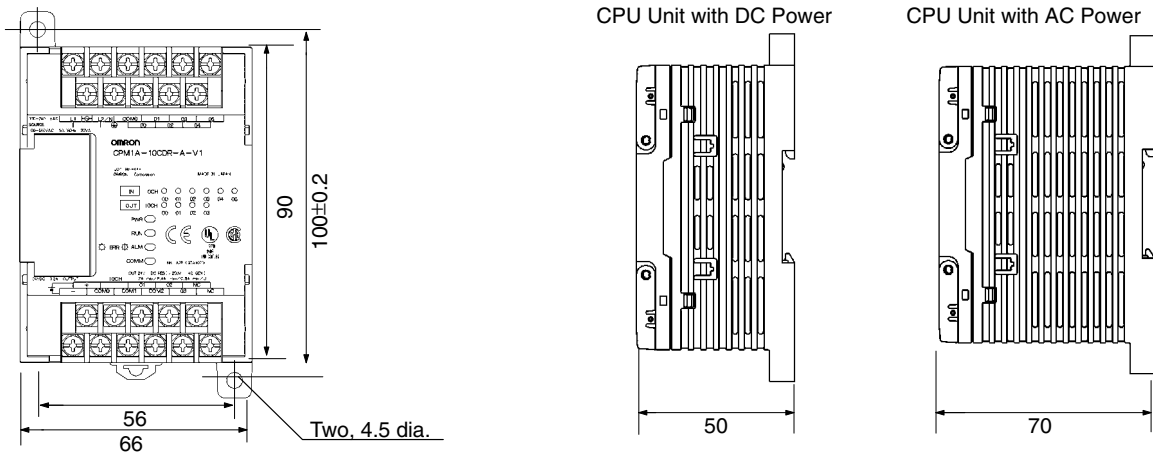

CPM1A-10CDR-□/10CDT-□/10CDT1-□ CPU Unit

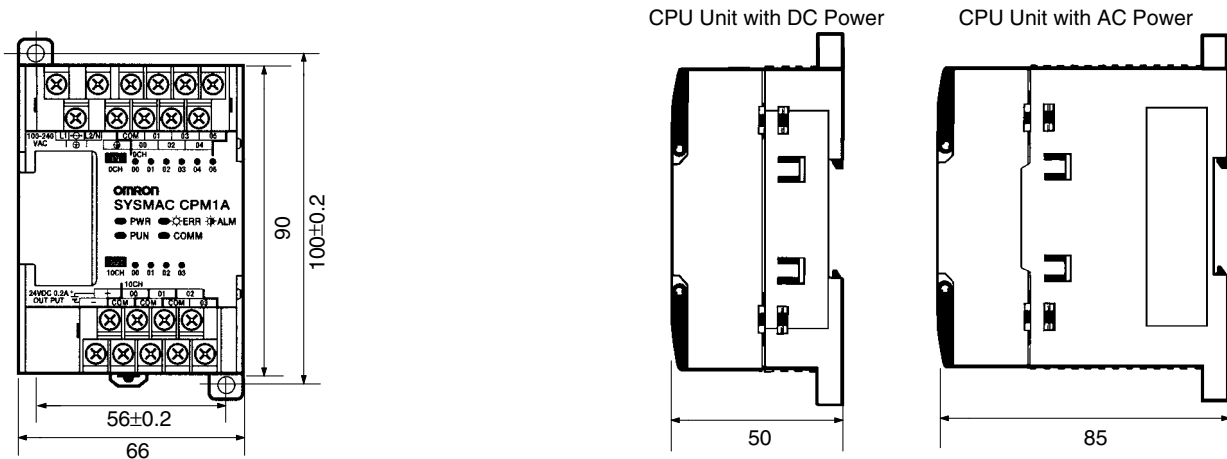

CPM1A-20CDR-□-V1/20CDT-□-V1/20CDT1-□-V1 CPU Unit

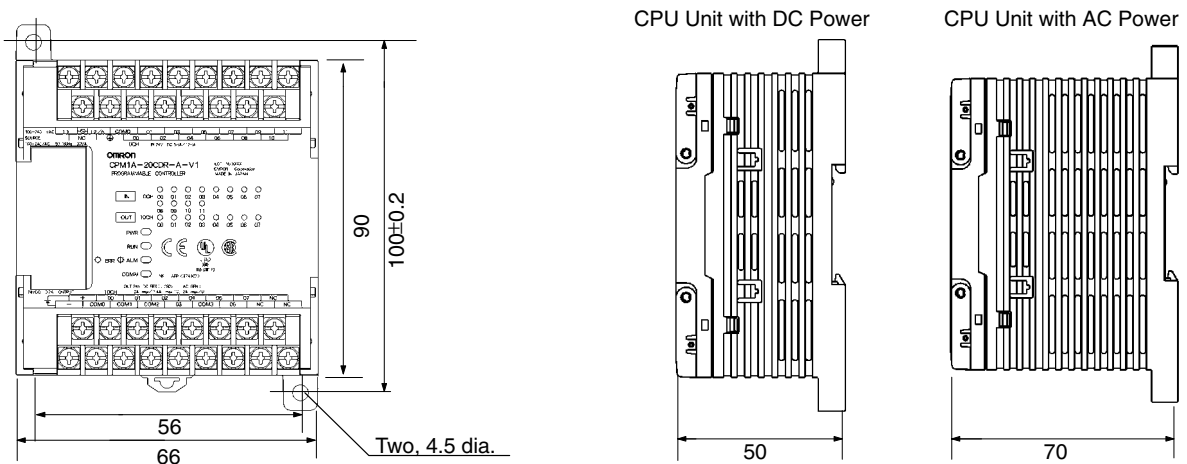

CPM1A-20CDR-□/20CDT-□/20CDT1-□ CPU Unit

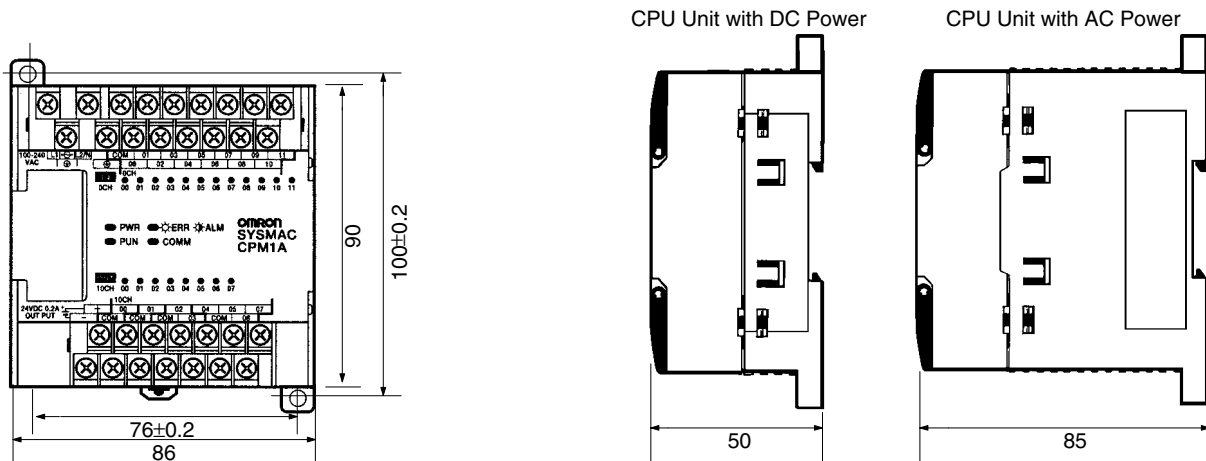

CPM1A-30CDR-□-V1/30CDT-□-V1/30CDT1-□-V1 CPU Unit

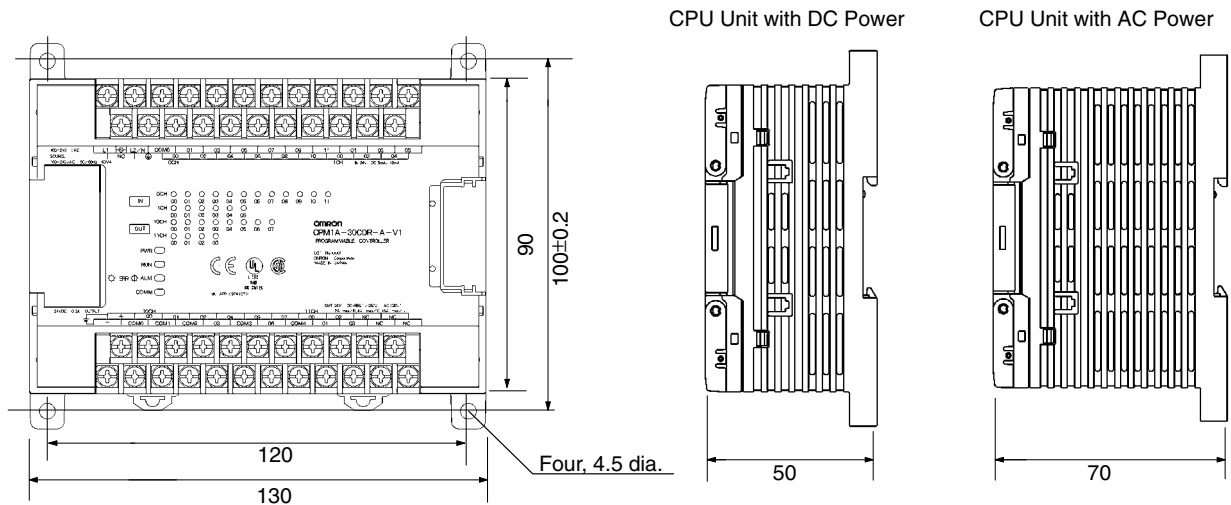

CPM1A-30CDR-□/30CDT-□/30CDT1-□ CPU Unit

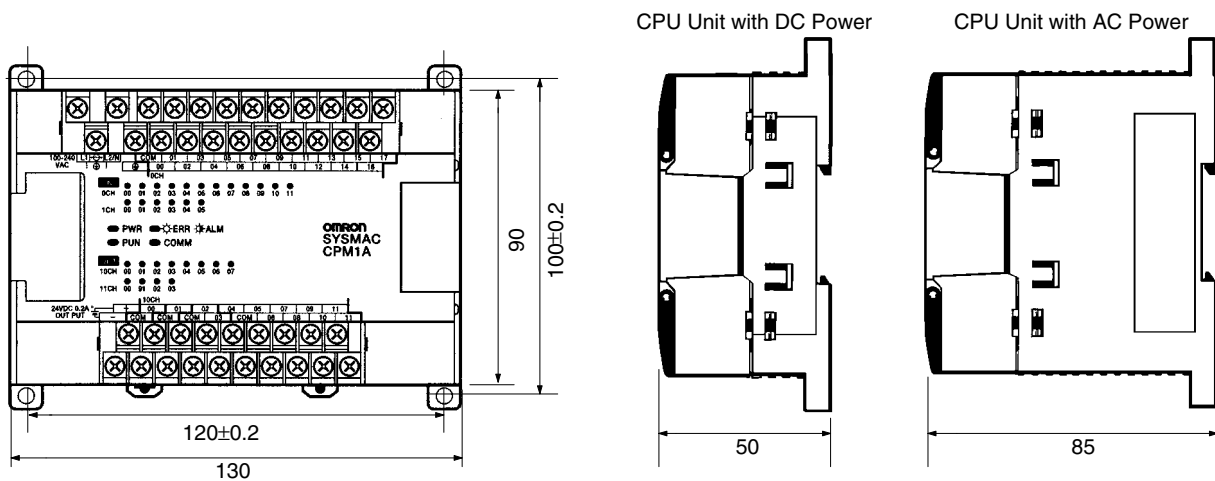

CPM1A-40CDR-□-V1/40CDT-□-V1/40CDT1-□-V1 CPU Unit

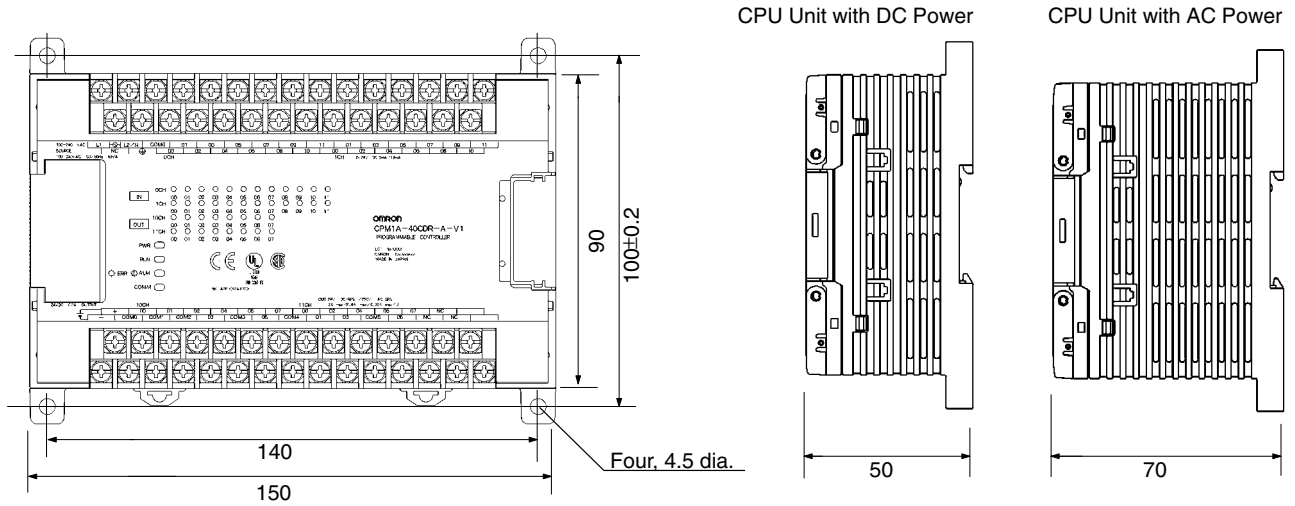

CPM1A-40CDR-□/40CDT-□/40CDT1-□ CPU Unit

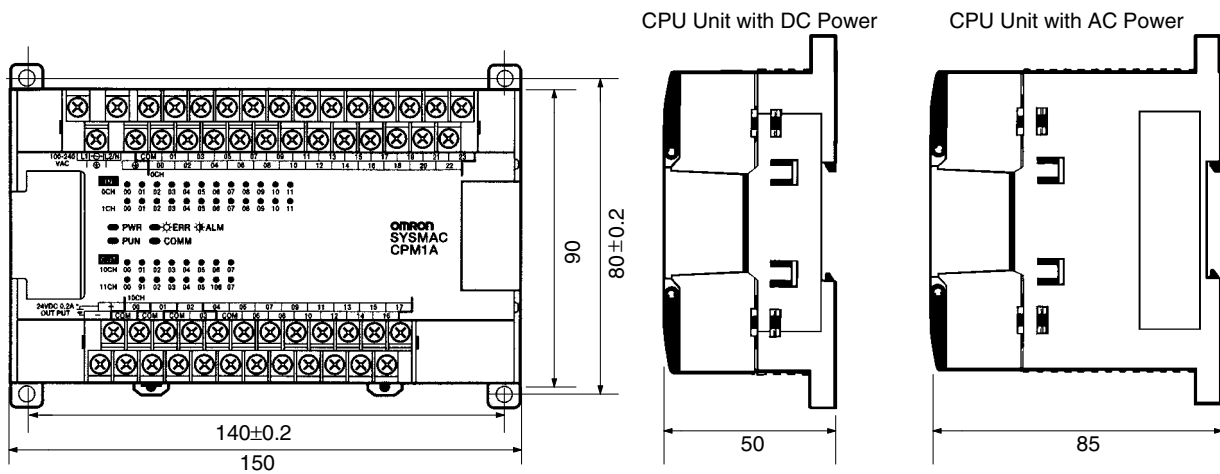

CPM1A-20ED□ Expansion I/O Unit

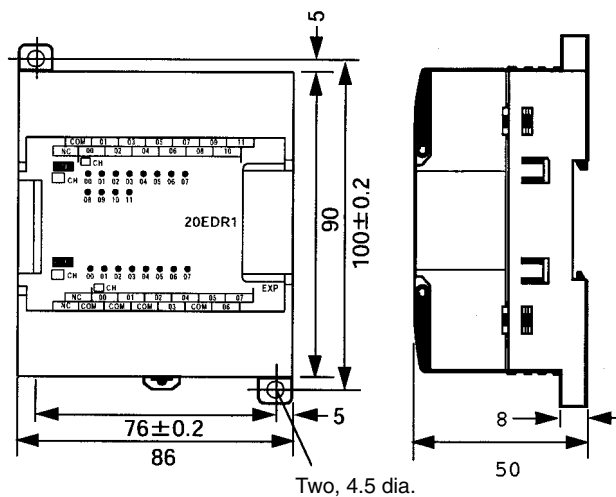

CPM1A-8 Expansion I/O Unit

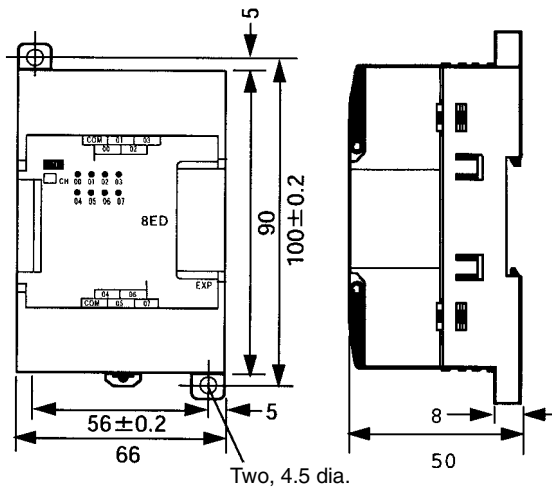

Analog I/O Unit

CPM1A-MAD01

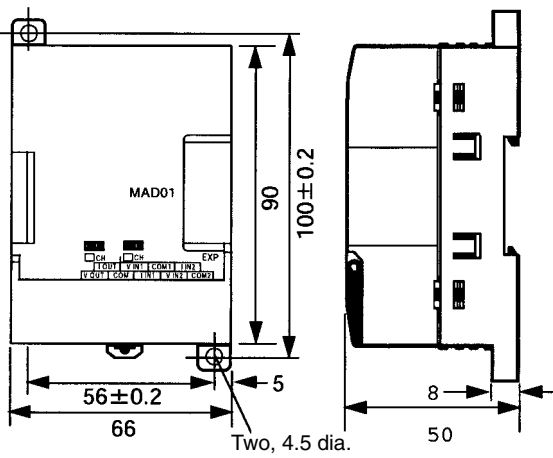

CPM1A-MAD11

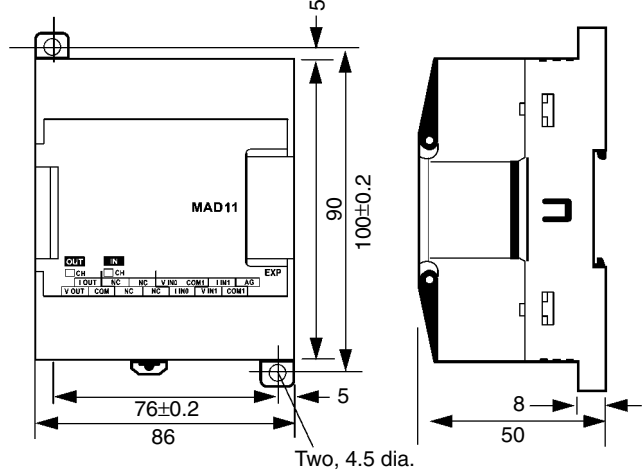

CPM1A-TS Temperature Sensor Unit

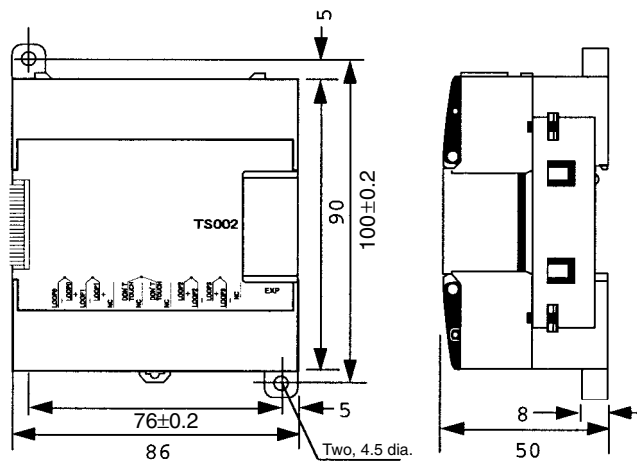

CPM1A-SRT21 CompoBus/S I/O Link Unit

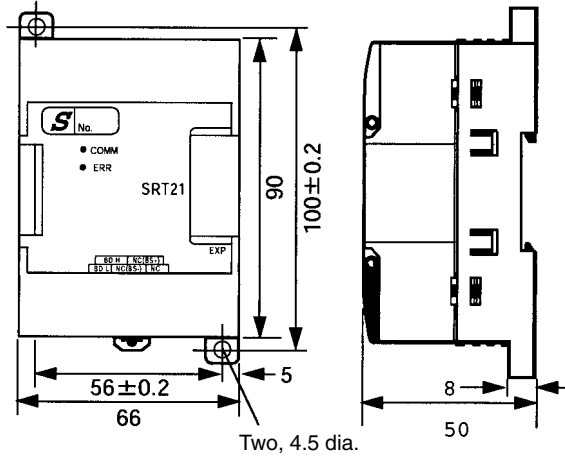

CPM1A-DRT21 DeviceNet I/O Link Unit

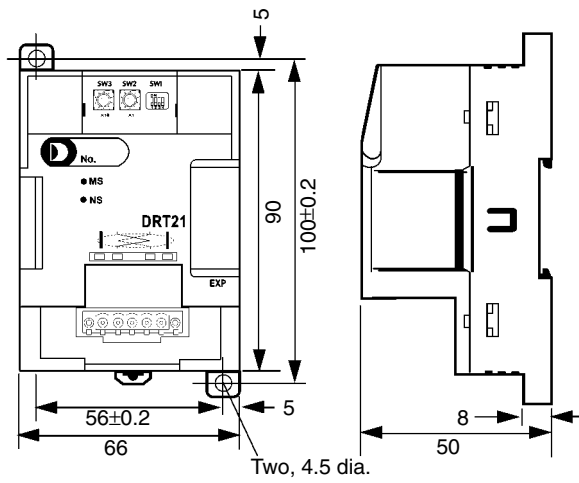

CPM1-CIF01 RS-232C Adapter

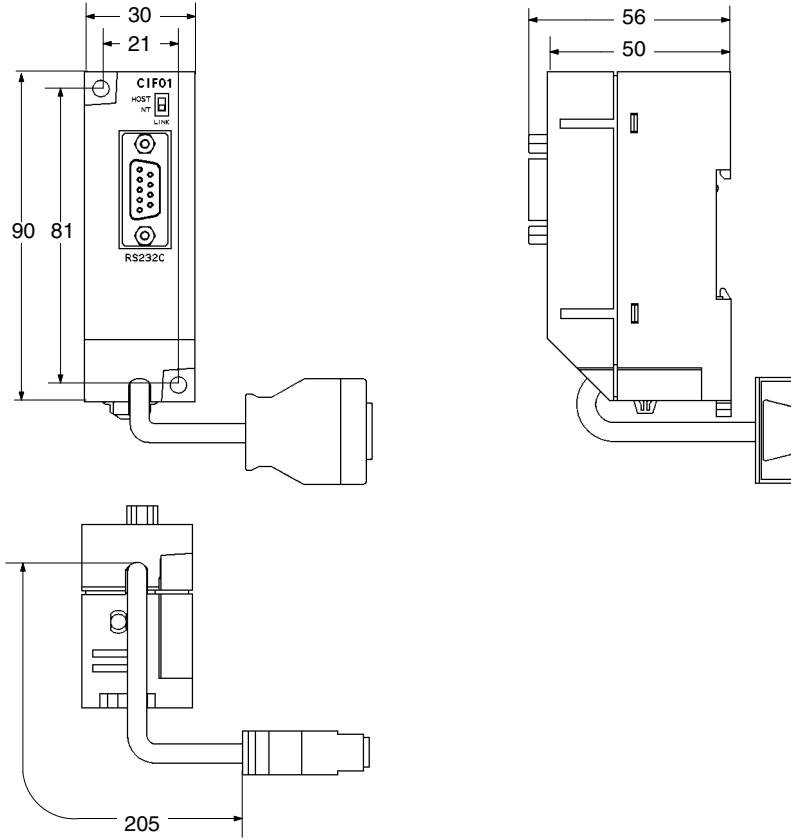

CPM1-CIF11 RS-422 Adapter

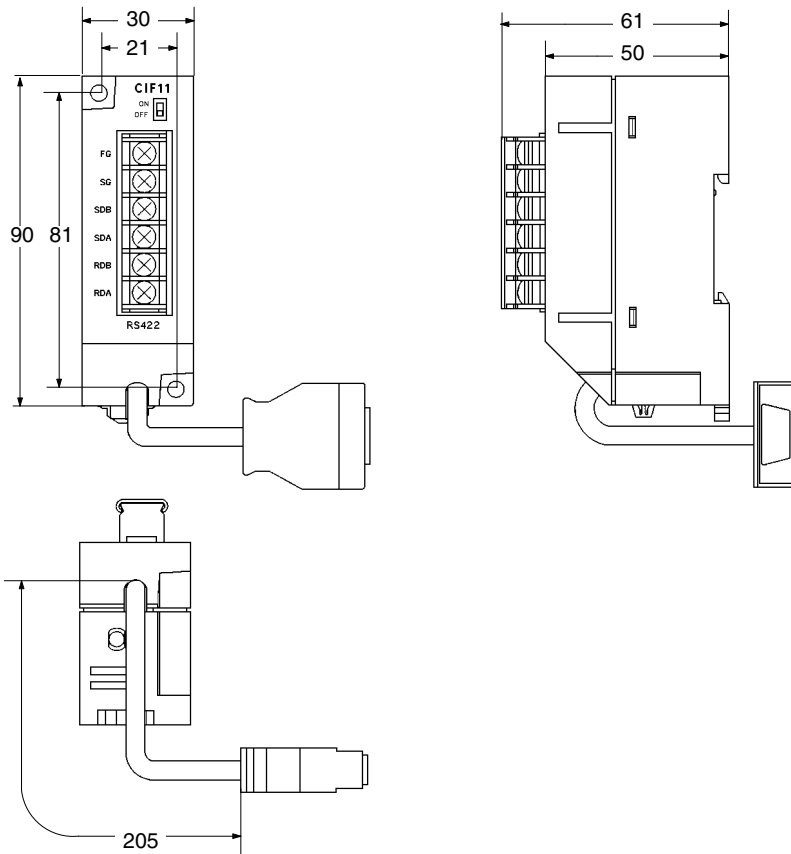

Dimensions with Peripheral Devices Attached

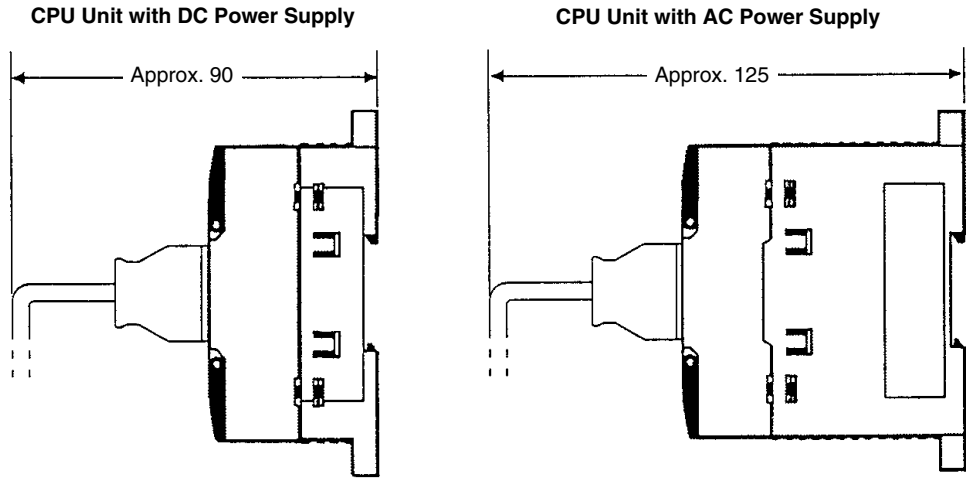

*110 mm for V1 Units.

Glossary

*DM	Indirectly addressed DM area. See <i>indirect address</i> and <i>DM area</i> .
1:1 PC Link	A link created between two PCs to create <i>common data</i> in their LR areas.
ACP	See <i>add count input</i> .
add count input	An input signal used to increment a counter when the signal changes from OFF to ON.
address	A number used to identify the location of data or programming instructions in memory.
AND	A logic operation whereby the result is true if and only if both premises are true. In ladder-diagram programming the premises are usually ON/OFF states of bits or the logical combination of such states called execution conditions.
area	See <i>data area</i> and <i>memory area</i> .
area prefix	A one or two letter prefix used to identify a memory area in the PC. All memory areas except the IR and SR areas require prefixes to identify addresses in them.
arithmetic shift	A shift operation wherein the carry flag is included in the shift.
ASCII	Short for American Standard Code for Information Interchange. ASCII is used to code characters for output to printers and other external devices.
AR Area	A PC data area allocated to flags and control bits.
AUTOEXEC.BAT	An MS-DOS file containing commands automatically executed at startup.
back-up	A copy made of existing data to ensure that the data will not be lost even if the original data is corrupted or erased.
basic instruction	A fundamental instruction used in a ladder diagram. See <i>advanced instruction</i> .
baud rate	The data transmission speed between two devices in a system measured in bits per second.
BCD	See <i>binary-coded decimal</i> .
BCD calculation	An arithmetic calculation that uses numbers expressed in binary-coded decimal.
binary	A number system where all numbers are expressed in base 2, i.e., numbers are written using only 0's and 1's. Each group of four binary bits is equivalent to one hexadecimal digit. Binary data in memory is thus often expressed in hexadecimal for convenience.
binary calculation	An arithmetic calculation that uses numbers expressed in binary.
binary-coded decimal	A system used to represent numbers so that every four binary bits is numerically equivalent to one decimal digit.
bit	The smallest piece of information that can be represented on a computer. A bit has the value of either zero or one, corresponding to the electrical signals ON and OFF. A bit represents one binary digit. Some bits at particular addresses are allocated to special purposes, such as holding the status of input from external devices, while other bits are available for general use in programming.
bit address	The location in memory where a bit of data is stored. A bit address specifies the data area and word that is being addressed as well as the number of the bit within the word.

bit designator	An operand that is used to designate the bit or bits of a word to be used by an instruction.
bit number	A number that indicates the location of a bit within a word. Bit 00 is the rightmost (least-significant) bit; bit 15 is the leftmost (most-significant) bit.
bit-control instruction	An instruction that is used to control the status of an individual bit as opposed to the status of an entire word.
block	See <i>logic block</i> and <i>instruction block</i> .
building-block PC	A PC that is constructed from individual components, or “building blocks.” With building-block PCs, there is no one Unit that is independently identifiable as a PC. The PC is rather a functional assembly of Units.
bus	A communications path used to pass data between any of the Units connected to it.
bus bar	The line leading down the left and sometimes right side of a ladder diagram. Instruction execution proceeds down the bus bar, which is the starting point for all instruction lines.
byte	A unit of data equivalent to 8 bits, i.e., half a word.
call	A process by which instruction execution shifts from the main program to a subroutine. The subroutine may be called by an instruction or by an interrupt.
Carry Flag	A flag that is used with arithmetic operations to hold a carry from an addition or multiplication operation, or to indicate that the result is negative in a subtraction operation. The carry flag is also used with certain types of shift operations.
central processing unit	A device that is capable of storing programs and data, and executing the instructions contained in the programs. In a PC System, the central processing unit executes the program, processes I/O signals, communicates with external devices, etc.
CH	See <i>word</i> .
channel	See <i>word</i> .
character code	A numeric (usually binary) code used to represent an alphanumeric character.
checksum	A sum transmitted with a data pack in communications. The checksum can be recalculated from the received data to confirm that the data in the transmission has not been corrupted.
clock pulse	A pulse available at specific bits in memory for use in timing operations. Various clock pulses are available with different pulse widths, and therefore different frequencies.
clock pulse bit	A bit in memory that supplies a pulse that can be used to time operations. Various clock pulse bits are available with different pulse widths, and therefore different frequencies.
common data	Data that is stored in a memory of a PC and which is shared by other PCs in the same the same system. Each PC has a specified section(s) of the area allocated to it. Each PC writes to the section(s) allocated to it and reads the sections allocated to the other PCs with which it shares the common data.
communications cable	Cable used to transfer data between components of a control system and conforming to the RS-232C or RS-422 standards.
comparison instruction	An instruction used to compare data at different locations in memory to determine the relationship between the data.

Completion Flag	A flag used with a timer or counter that turns ON when the timer has timed out or the counter has reached its set value.
condition	A symbol placed on an instruction line to indicate an instruction that controls the execution condition for the terminal instruction. Each condition is assigned a bit in memory that determines its status. The status of the bit assigned to each condition determines the next execution condition. Conditions correspond to LOAD, LOAD NOT, AND, AND NOT, OR, or OR NOT instructions.
CONFIG.SYS	An MS-DOS file containing environment settings for a personal computer.
constant	An input for an operand in which the actual numeric value is specified. Constants can be input for certain operands in place of memory area addresses. Some operands must be input as constants.
control bit	A bit in a memory area that is set either through the program or via a Programming Device to achieve a specific purpose, e.g., a Restart Bit is turned ON and OFF to restart a Unit.
control data	An operand that specifies how an instruction is to be executed. The control data may specify the part of a word is to be used as the operand, it may specify the destination for a data transfer instructions, it may specify the size of a data table used in an instruction, etc.
control signal	A signal sent from the PC to effect the operation of the controlled system.
Control System	All of the hardware and software components used to control other devices. A Control System includes the PC System, the PC programs, and all I/O devices that are used to control or obtain feedback from the controlled system.
controlled system	The devices that are being controlled by a PC System.
count pulse	The signal counted by a counter.
counter	A dedicated group of digits or words in memory used to count the number of times a specific process has occurred, or a location in memory accessed through a TIM/CNT bit and used to count the number of times the status of a bit or an execution condition has changed from OFF to ON.
CPU Unit	See <i>central processing unit</i> .
CTS	An acronym for clear-to-send, a signal used in communications between electronic devices to indicate that the receiver is ready to accept incoming data.
CY	See <i>Carry Flag</i> .
cycle	One unit of processing performed by the CPU Unit, including ladder program execution, peripheral servicing, I/O refreshing, etc.
cycle time	The time required to complete one cycle of CPU Unit processing.
cyclic interrupt	See <i>scheduled interrupt</i> .
data area	An area in the PC's memory that is designed to hold a specific type of data.
data area boundary	The highest address available within a data area. When designating an operand that requires multiple words, it is necessary to ensure that the highest address in the data area is not exceeded.
data disk	A floppy disk used to same user programs, DM area contents, comments, and other user data.
data length	In communications, the number of bits that is to be treated as one unit in data transmissions.

data link	An automatic data transmission operation that allows PCs or Units within PC to pass data back and forth via common data areas.
data link area	A common data area established through a data link.
data movement instruction	An instruction used to move data from one location in memory to another. The data in the original memory location is left unchanged.
data sharing	The process in which common data areas or common data words are created between two or more PCs.
data trace	A process in which changes in the contents of specific memory locations are recorded during program execution.
data transfer	Moving data from one memory location to another, either within the same device or between different devices connected via a communications line or network.
debug	A process by which a draft program is corrected until it operates as intended. Debugging includes both the removal of syntax errors, as well as the fine-tuning of timing and coordination of control operations.
decimal	A number system where numbers are expressed to the base 10. In a PC all data is ultimately stored in binary form, four binary bits are often used to represent one decimal digit, via a system called binary-coded decimal.
decrement	Decreasing a numeric value, usually by 1.
default	A value automatically set by the PC when the user does not specifically set another value. Many devices will assume such default conditions upon the application of power.
definer	A number used as an operand for an instruction but that serves to define the instruction itself, rather than the data on which the instruction is to operate. Definers include jump numbers, subroutine numbers, etc.
destination	The location where an instruction places the data on which it is operating, as opposed to the location from which data is taken for use in the instruction. The location from which data is taken is called the source.
differentiated instruction	An instruction that is executed only once each time its execution condition goes from OFF to ON. Non-differentiated instructions are executed for each scan as long as the execution condition stays ON.
differentiation instruction	An instruction used to ensure that the operand bit is never turned ON for more than one scan after the execution condition goes either from OFF to ON for a Differentiate Up instruction or from ON to OFF for a Differentiate Down instruction.
digit	A unit of storage in memory that consists of four bits.
digit designator	An operand that is used to designate the digit or digits of a word to be used by an instruction.
DIN track	A rail designed to fit into grooves on various devices to allow the devices to be quickly and easily mounted to it.
DIP switch	Dual in-line package switch, an array of pins in a signal package that is mounted to a circuit board and is used to set operating parameters.
direct output	A method in which program execution results are output immediately to eliminate the affects of the cycle time.
distributed control	A automation concept in which control of each portion of an automated system is located near the devices actually being controlled, i.e., control is decentralized

	and 'distributed' over the system. Distributed control is a concept basic to PC Systems.
DM area	A data area used to hold only word data. Words in the DM area cannot be accessed bit by bit.
DM word	A word in the DM area.
downloading	The process of transferring a program or data from a higher-level or host computer to a lower-level or slave computer. If a Programming Device is involved, the Programming Device is considered the host computer.
EEPROM	Electrically erasable programmable read-only memory; a type of ROM in which stored data can be erased and reprogrammed. This is accomplished using a special control lead connected to the EEPROM chip and can be done without having to remove the EEPROM chip from the device in which it is mounted.
electrical noise	Random variations of one or more electrical characteristics such as voltage, current, and data, which might interfere with the normal operation of a device.
EPROM	Erasable programmable read-only memory; a type of ROM in which stored data can be erased, by ultraviolet light or other means, and reprogrammed.
error code	A numeric code generated to indicate that an error exists, and something about the nature of the error. Some error codes are generated by the system; others are defined in the program by the operator.
Error Log Area	An area used to store records indicating the time and nature of errors that have occurred in the system.
even parity	A communication setting that adjusts the number of ON bits so that it is always even. See <i>parity</i> .
event processing	Processing that is performed in response to an event, e.g., an interrupt signal.
exclusive NOR	A logic operation whereby the result is true if both of the premises are true or both of the premises are false. In ladder-diagram programming, the premises are usually the ON/OFF states of bits, or the logical combination of such states, called execution conditions.
exclusive OR	A logic operation whereby the result is true if one, and only one, of the premises is true. In ladder-diagram programming the premises are usually the ON/OFF states of bits, or the logical combination of such states, called execution conditions.
execution condition	The ON or OFF status under which an instruction is executed. The execution condition is determined by the logical combination of conditions on the same instruction line and up to the instruction currently being executed.
execution cycle	The cycle used to execute all processes required by the CPU Unit, including program execution, I/O refreshing, peripheral servicing, etc.
execution time	The time required for the CPU Unit to execute either an individual instruction or an entire program.
extended counter	A counter created in a program by using two or more count instructions in succession. Such a counter is capable of counting higher than any of the standard counters provided by the individual instructions.
extended timer	A timer created in a program by using two or more timers in succession. Such a timer is capable of timing longer than any of the standard timers provided by the individual instructions.

FA	Factory automation.
factory computer	A general-purpose computer, usually quite similar to a business computer, that is used in automated factory control.
FAL error	An error generated from the user program by execution of an FAL(06) instruction.
FALS error	An error generated from the user program by execution of an FALS(07) instruction or an error generated by the system.
fatal error	An error that stops PC operation and requires correction before operation can continue.
FCS	See <i>frame checksum</i> .
flag	A dedicated bit in memory that is set by the system to indicate some type of operating status. Some flags, such as the carry flag, can also be set by the operator or via the program.
flicker bit	A bit that is programmed to turn ON and OFF at a specific frequency.
floating-point decimal	A decimal number expressed as a number (the mantissa) multiplied by a power of 10, e.g., 0.538×10^{-5} .
force reset	The process of forcibly turning OFF a bit via a programming device. Bits are usually turned OFF as a result of program execution.
force set	The process of forcibly turning ON a bit via a programming device. Bits are usually turned ON as a result of program execution.
forced status	The status of bits that have been force reset or force set.
frame checksum	The results of exclusive ORing all data within a specified calculation range. The frame checksum can be calculated on both the sending and receiving end of a data transfer to confirm that data was transmitted correctly.
function code	A two-digit number used to input an instruction into the PC.
hardware error	An error originating in the hardware structure (electronic components) of the PC, as opposed to a software error, which originates in software (i.e., programs).
header code	A code in an instruction that specifies what the instruction is to do.
hexadecimal	A number system where all numbers are expressed to the base 16. In a PC all data is ultimately stored in binary form, however, displays and inputs on Programming Devices are often expressed in hexadecimal to simplify operation. Each group of four binary bits is numerically equivalent to one hexadecimal digit.
host computer	A computer that is used to transfer data to or receive data from a PC in a Host Link system. The host computer is used for data management and overall system control. Host computers are generally small personal or business computers.
host interface	An interface that allows communications with a host computer.
host link	An interface connecting a PC to a host computer to enable monitoring or program control from the host computer.
HR area	A memory area that preserves bit status during power interrupts and used as work bits in programming.
I/O bit	A bit in memory used to hold I/O status. Input bits reflect the status of input terminals; output bits hold the status for output terminals.

I/O capacity	The number of inputs and outputs that a PC is able to handle. This number ranges from around one hundred for smaller PCs to two thousand for the largest ones.
I/O delay	The delay in time from when a signal is sent to an output to when the status of the output is actually in effect or the delay in time from when the status of an input changes until the signal indicating the change in the status is received.
I/O device	A device connected to the I/O terminals on I/O Units. I/O devices may be either part of the Control System, if they function to help control other devices, or they may be part of the controlled system.
I/O interrupt	An interrupt generated by a signal from I/O.
I/O point	The place at which an input signal enters the PC System, or at which an output signal leaves the PC System. In physical terms, I/O points correspond to terminals or connector pins on a Unit; in terms of programming, an I/O points correspond to I/O bits in the IR area.
I/O refreshing	The process of updating output status sent to external devices so that it agrees with the status of output bits held in memory and of updating input bits in memory so that they agree with the status of inputs from external devices.
I/O response time	The time required for an output signal to be sent from the PC in response to an input signal received from an external device.
I/O Unit	The Units in a PC that are physically connected to I/O devices to input and output signals. I/O Units include Input Units and Output Units, each of which is available in a range of specifications.
I/O word	A word in the IR area that is allocated to a Unit in the PC System and is used to hold I/O status for that Unit.
IBM PC/AT or compatible	A computer that has similar architecture to, that is logically compatible with, and that can run software designed for an IBM PC/AT computer.
increment	Increasing a numeric value, usually by 1.
indirect address	An address whose contents indicates another address. The contents of the second address will be used as the actual operand.
initialization error	An error that occurs either in hardware or software during the PC System startup, i.e., during initialization.
initialize	Part of the startup process whereby some memory areas are cleared, system setup is checked, and default values are set.
input	The signal coming from an external device into the PC. The term input is often used abstractly or collectively to refer to incoming signals.
input bit	A bit in the IR area that is allocated to hold the status of an input.
input device	An external device that sends signals into the PC System.
input point	The point at which an input enters the PC System. Input points correspond physically to terminals or connector pins.
input signal	A change in the status of a connection entering the PC. Generally an input signal is said to exist when, for example, a connection point goes from low to high voltage or from a nonconductive to a conductive state.
install	The preparation necessary to use a program or software package, such as the LSS or SSS, on a computer.

instruction	A direction given in the program that tells the PC of the action to be carried out, and the data to be used in carrying out the action. Instructions can be used to simply turn a bit ON or OFF, or they can perform much more complex actions, such as converting and/or transferring large blocks of data.
instruction block	A group of instructions that is logically related in a ladder-diagram program. A logic block includes all of the instruction lines that interconnect with each other from one or more line connecting to the left bus bar to one or more right-hand instructions connecting to the right bus bar.
instruction execution time	The time required to execute an instruction. The execution time for any one instruction can vary with the execution conditions for the instruction and the operands used in it.
instruction line	A group of conditions that lie together on the same horizontal line of a ladder diagram. Instruction lines can branch apart or join together to form instruction blocks. Also called a rung.
interface	An interface is the conceptual boundary between systems or devices and usually involves changes in the way the communicated data is represented. Interface devices perform operations like changing the coding, format, or speed of the data.
interlock	A programming method used to treat a number of instructions as a group so that the entire group can be reset together when individual execution is not required. An interlocked program section is executed normally for an ON execution condition and partially reset for an OFF execution condition.
interrupt (signal)	A signal that stops normal program execution and causes a subroutine to be run or other processing to take place.
interrupt program	A program that is executed in response to an interrupt.
inverse condition	See <i>normally closed condition</i> .
JIS	An acronym for Japanese Industrial Standards.
jump	A type of programming where execution moves directly from one point in a program to another, without sequentially executing any instructions in between.
jump number	A definer used with a jump that defines the points from and to which a jump is to be made.
ladder diagram (program)	A form of program arising out of relay-based control systems that uses circuit-type diagrams to represent the logic flow of programming instructions. The appearance of the program is similar to a ladder, and thus the name.
ladder diagram symbol	A symbol used in drawing a ladder-diagram program.
ladder instruction	An instruction that represents the conditions on a ladder-diagram program. The other instructions in a ladder diagram fall along the right side of the diagram and are called terminal instructions.
Ladder Support Software	A software package installed on a IBM PC/AT or compatible computer to function as a Programming Device.
least-significant (bit/word)	See <i>rightmost (bit/word)</i> .
LED	Acronym for light-emitting diode; a device used as for indicators or displays.
leftmost (bit/word)	The highest numbered bits of a group of bits, generally of an entire word, or the highest numbered words of a group of words. These bits/words are often called most-significant bits/words.

link	A hardware or software connection formed between two Units. "Link" can refer either to a part of the physical connection between two Units or a software connection created to data existing at another location (i.e., data links).
load	The processes of copying data either from an external device or from a storage area to an active portion of the system such as a display buffer. Also, an output device connected to the PC is called a load.
logic block	A group of instructions that is logically related in a ladder-diagram program and that requires logic block instructions to relate it to other instructions or logic blocks.
logic block instruction	An instruction used to locally combine the execution condition resulting from a logic block with a current execution condition. The current execution condition could be the result of a single condition, or of another logic block. AND Load and OR Load are the two logic block instructions.
logic instruction	Instructions used to logically combine the content of two words and output the logical results to a specified result word. The logic instructions combine all the same-numbered bits in the two words and output the result to the bit of the same number in the specified result word.
LR area	A data area that is used in data links.
LSS	See <i>Ladder Support Software</i> .
main program	All of a program except for subroutine and interrupt programs.
mark trace	A process in which changes in the contents of specific memory locations are recorded during program execution.
masked bit	A bit whose status has been temporarily made ineffective.
masking	'Covering' an interrupt signal so that the interrupt is not effective until the mask is removed.
megabyte	A unit of storage equal to one million bytes.
memory area	Any of the areas in the PC used to hold data or programs.
message number	A number assigned to a message generated with the MESSAGE instruction.
mnemonic code	A form of a ladder-diagram program that consists of a sequential list of the instructions without using a ladder diagram.
MONITOR mode	A mode of PC operation in which normal program execution is possible, and which allows modification of data held in memory. Used for monitoring or debugging the PC.
most-significant (bit/word)	See <i>leftmost (bit/word)</i> .
NC input	An input that is normally closed, i.e., the input signal is considered to be present when the circuit connected to the input opens.
negative delay	A delay set for a data trace in which recording data begins before the trace signal by a specified amount.
nesting	Programming one loop within another loop, programming a call to a subroutine within another subroutine, or programming one jump within another.
NO input	An input that is normally open, i.e., the input signal is considered to be present when the circuit connected to the input closes.
noise interference	Disturbances in signals caused by electrical noise.

non-fatal error	A hardware or software error that produces a warning but does not stop the PC from operating.
normal condition	See <i>normally open condition</i> .
normally closed condition	A condition that produces an ON execution condition when the bit assigned to it is OFF, and an OFF execution condition when the bit assigned to it is ON.
normally open condition	A condition that produces an ON execution condition when the bit assigned to it is ON, and an OFF execution condition when the bit assigned to it is OFF.
NOT	A logic operation which inverts the status of the operand. For example, AND NOT indicates an AND operation with the opposite of the actual status of the operand bit.
OFF	The status of an input or output when a signal is said not to be present. The OFF state is generally represented by a low voltage or by non-conductivity, but can be defined as the opposite of either.
OFF delay	The delay between the time when a signal is switched OFF (e.g., by an input device or PC) and the time when the signal reaches a state readable as an OFF signal (i.e., as no signal) by a receiving party (e.g., output device or PC).
offset	A positive or negative value added to a base value such as an address to specify a desired value.
ON	The status of an input or output when a signal is said to be present. The ON state is generally represented by a high voltage or by conductivity, but can be defined as the opposite of either.
ON delay	The delay between the time when an ON signal is initiated (e.g., by an input device or PC) and the time when the signal reaches a state readable as an ON signal by a receiving party (e.g., output device or PC).
one-shot bit	A bit that is turned ON or OFF for a specified interval of time which is longer than one scan.
One-to-one PC Link	See <i>1:1 PC Link</i> .
online edit	The process of changed the program directly in the PC from a Programming Device. Online editing is possible in PROGRAM or MONITOR mode. In MONITOR mode, the program can actually be changed while it is being
operand	The values designated as the data to be used for an instruction. An operand can be input as a constant expressing the actual numeric value to be used or as an address to express the location in memory of the data to be used.
operand bit	A bit designated as an operand for an instruction.
operand word	A word designated as an operand for an instruction.
operating modes	One of three PC modes: <i>PROGRAM mode</i> , <i>MONITOR mode</i> , and <i>RUN mode</i> .
operating error	An error that occurs during actual PC operation as opposed to an initialization error, which occurs before actual operations can begin.
OR	A logic operation whereby the result is true if either of two premises is true, or if both are true. In ladder-diagram programming the premises are usually ON/OFF states of bits or the logical combination of such states called execution conditions.
output	The signal sent from the PC to an external device. The term output is often used abstractly or collectively to refer to outgoing signals.

output bit	A bit in the IR area that is allocated to hold the status to be sent to an output device.
output device	An external device that receives signals from the PC System.
output point	The point at which an output leaves the PC System. Output points correspond physically to terminals or connector pins.
output signal	A signal being sent to an external device. Generally an output signal is said to exist when, for example, a connection point goes from low to high voltage or from a nonconductive to a conductive state.
overflow	The state where the capacity of a data storage location has been exceeded.
overseeing	Part of the processing performed by the CPU Unit that includes general tasks required to operate the PC.
overwrite	Changing the content of a memory location so that the previous content is lost.
parity	Adjustment of the number of ON bits in a word or other unit of data so that the total is always an even number or always an odd number. Parity is generally used to check the accuracy of data after being transmitted by confirming that the number of ON bits is still even or still odd.
parity check	Checking parity to ensure that transmitted data has not been corrupted.
PC	See <i>Programmable Controller</i> .
PC configuration	The arrangement and interconnections of the Units that are put together to form a functional PC.
PC System	With building-block PCs, all of the Units connected up to, but not including, the I/O devices. The boundaries of a PC System are the PC and the program in its CPU Unit at the upper end; and the I/O Units at the lower end.
PCB	See <i>printed circuit board</i> .
PC Setup	A group of operating parameters set in the PC from a Programming Device to control PC operation.
Peripheral Device	Devices connected to a PC System to aid in system operation. Peripheral devices include printers, programming devices, external storage media, etc.
peripheral servicing	Processing signals to and from peripheral devices, including refreshing, communications processing, interrupts, etc.
port	A connector on a PC or computer that serves as a connection to an external device.
positive delay	A delay set for a data trace in which recording data begins after the trace signal by a specified amount.
Power Supply Unit	A Unit that connected to a PC that provides power at the voltage required by the other Units.
present value	The current value registered in a device at any instant during its operation. Present value is abbreviated as PV. The use of this term is generally restricted to timers and counters.
printed circuit board	A board onto which electrical circuits are printed for mounting into a computer or electrical device.
PROGRAM mode	A mode of operation that allows inputting and debugging of programs to be carried out, but that does not permit normal execution of the program.

Programmable Controller	A computerized device that can accept inputs from external devices and generate outputs to external devices according to a program held in memory. Programmable Controllers are used to automate control of external devices. Although single-unit Programmable Controllers are available, building-block Programmable Controllers are constructed from separate components. Such Programmable Controllers are formed only when enough of these separate components are assembled to form a functional assembly.
programmed alarm	An alarm given as a result of execution of an instruction designed to generate the alarm in the program, as opposed to one generated by the system.
programmed error	An error arising as a result of the execution of an instruction designed to generate the error in the program, as opposed to one generated by the system.
programmed message	A message generated as a result of execution of an instruction designed to generate the message in the program, as opposed to one generated by the system.
Programming Console	The portable form of Programming Device for a PC.
Programming Device	A Peripheral Device used to input a program into a PC or to alter or monitor a program already held in the PC. There are dedicated programming devices, such as Programming Consoles, and there are non-dedicated devices, such as a host computer.
PROM	Programmable read-only memory; a type of ROM into which the program or data may be written after manufacture, by a customer, but which is fixed from that time on.
prompt	A message or symbol that appears on a display to request input from the operator.
protocol	The parameters and procedures that are standardized to enable two devices to communicate or to enable a programmer or operator to communicate with a device.
PV	See <i>present value</i> .
RAM	Random access memory; a data storage media. RAM will not retain data when power is disconnected.
RAS	An acronym for reliability, assurance, safety.
read-only area	A memory area from which the user can read status but to which data cannot be written.
refresh	The process of updating output status sent to external devices so that it agrees with the status of output bits held in memory and of updating input bits in memory so that they agree with the status of inputs from external devices.
relay-based control	The forerunner of PCs. In relay-based control, groups of relays are interconnected to form control circuits. In a PC, these are replaced by programmable circuits.
reserved bit	A bit that is not available for user application.
reserved word	A word in memory that is reserved for a special purpose and cannot be accessed by the user.
reset	The process of turning a bit or signal OFF or of changing the present value of a timer or counter to its set value or to zero.
response code	A code sent with the response to a data transmission that specifies how the transmitted data was processed.

response format	A format specifying the data required in a response to a data transmission.
response monitoring time	The time a device will wait for a response to a data transmission before assuming that an error has occurred.
Restart Bit	A bit used to restart part of a PC.
result word	A word used to hold the results from the execution of an instruction.
retrieve	The processes of copying data either from an external device or from a storage area to an active portion of the system such as a display buffer. Also, an output device connected to the PC is called a load.
retry	The process whereby a device will re-transmit data which has resulted in an error message from the receiving device.
return	The process by which instruction execution shifts from a subroutine back to the main program (usually the point from which the subroutine was called).
reversible counter	A counter that can be both incremented and decremented depending on the specified conditions.
reversible shift register	A shift register that can shift data in either direction depending on the specified conditions.
right-hand instruction	See <i>terminal instruction</i> .
rightmost (bit/word)	The lowest numbered bits of a group of bits, generally of an entire word, or the lowest numbered words of a group of words. These bits/words are often called least-significant bits/words.
rising edge	The point where a signal actually changes from an OFF to an ON status.
ROM	Read only memory; a type of digital storage that cannot be written to. A ROM chip is manufactured with its program or data already stored in it and can never be changed. However, the program or data can be read as many times as desired.
rotate register	A shift register in which the data moved out from one end is placed back into the shift register at the other end.
RS-232C interface	An industry standard for serial communications.
RUN mode	The operating mode used by the PC for normal control operations.
rung	See <i>instruction line</i> .
scan	The process used to execute a ladder-diagram program. The program is examined sequentially from start to finish and each instruction is executed in turn based on execution conditions.
scan time	See <i>cycle time</i> .
scheduled interrupt	An interrupt that is automatically generated by the system at a specific time or program location specified by the operator. Scheduled interrupts result in the execution of specific subroutines that can be used for instructions that must be executed repeatedly at a specified interval of time.
SCP	See <i>subtract count input</i> .
seal	See <i>self-maintaining bit</i> .
self diagnosis	A process whereby the system checks its own operation and generates a warning or error if an abnormality is discovered.

self-maintaining bit	A bit that is programmed to maintain either an OFF or ON status until set or reset by specified conditions.
series	A wiring method in which Units are wired consecutively in a string.
servicing	The process whereby the PC checks a connector or Unit to see if special processing is required.
set	The process of turning a bit or signal ON.
set value	The value from which a decrementing counter starts counting down or to which an incrementing counter counts up (i.e., the maximum count), or the time from which or for which a timer starts timing. Set value is abbreviated SV.
shift input signal	An input signal whose OFF to ON transition causes data to be shifted one bit.
shift register	One or more words in which data is shifted a specified number of units to the right or left in bit, digit, or word units. In a rotate register, data shifted out one end is shifted back into the other end. In other shift registers, new data (either specified data, zero(s) or one(s)) is shifted into one end and the data shifted out at the other end is lost.
signed binary	A binary value that is stored in memory along with a bit that indicates whether the value is positive or negative.
signed decimal	One-word signed hexadecimal values stored in the two's complement format can be displayed at the Programming Console as decimal values from -32,768 to 32,767.
software error	An error that originates in a software program.
software protect	A means of protecting data from being changed that uses software as opposed to a physical switch or other hardware setting.
source (word)	The location from which data is taken for use in an instruction, as opposed to the location to which the result of an instruction is to be written. The latter is called the destination.
special instruction	An instruction input with a function code that handles data processing operations within ladder diagrams, as opposed to a basic instruction, which makes up the fundamental portion of a ladder diagram.
SR area	A memory area containing flags and other bits/words with specific functions.
SSS	See <i>SYSMAC Support Software</i> .
store	The process of recording a program written into a display buffer permanently in memory.
subroutine	A group of instructions placed separate from the main program and executed only when called from the main program or activated by an interrupt.
subroutine number	A definer used to identify the subroutine that a subroutine call or interrupt activates.
subtract count input	An input signal used to decrement a counter when the signal changes from OFF to ON.
SV	See <i>set value</i> .
switching capacity	The maximum voltage/current that a relay can safely switch on and off.
synchronous execution	Execution of programs and servicing operations in which program execution and servicing are synchronized so that all servicing operations are executed each time the programs are executed.

syntax	The form of a program statement (as opposed to its meaning).
syntax error	An error in the way in which a program is written. Syntax errors can include 'spelling' mistakes (i.e., a function code that does not exist), mistakes in specifying operands within acceptable parameters (e.g., specifying read-only bits as a destination), and mistakes in actual application of instructions (e.g., a call to a subroutine that does not exist).
SYSMAC Support Software	A software package installed on a IBM PC/AT or compatible computer to function as a Programming Device.
system configuration	The arrangement in which Units in a System are connected. This term refers to the conceptual arrangement and wiring together of all the devices needed to comprise the System.
system error	An error generated by the system, as opposed to one resulting from execution of an instruction designed to generate an error.
system error message	An error message generated by the system, as opposed to one resulting from execution of an instruction designed to generate a message.
system setup	Operating environment settings for a Programming Device, e.g., the LSS or SSS.
terminal instruction	An instruction placed on the right side of a ladder diagram that uses the final execution conditions of an instruction line.
timer	A location in memory accessed through a TIM/CNT bit and used to time down from the timer's set value. Timers are turned ON and reset according to their execution conditions.
TR area	A data area used to store execution conditions so that they can be reloaded later for use with other instructions.
TR bit	A bit in the TR area.
trace	An operation whereby the program is executed and the resulting data is stored to enable step-by-step analysis and debugging.
trace memory	A memory area used to store the results of trace operations.
transfer	The process of moving data from one location to another within the PC, or between the PC and external devices. When data is transferred, generally a copy of the data is sent to the destination, i.e., the content of the source of the transfer is not changed.
transmission distance	The distance that a signal can be transmitted.
trigger	A signal used to activate some process, e.g., the execution of a trace operation.
trigger address	An address in the program that defines the beginning point for tracing. The actual beginning point can be altered from the trigger by defining either a positive or negative delay.
UM area	The memory area used to hold the active program, i.e., the program that is being currently executed.
Unit	In OMRON PC terminology, the word Unit is capitalized to indicate any product sold for a PC System. Most of the names of these products end with the word Unit.
unit number	A number assigned to some Units to facilitate identification when assigning words or other operating parameters.

unmasked bit	A bit whose status is effective. See <i>masked bit</i> .
unsigned binary	A binary value that is stored in memory without any indication of whether it is positive or negative.
unsigned decimal	One-word hexadecimal values can be displayed at the Programming Console as decimal values from 0 to 65,535.
uploading	The process of transferring a program or data from a lower-level or slave computer to a higher-level or host computer. If a Programming Device is involved, the Programming Device is considered the host computer.
watchdog timer	A timer within the system that ensures that the scan time stays within specified limits. When limits are reached, either warnings are given or PC operation is stopped depending on the particular limit that is reached.
WDT	See <i>watchdog timer</i> .
word	A unit of data storage in memory that consists of 16 bits. All data areas consists of words. Some data areas can be accessed only by words; others, by either words or bits.
word address	The location in memory where a word of data is stored. A word address must specify (sometimes by default) the data area and the number of the word that is being addressed.
work area	A part of memory containing work words/bits.
work bit	A bit in a work word.
work word	A word that can be used for data calculation or other manipulation in programming, i.e., a 'work space' in memory. A large portion of the IR area is always reserved for work words. Parts of other areas not required for special purposes may also be used as work words.
write protect switch	A switch used to write-protect the contents of a storage device, e.g., a floppy disk. If the hole on the upper left of a floppy disk is open, the information on this floppy disk cannot be altered.
write-protect	A state in which the contents of a storage device can be read but cannot be altered.

Index

Numbers

- 1:1 Host Link, 14
 - connections, 69
- 1:1 NT Link, 17
 - connections, 73
- 1:1 PC Link, 3, 16
 - connections, 72
- 1:N Host Link, 15
 - connections, 70

A

- Adapters, list of communications adapters, 15
- Analog I/O Unit, standard model, 148
- analog setting function, 3, 5
- analog volume controls, 5
 - location, 33
- ASCII, converting displays, Programming Console, 111
- atmosphere, 22

B

- binary data, modifying, Programming Console, 108
- bit status, force-set/reset, Programming Console, 110
- bits, searching, Programming Console, 98
- buzzer operation, Programming Console, 93

C

- cabinet
 - installation, precautions, 44
 - Programming Console installation, 87
- characteristics, 23
- check levels, program checks, 125
- checking, program syntax, Programming Console, 100
- circuit configuration
 - inputs, 25
 - outputs, relay, 27, 28, 29
- clearing, memory areas, Programming Console, 91
- communication errors, 123
- communications, adapters, list, 15
- communications adapters, standard models, 149
- communications baud rate, for SSS, 78
- CompoBus/S I/O Link, 17, 18
 - connections, 74

CompoBus/S I/O Unit, standard model, 148

components

- Analog I/O Unit, 35
- Communication Adapters, 40
- CompoBus/S I/O Link Unit, 37
- CPU Unit, 31
- Expansion I/O Unit, 33
- Temperature Sensor Unit, 36

computer

- 1:1 Host Link, 14
- 1:N Host Link, 15
 - connecting, 69

conduit installation, 51

configuration, 10

Counter Mode, 6

counters

- changing SV, Programming Console, 106
- example of inputting, 116

CPU Units, standard models, 147

cycle, CPM1A operating cycle, 122

cycle time

- displaying, Programming Console, 112
- processing, 122

D

data, modifying, Programming Console, 106, 107, 108, 109, 110

data link, 16, 72

decimal data with sign. *See* signed decimal data

decimal data without sign. *See* unsigned decimal data

dielectric strength, 22

differentiated instructions, entering, 96

dimensions, 151

DIN Track installation, 46

displays

- converting between hex and ASCII, Programming Console, 111
- cycle time, Programming Console, 112

downloading, programs, 143

duct installation, 50

E

EC Directives, precautions, xxi

EEPROM

- mounting/removing, 140
- specifications, 139

electrical noise, preventing, 44, 50

ERR/ALM indicator
 flashing, 123
 lit, 123

errors
 communications, 123
 error processing, 119
 fatal, 123
 identifying, 124
 non-fatal, 123
 programming, 125
 Programming Console operations, 125
 reading/clearing messages, Programming Console, 92
 user-defined errors, 124

Expansion I/O Units, 2
 available models, 12, 148
 components, 33
 connection, 47
 standard models, 148

Expansion Memory Unit, 137
 connections, 141

Expansion Units, available models, 13, 148

F–H

FAL numbers, 123

FAL(06), 124

FALS numbers, 123

FALS(07), 125

false inputs, 59

fatal errors, troubleshooting, 129

features, 2

filter function, 2

flash memory, precautions, 121

flicker output, example, 117

force-set/reset
 clearing, Programming Console, 111
 Programming Console, 110

functions, 5

grounding, 22, 32, 51

hexadecimal data, converting displays, Programming Console, 111

high-speed counter, 3, 9

Host Link, 3
 communications, 14
 connections, 69

I–L

I/O capacity, 23

I/O errors, troubleshooting, 131

I/O line noise, preventing, 50

I/O terminals, IR bit allocation, 5

incremental mode, 9

indicators
 CompoBus/S LED indicators, 38
 flashing ERR/ALM indicator, 123
 lit ERR/ALM indicator, 123
 PC status indicators, 33

inductive loads, 59, 68

initialization processes, 122

input devices, connecting, 58

input filter, 2

input filter function, 6

input interrupts, 2, 6

input specifications, 25, 26

input time constant, 6

inputs, wiring, 55
 configuration, 55

inspections, 135

installation, 45
 site, selecting, 43

instructions
 inserting and deleting, Programming Console, 99
 searching, Programming Console, 98

insulation resistance, 22

interlock circuit, example, 42

interlocks, 42

interrupt inputs, 2, 6

Interrupt Mode, 6

interval timer, 3, 8

IR bit allocation, 5

leakage current, 59

limit circuit, 42

limit switches, preventing false inputs, 59

M–N

maintenance, 135

memory
 backup, 2, 23
 Expansion Memory Unit, 137
 protection, 23

memory areas
 clearing, Programming Console, 91
 partial clear, 91
 uploading/downloading, 138

messages, reading/clearing, 92

mode, changing the PC mode, 86

Mode Setting Switch, RS-232C Adapter, 40

model numbers, 147

modifying
 binary data, Programming Console, 108
 data, Programming Console, 106
 hexadecimal/BCD data, Programming Console, 107
 signed decimal data, Programming Console, 109
 SV, Programming Console, 106
 unsigned decimal data, Programming Console, 110

MONITOR mode
 description, 86
 example test run, 118

monitoring
 3-word monitor, Programming Console, 104–105
 binary monitor, Programming Console, 103–104
 differentiation monitor, Programming Console, 103
 signed decimal monitor, Programming Console, 105
 status, Programming Console, 101
 unsigned decimal monitor, Programming Console, 105–106

MSG(46), 125

noise, preventing electrical noise, 44, 50

noise immunity, 22

non-fatal errors, troubleshooting, 130

NPN current output, connecting, 58

NPN open collector, connecting, 58

NT Link, 3

O

one-shot mode, 8

operating conditions, troubleshooting, 133

operation, preparations, 88

operations, internal processing, flowchart, 122

output short protection, 67

output specifications
 relay output, 27
 transistor output
 sink type, 28
 source type, 29

output wiring
 configuration, 62, 64, 66
 relay output, 61
 transistor output
 sink type, 64
 source type, 66

overseeing processes, 122

P–R

panel, Programming Console installation, 87

panel installation, precautions, 44

password, entering on Programming Console, 88

PC Link, 3

PC mode, changing, 86

PC Status, indicators, 33

Peripheral Devices, 4, 150
 available models, 150
 connecting, 18, 69
 using, 77

photoelectric switches, preventing false inputs, 59

PNP current output, connecting, 58

power, consumption, 22

power cables, 50

power interruptions, 42

power supply
 capacity, 22
 interrupt time, 22
 precautions, 42
 troubleshooting, 128, 134
 wiring, 52

precautions
 design precautions, 42
 general, xv
 handling, 136
 SSS, 78
 uploading/downloading, 138

program, programming example, 112

program capacity, 23

program memory, setting address and reading content, Programming Console, 94

PROGRAM mode, description, 86

Programmable Terminal, 4
 1:1 Host Link, 14
 1:1 Host Link connection, 70

programming
 checking the program, 118
 checks for syntax, Programming Console, 100–101
 errors, 125
 inserting and deleting instructions, Programming Console, 99–100
 preparation for, 112
 searching, Programming Console, 98–99
 setting and reading a memory address, Programming Console, 94

Programming Console
 connecting, 18, 69, 87
 keys, 84
 models, 84
 operations, 90

programming example, 112

programs
 checking, check levels, 125
 downloading, 143
 entering and editing, Programming Console, 95
 uploading, 142

proximity switches, preventing false inputs, 59

pulse output function, 3, 8

quick-response inputs, 2, 8

relay outputs, connecting, 58

response time, for interrupt inputs, 7

restrictions, SSS, 78
RS-232C Adapter
 components, 40
 specifications, 30
RS-422 Adapter
 components, 40
 specifications, 30
RUN mode, description, 86

S

scheduled interrupt mode, 8
scheduled interrupts, 3, 8
search
 instruction, Programming Console, 98
 operands, Programming Console, 98–99
self-diagnosis functions, 23, 123
self-holding bit, example, 115
shock resistance, 22
signed decimal data
 modifying, Programming Console, 109
 monitoring, 105
single-phase output, 8
specifications
 characteristics, 23
 Communications Adapters, 30
 Expansion Memory Unit, 139
 general specifications, 22
 input specifications, 25, 26
 output specifications
 relay output, 27
 transistor output, sink type, 28
 transistor output, source type, 29
SSS, 78
 See also SYSMAC Support Software
 offline and online operations, 83
 offline operations, 79
 online operations, 82
 precautions, 78
 restrictions, 78
 System Setup, 78
status, monitoring, Programming Console, 101
SV, modifying, Programming Console, 106
syntax, checking the program, Programming Console, 100
SYSMAC Support Software, 19
 See also SSS
 connecting, 18

SYSMAC-CPT, 19
SYSMAC-CPT, 78
system
 checks, 120
 configuration, 10
System Setup, 78

T–W

temperature
 effect on capacitor backup, 24
 operating, storage, 22
Temperature Sensor Units
 precautions, xix
 standard models, 148
temperature, ambient, 22
terminals, screw size, 22
Termination Resistance Switch, RS-422 Adapter, 40
test run
 example, 118
 procedure, 120
timers
 changing SV, Programming Console, 106
 example of inputting, 116
troubleshooting, 127
 fatal errors, 129
 I/O errors, 131
 non-fatal errors, 130
 operating conditions, 133
 power supply, 128, 134
unsigned decimal data
 modifying, Programming Console, 110
 monitoring, 105–106
up/down mode, 9
uploading, programs, 142
vibration resistance, 22
voltage
 operating voltage range, 22
 supply voltage, 22
voltage output, connecting, 58
weight
 CPU Unit, 22
 Expansion I/O Unit, 22
 Expansion Unit, 22
wiring, 50
 power supply, 52

Revision History

A manual revision code appears as a suffix to the catalog number on the front cover of the manual.

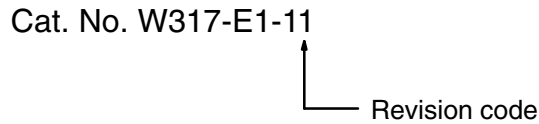

The following table outlines the changes made to the manual during each revision. Page numbers refer to the previous version.

Revision code	Date	Revised content	
1	April 1997	Original production	
2	July 1997	<p>Corrections and addition of supplementary explanation. CPU Unit model numbers changed throughout the manual.</p> <p>Page xiii: Minor change to AC Power Supply Unit precaution.</p> <p>Page xv: Changes made to crimp terminal wiring and forced set/reset precautions.</p> <p>Page 2: Information on sink-type and source-type transistor output models added. Pulse output function information added.</p> <p>Page 3: Information added to the note. Table in <i>1-1-2 I/O Terminal and IR Bit Allocation</i> changed to reflect the addition of transistor output models.</p> <p>Page 6: <i>Pulse Output Function</i> section added.</p>	<p>Pages 8, 19, 40, 103, 104: Information on sink-type and source-type transistor output models added.</p> <p>Pages 12, 48, 102: SYSMAC-CPT information added.</p> <p>Page 15: Changed the specifications for the analog controls. Pulse output added.</p> <p>Page 18, 19, 32, 34, 35, 39, 53 : Changed the wording of the caution.</p> <p>Page 35: Information for <i>24-VDC Power Supply</i> rewritten.</p> <p>Page 41: <i>Output Wiring Precautions</i> rewritten and added to.</p> <p>Page 101: CPU Unit and Expansion I/O Unit models added.</p>
3	November 1997	<p>Page xiii, xiv: Cautions rewritten and corrected.</p> <p>Page 3: Expansion I/O Unit model number corrected.</p> <p>Page 4: Information added to <i>Input Filter Function</i>.</p> <p>Page 13: SYSMAC-CPT added in text.</p> <p>Page 17: Memory protection and memory backup specs changed.</p> <p>Page 18: Entire page redone.</p> <p>Page 21: Voltage ranges for max. switching capacities changed.</p> <p>Page 22: Communications Adapter Specifications added.</p> <p>Page 23: Input indicator description corrected.</p> <p>Page 24: Note added to <i>2-2-2 Expansion I/O Unit Components</i>.</p> <p>Page 38: Voltage allowances added.</p>	<p>Page 52: Note and section on online editing added.</p> <p>Page 57: Note on the Programming Consoles added.</p> <p>Page 58: <i>4-2-3 Preparation for Operation</i> and <i>4-2-4 Entering the Password</i> sections added.</p> <p>Pages 61, 62, 67, 74, 80, 84: Screen messages corrected.</p> <p>Page 81: T001 in the ladder program corrected.</p> <p>Page 88: Notes changed below table.</p> <p>Page 91: AR 1309 corrected and AR 1314 added.</p> <p>Page 97: Reference to Memory Error Check flowchart added.</p> <p>Page 101: Memory Error Check flowchart added.</p> <p>Page 102: Changed humidity</p>
3A	January 1999	<p>Page 4: Information added to <i>Input Filter Function</i>.</p> <p>Page 11: RS-232C Adapter description at the top of the page changed.</p>	<p>Page 13: <i>1-3 Revised Specifications</i> added.</p> <p>Page 37: Crimp connector caution corrected.</p> <p>Pages 62, 81: Screen messages corrected.</p>
4	August 1999	Major revisions throughout the manual. Information on the Analog I/O Unit, CompoBus/S I/O Link Unit, and 8-point Expansion I/O Units added.	
5	February 2000	<p>Information on the Expansion Memory Unit and Temperature Sensor Units added throughout the manual. Layout and wording changed to distinguish between Expansion Units and Expansion I/O Units. In addition, the following changes were made.</p> <p>Page ix: Information on relevant manuals added.</p> <p>Page xv: Second item removed. "Memory Units" removed from third item. Safety precautions for Temperature Sensor Units added.</p> <p>Page 9: Information on Expansion Unit functions added.</p> <p>Page 15: Minor change to first graphic.</p> <p>Page 18: Information on inrush current and noise immunity changed.</p> <p>Page 38: Information added to table.</p> <p>Page 61: Minor changes to first paragraph.</p> <p>Page 66: Information added to introduction.</p> <p>Pages 73, 80, 81, 83, 86, 87, 88, 89, 90, 93, 95, 97, 98, 104: Minor changes to screen messages.</p> <p>Page 98: Note added to middle graphic.</p> <p>Page 124: Information added to "Peripheral Devices" table.</p> <p>Pages 125-126: Illustrations replaced.</p> <p>Page 126, 128: Minor changes to headings.</p>	
6	July 2000	<p>Added information on transistor output models with AC power supplies.</p> <p>Changed descriptions of EC Directives in the <i>Precautions</i> section.</p>	

Revision History

Revision code	Date	Revised content
7	May 2001	<p>Pages xiv, xvii, xviii, 2, 4, 6, 7, 10, 20, 21, 25, 26, 28, 29, 39 to 41, 43, 44, 47, 53, 55, 57, 125, 137, 141, 142, and 145: Changed made for V1 Units.</p> <p>Pages 3, 12, 31, 40, 137, and 143: Information on new Analog I/O Unit added (MAD11).</p> <p>Pages 3, 11, 12, 15, 33, 40, 65, 138, and 143: Information on DeviceNet I/O Link Unit added.</p> <p>Page 9: Information deleted or moved to page 3.</p> <p>Page 13: Cable model numbers added.</p> <p>Page 16: CX-Programmer added.</p> <p>Page 18: Table of revised specifications added.</p> <p>Pages 25, : Note added</p> <p>Pages 33, 34, : Model numbers added.</p> <p>Page 51: Precaution added on sensor surge current.</p> <p>Pages 80 and 82: New operations added.</p> <p>Pages 142 and 143: "Four" corrected to "Two" for the number of mounting holes.</p> <p>Page 145: Labels added to graphic.</p>
08	October 2002	Page 75: Note added at bottom of page.
09	March 2004	<p>Page xiii: Precaution added.</p> <p>Page xix: Information on changed specifications added.</p> <p>Pages 17, 18, and 75: "CS1" corrected to "CS" in graphic.</p> <p>Page 76: "+V" and "-V" swapped in graphic.</p> <p>Page 78: Reference details for <i>CX-Programmer Operation Manuals</i> changed.</p> <p>Page 114: "C" changed to "CNT" and "T" changed to "TIM" in table.</p> <p>Page 139: ATMEL model number changed.</p>
10	December 2005	<p>Page v: Information on general precautions notation added.</p> <p>Page xi: Information on liability and warranty added.</p> <p>Page xvii: EN50081-2 CHANGED TO en61000-6-4.</p>
11	October 2007	<p>Page ix: Changed reference to CX-Programmer manuals and added reference to CompoBus/S manual.</p> <p>Page 17: Changed last paragraph on page and added information to last line of table at bottom of page.</p>

OMRON Corporation

Control Devices Division H.Q.

Shiokoji Horikawa, Shimogyo-ku,
Kyoto, 600-8530 Japan

Tel: (81)75-344-7109/Fax: (81)75-344-7149

Regional Headquarters

OMRON EUROPE B.V.

Wegalaan 67-69, NL-2132 JD Hoofddorp
The Netherlands

Tel: (31)2356-81-300/Fax: (31)2356-81-388

OMRON ELECTRONICS LLC

One Commerce Drive Schaumburg,
IL 60173-5302 U.S.A.

Tel: (1) 847-843-7900/Fax: (1) 847-843-7787

OMRON ASIA PACIFIC PTE. LTD.

No. 438A Alexandra Road # 05-05/08 (Lobby 2),
Alexandra Technopark, Singapore 119967

Tel: (65) 6835-3011/Fax: (65) 6835-2711

OMRON (CHINA) CO., LTD.

Room 2211, Bank of China Tower,
200 Yin Cheng Zhong Road,

Pu Dong New Area, Shanghai, 200120, China

Tel: (86) 21-5037-2222/Fax: (86) 21-5037-2200

OMRON

Authorized Distributor: