

Equipment for special machines  
WF 725/WF 726  
Positioning modules

Installation Instructions

Edition 01.93

Part 1  
Description



# Index

	Page
<b>0</b> <b>Instructions for the reader</b> .....	0 - 1
<b>1</b> <b>Requirements and visual inspection</b> .....	1 - 1
<b>1.1</b> <b>Preliminary remarks</b> .....	1 - 1
<b>1.2</b> <b>Requirements for the initial start-up</b> .....	1 - 1
<b>1.3</b> <b>Visual inspection of the system</b> .....	1 - 2
1.3.1    General condition of control and modules .....	1 - 2
1.3.2    Grounding .....	1 - 2
1.3.3    Encoders (only when mounted externally to the motor) .....	1 - 2
1.3.4    Installation of cables .....	1 - 2
1.3.5    Shielding .....	1 - 3
1.3.6    Encoder cables .....	1 - 3
1.3.7    General condition .....	1 - 3
<b>1.4</b> <b>Handling of the modules</b> .....	1 - 4
<b>2</b> <b>WF hardware check</b> .....	2 - 1
<b>2.1</b> <b>Version up to spring 1989</b> .....	2 - 1
2.1.1    Check of the hardware version .....	2 - 1
2.1.2    Check of the software version .....	2 - 1
2.1.3    Check of the labels on the WF 725/WF 726 .....	2 - 2
<b>2.2</b> <b>Version as from spring 1989</b> .....	2 - 3

<b>3</b>	<b>Jumper and switch settings</b>	3 - 1
3.1	Connection between WF 725/WF 726 and drive unit	3 - 1
3.2	Settings for the encoders	3 - 2
3.3	Addressing of the WF 725/WF 726 as SIMATIC S5 periphery	3 - 2
3.4	Setting the length of the DPR (only WF 726)	3 - 3
3.5	Setting of jumpers on the WF 785	3 - 4
3.5.1	Application on the central bus	3 - 4
3.5.2	Setting of the module address	3 - 5
3.6	Jumper settings on WS 780	3 - 6
3.6.1	Device address	3 - 6
3.6.2	Language	3 - 6
3.6.3	Selection of functions	3 - 7
3.6.4	Fixed switch settings	3 - 7
<b>4</b>	<b>Machine data</b>	4 - 1
4.1	Subdivision of machine data	4 - 1
4.2	Order of obtaining machine data	4 - 2
4.3	Description of machine data	4 - 3
<b>5</b>	<b>Strategy for diagnosis and repair of faults</b>	5 - 1
5.1	Failures with error messages	5 - 2
5.2	Failures without error messages	5 - 2
5.3	Preliminary test	5 - 3
5.3.1	Power supply and grounding	5 - 3
5.3.2	Cables and connections	5 - 3
5.3.3	Machine data	5 - 3
5.3.4	Revision level	5 - 3
5.4	Error manifestation	5 - 4
5.4.1	Measuring system	5 - 4
5.4.2	Interface (machine control)	5 - 4
5.4.3	Memory	5 - 4
5.4.4	Input/output (operator panel)	5 - 4
5.4.5	CPU	5 - 4

<b>6</b>	<b>Error list and description</b> .....	6 - 1
<b>6.1</b>	<b>Error list</b> .....	6 - 1
6.1.1	WF errors in the traversing mode .....	6 - 1
6.1.2	WF errors in the mode program Input/Output .....	6 - 4
6.1.3	Messages of the STEP 5 virtual memory .....	6 - 5
6.1.4	Messages of the Software Schale .....	6 - 6
6.1.5	Messages of Standard II .....	6 - 7
<b>6.2</b>	<b>Description of errors</b> .....	6 - 9
6.2.1	Errors in the traversing mode .....	6 - 9
6.2.2	Errors in the mode program Input/Output .....	6 - 29
<b>7</b>	<b>Bibliography</b> .....	7 - 1



## 0 Instructions for the reader

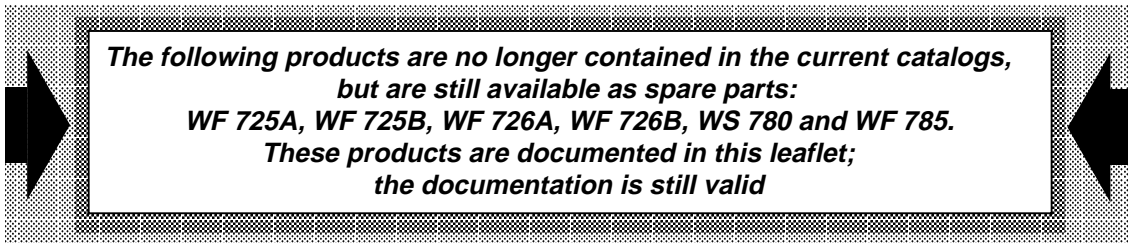

The documentation of installation and service of WF 725, WF 726, WF 785 and WS 780, is presented in two parts:

1. Installation instructions - Description  
(this documentation)
2. Installation instructions - Lists  
as supplement to part 1 with tables which refer to the particular versions.

Please pay also attention to the information leaflets enclosed with the delivered modules

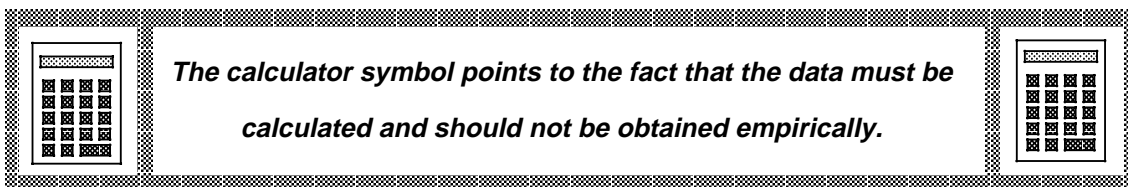
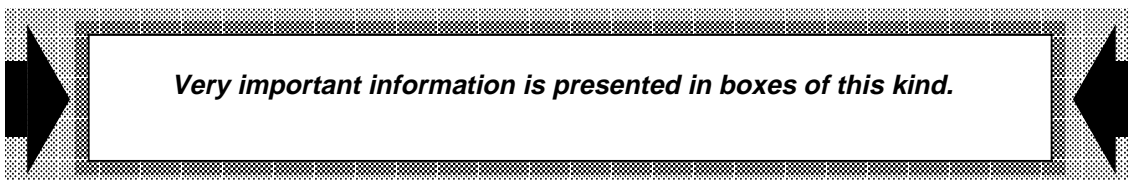





# 1 Requirements and visual inspection

*In connection with this section,  
see also the "EMC Recommendations for WS/WF Series" described in a  
separate leaflet (order No. 6ZB5 440-0QX02-0BA1).*

## 1.1 Preliminary remarks

*Never touch the printed circuit board or the  
components without first touching a grounded part*

Synthetic floors, carpets as well as synthetic or rubber soles can cause static electric charges of up to several kV in persons. Integrated circuits are very sensible to these discharges. It is absolutely necessary to prevent any discharge.

*Components, modules, bus cables and power supplies  
must never be inserted or withdrawn under power.*

## 1.2 Requirements for the initial start-up

- Electrical and mechanical installation of the machine is complete and prepared for movement of the axis.
- Drives commissioned and optimized.
- User S5 program operative and tested.
- Interface working and tested according to the interface description, machine and control coupled.
- Measuring system mounted and wired to the control (visual inspection)
- Machine control panel wired and tested.
- Cables from the machine to the control connected. Attention should be paid to the correct connection of the shields.
- Ground wires (visual inspection)  
Control - interface 10 mm square  
Control - machine 10 mm square  
According to schematic (Planning instruction part 1)
- Support by customer personnel for work on the S5 program and for work and operation of the machine.
- Recommendations:  
Narrow the traversing range by shifting the limit switches (bigger safety distances).
- If adapter plugs were installed in the encoder circuits, check for perfect connection and strain relief.

## 1.3 Visual inspection of the system

### 1.3.1 General condition of control and modules

- Check control for transport damage.
- Check all modules for valid revision (hardware and software).

### 1.3.2 Grounding

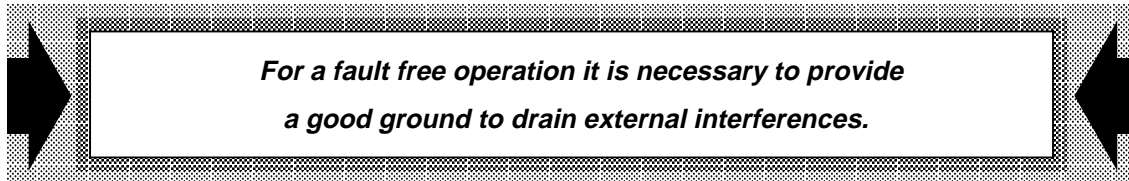

Care should be taken to avoid ground loops and to make sure that the ground wires are of sufficient size.

### 1.3.3 Encoders (only when mounted externally to the motor)

Special attention should be paid to the right mounting of the encoder (tightness of coupling, plug, torque support; any vibrations ?). What type of encoder is mounted (type, counts per revolution)?

### 1.3.4 Installation of cables

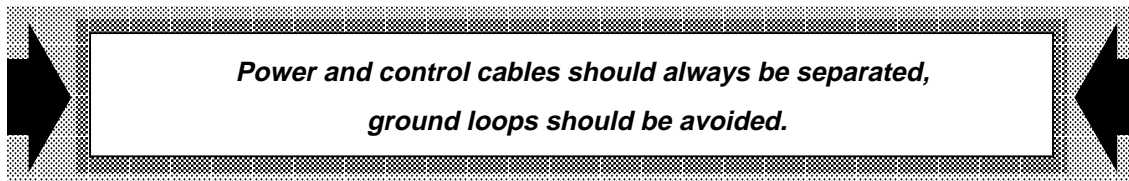

Faulty grounding and ground loops cause noise in the speed command value. A smooth movement at low speed will not be possible.

Special cables have to be used for cable drumming which have been marketed for this special use.

### 1.3.5 Shielding

The outer shielding of all cables to or from modules should be connected to the M-ext of the control or installation through the module plugs.

### 1.3.6 Encoder cables

In order to avoid any difficulties in the calibration or in the precision of the measuring circuit, the customer must use the cables as described in the planning instruction..

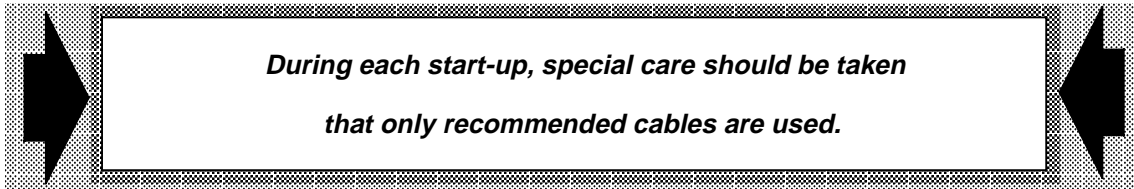

### 1.3.7 General condition

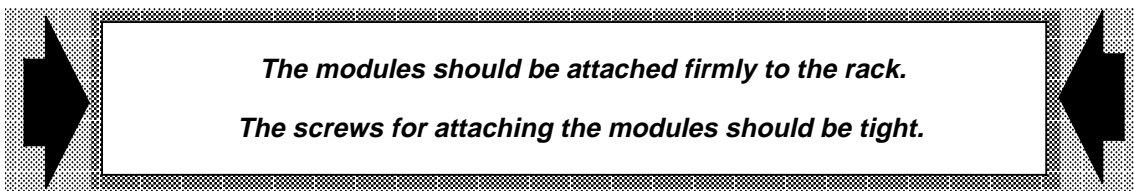

Cabinet doors should be kept closed during start up to keep the modules clean.

## 1.4 Handling of the modules

### Electrostatically endangered components (EEC)

Electronic modules should not be touched unless this is unavoidable because of work to be performed on them.

Before touching an electronic module, the human body must be in a discharged state. This can be done by simply touching a conductive grounded object immediately (e.g. bright metal cabinet parts, electrical socket protective ground contact).

Modules must not be brought into contact with highly insulating materials such as plastic films, insulating desk tops, items of clothing made of synthetic fibre.

Modules must be placed only on conductive surfaces.

Modules must be plugged in or withdrawn only when in a de-energized state.

When soldering on modules, the solder iron tip must be grounded.

Modules and components must always be stored or dispatched in conductive packaging (e.g. metallized plastic boxes, metal bushings).

If packagings are non-conductive, modules must be enclosed in conductive material before packaging. Conductive foam rubber or household aluminium foil, for example, can be used for this purpose.

The necessary protective measures for electrostatically endangered components are illustrated below.

a = conductive flooring  
b = EEC table  
c = EEC shoes

d = protective clothing of 100% cotton  
e = EEC chain  
f = ground connection of cabinets

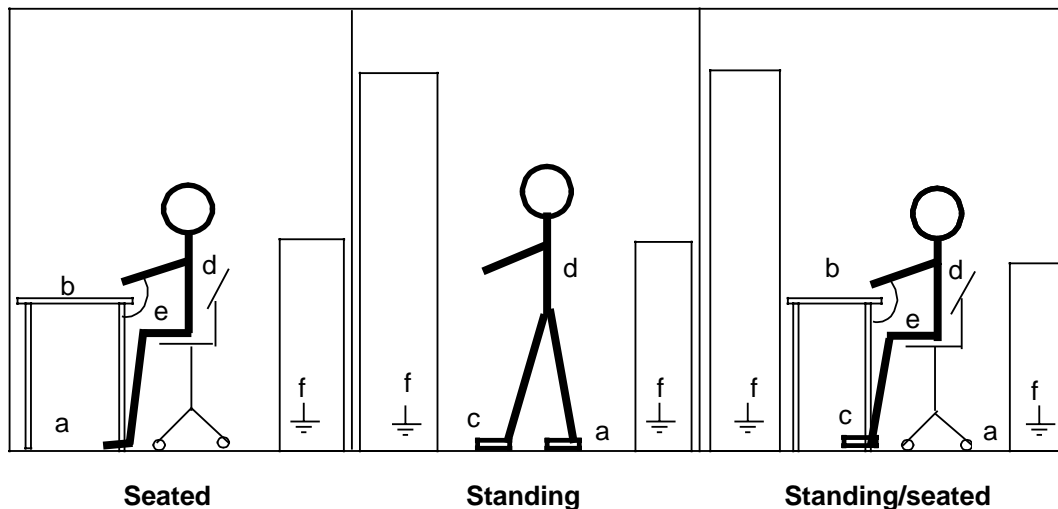

figure 1.1 EEC-Protective measures of safety for a workplace

## 2 WF hardware inspection

### 2.1 Version up to spring 1989

#### 2.1.1 Check of the hardware version

The version is written on the label on the bus connector. The latest version can be determined with the updates which can also be called over PRODOK.

#### 2.1.2 Check of the software version

##### *WF 725*

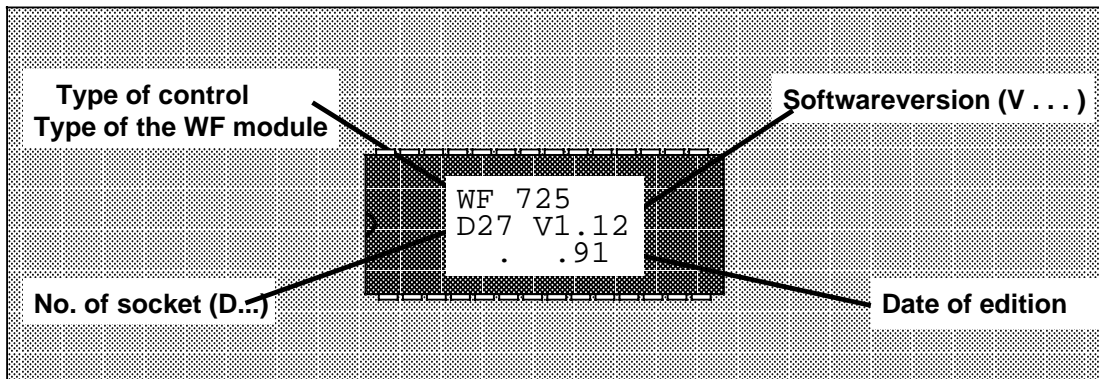

##### *WF 726*

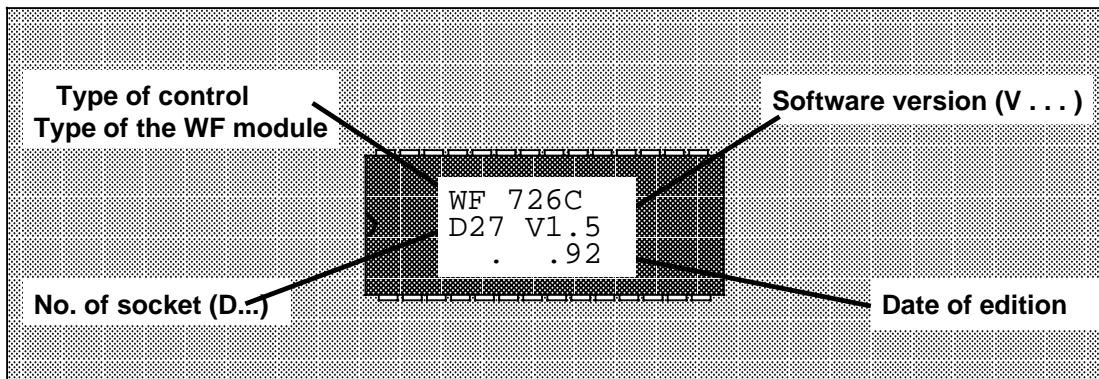

***The WF 726 C has its own EPROM-block.  
Therefore, WF 726 C is written in the first line of the label .***

Hardware and software versions can be read out with the "special routines" (Standard I - 726): also see Planning Instructions part 3, chapter 4.

The latest version is published in the updates which can also be called over PRODOK.

## WF 785

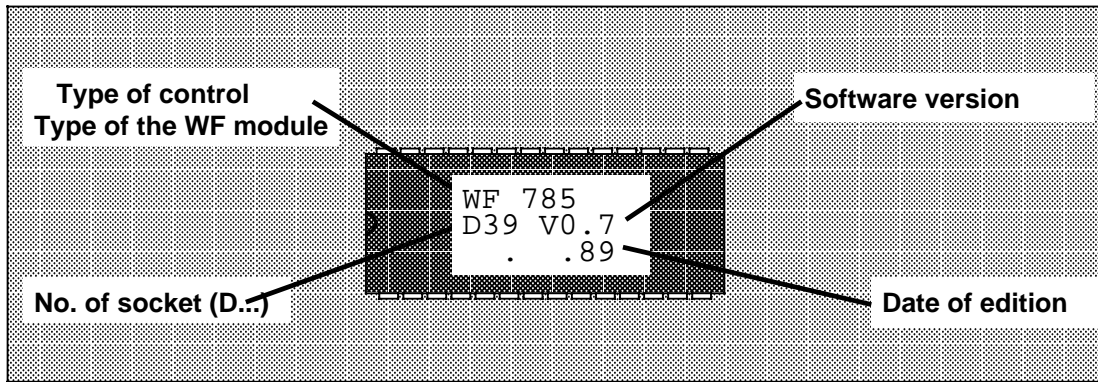

## WS 780

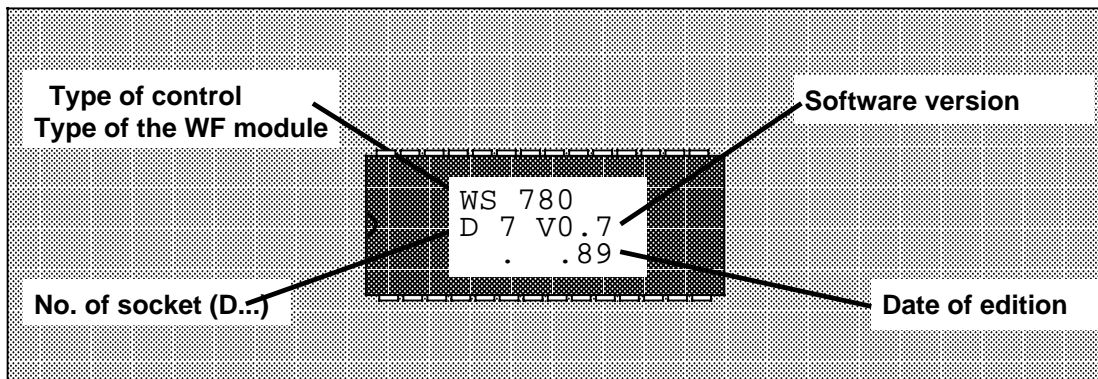

### 2.1.3 Check of the labels of the WF 725/726

#### Bus connector

- **Hardware version** (Basic module: A version, secondary module absolute encoder: B version)

Stand	A	B	C	D	00	01	02	03	04	05	06	07	08	09
-------	---	---	---	---	----	----	----	----	----	----	----	----	----	----

- **Checked label**

LB			61
Tested.			A1

- **Softwarestand**

Software version
------------------

## 2.2 Version as from spring 1989

- The following label is attached to the front panel of the modules.

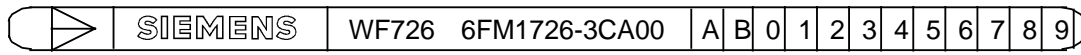

Object version (= Coding of hardware- and firmware version)

- EPROM label :  
The version date in the third line is replaced by the EPROM check sum.

### WF 726 (2 firmware EPROM's)

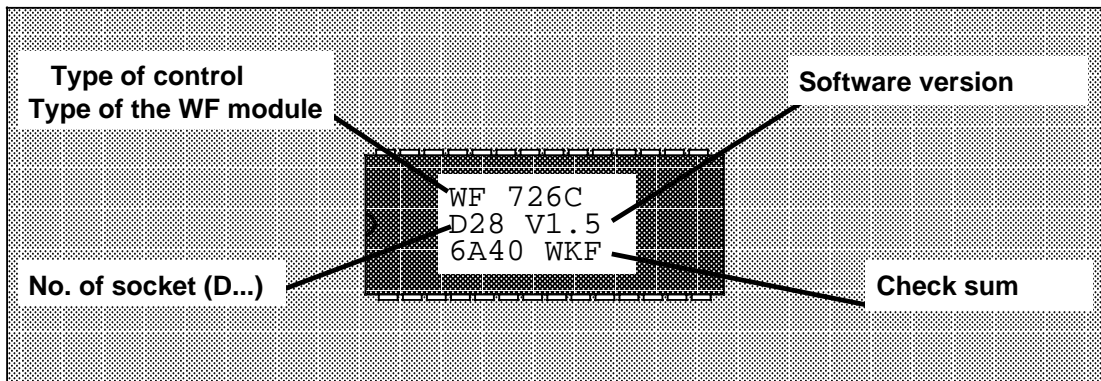
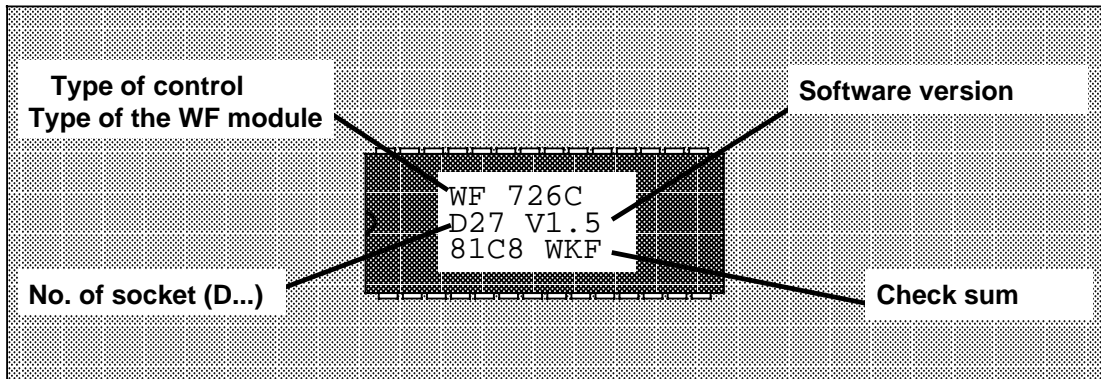

# WF 725 A

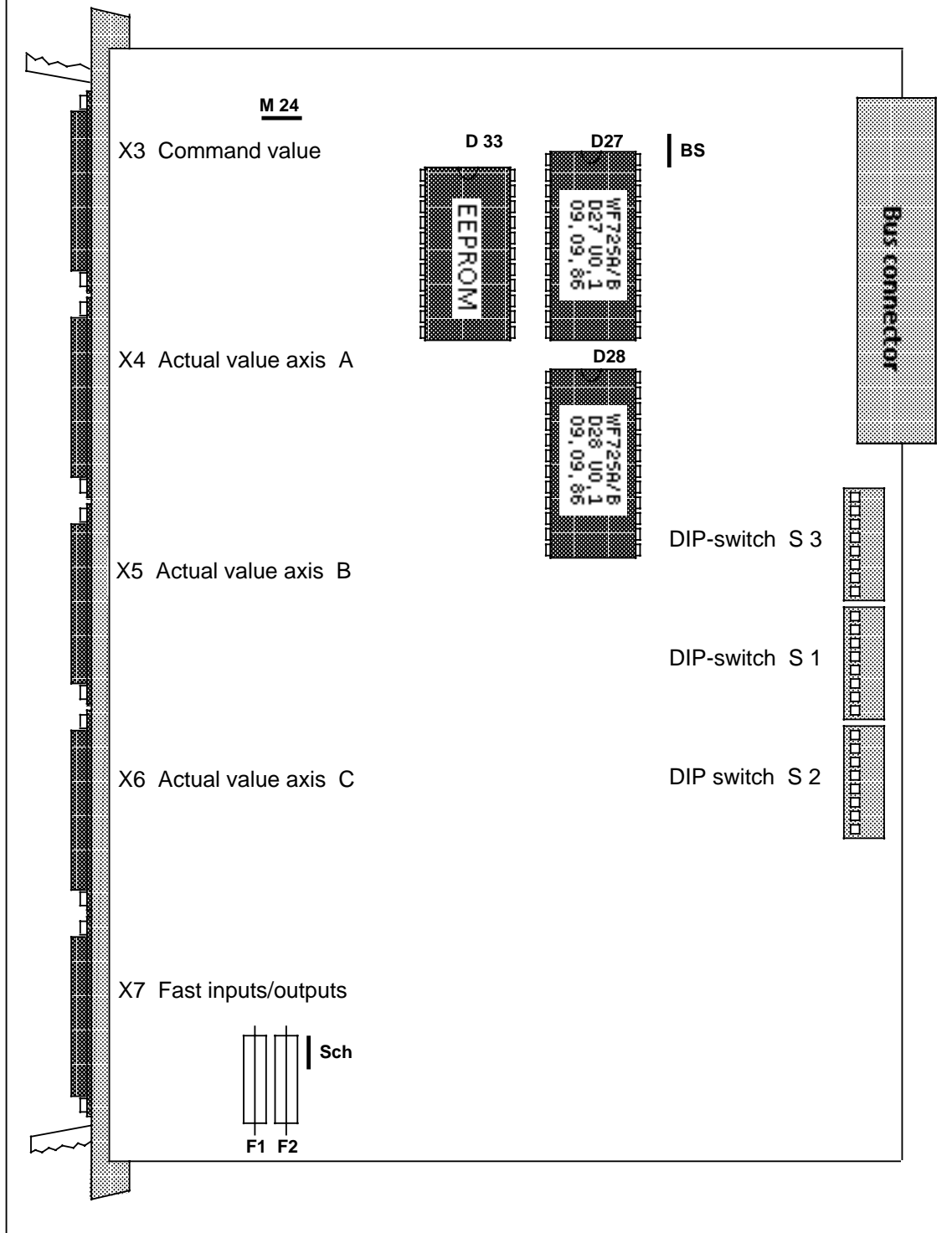

Fig. 2.1 Sockets for EPROM and EEPROM and for jumpers of the WF 725 A.

- F1: Fuse for 24V (encoders, outputs)
- F2: Fuse for 5V (incremental encoders)



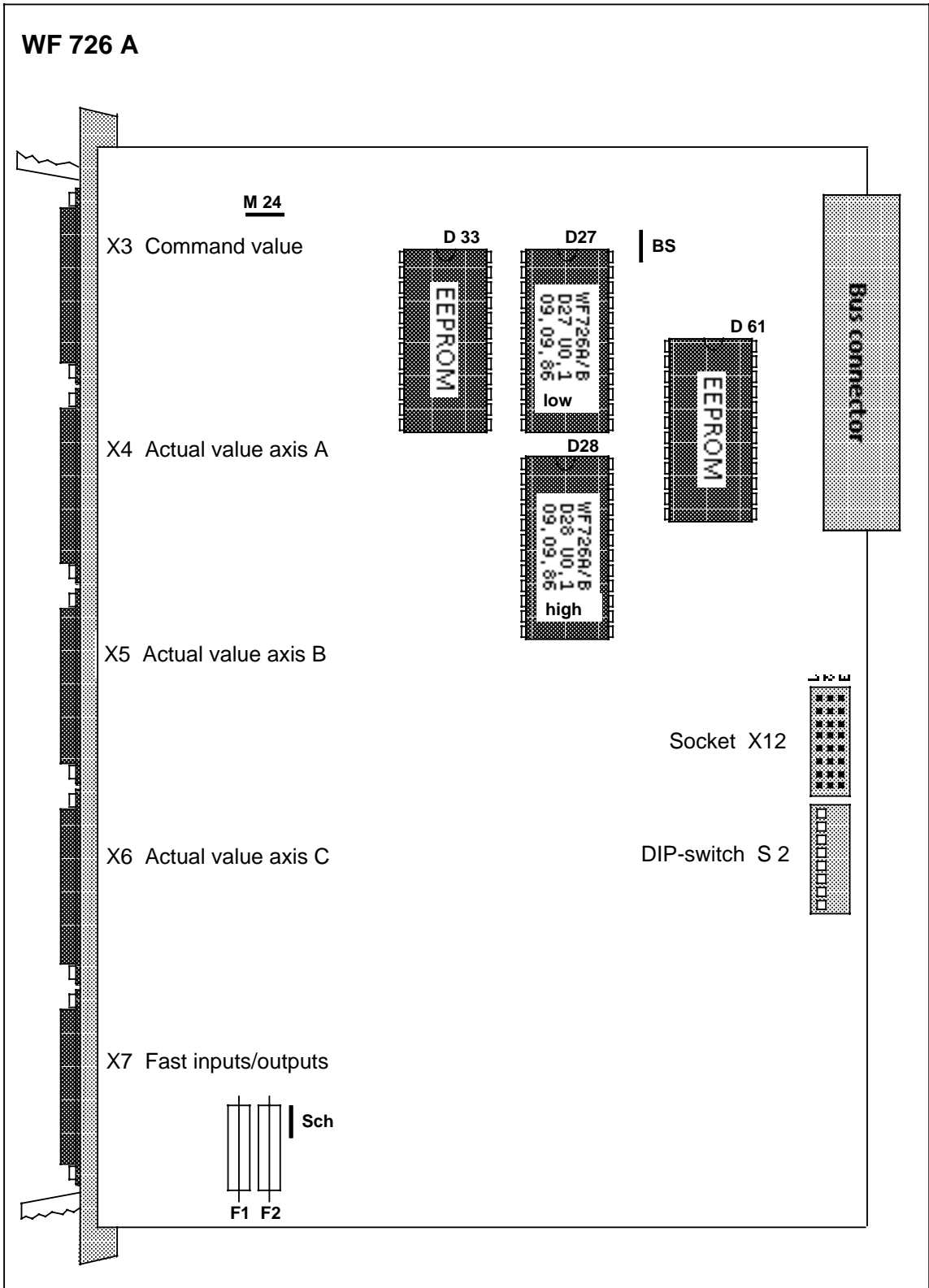

Fig. 2.2 Sockets for EPROM and EEPROM and for jumpers of the WF 725 A.

- F1: Fuse for 24V (encoders, outputs) : 1A, medium time-lag
- F2: Fuse for 5V (incremental encoders) : 1A, medium time-lag

# WF 726 C

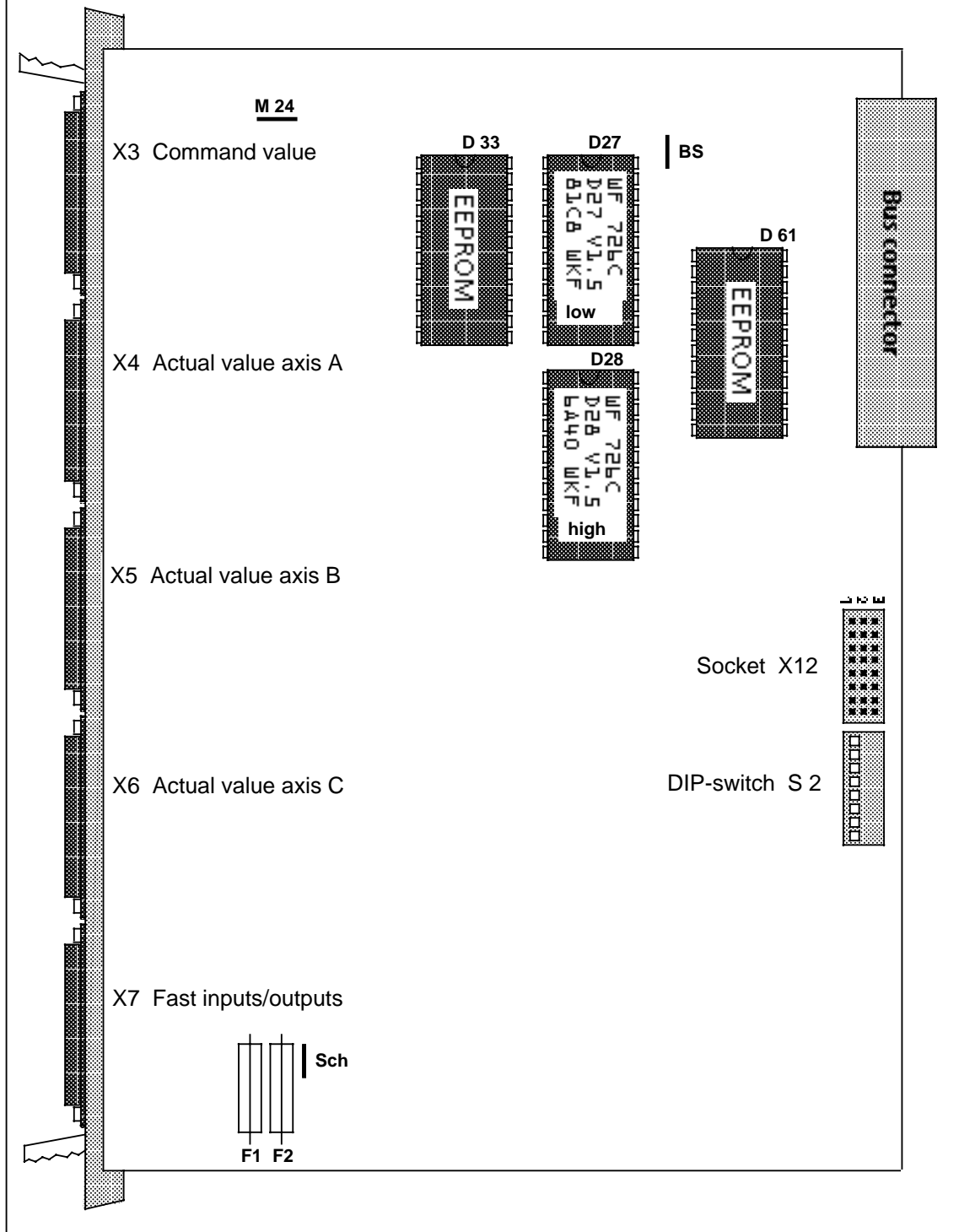

Fig. 2.3 Sockets for EPROM and EEPROM and for jumpers of the WF 725 C.

- F1: Fuse for 24V (encoders, outputs) : 1A, medium time-lag
- F2: Fuse for 5V (incremental encoders) : 1A, medium time-lag

# WF 785

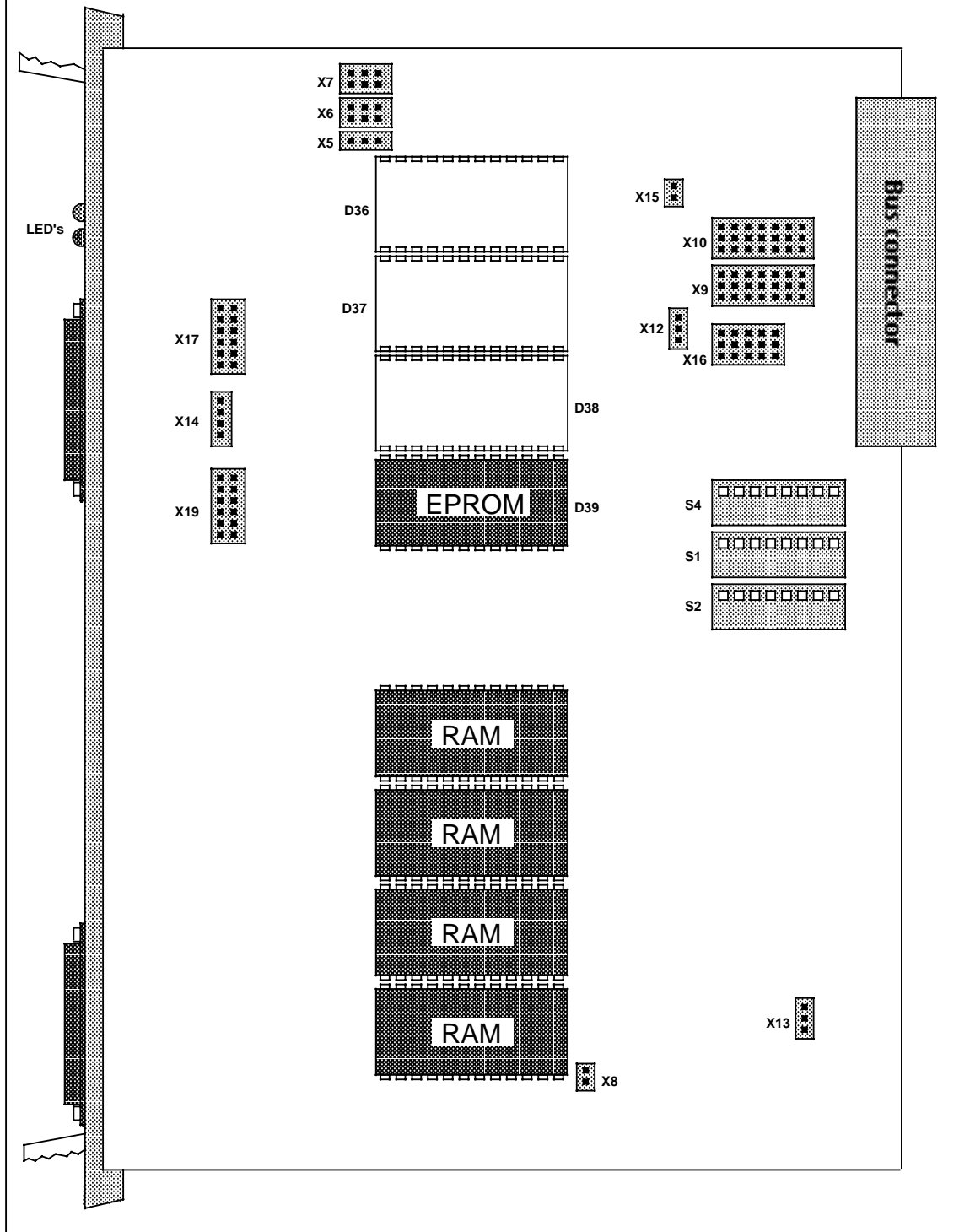

Fig. 2.4 Sockets for EPROM, RAM and jumpers for the WF 785

- LED at upper right on: WF 785 is in cyclic program
- both upper LED's on : Back up battery defective (error 922)
- Initial clear of data on WF 785
- LED at upper left goes off only after error acknowledgement (FB170)

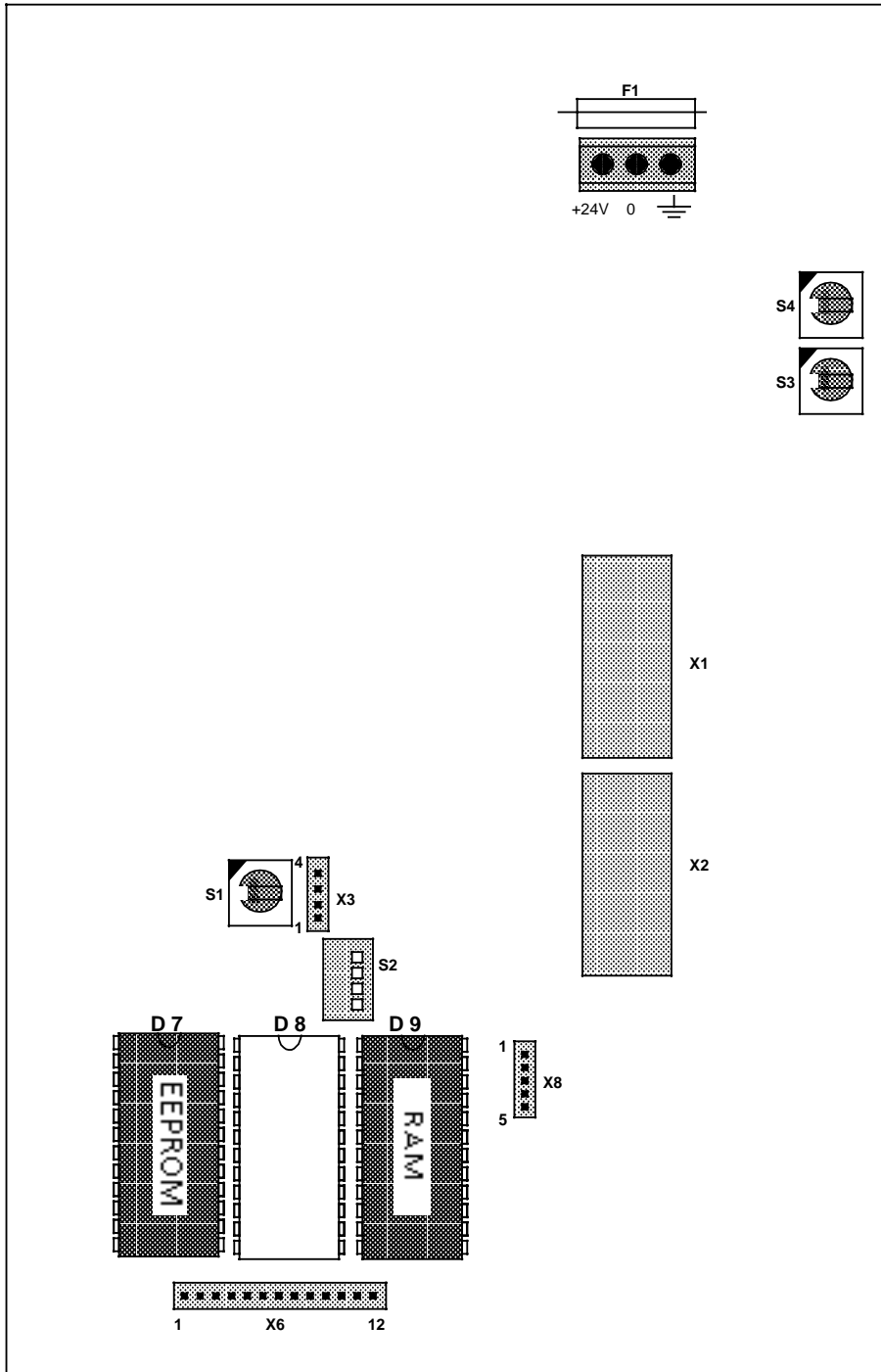

Fig. 2.5 Sockets for EPROM, RAM and jumpers for the WS 780

### 3 Jumper and switch settings

#### 3.1 Connection between WF 725/726 and drive unit

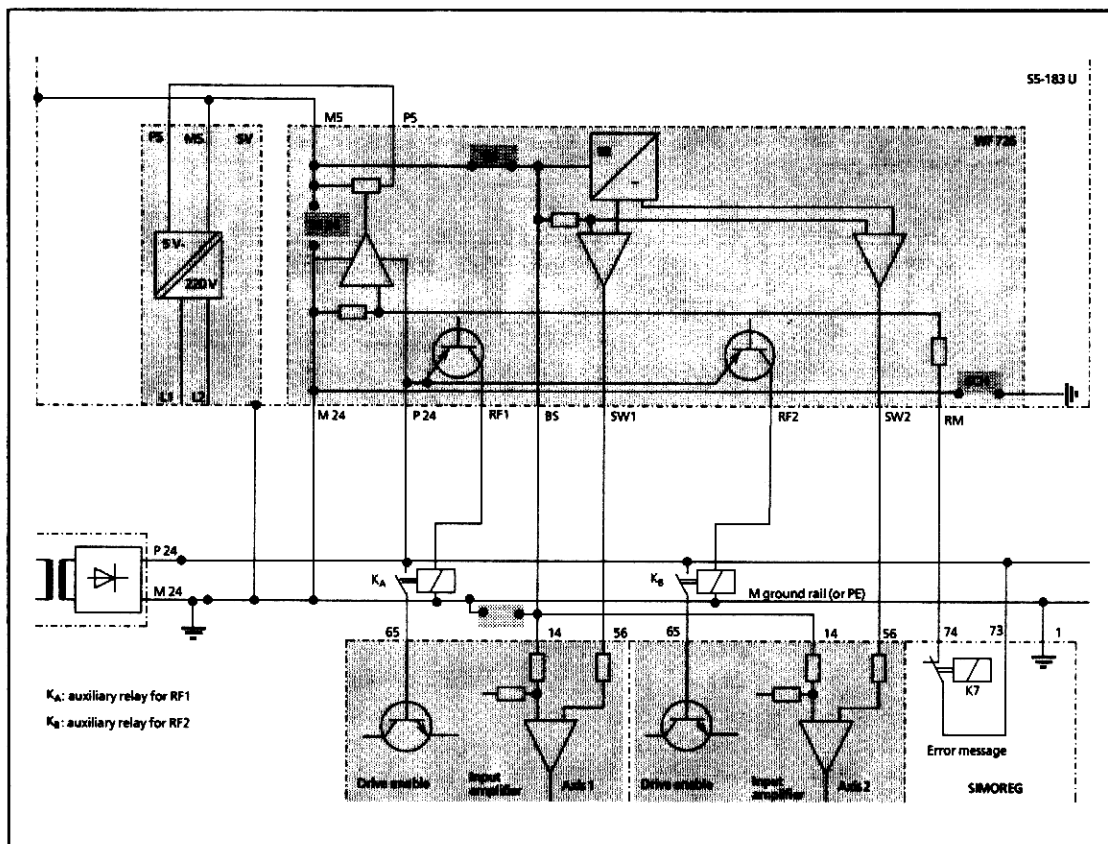

Fig. 3.1 Connection between WF 725/726 and drive unit (connected is a 2 axis SIMOREG)

**Jumper SCH:** It has to be inserted if the module WF 725/726 is used in racks or capsules without connection for the shields.

**Jumper M 24:** can only be factory-opened for tests.

**Jumper BS:** It has to be opened if the input of the drive unit is not floating (the voltage between M5 and BS must never be higher than 0.1 V)

BS	-	Reference ground	
SCH	-	M external (shields)	
SV	-	SIMATIC power supply	
SW	-	Command value	
E	-	24 V input	} from WF 726
A	-	24 V output	
RM	-	Feedback from the drive unit	
RF	-	Drive enable	

### 3.2 Settings for encoders

The settings for encoders are executed by the corresponding machine data. For details see chapter 4 of this manual.

### 3.3 Addressing of the WF 725/726 as SIMATIC periphery

The address of the module is set with switches 4 through 8 in the DIL switch block 2. Please note that the numerization of the switches is not the same as the bit numbers of the byte.

**Addressing of the WF 725/WF 726 as S5 periphery. Interface width of 32 bits only applies to the WF 726.**

Starting Address	Width of the interface in bytes		Switch setting on DIL block 2							
	16	32	1	2	3	4	5	6	7	8
			Bit pattern representation							
			0	1	2	3	4	5	6	7
16	X		OFF	OFF	OFF	OFF	OFF	ON	ON	ON
32	X	X	OFF	OFF	OFF	OFF	ON	OFF	ON	ON
48	X		OFF	OFF	OFF	OFF	OFF	OFF	ON	ON
64	X	X	OFF	OFF	OFF	OFF	ON	ON	OFF	ON
80	X		OFF	OFF	OFF	OFF	OFF	ON	OFF	ON
96	X	X	OFF	OFF	OFF	OFF	ON	OFF	OFF	ON
112	X		OFF	OFF	OFF	OFF	OFF	OFF	OFF	ON
128	X	X	OFF	OFF	OFF	OFF	ON	ON	ON	OFF
144	X		OFF	OFF	OFF	OFF	OFF	ON	ON	OFF
160	X	X	OFF	OFF	OFF	OFF	ON	OFF	ON	OFF
176	X		OFF	OFF	OFF	OFF	OFF	OFF	ON	OFF
192	X	X	OFF	OFF	OFF	OFF	ON	ON	OFF	OFF
208	X		OFF	OFF	OFF	OFF	OFF	ON	OFF	OFF
224	X	X	OFF	OFF	OFF	OFF	ON	OFF	OFF	OFF
240	X		OFF	OFF	OFF	OFF	OFF	OFF	OFF	OFF

**Cover on switch block 2 open: Switch setting for address 64  
(The position of the switches is shown in white)**

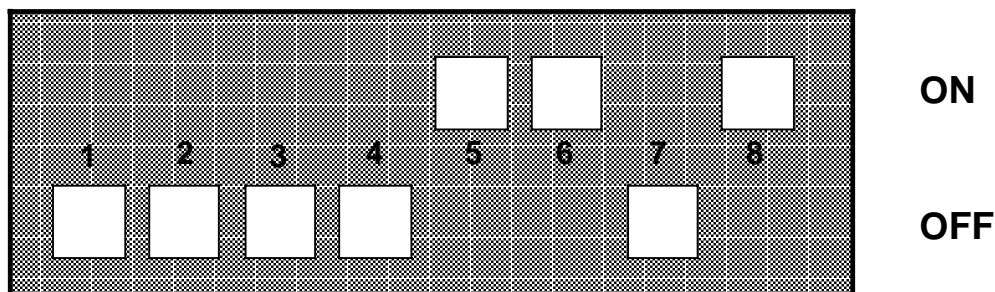

The starting address of the module is set with switches 4 through 7. If a switch is ON then the related bit on the address bus must be "0" in order to address the module.

The length of the DUAL PORT RAM of the WF 725 is fixed at 16 bytes.

The length of the DUAL PORT RAM of the WF 726 can be set at 16 bytes or 32 bytes. Accordingly, all shown starting addresses can be used if the length is set at 16 bytes, and if it is set at 32 bytes, all starting addresses which are marked in grey can be used.

### 3.4 Setting the length of the DPR (only WF 726)

The jumpers must be set at socket X12 according to the desired length of the DPR.

#### Setting of the DPR length at socket X12

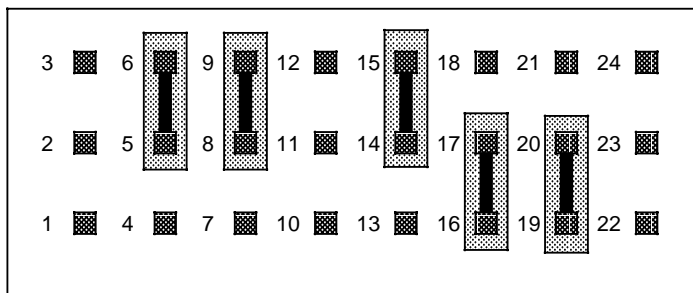

Setting of the KS plugs

for a DPR length of

**16 Byte**

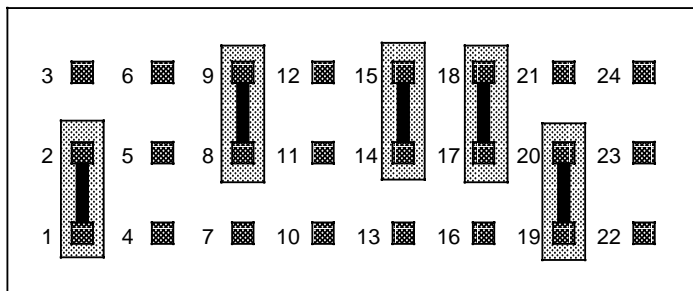

Setting of the KS plugs

for a DPR length of

**32 Byte**

### 3.5 Setting of jumpers on the WF 785

#### 3.5.1 Application on the central bus

Several different modules can be addressed with the same physical address. Then the identification number (0 - 255) set on each module with a switch can differentiate between the modules.

Only the module with the valid identification number reacts to read and write instructions on a physical address. The modules are delivered with the identification number "0", and all switches are in the ON position.

##### Setting of identification number - switch S1

Switch S1	1	2	3	4	5	6	7	8
Bit	0	1	2	3	4	5	6	7
Value	2 <sup>0</sup>	2 <sup>1</sup>	2 <sup>2</sup>	2 <sup>3</sup>	2 <sup>4</sup>	2 <sup>5</sup>	2 <sup>6</sup>	2 <sup>7</sup>

To declare the relating bit valid with the value 2<sup>n</sup> the corresponding switch has to be set in the OFF position.

Cover of switch block 1 open: switch setting for identification number 151.

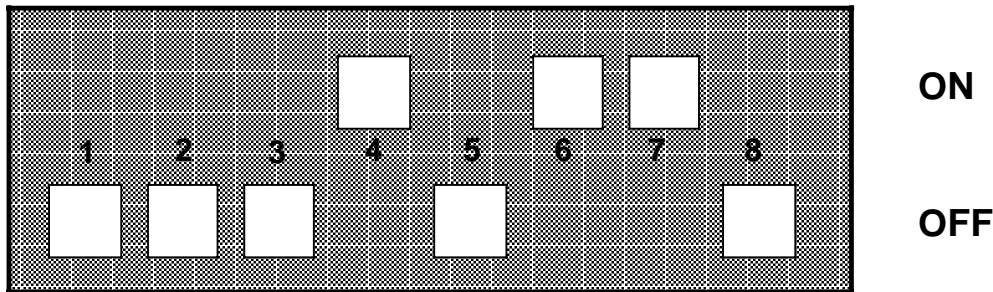



### 3.5.2 Setting of the module address

The physical address of the WF 785 module is set with switch S2. The module occupies a memory space of 512 bytes. The starting address can be set in steps of 512 bytes. The module is preset for the address E400<sub>Hex</sub>.

#### Setting of the module address for the central bus - switch S2

Switch S2	1	2	3	4	5	6	7	8
Bit	8	9	10	11	12	13	14	15
Value	-	2 <sup>9</sup>	2 <sup>10</sup>	2 <sup>11</sup>	2 <sup>12</sup>	2 <sup>13</sup>	2 <sup>14</sup>	2 <sup>15</sup>

If the address bit is to be set on 1, the related switch has to be in the OFF position.

#### Cover of switch block 2 open: switch setting for starting address E400<sub>Hex</sub>

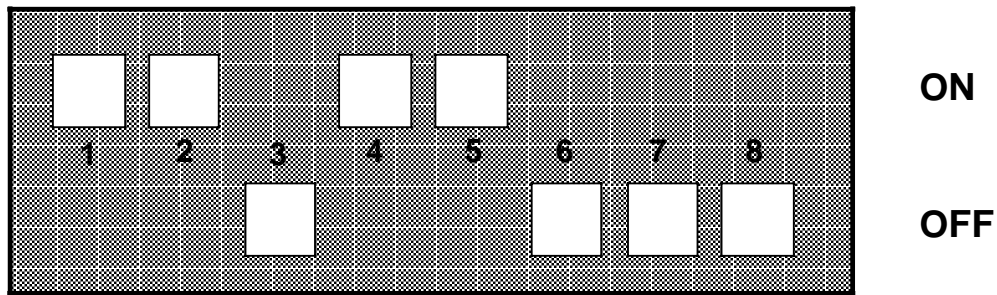

#### Addressing of the WF 785

starting address (HEX)	Switch setting on S2							
	1	2	3	4	5	6	7	8
	Related address bit							
	8	9	10	11	12	13	14	15
0000	X	ON	ON	ON	ON	ON	ON	ON
0200	X	OFF	ON	ON	ON	ON	ON	ON
0400	X	ON	OFF	ON	ON	ON	ON	ON
0600	X	OFF	OFF	ON	ON	ON	ON	ON
0800	X	ON	ON	OFF	ON	ON	ON	ON
0A00	X	OFF	ON	OFF	ON	ON	ON	ON
0C00	X	ON	OFF	OFF	ON	ON	ON	ON
0E00	X	OFF	OFF	OFF	ON	ON	ON	ON
1000	X	ON	ON	ON	OFF	ON	ON	ON
1200	X	OFF	ON	ON	OFF	ON	ON	ON
.	.	.	.	.	.	.	.	.
.	.	.	.	.	.	.	.	.
FE00	X	OFF	OFF	OFF	OFF	OFF	OFF	OFF

### 3.6 Jumper settings on WS 780

#### 3.6.1 Device address

The device addresses for the WS 780 are freely selectable anywhere from 0 through 15 (0 through F<sub>Hex</sub>) on the rotary switch 1.

##### Setting of device address - rotary switch S1

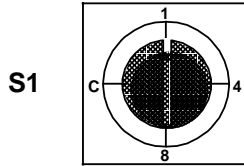

#### 3.6.2 Language

##### Selection of the language - rotary switch S3

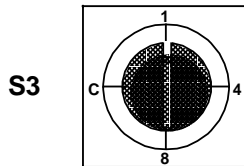

After firmware version V0.3, the language of the presentation of texts can be selected with the rotary switch 3:

Selection on switch	Language
0	german
1	english
2	french
4	italien
5	spanish

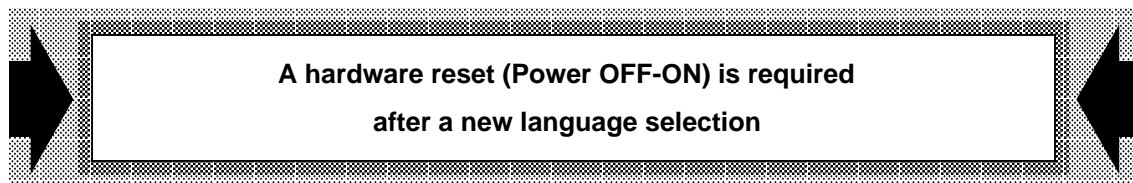

### 3.6.3 Selection of functions

Setting on rotary switch S4

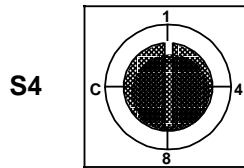

On the rotary switch S4, the following functions can be selected after firmware version WS 780 V0.7:

Selection on switch	Function
0	Capacity of functions of the V0.3 : Locking of input with a pass code number
1	Locking of input with key switch of cursor control at input of program
F	Test mode Display and keyboard test

### 3.6.4 Fixed switch settings

Termination resistors - Switch block S2

This setting of switches must not be changed.

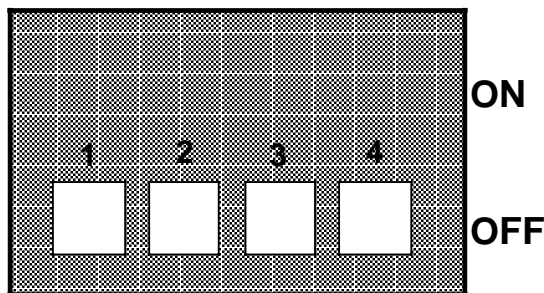



# 4 Machine data

## 4.1 Subdivision of machine data

The machine data can be subdivided in 3 large groups:

- **Elementary machine data for basic resolution and system data.**

This machine data is occupied by Standard I according to parametrization.

The following data belongs to this group:  
MD49, MD50

- **Elementary Machine data for fixing the closed loop and the variable.**

The correct setting of this machine data is of elementary meaning for the function of the closed loop.

The following data belongs to this group:  
MD3, MD4, MD5, MD6, MD7, MD19, MD20, MD21, MD22, MD23

- **Machine data for fixings and monitorings.**

The following data belongs to this group:  
MD1, MD2, MD8 to MD18, MD24 to MD48.

## 4.2 Order of obtaining machine data

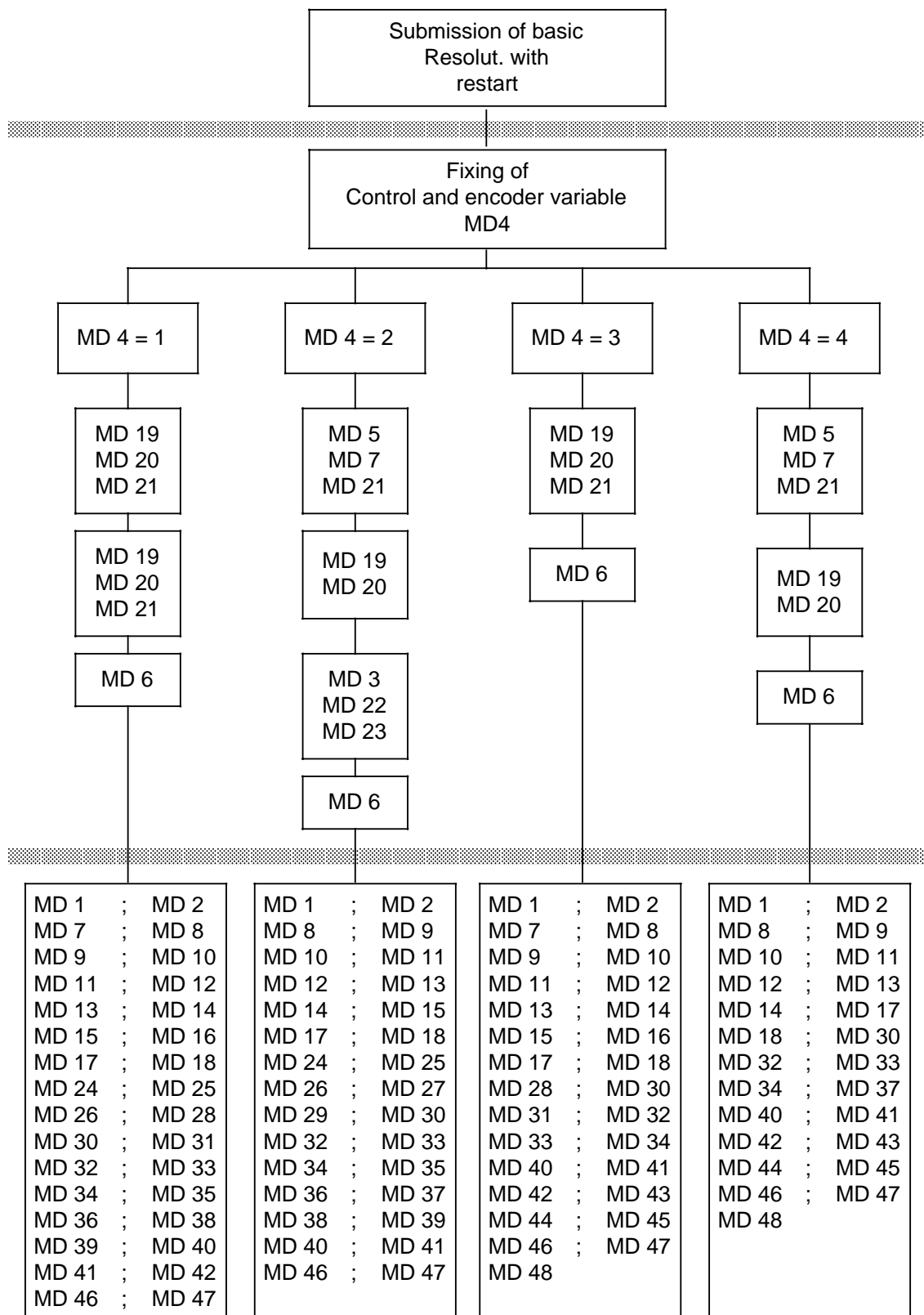

### 4.3 Description of machine data

The machine data (MD) in the following description is ordered numerically.

The following appears in each headline of the machine data:

- MD-number
- Short title
- Description of machine data
- Validity of machine data for special types of WF modules

The main part of the table lists:

- Resolut. - if machine data depends on the Resolut.
- Lower limit (smallest valid value)
- Upper limit (highest valid value)
- Unit - if applicable
- Steps (smallest step size for I/O)
- Input format in decimal form, each box contains 4 bits
- Cross reference to other machine data which is closely related to the described machine data

The lower part of the table contains a numerical example:

- Decimal input format and
- Binary (hexadecimal) input format

<b>No.</b>	<b>Short title of machine data</b>						<b>No.</b>		
	Description of machine data								
Letter code for validity	valid for	I	A <sub>p</sub>	A <sub>SSI</sub>	LR	AK	Letter code for validity		
	WF 725 Type	/	/	/	/	/			
	WF 726 Type	/	/	/	/	/			
Resolut.	Lower limit	Upper limit	Unit	Step	Input format decimal				
- or. values	smallest valid value	highest valid value	-	value	10 <sup>7</sup>	10 <sup>6</sup>	10 <sup>5</sup>	10 <sup>4</sup>	
					10 <sup>3</sup>	10 <sup>2</sup>	10 <sup>1</sup>	10 <sup>0</sup>	
<b>Cross reference</b>		<b>to other machine data</b>							
Numerical example		Input format: Decimal				Input format: Binary			
<b>360 000</b>		<b>0</b>	<b>0</b>	<b>3</b>	<b>6</b>	<b>0</b>	<b>0</b>	<b>0</b>	<b>5</b>
		<b>0</b>	<b>0</b>	<b>0</b>	<b>0</b>	<b>7</b>	<b>E</b>	<b>4</b>	<b>0</b>

The validity for the different WF types is stated here. The abbreviations have the following meaning:

- I . . . . . Incremental encoder ( WF 725 A/B,WF 726 A/B/C )
- A . . . . . Absolute encoder ( WF 725 B,WF 726 B, WF 726 C )
- A<sub>P</sub> . . . . . Parallel absolute encoder ( WF 725 B,WF 726 B )
- A<sub>SSI</sub> . . . . . Serial absolute encoder ( WF 726 C )
- LR . . . . . Closed loop ( WF 725 A/B,WF 726 A/B/C )
- AK . . . . . Open loop ( WF 725 A/B,WF 726 A/B/C )

The same abbreviations as above are used in the field "letter code for validity"; this shows that the machine data is only valid for this special encoder type or for closed loop or open loop

A calculation formula is stated for many machine data. If a calculation is absolutely necessary, it is shown with this sign:

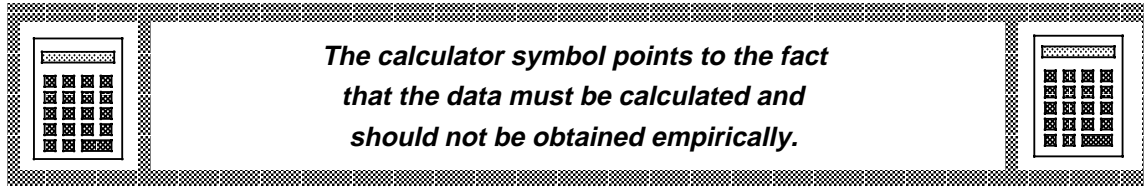

If the sign is missing, the calculation is not necessary.

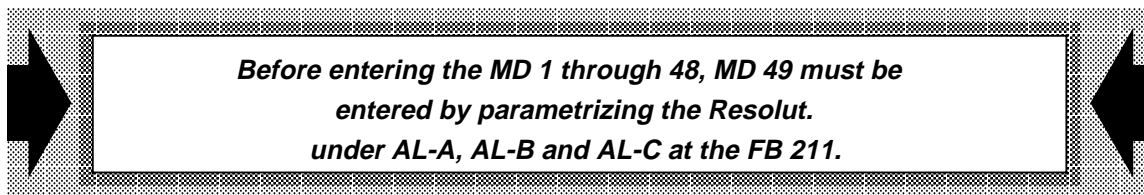

AL-A, AL-B, AL-C...basic Resolut. of the axis A, B, C [ $\mu\text{m}$ ]

If the basic Resolut. is changed, all machine data depending on it must be changed.

The basic Resolut. can be selected as:

- 1 $\mu\text{m}$
- 10 $\mu\text{m}$
- 100 $\mu\text{m}$

The least significant digit of the data which depends on the basic Resolut. has the following units:

- Times in: 1ms
- Positions in: 1 $\mu\text{m}$
- Feed rates in: 10 $\mu\text{m}/\text{min}$
- Accelerations in: 1 $\text{mm}/\text{s}^2$
- Jerk values in: 1 $\text{mm}/\text{s}^3$

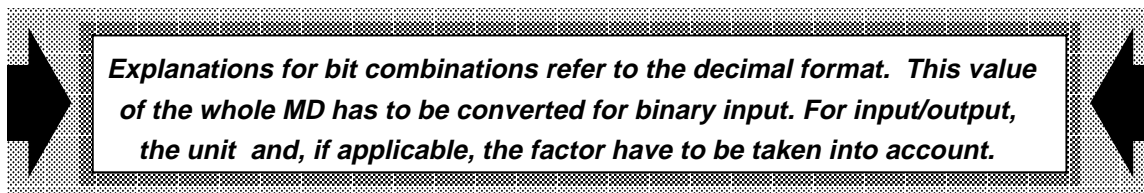



<b>1</b>	<b>Acceleration</b>						<b>1</b>	
	Acceleration: constant increase in feed rate							
<b>LR</b> Closed loop	valid for	I	A <sub>P</sub>	A <sub>SSI</sub>	LR	AK	<b>LR</b> Closed loop	
	WF 725 Type	A/B	B	/	A/B	/		
	WF 726 Type	A/B/C	B	C	A/B/C	/		
Resolut.	Lower limit	Upper limit	Unit	Step	Input format decimal			
1 μm	1	20000	mm/s	1	0	0	10 <sup>5</sup>	10 <sup>4</sup>
10 μm	10	200000		10	10 <sup>3</sup>	10 <sup>2</sup>	10 <sup>1</sup>	10 <sup>0</sup>
100 μm	100	200000		100				
<b>Cross reference</b>		<b>MD 2, MD 36, MD 38, MD 39</b>						
Numerical example		Input format: Decimal			Input format: Binary			
<b>1200 mm/s<sup>2</sup></b>		0	0	0	0	0	0	0
		1	2	0	0	0	4	B

**Feed rate-time-characteristics for acceleration and deceleration**

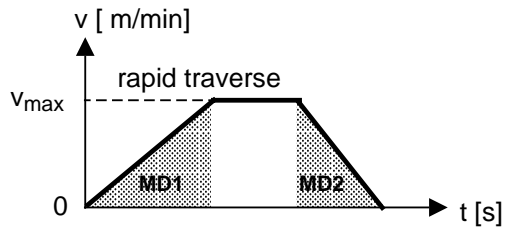

**Feed rate-time-characteristics**

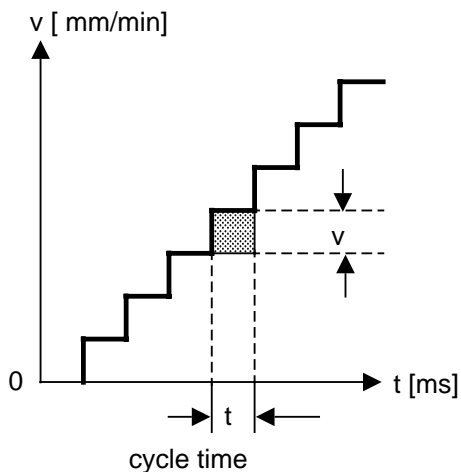

**Path-feed rate-characteristics**

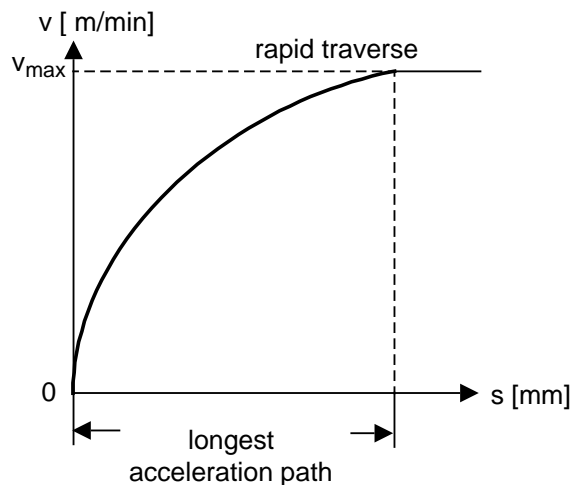

DC motors with permanent magnets deliver a constant torque if a constant rotor current is applied. The acceleration/deceleration times should be as short as possible, but the motor current should never reach the current limit.

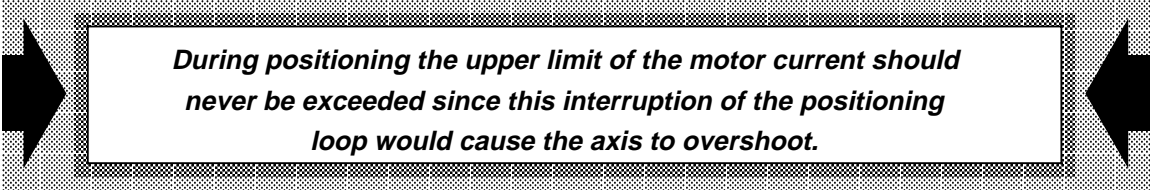

***During positioning the upper limit of the motor current should never be exceeded since this interruption of the positioning loop would cause the axis to overshoot.***

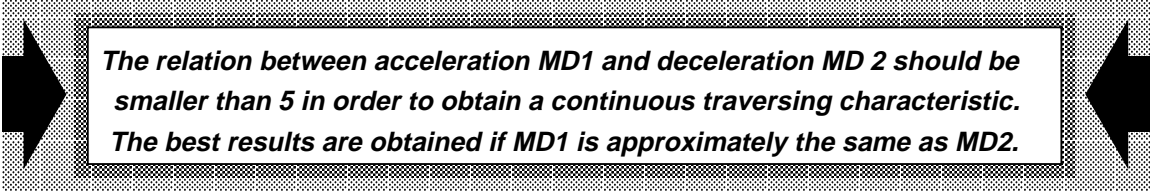

***The relation between acceleration MD1 and deceleration MD 2 should be smaller than 5 in order to obtain a continuous traversing characteristic. The best results are obtained if MD1 is approximately the same as MD2.***

<b>1</b>	<b>Acceleration encoder for voltage increment</b>					<b>1</b>		
Acceleration: constant increase of voltage current								
<b>AK</b> Open loop	valid for	I	A <sub>P</sub>	A <sub>SSI</sub>	LR	AK		
	WF 725 Type	/		/		/		
	WF 726 Type	A/B/C	B	C	/			
<b>AK</b> Open loop								
Resolut.	Lower limit	Upper limit	Unit	Step	Input format decimal			
	0	65535	mV/s	1 10 100	0 10 <sup>3</sup>	0 10 <sup>2</sup>	0 10 <sup>1</sup>	10 <sup>4</sup> 10 <sup>0</sup>
<b>Cross reference</b>		<b>MD 42</b>						
Numerical example		Input format: Decimal			Input format: Binary			
<b>1200 mV/s</b>		<b>0</b>	<b>0</b>	<b>0</b>	<b>0</b>	<b>0</b>	<b>0</b>	<b>0</b>
		<b>1</b>	<b>2</b>	<b>0</b>	<b>0</b>	<b>0</b>	<b>4</b>	<b>B</b>

When the open loop variable is used it is also possible to use the command value channel (plug X3) for approach of the final controlling element. To also simulate an acceleration encoder for this Type, the steepness of the slope can be pre-set with Md 1. If MD 1=0 is pre-set, a setpoint set-change follows.

$$MD\ 1 = \frac{G_{soll} \cdot 100}{t} \frac{mV}{s}$$

- G<sub>soll</sub>: programmed speed level of the desired point of acceleration [1...99].  
t: freely selectable time when acceleration to G-step takes place [s].

***MD 1 should be selected in a way that the maximum speed is reached as fast as possible without overloading the drive and the mechanical system.***

<b>2</b>	<b>Deceleration</b>						<b>2</b>
Deceleration: constant decrease in feed rate							
<b>LR</b> <small>Closed loop</small>	valid for	I	A <sub>P</sub>	A <sub>SSI</sub>	LR	AK	<b>LR</b> <small>Closed loop</small>
	WF 725 Type	A/B	B	/	A/B	/	
	WF 726 Type	A/B/C	B	C	A/B/C	/	

Resolut.	Lower limit	Upper limit	Unit	Step	Input format decimal			
1 μm	1	20000	mm/s	1	0	0	10 <sup>5</sup>	10 <sup>4</sup>
10 μm	10	200000		10	10 <sup>3</sup>	10 <sup>2</sup>	10 <sup>1</sup>	10 <sup>0</sup>
100 μm	100	200000	2	100				

**Cross reference** **MD 1, MD 36, MD 38, MD 39**

Numerical example	Input format: Decimal				Input format: Binary			
<b>500 mm/s<sup>2</sup></b>	0	0	0	0	0	0	0	0
	0	5	0	0	0	1	F	4

*The proportion between acceleration MD 1 and deceleration MD 2 should be smaller than "5" to reach a continuous traversing. The best proportion would be MD 1 MD 2.*

**Formula for calculating the acceleration or deceleration (without taking into account the jerk factors MD38 and MD39):**

$$MD\ 1\ \text{bzw.}\ MD\ 2 = \frac{MD\ 3\ [mm/min]}{60 * t\ [s]} \quad [mm/s^2]$$

t: time in seconds in which the desired feed rate should be reached.

**Example:** The maximum feed rate should be reached in 10s.  
 MD 3 = 30000 mm/min  
 t = 10 s

$$MD1 = \frac{30000}{60 * 10} = 50 \quad \left[ \frac{mm}{s^2} \right]$$

<b>2</b>	<b>Acceleration encoder for voltage decrement</b>					<b>2</b>		
Acceleration: constant decrease of voltage current								
<b>AK</b> Open loop	valid for	I	A <sub>P</sub>	A <sub>SSI</sub>	LR	AK		
	WF 725 Type	/						
	WF 726 Type	A/B/C	B	C	/			
						<b>AK</b> Open loop		
Resolut.	Lower limit	Upper limit	Unit	Step	Input format decimal			
	0	65535	mV/s	1 10 100	0 10 <sup>3</sup>	0 10 <sup>2</sup>	0 10 <sup>1</sup>	10 <sup>4</sup> 10 <sup>0</sup>
<b>Cross reference</b>		<b>MD 42</b>						
Numerical example		Input format: Decimal			Input format: Binary			
<b>1200 mV/s</b>		<b>0</b>	<b>0</b>	<b>0</b>	<b>0</b>	<b>0</b>	<b>0</b>	<b>0</b>
		<b>1</b>	<b>2</b>	<b>0</b>	<b>0</b>	<b>0</b>	<b>4</b>	<b>B</b>

When the open loop variable is used it is also possible to use the command value channel (plug X3) for approach of the final controlling element. To also simulate an acceleration encoder for this type, the steepness of the slope can be pre-set with MD 2. If MD 2=0 is pre-set, a setpoint set-change follows.

$$MD\ 2 = \frac{G_{soll} \cdot 100}{t} \frac{mV}{s}$$

G<sub>soll</sub>: programmed speed level of desired point of acceleration [1...99].

t: freely selectable time when acceleration to G-step takes place [s].

***MD 2 should be selected in a way that a safe stopping from the last speed level (MD 44 / MD 48) to the end position is guaranteed.***

<b>3</b>	<b>Maximum feed rate</b>						<b>3</b>		
Maximum feed rate with which the machine can traverse.									
<b>LR</b> Closed loop	valid for	I	A <sub>P</sub>	A <sub>SSI</sub>	LR	AK	<b>LR</b> Closed loop		
	WF 725 Type	A/B	B	/	A/B	/			
	WF 726 Type	A/B/C	B	C	A/B/C	/			
Resolut.	Lower limit	Upper limit	Unit	Step	Input format decimal				
1 μm	10	3000000	10-2mm min	1	10 <sup>7</sup>	10 <sup>6</sup>	10 <sup>5</sup>	10 <sup>4</sup>	
10 μm	10	30000000		10	10 <sup>3</sup>	10 <sup>2</sup>	10 <sup>1</sup>	10 <sup>0</sup>	
100 μm	100	300000000		100					
<b>Cross reference</b>		<b>MD 22, MD 23</b>							
Numerical example		Input format: Decimal				Input format: Binary			
<b>8521 mm/min</b>		<b>0</b>	<b>0</b>	<b>8</b>	<b>5</b>	<b>0</b>	<b>0</b>	<b>0</b>	<b>D</b>
		<b>2</b>	<b>1</b>	<b>0</b>	<b>0</b>	<b>0</b>	<b>0</b>	<b>8</b>	<b>4</b>

The highest feed rate at which the machine can be traversed is entered into MD3. This machine data also tells the WF the maximum speed for which the speed regulator has been optimized.

The value of command voltage at maximum feed rate is entered into MD 23.

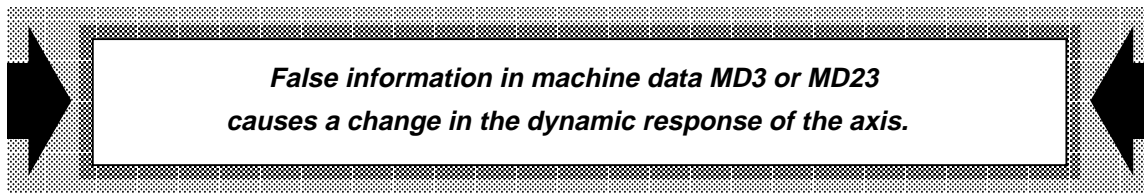

Inputs of feed rates (for example operating or program data) are checked for validity with the MD3. If higher values than MD3 are entered, they will be reduced to the value of MD3

### Formula for calculating the maximum feed rate, - incremental encoders

$$MD\ 3 = \frac{n[1/min] \cdot i_{GM} \cdot A[\mu m] \cdot I_G \cdot (MD\ 19, MD\ 20) \cdot MD\ 21}{10} \left[ \frac{10^{-2}mm}{min} \right]$$

### Formula for calculating the maximum feed rate, - absolute encoders

$$MD\ 3 = \frac{n[1/min] \cdot i_{GM} \cdot A[\mu m] \cdot I_G \cdot (MD\ 19, MD\ 20)}{10} \left[ \frac{10^{-2}mm}{min} \right]$$

#### Abbreviations:

- n maximum revolutions per minute of the motor in [1/min]
- i<sub>GM</sub> relation of speed between motor and encoder
- A resolution in [μm]
- I<sub>G</sub> number of pulses per revolution of the encoder, or number of steps per revolution of the absolute encoder (according to encoder specification)
- MD19 actual value evaluation factor, before the decimal point
- MD20 actual value evaluation factor, after the decimal point
- MD21 pulse evaluation

**The calculated maximum speed should always be entered rounded off.  
Otherwise, the supervision of following errors would react.**

#### Numerical example for MD 3:

- n = 3000 min<sup>-1</sup>
- A = 10 μm
- I<sub>G</sub> = 2500 Imp./Umdr.
- i<sub>GM</sub> = 1:1
- MD 19, MD 20 = 1,0
- MD 21 = 4

$$MD\ 3 = \frac{3000 \cdot 1 \cdot 10 \cdot 2500 \cdot 1,0 \cdot 4}{10} = 300\ 000\ 00 \left[ \frac{10^{-2}mm}{min} \right] = 300\ m/min$$

<b>4</b>	<b>Type of control and encoder</b> Differentiation between open and closed loop and between incremental/absolute encoders					<b>4</b>		
	valid for	I	A <sub>P</sub>	A <sub>SSI</sub>	LR	AK		
	WF 725 Type	A/B	B	/	A/B	A/B		
	WF 726 Type	A/B/C	B	C	A/B/C	A/B/C		
Values of the 4-bit combination X				Input format decimal				
<b>X=1: Closed loop with incremental encoder</b> <b>X=2: Closed loop with absolute encoder</b> <b>X=3: Open loop with incremental encoder</b> <b>X=4: Open loop with absolute encoder</b>				0	0	0	0	
				0	0	0	X	
<b>Cross reference</b>		<b>MD 42</b>						
Numerical example	Input format: Decimal				Input format: Binary			
<b>4</b>	0	0	0	0	0	0	0	0
	0	0	0	4	0	0	0	4

Since one module can have up to three axes, it is possible to have different control and encoder types on the same board. For the WF 725 A/WF 726 A , there is error message 30 for X=2 and X=4 (since no absolute encoder board exists).

**Parallel absolute encoders require the use of the WF 725 B, WF 726 B-version, serial absolute encoders require the use of the WF 726 C-Version. Machine data 4 will be only be accepted through RESET!**

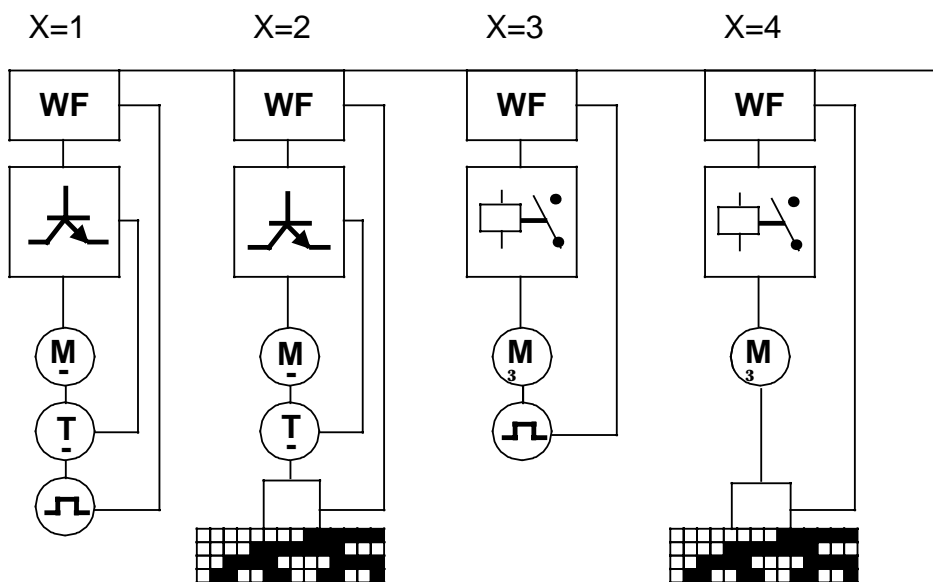



<b>5</b>		<b>Number of steps / Absolute encoder</b>						<b>5</b>	
<b>A</b> Absolute encoder	valid for	I	A <sub>P</sub>	A <sub>SSI</sub>	LR	AK	<b>A</b> Absolute encoder		
	WF 725 Type	/	B	/	B	B			
	WF 726 Type	/	B	C	B/C	B/C			
Resolut.	Lower limit	Upper limit	Unit	Step	Input format decimal				
-	1	16777216	-	1	10 <sup>7</sup>	10 <sup>6</sup>	10 <sup>5</sup>	10 <sup>4</sup>	
					10 <sup>3</sup>	10 <sup>2</sup>	10 <sup>1</sup>	10 <sup>0</sup>	
<b>Cross reference</b>		<b>MD 4, MD 7</b>							
Numerical example		Input format: Decimal			Input format: Binary				
<b>32768</b>		0	0	0	3	0	0	0	0
		2	7	6	8	8	0	0	0

Machine data 5 tells the WF how many steps the encoder can deliver. This enables the WF to monitor the limits of the encoder.

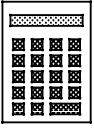
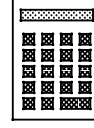
MD 5=Number of steps/revolution \* number of revolution

**Example:**



Specification of the encoder:

Number of steps per revolution : 512  
 Number of revolutions : 64

---

MD 5= 512 \* 64 = 32768

Of course the input of MD 5 is only necessary if an absolute encoder has been specified in MD 4.

Machine data 5 will only be accepted through RESET!

<b>6</b>	<b>Assignment of traverse direction to output voltage</b> Adaption of the command value and the counting direction to the desired movement direction						<b>6</b>
	valid for	I	A <sub>P</sub>	A <sub>SSI</sub>	LR	AK	
	WF 725 Type	A/B	B	/	A/B	A/B	
	WF 726 Type	A/B/C	B	C	A/B/C	A/B/C	

X	Voltage for positive traversing direction	Count direction of actual val.	Input format decimal			
0	+	+	0	0	0	0
1	-	+	0	0	0	0
2	+	-	0	0	0	X
3	-	-	0	0	0	X

<b>Cross reference</b>							
------------------------	--	--	--	--	--	--	--

  

Numerical example	Input format: Decimal				Input format: Binary			
2	0	0	0	0	0	0	0	0
	0	0	0	2	0	0	0	2

The adaption of the command value to the counting direction of the encoder is made with MD 6. It is usually determined by the timing of the A and the B channel of the encoder. This counting direction can only be inverted with:

$$MD\ 6 = 2 \text{ or } MD\ 6 = 3$$

Therefore it is not necessary to physically change the A and the B channel of the encoder in order to change the counting direction. A similar case is the direction of movement. In order to change the direction of movement it is not necessary to change the tach and the drive command value.

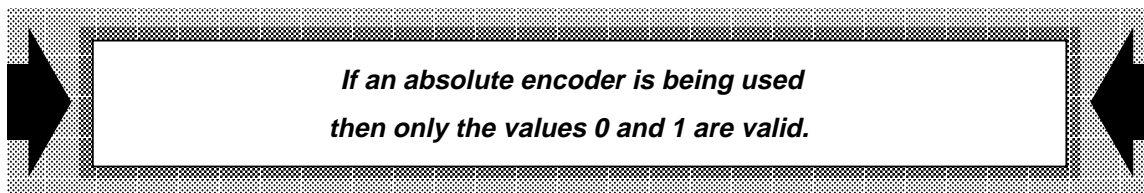

If an absolute encoder is used and MD 6 is 2 or 3 then the counting direction is reversed, but the previously added actual value is lost, since the absolute actual value is being read in on power up.

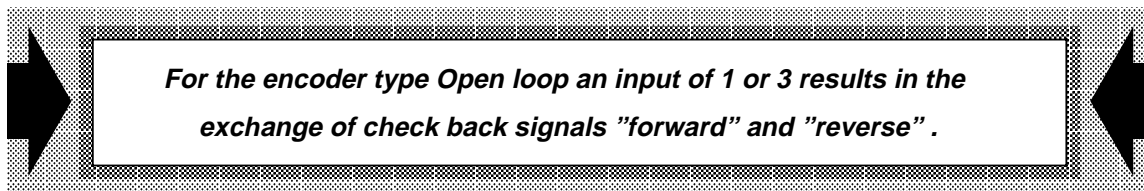

### Example 1:

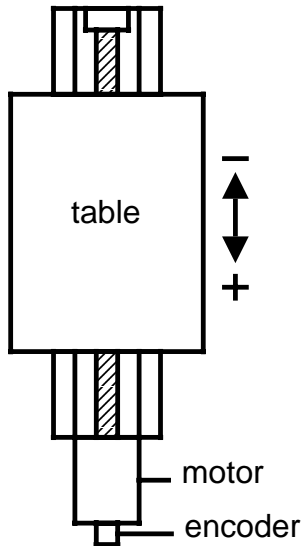

In this example the motor is directly coupled to the ball screw.

If the motor turns clockwise then the ball screw and the table motion are positive.

If in this case the encoder counting direction is positive then MD 6 = 0.

If the encoder counting direction is negative it has to be inverted. This is done by entering 2 into MD 6.

### Example 2:

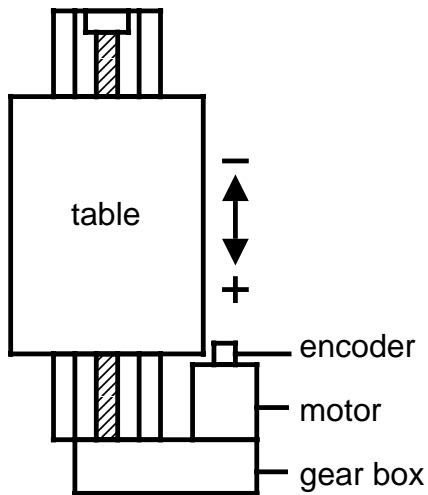

In this case the motor has been turned and the coupling to the ball screw is now done with a gear box.

If the machine data is not changed then a clockwise turning of the motor causes an anti-clockwise rotation of the ball screw and therefore a wrong traversing direction. This can be corrected with MD 6:

if MD 6 = 0 was in example 1,  
then there is now MD 6 = 3 in example 2

if MD 6 = 1 was in example 1,  
then there is now MD 6 = 2 in example 2.

<b>7</b>	<b>Reference point approach direction</b> Selection of the zero mark left or right of the cam as the reference point						<b>7</b>	
<b>I</b> Incremental encoder	valid for	I	A <sub>P</sub>	A <sub>SSI</sub>	LR	AK	<b>I</b> Incremental encoder	
	WF 725 Type	A/B	/	/	A/B	A/B		
	WF 726 Type	A/B/C	/	/	A/B/C	A/B/C		
Value for bit combination X				Input format decimal				
X=1: Zero mark right of the cam X=2: Zero mark left of the cam				0	0	0	0	
				0	0	0	X	
<b>Cross reference</b>			<b>MD 4, MD 15</b>					
Numerical example		Input format: Decimal			Input format: Binary			
<b>2</b>		0	0	0	0	0	0	0
		0	0	0	2	0	0	0

With MD 7 it is possible to determine whether to synchronize to the left or to the right of the reference cam, in order to move the reference point to the zero mark.

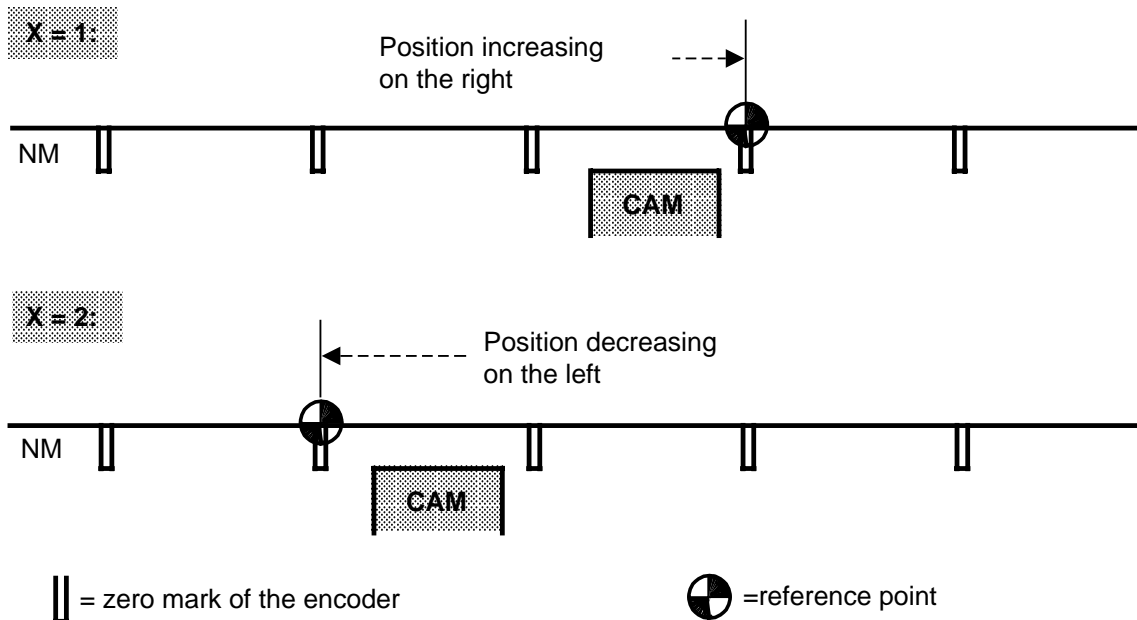

**Machine data 7 is only accepted through RESET!**

<b>7</b>	<b>Masked range of absolute encoder</b> Adaption to cut off GRAY code and rotary axis						<b>7</b>	
<b>Ap</b> parallel absolute encoder	valid for	I	Ap	AssI	LR	AK	<b>Ap</b> parallel absolute encoder	
	WF 725 Type	/	B	/	B	B		
	WF 726 Type	/	B	/	B	B		
Resolut.	Lower limit	Upper limit	Unit	Step	Input format decimal			
-	0	79999999	-	1	$10^7$	$10^6$	$10^5$	$10^4$
					$10^3$	$10^2$	$10^1$	$10^0$
<b>Cross reference</b>		<b>MD 4, MD 5, MD 18</b>						
Numerical example		Input format: Decimal			Input format: Binary			
<b>76</b>		<b>0</b>	<b>0</b>	<b>0</b>	<b>0</b>	<b>0</b>	<b>0</b>	<b>0</b>
		<b>0</b>	<b>0</b>	<b>7</b>	<b>6</b>	<b>0</b>	<b>0</b>	<b>4 C</b>

MD 7 tells the WF what the masked range is for a GRAY code which is cut off.

The resolution of a rotary axis should be related to degrees. However, 360 degrees is not part of the potential series of binary numbers (1, 2, 4, 8, 16). Therefore, encoders with a GRAY code which is cut off are used.

The encoder has for example 9 bit (512 steps) but uses only 360 steps. In order to maintain the single bit change from one step to another (also valid in the case of an overflow) of the GRAY code, the 360 step range is centered in the 512 step range. The steps 1-76 and 436-512 which are not used must be masked through the WF. This is done with MD 7:

**Formula for calculating the steps to be masked:**

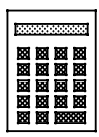

$$MD\ 7 = \frac{\text{possible steps} - \text{used steps}}{2}$$

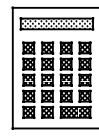

**Multiturn encoder:** The possible steps refer to the complete range of the encoder, i.e. number of turns \* number of steps per revolution.

**Machine data 7 will only be accepted through RESET!**

<b>7</b>	<b>Number of steps / encoder rotation</b> (max. 12 bit resolution)						<b>7</b>		
<b>AssI</b> serial absolute encoder	valid for	I	A <sub>P</sub>	A <sub>SSI</sub>	LR	AK	<b>AssI</b> serial absolute encoder		
	WF 725 Type	/	/	/	/	/			
	WF 726 Type	/	/	C	C	C			
Resolut.	Lower limit	Upper limit	Unit	Step	Input format decimal				
-	1	4096	-	-	0	0	0	0	
					10 <sup>3</sup>	10 <sup>2</sup>	10 <sup>1</sup>	10 <sup>0</sup>	
<b>Cross reference</b>		<b>MD 4, MD 5</b>							
Numerical example		Input format: Decimal				Input format: Binary			
<b>32</b>		0	0	0	0	0	0	0	0
		0	0	3	2	0	0	2	0

With MD7 the WF 726C is told how many steps the encoder executes per revolution.

Of course the input of MD 7 is only necessary if an absolute encoder has been specified in MD 4.

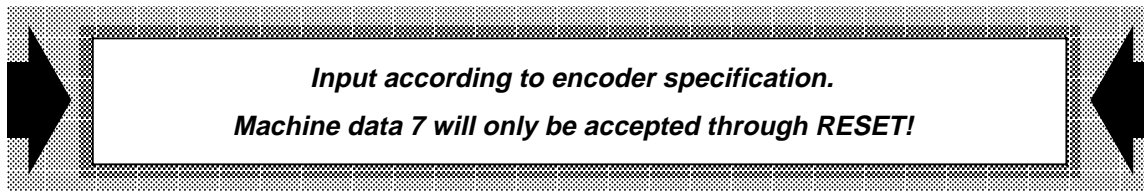

<b>8</b>	<b>Type of output / M-function</b> Differentiation between strobe controlled and time controlled output of M- (auxiliary) functions					<b>8</b>				
	valid for	I	A <sub>P</sub>	A <sub>SSI</sub>	LR	AK				
	WF 725 Type	A/B	B	/	A/B	A/B				
	WF 726 Type	A/B/C	B	C	A/B/C	A/B/C				
Lower limit		Upper limit		Unit	Step		Input format decimal			
time controlled:	4	65535		ms	1		0	0	0	10 <sup>4</sup>
strobe controlled:	0	3		-	-		10 <sup>3</sup>	10 <sup>2</sup>	10 <sup>1</sup>	10 <sup>0</sup>
<b>Cross reference</b>		<b>MD 9</b>								
Numerical example		Input format: Decimal				Input format: Binary				
<b>1200 ms</b>		0	0	0	0	0	0	0	0	
		1	2	0	0	0	4	B	0	

With MD 8 it is possible to select either time controlled or strobe controlled output of M-functions. If the input is smaller than the cycle time of the WF module (0...3) then the output is strobe controlled.

When programming the handshake sequence it should be observed that the M-function is acknowledged with the leading edge. With the trailing edge the output of the next M-function is started. The axis remains stopped until all M-functions have been acknowledged.

If MD 8 is greater than 3, then the value represents the time of output in ms.

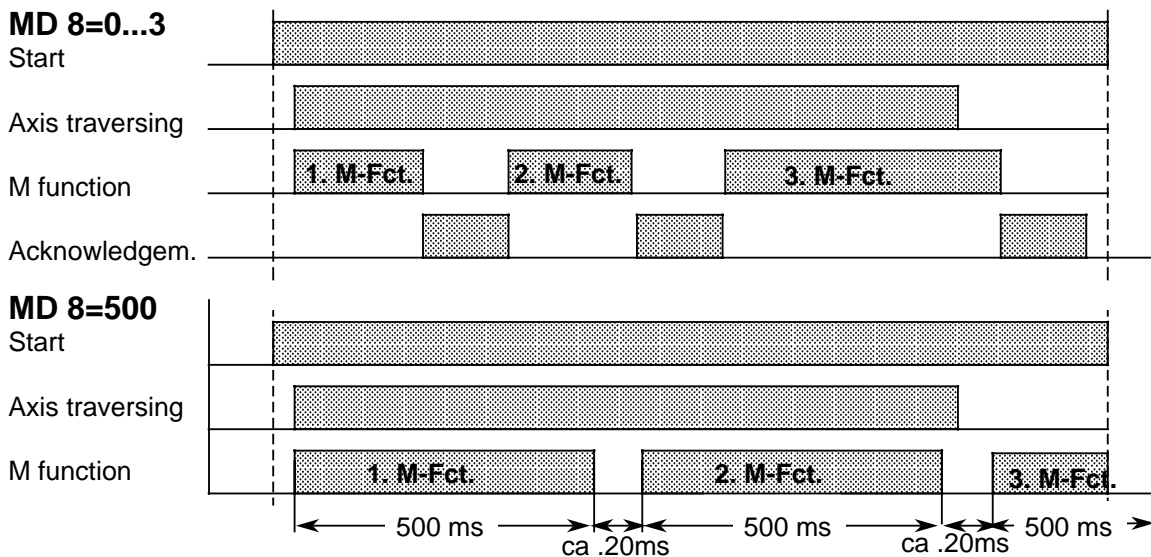

<b>9</b>	<b>Time of output / M-function</b>					<b>9</b>
	Time of M-signal output, before, during or after the execution of the block					
	valid for	I	A <sub>P</sub>	A <sub>SSI</sub>	LR	
	WF 725 Type	A/B	B	/	A/B	A/B
	WF 726 Type	A/B/C	B	C	A/B/C	A/B/C

Numerical value of the bit combination X				Input format decimal			
<b>X=1: during the execution</b> <b>X=2: before the execution</b> <b>X=3: after the execution</b>				0	0	0	0
				0	0	0	X

<b>Cross reference</b>	<b>MD 8</b>
------------------------	-------------

Numerical example	Input format: Decimal				Input format: Binary			
<b>1</b>	0	0	0	0	0	0	0	0
	0	0	0	1	0	0	0	1

MD 9 selects the time of M-function output.

**MD 9 = 1 Output of the M-function during the execution of the block**

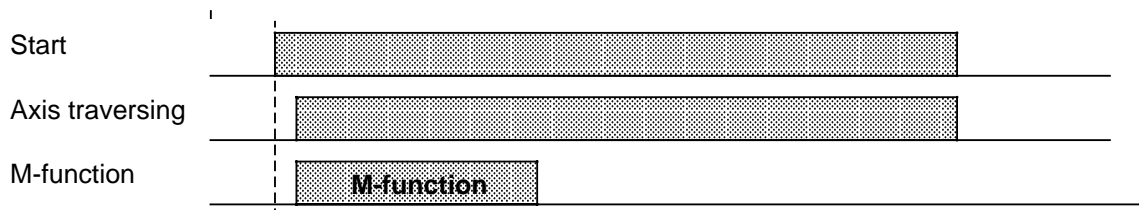

**MD 9 = 2 Output of the M-function before the execution of the block**

With MD 9=2 the M-function which is programmed in a block is read out before execution of the block is started (i.e. before traversing or dwell time) ausgegeben. If strobe controlled output had been selected in MD 8 then the execution is started only after all M-functions have been acknowledged.

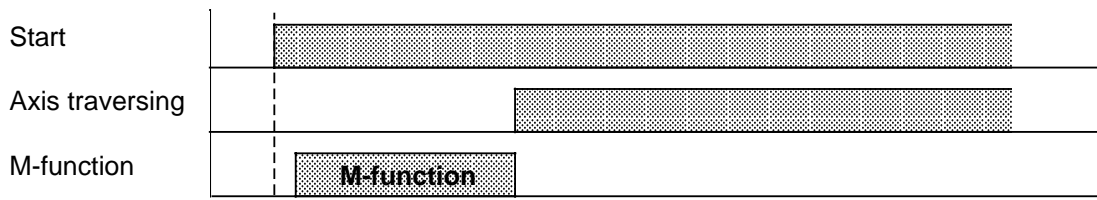



**MD 9 = 3 Output of the M-function after the execution of the block**

With MD 9=3 the M-function is read out after the execution of the dwell time or after the position has been reached.

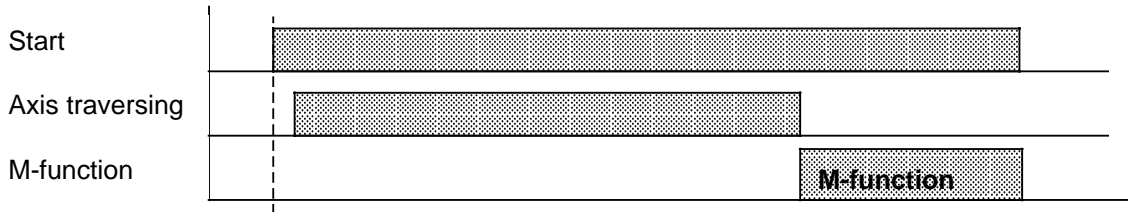

The different possibilities of input change the timings of the block end and the change into the next block.

A flying block change is only possible with MD 9 = 1 and if the M-function output is finished before the deceleration of the axis has been started.

**Feedback in data words 3 and 4 in DB-axis**

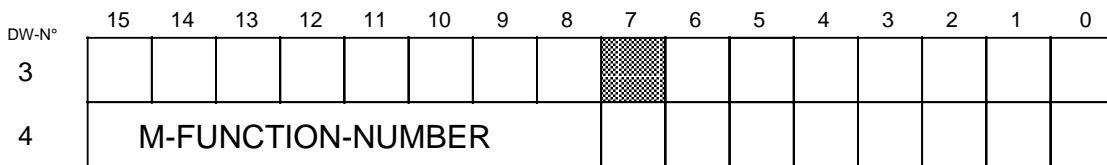

**Acknowledgement in data word 2 in DB-axis**

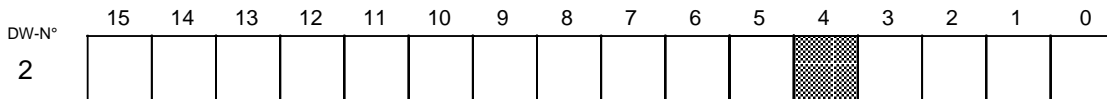

<b>10</b>	<b>Fast outputs</b> Assignment of the fast outputs (in the open loop version O1, O2 and O3 are assigned)						<b>10</b>	
	valid for	I	A <sub>P</sub>	A <sub>SSI</sub>	LR	AK		
	WF 725 Type	A/B	B	/	A/B	A/B		
	WF 726 Type	A/B/C	B	C	A/B/C	A/B/C		
Resolut.	Lower limit	Upper limit	Unit	Step	Input format decimal			
-	0	999999	-	-	0	0	A <sub>6</sub>	
					A <sub>4</sub>	A <sub>3</sub>	A <sub>2</sub>	
<b>Cross reference</b>		<b>MD 15</b>						
Numerical example		Input format: Decimal			Input format: Binary			
<b>Output A<sub>1</sub> PEH</b>		<b>0</b>	<b>0</b>	<b>0</b>	<b>0</b>			
<b>Output A<sub>2</sub> +</b>		<b>0</b>	<b>0</b>	<b>2</b>	<b>1</b>			

A<sub>1</sub> -<sub>6</sub>: Number of fast output on connector X7 which will be assigned:

The following functions can be implemented by entering a number between 0 and 9:

**0 = Output without function**

**1 = PEH** Position reached and stop  
for description see planning instruction part 3, chapter 2

**2 = traversing direction +** axis motion is positive

**3 = traversing direction -** axis motion is negative

In addition, the WF 726 open loop positioning has:

**4 = last but one cut off point**

**X7**

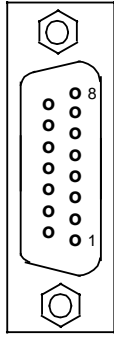

PIN 1	output 6	
PIN 2	output 5	
PIN 3	output 4	
PIN 4	output 3	open loop: cut off point C
PIN 5	output 2	open loop: cut off point B
PIN 6	output 1	open loop: cut off point A

- 1. O1, O2 and O3 have to be "0" in the open loop version.***
- 2. With the closed loop version all outputs can be used.***

<b>11</b>	<b>Pre-limit switch negative</b>						<b>11</b>
<b>Limit switch for the negative direction</b>							
	valid for	I	A <sub>P</sub>	A <sub>SSI</sub>	LR	AK	
	WF 725 Type	A/B	B	/	A/B	A/B	
	WF 726 Type	A/B/C	B	C	A/B/C	A/B/C	

Resolut.	Lower limit	Upper limit	Unit	Step	Input format decimal				
1 μm	greater than negative limit (MD 12)	smaller than positive limit (MD 13)	μm	1 10 100	VZ	10 <sup>7</sup>	10 <sup>6</sup>	10 <sup>5</sup>	10 <sup>4</sup>
10 μm					10 <sup>3</sup>	10 <sup>2</sup>	10 <sup>1</sup>	10 <sup>0</sup>	
100 μm									
<b>Cross reference</b>		<b>MD 12, MD 13, MD 14</b>							

Numerical example	Input format: Decimal				Input format: Binary			
<b>-24537 μm</b>	<b>8</b>	<b>0</b>	<b>0</b>	<b>2</b>	<b>F</b>	<b>F</b>	<b>F</b>	<b>F</b>
	<b>4</b>	<b>5</b>	<b>3</b>	<b>7</b>	<b>A</b>	<b>0</b>	<b>2</b>	<b>7</b>

The positioning module WF 725/726 has 4 software limit switches. With incremental encoders those limit switches are activated after the measuring system has been synchronized (approach reference point or setting of actual value) with the machine.

With absolute encoders the limit switches are active immediately after power-up. MD 11 and MD 13 define the pre-limit switches in "+" and "-" direction, e. g. they define the range in which the axis can be traversed. The position control is disabled when the axis reaches the limit switches defined in MD 12 and MD 14. Those limits can only be reached in the case of a malfunction.

The limit switches are shifted with the activation of the zero offset (G92, G54) and there is of course no mechanical shift. However, a change of the operation sub mode cancels that shift.

**Feed rate as a function of distance - depending on the prelimit switches.**

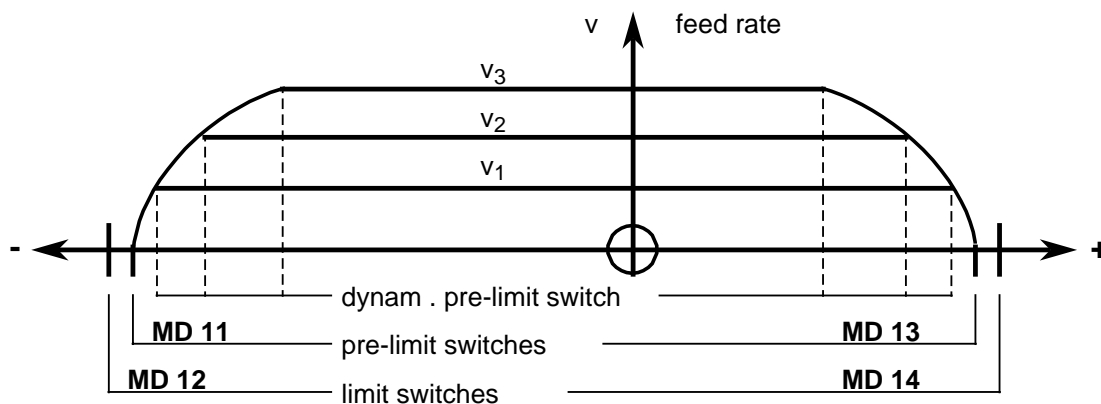

For every feed rate, the positioning module calculates a braking distance according to MD 2. This distance is used to calculate a dynamic limit switch in the direction of movement. When this dynamic limit switch is reached, the axis is decelerated with the braking ramp until it comes to a stop exactly on the pre-limit switch. Passing this pre-limit switch is not possible unless there is a malfunction.

This handling of the software limit switches has the advantage that the traversing range can be used almost completely. The limit switch is activated in other systems only after it has been passed. This means that the limit switch has to be separated from the emergency limit switch by the longest braking distance. This distance can be up to half a meter for each direction.

**Rotary axis:**

*If limit switches are not necessary then the following has to be entered:  
MD11 < 0 , MD12 < 0 and MD13 > MD18 , MD14 > MD18*

**Error messages:**

If MD 11 has been reached then the module reads out error 95 and, in addition, bit 3.3 (pre-limit switch reached) and bit 3.5 (error strobe) are set in DB axis.

**Data words 3 and 4 in DB-Axis**

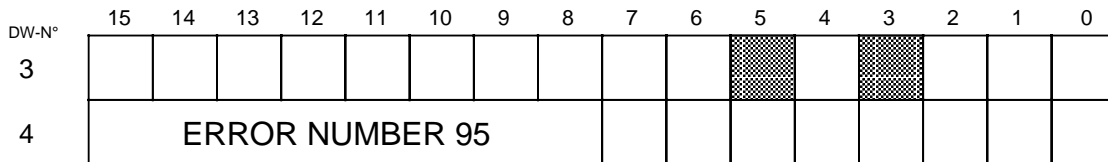

*Inputs for hardware limit switches are not planned.  
They can be connected to:  
- feed enable (too slow, because of ramps)  
- servo enable (best, since very fast)  
emergency stop (fast, but with additional functions)  
Software limit switches are not overridden.*

<b>12</b>	<b>Limit switch negative</b>					<b>12</b>
	Limit switch which disables the drive unit					
	valid for	I	A <sub>P</sub>	A <sub>SSI</sub>	LR	
	WF 725 Type	A/B	B	/	A/B	A/B
	WF 726 Type	A/B/C	B	C	A/B/C	A/B/C

Resolut.	Lower limit	Upper limit	Unit	Step	Input format decimal				
1 μm	-79999999	smaller than negative limit (MD 11)	μm	1	VZ	10 <sup>7</sup>	10 <sup>6</sup>	10 <sup>5</sup>	10 <sup>4</sup>
10 μm	-79999990			10		10 <sup>3</sup>	10 <sup>2</sup>	10 <sup>1</sup>	10 <sup>0</sup>
100 μm	-79999900			100					
<b>Cross reference</b>		<b>MD 11, MD 13, MD 14</b>							

Numerical example	Input format: Decimal				Input format: Binary			
<b>-42728, μm</b>	<b>8</b>	<b>0</b>	<b>0</b>	<b>4</b>	<b>F</b>	<b>F</b>	<b>F</b>	<b>F</b>
	<b>2</b>	<b>7</b>	<b>2</b>	<b>8</b>	<b>5</b>	<b>9</b>	<b>1</b>	<b>8</b>

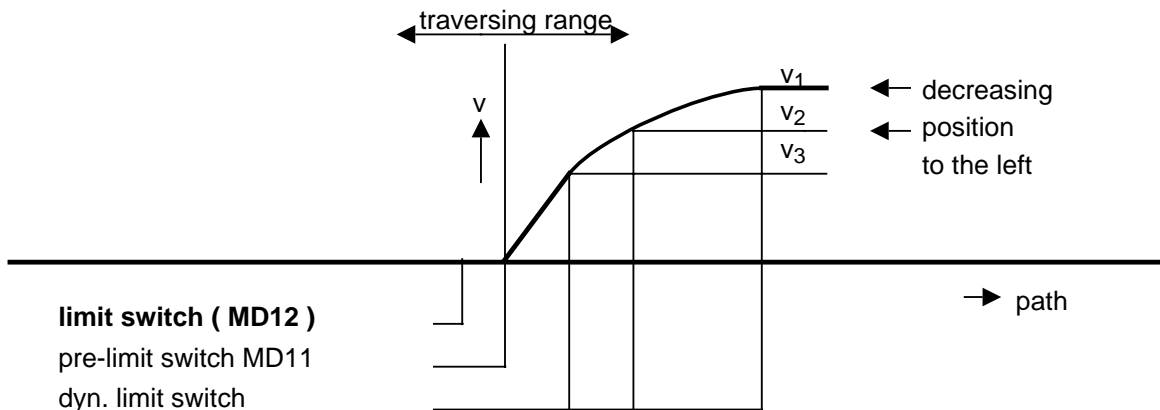

**Error message:**

When MD12 is reached, error message 15 appears and, in addition, bit 3.4 (limit switch reached) and bit 3.5 (error strobe) are set in the DB axis.

**Data word 3 and 4 in DB axis**

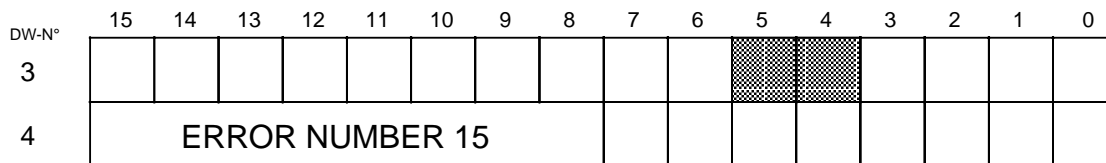

<b>13</b>	<b>Pre-limit switch positive</b>					<b>13</b>
	Limit switch for the positive direction					
	valid for	I	A <sub>P</sub>	A <sub>SSI</sub>	LR	
	WF 725 Type	A/B	B	/	A/B	A/B
	WF 726 Type	A/B/C	B	C	A/B/C	A/B/C

Resolut.	Lower limit	Upper limit	Unit	Step	Input format decimal				
1 μm 10 μm 100 μm	greater than negative limit (MD 11)	smaller than negative limit (MD 14)	μm	1 10 100	VZ	10 <sup>7</sup>	10 <sup>6</sup>	10 <sup>5</sup>	10 <sup>4</sup>
					10 <sup>3</sup>	10 <sup>2</sup>	10 <sup>1</sup>	10 <sup>0</sup>	
<b>Cross reference</b>					<b>MD 11, MD 12, MD 14</b>				

Numerical example	Input format: Decimal				Input format: Binary			
<b>96417,μm</b>	<b>0</b>	<b>0</b>	<b>0</b>	<b>9</b>	<b>0</b>	<b>0</b>	<b>0</b>	<b>1</b>
	<b>6</b>	<b>4</b>	<b>1</b>	<b>7</b>	<b>7</b>	<b>8</b>	<b>A</b>	<b>1</b>

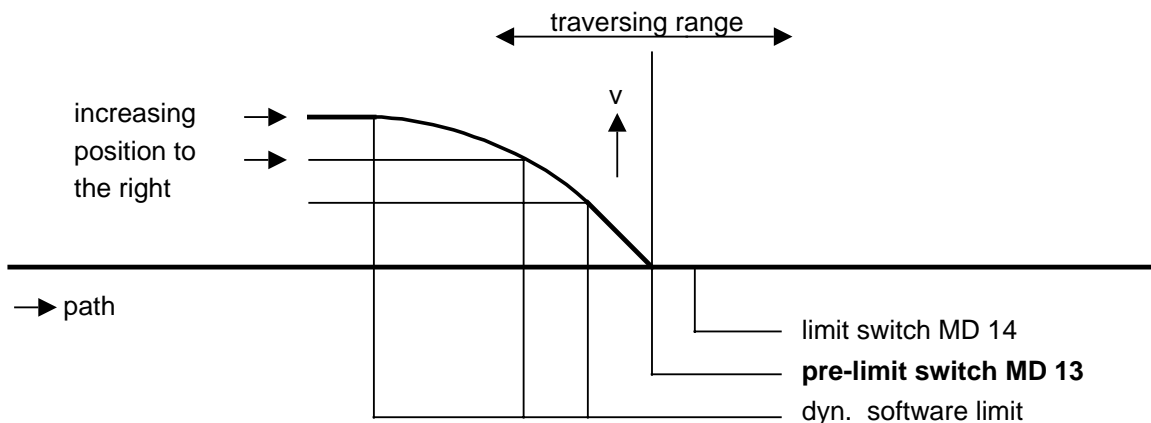

**Error message:**

When MD 13 is reached, error message 96 appears and, in addition, bit 3.3 (pre-limit reached) and bit 3.5 (error strobe) are set in the DB axis.

**Data word 3 and 4 in DB axis**

DW-N°	15	14	13	12	11	10	9	8	7	6	5	4	3	2	1	0
3																
4	ERROR NUMBER 96															

<b>14</b>	<b>Limit switch positive</b>					<b>14</b>
	Limit switch which disables the drive unit					
	valid for	I	A <sub>P</sub>	A <sub>SSI</sub>	LR	
	WF 725 Type	A/B	B	/	A/B	A/B
	WF 726 Type	A/B/C	B	C	A/B/C	A/B/C

Resolut.	Lower limit	Upper limit	Unit	Step	Input format decimal				
1 μm 10 μm 100 μm	greater than pre-limit positive	+79999999 +79999990 +79999900	μm	1 10 100	VZ	10 <sup>7</sup>	10 <sup>6</sup>	10 <sup>5</sup>	10 <sup>4</sup>
					10 <sup>3</sup>	10 <sup>2</sup>	10 <sup>1</sup>	10 <sup>0</sup>	
<b>Cross reference</b>		<b>MD 11, MD 12, MD 13</b>							

Numerical example	Input format: Decimal				Input format: Binary			
<b>137428μm</b>	<b>0</b>	<b>0</b>	<b>1</b>	<b>3</b>	<b>0</b>	<b>0</b>	<b>0</b>	<b>2</b>
	<b>7</b>	<b>4</b>	<b>2</b>	<b>8</b>	<b>1</b>	<b>8</b>	<b>D</b>	<b>4</b>

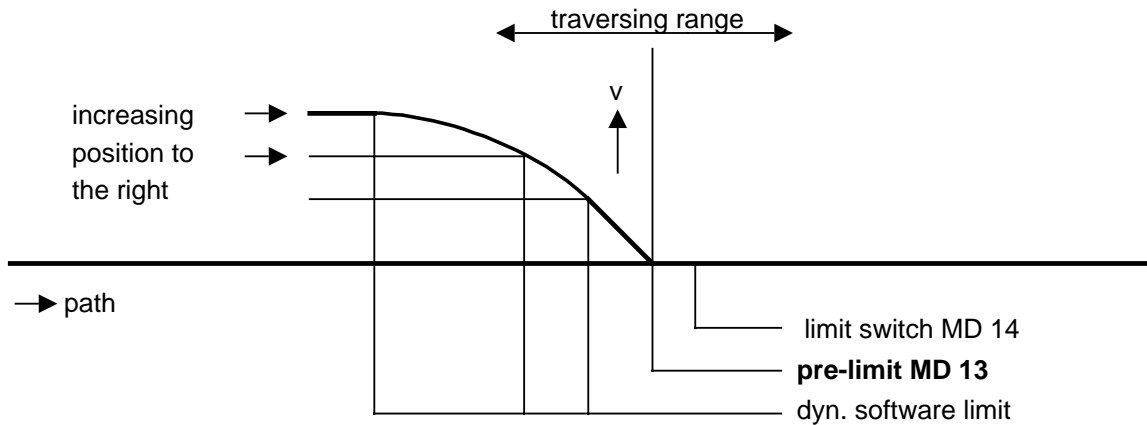

### Error messages:

When MD13 is reached, error message 16 appears and, in addition, bit 3.4 (limit switch reached) and bit 3.5 (error strobe) are set in the DB axis.

### Data word 3 and 4 in DB axis

DW-Nr	15	14	13	12	11	10	9	8	7	6	5	4	3	2	1	0
3																
4	ERROR NUMBER 16															



<b>15</b>	<b>Deceleration cam</b> Selection whether the cam signal comes over the S5 interface or over connector X7						<b>15</b>	
<b>I</b> Incremental encoder	valid for	I	A <sub>P</sub>	A <sub>SSI</sub>	LR	AK	<b>I</b> Incremental encoder	
	WF 725 Type	A/B	/	/	A/B	A/B		
	WF 726 Type	A/B	/	/	A/B	A/B		
Value of bit combination X				Input format: decimal				
X=1: BERO-Bit over S5 interface				0	0	0	0	
X=2: BERO as E1, E2, E3 on connector X7				0	0	0	X	
<b>Cross reference</b>			<b>MD 7, MD 16, MD 17</b>					
Numerical example		Input format: decimal			Input format: binary			
<b>1</b>		0	0	0	0	0	0	
		0	0	0	1	0	0	
		0	0	0	1	0	1	

With machine data 15 it is possible to select whether the WF looks for the deceleration cam signal on the fast inputs (directly on the module) or whether it looks for the signal on the SIMATIC S5 interface in the DB axis. If MD15 = 2 then X 7 must have at least the 24 VDC and the ground connected.

The reaction of the WF 725 / WF 726 is faster if the signal is connected to the fast inputs. If the signal comes over the SIMATIC (DB axis, bit 2.1) then the cycle time of the SIMATIC must be taken into account. It might be necessary to reduce the approach speed or to increase the length of the cam.

If MD15 = 2 then the axes on a WF 725 module can be referenced only one after another. Error message 99 is read out if they are referenced simultaneously.

**X7**

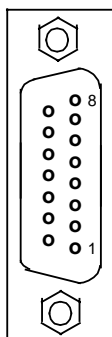

- PIN 10 Input 6
- PIN 11 Input 5
- PIN 12 Input 4
- PIN 13 Input 3 Deceleration cam C
- PIN 14 Input 2 Deceleration cam B
- PIN 15 Input 1 Deceleration cam A

**For the WF 726, the deceleration cams will be used as fast inputs. Input should be executed in every axis under E<sub>1</sub>. Another programming of E<sub>1</sub> to E<sub>3</sub> is impossible when three axes are used.**

<b>15</b>	<b>Fast inputs</b> Assignment of fast inputs						<b>15</b>	
<b>LR</b> WF 726	valid for	I	A <sub>P</sub>	A <sub>SSI</sub>	LR	AK	<b>LR</b> WF 726	
	WF 725 Type	/	/	/	/	/		
	WF 726 Type	A/B/C	B	C	A/B/C	/		
Resolut.	Lower limit	Upper limit	Unit	Step	Input format: decimal			
-	0	999999	-	-	0	0	E <sub>6</sub>	E <sub>5</sub>
					E <sub>4</sub>	E <sub>3</sub>	E <sub>2</sub>	E <sub>1</sub>
<b>Cross reference</b>								
Numerical example		Input format: decimal			Input format: binary			
<b>Input E<sub>1</sub>: 7</b> <b>Input E<sub>2</sub>: 4</b>		<b>0</b>	<b>0</b>	<b>0</b>	<b>0</b>			
		<b>0</b>	<b>0</b>	<b>4</b>	<b>7</b>			

E<sub>1</sub> - 6: Number of fast input on connector X7 which will be assigned:

***With the closed loop of the Wf 726 module, the following functions can be realized in addition to the deceleration cam by presetting a number between 0 and 9.***

As inputs E<sub>1</sub> to E<sub>3</sub> are port inputs and E<sub>4</sub> to E<sub>6</sub> are interrupt inputs, the following assignments must be kept:

**0 = input without function**  
**9 = Reserve**

E<sub>1</sub>-E<sub>3</sub>:  
**4 = External read-in enable**  
**5 = Reserve**  
**6 = Reserve**  
**7 = Start alternatively to the start in SIMATIC S5**  
**8 = Start only if SIMATIC S5 is also started**

E<sub>4</sub>-E<sub>6</sub>:  
**3 = Flying setting of actual value / flying measuring**

***Flying setting of actual value / flying measuring is only possible in the closed-loop version with incremental encoders.***

*The correlation input / axis can be selected freely.  
Double use of inputs, i.e. assignment of two axes to  
one input, is not possible.*

### **E<sub>x</sub>=3 Flying setting of actual value / flying measuring**

<b>Programming:</b>						
N1	G90			X 1000 000	F 12 000	
N2	G90	G92	G68	X 2000 000	F 10 000	(M0)
N3	G90			X 3000 000	F 15 000	

N1 is treated like a normal traversing block but no flying change of blocks from N1 to N2 takes place.

In the block N2, it is traversed with the speed F 10 000 in the direction which is set with G 68 (continuous loop in negative direction) or G 69 (continuous loop in positive direction), until the following reaction is started with the change of flanks at the fast input E<sub>x</sub> from 0 1.

#### **a) Flying setting of actual value (no M0 in N2)**

The actual position is set on the value X 2000 000 of N2 and traversed flying with F 15 000 on the position X 3000 000 of the block N3.

*The original actual value is lost through the  
flying setting of actual value.*

#### **b) Flying measuring (M0 in N2)**

The axis is stopped over the brake slope. With data coding 32, the actual value can be read out at the time of flank change at the E<sub>x</sub>. A new start signal has to be given to process N3.

## E<sub>x</sub>=4 External read-in enable

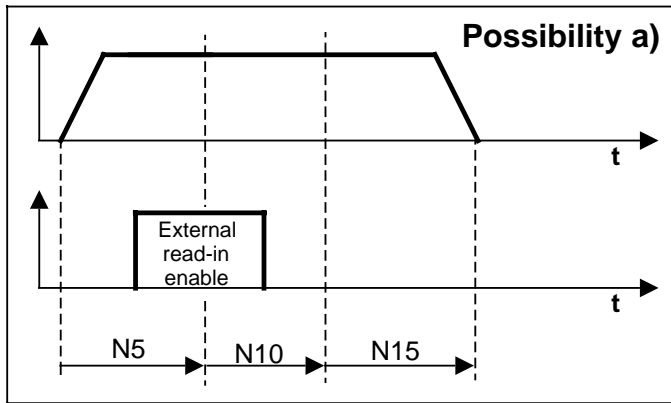

Block N 10 will only be processed when the external read-in enable on the connection X7 on the module is traversed. So there are three possibilities:

**a) the external read-in enable is already active when N10 is called:**

A flying change of blocks between N5 and N10 follows.

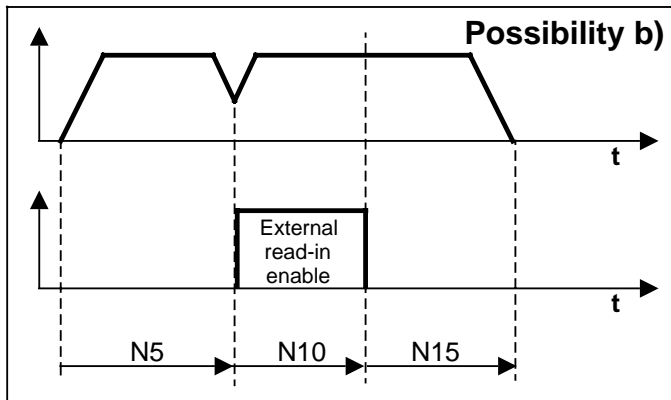

**b) the external read-in enable is traversed to in the deceleration phase of N5:**

An immediate start from block N5 to block N10 takes place.

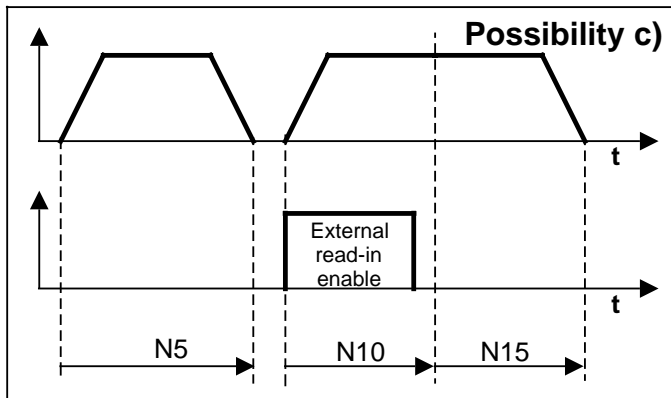

**c) the external read-in enable will be active after block N5 has been processed:**

Block N10 is only processed when the read-in enable is active.

### Example:

N5	G90		X 10 000	F 4000
N10	G90	G99	X 20 000	F 4000
N15	G90		X 30 000	F 4000

<b>16</b>	<b>Reference point coordinate</b> Input of position value which will be loaded after the reference point has been reached						<b>16</b>		
<b>I</b> Incremental encoder	valid for	I	A <sub>P</sub>	A <sub>SSI</sub>	LR	AK	<b>I</b> Incremental encoder		
	WF 725 Type	A/B	/	/	A/B	A/B			
	WF 726 Type	A/B/C	/	/	A/B/C	A/B/C			
Resolut.	Lower limit	Upper limit	Unit	Step	Input format: decimal				
1 μm	-79999999	+79999999	μm	1	VZ	10 <sup>7</sup>	10 <sup>6</sup>	10 <sup>5</sup>	10 <sup>4</sup>
10 μm	-79999990	+79999990		10					
100 μm	-79999900	+79999900		100		10 <sup>3</sup>	10 <sup>2</sup>	10 <sup>1</sup>	10 <sup>0</sup>
<b>Cross reference</b>		<b>MD 7, MD 11, MD 12, MD 13, MD 14, MD 15, MD 17</b>							
Numerical example		Input format: decimal				Input format: binary			
<b>-824967 μm</b>		<b>8</b>	<b>0</b>	<b>8</b>	<b>2</b>	<b>F</b>	<b>F</b>	<b>F</b>	<b>3</b>
		<b>4</b>	<b>9</b>	<b>6</b>	<b>7</b>	<b>6</b>	<b>9</b>	<b>7</b>	<b>9</b>

Each axis has a machine reference point within its traversing range in order to synchronize the control with the mechanical system. Each axis has a machine reference point within its traversing range. With digital rotary encoders a cam (rough) and the zero mark of the encoder (fine) are analyzed for the reference point.

The reference point should be chosen to be easily approachable after the power up. The deceleration cam is approached with the direction selection (+/-) and with the programmed feed rate ( $V_{\text{rapid}}$ ). The speed is reduced once the cam is reached ( $V_{\text{reduced}}$ ). The speed is further reduced ( $V_{\text{slow}}$ ) for approach of the zero mark and for the subsequent traversing of the zero marker shift. The three feed rates,  $V_{\text{fast}}$ ,  $V_{\text{reduced}}$  and  $V_{\text{slow}}$ , are programmed with data codes 8,9,A.

Machine data 15 selects whether the deceleration cam signal is connected directly to the fast input of the WF module or to the S5 interface.

MD 17 can be used to shift the reference point.



MD 16 specifies the value which is loaded as the actual position, once the reference point has been reached. After the axis has been synchronized the software limit switches are activated. The message "axis synchronized" is transferred to the PLC with bit 3.6. This bit remains set as long as the axis is synchronized. Bit 3.0 (in position) is also set.

### Data word 3 in DB axis

DW-Nr	15	14	13	12	11	10	9	8	7	6	5	4	3	2	1	0
3										SYN						PEH

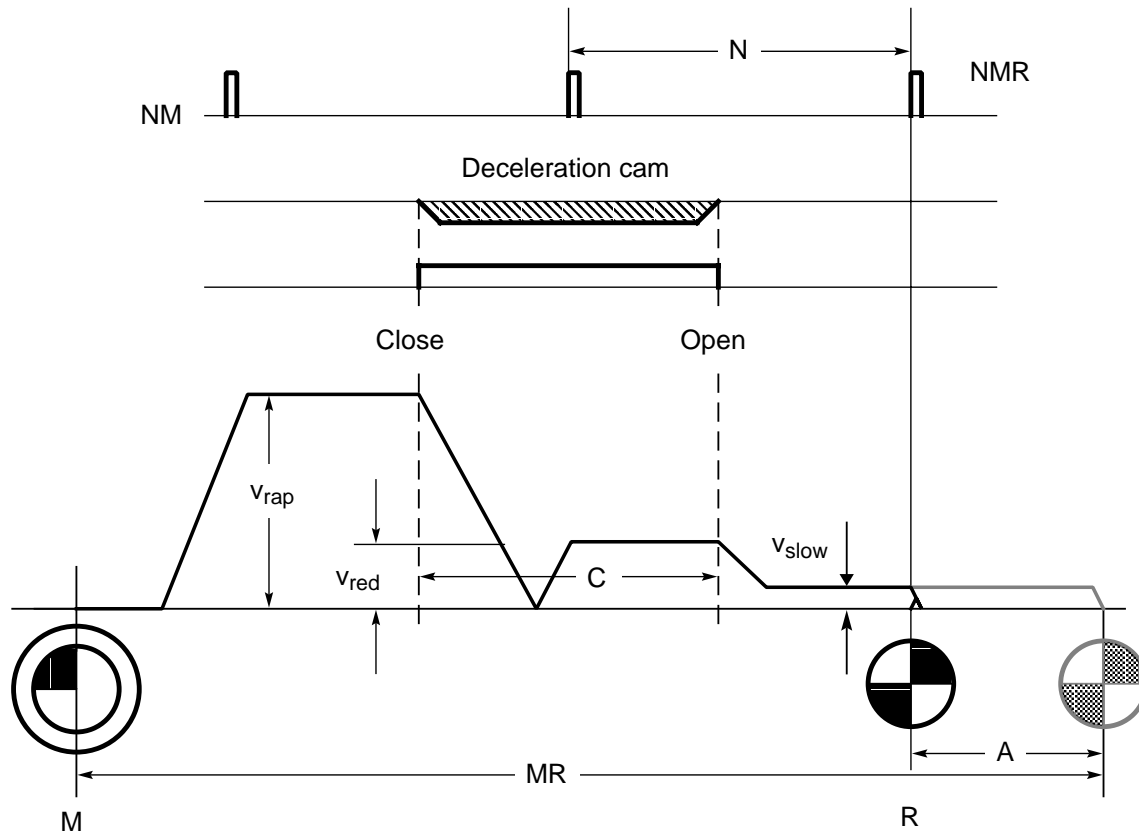
## Approach of the machine reference point with incremental rotary measuring system



 Referencing without reference marker shift  
 Referencing with reference marker shift

MR	reference point coordinate(MD16)
A	zero marker shift (MD17)
NM	zero mark encoder
NMR	zero mark reference code
N	distance per revolution of the encoder
R	machine reference point
C	length of the deceleration cam
M	machine zero point
$v_{rap}$	rapid traverse
$v_{red}$	reduced speed
$v_{slow}$	slow speed

<b>17</b>		<b>Zero marker shift</b> Additional distance after the zero mark					<b>17</b>		
<b>I</b> Incremental encoder	valid for	I	A <sub>P</sub>	A <sub>SSI</sub>	LR	AK	<b>I</b> Incremental encoder		
	WF 725 Type	A/B	/	/	A/B	A/B			
	WF 726 Type	A/B/C	/	/	A/B/C	A/B/C			
Resolut.	Lower limit	Upper limit	Unit	Step	Input format: decimal				
1 μm	-65535	+65535	μm	1	VZ	0	10 <sup>6</sup>	10 <sup>5</sup>	10 <sup>4</sup>
10 μm	-655350	+655350		10					
100 μm	-6553500	+6553500		100		10 <sup>3</sup>	10 <sup>2</sup>	10 <sup>1</sup>	10 <sup>0</sup>
<b>Cross reference</b>		<b>MD 7, MD 11, MD 12, MD 13, MD 14, MD 15, MD 16</b>							
Numerical example		Input format: decimal				Input format: binary			
<b>-25 μm</b>		<b>8</b>	<b>0</b>	<b>0</b>	<b>0</b>	<b>F</b>	<b>F</b>	<b>F</b>	<b>F</b>
		<b>0</b>	<b>0</b>	<b>2</b>	<b>5</b>	<b>F</b>	<b>F</b>	<b>E</b>	<b>7</b>

Machine data 17 offers the possibility of shifting the reference point a small distance from the zero marker. This is sensible, for example, when an encoder must be exchanged and the zero markers of the new and the defect encoder differ. The position shift can be compensated with the zero marker shift.

When approaching the reference point the zero marker shift is traversed after the zero mark has been reached. Afterwards the value of MD 16 is loaded into the actual value position register.

See Figure on page 4 - 34.

<b>17</b>		<b>Absolute encoder adjustment</b> Programmable shift of the encoder value						<b>17</b>	
<b>A</b> Absolute encoder	valid for	I	A <sub>P</sub>	A <sub>SSI</sub>	LR	AK	<b>A</b> Absolute encoder		
	WF 725 Type	/	B	/	B	B			
	WF 726 Type	/	B	C	B/C	B/C			
Resolut.	Lower limit	Upper limit	Unit	Step	Input format: decimal				
1 μm	-79999999	+79999999	μm	1	VZ	10 <sup>7</sup>	10 <sup>6</sup>	10 <sup>5</sup>	10 <sup>4</sup>
10 μm	-79999990	+79999990		10					
100 μm	-79999900	+79999900		100		10 <sup>3</sup>	10 <sup>2</sup>	10 <sup>1</sup>	10 <sup>0</sup>
<b>Cross reference</b>		<b>MD 11, MD 12, MD 13, MD 14, MD 15, MD 16</b>							
Numerical example		Input format: decimal				Input format: binary			
<b>1246,μm</b>		<b>0</b>	<b>0</b>	<b>0</b>	<b>0</b>	<b>0</b>	<b>0</b>	<b>0</b>	<b>0</b>
		<b>1</b>	<b>2</b>	<b>4</b>	<b>6</b>	<b>0</b>	<b>4</b>	<b>D</b>	<b>E</b>

With MD 17 it is possible to adjust the absolute encoder. A shift of the actual value is entered:

For example:     the value delivered from the encoder is to be 1246 μm higher.  
                           MD 17=1246 μm  
                           value from the encoder is 1000 μm  
                           the value 2246 μm is displayed



<b>18</b>	<b>Linear axis / rotary axis</b>					<b>18</b>
	Selection of linear axis or rotary axis. For the rotary axis, output of number of increments per revolution.					
	valid for	I	A <sub>P</sub>	A <sub>SSI</sub>	LR	
	WF 725 Type	A/B	B	/	A/B	A/B
	WF 726 Type	A/B/C	B	C	A/B/C	A/B/C

Resolut.	Lower limit	Upper limit	Unit	Step	Input format: decimal			
-	0 oder 1	Lineary axis	-	1	$10^7$	$10^6$	$10^5$	$10^4$
	2	79999999			$10^3$	$10^2$	$10^1$	$10^0$
<b>Cross reference</b>		<b>MD7, MD 11, MD 12, MD 13, MD 14</b>						

  

Numerical example	Input format: decimal				Input format: binary			
<b>200</b>	<b>0</b>	<b>0</b>	<b>0</b>	<b>0</b>	<b>0</b>	<b>0</b>	<b>0</b>	<b>0</b>
	<b>0</b>	<b>2</b>	<b>0</b>	<b>0</b>	<b>0</b>	<b>0</b>	<b>C</b>	<b>8</b>

The WF 725 / WF 726 can be set up either as a linear or as a rotary axis. The set up is done with machine data 18. If the machine data is 0 or 1, then it is set up as a linear axis.

If it is set up as a rotary axis then the number in machine data 18 is the number of increments after which the actual value counter is reset to zero. With a rotary axis the actual position is corrected if MD 18 is exceeded and if the value goes below 0. The following data is selected (see example above, MD18 = 200):

Forwards            ...198 - 199 - 0 - 1...  
 Backwards        ...1 - 0 - 199 - 198...

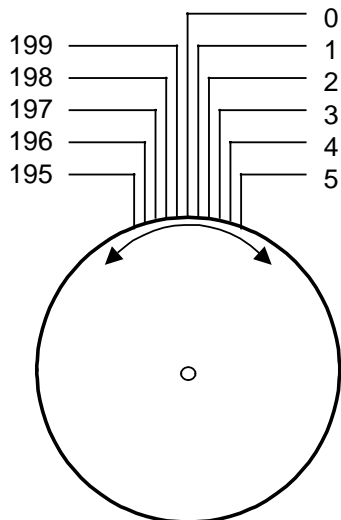

Rotary axis: 1 revolution = 200 impulses

If absolute programming is used then the approach direction to the programmed position can be selected with the bits which are used for traversing in the set up sub mode (bit 1.1 and 1.3). If no direction is selected or if both input bits carry a high-signal then the direction with the shortest distance will be chosen.

With incremental programming the sign of the programmed distance is used to select the direction of rotation. When there are several revolutions in one block, they can only be programmed with incremental programming.

### **Calculation of MD 18**

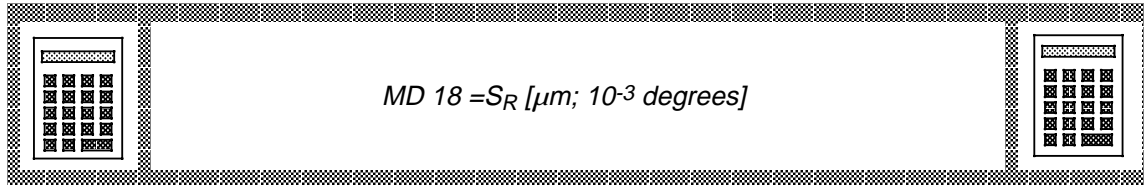
$$MD\ 18 = S_R [\mu m; 10^{-3}\ degrees]$$

$S_R$ : Desired movement range of actual value.

f. Ex.: After the measuring system has been adjusted for a revolution of the rotary axis to signal 36000 [1/1000 degrees], with the input of MD 18 = 360000 it is started from zero for every new revolution.

Therefore, the signal moves only between 0 and 359999 [1/1000 degrees]

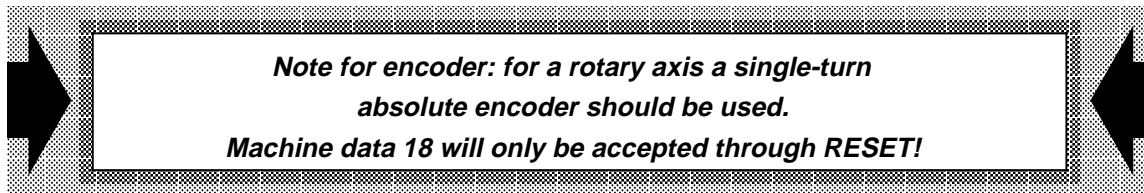

**Note for encoder: for a rotary axis a single-turn  
absolute encoder should be used.  
Machine data 18 will only be accepted through RESET!**

<b>19</b>	<b>Pulse evaluation, before the decimal point</b> Adaption of encoder pulses to traversing range						<b>19</b>		
	valid for	I	A <sub>P</sub>	A <sub>SSI</sub>	LR	AK			
	WF 725 Type	A/B	B	/	A/B	A/B			
	WF 726 Type	A/B/C	B	C	A/B/C	A/B/C			
Resolut.	Lower limit	Upper limit	Unit	Step	Input format: decimal				
-	0	9	-	1	0	0	0	0	
					0	0	0	10 <sup>0</sup>	
<b>Cross reference</b>		<b>MD 20, MD 21, MD 49</b>							
Numerical example		Input format: decimal				Input format: binary			
0		0	0	0	0	0	0	0	
		0	0	0	0	0	0	0	

Because of gear ratios and different encoders, an increment respectively one step from the encoder will result in an uneven traversing value.

The pre-decimal part of the pulse evaluation factor is entered in MD 19.

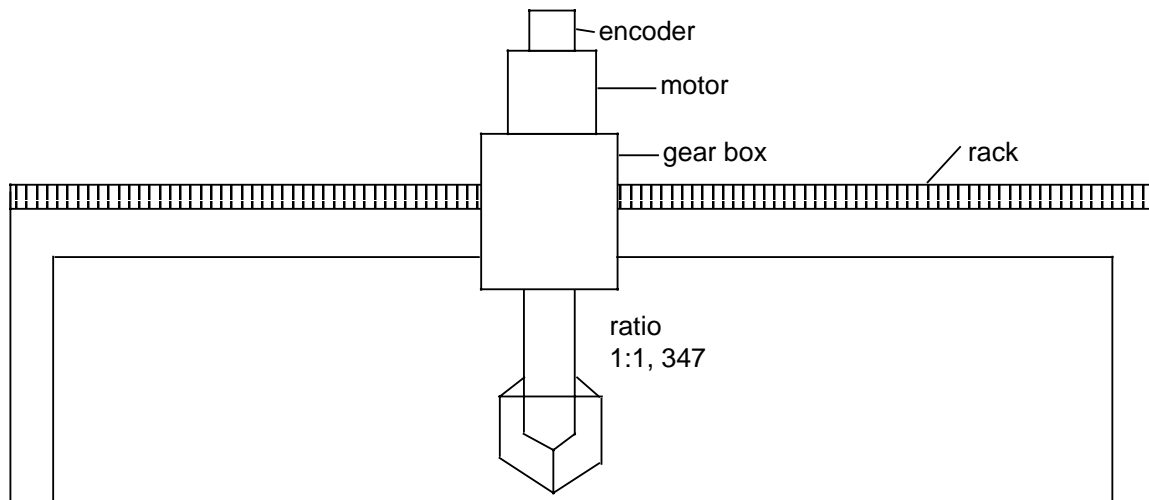

For further explanations see MD 20.

<b>20</b>	<b>Pulse evaluation, after the decimal point</b> Adaption of encoder pulses to traversing range						<b>20</b>		
	valid for	I	A <sub>P</sub>	A <sub>SSI</sub>	LR	AK			
	WF 725 Type	A/B	B	/	A/B	A/B			
	WF 726 Type	A/B/C	B	C	A/B/C	A/B/C			
Resolut.	Lower limit	Upper limit	Unit	Step	Input format: decimal				
-	0	99999999	-	1	10 <sup>-1</sup>	10 <sup>-2</sup>	10 <sup>-3</sup>	10 <sup>-4</sup>	
					10 <sup>-5</sup>	10 <sup>-6</sup>	10 <sup>-7</sup>	10 <sup>-8</sup>	
<b>Cross reference</b>		<b>MD 19, MD 21, MD 49</b>							
Numerical example		Input format: decimal				Input format: binary			
<b>31 830 980</b>		<b>3</b>	<b>1</b>	<b>8</b>	<b>3</b>	<b>0</b>	<b>1</b>	<b>E</b>	<b>5</b>
		<b>0</b>	<b>9</b>	<b>8</b>	<b>0</b>	<b>B</b>	<b>3</b>	<b>C</b>	<b>4</b>

The pulse evaluation factor after the decimal point is entered in MD 20.

f. Ex.: 1 increment = 1.347 µm

i.e., if a traversing distance of 1000 is set then it traverses 1000 increments = 1347 µm.

This relation of distance to increments can be pre-set as MD 19 and MD 20.

$$\begin{aligned} \text{MD 19} &= 1 \\ \text{MD 20} &= 34700000 \end{aligned}$$

i.e., the WF is told that 1 increment is 1.347 µm.

If a traversing distance of 1000 is set in the WF, the axis traverses

$$\frac{1000}{1.347} = 742.39 \text{ increments.}$$

As 742.39... increments are equivalent to 1000 µm, all positions can now be entered in µm.

MD 19 and MD 20 must not be zero simultaneously, otherwise error message 19 will be signalled..

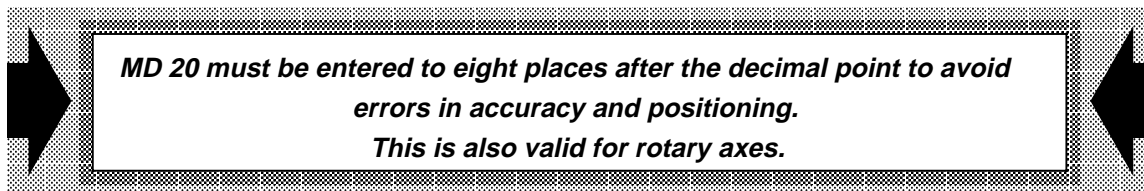

The encoder is selected as follows:

a) incremental encoder:

- what resolution is required (1,10,100 μm)??
- what spindle slope is used?
- what is the ratio encoder : spindle?

b) absolute encoder:

- what resolution is required (1,10,100 μm)?
- what is the size of the maximum traversing range?

When those questions are answered the encoders can be selected according to the following formula:

a) incremental encoder:

$$I_{GE} = \frac{S [\mu m]}{4 * i_{GS} * A [\mu m]}$$

calculated number of pulses for the encoder

b) absolute encoder:

$$I_{GE} = \frac{S_G [\mu m]}{A [\mu m]}$$

calculated number of steps for the encoder

S pitch of the spindle in [μm] or [10<sup>-3</sup> degrees] for rotary axis

i<sub>GS</sub> Ratio spindle:encoder

A Resolution in [μm] or [10<sup>-3</sup> degrees]

S<sub>G</sub> maximum traversing range in [μm] or number of increments of the rotary axis in [μm] or [10<sup>-3</sup> degrees]

Now the pulse evaluation factor can be calculated

a) incremental encoder:

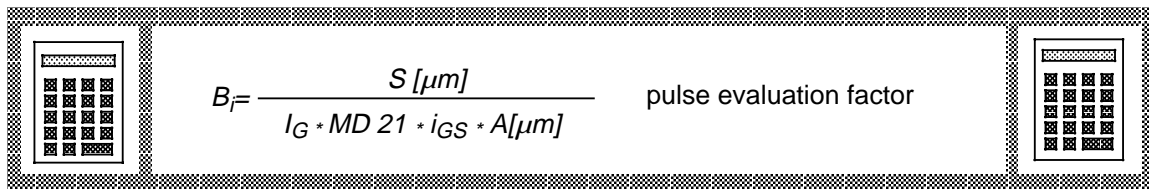

$$B_I = \frac{S [\mu m]}{I_G * MD 21 * i_{GS} * A [\mu m]}$$

pulse evaluation factor

b) absolute encoder:

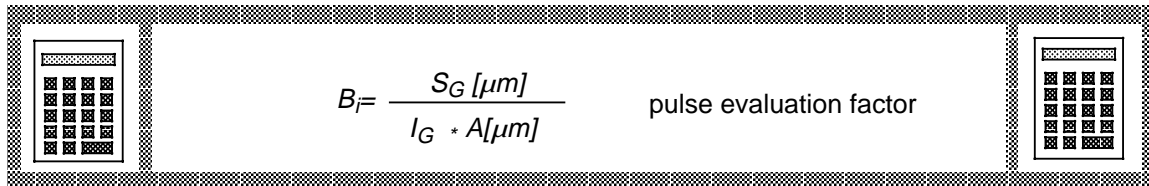

$$B_I = \frac{S_G [\mu m]}{I_G * A [\mu m]}$$

pulse evaluation factor

S pitch of the spindle in [μm] or number of increments of the rotary axis in [10<sup>-3</sup> degrees]

I<sub>G</sub> number of pulses for incremental encoder or number of steps of the absolute encoder

i<sub>GS</sub> ratio spindle : encoder

A Resolution in [μm] or [10<sup>-3</sup> degrees] for rotary axis

S<sub>G</sub> maximum traversing range in [μm] or number of increments of the rotary axis in [μm] or [10<sup>-3</sup> degrees]

<b>21</b>	<b>Pulse multiplication</b>						<b>21</b>							
Specification of the pulse multiplication														
<b>I</b> Incremental encoder	valid for	I	A <sub>P</sub>	A <sub>SSI</sub>	LR	AK	<b>I</b> Incremental encoder							
	WF 725 Type	A/B	/	/	A/B	A/B								
	WF 726 Type	A/B/C	/	/	A/B/C	A/B/C								
Numerical value for bit combination X				Input format: decimal										
X=1:	1	<b>Pulse evaluation</b>	<table border="1" style="width: 100%; text-align: center;"> <tr><td>0</td><td>0</td><td>0</td><td>0</td></tr> <tr><td>0</td><td>0</td><td>0</td><td>X</td></tr> </table>				0	0	0	0	0	0	0	X
0	0						0	0						
0	0						0	X						
X=2: Encoder pulse multipl. with	2 =													
X=4:	4													
<b>Cross reference</b>		<b>MD 19, MD 20</b>												
Numerical example		Input format: decimal			Input format: binary									
<b>4</b>		0	0	0	0	0	0	0						
		0	0	0	4	0	0	0	4					

MD 21 specifies which channels of an incremental encoder are used for the actual value counter.

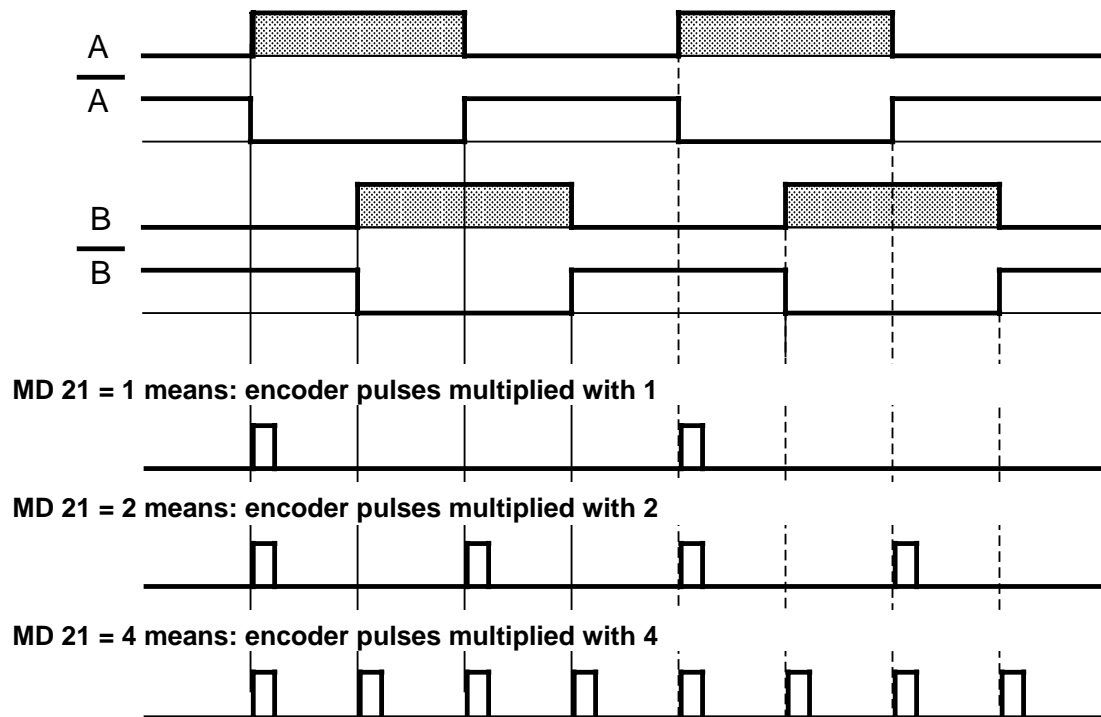

**Examples:**

a) incremental encoder:

- a1) Resolution: 1 μm  
 Spindle slope: 10 mm  
 Ratio: 1:1 1 encoder revolution equals one turn of the spindle

$$I_{GE} = \frac{10\,000}{4 \cdot 1 \cdot 1} = 2\,500 \quad \text{selected encoder with 2500 pulses/rev.}$$

$$B_i = \frac{10\,000}{2\,500 \cdot 4 \cdot 1 \cdot 1} = 1.0 \quad \text{evaluation factor MD 19, MD 20=1,0}$$

MD 19=1	MD 20=0	MD 21=4
---------	---------	---------

- a2) Resolution: 10 μm or 10<sup>-2</sup> degrees  
 Rotary axis: 360,000 degrees  
 Ratio: 2.51:1 2.51 turns of the encoder equal one turn of the axis

$$I_{GE} = \frac{360\,000}{4 \cdot 2.51 \cdot 10} = 3\,585.657 \quad \text{selected encoder with 5000 pulses/rev.}$$

$$B_i = \frac{360\,000}{5\,000 \cdot 4 \cdot 2.51 \cdot 10} = 0.717131474 \quad \text{evaluation factor MD 19, MD 20=0.71713147}$$

MD 19=0	MD 20=71713147	MD 21=4
MD 18 = 360 000		

b) absolute encoder:

- Resolution: 100 μm  
 maximum traversing range: 25m = 25 000 000 μm

$$I_{GE} = \frac{25\,000\,000}{100} = 250\,000 \quad \text{selected encoder with 512x512 steps=262 144 steps}$$

$$B_i = \frac{25\,000\,000}{262\,144 \cdot 100} = 0.95367432 \quad \text{evaluation factor MD 19, MD 20=0.95367432}$$

MD 19=0	MD 20=95367432
---------	----------------

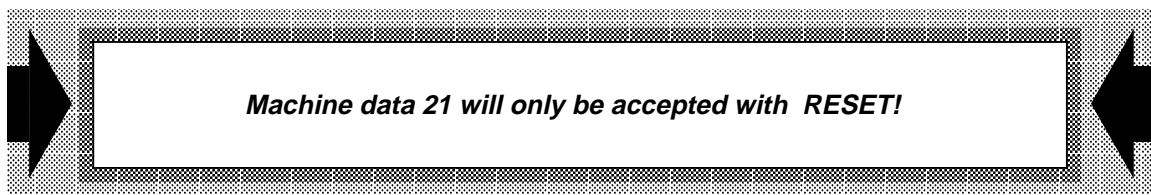

<b>21</b>	<b>Absolute encoder parameter</b> Selection of encoder code, with or without parity analysis						<b>21</b>		
<b>A<sub>P</sub></b> parallel absolute encoder	valid for	I	A <sub>P</sub>	A <sub>SSI</sub>	LR	AK	<b>A<sub>P</sub></b> parallel absolute encoder		
	WF 725 Type	/	B	/	B	B			
	WF 726 Type	/	B	/	B	B			
Numerical value for bit combination X					Input format: decimal				
<b>X=0: Binary code without Parity</b> <b>X=1: Binary code with Parity</b> <b>X=2: Gray-Code without Parity</b> <b>X=3: Gray-Code with Parity</b>					0	0	0	0	
					0	0	0	X	
<b>Cross reference</b>									
Numerical example		Input format: decimal				Input format: binary			
<b>2</b>		0	0	0	0	0	0	0	
		0	0	0	2	0	0	0	2

The encoder code is selected in MD 21.

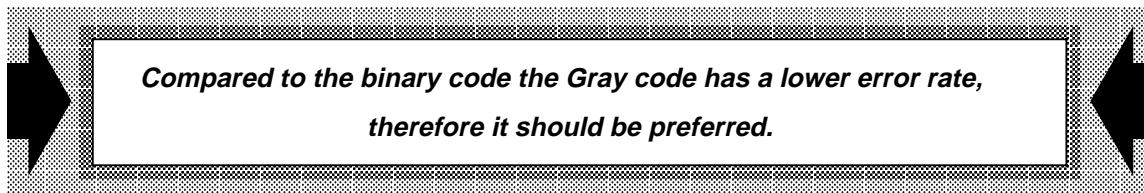

Security of data is also increased by using an encoder with parity bit.

A standard linear parity is expected from the WF. The encoder must be selected according to this fact.

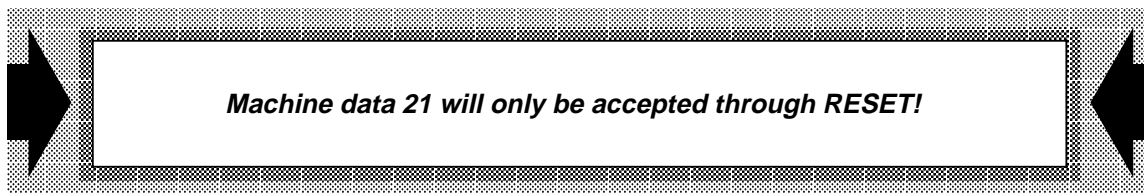



<b>21</b>	<b>Telegram length</b> Setting of telegram length of the SSI encoder					<b>21</b>			
<b>AssI</b> serial absolute encoder	valid for	I	A <sub>P</sub>	A <sub>SSI</sub>	LR	AK	<b>AssI</b> serial absolute encoder		
	WF 725 Type	/	/	/	/	/			
	WF 726 Type	/	/	C	C	C			
Numerical value for bit combination X					Input format: Decimal				
<b>X=1: 24 Bit telegram</b> <b>X=4: 21 Bit telegram</b>					0	0	0	0	
					0	0	0	X	
<b>Cross reference</b>					<b>MD 5, MD 7</b>				
Numerical example		Input format: Decimal				Input format: Binary			
<b>4</b>		0	0	0	0	0	0	0	0
		0	0	0	4	0	0	0	4

The absolute encoders which are permitted at the moment have a telegram length of 21 or 24 Bit.

This information must be set accordingly in MD 21.

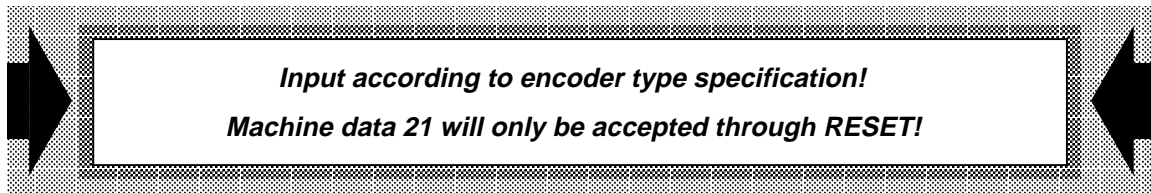

<b>22</b>		<b>K<sub>v</sub> - factor</b> Gain of the position control loop						<b>22</b>	
<b>LR</b> Closed loop	valid for	I	A <sub>P</sub>	A <sub>SSI</sub>	LR	AK	<b>LR</b> Closed loop		
	WF 725 Type	A/B	B	/	A/B	/			
	WF 726 Type	A/B/C	B	C	A/B/C	/			
Resolut.	Lower limit	Upper limit	Unit	Step	Input format: decimal				
-	20	900	10 <sup>-2</sup> m/min mm	1	0	0	0	0	0
					0	10 <sup>2</sup>	10 <sup>1</sup>	10 <sup>0</sup>	10 <sup>0</sup>
<b>Cross reference</b>			<b>MD 3, MD 23</b>						
Numerical example		Input format: decimal				Input format: binary			
<b>1,12</b> $\frac{\text{m/min}}{\text{mm}}$		0	0	0	0	0	0	0	0
		0	1	1	2	0	0	7	0

Definition : 
$$K_v = \frac{\text{feed rate}}{\text{following error}} \left[ \frac{\text{m/min}}{\text{mm}} \right]$$

A high K<sub>v</sub> factor is necessary to obtain a dynamic position in the control loop. However, if the K<sub>v</sub> factor is too high then the axis becomes unstable and oscillates. This puts a heavy strain on the machine.

The maximum K<sub>v</sub>-factor depends on:

- size or performance of the drives (response time, acceleration and deceleration)
- quality of the machine

Machines built in series usually have the same K<sub>v</sub> factor between 1 and 1.5 m/min/mm in about 80% of the cases . In these machines, the normal K<sub>v</sub> factor is entered and the response of the axis for overshoots is checked.

$$K_v \text{ 0.8 bis 1.5}$$

***For more axes with connected functions,  
the K<sub>v</sub>-Factor must be equal .***

Important: A good speed regulation and tach adjustment is always required for a correct  $K_v$  adjustment.

The positioning of the axis is checked with a chart recorder or with a memory oscilloscope. Either the command value to the drive or the tach signal is measured. The axis should be traversed with a number of different feed rates.

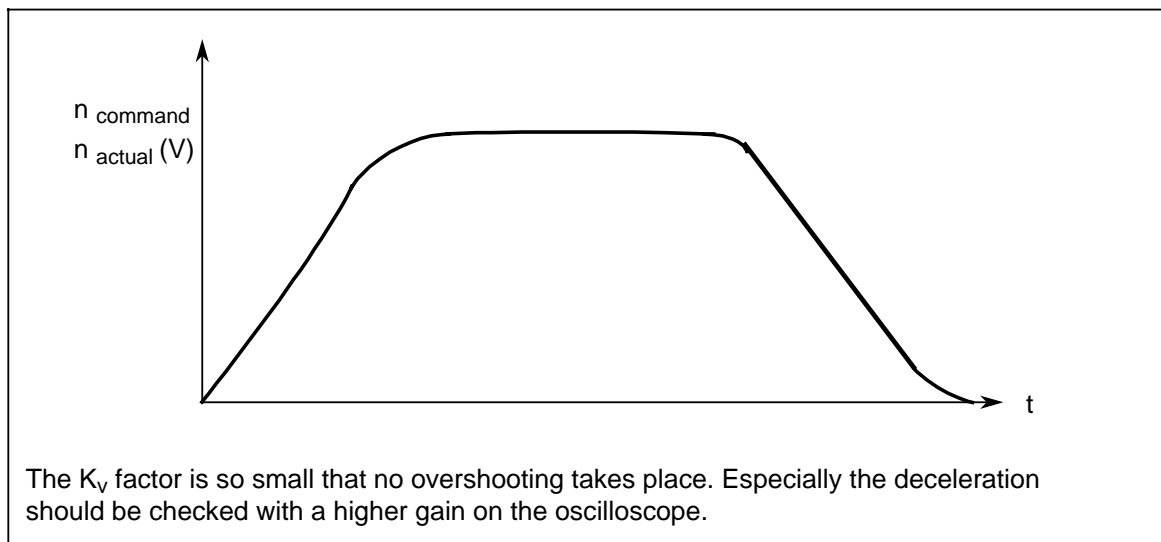
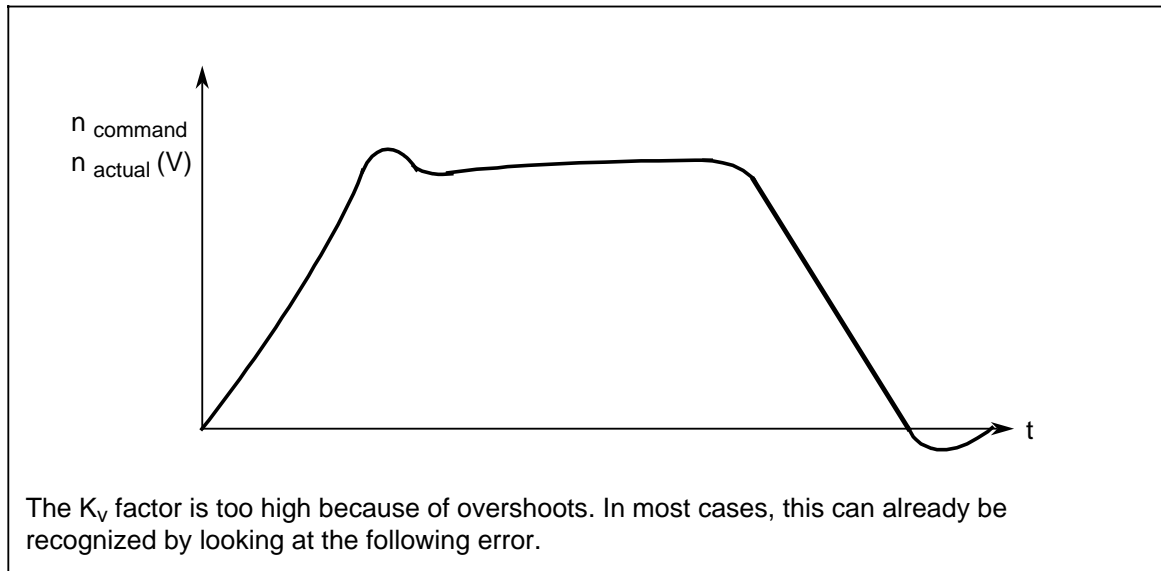

Overshooting can also be caused by the following factors:

- Acceleration too high (current limit is reached)
- Response time of the speed regulator too high
- Error in speed regulator (adjustment necessary?)
- Mechanical backlash
- Jammed mechanics
- Variation in load (vertical axis)

For safety reasons, a  $K_v$  factor lower than 10% is selected (and not the highest possible).

## Check of the $K_v$ factor

With data code B from standard I-726, the actual  $K_v$  factor can be read out.

If the drift is compensated, the signalled value is identical for positive and negative traversing direction, presuming identical feed rates.

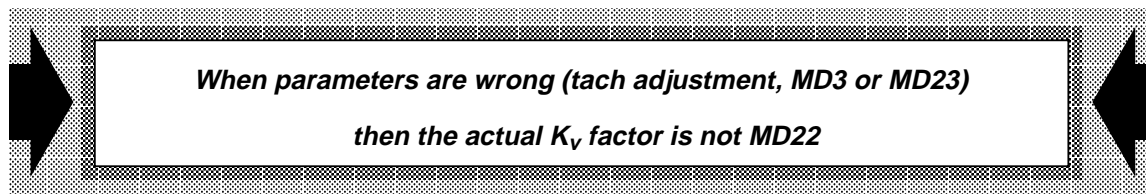

<b>23</b>	<b>Maximum command value voltage</b> Output voltage at which the highest feed rate (MD 3) is to be reached						<b>23</b>		
<b>LR</b> Closed Loop	valid for	I	A <sub>P</sub>	A <sub>SSI</sub>	LR	AK	<b>LR</b> Closed Loop		
	WF 725 Type	A/B	B	/	A/B	/			
	WF 726 Type	A/B/C	B	C	A/B/C	/			
Resolut.	Lower limit	Upper limit	Unit	Step	Input format: decimal				
-	1000	10000	mV	1	0	0	0	10 <sup>4</sup>	
					10 <sup>3</sup>	10 <sup>2</sup>	10 <sup>1</sup>	10 <sup>0</sup>	
<b>Cross reference</b>		<b>MD 3, MD 22</b>							
Numerical example		Input format: decimal				Input format: binary			
<b>8000 mV</b>		<b>0</b>	<b>0</b>	<b>0</b>	<b>0</b>	<b>0</b>	<b>0</b>	<b>0</b>	<b>0</b>
		<b>8</b>	<b>0</b>	<b>0</b>	<b>0</b>	<b>1</b>	<b>F</b>	<b>4</b>	<b>0</b>

With MD 23, the Wf 725 / WF 726 is told the rated command value on which the speed regulator has been optimized.  
MD 23 is closely related to MD 3.

In MD 3 the speed is entered which is reached when the speed regulator is supplied with the rated voltage MD 23. In addition, the K<sub>v</sub> factor (MD22) also influences calculation of the command value.

The WF module has an 11 bit DAC, a maximum output of 10 000 mV rated value voltage is possible . The highest feed rate should never be reached at 10 V command value in order to allow the WF to compensate variations in load. This means that the value in MD 23 has to be lower than 10 000.

Most drives are adjusted to a command value of 8 V for the maximum feed. Therefore, MD 23 has to be set on 8000. If the axis should traverse at 10 m/min with this 8 V command value then MD 3 has to be 1 000 000.

If a K<sub>v</sub> factor of 1.00 is selected in MD 22 then the WF calculates a factor from these values which is used to evaluate every s increment . The transformation to an analogue voltage is executed in a DAC.

**Example for the relation between MD 3, 22 and 23:**

$$\begin{aligned} v_{\max} &= 10 \text{ m/min} \\ U_{\max} &= 8 \text{ V} \\ K_v &= 1.00 \frac{\text{m/min}}{\text{mm}} \end{aligned}$$

$$s = \frac{v_{\max}}{K_v} = \frac{10\,000 \text{ mm/min}}{1.00 \frac{\text{mm/min}}{\mu\text{m}}} = 10\,000 \mu\text{m}$$

$$\text{value DAC}_{\max} = \frac{U_{\max} \cdot \text{Bit}}{U_{\text{DAC}_{\max}}} = \frac{8000 \text{ mV} \cdot 2047}{10\,000 \text{ mV}} = 1\,638$$

$$\text{factor DAC} = \frac{\text{value DAC}_{\max}}{s_{\max}} = \frac{1638}{10\,000 \mu\text{m}} = 0.1638 \frac{1}{\mu\text{m}}$$

The following formula can be formulated as a summary:

$$\text{Factor DAC} = \frac{2047 \cdot \text{MD 23}[\text{mV}] \cdot \text{MD 22} \frac{\text{mm/min}}{\mu\text{m}} \cdot A[\mu\text{m}]}{10\,000[\text{mV}] \cdot \text{MD 3} \frac{\text{mm}}{\text{min}}} < 3$$

A: resolution in [ $\mu\text{m}$ ]

Every following error increment is evaluated with the factor calculated above by the WF. To increase the value of the DAC by one increment during normal operation, it is necessary to increase the following error by 7 increments.

To get a smooth command value at very low feed rate the output voltage is reduced by 1/32, and the following error is multiplied by 32. This switch of the command value is implemented internally with an additional hysteresis. It is active only at very low feed rates. This makes it possible to traverse precisely and smoothly at very low feed rates.

For planning a system with the WF 725/WF 726 the factor has to be calculated approximately according to the formula above. But it can also be read out with data code 29.

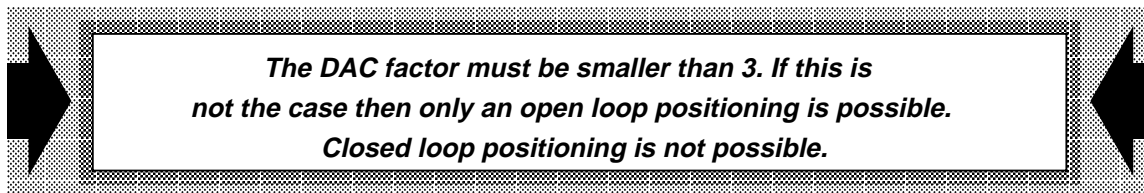

Positioning loop

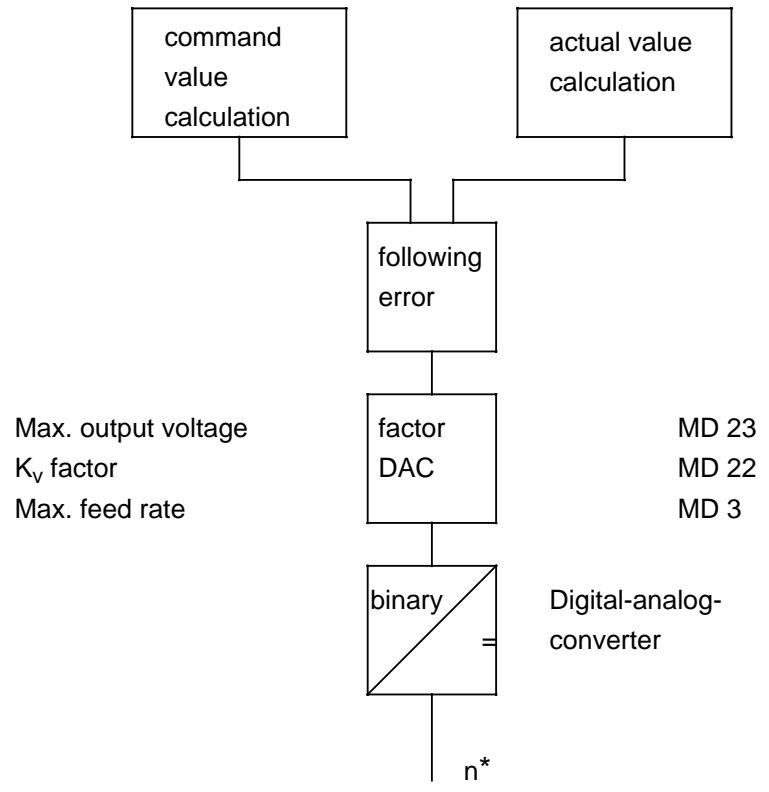

<b>24</b>	<b>Max. following error (dynamic)</b>						<b>24</b>		
Maximum following error allowed during traversing									
<b>LR</b> Closed Loop	valid for	I	A <sub>P</sub>	A <sub>SSI</sub>	LR	AK			
	WF 725 Type	A/B	B	/	A/B	/			
WF 726 Type	A/B/C	B	C	A/B/C	/	/			
<b>LR</b> Closed Loop									
Resolut.	Lower limit	Upper limit	Unit	Step	Input format: decimal				
1	0	65535	μm	1	0	10 <sup>6</sup>	10 <sup>5</sup>	10 <sup>4</sup>	
10	0	655350		10	10 <sup>3</sup>	10 <sup>2</sup>	10 <sup>1</sup>	10 <sup>0</sup>	
100	0	6553500		100	10 <sup>3</sup>	10 <sup>2</sup>	10 <sup>1</sup>	10 <sup>0</sup>	
<b>Cross reference</b>			<b>MD 3, MD 25, MD 26</b>						
Numerical example		Input format: decimal			Input format: binary				
<b>36700μm</b>		<b>0</b>	<b>0</b>	<b>0</b>	<b>3</b>	<b>0</b>	<b>0</b>	<b>0</b>	<b>0</b>
		<b>6</b>	<b>7</b>	<b>0</b>	<b>0</b>	<b>8</b>	<b>F</b>	<b>5</b>	<b>C</b>

The positioning module WF 725/WF 726 has 3 machine data to enter limits for checks. They are MD24, MD25 and MD26.

Machine data 24 determines the maximum following error ( S ) which is allowed during traversing. If this limit is exceeded the axis is stopped and error message 11 is read out.

MD26 determines the minimum following error checked during traversing.

The WF 725/726 calculates for every programmed feed rate a related limit for check of the following error, whereby this limit can only be in the dynamic range between MD26( s<sub>min</sub>) and MD24 ( s<sub>max</sub> ). If for example the calculated following error ( S<sub>calculated</sub>) is smaller than ( s<sub>min</sub>) then MD26 is used to check the following error

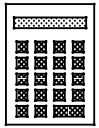

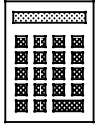
$$MD\ 24 = 1.2 \cdot \frac{v_{max}}{K_v}$$



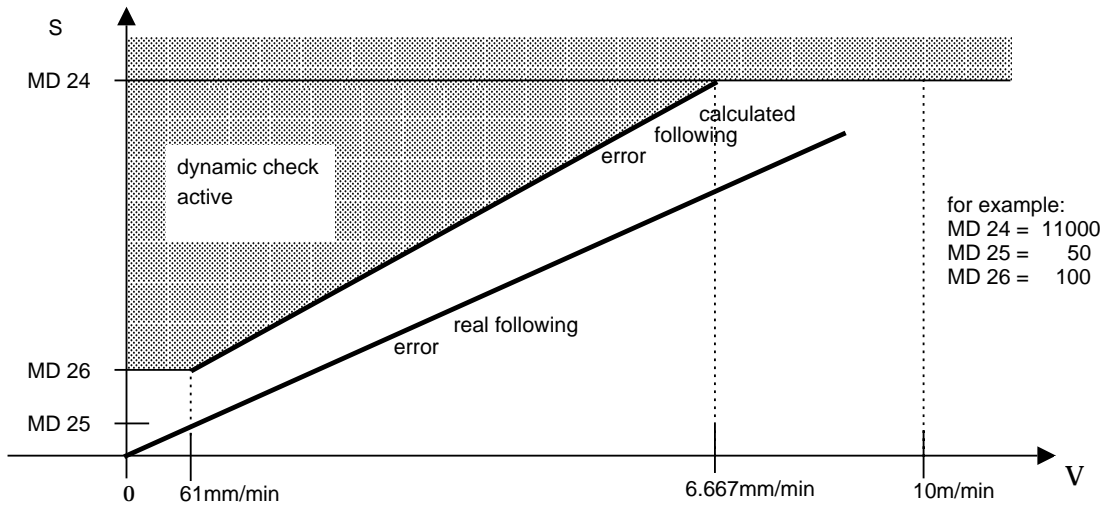

The example above shows the limit values. The WF 725/726 calculates the variable limits according to the following formula:

$$s_{Limit} = 1.5 \cdot \frac{v_{Com}}{v_{max} (MD 3)} \cdot s_{max} (MD 24)$$

The variables of the formula can be rearranged:

$$v_{Com} = \frac{s_{Limit} \cdot v_{max}}{1.5 \cdot s_{max}} = \frac{100 \cdot 10000}{1.5 \cdot 11000} = 60.606 \text{ mm/min}$$

After rearranging the variables a speed of 61mm/min is obtained; i.e. MD26 is used for smaller speed than 61 mm/min, for higher speed the calculated value is used for the following error check.

In the same way a speed of 6.667 m/min. can be calculated for the upper limit; i.e. for feed rates higher then 6.667 m/min. MD24 is always used for the following error check.

MD 26 and MD 24 define a curve of the limit for the following error check.

<b>25</b>	<b>Max. following error (standstill)</b>						<b>25</b>	
<b>Maximum following error allowed during standstill</b>								
<b>LR</b> <small>Closed Loop</small>	valid for	I	A <sub>P</sub>	A <sub>SSI</sub>	LR	AK		
	WF 725 Type	A/B	B	/	A/B	/		
WF 726 Type	A/B/C	B	C	A/B/C	/	/		
<b>Cross reference</b>								
			<b>MD 24, MD 26, MD 32, MD 33</b>					
Resolut.	Lower limit	Upper limit	Unit	Step	Input format: decimal			
1 μm	0	65535	μm	1	0	10 <sup>6</sup>	10 <sup>5</sup>	10 <sup>4</sup>
10 μm	0	655350		10	10 <sup>3</sup>	10 <sup>2</sup>	10 <sup>1</sup>	10 <sup>0</sup>
100 μm	0	6553500		100	10 <sup>3</sup>	10 <sup>2</sup>	10 <sup>1</sup>	10 <sup>0</sup>
<b>Numerical example</b>		Input format: decimal			Input format: binary			
<b>12μm</b>		0	0	0	0	0	0	0
		0	0	1	2	0	0	0

Machine data 25 fixes the following error limit for standstill of axis. If the axis leaves the tolerance set from MD 25 during the standstill, error message 10 is read out.

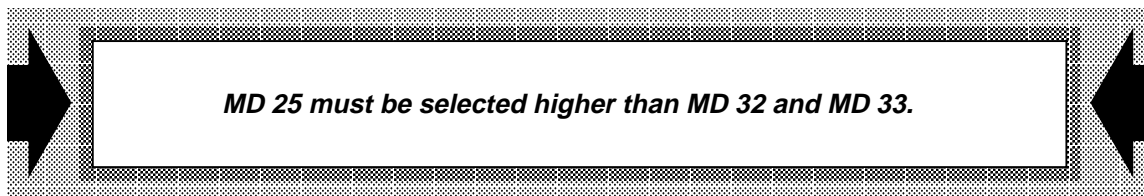

Explanation:

The standstill check is activated when the PEH window (MD33) is reached. If MD33 is greater than MD25, error number 10 appears every time the PEH window is reached.

In the operating sub mode "clamping" error 10 is also signalled when MD25 is smaller than MD32.

Input of MD 25 depends on the actual following error during standstill.  
A general rule should be:

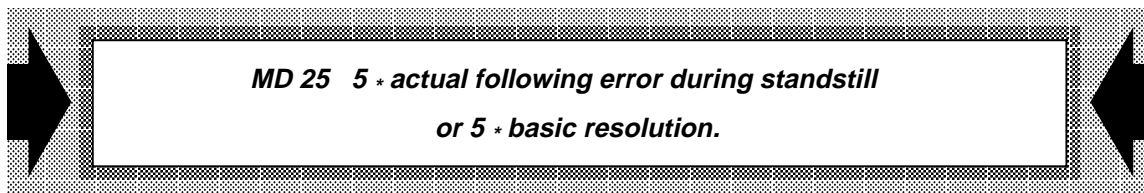

<b>26</b>	<b>Min. following error (dynamic)</b>					<b>26</b>
Minimum following error allowed during traversing						
<b>LR</b> <small>Closed Loop</small>	valid for	I	A <sub>P</sub>	A <sub>SSI</sub>	LR	AK
	WF 725 Type	A/B	B	/	A/B	/
	WF 726 Type	A/B/C	B	C	A/B/C	/
						<b>LR</b> <small>Closed Loop</small>

Resolut.	Lower limit	Upper limit	Unit	Step	Input format: decimal			
1	0	65535	$\mu\text{m}$	1	0	$10^6$	$10^5$	$10^4$
10	0	655350		10	$10^3$	$10^2$	$10^1$	$10^0$
100	0	6553500		100				
<b>Cross reference</b>			<b>MD 24, MD 25</b>					

Numerical example	Input format: decimal				Input format: binary			
<b>4315<math>\mu\text{m}</math></b>	<b>0</b>	<b>0</b>	<b>0</b>	<b>0</b>	<b>0</b>	<b>0</b>	<b>0</b>	<b>0</b>
	<b>4</b>	<b>3</b>	<b>1</b>	<b>5</b>	<b>1</b>	<b>0</b>	<b>D</b>	<b>B</b>

Description: see machine data 24

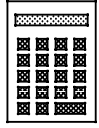
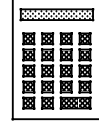
	<b>MD 26 0.1 * S<sub>max</sub></b>	
---	------------------------------------	---

<b>27</b>	<b>Definition of axes with split-drive</b>	<b>27</b>					
Definition: what axes are operated in permanent split-drive							
<b>LR</b> <small>Closed Loop</small>	valid for	I	A <sub>P</sub>	A <sub>SSI</sub>	LR	AK	<b>LR</b> <small>Closed Loop</small>
	WF 725 Type	/	/	/	/	/	
	WF 726 Type	/	<b>B</b>	<b>C</b>	<b>B/C</b>	/	

Numerical value for bit combination X	Input format: decimal			
<b>X=0: no split-drive axes</b>	<b>0</b>	<b>0</b>	<b>0</b>	<b>0</b>
<b>X=3: split-drive axes are A + B</b>	<b>0</b>	<b>0</b>	<b>0</b>	<b>X</b>
<b>X=5: split-drive axes are A + C</b>	<b>0</b>	<b>0</b>	<b>0</b>	<b>X</b>
<b>Cross reference</b>	<b>MD 29</b>			

Numerical example	Input format: decimal				Input format: binary			
<b>3</b>	<b>0</b>	<b>0</b>	<b>0</b>	<b>0</b>	<b>0</b>	<b>0</b>	<b>0</b>	<b>0</b>
	<b>0</b>	<b>0</b>	<b>0</b>	<b>3</b>	<b>0</b>	<b>0</b>	<b>0</b>	<b>3</b>

With MD 27, the axes can be selected which are intended to process synchronously.

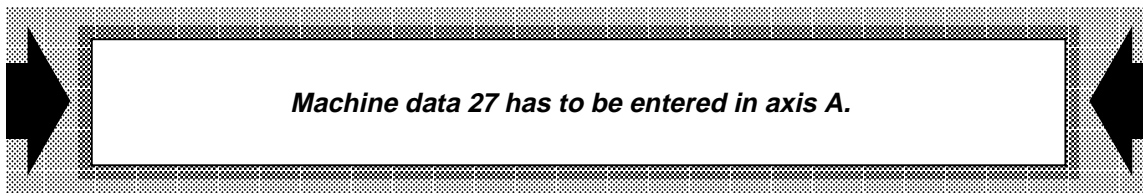

MD 27 has no significance for B+C.

The function "axes with split-drive" is possible in the following operating sub modes:

- Set up
- Manual data input (MDI)
- Single block
- Automatic cycle
- Single step
- Buffer

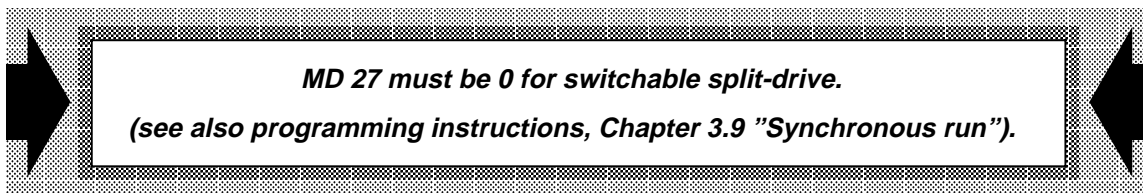

<b>28</b>	<b>Coordinate of actual value</b> Position value to which the actual value register is set in the mode "setting actual value"						<b>28</b>		
<b>I</b> Incremental encoder	valid for	I	A <sub>P</sub>	A <sub>SSI</sub>	LR	AK	<b>I</b> Incremental encoder		
	WF 725 Type	A	/	/	A	A			
	WF 726 Type	A/C	/	/	A/C	A/C			
Resolut.	Lower limit	Upper limit	Unit	Step	Input format: decimal				
1 μm	-79999999	+79999999	μm	1	VZ	10 <sup>7</sup>	10 <sup>6</sup>	10 <sup>5</sup>	10 <sup>4</sup>
10 μm	-79999990	+79999990		10	10 <sup>3</sup>		10 <sup>2</sup>	10 <sup>1</sup>	10 <sup>0</sup>
100 μm	-79999900	+79999900		100			10 <sup>0</sup>		
<b>Cross reference</b>		<b>MD 11, MD 12, MD 13, MD 14</b>							
Numerical example		Input format: decimal				Input format: binary			
<b>1 427 366 μm</b>		<b>0</b>	<b>1</b>	<b>4</b>	<b>2</b>	<b>0</b>	<b>0</b>	<b>1</b>	<b>5</b>
		<b>7</b>	<b>3</b>	<b>6</b>	<b>6</b>	<b>C</b>	<b>7</b>	<b>A</b>	<b>6</b>

Machine data 28 is used for setting the actual value register within the traversing range on the value entered in this machine data. The setting is only possible in the traversing range.

In order to do this, the operating submode "setting actual value" must be set in the traversing mode. With the start signal the machine data is loaded in the actual value register. This causes the synchronized bit in DB axis to be set and the software limit switches to be activated.

If the value is changed after the synchronization and the actual value is set again then the new value will be loaded.

<b>29</b>	<b>Tolerance of split-drive (coupled axes)</b>						<b>29</b>	
<b>Permitted difference of the actual values</b>								
<b>LR</b> <small>Closed Loop</small>	valid for	I	A <sub>P</sub>	A <sub>SSI</sub>	LR	AK	<b>LR</b> <small>Closed Loop</small>	
	WF 725 Type	/	/	/	/	/		
	WF 726 Type	A/B/C	B	C	A/B/C	/		
Resolut.	Lower limit	Upper limit	Unit	Step	Input format: decimal			
1 μm	0	65 535	μm	1	0	10 <sup>6</sup>	10 <sup>5</sup>	10 <sup>4</sup>
10 μm	0	655 350		10	10 <sup>3</sup>	10 <sup>2</sup>	10 <sup>1</sup>	10 <sup>0</sup>
100 μm	0	6 553 500		100	/	/	/	/
<b>Cross reference</b>		<b>MD 27</b>						
Numerical example		Input format: decimal			Input format: binary			
<b>32 μm</b>		0	0	0	0	0	0	0
		0	0	3	2	0	0	2

During traversing the actual values of the split-drive axes are constantly compared with each other. This applies for permanent split-drive as well as for switchable split-drive. Monitoring is also active with a programmed shift of synchronized axes (data coding 31).

If the difference is greater than entered in MD 29, the movement is terminated with error 25.

MD 29 has no significance for axes B+C.

With data coding 30<sub>Hex</sub>, the split-drive error can be read out.

***MD 29 must be entered in axis A.***

***Monitoring of split-drive axes synchronization must be selected with a bit***  
***(see programming instructions, chapter 3.9).***

$$MD\ 29 = 1.5 \cdot GL\text{-Error}_{max.}$$

<b>30</b>	<b>PEH timeout</b>						<b>30</b>		
Permitted time from reaching command position and traversing the following error until tolerance window PEH has been reached									
	valid for	I	A	SSI	LR	AK			
	WF 725 Type	A/B	B	/	A/B	A/B			
	WF 726 Type	A/B/C	B	C	A/B/C	A/B/C			
Resolut.	Lower limit	Upper limit	Unit	Step	Input format: decimal				
-	0	9999	ms	1	0	0	0	0	
					$10^3$	$10^2$	$10^1$	$10^0$	
<b>Cross reference</b>		<b>MD 33</b>							
Numerical example		Input format: decimal				Input format: binary			
<b>150 ms</b>		0	0	0	0	0	0	0	0
		0	1	5	0	0	0	9	6

Machine data 30 specifies a monitor time after which the WF signals a positioning error. The monitor time is started when the calculated command position (digital zero) has been reached.

*Depending on speed and mass inertia, a guide value of MD 30 = 500 bis 2000 ms can be calculated.*

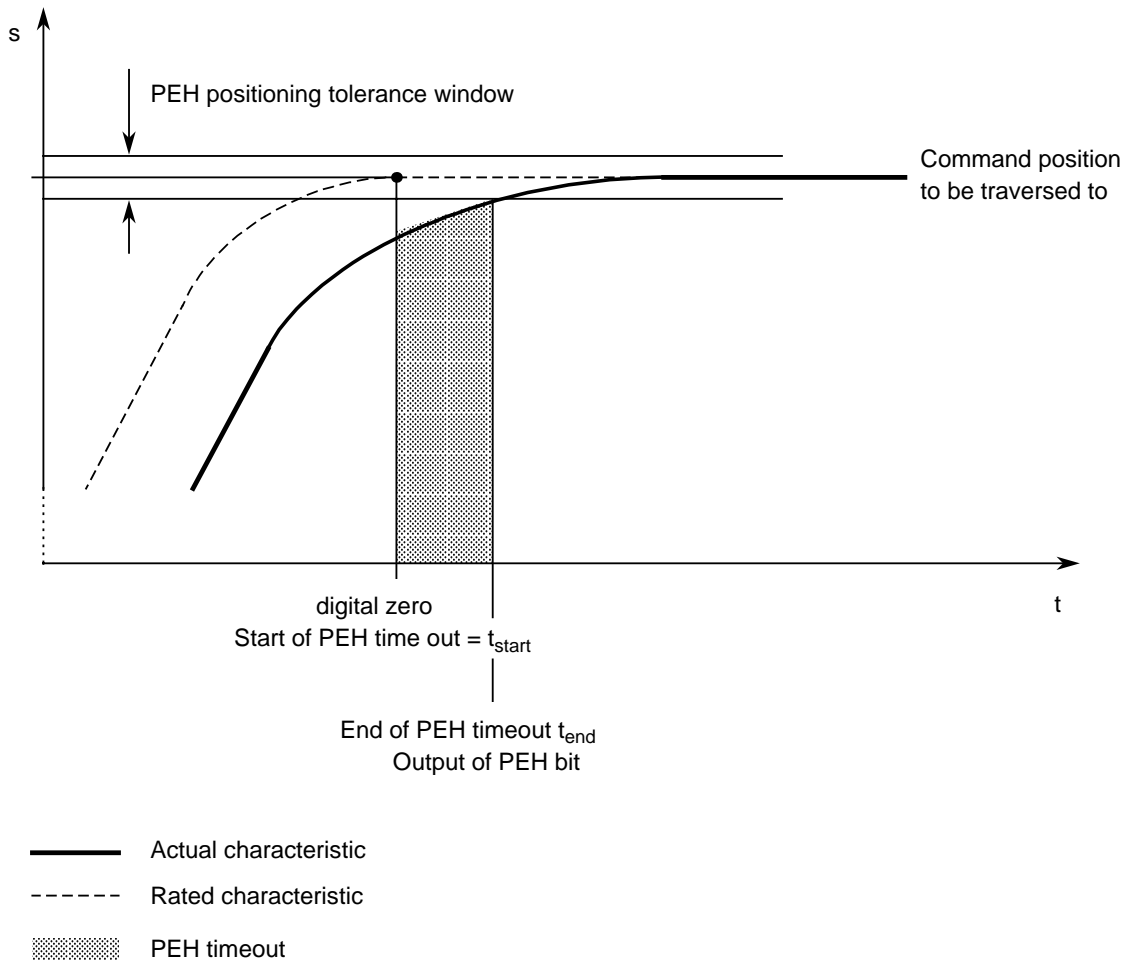

If the actual position does not reach the tolerance window before the end of the monitoring time ( $t_{end} - t_{start} > MD\ 30$ ), an error message is read out. If, on the other hand, the window is reached in time ( $t_{end} - t_{start} < MD\ 30$ ) then the time is stopped and no error is signalled. If this error appears in an installation then there could be some mechanical changes in it (mechanical resistance or defective drive unit).



<b>31</b>		<b>Backlash compensation</b> Backlash compensation when reversing direction of movement					<b>31</b>		
<b>I</b> Incremental encoder	valid for	I	A <sub>P</sub>	A <sub>SSI</sub>	LR	AK	<b>I</b> Incremental encoder		
	WF 725 Type	A/B	/	/	A/B	A/B			
	WF 726 Type	A/B/C	/	/	A/B/C	A/B/C			
Resolut.	Lower limit	Upper limit	Unit	Step	Input format: decimal				
1 μm	0	65535	μm	1	0	10 <sup>6</sup>	10 <sup>5</sup>	10 <sup>4</sup>	
10 μm	0	655350		10	10 <sup>3</sup>	10 <sup>2</sup>	10 <sup>1</sup>	10 <sup>0</sup>	
100 μm	0	6553500		100					
<b>Cross reference</b>		<b>MD 4</b>							
Numerical example		Input format: decimal				Input format: binary			
<b>41 μm</b>		0	0	0	0	0	0	0	0
		0	0	4	1	0	0	2	9

Machine data 31 is used to compensate mechanical backlash. When the measuring system is attached to the drive motor (rotary encoder) then a positioning error occurs at the table each time the movement changes direction. Since viewed from the measuring system, the axis is positioned accurately but the table stopped before the position by the distance of the backlash. This error can be compensated with MD 31. The WF module takes the value in MD 31 and adds it to the programmed position each time the axis reverses direction, thereby compensating the backlash.

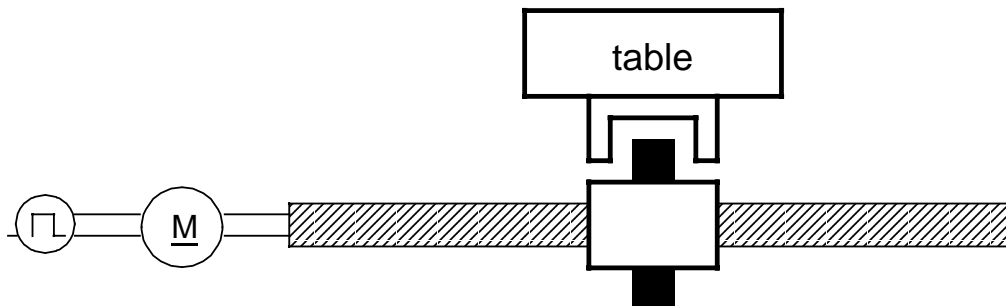

The axis moves too far if the entered value is greater than the backlash. Therefore it is necessary to measure the mechanical backlash as accurately as possible.

The backlash can be measured as follows:

In the operating sub mode "set up", the axis is moved in the negative direction for a distance greater than the backlash. Then a gauge is attached to the axis. The actual value is set to zero with the sub mode "setting actual value". In the MDI sub mode,  $+1\mu\text{m}$  (G91) is entered. With every start signal, the axis moves  $+1\mu\text{m}$ . The start is given until the gauge registers a movement. Then the backlash is equal to the actual value of the axis.

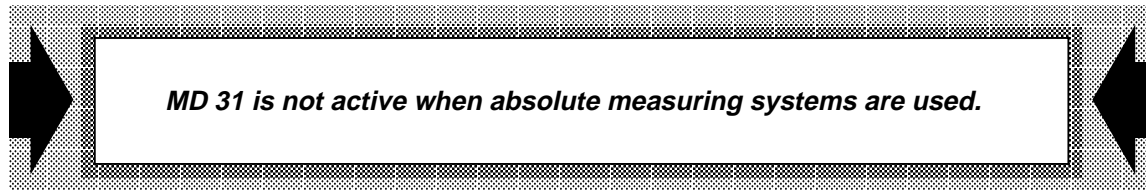

<b>32</b>	<b>Clamping tolerance</b>						<b>32</b>	
Check of the actual position during mechanical clamping								
	valid for	I	A <sub>P</sub>	A <sub>SSI</sub>	LR	AK		
	WF 725 Type	A/B	B	/	A/B	A/B		
	WF 726 Type	A/B/C	B	C	A/B/C	A/B/C		
Resolut.	Lower limit	Upper limit	Unit	Step	Input format: decimal			
1 μm	0	65535	μm	1	0	10 <sup>6</sup>	10 <sup>5</sup>	10 <sup>4</sup>
10 μm	0	655350		10	10 <sup>3</sup>	10 <sup>2</sup>	10 <sup>1</sup>	10 <sup>0</sup>
100 μm	0	6553500		100				
<b>Cross reference</b>						<b>MD 25</b>		
Numerical example		Input format: decimal			Input format: binary			
<b>42μm</b>		0	0	0	0	0	0	0
		0	0	4	2	0	0	2

In some applications the axis has to be clamped mechanically since the forces on the axis are too great for a motor operated in the closed loop. The drive unit is disabled in order to avoid the motor to work against the clamping and overheats.

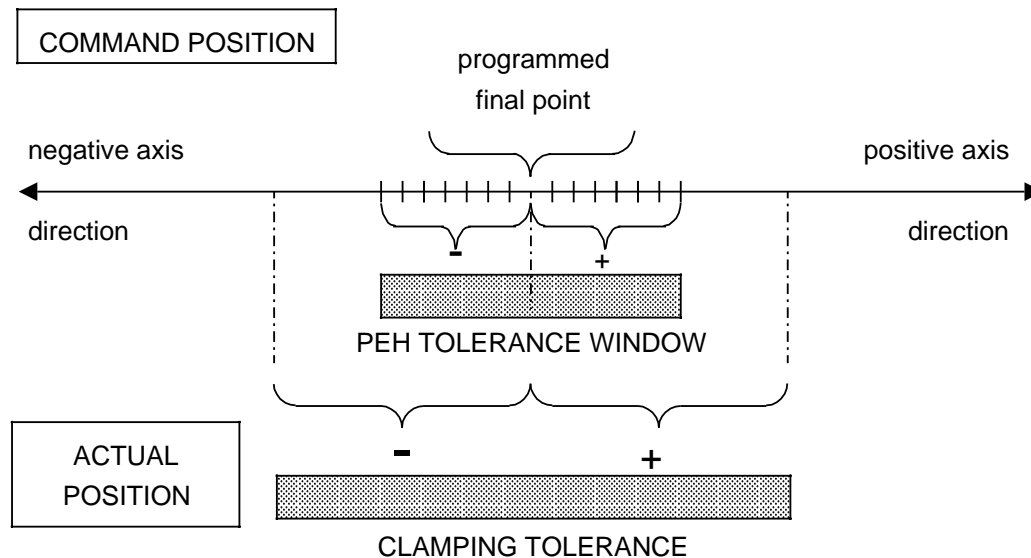

The WF now supplies the operating sub mode "clamping" whereby no command value is read out but only the actual position is monitored. If the forces are so great that the axis is pushed out of clamping tolerance then the WF reads out an error message.

<b>33</b>	<b>PEH positioning tolerance</b> Tolerance window (+/-) for the control of the PEH bits, and condition for positioning (standstill)					<b>33</b>
	valid for	I	A <sub>P</sub>	A <sub>SSI</sub>	LR	AK
	WF 725 Type	A/B	B	/	A/B	A/B
	WF 726 Type	A/B/C	B	C	A/B/C	A/B/C

Resolut.	Lower limit	Upper limit	Unit	Step	Input format: decimal			
1	0	65535	μm	1	0	10 <sup>6</sup>	10 <sup>5</sup>	10 <sup>4</sup>
10	0	655350		10				
100	0	6553500		100	10 <sup>3</sup>	10 <sup>2</sup>	10 <sup>1</sup>	10 <sup>0</sup>

  

<b>Cross reference</b>	<b>MD 25, MD 30</b>
------------------------	---------------------

Numerical example	Input format: decimal				Input format: binary			
<b>11μm</b>	0	0	0	0	0	0	0	0
	0	0	1	1	0	0	0	B

The desired high quality of CNC machines depends on many factors, one of them is accurate positioning.

	<p>MD 33 = 3 * actual following error during standstill</p>	
---	---	---

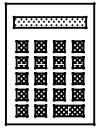
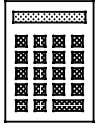

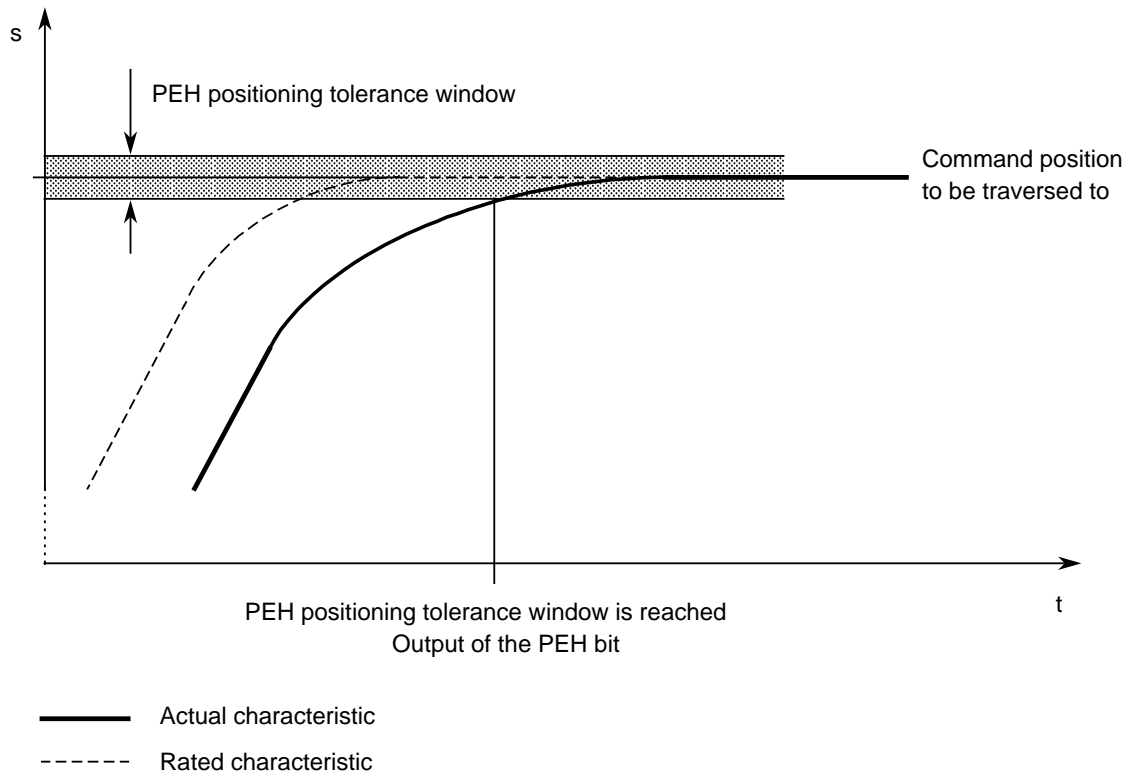
Note:

The value entered here is directly related to the maximum following error during standstill and therefore, a smaller value must be entered to avoid error message 10.

The PEH bit tells the user if a positioning has ended, and it normally serves as a condition for switching to following functions. With MD 33, the output accuracy of the PEH bit can be influenced.

When is PEH read out?

Reference point traversing:	With synchronization of the measuring system.
Manual input sub mode:	When the position value is reached ( $\pm$ tolerance MD 33).
Single block sub-mode:	After complete processing of the block, including output and acknowledgement of M functions.
Automatic sub-mode:	At the end of the program when no continuous loop is programmed. At the end of the block, if M00 is programmed or if the read-in enable is missing.

Generally, the following can be said:

PEH is always read out when a function has been ended or if there is a stop at block limits which needs a new reaction by the user (start, EFG) to continue the program.

Of course, the closed loop is also active in the PEH window and tries to decrease the following error to 0. A positioning accuracy in the size of MD 33 is generated by a flying change of blocks and reversing of direction of the axis as it will be traversed in the opposite direction when the PEH window is reached.

<b>34</b>	<b>Number of pulses / encoder revol.</b> Number of lines per encoder revolution for the encoder check						<b>34</b>			
<b>I</b> Incremental encoder	valid for	I	A <sub>P</sub>	A <sub>SSI</sub>	LR	AK	<b>I</b> Incremental encoder			
	WF 725 Type	A/B			A/B	A/B				
	WF 726 Type	A/B/C			A/B/C	A/B/C				
Resolut.	Lower limit	Upper limit	Unit	Step	Input format: decimal					
-	100	79999999	-	1	$10^7$	$10^6$	$10^5$	$10^4$		
					$10^3$	$10^2$	$10^1$	$10^0$		
<b>Cross reference</b>										
Numerical example			Input format: decimal				Input format: binary			
<b>10 000</b>			<b>0</b>	<b>0</b>	<b>0</b>	<b>1</b>	<b>0</b>	<b>0</b>	<b>0</b>	<b>0</b>
			<b>0</b>	<b>0</b>	<b>0</b>	<b>0</b>	<b>2</b>	<b>7</b>	<b>1</b>	<b>0</b>

This machine data contains the number of pulses per encoder revolution if incremental encoders are used. It is used for several functions in the WF 725/WF 726:

1. When traversing the reference point, the WF checks if the zero mark arrives within one encoder revolution after leaving the cam, otherwise it will signal error 9.
2. The WF 725/WF 726 has a pulse monitor which counts the encoder pulses from one zero mark to another, and compares it with MD 34 (data code 4). Extra or missing pulses are added to a register and if a certain limit is reached the axis will be stopped with error message 8.
3. It is possible to read out the encoder revolutions per minute directly (data code 3). For this calculation, MD 34 is used.  
The rotational speed is read out with data code 3<sub>Hex</sub>.

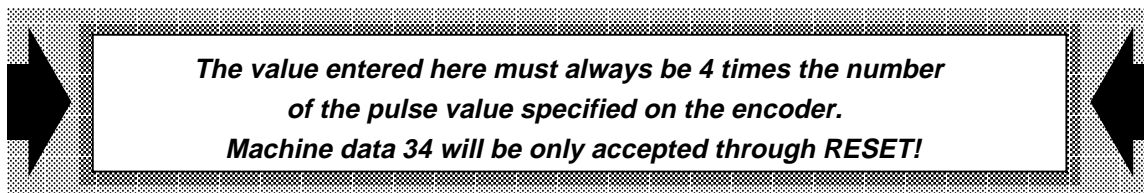

<b>34</b>	<b>Travel difference monitor</b> Travel difference which can be traversed in 20 ms without producing an error						<b>34</b>		
<b>A</b> <small>Absolute encoder</small>	valid for	I	A <sub>P</sub>	A <sub>SSI</sub>	LR	AK	<b>A</b> <small>Absolute encoder</small>		
	WF 725 Type	/	B	/	B	B			
	WF 726 Type	/	B	C	B/C	B/C			
Resolut.	Lower limit	Upper limit	Unit	Step	Input format: decimal				
-	0	79999999	-	1	$10^7$	$10^6$	$10^5$	$10^4$	
					$10^3$	$10^2$	$10^1$	$10^0$	
<b>Cross reference</b>						<b>MD 4</b>			
Numerical example		Input format: decimal				Input format: binary			
<b>1000</b>		<b>0</b>	<b>0</b>	<b>0</b>	<b>0</b>	<b>0</b>	<b>0</b>	<b>0</b>	<b>0</b>
		<b>1</b>	<b>0</b>	<b>0</b>	<b>0</b>	<b>0</b>	<b>3</b>	<b>E</b>	<b>8</b>

When absolute encoders are used for control in MD 4, MD 34 serves as the Travel-difference monitor.

Since the used absolute encoders have a parallel interface and the position is read out in a short time, it is possible that wrong pulses cause a drastic change in the position.

When the position is read out while a signal is high instead of low due to a fault, it can cause a big falsification of the actual position value.

The WF dynamically compares the received actual values per reading cycle with MD 34. If the actual value has become greater about 1 amount than MD 34 since the last measuring, then the wrong actual value will be ignored and another value will be formed which corresponds to the speed. Only if 5 successive cycles produce an acceptable actual value, will positioning be stopped with error 33.

***The minimal input value must not fall below the value for the maximum traversing distance in 5 cycle times, otherwise error 33 is signalled.***

***Machine data 34 is only accepted through RESET!***

## Formula for calculating MD 34 (A)

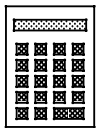
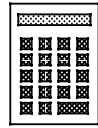
$$MD\ 34(A) > \frac{5 \cdot t_z [ms] \cdot v_{max} \left[ \frac{mm}{min} \right]}{60 \cdot MD\ 19,20 \cdot A [\mu m]} \left[ \frac{1}{5 \cdot t_z} \right]$$

$v_{max}$ : MD 3  
 $t_z$ : WF cycle time  
A: Resolution in [ $\mu m$ ]

### Example for the WF 725B:

z.B. MD 3 = 10 000 mm/min  
MD 19, 20 = 2.5  
A = 10  $\mu m$

$$MD\ 34\ (A) > \frac{5 \cdot 4 \cdot 10000}{60 \cdot 2.5 \cdot 10} = 133 \text{ steps in 5 WF 725 cycles}$$

If the result is bigger than the number of steps per revolution, there might be problems when switching from one disk to another. This should be taken into account when the encoder is specified.

The cycle times of the WF module are:

WF 725 : 4ms  
WF 726 : 6ms (without jerk limit)  
WF 726 : 8ms (with jerk limit)



<b>35</b>		<b>Drift compensation</b> Compensation of the drift of the drive unit					<b>35</b>		
<b>LR</b> Closed Loop	valid for	I	A <sub>P</sub>	A <sub>SSI</sub>	LR	AK	<b>LR</b> Closed Loop		
	WF 725 Type	A/B	B	/	A/B	/			
	WF 726 Type	A/B/C	B	C	A/B/C	/			
Resolut.	Lower limit	Upper limit	Unit	Step	Input format: decimal				
1	-255	+255	μm	1	VZ	0	0	0	10 <sup>4</sup>
10	-2550	+2550		10	10 <sup>3</sup>		10 <sup>2</sup>	10 <sup>1</sup>	10 <sup>0</sup>
100	-25500	+25500		100					
<b>Cross reference</b>					<b>MD 25</b>				
Numerical example		Input format: decimal			Input format: binary				
<b>47μm</b>		0	0	0	0	0	0	0	
		0	0	4	7	0	0	2	F

With machine data 35 it is possible to compensate a drift in the closed loop system.

First the drive unit of the installation is commissioned. This includes a drift adjustment on the drive unit. When the position control loop is connected it might cause the drive to drift once again, since the ground connections are changed slightly.

This drift can be compensated with MD 35. For this, the following error of the axis must be read out during standstill. This value must then be entered in MD 35 with the sign inverted. If the s is read out again it must be about "0". Input is limited to +/- 255, at 1 μm resolution, so that the drive fault is not masked.

To change the drift during operation, due to from thermal influences for example, a drift compensation can also be carried out with data code 10 in the sub mode "RUN" (see also programming instructions part 3, chapter 3).

MD 35 = - following error during standstill

<b>36</b>		<b>Acceleration correction</b> Input of an overshoot for the command value, to reach the programmed feed rate faster					<b>36</b>		
<b>LR</b> Closed Loop	valid for	I	A <sub>P</sub>	A <sub>SSI</sub>	LR	AK	<b>LR</b> Closed Loop		
	WF 725 Type	A/B	B	/	A/B	/			
	WF 726 Type	A/B/C	B	C	A/B/C				
Resolut.	Lower limit	Upper limit	Unit	Step	Input format: decimal				
Dez.	32769	32783			0	0	0	10 <sup>4</sup>	
Dual	8001	800F	-	1	10 <sup>3</sup>	10 <sup>2</sup>	10 <sup>1</sup>	10 <sup>0</sup>	
inactive	0	0							
<b>Cross reference</b>		<b>MD 1, MD 2</b>							
Numerical example		Input format: decimal			Input format: binary				
<b>32775</b>		<b>0</b>	<b>0</b>	<b>0</b>	<b>3</b>	<b>0</b>	<b>0</b>	<b>0</b>	<b>0</b>
		<b>2</b>	<b>7</b>	<b>7</b>	<b>5</b>	<b>8</b>	<b>0</b>	<b>0</b>	<b>7</b>

With machine data 36, the acceleration can be additionally influenced.

Normally the acceleration of the command value continues until the programmed feed rate has been reached. Since the actual feed always lags behind the command value it reaches the programmed feed rate later.

With MD36 the command value can be set to overshoot the programmed feed rate, and therefore the actual feed rate will reach the programmed feed rate faster.

The acceleration continues until it has overshoot the programmed feed rate by a given range.

This range is called the acceleration band. So the number of steps and therefore the width of the band is entered.

		decimal:	binary:
band width	1 Step	32769	8001
	2 Steps	32770	8002
	3 Steps	32771	8003
	:	:	:
	:	:	:
	15 Steps	32783	800F

Example:

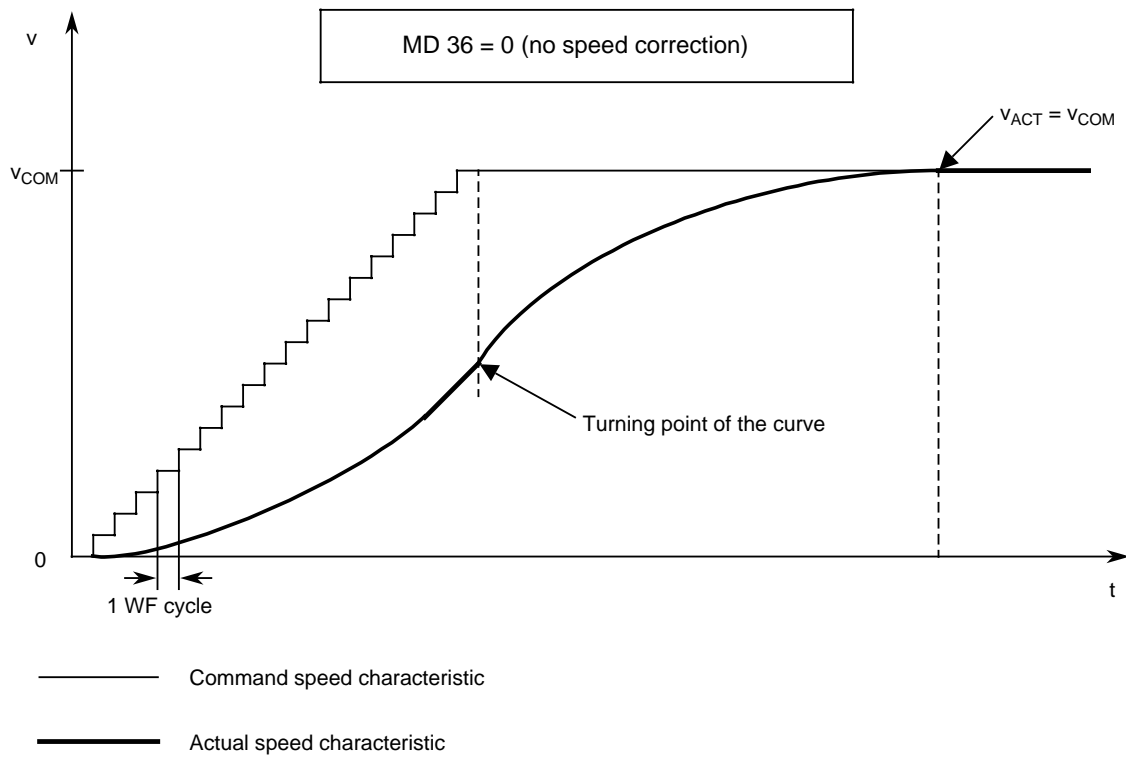
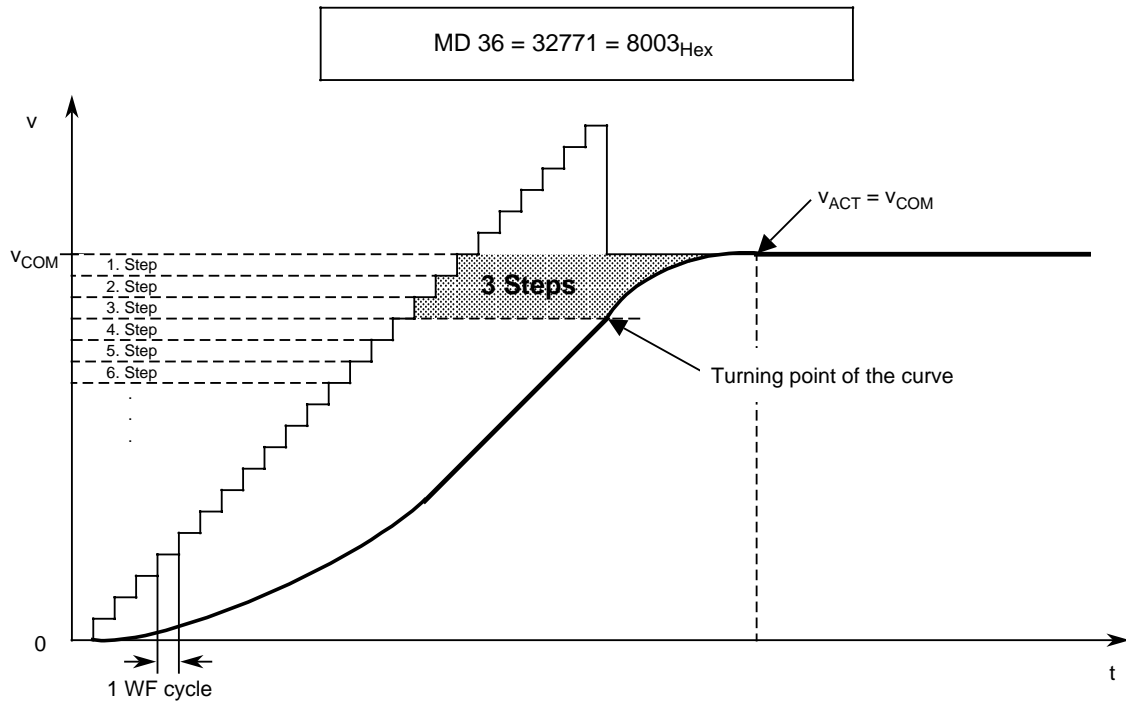

The smaller the value entered in MD 36 (XXXX), the longer the correction is active (the axis might overshoot).

<b>37</b>	<b>Length of cable / baud rate</b> Setting the cable length / baud rate						<b>37</b>	
<b>Assi</b> serial absolute encoder	valid for	I	A <sub>P</sub>	A <sub>SSI</sub>	LR	AK	<b>Assi</b> serial absolute encoder	
	WF 725 Type	/	/	/	/	/		
	WF 726 Type	/	/	C	C	C		
Value of bit combination X				Input format: decimal				
<b>X = 0</b> 50 m < cable length < 120 m => baud rate = 125kbit/s  <b>X = 1</b> 1 cable length < 50 m => baud rate = 1Mbit/s				0	0	0	0	
				0	0	0	X	
<b>Cross reference</b>			<b>MD 4</b>					
Numerical example	Input format: decimal				Input format: binary			
<b>1</b>	0	0	0	0	0	0	0	
	0	0	0	1	0	0	1	

For cable lengths of up to 50 m, data can be transferred with a rate of 1Mbit/s.

For cable lengths of more than 50 m, data can only be transferred with a rate of 125Kbit/s.

Even with the small speed of 125Kbit/s, the actual value of the WF is supplied with sufficient speed.

<b>38</b>		<b>Jerk limit for acceleration</b> Increase of acceleration or deceleration during traversing					<b>38</b>		
<b>LR</b> Closed Loop	valid for	I	A <sub>p</sub>	A <sub>SSI</sub>	LR	AK	<b>LR</b> Closed Loop		
	WF 725 Type	/	/	/	/	/			
	WF 726 Type	A/B/C	B	C	A/B/C	/			
Resolut.	Lower limit	Upper limit	Unit	Step	Input format: decimal				
1	0	1950	mm/s	1	0	0	10 <sup>5</sup>	10 <sup>4</sup>	
10	0	19500		10	10 <sup>3</sup>	10 <sup>2</sup>	10 <sup>1</sup>	10 <sup>0</sup>	
100	0	195000	3	100					
<b>Cross reference</b>		<b>MD 1, MD 2, MD 39</b>							
Numerical example		Input format: decimal				Input format: binary			
<b>2430 mm/s<sup>3</sup></b>		0	0	0	0	0	0	0	0
		2	4	3	0	0	9	7	E

The WF 725 moves the axis depending on the path p, the feed rate f and the acceleration a. This kind of movement is sufficient for most applications.

However, there are certain positioning applications for which a soft start is required. A constant acceleration is not advisable in these cases.

With the WF 726, by using MD38 and MD39 it is possible to enter the acceleration value and deceleration as a ramp.

The value of MD38 and MD39 determines the slope of the ramp.

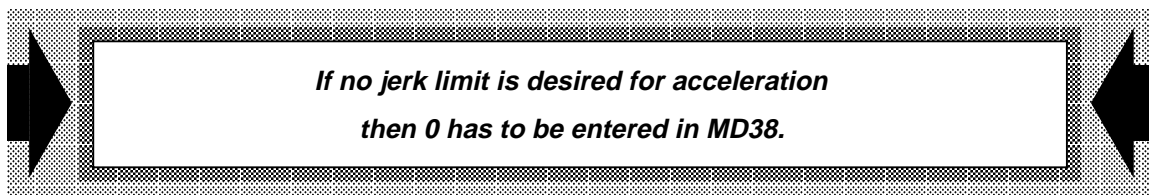

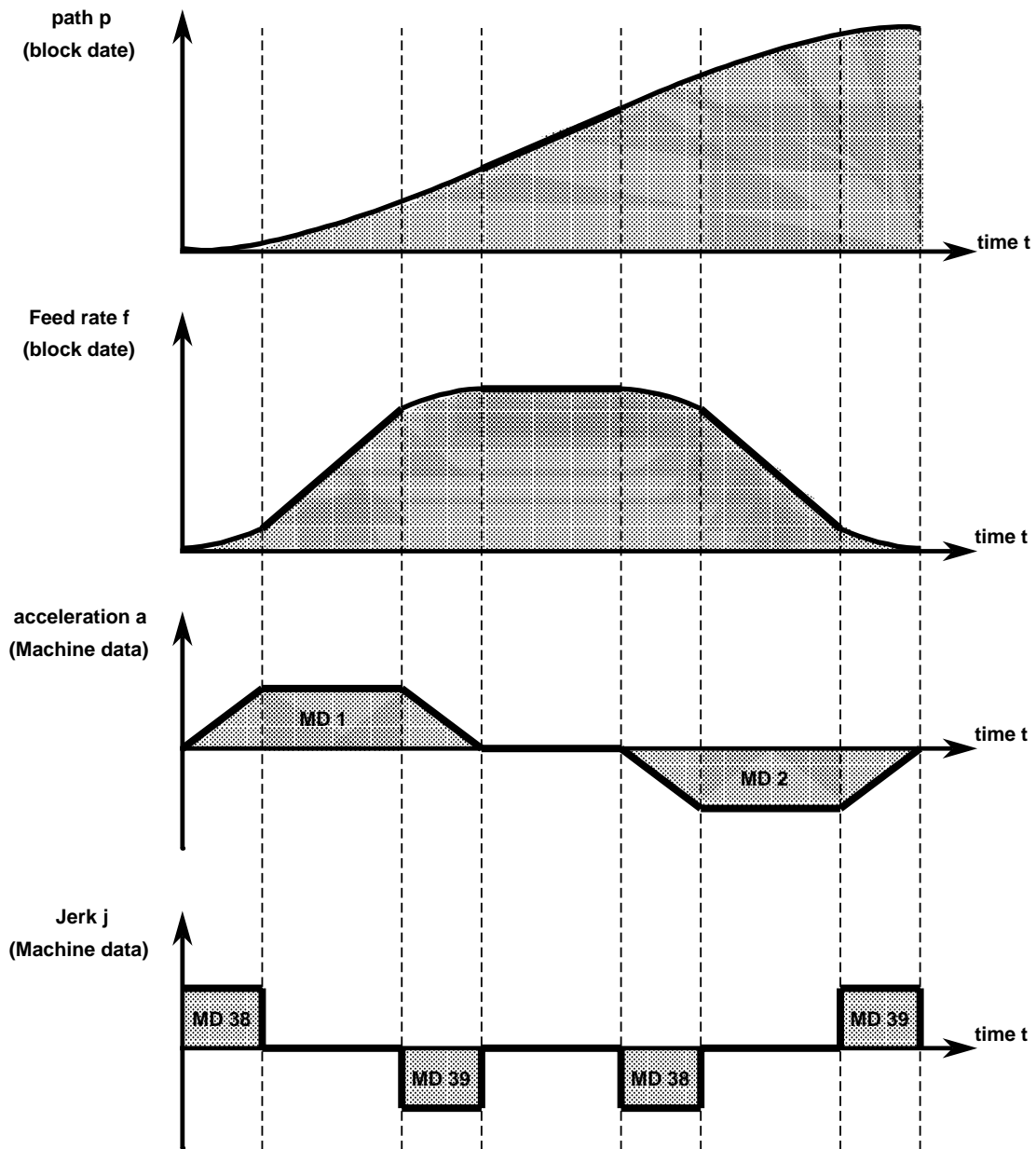

$$r = \frac{a}{t} \left[ \frac{\text{mm}}{\text{s}^3} \right]$$

<b>39</b>		<b>Jerk limit for deceleration</b>					<b>39</b>	
		Decrease of acceleration or deceleration during traversing						
<b>LR</b> Closed Loop	valid for	I	A <sub>P</sub>	A <sub>SSI</sub>	LR	AK		
	WF 725 Type	/	/	/	/	/		
	WF 726 Type	A/B/C	B	C	A/B/C	/		
<b>LR</b> Closed Loop								
	Resolut.	Lower limit	Upper limit	Unit	Step	Input format: decimal		
	1	0	1950	mm/s	1	0	0	10 <sup>5</sup>
10	0	19500	10		10 <sup>3</sup>	10 <sup>2</sup>	10 <sup>1</sup>	10 <sup>0</sup>
100	0	195000	3	100				
<b>Cross reference</b>			<b>MD 1, MD 2, MD 38</b>					
Numerical example		Input format: decimal			Input format: binary			
<b>2430 mm/s<sup>3</sup></b>		<b>0</b>	<b>0</b>	<b>0</b>	<b>0</b>	<b>0</b>	<b>0</b>	<b>0</b>
		<b>2</b>	<b>4</b>	<b>3</b>	<b>0</b>	<b>0</b>	<b>9</b>	<b>7</b>

***MD39 has to be set to zero for deceleration  
if no jerk limit is desired.***

See MD 38 for description.

<b>40</b>	<b>Simulation</b> Simulation of traversing programs without drive and without encoders						<b>40</b>		
	valid for	I	A <sub>P</sub>	A <sub>SSI</sub>	LR	AK			
	WF 725 Type	A/B	B	/	A/B	A/B			
	WF 726 Type	A/B/C	B	C	A/B/C	A/B/C			
Numerical number for 4 bit combination X				Input format: decimal					
X=0: no simulation				0	0	0	0		
X=1: simulation				0	0	0	X		
<b>Cross reference</b>									
Numerical example		Input format: decimal				Input format: binary			
<b>1</b>		0	0	0	0	0	0	0	0
		0	0	0	1	0	0	0	1

The WF module can also be operated without motor and encoder in the mode simulation. In this mode it is possible to test programs by simulating traversing in all operating submodes.

#### Closed loop:

The actual position is always made equal to the command position ( s = 0). The DAC is supplied with the current feed rate which is constantly updated. This feed rate is converted into an analogue voltage. The axis can therefore be moved without the following error check and in open loop. The checks for cable break and zero mark of the encoder are not active.

$$\text{Output voltage: } U_{com} = \frac{5 \text{ mV}}{15} * \frac{V_{prog}}{A} \left[ \frac{\text{mm}}{\text{min}} \right] \quad A = \text{Resolution in } [\mu\text{m}]$$

#### Open loop version:

The missing encoder pulses are incremented each cycle by the value of the speed  $G_{prog}$  erhöht.

$$\text{Output voltage: } U_{soll} = V_{prog} * 100\text{mV}$$

**A hardware reset or a power up (BASP/CPKL) of the module is required if the simulation is deactivated. (common interrupt controller for all axis).**



<b>41</b>	<b>Masking of check routines</b> Masking of certain encoder check routines						<b>41</b>			
	valid for	I	A <sub>P</sub>	A <sub>SSI</sub>	LR	AK				
	WF 725 Type	A/B	B	/	A/B	A/B				
	WF 726 Type	A/B/C	B	C	A/B/C	A/B/C				
K	S	U	J	N	Input format: decimal					
1	2	4	65536	131072	0	0	10 <sup>5</sup>	10 <sup>4</sup>		
					10 <sup>3</sup>	10 <sup>2</sup>	10 <sup>1</sup>	10 <sup>0</sup>		
<b>Cross reference</b>					<b>MD 4</b>					
Numerical example		Input format: decimal			Input format: binary					
<b>S</b>	=	<b>2</b>	<b>0</b>	<b>0</b>	<b>0</b>	<b>6</b>	<b>0</b>	<b>0</b>	<b>0</b>	<b>1</b>
<b>J</b>	=	<b>65536</b>	<b>5</b>	<b>5</b>	<b>3</b>	<b>8</b>	<b>0</b>	<b>0</b>	<b>0</b>	<b>2</b>
<b>S+J</b>	=	<b>65538</b>								

Possibilities of Input: N, J, S, K, U = 0: Enable (Monitoring active)  
N, J, S, K, U = 1: Monitoring masked (not active)

**K = Cable break check**

This monitoring controls the encoder cable. With incremental encoders the channels are checked with an exclusive-or comparison. Absolute encoders are checked by a voltage sensor.

**S = Voltage check (enter only in axis A)**

The µP 80186 checks all voltages (+5V, +24V, +/-15V). Furthermore all command values are reconverted into digital signals by an ADC and checked.

**U = Disabling of the multiple evaluation of actual value with absolute encoders**

For the cyclical read in of the absolute encoder, a different timing of the channels can lead to wrong values. Therefore the position is read out twice and compared. This repeated reading has to be disabled when GRAY-CODE encoders are used.

**J = Pulse check (only WF 726)**

With every zero mark the pulses are counted and compared with MD 34. Faulty pulses are added to each other. If they exceed a limit the axis is stopped with an error number.

**N = Zero mark check**

In the operating submode "reference point approach" the WF module counts the encoder pulses after the cam has been left. If the zero mark has not been detected after the number of pulses specified in MD34, it is stopped with error number 9.

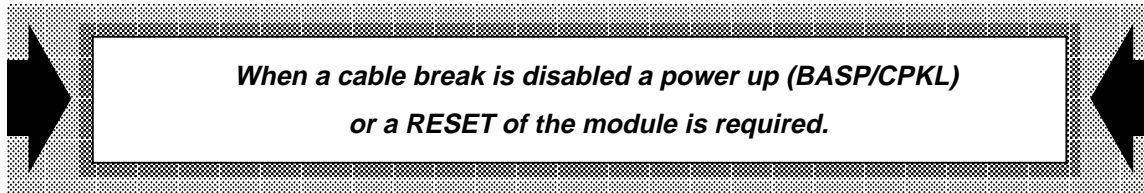

<b>42</b>	<b>Roller feed</b> Specification of the roller feed version of positioning						<b>42</b>
<b>LR</b> <small>Closed Loop</small>	valid for	I	A <sub>P</sub>	A <sub>SSI</sub>	LR	AK	<b>LR</b> <small>Closed Loop</small>
	WF 725 Type	A/B	/	/	A/B	/	
	WF 726 Type	A/B/C	/	/	A/B/C	/	

Numerical value for bit combination X				Input format: decimal			
<b>X=0: no roller feed</b>  <b>X=1: roller feed</b>				0	0	0	0
				0	0	0	X
<b>Cross reference</b>				<b>MD 4</b>			

Numerical example	Input format: decimal				Input format: binary			
<b>1</b>	0	0	0	0	0	0	0	0
	0	0	0	1	0	0	0	1

***The roller feed version is only possible for closed loop with incremental encoders (MD4 = 1). Only incremental positioning is allowed (G91). No reference approach is possible.***

The WF 725/WF 726 module offers the possibility of operating an axis as a roller feed. The selection is made with machine data 42 (LR).

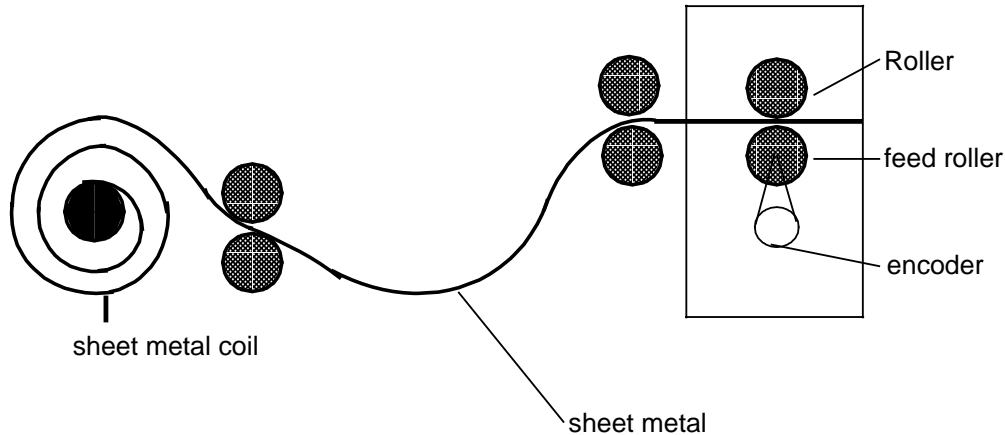

Roller feeds are used where bands of material have to be transported. Other requirements are needed for the positioning system than for a regular axis.

In normal positioning systems the axis moves in both directions within a defined traversing range. This is not the case with roller feeds. There, the material is only transported in one direction. Therefore, the actual value register is erased and loaded with zero for every start. The movement is not executed with a rigid coupling (for example: ball screw) but by friction of the feed roller. In most cases, the feed rates are extremely high, speeds of 200m/min are not uncommon.

<b>42</b>		<b>Speed reduction 1</b> Speed, if distance between programmed point and actual position is less than MD45					<b>42</b>		
<b>AK</b> Open loop	valid for	I	A <sub>P</sub>	A <sub>SSI</sub>	LR	AK			
	WF 725 Type	A/B	B			A/B			
	WF 726 Type	A/B/C	B	C		A/B/C			
Open loop		AK		Open loop		AK			
Resolut.	Lower limit	Upper limit	Unit	Step	Input format: decimal				
-	MD 43	99	-	1	0	0	0	0	
					0	0	10 <sup>1</sup>	10 <sup>0</sup>	
<b>Cross reference</b>		<b>MD 2, MD 43, MD 44, MD 45, MD 46, MD 47, MD 48</b>							
Numerical example		Input format: decimal				Input format: binary			
<b>87</b>		0	0	0	0	0	0	0	0
		0	0	8	7	0	0	5	7

This machine data is used only when the open loop version has been selected in MD4. The reduction speeds are entered in MD42-44, and the path differences are specified in MD45-48. The traversing speed is reduced at a certain distance to the programmed point, as shown in the following diagram:

With the open loop version, the command value can be read out with two different methods.

a) as analogue command value over connector X3

$$V_{com} = G_{step} * 100 \text{ [mV]}$$

b) as BCD-coded value [0...99] in DL4 from the DB axis

### Command value characteristic

#### 1. Open loop WF 725 or WF 726 with MD 1/2 = 0

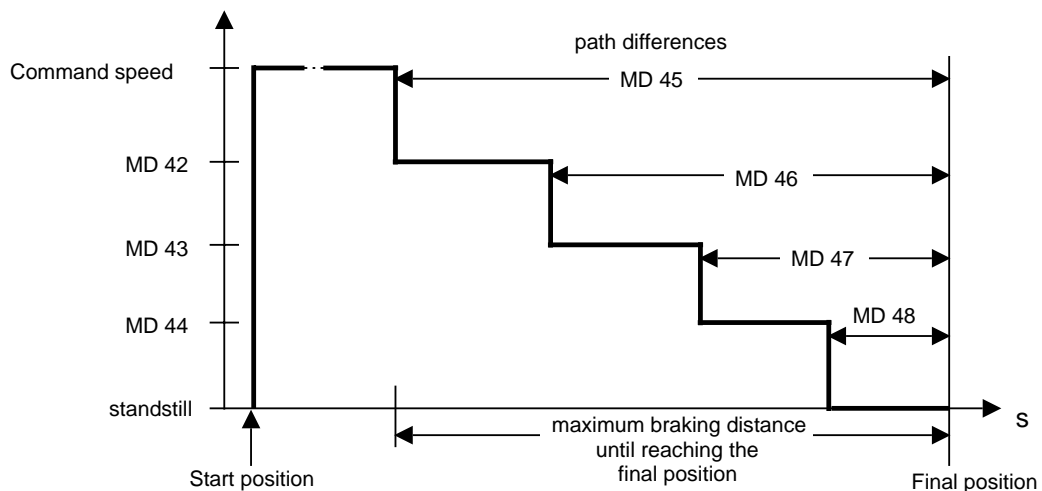

## 2. Open loop WF 726 with MD 1/2 0

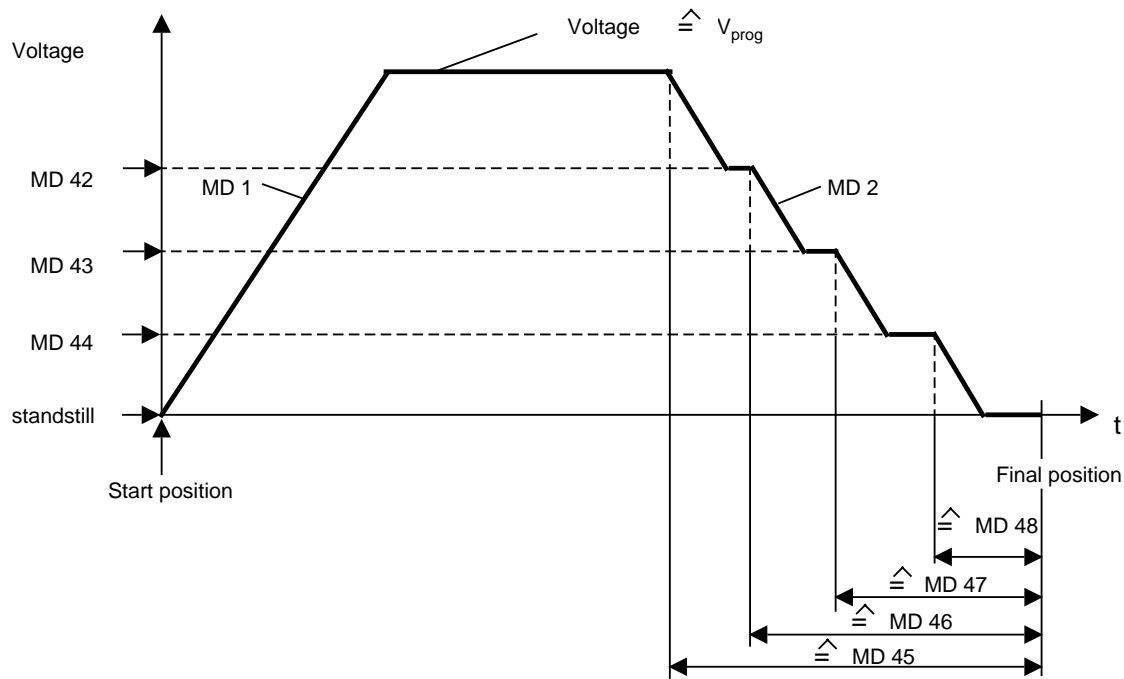

The diagram shows that MD 42 and MD 45, MD 43 and MD 46 and MD 44 and MD 47 belong together. Zero speed has been assigned for MD 48, therefore no speed value must be entered.

The speed values are read out in DW 4 in the DB axis.

### Data word 3 and 4 in DB axis

DW-N°	15	14	13	12	11	10	9	8	7	6	5	4	3	2	1	0
3																
4	Speed level															

With the start signal the programmed speed level is read out in BCD. This speed value has to be decoded by the user program and transferred to the motor controls. If the actual position falls below the programmed path difference MD 45, the v-step MD 42 will be read out. If the actual position falls below the programmed path difference MD 46, the speed will be further reduced, etc. When the last path difference is reached the output on connector X7 of the WF 725/WF 726 is switched to zero. With this output the axis must be stopped and clamped. The position checks are also active in this control version.

MD 42 through MD 48 are determined during the start up. They have to be adjusted to position as fast and as accurately as possible.

For the WF 726, only the use of MD 2 can cause a ramp function for braking.

With MD 10, the last but one zero point can also be programmed as a fast output on connector X7.

<b>43</b>	<b>Speed reduction 2</b> Speed, if distance between programmed point and actual position is less than MD46						<b>43</b>		
<b>AK</b> Open loop	valid for	I	A <sub>P</sub>	A <sub>SSI</sub>	LR	AK	<b>AK</b> Open loop		
	WF 725 Type	A/B	B	/	/	A/B			
	WF 726 Type	A/B/C	B	C	/	A/B/C			
Resolut.	Lower limit	Upper limit	Unit	Step	Input format: decimal				
-	MD 44	MD 42	-	1	0	0	0	0	
					0	0	10 <sup>1</sup>	10 <sup>0</sup>	
<b>Cross reference</b>		<b>MD 2, MD 42, MD 44, MD 45, MD 46, MD 47, MD 48</b>							
Numerical example		Input format: decimal				Input format: binary			
<b>52</b>		0	0	0	0	0	0	0	0
		0	0	5	2	0	0	3	4

See MD 42 for description (Open loop).

<b>44</b>	<b>Speed reduction 3</b> Speed, if distance between programmed point and actual position is less than MD47						<b>44</b>		
<b>AK</b> Open loop	valid for	I	A <sub>P</sub>	A <sub>SSI</sub>	LR	AK			
	WF 725 Type	A/B	B	/	/	A/B			
	WF 726 Type	A/B/C	B	C	/	A/B/C			
<b>AK</b> Open loop							<b>AK</b> Open loop		
Resolut.	Lower limit	Upper limit	Unit	Step	Input format: decimal				
-	1	MD 43	-	1	0	0	0	0	
					0	0	10 <sup>1</sup>	10 <sup>0</sup>	
<b>Cross reference</b>		<b>MD 2, MD 42, MD 43, MD 45, MD 46, MD 47, MD 48</b>							
Numerical example		Input format: decimal				Input format: binary			
<b>10</b>		<b>0</b>	<b>0</b>	<b>0</b>	<b>0</b>	<b>0</b>	<b>0</b>	<b>0</b>	<b>0</b>
		<b>0</b>	<b>0</b>	<b>1</b>	<b>0</b>	<b>0</b>	<b>0</b>	<b>0</b>	<b>A</b>

See MD 42 for description (Open loop).



<b>45</b>	<b>Travel difference 1</b> Travel difference to programmed point, at which the control switches to reduction speed MD 42 (AK)						<b>45</b>		
<b>AK</b> Open loop	valid for	I	A <sub>P</sub>	A <sub>SSI</sub>	LR	AK	<b>AK</b> Open loop		
	WF 725 Type	A/B	B	/	/	A/B			
	WF 726 Type	A/B/C	B	C	/	A/B/C			
Resolut.	Lower limit	Upper limit	Unit	Step	Input format: decimal				
1 10 100	MD 46	79999999	μm	1	10 <sup>7</sup>	10 <sup>6</sup>	10 <sup>5</sup>	10 <sup>4</sup>	
		79999999		10	10 <sup>3</sup>	10 <sup>2</sup>	10 <sup>1</sup>	10 <sup>0</sup>	
		79999999		100					
<b>Cross reference</b>		<b>MD 2, MD 42, MD 43, MD 44, MD 46, MD 47, MD 48</b>							
Numerical example		Input format: decimal				Input format: binary			
<b>50 000μm</b>		<b>0</b>	<b>0</b>	<b>0</b>	<b>5</b>	<b>0</b>	<b>0</b>	<b>0</b>	<b>0</b>
		<b>0</b>	<b>0</b>	<b>0</b>	<b>0</b>	<b>C</b>	<b>3</b>	<b>5</b>	<b>0</b>

See MD 42 for description (Open loop).

<b>46</b>	<b>Approx. positioning tolerance 1</b> Relative position value of 1 before block end position when the change of one block to another is allowed	<b>46</b>				
<b>LR</b> Closed loop	valid for	I	A <sub>P</sub>	A <sub>SSI</sub>	LR	AK
	WF 725 Type	/	/	/	/	/
	WF 726 Type	A/B/C	B	C	A/B/C	/
					<b>LR</b> Closed loop	

Resolut.	Lower limit	Upper limit	Unit	Step	Input format: decimal			
1	0	65535	$\mu\text{m}$	1	0	$10^6$	$10^5$	$10^4$
10	0	655350		10	$10^3$	$10^2$	$10^1$	$10^0$
100	0	6553500		100	$10^3$	$10^2$	$10^1$	$10^0$

<b>Cross reference</b>	<b>MD 47</b>
------------------------	--------------

Numerical example	Input format: decimal				Input format: binary			
<b>500<math>\mu\text{m}</math></b>	<b>0</b>	<b>0</b>	<b>0</b>	<b>0</b>	<b>0</b>	<b>0</b>	<b>0</b>	<b>0</b>
	<b>0</b>	<b>5</b>	<b>0</b>	<b>0</b>	<b>0</b>	<b>1</b>	<b>F</b>	<b>4</b>

With MD 46 (closed loop) and MD 47 (closed loop), there are two machine data available to realize a defined approximate positioning for combined traversing movements.

For programming processing programs, G23 to G29 and G73 to G79 are available as the fourth G function.

With these functions, block change points can be set.

MD 46 is analyzed by G23 to G29, and MD 47 is analyzed by G73 to G79.

**For example:**

```

N1 A G90 G23 X 10 000 F1000
N2 B G90 G24 X 10 000 F1000
N3 A G90 G73 X 20 000 F1000
N4 B G90 G74 X 20 000 F1000
    
```

MD 46 = 100 μm  
MD 47 = 700 μm

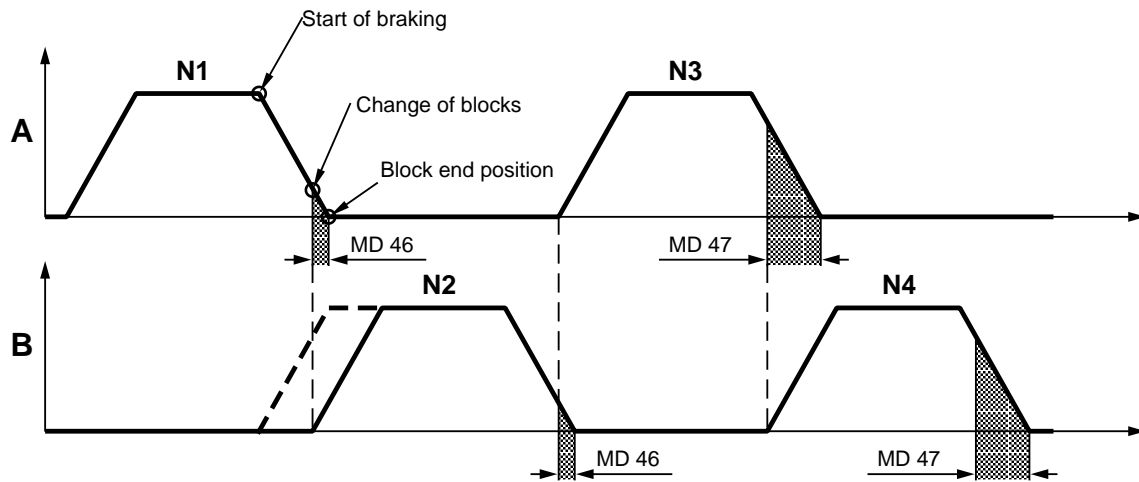

**When  $0 < MD\ 46$  ( $MD\ 47$ )  $<$  deceleration path, then the blocks are changed in the defined point for block change, otherwise the block change point is identical to the start point of braking.**

For further description see programming instructions, see chapter 3.7.4.

<b>46</b>	<b>Travel difference 2</b> Travel difference to programmed point at which the control switches to reduction speed MD43						<b>46</b>		
<b>AK</b> Open loop	valid for	I	A <sub>P</sub>	A <sub>SSI</sub>	LR	AK			
	WF 725 Type	A/B	B	/	/	A/B			
	WF 726 Type	A/B/C	B	C	/	A/B/C			
<b>AK</b> Open loop							<b>AK</b> Open loop		
Resolut.	Lower limit	Upper limit	Unit	Step	Input format: decimal				
1 10 100	MD 47	MD 45	μm	1 10 100	10 <sup>7</sup>	10 <sup>6</sup>	10 <sup>5</sup>	10 <sup>4</sup>	
					10 <sup>3</sup>	10 <sup>2</sup>	10 <sup>1</sup>	10 <sup>0</sup>	
<b>Cross reference</b>		<b>MD 2, MD 42, MD 43, MD 44, MD 45, MD 47, MD 48</b>							
Numerical example		Input format: decimal			Input format: binary				
<b>25 000μm</b>		<b>0</b>	<b>0</b>	<b>0</b>	<b>2</b>	<b>0</b>	<b>0</b>	<b>0</b>	<b>0</b>
		<b>5</b>	<b>0</b>	<b>0</b>	<b>0</b>	<b>6</b>	<b>1</b>	<b>A</b>	<b>8</b>

See MD 42 for description (Open loop).

<b>47</b>	<b>Approx. positioning tolerance 2</b> Relative position value of 2 before block end position when the change of one block to another is allowed					<b>47</b>
<b>LR</b> Closed loop	valid for	I	A <sub>P</sub>	A <sub>SSI</sub>	LR	AK
	WF 725 Type	/	/	/	/	/
	WF 726 Type	A/B/C	B	C	A/B/C	/
						<b>LR</b> Closed loop

Resolut.	Lower limit	Upper limit	Unit	Step	Input format: decimal			
1	0	65535	μm	1	0	10 <sup>6</sup>	10 <sup>5</sup>	10 <sup>4</sup>
10	0	655350		10				
100	0	6553500		100	10 <sup>3</sup>	10 <sup>2</sup>	10 <sup>1</sup>	10 <sup>0</sup>
<b>Cross reference</b>		<b>MD 46</b>						

Numerical example	Input format: decimal				Input format: binary			
<b>500μm</b>	0	0	0	0	0	0	0	0
	0	5	0	0	0	1	F	4

For description see MD 46 (Closed loop).

<b>47</b>	<b>Travel difference 3</b> Travel difference to programmed point, at which the control switches to reduction speed MD44						<b>47</b>		
<b>AK</b> Open loop	valid for	I	A <sub>P</sub>	A <sub>SSI</sub>	LR	AK			
	WF 725 Type	A/B	B	/	/	A/B			
	WF 726 Type	A/B/C	B	C	/	A/B/C			
<b>AK</b> Open loop							<b>AK</b> Open loop		
Resolut.	Lower limit	Upper limit	Unit	Step	Input format: decimal				
1 10 100	MD 48	MD 46	μm	1	10 <sup>7</sup>	10 <sup>6</sup>	10 <sup>5</sup>	10 <sup>4</sup>	
				10	10 <sup>3</sup>	10 <sup>2</sup>	10 <sup>1</sup>	10 <sup>0</sup>	
				100					
<b>Cross reference</b>		<b>MD 2, MD 42, MD 43, MD 44, MD 45, MD 46, MD 48</b>							
Numerical example		Input format: decimal				Input format: binary			
<b>5 000μm</b>		<b>0</b>	<b>0</b>	<b>0</b>	<b>0</b>	<b>0</b>	<b>0</b>	<b>0</b>	<b>0</b>
		<b>5</b>	<b>0</b>	<b>0</b>	<b>0</b>	<b>1</b>	<b>3</b>	<b>8</b>	<b>8</b>

For description see MD 42 (Open loop).

<b>48</b>	<b>Travel difference 4</b> Travel difference to programmed point, at which the control switches to reduction speed 0						<b>48</b>		
<b>AK</b> Open loop	valid for	I	A <sub>P</sub>	A <sub>SSI</sub>	LR	AK	<b>AK</b> Open loop		
	WF 725 Type	A/B	B	/	/	A/B			
	WF 726 Type	A/B/C	B	C	/	A/B/C			
Resolut.	Lower limit	Upper limit	Unit	Step	Input format: decimal				
1 10 100	0	MD 47	μm	-	10 <sup>7</sup>	10 <sup>6</sup>	10 <sup>5</sup>	10 <sup>4</sup>	
					10 <sup>3</sup>	10 <sup>2</sup>	10 <sup>1</sup>	10 <sup>0</sup>	
<b>Cross reference</b>		<b>MD 2, MD 42, MD 43, MD 44, MD 45, MD 46, MD 47</b>							
Numerical example		Input format: decimal				Input format: binary			
<b>55μm</b>		0	0	0	0	0	0	0	0
		0	0	5	5	0	0	3	7

For description see MD 42 (Open loop).

<b>49</b>	<b>Basic Resolution</b>					<b>49</b>
	Resolution of the measuring system					
	valid for	I	A <sub>P</sub>	A <sub>SSI</sub>	LR	
	WF 725 Type	A/B	B	/	A/B	A/B
	WF 726 Type	A/B/C	B	C	A/B/C	A/B/C

Numerical value for bit combination X	Input format: decimal			
<b>X=1: Resolution 1 μm</b>	<b>0</b>	<b>0</b>	<b>0</b>	<b>0</b>
<b>X=2: Resolution 10 μm</b>				
<b>X=3: Resolution 100 μm</b>	<b>0</b>	<b>0</b>	<b>0</b>	<b>X</b>
<b>Cross reference</b>				

Numerical example	Input format: decimal				Input format: binary			
<b>1</b>	<b>0</b>	<b>0</b>	<b>0</b>	<b>0</b>	<b>0</b>	<b>0</b>	<b>0</b>	<b>0</b>
	<b>0</b>	<b>0</b>	<b>0</b>	<b>1</b>	<b>0</b>	<b>0</b>	<b>0</b>	<b>1</b>

***MD 49 is transferred by Standard I-726 to the WF (FB211).***

***After input or change of the resolution all machine data depending on it must be newly entered.***



<b>50</b>		<b>System data</b>					<b>50</b>	
		valid for	I	A <sub>P</sub>	A <sub>SSI</sub>	LR	AK	
		WF 725 Type	A/B	B	/	A/B	A/B	
		WF 726 Type	A/B/C	B	C	A/B/C	A/B/C	
Resolut.	Lower limit	Upper limit	Unit	Step	Input format: decimal			
		<b>Cross reference</b>						
Numerical example		Input format: decimal			Input format: binary			

***MD 50 is transferred by Standard I-726  
and is not relevant for the user.***



## 5 Strategy for diagnosis and repair of faults

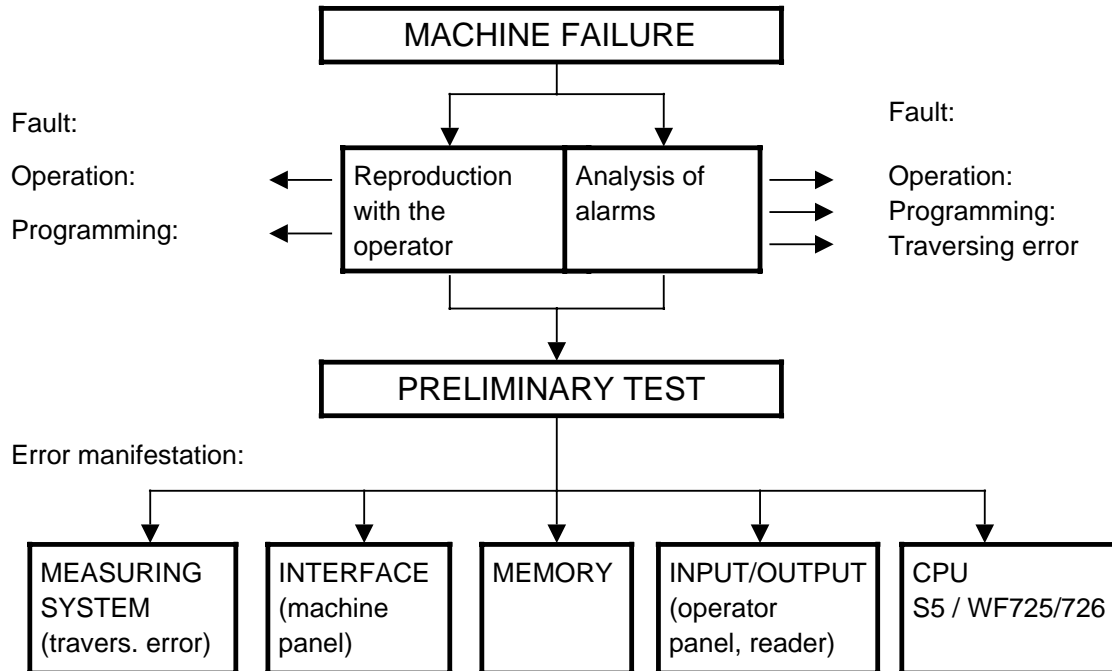

Continuing advances in electronics and machine design made it possible to reduce the down time of systems despite the growing complexity and the increasing range of functions of numerically controlled machine tools. Failures have been reduced to an economically acceptable level by the use of modern electronics (digital components of the highest density, microprocessors), simplified mechanical and electrical configuration (elimination of gears, big PC boards, bus wiring) and stringent quality controls (artificial aging, long duration tests, etc.).

Nevertheless, it still happens that the CNC machine suffers a failure and is not available for production. The down time can be drastically reduced with highly trained service technicians in connection with tools for the fault diagnostics and fast access to the required spare parts.

Failures can be caused by the diversity of machine elements, electronic and electrical components and problems in the operation and programming. If the service personnel of the machine user cannot localize and repair the fault then a service technician of the control manufacturer is requested in most cases. Even though he is only responsible for components supplied by his company, an extensive knowledge of all technologies of the CNC machine helps in the fault diagnostics.

A localization of the fault is sometimes difficult since the control loops are affected by mechanical, electrical and electronic components. For example:

Mechanic: backlash with indirect measuring systems affect the accuracy

Electronic: wrong regulator adjustment affects the contour of the part

The procedure for localizing a failure depends on the individual case, and also on the previous experience of the service technician. A rough guide with some basic checks follows.

## 5.1 Failures with error message

Numerical controls, especially CNC controls, are equipped with internal fault diagnostics (On-line-Diagnosis) which are always active, and in the case of a fault they give an error message. In most cases an error number is shown on the operator panel. This number can be "decoded" with the error list (see chapter 6).

Important errors which might damage the tool, a part or the machine cause an immediate stop (emergency stop) of the machine. After eliminating the error the program has to be started at the beginning.

Less important errors only cause a stop of the program execution.

Examples of parts and parameters constantly checked by the control:

- measuring systems and drive units
- data input and data transfer
- general operation
- programming
- data and program memory
- interface signals
- voltages etc.

In the case of a failure it should be first checked if there are any errors displayed. Those error displays help in the fault diagnostic and repair.

## 5.2 Faults without error message

Since not all possible faults can be analyzed by the internal diagnostics there are some faults which do not cause an error message. Even though they are relatively rare they are still important since the fault localization is more difficult. In this case it should be tried to reproduce the fault together with the machine operator.

The best way is usually to repeat the program and to let the operator handle the machine. Sometimes the wrong operation is carried out unconsciously and the operator cannot describe it.

With the help of error messages and operator and programming descriptions all operating and programming errors should be recognized and avoided at this stage of the fault diagnosis.

## **5.3 Preliminary test**

If there is no operator or programming error and if the internal diagnostics of the CNC do not help, then the following basic checks should be carried out:

### **5.3.1 Power supply and grounding**

Voltage supply in tolerance band (+10% - 15%)? Voltage variations or interferences?

Check power supply directly at the modules!

Does the error always occur at the same time? Take into account switching on and off of other machines.

Take into account changes in the environment, for example the set up of new machines!

Are all cables to and from the control shielded and are all shields connected properly?

Are all ground connections without loops, and of sufficient size?

### **5.3.2 Cables and connections**

Are the modules connected and addressed properly?

Do all integrated circuits fit tight into their sockets; any bent pins?

Are all cables and connectors made and installed according to the interface description?

### **5.3.3 Machine data**

Is the stored machine data the same as in the machine data list?

It might be necessary to delete all machine data and read them in again; check the memory afterwards!

### **5.3.4 Revision level**

Check the hardware and software revision levels. Errors might already be known and repaired in newer revisions.

## 5.4 Error manifestation

By looking at the error manifestation it is often possible to deduct the localization of the error. The design and use of programs in which the error conditions are reproduced should cause the appearance of the error or at least cause it to appear more often.

### 5.4.1 Measuring system

- axis does not move, or slowly drifts (drive enable, command value output)
- axis does not position accurately
- axis takes off (with maximum speed)
- measuring error, physical machine position and displayed position are not the same
- axis oscillates
- contour error (programming?)
- surface ripple (turned or milled surface is bad)

### 5.4.2 Interface (machine control)

- no or wrong output of auxiliary functions
- machine does not start (no enables)
- clamping opens too soon or too late
- error always in the same operating submode?

### 5.4.3 Memory

- programmed functions are distorted
- no reading or writing of memory is possible

### 5.4.4 Input/output (operator panel)

- no reaction when a key is pushed
- LED is always on/off
- wrong decoding of operating submodes (input not possible)

### 5.4.5 CPU

- no displays, all LED's on
- no reaction to input

In most cases a hardware fault in the CPU or in the system memory causes a stop of the CPU. The theoretical possibility that a faulty microprocessor still executes the part program but also causes defects of the control from within, is practically zero.

If, in addition to the On Line diagnostics, there also is an Off Line diagnostic (not always active, can be activated for example with EPROM's) then it should be used depending on the particular error.

- a) It is quite obvious when the diagnostic program finds a hardware error. The repair, the change of the module in most cases, can be done immediately. In some cases a component might be changed (for example if no spare module is available).
- b) If the diagnostic does not find a fault then it should be assumed that the module itself is working properly. The fault localization should proceed to the next area with the highest probability of a fault. (In some rare exceptions the diagnostic program might not be able to find the fault. Then, in cooperation with the developing department of the CNC manufacturer, the diagnostic program is upgraded.)

In all other cases the diagnostic program assures the customer and the service technician that the module is working properly.

In some rare cases the errors might be sporadic, this makes them very hard to find. The localization requires a great deal of experience, care and tenacity on the part of the service technician. Often those errors have a common characteristic which may be used to reproduce them. This facilitates the error localization a great deal.

If the error localization, and therefore the down time of the machine, takes an unacceptably long time (in some very rare faults) then components which might be the cause of the fault have to be exchanged.

The exchanged components should be returned for checks, together with a description of why they have been exchanged, or they should be stored separately until the error has been found!

Operators and programmers should participate in the error localization so they can learn, for example new ways of diagnostics.

The installation of special programs with optical displays enable the customer to perform certain checks (with help over the telephone), in the case of a fault, even if the service technician is not present.





# 6 Error list and description

## 6.1 Error list

### 6.1.1 WF-Messages in MODE Traversing



No.	Explanation	Output	A
01	System fault	1/5	
02	System fault	1/5	
03	System fault	1/5	
04	System fault	1/5	
05	System fault	1/5	
06	Stack overflow	1/5	
07	Cable break in the encoder cable	1/5	
08	Wrong impulse	1/5	
09	No zero mark	1/5	
0A			
0B	Voltage sensor error	1/5	
0C			
0D			
0E			
0F			
10	Following error in standstill	1/5	
11	Following error while traversing	1/5	
12			
13	Drive enable is missing (D 2.0)	1/5	
14	Drive not ready	1/5	
15	Range limit switch negative	1/5	
16	Range limit switch positive	1/5	
17	Drive enable went to data transfer/ machine data zero in mode	1/5	
18			
19	Pulse evaluation factor (MD19 and MD20) = 0	1/5	
1A	Number of pulses per revolution = 0 is not allowed	1/5	
1B	Negative limit switch greater than pre-limit switch negative	1/5	
1C	Positive limit switch smaller than pre-limit switch positive	1/5	

Output:

- 1 = DB axis DW 4
- 2 = DB axis DW 40
- 3 = DBWF DW 40
- 4 = Memory administration
- 5 = Overlay parameter FEHL
- 6 = Blocks of the comfort version
- 7 = Memory administration
- 8 = Display WS 780
- 9 = Fault output Standard II

No.	Explanation	Output	A
1D			
1E			
1F			
20	Max. traversing speed too fast	1/5	
21	Positioning (PEH) window left again	1/5	
22	Positioning (PEH) timeout	1/5	
23	Clamping tolerance exceeded	1/5	
24			
25	Synchronization tolerance exceeded	1/5	
26			
27			
28			
29			
30	Absolute encoder module does not exist	1/5	
31	Fault error	1/5	
32	Parity error	1/5	
33	Difference error	1/5	
34	Masking error	1/5	
35			
36			
37			
38	Zero mark faulty	1/5	
39	Watchdog error	1	
40	ADC error	1/5	
41	± 15V not within tolerance	1/5	
42	+ 15V not within tolerance	1/5	
43	- 15V not within tolerance	1/5	
44	5Vfuse defective	1/5	
45	24Vfuse defective	1/5	
46	Short circuit in command value	1/5	
47	Fault in back up battery	1/5	
48			
49	EEPROM defective	1/5	

Acknowledgement A:



-  = Self acknowledging
-  = Acknowledgement with data code 800C<sub>Hex</sub>
-  = Reset





No.	Explanation	Output	A
50			
51	Current brake value = 0	1/5	
52			
53			
54			
55			
56			
57			
58			
59			
60			
61	No Block data	1/5	
62	Missing block data	1/5	
63			
64	Block number 0 not permitted	1/5	
65	MDI: No position	1/5	
66	MDI: No feed rate	1/5	
67	No block number	1/5	
68	Number of blocks per program not permitted	1/5	
69	Operating mode in slave axis 0	1/5	
6A	Fault in slave axis	1/5	
6B	Operating mode in slave axis 0	1/5	
6C	Program number changed	1/5	
6D	MD1 and/or MD2 are different during synchronous operation	1/5	
6E			
6F			



No.	Explanation	Output	A
70	Absolute programming with Roll feed	1/5	
71	Deceleration = 0	1/5	
72	Selected jog speed = 0	1/5	
73	Feed rate = 0 in the block data	1/5	
74	Reference point appr. speed 1 = 0	1/5	
75	Reference point appr. speed 2 = 0	1/5	
76	Reference point appr. speed 3 = 0	1/5	
77	Both directions selected (jog+/-)	1/5	
78	no direction selected (jog+-)	1/5	
79	direction selection changed (jog+-)	1/5	
7A	Open loop: 4th.G-Group not allowed	1/5	
7B			
7C			
80	Program number 0 not permitted	1/5	
81	No program number	1/5	
82	No block data available	1/5	
83	1st. G-Function not permitted	1/5	
84	2nd. G-Function not permitted	1/5	
85	3rd. G-Function not permitted	1/5	
86	4th. G-Function not permitted	1/5	
87	Deactivation of tool offset which was not active	1/5	
88	Last block in a program must not be skipped	1/5	
89	Deactivation of zero offset which was not active	1/5	
90	Program number not valid for this axis	1/5	
91	Subroutine level not permitted	1/5	
92	"Setting of act. value" already active	1/5	
93	"Setting of act. value" not yet active	1/5	
94			
95	Pre-limit switch negative (MD 11)	1/5	
96	Pre-limit switch positive (MD 13)	1/5	
97			
98			
99	Hardware version <2: simultaneous homing ist not possible	1/5	

Output:

- 1 = DB axis DW 4
- 2 = DB axis DW 40
- 3 = DBWF DW 40
- 4 = Memory administration
- 5 = Overlay parameter FEHL
- 6 = Blocks of the comfort version
- 7 = Memory administration
- 8 = Display WS 780
- 9 = Fault output Standard II

- Acknowledgement A:
-  = Self acknowledging
  -  = Acknowledgement with data code 800C<sub>Hex</sub>
  -  = Reset



No.	Explanation	Output	A
A0			
A1			
A2			
A3			
A4			
A5			
A6			
A7			
A8			
A9			
AA			
AB			
AC			
AD			
AE			
AF			
B0	Buffer number not permitted	1/5	
B1	Buffer number not enabled	1/5	
B2	Buffer: M11 not permitted	1/5	
B3	Buffer: M12 not permitted	1/5	
B4			
B5			
B6			
B7			
B8			
B9	"Flying setting of actual value": MD15 not programmed	1/5	
BA			
BB			
BC			
BD			
BE			
BF			

No.	Explanation	Output	A
C0			
C1			
C2			
C3			
C4			
C5			
C6			
C7			
C8			
C9			
D0	Rate-of-change limiting for Acceleration to large	1/5	
D1	Rate-of-change limiting for Deceleration to large	1/5	
D2	Interpolation and jerk limit are not simultaneously possible.	1/5	
D2			
D3			
D4			
D5			
D6			
D7			
D8			
D9			

Output:

- 1 = DB axis DW 4
- 2 = DB axis DW 40
- 3 = DBWF DW 40
- 4 = Memory administration
- 5 = Overlay parameter FEHL
- 6 = Blocks of the comfort version
- 7 = Memory administration
- 8 = Display WS 780
- 9 = Fault output Standard II

Acknowledgement A:

-  = Self acknowledging
-  = Acknowledgement with data code 800C<sub>Hex</sub>
-  = Reset

## 6.1.2 WF-Messages in MODE Program Input/Output



No.	Explanation	Output	A
100			
101	EEPROM: Addressing fault	2/3/5/6	
102	RAM: Addressing fault	2/3/5/6	
103			
104			
105	Memorization not possible	2/3/5/6	
106			
107			
108			
109			
110			
111	Read-In /Read-Out not possible simultaneously	2/3/8	
112	Data code 0 not valid	2/8	
113	Data code not valid	2/5/8	
114	Axis number = 0 not valid	8	
115			
116			
117			
118			
119			
120			
121	MD number not valid	2/8	
122			
123	Max. number of blocks stored	3/5/6/7/8	
124	Max. number of programs stored	3/5/6/7/8	
125	Program number 0 is not valid	3/5/6/7/8	
126	Block number not valid	3/5/6/7/8	
127	Program number not available	3/5/6/8	
128	Block number not available	3/8	
129	No block numbers available	3/5/8	

Output:

- 1 = DB axis DW 4
- 2 = DB axis DW 40
- 3 = DBWF DW 40
- 4 = Memory administration
- 5 = Overlay parameter FEHL
- 6 = Blocks of the comfort version
- 7 = Memory administration
- 8 = Display WS 780
- 9 = Fault output Standard II

No.	Explanation	Output	A
130	Validity missing	3/5/8	
131	EEPROM socket empty	2/3/8	
132	EEPROM: Programming Error	2/3/8	
133			
134			
135	Teach-In: Program number 0 not valid	2/8	
136	Teach-In: Block number 0 not valid	2/8	
137	Teach-In: No program n° available	2/8	
138	Teach-In: Program memory full	2/8	
139			
140			
141			
142	Tool offset number not valid	2/8	
143	Reloading: block number not valid	2/7/8	
144	Reloading: Incorrect sequence	2/7/8	
145	Feed rate is zero in MDI mode/ invalid page number	2/3/8	
146	Reloading: No block data	3/8	
147	Invalid block number or > 50	2/7/8	
148	Diagnostic: invalid additional information		
149			
150			
151	invalid buffer number	2/7	
152	Reloading: Number of blocks per buffer > 50	2/7	
153			
154			
155	Reloading: No buffer number selected for uploading	2/7	
156			
157			
158			
159			
172			
173	Interpolation: missing block information	2/7	
174	Interpolation: G-Function 4 not valid	2/7	
175			
181	Interpolation: Sequence of Input not valid		
182			

Acknowledgement A:

-  = Self acknowledging
-  = Acknowledgement with data code 800C<sub>Hex</sub>
-  = Reset

### 6.1.3 Messages from the STEP 5 Memory Administration



No.	Explanation	Output	A
200			
201	Wrong mode	4/5/9	
202	WF not ready	4/5/9	
203	Reloading not permitted	6/9	
204			
205			
206			
207			
208			
209			
210			
211	Invalid axis number	6/9	
212	Invalid parameter GUA	6/9	
213	Validity declaration missing	9	
214	Buffer number = 0 or does not conform to axis number	6/9	
215	Gaps in block numbers	7	
216			
217			
218			
219			
220	Wrong parameters in FB call	6	
221			
222			
223			
224			
225			
226			
227			
228			
229			

No.	Explanation	Output	A
230	Program number = 0	6	
231	Block number = 0	6	
232	G1 not valid	6	
233	G2 not valid	6	
234	G3 not valid	6	
235	G4 not valid	6	
236	G04 without time value	6	
237	Subroutine without number of cycles	6	
238	Subroutine + G function	6	
239	Number of tool length offset memory >20	6	
240	Number of cycles		
241	Selected program group, program or block not available	7/9	
242			
243			
244	Error during generation of DB, or DB does already exist	7/9	
245	No storage of block possible (all DB's are full)	7	
246			
247			
248			
249			
250			
251			
252			
253			
254			
255			
256			
257			
258			
259			

Output:

- 1 = DB axis DW 4
- 2 = DB axis DW 40
- 3 = DBWF DW 40
- 4 = Memory administration
- 5 = Overlay parameter FEHL
- 6 = Blocks of the comfort version
- 7 = Memory administration
- 8 = Display WS 780
- 9 = Fault output Standard II

Acknowledgement A:

-  = Self acknowledging
-  = Acknowledgement with data code 800C<sub>Hex</sub>
-  = Reset

## 6.1.4 Messages from the Software Schale

No.	Explanation	Output	A
400	More then 1 bit is set in parameter I/O (E/A)	5	
401	The program to be read in is not present in the user data block	5	
402	The program to be read out does not fit completely in the user data block	5	
403			
404			
405			
406			
407			
408			
409			
410			
411			
412			
413			
414			
415			
416			
417			
418			
419			
420			
421			
422			
423			
424			
425			
426			
427			
428			
429			

No.	Explanation	Output	A
430			
431			
432			
433			
434			
435			
436			
437			
438			
439			
440			
441			
442			
443			
444			
445			
446			
447			
448			
449			
450			
451			
452			
453			
454			
455			
456			
457			
458			
459			

Output:

- 1 = DB axis DW 4
- 2 = DB axis DW 40
- 3 = DBWF DW 40
- 4 = Memory administration
- 5 = Overlay parameter FEHL
- 6 = Blocks of the comfort version
- 7 = Memory administration
- 8 = Display WS 780
- 9 = Fault output Standard II

Acknowledgement A:



= Self acknowledging

= Acknowledgement with data code 800C<sub>Hex</sub>

= Reset

## 6.1.5 Messages from Standard II



No.	Explanation	Output	A
800	Select. not possible, wrong password	8	
801	Delete function complete	8	
802	Program/block number not valid in teach in	8	
803	No input of group/program or block number	8	
804	No block data, storage not executed	8	
805			
806			
807			
808			
809			
810	No further message	8	
811			
812			
813			
814			
815			
816			
817			
818			
819			
870	Bus fault is given: when for 30s no character is transferred over the serial bus when telegrams between WF 785 and WS 780 are not received correctly	8	
871			
872			
873			
874			
875			
876			
877			
878			
879			

Output:

- 1 = DB axis DW 4
- 2 = DB axis DW 40
- 3 = DBWF DW 40
- 4 = Memory administration
- 5 = Overlay parameter FEHL
- 6 = Blocks of the comfort version
- 7 = Memory administration
- 8 = Display WS 780
- 9 = Fault output Standard II

No.	Explanation	Output	A
900	Wrong mode/submode to WF725 / WF726	8	
901	Invalid identification number of WF 785 module	8/9	
902	WF785 not ready (on start up)	8/9	
903	Invalid axis number	8/9	
904	S5 not ready for data transfer	8/9	
905	FB175 disabled, since FB227 is still active	8/9	
906	Invalid job number		
907			
908			
909			
910	Feedback WF785 Memory deleted - memory administration	8/9	
911	WF785 memory full	7/8	
912	Block does not exist	7/8	
913	Program does not exist	7/8	
914	Group does not exist	7/8	
915	Message text does not exist	8/9	
916	Block number not entered	7/8	
917	Program number or assignment number not entered	8	
918	Group number or message number not entered	7/8/9	
919	Function disabled due to saving	7/8	
920	Wrong control word (internal)	7/8	
921	Do not enter program number	8	
922	Back up battery defective	8/9	
923	Output of existing numbers: page number not entered	7/8	
924	Traversing blocks do not exist	7/8	
925	WF785 memory empty	8/9	
926	Reloading: 1st. block in buffer does not have the number 1 1	7/8	
927	Reloading: Block numbers in program have gaps	7/8	
928	Group or program protected reloading of WF 726	7/8	
929	Function disabled, since WF 785 underwent an initial clear	7/8/9	

Acknowledgement A:

-  = Self acknowledging
-  = Acknowledgement with data code 800C<sub>Hex</sub>
-  = Reset

No.	Explanation	Output	A
930			
931			
932			
933			
934			
935			
936			
937			
938			
939			
940			
941			
942			
943			
944			
945			
946			
947			
948			
949			
950			
951			
952			
953			
954			
955			
956			
957			
958			
959			

No.	Explanation	Output	A
960			
961			
962			
963			
964			
965			
966			
967			
968			
969			
970	Bus fault	9	
971	Fault with message to 1st. operator panel: Operator panel does not exist	9	
972	Fault with message to several operator panels: all panels addressed do not exist	9	
973	Fault with message to several operator panels: at least one panel addressed does not exist	9	
974	Fault with message: Axis number cannot be assigned to any operator panel	9	
975			
976			
977			
978			
979			
980			
981			
982			
983			
984			
985			
986			
987			
988			
989			

Output:

- 1 = DB axis DW 4
- 2 = DB axis DW 40
- 3 = DBWF DW 40
- 4 = Memory administration
- 5 = Overlay parameter FEHL
- 6 = Blocks of the comfort version
- 7 = Memory administration
- 8 = Display WS 780
- 9 = Fault output Standard II

Acknowledgement A:



= Self acknowledging



= Acknowledgement with data code 800C<sub>Hex</sub>

= Reset



## 6.2 Description of errors

The squares beside the error number define the kind of acknowledgement. They have the following meaning:

-  self-acknowledging
-  Acknowledgement with data code 800C<sub>Hex</sub>
-  RESET

### 6.2.1 Errors in the MODE Traversing

<b>01-05</b>	<b>System errors</b>
Error significance	Errors caused by the internal software of the control
Cause of error	Nothing should be changed about these errors. The setting of the interface signals is required for the diagnosis. Errors are caused during the internal processing which are not possible normally.
Repair	When this error appears, the sales representative should be contacted

<b>06</b>	<b>Stack overflow</b>
Error significance	Errors caused by the internal software of the control
Cause of error	Nesting depth of the firmware program is too great to guarantee proper execution. In order to diagnose the error, the last operations have to be repeated exactly.
Repair	When this error appears, the sales representative should be contacted

<b>07</b>	<b>Cable break in the measuring circuit</b>
Error significance	There are causes which do not guarantee a correct reading of the actual value
Cause of error	<p>incremental enc.:</p> <ul style="list-style-type: none"> <li>- Cable broken or not connected</li> <li>- Sensor input PEF (pin 4 on the encoder plug) not connected with 5V or 24V</li> <li>- Encoder without cross-signals</li> <li>- TTL level of the s-signals is below 3,5V</li> <li>- Phase difference between channel A and channel B 90°</li> <li>- Limit frequency greater than 200 kHz</li> <li>- Plug wired wrong</li> </ul> <p>Absolute encoder:</p> <ul style="list-style-type: none"> <li>- Absolute encoder selected (MD 4=2 or 4)</li> <li>- Cable broken or not connected</li> <li>- Sensor input PEF (pin 4 on the encoder plug) not connected with 24V</li> <li>- Plug wired wrong</li> </ul>
Repair	If the cable check is set in MD41, it has to be activated with a RESET

<b>08</b>	<b>Pulse monitor (MD 34)</b>
Error significance	The number of pulses between two zero marks is not equal to MD34.
Cause of error	<ul style="list-style-type: none"> <li>- MD 34 wrong: MD 34 <math>4 \cdot</math> pulses per encoder revolution</li> <li>- Encoder defective: the encoder does not deliver the number of pulses specified on the encoder</li> <li>- Encoder does not have a zero mark</li> <li>- Linear scale with only one zero mark</li> <li>- Length of zero mark smaller than 1.25 <math>\mu</math>s</li> </ul>
Repair	<p>Correct MD 34; exchange encoder, and if no zero mark exists it must be deactivated.</p> <p>If the pulse check is active the difference between MD34 and the actual number of pulses can be read out with data code 4.</p>

<b>09</b>	<b>Zero mark check (MD 34)</b>
Error significance	No zero mark was detected after leaving the deceleration cam and moving the number of pulses in MD34.
Cause of error	<ul style="list-style-type: none"> <li>- MD 34 wrong: MD 34 <math>4 \cdot</math> pulses per encoder revolution</li> <li>- Encoder defective: the encoder does not deliver the number of pulses specified on the encoder</li> <li>- Encoder does not have a zero mark</li> <li>- Linear scale with only one zero mark</li> <li>- Length of zero mark smaller than 1.25 <math>\mu</math>s</li> </ul>
Repair	<p>Correct MD 34; exchange encoder, and if no zero mark exists it must be deactivated.</p> <p>If the pulse check is active the difference between MD34 and the actual number of pulses can be read out with data code 4.</p>

<b>0B</b>	<b>Level sensor error</b>
Error significance	The level sensor is used to check the encoder voltage level. If the module recognizes no or too little voltage, then error B is read out.
Cause of error	<ul style="list-style-type: none"> <li>- Sensor not connected</li> <li>- Brake of cable</li> <li>- Plug disconnected</li> <li>- no voltage available</li> <li>- Voltage level too low</li> </ul>
Repair	Check cable connections and voltage level.

<b>10</b>	<b>Standstill monitor (MD 25)</b>
Error significance	Following error in standstill (MD25) is exceeded.
Cause of error	<ul style="list-style-type: none"> <li>- MD 25 must be entered within input limits.</li> <li>- Check MD 32: clamping tolerance must be entered smaller than MD 25.</li> <li>- MD 6 wrong: system adaption is faulty.</li> <li>- Check MD 33: PEH-window tolerance limit must be entered smaller than MD 25. Internally, it is changed from traversing to standstill in dependance on MD 33 and therefore, the following error changes from MD 24 to the MD 25 window.</li> <li>- MD 35 wrong: the drift compensation has to be adjusted to the drive unit. In standstill the following error should not be greater than the resolution.</li> <li>- Axis was mechanically pushed out of position.</li> </ul>
Repair	Optimization of the speed regulator and the gain Optimization of the standstill check Compensation of drift

<b>11</b>	<b>Traversing monitor of following error (MD 24, MD 26)</b>
Error significance	Following error too great while traversing
Cause of error	<ul style="list-style-type: none"> <li>- The actual following error is greater than the calculated following error.</li> <li>- Check MD 24: this machine data determines the upper limit of the following error while traversing</li> <li>- Check MD 26: this machine data determines the lower limit of the following error while traversing</li> <li>- Check MD 6: system adaption is faulty.</li> <li>- Check MD 3/22/23 MD 19/20/21: With the voltage entered in MD 23 the drive should reach a speed which is equal to a following error of MD 3/22 when it is evaluated with MD 19/20/21.</li> </ul>
Repair	Correct machine data Optimize regulator

<b>13</b>	<b>Drive enable is missing (D 2.0)</b>
Error significance	The bit D2.0 in DB axis went to zero while traversing
Cause of error	<p>It was attempted to move the axis without drive enable. Bit 2.0 from DB axis=0</p> <p><u>Attention:</u> The drive enable bit directly controls the drive enable output</p> <p>Exceptions:</p> <ul style="list-style-type: none"> <li>- Error number &lt; 60 has happened</li> <li>- RESET-Bit =1</li> <li>- Drive not ready (fault)</li> </ul> <p>The 24V signal "drive enable" and the "drive ready" signal have to be wired for each axis individually (seen from the WF).</p>
Repair	Check why the drive enable went to zero.

<b>14</b>	<b>Drive not ready</b>
Error significance	The signal "drive ready" is zero.
Cause of error	<ul style="list-style-type: none"> <li>- With the start or with the drive enable, the WF input for the drive ready signal does not have 24V.</li> <li>- Power supply not connected to connector X7.</li> </ul> <p>The WF gives drive enable only if the drive ready signal is already one. Therefore one has to use the drive fault signal and not the drive active signal.</p>
Repair	Check why drive ready input does not have 24V.

<b>15</b>	<b>Negative limit switch reached (MD 12)</b>
Error significance	It was attempted to pass the negative limit switch.
Cause of error	<p>Command position in the closed loop version or actual position in the open loop version is smaller than MD12, because:</p> <ul style="list-style-type: none"> <li>- it was attempted to pass MD12 in the negative direction.</li> <li>- MD 16 is smaller than MD 12 in the incremental encoder version.</li> <li>- a value smaller than MD 12 is falsely delivered by an encoder in the absolute encoder version.</li> <li>- in the absolute version the encoder plug has been disconnected</li> <li>- MD 12 has been entered wrong</li> <li>- MD 28 has been entered smaller than MD 14.</li> </ul>
Repair	<p>Check MD12: negative limit switch  Check MD16: reference point coordinate  Check MD28: setting of actual value  Check encoder and encoder cable</p>

<b>16</b>	<b>Positive limit switch reached (MD 14)</b>
Error significance	It was attempted to pass the positive limit switch.
Cause of error	<p>Command position in the closed loop version or actual position in the open loop version is greater than MD12, because:</p> <ul style="list-style-type: none"> <li>- it was attempted to pass MD12 in the positive direction.</li> <li>- MD 16 is greater than MD 12 in the incremental encoder version.</li> <li>- a value greater than MD 12 is falsely delivered by an encoder in the absolute encoder version.</li> <li>- in the absolute version the encoder plug has been disconnected</li> <li>- MD 12 has been entered wrong</li> <li>- MD 28 has been entered greater than MD 14.</li> </ul>
Repair	<p>Check MD14: positive limit switch  Check MD16: reference point coordinate  Check MD28: setting of actual value  Check encoder and encoder cable</p>

<b>17</b>	<b>Drive enable went to zero in the MODE program data/ machine data</b>
Error significance	In the mode program data or the mode machine data, an error occurred which disabled the drive unit.
Cause of error	In the mode traversing, before the mode change, the drive enable bit was traversed to (DB axis Bit 2.0). An error < 60 occurred in the measuring circuit in the mode program data or machine data.
Repair	According to error numbers < 60

<b>19</b>	<b>Pulse evaluation factor = 0 (MD 19, MD 20)</b>
Error significance	MD 19 and MD 20 =0
Cause of error	Each time the traversing mode is selected the control checks MD19 and 20. If both are zero the error is activated.
Repair	MD 19 and MD 20 must be entered correctly.

<b>1A</b>	<b>Number of pulses per revolution = 0 is not allowed</b>
Error significance	MD 34 is monitored for switching from the mode machine data input/output to the mode traversing. If zero is entered into MD 34, then error 1A is read out when the modes change.
Cause of error	MD 34 = 0
Repair	Note the lower input limit of MD 34.

<b>1B</b>	<b>Negative limit switch greater than negative pre-limit switch is not allowed</b>
Error significance	For switching from the mode machine data input/output to the mode traversing it is monitored whether the negative pre-limit switch is set before the negative limit switch.
Cause of error	MD 12 > MD 11 (limit end switch after pre-limit switch)
Repair	Correct lower input limit of MD 11 or the upper input limit of MD 12.

<b>1C</b>	<b>Positive limit switch smaller than positive pre-limit switch is not allowed</b>
Error significance	For switching from the mode machine data input/output to the mode traversing it is monitored whether the negative pre-limit switch is set before the negative limit switch.
Cause of error	MD 14 < MD 13
Repair	Correct upper input limit of MD 13 or lower input limit of MD 14

<b>20</b>	<b>Max. traversing speed too high (MD 3)</b>
Error significance	MD 3 is beyond input limits.
Cause of error	With internal calculations, a value higher than MD 3 would result in an overflow which is blocked by error 20.
Repair	Correct MD 3.

<b>21</b>	<b>PEH (positioning) window exceeded</b>
Error significance	The axis left the already reached PEH (positioning) window
Cause of error	If, in the open loop version, a window is left which has already been reached, then error 21 is signalled.
Repair	<ul style="list-style-type: none"> <li>- Check MD33 - positioning (PEH) tolerance</li> <li>- Check MD48 - path difference to prog. position</li> <li>- Is axis physically pushed out of position after the program point has been reached?</li> </ul>

<b>22</b>	<b>PEH (positioning) timeout (MD 30)</b>
Error significance	The PEH window tolerance (MD 33) was not reached within the set PEH time monitoring (MD 30).
Cause of error	<p>Closed loop version: The command position has reached the programmed value. Internal switch to standstill. The time in MD30 is started. If the axis does not reach the PEH (positioning) window before the end of the time, error number 22 is activated.</p> <p>Open loop version: With the output of speed zero the control switches to standstill and starts the time. Error 22 appears if the time ends and the axis still has not reached the positioning window.</p> <p>Causes:</p> <ul style="list-style-type: none"> <li>- PEH time monitoring (MD 30) has been entered too small</li> <li>- PEH tolerance window (MD 33) has been entered too small</li> <li>- Drift too high</li> <li>- K<sub>v</sub>-Factor (MD 22) too low</li> <li>- last cut off point (MD 44, MD 48) not right (only open loop)</li> <li>- mechanical problem</li> </ul>
Repair	Check MD 30, 33, 22, 35, 44, 48 Mechanical system: make suitable changes

<b>23</b>	<b>Clamping tolerance exceeded (MD 32)</b>
Error significance	The axis left the window in MD32 in the operating submode "clamping".
Cause of error	The error is activated only if the difference between the command position, set with the start, and the actual position is greater than MD32 (only active in the operating submode clamping) Causes: <ul style="list-style-type: none"> <li>- the axis was not clamped right</li> <li>- the mechanical forces are greater than the clamping</li> <li>- clamping tolerance (MD32) too small</li> </ul>
Repair	check mechanical clamping optimize clamping tolerance (MD32)

<b>25</b>	<b>Twin-drive tolerance exceeded (MD 29)</b>
Error significance	Between the two twin-drive axes, a difference of the actual value is registered which is greater than allowed in MD 29. (Kv factor, speed regulator, tachy, drift adjustment)
Cause of error	<ul style="list-style-type: none"> <li>- twin-drive axes are not perfectly synchronized</li> <li>- twin-drive tolerance is too small</li> <li>- drift caused by mechanical influence</li> <li>- actual value error</li> </ul>
Repair	Optimize twin-drive axes Correct twin-drive tolerance Check the mechanical system

<b>30</b>	<b>No absolute encoder module (MD 4)</b>
Error significance	No absolute encoder module
Cause of error	The absolute version was selected in MD4, but no absolute encoder submodule is present. Faulty connection between basic card and the absolute encoder submodule
Repair	Check MD 4: Control and encoder version Check plug connections

<b>31</b>	<b>Interference fault (MD 5)</b>
Error significance	The absolute encoder has sent actual value data which is not valid.
Cause of error	<p>For parallel absolute encoders:</p> <ul style="list-style-type: none"> <li>- Absolute encoder defective</li> <li>- Shielding of cable not good enough (connect shield to pin 1 on connector X 8/9/10)</li> <li>- Bad connection at one of the channel signals</li> <li>- Feed rate too high</li> </ul> <p>At speeds higher than 2m/min, at 1 <math>\mu</math>m resolution, it is not possible to use the multi readout of the position. It has to be disabled in MD 41. Furthermore, a GRAY code encoder should be used for safety reasons.</p> <p>For serial absolute encoders:</p> <ul style="list-style-type: none"> <li>- Cable break</li> <li>- Telegram not operative</li> <li>- Plug not connected</li> </ul>
Repair	<p>Check encoder</p> <p>Check connection cable and shielding</p> <p>Check feed rate</p>

<b>32</b>	<b>Parity fault (MD 5, MD 21)</b>
Error significance	An odd bit combination has been detected for the actual position.
Cause of error	<p>The WF 725/726 checks for even parity. If an odd bit combination is detected for the actual position then an error message is read out.</p> <ul style="list-style-type: none"> <li>- Parity signal not connected to PIN 26 on connector X 8/9/10</li> <li>- Encoder has no parity bit (MD 21)</li> <li>- bad plug connections</li> <li>- defective encoder</li> <li>- wrong number of steps of the absolute encoders (MD 5)</li> </ul>
Repair	<p>Check encoder, cable and connections</p> <p>Check MD 5, MD 21</p>

<b>33</b>	<b>Difference fault (MD 5, MD 34)</b>
Error significance	The actual position changed more than permitted in MD34.
Cause of error	<p>A path difference is calculated from the present position and the previously (4ms ago) read position. If this result is greater than MD34 four times in a row, then error 33 is activated.</p> <ul style="list-style-type: none"> <li>- Defective absolute encoder</li> <li>- Faulty cable or connector</li> <li>- Path difference (MD34) too small</li> <li>- Absolute encoder parameters (MD 21) are wrong</li> <li>- Number of steps of the absolute encoder (MD 5) are wrong</li> </ul>
Repair	<p>Check encoder, cable and connections.</p> <p>Check MD 5, MD 21, MD 34.</p>



<b>34</b>	<b>Masking error (MD 5, MD 7)</b>
Error significance	The range masked in MD7 has been violated.
Cause of error	The masked range (MD7) is subtracted every cycle from the position which is read in, e.g. symmetrically cut off. The result is checked for a low limit of 0 and for a high limit of the maximum number of steps (machine data). If those limits are violated error 34 appears <ul style="list-style-type: none"> <li>- defective cable</li> <li>- defective encoder</li> <li>- wrong number of steps (MD5)</li> <li>- wrong masking range (MD7)</li> </ul>
Repair	Check encoder, cable and connections Check MD 5, MD 7

<b>38</b>	<b>Zero mark faulty</b>
Cause of error	Path-measuring encoder is not in accordance with the permitted specification.
Repair	Replace it with a permitted encoder.

<b>39</b>	<b>Watch-Dog error</b>
Error significance	The watch-dog error on the WF module has reacted.
Cause of error	The watch-dog is an electric circuit of the hardware which monitors the processor. The WF software must tell the the watch-dog in fixed intervals (about 500 ms) that everything is correct. If there is an error of the WF software, e.g. continuous loop or cycle time overload, then the watch-dog switches the hardware of the WF module off. Furthermore, the S5 is stopped with execution of acknowledgement. After restart, error 39 will now be signalled.
Repair	When this error occurs, there is probably a firmware error which must be reported to the next Siemens agency for repair.

<b>40</b>	<b>ADC fault</b>
Error significance	Fault in the analog-digital-converter.
Cause of error	The voltage check has been activated in MD41. The analog-digital-converter used to check the voltage is defective, or the complete analogue part ( $\pm 15V$ ) of the module is defective.
Repair	Exchange module

<b>41</b>	<b>Voltage <math>\pm 15V</math> out of tolerance</b>
Error significance	The internal $\pm 15V$ are out of tolerance.
Cause of error	The ADC checks the $\pm 15V$ which is generated internally from the 5V. If this voltage exceeds a certain limit, then error 41 is activated. The fault might be in the $\pm 15V$ power supply or in the ADC.
Repair	Exchange module

<b>42</b>	<b>Voltage +15V out of tolerance</b>
Error significance	The internal +15V are out of tolerance.
Cause of error	The ADC checks the +15V which is generated internally from the 5V. If this voltage exceeds a certain limit, then error 42 is activated. The fault might be in the +15V power supply or in the ADC.
Repair	Exchange module

<b>43</b>	<b>Voltage -15V out of tolerance</b>
Error significance	The internal -15V are out of tolerance.
Cause of error	The ADC checks the -15V which is generated internally from the 5V. If this voltage exceeds a certain limit, then error 43 is activated. The fault might be in the -15V power supply or in the ADC.
Repair	Exchange module

<b>44</b>	<b>5V-fuse defective</b>
Error significance	The 5V-fuse is checked.
Cause of error	The ADC checks the 5V voltage. If it falls below a limit, then error 44 is activated. The 5V fuse or the ADC can be defective. A defective fuse can be caused by a short circuit on the 5V in the encoder part.
Repair	Check fuse Check encoder and cables Exchange module

<b>45</b>	<b>24V-fuse defective</b>
Error significance	The 24V-fuse is checked.
Cause of error	The ADC checks the 24V voltage. If it falls below a limit, then error 45 is activated. The 24V fuse or the ADC can be defective. A defective fuse can be caused by a short circuit on the 24V in the encoder part.
Repair	Check fuse Check 24V connections Exchange module

<b>46</b>	<b>Short circuit in the command value A/B/C</b>
Error significance	A short circuit has been detected in the command value A/B/C.
Cause of error	If the command value of an axis is > 1V and the measured voltage at the output of the DAC is 0V, then error 46 is activated. <ul style="list-style-type: none"> <li>- DAC defective</li> <li>- ADC defective</li> <li>- Command value overload or short-circuit</li> </ul>
Repair	Check command value Exchange module

<b>47</b>	<b>Back-up battery defective</b>
Error significance	The voltage of the back-up battery is checked.
Cause of error	<ul style="list-style-type: none"> <li>- Battery has voltage too low or is empty.</li> <li>- Hardware error of the absolute encoder module.</li> <li>- MD 4=0</li> </ul>
Repair	Exchange absolute encoder module

<b>49</b>	<b>EEPROM defective</b>
Cause of error	EEPROM defective or not connected
Repair	Connect or exchange EEPROM

<b>51</b>	<b>Brake value = 0</b>
Error significance	It is checked whether the cyclically subtracted brake distance = 0.
Cause of error	If the cyclically subtracted brake distance is zero during deceleration of the axis, then error 51 appears. Delay MD 2 = 0 Defective RAM-register.
Repair	Check MD 2: delay

<b>61</b>	<b>No block data</b>
Error significance	The processed block does not contain any information.
Cause of error	<ul style="list-style-type: none"> <li>- Wrong programming</li> <li>- Defect of the RAM- or EEPROM register</li> </ul>
Repair	Check program Exchange EEPROM Exchange module

<b>62</b>	<b>Missing block data</b>
Error significance	The executed block does not have a dwell time and/or M function nor a position and feed rate.
Cause of error	<ul style="list-style-type: none"> <li>- wrong programming</li> <li>- skipping of a block which has a latching function for the next block</li> <li>- Defect of the RAM- or EEPROM register</li> </ul>
Repair	Check program Check operation Exchange EEPROM Exchange module

<b>64</b>	<b>Block number 0 invalid</b>
Error significance	The block number selected on the interface = 0.
Cause of error	The block number in DL2 (DB axis) is "0" while the start signal was given in the operating submode Single Step.
Repair	Enter correct block number

<b>65</b>	<b>MDI: Position is missing</b>
Error significance	No position was given for positioning.
Cause of error	The start signal was given in the operating submode Manual Data Input (MDI) without entering a position. Error in the supply by user program.
Repair	Transfer position.

<b>66</b>	<b>MDI: Feed rate is missing</b>
Error significance	No feed rate was given for positioning.
Cause of error	The start signal was given in the operating submode Manual Data Input (MDI) without entering a feed rate. Error in the supply by user program.
Repair	Transfer feed rate

<b>67</b>	<b>Block number not available</b>
Error significance	A block number was selected which was not programmed.
Cause of error	The start signal was given in the operating submode Single Step with a block number which does not exist. A block which does not exist was searched in the operating submodes Automatic Cycle and Automatic Single Step. Error in the supply by user program.
Repair	Enter correct block number

<b>68</b>	<b>Number of blocks per program not valid</b>
Error significance	A program has more than 40 blocks (WF 725) or 200 blocks (WF726).
Cause of error	A program was made with more than 40 blocks (WF 725) or 200 blocks (WF 726). In the operating submodes Single Step, Automatic Cycle and Automatic Single Step, the number of blocks in the program is checked with every start signal. If more than 40 or 200 blocks are detected then error 68 is activated.
Repair	Limit program length to 40 (WF 725) or 200 (WF 726) blocks.

<b>69</b>	<b>Operating submode in slave-axis 0</b>
Error significance	The operating submode "0" was not set in the slave axis for the MASTER (slave operation).
Cause of error	As soon as combined functions like twin-drive or the combined program are used, the operating submode "0" must be set in the slave axes. If this is not the case, then error 69 is read out in the slave axes (and error 6B in the master axis) Selection MASTER/SLAVE operation is realized for use of the overlay via the SLAVE/MASTER bit.
Repair	Set operating submode in the slave axes Enter S/M bit correctly Cancel combined functions

<b>6A</b>	<b>Error in slave-axis</b>
Error significance	If there is an error in the slave axis it will be signalled in the master axis with error 6A.
Cause of error	An error appears during the processing of a combined function (e.g. error 111). As the master axis can also no longer key its function, error 6A will be signalled.
Repair	Find and repair the cause of error

<b>6B</b>	<b>Operating submode in slave-axis 0</b>
Error significance	The operating submode in slave-axis 0
Cause of error	Error 69 means operating submode 0 and is read out in the slave axis. Error 6A means any kind of error in the slave axis and will be read-out in the master axis. Exception: If error 69 is read out in the slave axis then error 6B will be signalled in the master axis.
Repair	Find and repair the cause of error

<b>6C</b>	<b>Program number changed</b>
Cause of error	During the processing of a program, the program number was changed.
Repair	Avoid the program number to be changed during the processing of a program.

<b>6D</b>	<b>MD 1/2 and/or MD 38/39 are different during twin-drive</b>
Error significance	MD 1 (acceleration) or MD 2 (deceleration) respectively MD 38 and MD 39 of the concerned axes must be identical for twin-drive.
Cause of error	If a twin-drive function is started, the WF 726 controls MD1 and MD2 or MD 38 and MD 39 of the concerned axes. The traversing movement is stopped with error 61 when these axes are not identical.
Repair	MD 1/2 of the Master must be identical with MD 1/2 of the slave. MD 38/39 of the Master must be identical with MD 38/39 of the slave.

<b>70</b>	<b>Absolute measure not valid for roller feed</b>
Error significance	It was tried to program G90 in the roller feed version.
Cause of error	As soon as the WF is operated as W., only traversing blocks with incremental measuring (G91) must be programmed in the operating submodes "MANUAL INPUT", "SINGLE BLOCK", "SINGLE STEP" or "AUTOMATIC SUBMODE"
Repair	Change G90 to G91.

<b>71</b>	<b>Delay = 0</b>
Error significance	MD 2 = 0 during the traversing enable.
Cause of error	MD 2 = 0 RAM register defective
Repair	Enter MD 2 correctly.

<b>72</b>	<b>Fixed setpoint level = 0</b>
Error significance	The speed value of the selected fixed level= 0
Cause of error	"0" was set as speed value for selected fixed level. RAM register defective
Repair	Enter correct speed value.

<b>73</b>	<b>Speed = 0</b>
Error significance	A block with speed "0" was entered.
Cause of error	Error 73 is signalled when the actual speed as well as the command speed are zero during the traversing without activation of the override of zero %.
Repair	Control and correct block data

<b>74</b>	<b>Reference point speed 1 = 0</b>
Cause of error	Reference speed 1 was entered with 0.
Repair	Enter correct reference speed 1

<b>75</b>	<b>Reference point speed 2 = 0</b>
Cause of error	Reference speed 2 was entered with 0.
Repair	Enter correct reference speed 2

<b>76</b>	<b>Reference point speed 3 = 0</b>
Cause of error	Reference speed 3 was entered with 0.
Repair	Enter correct reference speed 3

<b>77</b>	<b>Both directions are selected (Jog +/-)</b>
Error significance	Both directions were selected with the start in the operating submodes "reference point approach" or "control".
Cause of error	Error in operating The old direction must be cancelled before activation of a new direction, otherwise it is not set clearly.
Repair	Correct setting of direction

<b>78</b>	<b>No direction is selected (Jog +/-)</b>
Error significance	No direction was selected with the start in the operating submodes "reference point approach" or "control".
Cause of error	Error in operating Submode Control: The polarity of the entered voltage must also be entered. Submode Reference point approach: The WF does not have the information in which direction the reference cam is located because it is not approached.
Repair	Correct setting of direction

<b>79</b>	<b>Selection of direction is changed (Jog +/- )</b>
Error significance	In the operating submode "Reference point approach" the setting of direction was changed during the traversing movement.
Cause of error	Error in operating
Repair	Correct setting of direction

<b>7A</b>	<b>Open loop: The fourth G group is not valid</b>
Error significance	Combined programs can be generated with the WF 726. However, the function is not valid for use of open loop version
Cause of error	Combined programs were entered for the open loop version.
Repair	Correct programs

<b>80</b>	<b>Program number 0 is not allowed</b>
Cause of error	Error in operating A program was started with the setting of "0" as program number.
Repair	Enter correct program number

<b>81</b>	<b>Program number not available</b>
Cause of error	Error in operating It was tried to start a program which does not exist. The wrong program number and/or the wrong memory (EEPROM/RAM) was set..
Repair	Enter correct program number Check the selection EEPROM/RAM

<b>82</b>	<b>Program without block data</b>
Cause of error	Error in operating The selected program number was declared valid for the concerned axis. However, there is no block data available in the memory.
Repair	Enter block data

<b>83</b>	<b>1st G-Function not permitted</b>
Cause of error	Programming error From the block list, an unpermitted G-function of the 1st group was loaded.
Repair	Enter correct G-function



<b>84</b>	<b>2nd G-Function not permitted</b>
Cause of error	Programming error From the block list, an unpermitted G-function of the 2nd group was loaded.
Repair	Enter correct G-function

<b>85</b>	<b>3rd G-Function not permitted</b>
Cause of error	Programming error From the block list, an unpermitted G-function of the 3rd group was loaded.
Repair	Enter correct G-function

<b>86</b>	<b>4th G-Function not permitted</b>
Cause of error	Programming error From the block list, an unpermitted G-function of the 4th group was loaded.
Repair	Enter correct G-function

<b>87</b>	<b>Cancelling of tool offset although not active</b>
Cause of error	Operating or programming error During the processing of a program, the tool offset was cancelled although it was not selected. This can be caused for example by the masking of the block in which tool offset was selected.
Repair	Check cause of program Check program data

<b>88</b>	<b>Masking of last block data not permitted</b>
Cause of error	Programming error The last block in the program was marked as a masking block, and in the interface, the bit for "skip a block" was set.
Repair	The last block of a program must not be masked.

<b>89</b>	<b>Cancelling of zero marker shift although not active</b>
Cause of error	Operating or programming error During the processing of a program, the zero marker shift was cancelled although it was not selected. This can be caused for example by the masking of the block in which zero marker shift was selected.
Repair	Check cause of program Check program data

<b>90</b>	<b>Program number not permitted (validity)</b>
Cause of error	Operating or programming error A program was started in an axis to which it was not assigned to when validity was entered.
Repair	Check validity.

<b>91</b>	<b>UP-level is not permitted</b>
Error significance	When a program was called, an unpermitted level was reached.
Cause of error	Programming error Two sub-program levels are permitted at most for the WF. If a jump to a third level is programmed, then error 91 is signalled.
Repair	Check and correct program.

<b>92</b>	<b>"Set actual value" already active (G92)</b>
Cause of error	Programming error "Set actual value" was activated during the processing of a program although it was already selected.
Repair	Keep order of selection/cancelling for "Set actual value".

<b>93</b>	<b>"Set actual value" not yet active</b>
Cause of error	Programming error "Set actual value" was cancelled during the processing of a program although it was not yet selected.
Repair	Keep order of selection/cancelling for "Set actual value".

<b>95</b>	<b>Pre-limit switch negative (MD 11)</b>
Cause of error	The command position (LR) or the actual position (AK) are on or in negative direction from the pre-limit switch. The axis stands in negative direction from the MD 11, and the traversing direction is set with negative.
Repair	Check MD 11: Pre-limit switch negative Check MD 16: Reference point coordinate Check MD 28: Actual value coordinate

<b>96</b>	<b>Pre-limit switch positive (MD 13)</b>
Cause of error	The command position (LR) or the actual position (AK) are on or in positive direction from the pre-limit switch. The axis stands in positive direction from the MD 11, and the traversing direction is set with positive.
Repair	Check MD 11: Pre-limit switch negative Check MD 16: Reference point coordinate Check MD 28: Actual value coordinate

<b>99</b>	<b>HW version &lt; 2: Simultaneous reference point approach of several axes is not possible</b>
Cause of error	This error can only occur with the WF 725.
Repair	When MD 15 is parametrized with 2, the axes can only traverse to the reference point one after another.

<b>B0</b>	<b>Buffer number not permitted</b>
Error significance	Fixed buffer numbers are assigned to the axes for the operating submode "AUTOMATIC buffer": Axis A: Buffer 1 + 2 Axis B: Buffer 3 + 4 Axis C: Buffer 5 + 6
Cause of error	Error in operating It was tried to start a buffer which is not assigned to the selected axis.
Repair	Select correct axis Enter correct buffer number

<b>B1</b>	<b>Buffer number not enabled</b>
Error significance	The started buffer is not yet enabled. Only a completely loaded buffer can be started.
Cause of error	Error in operating: Buffer not yet loaded Buffer deleted: Wrong buffer number was set
Repair	Load buffer Enter correct buffer number

<b>B2</b>	<b>Buffer: M11 not permitted</b>
Error significance	The function M11 can cause an automatic buffer change in the 1st, the 3rd or the 5th buffer.
Cause of error	Programming error A program which was loaded in buffer 1, 3 or 5, contains the M function M11
Repair	Enter M function correctly

<b>B3</b>	<b>Buffer: M12 not permitted</b>
Error significance	The function M11 can cause an automatic buffer change in the 2nd, the 4th or the 6th buffer.
Cause of error	Programming error A program which was loaded in buffer 2, 4 or 6, contains the M function M12
Repair	Enter M function correctly

<b>B9</b>	<b>"Flying setting of actual value": MD15 not programmed</b>
Error significance	"Flying setting of actual value" can be programmed in a traversing block. The setting of actual value is caused by a fast input which must be programmed over MD 15.
Cause of error	Programming error The fast input "setting of actual value" was not programmed in MD 15.
Repair	Correct MD 15

<b>D0</b>	<b>Jerk limit for acceleration too high</b>
Error significance	MD 38            1950        at        1µm resolution 19500        at        10µm resolution 195000        at        100µm resolution
Cause of error	The value for MD 38 is higher than allowed.
Repair	Correct MD 38: Jerk limit for acceleration

<b>D1</b>	<b>Jerk limit for deceleration too high</b>
Error significance	MD 39            1950        at        1µm resolution 19500        at        10µm resolution 195000        at        100µm resolution
Cause of error	The value for MD 39 is higher than allowed.
Repair	Correct MD 38: Jerk limit for deceleration

<b>D2</b>	<b>Interpolation and jerk limit not simultaneously possible</b>
Cause of error	The functions nterpolation (by means of G17, G18 or G19) and jerk limit (MD 38 or MD 39) cannot be executed simultaneously.
Repair	Correct MD 38: Jerk limit for deceleration

## 6.2.2 Errors in the MODE Program input/output

	<b>101</b>	<b>EEPROM: Addressing error</b>
Cause	Defective EEPROM	
Repair	Change EEPROM	

	<b>102</b>	<b>RAM: Addressing error</b>
Cause	Defective RAM	
Repair	Change module	

	<b>105</b>	<b>EEPROM: data storage not possible</b>
Cause	No data can be stored in the EEPROM when the axis is in the processing state (operations engaged).	
Repair	Save data during standstill	

	<b>111</b>	<b>Input/output is not possible simultaneously</b>
Cause	It was tried to read in and out at the same time.	
Repair	This error is blocked by Standard I which prevents simultaneous input and output.	

	<b>112</b>	<b>Data coding 0 not permitted</b>
Cause	"0" was selected as data code for input/output	
Repair	Enter correct Data coding	

	<b>113</b>	<b>Data coding not permitted</b>
Cause	An unpermitted data code was selected for input/output.	
Repair	Enter correct Data coding	

	<b>114</b>	<b>Axis number 0 not permitted</b>
Cause	No axis number was set for input/output.	
Repair	This error is blocked by Standard I which organises assignment of the axis number.	

	<b>121</b>	<b>MD number not permitted</b>
Cause	The MD number was entered as "0" or greater than 50.	
Repair	Enter correct MD number	

	<b>123</b>	<b>Maximum number of blocks stored</b>
Cause	The RAM or EEPROM memory is full. WF 725: EEPROM 50 blocks RAM 50 blocks WF 726: EEPROM 350 blocks RAM 50 blocks The number of blocks is entered in the OB 21 at parameter S/EP.	
Repair	Control if correct block capacity is entered at parameter S/EP.	

	<b>124</b>	<b>Maximum number of programs stored</b>
Cause	Too many programs cannot be stored on the WF module. WF 725: maximum of 10 programs WF 726: maximum of 64 programs	
Repair	Check if all programs are still needed.	

	<b>125</b>	<b>Program number 0 not permitted</b>
Cause	Error in operating For input/output or deleting a block, "0" was set as program number.	
Repair	Enter correct program number	

	<b>126</b>	<b>Block number 0 not permitted</b>
Cause	Error in operating For input/output or deleting a block, "0" was set as block number.	
Repair	Enter correct block number	

	<b>127</b>	<b>Program number not available</b>
Cause	Error in operating A program number which is not on the module was set for output or deleting a program.	
Repair	Enter correct program number	

	<b>128</b>	<b>Block number not available</b>
Cause	Error in operating A block number which is not on the module was set for output or deleting a program.	
Repair	Enter correct block number	

	<b>129</b>	<b>No blocks available</b>
Cause	For output of available programs, the selected program was declared valid but it contains no block numbers.	
Repair	Enter blocks first	

	<b>130</b>	<b>Validity is missing</b>
Error significance	The selected program has no validity.	
Cause	Error in operating Declaration of validity was forgotten when the program was entered.	
Repair	Declare program valid	

	<b>131</b>	<b>EEPROM: Socket empty</b>
Cause	EEPROM defective or not plugged in	
Repair	Plug in or change EEPROM	

	<b>132</b>	<b>EEPROM: Programming error</b>
Cause	When the EEPROM was programmed, there is a read-process to every write-process for control of entered data. A defective EEPROM cell was registered hereby.	
Repair	Exchange module or EEPROM	

	<b>135</b>	<b>TEACH IN: Program number 0 not permitted</b>
Cause	"0" was set as program number for TEACH IN.	
Repair	Enter correct program number	

	<b>136</b>	<b>TEACH IN: Block number 0 not permitted</b>
Cause	Error in operating "0" was set as block number for TEACH IN.	
Repair	Enter correct block number	

	<b>137</b>	<b>TEACH IN: No program number free</b>
Cause	With TEACH IN this error appears at the 11th program of the WF 725 the 65th program of the WF 726. Only 10 or 64 programs are valid at the most.	
Repair	Keep limitations	

	<b>138</b>	<b>TEACH IN: Memory full</b>
Cause	There is no space in the WF memory for another block. WF 725: max. 50 blocks WF 726: max. 350 blocks	
Repair	Keep limitations	

	<b>142</b>	<b>Tool offset number not permitted</b>
Cause	The tool offset number was entered with "0" or greater than 20.	
Repair	Enter correct tool offset number	

	<b>143</b>	<b>RELOAD: Block number not permitted</b>
Cause	Error in operating Operating error: For buffer operation, the length of the buffer is set before it is loaded.	
Repair	Buffer length and number of blocks for reloading must be the same.	

	<b>144</b>	<b>RELOAD: wrong order of blocks</b>
Cause	For buffer reloading the blocks must be transferred without a gap in ascending order, beginning with block number 1.	
Repair	Set correct order of block numbers	

	<b>145</b>	<b>Speed in operating submode MDI = 0 / page number 0 not permitted</b>
Cause	Error in operating - It was tried to transfer the speed "0" in the data coding 1A <sub>Hex</sub> of the submode MDI - "0" was set as page number for output of existing programs or blocks.	
Repair	Enter correct speed Enter correct page number	



	<b>146</b>	<b>RELOAD: No block information</b>
Cause	Programming error The traversing blocks contain no other information except the block numbers.	
Repair	Enter block information correctly	

	<b>147</b>	<b>RELOAD: Block number 0 or &gt;50 not permitted</b>
Cause	Programming error Block number "0" or a number greater than 50 was entered.	
Repair	Keep limitations	

	<b>148</b>	<b>Diagnosis: Additional coding not permitted</b>
Cause	Error in operating For output of diagnosis information, a data code which is not valid was set.	
Repair	Enter correct additional code	

	<b>151</b>	<b>RELOAD: Buffer number not permitted</b>
Error significance	The 6 available buffers have fixed assignments to the 3 axes on the module: Buffer 1 + 2 : Axis A Buffer 3 + 4 : Axis B Buffer 5 + 6 : Axis C	
Cause	Buffering "0" or greater than 6 was set, or the buffer number and the axis are not in accordance with each other.	
Repair	Enter correct buffer number	

	<b>152</b>	<b>RELOAD: Number of blocks &gt; 50</b>
Cause	Error in operating A buffer size greater than 50 was entered.	
Repair	Keep limitations	

	<b>155</b>	<b>RELOAD: Buffer number 0 not permitted</b>
Cause	Error in operating "0" was selected as the number for setting the buffer length.	
Repair	Enter correct buffer number	

	<b>173</b>	<b>Interpolation: missing block information</b>
Cause	Programming error: - the block data for interpolation is not complete - Position is missing - Speed is missing	
Repair	Enter missing block data	

	<b>174</b>	<b>Interpolation: 4.G-function not permitted</b>
Cause	Programming error The following 3 G-functions are used for interpolation: G17 Interpolation between A + B G18 Interpolation between A + C G19 Interpolation between B + C Error 174 is signalled when this assignment is not kept.	
Repair	Enter correct G-function and axis markings.	

	<b>181</b>	<b>Interpolation: Order of input not permitted</b>
Cause	Programming error The order which is set has to be kept for input of interpolation blocks, because the blocks are already converted when entered. Fixed order: 1. The pair of interpolation blocks must be entered in sequence. 2. The order must always be in the direction of the ascending number.	
Repair	Keep correct order	

# 7 Bibliography

## Available manuals

Documentation:

necessary  or sensible  for using the software for

### WF modules with SIMATIC S5

Planning Instructions  
Hardware  
6ZB5 440-0GJ02-0AA2

Planning Instructions  
Software Shell  
6ZB5 440-0GK02-0AA2

Planning Instructions  
Software I, II, III  
6ZB5 440-0GL02-0AA3

Installation Instructions  
Description  
6ZB5 440-0FW02-0AA3

Installation Instructions  
Lists  
6ZB5 440-0JQ02-0AA2

Operating Instructions  
Standard II with WS 780  
6ZB5 440-0FY02-0AA0

Operating Instructions  
Standard III with WF 470  
6ZB5 440-0FX02-0AA1

WF 470 Description  
Video Display Module  
6ZB5 440-0QS02-0AA2

Programming instruction  
6ZB5 440-0GA02-0AA1

Description  
Software COM 726  
6ZB5 440-0AX02-0AA4

	FB-Schale +							
	S I-726	S I-726 + S II-726	S I-726 + S III-726	S I-726 + COM 726	S I-726	S I-726 + S II-726	S I-726 + S III-726	S I-726 + COM 726
Planning Instructions Hardware 6ZB5 440-0GJ02-0AA2								
Planning Instructions Software Shell 6ZB5 440-0GK02-0AA2								
Planning Instructions Software I, II, III 6ZB5 440-0GL02-0AA3								
Installation Instructions Description 6ZB5 440-0FW02-0AA3								
Installation Instructions Lists 6ZB5 440-0JQ02-0AA2								
Operating Instructions Standard II with WS 780 6ZB5 440-0FY02-0AA0								
Operating Instructions Standard III with WF 470 6ZB5 440-0FX02-0AA1								
WF 470 Description Video Display Module 6ZB5 440-0QS02-0AA2								
Programming instruction 6ZB5 440-0GA02-0AA1								
Description Software COM 726 6ZB5 440-0AX02-0AA4								



Siemens AG

AUT V240  
Postfach 3180  
D-91050 Erlangen  
Fed. Rep. of Germany

**Corrections**

For Publication/Manual:  
Equipment for special machines  
WF 725/WF 726  
Positioning modules

Installation Instructions - Description

Order-No.: 6ZB5 440-0FW02-0AA3  
Edition: January 1993

**From:**

Name \_\_\_\_\_

Company/Dept. \_\_\_\_\_

Address \_\_\_\_\_

Telephone            / \_\_\_\_\_

If you find any printing errors when reading this publication, please let us know, using this form. We also welcome any suggestions to improve the manual.

**Suggestions and/or corrections**

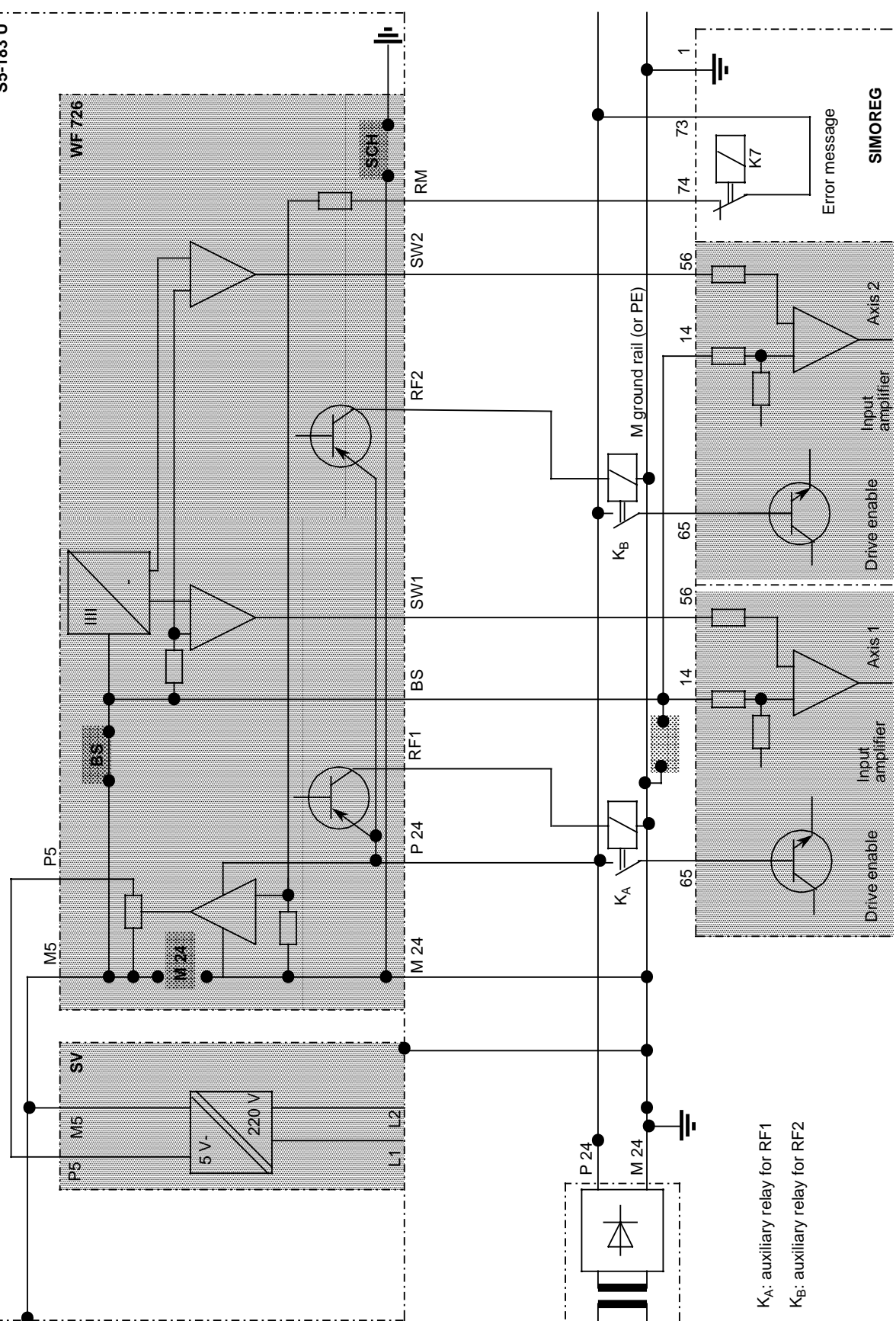

K<sub>A</sub>: auxiliary relay for RF1  
K<sub>B</sub>: auxiliary relay for RF2

# Equipment for special machines

## WF 725/WF 726

### Manual

Siemens AG  
Automation Group  
Automation Systems  
for Machine Tools, Robots  
and Special-Purpose Machines  
P.O. Box 31 80, D-91050 Erlangen  
Federal Republic of Germany

© Siemens AG 1994 All Rights Reserved  
Subject to change without prior notice  
570 093 300 335