

Block Diagram

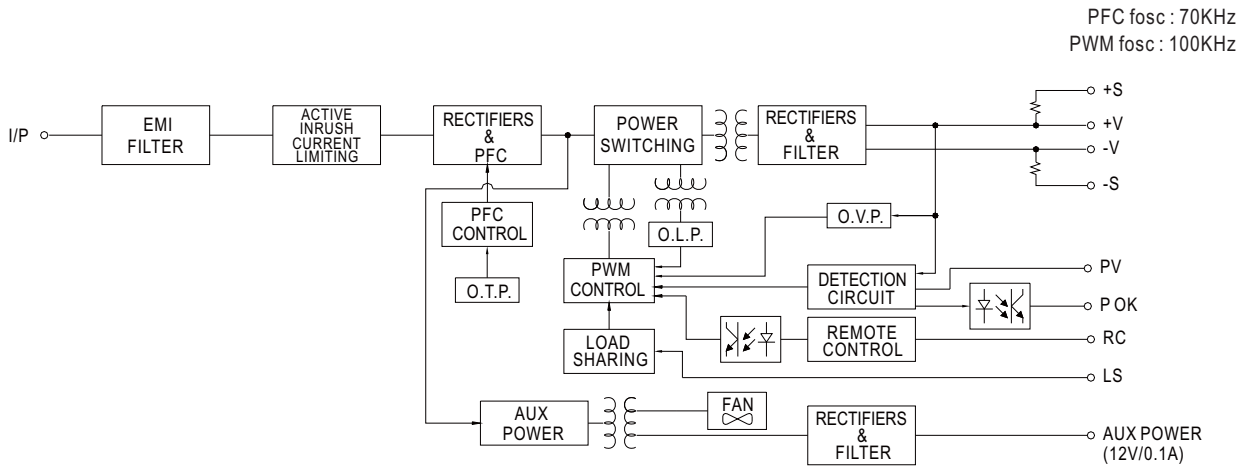

Static Characteristics

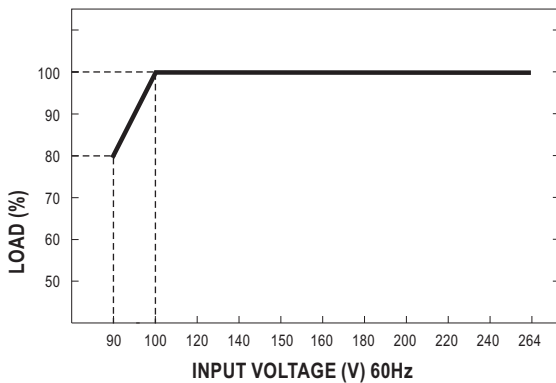

INPUT \ MODEL	5V	12V	15V
100~264VAC	1200W 240A	1500W 125A	1500W 100A
90VAC	960W 192A	1200W 100A	1200W 80A
INPUT \ MODEL	24V	27V	48V
100~264VAC	1512W 63A	1512W 56A	1536W 32A
90VAC	1209.6W 50.4A	1209.6W 44.8A	1228.8W 25.6A

Derating Curve

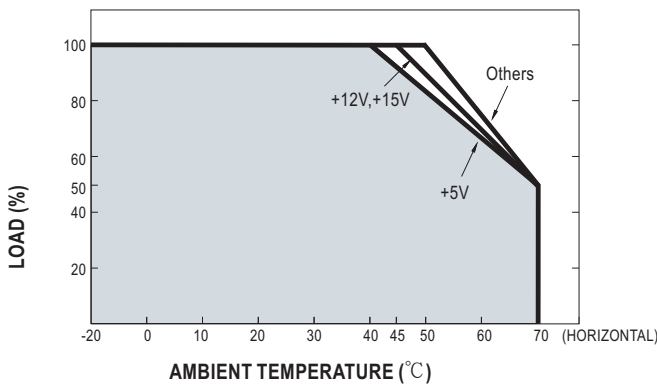

Efficiency vs Load (48V Model)

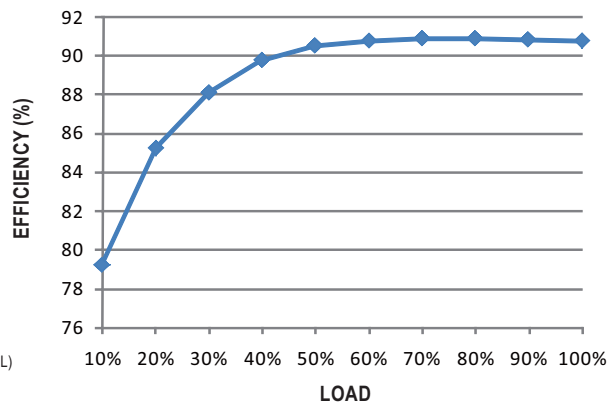

© The curve above is measured at 230VAC.

■ Function Manual

1. Remote Sense

※ The Remote Sense compensates voltage drop on the load wiring up to 0.3V

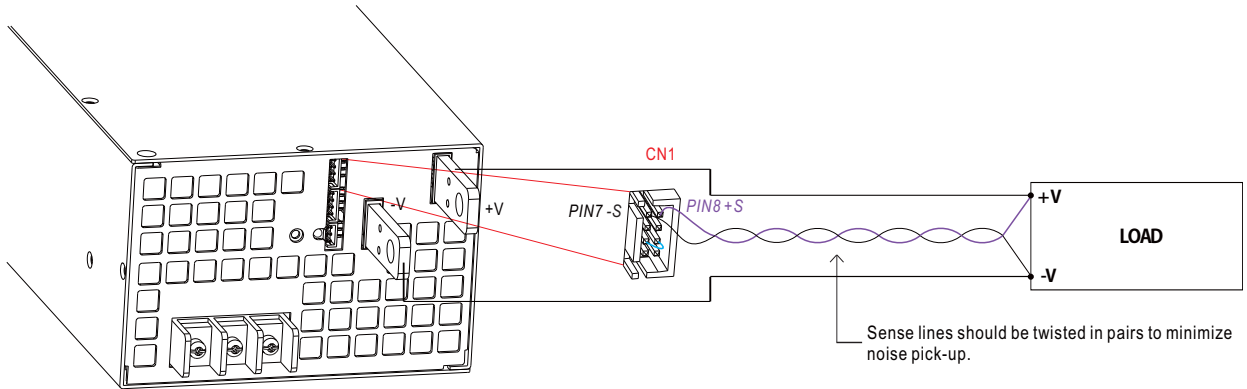

2. Output Voltage Programming (or, PV / remote voltage programming / remote adjust / margin programming / dynamic voltage trim)

※ In addition to the adjustment via the built-in potentiometer, the output voltage can be trimmed to 70~100%(Typ.) of the nominal voltage by applying EXTERNAL RESISTANCE

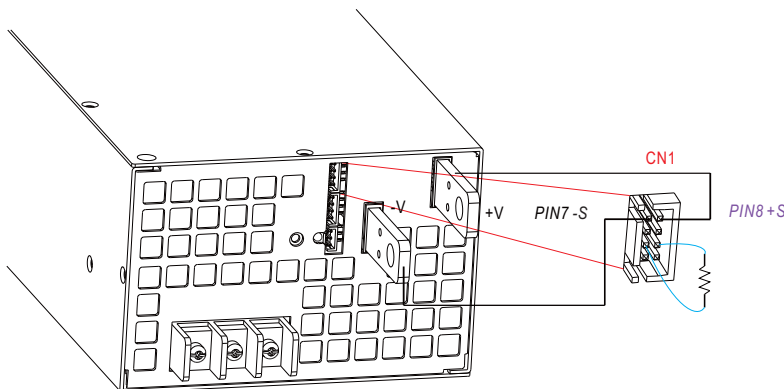

◎ Connect an external resistor between TRIM(pin4) & -S(pin3 or pin4 or pin5) on CN1 or CN2, and +S & +V, -S & -V also need to be connected.

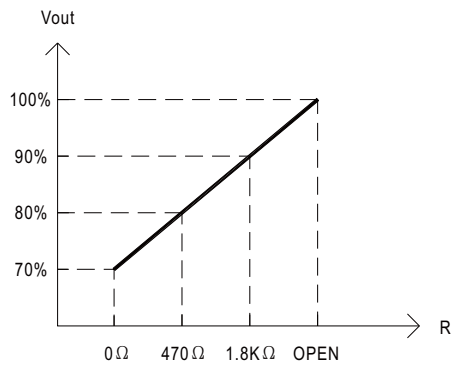

Fig. 2.2 External Resistance (Typical)