

EDSVS9332S-EXT
13375724

Global Drive

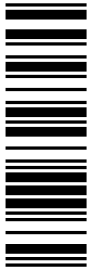

System Manual

(Extension)

9300

0.37 ... 75 kW



EVS9321xS ... EVS9332xS

Servo inverter

Lenze

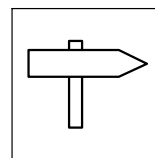

1	Preface	1-1
1.1	How to use this System Manual	1-3
1.1.1	Information provided by the System Manual	1-3
1.1.2	Document history	1-4
1.1.3	Products to which the System Manual applies	1-5
1.2	Definition of notes used	1-6
2	Configuration	2-1
2.1	Configuration with Global Drive Control	2-3
2.2	Basic configurations	2-4
2.2.1	Changing the basic configuration	2-5
2.2.2	Speed control C0005 = 1XXX (1000)	2-6
2.2.3	Torque control with speed limitation 4000	2-11
2.2.4	Master frequency coupling	2-13
2.2.5	Speed synchronism	2-25
2.2.6	Angular synchronism	2-26
2.3	Operating modes	2-36
2.3.1	Parameter setting	2-36
2.3.2	Control	2-36
2.4	Change of the terminal assignment	2-37
2.4.1	Freely assignable digital inputs	2-37
2.4.2	Freely assignable digital outputs	2-39
2.4.3	Freely assignable analog inputs	2-39
2.4.4	Freely assignable monitor outputs	2-40
3	Function library	3-1
3.1	Working with function blocks	3-3
3.1.1	Signal types	3-3
3.1.2	Elements of a function block	3-4
3.1.3	Connecting function blocks	3-6
3.1.4	Entries into the processing table	3-10
3.2	Function blocks	3-12
3.2.1	Table of function blocks	3-12
3.2.2	Table of free control codes	3-14
3.2.3	Addition block (ADD)	3-16
3.2.4	Automation interface (AIF-IN)	3-17
3.2.5	Automation interface (AIF-OUT)	3-20
3.2.6	Analog inputs via terminal X6/1, X6/2 and X6/3, X6/4 (AIN)	3-22
3.2.7	AND operation (AND)	3-24
3.2.8	Inverter (ANEG)	3-28
3.2.9	Analog output via terminal 62/63 (AOUT)	3-29
3.2.10	Arithmetic block (ARIT)	3-31

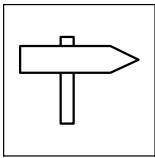

Contents

3.2.11	Arithmetic block (ARITPH)	3-32
3.2.12	Analog signal changeover switch (ASW)	3-33
3.2.13	Holding brake (BRK)	3-35
3.2.14	System bus (CAN-IN)	3-40
3.2.15	System bus (CAN-OUT)	3-41
3.2.16	Comparator (CMP)	3-42
3.2.17	Signal conversion (CONV)	3-47
3.2.18	Angle conversion (CONVPHA)	3-50
3.2.19	Angle conversion (CONVPHPH)	3-51
3.2.20	Speed conversion (CONVPP)	3-52
3.2.21	Characteristic function (CURVE)	3-53
3.2.22	Dead band (DB)	3-56
3.2.23	Control of the drive controller (DCTRL)	3-57
3.2.24	Master frequency input (DFIN)	3-62
3.2.25	Digital frequency output (DFOUT)	3-65
3.2.26	Digital frequency ramp function generator (DFRFG)	3-69
3.2.27	Digital frequency processing (DFSET)	3-75
3.2.28	Delay elements (DIGDEL)	3-81
3.2.29	Freely assignable digital inputs (DIGIN)	3-84
3.2.30	Freely assignable digital outputs (DIGOUT)	3-85
3.2.31	First order derivative-action element (DT1)	3-86
3.2.32	Free piece counter (FCNT)	3-87
3.2.33	Free digital outputs (FDO)	3-88
3.2.34	Freely assignable input variables (FEVAN)	3-90
3.2.35	Fixed setpoints (FIXSET)	3-95
3.2.36	Flipflop element (FLIP)	3-97
3.2.37	Gearbox compensation (GEARCOMP)	3-100
3.2.38	Limiting element (LIM)	3-101
3.2.39	Internal motor control (MCTRL)	3-102
3.2.40	Mains failure control (MFAIL)	3-111
3.2.41	Motor phase failure detection (MLP)	3-122
3.2.42	Monitor outputs of monitoring system (MONIT)	3-123
3.2.43	Motor potentiometer (MPOT)	3-125
3.2.44	Logic NOT	3-128
3.2.45	Speed setpoint conditioning (NSET)	3-130
3.2.46	OR operation (OR)	3-135
3.2.47	Oscilloscope function (OSZ)	3-138
3.2.48	Process controller (PCTRL1)	3-142
3.2.49	Angle addition block (PHADD)	3-145
3.2.50	Angle comparator (PHCMP)	3-146
3.2.51	Actual angle integrator (PHDIFF)	3-148
3.2.52	Signal adaptation for angle signals (PHDIV)	3-149
3.2.53	Phase integrator (PHINT)	3-150

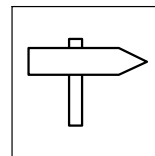

3.2.54	Delay element (PT1-1)	3-156
3.2.55	CW/CCW/QSP linking (R/L/Q)	3-157
3.2.56	Homing function (REF)	3-158
3.2.57	Ramp function generator (RFG)	3-164
3.2.58	Sample and hold function (S&H)	3-166
3.2.59	S-shaped ramp function generator (SRFG)	3-167
3.2.60	Output of digital status signals (STAT)	3-169
3.2.61	Control of a drive network (STATE-BUS)	3-170
3.2.62	Storage block (STORE)	3-171
3.2.63	Multi-axis synchronisation (SYNC1)	3-175
3.2.64	Edge evaluation (TRANS)	3-183
4	Application examples	4-1
4.1	Important notes	4-3
4.2	Speed control (C0005 = 1000)	4-4
4.3	Torque control with speed limitation (C0005 = 4000)	4-7
4.4	Master frequency - Master - Drive (C0005 = 5000)	4-9
4.5	Master frequency bus - slave - drive (C0005 = 6000)	4-12
4.6	Master frequency cascade - slave - drive (C0005 = 7000)	4-14
5	Appendix	5-1
5.1	Glossary	5-3
5.1.1	Terminology and abbreviations used	5-3
5.2	Index	5-5

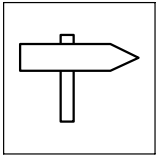

Contents

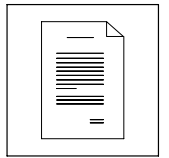

1 Preface

Contents

1.1	How to use this System Manual	1-3
1.1.1	Information provided by the System Manual	1-3
1.1.2	Document history	1-4
1.1.3	Products to which the System Manual applies	1-5
1.2	Definition of notes used	1-6

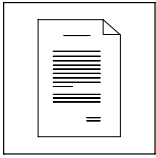

Preface and general information

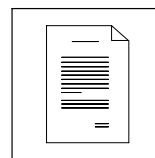

1.1 How to use this System Manual

1.1.1 Information provided by the System Manual

Target group

This System Manual addresses to all persons who dimension, install, commission, and set 9300 servo inverters.

Together with the System Manual, document no. EDSVS9332S, and the catalogue, it forms the basis for project planning for the manufacturer of plants and machinery.

Contents

The System Manual (Extension) completes the System Manual, document no. EDSVS9332S:

- The features and functions are described in detail.
- It describes additional possible applications in detail.
- Examples describe how to set the parameters for typical applications.
- In case of doubt always the mounting instructions supplied with the 9300 servo inverter are valid.

Contents of the System Manual	Contents of the System Manual (Extension)
1 Preface	1 Preface
2 Safety	-
3 Technical data	-
4 Mounting the standard device	-
5 Wiring the standard device	-
6 Commissioning	-
7 Parameter setting	-
8 Configuration	2 Configuration
8.1 Monitoring	2.1 Configuration with Global Drive Control
8.2 Monitoring functions	2.2 Basic configurations
8.3 Code table	2.3 Modes of operation
8.4 Selection lists	2.4 Change of the terminal assignment
8.5 Table of attributes	
-	3 Function library
-	4 Application examples
9 Troubleshooting and fault elimination	-
10 DC-bus operation	-
11 Safe standstill	-
12 Accessories	-
13 Appendix	5 Appendix

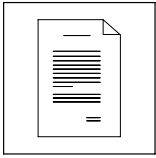

Preface and general information

How to use this System Manual

Document history

How to find information

Use the System Manual as the basis. It contains references to the corresponding chapters in the System Manual Supplement:

- Each chapter is a complete unit and comprehensively informs about a subject.
- The Table of Contents and Index help you to find all information about a certain topic.
- Descriptions and data of other Lenze products (Drive PLC, Lenze geared motors, Lenze motors, ...) can be found in the corresponding catalogs, Operating Instructions and manuals. The required documentation can be ordered at your Lenze sales partner or downloaded as PDF file from the Internet.



Note!

Information and tools concerning the Lenze products can be found in the download area under

<http://www.Lenze.com>

1.1.2 Document history

What is new / what has changed?

Material number	Version			Description
13375724	2.0	03/2012	TD23	Error corrections
13296208	1.0	05/2010	TD23	Extended by functions for software version 8.0 Error correction Division of the System Manual into 2 parts (EDSVS9332S and EDSVS9332S-EXT)

Preface and general information

How to use this System Manual
Products to which the System Manual applies

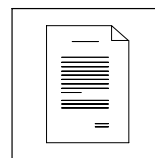

1.1.3 Products to which the System Manual applies

This documentation is valid for 9300 servo inverters as of nameplate data:

	①		②		③			
	EVS	93xx	-	x	S	Vxx	1x	8x
Product series	EVS = Servo controller							
Type no. / rated power	400V 480 V							
9321 =	0.37 kW	0.37 kW						
9322 =	0.75 kW	0.75 kW						
9323 =	1.5 kW	1.5 kW						
9324 =	3.0 kW	3.0 kW						
9325 =	5.5 kW	5.5 kW						
9326 =	11 kW	11 kW						
9327 =	15 kW	18.5 kW						
3928 =	22 kW	30 kW						
9329 =	30 kW	37 kW						
9330 =	45 kW	45 kW						
9331 =	55 kW	55 kW						
9332 =	75 kW	90 kW						
Design	E = Panel-mounted unit C = Built-in unit in "cold plate" technique							
Model	S = Servo inverter							
Variant	- Standard V003 = In "cold plate" technique V004 = With "safe standstill" function V100 = For IT systems V104 = With "safe standstill" function and for IT systems							
Hardware version								
Software version								

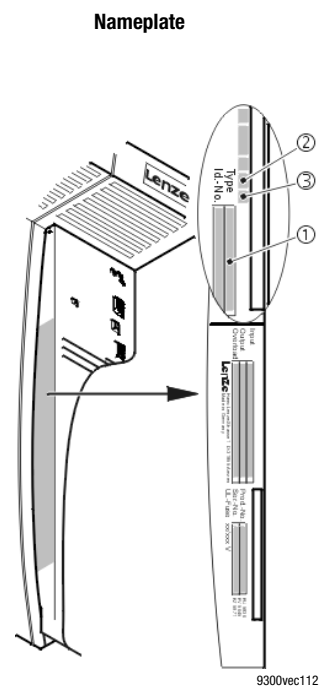

9300vec112

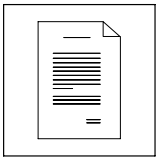

Preface and general information

Definition of the notes used





1.2 Definition of notes used

All safety information given in these instructions has the same layout:

 Pictograph (indicates the type of danger)

Signal word! (indicates the severity of danger)

Note (describes the danger and explains how to avoid it)

Pictograph	Signal word		Consequences if disregarded
	Signal word	Meaning	
 Dangerous electrical voltage	Danger!	Impending danger for persons	Death or severe injuries
	Warning!	Possible, very dangerous situation for persons	Death or severe injuries
	 General danger	Caution!	Possible, dangerous situation for persons
	Stop!	Possible damage to material	Damage of the drive system or its environment
	Note!	Useful tip If you observe it, handling of the drive system will be easier.	

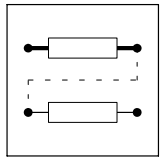

2 Configuration

Contents

2.1	Configuration with Global Drive Control	2-3
2.2	Basic configurations	2-4
2.2.1	Changing the basic configuration	2-5
2.2.2	Speed control C0005 = 1XXX (1000)	2-6
2.2.3	Torque control with speed limitation 4000	2-11
2.2.4	Master frequency coupling	2-13
2.2.5	Speed synchronism	2-25
2.2.6	Angular synchronism	2-26
2.3	Operating modes	2-36
2.3.1	Parameter setting	2-36
2.3.2	Control	2-36
2.4	Change of the terminal assignment	2-37
2.4.1	Freely assignable digital inputs	2-37
2.4.2	Freely assignable digital outputs	2-39
2.4.3	Freely assignable analog inputs	2-39
2.4.4	Freely assignable monitor outputs	2-40

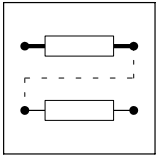

Configuration



2.1 Configuration with Global Drive Control

With Global Drive Control (GDC), a program for the PC, Lenze offers an easy-to-understand, clearly-laid-out and convenient tool for configuring your application-specific drive task.

Function block library

GDC provides a clear overview of the function blocks (FB) available in a library. GDC also lists the complete assignment of a function block.

Signal configuration

Signals can be configured in a single dialog box. This is a convenient way

- to display every FB as a block diagram.
- to see the assignment of all signal inputs at a glance.
- to enter the FB in the processing table.
- to print your signal configuration.

Terminal assignment

Freely assignable terminals can be configured using two dialog boxes:

- Dialog box - to link digital inputs and outputs.
- Dialog box - to link analog inputs and outputs.



Configuration

Basic configurations

2.2 Basic configurations



Stop!

It is possible to load predefined basic configurations via code C0005. If you load a configuration via C0005, the assignment of all inputs and outputs will be overwritten with the corresponding basic configuration.

Adapt the function assignment to the wiring.

The internal signal processing is adapted to the drive task by selecting a predefined basic configuration. You can, for instance, use the Lenze setting for speed control.

- A detailed description of the basic configurations with terminal assignments, signal flow diagrams, and application examples can be found in chapter "Application examples".
- Before loading a basic configuration via C0005, the controller must be inhibited.

Several predefined signal configurations can be loaded by using code C0005. The selection numbers have the following meaning:

C0005 =	X	X	X	X
				Control 0 - Terminal control 1 - Control via LECOM A/B/LI 3 - Control via AIF (INTERBUS, PROFIBUS) 5 - Control via system bus (CAN)
				Voltage source for the control terminals 0 - External supply of control terminals 1 - Internal supply of control terminals
				Additional function 0 - No additional function 1 - Brake control via digital output X5/A2 9 - At quick stop (QSP) deceleration of the complete drive system to zero speed in an angle-controlled mode
				Basic function 1 - Speed control 4 - Torque control with speed limitation 5 - Master for digital frequency coupling 6 - Slave on digital frequency bus 7 - Slave on digital frequency cascade

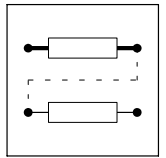

2.2.1 Changing the basic configuration

If the basic configuration must be changed for a special application, proceed as follows:

1. Select a basic configuration via C0005 which largely meets the requirements.
2. Add functions by:
 - Reconfiguring inputs and/or outputs.
 - Setting parameters for function blocks. (☞ 3-4)
 - Inserting or removing function blocks. (☞ 3-10)



Note!

If you change the signal flow of the basic configuration, e. g. by adding function blocks, C0005 is set to 0. The display indicates "COMMON".



Configuration

Basic configurations

Speed control C0005 = 1XXX (1000)

2.2.2 Speed control C0005 = 1XXX (1000)

For standard applications, with the default settings you can commission the drive immediately. In order to adapt it to specific requirements, observe the notes in the following sections.

2.2.2.1 Setpoint selection

Main setpoint

Via the setpoint n_{set} (display in C0046) the speed is defined, relating to the value n_{max} (C0011) which can be set. The setpoint is specified in a bipolar analog manner via input X6/1,2. By the settings carried out, the drive runs with the speed set in C0011 if a master voltage of 10 V is selected. If you want to actuate the drive at master voltages with low voltages you can adapt the system via codes C0026/1 (offset) and C0027/1 (gain).

Alternatively you can also specify the setpoints via

- Keyboard,
- Integrated system bus (CAN),
- Automation interface (LECOM, InterBus, Profibus DP, RS 232, RS 485, optical fibre).

Which input is active as setpoint source depends on the configuration selected in C0005, or the setpoint source can be set via configuration code C0780 in the NSET function block.

Current master value

If the analog main setpoint is to be specified as current master value via X6/1,2, you can select the current setting range with code C0034:

- For -20 mA ... +20 mA: C0034 = 2
- For 4 ... 20 mA: C0034 = 1 (can only be used in unipolar mode)

If the range 4...20 mA has been selected, the error message Sd5 appears when the value is lower than 2 mA.

The signal conditioning for this is effected in function block AIN1.

The change-over from the voltage master value to the current master value (current load 242R) has to be effected via the jumper position at X3:

- Voltage master value/potentiometer:
 - Jumper X3 in the lower position (default setting)
- Current master value:
 - Jumper X3 in the upper position

JOG setpoints

If you require specific fixed settings as main setpoint, you can call parameterisable setpoints from the memory via the JOG inputs. JOG setpoints replace the main setpoint. The JOG setpoints are entered in a relative manner in % of n_{max} . If you set input E3 to HIGH signal, the main setpoint is switched off and at the same time the first JOG setpoint is activated. A total of 15 JOG setpoints can be selected.

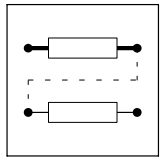

Inverting the main setpoint

Via terminals E1 and E2 the main setpoint can be inverted (i.e. the sign of the input value is changed). The following applies:

E1	E2	Main setpoint
0	0	Drive executes QSP (quick stop)
1	0	Main setpoint not inverted
0	1	Main setpoint inverted
1	1	Drive maintains its previous state

Acceleration and deceleration times for the main setpoint path

The main setpoint is controlled via a ramp function generator. Like this, input steps can be converted to a ramp.

The acceleration time and deceleration time refer to a change in speed from 0 to n_{\max} (0% to 100%). The calculation of the times T_{ir} (C0012) and T_{if} (C0013) to be set is described in the NSET function block description.

Additional acceleration and deceleration times

For the ramp function generator of the main setpoint (NSET-N/JOG setpoint) you can call additional acceleration and deceleration times from the memory via the NSET-TI*x inputs, e.g. to change over the acceleration speed of the drive from a specific speed. For this, these inputs have to be assigned to a signal source. A maximum of 15 additional acceleration and deceleration times can be programmed.

S-shaped ramp function generator characteristic

For the ramp function generator of the main setpoint you can select two different characteristics via C0134:

- Linear characteristic for all acceleration processes requiring a constant acceleration
- S-shaped characteristic for all acceleration processes requiring a jerk-free acceleration

Code	Parameter	Meaning
C0134	0 1	Linear characteristic S-shaped characteristic
C0182	0.01 ... 50.0 s	T_i -time for the S-shaped ramp function generator
C0012	0.00 ... 999.9 s	T_{ir} -time for the acceleration
C0013	0.00 ... 999.9 s	T_{if} -time for the deceleration

Additional setpoint

Via input X6/3,4 (or also another signal source) an analog additional setpoint (bipolar) can be connected. The additional setpoint (display in C0049) internally first goes to the NSET function block via an analog switch. Here the additional setpoint first is lead across a facility for inversion. This facility for inversion is deactivated. Furthermore there is a ramp function generator (acceleration and deceleration times via C0220/C0221) before the additional setpoint is linked with the main setpoint in the arithmetic block. The additional setpoint for instance can be used as a correcting signal for grinding machines (for controlling a constant circumferential speed when the grinding wheel diameter is decreased).

If you want to use the additional setpoint, set code C0190 to the desired arithmetic link. According to the default setting, code C0190 is parameterised to 0. Thus the additional setpoint is switched off.

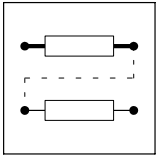

Configuration

Basic configurations

Speed control C0005 = 1XXX (1000)

Selection of direction of rotation

The selection of direction of rotation results from the sign of the speed setpoint at the input MCTRL-N-SET of the MCTRL function block.

In turn, the sign of this speed setpoint results from

- the sign of the main and additional setpoint,
- the level position at terminals E1 and E2,
- the selected link of the main and additional setpoint via the arithmetic block in the NSET function block

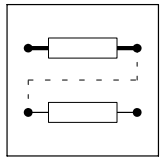

Limitation of the speed setpoint

The speed setpoint is always limited to 100% n_{\max} (C0011) in the MCTRL function block. This means that the maximum speed is always specified to the greatest speed possible in C0011.

Example:

With this configuration a speed of 4500 rpm is to be travelled. The speed is to be corrected in the range from 0 to +10% using the additional setpoint. At inputs X6/1,2 and X6/3,4 a master voltage of 0 to +10 V is provided.

The following parameter setting results from this:

- C0011 = 5000 rpm, C0190 = 1 (addition)
- C0027/1 = 90%
- C0027/2 = 10%

Code C0909 presents another possibility of influencing the speed limit. Here the direction of rotation can be specified:

- C0909 = 0 → clockwise and counter-clockwise rotating direction permitted
- C0909 = 1 → only clockwise rotating direction permitted
- C0909 = 2 → only counter-clockwise rotating direction permitted

For systems that only permit one rotating direction this serves to prevent the drive from rotating backwards which would be caused by the setpoint.

Additional torque setpoint

For some applications it may be required to apply an additional torque setpoint.

Example: An acceleration connection for winding and positioning applications:

For this purpose, the input MCTRL-M-ADD is provided. This input is not active by default (is on FIXED0%). To use this input, an analog signal source has to be assigned to it.

Torque limitation

The torque can be limited in the range from 0 to +100% via code C0472/3.

Every other signal source can be assigned as well.

Actual speed value feedback

In this configuration all specified actual value encoders can be used. The corresponding actual value encoder can be selected via code C0025. An adjustment is not required.



Configuration

Basic configurations

Speed control C0005 = 1XXX (1000)

Quick stop (QSP)

When the quick stop function is activated, the drive runs to speed 0 via the ramp set in C0105 and executes a holding torque with a drift-free standstill. The torque limitation and the additional torque setpoint have no effect. This means that the drive outputs the maximum possible torque (observe settings of motor data). When the QSP request is cancelled, the drive synchronises to the current speed.

Controller inhibit (CINH)

By setting controller inhibit the drive becomes torqueless, the machine coasts. When the controller inhibit request is cancelled, the drive synchronises to the current speed.

Shutting down the controller via TRIP (TRIP-SET)

With LOW signal at terminal X5/E4, the controller can be shut down via the monitoring function. This input mainly serves to evaluate external binary encoders.

The response to this input signal can be programmed.

Resetting a fault (TRIP-RESET)

With a LOW-HIGH edge at terminal X5/E5 a pending TRIP can be reset if the cause of the fault has been eliminated.

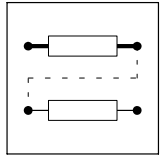

2.2.3 Torque control with speed limitation 4000

The drive is set to torque control with the configuration C0005 = 4XXX "Torque control with speed limitation". The torque can be provided in both directions.

The speed in the different operating cases is monitored using the n-controllers via a speed limitation.

2.2.3.1 Function

If the actual speed is within its limitation, the drive is torque-controlled. If one of the speed limits (CCW or CW rotation) is reached, the drive becomes speed-controlled.

2.2.3.2 Setpoint input

Torque setpoint

The torque setpoint is entered via the analog terminal X6/3,4. When all motor data are entered correctly, the drive provides 100 % of the possible torque (C0057) in the positive direction (CW) with an input voltage of +10 V (corresponding to 100 % in negative direction (CCW) with -10 V).

If you want to operate the controller with a lower master voltage, you can adapt the system via the codes C0026/2 (offset) and C0027/2 (gain).

Alternatively, you can also enter the setpoints via

- keypad,
- integrated system bus (CAN),
- automation interface (LECOM, InterBus, Profibus DP, RS 232, RS 485, fiber optics).

It depends on the selected configuration C0005, which of these inputs is active as a setpoint source. The signal source can also be set under the configuration C0891 (MCTRL-M-ADD) in the MCTRL function block.



Configuration

Basic configurations

Torque control with speed limitation 4000

Speed setpoint (speed limits)

The speed limitation is carried out via the n-controllers in the MCTRL function block. The first speed controller (main speed controller) is the upper speed limit and the second speed controller is the lower speed limit.

Example:

The speed can be within a range of ± 5000 rpm.

+5000rpm (CW rotation) is the upper limit and -5000 rpm (CCW rotation) is the lower limit. The parameter setting is explained below.

The upper speed limit is provided via the analog terminal X6/1,2. This input can be used as a speed setpoint e.g. in the threading in winding systems, wire-drawing machines, etc.

Please observe:

- The torque cannot exceed the input at terminal X6/3,4. The input voltage must be set to 10 V, if necessary.
- The value cannot fall below the lower speed limit (code C0472/4).
- The setpoint speed is conditioned in the same way as for speed control (C0005=1000).

Reference values:

- When a master voltage of +10 V is entered, the setting under C0011 is the upper speed limit (CW rotation).
- If -10 V are provided, C0011 is the upper speed limit in CCW rotation.

The lower speed limit is entered under code C0472/4.

Reference values:

- If -100% are entered, the setting under C0011 is the lower speed limit in CCW rotation.

Quick stop (QSP) and controller inhibit (CINH)

See quick stop (QSP) and controller inhibit (CINH).

TRIP-SET and TRIP-RESET

See TRIP-SET and TRIP-RESET.

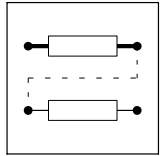

2.2.4 Master frequency coupling

2.2.4.1 General system description

The master frequency coupling described here provides a digital setpoint transmission and evaluation path between a setpoint source and one or several controllers. Here, the transmission path can either be used as bus or cascade (see later explanation) for:

- phase-synchronous running
- speed-synchronous running
- speed-ratio synchronism
- Positioning control with driftfree standstill

In each controller the setpoint can be evaluated with a factor and, electrically buffered, be output at the corresponding master frequency output.

The master frequency coupling is a purely digital setpoint transmission with all the advantages involved:

- driftfree
- high-precision
- increased interference immunity

A drive system consists of a master and several slaves. For implementing a master frequency coupling, three configurations are offered:

- master, C0005 = 5XXX (master integrator)
- slave for master frequency bus, C0005 = 6XXX (parallel connection)
- slave for master frequency cascade, C0005 = 7XXX (series connection)

Setpoint conditioning

In the setpoint arm the speed and phase setpoints are processed as absolute values.

Gearbox factors (C0032 and C0033)

The weighting factors C0032 and C0033 are in the setpoint channel of the corresponding drive (slave). Here, a gearbox factor can be set.

Setting range of factors:

- C0032 from -32767 ... +32767
- C0033 from +1 ... +32767

The quotient is limited to a maximum of ± 32767 .

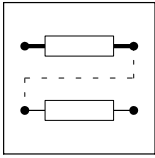

Configuration

Basic configurations

Master frequency coupling

2.2.4.2 Master configuration

Purpose

The master configuration serves to

- activate the phase control, which is upstream to the speed controller and
- configure the drive as master drive for the master frequency coupling for generating the master frequency for the slave drives.

The phase control improves the control properties of the drive so that a driftfree standstill is achieved for e. g. positioning tasks, hoists etc.

Features

The features describe the basic properties of this configuration. Some of them, however, can only be used after reprogramming.

- Master with the option of signal conditioning as in the configurations C0005 = 1XXX, 4XXX except the setpoint inversion via terminal X5/E1, X5/E2
- Master frequency output signal is setpoint for slave 0 (master drive) and other slaves
- Setpoint evaluation for slave 0 with a factor (numerator/denominator) and gearbox adaptation (numerator/denominator). Can be set via
 - automation interface or system bus
 - motor potentiometer
 - other signal source
- External torque limitation possible by means of reconfiguration
- Emergency stop function for the entire drive system possible by means of reconfiguration (C0005 = 5900)
- Controller enable function causes a reloading of the setpoint integrator with the actual value of slave 0 (setpoint = actual value)
- Possible interventions for phase trimming and speed correction via
 - automation interface or system bus
 - analog terminal
 - one of the signal sources (function blocks)
- Message "following error limit reached" can be set via code
- TRIP when reaching the phase controller limit
- Speed limit of slave 0 = C0011
- Phase controller influence can be set and switched off via the digital input
- Homing function is possible via zero track or touch probe
- Synchronising to a setpoint is possible via zero track or touch probe
- Synchronising characteristic can be set via ramp-function generator

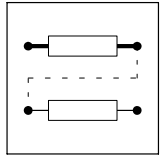

Master integrator (setpoint generation)

The setpoint path is designed according to the configurations 1XXX and 4XXX, but without inverting the main setpoint via the terminals X5/E1,E2. This means:

- Main setpoint is generated by analogy via terminal X6/1, X6/2
- Additional setpoint is generated by analogy via terminal X6/3, X6/4 (when used, the additional setpoint must be enabled via C0190)

In this configuration, the setpoint selection refers to the frequency at the master frequency output X10.



Tip!

The resulting speed setpoint is output at the master frequency output X10. It is the setpoint in terms of amount and direction of rotation for the following slaves. At the same time it is considered to be the setpoint for slave 0 (included in the master drive), i.e. for the entire drive system.

The master drive consists of the master integrator and the slave 0. Slave 0 is the first drive at the master frequency.

Master frequency output X10

The master frequency output simulates an incremental encoder with two 5 V complementary signals shifted by 90°. The encoder constant (inc/rev.) can be set and scaled in code C0030. Here, the encoder type 2048 inc/rev. is set as standard.

The output frequency is determined by the speed set in C0011 (n_{max}) and the encoder constant.

Example:

C0011 = 5000 rpm, C0030 = 4 → 4096 inc/rev. setpoint = 100 %

The output frequency is 341.3 kHz ($5000/60s \times 4096$).

With higher speeds, e. g. 8000 rpm in this setting, the output frequency is 564.1 kHz. In this case, the maximum possible output frequency of 500 kHz would be exceeded. Hence, an encoder constant with a smaller number of increments must be selected.



Tip!

In principle, the highest possible frequencies should be selected since the 400 kHz range provides the best resolution.



Configuration

Basic configurations

Master frequency coupling

Setpoint conditioning

All settings that follow only refer to this drive, not to the entire drive system.

The setpoint is controlled via the function block DFSET. With this, essential adaptations to the drive tasks can be done.

The setpoint is evaluated with a factor (numerator/denominator). With this, the ratio can be set with which the drive is to run to its setpoint. For changing the direction of rotation of the drive, negative values can be set here.

The denominator is preset via code C0533. The numerator in this setting is selected via the free control code C0473/1, but can also be selected by every analog source by reprogramming (reconfiguring).

Another possible adaptation can be done via the gearbox factor (numerator/denominator). With this, the gearbox ratio of the drive can be set. The denominator is selected via C0033. The numerator is selected in this configuration via the free control code C0032, but can be selected by every analog source by reprogramming (reconfiguring).

Speed trimming (additional speed setpoint)

An additional setpoint can be added to the speed setpoint via the control code C0472/5. This serves to accelerate or decelerate the drive. The input is done in % of n_{max} . Here, however, every analog source can be used as signal source.

Purpose:

e. g. input for correction values

Phase trimming

Via the control code C0473/3 an additional setpoint can be added to the phase setpoint. This serves to move the rotor position forwards or backwards compared to the setpoint (leading or lagging). The input is done in increments. One revolution is split up into 65535 increments. The phase trimming can take place in the range ± 32767 (i.e. $\pm 1/2$ revolution). Via C0529 a multiplier can be set, which serves to expand the setting range.

Example: Phase trimming = DFSET_A_TRIM * C0529

Here, every analog source can also be used as signal source.

100 % correspond to 1/4 revolution = 16383 inc.

Purpose:

e. g. input for correction values

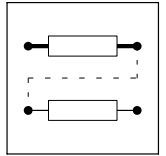

Phase offset

Via C0252 a fixed phase offset can be added to the setpoint of the drive. This can be set in the range ± 245760000 inc.

Reference:

see phase trimming

Phase adjustment

In some applications it is necessary that the phase leads or lags with increasing speed. For this, an adjustment of $\pm 1/2$ revolution can be entered under C0253. The phase adjustment set is reached at 15000 rpm (linear connection).

QSP at the master

If QSP is set at the master drive, the setpoint (C0050) for all drives is decelerated along the QSP ramp. The complete drive system can thus be stopped, led by the QSP integrator. If QSP is cancelled before the drives come to a standstill, the drive system starts to decelerate or accelerate with the value in C0050 to the speed setpoint at the setpoint integrator.

Unlike the configuration 5900, the phase synchronism between master and slave gets lost in the configuration 5000.

QSP at the slave 0 (master drive)

If the deceleration ramp is very short and can only be reached with I_{max} , the phase synchronism gets lost. A driftfree standstill is obtained. Switching QSP is a continuous operation for the downstream slaves so that a reversal is possible if the deceleration ramp set at the master is too short for one of the slave drives (e. g. to high centrifugal mass for the set deceleration ramp).

CINH at the master

If the master drive is inhibited, the actual value of slave 0 is used as setpoint for the other slaves. This could bring the entire drive system to a standstill led by the coasting slave 0. If the master is re-enabled before reaching the standstill, the drive system starts to accelerate with the actual speed.

When setting CINH, the phase difference is set to zero.

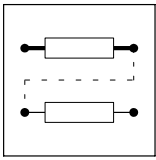

Configuration

Basic configurations

Master frequency coupling

2.2.4.3 Slave for master frequency bus

Purpose

The configuration C0005 = 6XXX for the setpoint bus serves to

- activate the phase control, which is upstream to the speed controller
- change the setpoint signal path to master frequency coupling for phase or speed-synchronous operation

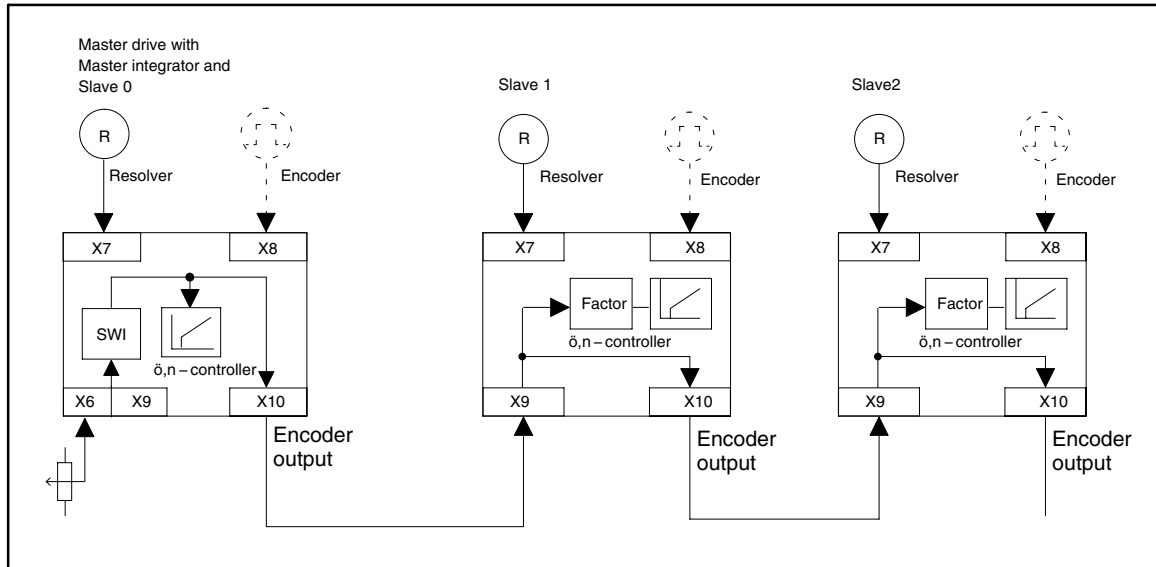
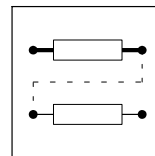

Fig. 2-1 Slave for master frequency bus



Features

The features describe the basic properties of this configuration. Some of them, however, can only be used by reprogramming.

- Hardware connection of the master frequency input with the master frequency output (so that any number of drives can be connected in series)
- Setpoint evaluation with a factor (numerator/denominator) for the corresponding slave (gearbox adaptation). Can be set via an analog signal source:
 - Terminal,
 - code or
 - function block.
- external torque limitation is possible
- QSP function for the individual drive. The setpoint is continued to be output.
- CINH function for the individual drive. The setpoint is continued to be output to the master frequency output.
- Possible interventions for phase trimming and speed correction via
 - LECOM
 - analog terminal
 - one of the signal sources (function blocks)
- Message "following error limit reached" can be set via code
- TRIP when reaching the phase controller limit
- Speed limit of slave 0 = C0011
- Phase controller influence can be set and switched off via the digital input
- Homing function is possible via zero track or touch probe
- Synchronising to a setpoint is possible via zero track or touch probe
- Synchronising characteristic can be set via ramp-function generator



Configuration

Basic configurations

Master frequency coupling

Cascading factor (C0473/1 and C0533)

This function is valid only if the configuration is not changed.

The following constants for the master frequency input (X9) can be set under C0425:

- 16384 inc/rev.
- 8192 inc/rev.
- 4096 inc/rev.
- 2048 inc/rev.
- 1024 inc/rev.
- 512 inc/rev.
- 256 inc/rev.

Cascading factors which cannot be raised to the power of two can be assigned via C0473/1 and C0533. The following connection applies:

$$\frac{C0425}{\text{Encoder constant}} = \frac{C0473/1}{C0533}$$

The quotient is limited to a maximum of ± 32767 .

Setting range of factors:

- C0473/1: -32767 ... +32767
- C0533: +1 ... +32767

Setpoint conditioning of the slave

The value read by the input Dig.-Set (X9) is the setpoint (speed and phase) for the internal control.

Differences compared to the speed control:

- No setpoint integrator in the setpoint channel
- Change to the JOG value is not possible
- The additional setpoint is not active
- The CW/CCW changeover must be performed via the sign of the gearbox factor

QSP at the slave

If you set QSP at the slave drive, the setpoint (C0050) is decelerated along the QSP ramp. Home positions get lost. A driftfree standstill is obtained since the set phase is led by the QSP integrator when switching QSP.

CINH at the slave

If a slave drive is inhibited, the motor is coasting at the friction torque. The master frequency output, however, continues to output the setpoint for the following slave. If the slave is enabled again, the drive accelerates to its setpoint. (possibly at the current limit). When CINH is set, the phase integrators are set to zero. Home positions get lost.

Exception:

If pulse inhibit (IMP) is released due to short-term mains undervoltage (< 500 ms), the phase integrators are not reset. After mains recovery, the drive is able to follow its setpoint again. A phase difference which emerged before is balanced.

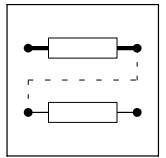

2.2.4.4 Slave for master frequency cascade

Purpose

The configuration C0005 = 7XXX for the setpoint cascade serves to

- activate the phase control, which is upstream to the speed controller
- change the setpoint signal path to master frequency coupling for speed ratio synchronism

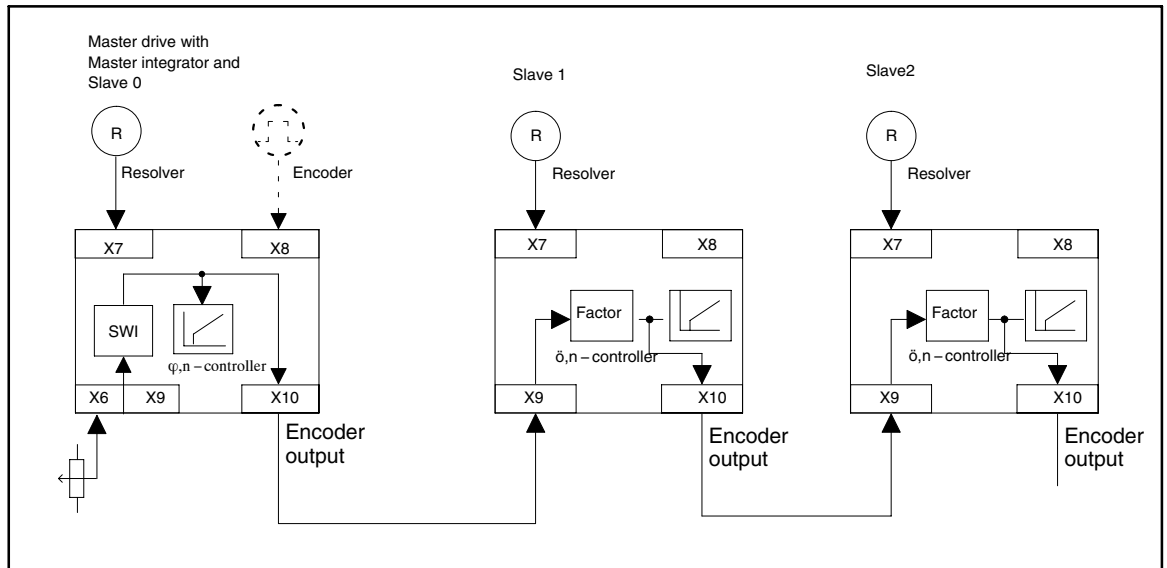
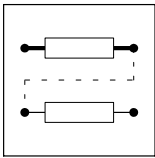

Fig. 2-2 Slave for master frequency cascade



Configuration

Basic configurations **Master frequency coupling**

Features

The features describe the basic properties of this configuration. Some of them, however, can only be used by reprogramming.

- **Resolver feedback is possible only**
- Evaluation of the setpoint (cascading factor) is possible with a factor (numerator/denominator) for the master frequency output (and thus for all following drives)
- Other evaluation of the setpoint is possible with a factor (numerator/denominator) for the corresponding slave (gearbox adaptation). Can be set via an analog signal source (standard: code C0032, C0033)
- External torque limitation is possible
- The QSP or CINH function in the individual drive do not influence the setpoint for the cascade.
- Possible interventions for phase trimming and speed correction via
 - LECOM,
 - analog terminal or
 - one of the signal sources (function blocks).
- Message "following error limit reached" can be set via code
- TRIP when reaching the phase controller limit
- Speed limit of slave 0 = C0011
- Phase controller influence can be set and switched off via the digital input
- Homing function is possible via zero track or touch probe
- Synchronising to a setpoint is possible via zero track or touch probe
- Synchronising characteristic can be set via ramp-function generator

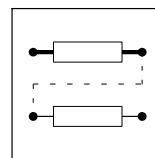

Cascading factor (C0473/1 and C0533)

This function is valid only if the configuration is not changed.

The following constants for the master frequency input (X9) can be set under C0425:

- 16384 inc/rev.
- 8192 inc/rev.
- 4096 inc/rev.
- 2048 inc/rev.
- 1024 inc/rev.
- 512 inc/rev.
- 256 inc/rev.

Cascading factors which cannot be raised to the power of two can be assigned via C0473/1 and C0533. The following connection applies:

The quotient is limited to a maximum of ± 32767 .

Setting range of factors:

- C0473/1: -32767 ... +32767
- C0533: +1 ... +32767

Setpoint conditioning of the slave

The value read from X9, evaluated with C0425, C0473/1 and C0533, is the setpoint (speed and phase) for the internal control and also the output value at the master frequency output X10.

The setpoint for the corresponding drive can be evaluated via the gearbox factor C0032 and C0033.

The direction of rotation of the corresponding slave can be set via the evaluation factors.

Differences compared to the speed control:

- As standard, there is no setpoint path in the setpoint integrator
- Change to the JOG value is not possible
- The additional setpoint is not active

Feedback system (X7)

Only the resolver can be selected as feedback system.

QSP at the slave

If you set QSP at the slave drive, the setpoint (C0050) is decelerated along the QSP ramp. Home positions get lost. A driftfree standstill is obtained since the set phase is led by the QSP integrator when switching QSP.

If the deceleration ramp is very short and can only be obtained with I_{\max} , the phase synchronism gets lost (e.g. too high centrifugal mass for the set deceleration ramp).

The setpoint for the following slave(s) is continued to be output at the master frequency output.

CINH at the slave

If a slave drive is inhibited, the motor is coasting at the friction torque. The master frequency output, however, continues to output the setpoint for the following slave. If the slave is enabled again, the drive accelerates to its setpoint (possibly at the current limit):

The phase difference is set to zero when switching CINH. Home positions get lost.

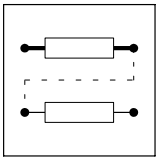

Configuration

Basic configurations

Master frequency coupling

Exception:

If controller inhibit is released due to short-term mains undervoltage (< 500 ms), the phase difference is not reset. After mains recovery, the drive can follow again its set phase. A phase difference which emerged before is balanced. The setpoint for the slave(s) is continued to be output at the master frequency output.

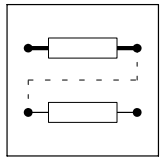

2.2.5 Speed synchronism

2.2.5.1 How to select the correct configuration

The following slave configurations can be selected for the speed synchronism with the master configuration C0005 = 5XXX:

- Slave for setpoint bus C0005 = 6XXX;
for only two drives or fixed speed relationships which must be set only once (commissioning)
- Slave for setpoint cascade C0005 = 7XXX;
for more than two drives or simple change of the speed relationship with stretching factors in the running process

A correction value for the speed synchronism can be changed and displayed via the input DFSET-N-TRIM in the DFSET function block.

The input can be changed by reconfiguration via:

- analog terminal
- motor potentiometer
- keypad
- automation interface or system bus

The correction value is provided in % of C0011 (n_{max}).

Deactivate the phase controller for the speed synchronism. This means that the phase-synchronous running becomes a speed-synchronous running, which results in adding phase errors between the drives. The phase controller can be deactivated by setting code C0254 to zero.

2.2.5.2 Speed-synchronous running

Purpose

For material transports with very low stretching coefficients, such as paper, metal, etc., the tension can be set via the gearbox factor C0032/C0033 by oversynchronism in the ‰ range. A specified tension thus results from the stretching coefficient of the material. For a better operation and higher accuracy in the digital frequency coupling, we recommend the digital frequency cascade C0005 = 7XXX.

2.2.5.3 Speed ratio synchronism

Purpose

- Stretching systems
- Wire-drawing plants

Example

Extruder system with stretching of plastic threads by a speed ratio synchronism. The stretching is performed online during the process via a motor potentiometer function.



Configuration

Basic configurations

Angular synchronism

2.2.6 Angular synchronism

Purpose

- Drive concept for positive movements (e.g. packing of bottles on conveyor belts)
- Electrical shaft (e.g. vertical shaft, printing machines with embossing or printing rolls depending on the format).

Conditions

Configuration C0005 = 6XXX or 7XXX.

In the configurations C0005 = 5XXX the specifications only apply to the slave 0.

Angle-synchronous operation

When the angle controller is active, every controller can perform angle-synchronous, drift-free angular synchronism with regard to its setpoint. Since in the master frequency cascade the setpoint of the second slave is conditioned in the first slave and both systems are not synchronous, a fixed angular offset develops between the motor shafts which, however, does not add up over time.

2.2.6.1 Angle controller

Angle controller adaptation

A value at MCTRL-P-ADAPT affects the gain set in C0254.

Special features

The difference between setpoint and actual angle is supplied to the angle controller. With reference to the angle it is designed as P controller. Its influence can be set via C0254. C0254 = 0 means the complete disconnection of the angle controller from the controlled system.

Setting range of C0254 = 0.0001 ... 3.9999, C0254=1.00 and 16384 INC system deviation (1/4 revolution) correspond to a speed variation of n_{\max} .

The output of the angle controller can be limited via C0472/6. The limitation can also be connected with another analog signal source.

Angle controller limit

The angle controller limit is fixed to an angular difference of 65531 revolutions. If this angular difference is exceeded, the angle controller cannot balance the setpoint angle anymore. When reaching the angle controller limit, a TRIP P13 is generated. The error message can be evaluated according to its priority.



Note!

When reaching the angle controller limit and monitoring is switched off, the sign at the angle controller output may reverse. When setting CINH, the angular difference is set to zero.



2.2.6.2 Angular trimming

The angular trimming can be changed via C0473/3. It is displayed via C0536/3. Angular trimming can also be carried out via another analog signal source:

- Analog output of a function block
- Motor potentiometer
- Analog terminal
- Keyboard
- Automation interface or system bus

The input of the angle trimming can be multiplied in C0529.

This serves to change the rotor position by up to 20000 revolutions:

- Negative values = CCW offset
- Positive values = CW offset

Resolution: $65536 \text{ inc/rev.} = 1 \text{ rev.} \times C0529$

2.2.6.3 Following error limit

The absolute value of the following error limit can be set in increments via C0255. The setting range is: $0 \dots 1.8 \times 10^9$ increments.

When reaching the following error limit, a signal is generated which is evaluated via "Monitoring". This signal can be evaluated with the priority (TRIP, MESSAGE or WARNING) required by the user.

When setting CINH, the angular difference is set to zero. Thus, neither the signal "following error limit" is generated any longer.

2.2.6.4 Processing of the zero pulse (flying synchronising)

If the zero pulses are not used for the master frequency processing, an angular synchronism with a constant phase offset is achieved.

Initial situation

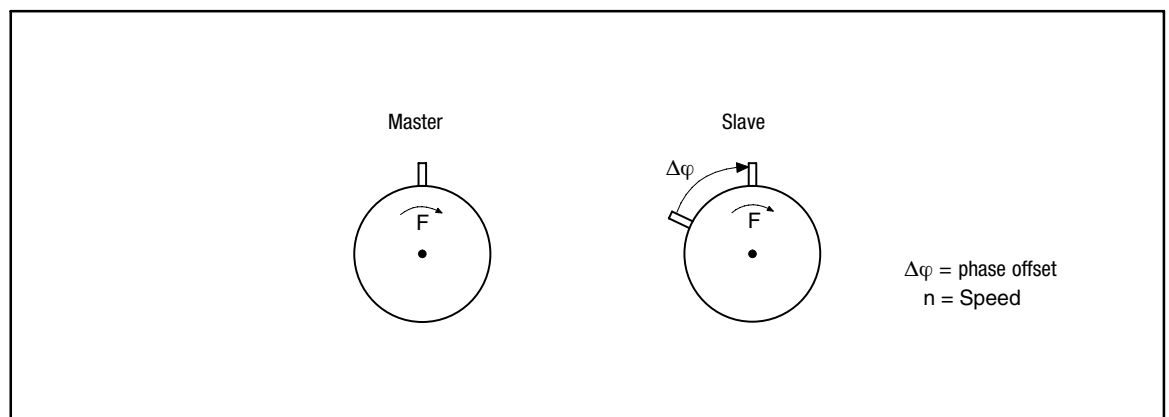

Fig. 2-3 Initial situation for zero pulse processing ($\Delta\varphi \neq 0$)

If this phase offset is to be corrected to 0, either

- homing is required or
- the zero pulses of the master frequency input and the feedback system are to be processed.



Configuration

Basic configurations Angular synchronism

Target situation

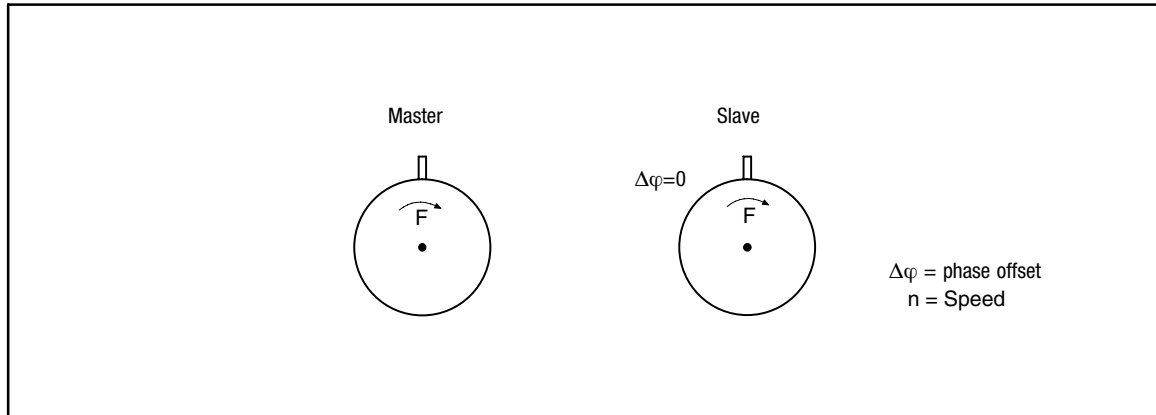

Fig. 2-4

Target situation for zero pulse processing ($\Delta\varphi = 0$)

Conditions for reaching the target situation:

- The function must be activated via code C0534 (function block DFSET)
- The input DFSET-0-PULSE must be triggered with a HIGH signal when the zero pulse is evaluated once (function block DFSET)
- The angle control must be activated (function block MCTRL)
- The zero pulses must be connected to the Sub-D connectors X9 and X8 (X8 when using an encoder)

Zero pulse at the setpoint

The set rotor position is specified via the setpoint zero pulse (i.e. when the drive system is running). It is only synchronised if one setpoint zero pulse and actual zero pulse have occurred before, i.e. not before the second zero pulse.

Control mode:

The phase offset is compensated via acceleration or deceleration. The direction (acceleration or deceleration) depends on the detected phase offset. If the rotor is leading in the range from 0 to 180 °, the drive is synchronised by deceleration. If the rotor is lagging in the range from 0 to 180 °, the drive is synchronised by acceleration.

Different synchronisation modes

In C0534 you can select between different synchronisation modes.

C0534	Synchronisation mode
1	Continuous synchronisation as described under "Zero pulse at the setpoint" (see page 2-28)
2	Same as selection 1, but DFSET-0-PULSE must be triggered with a LOW-HIGH edge
10	One-time synchronisation; control mode as described under "Zero pulse at the setpoint" (see page 2-28)
11	One-time synchronisation; the drive is always synchronised by clockwise rotation
12	One-time synchronisation; the drive is always synchronised by counter-clockwise rotation
13	One-time evaluation of the setpoint pulse and the actual pulse; the synchronisation direction results from the sign between setpoint pulse and actual pulse



Configuration

Basic configurations Angular synchronism

2.2.6.5 Referencing

The homing function is available with the configurations 5XXX, 6XXX and 7XXX.. The drive shaft can be positioned via the homing function. For this purpose, the drive is disconnected from the setpoint path and follows the profile generator.

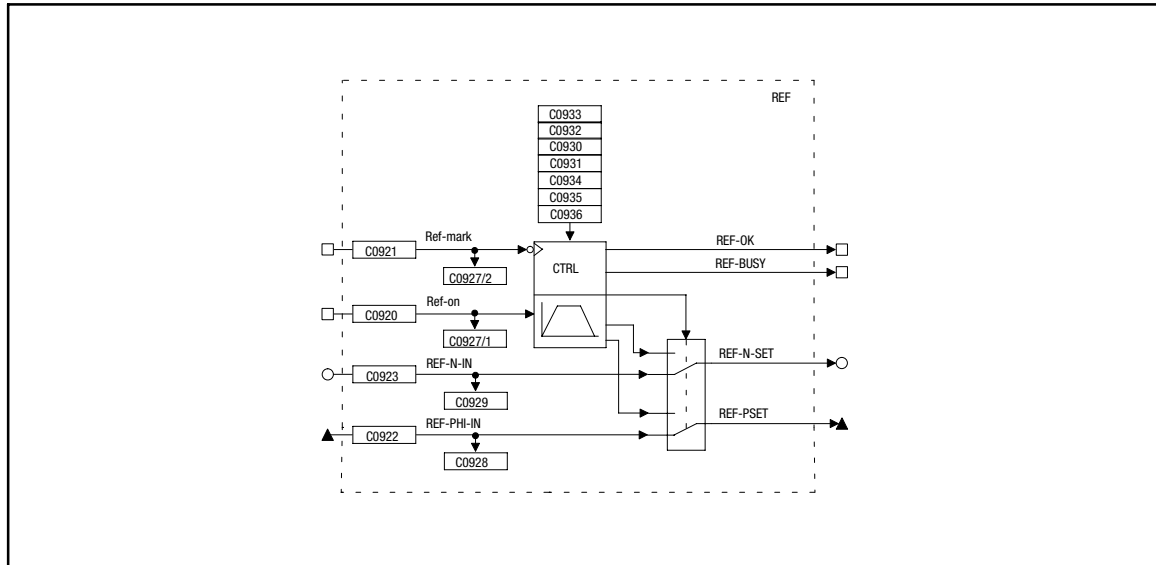

Fig. 2-6 Homing function block (REF)

Homing is started via a rising edge at the digital input "REF-ON" (default setting is assigned to terminal X5/E3); this input must be applied until the end of the homing process.

After the negative edge has occurred at the input REF-MARK (default setting is assigned to terminal X5/E2), it is positioned to the home position. This input is intended for a reference switch. The speed travel profile is created via a profile generator which is integrated in the REF function block. Via this, the acceleration and deceleration times as well as the speed during the homing process can also be set.

The home position is defined as follows:

Next zero pulse after the negative edge of the reference switch plus the home position offset (C09334).

For position feedback via resolver, the zero position (depending on the resolver attachment to the motor) is used instead of the zero pulse. Accordingly, the touch probe angle is used for homing via touch probe.

The output signal "REF-BUSY" indicates with HIGH signal, whether the homing function is active.

The output signal "REF-OK" indicates with HIGH signal that homing is completed successfully. This signal can be scanned via the output terminal X5/A4.

The setpoint outputs for position and speed of the REF function block are connected with the corresponding setpoint inputs of the function block MCTRL (see signal flow diagram for the configurations 5XXX, 6XXX and 7XXX). If the homing function is active (input REF-ON = HIGH), the drive is disconnected from the setpoint path. The drive then follows the profile generator.

During the homing process the input DFSET-SET of the master frequency processing is active. This is done through the output REF-BUSY of the REF function block. After the homing process is completed, REF-BUSY=LOW is switched back to master frequency without jerk.

A renewed homing process requires an edge at the input REF-ON.



2.2.6.6 Homing modes

Mode 0

Homing with zero pulse/zero position.

Travel in clockwise rotation to the home position. The home position lies at the next zero pulse/zero position after the negative edge of the reference switch REF-MARK plus the home position offset.

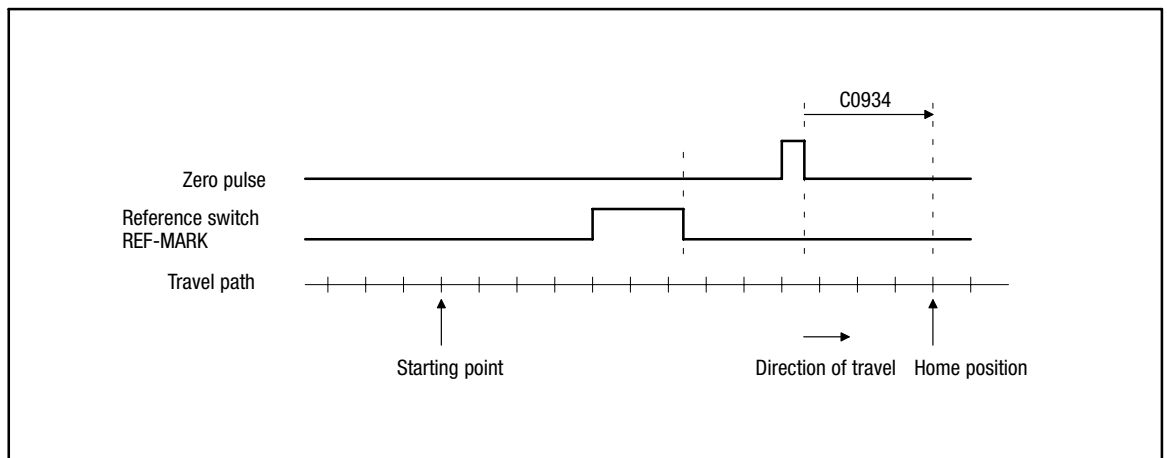

Fig. 2-7 Homing with zero pulse/zero position; approaching the home position in CW rotation

Mode 1

Homing with zero pulse/zero position.

Travel in counter-clockwise rotation to the home position. The home position lies at the next zero pulse/zero position after the negative edge of the reference switch REF-MARK plus the home position offset (C0934).

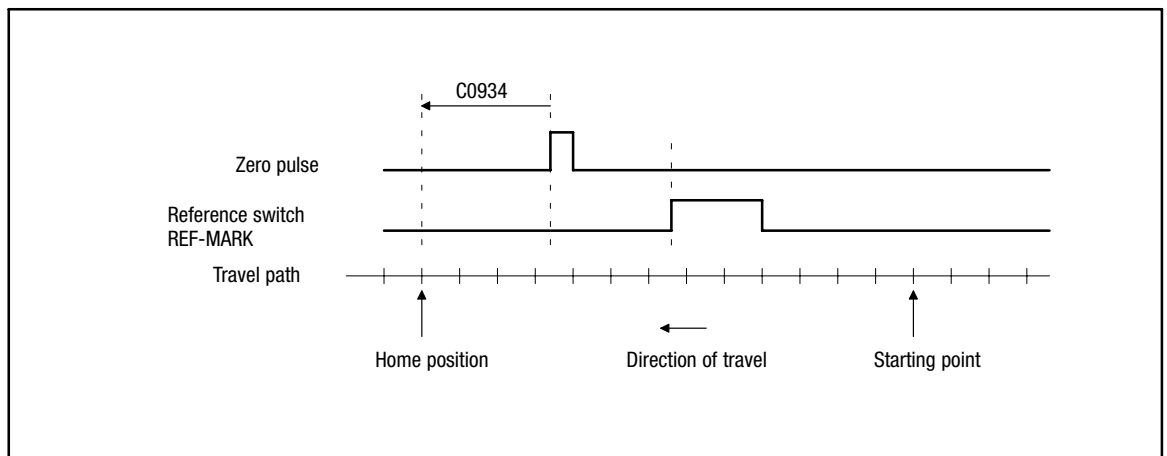

Fig. 2-8 Homing with zero pulse/zero position; approaching the home position in CCW rotation

Modes 2 ... 5

Modes 2 ... 5 are reserved.



Configuration

Basic configurations Angular synchronism

Mode 6

Homing with touch probe.

Travel in clockwise rotation to the home position. The home position lies at the touch probe signal after the negative edge of the reference switch REF-MARK plus the home position offset (C0934).

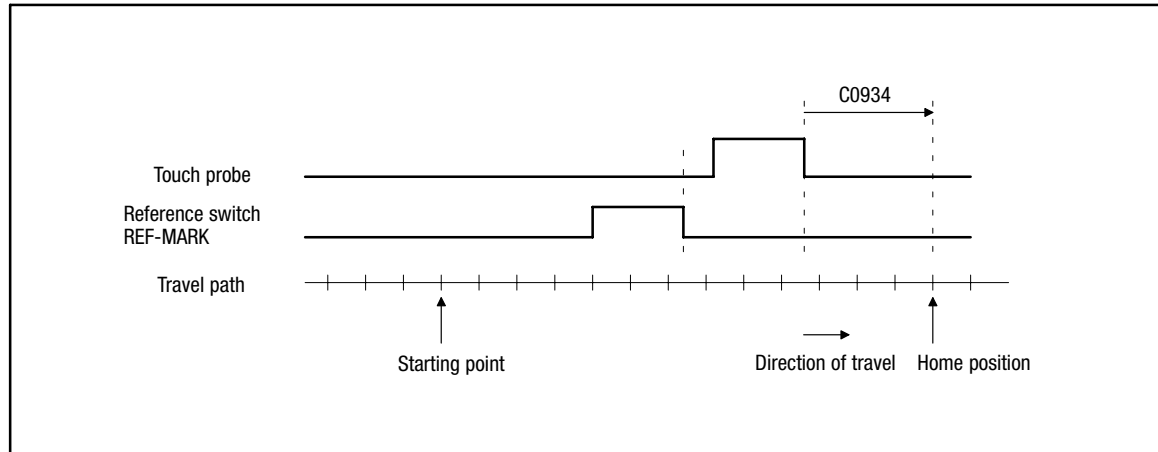

Fig. 2-9 Homing with touch probe; approaching the home position in CW rotation

Mode 7

Homing with touch probe.

Travel in counter-clockwise rotation to the home position. The home position lies at the TP signal after the negative edge of the reference switch plus the home position offset.

Mode 8

Homing with touch probe.

Travel in clockwise rotation to the home position. The home position lies at the next TP signal plus the home position offset.

Mode 9

Homing with touch probe.

Travel in counter-clockwise rotation to the home position. The home position lies at the next touch probe signal plus the home position offset.

Note concerning mode 6 to mode 9

In code C0933 you can select the edge of the zero pulse or touch probe signal (LOW → HIGH or HIGH → LOW) determining the home position.

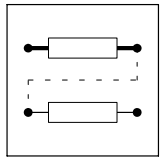

2.2.6.7 Profile generator

The speed travel profile for homing is generated via a profile generator. During the homing process the target can be changed.

The profile generator generates a speed travel profile with linear ramps.

The following parameters must be entered:

Code	Meaning	Input
C0930	Gearbox ratio - numerator	1 ... 65535 Numerator of the gearbox ratio between motor and position encoder (motor side)
C0931	Gearbox ratio - denominator	1 ... 65535 Denominator of the gearbox ratio between motor and position encoder (encoder side)
C0934	Home position offset	-2,140,000,000 ... +2,140,000,000 inc Distance between zero pulse or touch probe and the home position during the homing process
C0935	Homing speed	0.0001 ... 100.0000 % n_{max} Motor speed during the homing process
C0936	Homing T_i time	0.01 ... 990.00 s Acceleration and deceleration time during the homing process. Reference: 0 ... n_{max} or n_{max} ... 0

The travel profile for homing is determined by entering a percentage speed and an integration time (T_i) for the ramps. The home position offset is directly entered in increments of the encoder system. (In this way, complex conversions and the entry of e. g. the feed constant can be avoided)

The home position can be approached in three ways:

- Case 1: High home position offset
- Case 2: Home position offset = 0; the zero pulse has not yet occurred during the homing process
- Case 3: Home position offset = 0; the zero pulse has occurred once during the homing process

High home position offset (case 1)

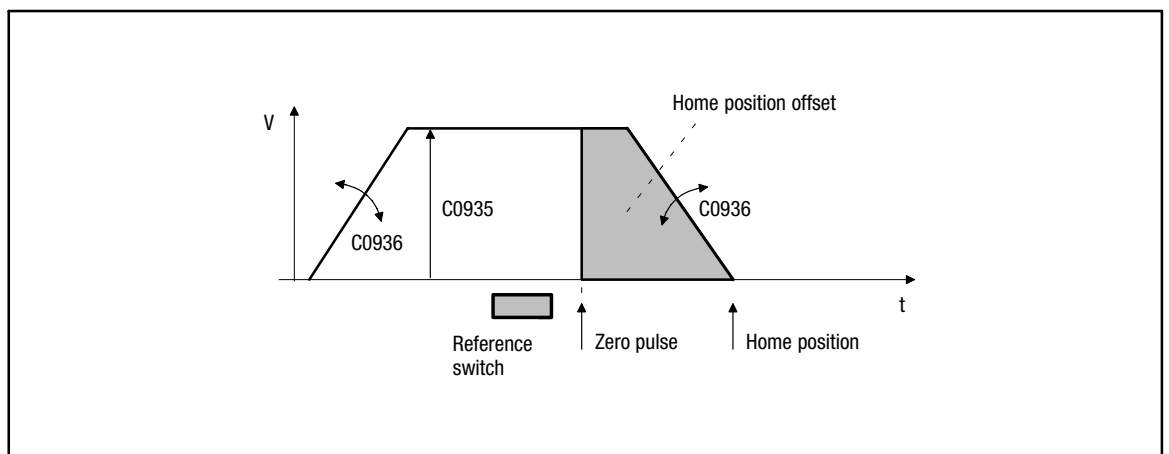

Fig. 2-10 Approaching the home position (case 1)



Configuration

Basic configurations Angular synchronism

Home position offset = 0 (case 2)

The zero pulse has not yet occurred during the homing process (e.g. in case of incremental encoders, the position is only determined after one revolution):

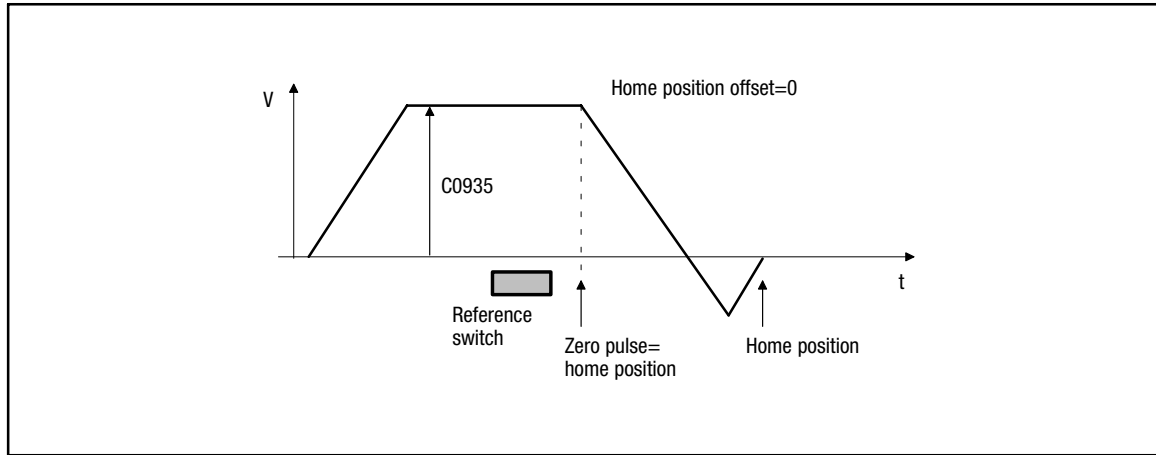
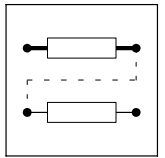

Fig. 2-11 Approaching the home position (case 2)

If the parameter setting or the position of the reference switch have been selected unfavourably, the drive is unable to directly approach the home position due to a too high moment of inertia. This means that the drive travels beyond the home position and then back again.

Reversing during the homing process can be prevented by setting the home position offset so that the path is long enough to decelerate into standstill. The reference switch and the subsequent zero pulse must be brought forward accordingly.



Home position offset = 0 (case 3)

The zero pulse has already occurred once during the homing process.

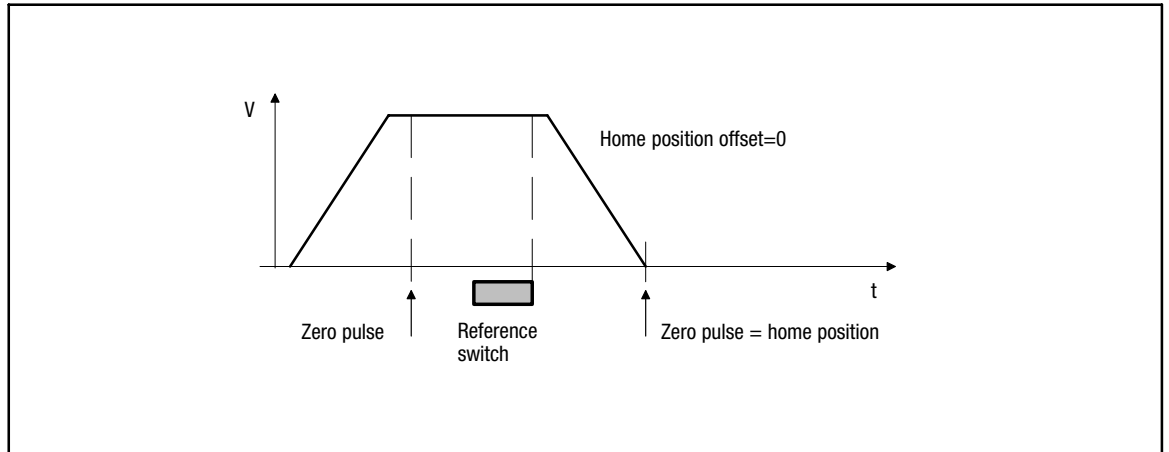

Fig. 2-12 Approaching the home position (case 3)

If the zero pulse has already occurred once during traversing or if an absolute value encoder (e.g. aresolver) is used as an actual value encoder, the drive traverses to its home position along the set ramp as described in Fig. 2-12 Approaching....

Acceleration and deceleration time

The deceleration and acceleration time refers to a change of the output value from 0 to 100% (C0011). The time C0936 to be set can be calculated as follows:

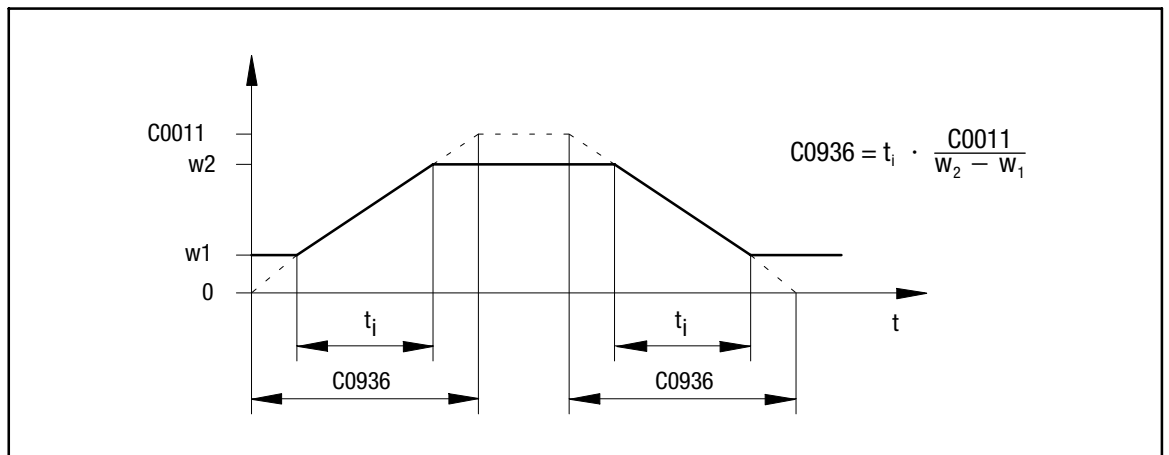
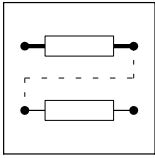

Fig. 2-13 Calculation of the acceleration and deceleration time

In this case the time desired for the change lies between w_1 and w_2 .

The calculated time is to be entered into C0936.



Configuration

Operating modes

Parameter setting

2.3 Operating modes

By selecting the operating mode you can also select the interface you want to use for parameter setting or control of the controller.

C0005 contains predefined configurations which allow a very easy change of the operating mode.

2.3.1 Parameter setting

Parameters can be set with one of the following modules:

- Communication module
 - 2102 (LECOM A/B/LI)
 - 2111, 2113 (INTERBUS)
 - 2131, 2133 (PROFIBUS)
 - 2175 (CANopen/DeviceNet)
- PC system bus module (CAN)
 - 2173

2.3.2 Control

The drive controller can be controlled via terminals (X5 and X6), via the fieldbus module at X1 or via the system bus (X4). Mixed forms are also possible.

Example: C0005 = 1005

This configuration corresponds to a speed control with control via system bus (CAN).

If more inputs of the function blocks are to be controlled via an interface, proceed as follows:

- Assign the function block inputs to be controlled to "control objects" depending on the interface used (see System Manual):
 - Free control codes
in case of control via LECOM A/B/LI (RS232, RS485 or optical fibre interface) or operating module.
 - AIF objects
in case of control using InterBus S or Profibus DP.
 - CAN objects
in case of control using system bus.
- Then the inputs can be controlled using these codes or input objects by accessing them via the interface.

Example for a distribution of the control on terminals and RS232:

The main speed setpoint in the configuration C0005=1000 is to be controlled via LECOM A/B/LI. All other inputs remain on terminal control.

1. Select C0780 via LECOM:
 - C0780 is the configuration code for the main setpoint NSET-N in the function block "Speed setpoint conditioning" (NSET).
2. Assign a free control code via a selection number.
 - e.g. 19515 (control code C0141)

The main speed setpoint is now controlled by C0141.

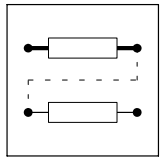

2.4 Change of the terminal assignment

(see also chapter 3.1 "Working with function blocks")

If the configuration is changed via C0005, the assignment of all inputs and outputs is overwritten with the corresponding basic assignment. If necessary, the function assignment must be adapted to the wiring.



Tip!

Use the menu "Terminal I/O" for the keypad 9371BB or the menu "Terminal I/O" for Global Drive Control or LEMOC2.



Stop!

If you reassign an input, the signal source that has been assigned up to now will **not** be overwritten! Those active connections that are not required must be removed (see chapter 3.1.3).

2.4.1 Freely assignable digital inputs

Five freely assignable digital inputs are available (X5/E1 ... X5/E5). You can define a polarity for each input which serves to determine the input to be HIGH active or LOW active.

Change assignment:



Tip!

Use the submenu "DIGIN" for the keypad 9371BB or the submenu "Digital inputs" for Global Drive Control or LEMOC2.

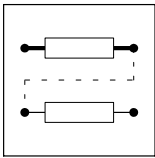

Configuration

Change of the terminal assignment Freely assignable digital inputs

Example: Menu "Terminal I/O; DIGIN" (terminal I/O; digital inputs)

Here are the most important aims for digital inputs

Valid for the basic configuration C0005 = 1000.

CFG	Code		controlled by		Note
	Subcode	Signal name	Signal (interface)	Selection list 2	
C0885	000	R/L/Q-R	DIGIN1 (Term. X5/E1)	0051	HIGH = do not invert main setpoint (CW rotation)
C0886	000	R/L/Q-L	DIGIN2 (Term. X5/E2)	0052	HIGH = Invert main setpoint (CCW rotation)
C0787	001	NSET-JOG*1	DIGIN3 (Term. X5/E3)	0053	HIGH = Main setpoint is substituted by the fixed speed from C0039/x The signals are binary coded.
	002	NSET-JOG*2	FIXED0 -	1000	
	003	NSET-JOG*4	FIXED0 -	1000	
	004	NSET-JOG*8	FIXED0 -	1000	
C0788	001	NSET-TI*1	FIXED0 -	1000	Additional acceleration and deceleration times from C0101/x and C0103/x The signals are binary coded.
	002	NSET-TI*2	FIXED0 -	1000	
	003	NSET-TI*4	FIXED0 -	1000	
	004	NSET-TI*8	FIXED0 -	1000	
C0880	001	DCTRL-PAR*1	FIXED0 -	1000	Parameter set selection: The signals are binary coded.
	002	DCTRL-PAR*2	FIXED0 -	1000	
C0881	000	DCTRL-PAR-LOAD	FIXED0 -	1000	Signal LOW-HIGH loads selected parameter set with DCTRL-PAR*x
C0871	000	DCTRL-TRIP-SET	DIGIN4 (Term. X5/E4)	0054	LOW = Controller sets TRIP (Eer)
C0876	-	DCTRL-TRIP-RES	DIGIN5 (Term. X5/E5)	0055	Signal LOW-HIGH = Resets active trip
C0920	000	REF-ON	FIXED0 -	1000	HIGH = Start homing
C0921	000	REF-MARK	FIXED0 -	1000	LOW-HIGH edge = Stop homing

- Select the input of the function blocks which is to be assigned to a new source under the configuration code CFG in the code level.
 - Example:
C0787/2 (CFG/subcode) determines the source for the input "NSET-JOG*2" (signal name) in the function block "Speed setpoint conditioning" (NSET).
- Change to the parameter level with PRG. Select the source (signal) from the indicated list. Ask yourself: Where does the signal for controlling this input is to come from?
 - Example:
"NSET-JOG*2" is to be controlled by terminal X5/E5 (interface).
 - For this, select DIGIN5 (signal) and confirm with SHIFT + PRG.
- Change to the code level with 2 * .
- Determine the polarity of the input terminals X5/E1 to X5/E5 (HIGH active or LOW active) under code C0114 and subcode.
 - In the code level the terminal is selected via subcode.
 - Change to the parameter level using PRG and select the polarity.
 - Change to the code level by 2 * PRG.
- Repeat steps 1. to 4. until all inputs required are assigned.
- Remove undesired connections (see chapter 3.1.3). The connection so far of the terminal X5/E5 is not cancelled automatically. If the connection is to be cancelled:
 - Select C0876 in the code level (previous target of terminal X5/E5)
 - Change to the parameter level using PRG.
 - Select FIXED0 (signal) and acknowledge with SHIFT+PRG.

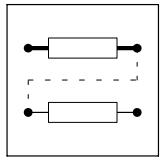

2.4.2 Freely assignable digital outputs

Four freely assignable digital outputs are available (X5/A1 ... X5/A4). You can define a polarity for each input which serves to determine the input to be HIGH active or LOW active.

The most important codes can be found in the submenu: DIGOUT (digital outputs).

Change assignment:

1. Select the output which is to be assigned to another function via the subcode under C0117.
2. Change to the parameter level with PRG. Select the signal from the indicated list, which is to be output via the selected output terminal. Change to the code level with PRG.
3. Determine the polarity (HIGH active or LOW active) via the subcode of the output under C0118.
4. Repeat step 1. to 3., until all outputs desired are assigned.

2.4.3 Freely assignable analog inputs

The most important codes can be found in the submenu: AIN1 X6.1/2 or AIN2 X6.3/4 (analog input 1 (X6.1/2) or analog input 2 (X6.3/4))

Change assignment:

1. Select the input of the function block to be assigned to a new source in the code level.
 - Example
Determine the source for the input "Main setpoint" (NSET-N) in the function block "Speed setpoint conditioning" (NSET) under C0780.
2. Change to the parameter level with PRG. Select the signal from the indicated list, which is to be used for the selected input.
3. Repeat steps 1. and 2. until all inputs required are assigned.
4. Remove unwanted links (see Chapter 3.1.3).



Configuration

Change of the terminal assignment

Freely assignable monitor outputs

2.4.4 Freely assignable monitor outputs

Use the monitor outputs X6/62 and X6/63 to output internal signals as voltage signals.

Under C0108 and C0109 the outputs can be adapted to e.g. a measuring device or a slave drive.

The most important codes can be found in the submenu: AOUT1 X6.62 or AIN2 X6.63 (analog output 1 (X6.62) or analog output 1 (X6.63))

Change assignment:

1. Select the output to be assigned to another signal (source) (e.g. C0431 for output X6/62) in the code level.
2. Change to the parameter level with PRG. Select the signal from the indicated list which is to be output via the monitor output.
3. If necessary, adjust an offset in the hardware under C0109
4. If necessary, the signal gain can be adapted to the hardware under C0108.
5. Repeat steps 1. to 4. to assign the second output.

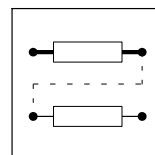

3 Function library

Contents

3.1	Working with function blocks	3-3
3.1.1	Signal types	3-3
3.1.2	Elements of a function block	3-4
3.1.3	Connecting function blocks	3-6
3.1.4	Entries into the processing table	3-10
3.2	Function blocks	3-12
3.2.1	Table of function blocks	3-12
3.2.2	Table of free control codes	3-14
3.2.3	Addition block (ADD)	3-16
3.2.4	Automation interface (AIF-IN)	3-17
3.2.5	Automation interface (AIF-OUT)	3-20
3.2.6	Analog inputs via terminal X6/1, X6/2 and X6/3, X6/4 (AIN)	3-22
3.2.7	AND operation (AND)	3-24
3.2.8	Inverter (ANEG)	3-28
3.2.9	Analog output via terminal 62/63 (AOUT)	3-29
3.2.10	Arithmetic block (ARIT)	3-31
3.2.11	Arithmetic block (ARITPH)	3-32
3.2.12	Analog signal changeover switch (ASW)	3-33
3.2.13	Holding brake (BRK)	3-35
3.2.14	System bus (CAN-IN)	3-40
3.2.15	System bus (CAN-OUT)	3-41
3.2.16	Comparator (CMP)	3-42
3.2.17	Signal conversion (CONV)	3-47
3.2.18	Angle conversion (CONVPHA)	3-50
3.2.19	Angle conversion (CONVPHPH)	3-51
3.2.20	Speed conversion (CONVPP)	3-52
3.2.21	Characteristic function (CURVE)	3-53
3.2.22	Dead band (DB)	3-56
3.2.23	Control of the drive controller (DCTRL)	3-57
3.2.24	Master frequency input (DFIN)	3-62
3.2.25	Digital frequency output (DFOUT)	3-65
3.2.26	Digital frequency ramp function generator (DFRFG)	3-69
3.2.27	Digital frequency processing (DFSET)	3-75
3.2.28	Delay elements (DIGDEL)	3-81
3.2.29	Freely assignable digital inputs (DIGIN)	3-84
3.2.30	Freely assignable digital outputs (DIGOUT)	3-85
3.2.31	First order derivative-action element (DT1)	3-86
3.2.32	Free piece counter (FCNT)	3-87
3.2.33	Free digital outputs (FDO)	3-88
3.2.34	Freely assignable input variables (FEVAN)	3-90
3.2.35	Fixed setpoints (FIXSET)	3-95



Function library

3.2.36	Flipflop element (FLIP)	3-97
3.2.37	Gearbox compensation (GEARCOMP)	3-100
3.2.38	Limiting element (LIM)	3-101
3.2.39	Internal motor control (MCTRL)	3-102
3.2.40	Mains failure control (MFAIL)	3-111
3.2.41	Motor phase failure detection (MLP)	3-122
3.2.42	Monitor outputs of monitoring system (MONIT)	3-123
3.2.43	Motor potentiometer (MPOT)	3-125
3.2.44	Logic NOT	3-128
3.2.45	Speed setpoint conditioning (NSET)	3-130
3.2.46	OR operation (OR)	3-135
3.2.47	Oscilloscope function (OSZ)	3-138
3.2.48	Process controller (PCTRL1)	3-142
3.2.49	Angle addition block (PHADD)	3-145
3.2.50	Angle comparator (PHCMP)	3-146
3.2.51	Actual angle integrator (PHDIFF)	3-148
3.2.52	Signal adaptation for angle signals (PHDIV)	3-149
3.2.53	Phase integrator (PHINT)	3-150
3.2.54	Delay element (PT1-1)	3-156
3.2.55	CW/CCW/QSP linking (R/L/Q)	3-157
3.2.56	Homing function (REF)	3-158
3.2.57	Ramp function generator (RFG)	3-164
3.2.58	Sample and hold function (S&H)	3-166
3.2.59	S-shaped ramp function generator (SRFG)	3-167
3.2.60	Output of digital status signals (STAT)	3-169
3.2.61	Control of a drive network (STATE-BUS)	3-170
3.2.62	Storage block (STORE)	3-171
3.2.63	Multi-axis synchronisation (SYNC1)	3-175
3.2.64	Edge evaluation (TRANS)	3-183

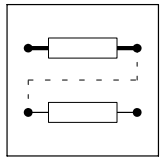

3.1 Working with function blocks

The signal flow of the controller can be configured by connecting function blocks. The controller can thus be easily adapted to diverse applications.

3.1.1 Signal types

Each function block has a certain number of inputs and outputs, which can be interlinked. Corresponding to their respective functions, only particular signal types occur at the inputs and outputs:

- Quasi analog signals
 - Symbol: ○
 - Unit: %
 - Designation: a
 - Value range: $\pm 16384 = \pm 100 \%$
 - Resolution: 16 bits, scaling: $\pm 16384 \triangleq \pm 100 \%$
- Digital signals
 - Symbol: □
 - Unit: binary, with HIGH or LOW level
 - Designation: d
 - Resolution: 1 bit
- Speed signals
 - Symbol: Δ
 - Unit: rpm (for display, internal representation in [inc/ms])
 - Designation: phd
 - Value range: $\pm 2^{15} - 1$
 - Resolution: 16 bit
- Angle signals
 - Symbol: ▲
 - Unit: inc
 - Designation: ph
 - Value range: $\pm 2^{31} - 1$
 - Resolution: 32 bits, scaling: 1 revolution $\triangleq 65536$ inc

Only the same signal types can be connected with each other. Thus, an analog output signal of one function block can only be connected to the analog output of the other function block. If two different signal types are connected, the connection will be rejected.



Function library

Working with function blocks Elements of a function block

3.1.2 Elements of a function block

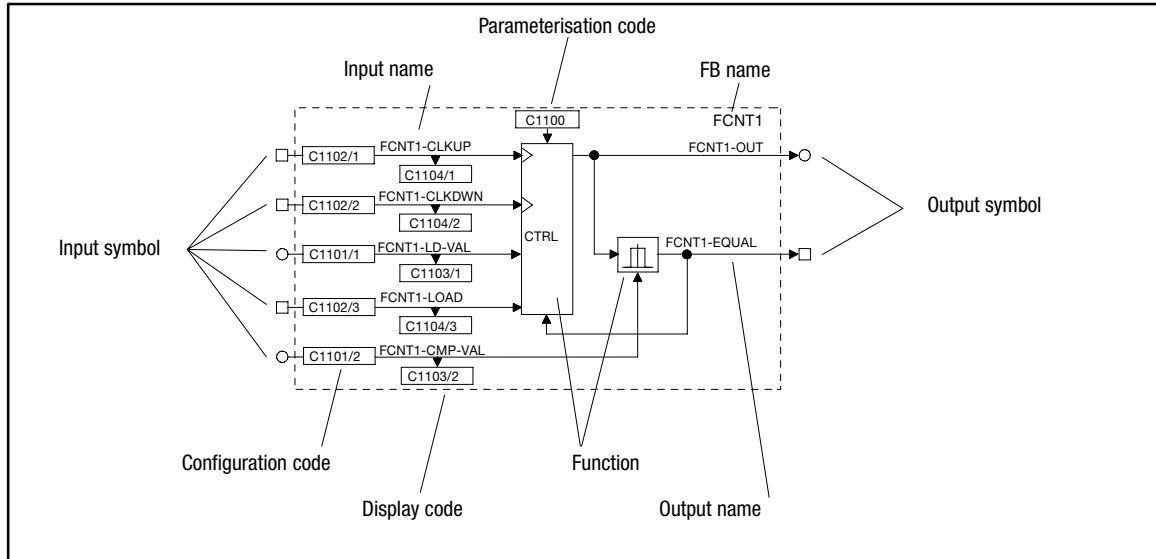

Fig. 3-1 Structure of a function block (FB) using the example of FCNT1

FB name

Clearly identifies the FB. The FB name is followed by a number distinguishing the function of the FB. Each FB is defined via its selection number. For calculating the FB the input of the selection number into the processing table is always required. (📖 3-10)

The selection numbers are listed in selection list 5.

Example:

(FCNT1, see Fig. 3-1)

- FCNT1 selection number 6400 (selection list 5).

Input symbol

Indicates the signal type which can be used as a signal source for this input. (📖 3-3)



Note!

Only inputs led through the FB can be configured.

Input name

Consists of the FB name and a designation. Inputs with the same function are distinguished by the number that is added to the designation.

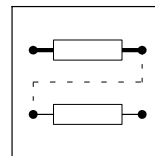

Configuration code

Configures the input with a signal source (e. g. terminal signal, control code, output of an FB, ...). Inputs with identical codes are distinguished by the attached subcode (Cxxxx/1). These codes are configured via the subcode.

It is not possible to connect an input with several signal sources.

Display code

Displays the current input value. Inputs with identical codes are distinguished by the attached subcode (Cxxxx/1). These codes are displayed via the subcode.

Display codes cannot be processed.

Function

Represents the mathematical function as a block diagram (see Fig. 3-1).

Parameterisation code

Adaptation of the function or behaviour to the drive task. Possible settings are described in the text editor and / or the line diagrams. (📖 3-12)

Output symbol

Designates the signal type. Connections with inputs of the same signal type are possible. (📖 3-3)

Each output is defined by a selection number. The selection numbers are divided into selection lists (1 ... 4) according to the different signal types.

An output is linked to an input by the selection numbers.

Example:

(FCNT1, see Fig. 3-1)

- FCNT1-OUT \triangle selection number 6400 (analog signal, selection list 1).
- FCNT1-EQUAL \triangle selection number 6400 (digital signal, selection list 2).



Note!

Only outputs brought out of the FB can be configured.

Output name

Consists of the FB name and a designation. Outputs with the same function are distinguished by the number that is added to the designation.



Function library

Working with function blocks Connecting function blocks

3.1.3 Connecting function blocks

General rules

- Assign a signal source to an input.
- One input can have only one signal source.
- Inputs of different function blocks can have the same signal source.
- Only signals of the same type can be connected.



Stop!

Existing connections which are not required must be removed by reconfiguration. Otherwise the drive cannot perform the desired function.

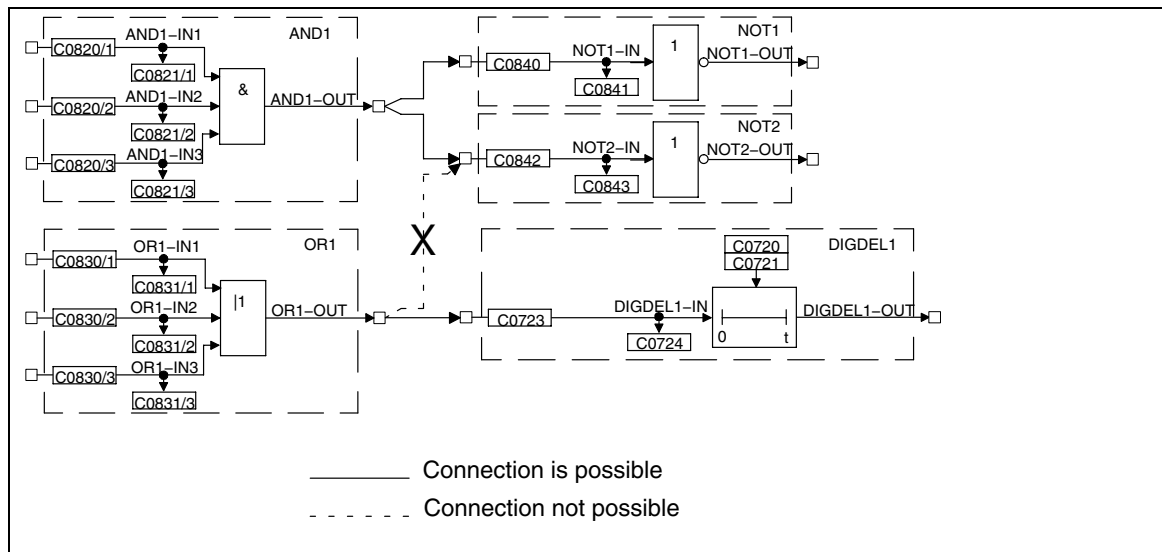
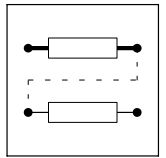

Fig. 3-2 Correct connection of function blocks



Basic procedure

1. Select the configuration code of the function block input which is to be changed.
2. Determine the source of the input signal for the selected input (e.g. from the output of another function block).
3. The function block input is assigned via a menu which contains only those signal sources which are of the same type as the function block input to be assigned.
4. Select and confirm the signal source.
5. Remove undesired connections, if any.
 - For this, select the corresponding signal assignment of the input via the configuration code (e.g. FIXED0, FIXED1, FIXED0%, ...).
6. Repeat 1. to 5. until the desired configuration is set.
7. Save modified configuration in the desired parameter set.

Example

- Condition:
 - Default setting
- Task:
 - Square the analog signal of X6/3, X6/4 and output to X6/62.
- Solution:
 - You need the function blocks AIN2, ARIT2 and AOUT2.

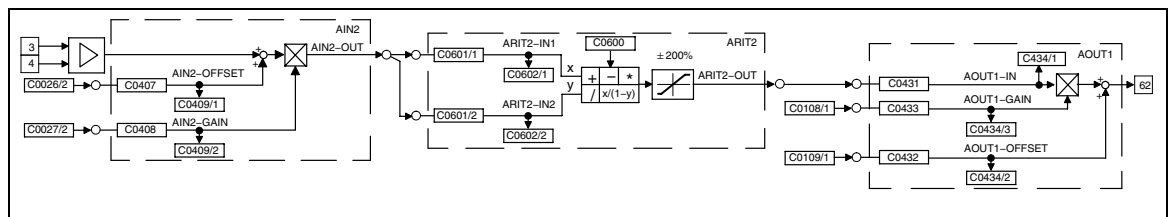

Fig. 3-3

Example of a simple configuration



Function library

Working with function blocks

Connecting function blocks

Create connections

1. Determine the signal source for ARIT2-IN1:
 - Change to the code level using the arrow keys
 - Select C0601/1 using **▲** or **▼**.
 - Change to the parameter level using PRG.
 - Select output AIN2-OUT (selection number 55) using **▲** or **▼**.
 - Confirm using SH + PRG
 - Change to the code level again using PRG.
2. Determine signal source for ARIT2-IN2:
 - Select C0601/2 using **▲**.
 - Change to the parameter level using PRG.
 - Select output AIN2-OUT (selection number 55) using **▲** or **▼**.
 - Confirm using SH + PRG
 - Change to the code level again using PRG.
3. Parameterise ARIT2:
 - Select C0600 using **▼**.
 - Change to the parameter level using PRG.
 - Select multiplication (selection number 3).
 - Confirm using SH + PRG
 - Change to the code level again using PRG.
4. Determine signal source for AOUT1:
 - Select C0431 using **▼**.
 - Change to the parameter level using PRG.
 - Select output ARIT2-OUT (selection number 5505).
 - Confirm using SH + PRG
 - Change to the code level again using PRG.
5. Enter function block ARIT2 in the processing table:
 - Select C0465 and subcode 8 using **▲**.
 - Change to the parameter level using PRG.
 - Enter function block ARIT2 (selection number 5505).
 - Confirm using SH + PRG
 - Change to the code level again using PRG.
 - The sequence of the FB processing is thus determined.

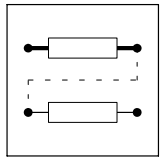

Remove connections

- Since a source can have several targets, there may be additional, unwanted signal connections.
- Example:
 - In the basic configuration C0005 = 1000, ASW1-IN1 and AIN2-OUT are connected.
 - This connection is not automatically removed by the settings described above! If you do not want this connection, remove it.

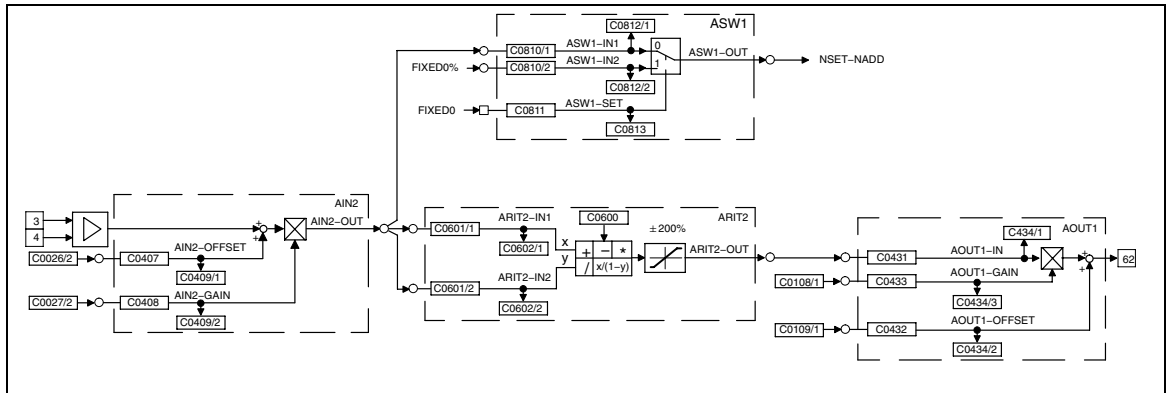

Fig. 3-4 Removing connections in a configuration

1. Remove connection between ASW1-IN1 and AIN2-OUT:
 - Select C0810/1 using **▲** or **▼**.
 - Change to the parameter level using PRG.
 - Select the constant FIXED0% (selection number 1000) using **▲** or **▼**.
 - Confirm using SH + PRG
 - Change to the code level again using PRG.

Now, the connection is removed.

2. Save new configuration, if desired:
 - If you do not want to lose the modifications after mains disconnection, save the new signal configuration under C0003 in one of the parameter sets.



Function library

Working with function blocks
Entries into the processing table

3.1.4 Entries into the processing table

The 93XX drive controller provides a certain computing time for processing function blocks. Since the type and number of the function blocks used can vary considerably, not all function blocks available are permanently calculated. Therefore the code C0465 provides a processing table, in which only the FBs used are entered. This means that the drive system is perfectly adapted to the task to be solved. If further FBs are used in an extant configuration, they must be entered into the processing table.

The following aspects must be observed:

The number of FBs to be processed is limited

A maximum of 50 FBs can be integrated into a configuration. Each FB needs a certain processing time (operating time). The code C0466 shows the time still remaining for processing the FBs. If this time has elapsed, no further FBs can be integrated.

Sequence for entering FBs

Normally, the sequence of the entries into C0465 is discretionary, but it may be important for applications with a highly dynamic response. In general the most favourable sequence is adapted to the signal flow.

Example:

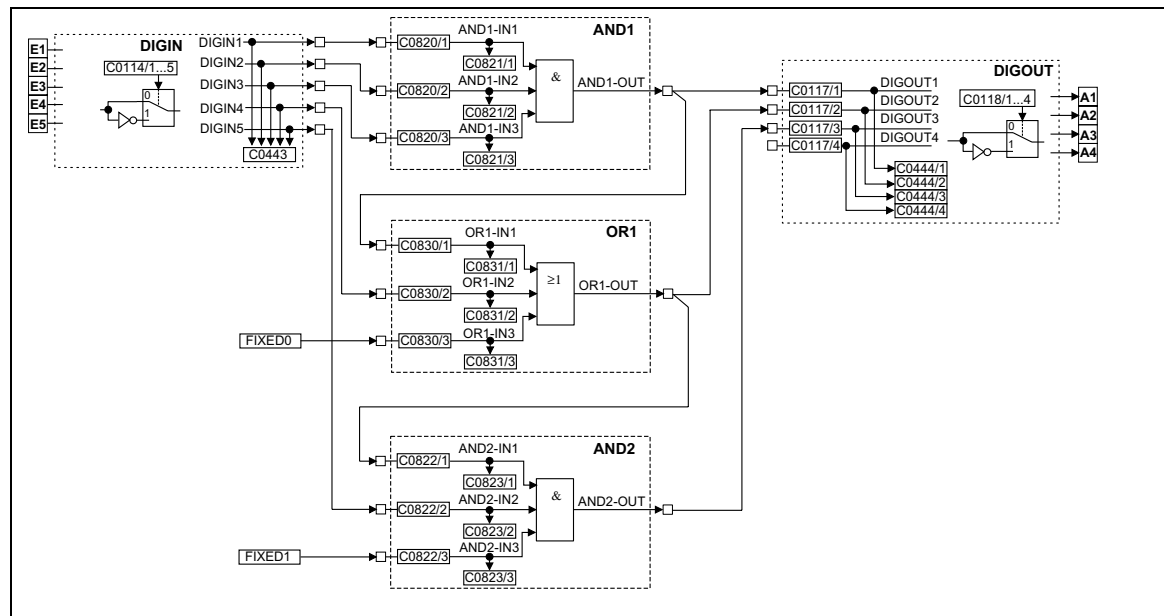
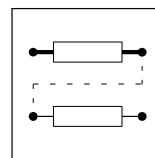

Fig. 3-5 Example of a configuration



Structure of the processing table for the configuration example Fig. 3-5:

1. DIGIN does not have to be entered into the processing table.
2. The first FB is AND1, since it receives its input signals from DIGIN and only has successors.
3. The second FB is OR1, since its signal source is the output of AND1 (predecessor). Hence, the output signal in AND1 must be generated first, before being processed in OR1. At the same time, OR1 has a successor. Hence, OR1 must be entered into the processing table before the successor.
4. The third FB is AND2, since it has a predecessor (see 3.)
5. The entries under C0465 are as follows:
 - Position 10: AND1 10500
 - Position 11: OR1 10550
 - Position 12: AND2 10505

This example was started with position 10, since these positions are not assigned in the default setting.

FBs do not have to be entered into the processing table directly one after the other. Empty positions in the processing table are permissible.



Note!

It is also possible that other FBs are entered between the FBs listed in the example.

FBs, which do not have to be entered into the processing table

The following signal sources are always executed and therefore do not need to be entered into the processing table:

- AIF-IN
- CANx-IN
- DIGIN
- DIGOUT
- FCODE (all free codes)
- MCTRL
- fixed signal sources (FIXED0, FIXED0%, etc.)

Frequent errors

Malfunction	Cause	Remedy
FB does not supply an output signal	FB was not entered into the processing table C0465	Enter FB
FB only supplies constant signals	FB was deleted from or overwritten in the processing table C0465	Enter FB again, possibly under a different subcode (list position)
The output signal does not arrive at the following FB	The connection between the FBs has not been established	Establish the connection (from the view of the following FB) via the configuration code (CFG)
FB cannot be entered into the table C0465	Residual processing time is too short (see C0466)	Delete unused FBs (e. g. inputs and outputs not used) In networked drives, functions may be assigned to other controllers
The drive controller transmits internally calculated signals with a delay to the outputs.	The FBs are processed in an incorrect sequence	Adapt the processing table under C0465 to the signal flow



Function library

Function blocks

Table of function blocks

3.2 Function blocks

3.2.1 Table of function blocks

Function block	Description	CPU time [μs]	used in basic configuration C0005								
			1000	4000	5000	6000	7000	20	21		
ABS1	Absolute value generator	4							•	•	
ADD1	Addition block	8								•	
AIF-IN	Fieldbus	–	•	•	•	•	•				
AIF-OUT	Fieldbus	56	•	•	•	•	•				
AIN1	Analog input X6/1, X6/2	10	•	•	•	•	•	•	•	•	
AIN2	Analog input X6/3, X6/4	28	•	•	•	•	•	•	•	•	
AND1	Logic AND, block1	6							•	•	
AND2	Logic AND, block2								•	•	
AND3	Logic AND, block3								•	•	
AND4	Logic AND, block4									•	
AND5	Logic AND, block5										
AND6	Logic AND, block6										
AND7	Logic AND, block7										
ANEG1	Analog inverter 1	3	•	•	•	•	•	•	•	•	
ANEG2	Analog inverter 2									•	
AOUT1	Analog output X6/62	12	•	•	•	•	•	•	•	•	
AOUT2	Analog output X6/63			•	•	•	•	•	•	•	
ARIT1	Arithmetic block 1	11							•	•	
ARIT2	Arithmetic block 2										
ARITPH1	32 Bit arithmetic block	15									
ASW1	Analog changeover 1	4	•		•				•	•	
ASW2	Analog changeover 2								•	•	
ASW3	Analog changeover 3										
ASW4	Analog changeover 4										
BRK	Trigger holding brake	15									
CAN-IN1	System bus	–									
CAN-IN2	System bus										
CAN-IN3	System bus										
CAN-OUT1	System bus	56	•	•	•	•	•				
CAN-OUT2	System bus										
CAN-OUT2	System bus										
CMP1	Comparator 1	15	•	•	•	•	•	•	•	•	
CMP2	Comparator 2								•	•	
CMP3	Comparator 3									•	
CONV1	Conversion	8									
CONV2	Conversion										
CONV3	Conversion										•
CONV4	Conversion										
CONV5	Conversion										•
CONV6	Conversion										
CONVPHA1	32 bit conversion	6									
CONVPHPH1	32 bit conversion	80									
CONVPP1	32 bit / 16 bit conversion	55									
CURVE1	Characteristic function	15									
DB1	Dead band	7							•		
DCTRL	Device control	–	•	•	•	•	•	•	•	•	
DFIN	Digital frequency input	5	•	•	•	•	•			•	
DFOUT	Digital frequency output	35	•	•	•	•	•	•	•	•	
DFRFG1	Digital frequency ramp function generator	40									
DFSET	Digital frequency processing	85			•	•	•			•	
DIGDEL1	Binary delay element 1	9									
DIGDEL2	Binary delay element 2										

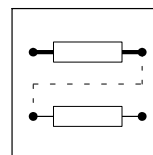

Function block	Description	CPU time [μs]	used in basic configuration C0005							
			1000	4000	5000	6000	7000	20	21	
DIGIN	Input terminals X5/E1...X5/E5	–	•	•	•	•	•	•	•	
DIGOUT	Output terminals X5/A1...X5/A4	–	•	•	•	•	•	•	•	
DT1-1	Differential element	12								
FCNT1	Piece counter	11								
FEVAN1	Free analog input variable	4								
FEVAN2	Free analog input variable									
FDO	Free digital outputs	–								
FIXED	Constant signals	–	•	•	•	•	•	•	•	
FIXSET1	Fixed setpoints	9								
FLIP1	D-flipflop 1	6						•	•	
FLIP2	D-flipflop 2									
GEARCOMP	Gearbox torsion	1								
LIM1	Limiter	5						•	•	
MCTRL	Motor control	–	•	•	•	•	•	•	•	
MFAIL	Mains failure detection	40						•	•	
MLP1	Motor phase failure detection	30								
MONIT	Monitoring	–	•	•	•	•	•	•	•	
MPOT1	Motor potentiometer	20								
NOT1	Logic NOT, block1	4		•			•	•	•	
NOT2	Logic NOT, block2							•	•	
NOT3	Logic NOT, block3							•	•	
NOT4	Logic NOT, block4								•	
NOT5	Logic NOT, block5								•	
NSET	Speed setpoint conditioning	70	•	•	•			•	•	
OR1	Logic OR, block1	6			•	•	•	•	•	
OR2	Logic OR, block2							•	•	
OR3	Logic OR, block3							•		
OR4	Logic OR, block4								•	
OR5	Logic OR, block5								•	
OSZ	Oscilloscope function	70								
PCTRL1	Process controller	58								
PHADD1	32 bit addition block	10								
PHCMP1	Comparator	8							•	
PHCMP2	Comparator									
PHCMP3	Comparator									
PHDIFF	32 bit setpoint/act. value comparison	10								
PHDIV1	Conversion	8								
PHINT1	Phase integrator	7								
PHINT2	Phase integrator									
PHINT3	Phase integrator	10								
PT1-1	1st order delay element	8								
CW/CCW/Q	QSP / setpoint inversion	8	•	•				•	•	
REF	Homing function	100			•	•	•	•	•	
RFG1	Ramp function generator	16							•	
S&H	Sample and Hold	4								
SRFG1	S-shape ramp function generator	15								
STAT	Digital status signals	–	•	•	•	•	•	•	•	
STATE-BUS	State bus	–								
STORE1	Memory 1	35								
STORE2	Memory 2	20								
SYNC1	Multi-axis positioning	55								
TRANS1	Binary edge evaluation	7								
TRANS2	Binary edge evaluation									
TRANS3	Binary edge evaluation									
TRANS4	Binary edge evaluation									

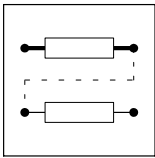

Function library

Function blocks

Table of free control codes

3.2.2 Table of free control codes

Function block	Description	CPU time [μs]	used in basic configuration C0005							
			1000	4000	5000	6000	7000	20	21	
FCODE 17	Free control codes	-	•	•	•	•	•	•	•	•
FCODE 26/1			•	•	•	•	•	•	•	
FCODE 26/2			•	•	•	•	•	•	•	
FCODE 27/1			•	•	•	•	•	•	•	
FCODE 27/2			•	•	•	•	•	•	•	
FCODE 32				•	•	•			•	
FCODE 37								•	•	
FCODE 108/1			•	•	•	•	•	•	•	
FCODE 108/2			•	•	•	•	•	•	•	
FCODE 109/1			•	•	•	•	•	•	•	
FCODE 109/2			•	•	•	•	•	•	•	
FCODE 135										
FCODE 141								•	•	
FCODE 250								•	•	
FCODE 471								•	•	
FCODE 472/1										
FCODE 472/2										
FCODE 472/3			•	•	•	•	•			
FCODE 472/4				•						
FCODE 472/5					•	•	•			
FCODE 472/6					•	•	•			
FCODE 472/7										
FCODE 472/8										
FCODE 472/9								•	•	
FCODE 472/10								•	•	
FCODE 472/11								•	•	
FCODE 472/12										
FCODE 472/13										
FCODE 472/14										
FCODE 472/15										
FCODE 472/16										
FCODE 472/17										
FCODE 472/18										
FCODE 472/19										
FCODE 472/20										
FCODE 473/1						•	•	•	•	
FCODE 473/2						•	•	•		
FCODE 473/3						•	•	•		
FCODE 473/4										
FCODE 473/5										
FCODE 473/6										
FCODE 473/7										
FCODE 473/8										
FCODE 473/9										
FCODE 473/10										
FCODE 474/1										
FCODE 474/2										
FCODE 474/3										
FCODE 474/4										
FCODE 474/5										
FCODE 475/2										

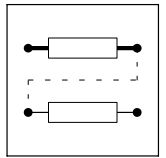

Description

This function block converts bipolar signals to unipolar signals.

The absolute value is generated by the input signal and is provided at the output.



Fig. 3-6

Absolute value generator (ABS1)



Function library

Function blocks Addition block (ADD)

3.2.3 Addition block (ADD)

Purpose

Adds or subtracts "analog" signal depending on the input used.

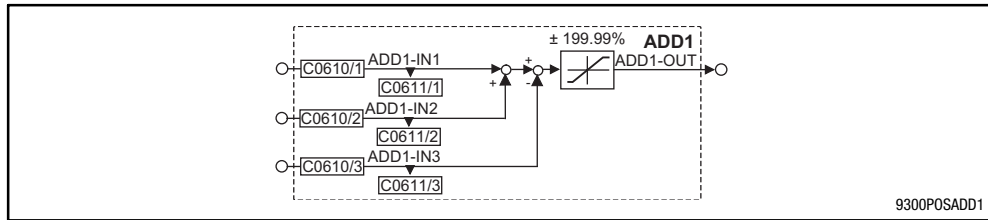
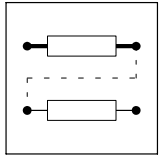

Fig. 3-7 Addition block (ADD1)

Name	Signal			Source			Note
	Type	DIS	DIS format	CFG	List	Lenze	
ADD1-IN1	a	C0611/1	dec [%]	C0610/1	1	1000	Addition input
ADD1-IN2	a	C0611/2	dec [%]	C0610/2	1	1000	Addition input
ADD1-IN3	a	C0611/3	dec [%]	C0610/3	1	1000	Subtraction input
ADD1-OUT	a	-	-	-	-	-	Limited to ±199.99%

Function

- Input ADD1-IN1 is added to input ADD1-IN2.
- The input ADD-IN3 is subtracted from the calculated result.
- Then, the result of the subtraction is limited to ±199.99 %.



3.2.4 Automation interface (AIF-IN)

Purpose

Interface for input signals of the plug-on fieldbus module (e.g. INTERBUS, PROFIBUS) for setpoints and actual values as binary, analog, or angle information. Please observe the corresponding Operating Instructions for the plug-on fieldbus module.

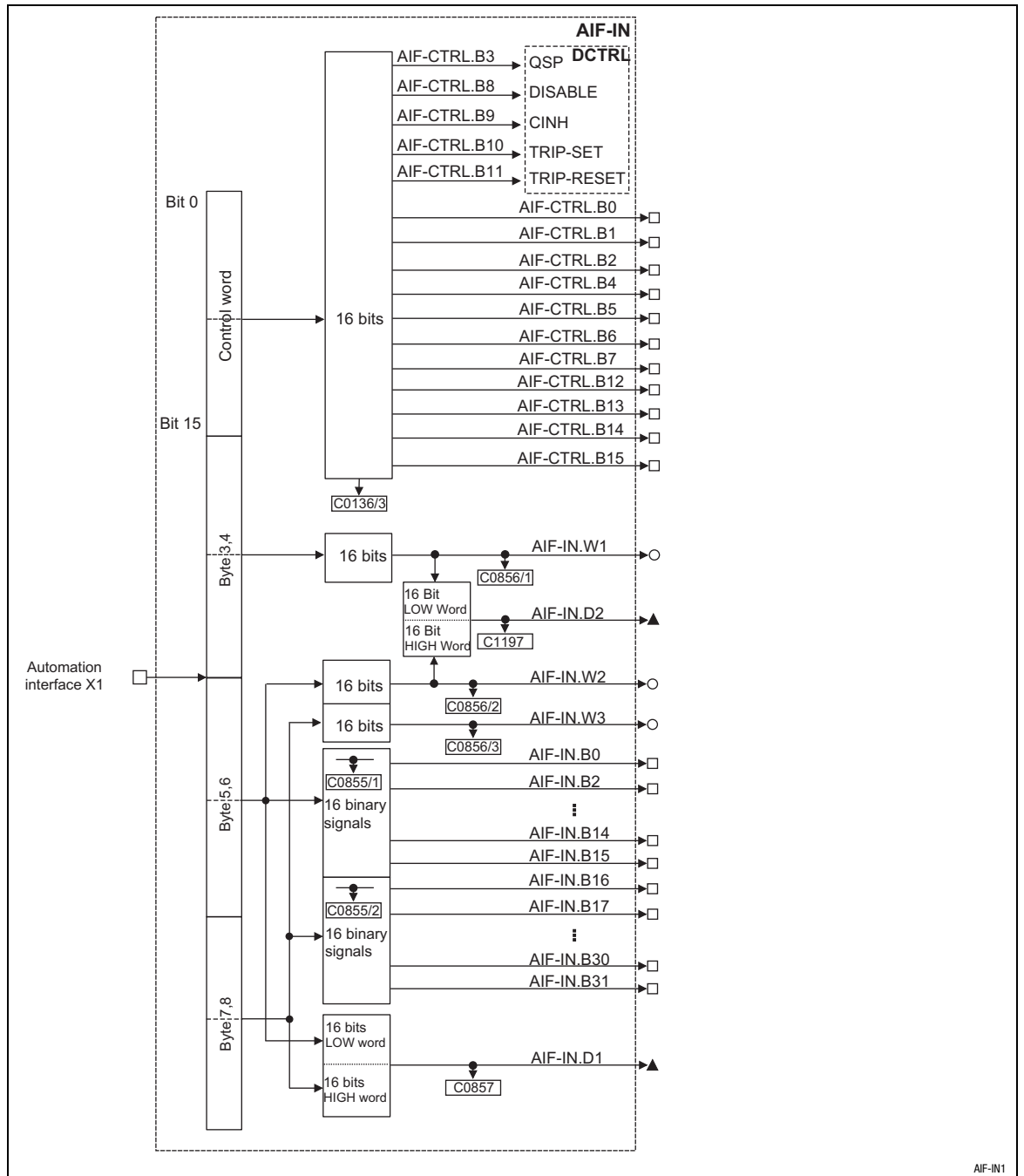

Fig. 3-8 Automation interface (AIF-IN)



Function library

Function blocks Automation interface (AIF-IN)

Name	Signal			Source			Note
	Type	DIS	DIS format	CFG	List	Lenze	
AIF-CTRL.B0	d	C0136/3	bin	-	-	-	
AIF-CTRL.B1	d	C0136/3	bin	-	-	-	
AIF-CTRL.B2	d	C0136/3	bin	-	-	-	
AIF-CTRL.B4	d	C0136/3	bin	-	-	-	
AIF-CTRL.B5	d	C0136/3	bin	-	-	-	
AIF-CTRL.B6	d	C0136/3	bin	-	-	-	
AIF-CTRL.B7	d	C0136/3	bin	-	-	-	
AIF-CTRL.B12	d	C0136/3	bin	-	-	-	
AIF-CTRL.B13	d	C0136/3	bin	-	-	-	
AIF-CTRL.B14	d	C0136/3	bin	-	-	-	
AIF-CTRL.B15	d	C0136/3	bin	-	-	-	
AIF-IN.W1	a	C0856/1	dec [%]	-	-	-	+16384 = +100 %
AIF-IN.W2	a	C0856/2	dec [%]	-	-	-	+16384 = +100 %
AIF-IN.W3	a	C0856/3	dec [%]	-	-	-	+16384 = +100 %
AIF-IN.D1	ph	C0857	dec [inc]	-	-	-	65536 = 1 rev.
AIF-IN.D2	ph	C1197	dec [inc]	-	-	-	65536 = 1 rev.
AIF-IN.B0	d	C0855/1	hex	-	-	-	
AIF-IN.B1	d	C0855/1	hex	-	-	-	
AIF-IN.B2	d	C0855/1	hex	-	-	-	
AIF-IN.B3	d	C0855/1	hex	-	-	-	
AIF-IN.B4	d	C0855/1	hex	-	-	-	
AIF-IN.B5	d	C0855/1	hex	-	-	-	
AIF-IN.B6	d	C0855/1	hex	-	-	-	
AIF-IN.B7	d	C0855/1	hex	-	-	-	
AIF-IN.B8	d	C0855/1	hex	-	-	-	
AIF-IN.B9	d	C0855/1	hex	-	-	-	
AIF-IN.B10	d	C0855/1	hex	-	-	-	
AIF-IN.B11	d	C0855/1	hex	-	-	-	
AIF-IN.B12	d	C0855/1	hex	-	-	-	
AIF-IN.B13	d	C0855/1	hex	-	-	-	
AIF-IN.B14	d	C0855/1	hex	-	-	-	
AIF-IN.B15	d	C0855/1	hex	-	-	-	
AIF-IN.B16	d	C0855/2	hex	-	-	-	
AIF-IN.B17	d	C0855/2	hex	-	-	-	
AIF-IN.B18	d	C0855/2	hex	-	-	-	
AIF-IN.B19	d	C0855/2	hex	-	-	-	
AIF-IN.B20	d	C0855/2	hex	-	-	-	
AIF-IN.B21	d	C0855/2	hex	-	-	-	
AIF-IN.B22	d	C0855/2	hex	-	-	-	
AIF-IN.B23	d	C0855/2	hex	-	-	-	
AIF-IN.B24	d	C0855/2	hex	-	-	-	
AIF-IN.B25	d	C0855/2	hex	-	-	-	
AIF-IN.B26	d	C0855/2	hex	-	-	-	
AIF-IN.B27	d	C0855/2	hex	-	-	-	
AIF-IN.B28	d	C0855/2	hex	-	-	-	
AIF-IN.B29	d	C0855/2	hex	-	-	-	
AIF-IN.B30	d	C0855/2	hex	-	-	-	
AIF-IN.B31	d	C0855/2	hex	-	-	-	



Function

The input signals of the 8-byte user data of the AIF object are converted into corresponding signal types. The signals can be used via further function blocks.

Byte 1 and 2

Byte 1 and 2 form the control word for the controller. The bits 3, 8, 9, 10, and 11 of these bytes are directly transferred into the function block DCTRL where they are linked with further signals. The other 11 bits can be used to control further function blocks.

Byte 3 and 4

form the signal to AIF-IN.W1.

Byte 5, 6, 7, and 8

This user data can be interpreted as different signal types. According to the requirement this data can be evaluated as up to two analog signals, 32 digital signals or one angle signal. Mixed forms are also possible.



Function library

Function blocks

Automation interface (AIF-OUT)

3.2.5 Automation interface (AIF-OUT)

Purpose

Interface for output signals of the plug-on fieldbus modules (e.g. INTERBUS, PROFIBUS) for setpoints and actual values as binary, analog or angle information. Please observe the corresponding Operating Instructions for the plug-on fieldbus module.

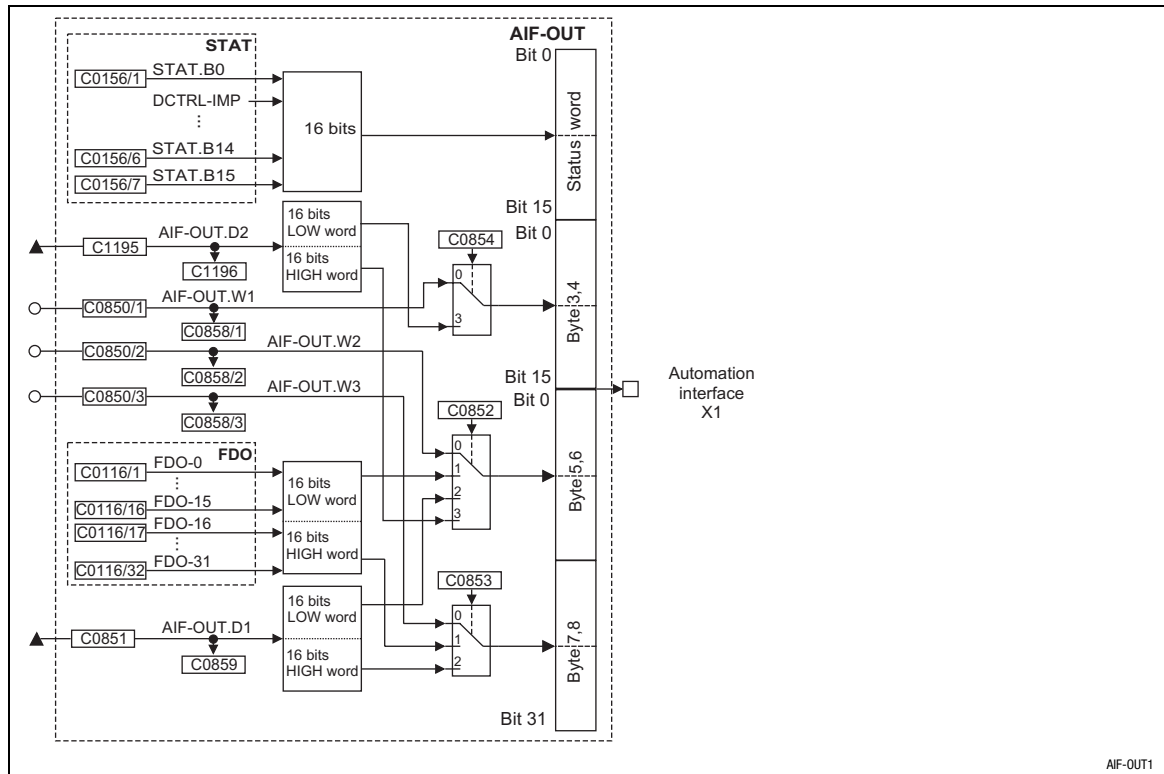
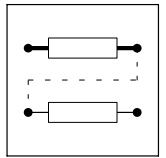

Fig. 3-9 Automation interface (AIF-OUT)

Name	Signal			Source			Note
	Type	DIS	DIS format	CFG	List	Lenze	
AIF-OUT.W1	a	C0858/1	dec [%]	C0850/1	1	1000	+100 % = +16384
AIF-OUT.W2	a	C0858/2	dec [%]	C0850/2	1	1000	+100 % = +16384
AIF-OUT.W3	a	C0858/3	dec [%]	C0850/3	1	1000	+100 % = +16384
AIF-OUT.D1	ph	C0859	abs [inc]	C0851	4	1000	1 rev. = 65536
AIF-OUT.D2	ph	C1196	abs [inc]	C1195	4	1000	1 rev. = 65536



Function

The input signals of this function block are copied into the 8-byte user data of the AIF object and assigned to the plug-on fieldbus module. The meaning of the user data can be determined very easily with C0852 and C0853 and the corresponding configuration code (CFG).

Byte 1 and 2

Here, the status word from the function block STAT is mapped. Some of the bits are freely assignable (see description of the function block STAT in chapter 3.2.60)

Byte 3 and 4

- C0854 = 0
 - The analog signal at AIF-OUT.W1 is output.
- C0854 = 3
 - The LOW-WORD of AIF-OUT.D2 is output.

Byte 5 and 6

- C0852 = 0
 - The analog signal at AIF-OUT.W2 is output at bytes 5 and 6.
- C0852 = 1
 - The bits 0 ... 15 of FDO are output.
- C0852 = 2
 - The LOW-WORD of AIF-OUT.D1 is output.
- C0852 = 3
 - The HIGH-WORD of AIF-OUT.D2 is output.

Byte 7 and 8

- C0853 = 0
 - The analog signal at AIF-OUT.W3 is output.
- C0853 = 1
 - The bits 16 ... 31 of FDO are output.
- C0853 = 2
 - The HIGH-WORD of AIF-OUT.D1 is output.

Example

You want to output 16 digital signals of FDO and the LOW-WORD of AIF-OUT.D1:

- The LOW-WORD of AIF-OUT.D1 can only be output at bytes 5 and 6.
 - For this purpose, C0852 is set to 2. The angle signal at C0851 is output at bytes 5 and 6.
- For the digital signals, only the bits 16 ... 31 (bytes 7 and 8) are available (bytes 5 and 6 are assigned):
 - For this purpose, C0853 is set to 1. Bits 16 ... 31 (FDO) are output at bytes 7 and 8.



Function library

Function blocks

Analog inputs via terminal X6/1, X6/2 and X6/3, X6/4 (AIN)

3.2.6 Analog inputs via terminal X6/1, X6/2 and X6/3, X6/4 (AIN)

Purpose

These function blocks are the interface for analog signals as the

- setpoint input,
- actual value input and
- parameter control.

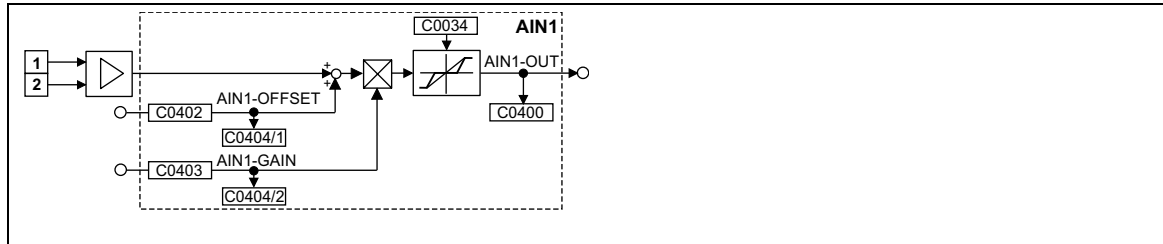

Fig. 3-10 Analog input via terminal X6/1, X6/2 (AIN1)

Name	Signal			Source			Note
	Type	DIS	DIS format	CFG	List	Lenze	
AIN1-OFFSET	a	C0404/1	dec [%]	C0402	1	19502	-
AIN1-GAIN	a	C0404/2	dec [%]	C0403	1	19504	-
AIN1-OUT	a	C0400	-	-	-	-	-

Special features of AIN1

- A dead band element can be integrated into the output signal at AIN1 via code C0034. Together with the jumper position X2 (controller front) the function 4 ... 20 mA can be implemented as a master current value.
- The signal is read cyclically (1 ms).

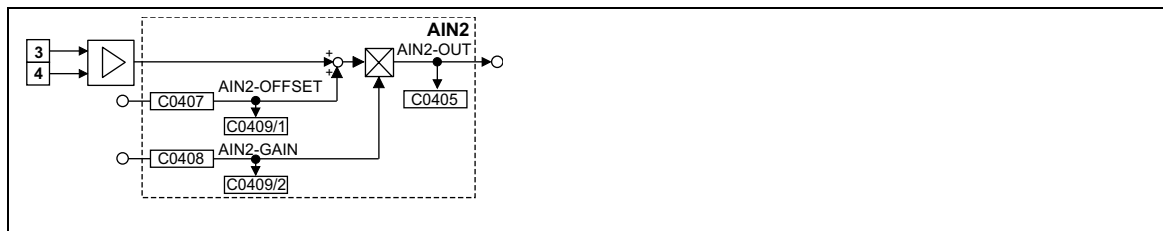
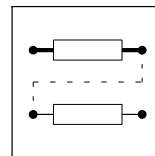

Fig. 3-11 Analog input via terminal X6/3, X6/4 (AIN2)

Name	Signal			Source			Note
	Type	DIS	DIS format	CFG	List	Lenze	
AIN2-OFFSET	a	C0409/1	dec [%]	C0407	1	19503	-
AIN2-GAIN	a	C0409/2	dec [%]	C0408	1	19505	-
AIN2-OUT	a	C0405	-	-	-	-	-

Special feature of AIN2

- The signal is read cyclically every 250 μs.



Function

- The analog input value is added to the value at input AINx-OFFSET.
- The result of the addition is limited to $\pm 200\%$.
- The limited value is multiplied by the value which is applied to input AINx-GAIN.
- Then the signal is limited to $\pm 200\%$.
- The signal is output at AINx-OUT.

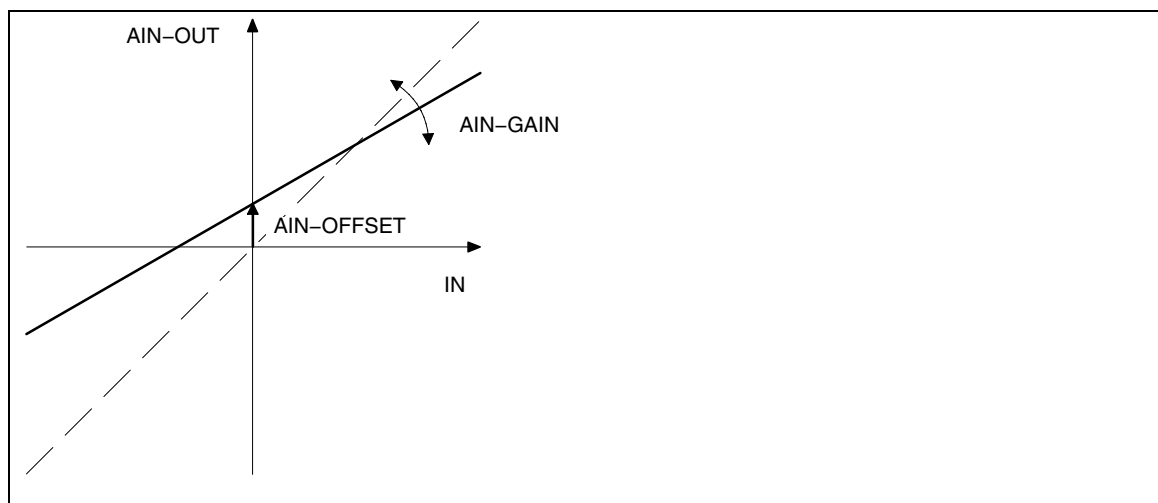

Fig. 3-12

Offset and gain of the analog input



Function library

Function blocks AND operation (AND)

3.2.7 AND operation (AND)

Purpose

With this function digital signals can be logically ANDed. These links can be used to control functions or to create status information.

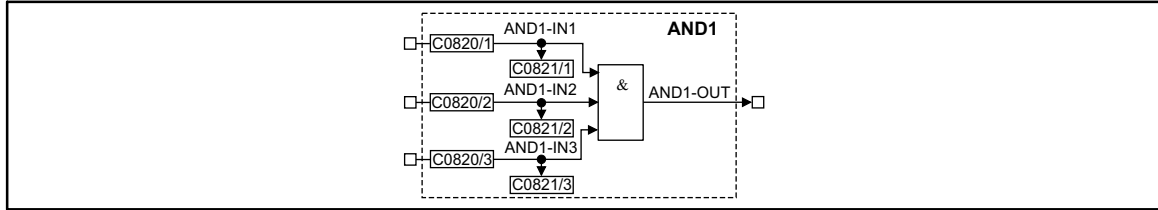

Fig. 3-13 AND operation (AND1)

Name	Signal			Source			Note
	Type	DIS	DIS format	CFG	List	Lenze	
AND1-IN1	d	C0821/1	bin	C0820/1	2	1000	-
AND1-IN2	d	C0821/2	bin	C0820/2	2	1000	-
AND1-IN3	d	C0821/3	bin	C0820/3	2	1000	-
AND1-OUT	d	-	-	-	-	-	-

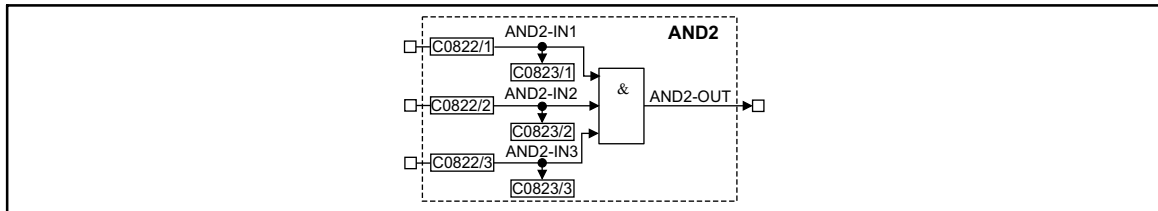

Fig. 3-14 AND operation (AND2)

Name	Signal			Source			Note
	Type	DIS	DIS format	CFG	List	Lenze	
AND2-IN1	d	C0823/1	bin	C0822/1	2	1000	-
AND2-IN2	d	C0823/2	bin	C0822/2	2	1000	-
AND2-IN3	d	C0823/3	bin	C0822/3	2	1000	-
AND2-OUT	d	-	-	-	-	-	-

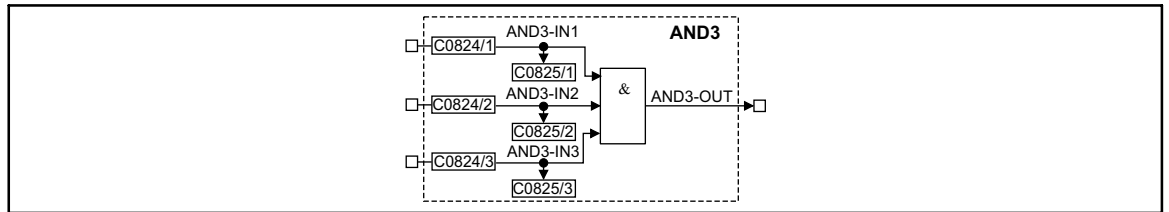
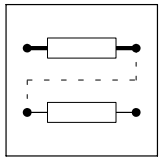

Fig. 3-15 AND operation (AND3)

Name	Signal			Source			Note
	Type	DIS	DIS format	CFG	List	Lenze	
AND3-IN1	d	C0825/1	bin	C0824/1	2	1000	-
AND3-IN2	d	C0825/2	bin	C0824/2	2	1000	-
AND3-IN3	d	C0825/3	bin	C0824/3	2	1000	-
AND3-OUT	d	-	-	-	-	-	-

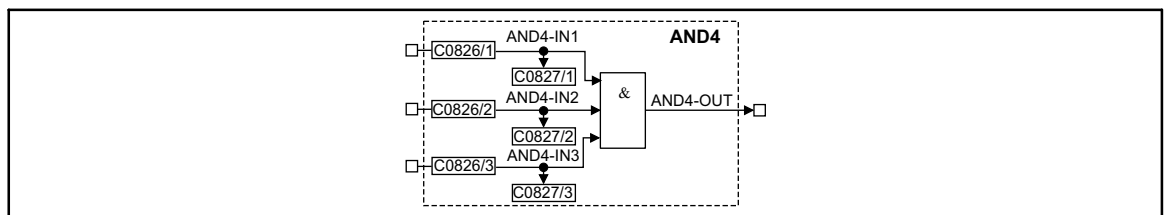

Fig. 3-16 AND operation (AND4)

Name	Signal			Source			Note
	Type	DIS	DIS format	CFG	List	Lenze	
AND4-IN1	d	C0827/1	bin	C0826/1	2	1000	-
AND4-IN2	d	C0827/2	bin	C0826/2	2	1000	-
AND4-IN3	d	C0827/3	bin	C0826/3	2	1000	-
AND4-OUT	d	-	-	-	-	-	-

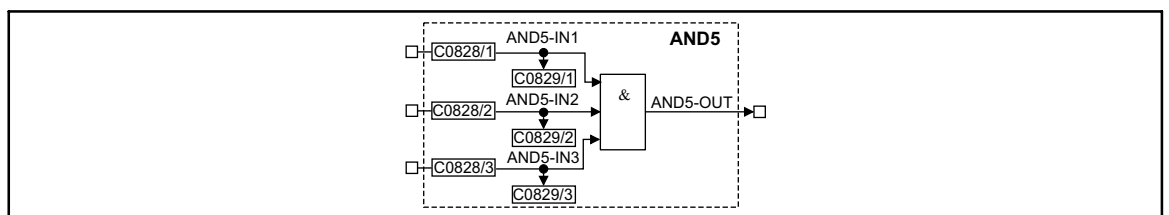

Fig. 3-17 AND operation (AND5)

Name	Signal			Source			Note
	Type	DIS	DIS format	CFG	List	Lenze	
AND5-IN1	d	C0829/1	bin	C0828/1	2	1000	-
AND5-IN2	d	C0829/2	bin	C0828/2	2	1000	-
AND5-IN3	d	C0829/3	bin	C0828/3	2	1000	-
AND5-OUT	d	-	-	-	-	-	-



Function library

Function blocks AND operation (AND)

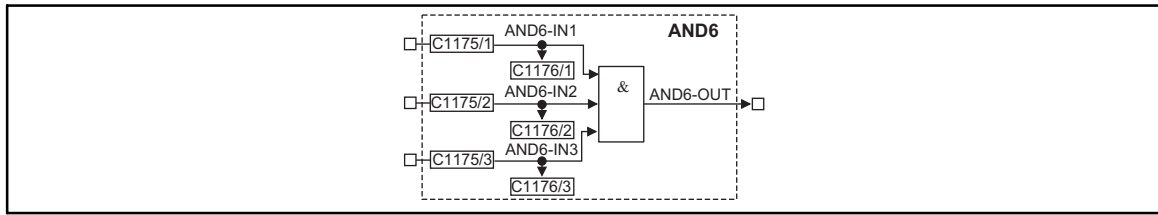

Fig. 3-18

AND operation (AND6)

Name	Signal			Source			Note
	Type	DIS	DIS format	CFG	List	Lenze	
AND6-IN1	d	C1176/1	bin	C1175/1	2	1000	-
AND6-IN2	d	C1176/2	bin	C1175/2	2	1000	-
AND6-IN3	d	C1176/3	bin	C1175/3	2	1000	-
AND6-OUT	d	-	-	-	-	-	-

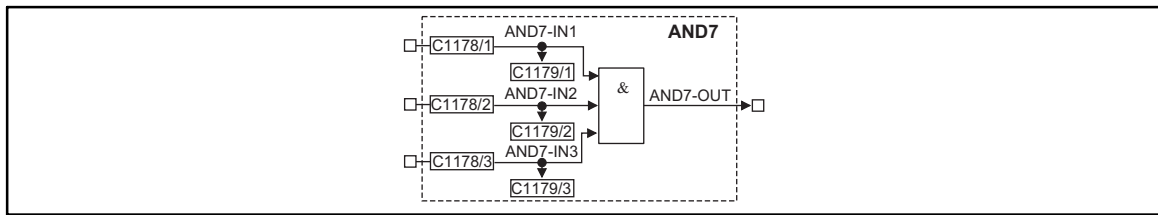

Fig. 3-19

AND operation (AND7)

Name	Signal			Source			Note
	Type	DIS	DIS format	CFG	List	Lenze	
AND7-IN1	d	C1179/1	bin	C1178/1	2	1000	-
AND7-IN2	d	C1179/2	bin	C1178/2	2	1000	-
AND7-IN3	d	C1179/3	bin	C1178/3	2	1000	-
AND7-OUT	d	-	-	-	-	-	-



Function

ANDx-IN1	ANDx-IN2	ANDx-IN3	ANDx-OUT
0	0	0	0
1	0	0	0
0	1	0	0
1	1	0	0
0	0	1	0
1	0	1	0
0	1	1	0
1	1	1	1

The function corresponds to a series connection of normally-open contacts in a contactor control.

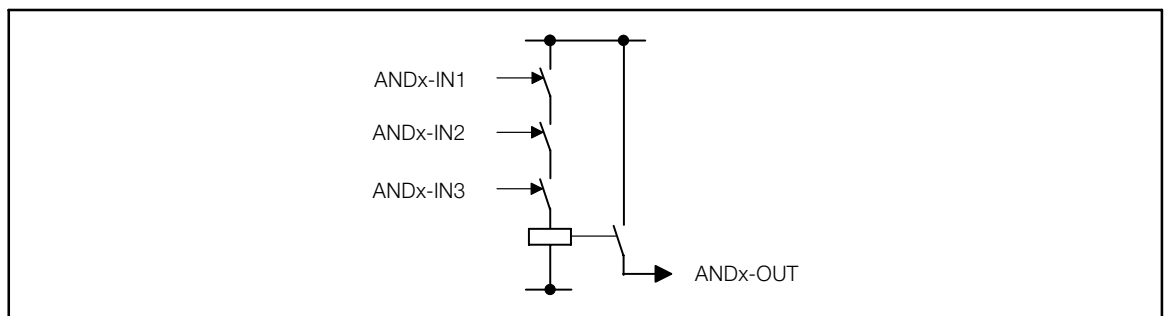

Fig. 3-20

AND function as a series connection of normally-open contacts



Tip!

If only two inputs are required, use the inputs ANDx-IN1 and ANDx-IN2. Assign the input ANDx-IN3 to the signal source FIXED1 via the configuration code.



Function library

Function blocks Inverter (ANEG)

3.2.8 Inverter (ANEG)

Purpose

This FB inverts the sign of an analog signal.

Two inverters are available:

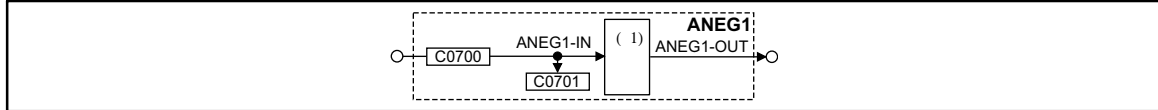

Fig. 3-21

Inverter (ANEG1)

Name	Signal			Source			Note
	Type	DIS	DIS format	CFG	List	Lenze	
ANEG1-IN	a	C0701	dec [%]	C0700	1	19523	-
ANEG1-OUT	a	-	-	-	-	-	-

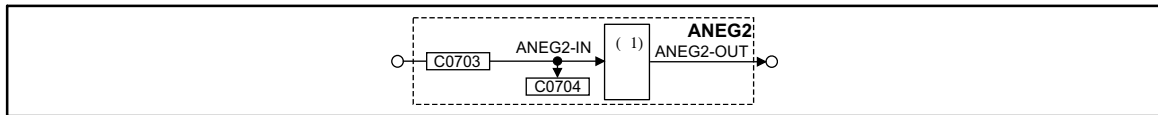

Fig. 3-22

Inverter (ANEG2)

Name	Signal			Source			Note
	Type	DIS	DIS format	CFG	List	Lenze	
ANEG2-IN	a	C0704	dec [%]	C0703	1	1000	-
ANEG2-OUT	a	-	-	-	-	-	-

Function

The input value is multiplied by -1 and then output again.

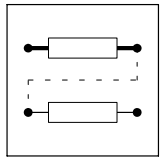

3.2.9 Analog output via terminal 62/63 (AOUT)

Purpose

AOUT1 and AOUT2 can be used as monitor outputs.

Internal analog signals can be output as voltage signals and be used e.g. as display values or setpoints for slaves.

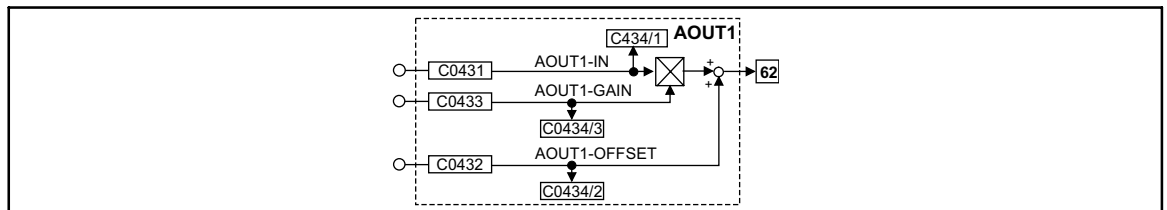

Fig. 3-23 Analog output via terminal X6/62 (AOUT1)

Name	Signal			Source			Note
	Type	DIS	DIS format	CFG	List	Lenze	
AOUT1-IN	a	C0434/1	dec [%]	C0431	1	5001	-
AOUT1-GAIN	a	C0434/3	dec [%]	C0433	1	19510	-
AOUT1-OFFSET	a	C0434/2	dec [%]	C0432	1	19512	-

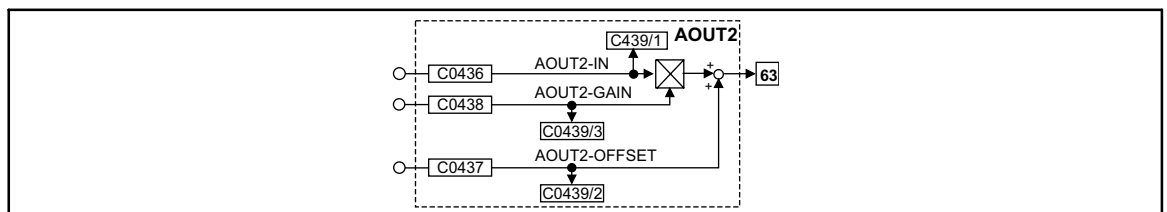
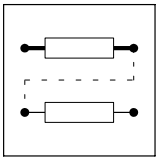

Fig. 3-24 Analog output via terminal X6/63 (AOUT2)

Name	Signal			Source			Note
	Type	DIS	DIS format	CFG	List	Lenze	
AOUT2-IN	a	C0439/1	dec [%]	C0436	1	5002	-
AOUT2-GAIN	a	C0439/3	dec [%]	C0438	1	19511	-
AOUT2-OFFSET	a	C0439/2	dec [%]	C0437	1	19513	-

Function

- The value at input AOUTx-IN is multiplied by the value at input AOUTx-GAIN.
 - The formula for the multiplication is: $100\% * 100\% = 100\%$.
- The result of the multiplication is limited to $\pm 200\%$.
- The limited value is added to the value which is applied at input AOUTx-OFFSET.
 - The formula for the addition is $50\% + 10\% = 60\%$. The result of the calculation is mapped in such a way that $100\% = 10\text{ V}$.
- The result of the addition is again limited to $\pm 200\%$.
- The result of the calculation is mapped in such a way that $100\% = 10\text{ V}$ and is output as a signal at terminal 62 or 63.



Function library

Function blocks

Analog output via terminal 62/63 (AOUT)

Example for an output value

AOUT1-IN = 50%, AOUT1-GAIN = 100%, AOUT1-OFFSET = 10%

Output terminal 62 = $((50\% * 100\% = 50\%) + 10\% = 60\%) = 6\text{ V}$

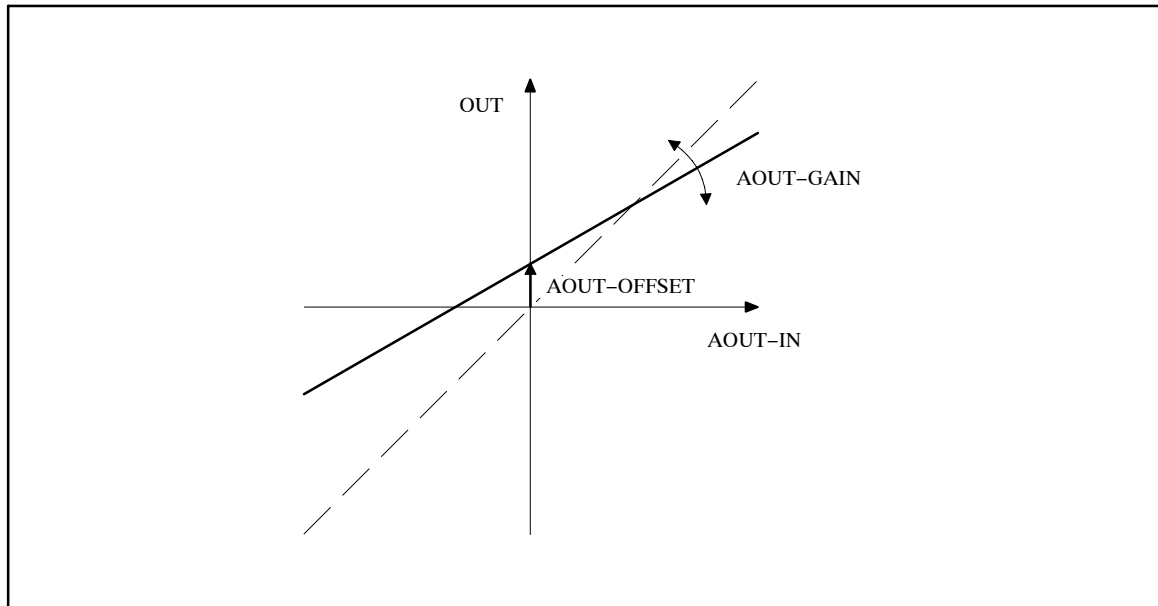
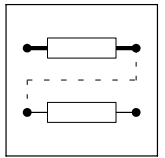

Fig. 3-25

Offset and gain of the analog output



3.2.10 Arithmetic block (ARIT)

Purpose

Arithmetic operation of two "analog" signals.

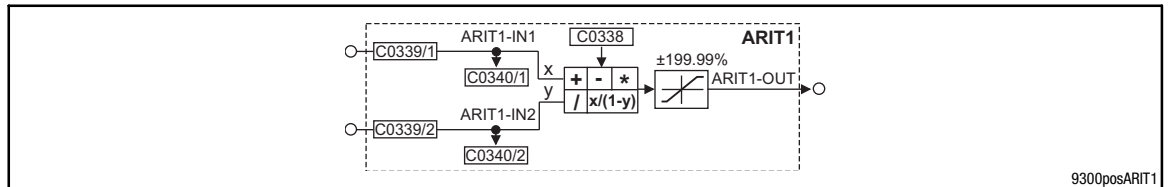

Fig. 3-26 Arithmetic block (ARIT1)

Name	Signal			Source			Note
	Type	DIS	DIS format	CFG	List	Lenze	
ARIT1-IN1	a	C0340/1	dec [%]	C0339/1	1	1000	-
ARIT1-IN2	a	C0340/2	dec [%]	C0339/2	1	1000	-
ARIT1-OUT	a	-	-	-	-	-	Limited to ±199.99 %

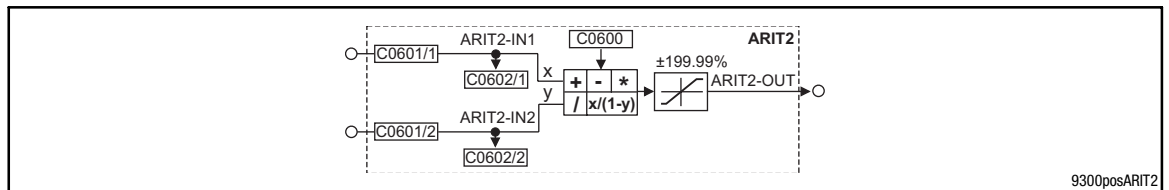

Fig. 3-27 Arithmetic block (ARIT2)

Name	Signal			Source			Note
	Type	DIS	DIS format	CFG	List	Lenze	
ARIT2-IN1	a	C0602/1	dec [%]	C0601/1	1	1000	-
ARIT2-IN2	a	C0602/2	dec [%]	C0601/2	1	1000	-
ARIT2-OUT	a	-	-	-	-	-	Limited to ±199.99 %

Function

For both arithmetic blocks the following functions can be preselected:

Code	Subcode	Arithmetic function	Example
ARIT1: C0338	0	OUT = IN1 Note: IN2 will not be processed	
	1	OUT = IN1 + IN2	100% = 50% + 50%
	2	OUT = IN1 - IN2	50% = 100% - 50%
	3	OUT [inc] = IN1 [inc] × IN2 [inc] ÷ 16384 OUT [%] = IN1 [%] × IN2 [%] ÷ 100	100% = 100% × 100% ÷ (100)
	4	OUT [inc] = IN1 [inc] × 16384 ÷ 100 ÷ IN2 [inc] OUT [%] = IN1 [%] ÷ IN2 [%]	1% = 100% ÷ 100%
5	OUT [inc] = IN1 [inc] × 16384 ÷ (16384 - IN2 [inc]) OUT [%] = IN1 [%] × 100 ÷ (100 - IN2 [%])	200% = 100% × (100) ÷ (100 - 50%)	

Conversion: [inc] = [%] ÷ 100 × 16384



Function library

Function blocks

Arithmetic block (ARITPH)

3.2.11 Arithmetic block (ARITPH)

Purpose

The FB ARITPH calculates a angle output signal from two angle input signals.

ARITPH1

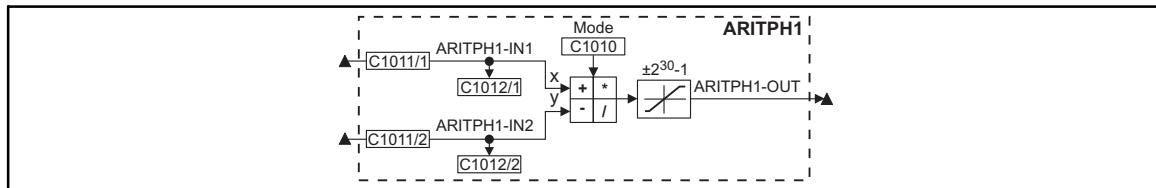

Fig. 3-28

Function block ARITPH1

Name	Signal			Source		Note
	Type	DIS	DIS format	CFG	List	
ARITPH1-IN1	ph	C1012/1	dec [inc]	C1011/1	3	-
ARITPH1-IN2	ph	C1012/2	dec [inc]	C1011/2	3	-
ARITPH1-OUT	ph	-	-	-	-	-

Function

- Selection of the arithmetic function with the code ARITPH mode.
- The function block limits the result (see table)

ARITPH mode	Arithmetic function	Limitation	
C1010 = 0	OUT = IN1	$2^{30} - 1$	
C1010 = 1	OUT = IN1 + IN2	$2^{30} - 1$	
C1010 = 2	OUT = IN1 - IN2	$2^{30} - 1$	
C1010 = 3	OUT = (IN1 * IN2) / 2^{30}	$2^{30} - 1$	(remainder not considered)
C1010 = 13	OUT = IN1 * IN2	2^{31}	
C1010 = 14	OUT = IN1 / IN2	$2^{30} - 1$	(remainder not considered)
C1010 = 21	OUT = IN1 + IN2	without	with overflow
C1010 = 22	OUT = IN1 - IN2	without	with overflow

- The calculation is performed cyclically in the control program.

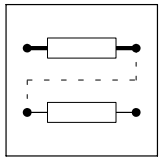

3.2.12 Analog signal changeover switch (ASW)

Purpose

This FB changes between two analog signals.

This FB enables you to change e.g. during a winding process between an initial diameter and a calculated diameter.

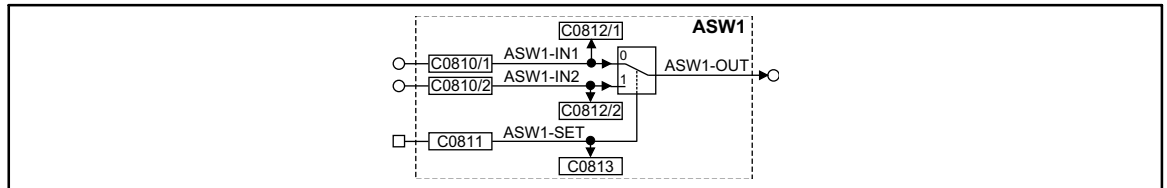

Fig. 3-29 Changeover switch for analog signals (ASW1)

Name	Signal			Source			Note
	Type	DIS	DIS format	CFG	List	Lenze	
ASW1-IN1	a	C0812/1	dec [%]	C0810/1	1	55	-
ASW1-IN2	a	C0812/2	dec [%]	C0810/2	1	1000	-
ASW1-SET	d	C0813	bin	C0811	2	1000	-
ASW1-OUT	a	-	-	-	-	-	-

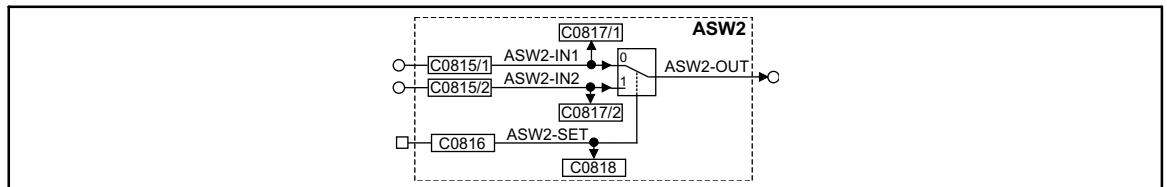

Fig. 3-30 Changeover switch for analog signals (ASW2)

Name	Signal			Source			Note
	Type	DIS	DIS format	CFG	List	Lenze	
ASW2-IN2	a	C0817/1	dec [%]	C0815/1	1	1000	-
ASW2-IN1	a	C0817/2	dec [%]	C0815/2	1	1000	-
ASW2-SET	d	C0818	bin	C0816	2	1000	-
ASW2-OUT	a	-	-	-	-	-	-

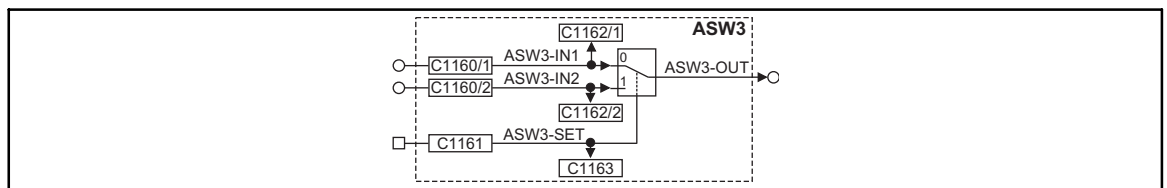

Fig. 3-31 Changeover switch for analog signals (ASW3)

Name	Signal			Source			Note
	Type	DIS	DIS format	CFG	List	Lenze	
ASW3-IN2	a	C1162/1	dec [%]	C1160/1	1	1000	-
ASW3-IN1	a	C1162/2	dec [%]	C1160/2	1	1000	-
ASW3-SET	d	C1163	bin	C1161	2	1000	-
ASW3-OUT	a	-	-	-	-	-	-



Function library

Function blocks

Analog signal changeover switch (ASW)

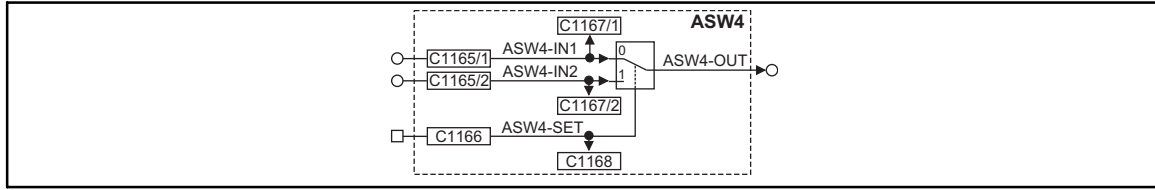

Fig. 3-32

Changeover switch for analog signals (ASW4)

Name	Signal			Source			Note
	Type	DIS	DIS format	CFG	List	Lenze	
ASW4-IN2	a	C1167/1	dec [%]	C1165/1	1	1000	-
ASW4-IN1	a	C1167/2	dec [%]	C1165/2	1	1000	-
ASW4-SET	d	C1168	bin	C1166	2	1000	-
ASW4-OUT	a	-	-	-	-	-	-

Function

This FB is controlled via the binary input. Depending on the input signal, different signals are sent to the output:

- If a HIGH signal is applied at the binary input, the signal which is applied at the ASWx-IN2 input is sent to the output.
- If a LOW signal is applied, the signal which is applied at the ASW-IN2 input is sent to the output.



3.2.13 Holding brake (BRK)



Danger!

Condition for using the BRK function block

Triggering the holding brake solely via the function block BRK is not permissible!

The **safe** triggering of the holding brake additionally requires a second switch-off path. Unsafe triggering creates the risk of severe personal injury and danger to material assets!

Applications with active loads

When the DC-bus voltage increases (e.g. by braking processes), the torque limitation may be activated via code C0172. The torque limitation becomes active if for instance the brake resistor is defective or the switching threshold set on the brake chopper or the brake module is not correctly adjusted.

Code C0172 is a pre-stage of the monitoring function "OU" (overvoltage of the DC-bus voltage). Code C0172 defines the voltage difference to OU causing a reduction in torque. In the Lenze setting, the torque is reduced to "0" if the DC-bus voltage reaches 760 V (770 V - 10 V):

- OU threshold = 770V (C0173 = 0...3)
 - Exception: OU threshold 800 V for C0173 = 4 (see description in code table)
- C0172 = 10 V
- No message is generated.

Only after the DC-bus voltage has decreased below the OU reconnection threshold, the torque is reconnected.

With unchanged basic conditions the continuously "chopping" drive behaviour may lead to undefined motions.

Remedy

1. Set C0172 = 0 V
2. MONIT-OU has to generate EEr-TRIP (e.g. by C0871/0 = 15011).
 - By this, the standstill brake is engaged via controller inhibit (CINH) if the braking energy cannot be dissipated.



Function library

Function blocks Holding brake (BRK)

Purpose

The FB is used to trigger a holding brake.

Possible applications:

- Hoists
- Traversing drives
- Active loads

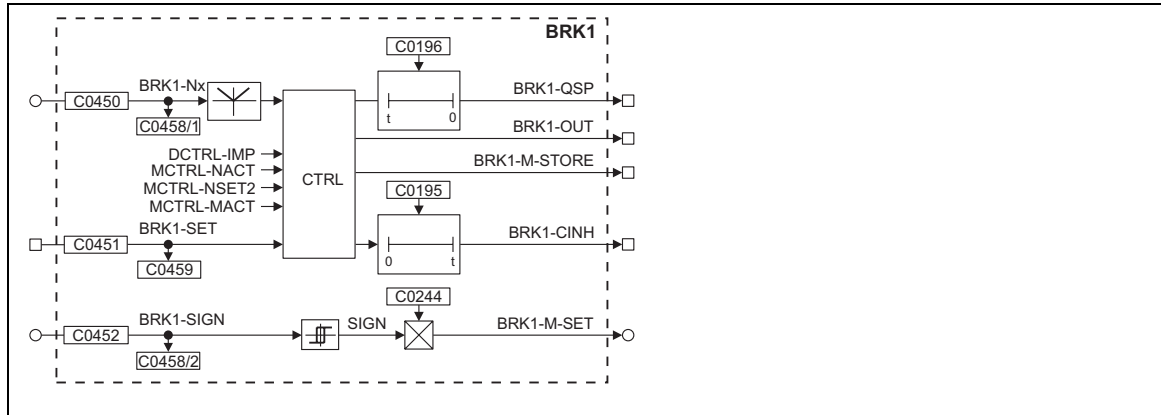

Fig. 3-33

Holding brake (BRK1)

Name	Signal			Source			Note
	Type	DIS	DIS format	CFG	List	Lenze	
BRK1-SET	d	C0459	bin	C0451	2	1000	-
BRK1-NX	a	C0458/1	dec [%]	C0450	1	1000	Speed threshold from which the drive may output the signal "Close brake". The signal source for this input can be a control code, a fixed value, or any other analog FB output. The input signal is processed internally as an absolute value.
BRK1-SIGN	a	C0458/2	dec [%]	C0452	1	1000	Direction of the torque with which the drive is to set up a torque against the brake. The signal source for this input can be a control code, a fixed value, or any other FB output.
BRK1-M-SET	a						Feedforward control torque for releasing the brake 100 % = value of C0057



Note!

The internal signals MCTRL-NACT, MCTRL-MACT and MCTRL-NSET2 are processed as absolute values.

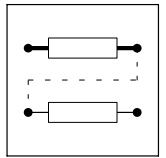

3.2.13.1 Engaging the brake

<p>Purpose</p>	<p>A HIGH signal at the BRK1-SET input activates the function. The output BRK1-QSP is simultaneously switched to HIGH. This signal can be used to decelerate the drive to zero speed via a deceleration ramp.</p>	
<p>Function</p>	<p>If the setpoint speed falls below the value set at the BRK1-Nx input, the output BRK1-OUT is set to HIGH. In order to ensure a fail-safe design this signal must be inverted at the output (e.g. via C0118).</p>	

3.2.13.2 Disengaging (releasing) the brake

<p>Purpose</p>	<p>A LOW signal at the BRK1-SET input immediately sets the BRK1-CINH output to LOW. At the same time the BRK1-M-STORE output is set to HIGH. This signal can be used to generate a defined torque against the brake. The drive thus takes over the torque while the brake is released. The signal is only reset after the time set under C0196 has elapsed.</p>	
<p>Function</p>	<p>As soon as the torque reaches the value set under C0244 (holding torque), the output BRK1-OUT is set to LOW. When the input is reset, a timing element is triggered. After the time set under C0196 has elapsed the BRK1-QSP output is reset. This signal serves to e.g. release the setpoint integrator after the brake release time has elapsed.</p>	
<p>Note</p>	<p>If an actual speed higher than the value at BRK1-Nx is detected before the brake release time (C0196) has elapsed, the signals BRK1-QSP and BRK1-M-STORE are reset immediately. The drive can operate in a speed or angle-controlled manner immediately. If the BRK1-QSP output acts on the QSP control word, then the drive is synchronised to the actual speed and follows its setpoint.</p>	

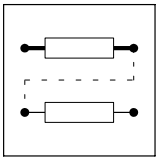

Function library

Function blocks Holding brake (BRK)

3.2.13.3 Setting controller inhibit

Setting controller inhibit may for instance be required in the case of a fault (LU, OU, ...).

Function

When the controller is inhibited (CINH), the BRK1-OUT signal is set to HIGH immediately. The drive is then braked via the mechanical brake.

If the fault is eliminated quickly, i.e. the controller inhibit (CINH) is reset before the actual speed falls below the threshold value BRK1-Nx, the BRK1-OUT signal is set to LOW immediately. The drive is synchronised to the actual speed and follows its setpoint.

If the value falls below the threshold, the drive starts as described under "Release brake".

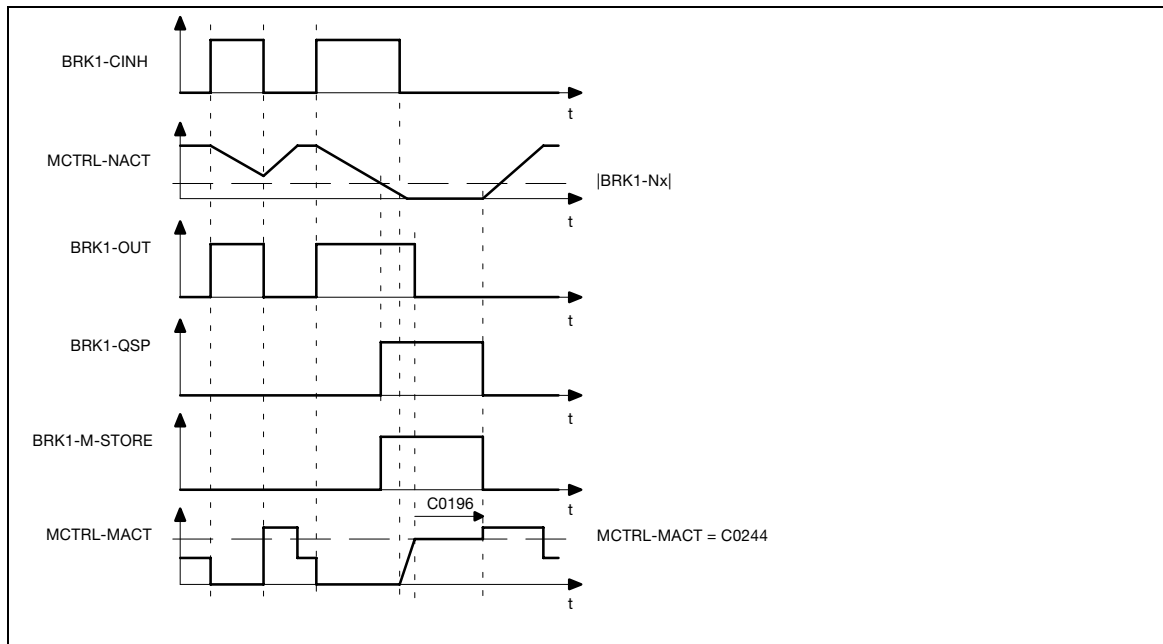

Fig. 3-34

Brake control with CINH

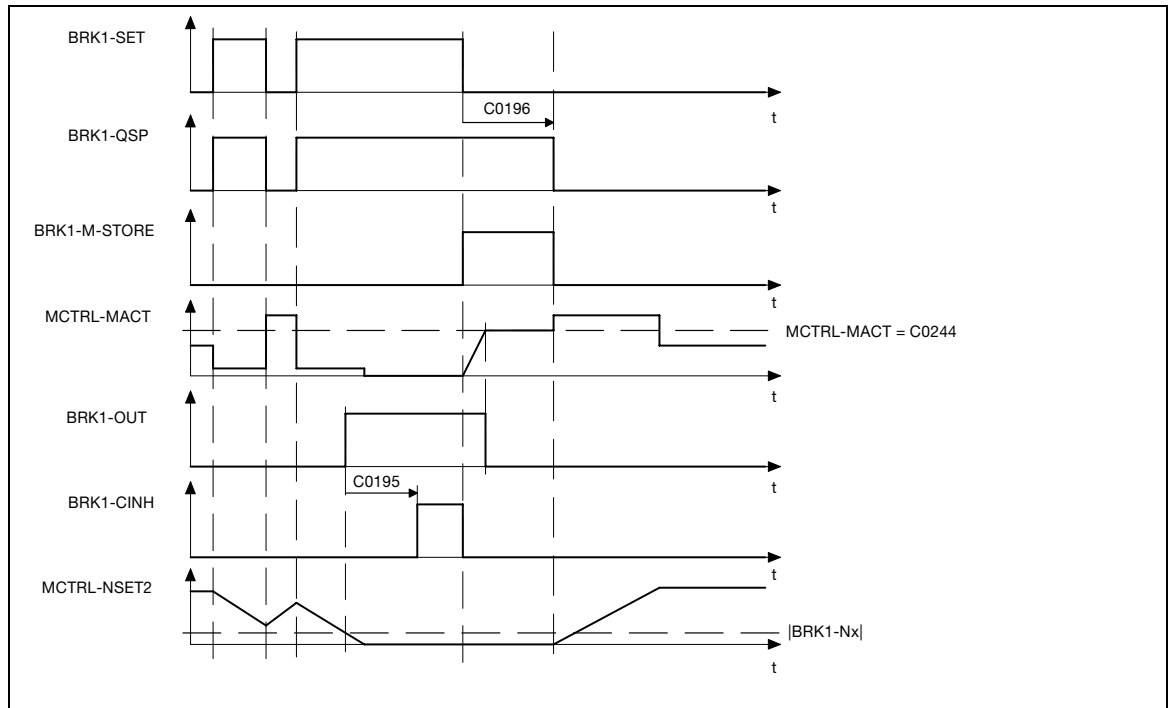
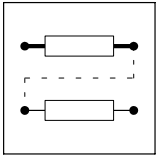

Fig. 3-35 Switching cycle when braking



Function library

Function blocks
System bus (CAN-IN)

3.2.14 System bus (CAN-IN)

A detailed description of the system bus (CAN) can be found in the "CAN Communication Manual".

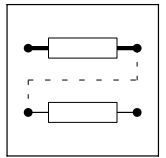

3.2.15 System bus (CAN-OUT)

A detailed description of the system bus (CAN) can be found in the "CAN Communication Manual".



Function library

Function blocks Comparator (CMP)

3.2.16 Comparator (CMP)

Purpose

These FBs serve to compare two analog signals. Three comparators are available which serve to implement triggers.

CMP1



Fig. 3-36

Comparator (CMP1)

Name	Signal			Source			Note
	Type	DIS	DIS format	CFG	List	Lenze	
CMP1-IN1	a	C0684/1	dec [%]	C0683/1	1	5001	-
CMP1-IN2	a	C0684/2	dec [%]	C0683/2	1	19500	-
CMP1-OUT	a	-	-	-	-	-	-

CMP2



Fig. 3-37

Comparator (CMP2)

Name	Signal			Source			Note
	Type	DIS	DIS format	CFG	List	Lenze	
CMP2-IN1	a	C0689/1	dec [%]	C0688/1	1	1000	-
CMP2-IN2	a	C0689/2	dec [%]	C0688/2	1	1000	-
CMP2-OUT	a	-	-	-	-	-	-

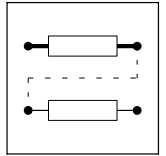

CMP3

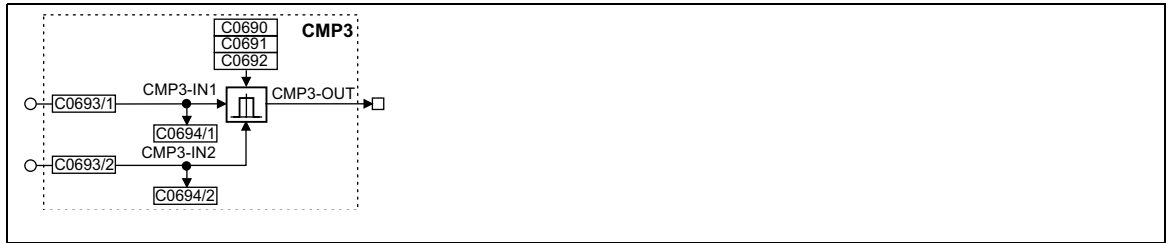

Fig. 3-38

Comparator (CMP3)

Name	Signal			Source			Note
	Type	DIS	DIS format	CFG	List	Lenze	
CMP3-IN1	a	C0694/1	dec [%]	C0693/1	1	1000	-
CMP3-IN2	a	C0694/2	dec [%]	C0693/2	1	1000	-
CMP3-OUT	a	-		-	-	-	-

Function

The description uses the example of CMP1 and also applies to CMP2 and CMP3.

The function of these function blocks can be set via code C0680 (CMP1). The following comparison operations are available:

- $CMP1-IN1 = CMP1-IN2$
- $CMP1-IN1 > CMP1-IN2$
- $CMP1-IN1 < CMP1-IN2$
- $|CMP1-IN1| = |CMP1-IN2|$
- $|CMP1-IN1| > |CMP1-IN2|$
- $|CMP1-IN1| < |CMP1-IN2|$

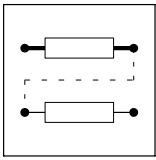

Function library

Function blocks Comparator (CMP)

3.2.16.1 Function 1: $CMP1-IN1 = CMP1-IN2$

This function serves to compare two signals with regard to equality. Hence, the comparison "actual speed equals setpoint speed ($n_{act} = n_{set}$)" can be carried out.

- Via code C0682 the window of equality can be set.
- Via code C0681 a hysteresis can be set if the input signals are not stable and cause the output to oscillate.

The exact function can be obtained from the line diagram.

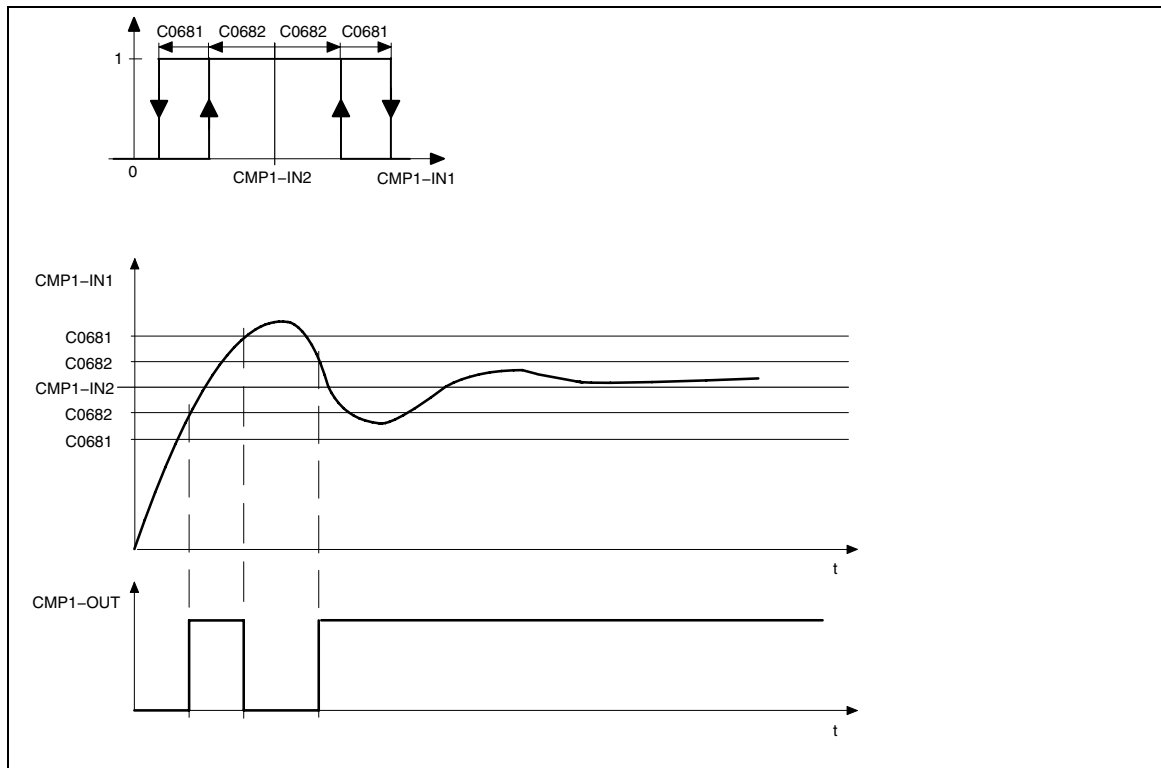
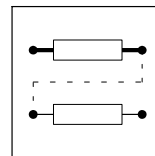

Fig. 3-39 Equality of signals ($CMP1-IN1 = CMP1-IN2$)



3.2.16.2 Function 2: $CMP1-IN1 > CMP1-IN2$

This function is used, for example, to implement the comparison "Actual speed is higher than a limit value ($n_{act} > n_x$)" for a direction of rotation.

- If the value at input $CMP1-IN1$ exceeds the value at input $CMP1-IN2$, the output $CMP1-OUT$ changes from LOW to HIGH.
- Only if the signal at input $CMP1-IN1$ falls below the value of $CMP1-IN2 - C0681$ again, the output changes from HIGH to LOW.

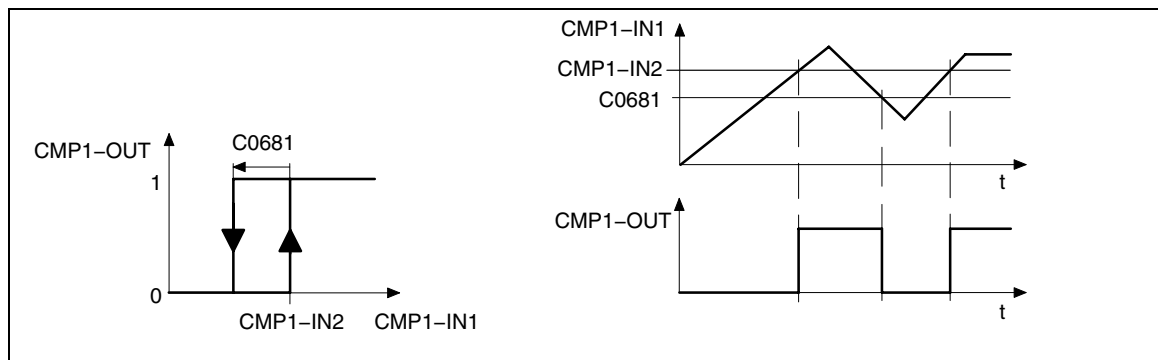

Fig. 3-40 Exceeding signal values ($CMP1-IN1 > CMP1-IN2$)

3.2.16.3 Function 3: $CMP1-IN1 < CMP1-IN2$

This function is used, for example, to implement the comparison "Actual speed is lower than a limit value ($n_{act} < n_x$)" for a direction of rotation.

- If the value at input $CMP1-IN1$ falls below the value at input $CMP1-IN2$, the output $CMP1-OUT$ changes from LOW to HIGH.
- Only if the signal at input $CMP1-IN1$ exceeds the value of $CMP1-IN2 - C0681$ again, the output changes from HIGH to LOW.

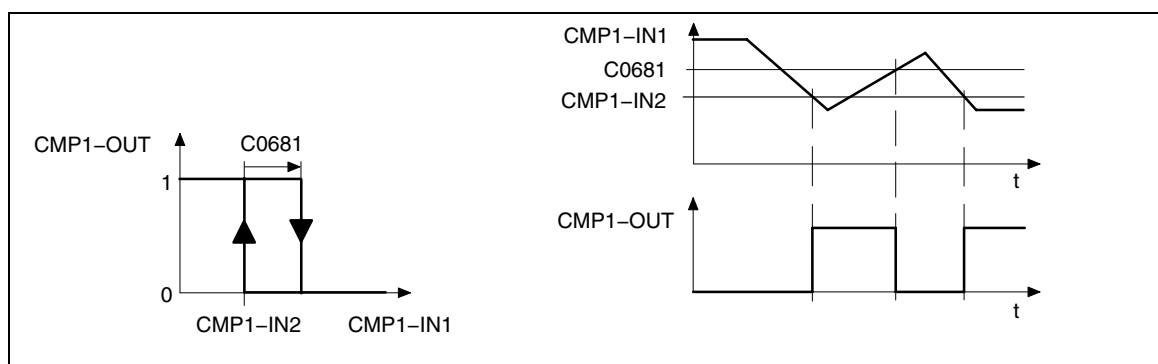

Fig. 3-41 Values falling below signal values ($CMP1-IN1 < CMP1-IN2$)

3.2.16.4 Function 4: $|CMP1-IN1| = |CMP1-IN2|$

This function is the same as function 1. Before signal processing the absolute value of the input signals (without sign) is generated.

This can be used to implement the comparison " $n_{act} = 0$ ".

3.2.16.5 Function 5: $|CMP1-IN1| > |CMP1-IN2|$

This function is the same as function 3. Before signal processing the absolute value of input signals (without sign) is generated.

This can be used to implement the comparison " $|n_{act}| > |n_x|$ " irrespective of the direction of rotation.

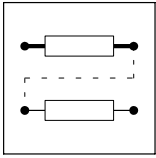

Function library

Function blocks ***Comparator (CMP)***

3.2.16.6 Function 6: $|\text{CMP1-IN1}| < |\text{CMP1-IN2}|$

This function is the same as function 2. Before signal processing the absolute value of input signals (without sign) is generated.

This can be used to implement the comparison " $|n_{\text{act}}| < |n_x|$ " irrespective of the direction of rotation.



3.2.17 Signal conversion (CONV)

Purpose

These function blocks can be used to standardize signals or signal types or to convert signal types into different signal types. The conversion is very precise by providing the conversion factor as numerator and denominator.

CONV1

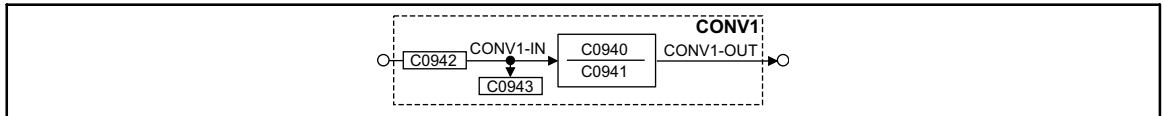

Fig. 3-42 Function block CONV1

Name	Signal			Source			Note
	Type	DIS	DIS format	CFG	List	Lenze	
CONV1-IN	a	C0943	dec [%]	C0942	1	1000	
CONV1-OUT	a	-	-	-	-	-	Limited to ±199.99 %

This function block is used to multiply or divide analog signals.

The conversion is done according to the formula:

$$\text{CONV1-OUT} = \text{CONV1-IN} \cdot \frac{\text{C0940}}{\text{C0941}}$$

Example:

An analog signal is to be multiplied with 1.12.
For this, enter C0940 = 112 and C0941 = 100.

CONV2

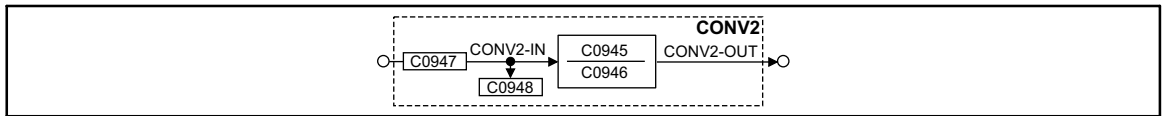

Fig. 3-43 Function block CONV2

Name	Signal			Source			Note
	Type	DIS	DIS format	CFG	List	Lenze	
CONV2-IN	a	C0948	dec [%]	C0947	1	1000	
CONV2-OUT	a	-	-	-	-	-	Limited to ±199.99 %

This function block is used to multiply or divide analog signals.

The conversion is done according to the formula:

$$\text{CONV2-OUT} = \text{CONV2-IN} \cdot \frac{\text{C0945}}{\text{C0946}}$$



Function library

Function blocks

Signal conversion (CONV)

CONV3

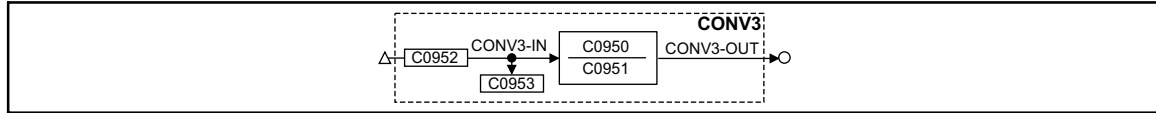

Fig. 3-44

Function block CONV3

Name	Signal			Source			Note
	Type	DIS	DIS format	CFG	List	Lenze	
CONV3-IN	phd	C0953	dec [rpm]	C0952	4	1000	
CONV3-OUT	a	-	-	-	-	-	Limited to ±199.99 %

This function block is used to convert speed signals into analog signals.

The conversion is done according to the formula:

$$\text{CONV3-OUT} = \text{CONV3-IN} \cdot \frac{100\%}{15000 \text{ rpm}} \cdot \frac{\text{C0950}}{\text{C0951}}$$

CONV4

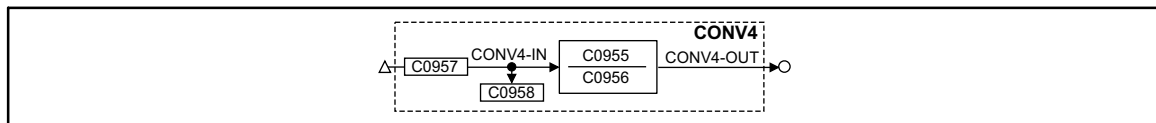

Fig. 3-45

Function block CONV4

Name	Signal			Source			Note
	Type	DIS	DIS format	CFG	List	Lenze	
CONV4-IN	phd	C0958	dec [rpm]	C0957	4	1000	
CONV4-OUT	a	-	-	-	-	-	Limited to ±199.99 %

This function block is used to convert speed signals into analog signals.

The conversion is done according to the formula:

$$\text{CONV4-OUT} = \text{CONV4-IN} \cdot \frac{100\%}{15000 \text{ rpm}} \cdot \frac{\text{C0955}}{\text{C0956}}$$

CONV5

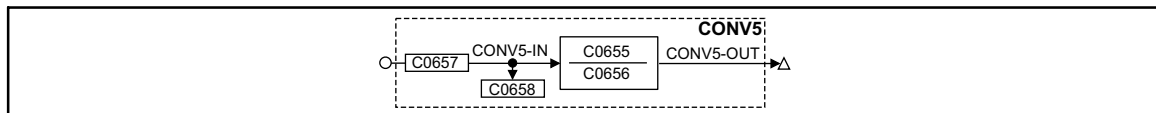

Fig. 3-46

Function block CONV5

Name	Signal			Source			Note
	Type	DIS	DIS format	CFG	List	Lenze	
CONV5-IN	a	C0658	dec [%]	C0657	1	1000	
CONV5-OUT	phd	-	-	-	-	-	Limited to ±29999 rpm

This function block is used to convert analog signals into speed signals.

Conversion according to formula:

$$\text{CONV5-OUT} = \text{CONV5-IN} \cdot \frac{15000 \text{ rpm}}{100\%} \cdot \frac{\text{C0655}}{\text{C0656}}$$

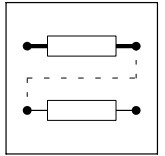

CONV6

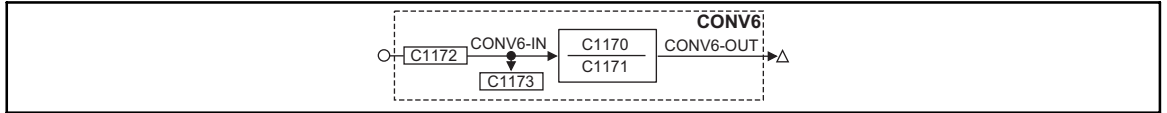

Fig. 3-47

Function block CONV6

Name	Signal			Source			Note
	Type	DIS	DIS format	CFG	List	Lenze	
CONV6-IN	a	C1173	dec [%]	C1172	1	1000	
CONV6-OUT	phd	-	-	-	-	-	Limited to ±29999 rpm

This function block is used to convert analog signals into speed signals.

Conversion according to formula:

$$\text{CONV6-OUT} = \text{CONV6-IN} \cdot \frac{15000\text{rpm}}{100\%} \cdot \frac{\text{C1170}}{\text{C1171}}$$

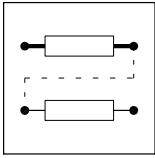

Function library

Function blocks Angle conversion (CONVPHA)

3.2.18 Angle conversion (CONVPHA)

Purpose

- Converts a angle signal into an analog signal
- or
- converts a angle difference signal into a speed signal.

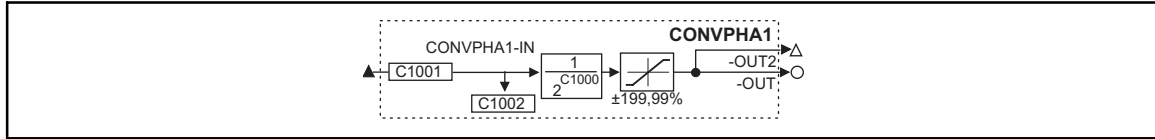

Fig. 3-48

Angle conversion (CONVPHA1)

Name	Signal			Source		Note
	Type	DIS	DIS format	CFG	List	
CONVPHA1-IN	ph	C1002	dec [inc]	C1001	3	-
CONVPHA1-OUT	a	-	-	-	-	Limited to ±199.99 %, remainder considered
CONVPHA1-OUT2	phd	-	-	-	-	Limited to ±32767 rpm, remainder considered

Function

- Conversion with adaptation using a divisor.
- Conversion according to formula:

$$\text{CONVPHA1-OUT} [\%] = \text{CONVPHA1-IN} [\text{inc}] \cdot \frac{100}{2^{14} \cdot 2^{C1000}}$$

$$\text{CONVPHA1-OUT2} [\text{rpm}] = \text{CONVPHA1-IN} [\text{inc}] \cdot \frac{15000}{2^{14} \cdot 2^{C1000}}$$

$$\text{CONVPHA1-OUT2} [\text{inc}] = \text{CONVPHA1-IN} [\text{inc}] \cdot \frac{1}{2^{C1000}}$$

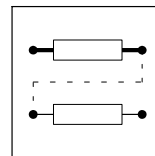

3.2.19 Angle conversion (CONVPHPH)

Purpose

Conversion of a angle signal with dynamic fraction.

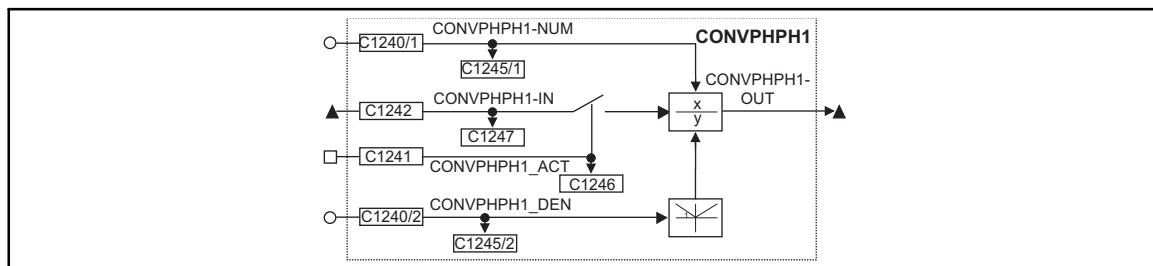

Fig. 3-49 Angle conversion (CONVPHPH1)

Name	Signal			Source		Note
	Type	DIS	DIS format	CFG	List	
CONVPHPH1-IN	ph	C1247	dec [inc]	C1242	3	-
CONVPHPH1-NUM	a	C1245/1	dec	C1240/1	1	Numerator
CONVPHPH1-DEN	a	C1245/2	dec	C1240/2	1	Denominator (with absolute value generation)
CONVPHPH1-ACT	d	C1246	bin	C1241	2	-
CONVPHPH1-OUT	ph	-	-	-	-	Without limitation, remainder considered

Function



Caution!

The conversion result is not limited. The result must therefore not exceed the range of ± 2147483647 .

- C1241 = HIGH
 - The angle signal at CONVPHPH1-IN is evaluated using the factor from C1245/1 / C1245/2.
- C1241 = LOW
 - The value 0 is evaluated using the factor from C1245/1 / C1245/2.

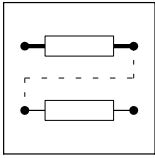

Function library

Function blocks Speed conversion (CONVPP)

3.2.20 Speed conversion (CONVPP)

Purpose

Conversion of a speed signal with dynamic fraction.

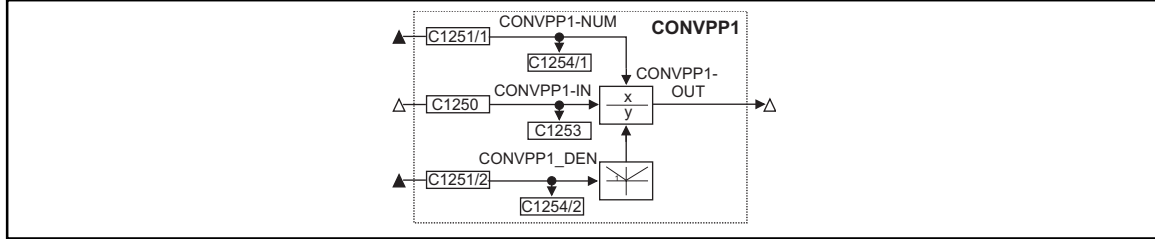

Fig. 3-50 Speed conversion (CONVPP1)

Name	Signal			Source		Note
	Type	DIS	DIS format	CFG	List	
CONVPP1-IN	phd	C1253	dec [rpm]	C1250	4	-
CONVPP1-NUM	ph	C1254/1	dec [inc]	C1251/1	3	Numerator
CONVPP1-DEN	ph	C1254/2	dec [inc]	C1251/2	3	Denominator (with absolute value generation)
CONVPP1-OUT	phd	-	-	-	-	Without limitation, remainder considered

Function



Caution!

The conversion result is not limited. The result must therefore not exceed ± 32767 .

- The speed signal at CONVPP1-IN is evaluated using the factor from C1251/1 / C1251/2.

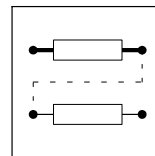

3.2.21 Characteristic function (CURVE)

Purpose

Conversion of an analog signal into a characteristic.

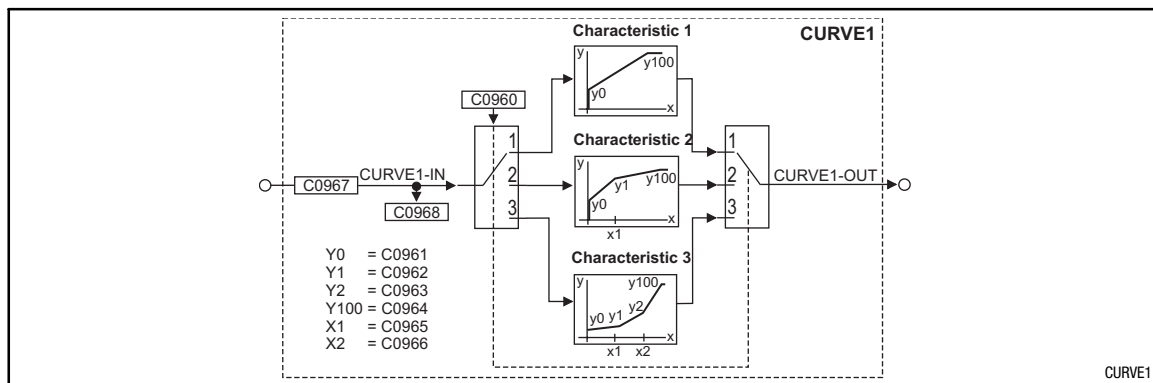

Fig. 3-51 Characteristic function (CURVE1)

Name	Signal			Source			Note
	Type	DIS	DIS format	CFG	List	Lenze	
CURVE1-IN	a	C0968	dec [%]	C0967	1	5001	-
CURVE1-OUT	a	-	-	-	-	-	-

Range of functions

Under C0960, you can select the function:

- Characteristic with two interpolation points
- Characteristic with three interpolation points
- Characteristic with four interpolation points

The codes for entering the interpolation points can be obtained from the line diagrams.

Linear interpolation between the points.

For negative input values at CURVEx-IN, the settings of the interpolation points are processed inversely (see line diagrams). If this is not desired:

- Connect an absolute value generator (ABS) before or behind the CURVE function block
- or
- connect a limiter (LIM) before or behind the CURVE function block



Function library

Function blocks Characteristic function (CURVE)

3.2.21.1 Characteristic with two interpolation points

Set C0960 = 1.

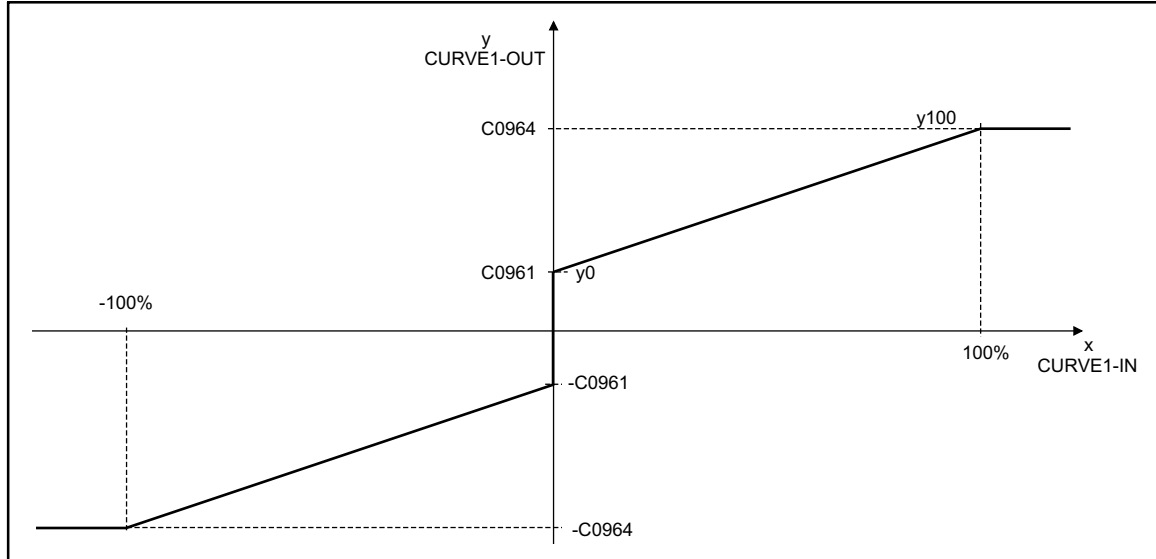

Fig. 3-52 Line diagram of characteristic with 2 interpolation points

3.2.21.2 Characteristic with three interpolation points

Set C0960 = 2.

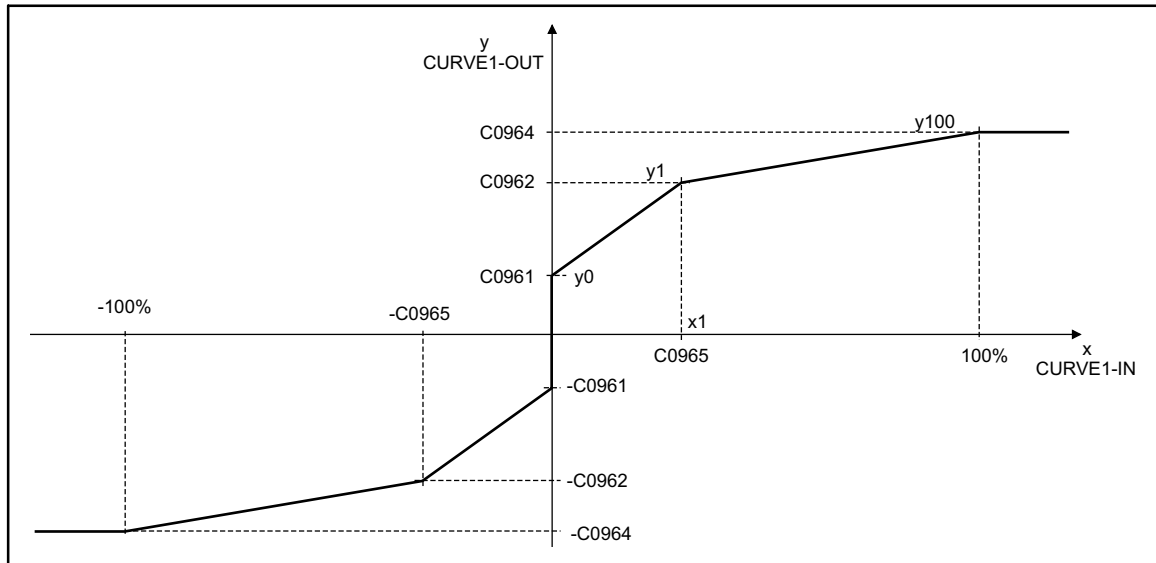
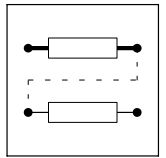

Fig. 3-53 Line diagram of characteristic with 3 interpolation points



3.2.21.3 Characteristic with four interpolation points

Set C0960 = 3.

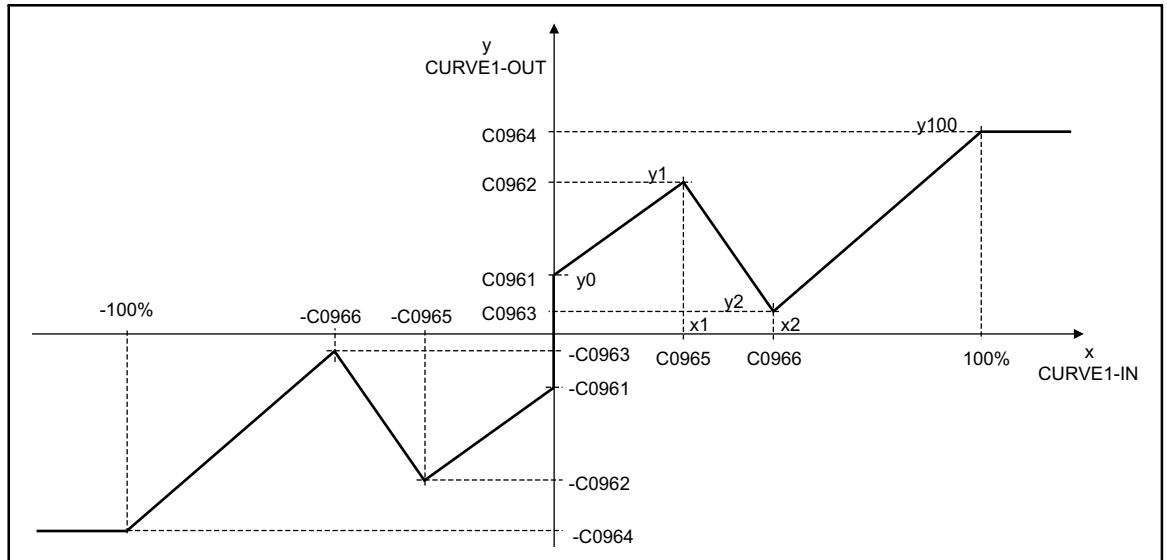
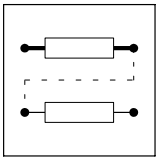

Fig. 3-54 Line diagram of characteristic with 4 interpolation points



Function library

Function blocks Dead band (DB)

3.2.22 Dead band (DB)

Purpose

The dead band element is used to set interfering influences around zero, e.g. interferences on analog input voltages, to digital zero.

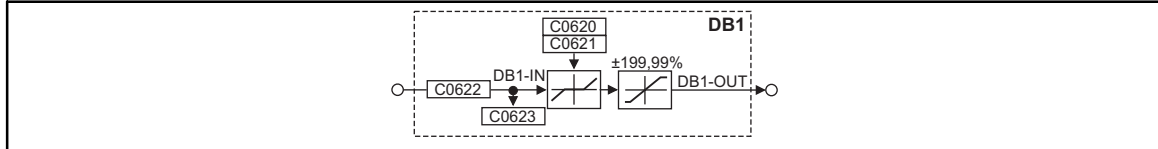

Fig. 3-55

Dead band element (DB1)

Name	Signal			Source			Note
	Type	DIS	DIS format	CFG	List	Lenze	
DB1-IN	a	C0623	dec [%]	C0622	1	1000	-
DB1-OUT	a	-	-	-	-	-	Limited to $\pm 199.99\%$

Function

- The dead band is parameterised under C0621.
- The gain is set under C0620.

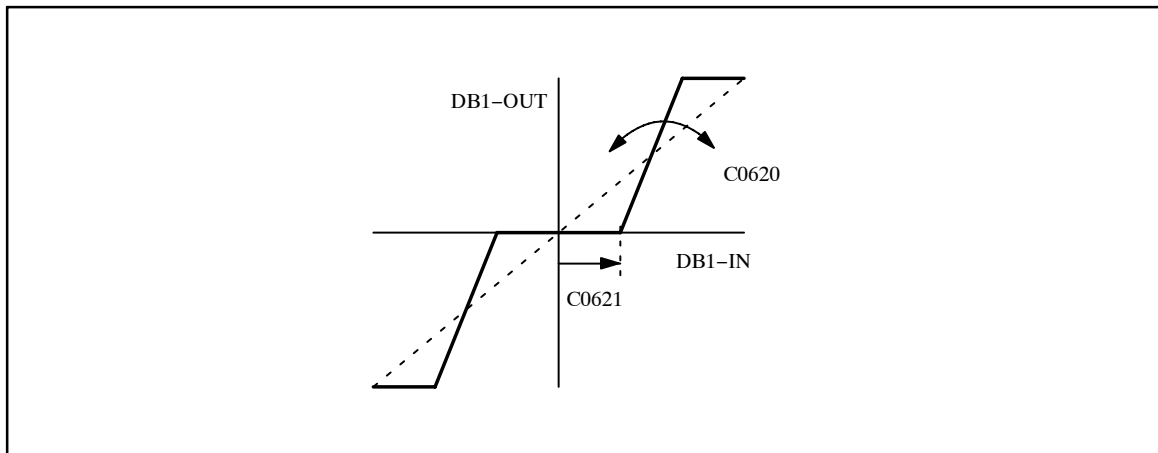
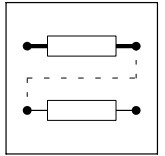

Fig. 3-56

Dead band and gain



3.2.23 Control of the drive controller (DCTRL)

Purpose

Directs the controller to certain states (e.g. trip, trip reset, quick stop or controller inhibit).

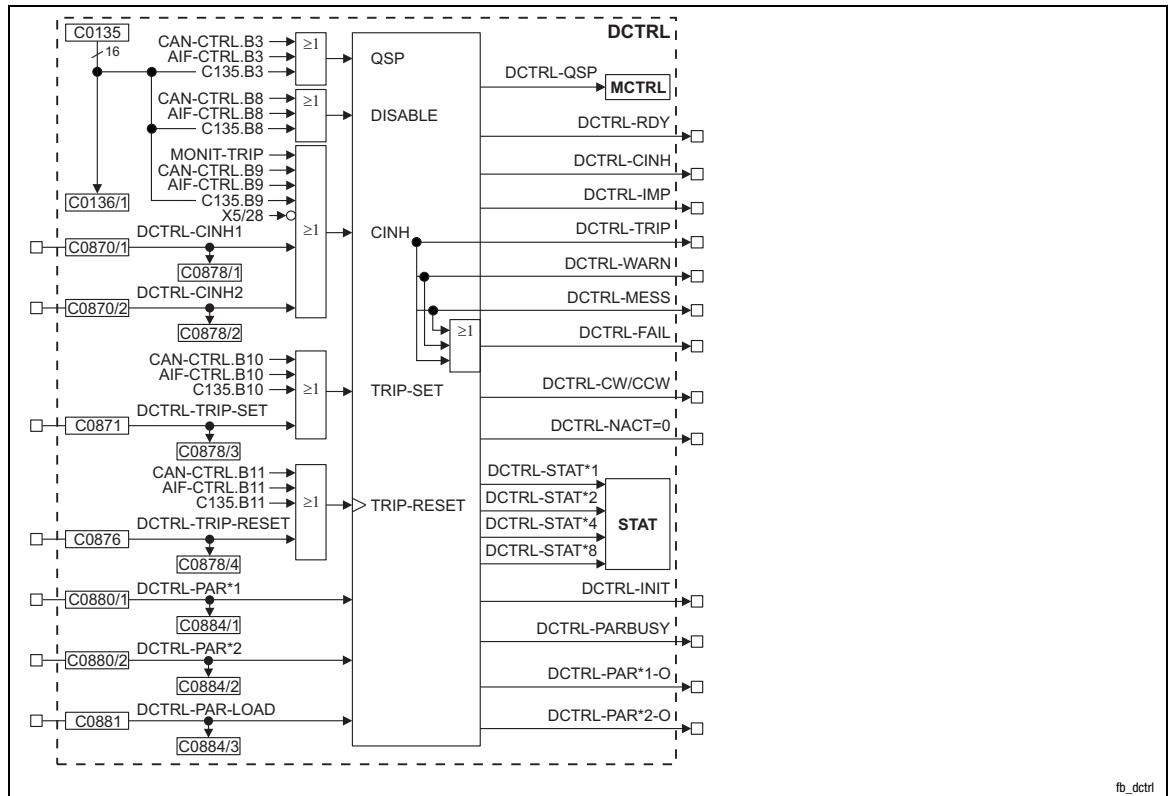
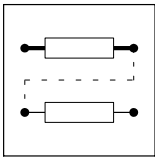

Fig. 3-57

Control of the drive controller (DCTRL)



Function library

Function blocks

Control of the drive controller (DCTRL)

Name	Signal			Source			Note
	Type	DIS	DIS format	CFG	List	Lenze	
DCTRL-CINH1	d	C0878/1	bin	C0870/1	2	1000	HIGH = Inhibit controller
DCTRL-CINH2	d	C0878/2	bin	C0870/2	2	1000	HIGH = Inhibit controller
DCTRL-TRIP-SET	d	C0878/3	bin	C0871	2	54	HIGH = Fault signal EEr
DCTRL-TRIP-RESET	d	C0878/4	bin	C0876	2	55	LOW-HIGH signal = TRIP reset
DCTRL-PAR*1	d	C0884/1	bin	C0880/1	2	1000	Selecting a parameter set
DCTRL-PAR*2	d	C0884/2	bin	C0880/2	2	1000	Selecting a parameter set
DCTRL-PAR-LOAD	d	C0884/3	bin	C0881	2	1000	LOW-HIGH edge = Loading a parameter set
DCTRL-QSP	d	-	-	-	-	-	HIGH = Drive performs quick stop
DCTRL-RDY	d	-	-	-	-	-	HIGH = Ready for operation
DCTRL-CINH	d	-	-	-	-	-	HIGH = Controller reset
DCTRL-IMP	d	-	-	-	-	-	HIGH = High-resistance power output stages
DCTRL-TRIP	d	-	-	-	-	-	HIGH = Active fault
DCTRL-WARN	d	-	-	-	-	-	HIGH = Active warning
DCTRL-MESS	d	-	-	-	-	-	HIGH = Active message
DCTRL-FAIL	d	-	-	-	-	-	-
DCTRL-CW/CCW	d	-	-	-	-	-	LOW = CW rotation, HIGH = CCW rotation
DCTRL-NACT=0	d	-	-	-	-	-	HIGH = Motor speed < C0019
DCTRL-STAT*1	d	-	-	-	-	-	General status (binary coded)
DCTRL-STAT*2	d	-	-	-	-	-	General status (binary coded)
DCTRL-STAT*4	d	-	-	-	-	-	General status (binary coded)
DCTRL-STAT*8	d	-	-	-	-	-	General status (binary coded)
DCTRL-INIT	d	-	-	-	-	-	-
DCTRL-PARBUSY	d	-	-	-	-	-	HIGH = Parameter set changeover is active
DCTRL-PAR*1-0	d	-	-	-	-	-	Parameter set X is active (binary coded)
DCTRL-PAR*2-0	d	-	-	-	-	-	Parameter set X is active (binary coded)

Function

- Quick stop (QSP)
- Operation inhibited (DISABLE)
- Controller inhibit (CINH)
- TRIP-set
- TRIP-RESET
- Change of parameter set (PAR)
- Controller state

3.2.23.1

Quick stop (QSP)

The drive is braked to standstill via the deceleration ramp C105 and generates a holding torque.

- The function can be controlled by three inputs
 - Control word CAN-CTRL bit 3 of CAN-IN1
 - Control word AIF-CTRL bit 3 of AIF-IN
 - Control word C0135 bit 3
- All inputs are linked by an OR-operation.
- C0136/1 displays the control word C0135



3.2.23.2 Operation inhibit (DISABLE)

In this state the drive cannot be started by the "Controller enable" command. The power output stages are inhibited. All controllers are reset.

- The function can be controlled by three inputs
 - Control word CAN-CTRL bit 8 of CAN-IN1
 - Control word AIF-CTRL bit 8 of AIF-IN
 - Control word C0135 bit 8
- All inputs are linked by an OR-operation.
- C0136/1 displays the control word C0135

3.2.23.3 Controller inhibit (CINH)

The power output stages are inhibited. All controllers are reset.

- The function can be controlled by seven inputs:
 - Terminal X5/28 (LOW = controller inhibit)
 - Control word CAN-CTRL bit 9 of CAN-IN1
 - Control word AIF-CTRL bit 9 of AIF-IN
 - Control word C0135 bit 9
 - MONIT-TRIP (HIGH = in the function block MONIT a monitoring function configured to TRIP has been triggered)
 - Free input DCTRL-CINH1
 - Free input DCTRL-CINH2
- All inputs are linked by an OR-operation.
- C0136/1 displays the control word C0135



Note!

If an LU message or an OU message occurs, the CINH signal will not be set.

3.2.23.4 TRIP-SET

The drive is controlled into the state under code C0581 and indicates EEr (external monitoring).

- The function can be controlled by four inputs
 - Control word CAN-CTRL bit 10 of CAN-IN1
 - Control word AIF-CTRL bit 10 of AIF-IN
 - Control word C0135 bit 10
 - Free input DCTRL-TRIP-SET
- All inputs are linked by an OR-operation.
- C0136/1 displays the control word C0135

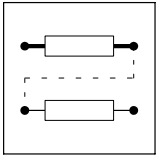

Function library

Function blocks

Control of the drive controller (DCTRL)

3.2.23.5 TRIP-RESET

Resets a pending trip as soon as the cause of malfunction has been removed. If the cause is still active, no reaction occurs.

- The function can be controlled by four inputs
 - Control word CAN-CTRL bit 11 of CAN-IN1
 - Control word AIF-CTRL bit 11 of AIF-IN
 - Control word C0135 bit 11
 - Free input DCTRL-TRIP-RESET
- All inputs are linked by an OR-operation.
- The function can only be performed by a LOW-HIGH edge of the signal resulting from the OR operation.
- C0136/1 displays the control word C0135



Note!

If one of the inputs is set to HIGH, it is not possible that a LOW-HIGH edge will occur on the resulting signal.

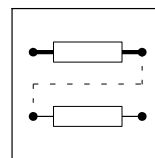

3.2.23.6 Parameter set changeover (PAR)

The controller loads and operates with the parameter set selected.

- The parameter set to be loaded is selected via the inputs DCTRL-PAR*1 and DCTRL-PAR*2. The inputs are binary coded (1 from 4).

PAR*2	PAR*1	Selected parameter set
0	0	Parameter set 1
0	1	Parameter set 2
1	0	Parameter set 3
1	1	Parameter set 4

- A LOW-HIGH edge at the input DCTRL-PAR-LOAD enables the controller to switch to the new parameter set.



Note!

If the parameter set to be loaded via the terminal X5/Ex is already selected before switching on the supply voltage, there is no need for the LOW-HIGH edge at the input DCTRL-PAR-LOAD. In this case, the controller loads the selected parameter set automatically.

- The controller is not ready for operation for approx. one second. During this period, DCTRL-RDY displays LOW.

3.2.23.7 Controller state

The binary-coded status of the controller is output via DCTRL-STAT*x. These outputs are connected to the STAT function block inside the device.

The status can be evaluated via the status word C0150, CAN status word and AIF status word.

STAT*8	STAT*4	STAT*2	STAT*1	Action of the controller
0	0	0	0	Initialisation after the supply voltage has been connected
0	0	0	1	Lock mode, restart protection is active C0142
0	0	1	1	Drive is in controller inhibit mode
0	1	1	0	Controller enabled
0	1	1	1	The release of a monitoring function resulted in a "message"
1	0	0	0	The release of a monitoring function resulted in a "trip"

3.2.23.8 Standstill message (DCTRL-NACT=0)

The standstill message (DCTRL-NACT=0) is set immediately if the actual speed (MCTRL-NACT) falls below the speed threshold (without any hysteresis effect) set in C0019.

The standstill message disappears if the actual speed (MCTRL-NACT) exceeds the sum of the speed threshold set in C0019 and the hysteresis. The hysteresis amounts to 1 % of the maximum speed set in C0011.



Note!

The hysteresis ensures a stable standstill signal even if the actual speed value jitters.



Function library

Function blocks

Master frequency input (DFIN)

3.2.24 Master frequency input (DFIN)

Purpose

Converting and scaling a power pulse current at the digital frequency input X9 into a speed and phase setpoint. The digital frequency is transferred in a high-precision mode (with offset and gain errors).



Fig. 3-58

Digital frequency input (DFIN)

Name	Signal			Source		Note
	Type	DIS	DIS format	CFG	List	
DFIN-OUT	phd	C0426	dec [rpm]	-	-	

Function

- The input X9 is designed for signals with TTL level.
- In the event of digital frequency cascade or digital frequency rail, adapt the drive to the connected encoder or controller via C0425.
- The input of a zero track is optional.
- Via C0427 the following input signals can be evaluated:

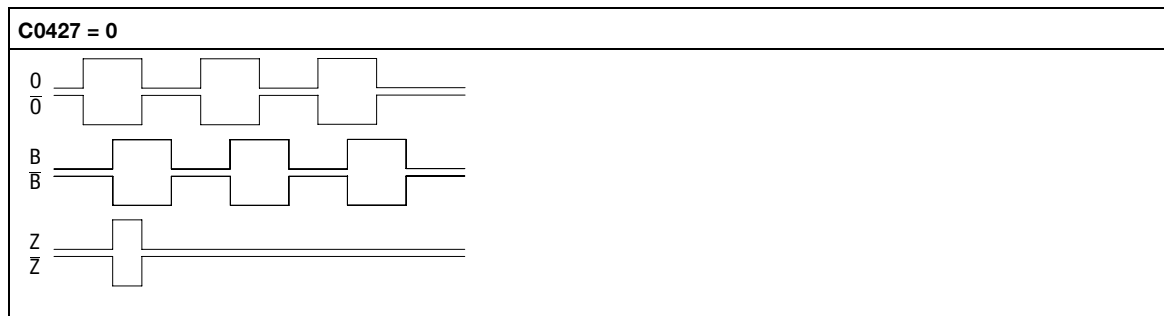

Fig. 3-59

Phase-delayed signal sequence (CW rotation)

CW rotation Track A is leading track B by 90° (positive value at DFIN-OUT).
 CCW rotation Track A is lagging track B by 90° (negative value at DFIN-OUT).

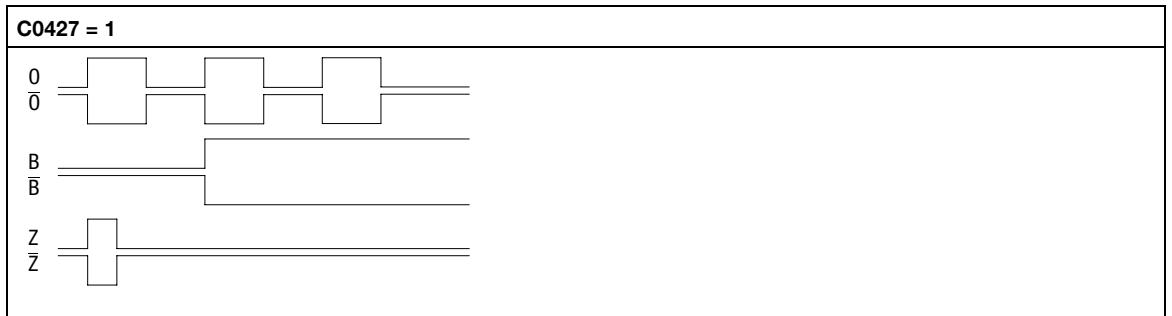
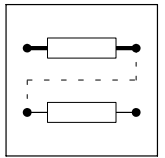

Fig. 3-60

Control of direction of rotation via track B

- | | |
|--------------|---|
| CW rotation | Track A transmits the speed |
| | Track B = LOW (positive value at DFIN-OUT) |
| CCW rotation | Track A transmits the speed |
| | Track B = HIGH (negative value at DFIN-OUT) |

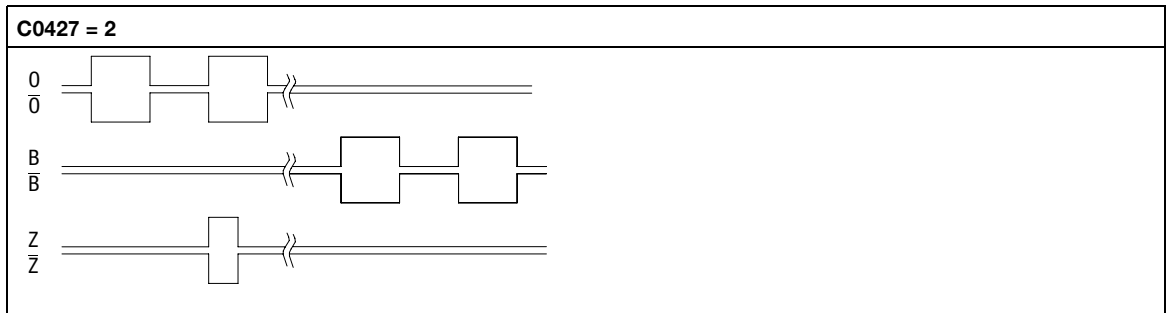

Fig. 3-61

Control of speed and direction of rotation via track A or track B

- | | |
|--------------|--|
| CW rotation | Track A transmits the speed and direction of rotation (positive value at DFIN-OUT) |
| | Track B = LOW |
| CCW rotation | Track B transmits the speed and direction of rotation (negative value at DFIN-OUT) |
| | Track A = LOW |

Transfer function

$$\text{DFIN-OUT [rpm]} = f \text{ [Hz]} \cdot \frac{60}{\text{Number of increments from C0425}}$$

Example:

Input frequency = 200 kHz

C0425 = 3 (Δ a number of increments of 2048 Inc/rev.)

$$\text{DFIN-OUT [rpm]} = 200000 \text{ Hz} \cdot \frac{60}{2048} = 5859 \text{ rpm}$$



Function library

Function blocks

Master frequency input (DFIN)

Signal adaptation

Finer resolutions than the power-of-two format can be realised by connecting an FB (e.g. CONV3 or CONV4).

Example:

The FB CONV3 converts the speed signal into a quasi-analog signal. The conversion is done according to the formula:

$$\text{CONV3-OUT [\%]} = f \text{ [Hz]} \cdot \frac{0,4}{\text{Number of increments from C0425}} \cdot \frac{\text{C0950}}{\text{C0951}}$$

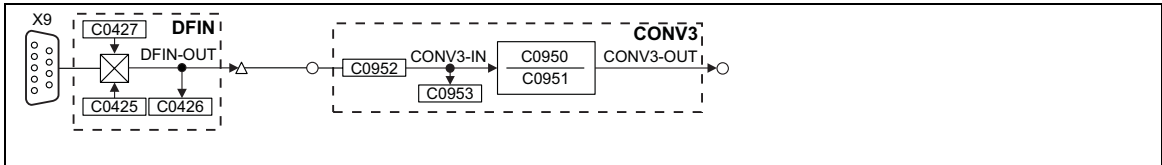

Fig. 3-62

Digital frequency input (DFIN) with connected converter



STOP!

If C0540 = 0, 1, 2, 3 and a feedback system C0025 > 10, you must not use the digital frequency input X9 anymore.



3.2.25 Digital frequency output (DFOUT)

Purpose

Converts internal speed signals into frequency signals and outputs them to subsequent drives. The transmission is highly precise (without offset and gain errors).

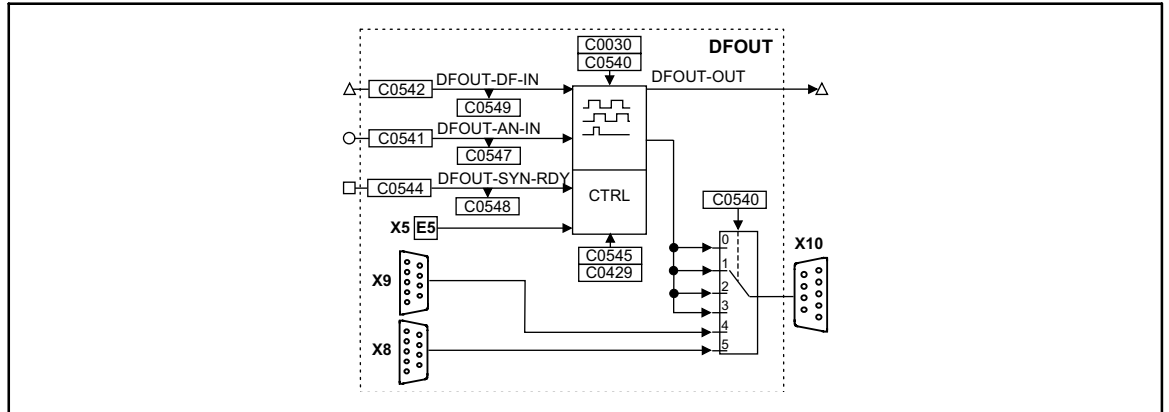

Fig. 3-63 Digital frequency output (DFOUT)

Name	Signal			Source		Note
	Type	DIS	DIS format	CFG	List	
DFOUT-DF-IN	phd	C0549	dec [rpm]	C0542	4	-
DFOUT-AN-IN	a	C0547	dec [%]	C0541	1	Input in [%] of nmax (C0011)
DFOUT-SYN-RDY	d	C0548	bin	C0544	2	-
DFOUT-OUT	phd	-	-	-	-	-

Function

- Output signals on X10
- Output of an analog signal
- Output of a speed signal
- Encoder simulation of the resolver with internal zero track
- Encoder simulation of the resolver with external zero track
- Direct output of X8
- Direct output of X9



Function library

Function blocks

Digital frequency output (DFOUT)

3.2.25.1 Output signals on X10

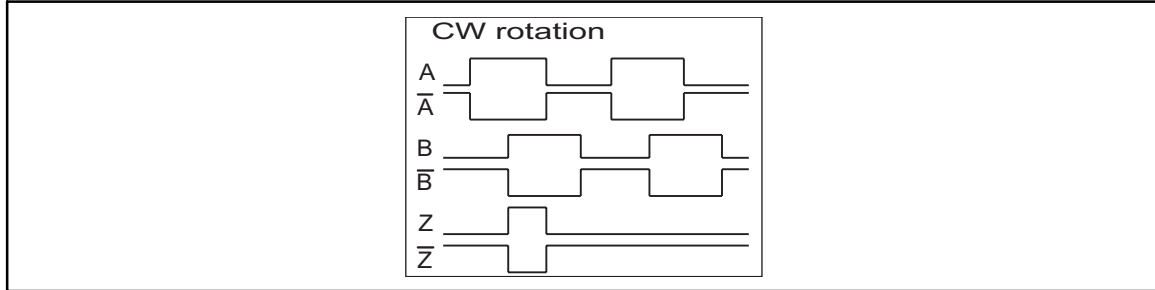

Fig. 3-64

Signal sequence for CW rotation (definition)

- The output signal corresponds to the simulation of an incremental encoder:
 - Track A, B and, if necessary, zero track as well as the corresponding inverted tracks are output with tracks shifted by 90 degrees.
 - The levels are TTL-compatible.
- Positive input values (CW rotation) result in the represented signal sequence.
- With negative input values (CCW rotation) track B is leading track A by 90° .
- The zero track is output according to the function set in C0540
- With C0030 the encoder constant of the encoder simulation is set.
- The function of the digital frequency output X10 is defined via C0540.



Stop!

C0540 = 0 to C0540 = 3 cannot be set if the connection to the digital frequency input DFIN X9 has been established and C0025 > 10 has been selected.

C0540	Signal at X10
0	DFOUT-AN-IN is output at X10; zero track can be input externally
1	DFOUT-DF-IN is output at X10; zero track can be input externally
2	Encoder simulation of the resolver with zero track in resolver zero position (mounted on the motor)
3	Encoder simulation of the resolver with external input of the zero track (terminal X5/E5)
4	The signal at input X9 is electrically amplified and directly output (C0030 is without function)
5	The signal at input X8 is electrically amplified and directly output (C0030 is without function)

Create zero track (Z track)

- Condition:
 - Set C0540 = 0, C0540 = 1 or C0540 = 3.
 - Encoder simulation must be active.
- Start creation:
 - The creation starts immediately with the first rising or falling edge on track A or track B.



3.2.25.2 Output of an analog signal

For this purpose, set code C0540 = 0. The value applied at input DFOUT-AN-IN is converted into a frequency.

Transfer function

$$f [\text{Hz}] = \text{DFOUT-AN-IN} [\%] \cdot \frac{\text{No. of increments from C0030}}{100} \cdot \frac{\text{C0011}}{60}$$

Example:

DFOUT-AN-IN = 50 %

C0030 = 3, this corresponds to a number of increments of 2048 inc/rev.

C0011 = 3000 rpm

$$f [\text{Hz}] = 50 \% \cdot \frac{2048}{100} \cdot \frac{3000}{60} = 51200 \text{ Hz}$$

Generating a zero pulse

An artificial zero pulse can be generated for the output frequency.

1. Activate the function through a LOW → HIGH edge at the input DFOUT-SYN-RDY.
2. A LOW → HIGH edge at terminal X5/E5 causes the generation of the zero pulse after 360°. After this, every 360° a zero pulse is generated according to the setting in C0030.
3. The zero pulse is automatically shifted by the value C0545.



Note!

This procedure must be done after every mains switching.

3.2.25.3 Output of a speed signal

- Set C0540 = 1.
 - This setting only converts the value at input DFOUT-DF-IN into a frequency.

Transfer function

$$f [\text{Hz}] = \text{DFOUT-DF-IN} [\text{rpm}] \cdot \frac{\text{No. of increments from C0030}}{60}$$

Example:

DFOUT-DF-IN = 3000 rpm

C0030 = 3, this corresponds to a number of increments of 2048 inc/rev.

$$f [\text{Hz}] = 3000 [\text{rpm}] \cdot \frac{2048}{60} = 102400 [\text{Hz}]$$

Generating a zero pulse

An artificial zero pulse can be generated for the output frequency.

1. Set input DFOUT-SYN-RDY = edge from LOW → HIGH.
2. A LOW-HIGH edge at terminal X5/E5 causes the generation of the zero pulse after 360°. After this, every 360° a zero pulse is generated according to the setting in C0030.
3. The zero pulse can be shifted by +360° via C0545 (65536 inc = 360°).

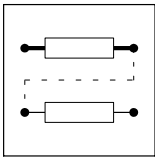

Function library

Function blocks

Digital frequency output (DFOUT)

3.2.25.4 Encoder simulation of the resolver

Set C0540 = 2 or C0540 = 3 (depending on the desired generation of the zero track)

- The function is used when a resolver is connected to X7.
- The encoder constant for output X10 is set in C0030.

Generating a zero pulse in resolver zero position (C0540 = 2)

The output of the zero pulse with regard to the rotor depends on how the resolver is mounted to the motor.

- The zero pulse can be shifted by +360° via C0545 (65536 inc = 360°).

Generating an external zero pulse (C0540 = 3)

An artificial zero pulse can be generated for the output frequency.

- The function is activated through a LOW-HIGH edge at the input DFOUT-SYN-RDY.
- A LOW-HIGH edge at terminal X5/E5 causes the generation of the zero pulse after 360°.
 - After this, every 360° a zero pulse is generated according to the setting in C0030.
- The zero pulse can be shifted by +360° via C0545 (65536 inc = 360°).



Note!

The procedure for generating an artificial zero pulse must be repeated after every mains switching and after every setting of C0540 = 3.

3.2.25.5 Direct output of X8 (C0540 = 5)

- The input signal at X8 is electrically amplified and directly output.
- The signals depend on the assignment of the input X8.
- C0030 and C0545 have no function.
- The zero track is only output if it is connected to X8.

3.2.25.6 Direct output of X9 (C0540 = 4)

- The input signal at X9 is electrically amplified and directly output.
- The signals depend on the assignment of the input X9.
- C0030 and C0545 have no function.
- The zero track is only output if it is connected to X9.



Note!

For directly outputting X8 or X9 to the digital frequency output X10 the function block DFOUT does not need to be entered into the processing table.

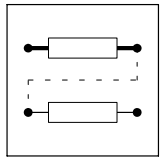

3.2.26 Digital frequency ramp function generator (DFRFG)

Purpose

The drive (motor shaft) is synchronised to a digital frequency (phase selection). The drive then performs a phase-synchronous operation with the digital frequency.

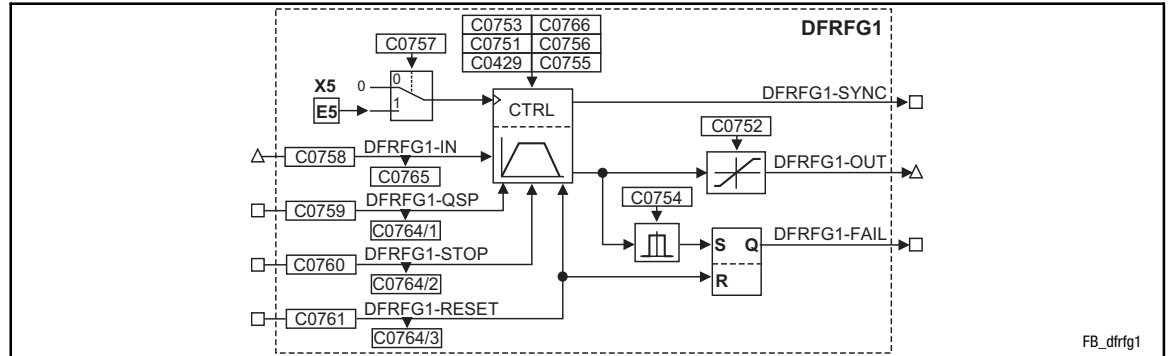

Fig. 3-65 Digital frequency ramp function generator (DFRFG1)

Designation	Signal			Source		Note
	Type	DIS	DIS format	CFG	List	
DFRFG1-SET	phd	C0769	-	C0768	-	Initial speed
DFRFG1-IN	phd	C0765	dec [rpm]	C0758	4	Speed/Phase setpoint
DFRFG1-QSP	d	C0764/1	bin	C0759	2	HIGH = quick stop
DFRFG1-STOP	d	C0764/2	bin	C0760	2	HIGH = save setpoint
DFRFG1-RESET	d	C0764/3	bin	C0761	2	HIGH = reset
DFRFG1-OUT	phd	-	-	-	-	Speed/Phase setpoint
DFRFG1-SYNC	d	-	-	-	-	HIGH = drive runs synchronously
DFRFG1-FAIL	d	-	-	-	-	HIGH = phase difference exceeded

Function

- Profile generator
- Quick stop
- Ramp function generator stop
- RESET
- Detect phase difference
- Start via touch probe initiator (terminal X5/E5)
- Correction of the touch probe initiator (terminal X5/E5)



Function library

Function blocks

Digital frequency ramp function generator (DFRFG)

3.2.26.1 Profile generator

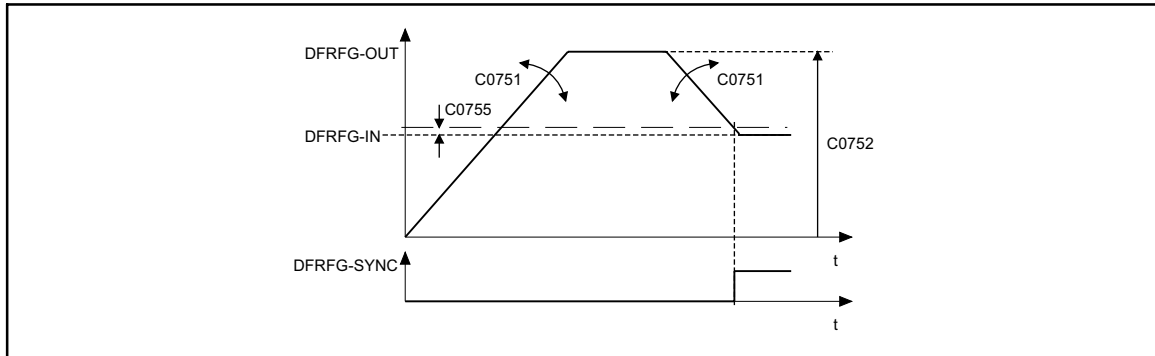

Fig. 3-66

Synchronisation on DFRFG

The profile generator generates ramps which lead the setpoint phase to its target position.

- Set acceleration and deceleration via C0751.
- Set max. speed via C0752.
- When the distance and speed reach their setpoints, the output switches DFRFG1-SYNC = HIGH. At the same time the FB switches the profile generator to "inactive".
- Set the switching point via C0755.



Stop!

Do not operate the drive with this function at the torque limitation M_{max} , I_{max} .

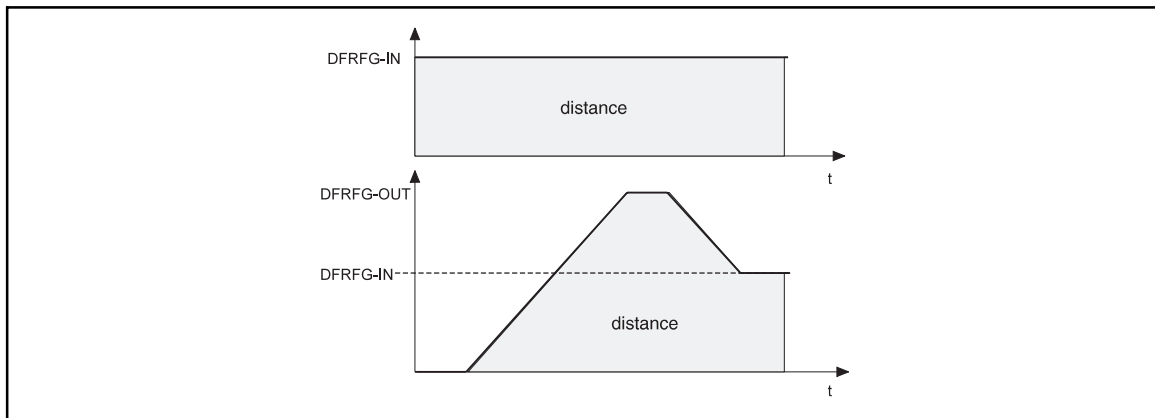
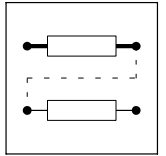

Fig. 3-67

Speed-time diagram DFRFG

The number of increments at DFRFG-IN (master drive) defines the target position. The target can be displayed as a path. The speed-time diagram shows the distance covered (angle) as the area below the speed profile. When synchronicity is reached, master and slave have covered the same distance (angle).



3.2.26.2 Quick stop

Removes the drive from the network and brakes it to standstill.

- Activate with DFRFG-QSP = HIGH.
- Set deceleration time via C0753.
- Store the setpoint phase detected at DFRFG-IN.
- Approach the setpoint phase via the profile generator after resetting the quick stop request.

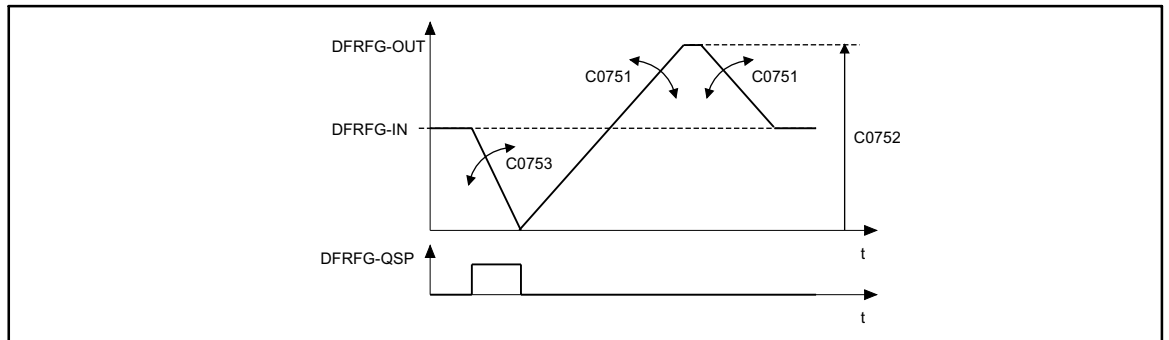

Fig. 3-68 Quick stop DFRFG

3.2.26.3 Ramp function generator stop

Maintains the state of the profile generator during operation.

- Activate with DFRFG-STOP = HIGH
- Output of the last state at DFRFG-OUT.
- Store the setpoint phase detected at DFRFG-IN.
- Approach the setpoint phase via the profile generator after resetting the stop request.

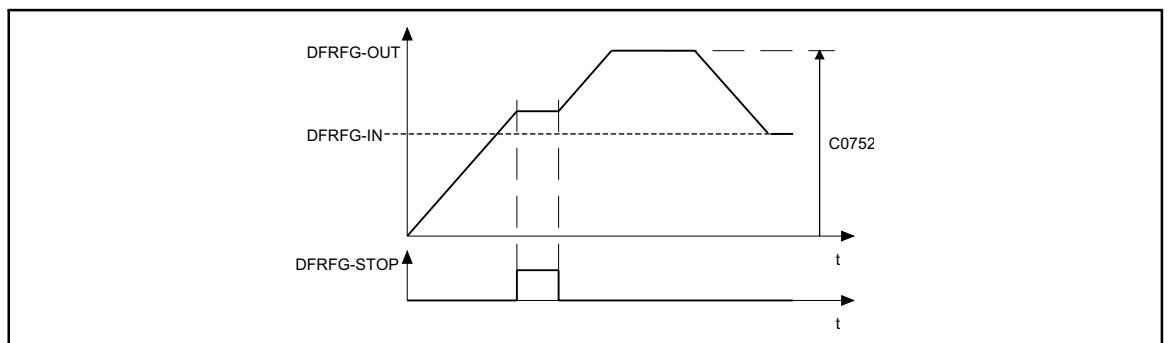
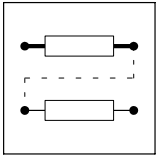

Fig. 3-69 Ramp function generator stop



Function library

Function blocks

Digital frequency ramp function generator (DFRFG)

3.2.26.4 RESET

DFRFG-RESET = HIGH:

- Resets setpoint phases which are internally added.
- Activates the profile generator.
- HIGH-LOW edge at DFRFG-RESET: Detecting the setpoint phase.

3.2.26.5 Detect phase difference

Monitoring the phase difference between input DFRFG-IN and output DFRFG-OUT.

- Set limit value of monitoring via C0754.
- Activates the monitoring: DFRFG-FAIL = HIGH
- Storing the signal until DFRFG-RESET = HIGH.
- The profile generator can accept a phase difference of up to ± 214000000 inc (= 32000 revolutions).

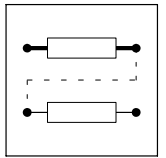

3.2.26.6 Start via touch probe initiator (terminal X5/E5)



Stop!

In the default setting the terminal X5/E5 is assigned to another function.

Function

- Set C0757 = 1.
- The function is activated by **simultaneously** setting the inputs:
 - DFRFG-QSP and DFRFG-RESET = HIGH.
- Starting procedure:
 - Signals at DFRFG-QSP and DFRFG-RESET = LOW.
 - Otherwise touch probe signals are ignored.
- A LOW-HIGH edge at terminal X5/E5 starts the process:

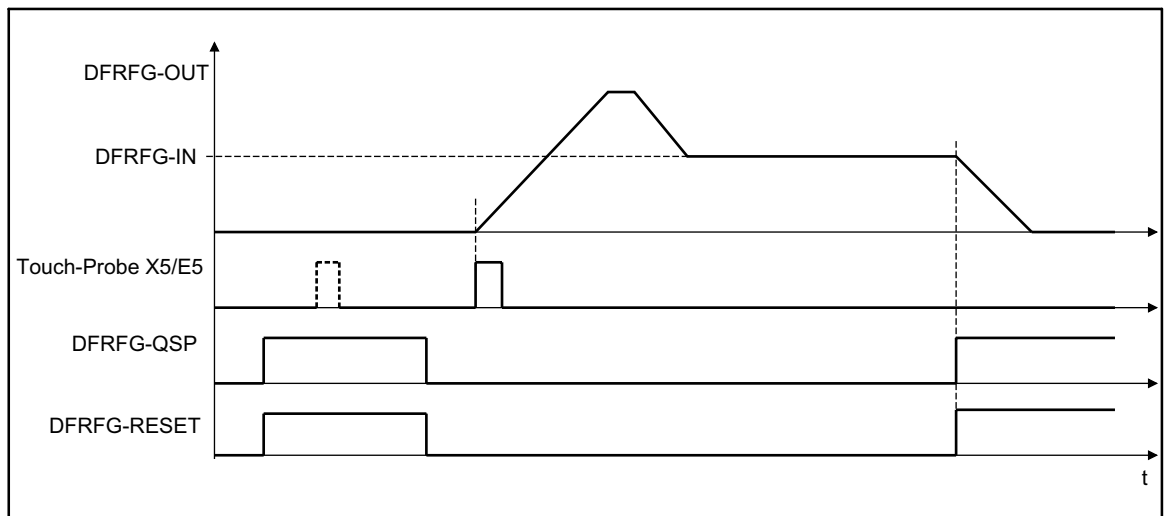
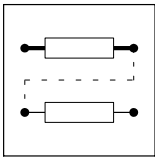

Fig. 3-70 Start via touch probe initiator (terminal X5/E5)



Function library

Function blocks

Digital frequency ramp function generator (DFRFG)

3.2.26.7 Correction of the touch probe initiator (terminal X5/E5)

Delay times during the activation of the initiator cause a speed-dependent phase offset (e.g. during positioning, synchronising).

In order to take this angular offset into account, the response time [ms] of the initiators as a function of the setpoint speed DFRFG-IN is converted to a phase angle correction and is then taken into consideration in the setpoint angle. For this, the response time [ms] has to be converted to a correction value [Inc.] first.

- Set correction value for the phase offset under C0429.
- Formula for input value in C0429:

$$\text{Input value C0429} = 16384 \times \text{response time [ms]}$$

- The response time [ms] can be gathered from the data sheet of the initiator or requested by the manufacturer.

3.2.26.8 Offset setting

The offset can be set with code C0756. The offset refers to the digital frequency input and is scaled to 1 revolution (\triangleq 65536 increments).

The touch probe (TP) initiates the start of the ramp function generator. The leading of the master drive from the moment of starting or the resulting path/phase difference is taken up during the acceleration phase.

- Setting: positive offset values
 - Causes a time shift of the TP
 - This means that less time is necessary - compared to the setting with e.g. offset = 0 - to obtain synchronism with the master drive.



Tip!

With high offsets and low input speeds the drive may reverse. To avoid this, a direction of rotation can be selected for the output via C0766.



3.2.27 Digital frequency processing (DFSET)

Purpose

Conditions the digital frequency for the controller. Selection of stretch factor, gearbox factor and speed trimming or angular trimming.

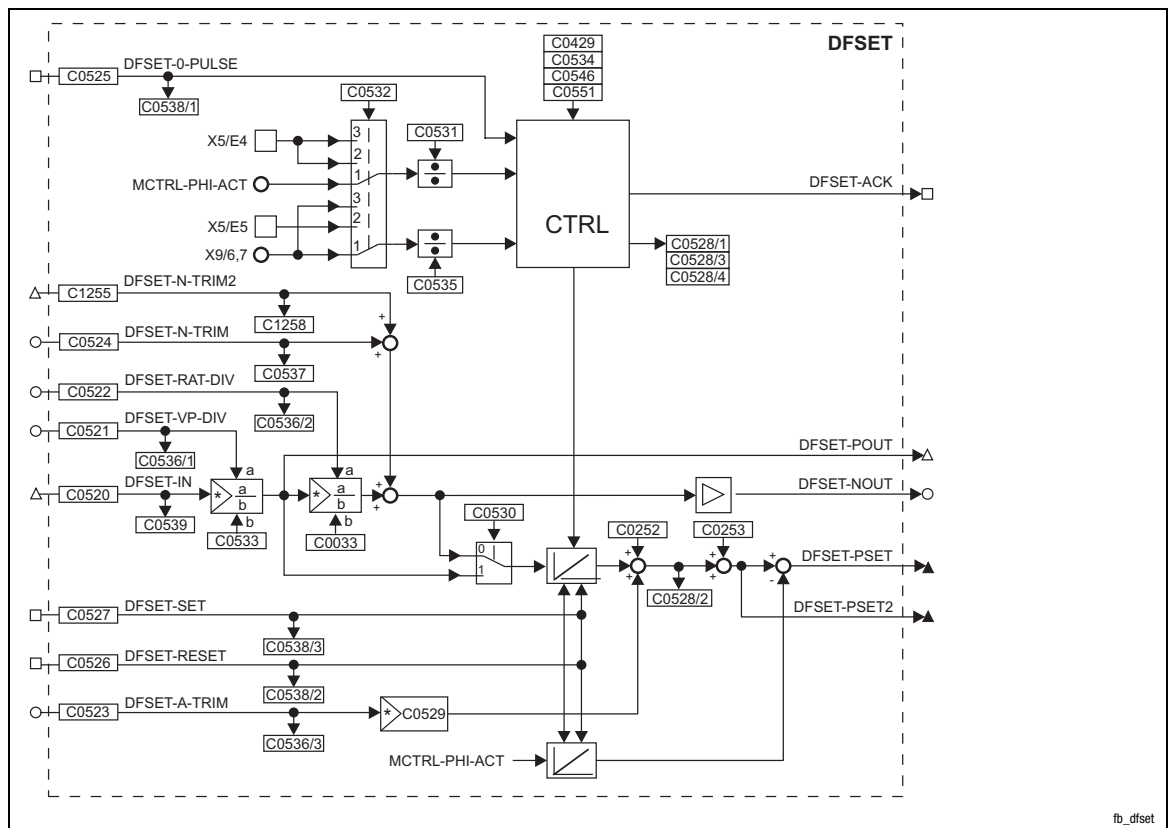

Fig. 3-71 Digital frequency processing (DFSET)

Name	Signal			Source		Note
	Type	DIS	DIS format	CFG	List	
DFSET-IN	phd	C0539	dec [rpm]	C0520	4	Speed/angle setpoint
DFSET-N-TRIM	a	C0537	dec [%]	C0524	1	Speed trimming in [%] of C0011
DFSET-N-TRIM2	phd	C1258	dec [rpm]	C1255	4	Speed trimming in [rpm] of C0011
DFSET-A-TRIM	a	C0536/3	dec [inc]	C0523	1	Angular trimming 100% = 16384 inc
DFSET-VP-DIV	a	C0536/1	dec	C0521	1	Numerator of stretch factor 100 % = 16384 inc
DFSET-RAT-DIV	a	C0536//2	dec	C0522	1	Numerator of gearbox factor 100 % = 16384 inc
DFSET-0-PULSE	d	C0538/1	bin	C0525	2	HIGH = Enabling of zero pulse synchronisation
DFSET-SET	d	C0538/3	bin	C0527	2	<ul style="list-style-type: none"> • HIGH = Sets angle integrators to equal values • LOW-HIGH edge sets DFSET-PSET = 0 • HIGH-LOW edge sets DFSET-PSET = current value of MCTRL-PHI-SET • DFSET-SET has a higher priority than DFSET-RESET
DFSET-RESET	d	C0538/2	bin	C0526	2	<ul style="list-style-type: none"> • HIGH = Sets position difference = 0 • HIGH = Sets DFSET-PSET and DFSET-PSET2 = 0
DFSET-NOUT	a	-	-	-	-	In [%] of nmax (C0011)
DFSET-POUT	phd	-	-	-	-	Speed/angle setpoint
DFSET-PSET	ph	-	-	-	-	Following error for angle controller
DFSET-PSET2	ph	-	-	-	-	Angle setpoint 65536 inc = 1 revolution
DFSET-ACK	d	-	-	-	-	HIGH = Synchronising is performed



Function library

Function blocks

Digital frequency processing (DFSET)

Function

- Setpoint conditioning with stretch and gearbox factor
- Processing of correction values
- Synchronising to zero track or touch probe (for resolver feedback touch probe only)
- Suppressing fault signals when synchronising via touch probe

3.2.27.1 Setpoint conditioning with stretch and gearbox factor

Stretch factor

The stretch factor defines the ratio between the drive in operation and its setpoint.

The evaluation is based on the setpoint at DFSET-IN. DFSET-POUT outputs the result.

$$\text{DFSET-POUT} = \text{DFSET-IN} \cdot \frac{\text{DFSET-VP-DIV}}{\text{C0533}}$$

The stretch factor results from numerator and denominator:

- The numerator (DFSET-VP-DIV) can be variable (provided by an analog signal source) or a constant value (provided by a code).
- The denominator must be set in C0533.

Gearbox factor

The gearbox factor defines the gearbox ratio of the drive. Enter the transmission ratio of the drive.

The evaluation is based on the setpoint at DFSET-IN multiplied by the stretch factor. DFSET-NOUT outputs the result.

$$\text{DFSET-NOUT} = \text{Reckfaktor} \cdot \frac{\text{DFSET-RAT-DIV}}{\text{C0033}}$$

$$\text{DFSET-NOUT} = \text{DFSET-IN} \cdot \frac{\text{DFSET-VP-DIV}}{\text{C0533}} \cdot \frac{\text{DFSET-RAT-DIV}}{\text{C0033}}$$

The gearbox factor results from numerator and denominator.

- The numerator can be variable (provided by an analog signal source) or a constant value (provided by a code).
- The denominator must be set in C0033.



Note!

With code C0530 you can deactivate the use of the gearbox factor and the DFSET-N-TRIM values as the basis for the setpoint angle integrator. When C0530 = 1, only the stretch factor is used for the calculation of the setpoint angle.

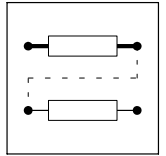

3.2.27.2 Processing of correction values

Speed trimming

This is used to add correction values, e.g. by a superimposed control loop. This enables the drive to accelerate or decelerate.

- Adds an analog value at DFSET-N-TRIM (see C0537) to the speed setpoint.
- Adds a speed value at DFSET-N-TRIM2 (see C1258) to the speed setpoint.
 - The speed trimming via this input is more precise.

Angular trimming

Adds a setpoint at DFSET-A-TRIM (see C0536/3) to the angle setpoint. The rotor position with respect to the setpoint can be changed in either direction by the defined number of increments (the drive is leading or lagging). The angle is trimmed within a range of ± 32767 increments (corresponds to $\pm 1/2$ revolution). Every analog signal can be used as a source.

- The input is made in increments (one revolution corresponds to 65536 increments).
- When analog values are entered, 100% correspond to 1/4 revolution = 16384 increments.
- Extension of the setting range with a multiplier under C0529.

Angular offset

The angular offset (C0252) adds a constant angular offset to the setpoint of the drive.

Speed-proportional angle adjustment

With speed-proportional angle adjustment the angle lags or leads with rising speed.

- Enter a corresponding adjustment value in increments in C0253.
- The set angle adjustment is reached at 15000 rpm of the drive (linear relationship).

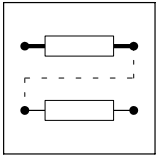

Function library

Function blocks

Digital frequency processing (DFSET)

3.2.27.3 Synchronising to zero track or touch probe



Stop!

If synchronisation via terminals X5/E4 and X5/E5 (C0532 = 2) is activated, there must not be any other signal connections to the terminals. If you have selected a basic configuration via C0005, the terminals are subject to a basic assignment.

The synchronisation mode can be selected in C0532.

- C0532 = 1, zero pulse
 - Zero track of digital frequency input X9 and zero track by the feedback system set under C0490 (not for resolver evaluation).
- C0532 = 2, touch probe
 - Via terminals X5/E4 (actual pulse) and X5/E5 (setpoint pulse).
- C0532 = 3, zero pulse (setpoint) and touch probe (actual value)
 - Setpoint pulses of digital frequency input X9 and actual pulses via the touch probe input at terminal X5/E4.



Note!

For all three modes you can define a division factor for the actual pulses (code C0531) and for the setpoint pulses (code C0535).

- Example: For C0531 = 10 only every tenth actual pulse is evaluated. The other 9 pulses are ignored.
- Lenze setting: C0531 = 1, C0533 = 3

Correction of the touch probe initiator (terminal X5/E5)

Delay times during the activation of the initiator cause a speed-dependent angular offset (e.g. during positioning, synchronising). To compensate this angular offset, the response time [ms] of the initiators is converted into an angular correction value depending on the setpoint speed and then taken into account in the setpoint angle.

How to determine the angular correction value:

1. Use the below formula to convert the response time [ms] into a correction value [inc]:

$$\text{Angular correction value in C0429} = 16384 \times \text{response time [ms]}$$

– Please refer to the data sheet for the response time [ms] or contact the manufacturer of the initiator.

2. Set the angular correction value for the angular offset in C0429.

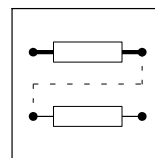

Synchronisation mode

For the synchronisation, different modes are available which can be set under C0534.

C0534	Synchronisation mode	Note
0	Inactive	Function inactive
1	Continuous synchronisation with correction in the shortest possible way	A LOW-HIGH edge at DFSET-0-Pulse initiates continuous synchronisation
2	Continuous synchronisation with correction in the shortest possible way	
10	One-time synchronisation, an angular deviation is corrected in the shortest possible way	A LOW-HIGH edge at DFSET-0-Pulse initiates a one-time synchronisation
11	One-time synchronisation, an angular deviation is corrected in CW direction	
12	One-time synchronisation, an angular deviation is corrected in CCW direction	
13	One-time synchronisation, an angular difference is determined between setpoint pulse and actual pulse and is corrected to the corresponding direction of rotation according to the sign	

Code C0528/1 displays the number of increments (angular difference) between the setpoint pulse and the actual pulse before the synchronisation.



Function library

Function blocks

Digital frequency processing (DFSET)

3.2.27.4 Suppressing fault signals when synchronising via touch probe

Interference pulses which act on the actual pulse and setpoint pulse signal at the inputs X5/E4 and X5/E5 can cause unwanted transients and faulty functions.

As of software version 6.2 it is possible to filter interference pulses via masking windows, thus reducing interferences by up to 90%, depending on the application.

The masking windows can be set separately, for the actual pulses (X5/E4) via C0551 and for the setpoint pulses (X5/E5) via C0546.

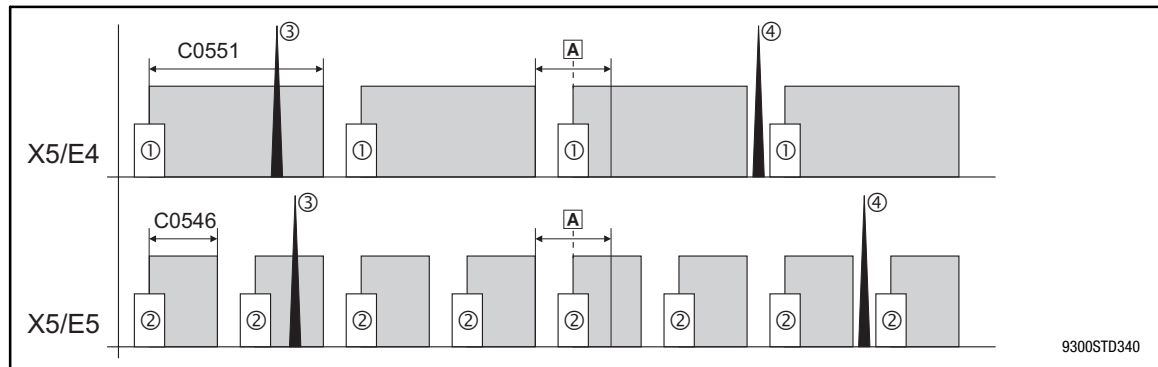

Fig. 3-72 Masking of interference pulses for setpoint and actual pulses

- ▣ Variations of the actual / setpoint pulses
- ① Actual pulses at X5/E4
- ② Setpoint pulses at X5/E5
- ③ Interference pulse in the masked area is filtered out
- ④ Interference pulse in a non-masked area causes transients

Setting of masking window

1. Measure the number of increments between two pulses. Since the number varies depending on the application, the variation limits must be detected and considered when setting the masking windows.
 - C0528/4 displays the number of increments between 2 actual pulses at X5/E4 (e.g. motor increments).
 - C0528/3 displays the number of increments between 2 setpoint pulses at X5/E5 (e.g. master increments).
2. Set the size of the masking window, considering the variation limits. The higher the limits the smaller the masking window must be set.
 - In C0551 the size of the masking window between 2 actual pulses at X5/E4 can be set by entering the corresponding number of increments.
 - In C0546 the size of the masking window between 2 setpoint pulses at X5/E5 can be set by entering the corresponding number of increments.
 - Consider the division factors C0531 and C0535 when setting the masking windows.



Note!

- The range to be masked out (masking windows C0546 and C0551) starts with the first touch probe pulse and restarts with every new touch probe pulse. Modifications of the masking window via C0546 or C0551 are accepted immediately.
- If very low speeds are used, the masking window in C0551 should be set to 1 increment to prevent that actual pulses are classified as interference pulses.



3.2.28 Delay elements (DIGDEL)

Purpose

This function is used to delay digital signals. This function can be used for the control of functions or the generation of status information.

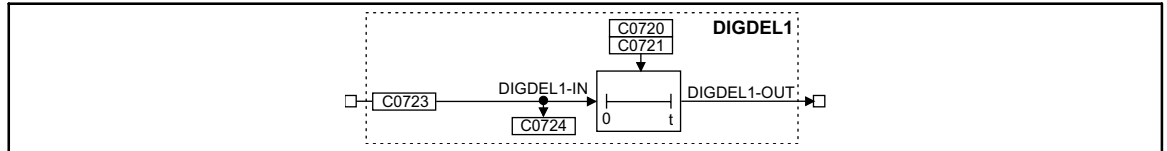

Fig. 3-73

Delay element (DIGDEL1)

Name	Signal			Source			Note
	Type	DIS	DIS format	CFG	List	Lenze	
DIGDEL1-IN	d	C0724	bin	C0723	2	1000	-
DIGDEL1-OUT	d	-	-	-	-	-	-

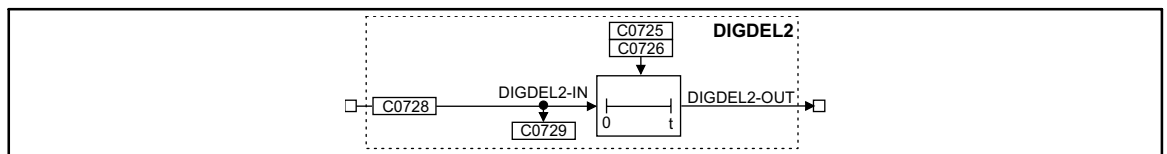

Fig. 3-74

Delay element (DIGDEL2)

Name	Signal			Source			Note
	Type	DIS	DIS format	CFG	List	Lenze	
DIGDEL2-IN	d	C0729	bin	C0728	2	1000	-
DIGDEL2-OUT	d	-	-	-	-	-	-

Function

You can select the following functions under C0720 (DIGDEL1) and C0725 (DIGDEL2):

- On-delay
- Off-delay
- General delay



Function library

Function blocks

Delay elements (DIGDEL)

3.2.28.1 On-delay

If the on-delay is set, a signal change from LOW to HIGH at the input DIGDELx-IN is passed on to the DIGDELx-OUT output after the delay time set under C0721 or C0726 has elapsed.

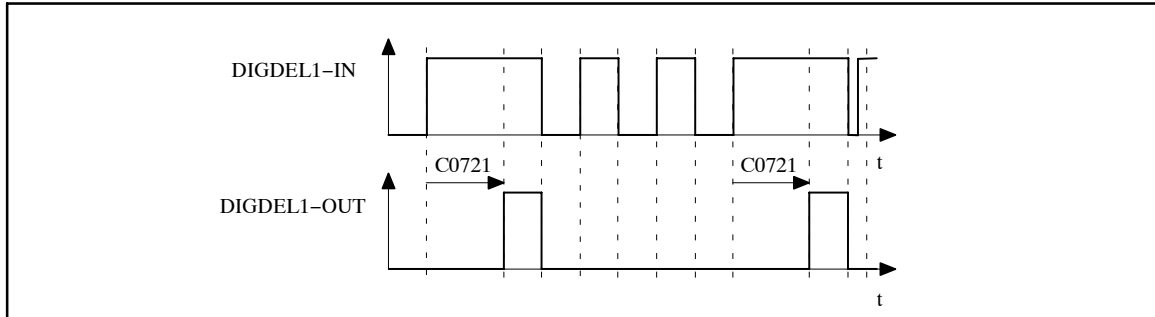

Fig. 3-75 On-delay (DIGDEL1)

In this function, the time element operates like a retriggerable monoflop:

- A LOW-HIGH edge at the input DIGDELx-IN starts the time element.
- If the delay time set under C0721 or C0726 has elapsed, the output DIGDELx-OUT is set to HIGH.
- The time element is reset and the output DIGDELx-OUT is set to LOW with a HIGH-LOW edge at the input DIGDELx-IN.

3.2.28.2 Off-delay

An off-delay causes a signal change from HIGH to LOW at the input DIGDELx-IN to be passed on to the output DIGDELx-OUT after the delay time set under C0721 or C0726 has elapsed.

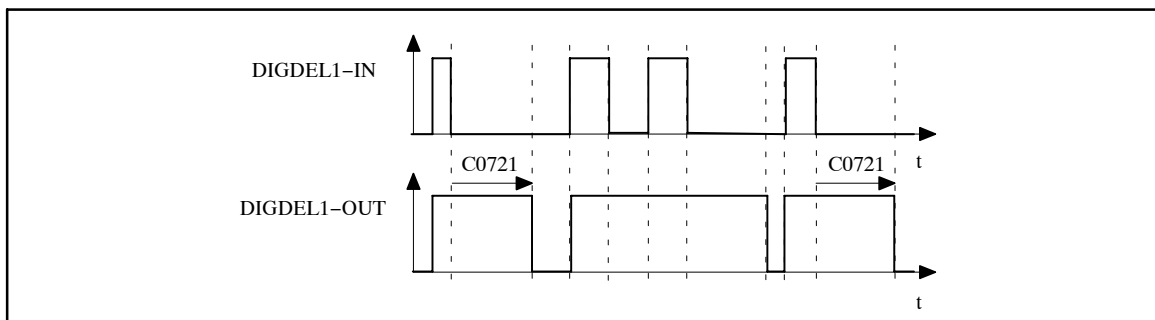

Fig. 3-76 Off-delay (DIGDEL1)

- A LOW-HIGH edge at the input DIGDELx-IN causes the output DIGDELx-OUT to be set to HIGH and the time element to be reset.
- The time element is started with a HIGH-LOW edge at the input DIGDELx-IN.
- After the delay time set under C0721 or C0726 has elapsed, the output DIGDELx-OUT is set to LOW.



3.2.28.3 General delay

A general delay causes any signal change at the input DIGDELx-IN to be passed onto the output DIGDELx-OUT only after the time set under C0721 or C0726 has elapsed.

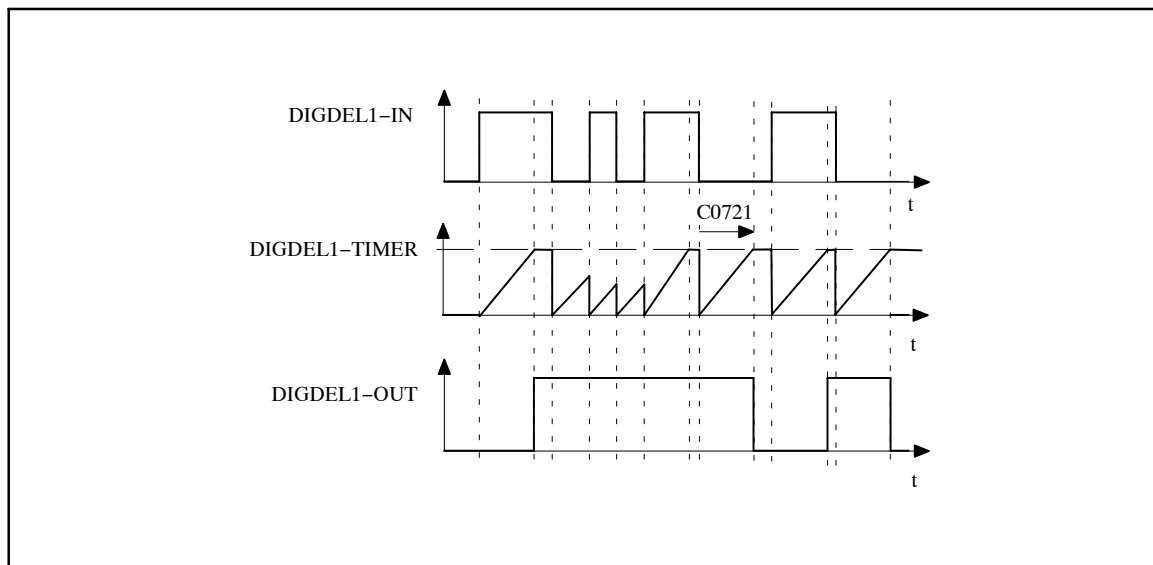

Fig. 3-77

General delay

- The time element is started with any edge at the input DIGDELx-IN.
- When the timer (can be set under C0721 or C0726) has reached the upper limit, the output DIGDELx-OUT is set to the same value as the input DIGDEL1-IN.



Function library

Function blocks

Freely assignable digital inputs (DIGIN)

3.2.29 Freely assignable digital inputs (DIGIN)

Purpose

Reading and conditioning of the signals at the terminals X5/E1 to X5/E5.

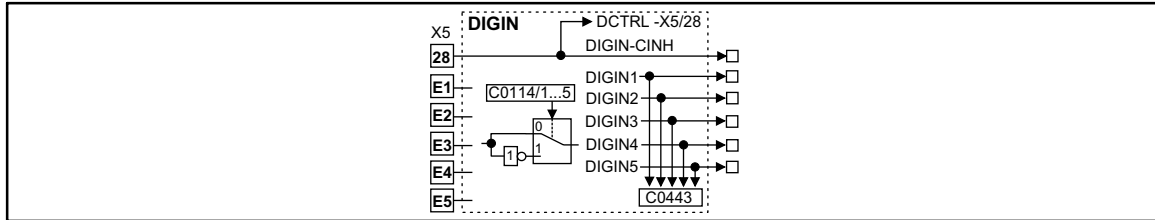

Fig. 3-78 Freely assignable digital inputs (DIGIN)

Name	Signal			Source			Note
	Type	DIS	DIS format	CFG	List	Lenze	
DIGIN-CINH	d	-	dec	-	-	-	Controller inhibit acts directly on the DCTRL control
DIGIN1	d	C0443	dec	-	-	-	-
DIGIN2	d	C0443	dec	-	-	-	-
DIGIN3	d	C0443	dec	-	-	-	-
DIGIN4	d	C0443	dec	-	-	-	-
DIGIN5	d	C0443	dec	-	-	-	-

Function

The terminals X5/E1 to X5/E5 are scanned every millisecond. The level for every input can be inverted. For this, proceed as follows:

- Select code C0114 with corresponding subcode (e.g. subcode 3 for input X5/E3)
- Enter the desired level as a parameter:
 - 0 = Level not inverted (HIGH active)
 - 1 = Level inverted (LOW active)

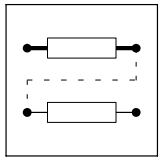

3.2.30 Freely assignable digital outputs (DIGOUT)

Purpose

Conditioning of the digital signals and output at the terminals X5/A1 to X5/A4.

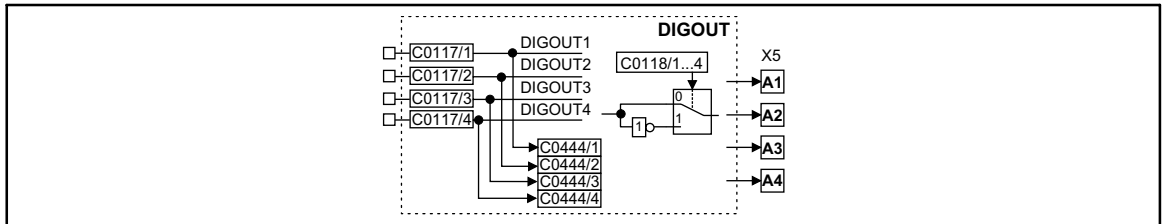

Fig. 3-79 Freely assignable digital outputs (DIGOUT)

Name	Signal			Source			Note
	Type	DIS	DIS format	CFG	List	Lenze	
DIGOUT1	d	C0444/1	bin	C0117/1	2	15000	-
DIGOUT2	d	C0444/2	bin	C0117/2	2	10650	-
DIGOUT3	d	C0444/3	bin	C0117/3	2	500	-
DIGOUT4	d	C0444/4	bin	C0117/4	2	5003	-

Function

The terminals X5/A1 to X5/A4 are updated every millisecond. The level for every output can be inverted. For this, proceed as follows:

- Select code C0118 with corresponding subcode (e.g. subcode 3 for output X5/A3)
- Enter the desired level as a parameter:
 - 0 = Level not inverted (HIGH active)
 - 1 = Level inverted (LOW active)



Function library

Function blocks

First order derivative-action element (DT1)

3.2.31 First order derivative-action element (DT1)

Purpose

Derivative action on signals.

For instance, used for the acceleration processes (dv/dt).

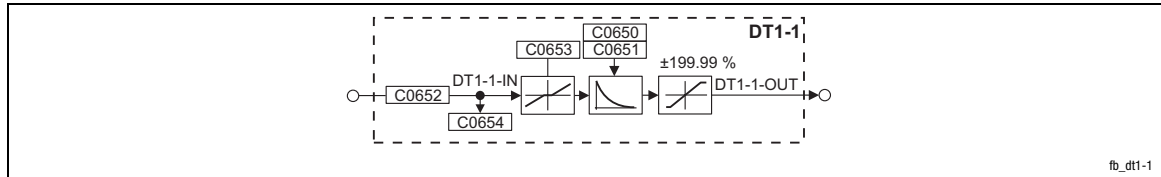

Fig. 3-80 First order derivative-action element (DT1-1)

Name	Signal			Source			Note
	Type	DIS	DIS format	CFG	List	Lenze	
DT1-1-IN	a	C0654	dec [%]	C0652	1	1000	-
DT1-1-OUT	a	-	-	-	-	-	Limited to ±199.99 %

Function

- The gain is set under C0650.
- The delay T_v is set under C0651.
- The input sensitivity of the DT1-1 element can be reduced under C0653.
- The FB only evaluates the specified most significant bits, according to the setting.

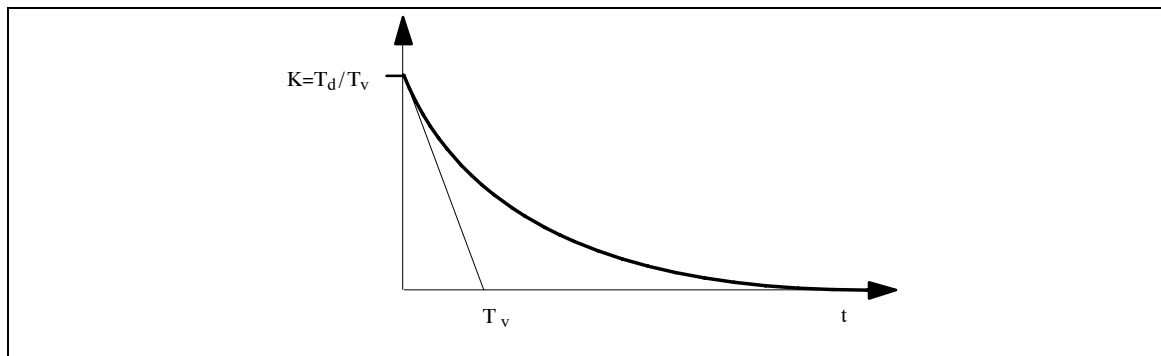

Fig. 3-81 Delay time T_v of the first order derivative-action element



3.2.32 Free piece counter (FCNT)

Purpose

Digital up/down counter

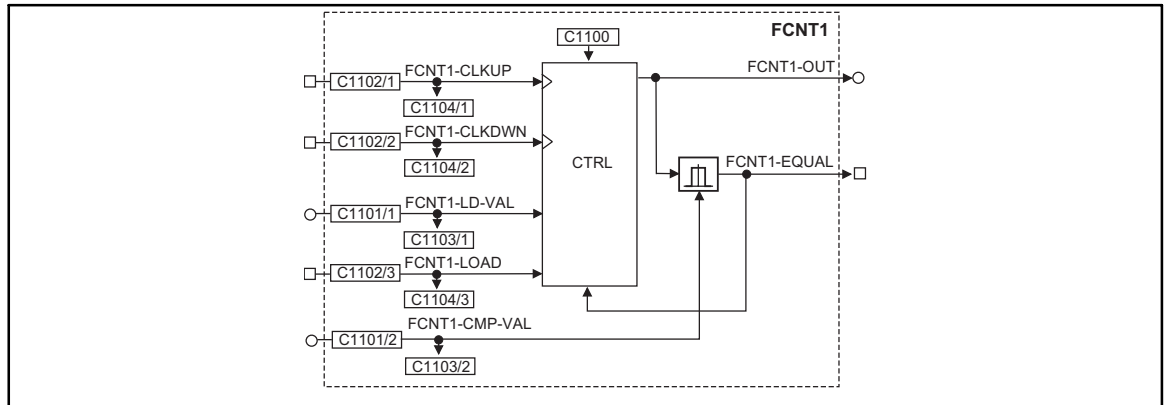

Fig. 3-82 Free piece counter (FCNT1)

Name	Signal			Source		Note
	Type	DIS	DIS format	CFG	List	
FCNT1-CLKUP	d	C1104/1	bin	C1102/1	2	LOW-HIGH edge = counts up by 1
FCNT1-CLKDWN	d	C1104/2	bin	C1102/2	2	LOW-HIGH edge = counts down by 1
FCNT1-LD-VAL	a	C1103/1	dec	C1101/1	1	Starting value
FCNT1-LOAD	d	C1104/3	bin	C1102/3	2	<ul style="list-style-type: none"> • HIGH = Accept starting value • The input has the highest priority
FCNT1-CMP-VAL	a	C1103/2	dec	C1101/2	1	Comparison value
FCNT1-OUT	a	-	-	-	-	Counter limited to $\pm 199.99\%$ ($\Delta \pm 32767$)
FCNT1-EQUAL	d	-	-	-	-	HIGH = comparison value reached

Function

- C1100 = 1
 - If $|\text{counter content}| \geq |\text{FCNT1-CMP-VAL}|$ (comparison value), FCNT1-EQUAL is set = HIGH for 1 ms. Afterwards the counter is reset to the starting value (FCNT1-LD-VAL).



Note!

If the signal is to be available longer, e. g. for a query of the output via a PLC, you can prolong the signal via the TRANS function block.

- C1100 = 2
 - If $|\text{counter content}| \geq |\text{FCNT1-CMP-VAL}|$ (comparison value), the counter is stopped.
 - Via FCNT1-LOAD = HIGH, the counter is reset to the starting value (FCNT1-LD-VAL).
- C1100 = 3
 - If $|\text{counter content}| = |\text{FCNT1-CMP-VAL}|$ (comparison value), the counter is stopped.
 - Via FCNT1-LOAD = HIGH, the counter is reset to the starting value (FCNT1-LD-VAL).
 - FCNT1-OUT is limited to 32767 for counting upwards and to -32767 for counting downwards.



Function library

Function blocks

Free digital outputs (FDO)

3.2.33 Free digital outputs (FDO)

Purpose

This function block can be used to connect digital signals via C0151, the function block AIF-OUT and function block CAN-OUT to the connected fieldbus systems.

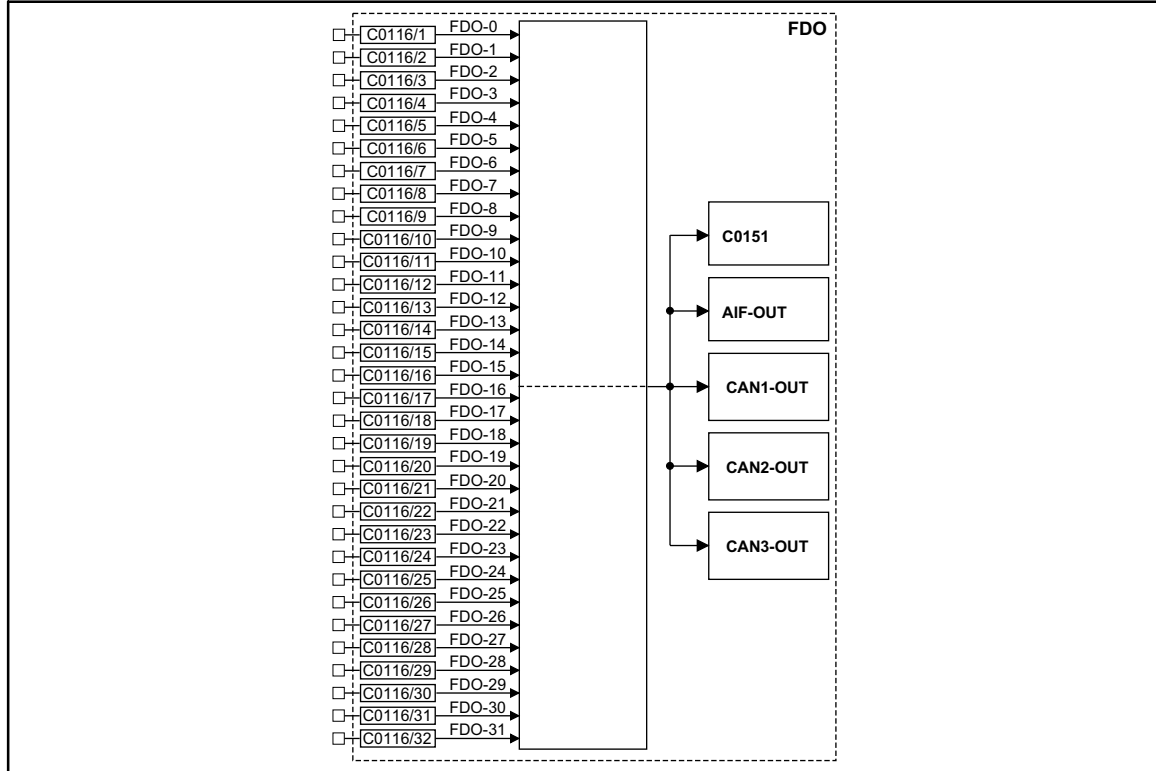
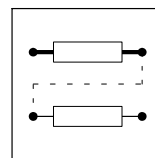

Fig. 3-83 Free digital outputs (FDO)



Name	Signal			Source			Note
	Type	DIS	DIS format	CFG	List	Lenze	
FDO-0	d	C0151	hex	C0116/1	2	1000	
FDO-1	d	C0151	hex	C0116/2	2	1000	
FDO-2	d	C0151	hex	C0116/3	2	1000	
FDO-3	d	C0151	hex	C0116/4	2	1000	
FDO-4	d	C0151	hex	C0116/5	2	1000	
FDO-5	d	C0151	hex	C0116/6	2	1000	
FDO-6	d	C0151	hex	C0116/7	2	1000	
FDO-7	d	C0151	hex	C0116/8	2	1000	
FDO-8	d	C0151	hex	C0116/9	2	1000	
FDO-9	d	C0151	hex	C0116/10	2	1000	
FDO-10	d	C0151	hex	C0116/11	2	1000	
FDO-11	d	C0151	hex	C0116/12	2	1000	
FDO-12	d	C0151	hex	C0116/13	2	1000	
FDO-13	d	C0151	hex	C0116/14	2	1000	
FDO-14	d	C0151	hex	C0116/15	2	1000	
FDO-15	d	C0151	hex	C0116/16	2	1000	
FDO-16	d	C0151	hex	C0116/17	2	1000	
FDO-17	d	C0151	hex	C0116/18	2	1000	
FDO-18	d	C0151	hex	C0116/19	2	1000	
FDO-19	d	C0151	hex	C0116/20	2	1000	
FDO-20	d	C0151	hex	C0116/21	2	1000	
FDO-21	d	C0151	hex	C0116/22	2	1000	
FDO-22	d	C0151	hex	C0116/23	2	1000	
FDO-23	d	C0151	hex	C0116/24	2	1000	
FDO-24	d	C0151	hex	C0116/25	2	1000	
FDO-25	d	C0151	hex	C0116/26	2	1000	
FDO-26	d	C0151	hex	C0116/27	2	1000	
FDO-27	d	C0151	hex	C0116/28	2	1000	
FDO-28	d	C0151	hex	C0116/29	2	1000	
FDO-29	d	C0151	hex	C0116/30	2	1000	
FDO-30	d	C0151	hex	C0116/31	2	1000	
FDO-31	d	C0151	hex	C0116/32	2	1000	

Function

You can freely select a digital signal source for every signal input.

- The corresponding bit in the data word (DWORD) is marked with FDO-x (e.g. FDO-0 for the LSB and FDO-31 for the MSB).
- The DWORD is transferred to code C0151 and to the function blocks AIF-OUT, CAN-OUT1, CAN-OUT2, and CAN-OUT3.



Function library

Function blocks

Freely assignable input variables (FEVAN)

3.2.34 Freely assignable input variables (FEVAN)

Purpose

Transfer of analog signals to any code. At the same time, the FB converts the signal into the data format of the target code.

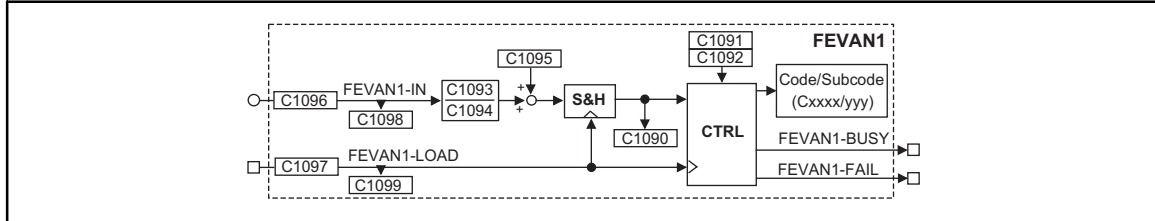

Fig. 3-84 Freely assignable input variables (FEVAN1)

Name	Signal			Source		Note
	Type	DIS	DIS format	CFG	List	
FEVAN1-IN	a	C1098	dec	C1096	1	Input value
FEVAN1-LOAD	d	C1099/1	bin	C1097/1	2	A LOW-HIGH edge transmits the converted signal to the target code.
FEVAN1-BUSY	d	-	-	-	-	HIGH = transmitting
FEVAN1-FAIL	d	-	-	-	-	HIGH = transmission failed A LOW-HIGH edge at FEVAN1-LOAD sets FEVAN1-FAIL = LOW.
-	-	C1090	-	-	-	Display of the converted signal

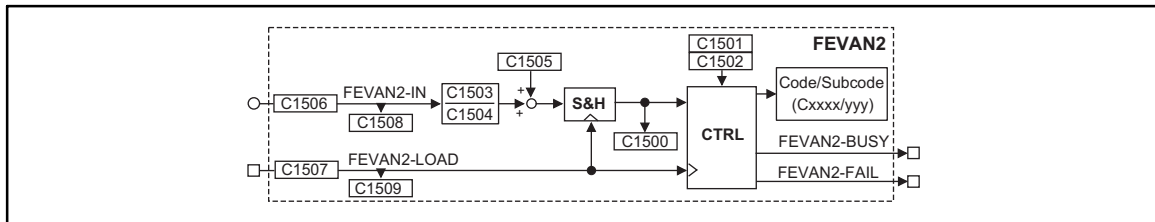
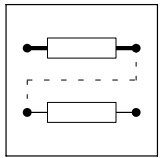

Fig. 3-85 Freely assignable input variables (FEVAN2)

Name	Signal			Source		Note
	Type	DIS	DIS format	CFG	List	
FEVAN2-IN	a	C1508	dec	C1506	1	Input value
FEVAN2-LOAD	d	C1509/1	bin	C1507/1	2	A LOW-HIGH edge transmits the converted signal to the target code.
FEVAN2-BUSY	d	-	-	-	-	HIGH = transmitting
FEVAN2-FAIL	d	-	-	-	-	HIGH = transmission failed A LOW-HIGH edge at FEVAN2-LOAD sets FEVAN2-FAIL = LOW.
-	-	C1500	-	-	-	Display of the converted signal



Function

- Conversion of the read data via:
 - Numerator, denominator.
 - Offset.
- Selection of a target code for the read data.

Codes for the conversion of the read data and for the selection of the target code

Function block	Numerator	Denominator	Offset	Selection of the target code		
				Code	Subcode	Examples
FEVAN1	C1093	C1094	C1095	C1091	C1092	
FEVAN2	C1503	C1504	C1505	C1501	C1502	

Data transmission

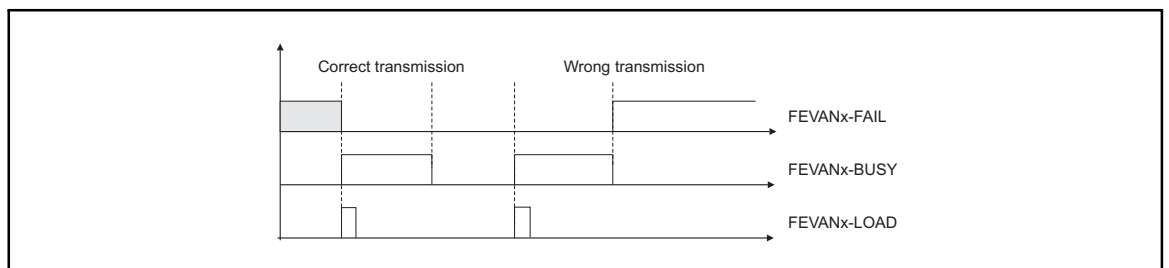

Fig. 3-86

Signal flow

Transmission errors may occur if

- no target code is available,
- no target subcode is available,
- the data transmitted are out of the target code limits,
- the target code is inhibited since it may only be written if the controller is inhibited. Inhibit the controller (see code table).

Cyclic data transmission

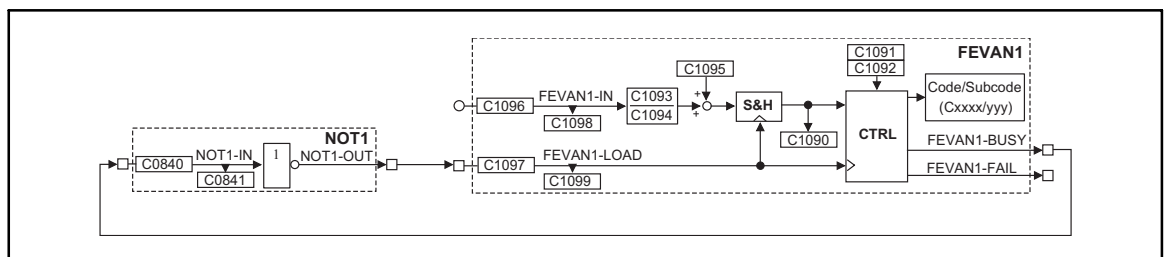

Fig. 3-87

Example for a cyclic data transmission to a target code



Function library

Function blocks

Freely assignable input variables (FEVAN)

Conversion

In the example, the conversion is made at FB FEVAN1.

- The data format of the target code is important for the conversion (see attribute table).
- Adapt the input signal to the data format of the target code:
 - C1093 (numerator).
 - C1094 (denominator).
- C1094 also fixes the decimal positions of the target code:
 - Set C1094 according to the existing decimal positions of the target code. The number of decimal positions can be obtained from the code table.
 - 0.0001 $\underline{\triangle}$ no decimal positions.
 - 0.001 $\underline{\triangle}$ one decimal position.
 - 0.01 $\underline{\triangle}$ two decimal positions.
 - 0.1 $\underline{\triangle}$ three decimal positions.
 - 1 $\underline{\triangle}$ four decimal positions.
- For target codes with % scaling the formula for conversion must include a scaling factor (see example 1).

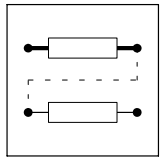

Example 1 (only for FIX32 format with % scaling):

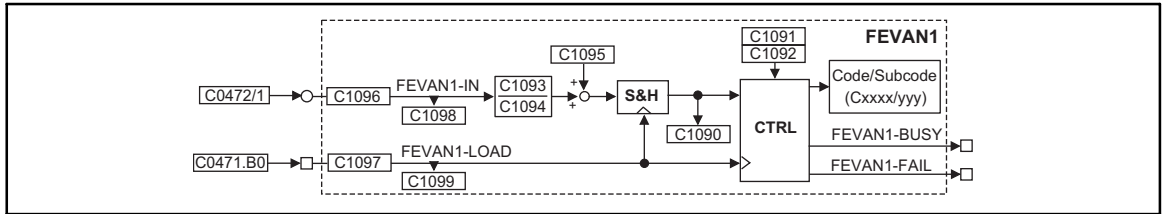

Fig. 3-88

Example of a circuit for FIX32 format with % scaling

Task:

- C0472/1 = 1.05 %. Write this value to C0141.

Configuration:

- Connect FEVAN1-IN (C1096) with FCODE-472/1 (19521).
- Connect FEVAN1-LOAD (C1097/1) with FCODE-471.B0 (19521).

Parameter setting:

- Set C1091 = 141 ($\underline{\Delta}$ C0141)
- Set C1092 = 0 (no subcode available)
- C1093 = calculate numerator
- Set C1094 = 0.01 (two decimal positions)
- Set C1095 = 0 (no offset).

Calculation:

$$\text{FEVAN1-IN [\%]} \cdot \underbrace{\frac{1}{10000}}_{\text{Scaling factor}} \cdot \underbrace{\frac{16384}{100}}_{\text{Scaling factor}} \cdot \frac{\text{C1093}}{\text{C1094}} + \text{C1095} = \text{C0141 [\%]}$$

Control:

- Set C0471.B0 = 1 ($\underline{\Delta}$ 00000001h) so that the data are transmitted to the target code.

Example for converting to C1093:

$$1.05 \% \cdot 10000 \cdot \frac{100}{16384} \cdot \text{C1094} \cdot \frac{1}{1.05 \%} = \text{C1093} = 0.6103$$

Setpoint in C0141
FEVAN1-IN

Display:

- C0141 = 1.00 %



Function library

Function blocks

Freely assignable input variables (FEVAN)

Example 2 (only for FIX32 format without % scaling):

Task:

- C0473/1 = 1000. Write this value to C0011.

Configuration:

- Connect FEVAN1-IN (C1096) with FCODE-473/1 (19551).
- Connect FEVAN1-LOAD (C1097/1) with FCODE-471.B0 (19521).

Parameter setting:

- Set C1091 = 11 ($\underline{\Delta}$ C0011)
- Set C1092 = 0 (no subcode available)
- Set C1093 = 1.0
- Set C1094 = 0.0001 (no decimal position)
- Set C1095 = 0 (no offset).

The source code has no unit. The scaling factor is dropped.

Calculation:

$$\text{FEVAN1-IN} \cdot \frac{1}{10000} \cdot \frac{\text{C1093}}{\text{C1094}} + \text{C1095} = \text{C0011 [rpm]}$$

Scaling factor

$$1000 \cdot \frac{1}{10000} \cdot \frac{1,0}{0.0001} + 0 = 1000 \text{ rpm}$$

Control:

- Set C0471.B0 = 1 ($\underline{\Delta}$ 00000001h) so that the data are transmitted to the target code.

Display:

- C0011 displays the value 1000 rpm.

The other formats are calculated with the following formula:

$$\text{FEVAN1-IN} \cdot \frac{\text{C1093}}{\text{C1094}} + \text{C1095} = x$$



3.2.35 Fixed setpoints (FIXSET)

Purpose

This FB serves to program up to 15 fixed setpoints which can be retrieved via digital terminals or control codes.

The fixed setpoints can e.g. be used for:

- different setpoint dancer positions for one dancer position control or
- different stretching ratios (gearbox factor) for a speed ratio control with digital frequency coupling

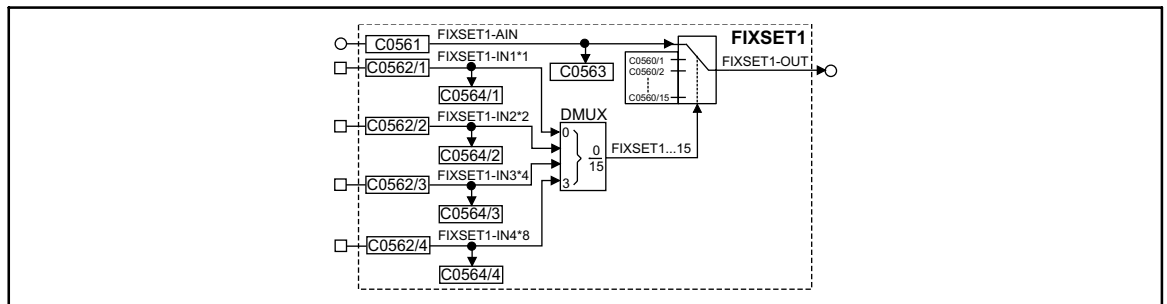

Fig. 3-89

Fixed setpoint (FIXSET1)

Name	Signal			Source			Note
	Type	DIS	DIS format	CFG	List	Lenze	
FIXSET1-AIN	a	C0563	dec [%]	C0561	1	1000	The input is switched to the output if a LOW level is applied to all selection inputs FIXSET-INx.
FIXSET1-IN1*1	d	C0564/1	bin	C0562/1	2	1000	The number of the inputs to be assigned depends on the number of the FIXSET setpoints required.
FIXSET1-IN2*2	d	C0564/2	bin	C0562/2	2	1000	
FIXSET1-IN3*4	d	C0564/3	bin	C0562/3	2	1000	
FIXSET1-IN4*8	d	C0564/4	bin	C0562/4	2	1000	
FIXSET1-OUT	a	-	-	-	-	-	

Function

The FB output can be used as a setpoint source (signal source) for another FB (e.g. process controller, arithmetic block etc.). Parameter setting and handling are similar to JOG but independent of JOG (cp. FB NSET).

- Parameter setting of the fixed setpoints:
 - The single fixed setpoints are parameterised via the subcodes of C0560.
- Output of the fixed setpoint selected:
 - If the binary inputs are triggered with HIGH signal, a fixed setpoint from the table is switched to the output.
- Value range:
 - The values for the fixed setpoint can be set between -200% and +200%.

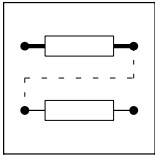

Function library

Function blocks

Fixed setpoints (FIXSET)

3.2.35.1 Release of the FIXSET1 setpoints

Number of the fixed setpoints required	Number of inputs to be assigned
1	at least 1
1 ... 3	at least 2
4 ... 7	at least 3
8 ... 15	4

System for decoding the binary input signals:

Output signal FIXSET1-OUT =	1st input FIXSET1-IN1	2nd input FIXSET1-IN2	3rd input FIXSET1-IN3	4th input FIXSET1-IN4
FIXSET1-Ain	0	0	0	0
C0560/1	1	0	0	0
C0560/2	0	1	0	0
C0560/3	1	1	0	0
C0560/4	0	0	1	0
C0560/5	1	0	1	0
C0560/6	0	1	1	0
C0560/7	1	1	1	0
C0560/8	0	0	0	1
C0560/9	1	0	0	1
C0560/10	0	1	0	1
C0560/11	1	1	0	1
C0560/12	0	0	1	1
C0560/13	1	0	1	1
C0560/14	0	1	1	1
C0560/15	1	1	1	1

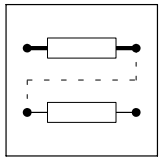

3.2.36 Flipflop element (FLIP)

Purpose

This FB is a D flipflop. This function is used to evaluate and save digital signal edges.

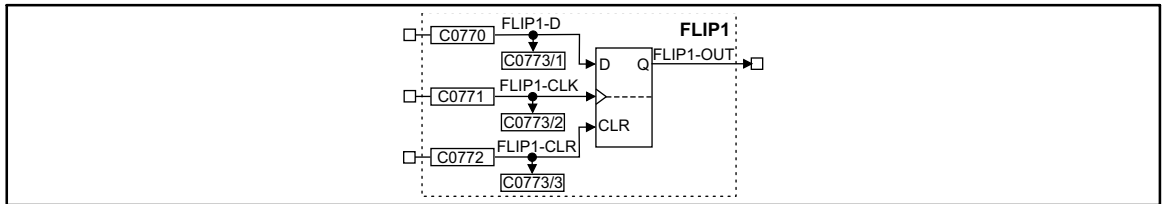

Fig. 3-90 Flipflop element (FLIP1)

Name	Signal			Source			Note
	Type	DIS	DIS format	CFG	List	Lenze	
FLIP1-D	d	C0773/1	bin	C0770	2	1000	-
FLIP1-CLK	d	C0773/2	bin	C0771	2	1000	Evaluates LOW-HIGH edges only
FLIP1-CLR	d	C0773/3	bin	C0772	2	1000	Evaluates the input level only: input has highest priority
FLIP1-OUT	d	-	-	-	-	-	-

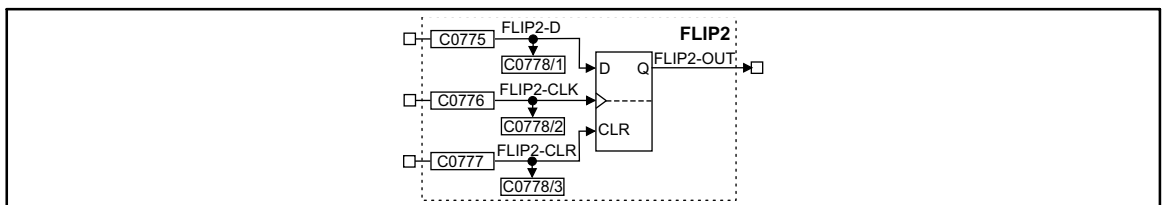

Fig. 3-91 Flipflop element (FLIP2)

Name	Signal			Source			Note
	Type	DIS	DIS format	CFG	List	Lenze	
FLIP2-D	d	C0778/1	bin	C0775	2	1000	-
FLIP2-CLK	d	C0778/2	bin	C0776	2	1000	Evaluates LOW-HIGH edges only
FLIP2-CLR	d	C0778/3	bin	C0777	2	1000	Evaluates the input level only: input has highest priority
FLIP2-OUT	d	-	-	-	-	-	-



Function library

Function blocks

Flipflop element (FLIP)

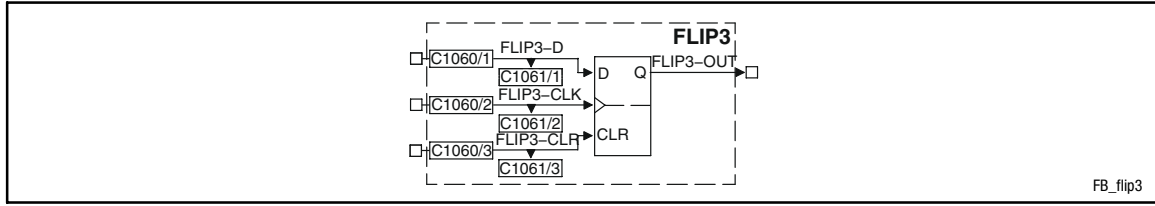

Fig. 3-92

Flipflop element (FLIP3)

Name	Signal			Source			Note
	Type	DIS	DIS format	CFG	List	Lenze	
FLIP3-D	d	C1061/1	bin	C1060/1	2	1000	-
FLIP3-CLK	d	C1061/2	bin	C1060/2	2	1000	Evaluates LOW-HIGH edges only
FLIP3-CLR	d	C1061/3	bin	C1060/3	2	1000	Evaluates the input level only: input has highest priority
FLIP3-OUT	d	-	-	-	-	-	-

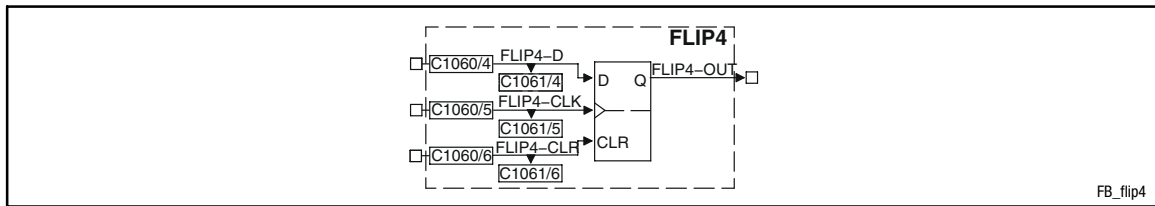

Fig. 3-93

Flipflop element (FLIP4)

Name	Signal			Source			Note
	Type	DIS	DIS format	CFG	List	Lenze	
FLIP4-D	d	C1061/4	bin	C1060/4	2	1000	-
FLIP4-CLK	d	C1061/5	bin	C1060/5	2	1000	Evaluates LOW-HIGH edges only
FLIP4-CLR	d	C1061/6	bin	C1060/6	2	1000	Evaluates the input level only: input has highest priority
FLIP4-OUT	d	-	-	-	-	-	-



Function library

Function blocks

Gearbox compensation (GEARCOMP)

3.2.37 Gearbox compensation (GEARCOMP)

Purpose

Compensates elasticities in the drive train (e.g. gearbox torsion).

Implementation of an adaptive linkage of e.g. the phase setpoint (32 bits) and the torque feedforward control (14 bits).

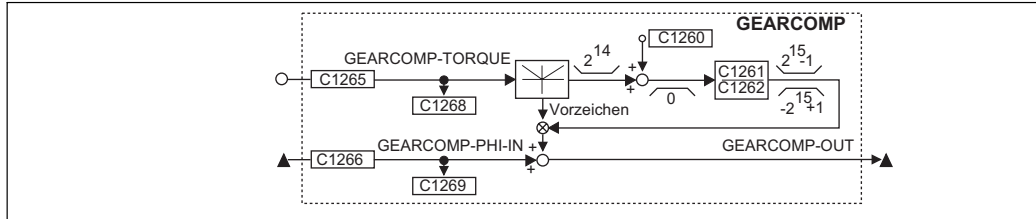

Fig. 3-95

Gearbox compensation (GEARCOMP)

Name	Signal			Source		Comment
	Type	DIS	DIS format	CFG	List	
GEARCOMP-TORQUE	a	C1268	dec [%]	C1265	2	Input value
GEARCOMP-PHI-IN	ph	C1269	dec [inc]	C1266	3	
GEARCOMP-OUT	ph	-	-	-	-	Outputs the compensated phase setpoint.

Function

- The signal at GEARCOMP-TORQUE is broken down into the absolute value and the sign.
 - The absolute value is limited to 2^{14} (+16384) first.
- The absolute value is converted (via C1260, C1261, C1262).
- The result is evaluated with the sign and is added to the signal at GEARCOMP-PHI-IN.

Codes for the conversion of the absolute value:

Code	Function	Selection		Comment
C1260	Offset	-16383	{1}	16383
C1261	Numerator	-32767	{1}	32767
C1262	Denominator	1	{1}	32767

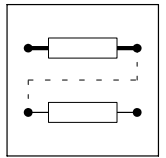

3.2.38 Limiting element (LIM)

Purpose

This FB is used to limit signals to adjustable value ranges.

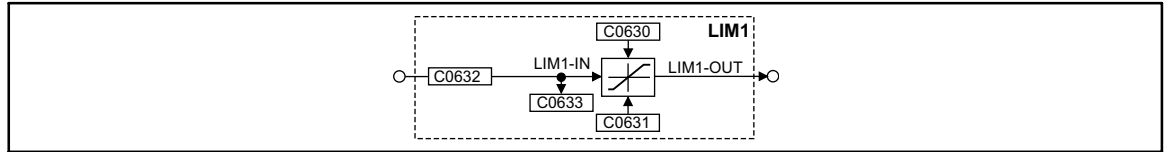

Fig. 3-96

Limiting element (LIM1)

Name	Signal			Source			Note
	Type	DIS	DIS format	CFG	List	Lenze	
LIM1-IN1	a	C0633	dec [%]	C0632	1	1000	-
LIM1-OUT	a	-	-	-	-	-	-

Function

- If the input signal exceeds the upper limit (C0630), the upper limit is effective.
- If the input signal falls below the lower limit (C0631), the lower limit is effective.



Tip!

The lower limit (C0631) must be smaller than the upper limit (C0630).

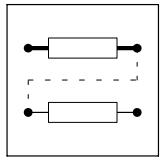

Name	Signal			Source			Note
	Type	DIS	DIS format	CFG	List	Lenze	
MCTRL-PHI-SET	ph	C0908	dec [inc]	C0894	3	1000	Angle controller input for difference of setpoint angle to actual angle
MCTRL-N-SET	a	C0906/1	dec [%]	C0890	1	5050	Speed setpoint input
MCTRL-M-ADD	a	C0906/2	dec [%]	C0891	1	1000	Additional torque setpoint or torque setpoint
MCTRL-LO-MLIM	a	C0906/3	dec [%]	C0892	1	5700	Lower torque limitation in % of C0057
MCTRL-HI-MLIM	a	C0906/4	dec [%]	C0893	1	19523	Upper torque limitation in % of C0057
MCTRL-PHI-LIM	a	C0906/5	dec [%]	C0895	1	1006	Influence of angle controller in % of nmax C0011
MCTRL-N2-LIM	a	C0906/6	dec [%]	C0896	1	1000	Lower speed limit at speed limitation
MCTRL-FLDWEAK	a	C0906/7	dec [%]	C0898	1	1006	Motor excitation
MCTRL-I-SET	a	C0906/8	dec [%]	C0901	1	1006	Input for setting the I component of the speed controller
MCTRL-P-ADAPT	a	C0906/9	dec [%]	C0903	1	1006	Influence in % on V_p of C0254, the absolute value is processed (without sign)
MCTRL-PHI-ON	d	C0907/1	bin	C0897	2	1000	HIGH = Activation of angle controller
MCTRL-N/M-SWT	d	C0907/2	bin	C0899	2	1000	LOW = active speed control HIGH = active torque control
MCTRL-QSP	d	C0907/3	bin	C0900	2	10250	HIGH = drive performs QSP
MCTRL-I-LOAD	d	C0907/4	bin	C0902	2	1000	HIGH = I component of the n-controller is accepted by MCTRL-I-SET
MCTRL-QSP-OUT	d	-	-	-	-	-	HIGH = drive performs QSP
MCTRL-NSET2	a	-	-	-	-	-	In % of n_{max} (C0011)
MCTRL-MMAX	d	-	-	-	-	-	HIGH = speed controller operates within the limits
MCTRL-MSET2	a	-	-	-	-	-	In % of M_{max} (C0057)
MCTRL-MACT	a	-	-	-	-	-	In % of M_{max} (C0057)
MCTRL-IACT	a	-	-	-	-	-	MCTRL-IACT = 100 % = C0022
MCTRL-IMAX	d	-	-	-	-	-	HIGH = drive operates at the current limit C0022
MCTRL-DCVOLT	a	-	-	-	-	-	100 % = 1000 V
MCTRL-LOAD-I2xt	a	-	-	-	-	-	$I^2 \times t$ utilisation of the motor in %
MCTRL-UTILIZATION	a	-	-	-	-	-	Device utilisation $I \times t$ in %
MCTRL-PHI-ANA	a	-	-	-	-	-	Actual angle value as analog signal 90° = 100 %
MCTRL-PHI-ACT	phd	-	-	-	-	-	
MCTRL-NACT	a	-	-	-	-	-	In % of n_{max} (C0011)
MCTRL-PHI-ANG	ph	-	-	-	-	-	65536 inc = one revolution



Function library

Function blocks

Internal motor control (MCTRL)

Function

- Current controller
- Torque limitation
- Additional torque setpoint
- Speed controller
- Torque control with speed limitation
- Speed setpoint limitation
- Angle controller
- Quick stop QSP
- Field weakening
- Switching frequency changeover

3.2.39.1 Current controller

Adapt current controller via C0075 (proportional gain) and C0076 (reset time) to the machine connected.



Note!

Use C0086 to select a suitable motor from the motor selection list. In this way, the parameters of the current controller are automatically set to the correct values.

3.2.39.2 Additional torque setpoint

The input MCTRL-M-ADD serves as torque setpoint or additional torque setpoint, depending on the control of the input MCTRL-N/M-SWT. The additional torque setpoint can be used e.g. for friction compensation or speed injection (dv/dt).

- When MCTRL-N/M-SWT = LOW the speed control is active.
 - MCTRL-M-ADD is added to the output of the n-controller.
 - The limits defined by the torque limitations MCTRL-LO-M-LIM and MCTRL-HI-M-LIM cannot be exceeded.
- When MCTRL-N/M-SWT = HIGH, the torque control is active.
 - MCTRL-M-ADD acts as torque setpoint
 - The n-controllers have a monitoring function.
- The torque setpoint is specified in [%] of the max. possible torque (see C0057).
 - Negative values mean a torque with CCW rotation of the motor.
 - Positive values mean a torque with CW rotation of the motor.

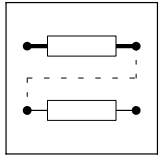

3.2.39.3 Torque limitation

Via the inputs MCTRL-LO-M-LIM and MCTRL-HI-M-LIM an external torque limitation can be set. This serves to set different torques for the quadrants "driving" and "braking".

- MCTRL-HI-M-LIM is the upper torque limit in [%] of the max. possible torque (C0057).
- MCTRL-LO-M-LIM is the lower torque limit in [%] of the max. possible torque (C0057).
- In case of quick stop (QSP) the torque limitation is deactivated.



Stop!

Only apply positive values to MCTRL-HI-M-LIM and negative values to MCTRL-LO-M-LIM. Otherwise the speed controller may lose control and the drive may rev up in an uncontrolled manner.



Function library

Function blocks

Internal motor control (MCTRL)

3.2.39.4 Speed controller

The speed controller is designed as an ideal PID controller.

Parameter setting

If you select a motor via C0086, the parameters are preset so that only a few (if any) adaptations to the application are necessary.

- Parameterisation of the proportional gain V_p in C0070:
 - Enter approx. 50 % of the speed setpoint
 - Increase C0070 until the drive becomes unstable (observe motor noises)
 - Reduce C0070 until the drive runs stable again
 - Reduce C0070 to approx. 50 %
- Parameterisation of the reset time T_n in C0071:
 - Reduce C0071 until the drive becomes unstable (observe motor noises)
 - Increase C0071 until the drive runs stable again
 - Set C0071 to the double value
- Parameterisation of the derivative gain T_d in C0072:
 - Increase C0072 during operation until an optimum behaviour is achieved.

Signal limitation

When the drive outputs the max. torque, the speed controller operates within the limits.

- The drive cannot follow the speed setpoint.
- This state is indicated with MCTRL-MMAX = HIGH.

Setting the integral component

To enter defined starting values for the torque the integral component of the n-controller can be set externally (e.g. when using the brake control).

- MCTRL-I-LOAD = HIGH
 - The n-controller accepts the value at input MCTRL-I-SET as its integral component.
 - The value at input MCTRL-I-SET acts as a torque setpoint for the motor control.
- MCTRL-I-LOAD = LOW
 - Function is switched off.



3.2.39.5 Torque control with speed limitation

This function is activated with MCTRL-N/M-SWT = HIGH. A second speed controller (auxiliary speed controller) is connected for the speed limitation.

- MCTRL-M-ADD acts as bipolar torque setpoint.
- The n-controller 1 is used to create the upper speed limit.
 - The upper speed limit is selected at the input MCTRL-N-SET in [%] of n_{max} (C0011) (pos. sign for CW rotation).
 - The upper speed limit is only to be used for CW rotation.
- The n-controller (auxiliary speed controller) is used to form the lower speed limit
 - The lower speed limit is selected at the input MCTRL-N2-LIM in [%] of n_{max} (C0011) (neg. sign for CCW rotation).
 - The lower speed limit is only to be used for CCW rotation.

3.2.39.6 Speed setpoint limitation

The speed setpoint is limited to $\pm 100\%$ of n_{max} (C0011) at the MCTRL-N-SET input.

C0909 is used to set a limitation of the direction of rotation for the speed setpoint.



Function library

Function blocks

Internal motor control (MCTRL)

3.2.39.7 Angle controller

The angle controller is required to achieve angular synchronism and drift-free standstill.



Note!

Select a configuration with digital frequency coupling in C0005 since this serves to link all important signals automatically. On this basis the system can be optimised.

Activating the angle controller

1. Configure a signal source with C0894, which provides the angular difference between setpoint and actual angle (see "Digital frequency configuration under C0005).
2. Select a value > 0 at the MCTRL-PHI-LIM input.
3. Trigger the input MCTRL-PHI-ON with HIGH (e.g. with FIXED1).
4. Set the gain of the angle controller > 0 in C0254 (see chapter 3.2.39.4)
 - Before setting C0254, select an as high as possible P-gain for the n-controller in C0070.
 - Increase C0254 during operation until the drive shows the required control response.

Influence of angle controller

The output of the angle controller is added to the speed setpoint.

- If the actual angle is lagging, the drive is accelerated
- If the actual angle is leading the drive is decelerated until the required angular synchronism is achieved.

The influence of the angle controller consists of:

- Angular difference multiplied by the P-gain C0254
- Additional influence via analog signal at MCTRL-P-ADAPT
- Limitation of the angle controller output to \pm MCTRL-PHI-LIM

Limitation of the angle controller output

This limits the max. speed-up of the drive at high angular differences.

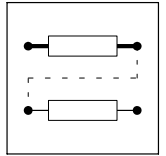

3.2.39.8 Quick stop QSP

The QSP function is used to stop the drive within an adjustable time independently of the setpoint selection.

The QSP function is active

- if the input MCTRL-QSP is triggered with HIGH.
- if the controller is triggered via the control words (DCTRL).

Function:

- If torque control has been selected, it will be deactivated. The drive is controlled by the speed controller.
- The speed runs with the deceleration time set under C0105 to zero speed.
- The torque limitations MCTRL-LO-M-LIM and MCTRL-HI-M-LIM are deactivated.
- The angle controller is activated. If the rotor position is shifted actively, the drive generates a torque against this displacement if:
 - C0254 is not zero
 - The input MCTRL-PHI-LIM is triggered with a value $> 0\%$.



Stop!

If the field is weakened manually (MCTRL-FLD-WEAK $< 100\%$), the drive is unable to generate the max. torque.



Function library

Function blocks

Internal motor control (MCTRL)

3.2.39.9 Field weakening

The field weakening range does not need to be set if the motor type has been set in C0086. In this case all settings required are made automatically. The motor is operated in the field weakening mode if

- the output voltage of the controller exceeds the rated motor voltage set in C0090,
- the controller cannot increase the output voltage with rising speed any more because of the mains voltage / DC-bus voltage.

Manual field weakening

A manual field weakening is possible via the input MCTRL-FLD-WEAK. For reaching the maximum excitation this input must be triggered with +100 % (e.g. FIXED100%).



Stop!

The available torque is reduced by the field weakening.

3.2.39.10 Switching frequency changeover

The switching frequency of the inverter can be selected:

- 8 kHz fixed, for power-optimised operation (C0018 = 1)
 - maximum power output of the controller, but with audible pulse operation
- 16 kHz fixed, for noise-optimised operation (C0018 = 2)
 - inaudible pulse operation of the controller, but with reduced power output (torque)
- Automatic changeover between power-optimised and noise-optimised operation (C0018 = 0)

Automatic switching frequency changeover

The automatic switching frequency changeover can be used if the drive is to be operated in the noise-optimised range, but the available torque is not sufficient for acceleration processes.

Condition $M = f(I)$	Function
$M < M_{N16} (I_{N16})$	Controller is operated with 16 kHz (noise-optimised)
$M_{N16} (I_{N16}) < M < M_{N8} (I_{N8})$	Controller switches over to 8 kHz (power-optimised)
$M > M_{max8} (I_{max8})$	Controller operates with 8 kHz in the current limitation



3.2.40 Mains failure control (MFAIL)

Purpose

If the supply voltage via L1, L2, L3 or +UG, -UG fails, the drive (drive network) can be decelerated (braked) in a controlled way. Without this function, the drive (drive network) would coast.

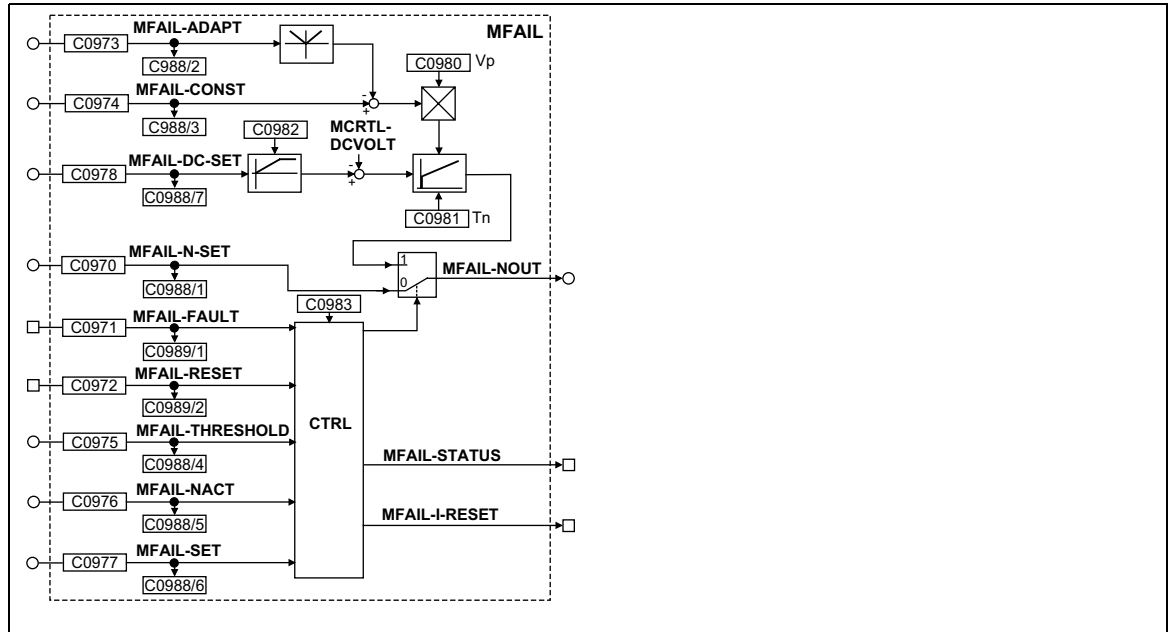

Fig. 3-98 Mains failure control (MFAIL)

Name	Signal			Source			Note
	Type	DIS	DIS format	CFG	List	Lenze	
MFAIL-N-SET	a	C0988/1	dec [%]	C0970	1	1000	Speed setpoint in [%] of C0011
MFAIL-ADAPT	a	C0988/2	dec [%]	C0973	1	1000	Dynamic adaptation of the proportional gain of the U_{Gset} controller in [%] of C0980
MFAIL-KONST	a	C0988/3	dec [%]	C0974	1	1000	Proportional gain of the U_{Gset} controller in [%] of C0980
MFAIL-THRESHOLD	a	C0988/4	dec [%]	C0975	1	1000	Restart threshold in [%] of C0011
MFAIL-NACT	a	C0988/5	dec [%]	C0976	1	1000	Comparison value for the restart threshold in [%] of C0011
MFAIL-SET	a	C0988/6	dec [%]	C0977	1	1000	Speed start point for the deceleration in [%] of C0011
MFAIL-DC-SET	a	C0988/7	dec [%]	C0978	1	1000	Voltage setpoint on which the DC bus voltage is to be maintained, 100% = 1000V
MFAIL-FAULT	d	C0989/1	bin	C0971	2	1000	HIGH = activates the mains failure control
MFAIL-RESET	d	C0989/2	bin	C0972	2	1000	HIGH = reset
MFAIL-N-OUT	a	-	-	-	-	-	Speed setpoint in [%] of C0011
MFAIL-STATUS	d	-	-	-	-	-	HIGH = mains failure control active
MFAIL-I-RESET	d	-	-	-	-	-	HIGH = mains failure control active, the drive is braking



Function library

Function blocks Mains failure control (MFAIL)

Range of functions

- Mains failure detection
- Mains failure control
- Restart protection
- Reset of the mains failure control
- Dynamic adaptation of the control parameters
- Fast mains recovery (KU)
- Application examples

3.2.40.1 Mains failure control

A failure of the controller's power section supply can be detected by

- evaluating the DC-bus voltage or
- an external system for mains failure detection (e.g. 934X module or voltage measuring relay).

It is possible to combine the two methods.

The type of the mains failure detection to be used depends on the drive system used.

DC-bus voltage evaluation

Use with single drives or multi-axis drives, which do not use external monitoring systems.

- For this you can use a comparator (e.g. CMP2). Set the following signal combinations:
 - C0688/1 = 5005 (MCTRL-DCVOLT to CMP2-IN1)
 - C0688/2 = 19540 (free code C0472/20 to CMP2-IN2)
 - C0971 = 10655 (CMP2-OUT to MFAIL-FAULT)
 - Set function of the comparator CMP2 with C0685 = 3

Enter the function blocks CMP2 and MFAIL into free positions of the processing table in C0465.

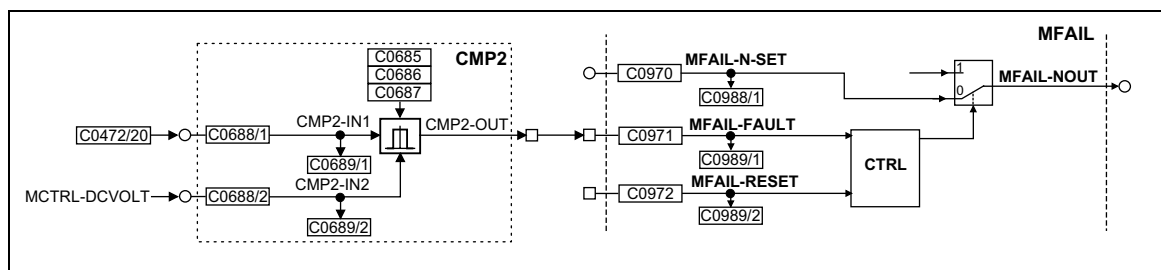
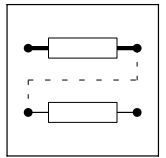

Fig. 3-99 Example of a mains failure detection with internal function blocks (section)



External system for mains failure detection (934x supply module)

- A digital output of the supply module 934x is applied to the function block MFAIL via the digital inputs DIGIN of the controller 93XX. In the example the input X5/E4 is used. For this purpose the signal combination must be set as follows:
 - C0971 = 54 (DIGIN4 to MFAIL-FAULT)
 - C0871 = 1000 (remove DCTRL-TRIP-SET from terminal X5/E4)
 - Select level (HIGH or LOW active) with C0114/4

Enter the function block MFAIL into a free position of the processing table in C0465.

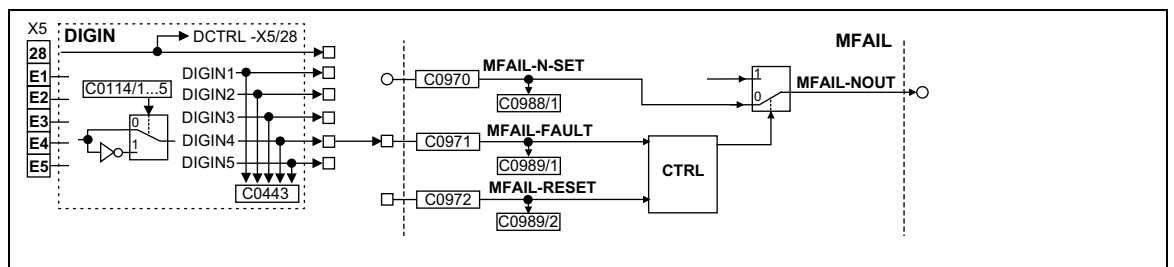

Fig. 3-100 Example of a mains failure detection by an external monitoring system

Combination of the two methods

- The combination of both processes is done via an OR operation with an internal function block. In the example, OR5 is used. For this, set the following signal combinations:
 - C0688/1 = 5005 (MCTRL-DCVOLT to CMP2-IN1)
 - C0688/2 = 19540 (free code C0472/20 to CMP2-IN2)
 - Set function of the comparator CMP2 with C0685 = 3
 - C0838/1 = 10655 (CMP2-OUT to OR5-IN1)
 - C0838/2 = 54 (DIGIN5 to OR5-IN2)
 - C0971 = 10570 (OR5-OUT to MFAIL-FAULT)

Enter the function blocks CMP2, OR5 and MFAIL into free positions of the processing table in C0465.

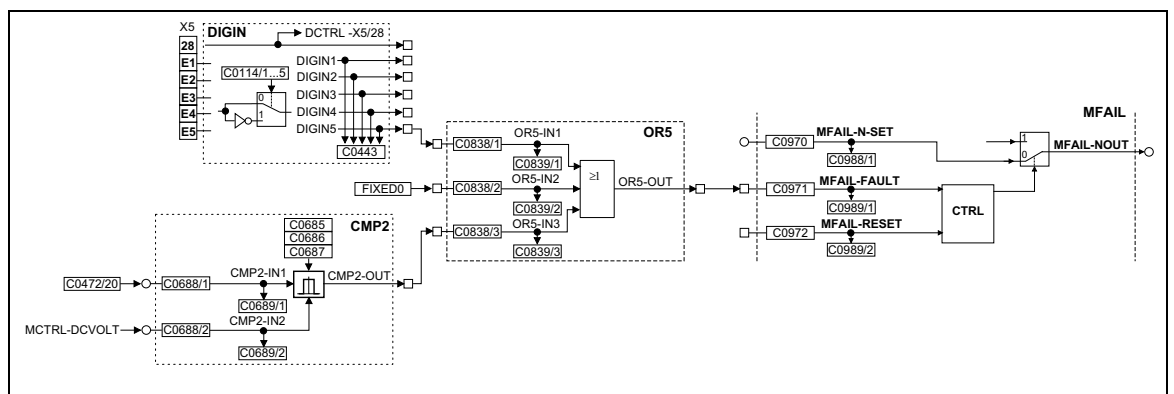

Fig. 3-101 Example of a mains failure detected by different sources



Function library

Function blocks Mains failure control (MFAIL)

3.2.40.2 Mains failure control

Integration of the function block into the signal flow of the controller

As an example, the function block is integrated into the basic configuration C0005 = 1000 (speed control).

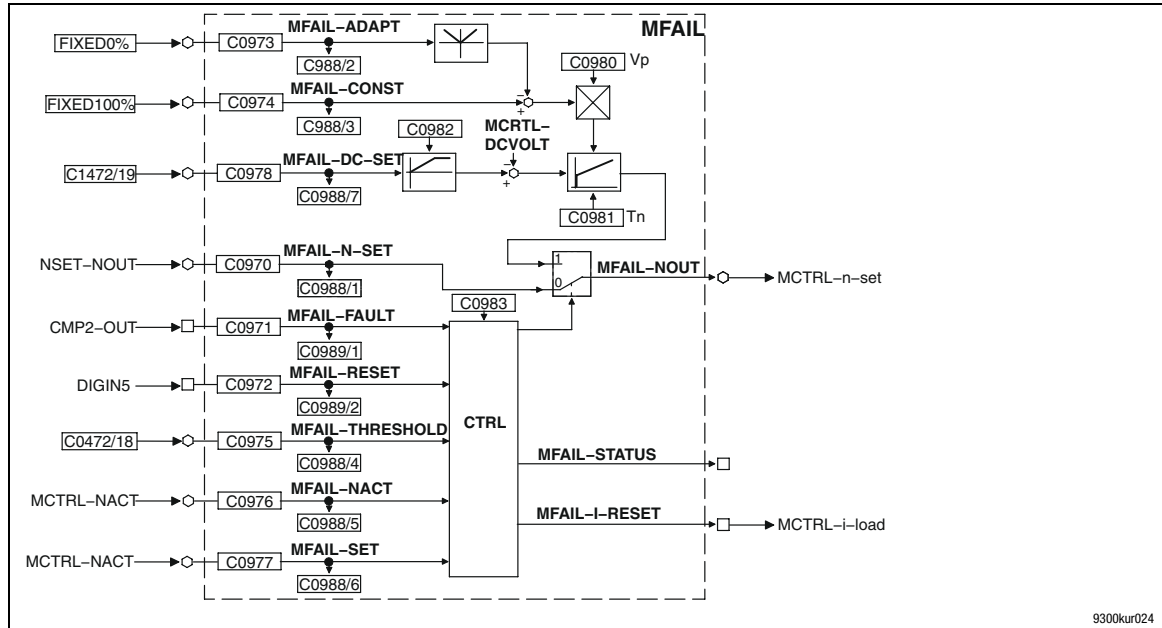

Fig. 3-102 Linkage for the base configuration C0005 = 1000

1. Create speed setpoint path	<ul style="list-style-type: none"> • C0970 = 5050 (NSET-NOUT to MFAIL-N-SET) • C0890 = 6100 (MFAIL-NOUT to MCTRL-N-SET)
2. Start value selection (here: act. speed value)	<ul style="list-style-type: none"> • C0977 = 6100 (MFAIL-NOUT to MFAIL-SET)
3. Selection of setpoint source for DC-bus voltage (here: by the freely connectable code FCODE C0472/19)	<ul style="list-style-type: none"> • C0978 = 19539 (C0472/19 to MFAIL-DC-SET)
4. Selection of source which activates the mains failure control	<ul style="list-style-type: none"> • see chapter 3.2.40.1
5. Adaptation of proportional gain and DC-bus voltage controller	<ul style="list-style-type: none"> • C0974 = 1006 (FIXED100% to MFAIL-CONST) • C0973 = 1000 (FIXED0% to MFAIL-ADAPT)
6. Achieve restart protection	<ul style="list-style-type: none"> • C0976 = 6100 (MFAIL-NACT to MCTRL-NACT) • C0975 = 19538 (C0472/18 to MFAIL-THRESHLD) • First enter approx. 2 % under C0472/18 (reference: nmax C0011)
7. Connect reset input (here with terminal X5/E5 TRIP-RESET)	<ul style="list-style-type: none"> • C0972 = 55 (DIGIN5 to MFAIL-RESET)
8. Enter all function blocks used (except for codes and digital inputs DIGIN) into free positions of the processing table in C0465.	



Note!

All settings must be saved non-volatile in a parameter set under C0003.



Activation

- MFAIL-FAULT = HIGH activates the mains failure control.
- MFAIL-FAULT = LOW triggers a timing element. After the time set under C0983 has elapsed, the mains failure control is completed/cancelled (see description of mains recovery, chapter 3.2.40.6).
 - The drive is accelerated to the speed setpoint if the restart protection is not active.
 - The drive is continued to be braked to zero speed if the restart protection is active (see description for restart protection, chapter 3.2.40.3).
 - If the restart protection is active, the drive can only be reset by a HIGH level signal at the MFAIL-RESET input.

Function

The controller generates the operational energy required from the rotational energy of the driving machine. The driving machine is braked via the power loss of the controller and the motor. Thus, the speed deceleration ramp is shorter than with a non-controlled system (coasting drive).

With the activation,

- the DC bus voltage is controlled to the value at the MFAIL-DC-SET input.
- An internally generated speed setpoint is output at output MFAIL-N-OUT. This serves to brake the drive (via the speed setpoint) to a speed of almost zero.
 - Starting value for the controlled deceleration is the value at input MFAIL-SET. This input is generally connected to the output MCTRL-NACT (actual speed value) or MCTRL-NSET2, MFAIL-NOUT (speed setpoint).
 - The speed deceleration ramp (and thus the brake torque) results from the moment of inertia of the driven machine(s), the power loss, and the parameterisation.



Stop!

- If a connected braking unit is activated, the drive is braked with the max. possible torque (I_{max}). In this case, the parameter setting can be adapted, if required (see description for parameter setting).
- If the power stage is not supplied, the drive cannot generate a standstill torque (important for active loads such as hoists).



Function library

Function blocks

Mains failure control (MFAIL)

Parameter setting

The parameters to be set depend strongly on the motor used, the inertia of the driven machine and the drive configuration (single drive, drive network, master/slave operation etc.). For this reason, this function must be adjusted to the prevailing application case.

The following specifications refer to chapter 3.2.40.1.

Important settings prior to the initial set-up:

1. Save the previous setting in a parameter set (e.g. parameter set 4)



Stop!

For the internal voltage supply of the terminals (C0005 = xx1x) the terminal X6/63 is used as a voltage source for external potentiometers. In this case, measure at the terminals +UG, -UG.

2. Measure the DC bus voltage with an oscilloscope (channel 1)
 - with a suitable voltage divider across terminals +UG, -UG. or
 - by outputting the DC-bus voltage e.g. to terminal X6/62. For this purpose set C0436 = 5005 (MCTRL-DCVOLT). 1 V at terminal X6/63 = 100 V to +UG, -UG.
3. Measure the speed with an oscilloscope (channel 2)
 - by outputting the speed e.g. to terminal X6/62. (Standard setting). For this purpose set C0431 = 5001 (MCTRL-NACT). 10 V to terminal X6/62 = nmax (C0011).
4. Defining the operating threshold for the mains failure detection in C0472/20. The definition depends on the setting in C0173.
 - Set the operating threshold approx. 50 V above the LU switch-off threshold (e.g. C0173 = 0, 1; C0472/20 = 48 % \triangleq 480 V).

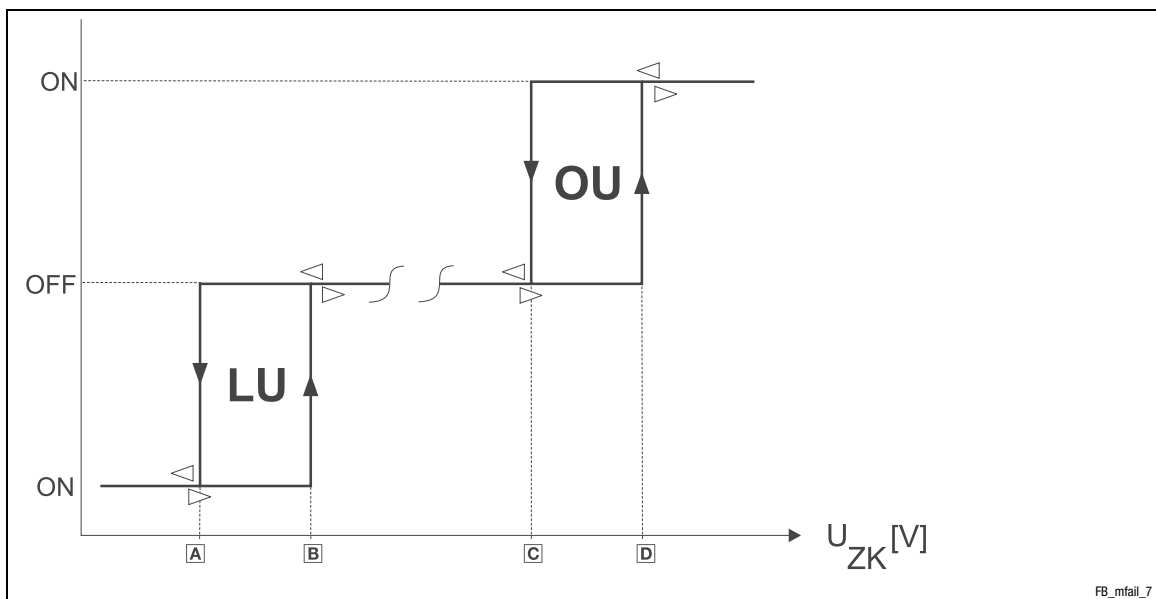
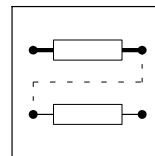

FB_mfail_7

Mains voltage range	C0173	Message LU		Message OU	
		A	B	C	D
< 400 V	0	285 V	430 V	755 V	770 V
400 V	1	285 V	430 V	755 V	770 V
400 V ... 460 V	2	328 V	473 V	755 V	770 V
480 V without brake chopper	3	342 V	487 V	755 V	770 V
Operation with brake chopper (up to 480 V)	4	342 V	487 V	785 V	800 V
DC-bus voltage (U_{ZK})					



Stop!

This setpoint must be below the operating threshold of a possibly connected braking unit. If a connected braking unit is activated, the drive will be braked with the max. possible torque (I_{max}). The desired operational performance gets lost.

- Set the setpoint on which the DC bus voltage is to be controlled:
 - Set the setpoint to approx. 700 V ($C0472/19 = 70\%$).

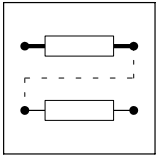

Function library

Function blocks

Mains failure control (MFAIL)

Commissioning

The commissioning should be carried out with motors without load.

1. The drive can be started with a LOW-HIGH edge at X5/E5.
2. Set the acceleration time T_{ir} :
 - Set speed setpoint to 100%, operate controller with maximum speed.
 - Inhibit controller via terminal X5/28 (you can also use any other controller inhibit source, CINH) and measure deceleration time until standstill.
 - Set approx. 1/10 of the deceleration time in C0982.
3. Setting the retrigger time
 - In case of mains failure detection by detecting the DC bus voltage level:
 - Set measured deceleration time from item 2. under C0983.
 - In case of mains failure detection via an external system (e.g. supply module 934X):
 - Under C0983, set the time in which the drive is to be continued to be braked in a controlled way for short-term mains recovery.
4. Switch off supply voltage (mains or DC bus).

The oscilloscope should display the following characteristic:

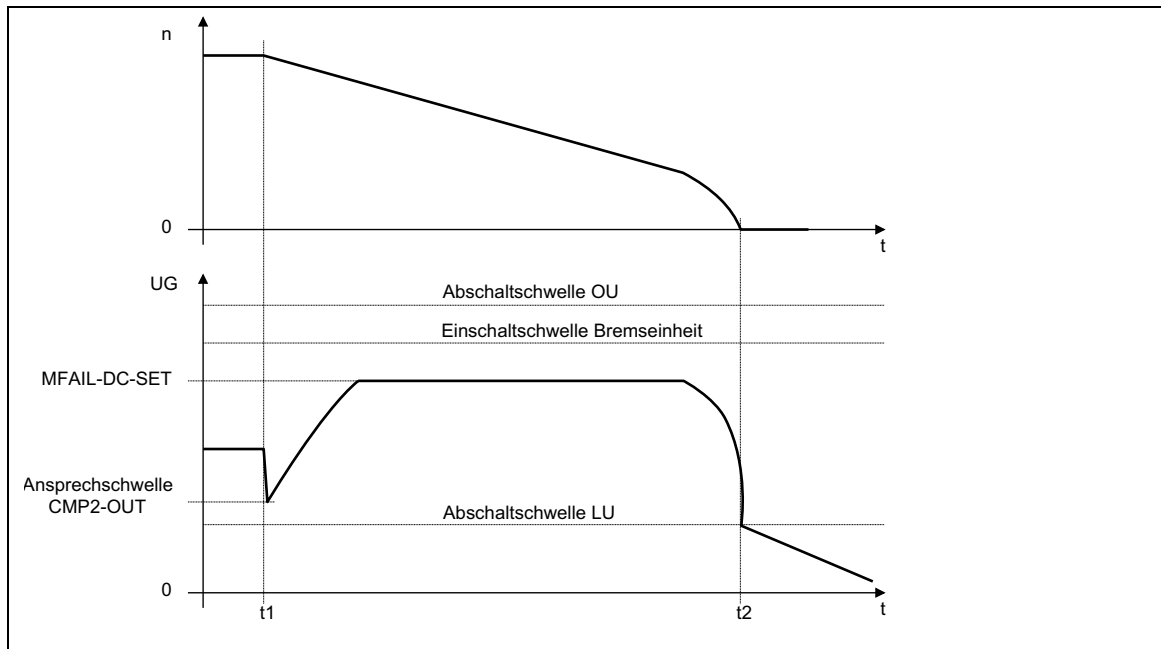

Fig. 3-103

Schematic representation with activated mains failure control (ideal characteristic)

t1 Mains failure

t2 Zero speed reached



Fine setting

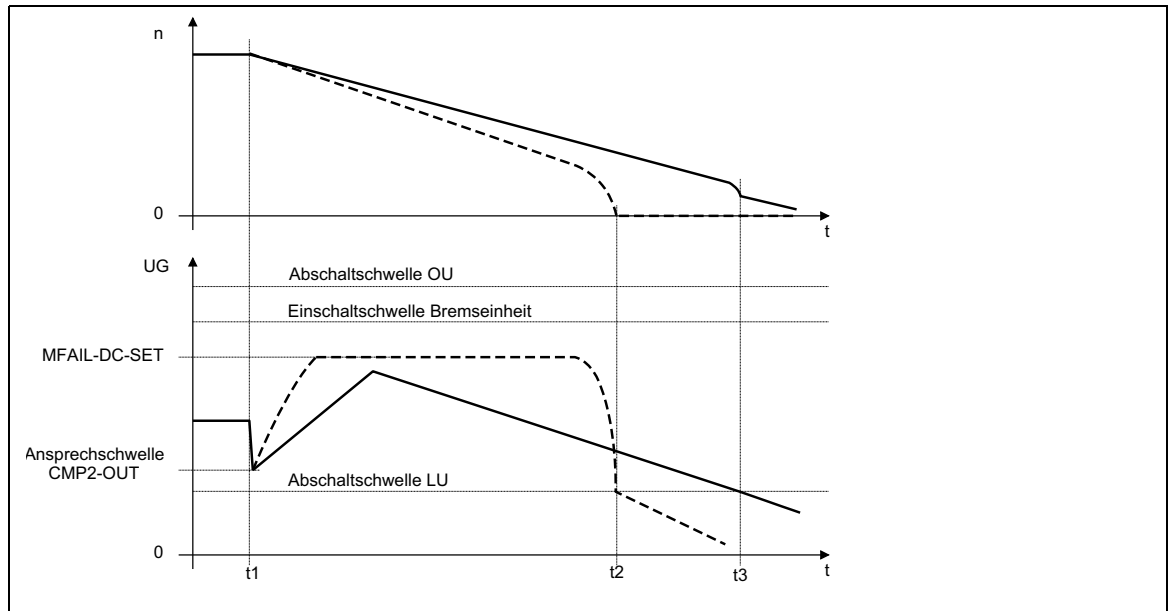

Fig. 3-104

Schematic with different brake torques

- t = t1 Mains failure
- t = t2 Zero speed with higher braking torque (short adjustment time)
- t = t3 Drive reaches the LU switch-off threshold with lower brake torque (higher adjustment time) without reaching speed 0
- t > t3 Drive is no longer controlled (is braked by friction)

Repeat the following steps several times.

1. Obtaining a very low final speed before the controller reaches the undervoltage threshold LU:
 - Increasing the proportional gain MFAIL V_p (C0980).
 - Decreasing the integral-action time MFAIL T_n (C0981).
2. Avoid activation of the brake unit or the overvoltage threshold:
 - Increasing the integral-action time MFAIL T_n (C0981) until the characteristic in Fig. 3-103 is almost reached.
 - Reduce additionally the setpoint of the DC bus voltage at the input MFAIL-DC-SET (in the example C0472/19), if necessary.



Function library

Function blocks

Mains failure control (MFAIL)

- Increase of the deceleration time or reduction of the brake torque (see Fig. 3-104) is only possible with restrictions:
 - An increase of the acceleration time MFAIL T_{ir} (C0982) reduces the initial brake torque and increases the deceleration time.
 - Increasing the integral-action time MFAIL T_n (C0981) decreases the braking torque and simultaneously increases the deceleration time. If C0981 contains too high integral-action times, the controller runs into the LU threshold before speed 0 is reached. Thus, the drive is not controlled anymore.
- Re-establish possibly required signal connections to the outputs of the controller (terminals X6).



Note!

All settings must be saved non-volatile in a parameter set under C0003.

3.2.40.3 Restart protection

The integrated restart protection is to avoid a restart in the lower speed range, after the supply voltage was interrupted for a short time only (mains recovery before the drive has come to standstill).

- How to protect the drive from restart is explained in chapter 3.2.40.2.
- Go to C0472/18 and enter the threshold in [%] of n_{max} (C0011) if you do not want an automatic restart below this threshold after mains recovery.
 - Speed at mains recovery < threshold in C0472/18: Drive is continued to be braked in a controlled way. This function can only be completed by MFAIL-RESET = HIGH.
 - Speed after mains recovery > threshold in C0472/18 Drive accelerates to its setpoint along the set ramps.
- The function is deactivated by:
 - C0472/18 = 0 % or
 - C0975 = 1000 (FIXED0% to MFAIL-THRESHLD)
- Reset with MFAIL-RESET = HIGH
 - is required after every mains connection
 - is displayed by MFAIL-STATUS = HIGH, if MFAIL-FAULT = LOW

3.2.40.4 Reset of the mains failure control

- The mains failure control is reset with MFAIL-RESET = HIGH (in the example with terminal X5/E5).
- The reset pulse is always required if:
 - the restart protection is active.
 - the restart protection is used and the supply (mains or DC supply) was switched on.

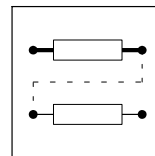

3.2.40.5 Dynamic adaptation of the control parameters

In special cases a dynamic change of the proportional gain may be sensible. For this purpose, the function block MFAIL is provided with two inputs (MFAIL-CONST and MFAIL-ADAPT). The resulting proportional gain arises from:

$$V_p = C0980 \cdot \frac{\text{MFAIL-CONST} - |\text{MFAIL-ADAPT}|}{100 \%}$$

3.2.40.6 Fast mains recovery (KU)

The fast mains recovery leads to the restart of the controller if the restart protection is not activated. Then the drive runs to its setpoint. If this is not required, the restart can be decelerated via the retrigger time C0983 or prevented in connection with the restart protection.

A fast mains recovery occurs:

- Due to the system, the mains recovery is indicated by the mains failure detection via the level of the DC bus voltage (see chapter 3.2.40.1).
- because of a "short interrupt" (KU) of the utility company (e.g. in case of thunderstorms)
- because of faulty components in the supply cables

Set the retrigger time C0983 higher than the measured deceleration time during braking.

3.2.40.7 Application example

Drive network with pulse train coupling



Stop!

In drive networks which are connected via pulse trains (a master and one or more slaves):

- the mains failure detection may only be activated for the master.
 - the mains failure control must be integrated correspondingly into the signal flow.
- All controllers must be operated via the terminals +UG, -UG in the DC-bus connection. For this, the information in the "Dimensioning" chapter must be observed.



Note!

Further information and predefined configurations can be obtained from Lenze.



Function library

Function blocks

Motor phase failure detection (MLP)

3.2.41 Motor phase failure detection (MLP)

Purpose

Motor phase monitoring.

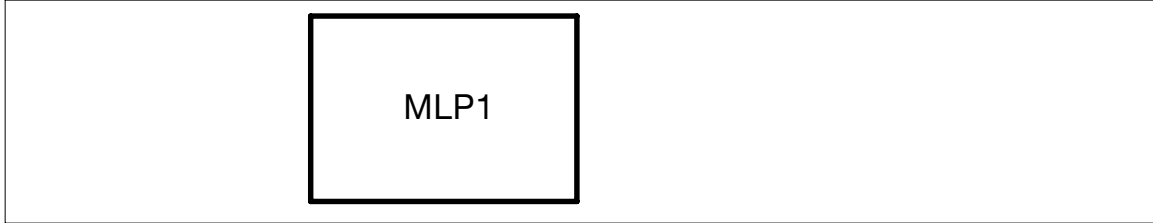

Fig. 3-105 Motor phase failure detection (MLP1)

Code	LCD	Possible settings		Important
		Lenze	Selection	
C0597	MONIT LP1	3	0 Trip 2 Warning 3 Off	Conf. LP1 Configuration of motor phase failure monitoring
C0599	LIMIT LP 1	5.0	1.0 {0.1}	10.0 Current limit LP1 Current limit for motor phase failure monitoring

Function

Detailed descriptions of monitoring systems and error messages can be found in the system manual, document number EDSVS9332P.

The function block MLP1 must be entered in the processing table if the motor phase failure detection is to be used.

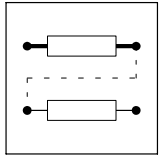

3.2.42 Monitor outputs of monitoring system (MONIT)

Purpose

The monitoring functions output digital monitor signals.

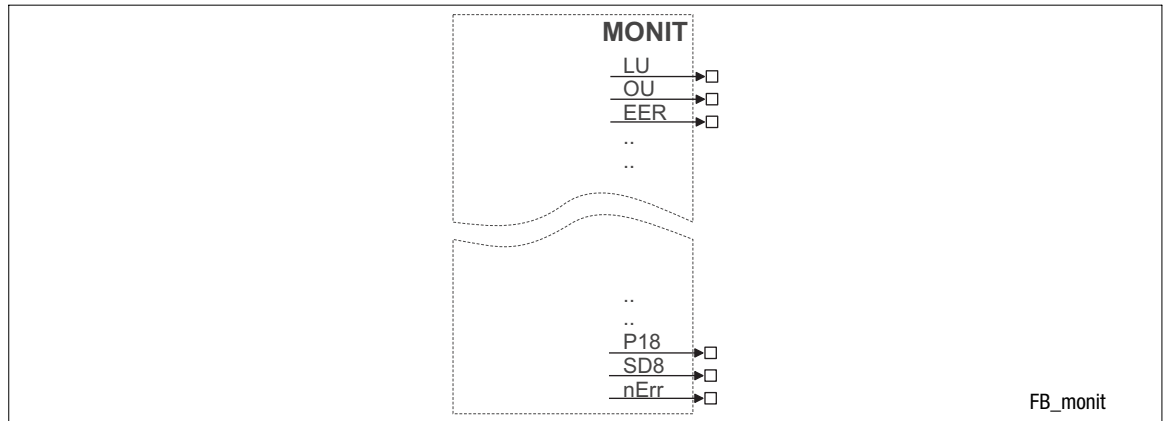

Fig. 3-106 Monitor outputs of the monitoring system (MONIT)

Function

The MONIT outputs switch to HIGH level if one of the monitoring functions responds.

The digital monitor signals respond dynamically, i.e.

- depending on the state of the monitoring function, but
- independently of the selected fault reaction (e.g. TRIP).

Example

MONIT-LP1 (motor phase monitoring) responds if a cable disruption is detected in a motor connection phase, although the fault reaction of LP1 is set to "Off" (C0597 = 3).



Note!

- With appropriate signal conditioning, the MONIT outputs can be used to locate the cause of malfunction (e.g. by storing the MONIT output signal via the FLIP function block).
- More detailed descriptions of the monitoring functions / error messages can be found in the chapter "Troubleshooting and fault elimination".



Function library

Function blocks

Monitor outputs of monitoring system (MONIT)

MONIT outputs

MONIT output	Description
CE0	Communication error - automation interface (AIF)
CE1	Communication error - process data input object CAN1_IN
CE2	Communication error - process data input object CAN2_IN
CE3	Communication error - process data input object CAN3_IN
CE4	BUS-OFF state of system bus (CAN)
EEr	External monitoring, triggered via DCTRL
H05	Internal fault (memory)
H07	Internal fault (power section)
H10	Thermal sensor error - heatsink
H11	Thermal sensor error - inside the device
LP1	Motor phase failure
LU	Undervoltage in the DC bus
nErr	Speed control error
NMAX	Maximum speed (C0596) exceeded
OC2	Earth fault - motor cable
OC5	$I \times t$ overload
OC6	$I^2 \times t$ overload
OC8	$I^2 \times t$ overload advance warning
OH	Heatsink temperature > +90 °C
OH3	Motor temperature > +150 °C threshold (temperature detected via resolver or incremental value encoder)
OH4	Heatsink temperature > C0122
OH7	Motor temperature > C0121 (temperature detected via resolver or incremental value encoder)
OH8	Motor temperature measured via inputs T1 and T2 too high
OU	DC-bus overvoltage
P03	Following error
P16	Faulty transmission of sync telegram on system bus (CAN)
P19	Limitation of input values at X9
PL	Error during rotor position adjustment
Sd2	Resolver error at X7
Sd3	Encoder error at X9
Sd5	Encoder error at X6 pins 1 and 2
Sd6	Thermal sensor error - motor (X7 or X8)
Sd7	Absolute value encoder at X8 Initialisation error or communication error during rotor position adjustment
Sd8	Sin/cos encoder at X8 transmits no or inconsistent data

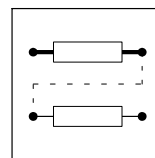

3.2.43 Motor potentiometer (MPOT)

Purpose

The FB replaces a hardware motor potentiometer.

The motor potentiometer is used as an alternative setpoint source, which is controlled via two terminals.

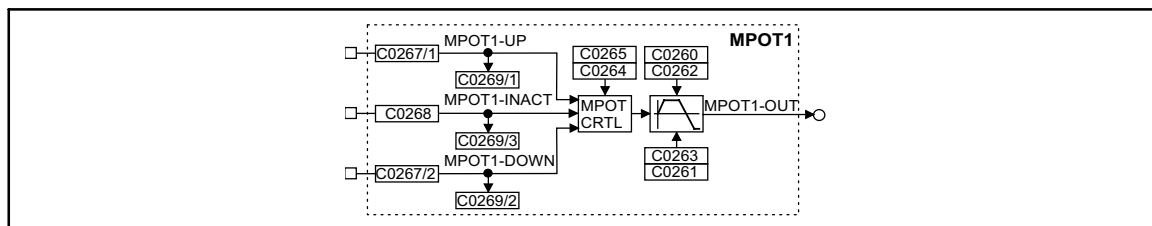

Fig. 3-107 Motor potentiometer (MPOT1)

Name	Signal			Source			Note
	Type	DIS	DIS format	CFG	List	Lenze	
MPOT1-UP	d	C0269/1	bin	C0267/1	2	1000	-
MPOT1-INACT	d	C0269/3	bin	C0268	2	1000	-
MPOT1-DOWN	d	C0269/2	bin	C0267/2	2	1000	-
MPOT1-OUT	a	-	-	-	-	-	-

Function

Control of the motor potentiometer:

- MPOT1-UP = HIGH
 - The motor potentiometer approaches its upper limit value.
- MPOT1-DOWN = HIGH
 - The motor potentiometer approaches its lower limit value.
- MPOT1-UP = LOW and MPOT1-DOWN = LOW or
MPOT1-UP = HIGH and MPOT1-DOWN = HIGH:
 - The motor potentiometer does not change the output signal.



Function library

Function blocks

Motor potentiometer (MPOT)

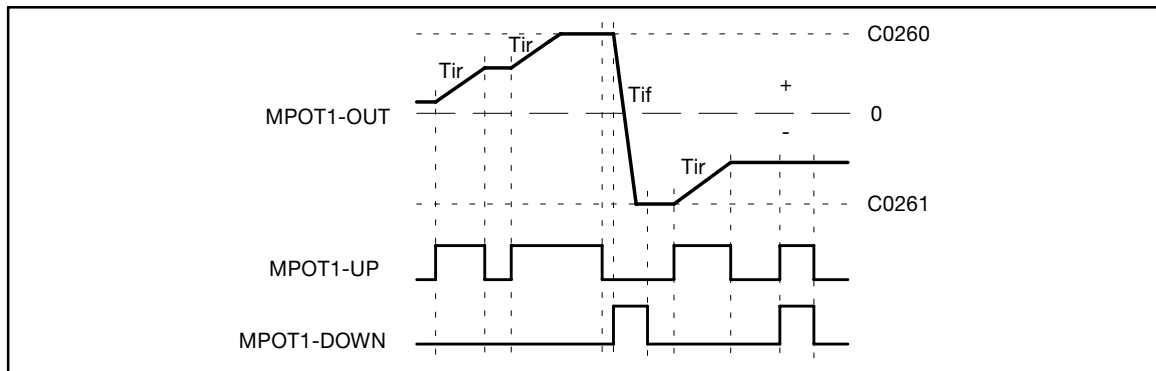

Fig. 3-108

Control signals of the motor potentiometer

In addition to the digital signals MPOT1-UP and MPOT1-DOWN another digital input exists (MPOT1-INACT). The input MPOT1-INACT is used to activate or deactivate the motor potentiometer function. Logic 1 at this input deactivates the motor potentiometer function. The input MPOT1-INACT has priority over the inputs MPOT1-UP and MPOT1-DOWN.

When the motor potentiometer is deactivated, the motor potentiometer output (MPOT1-OUT) follows the function set under C0264. The following functions can be set under C0264:



C0264 =	Meaning
0	No further action; the output MPOT1-OUT keeps its value
1	The motor potentiometer returns to 0 % with the corresponding deceleration time
2	The motor potentiometer approaches the lower limit value with the corresponding deceleration time (C0261)
3	The motor potentiometer immediately changes its output to 0%. (Important for EMERGENCY-OFF function)
4	The motor potentiometer immediately changes its output to the lower limit value (C0261)
5	The motor potentiometer approaches the upper limit value with the corresponding acceleration time (C0260)

If the motor potentiometer is activated (input MPOT1-INACT = 0), the subsequent function depends on

- the current output signal,
- the set limit values of the MPOT,
- the control signals UP and DOWN.

If the output value is out of the set limits, the MPOT approaches the next limit with the set T_i times. This function is independent of the control inputs MPOT1-UP and MPOT1-DOWN

If the output value is within the set limits, the output follows the selected control function UP, DOWN or no action.

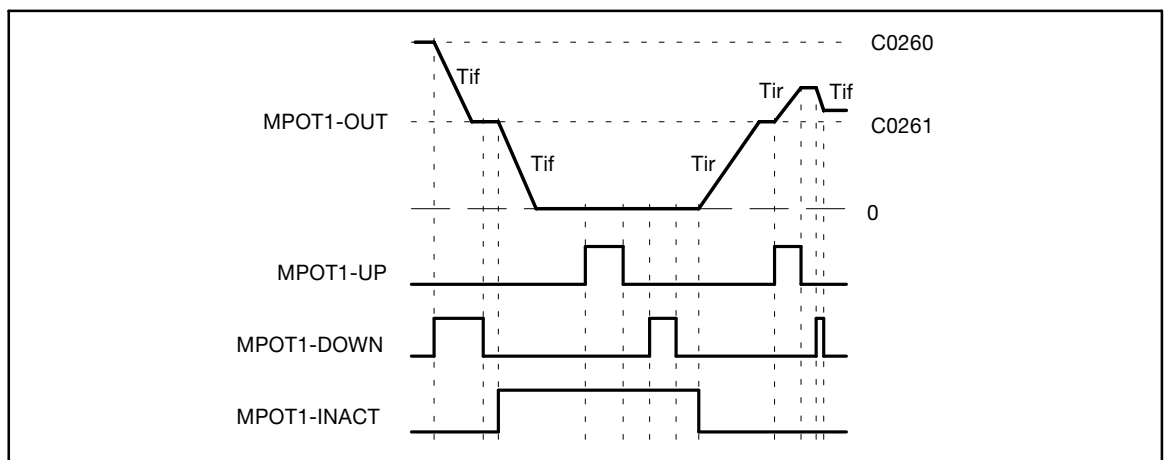

Fig. 3-109 Deactivation of the motor potentiometer via the input MPOT1-INACT

Initialisation

This function is used to store the output value of the MPOT non-volatilely in the internal memory of the device, when the mains is switched off. The value is saved automatically if this function was selected via the code. When the mains is switched on, the value is reloaded into the MPOT.

C0265 can be used to activate other initialisation functions (see code table).

When the initialisation is completed, the MPOT follows the applied control function.



Function library

Function blocks Logic NOT

3.2.44 Logic NOT

Purpose

Logic inversion of digital signals. The inversion can be used to control functions or generate status information.

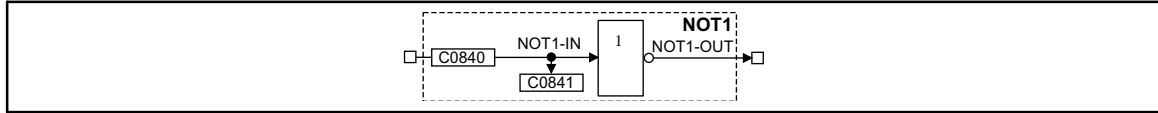

Fig. 3-110 Logic NOT (NOT1)

Name	Signal			Source			Note
	Type	DIS	DIS format	CFG	List	Lenze	
NOT1-IN	d	C0841	bin	C0840	2	1000	-
NOT1-OUT	d	-	-	-	-	-	-

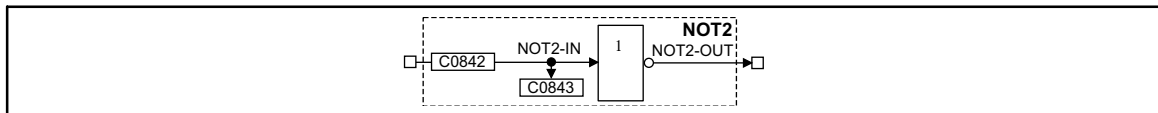

Fig. 3-111 Logic NOT (NOT2)

Name	Signal			Source			Note
	Type	DIS	DIS format	CFG	List	Lenze	
NOT2-IN	d	C0843	bin	C0842	2	1000	-
NOT2-OUT	d	-	-	-	-	-	-

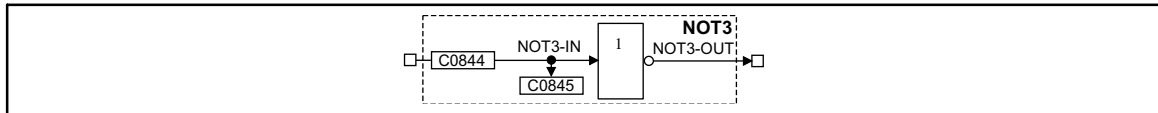

Fig. 3-112 Logic NOT (NOT3)

Name	Signal			Source			Note
	Type	DIS	DIS format	CFG	List	Lenze	
NOT3-IN	d	C0845	bin	C0844	2	1000	-
NOT3-OUT	d	-	-	-	-	-	-

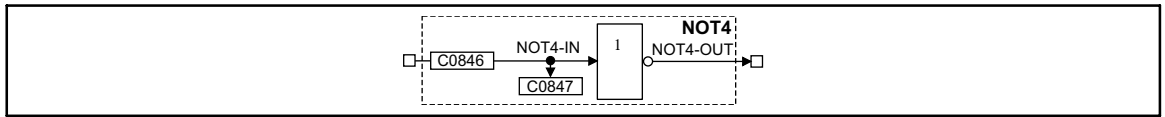
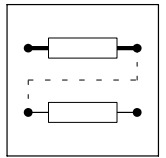

Fig. 3-113

Logic NOT (NOT4)

Name	Signal			Source			Note
	Type	DIS	DIS format	CFG	List	Lenze	
NOT4-IN	d	C0847	bin	C0846	2	1000	-
NOT4-OUT	d	-	-	-	-	-	-

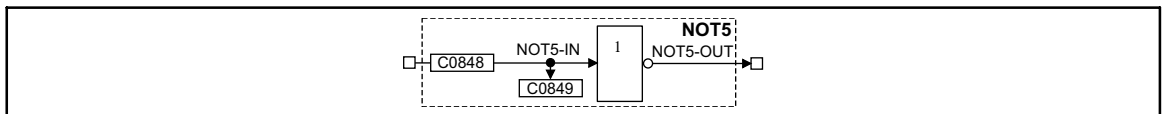

Fig. 3-114

Logic NOT (NOT5)

Name	Signal			Source			Note
	Type	DIS	DIS format	CFG	List	Lenze	
NOT5-IN	d	C0849	bin	C0848	2	1000	-
NOT5-OUT	d	-	-	-	-	-	-

Function

NOTx-IN1	NOTx-OUT
0	1
1	0

The function corresponds to a change from an NO contact to an NC contact in a contactor control.

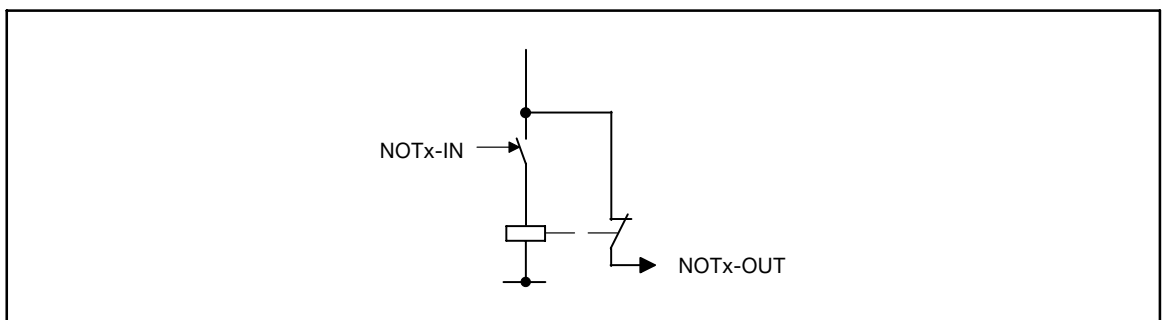

Fig. 3-115

Function of NOT when changing an NO contact to an NC contact.



Function library

Function blocks

Speed setpoint conditioning (NSET)

3.2.45 Speed setpoint conditioning (NSET)

Purpose

This FB conditions

- the main speed setpoint and
- an additional setpoint (or other signals as well)

for the following control structure via ramp function generator or fixed speeds.

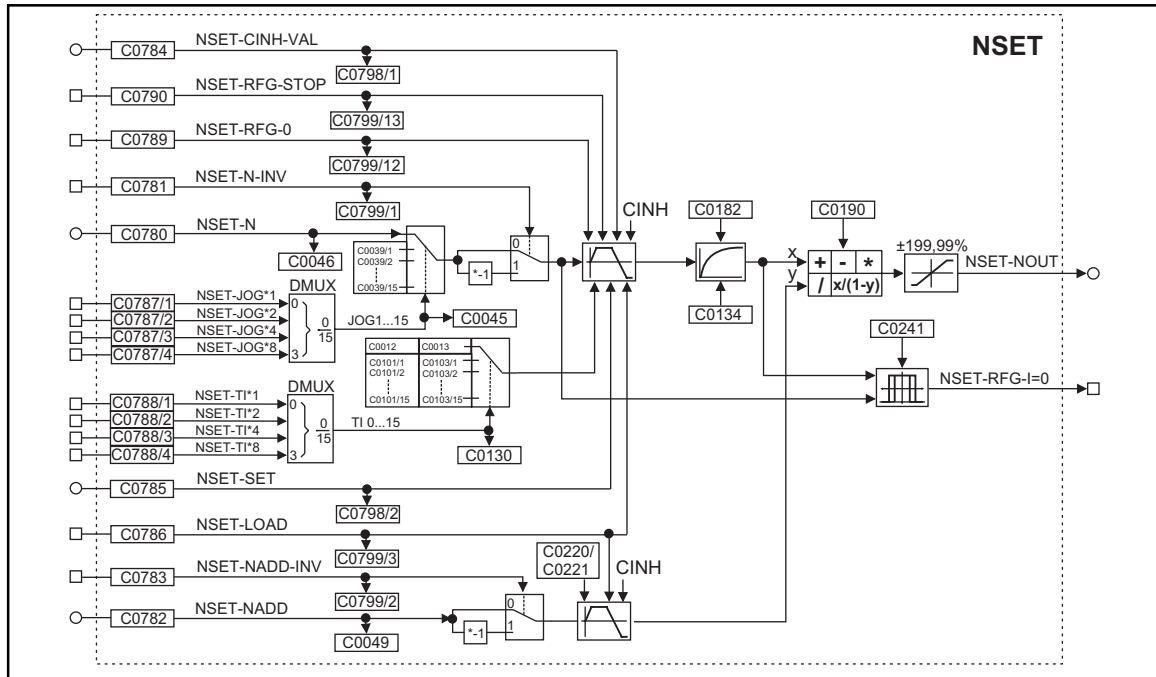
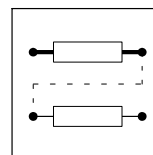

Fig. 3-116 Speed setpoint conditioning (NSET)



Name	Signal			Source			Note
	Type	DIS	DIS format	CFG	List	Lenze	
NSET-N	0	C0046	dec [%]	C0780	1	50	Intended for main setpoint, other signals are permissible
NSET-NADD	0	C0047	dec [%]	C0782	1	5650	Intended for additional setpoint, other signals are permissible
NSET-JOG*1	d	C0799/4	bin	C0787/1	2	53	Selection and control of overriding "fixed setpoints" for the main setpoint
NSET-JOG*2	d	C0799/5	bin	C0787/2	2	1000	
NSET-JOG*4	d	C0799/6	bin	C0787/3	2	1000	
NSET-JOG*8	d	C0799/7	bin	C0787/4	2	1000	
NSET-TI*1	d	C0799/8	bin	C0788/1	2	1000	
NSET-TI*2	d	C0799/9	bin	C0788/2	2	1000	Selection and control of alternative acceleration and deceleration times for the main setpoint
NSET-TI*4	d	C0799/10	bin	C0788/3	2	1000	
NSET-TI*8	d	C0799/11	bin	C0788/4	2	1000	
NSET-N-INV	d	C0799/1	bin	C0781	2	10251	Control of the signal inversion for the main setpoint
NSET-NADD-INV	d	C0799/2	bin	C0783	2	1000	Control of the signal inversion for the additional setpoint
NSET-RFG-0	d	C0799/12	bin	C0789	2	1000	The main setpoint integrator is led to zero via the current T_i times.
NSET-RFG-STOP	d	C0799/13	bin	C0790	2	1000	Keeping (freezing) of the main setpoint integrator to its actual value.
NSET-CINH-VAL	0	C0798/1	dec [%]	C0784	1	5001	Here, the signal is applied which is to be accepted by the main setpoint integrator when the controller is inhibited
NSET-SET	0	C0798/2	dec [%]	C0785	1	5000	Here, the signal is applied which is to be accepted by the main setpoint integrator when the NSET-LOAD input is set
NSET-LOAD	d	C0799/3	bin	C0786	2	5001	Control of both ramp function generators in special situations, e.g. QSP
NSET-OUT	0	-	-	-	-	-	-
NSET-RFG-I=0	d	-	-	-	-	-	-

Function

- Main setpoint path
- JOG setpoints
- Setpoint inversion
- S ramp

3.2.45.1

Main setpoint path

- The signals in the main setpoint path are limited to the value range $\pm 199.99\%$.
- The signal at input NSET-N is led via the function JOG selection.
- The JOG function has priority over the setpoint input NSET-N. This means a selected JOG value deactivates the input. The subsequent signal conditioning the JOG value instead.

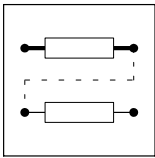

Function library

Function blocks

Speed setpoint conditioning (NSET)

3.2.45.2 JOG setpoints

- Are fixed values which are stored in the memory.
- JOG values can be called from the memory via the inputs NSET-JOG*x.
- The inputs NSET-JOG*x are binary coded so that 15 JOG values can be called.
- The decoding for enabling the JOG values (called from the memory) is carried out according to the following table:

Output signal	1st input NSET-JOG*1	2nd input NSET-JOG*2	3rd input NSET-JOG*4	4th input NSET-JOG*8
NSET-N	0	0	0	0
JOG 1	1	0	0	0
JOG 2	0	1	0	0
JOG 3	1	1	0	0
JOG 4	0	0	1	0
JOG 5	1	0	1	0
JOG 6	0	1	1	0
JOG 7	1	1	1	0
JOG 8	0	0	0	1
JOG 9	1	0	0	1
JOG 10	0	1	0	1
JOG 11	1	1	0	1
JOG 12	0	0	1	1
JOG 13	1	0	1	1
JOG 14	0	1	1	1
JOG 15	1	1	1	1

- When all inputs are assigned with 0, the input NSET-N is active.
- The number of inputs that must be assigned depends on the required number of JOG values. Four inputs and thus 15 possible selections are available. A digital signal source is assigned via C0787 and the corresponding subcode.

Number of required JOG setpoints	Number of inputs to be assigned
1	at least 1
1 ... 3	at least 2
4 ... 7	at least 3
8 ... 15	4

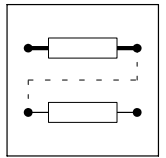

3.2.45.3 Setpoint inversion

The output signal of the JOG function is led via an inverter.

The sign of the setpoint is inverted, if the input NSET-N-INV is triggered with HIGH signal.

Ramp function generator for the main setpoint

The setpoint is then led via a ramp function generator with linear characteristic. Setpoint step-changes at the input are thus led into a ramp.

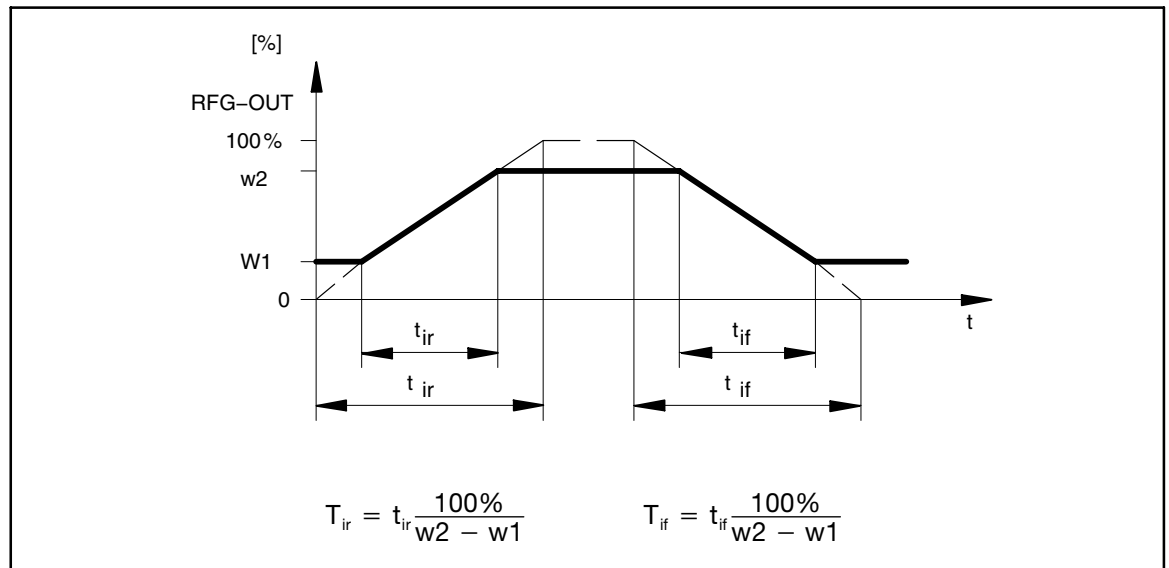
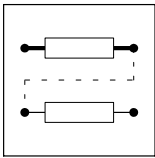

Fig. 3-117

Acceleration and deceleration times of the ramp function generator

- The ramps can be set separately for acceleration and deceleration.
 - Different acceleration and deceleration times can be activated via the inputs NSET-TI*x 16 (for table and function see JOG setpoints; the decoding must be done according to the signal graphic).
 - The T_i times can only be activated in pairs.
- When the controller is inhibited (CINH) the ramp function generator accepts the value that was applied to the input NSET-CINH-VAL and transmits it to the next function. This function has priority over all other functions.
- NSET-RFG-STOP = HIGH
 - The ramp function generator is stopped. Changes at the input of the ramp function generator have no effect on the output.
- NSET-RFG-0 = HIGH
 - The ramp function generator decelerates to zero along the deceleration ramp.
- It is also possible to load the ramp function generator online with a defined value. For this, the input NSET-LOAD must be set to HIGH. As long as this input is set, the value at input NSET-SET is accepted by the ramp function generator and provided the output.



Function library

Function blocks

Speed setpoint conditioning (NSET)

Priorities:

CINH	NSET-LOAD	NSET-RFG-0	NSET-RFG-STOP	Function
0	0	0	0	RFG follows the input value via the set ramps
0	0	0	1	The value at the output of RFG is frozen
0	0	1	0	RFG decelerates to zero along the set deceleration time
0	0	1	1	
0	1	0	0	RFG accepts the value applied to input NSET-SET and provides it at its output
0	1	0	1	
0	1	1	0	
0	1	1	1	
1	0	0	0	RFG accepts the value applied to input CINH-VAL and provides it at its output
1	0	0	1	
1	0	1	0	
1	0	1	1	
1	1	0	0	
1	1	0	1	
1	1	1	0	
1	1	1	1	

3.2.45.4 S ramp

The linear ramp function generator is connected to a PT1 element. This arrangement implements an S ramp for an almost jerk-free acceleration and deceleration.

- The PT1 element is switched on and off via C0134.
- The time constant is set via C0182.

3.2.45.5 Arithmetic operation

The output value is led to an arithmetic module. This module links the main setpoint and the additional setpoint arithmetically. The arithmetic operation is selected via C0190 (see the following table).

C0190	Function	Example
0	Output = X (Y is not processed)	-
1	Output = X + Y	100 % = 50 % + 50 %
2	Output = X - Y	50 % = 100 % - 50%
3	Output = X * Y	100 % = 100 % * 100%
4	Output = X/Y	1 % = 100 % / 100%
5	Output = X/(100% - Y)	200 % = 100 % / (100 % - 50 %)

3.2.45.6 Additional setpoint

- An additional setpoint (e.g. a correction signal) can be linked with the main setpoint via the input NSET-NADD.
- The input signal can be inverted via the input NSET-NADD-INV before affecting the ramp function generator. The ramp function generator has a linear characteristic and an acceleration time and deceleration time each.
- With NSET-LOAD = HIGH the ramp function generator is set to zero and kept there without considering the T_i times. The same applies when the controller is inhibited.

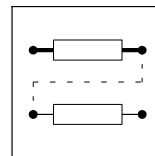

3.2.46 OR operation (OR)

Purpose

Logical ORing of digital signals. The operations are used for controlling functions or creating status information.

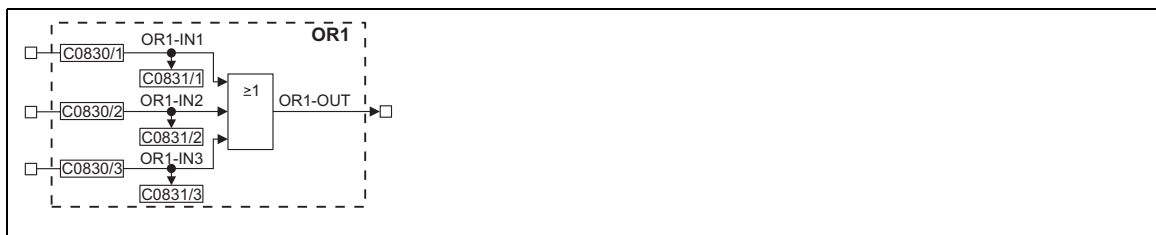

Fig. 3-118

OR operation (OR1)

Name	Signal			Source			Note
	Type	DIS	DIS format	CFG	List	Lenze	
OR1-IN1	d	C0831/1	bin	C0830/1	2	1000	-
OR1-IN2	d	C0831/2	bin	C0830/2	2	1000	-
OR1-IN3	d	C0831/3	bin	C0830/3	2	1000	-
OR1-OUT	d	-	-	-	-	-	-



Fig. 3-119

OR operation (OR2)

Name	Signal			Source			Note
	Type	DIS	DIS format	CFG	List	Lenze	
OR2-IN1	d	C0833/1	bin	C0832/1	2	1000	-
OR2-IN2	d	C0833/2	bin	C0832/2	2	1000	-
OR2-IN	d	C0833/3	bin	C0832/3	2	1000	-
OR2-OUT	d	-	-	-	-	-	-



Function library

Function blocks OR operation (OR)

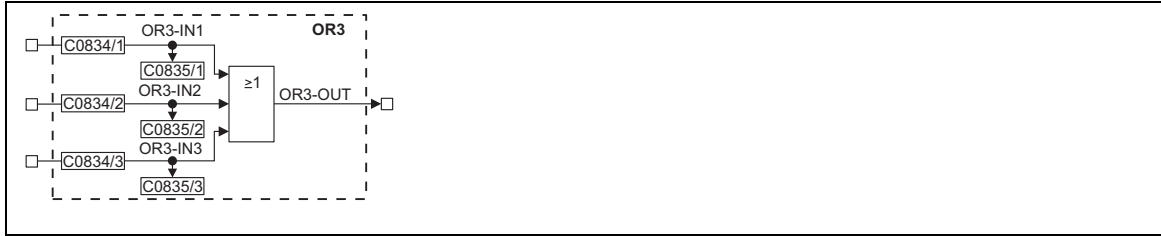

Fig. 3-120

OR operation (OR3)

Name	Signal			Source			Note
	Type	DIS	DIS format	CFG	List	Lenze	
OR3-IN1	d	C0835/1	bin	C0834/1	2	1000	-
OR3-IN2	d	C0835/2	bin	C0834/2	2	1000	-
OR3-IN3	d	C0835/3	bin	C0834/3	2	1000	-
OR3-OUT	d	-	-	-	-	-	-



Fig. 3-121

OR operation (OR4)

Name	Signal			Source			Note
	Type	DIS	DIS format	CFG	List	Lenze	
OR4-IN1	d	C0837/1	bin	C0826/1	2	1000	-
OR4-IN2	d	C0837/2	bin	C0826/2	2	1000	-
OR4-IN3	d	C0837/3	bin	C0826/3	2	1000	-
OR4-OUT	d	-	-	-	-	-	-



Fig. 3-122

OR operation (OR5)

Name	Signal			Source			Note
	Type	DIS	DIS format	CFG	List	Lenze	
OR5-IN1	d	C0839/1	bin	C0828/1	2	1000	-
OR5-IN2	d	C0839/2	bin	C0828/2	2	1000	-
OR5-IN3	d	C0839/3	bin	C0828/3	2	1000	-
OR5-OUT	d	-	-	-	-	-	-



Function of OR1 ... OR5

- $ORx-OUT = ORx-IN1 \vee ORx-IN2 \vee ORx-IN3$
- Equivalent network:

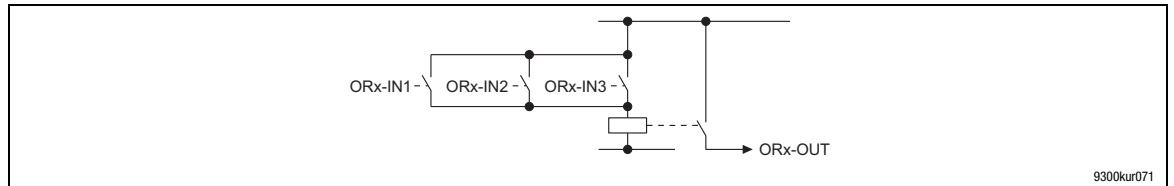

Fig. 3-123

Equivalent network of the OR operation for OR1 ... OR5



Note!

Connect inputs that are not used to FIXED0.



Function library

Function blocks

Oscilloscope function (OSZ)

3.2.47 Oscilloscope function (OSZ)

Purpose

Detection of any measured variable (e. g. speed setpoint, actual speed, torque etc.). They are visualised in Global Drive Control.

Supports the commissioning of controllers and the troubleshooting.

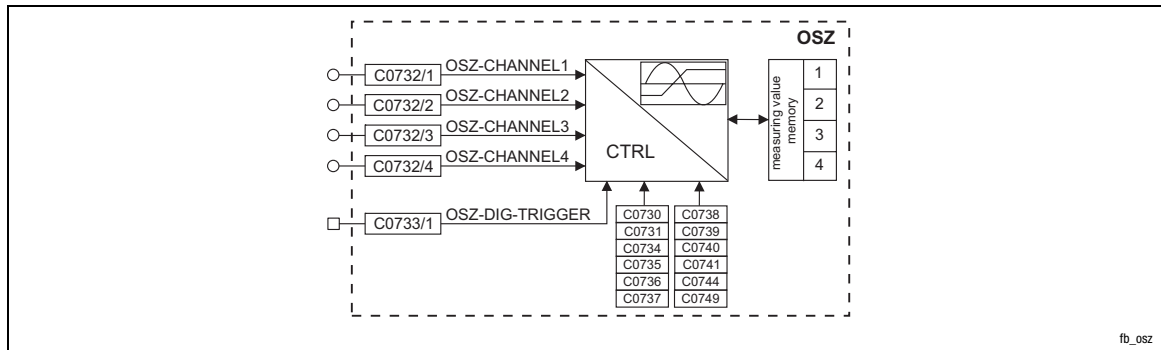

Fig. 3-124

Oscilloscope function (OSZ)

Name	Signal			Source			Note
	Type	DIS	DIS format	CFG	List	Lenze	
OSZ CHANNEL1	a	-	-	C0732/1	1	-	-
OSZ CHANNEL2	a	-	-	C0732/2	1	-	-
OSZ CHANNEL3	a	-	-	C0732/3	1	-	-
OSZ CHANNEL4	a	-	-	C0732/4	1	-	-
OSZ-DIG-TRIGGER	d	-	-	C0733/1	2	-	-

Function

The FB has three function units:

- Trigger check
 - Monitoring of the digital trigger source for a valid trigger event
- Processing of the measured signal
 - Linking the measurement inputs
 - Calculating the time base
 - Monitoring of the analog trigger source for a valid trigger event.
- Measuring value memory
 - Scaling the ring buffer
 - Filing the measured data in the ring buffer
 - Saving the measuring points for image generation

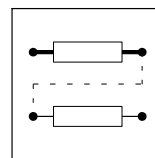

Functional description

Function	Code	Selection	Description
OSZ mode	C0730	1	<ul style="list-style-type: none"> Starts the recording of the measured values
		0	<ul style="list-style-type: none"> Cancels a running measurement
OSZ status	C0731	1	<ul style="list-style-type: none"> Measurement completed <ul style="list-style-type: none"> The memory of the measured values is completely filled with measured data. The measured values can be accessed via the PC.
		2	<ul style="list-style-type: none"> Measurement active <ul style="list-style-type: none"> A measurement was started with C0730 = 1. The FB is waiting for a valid trigger event.
		3	<ul style="list-style-type: none"> Trigger detected <ul style="list-style-type: none"> The FB has detected a valid trigger event. Depending on the trigger delay the saving of the measured data is not yet completed. It is automatically completed with the entry into the last memory unit.
		4	<ul style="list-style-type: none"> Measurement cancelled <ul style="list-style-type: none"> Cancel of a running recording of the measured values (C0730 = 0). The memory of the measured values is filled with the data that has just been measured. The data can be accessed via the PC.
		5	<ul style="list-style-type: none"> Read data memory <ul style="list-style-type: none"> The measured data memory is being read at the moment. No settings are possible in this operating state.
		Configuration OSZ channel 1 ... 4	C0732/1 to C0732/4
Configuration OSZ trigger	C0733/1		<ul style="list-style-type: none"> Links the digital trigger input with a digital signal in the process environment. <ul style="list-style-type: none"> The trigger input can be assigned with any digital signal. Enter the corresponding signal number into C0733/1.
Trigger source	C0734	1	Source is one of the four measuring channels (C0734/1 ... C0734/4)
		0	Source is the digital trigger input (C0733/1)
Trigger level	C0735	-32767 ... 32767	<ul style="list-style-type: none"> Defines the trigger level which activates the triggering when the level is exceeded. <ul style="list-style-type: none"> The trigger level is only monitored when the triggering is done on one of the four channels. The trigger level is not effective with digital triggering.
Trigger edge	C0736		<ul style="list-style-type: none"> Defines the trigger edge which activates the triggering. <ul style="list-style-type: none"> Triggering on an analog input channel <ul style="list-style-type: none"> With a LOW-HIGH trigger edge the analog trigger signal must exceed a defined trigger level to activate the triggering. With a HIGH-LOW trigger edge the analog trigger signal must fall below a defined trigger level to activate the triggering. Triggering on a digital trigger input <ul style="list-style-type: none"> With a LOW-HIGH trigger edge the digital trigger signal must change from LOW to HIGH to activate the triggering. With a HIGH-LOW trigger edge the digital trigger signal must change from HIGH to LOW to activate the triggering.
		1	– HIGH-LOW trigger edge
		0	LOW-HIGH trigger edge



Function library

Function blocks

Oscilloscope function (OSZ)

Function	Code	Selection	Description
Trigger delay			The trigger delay defines when to begin with the saving of the measured values with regard to the trigger time.
	C0737	-100.0 % ... 0 %	<ul style="list-style-type: none"> Negative trigger delay (pre-triggering) <ul style="list-style-type: none"> – Defines a percentage of the whole memory content. This part of the memory content is filled with measured values before the triggering (see Fig. 3-126).
0 % ... 999.9 %		<ul style="list-style-type: none"> Positive trigger delay (post-triggering) <ul style="list-style-type: none"> – Defines a percentage of the whole memory content. The saving of the measured values after triggering is delayed by this part of the memory content (Fig. 3-125). 	
Sampling period	C0738	1 ms ... 10 min	<ul style="list-style-type: none"> Setting of the sampling period <ul style="list-style-type: none"> – The sampling period is the time between two measurements – The measurements are carried out simultaneously for all channels (e. g. value measured at channel 1 is measured at the same time as the measured value at channel 2, 3 or 4. – The sampling period can be set in steps of 1, 2 and 5.
Number of Channels	C0739		Number of channels used for measurements.
Read data memory			The code is required if the GDC is not used for the visualisation.
	C0740/1	0 ... 16383	<ul style="list-style-type: none"> Defines the starting point for reading the data memory and thus enables the memory array to be selectively accessed. <ul style="list-style-type: none"> – In order to read the data memory bit by bit (e. g. reading only the measured values of one channel or reading with reduced memory depth), the starting point can be changed.
		C0740/2	1
0	<ul style="list-style-type: none"> Inhibit “Read memory” <ul style="list-style-type: none"> – Inhibits the access to the memory. The access must be inhibited after every reading of the data 		
Information about the function block			Provides information on the function block
	C0741/1		Version of the function block (e. g. 120: Version 1.20)
	C0741/2		Data memory size (1024 ... 16384 bytes)
	C0741/3		Data width of the measured values (1 byte / 2 bytes)
	C0741/4		Number of the available measuring channels (1 ... 4)

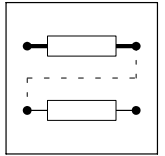

Function	Code	Selection	Description
Memory size	C0744	0 ... 6	Set memory depth of the data memory – Max. size of the data memory: 8192 measured values \triangleq 16384 bytes (C0744 = 6) – Min. size of the data memory: 512 measured values \triangleq 1024 bytes (C0744 = 0) – Changing the memory depth from 512 to 8192 measured values/step – A memory depth which is optimally adapted to the corresponding measuring task reduces the data transmission time.
Information on saving			Information on saving the measured values in the data memory The FB saves the data in a ring format. For reconstructing the chronological signal sequence the following three "graphic points" are marked.
	C0749/1		Measured value no. of the instant of abortion
	C0749/2		Measured value no. of the instant of triggering
	C0749/3		Measured value no. of the instant of completion

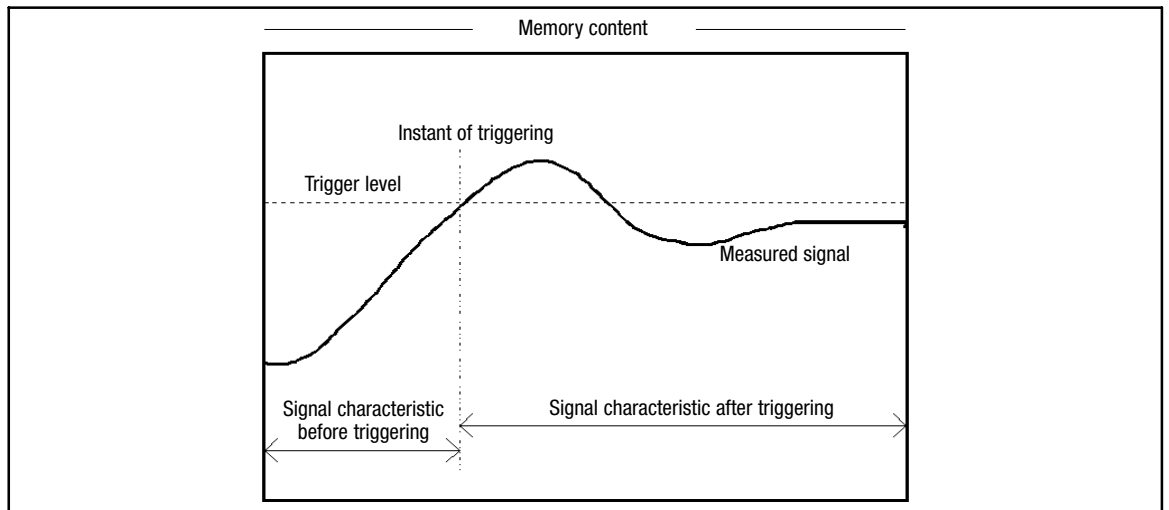

Fig. 3-125 Example: Trigger level and trigger delay with approx. -30 % of pre-triggering

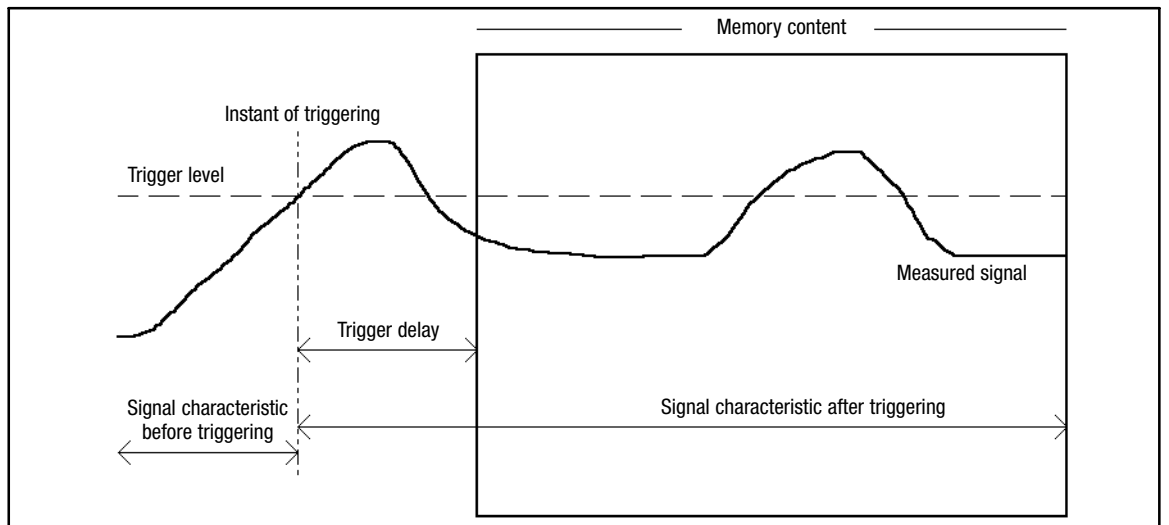

Fig. 3-126 Example: Trigger level and trigger delay with approx. -30 % of post-triggering



Function library

Function blocks

Process controller (PCTRL1)

3.2.48 Process controller (PCTRL1)

Purpose

The FB is used, for instance, as a higher-level controller (dancer position controller, tension controller, pressure controller etc.).

The control characteristic follows the ideal PID algorithm, but it can also be changed over to a PI or P characteristic.

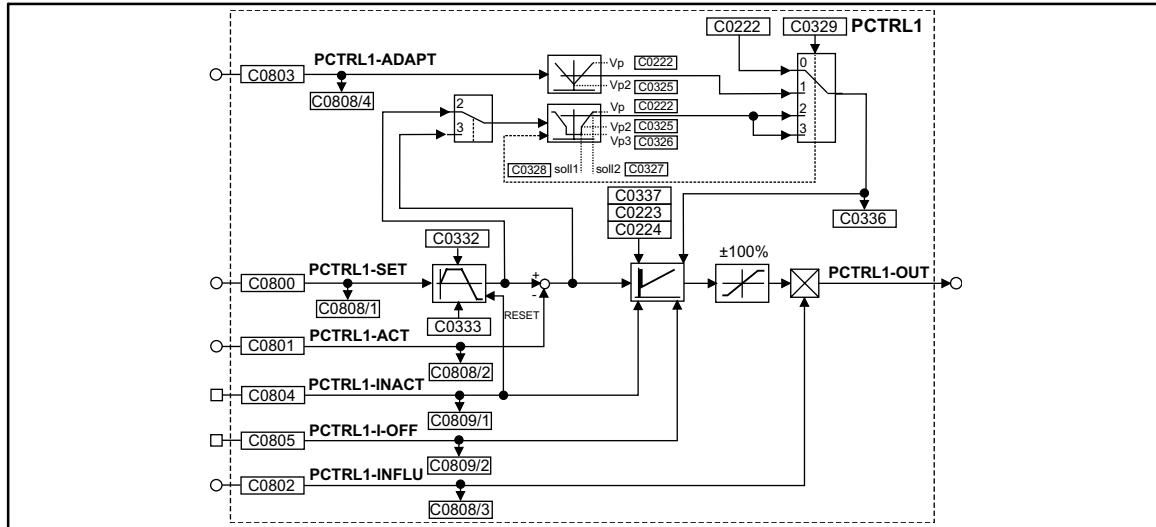

Fig. 3-127

Process controller (PCTRL1)

Name	Signal			Source			Note
	Type	DIS	DIS format	CFG	List	Lenze	
PCTRL1-SET	a	C0808/1	dec [%]	C0800	1	1000	Input of the process setpoint. Possible value range: $\pm 200\%$. The time characteristic of step-change signals can be affected via the ramp function generator (C0332 for the acceleration time; C0333 for the deceleration time).
PCTRL1-ACT	a	C0808/2	dec [%]	C0801	1	1000	Actual value input; value range $\pm 200\%$
PCTRL1-INFLU	a	C0808/3	dec [%]	C0802	1	1000	Evaluation or suppression of the output signal; value range $\pm 200\%$
PCTRL1-ADAPT	a	C0808/4	dec [%]	C0803	1	1000	Online change of the P gain; value range $\pm 200\%$
PCTRL1-INACT	d	C0809/1	bin	C0804	2	1000	Online deactivation of the process controller
PCTRL1-I-OFF	d	C0809/2	bin	C0805	2	1000	Online setting of the I component to zero
PCTRL1-OUT	a	-	-	-	-	-	-

Function

Setpoint and actual value are sent to the process controller via the corresponding inputs and processed according to the selected control algorithm (control characteristic).



3.2.48.1 Control characteristic

- In the default setting, the PID algorithm is active.
- The D-component can be deactivated by setting code C0224 to zero. Thus, the controller becomes a PI-controller (or P-controller if the I-component is also switched off).
- The I-component can be switched on or off online via the PCTRL-I-OFF input. For this, the input is assigned a digital signal source (e.g. one of the freely assignable digital input terminals). If the I-component is to be switched off permanently, the input is assigned the signal source "FIXED1".
 - PCTRL-I-OFF = HIGH switches off the I-component
 - PCTRL-I-OFF = LOW switches on the I-component
- The reset time is parameterised via C0223.
- The P-gain can be set in different ways. The function providing the P-gain is selected under C0329:
 - C0329 = 0
The P-gain is entered under C0222.
 - C0329 = 1
The P-gain is entered via the PCTRL-ADAPT input. The input value is led via a linear characteristic. The slope of the characteristic is set under C0222 (upper limit) and C0325 (lower limit). The value under C0222 is valid if the input value = +100 % or -100 %. The value under C0325 applies if the input value is 0 %.

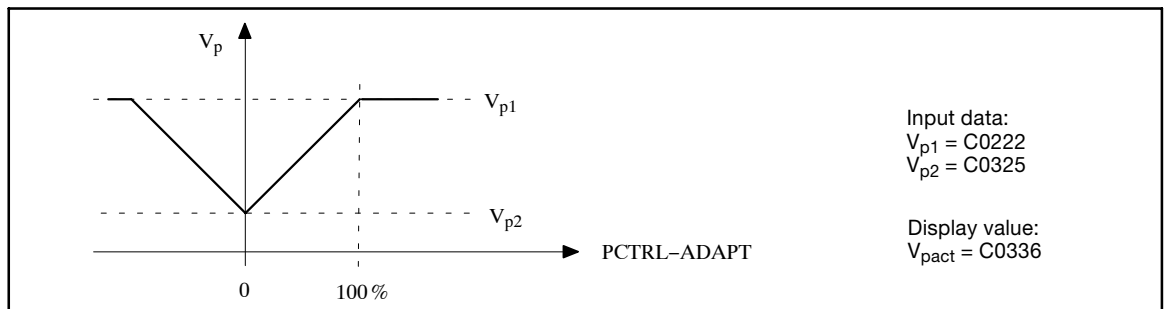

Fig. 3-128 Input of the P-gain via PCTRL-ADAPT input

- C0329 = 2

The P-gain is derived from the process setpoint PCTRL-SET. The setpoint is measured after the ramp function generator and calculated by means of a characteristic with three interpolation points.

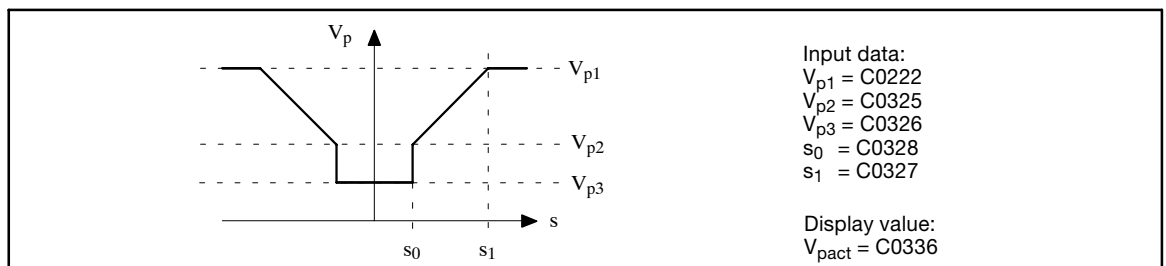

Fig. 3-129 P-gain derived from the PCTRL-SET process setpoint

- C0329 = 3

The P-gain is derived from the control difference and calculated by means of a characteristic as for C0329 = 2.



Function library

Function blocks

Process controller (PCTRL1)

3.2.48.2 Ramp function generator

The setpoint PCTRL-SET is led via a ramp function generator with linear characteristic. Thus, setpoint step-changes at the input can be transformed into a ramp.

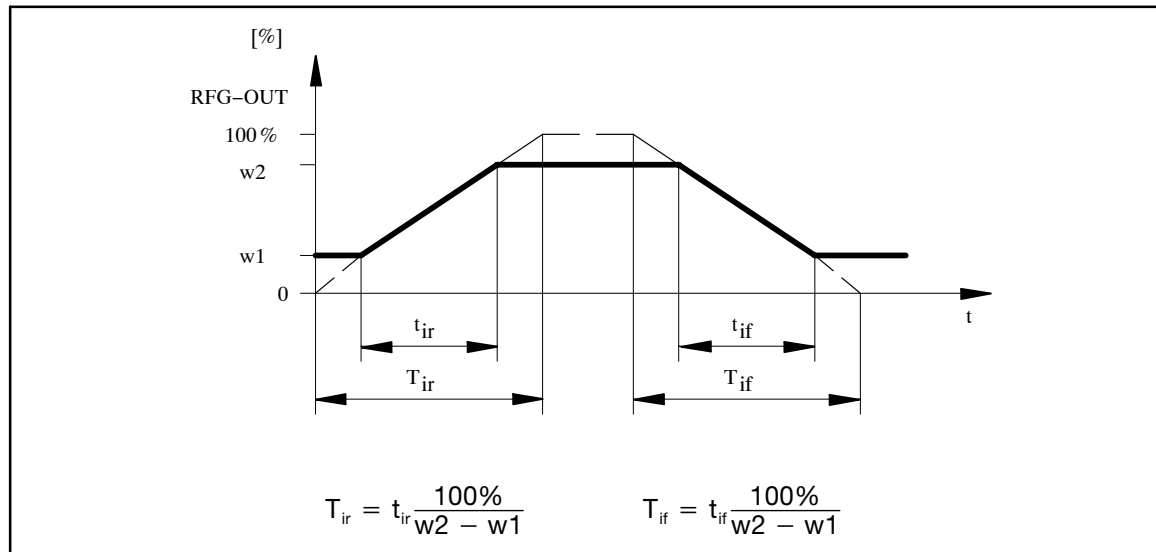

Fig. 3-130 Acceleration and deceleration times of the ramp function generator

- The ramps can be adjusted separately for acceleration and deceleration.
 - Acceleration time t_{ir} with C0332.
 - Deceleration time t_{if} with C0333.
- PCTRL-INACT = HIGH
 - The ramp function generator is immediately set to zero.

3.2.48.3 Value range of the output signal

- The process controller operates in bipolar mode in the default setting.
 - The output value is limited to $\pm 100\%$.
- The function can be set to unipolar mode under C0337.
 - The output value is limited to $0 \dots +100\%$.

3.2.48.4 Evaluation of the output signal

- The output signal can be evaluated after the limitation block via PCTRL-INFLU.
 - The process controller can be hidden or unhidden with this evaluation.
 - The calculation is done according to the following formula:
 $100\% \text{ (PCTRL-OUT)} = 100\% * 100\% \text{ (PCTRL-INFLU)}$.

3.2.48.5 Deactivation of the process controller

- PCTRL-INACT = HIGH deactivates the process controller
 - PCTRL-OUT is set to zero.
 - The I-component is set to zero.
 - The ramp function generator is set to zero.

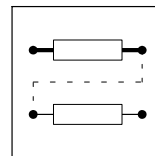

3.2.49 Angle addition block (PHADD)

Purpose

Adds or subtracts angle signals depending on the input used.

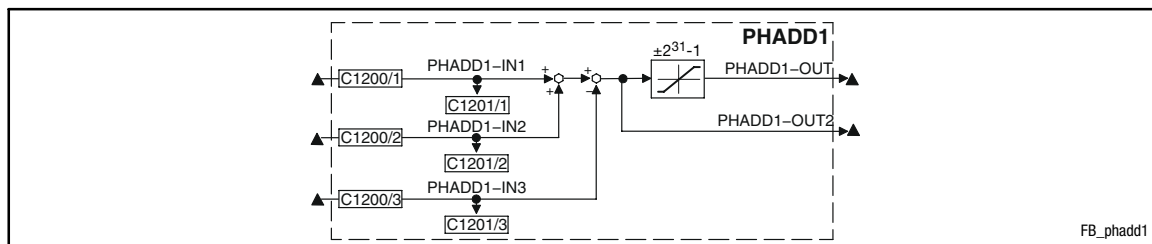
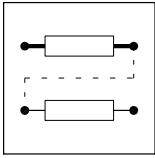

Fig. 3-131 Angle addition block (PHADD1)

Name	Signal			Source			Note
	Type	DIS	DIS format	CFG	List	Lenze	
PHADD1-IN1	ph	C1201/1	dec [inc]	C1200/1	3	1000	Addition input
PHADD1-IN2	ph	C1201/2	dec [inc]	C1200/2	3	1000	Addition input
PHADD1-IN3	ph	C1201/3	dec [inc]	C1200/3	3	1000	Subtraction input
PHADD1-OUT	ph	-	-	-	-	-	Limited to ± 2147483647
PHADD1-OUT2	ph	-	-	-	-	-	-

Function

- Input PHADD1-IN1 is added to input PHADD1-IN2.
- The input PHADD1-IN3 is subtracted from the calculated result.
- Then the result of the subtraction
 - is limited to ± 2147483647 and output at PHADD1-OUT.
 - is output at PHADD1-OUT2 without limitations.



Function library

Function blocks

Angle comparator (PHCMP)

3.2.50 Angle comparator (PHCMP)

Purpose

Compares two angle signals (distances) with each other.

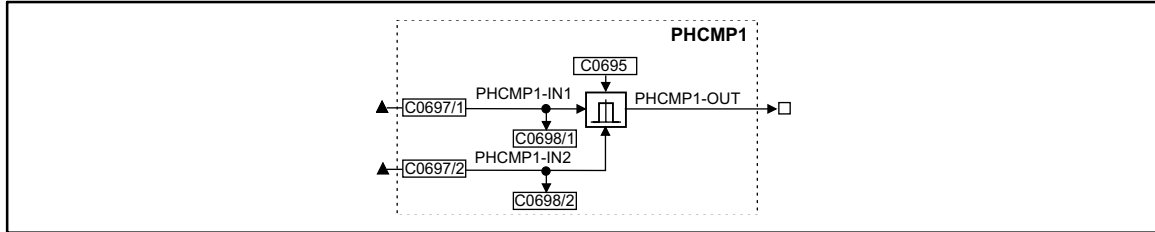

Fig. 3-132 Angle comparator (PHCMP1)

Name	Signal			Source			Note
	Type	DIS	DIS format	CFG	List	Lenze	
PHCOMP1-IN1	ph	C0698/1	dec [inc]	C0697/1	3	1000	Signal to be compared
PHCOMP1-IN2	ph	C0698/2	dec [inc]	C0697/2	3	1000	Comparison value
PHCOMP1-OUT	d	-	-	-	-	-	

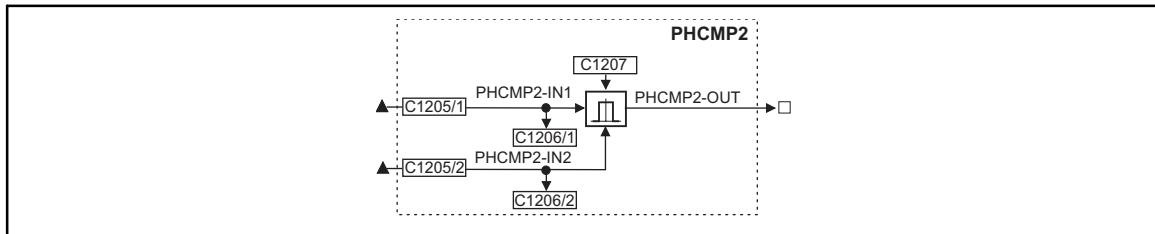

Fig. 3-133 Angle comparator (PHCMP2)

Name	Signal			Source			Note
	Type	DIS	DIS format	CFG	List	Lenze	
PHCOMP2-IN1	ph	C1206/1	dec [inc]	C1205/1	3	1000	Signal to be compared
PHCOMP2-IN2	ph	C1206/2	dec [inc]	C1205/2	3	1000	Comparison value
PHCOMP2-OUT	d	-	-	-	-	-	

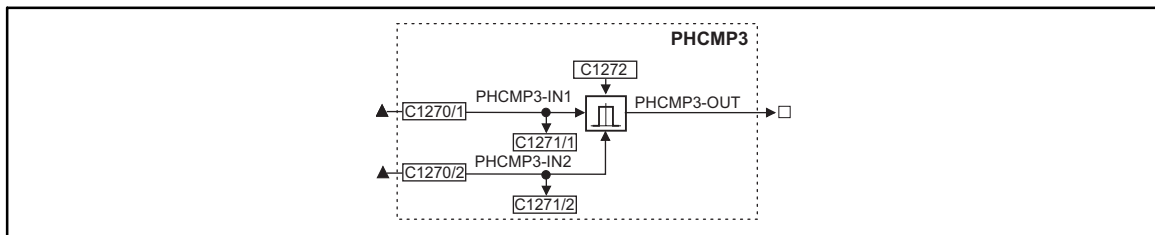

Fig. 3-134 Angle comparator (PHCMP3)

Name	Signal			Source			Note
	Type	DIS	DIS format	CFG	List	Lenze	
PHCOMP3-IN1	ph	C1271/1	dec [inc]	C1270/1	3	1000	Signal to be compared
PHCOMP3-IN2	ph	C1271/2	dec [inc]	C1270/2	3	1000	Comparison value
PHCOMP3-OUT	d	-	-	-	-	-	



Function

Function block	Code	Function	Note
PHCMP1	C0695 = 1	<ul style="list-style-type: none"> If $\text{PHCMPx-IN1} < \text{PHCMPx-IN2}$, PHCMPx-OUT switches to HIGH If $\text{PHCMPx-IN1} \geq \text{PHCMPx-IN2}$, PHCMPx-OUT switches to LOW 	
PHCMP2	C1207 = 1		
PHCMP3	C1272 = 1		
PHCMP1	C0695 = 2	<ul style="list-style-type: none"> If $\text{PHCMPx-IN1} < \text{PHCMPx-IN2}$, PHCMPx-OUT switches to HIGH If $\text{PHCMPx-IN1} \geq \text{PHCMPx-IN2}$, PHCMPx-OUT switches to LOW 	Compares the absolute values of the inputs
PHCMP2	C1207 = 2		
PHCMP3	C1272 = 2		

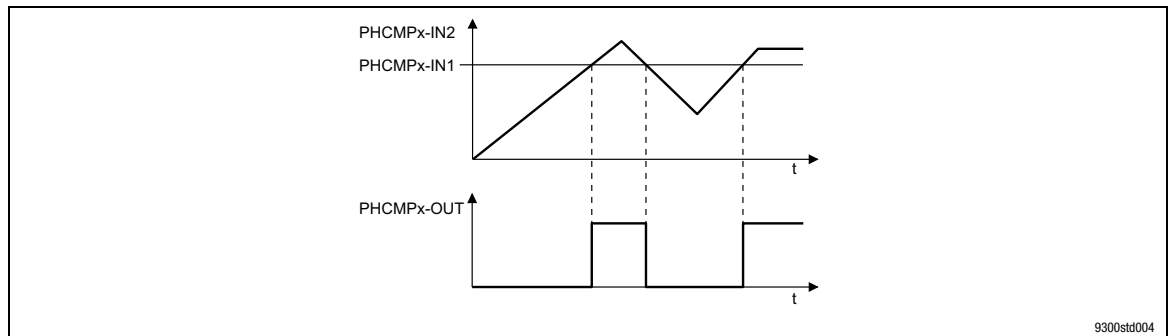

Fig. 3-135

Diagram of the function

9300std004



Function library

Function blocks

Actual angle integrator (PHDIFF)

3.2.51 Actual angle integrator (PHDIFF)

Purpose

Selective addition of a angle signal to the setpoint angle.

It is also possible to compare setpoint and actual angle signals.

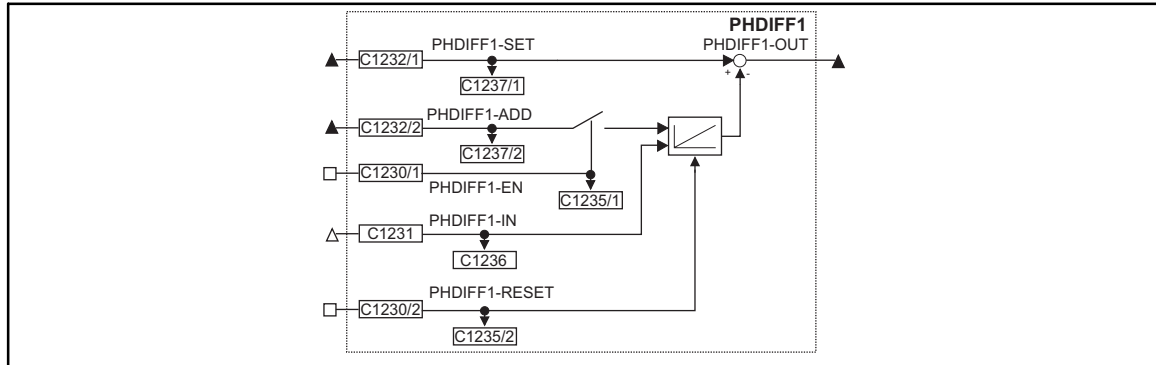

Fig. 3-136

Actual angle integrator (PHDIFF1)

Name	Signal			Source		Note
	Type	DIS	DIS format	CFG	List	
PHDIFF1-IN	phd	C1236	dec [rpm]	C1231	4	-
PHDIFF1-SET	ph	C1237/1	dec [inc]	C1232/1	3	-
PHDIFF1-ADD	ph	C1237/2	dec [inc]	C1232/2	3	-
PHDIFF1-EN	d	C1235/1	bin	C1230/1	2	-
PHDIFF1-RESET	d	C1235/2	bin	C1230/2	2	HIGH = sets the actual angle integrator = 0
PHDIFF1-OUT	ph	-	-	-	-	Without limit

Function

C1230/1 = HIGH

- The speed signal at PHDIFF1-IN is integrated by the actual angle integrator.
- The angle signal at PHDIFF1-ADD is added to the integrated speed signal.
- The result of the actual angle integrator is subtracted from the angle signal at PHDIFF1-SET.

C1230/1 = LOW

- The speed signal at PHDIFF1-IN is integrated by the actual angle integrator.
- The result of the actual angle integrator is subtracted from the angle signal at PHDIFF1-SET.

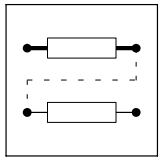

3.2.52 Signal adaptation for angle signals (PHDIV)

Purpose

Power-of-two division or multiplication of angle signals.

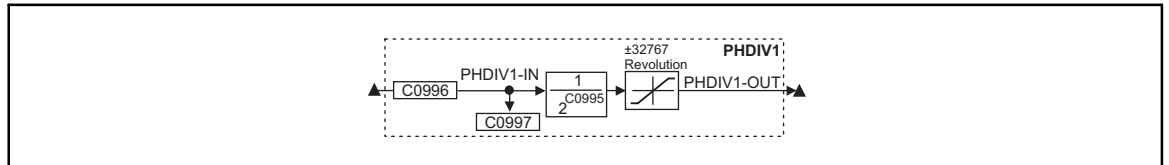

Fig. 3-137

Signal adaptation for angle signals (PHDIV1)

Name	Signal			Source			Note
	Type	DIS	DIS format	CFG	List	Lenze	
PHDIV1-IN	ph	C0997	dec [inc]	C0996	3	1000	
PHDIV1-OUT	ph	-	-	-	-	-	65536 inc = one encoder revolution

Function

- Arithmetic function:

$$\text{PHDIV1-OUT} = \frac{\text{PHDIV1-IN}}{2^{\text{C0995}}}$$

- Positive values in C0995 result in a division.
- Negative values in C0995 result in a multiplication.
- The output value is limited to $\pm(2^{31}-1)$ inc (corresponds to ± 32767 encoder revolutions).
 - If the limit is exceeded, the output is kept at the limit value.



Function library

Function blocks

Phase integrator (PHINT)

3.2.53 Phase integrator (PHINT)

Purpose

Integrates a speed or a velocity to a phase (distance). The integrator can maximally accept ± 32000 encoder revolutions.

PHINT3 can recognise a relative distance.

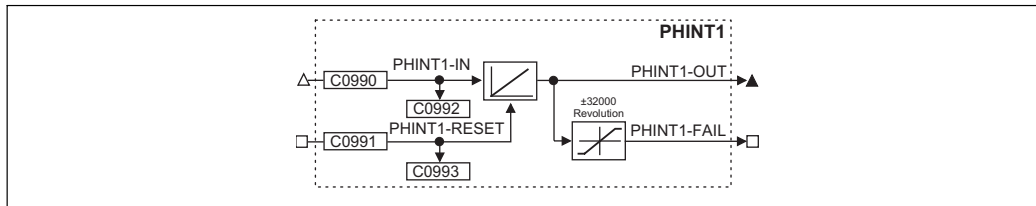

Fig. 3-138

Phase integrator (PHINT1)

Name	Signal			Source		Note
	Type	DIS	DIS format	CFG	List	
PHINT1-IN	phd	C0992	dec [rpm]	C0990	4	1 revolution = 65536 increments
PHINT1-RESET	d	C0993	bin	C0091	2	HIGH = sets the phase integrator to 0 and PHINT1-FAIL = LOW
PHINT1-OUT	ph	-	-	-	-	65536 inc = 1 encoder revolution, overflow is possible
PHINT1-FAIL	d	-	-	-	-	HIGH = overflow

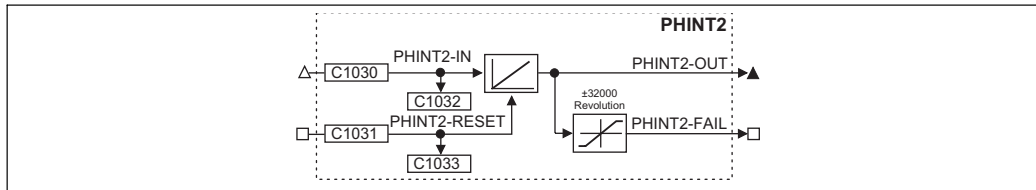

Fig. 3-139

Phase integrator (PHINT2)

Name	Signal			Source		Note
	Type	DIS	DIS format	CFG	List	
PHINT2-IN	phd	C1032	dec [rpm]	C1030	4	1 revolution = 65536 increments
PHINT2-RESET	d	C1033	bin	C1031	2	HIGH = sets the phase integrator to 0 and PHINT2-FAIL = LOW
PHINT2-OUT	ph	-	-	-	-	65536 inc = 1 encoder revolution, overflow is possible
PHINT2-FAIL	d	-	-	-	-	HIGH = overflow

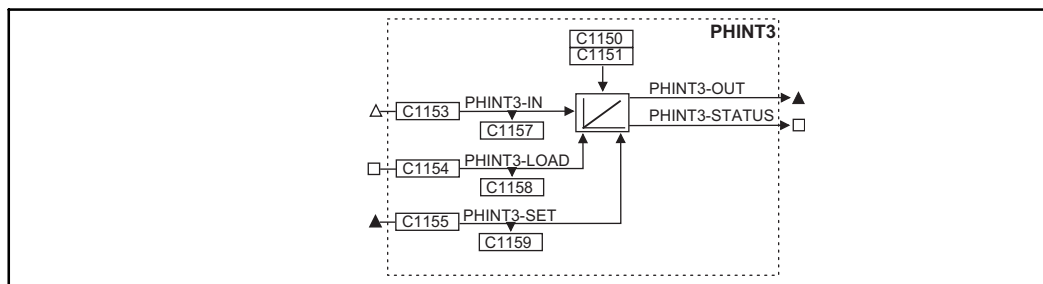
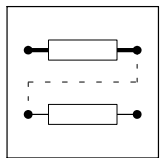
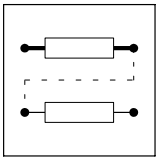

Fig. 3-140 Phase integrator (PHINT3)

Name	Signal			Source		Note
	Type	DIS	DIS format	CFG	List	
PHINT3-IN	phd	C1157	dec [rpm]	C1153	4	1 revolution = 65536 increments
PHINT3-LOAD	d	C1158	bin	C1154	2	HIGH = sets the phase integrator to the input signals of PHINT3-IN and PHINT3-STATUS = LOW
PHINT3-SET	ph	C1159	dec [inc]	C1155	3	
PHINT3-OUT	ph	-	-	-	-	65536 inc = 1 encoder revolution, overflow is possible
PHINT3-STATUS	d	-	-	-	-	HIGH = Overflow or distance is processed

Function

- Constant input value (PHINT1, PHINT2 and PHINT3)
- Input value with sign reversal (PHINT3)
- Scaling of PHINTx-OUT



Function library

Function blocks

Phase integrator (PHINT)

3.2.53.1 Constant input value (PHINT1 and PHINT2)

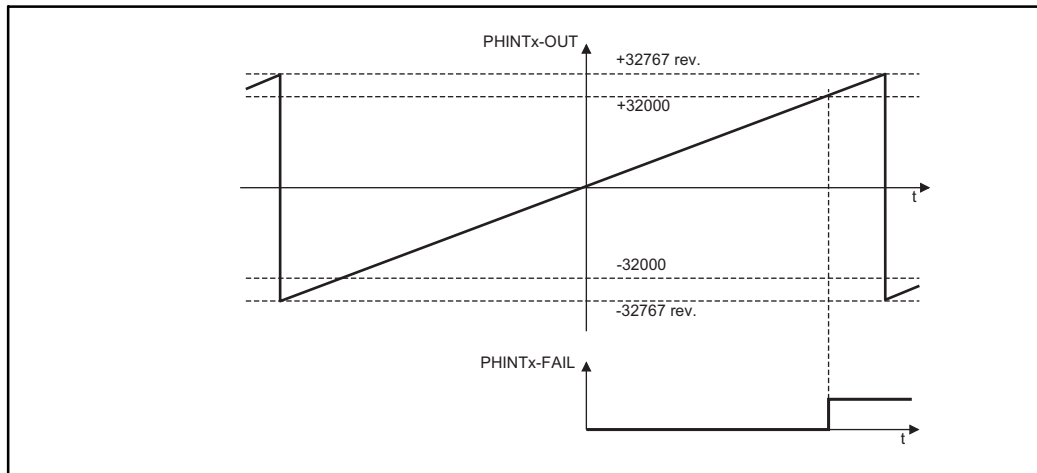
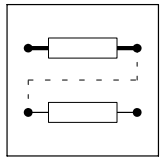

Fig. 3-141 Function of PHINTx with constant input value

- The FB integrates speed or velocity values at PHINTx-IN to a phase (distance).
- PHINTx-OUT outputs the count of the bipolar integrator.
 - A positive value at PHINTx-IN increments the integrator (count is increased).
 - A negative value at PHINTx-IN decrements the integrator (count is reduced).
- If the count exceeds the value of +32767 encoder revolutions (Δ +2147483647 inc)
 - an overflow occurs. The counting is continued with the value -32768.
 - PHINTx-FAIL switches to HIGH when the value \geq +32000 is reached. PHINTx-FAIL = HIGH.
- If the count falls below the value of -32768 encoder revolutions (Δ -2147483648 inc)
 - an overflow occurs. The counting starts at the value +32767.
 - PHINTx-FAIL switches to HIGH when the value \leq -32000 is reached.
- PHINTx-RESET = HIGH
 - sets the integrator to 0
 - sets PHINTx-OUT = 0, as long as a HIGH level is applied to PHINTx-IN.
 - sets PHINTx-FAIL = LOW.



3.2.53.2 Constant input value (PHINT3)

The FB PHINT3 has three modes which can be set via C1150.

Mode C1150 = 2 is in chapter. 3.2.53.3.

C1150 = 0	C1150 = 1
The input PHINT3-LOAD is state-controlled (HIGH level).	The input PHINT3-LOAD is edge-triggered (LOW-HIGH edge).
<ul style="list-style-type: none"> PHINT3-LOAD = HIGH <ul style="list-style-type: none"> The integrator is loaded with the input value at PHINT3-SET. Sets the output PHINT3-STATUS = LOW 	<ul style="list-style-type: none"> PHINT3-LOAD = LOW-HIGH edge <ul style="list-style-type: none"> The integrator is loaded with input value at PHINT3-SET and immediately starts to integrate Sets the output PHINT3-STATUS = LOW

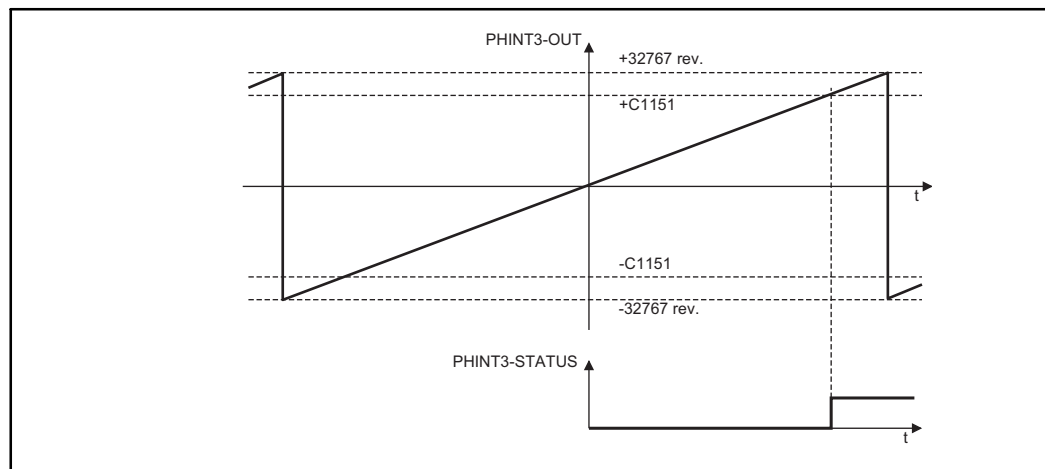

Fig. 3-142

Function of PHINT3 with constant input value at C1150 = 0 and C1150 = 1

- The FB integrates speed or velocity values at PHINT3-IN to a phase (distance).
- PHINT3-OUT outputs the count of the bipolar integrator.
 - A positive value at PHINT3-IN increments the integrator (count is increased).
 - A negative value at PHINT3-IN decrements the integrator (count is reduced).
- If the count exceeds the value of +32767 encoder revolutions (Δ +2147483647 inc)
 - an overflow occurs. The counting is continued with the value -32768,
 - PHINT3-STATUS switches to HIGH when the value of (+) C1151 is reached.
- If the count falls below the value of -32768 encoder revolutions (Δ -2147483648 inc)
 - an overflow occurs. The counting starts at the value +32767,
 - PHINT3-STATUS switches to HIGH when the value of (-) C1151 is reached.



Function library

Function blocks

Phase integrator (PHINT)

3.2.53.3 Input value with sign reversal (PHINT3)

C1150 = 2

The input PHINT3-LOAD is state-controlled (HIGH level).

- PHINT3-LOAD = HIGH
 - The integrator is loaded with the input value at PHINT3-SET.
 - Sets the output PHINT3-STATUS = LOW.

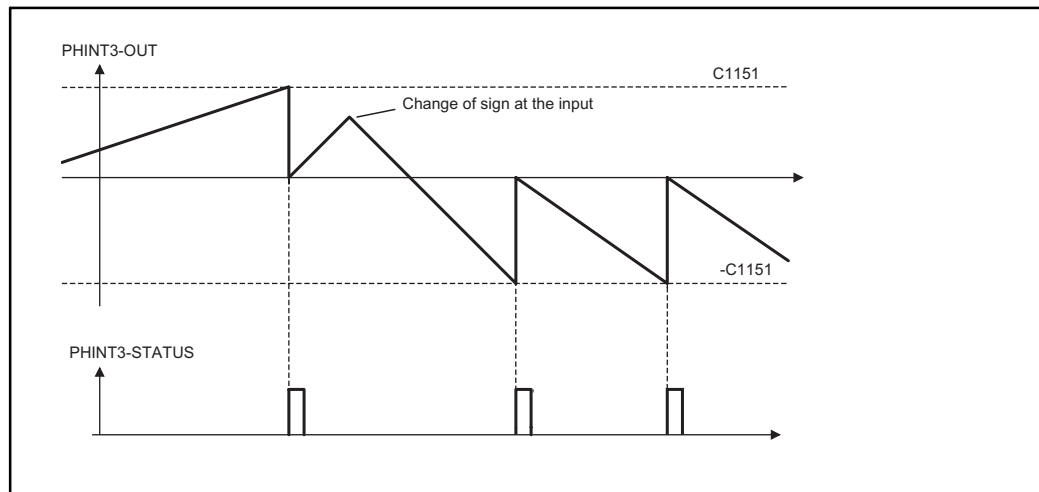

Fig. 3-143 Function of PHINT3 with sign reversal of the input value at C1150 = 2

- The FB integrates speed or velocity values at PHINT3-IN to a phase (distance).
- PHINT3-OUT outputs the count of the bipolar integrator.
 - A positive value at PHINT3-IN increments the integrator (count is increased).
 - A negative value at PHINT3-IN decrements the integrator (count is reduced).
- If the counter content exceeds the value of (+) C1151
 - the value of C1151 is subtracted from the counter content,
 - switches PHINT3-STATUS = HIGH for 1 ms.
- If the counter content falls below the value of () C1151
 - the value of C1151 is added to the counter content,
 - switches PHINT3-STATUS = HIGH for 1 ms.



3.2.53.4 Scaling of PHINTx-OUT

Mathematical description of PHINTx-OUT:

$$\text{PHINTx-OUT}[\text{inc}] = \text{PHINTx-IN}[\text{rpm}] \cdot t[\text{s}] \cdot 65536[\text{inc/rev.}]$$

t Integration time

Example:

You want to determine the count of the integrator with a certain speed at the input and a certain integration time.

- Given values:
 - PHINTx-IN = 1000 rpm
 - t = 10 s
 - Start value of the integrator = 0

- Solution:
 - Conversion of PHINTx-IN:

$$1000 \text{ rpm} = \frac{1000 \text{ rev.}}{60 \text{ s}}$$

- Calculation of PHINTx-OUT:

$$\text{PHINTx-OUT} = \frac{1000 \text{ rev.}}{60 \text{ s}} \cdot 10 \text{ s} \cdot \frac{65536 \text{ inc}}{\text{rev.}} = 10922666 \text{ inc}$$



Function library

Function blocks

Delay element (PT1-1)

3.2.54 Delay element (PT1-1)

Purpose

Filtering and delaying of analog signals.



Fig. 3-144

Delay element (PT1-1)

Name	Signal			Source			Note
	Type	DIS	DIS format	CFG	List	Lenze	
PT1-1-IN	a	C0642	dec [%]	C0641	1	1000	-
PT1-1-OUT	a	-	-	-	-	-	-

Function

- The delay time T is set under C0640.
- The proportional coefficient is fixed at $K = 1$.

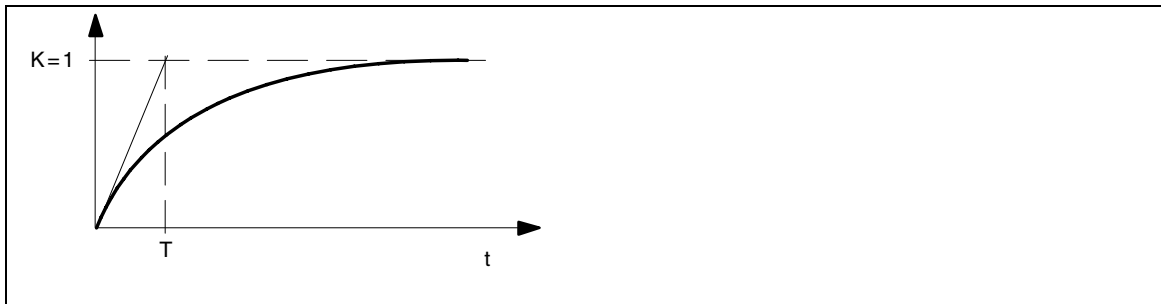
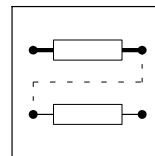

Fig. 3-145

Delay time T of the first order delay element



3.2.55 CW/CCW/QSP linking (R/L/Q)

Purpose

The FB provides a fail-safe connection for the selection of a rotation direction and the QSP function.

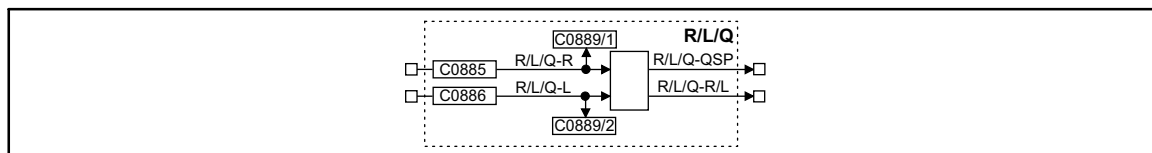

Fig. 3-146

CW/CCW/QSP linking (R/L/Q)

Name	Signal			Source			Note
	Type	DIS	DIS format	CFG	List	Lenze	
R/L/Q-R	d	C0889/1	bin	C0885	2	51	-
R/L/Q-L	d	C0889/2	bin	C0886	2	52	-
R/L/Q-QSP	d	-	-	-	-	-	-
R/L/Q-R/L	d	-	-	-	-	-	-

Function

- After mains connection and simultaneous HIGH level at both inputs, the outputs are set as follows:

Inputs		Outputs	
R/L/Q-R	R/L/Q-L	R/L/Q-R/L	R/L/Q-QSP
1	1	0	1

- The following truth table results if one of the inputs is set to LOW once after mains connection:

Inputs		Outputs	
R/L/Q-R	R/L/Q-L	R/L/Q-R/L	R/L/Q-QSP
0	0	0	1
1	0	0	0
0	1	1	0
1	1	unchanged	unchanged

- If both inputs are set to HIGH during operation, the values at both outputs remain unchanged.



Function library

Function blocks

Homing function (REF)

3.2.56 Homing function (REF)

Purpose

The homing function serves to bring the drive shaft to a defined position.



Note!

At first, select the predefined configuration in C0005, which already contains the REF function block. This ensures that all important signal connections are restored automatically. Then, adapt the configuration to your application.

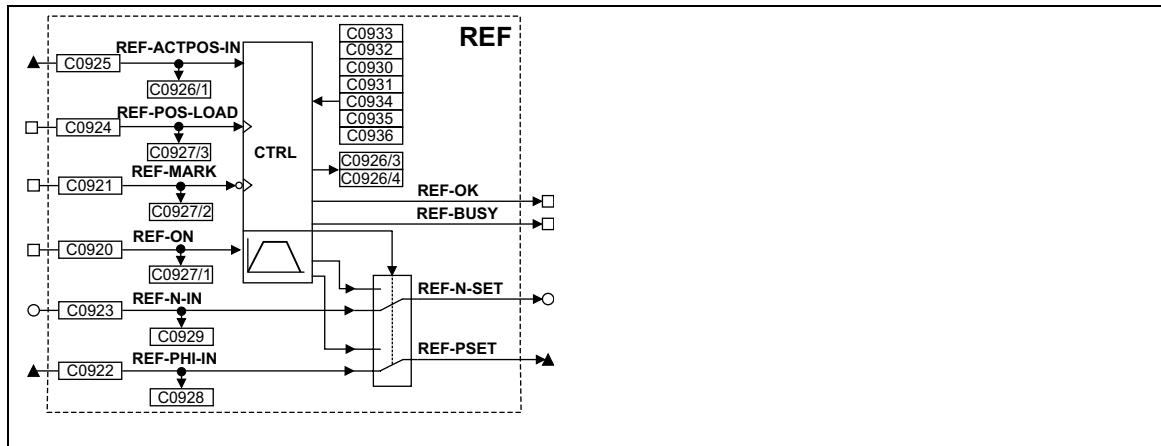

Fig. 3-147

Homing function (REF)

Name	Signal			Source			Note
	Type	DIS	DIS format	CFG	List	Lenze	
REF-N-IN	a	C0929	dec [%]	C0923	1	1000	Speed setpoint in [%] of nmax C0011
REF-PHI-IN	ph	C0928 C0926/2	dec [inc]	C0922	3	1000	Angle setpoint (following error for angle controller in FB MCTRL)
REF-ACTPOS-IN	ph	C0926/1	dec [inc]	C0925	3	1000	Loading value for current position (REF-ACTPOS)
REF-ON	d	C0927/1	bin	C0920	2	1000	HIGH = Start homing
REF-MARK	d	C0927/2	bin	C0921	2	1000	Reference switch
REF-POS-LOAD	d	C0927/3	bin	C0924	2	1000	LOW-HIGH edge = Angle at the input REF-ACTPOS-IN is loaded in REF-ACTPOS (starting value)
REF-OK	d	-	-	-	-	-	HIGH = Homing completed/home position known
REF-BUSY	d	-	-	-	-	-	HIGH = Homing function active
REF-N-SET	a	-	-	-	-	-	Speed setpoint for n-controller
REF-PSET	ph	-	-	-	-	-	Angle setpoint (following error for angle controller in FB MCTRL)

Range of functions

- Profile generator
- Homing modes
- Control via input signals
- Output of status signals

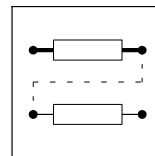

3.2.56.1 Profile generator

The speed profile for homing can be adapted to the application.

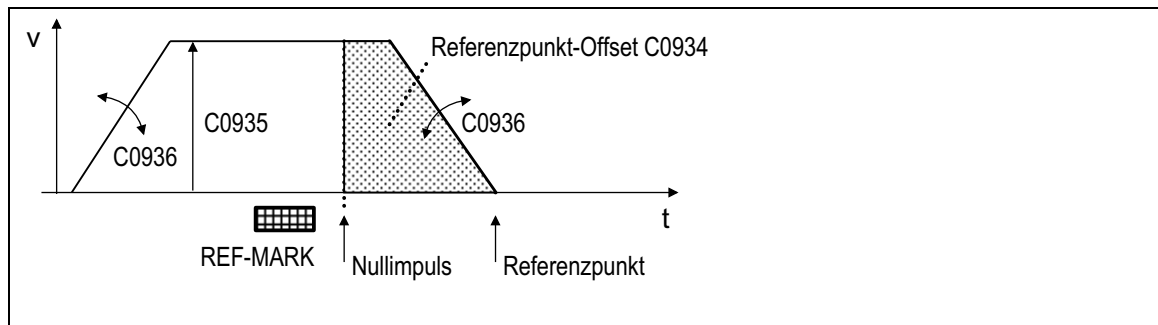

Fig. 3-148

Homing speed profile

Code	Meaning	Note
C0930	Encoder/gearbox factor - numerator (motor speed)	Setting only required if the actual value encoder is not mounted to the motor
C0931	Encoder/gearbox factor - denominator (encoder speed)	
C0933	Selection of the edge of the touch probe signal at X5/E4	The touch probe edge provides the bench mark for the home position offset to the homing modes that include touch probe.
C0934	Home position offset = number of increments after zero pulse	Reference: 65536 inc = 1 revolution. Max. entry: 2140000000 inc
C0935	Homing speed	Input in [%] of nmax (C0011)
C0936	Homing acceleration time, homing deceleration time	Linear ramps
C0926/3	REFC-ACTPOS, actual positioning value	Read only
C0926/4	REFC-TARGET, current target position	Read only

The profile generator calculates the speed profile from the set profile parameters.

- The parameters can be changed during homing.
 - C0935 and C0936 become active if REF-ON = LOW.
- The drive should not be driven at the torque limit (MCTRL-MMAX = HIGH), otherwise the drive cannot follow the speed profile.
 - Prolonging the acceleration / deceleration time until MCTRL-MMAX does not respond anymore.
- The angle controller in the MCTRL function block must be activated.



Function library

Function blocks

Homing function (REF)

3.2.56.2 Homing modes

The home position is defined via

- the homing mode C0932
- the signal edge of the zero pulse or touch probe signal C0933
- the home position offset C0934



Note!

For position feedback via resolver, the zero position (depending on the resolver attachment to the motor) is used instead of the zero pulse. Accordingly, the touch probe angle is used for homing via touch probe.

Homing to zero pulse/zero position with reference switch

The home position is after the negative edge of the reference switch REF-MARK, at the next zero pulse/zero position plus the home position offset:

- Mode 0 (C0932 = 0):
 - Move to the home position in CW rotation.
 - Enter positive home position offset C0934.

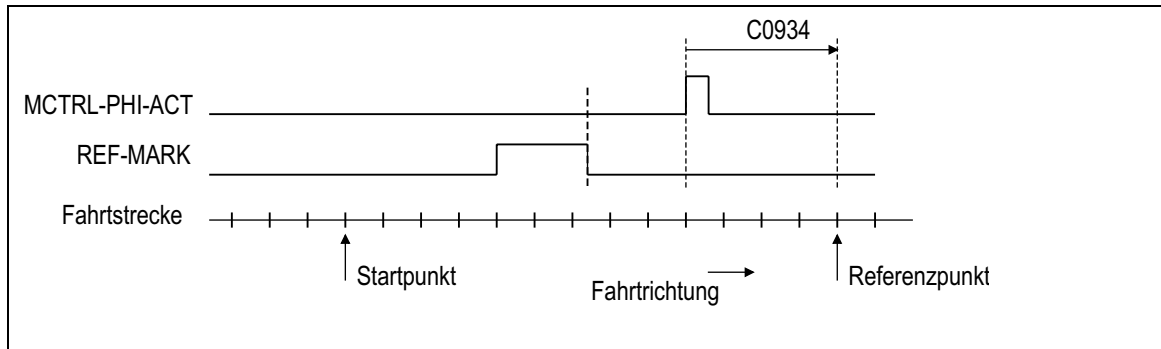

Fig. 3-149 Homing with zero pulse/zero position; approaching the home position in CW rotation

- Mode 1 (C0932 = 1):
 - Move to the home position in CCW rotation.
 - Enter negative home position offset C0934.

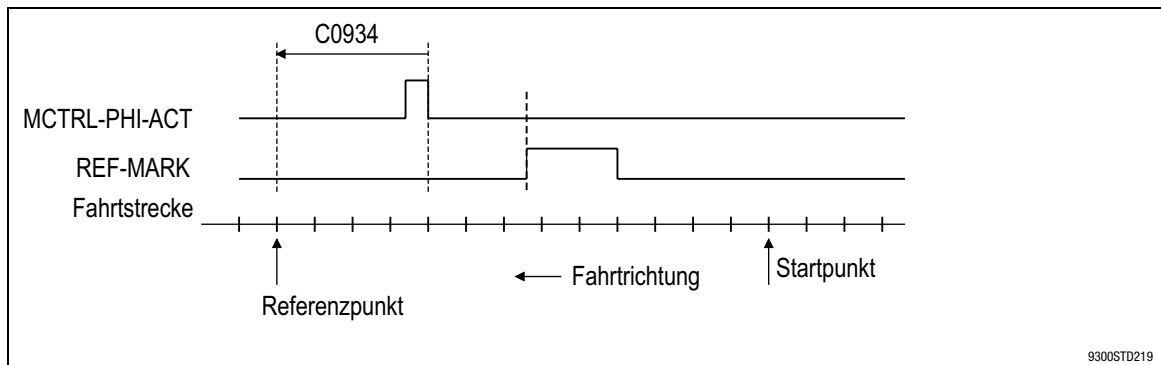
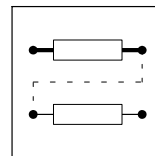

Fig. 3-150 Homing with zero pulse/zero position; approaching the home position in CW rotation



Homing with reference switch and touch probe (TP)

The home position is after the negative edge of the reference switch REF-MARK, at the touch probe signal (terminal X5/E4) plus the home position offset:

- Mode 6 (C0932 = 6):
 - Move to the home position in CW rotation.
 - Enter positive home position offset C0934.

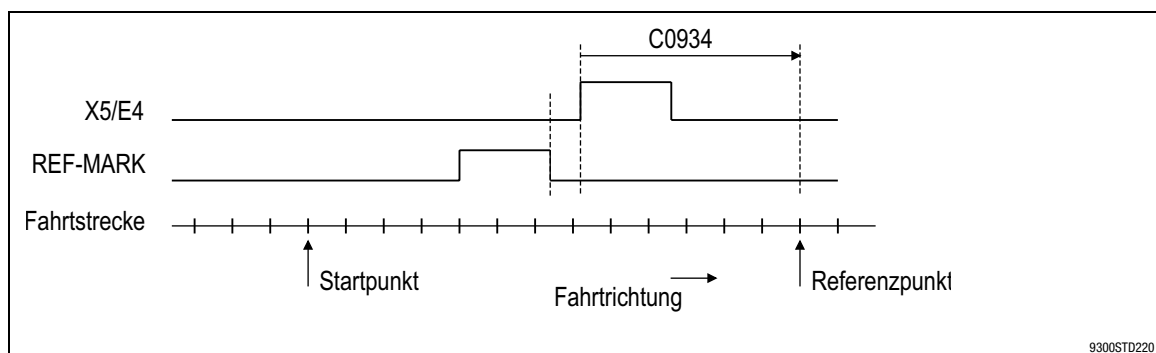

Fig. 3-151

Homing with touch probe; approaching the home position in CW rotation

- Mode 7 (C0932 = 7):
 - Move to the home position in CCW rotation.
 - Enter negative home position offset C0934.

Homing with touch probe (TP)

The home position is at the next touch probe signal (terminal X5/E4) plus the home position offset.

- Mode 8 (C0932 = 8):
 - Move to the home position in CW rotation.
 - Enter positive home position offset C0934.
- Mode 9 (C0932 = 9):
 - Move to the home position in CCW rotation.
 - Enter negative home position offset C0934.



Function library

Function blocks

Homing function (REF)

Direct homing

The home position is on the home position offset.

- Mode 20 (C0932 = 20):
 - Directly after the activation (REF-ON = HIGH), the drive traverses from the actual position (REF-ACTPOS) to the home position.
 - Before that, the actual position (REF-ACTPOS) can be loaded with the input value REF-ACTPOS-IN (see chapter 3.2.56.3).
 - The route and direction of travel results from the actual position (REF-ACTPOS) and the home position offset (C0934) set.

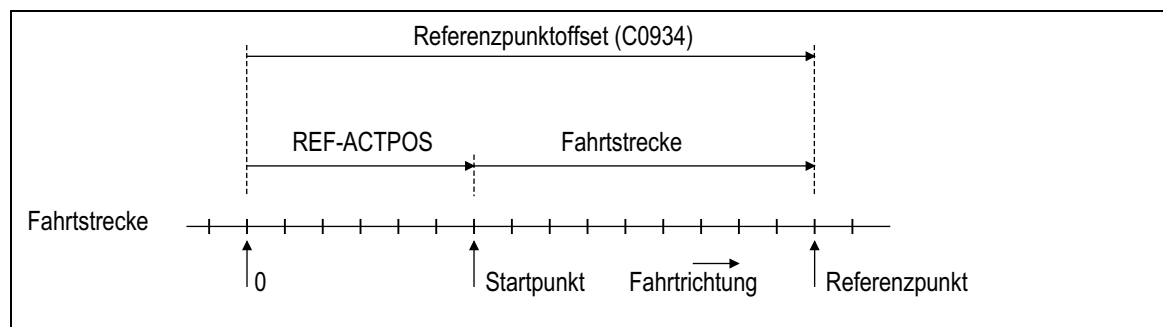

Fig. 3-152 Direct homing; approaching the home position in CW rotation

- Mode 21 (C0932 = 21) is the same as mode 20 but additionally features:
 - The actual position value (REF-ACTPOS) is stored when the mains is disconnected and reloaded when the mains is connected.

3.2.56.3

Control via input signals

- REF-ON = LOW-HIGH edge starts homing:
 - The input must remain on HIGH until the end of the homing process. Homing is aborted if the input is set to LOW before the home position is reached.
- REF-ON = LOW interrupts homing:
 - The drive is decelerated to zero speed along the ramp set under C0936.
 - The inputs REF-N-IN and REF-PHI-IN are switched to the outputs REF-N-SET and REF-PSET.
 - Has no effect if homing is already completed (REF-BUSY = LOW).
- REF-POS-LOAD = LOW-HIGH edge
 - The profile generator accepts the angle at the input REF-ACTPOS-IN as starting value in the actual position value REF-ACTPOS.
 - The function is only active if REF-ON = LOW
 - The function is only active in the modes 20 and 21.



3.2.56.4 Output of status signals

- REF-BUSY = HIGH: the homing function is active:
 - The profile generator is switched to the outputs REF-PSET and REF-N-SET.
- REF-BUSY = LOW: the homing function is not active nor is it completed:
 - The inputs REF-N-IN and REF-PHI-IN are switched to the outputs REF-N-SET and REF-PSET.
- REF-OK = HIGH: homing has been completed successfully:
 - Homing is completed when the setpoint of the profile generator has reached the home position.
 - If a following error is present, it is transferred into the function block DFSET and corrected (see chapter 3.2.56.5), provided that the drive is not operated within the torque limitation.
- REF-OK = LOW:
 - Homing is currently being executed or
 - the home position is no longer known, e.g. due to a failure, or
 - homing has been interrupted.

3.2.56.5 Function block interconnection

- REF-PSET provides the angle setpoint belonging to REF-N-SET (following error) for the angle controller in the function block MCTRL.
 - Faultless homing requires a processing of both signals (REF-PSET and REF-N-SET).
- The homing function must be connected to the function block DFSET (see signal flow diagram for the configurations 5000, 6000 and 7000).
 - Otherwise accumulating angle errors may occur.



Function library

Function blocks

Ramp function generator (RFG)

3.2.57 Ramp function generator (RFG)

Purpose

The ramp function generator limits the rise of signals.

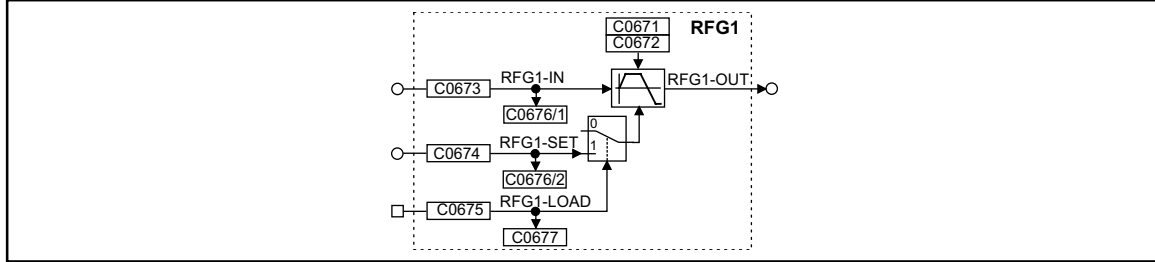

Fig. 3-153

Ramp function generator (RFG1)

Name	Signal			Source			Note
	Type	DIS	DIS format	CFG	List	Lenze	
RFG1-IN	a	C0676/1	dec [%]	C0673	1	1000	-
RFG1-SET	a	C0676/2	dec [%]	C0674	1	1000	-
RFG1-LOAD	d	C0677	-	C0675	2	1000	-
RFG1-OUT	a	-	-	-	-	-	-

Function

- Calculation and setting of the times T_{ir} and T_{if}
- Loading of the ramp function generator

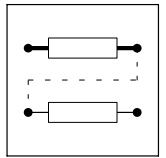

3.2.57.1 Calculation and setting of the times T_{ir} and T_{if}

The acceleration time and deceleration time refer to a change of the output value from 0 to 100 %. The times T_{ir} and T_{if} to be set can be calculated as follows:

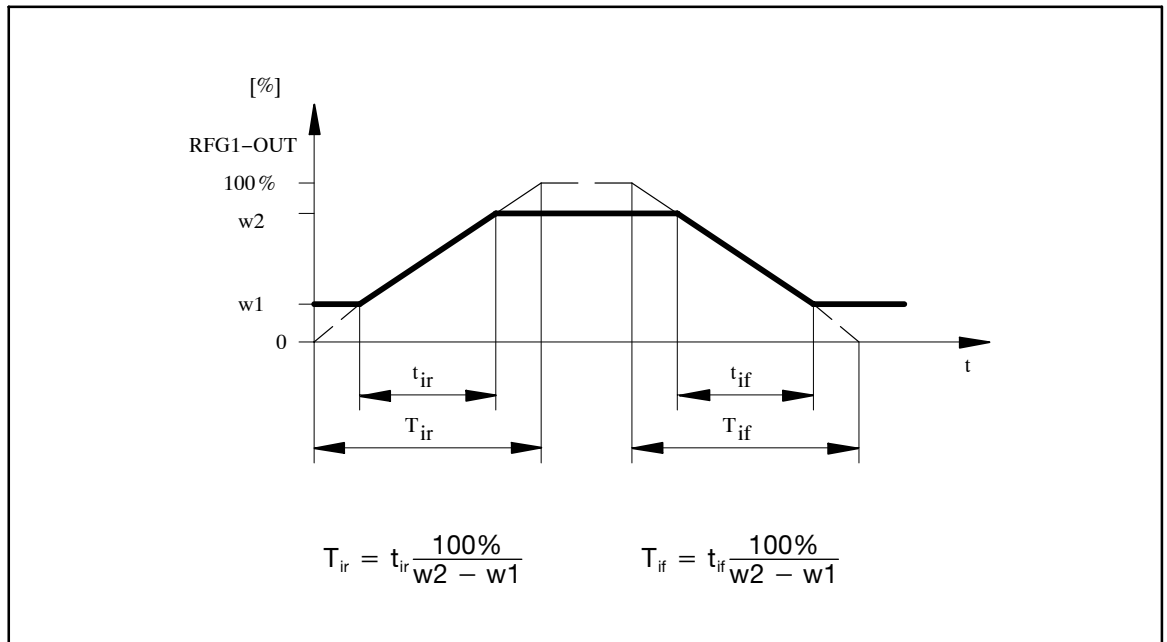

Fig. 3-154 Acceleration and deceleration times of the ramp function generator

t_{ir} and t_{if} are the times desired for the change between w_1 and w_2 . The values for T_{ir} and T_{if} can be set under C0671 and C0672.

3.2.57.2 Loading of the ramp function generator

The ramp function generator can be initialised with defined values via the inputs RFG1-SET and RFG1-LOAD.

- As long as the input RFG1-LOAD = HIGH, the input RFG1-SET is switched to the output.
- If the input RFG1-LOAD = LOW, the ramp function generator accelerates/decelerates from this value to its input value within the set T_i times.

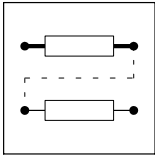

Function library

Function blocks

Sample and hold function (S&H)

3.2.58 Sample and hold function (S&H)

Purpose

The FB can save analog signals. The saved value is also available after mains switching.

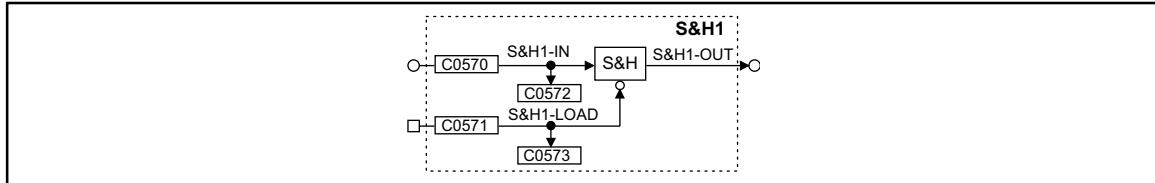

Fig. 3-155

Sample and hold function (S&H1)

Name	Signal			Source			Note
	Type	DIS	DIS format	CFG	List	Lenze	
S&H1-IN	a	C0572	dec [%]	C0570	1	1000	
S&H1-LOAD	d	C0573	bin	C0571	2	1000	LOW = save
S&H1-OUT	a	-	-	-	-	-	

Function

- With S&H1-LOAD = HIGH the signal at the input S&H1-IN is switched to the output S&H1-OUT.
- With S&H1-LOAD = LOW the output S&H1-OUT is disconnected from the input S&H1-IN and outputs the value which was last valid.

Saving in the case of mains disconnection:

- Keep S&H1-LOAD at LOW level when disconnecting the supply voltage (mains, DC bus or terminal 59).
- Keep S&H1-LOAD at LOW level when connecting the supply voltage (mains, DC bus or terminal 59).

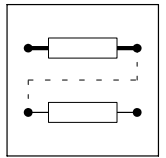

3.2.59 S-shaped ramp function generator (SRFG)

Purpose

The function block serves to direct the input signal via a jerk-limited ramp generator (S shape) in order to avoid setpoint step-changes.

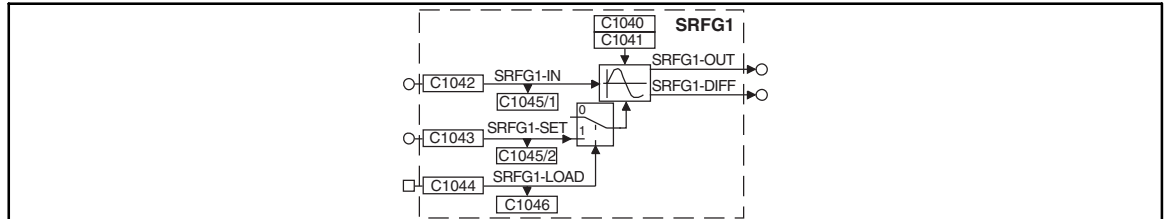

Fig. 3-156 S-shaped ramp function generator (SRFG1)

Name	Signal			Source		Note
	Type	DIS	DIS format	CFG	List	
SRFG1-IN	a	C1045/1	dec [%]	C1042	1	input
SRFG1-SET	a	C1045/2	dec [%]	C1043	1	Starting value for the ramp function generator, will be accepted if SRFG1-LOAD = High
SRFG1-LOAD	d	C1046	bin	C0144	2	HIGH = accepts the value at SRFG1-SET and provides it at SRFG1-OUT; SRFG1-DIFF always remains at 0 %
SRFG1-OUT	a	-	-	-	-	Output limited to ± 100 %
SRFG1-DIFF	a	-	-	-	-	Output limited to ± 100 %, provides the acceleration of the ramp function generator

SRFG1-LOAD

- Via digital input SRFG1-LOAD, the ramp function generator is loaded (set) with the signal from SRFG1-SET.
- This value is immediately accepted, i.e. there is no acceleration/deceleration via S shape (the output skips to this value).
- As long as SRFG1-LOAD = HIGH, the ramp function generator remains inhibited.



Function library

Function blocks

S-shaped ramp function generator (SRFG)

Function

The maximum acceleration and the jerk can be set separately.

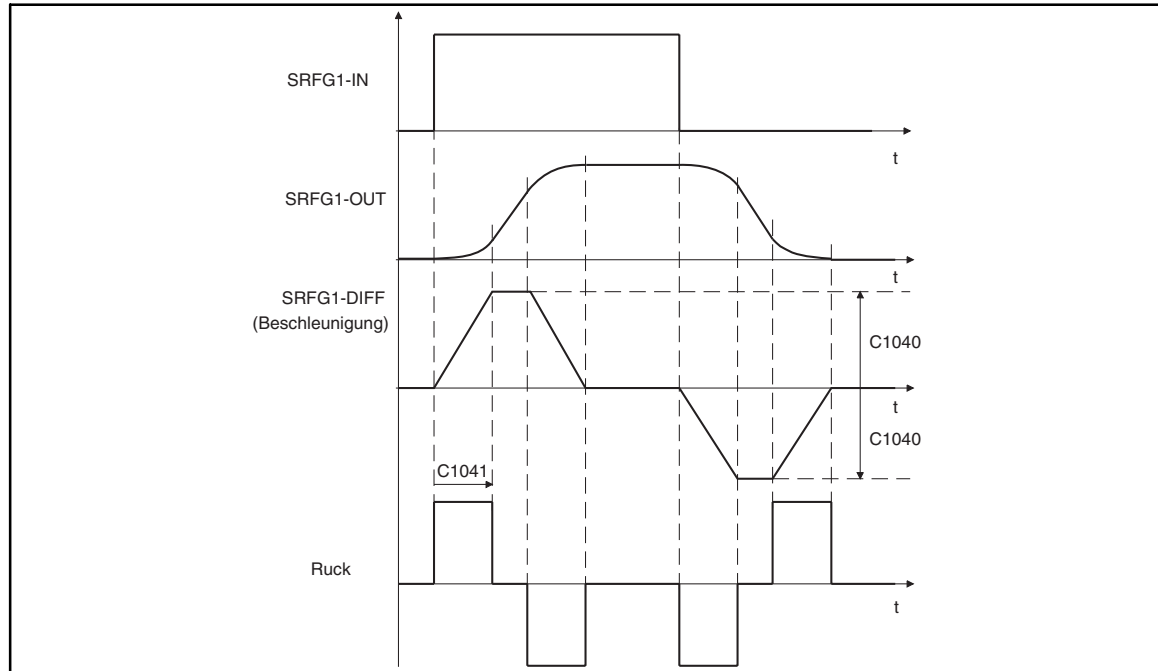
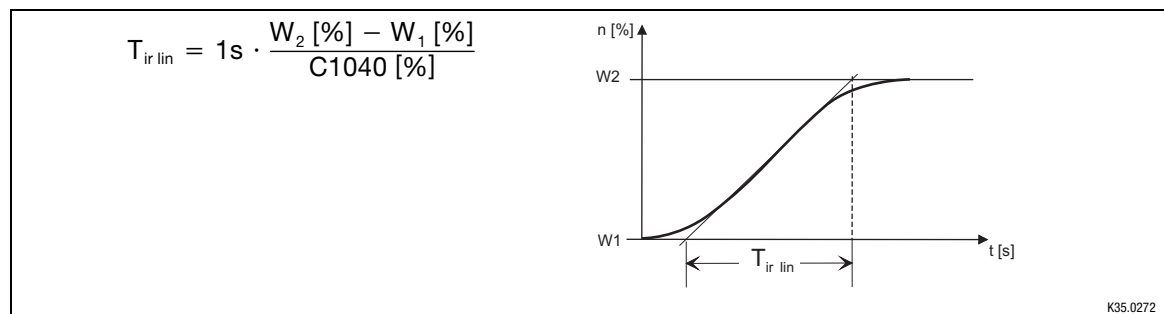

Fig. 3-157

Line diagram

- Max. acceleration:
 - C1040 applies to both the positive and the negative acceleration.
 - Setting according to formula:



- Jerk (C1041):
 - The jerk is selected in [s] until the ramp function generator operates at max. acceleration (see Fig. 3-157).



3.2.60 Output of digital status signals (STAT)

Purpose

The FB evaluates digital signals of function blocks and the status of the controller and passes them on to C0150 and FB AIF-OUT and CAN-OUT1.

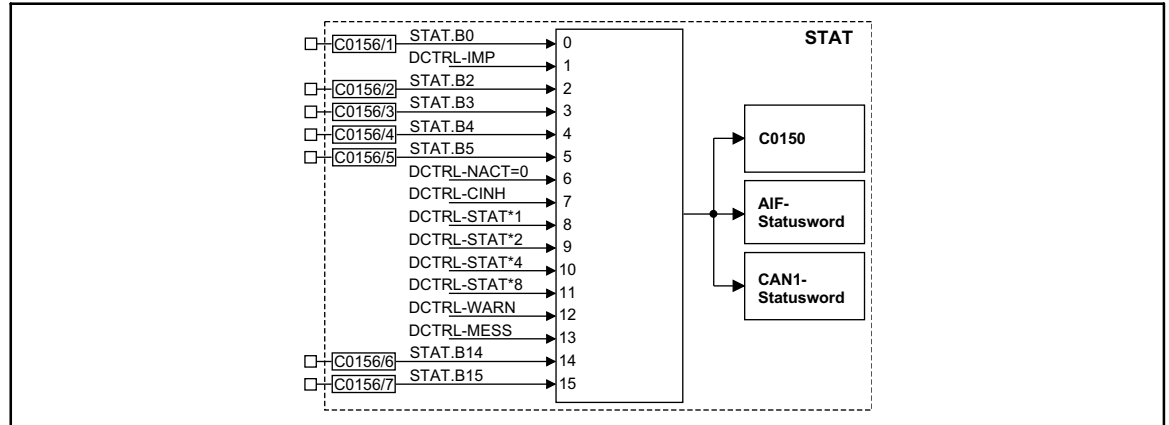

Fig. 3-158 Output of digital status signals (STAT)

Name	Signal			Source			Note
	Type	DIS	DIS format	CFG	List	Lenze	
STAT.B0	d	-	bin	C0156/1	2	2000	
STAT.B2	d	-	bin	C0156/2	2	5002	
STAT.B3	d	-	bin	C0156/3	2	5003	
STAT.B4	d	-	bin	C0156/4	2	5050	
STAT.B5	d	-	bin	C0156/5	2	10650	
STAT.B14	d	-	bin	C0156/6	2	505	
STAT.B15	d	-	bin	C0156/7	2	500	

Function

The status word consists of some fixedly linked (DCTRL-xxxx-) and some freely linkable signal inputs (STAT.Bx).

- Digital signal sources can be freely assigned to the inputs STAT.Bx.
- The corresponding bit in the data word is marked with STAT.Bx (e.g. STAT.B0 for the LSB)
- The status word is transferred to code C0150 and to the function blocks AIF-OUT and CAN-OUT1.
- The inputs with the name DCTRL-xxxx are directly accepted from the function block DCTRL. (3-57)



Function library

Function blocks

Control of a drive network (STATE-BUS)

3.2.61 Control of a drive network (STATE-BUS)

Purpose

The FB controls the drive network to specified states (e.g. trip, quick stop or controller inhibit).

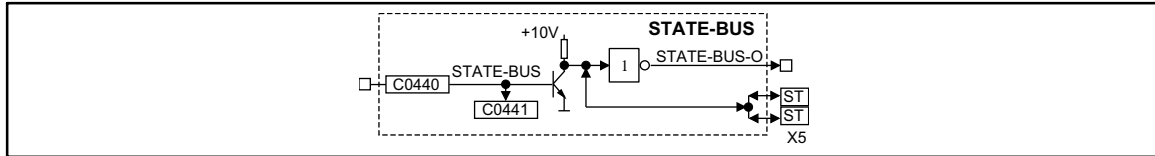

Fig. 3-159 Control of a function block STATE-BUS

Name	Signal			Source			Note
	Type	DIS	DIS format	CFG	List	Lenze	
STATE-BUS	d	C0441	bin	C0440	2	1000	
STATE-BUS-O	d	-	-	-	-	-	
TERMINAL X5/ST	d	-	-	-	-	-	

Function

The STATE-BUS is a device-specific bus system which is designed for Lenze controllers only. The function block STATE-BUS acts on the terminals X5/ST or reacts on a LOW signal at these terminals (multi-master capable).

- Every connected controller can set these terminals to LOW.
- All connected controllers evaluate the signal level at these terminals and control the internally configured function blocks.
- Up to 20 controllers can be connected.



Stop!

Do not apply an external voltage at terminals X5/ST.

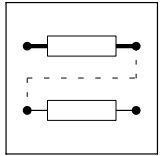

3.2.62 Storage block (STORE)

Purpose

Stores a set phase signal created from a speed signal. The storage process is activated via the TP input Ex.

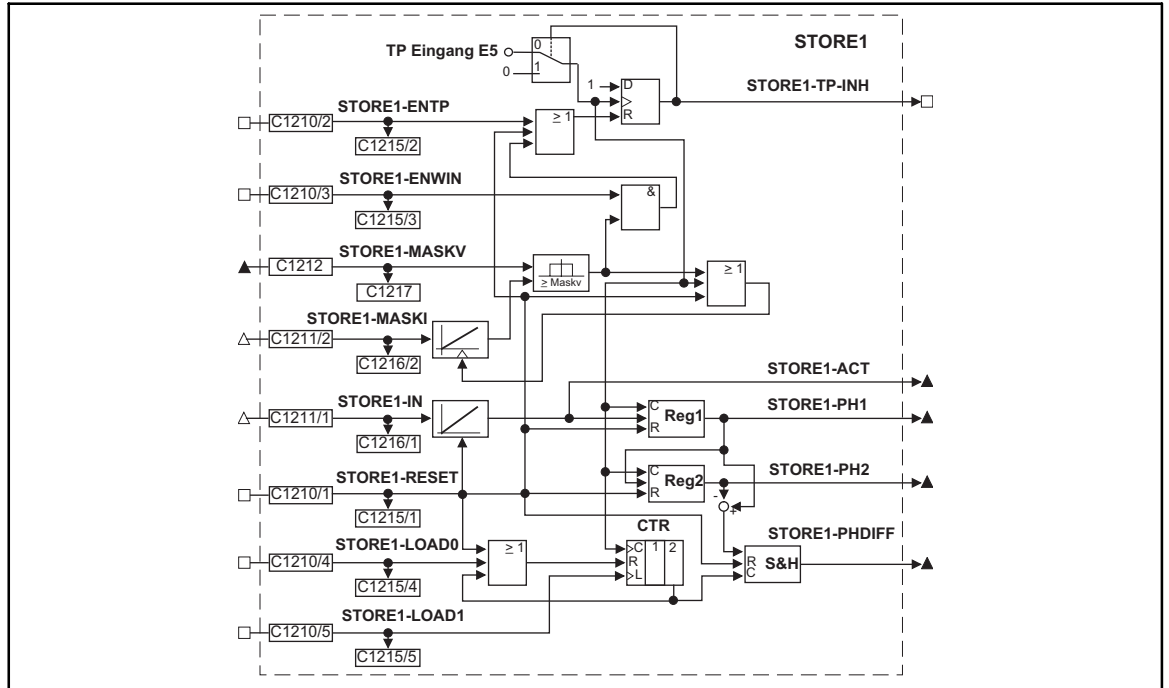

Fig. 3-160 Storage block (STORE1)

Name	Signal			Source			Note
	Type	DIS	DIS format	CFG	List	Lenze	
STORE1-IN	phd	C1216/1	dec [rpm]	C1211/1	4	1000	-
STORE1-RESET	d	C1215/1	bin	C1210/1	2	1000	HIGH = resets all functions
STORE1-ENTP	d	C1215/2	bin	C1210/2	2	1000	HIGH = enables the triggering via the TP input E5
STORE1-MASKI	phd	C1216/2	dec [rpm]	C1211/2	4	1000	-
STORE1-MASKV	ph	C1217	dec [inc]	C1212	3	1000	-
STORE1-ENWIN	d	C1215/3	bin	C1210/3	2	1000	HIGH = signal enable when STORE1-MASKI ≥ STORE1-MASKV
STORE1-LOAD0	d	C1215/4	bin	C1210/4	2	1000	HIGH = resets the counter which controls the output at STORE1-PHDIFF
STORE1-LOAD1	d	C1215/5	bin	C1012/5	2	1000	LOW-HIGH edge = sets the counter = 1 which controls the output to STORE1-PHDIFF



Function library

Function blocks

Storage block (STORE)

Name	Type	DIS	DIS format	CFG	List	Lenze	
STORE1-ACT	ph	-	-	-	-	-	Outputs the currently integrated value
STORE1-PH1	ph	-	-	-	-	-	Outputs the last value stored by X5/E5
STORE1-PH2	ph	-	-	-	-	-	Outputs the last but one value stored by X5/E5
STORE1-PHDIFF	ph	-	-	-	-	-	Outputs the difference of STORE1-PH1 and STORE1-PH2
STORE1-TP-INH	d	-	-	-	-	-	HIGH = triggering via TP input E5 has been done. For another triggering a positive edge must be activated at the input STORE1-ENTP.

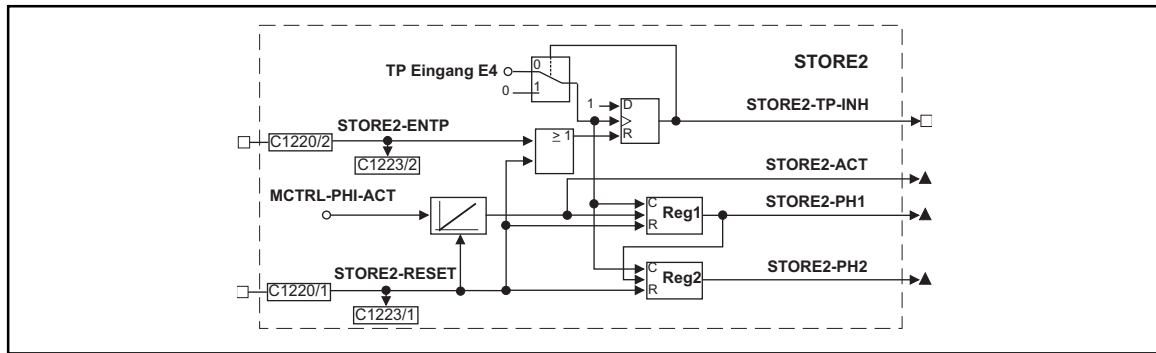

Fig. 3-161

Storage block (STORE2)

Name	Signal			Source			Note
	Type	DIS	DIS format	CFG	List	Lenze	
STORE2-RESET	d	C1223/1	bin	C1220/1	2	1000	HIGH = resets all functions
STORE2-ENTP	d	C1223/2	bin	C1220/2	2	1000	HIGH = enables the triggering via the TP input E4 free
STORE2-ACT	ph	-	-	-	-	-	Outputs the currently integrated value
STORE2-PH1	ph	-	-	-	-	-	Outputs the last value stored by X5/E5
STORE2-PH2	ph	-	-	-	-	-	Outputs the last but one value stored by X5/E5
STORE2-TP-INH	d	-	-	-	-	-	HIGH = triggering via TP input E4 has been done. For another triggering a positive edge must be activated at the input STORE1-ENTP.

Function

- STORE1 control via TP input E5
- Storing STORE1 phase signal
- Storing STORE2 phase signal

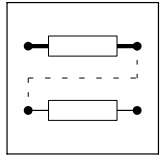

3.2.62.1 STORE1 control via TP input E5

The trigger signal STORE1-TP-INH indicates a triggering done via the TP input E5 with a HIGH signal (LOW-HIGH edge at X5/E5). At the same time it is signalled with STORE1-TP-INH that the triggering is deactivated and must be reset to the active state. This can be done via

- STORE1-RESET = HIGH
- STORE1-ENTP = LOW-HIGH edge
- STORE1-ENWIN = HIGH **and** the comparison of phase signals

Comparison of phase signals

A phase signal is created from the speed signal at STORE1-MASKI and is compared with the phase signal at STORE1-MASKV.

If the condition $| \text{STORE1-MASKI} | \geq \text{STORE1-MASKV}$

is fulfilled,

- the TP input E5 is enabled for the next triggering with STORE1-ENWIN = HIGH,
- the integrator for the speed signal at STORE1-MASKI is reset.

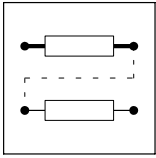

Function library

Function blocks

Storage block (STORE)

3.2.62.2 Storing STORE1 phase signal

A phase signal is created from a speed signal at STORE1-IN. The following sequence shows, in addition to storing, the options of signal output

- The actual phase signal is output at STORE1-ACT.
- 1. A LOW-HIGH edge at the TP input E5 stores the last phase signal and outputs it at STORE1-PH1.
- 2. STORE1-ENTP = LOW-HIGH edge enables the TP input E5 for the next triggering.
- 3. A renewed LOW-HIGH edge at the TP input E5 stores the last phase signal.
 - STORE1-PH1 outputs this last phase signal.
 - STORE1-PH2 outputs the last but one phase signal.
 - STORE1-PHDIFF outputs the difference of STORE1-PH1 and STORE1-PH2.
- STORE1-RESET = HIGH resets memory, counter and integrators and activates the TP input for triggering.

Output of the difference between both phase signals stored

- A two-stage counter controls the output to STORE1-PHDIFF.
- Every second triggering via the TP input results in a new output to STORE1-PHDIFF.
- STORE1-LOAD0 = HIGH resets the counter.

Additional control

1. STORE1-LOAD1 = LOW-HIGH edge, sets the counter to the first stage (preparation for the output to STORE1-PHDIFF).
2. Triggering via TP input E5 sets the counter to the second stage (output to STORE1-PHDIFF is done).



Tip!

If STORE1-LOAD1 is set cyclically, STORE1-PHDIFF outputs a new difference signal after every triggering.

3.2.62.3 Storing STORE2 phase signal

A phase signal is created from a speed signal at MCTRL-PHI-ACT. The following sequence shows, in addition to storing, the options of signal output.

- The actual phase signal is output to STORE2-ACT.
- 1. A LOW-HIGH edge at the TP input E4 stores the last phase signal and outputs it at STORE2-PH1.
- 2. STORE2-ENTP = LOW-HIGH edge activates the TP input E4 for the next triggering.
- 3. A renewed LOW-HIGH edge at the TP input E4 stores the last phase signal.
 - STORE2-PH1 outputs this last phase signal.
 - STORE2-PH2 outputs the last but one phase signal.
- STORE2-RESET = HIGH resets the memory and integrator and activates the TP input E4 for triggering.

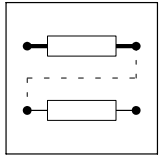

3.2.63 Multi-axis synchronisation (SYNC1)

Purpose

Synchronises the control program cycle of the drives to the cycle of a master control.

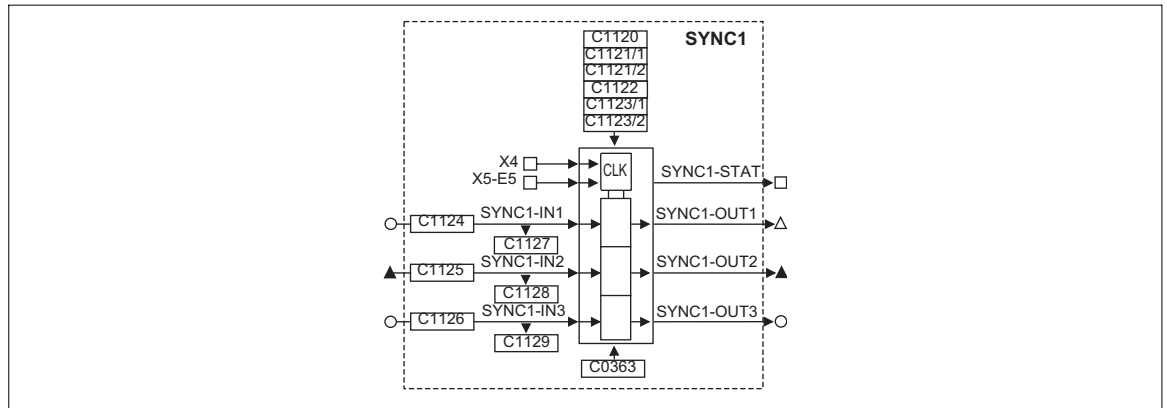

Name	Signal			Source			Note
	Type	DIS	DIS format	CFG	List	Lenze	
SYNC1-IN1	a	C1127	dec [inc]	C1124	1	1000	-
SYNC1-IN2	ph	C1128	dec [inc]	C1125	3	1000	-
SYNC1-IN3	a	1129	dec	C1126	1	1000	-
SYNC1-STAT	d	-	-	-	-	-	After the synchronisation is completed, SYNC1-STAT switches to HIGH. If the synchronisation is quit, SYNC1-STAT switches to LOW.
SYNC1-OUT1	phd	-	-	-	-	-	Cannot be used for angle-accurate speed/angle difference transmission
SYNC1-OUT2	ph	-	-	-	-	-	With interpolation, for cyclically synchronised position information
SYNC1-OUT3	a	-	-	-	-	-	With interpolation, for analog values



Function library

Function blocks

Multi-axis synchronisation (SYNC1)

Function

- Possible axis synchronisations (chapter 3.2.63.1)
- Cycle times (chapter 3.2.63.2)
- Phase displacement (chapter 3.2.63.3)
- Synchronisation window for synchronisation via terminal (SYNC WINDOW) (chapter 3.2.63.4)
- Correction value of phase controller (SYNC CORRECT) (chapter 3.2.63.5)
- Fault indications (chapter 3.2.63.6)
- Configuration examples (chapter 3.2.63.7)
- Scaling (chapter 3.2.63.8)

3.2.63.1 Possible axis synchronisations

Operating mode

Code	Value	Function
C1120	0	FB without function. Assigns the data at the inputs directly to the outputs.
	1	CAN Sync active Synchronises the controllers to the sync telegram of the system bus.
	2	Terminal Sync active Synchronises the controllers to the sync signal of terminal X5/E5.

Synchronisation time

In addition to certain mains connection and initialisation time of the controller, the FB SYNC1 also requires a synchronisation time.

The synchronisation time depends on

- the baud rate of the system bus (CAN-SYNC),
- the starting time (reception of the first SYNC telegram / signal),
- the time between the SYNC telegrams,
- the SYNC correction factor (C0363),
- the operating mode of the FB SYNC1.



Axis synchronisation via system bus (CAN)

The system bus (CAN) transmits the sync telegram and the process signals.

Application examples:

- Selection of cyclic, synchronised position setpoint information for multi-axis positioning via the system bus (CAN).

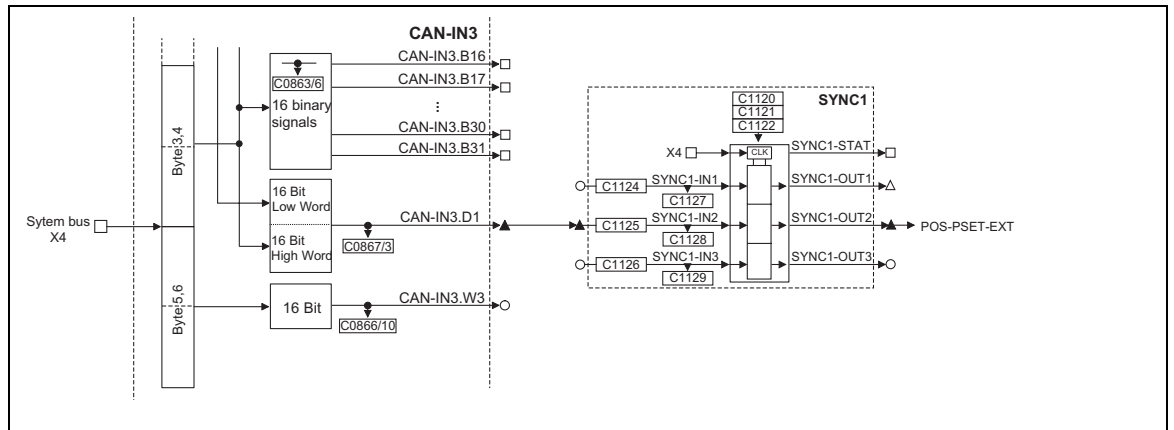

Fig. 3-162

Example for linking the FB SYNC1

Axis synchronisation via terminal control (X5/E5)

The transmission paths for the sync signal and the process signals are separated.

- The process signals are connected via a freely selectable input channel (e. g. AIF interface, DF input).
- The sync signal is injected via terminal X5/E5.

Application examples:

- Selection of cyclic, synchronised position setpoint information for multi-axis positioning via other bus systems (e. g. Interbus).
- Synchronisation of the internal processing cycles of the FB to higher-level process controls.



Function library

Function blocks

Multi-axis synchronisation (SYNC1)

3.2.63.2 Cycle times

Sync cycle time (SYNC CYCLE)

The master (e. g. PLC) sends the periodic sync telegram¹⁾ (sync signal²⁾).

The controllers (slaves) receive the sync telegram and compare the time between two LOW-HIGH edges of the signal with the selected cycle time (1121/1).

The cycle time is entered in integers (1 ms, 2 ms, 3 ms, ...).

- 1) Designation for the synchronisation via system bus (CAN)
- 2) Designation for the synchronisation via terminal

Code	Value	Function
C1121/1	1 ... 13 ms	Definition of the cycle time of the sync telegram (sync signal). Parameters must only be set for the slave. <ul style="list-style-type: none"> • C1120 = 1 (CAN sync) <ul style="list-style-type: none"> – Time between two sync telegrams of the master. Adapt the time to the master SYNC. C0362 indicates the time (CAN sync cycle) for the slave. Set the value in C1121/1 higher than the value in C0362. • C1120 = 2 (terminal SYNC) <ul style="list-style-type: none"> – Time between two sync signals of the master at X5/E5. Adapt the time to the master SYNC. Set the value in C1121/1 \geq the cycle time of the master.

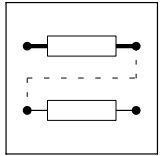

Interpolation cycle time (INTPOL. CYCLE)

The FB interpolates the input signals (C1124, C1125, C1126) between the sync telegrams or sync signals and transmits them to the corresponding output. This ensures an optimum signal course with regard to the internal processing cycle (e. g. minimising signal jumps in the output variable when operating with high sync cycles).

The interpolation is restarted with every sync signal (LOW-HIGH edge).

Code	Value	Function
C1121/2	1 ... 13 ms	Definition of the interpolation cycles/steps <ul style="list-style-type: none"> • C1120 = 1 <ul style="list-style-type: none"> – C1121/2 has no effect. – The interpolation cycles are derived from the sync cycle (C1121/1). • C1120 = 2 <ul style="list-style-type: none"> – The interpolation cycle can be selected irrespective of the sync cycle. – The parameter setting of C1121/2 must be selected according to the cycle of the process value input.

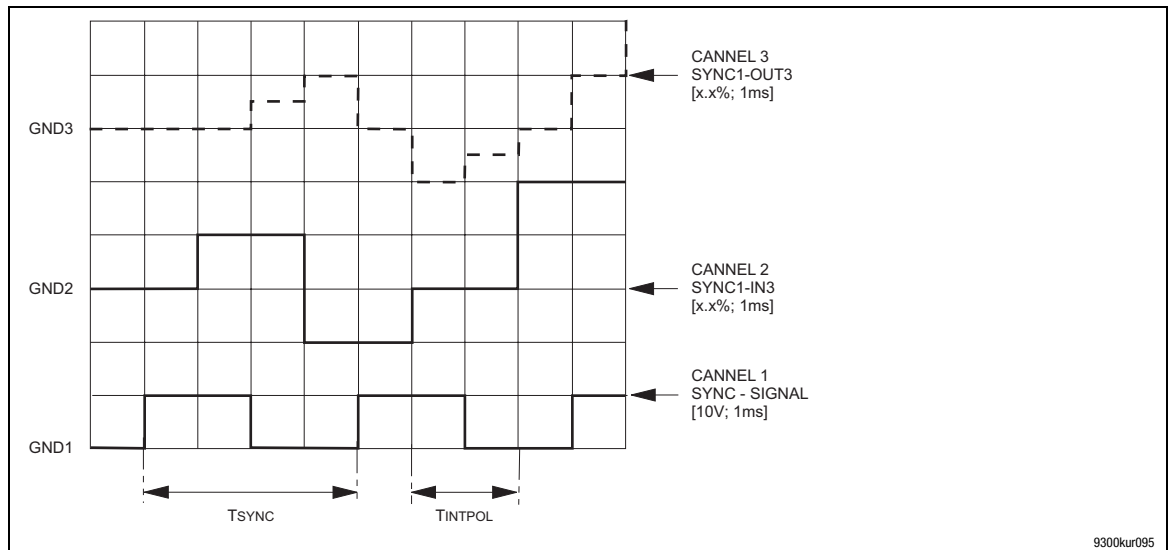

Fig. 3-163

Interpolation example

See Fig. 3-163:

An analog value at SYNC1-IN3 is output as an interpolated value at SYNC1-OUT3.

- Sync cycle (C1121/1) = 4 ms
- Interpol. cycle (C1121/2) = process cycle = 2 ms
- Phase displacement (C1123/1) = 0 ms



Function library

Function blocks

Multi-axis synchronisation (SYNC1)

3.2.63.3 Phase displacement

Phase displacement for synchronisation via system bus (SYNC TIME)

Code	Value	Function
C1122	0 ... 10.000 μ s	<ul style="list-style-type: none"> • C1120 = 1 <ul style="list-style-type: none"> – Phase displacement between the sync telegram and the start of the internal control program. – The parameters are set automatically depending on the parameter setting of the system bus (CAN). • C1120 = 2 <ul style="list-style-type: none"> – C1122 has no effect.

Phase displacement for synchronisation via terminal (PHASESHIFT)

Code	Value	Function
C1123/1	-1.000 ms to +1.000 ms	<ul style="list-style-type: none"> • C1120 = 1 <ul style="list-style-type: none"> – C1123/1 has no effect. • C1120 = 2 <ul style="list-style-type: none"> – Phase displacement between the sync signal and the start of the internal control program (e. g. for compensating the effects of signal propagation delays/dead times for the sync signal of the single slave drives).

3.2.63.4 Time slot for synchronisation via terminal

Code	Value	Function
C1123/2	0 ... 1.000 ms	<ul style="list-style-type: none"> • C1120 = 1 <ul style="list-style-type: none"> – C1123/2 has no effect. • C1120 = 2 <ul style="list-style-type: none"> – Definition of a "time slot" for the LOW-HIGH edges of the sync signal for the slave (defined via C1121/1). – If the sync signal sent by the master is within the "time slot", the SYNC1-STAT is switched to HIGH.

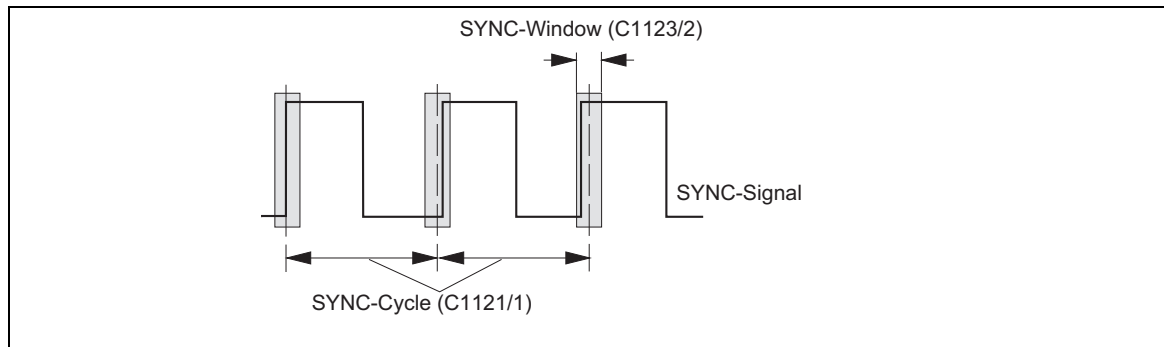

Fig. 3-164

"Time slot" for the LOW-HIGH edges of the sync signal



Tip!

A jitter of up to $\pm 200 \mu$ s on the LOW-HIGH edges of the sync signal is permissible. The size of the jitter affects the parameter setting of the "time slot".

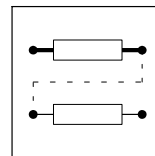

3.2.63.5 Correction value of the phase controller

Code	Value	Function
C0363	1 ... 5	<ul style="list-style-type: none"> • Correction values for C0363 = <ul style="list-style-type: none"> 1 → 0.8 μs 2 → 1.6 μs 3 → 2.4 μs 4 → 3.2 μs 5 → 4.0 μs • C1120 = 1 <ul style="list-style-type: none"> – The value is automatically derived from the internal parameters of the system bus (CAN). • C1120 = 2 <ul style="list-style-type: none"> – Optimising the rise time of the phase controller depending on the frequency of the sync signal. – Increase the value if the frequency of the sync signal decreases. – A stable signal at SYNC1-STAT is an indicator for an optimal parameter setting.

3.2.63.6 Fault indications

Fault indications for the synchronisation via system bus

Fault	Cause	Remedy
P16	Controller was enabled in an unsynchronised state (SYNC1-STAT = LOW)	Only enable the controller when SYNC1-STAT = HIGH
	The time between two sync telegrams is faulty	C0362 indicates the time between two sync telegrams <ul style="list-style-type: none"> • Set the time in C1121/1 to the time in C0362 • Adapt the time interval of the sync telegram from the master

Fault indications for the synchronisation via terminal

Fault	Cause	Remedy
P16	Controller was enabled in an unsynchronised state (SYNC1-STAT = LOW)	Only enable the controller when SYNC1-STAT = HIGH
	Sync signal is missing	Connect sync signal with terminal X5/E5
	The period of the sync signal is not a multiple of 1 ms	Adapt the period
	Sync window is too small	Adapt C1123/2 to the conditions



Function library

Function blocks

Multi-axis synchronisation (SYNC1)

3.2.63.7 Configuration examples

Configuration example CAN-SYNC

Observe the following order for commissioning:

Step	Where	Operation
1.	-	Commission controller and system bus without FB SYNC1
2.	-	Inhibit controller
3.	CAN master	Define the sequence of the telegrams 1. Send new setpoint to all slaves 2. Send sync telegram 3. All slaves must respond
4.	CAN slave drives	Enter FB SYNC1 into the first position of the processing table
5.		Parameterise the signal assignment of the inputs at FB SYNC1
6.		Select C1120 = 1 (sync mode for FB SYNC1)
7.	CAN master	Start communication, send sync telegrams
8.	CAN slave drives	FB SYNC1 (CAN SYNC-CYCLE) • Retrieve cycle time of the SYNC telegram from the master via C0362
9.		FB SYNC1 (SYNC CYCLE) • Set C1121 according to the time interval of the sync telegrams from the control • Set C1121 ≥ C0362
10.		Parameterise the monitoring function P16 via C1290
11.		Connect the output signals of SYNC1 with the required inputs of the corresponding FB
12.		Via FB DIGOUT • Detect signal of SYNC1-STAT
13.		Only enable the controller when SYNC1-STAT = HIGH

Configuration example TERMINAL-SYNC

Observe the following order for commissioning:

Step	Where	Operation
1.	-	Commission controller without FB SYNC1
2.	-	Inhibit controller
3.	Slave drives	Enter FB SYNC1 into the first position of the processing table
4.		Apply sync signal to terminal X5/E5
5.		Parameterise the signal assignment of the inputs at FB SYNC1
6.		Select C1120 = 2 (sync mode for FB SYNC1)
7.	Sync master	Start communication, send sync signals
8.	Slave drives	FB SYNC1 (SYNC CYCLE) • Parameterise the sync cycle time of the sending source via C1121
9.		Parameterise the monitoring function P16 via C1290
10.		Connect the output signals of SYNC1 with the required inputs of the corresponding FB
11.		Via FB DIGOUT • Output signal of SYNC1-STAT
12.		FB SYNC1 (SYNC WINDOW) • Enter the optimal size of the "time slot" via C1123/2 • If the sync signal jitters strongly, increase the "time slot"
13.		Only enable the controller when SYNC1-STAT = HIGH

3.2.63.8 Scaling

The signal at input is transmitted in a scaled form to SYNC1-OUT1.

Scaling formula:

$$\text{SYNC1-OUT1 [rpm]} = \text{SYNC1-IN1 [inc]} \cdot \frac{1875 \text{ rpm}}{2048 \text{ inc}}$$

The inputs SYNC1-IN2 and SYNC1-IN3 are not scaled. The FB transmits the data to SYNC1-OUT2 or SYNC1-OUT3 without any evaluation.

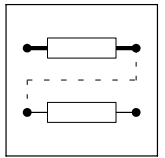

3.2.64 Edge evaluation (TRANS)

Purpose

This function is used to evaluate digital signal edges and convert them into pulses of a defined duration.

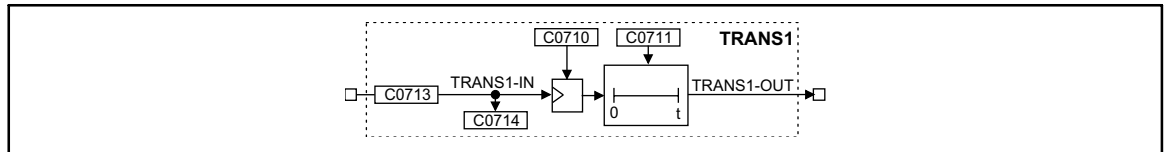

Fig. 3-165 Edge evaluation (TRANS1)

Name	Signal			Source			Note
	Type	DIS	DIS format	CFG	List	Lenze	
TRANS1-IN	d	C0714	bin	C0713	2	1000	-
TRANS1-OUT	d	-	-	-	-	-	-

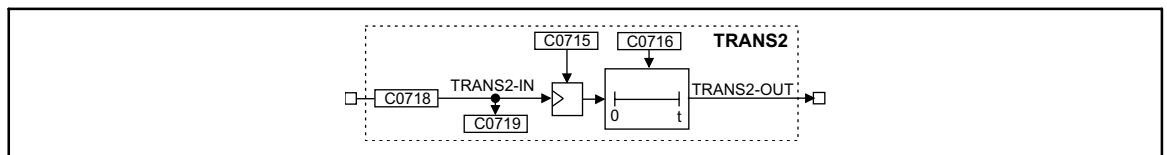

Fig. 3-166 Edge evaluation (TRANS2)

Name	Signal			Source			Note
	Type	DIS	DIS format	CFG	List	Lenze	
TRANS2-IN	d	C0719	bin	C0718	2	1000	-
TRANS2-OUT	d	-	-	-	-	-	-

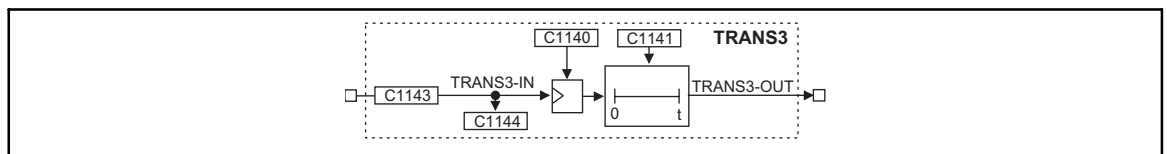

Fig. 3-167 Edge evaluation (TRANS3)

Name	Signal			Source			Note
	Type	DIS	DIS format	CFG	List	Lenze	
TRANS3-IN	d	C1144	bin	C1143	2	1000	-
TRANS3-OUT	d	-	-	-	-	-	-

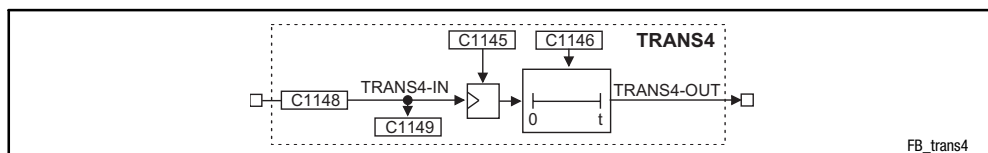
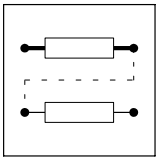

Fig. 3-168 Signal evaluation (TRANS4)

Name	Signal			Source			Note
	Type	DIS	DIS format	CFG	List	Lenze	
TRANS4-IN	d	C1149	bin	C1148	2	1000	-
TRANS4-OUT	d	-	-	-	-	-	-



Function library

Function blocks Edge evaluation (TRANS)

Function

This FB is an edge evaluator which can be retriggered. This FB can react to different events. The following functions can be selected under code C0710 or C0716:

- Positive edge
- Negative edge
- Positive or negative edge

3.2.64.1 Evaluate positive edge

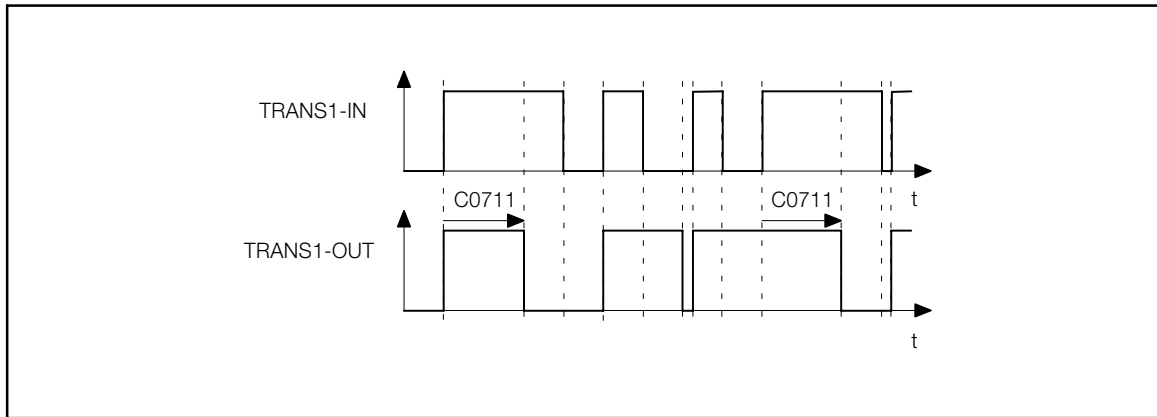

Fig. 3-169 Evaluation of positive edges (TRANS1)

- The output TRANSx-OUT is set to HIGH as soon as a LOW-HIGH edge is sent to the input.
- After the time set under C0711 or C0716 has elapsed, the output changes again to LOW unless there is another LOW-HIGH edge at the input.

3.2.64.2 Evaluate negative edge

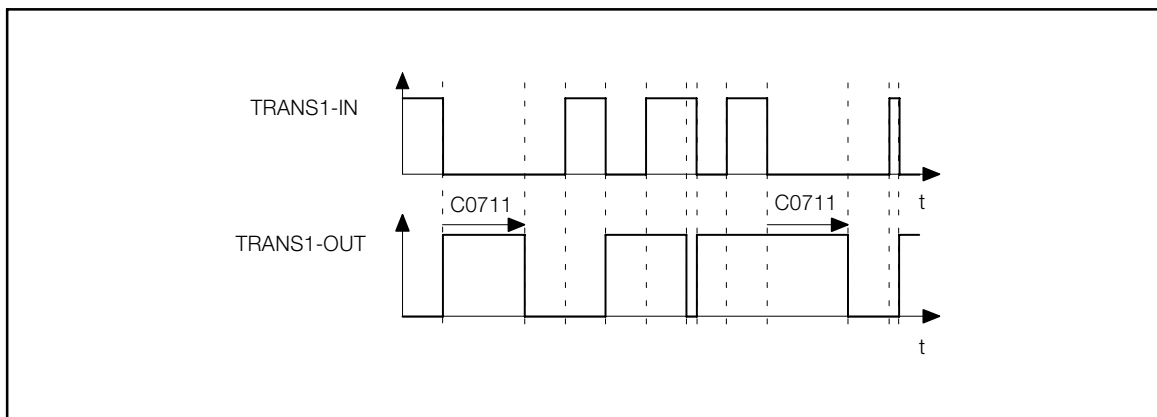
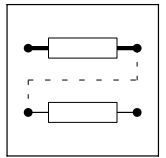

Fig. 3-170 Evaluation of negative edges (TRANS1)

- The output TRANSx-OUT is set to HIGH as soon as a HIGH-LOW edge is sent to the input.
- After the time set under C0711 or C0716 has elapsed, the output changes again to LOW, unless there is another HIGH-LOW edge at the input.



3.2.64.3 Evaluate positive or negative edge

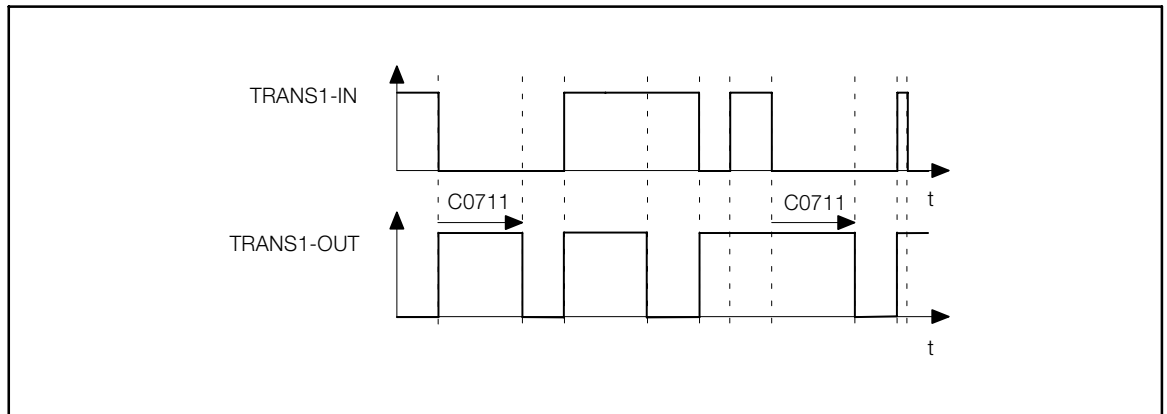
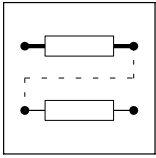

Fig. 3-171 Evaluation of positive and negative edges (TRANS1)

- The output TRANSx-OUT is set to HIGH as soon as a HIGH-LOW edge or a LOW-HIGH edge is sent to the input.
- After the time set under C0711 or C0716 has elapsed, the output changes again to LOW unless there is another HIGH-LOW edge or LOW-HIGH edge at the input.



Function library

Function blocks

Edge evaluation (TRANS)

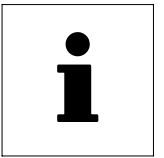

4 Application examples

Contents

4.1	Important notes	4-3
4.2	Speed control (C0005 = 1000)	4-4
4.3	Torque control with speed limitation (C0005 = 4000)	4-7
4.4	Master frequency - Master - Drive (C0005 = 5000)	4-9
4.5	Master frequency bus - slave - drive (C0005 = 6000)	4-12
4.6	Master frequency cascade - slave - drive (C0005 = 7000)	4-14



Application examples



4.1 Important notes

Signal processing in the controller is saved in basic configurations for common applications.

- You can select and activate the basic configurations via C0005 and adapt them with only a few settings to your application (short setup). (📖 2-4)
- The setting of the motor data and the adaptation of the motor control is generally independent of the configuration and is described in chapter "Commissioning".

Configuration	Basic function	
1xxx	Speed control	📖 4-4
4xxx	Torque control with speed limitation	📖 4-7
5xxx	Master for digital frequency coupling	📖 4-9
6xxx	Slave to digital frequency bus	📖 4-12
7xxx	Slave to digital frequency cascade	📖 4-14



Note!

The GDC and the keypad include the most important codes for the basic configurations in the "Short setup" menus.



Application examples

Speed control (C0005 = 1000)

4.2 Speed control (C0005 = 1000)



Tip!

The most important settings can be found in the menu: "Short Setup / Speed mode" of the XT keypad or in the menu "Short setup / Speed mode" in Global Drive Control.

Enter motor type (contains all nameplate data of the motor)

C0173	xxx	Enter UG limit (mains voltage)
C0086	000	Enter motor data manually

Enter maximum motor current

C0022	xxxA	Determine I _{max}
-------	------	----------------------------

Enter controller configuration

C0005	1000	Select speed control
C0025	xxx	Enter feedback system

Speed setpoint settings

C0011	xxx rpm	Determine max. speed
C0012	xxx s	Set acceleration time
C0013	xxx s	Set deceleration time
C0105	xxx s	Set QSP deceleration time

Application parameters

C0070	xxx	V _p n-controller
C0071	xxx	T _n n-controller

Save parameters

C0003	xxx	Save all parameters
-------	-----	---------------------

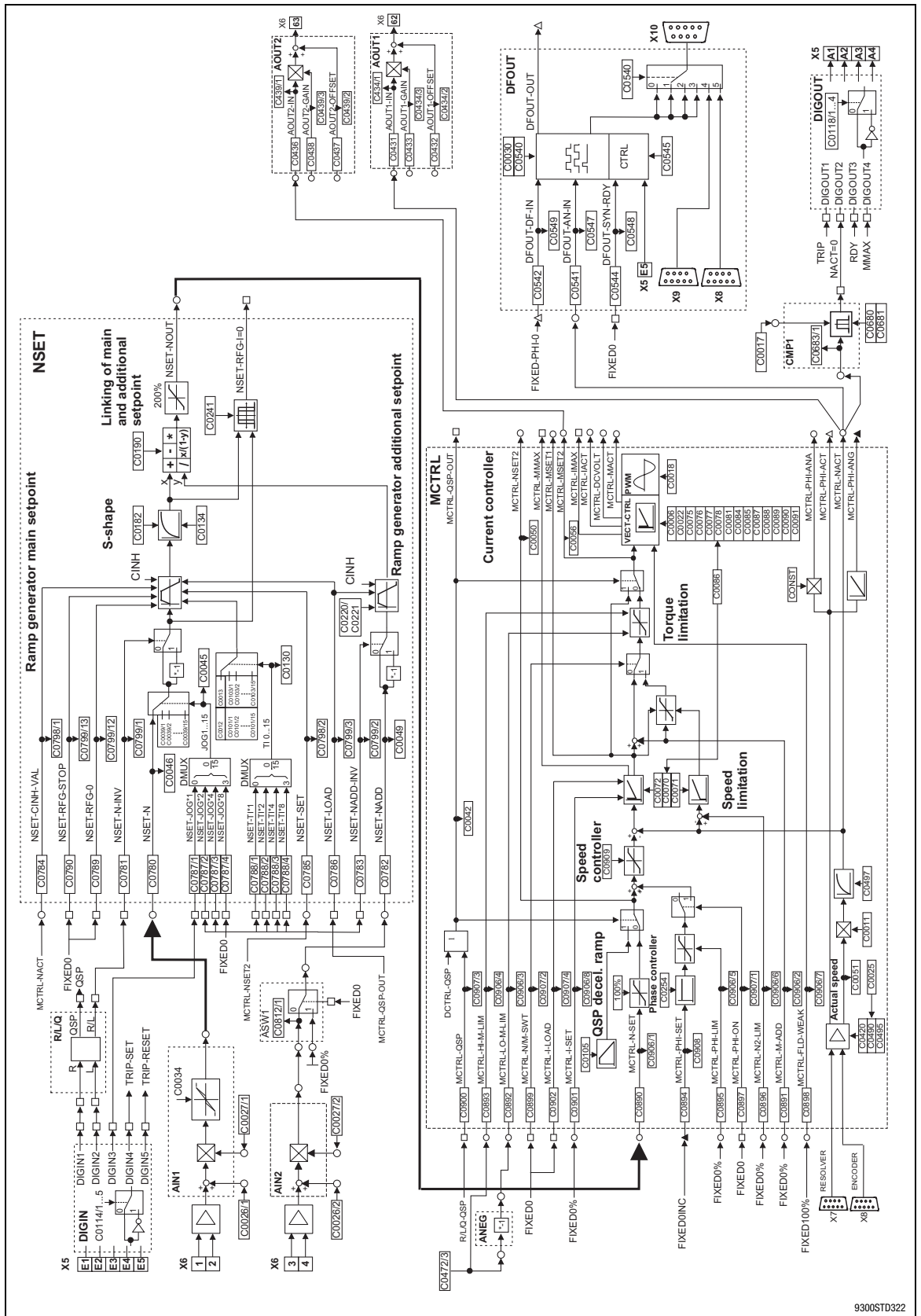

Fig. 4-1

Signal flow diagram for configuration 1000

9300SD322



Application examples

Speed control (C0005 = 1000)

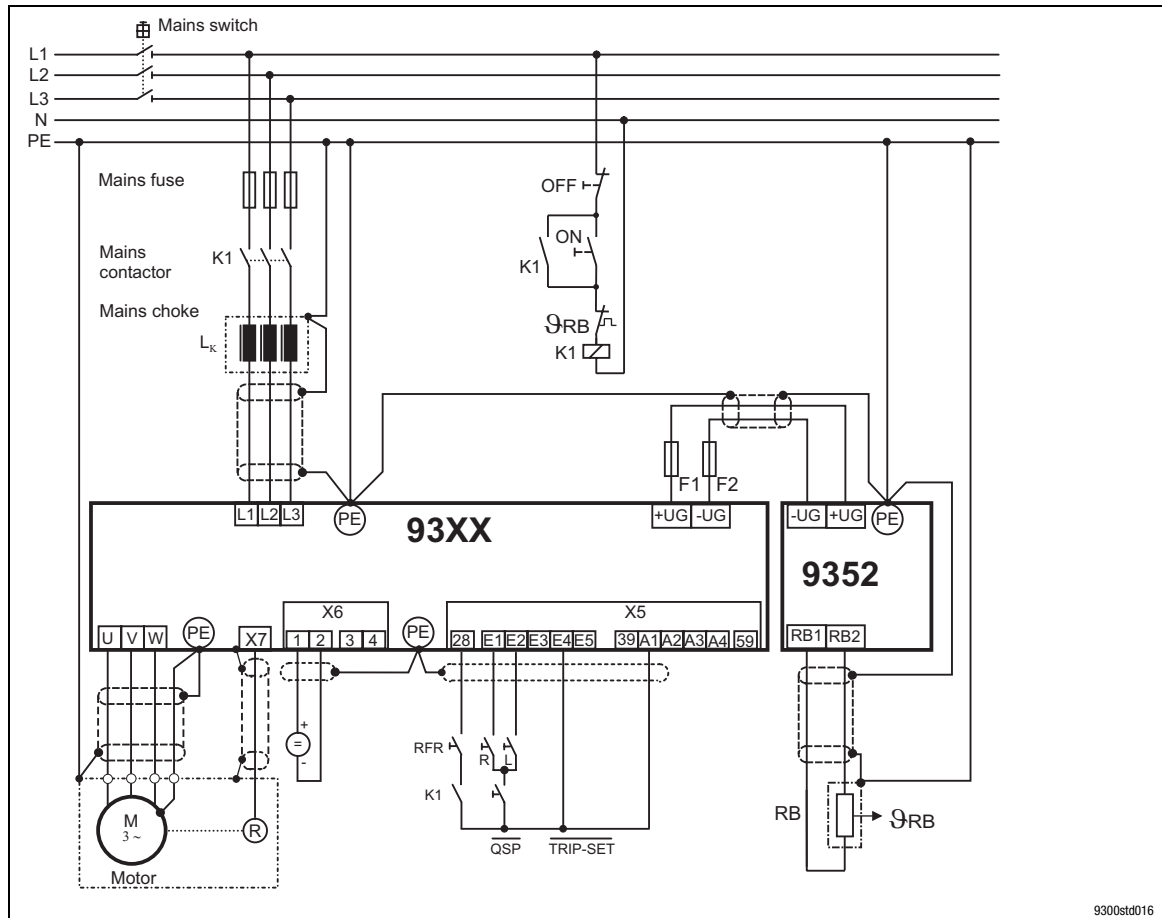

Fig. 4-2

Connection diagram of configuration 1000

9300std016



Tip!

A braking unit is only required if the DC-bus voltage in the 93XX servo inverter exceeds the upper switch-off threshold set in C0173 when operating in generator mode (activation of the monitoring function "OU"). The braking unit prevents "OU" from being activated by converting the kinetic energy of the machine into heat which prevents the DC-bus voltage from exceeding the upper switch-off threshold.



4.3 Torque control with speed limitation (C0005 = 4000)



Tip!

The most important settings can be found in the menu: "Short Setup / Speed mode" of the operating module or in the menu "Short setup / Speed mode" in Global Drive Control.

Enter motor type (contains all nameplate data of the motor)

C0173	xxx	Enter UG limit (mains voltage)
C0086	000	Enter motor data manually

Enter maximum motor current

C0022	xxxA	Determine I _{max}
-------	------	----------------------------

Enter controller configuration

C0005	4000	Select torque control
C0025	xxx	Enter feedback system

Speed setpoint settings

C0011	xxx rpm	Determine max. speed
C0105	xxx s	Set QSP deceleration time

Speed limitation

C0472/4	xxx % n _{max}	Determine lower speed limit
---------	------------------------	-----------------------------

Application parameters

C0070	xxx	V _p n-controller
C0071	xxx	T _n n-controller

Save parameters

C0003	xxx	Save all parameters
-------	-----	---------------------



Application examples

Torque control with speed limitation (C0005 = 4000)

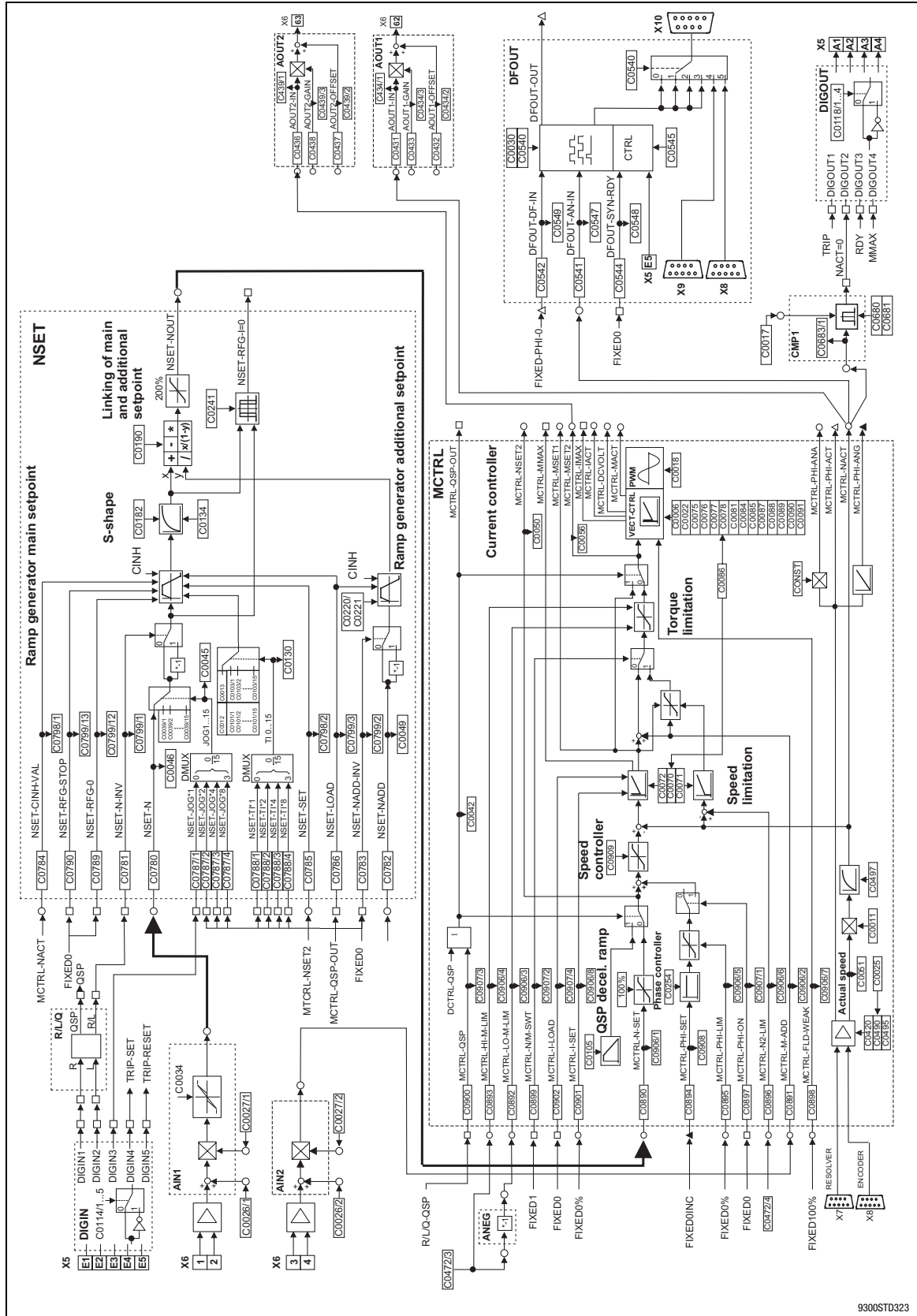

9300STD323

Fig. 4-3 Signal flow diagram of configuration 4000

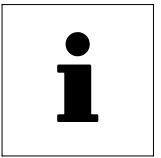

4.4 Master frequency - Master - Drive (C0005 = 5000)



Tip!

The most important settings can be found in the menu: "Short Setup / Speed mode" of the operating module or in the menu "Short setup / Speed mode" in Global Drive Control.

Enter motor type (contains all nameplate data of the motor)

C0173	xxx	Enter UG limit (mains voltage)
C0086	000	Enter motor data manually

Enter maximum motor current

C0022	xxxA	Determine I _{max}
-------	------	----------------------------

Enter controller configuration

C0005	5000	Master frequency - master - general drive
	5900	with emergency stop for the drive system with QSP
C0025	xxx	Enter feedback system

Speed setpoint settings

C0011	xxx rpm	Determine max. speed
C0012	xxx s	Set acceleration time
C0013	xxx s	Set deceleration time
C0105	xxx s	Set QSP deceleration time under C0005 = 5000
C0672	xxx s	Set QSP deceleration time under C0005 = 59xx
C0032	xxx	Numerator of gearbox factor
C0033	xxx	Denominator of gearbox factor
C0473/1	xxx	Numerator of stretching factor
C0533	xxx	Denominator of stretching factor

Application parameters

C0070	xxx	Vp n-controller
C0071	xxx	Tn n-controller
C0254	xxx	Gain of the angle controller

Save parameters

C0003	xxx	Save all parameters
-------	-----	---------------------



Application examples

Master frequency - Master - Drive (C0005 = 5000)

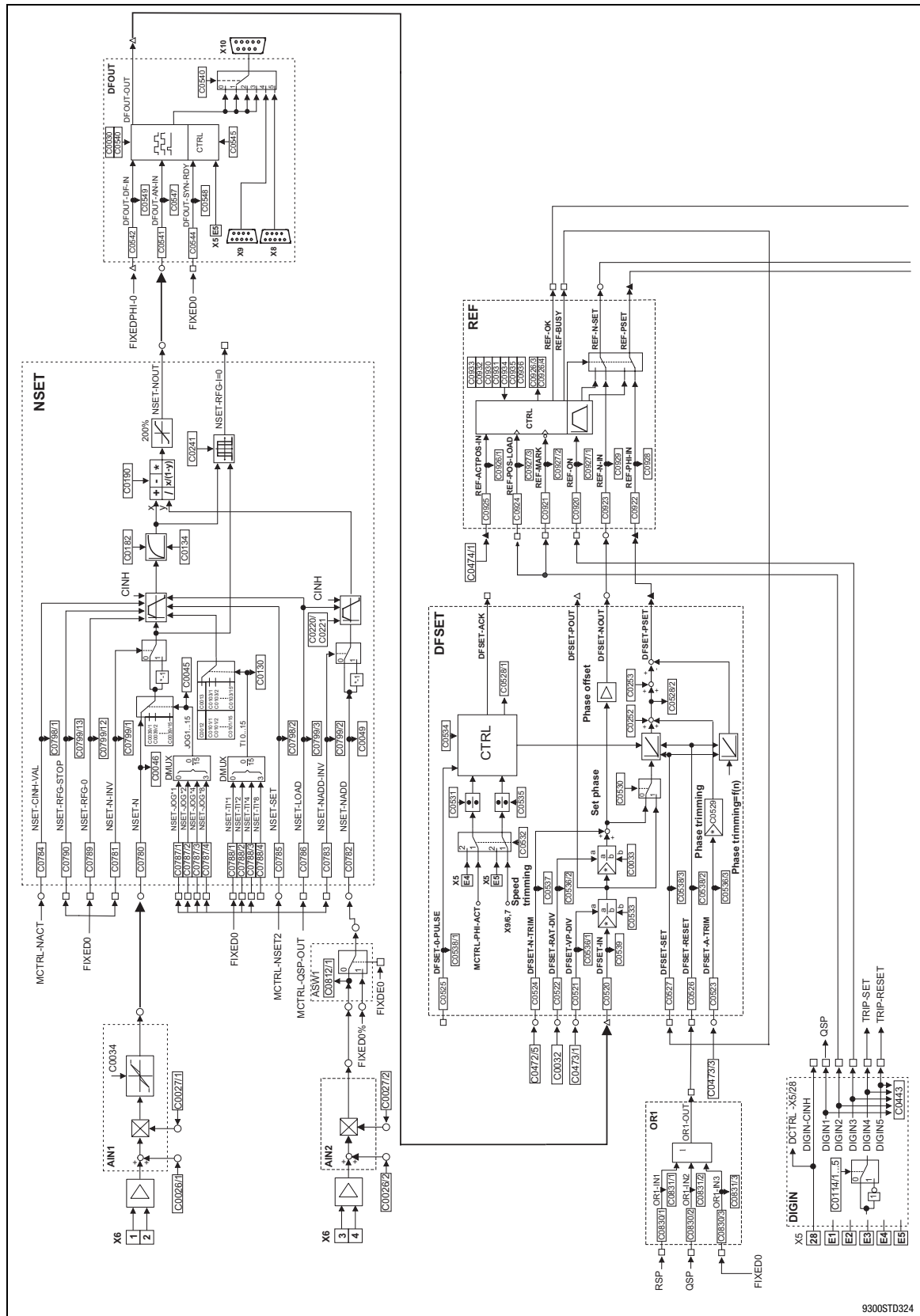

9300STD324

Fig. 4-4 Signal flow diagram for configuration 5000 (sheet 1)

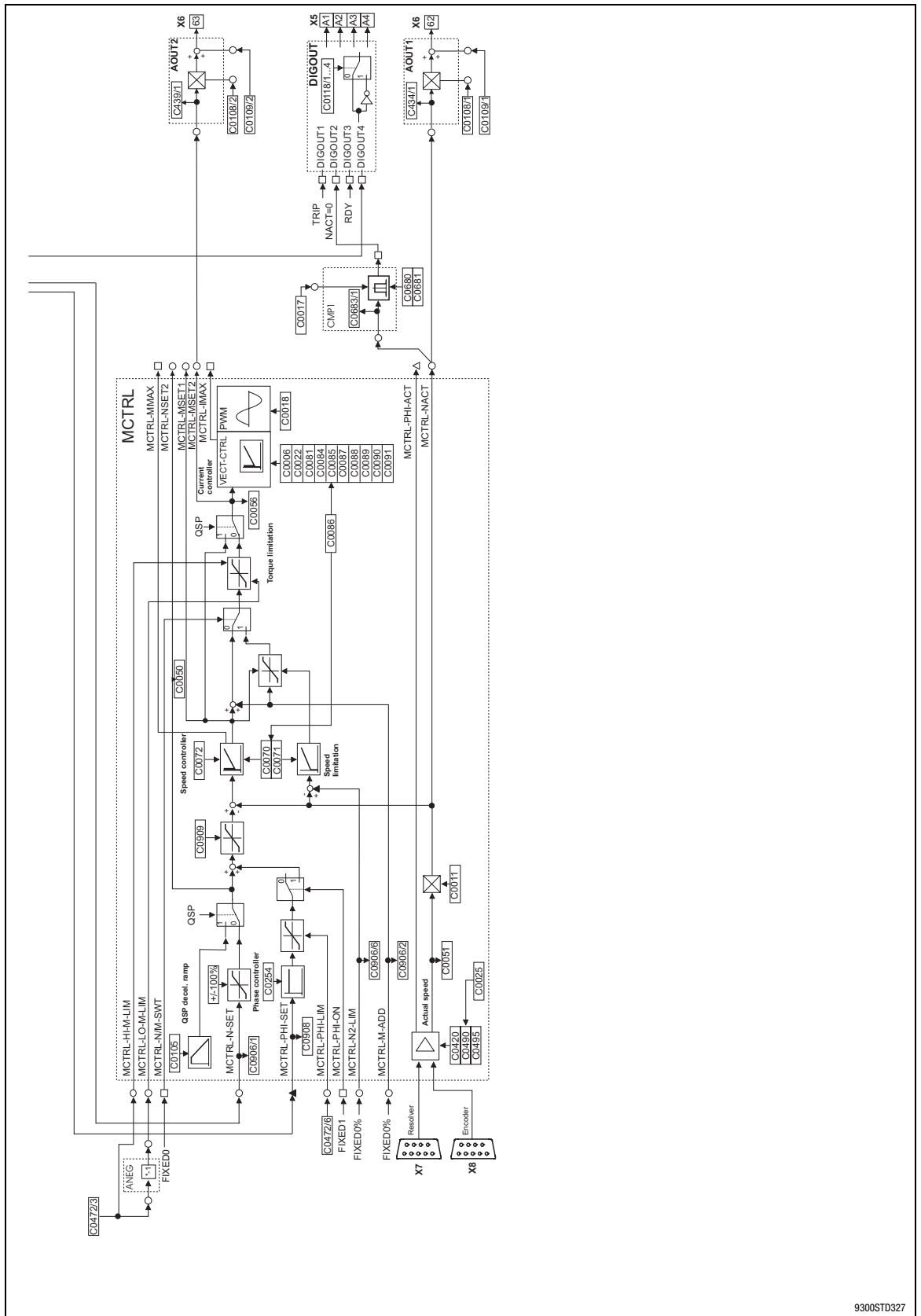

Fig. 4-5

Signal flow diagram for configuration 5000 (sheet 2)

9300ST0327



Application examples

Master frequency bus - slave - drive (C0005 = 6000)

4.5 Master frequency bus - slave - drive (C0005 = 6000)



Tip!

The most important settings can be found in the menu: "Short Setup / Speed mode" of the operating module or in the menu "Short setup / Speed mode" in Global Drive Control.

Enter motor type (contains all nameplate data of the motor)

C0173	xxx	Enter UG limit (mains voltage)
C0086	000	Enter motor data manually

Enter maximum motor current

C0022	xxxA	Determine I _{max}
-------	------	----------------------------

Enter controller configuration

C0005	6000	Select digital frequency cascade - slave
C0025	xxx	Enter feedback system

Speed setpoint settings

C0011	xxx rpm	Determine max. speed
C0032	xxx	Numerator of gearbox factor
C0033	xxx	Denominator of gearbox factor
C0425	xxx	Adjust encoder constant to the master

Application parameters

C0070	xxx	V _p n-controller
C0071	xxx	T _n n-controller
C0254	xxx	Gain of the angle controller

Save parameters

C0003	xxx	Save all parameters
-------	-----	---------------------

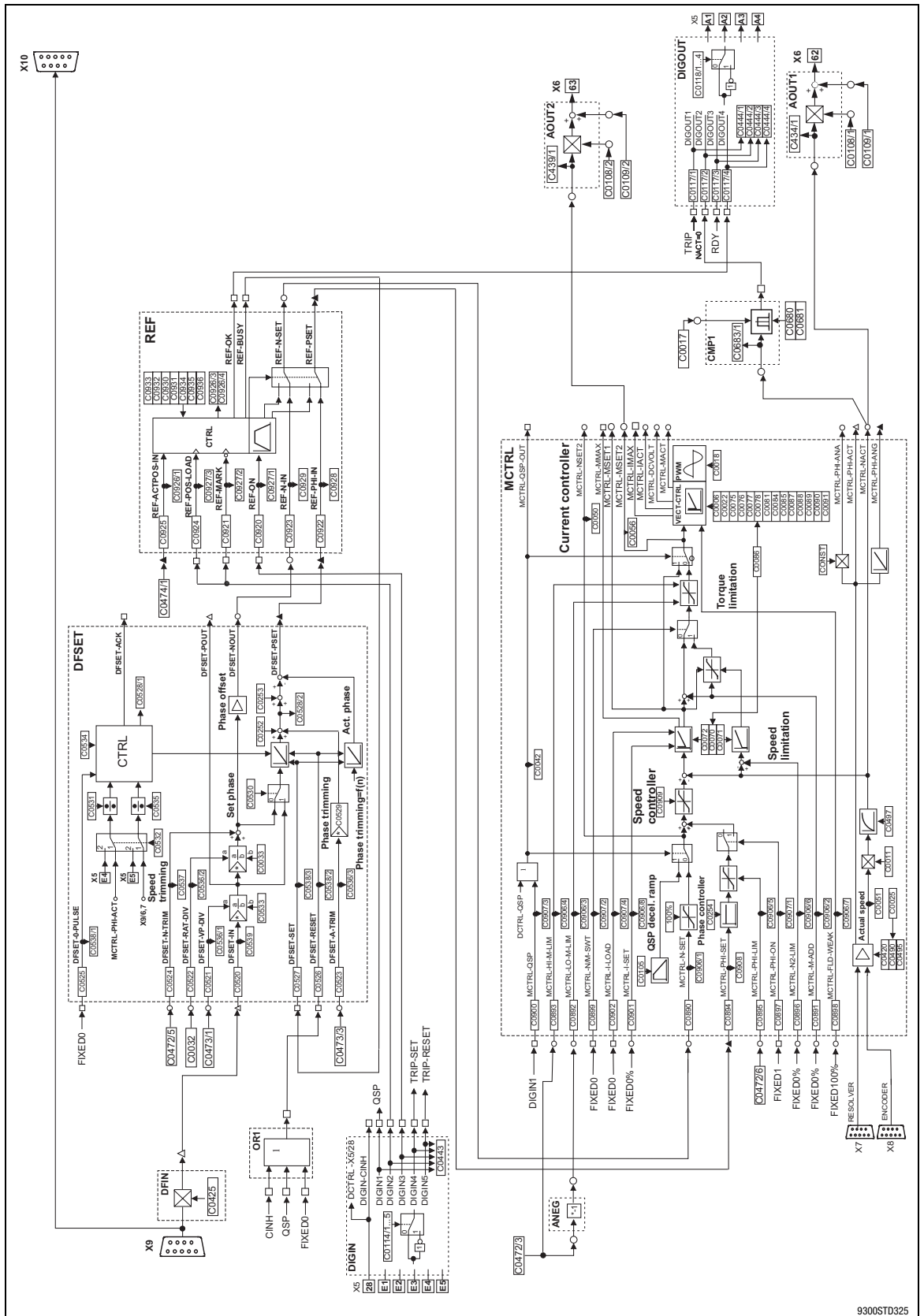

Fig. 4-6

Signal flow diagram for configuration 6000

9300STD325



Application examples

Master frequency cascade - slave - drive (C0005 = 7000)

4.6 Master frequency cascade - slave - drive (C0005 = 7000)



Tip!

The most important settings can be found in the menu: "Short Setup / Speed mode" of the operating module or in the menu "Short setup / Speed mode" in Global Drive Control.

Enter motor type (contains all nameplate data of the motor)

C0173	xxx	Enter UG limit (mains voltage)
C0086	000	Enter motor data manually

Enter maximum motor current

C0022	xxxA	Determine I _{max}
-------	------	----------------------------

Enter controller configuration

C0005	7000	Select digital frequency cascade - slave
-------	------	--

Speed setpoint settings

C0011	xxx rpm	Determine max. speed
C0032	xxx	Numerator of gearbox factor
C0033	xxx	Denominator of gearbox factor
C0425	xxx	Adjust encoder constant to the master
C0473/1	xxx	Numerator of stretching factor
C0533	xxx	Denominator of stretching factor

Application parameters

C0070	xxx	V _p n-controller
C0071	xxx	T _n n-controller
C0254	xxx	Gain of the angle controller

Save parameters

C0003	xxx	Save all parameters
-------	-----	---------------------

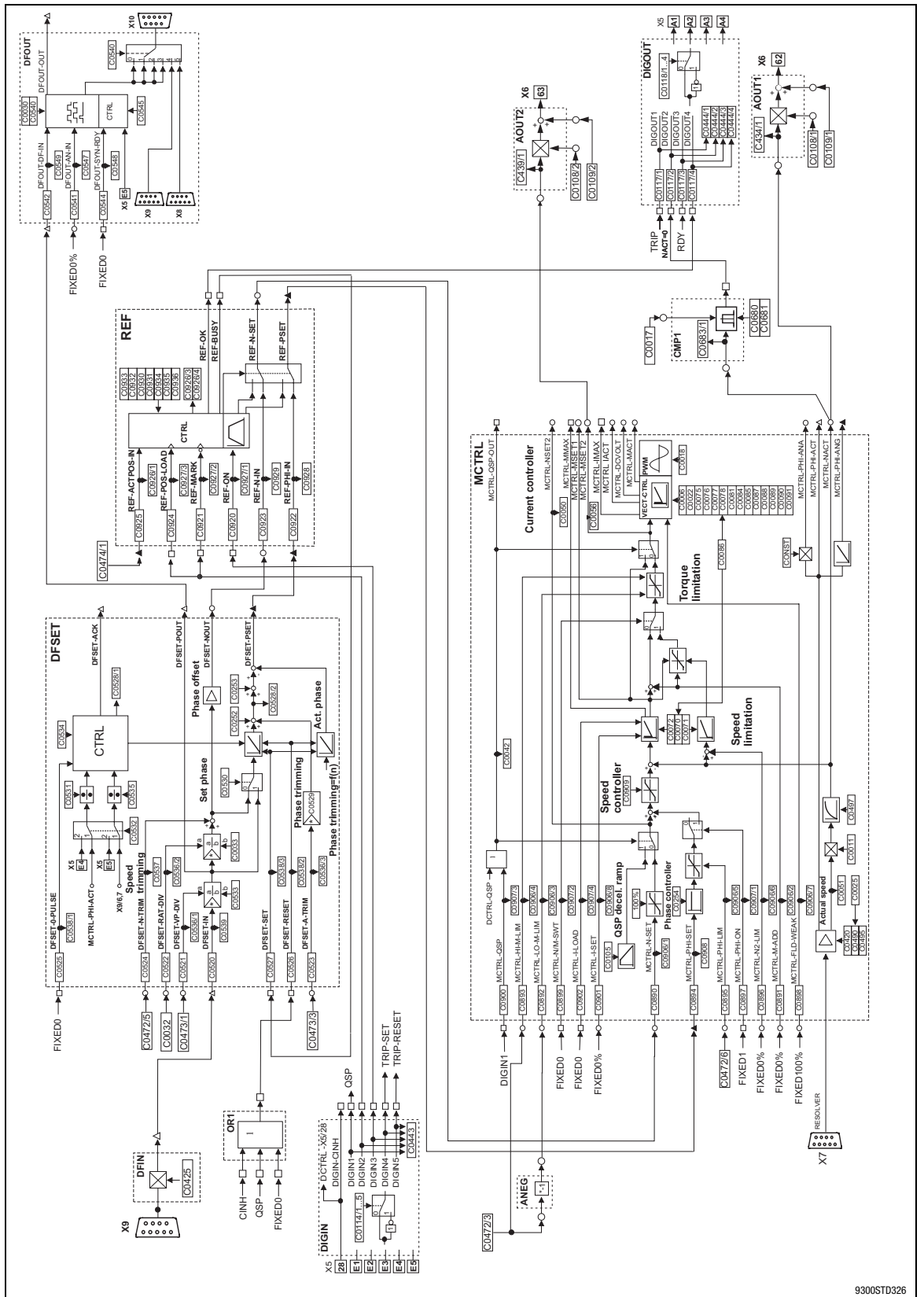

Fig. 4-7 Signal flow diagram for configuration 7000

9300ST0326



Application examples

Master frequency cascade - slave - drive (C0005 = 7000)

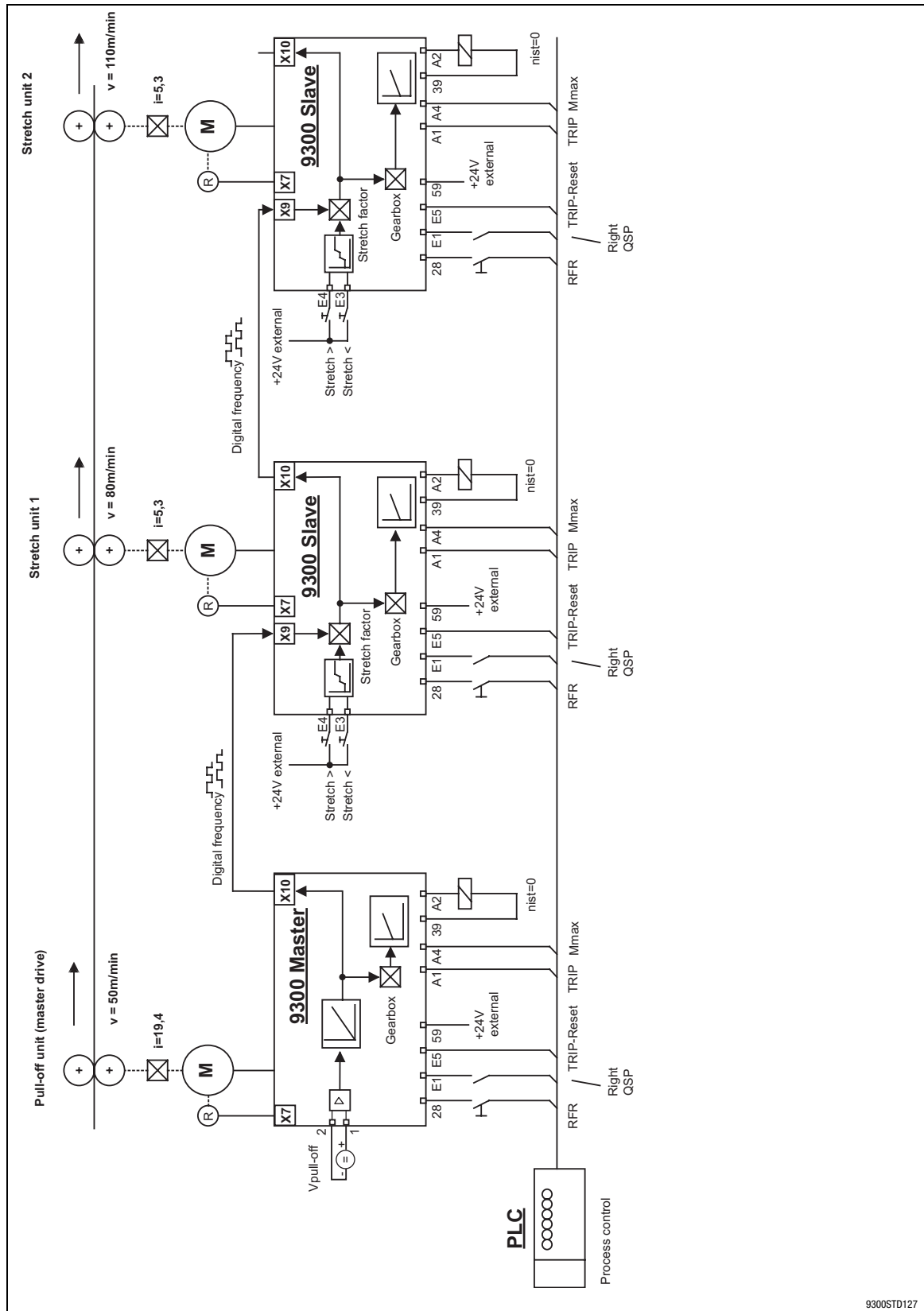

9300STD127

Fig. 4-8

Connection diagram of digital frequency configuration

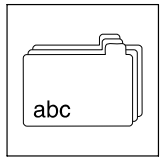

5 Appendix

Contents

5.1	Glossary	5-3
5.1.1	Terminology and abbreviations used	5-3
5.2	Index	5-5

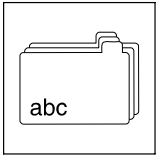

Appendix

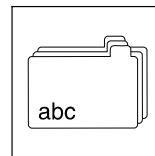

5.1 Glossary

5.1.1 Terminology and abbreviations used

	Cross-reference to a chapter with the corresponding page number
AC	AC current or AC voltage
AIF	Automation interface AIF interface, interface for communication modules
CE	Communauté Européene
Controller	Any frequency inverter, servo inverter, or DC speed controller
Cxxxx/y	Subcode y of code Cxxxx (e. g. C0404/2 = subcode 2 of code C0404)
DC	DC current or DC voltage
DIN	Deutsches Institut für Normung(German Institute for Standardization)
Drive	Lenze controller in combination with a geared motor, a three-phase AC motor, and other Lenze drive components
EMC	Electromagnetic compatibility
EN	European standard
f_r [Hz]	Rated motor frequency
I_a [A]	Current output current
IEC	International Electrotechnical Commission
I_{mains} [A]	Mains current
I_{max} [A]	Maximum output current
IP	International Protection Code
IPC	Industrial PC
I_{PE} [mA]	Discharge current
I_r [A]	Rated output current
L [mH]	Inductance
M_r [Nm]	Rated motor torque
NEMA	National Electrical Manufacturers Association
P_{DC} [kW]	Power that can be additionally taken from the DC bus if a power-adapted motor is used for operation
PLC	Programmable control system
P_{loss} [W]	Power loss of inverter
P_r [kW]	Rated motor power
R [Ω]	Resistance

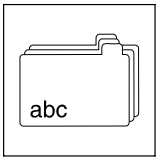

Appendix

Glossary

S_N [kVA]	Controller output power
U_{DC} [V]	DC supply voltage
UL	Underwriters Laboratories
U_M [V]	Output voltage
U_{mains} [V]	Mains voltage
VDE	Verband deutscher Elektrotechniker (Association of German Electrical Engineers)
Xk/y	Terminal y on terminal strip Xk (e. g. X5/28 = terminal 28 on terminal strip X5)

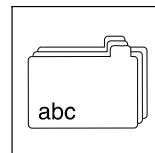

5.2 Index

A

Absolute position determination, 2-34

Acceleration and deceleration times, 2-7
- additional, 2-7

Actual angle integrator (PHDIFF), 3-148

Addition block (ADD), 3-16

Additional setpoint, 2-7 , 3-134
- correcting signal, 2-7

Additional torque setpoint, 2-9 , 3-104

Analog input (AIN), 3-22

Analog output (AOUT), 3-29

Analog signal changeover switch (ASW), 3-33

AND operation (AND), 3-24

angle addition block (PHADD), 3-145

Angle comparator (PHCMP), 3-146

Angle controller, 2-26
- Angle controller limits, 2-26
- Influence of angle controller, 3-108

Angle controller limits, 2-26

Angle conversion (CONVPHA), 3-50

Angle conversion (CONVPHPH), 3-51

Angle signal adaptation (PHDIV), 3-149

Angle-synchronous operation, 2-26

Angular synchronism, 2-26

Angular trimming, 2-27

Application examples, 4-1
- Speed control, 4-4 , 4-7 , 4-9 , 4-12 , 4-14

Arithmetic blocks (ARIT), 3-31

Automation interface (AIF-IN), 3-17

Automation interface (AIF-OUT), 3-20

C

Cascading factor, 2-20 , 2-23

Characteristic function (CURVE), 3-53

CINH at the master, 2-17

CINH at the slave, 2-20 , 2-23

Comparator (CMP), 3-42

Configuration, 2-1

- Basic configurations, 2-4

- Function blocks, 3-3

- Function library, 3-1

- Global Drive Control, 2-3

Control characteristic, 3-143

Control of drive controller (DCTRL), 3-57

Controller inhibit, 2-10

Controller inhibit (CINH), 3-59

Current controller, 3-104

Current master value, 2-6

CW/CCW/QSP linking (R/L/Q), 3-157

D

Dead band(DB), 3-56

Definition of notes used, 1-6

Definitions, Terms, 5-3

Delay element (PT1-1), 3-156

Delay elements (DIGDEL), 3-81

Derivative-action element (DT1), 3-86

Digital frequency output (DFOUT), 3-65

Digital frequency processing (DFSET), 3-75

Digital frequency ramp function generator (DFRFG), 3-69

Digital inputs (DIGIN), 3-84

Digital outputs (DIGOUT), 3-85

Digital status signals (STAT), 3-169

Drive system, 2-13

E

Edge evaluation (TRANS), 3-183

Electrical shaft, 2-26

F

Fast mains recovery (KU), 3-121

Field weakening, 3-110

Fieldbus module, 3-17

Fixed setpoints (FIXSET), 3-95

Flipflop (FLIP), 3-97

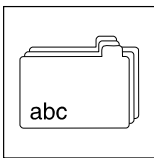

Appendix

Index

Flying synchronising, 2-27

Following error limit, 2-27

Free control codes, overview, 3-14

Free digital outputs (FDO), 3-88

Free piece counter (FCNT), 3-87

Freely assignable input variables (FEVAN), 3-90

Function blocks, 3-3 , 3-12

- Actual angle integrator (PHDIFF), 3-148
- Addition block (ADD), 3-16
- analog input (AIN), 3-22
- Analog output (AOUT), 3-29
- Analog signal changeover switch (ASW), 3-33
- AND operation (AND), 3-24
- angle addition block (PHADD), 3-145
- Angle comparator (PHCMP), 3-146
- angle conversion (CONVPHA), 3-50
- Angle conversion (CONVPPH), 3-51
- Angle conversion (CONVPP), 3-52
- Angle signal adaptation (PHDIV), 3-149
- Arithmetic blocks (ARIT), 3-31
- Automation interface (AIF-IN), 3-17
- Automation interface (AIF-OUT), 3-20
- Characteristic function (CURVE), 3-53
- comparator (CMP), 3-42
- Configuration code, 3-5
- Connection, 3-6
- Control of drive controller (DCTRL), 3-57
- Controller inhibit (CINH), 3-59
- Operation inhibit (DISABLE), 3-59
- Parameter set changeover (PAR), 3-61
- Quick stop (QSP), 3-58
- TRIP-RESET, 3-60
- TRIP-SET, 3-59
- Create connections, 3-8
- CW/CCW/QSP linking (R/L/Q), 3-157
- Dead band (DB), 3-56
- delay element (PT1-1), 3-156
- Delay elements (DIGDEL), 3-81
- Derivative-action element (DT1), 3-86
- Digital frequency output (DFOUT), 3-65
- Digital frequency processing (DFSET), 3-75
- digital frequency ramp function generator (DFRFG), 3-69
- Digital inputs (DIGIN), 3-84
- Digital outputs (DIGOUT), 3-85
- Digital status signals (STAT), 3-169
- Display code, 3-5
- Edge evaluation (TRANS), 3-183
- Fixed setpoints (FIXSET), 3-95
- Flipflop (FLIP), 3-97
- Free digital outputs (FDO), 3-88
- Free piece counter (FCNT), 3-87
- gearbox compensation (GEARCOMP), 3-100
- holding brake (BRK), 3-35
- holding brake (BRK1)

- disengaging the brake, 3-37
- engaging the brake, 3-37
- setting controller inhibit, 3-38
- Homing function (REF), 3-158
- Input name, 3-4
- Input symbol, 3-4
- Internal motor control (MCTRL), 3-102
- Inverter (ANEG), 3-28
- Limiting element (LIM), 3-101
- Logic NOT, 3-128
- Mains failure control (MFAIL), 3-111
- master frequency input (DFIN), 3-62
- Monitor outputs of monitoring system (MONIT), 3-123
- motor phase failure detection (MLP), 3-122
- Motor potentiometer (MPOT), 3-125
- Multi-axis synchronisation (SYNC), 3-175
- Names, 3-4
- OR operation (OR), 3-135
- Oscilloscope function (OSZ), 3-138
- Output name, 3-5
- Output symbol, 3-5
- overview, 3-12
- Parameterisation code, 3-5
- Phase integrator (PHINT), 3-150
- Process controller (PCTRL1), Dancer position, tension, pressure controller, 3-142
- Ramp generator (RFG), 3-164
- Remove connections, 3-9
- Sample and hold function (S&H), 3-166
- Signal conversion (CONV), 3-47
- Signal types, 3-3
- speed setpoint conditioning (NSET), 3-130
- State bus connection, 3-170
- storage block (STORE), 3-171
- system bus (CAN-IN), 3-40
- system bus (CAN-OUT), 3-41

Function blocks , Freely assignable input variables (FEVAN), 3-90

function blocks, S-shaped ramp function generator (SRFG), 3-167

Function library, 3-1

G

Gearbox compensation (GEARCOMP), 3-100

Gearbox factors, weighting factors, 2-13

Global Drive Control, configuration with, 2-3

H

Holding brake (BRK), 3-35

Homing, 2-30 , 2-33

Homing function (REF), 3-158

- Homing modes, 3-160
- profile generator, 3-159

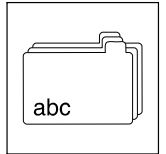

Homing modes, 2-31 , 3-160

I

Internal motor control (MCTRL), 3-102

- Additional torque setpoint, 3-104
- Angle controller, Influence of angle controller, 3-108
- Current controller, 3-104
- Quick stop (QSP)
 - Field weakening, 3-110
 - Switching frequency changeover, 3-110
- Quick stop QSP, 3-109
- Speed controller, 3-106
- Speed setpoint limitation, 3-107
- Torque control, with speed limitation, 3-107
- Torque limitation, 3-105

Inverter (ANEG), 3-28

Inverting the main setpoint, 2-7

J

JOG setpoint, 2-6

JOG setpoints, 3-132

L

Limiting element (LIM), 3-101

Logic NOT, 3-128

M

Main setpoint, 2-6

Main setpoint path, 3-131

Mains failure control, 3-112 , 3-114

Mains failure control (MFAIL), 3-111

- fast mains recovery (KU), 3-121
- mains failure control, 3-112 , 3-114
- restart protection, 3-120

Master configuration, 2-14

- CINH at the master, 2-17
- features, 2-14
- following error limit, 2-14
- homing function, 2-14
- master frequency output X10, 2-15
- Master integrator, 2-15
- phase adjustment, 2-17
- Phase offset, 2-17
- phase trimming, 2-16
- phase trimming, speed correction, 2-14
- QSP at the master, 2-17
- QSP at the slave 0, 2-17
- Setpoint conditioning, 2-16
- speed trimming, 2-16

Master frequency bus, 2-18

- cascading factor, 2-20

Master frequency cascade, 2-21

- cascading factor, 2-23
- CINH at the slave, 2-23
- QSP at the slave, 2-23

Master frequency coupling, 2-13

- gearbox factors, 2-13
- master configuration, 2-14
- System description, 2-13

Master frequency input (DFIN), 3-62

Master frequency output X10, 2-15

- encoder constant, 2-15

Master integrator, 2-13 , 2-15

Monitor outputs of monitoring system (MONIT), 3-123

Motor phase failure detection (MLP), 3-122

Motor potentiometer (MPOT), 3-125

Multi-axis synchronisation (SYNC)

- Configuration examples, 3-182
- Correcting the angle controller, 3-181
- Cycle times, 3-178
- Fault indications, 3-181
- Operating mode, 3-176
- Phase displacement, 3-180
- Scaling, 3-182
- synchronising, 3-176
- Time slot, 3-180

Multi-axis synchronisation (SYNC1), 3-175

N

Nameplate, 1-5

Notes, definition, 1-6

O

Operation inhibit (DISABLE), 3-59

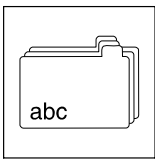

Appendix

Index

OR operation (OR), 3-135

Oscilloscope function (OSZ), 3-138

P

Parameter set changeover (PAR), 3-61

Phase adjustment, 2-17

Phase integrator (PHINT), 3-150

- constant input value, 3-152 , 3-153
- Input value with sign reversal, 3-154
- Scaling of PHINTx-OUT, 3-155

Phase offset, 2-17 , 2-27

Phase trimming, 2-16

Phase-synchronous operation, 2-13

Positioning control with driftfree standstill, 2-13

Process controller (PCTRL1)

- Control characteristic, 3-143
- Dancer position, tension, pressure controller, 3-142
- Ramp function generator, 3-144

Processing table, 3-10

- Frequent faults, 3-11

Profile generator, 2-30 , 2-33 , 3-159

- gearbox ratio, 2-33
- home position offset, 2-33
- homing speed, 2-33
- homing Ti time, 2-33

Q

QSP (quick stop), 2-10 , 3-109

QSP at the master, 2-17

QSP at the slave, 2-20 , 2-23

QSP at the slave 0, 2-17

Quick stop (QSP), 2-10 , 3-58

Quick stop QSP, 3-109

R

Ramp function generator, 3-144

Ramp generator(RFG), 3-164

Referencing, 2-30

Resetting a fault, 2-10

Restart protection, 3-120

S

S ramp, PT1 element, 3-134

S-shaped ramp function generator (SRFG), 3-167

S-shaped ramp function generator characteristic, 2-7

Safety instructions

- Definition, 1-6
- Structure, 1-6

Sample and hold function (S&H), 3-166

Selection of direction of rotation, 2-8

Setpoint conditioning of the slave, 2-20

Setpoint inversion, Ramp function generator, main setpoint, 3-133

Setting the integral component, 3-106

Signal conversion (CONV), 3-47

Slave, 2-18

Speed control, 2-6 , 4-4 , 4-7 , 4-9 , 4-12 , 4-14

- acceleration and deceleration times, 2-7
- additional acceleration and deceleration times, 2-7
- additional setpoint, 2-7
- additional torque setpoint, 2-9
- controller inhibit, 2-10
- current master value, 2-6
- inverting the main setpoint, 2-7
- JOG setpoint, 2-6
- main setpoint, 2-6
- resetting a fault, 2-10
- S-shaped ramp function generator characteristic, 2-7
- selection of direction of rotation, 2-8
- setpoint selection, 2-6
- speed limit, 2-9

Speed controller, 3-106

- Setting the integral component, 3-106

Speed conversion (CONVPP), 3-52

Speed limit, 2-9

Speed limitation, 2-12

Speed ratio synchronism, 2-25

Speed setpoint conditioning (NSET), 3-130

- Additional setpoint, 3-134
- JOG setpoints, 3-132
- Main setpoint, 3-131
- S ramp, PT1 element, 3-134
- Setpoint inversion, Ramp function generator, main setpoint, 3-133

Speed setpoint limitation, 3-107

Speed synchronism, 2-25

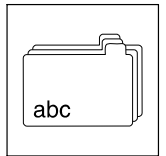

Speed travel profile, 2-33
Speed trimming, 2-16
Speed-ratio synchronism, 2-13
Speed-synchronous operation, 2-13 , 2-18
Speed-synchronous running, 2-25
State bus connection, 3-170
Storage block (STORE), 3-171
Switching frequency changeover, 3-110
System bus (CAN-IN), 3-40
System bus (CAN-OUT), 3-41

T

Terms

- controller, 5-3
- Definitions, 5-3
- drive, 5-3

Torque control, 2-11

- Setpoint input, 2-11
- Speed limitation, 2-12
- with speed limitation, 3-107

Torque limitation, 3-105

Torque setpoint, 2-11

Touch probe, 2-32

Touch-Probe, 2-29

TRIP, 2-10

TRIP-RESET, 3-60

TRIP-SET, 3-59

V

Vertical shaft, 2-26

Preface, 1-1

Z

Zero pulse, 2-27

Zero pulse at the setpoint, 2-28

Zero pulse evaluation, 2-28

Zero pulse synchronisation, 2-28



© 03/2012

Lenze Automation GmbH
Hans-Lenze-Str. 1
D-31855 Aerzen
Germany



+49 (0)51 54 / 82-0



+49 (0)51 54 / 82 - 28 00



Lenze@Lenze.de



www.Lenze.com

Service

Lenze Service GmbH
Breslauer Straße 3
D-32699 Extertal
Germany



00 80 00 / 24 4 68 77 (24 h helpline)



+49 (0)51 54 / 82-11 12



Service@Lenze.de



EDSVS9332S-EXT ■ 13375724 ■ EN ■ 2.0 ■ TD23

10 9 8 7 6 5 4 3 2 1