



Brushless DC motor

BX Series

OPERATING MANUAL



Table of contents

Introduction	Page 2
Safety precautions	Page 4
Precautions for use	Page 6
Preparation	Page 8
Checking the product	Page 8
Names and functions of parts	Page 12
Installation	Page 14
Installation site	Page 14
Installation of motor (gearhead)	Page 14
Load installation	Page 15
Overhung load and thrust load	Page 16
Driver installation	Page 17
Regeneration unit installation	Page 18
Installing and wiring in compliance with EMC directive	Page 19
Connection	Page 22
Power connection	Page 22
Turning on the power	Page 23
Regeneration unit connection	Page 23
Motor connection	Page 24
Grounding the motor and driver	Page 24
Connection of input signal and output signal	Page 25
About input signal and output signal	Page 28
Running	Page 33
Setting of running speed	Page 33
Inspection	Page 36
Troubleshooting and remedial actions	Page 37
Alarm display and details	Page 38
Appendix	Page 39

Thank you for purchasing an Oriental Motor product.

This Operating Manual describes product handling procedures and safety precautions.

- Please read it thoroughly to ensure safe operation.
- Always keep the manual where it is readily available.

Introduction

Before using the motor unit

Only qualified personnel should work with the product.

Before using it, carefully read the "Safety precautions" to ensure correct operation.

This product is designed to be incorporated into general industrial machinery, and must not be used for other purposes. It should be noted that we are not responsible for any damages caused by ignoring this warning.

Overview of the product

The **BX** series is a brushless DC motor adopting a thin, high torque motor with encoder and high-precision driver. This product is available in two types; a combination type equipped with a special-purpose gearhead, which is best, suited to high-torque operation by gear speed reduction and a round shaft type which is the optimum for high speed requirements.

Characteristics

- A wide speed range from 30 to 3000 r/min
 - Flat torque characteristics free of torque reduction in the low speed range
 - Compatible with global power input
 - Operations in 2-step speed change ensured by the internal potentiometer and external potentiometer
 - Interlock between motor start/stop and application/release of electromagnetic brake
 - Digital speed setting: 3 to 3000 r/min
 - Speed control mode: 8-step speed setting
 - Position control mode
 - Positioning: setting 6 points movement
 - Return to mechanical home position
 - Return to electrical home position
 - Digital setting of slow start time and slowdown time: 0 to 30 sec.
 - Torque limiting function
 - Servo lock function at motor standstill (speed control mode)
 - Operation monitor function
 - Data copy function
 - Permits abrupt braking of the inertial load and operations in the vertical direction.
- Functions may be further enhanced by a system upgrading tool
- System upgrading tool (sold separately)
- Data setter **OPX-1A**
- * For details, see the operating manual for **BX** series extension functions.
- Regeneration unit (sold separately)
EPRC-400P, RGB100

System configuration

A sample system configuration using the **BX** series is provided below.

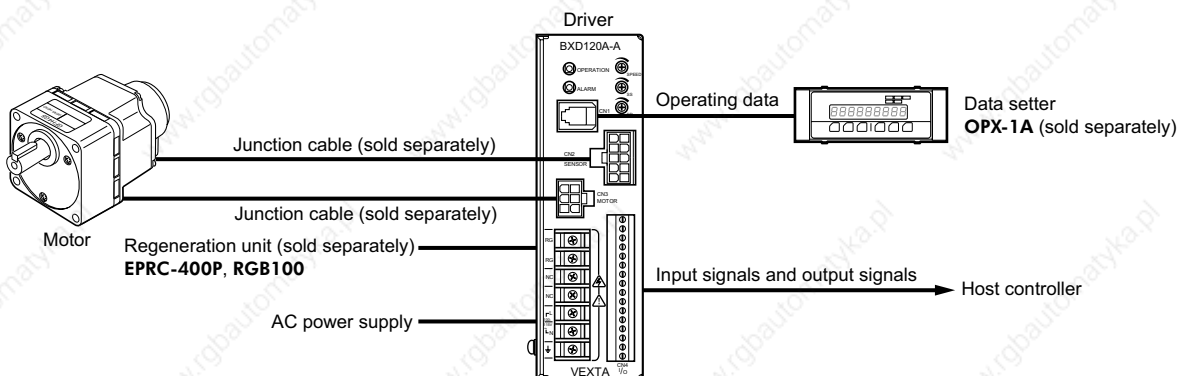

- Three types of input power sources can be used: single-phase 100-115 V, single-phase 200-230 V and three-phase 200-230 V.
- The mechanical home seeking function requires home-position detection sensors.

For EC directives

This product conforms with the EC's low voltage directive and EMC directive under the following conditions. Take the following measures to ensure conformance with the EC's low voltage directive and EMC directive.

■ For low voltage directive

This product is designed for use as a built-in component.

- Install the product within an enclosure in order to avoid contact with the hands.
- Be sure to maintain a protective earth in case the hands should make contact with the product. Securely ground the protective earth terminals of the motor and driver.

Item	Motor	Driver
Protective range	IP54 (except for the shaft of the round shaft motor)	IP10
Operation environment	Ambient temperature	0 to +50 °C (+32 to +122 °F) (non-freezing)
	Humidity	85% or less (non-condensing)
	Altitude	Up to 1000 m (3280 ft.) above sea level
	Surrounding atmosphere	No corrosive gas, dust, water or oil
Storage environment	Ambient temperature	-20 to +60 °C (-4 to +140 °F) (non-freezing) -25 to +70 °C (-13 to +158 °F) (non-freezing)
	Humidity	85% or less (non-condensing)
	Altitude	Up to 3000 m (9840 ft.) above sea level
	Surrounding atmosphere	No corrosive gas, dust, water or oil
Shipping environment	Ambient temperature	-20 to +60 °C (-4 to +140 °F) (non-freezing) -25 to +70 °C (-13 to +158 °F) (non-freezing)
	Humidity	85% or less (non-condensing)
	Altitude	Up to 3000 m (9840 ft.) above sea level
	Surrounding atmosphere	No corrosive gas, dust, water or oil
Applicable standards	EN60034-1, EN60034-5	EN50178
Installation conditions	Motor is to be used as a component within other equipment. Overvoltage category: III Pollution degree: Class 3 Protection against electric shock: Class I	Driver is to be used as a component within other equipment. Overvoltage category: III Pollution degree: Class 2 Protection against electric shock: Class I

■ For EMC directive

This product has received EMC measures under the conditions specified in "Example of motor and driver installation and wiring" on page 21.

Be sure to conduct EMC measures with the product assembled in your equipment by referring to "Installing and wiring in compliance with EMC directive" on page 19.

■ UL/CSA standards

Item	Motor		Driver
	BXM230, BXM460, BXM5120	BXM6200, BXM6400	
Certification body	UL	UL	UL
Applicable standards	UL60950 CSA C22.2 No.60950	UL1004 CSA C22.2 No.100	UL508C CSA C22.2 No.14
File No.	E208200	E62327	E171462

Safety precautions

The precautions described below are intended to prevent danger or injury to the user and other personnel through safe, correct use of the product.

Use the product only after carefully reading and fully understanding these instructions.

Warning

Failure to observe the warnings contained herein may result in a situation leading to serious injury or death.

Caution



Failure to observe the following precautions may result in injury or property damage.

Note

The items under this heading contain important handling instructions that the user should observe to ensure the safe use of the product.

Warning

General

- Do not use the product in an explosive, flammable, or corrosive atmosphere to avoid possible fire, an electric shock or personal injury. Do not use it where it may be splashed with water, or near the combustible substances.
- Only qualified installers should be assigned to the work of installation, connection, running, operation, inspection and trouble diagnosis. This is intended to prevent fire, an electric shock and injury.
- Do not move, install, connect or inspect the product when power is applied. Turn off power before starting such work. This caution is to prevent possible an electric shock.
- Do not touch the marked positions when power is turned on. Marks  and  on the driver front panel indicate the terminal where high voltage is applied. This is prevent fire and an electric shock.
- The equipment provided with electromagnetic brake should be used when you want to utilize it for vertical application. If the motor has no electromagnetic brake, the holding force of the motor is insufficient when power is off, the movable parts may fall and cause injuries or damage of the equipment.
- Do not use the brake mechanism of the motor with electromagnetic brake as a safety brake. It is intended to hold the movable parts and motor position. This caution is to avoid personal injury or damage to the equipment.
- When the driver's protection function is triggered, first remove the cause and then clear the protection function. Continuing the operation without removing the cause of the problem may cause malfunction of the motor, leading to injury or damage to equipment.

Installation

- To prevent the risk of electric shock, use the motor and driver for class I equipment only.
- Install the motor (gearhead) and driver inside a cabinet. This is to prevent an electric shock and injury.
- Install the motor and driver so as to avoid contact with hands, or ground them to prevent the risk of electric shock.

Electrical connections

- The driver power input voltage should be within the rated range. Otherwise, fire and an electric shock may occur.
- Electrical connections must be made in strict accordance with the connection diagram. Otherwise, fire and an electric shock may occur.
- Do not forcibly bend, pull or pinch the connection cable. Doing so may fire and electric shock.
- To prevent electric shock, be sure to install the terminal cover (supplied) over the driver's power supply terminals after making connections.

Running

- Turn off drive power in the event of power interruption. When the power is restored, the motor may start up suddenly and cause injuries or damage to the equipment.
- Do not turn ON the FREE input when the position is held in the vertical direction. Otherwise, the holding force of the motor and electromagnetic brake will be lost, causing personal injury and equipment damage.

Maintenance and inspection

- Do not touch the connection terminals of the driver immediately after the power is turned off (for a period of 1 minute). The residual voltage may cause electric shock.

Repair, disassembly and modification

- Do not disassemble or modify the motor, (gearhead) and driver. Otherwise you may get an electric shock or injury. When internal inspection and repair must be made, contact your local sales office.

Caution

General

- Do not use the motor (gearhead), driver and the regeneration unit beyond their specifications, or electric shock, injury or damage to equipment may result.
- Keep your fingers and objects out of the openings in the motor and driver. Failure to do so may result in fire, electric shock or injury.
- During running and for some time after stopping the equipment, do not touch the motor, driver and the regeneration unit. You may be burnt by high temperature on the surfaces of the motor, driver and the regeneration unit.

Transport

- Do not grip the motor (gearhead) output shaft and cable. Otherwise, injury may occur.

Installation

- Do not place combustibles around the motor and driver. Otherwise, fire may occur or you may be burnt.
- Do not place around the motor and driver any obstacle which may interfere with ventilation. Otherwise, the equipment may be damaged.
- The motor and driver should be firmly secured on the metallic plate in order to prevent personal injury and damage to the equipment.
- The rotating part (output shaft) of the motor (gearhead) should be provided with a cover. Otherwise, injury may occur.
- Do not allow your finger to be caught between the equipment and motor or gearhead when installing the motor with or without gearhead on the equipment. Otherwise, injury may occur.

Running

- Use the motor and driver in it's specified combination. This is to prevent fire.
- Start running after making sure that the emergency stop can be used whenever required. Otherwise, injury may occur.
- To prevent bodily injury, do not touch the rotating parts (output shaft) of the motor during operation.
- When an abnormality is noted, stop the operation immediately, or fire, electric shock or injury may occur.
- To prevent electric shock, use only an insulated screwdriver to adjust the internal switches.

Maintenance and inspection

- When testing the insulation resistance or dielectric strength, do not touch the terminal. Otherwise, an electric shock may occur.

Scrapping

- When scrapping the motor (gearhead) and driver, scrap them as industrial waste

Precautions for use

This section covers limitations and requirements the user should consider when using the **BX** series.

■ Do not apply an overhung load in excess of the specified permissible limit.

Be sure to operate the motor within the specified permissible limit of overhung load. Operating it under an excessive overhung load may damage the motor bearings (ball bearings).

■ Use an electromagnetic brake motor for an application involving up/down travel.

When the motor is used in an application involving up/down travel, use an electromagnetic brake motor to hold the load in position. To hold the load in position, apply the electromagnetic brake only after the motor has stopped. Do not use the brake to bring the moving motor to a halt. Repeated braking for such a purpose will wear the brake hub excessively, causing its holding ability to drop.

Since the electromagnetic brake is of the non-excitation type, it can also be used to hold the load in position upon the occurrence of a power failure. However, this is not a secure means of holding the load.

Do not use the electromagnetic brake as a safety brake.

■ Install the driver in a vertical orientation.

The driver's heat-dissipation function is designed according to vertical orientation. Installing the driver in any other orientation may shorten the life of electronic parts due to temperature increases within the driver.

■ Use a regeneration unit (sold separately) for vertical drive applications and those involving high inertial loads.

The driver may be damaged if the energy that is regenerated during a vertical (gravitational) operation or due to an abrupt start/stop involving a large inertial load exceeds the maximum level that can be absorbed by the driver. The optional regeneration unit (sold separately) is designed to discharge the regenerated energy, thereby protecting the driver.

■ Measures against leakage current

Stray capacitance is present between current-carrying cable of the driver and other current-carrying cables, and between the ground and motor, and high frequency leakage current may flow through this, adversely affecting the peripheral equipment. This depends on driver switching frequency and wire length between the driver and motor.

When you want to install a ground fault interrupt circuit, use product provided with high frequency measures:

- NV series by Mitsubishi Electric Corporation
- EG and SG series by Fuji Electric FA Components & Systems Co., Ltd.

■ Measures against noise

To prevent possible driver and motor operation errors due to external noise, take the following measures against noise:

• Electrical connection of the motor

For electrical connection of the driver and motor, use an optional junction cable.

• Electrical connection of input/output signal cable

- Connect the input/output signal cable in the shortest possible distance.
- Connect the input/output signal cable 300 mm (12 in.) or more away from the induction load such as electromagnetic relay and current carrying cables (for power supply, motor, etc.). Do not connect it together with the current carrying cable, for example, by routing them together through the same duct or conduit.
- Furthermore, use the braided-screen cable as the input/output signal cable. When the braided-screen cable cannot be used, it will be effective to install a Ferrite core on each of the controller and driver sides.

- **Connection of mains filter for power supply line**

To prevent external noise from being transferred through the power line, connect a mains filter to the driver AC power supply line input section.

Ground the mains filter ground terminal using a cable with a diameter of equivalent to AWG18 (0.75 mm²) or greater.

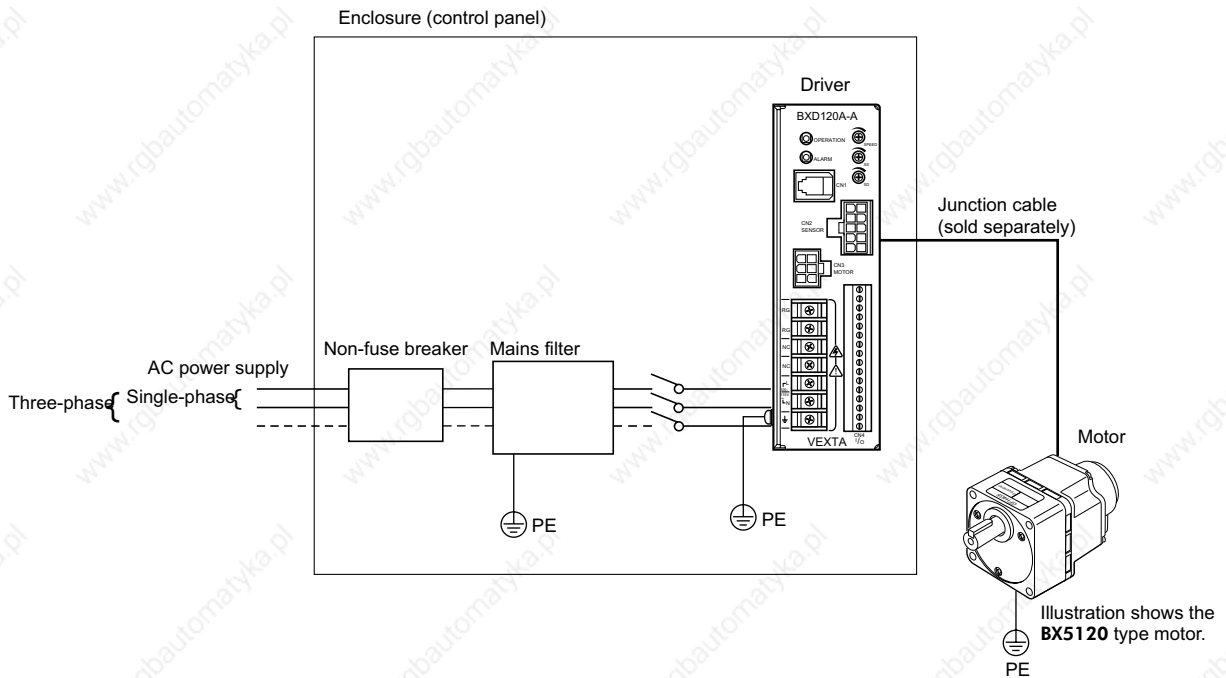

- **About grease of geared motor**

On rare occasions, a small amount of grease may ooze out from the geared motor. If there is concern over possible environmental damage resulting from the leakage of grease, check for grease stains during regular inspections.

Alternatively, install an oil pen or other device to prevent leakage from causing further damage. Oil leakage may lead to problems in the customer's equipment or products.

Preparation

This section covers the points to be checked along with the names and functions of respective parts.

Checking the product

Upon opening the package, verify that the items listed below are included.

Report any missing or damaged items to the branch or sales office from which you purchased the product.

The unit name of the product you bought should be checked by reference to the name on the label of the package.

Check the names of the gearhead, motor and driver by reference to the names on the name plate of each product.

The table on pages 9 to 11 show the combination of the gearhead, motor and driver according to unit names.

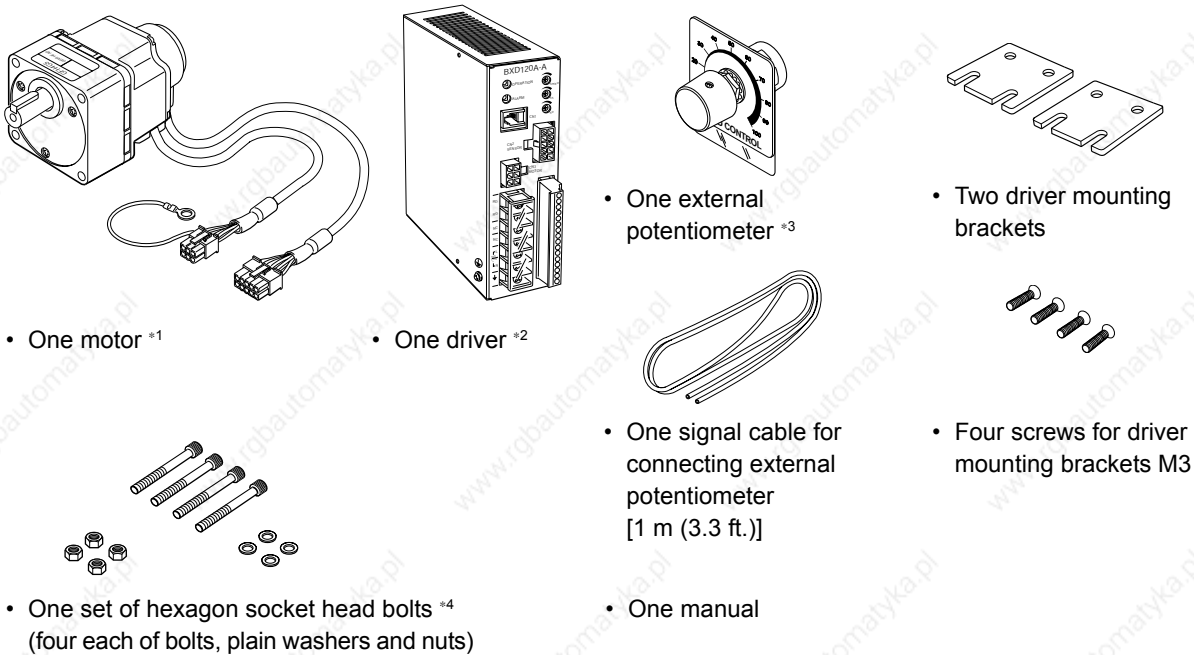

*1 One shaft key is supplied for the combination type.

*2 One combination type connector is supplied.

*3 The external potentiometer in the illustration indicates the setter in the assembled state.

*4 Supplied for the motor/gearhead combination type only

How to identify the product model

BX 5 120 A M - 5

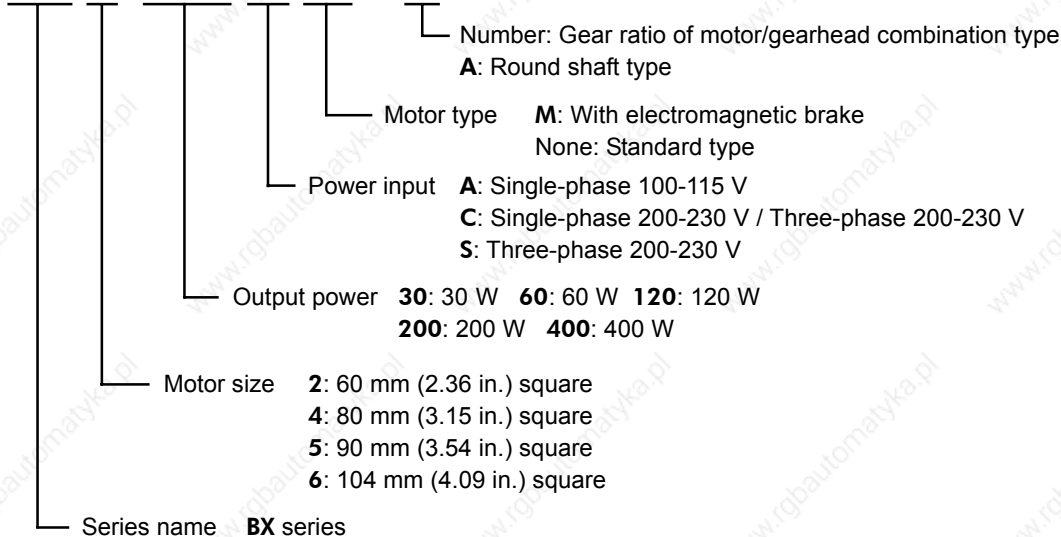

Combinations of gearheads, motors and drivers

- Motor/gearhead combination type, standard model

Unit model	Gearhead model	Motor model	Driver model
BX230A-5	GFH2G5	BXM230-GFH2	BXD30A-A
BX230A-10	GFH2G10	BXM230-GFH2	BXD30A-A
BX230A-15	GFH2G15	BXM230-GFH2	BXD30A-A
BX230A-20	GFH2G20	BXM230-GFH2	BXD30A-A
BX230A-30	GFH2G30	BXM230-GFH2	BXD30A-A
BX230A-50	GFH2G50	BXM230-GFH2	BXD30A-A
BX230A-100	GFH2G100	BXM230-GFH2	BXD30A-A
BX230A-200	GFH2G200	BXM230-GFH2	BXD30A-A
BX230C-5	GFH2G5	BXM230-GFH2	BXD30A-C
BX230C-10	GFH2G10	BXM230-GFH2	BXD30A-C
BX230C-15	GFH2G15	BXM230-GFH2	BXD30A-C
BX230C-20	GFH2G20	BXM230-GFH2	BXD30A-C
BX230C-30	GFH2G30	BXM230-GFH2	BXD30A-C
BX230C-50	GFH2G50	BXM230-GFH2	BXD30A-C
BX230C-100	GFH2G100	BXM230-GFH2	BXD30A-C
BX230C-200	GFH2G200	BXM230-GFH2	BXD30A-C
BX460A-5	GFH4G5	BXM460-GFH2	BXD60A-A
BX460A-10	GFH4G10	BXM460-GFH2	BXD60A-A
BX460A-15	GFH4G15	BXM460-GFH2	BXD60A-A
BX460A-20	GFH4G20	BXM460-GFH2	BXD60A-A
BX460A-30	GFH4G30	BXM460-GFH2	BXD60A-A
BX460A-50	GFH4G50	BXM460-GFH2	BXD60A-A
BX460A-100	GFH4G100	BXM460-GFH2	BXD60A-A
BX460A-200	GFH4G200	BXM460-GFH2	BXD60A-A
BX460C-5	GFH4G5	BXM460-GFH2	BXD60A-C
BX460C-10	GFH4G10	BXM460-GFH2	BXD60A-C
BX460C-15	GFH4G15	BXM460-GFH2	BXD60A-C
BX460C-20	GFH4G20	BXM460-GFH2	BXD60A-C
BX460C-30	GFH4G30	BXM460-GFH2	BXD60A-C
BX460C-50	GFH4G50	BXM460-GFH2	BXD60A-C
BX460C-100	GFH4G100	BXM460-GFH2	BXD60A-C
BX460C-200	GFH4G200	BXM460-GFH2	BXD60A-C
BX5120A-5	GFH5G5	BXM5120-GFH2	BXD120A-A
BX5120A-10	GFH5G10	BXM5120-GFH2	BXD120A-A
BX5120A-15	GFH5G15	BXM5120-GFH2	BXD120A-A
BX5120A-20	GFH5G20	BXM5120-GFH2	BXD120A-A
BX5120A-30	GFH5G30	BXM5120-GFH2	BXD120A-A
BX5120A-50	GFH5G50	BXM5120-GFH2	BXD120A-A
BX5120A-100	GFH5G100	BXM5120-GFH2	BXD120A-A
BX5120A-200	GFH5G200	BXM5120-GFH2	BXD120A-A
BX5120C-5	GFH5G5	BXM5120-GFH2	BXD120A-C
BX5120C-10	GFH5G10	BXM5120-GFH2	BXD120A-C
BX5120C-15	GFH5G15	BXM5120-GFH2	BXD120A-C
BX5120C-20	GFH5G20	BXM5120-GFH2	BXD120A-C
BX5120C-30	GFH5G30	BXM5120-GFH2	BXD120A-C
BX5120C-50	GFH5G50	BXM5120-GFH2	BXD120A-C
BX5120C-100	GFH5G100	BXM5120-GFH2	BXD120A-C
BX5120C-200	GFH5G200	BXM5120-GFH2	BXD120A-C
BX6200A-5	6GH5K	BXM6200-GH	BXD200A-A
BX6200A-10	6GH10K	BXM6200-GH	BXD200A-A
BX6200A-15	6GH15K	BXM6200-GH	BXD200A-A
BX6200A-20	6GH20K	BXM6200-GH	BXD200A-A
BX6200A-30	6GH30K	BXM6200-GH	BXD200A-A
BX6200A-50	6GH50K	BXM6200-GH	BXD200A-A
BX6200A-100	6GH100K	BXM6200-GH	BXD200A-A
BX6200A-200	6GH200K	BXM6200-GH	BXD200A-A
BX6200C-5	6GH5K	BXM6200-GH	BXD200A-C
BX6200C-10	6GH10K	BXM6200-GH	BXD200A-C
BX6200C-15	6GH15K	BXM6200-GH	BXD200A-C
BX6200C-20	6GH20K	BXM6200-GH	BXD200A-C
BX6200C-30	6GH30K	BXM6200-GH	BXD200A-C
BX6200C-50	6GH50K	BXM6200-GH	BXD200A-C
BX6200C-100	6GH100K	BXM6200-GH	BXD200A-C
BX6200C-200	6GH200K	BXM6200-GH	BXD200A-C
BX6400S-5	6GH5K	BXM6400-GH	BXD400B-S
BX6400S-10	6GH10K	BXM6400-GH	BXD400B-S
BX6400S-15	6GH15K	BXM6400-GH	BXD400B-S
BX6400S-20	6GH20K	BXM6400-GH	BXD400B-S
BX6400S-30	6GH30K	BXM6400-GH	BXD400B-S
BX6400S-50	6GH50K	BXM6400-GH	BXD400B-S
BX6400S-100	6GH100K	BXM6400-GH	BXD400B-S
BX6400S-200	6GH200K	BXM6400-GH	BXD400B-S

• Motor/gearhead combination type, electromagnetic brake model

Unit model	Gearhead model	Motor model	Driver model
BX230AM-5	GFH2G5	BXM230M-GFH2	BXD30A-A
BX230AM-10	GFH2G10	BXM230M-GFH2	BXD30A-A
BX230AM-15	GFH2G15	BXM230M-GFH2	BXD30A-A
BX230AM-20	GFH2G20	BXM230M-GFH2	BXD30A-A
BX230AM-30	GFH2G30	BXM230M-GFH2	BXD30A-A
BX230AM-50	GFH2G50	BXM230M-GFH2	BXD30A-A
BX230AM-100	GFH2G100	BXM230M-GFH2	BXD30A-A
BX230AM-200	GFH2G200	BXM230M-GFH2	BXD30A-A
BX230CM-5	GFH2G5	BXM230M-GFH2	BXD30A-C
BX230CM-10	GFH2G10	BXM230M-GFH2	BXD30A-C
BX230CM-15	GFH2G15	BXM230M-GFH2	BXD30A-C
BX230CM-20	GFH2G20	BXM230M-GFH2	BXD30A-C
BX230CM-30	GFH2G30	BXM230M-GFH2	BXD30A-C
BX230CM-50	GFH2G50	BXM230M-GFH2	BXD30A-C
BX230CM-100	GFH2G100	BXM230M-GFH2	BXD30A-C
BX230CM-200	GFH2G200	BXM230M-GFH2	BXD30A-C
BX460AM-5	GFH4G5	BXM460M-GFH2	BXD60A-A
BX460AM-10	GFH4G10	BXM460M-GFH2	BXD60A-A
BX460AM-15	GFH4G15	BXM460M-GFH2	BXD60A-A
BX460AM-20	GFH4G20	BXM460M-GFH2	BXD60A-A
BX460AM-30	GFH4G30	BXM460M-GFH2	BXD60A-A
BX460AM-50	GFH4G50	BXM460M-GFH2	BXD60A-A
BX460AM-100	GFH4G100	BXM460M-GFH2	BXD60A-A
BX460AM-200	GFH4G200	BXM460M-GFH2	BXD60A-A
BX460CM-5	GFH4G5	BXM460M-GFH2	BXD60A-C
BX460CM-10	GFH4G10	BXM460M-GFH2	BXD60A-C
BX460CM-15	GFH4G15	BXM460M-GFH2	BXD60A-C
BX460CM-20	GFH4G20	BXM460M-GFH2	BXD60A-C
BX460CM-30	GFH4G30	BXM460M-GFH2	BXD60A-C
BX460CM-50	GFH4G50	BXM460M-GFH2	BXD60A-C
BX460CM-100	GFH4G100	BXM460M-GFH2	BXD60A-C
BX460CM-200	GFH4G200	BXM460M-GFH2	BXD60A-C
BX5120AM-5	GFH5G5	BXM5120M-GFH2	BXD120A-A
BX5120AM-10	GFH5G10	BXM5120M-GFH2	BXD120A-A
BX5120AM-15	GFH5G15	BXM5120M-GFH2	BXD120A-A
BX5120AM-20	GFH5G20	BXM5120M-GFH2	BXD120A-A
BX5120AM-30	GFH5G30	BXM5120M-GFH2	BXD120A-A
BX5120AM-50	GFH5G50	BXM5120M-GFH2	BXD120A-A
BX5120AM-100	GFH5G100	BXM5120M-GFH2	BXD120A-A
BX5120AM-200	GFH5G200	BXM5120M-GFH2	BXD120A-A
BX5120CM-5	GFH5G5	BXM5120M-GFH2	BXD120A-C
BX5120CM-10	GFH5G10	BXM5120M-GFH2	BXD120A-C
BX5120CM-15	GFH5G15	BXM5120M-GFH2	BXD120A-C
BX5120CM-20	GFH5G20	BXM5120M-GFH2	BXD120A-C
BX5120CM-30	GFH5G30	BXM5120M-GFH2	BXD120A-C
BX5120CM-50	GFH5G50	BXM5120M-GFH2	BXD120A-C
BX5120CM-100	GFH5G100	BXM5120M-GFH2	BXD120A-C
BX5120CM-200	GFH5G200	BXM5120M-GFH2	BXD120A-C
BX6200AM-5	6GH5K	BXM6200M-GH	BXD200A-A
BX6200AM-10	6GH10K	BXM6200M-GH	BXD200A-A
BX6200AM-15	6GH15K	BXM6200M-GH	BXD200A-A
BX6200AM-20	6GH20K	BXM6200M-GH	BXD200A-A
BX6200AM-30	6GH30K	BXM6200M-GH	BXD200A-A
BX6200AM-50	6GH50K	BXM6200M-GH	BXD200A-A
BX6200AM-100	6GH100K	BXM6200M-GH	BXD200A-A
BX6200AM-200	6GH200K	BXM6200M-GH	BXD200A-A
BX6200CM-5	6GH5K	BXM6200M-GH	BXD200A-C
BX6200CM-10	6GH10K	BXM6200M-GH	BXD200A-C
BX6200CM-15	6GH15K	BXM6200M-GH	BXD200A-C
BX6200CM-20	6GH20K	BXM6200M-GH	BXD200A-C
BX6200CM-30	6GH30K	BXM6200M-GH	BXD200A-C
BX6200CM-50	6GH50K	BXM6200M-GH	BXD200A-C
BX6200CM-100	6GH100K	BXM6200M-GH	BXD200A-C
BX6200CM-200	6GH200K	BXM6200M-GH	BXD200A-C
BX6400SM-5	6GH5K	BXM6400M-GH	BXD400B-S
BX6400SM-10	6GH10K	BXM6400M-GH	BXD400B-S
BX6400SM-15	6GH15K	BXM6400M-GH	BXD400B-S
BX6400SM-20	6GH20K	BXM6400M-GH	BXD400B-S
BX6400SM-30	6GH30K	BXM6400M-GH	BXD400B-S
BX6400SM-50	6GH50K	BXM6400M-GH	BXD400B-S
BX6400SM-100	6GH100K	BXM6400M-GH	BXD400B-S
BX6400SM-200	6GH200K	BXM6400M-GH	BXD400B-S

• **Round shaft type, standard model**

Unit model	Motor model	Driver model
BX230A-A	BXM230-A2	BXD30A-A
BX230C-A	BXM230-A2	BXD30A-C
BX460A-A	BXM460-A2	BXD60A-A
BX460C-A	BXM460-A2	BXD60A-C
BX5120A-A	BXM5120-A2	BXD120A-A
BX5120C-A	BXM5120-A2	BXD120A-C
BX6200A-A	BXM6200-A	BXD200A-A
BX6200C-A	BXM6200-A	BXD200A-C
BX6400S-A	BXM6400-A	BXD400A-S

• **Round shaft type, electromagnetic brake model**

Unit model	Motor model	Driver model
BX230AM-A	BXM230M-A2	BXD30A-A
BX230CM-A	BXM230M-A2	BXD30A-C
BX460AM-A	BXM460M-A2	BXD60A-A
BX460CM-A	BXM460M-A2	BXD60A-C
BX5120AM-A	BXM5120M-A2	BXD120A-A
BX5120CM-A	BXM5120M-A2	BXD120A-C
BX6200AM-A	BXM6200M-A	BXD200A-A
BX6200CM-A	BXM6200M-A	BXD200A-C
BX6400SM-A	BXM6400M-A	BXD400A-S

Names and functions of parts

The following describes the names and functions of individual components of the driver and motor, and the specifications.

For detailed information of each unit, see the page described in the [].

■ Driver (common to round shaft type and combination type)

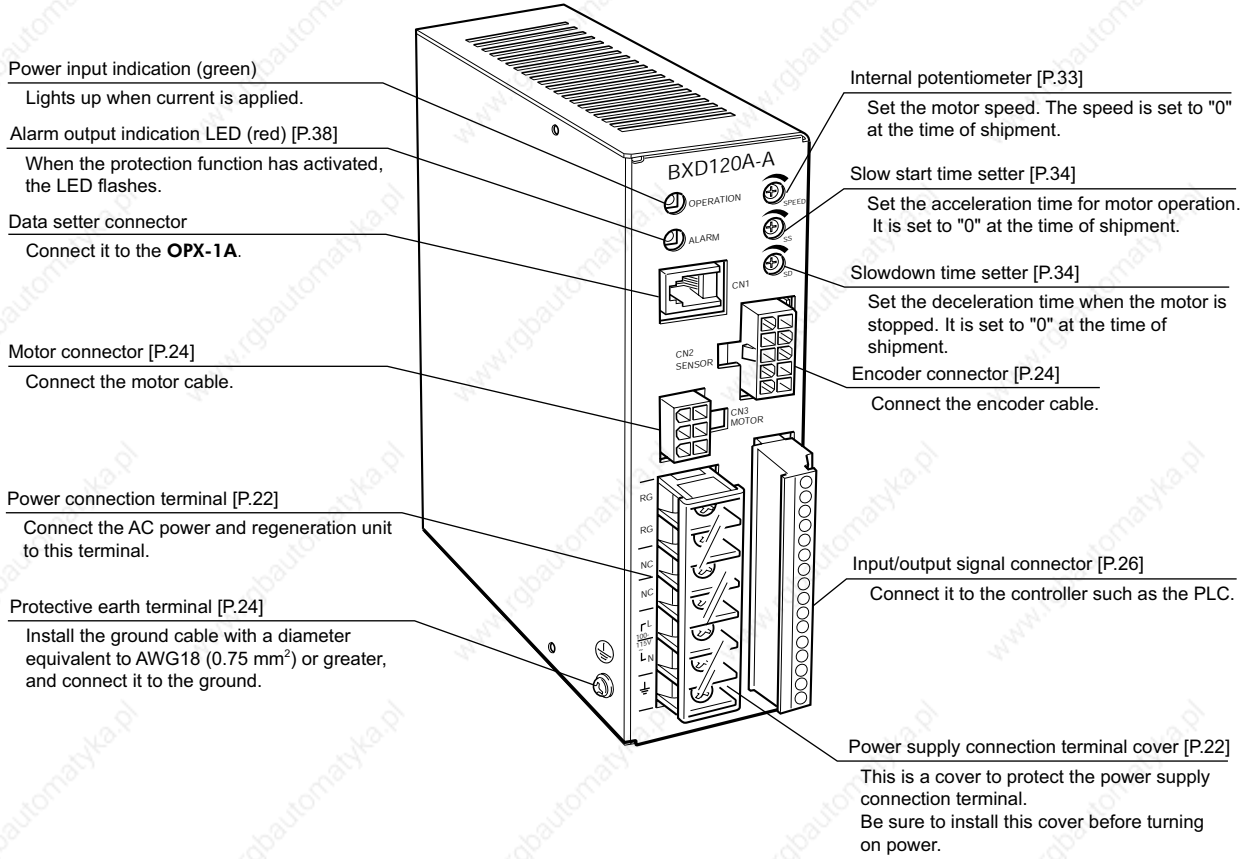

■ Motor

• BX230, BX460, BX5120

Illustration shows the combination type motor, standard model.

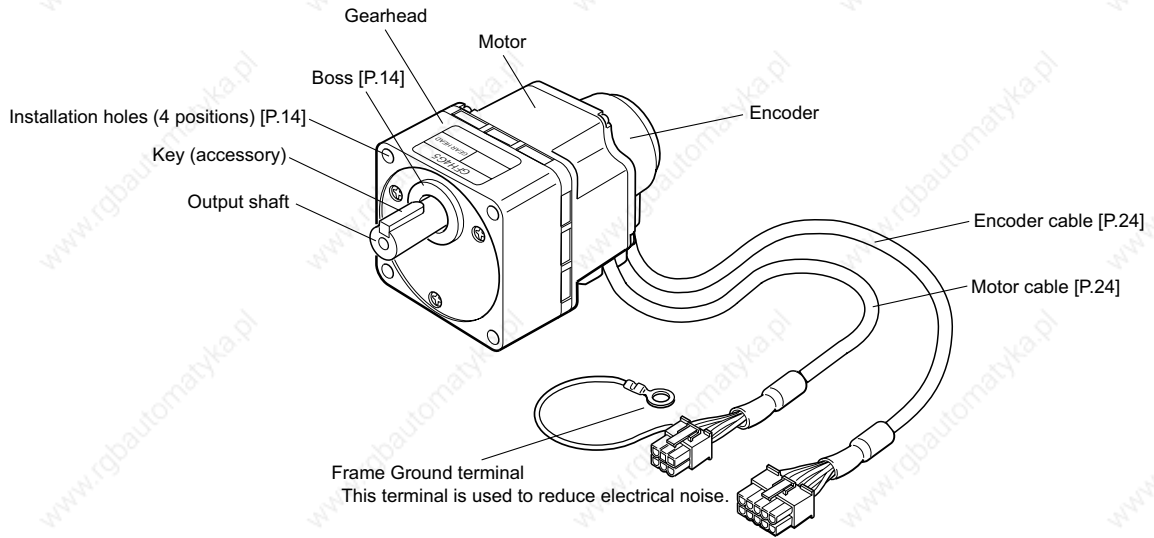

• BX6200, BX6400

Illustration shows the round shaft type motor, electromagnetic brake model.

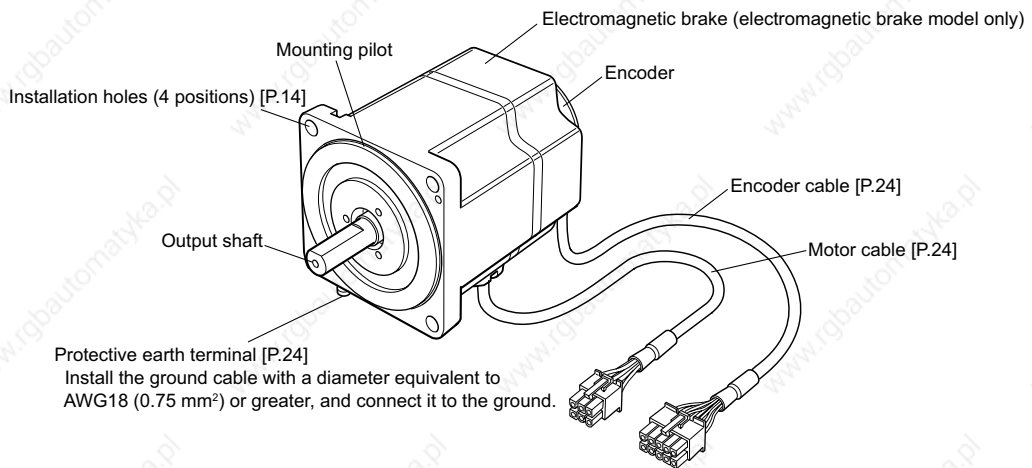

Installation

The following shows the motor (gearhead) and driver installation environment, installation method and load installation.

Installation site

The motor (gearhead) and driver are designed and manufactured to be incorporated into the equipment.

To ensure effective ventilation and easy inspection, install it in the following site.

- In the indoor housing (where a ventilation port must be provided)
- Ambient temperature: 0 to +50 °C (+32 to +122 °F) (non-freezing)
- Ambient humidity: 85% or less (non-condensing)
- Not in the explosive atmosphere with hazardous gas or liquid
- Not exposed to sunlight
- Not at the site exposed to much dust or metallic particles
- Not at the place splashed with water (rain or water drop), oil (oil drop) or other liquid
- Not at the site containing much salt
- Not subjected to continuous vibration or excessive shock
- Not at the position exposed to much electromagnetic noise (caused by welder and power driven equipment)
- Not at the site near radiation, magnetic field or vacuum environment

Installation of motor (gearhead)

■ Method of installation

Install the motor (gearhead) on a flat metallic plate having an excellent resistance to vibration and heat conduction.

• Combination type

To install the motor with gearhead, use the four installation holes and mount the motor with four hexagon socket head bolts (provided) so that there is no gap with the metallic plate.

Frame size	Bolt size	Tightening torque
60 mm (2.36 in.)	M4	2 N·m (280 oz-in)
80 mm (3.15 in.)	M6	3 N·m (420 oz-in)
90 mm (3.54 in.)	M8	4 N·m (560 oz-in)
104 mm (4.09 in.)	M8	4 N·m (560 oz-in)

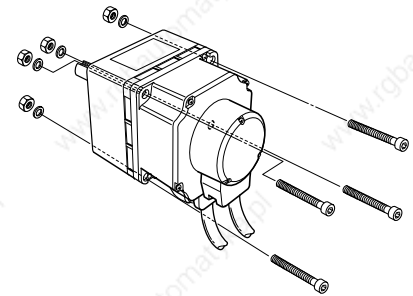

• Round shaft type

To install the motor, use the four installation holes and mount the motor with four bolts (not provided) so that there is no gap with the metallic plate.

Frame size	Bolt size	Tightening torque
60 mm (2.36 in.)	M4	2 N·m (280 oz-in)
80 mm (3.15 in.)	M6	3 N·m (420 oz-in)
90 mm (3.54 in.)	M8	4 N·m (560 oz-in)
104 mm (4.09 in.)	M8	4 N·m (560 oz-in)

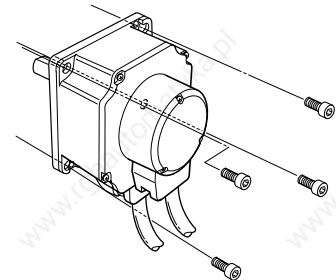

Note

- The mounting pilot located on the motor installation surface should be inserted into a countersunk or drilled through hole.
- The boss on the gearhead installation surface should be inserted into a countersunk or drilled through hole.
- To ensure that the motor case temperature will not exceed 90°C (194°F), install the round shaft type on a metallic plate having the following dimensions:

BX230-A: 115 mm × 115 mm
(4.53 in. × 4.53 in.)

BX460-A: 135 mm × 135 mm
(5.31 in. × 5.31 in.)

BX5120-A: 165 mm × 165 mm
(6.5 in. × 6.5 in.)

BX6200-A: 200 mm × 200 mm
(7.87 in. × 7.87 in.)

Thickness: 5 mm (0.2 in.)

Material: aluminum

BX6400-A: 250 mm × 250 mm
(9.84 in. × 9.84 in.)

Thickness: 6 mm (0.24 in.)

Material: aluminum

Load installation

When installing the load to the motor or gearhead, ensure that the motor output shaft or gearhead output shaft and load shaft are aligned with each other.

The round shaft type motor output shaft is provided with a flat. Use double point screws on the flat and provide reliable locking to prevent idle rotation of the load. The combination type gearhead output shaft is provided with a key groove. A key groove must also be provided on the side of the load to be installed. Use the attached key to lock it in position.

Key dimensions

- BX230**-□: 4 mm (0.16 in.)
- BX460**-□: 5 mm (0.2 in.)
- BX5120**-□: 6 mm (0.24 in.)
- BX6200**-□: 6 mm (0.24 in.)
- BX6400**-□: 6 mm (0.24 in.)

■ Direct connection of coupling

Ensure that the motor (gearhead) output shaft and load shaft are aligned with each other.

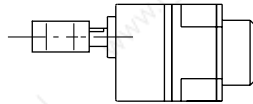

■ Belt connection

Ensure that the centerlines of the motor (gearhead) output shaft and load shaft are parallel with each other, and that the line connecting the centers of both pulleys and shaft are at a right angle to each other.

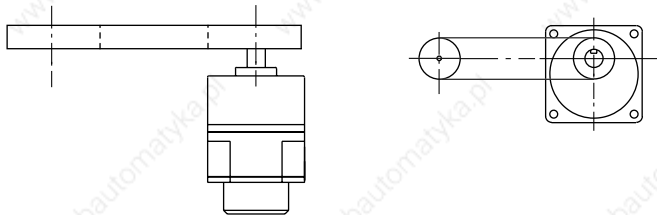

■ Gear connection

Provide correct engagement with the center of the gear tooth surface to ensure that the motor (gearhead) output shaft and gear shaft are parallel to each other.

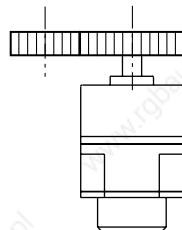

Note

- When connecting the motor (gearhead) with a load, care must be taken to ensure adequate alignment, belt tension and pulley parallelism. The coupling and pulley locking screws must be clamped firmly in position.
- To install a coupling or pulley to the motor output shaft or gear output shaft, sufficient care must be taken not to damage the output shaft and bearing.
- Do not modify or machine the motor (gearhead) output shaft. It may damage the bearing, which may result in motor (gearhead) failure.

Note

If the overhung load and thrust load exceeds the tolerance, the motor (gearhead) bearing and output shaft may be subjected to failure damage.

Overhung load and thrust load

Ensure that the overhung load and thrust load applied to the motor shaft or gearhead do not exceed the tolerances shown in the table below.

Unit model	Overhung load N (lb.) Distance from shaft tip		Thrust load N (lb.)
	10 mm (0.39 in.)	20 mm (0.79 in.)	
BX230A(C)-A, BX230A(C)M-A	87.2 (19.6)	107 (24)	0.7 [1] (1.54 [2.2])*
BX460A(C)-A, BX460A(C)M-A	117 (26)	137 (30)	1 [1.5] (2.2 [3.3])*
BX5120A(C)-A, BX5120A(C)M-A	156 (35)	176 (39)	1.6 [2.2] (3.5 [4.8])*
BX6200A(C)-A, BX6200A(C)M-A	197 (44)	221 (49)	2.5 [3.5] (5.5 [7.7])*
BX6400S-A, BX6400SM-A	197 (44)	221 (49)	2.5 [3.5] (5.5 [7.7])*
BX230A(C)-5 BX230A(C)M-5	100 (22)	150 (33)	40 (9)
BX230A(C)-10, 15, 20 BX230A(C)M-10, 15, 20	150 (33)	200 (45)	40 (9)
BX230A(C)-30, 50, 100, 200 BX230A(C)M-30, 50, 100, 200	200 (45)	300 (67)	40 (9)
BX460A(C)-5 BX460A(C)M-5	200 (45)	250 (56)	100 (22)
BX460A(C)-10, 15, 20 BX460A(C)M-10, 15, 20	300 (67)	350 (78)	100 (22)
BX460A(C)-30, 50, 100, 200 BX460A(C)M-30, 50, 100, 200	450 (101)	550 (123)	100 (22)
BX5120A(C)-5 BX5120A(C)M-5	300 (67)	400 (90)	150 (33)
BX5120A(C)-10, 15, 20 BX5120A(C)M-10, 15, 20	400 (90)	500 (112)	150 (33)
BX5120A(C)-30, 50, 100, 200 BX5120A(C)M-30, 50, 100, 200	500 (112)	650 (146)	150 (33)
BX6200A(C)-5, 10, 15 BX6200A(C)M-5, 10, 15	550 (123)	800 (180)	200 (45)
BX6200A(C)-20, 30, 50, 100, 200 BX6200A(C)M-20, 30, 50, 100, 200	650 (146)	1000 (220)	200 (45)
BX6400S-5, 10, 15 BX6400SM-5, 10, 15	550 (123)	800 (180)	200 (45)
BX6400S-20, 30, 50, 100, 200 BX6400SM-20, 30, 50, 100, 200	650 (146)	1000 (220)	200 (45)

- The figures indicated by * are the motor's mass [kg (lb.)]. The thrust load should not exceed the motor's dead mass.
- The figures in parenthesis [] are the values for the electromagnetic brake motor.

Driver installation

Direction of installation

The driver is designed on the basis of heat radiation by air convection and heat conduction to the housing.

When installing the driver in the housing, be sure to mount it in a vertical orientation using the mounting holes provided on the driver.

The driver should be installed 25 mm (1 in.) or more in the horizontal direction away from the housing sides and other equipment inside the housing, and 25 mm (1 in.) or more away from them in the vertical direction.

When two or more drivers are to be installed in parallel, separate them by 20 mm (0.8 in.) or more in the horizontal direction and by 25 mm (1 in.) or more in the vertical direction as illustrated.

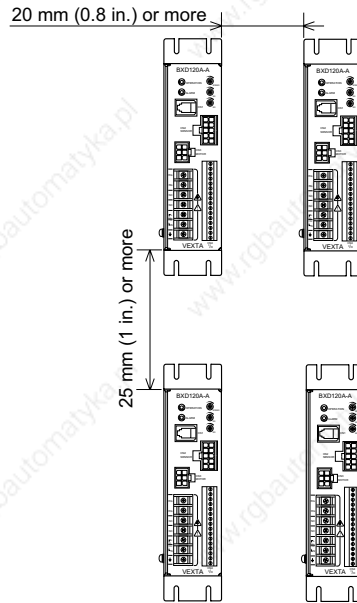

How to install the driver

Install the driver on a flat metal plate having excellent vibration resistance and heat conductivity.

Using driver mounting brackets

- Using the attached driver fitting screws (four M3 screws), install the driver fittings on the back of the driver.

Tightening torque: 0.5 to 0.6 N·m
(71 to 85 oz-in)

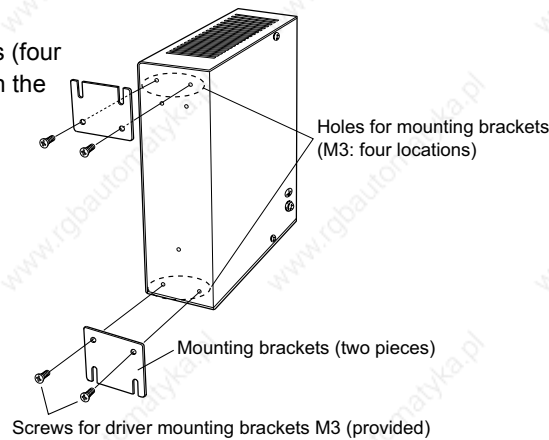

- Using the driver mounting hole, fix the driver with four M4 screws (not attached) so that there will be no gap with the metallic plate.

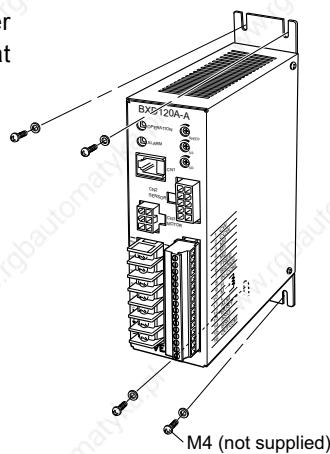

Note

- Install the driver in an enclosure.
- Do not install any equipment that generates a large amount of heat near the driver.
- Check ventilation if the ambient temperature of the driver exceeds 50°C (122°F).

Note

- Do not use the mounting holes (M3: four locations) for the driver mounting brackets provided in the back of the driver for any purpose other than securing the driver mounting brackets.
- Be sure to use the supplied screws when securing the driver mounting brackets.

Note

- Do not use the mounting holes (M3: three locations) for the DIN rail mounting plate provided in the back of the driver for any purpose other than securing the DIN rail mounting plate.
- Be sure to use the supplied screws when securing the DIN rail mounting plate. The use of screws that would penetrate 3 mm (0.118 in.) or more through the surface of the driver may cause damage to the driver.

• Mounting to DIN rail

When mounting the driver to a DIN rail, use a separately sold DIN rail mounting plate (model number: **PADP01**) and attach it to a 35 mm (1.38 in.) wide DIN rail.

1. Attach the DIN rail mounting plate to the rear panel of the driver by tightening the supplied mounting screws into the mounting holes provided (three locations).

Tightening torque: 0.3 to 0.4 N·m
(42 to 56 oz-in)

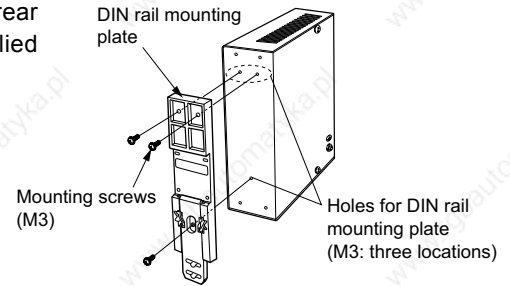

2. Pulling the DIN lever downward, hook the tab of the DIN rail mounting plate on the DIN rail and push the driver until the DIN lever locks.

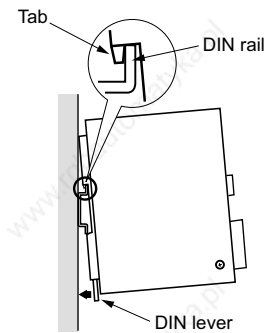

3. Secure the driver using end plates (not supplied).

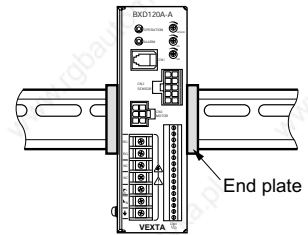

• Removing from DIN rail

Pull the DIN lever down until it locks using a flat blade-parallel tip type screwdriver, and lift the bottom of the driver to remove it from the rail. Use force of about 10 to 20 N (2.2 to 4.5 lb.) to pull the DIN lever to lock it. Excessive force may damage the DIN lever.

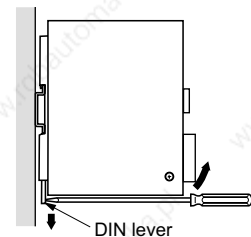

Regeneration unit installation

• EPRC-400P, RGB100 (sold separately)

Using two screws (not attached), secure the regeneration unit on a flat metal plate having excellent heat conductivity.

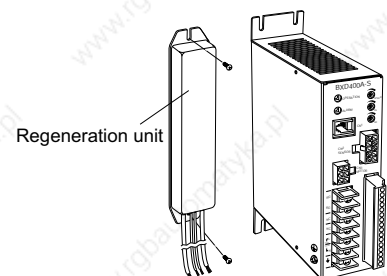

Installing and wiring in compliance with EMC directive

General

■EMC directive (89/336/EEC, 92/31/EEC)

The **BX** series has been designed and manufactured for incorporation in general industrial machinery. The EMC directive requires that the equipment incorporating this product comply with these directives.

The installation and wiring method for the motor and driver are the basic methods that would effectively allow the customer's equipment to be compliant with the EMC directive.

The compliance of the final machinery with the EMC directive will depend on such factors as the configuration, wiring, layout and risk involved in the control-system equipment and electrical parts. It therefore must be verified through EMC measures by the customer of the machinery.

■Applicable standards

EMI

Emission Tests	EN61000-6-4
Radiated Emission Test	EN55011
Conducted Emission Test	EN55011

EMS

Immunity Tests	EN61000-6-2
Radiation Field Immunity Test	IEC61000-4-3
Electrostatic Discharge Immunity Test	IEC61000-4-2
Fast Transient / Burst Immunity Test	IEC61000-4-4
Conductive Noise Immunity Test	IEC61000-4-6
Surge Immunity Test	IEC61000-4-5
Voltage Dip Immunity Test	IEC61000-4-11
Voltage Interruption Immunity Test	IEC61000-4-11

Installing and wiring

Effective measures must be taken against the EMI that the **BX** series may give to adjacent control-system equipment, as well as the EMS of the **BX** series itself, in order to prevent a serious functional impediment in the machinery.

The use of the following installation and wiring methods will enable the **BX** series to be compliant with the EMC directive (the aforementioned compliance standards).

■Connecting mains filter for power source line

Connect a mains filter in the AC input line to prevent the noise generated in the driver from propagating externally through the power-source line.

Use a mains filter or equivalent as below table.

Maker	Single-phase 100 V	Single-phase 200 V	Three-phase 200 V
Schaffner Electronics AG	FN2070-10-06	–	FN251-8-07
EPCOS	B84113-C-B110	–	–
TDK Corporation	–	ZAG2210-11S	–

- Install a mains filter at a point as close to the driver as possible. Further, secure the input and output cables with cable clamps or the like so that they won't rise from the surface of the enclosure panel.
- Use as thick a cable as possible to connect the mains filter's ground terminal with the grounding point, and do so using the shortest possible distance.
- Do not wire the AC input-side cable (AWG18: 0.75 mm² or more) and the mains filter's output cable (AWG18: 0.75 mm² or more) in parallel. If they are wired in parallel, noise occurring within the enclosure will be transmitted to the power-source cable via stray capacitance, thereby reducing the mains filter's effectiveness.

■How to ground

The cable used to ground the driver, motor and mains filter must be as thick and short to the grounding point as possible so that no potential difference is generated. Choose a large, thick and uniformly conductive surface for the grounding point.

• Grounding the driver

Use the protective earth terminal located on the side of the driver.

See page 24, for details on how to ground the driver.

• Grounding the motor

• BX230, BX460, BX5120

Ground the Frame Ground terminal of the motor cable.

• BX6200, BX6400

Ground the motor's protective earth terminal.

See page 24, for details on how to ground the driver.

■Wiring the signal cable

Use a braided screen cable with a wire of a size ranging between AWG24 to 22 (0.2 to 0.3 mm²) for the driver signal cable, and keep it as short as possible.

When grounding the braided screen cable, use a metal cable clamp and ensure that it contacts the braided screen cable along the cable's entire circumference. Install the cable clamp at the end of the braided screen cable and secure it to an appropriate grounding point

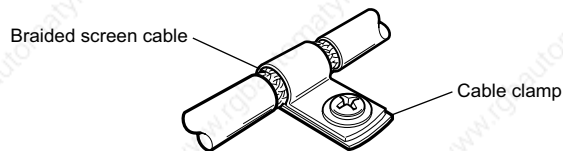

■Notes about installation and wiring

- Grounding connections should be made directly to the grounding points so that differences won't occur between the grounding potentials of the motor and driver and those of surrounding control-systems equipment.
- When relays or electromagnetic switches are used together with the system, use mains filter and CR circuits to suppress surges generated by them.
- Wire the cables along the shortest possible distance, being sure not to wind or bundle excess lengths.
- Separate the signal cables from the power cables such as the motor cable and power-source cable, and wire them so that they're separated by a distance approximately 100 to 200 mm (4 to 8 in.). If a power cable and signal cable must cross, let them cross at a right angle. Additionally, keep a distance between the mains filter's AC input-side cable and output-side cable.
- If an extension cable is required between the motor and driver, it is recommended that an optional junction cable (sold separately) be used, since the EMC measures are conducted using the Oriental Motor junction cable.

■ Example of motor and driver installation and wiring

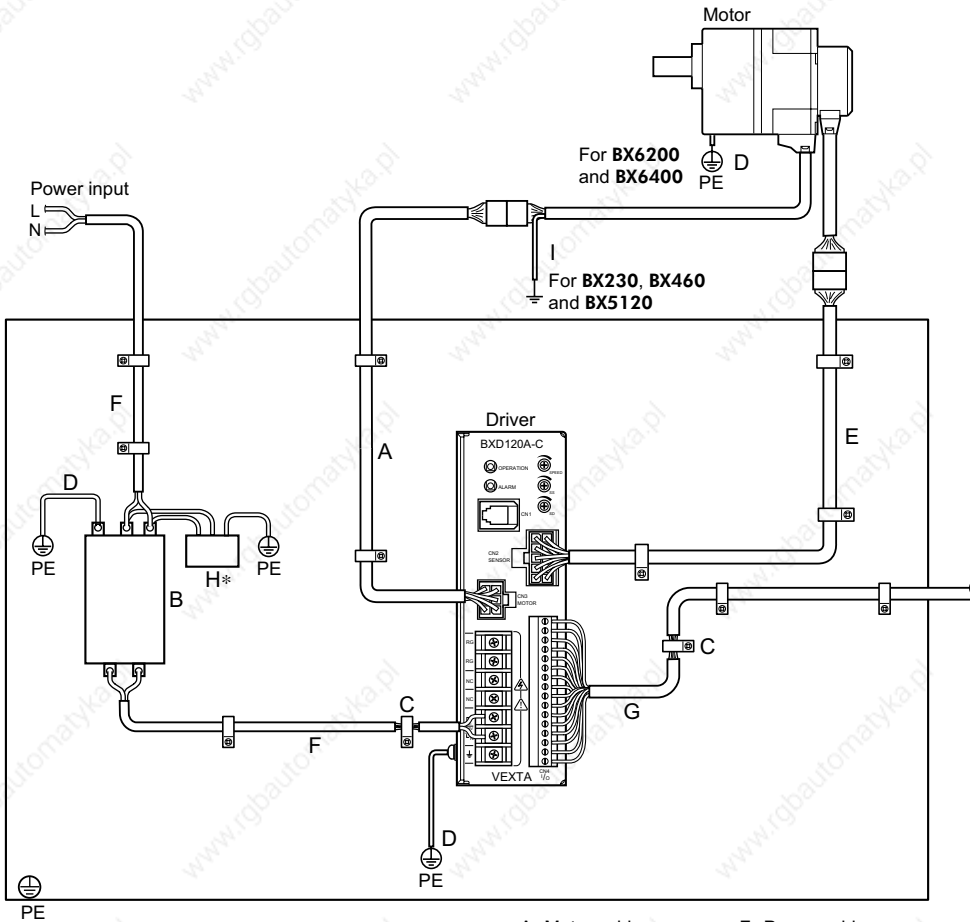

* When operating the product with a single-phase 200-230 V or three-phase 200-230 V power source under overvoltage category III, install and connect a surge absorber on the primary side of a mains filter.

A: Motor cable
B: Mains filter
C: Cable clamp
D: Protective earth cable
E: Encoder cable

F: Power cable
G: Signal cable
H: Surge absorber
I: Frame Ground terminal lead

Precautions about static electricity

Static electricity may cause the driver to malfunction or suffer damage. Be careful when handling the driver with the power on.

Always use an insulated screwdriver to adjust the driver's built-in motor current switch.

Note

Do not come close to or touch the driver while the power is on.

Connection

The following shows the method of connecting the driver and power source/regeneration unit/motor/external controller, earth connection method, an example of connection and input/output signals.

- Warning**
- Do not make connections when the power is on. Always turn the power off before carrying out these operations. Failure to do so may result in electric shock.
 - To prevent electric shock, be sure to install the terminal cover (supplied) over the driver's power supply terminals after making connections.

Power connection

Connect the power cable to the driver power connection terminal L and N or terminal L1, L2 and L3.

Note

- Do not route the driver power cable in the same conduit with other power lines or motor cables.
- Prepare a power supply which is capable of supplying a sufficient amount of driver power input current. In the event of insufficient current capacitance, the transformer may be damaged or motor torque may be reduced, thereby resulting in motor driving failure.

Single-phase 100 V

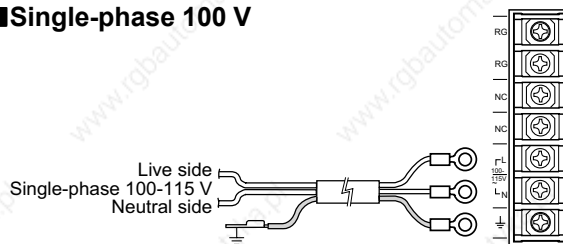

Connect the live side (phase wire side) of the single-phase 100-115 V power supply to the terminal L, and the neutral side (neutral line) to the terminal N.

Connect the \oplus terminal to the ground point on the power supply side.

Unit model	Rated current capacity	Maximum current capacity
BX230 □□	1.4 A	2.4 A
BX460 □□	2.2 A	3.5 A
BX5120 □□	3.7 A	6.7 A
BX6200 □□	4.7 A	9 A

Each of the square boxes will contain number representing the availability of the electromagnetic brake, power supply input or gear ratio.

Single-phase 200 V

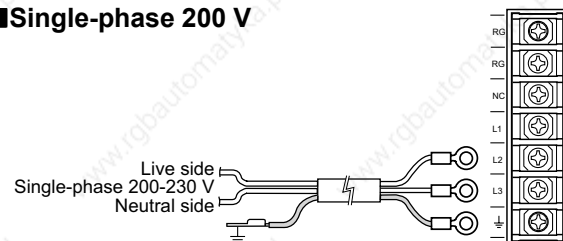

Connect the live side (phase wire side) of the single-phase 200-230 V power supply to the terminal L2, and the neutral side (neutral line) to the terminal L3.

Connect the \oplus terminal to the ground point on the power supply side.

Unit model	Rated current capacity	Maximum current capacity
BX230 □□	0.8 A	1.6 A
BX460 □□	1.4 A	2.2 A
BX5120 □□	2.3 A	4.1 A
BX6200 □□	2.8 A	5.3 A

Each of the square boxes will contain number representing the availability of the electromagnetic brake, power supply input or gear ratio.

Three-phase 200 V

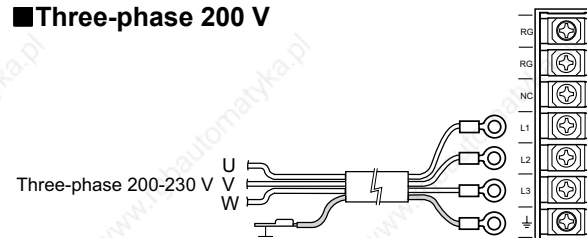

Connect the U, V and W phases of the three-phase 200-230 V power supply to terminals L1, L2 and L3, respectively.

Connect the \oplus terminal to the ground point on the power supply side.

Unit model	Rated current capacity	Maximum current capacity
BX230 □□	0.5 A	0.8 A
BX460 □□	0.7 A	1.2 A
BX5120 □□	1.1 A	2 A
BX6200 □□	1.7 A	3.2 A
BX6400 □□	2.8 A	Combination type: 3.2 A Round shaft type: 4.4 A

Each of the square boxes will contain number representing the availability of the electromagnetic brake, power supply input or gear ratio.

■ Dimensions of power supply connection terminal screw and cable

For connection, use an insulated round crimp terminal.

- Terminal screw: M3
- Tightening torque: 0.8 to 1 N·m (113 to 142 oz-in)
- Connectable cable: AWG16 to 18 (1.25 to 0.75 mm²)

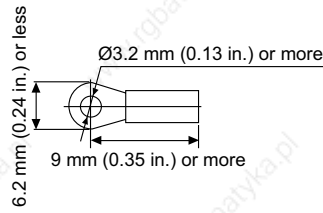

Turning on the power

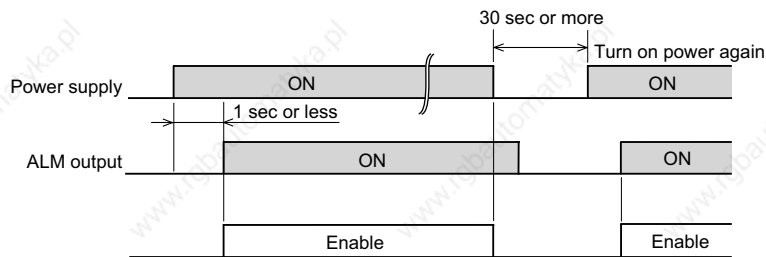

Note

After shutting down the power, wait at least 30 seconds before turning it back on.

Regeneration unit connection

• EPRC-400P, RGB100 (sold separately) with thermal protector

- Connect the two thick lead wires (AWG18) of the regeneration unit to the driver's RG terminals.
- The thin lead wires (AWG22) of the regeneration unit are thermal protector output. Provide a measure on the thermal protector contact to shut off the power supply in the event an error is detected.

Action of thermal protector:

- The thermal protector (N.C.) will open when the temperature of the regeneration unit exceeds 150°C (302°F).
- The thermal protector will automatically return to the normal state when the temperature of the regeneration unit drops to 140°C (284°F).

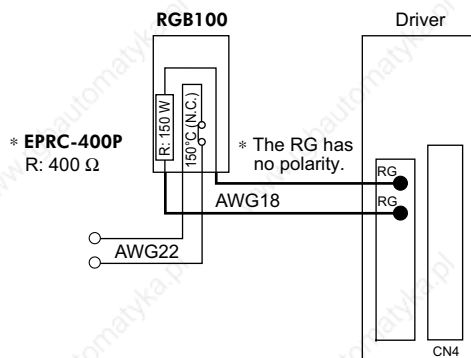

⚠ Warning • In the event the thermal protector is triggered, shut off the power.

Note

Firmly insert the connector in position.
Incomplete connection of the connector may cause operation failure, or may damage the motor or driver.

Motor connection

Insert the motor cable connector into the driver motor connector (CN3). Insert the encoder connector cable into the driver encoder connector (CN2).

To increase the distance between the motor and driver, use the optional junction cable. For the details of this cable, see page 39.

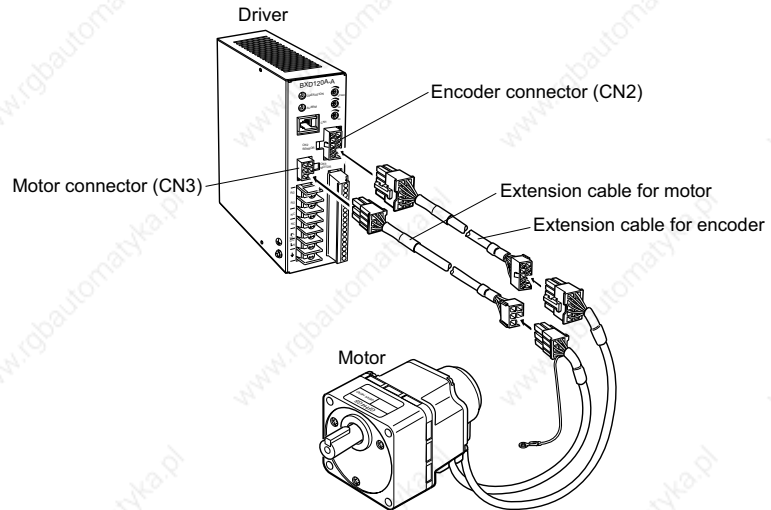

Grounding the motor and driver

■ Grounding the motor

• BX230, BX460, BX5120

Ground the motor using one of its four mounting holes.

Use a grounding cable of AWG18 (0.75 mm²) or more in diameter.

Use a round, insulated crimp terminal in combination with an inner-clip washer and bolt it in place to secure the grounding connection.

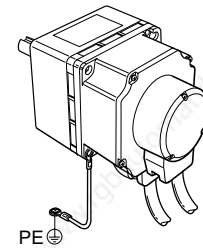

• BX6200, BX6400

Be sure to ground the motor's protective earth terminal (screw size: M4).

Use a grounding cable of AWG18 (0.75 mm²) or more in diameter.

Use a round, insulated crimp terminal in combination with an inner-clip washer and bolt it in place to secure the grounding connection.

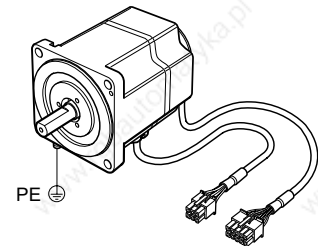

■ Grounding the driver

Be sure to ground the protective earth terminal (screw size: M4) located on the driver side.

Use a grounding cable of AWG18 (0.75 mm²) or more in diameter.

Do not share the grounding cable with a welder or power equipment.

Use a round, insulated crimp terminal to ground the cable near the driver.

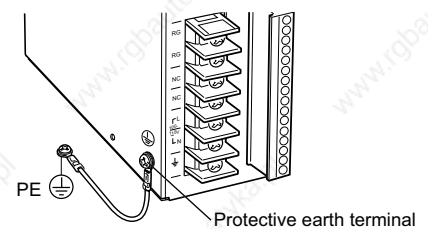

Connection of input signal and output signal

■ Input/output signal connector connection

The combination type connector is used for the input/output signal connection (CN4).

The combination connector may be installed and removed with the lead wire connected, as shown below, thereby offering better work efficiency for driver installation and maintenance.

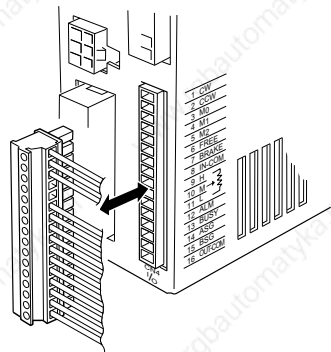

1. Strip the lead wire and twist the cable conductor.
Applicable lead wire diameter: AWG24 to 20 (0.2 to 0.5 mm²)
Length of the lead wire which can be peeled: 4 mm (0.16 in.)

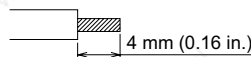

2. Loosen the combination connector screw.
3. Insert the peeled cable conductor into the combination connector, and tighten the screw.
Use a 3 mm (0.12 in.) wide slotted head screwdriver.

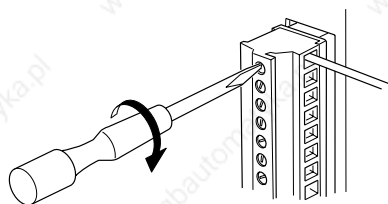

Tightening torque: 0.5 to 0.8 N·m (71 to 113 oz-in)

Note

The output signal voltage must be no less than 4.5 VDC and no greater than 26.4 VDC.
 Since output signals are open collector outputs, be sure to connect an external resistance and limit the output current as follows:
 ALM output, BUSY output: 40 mA or less
 ASG output, BSG output: 20 mA or less

■ Connection diagram

Using the driver input/output signal connector (CN4), make a connection as illustrated below:

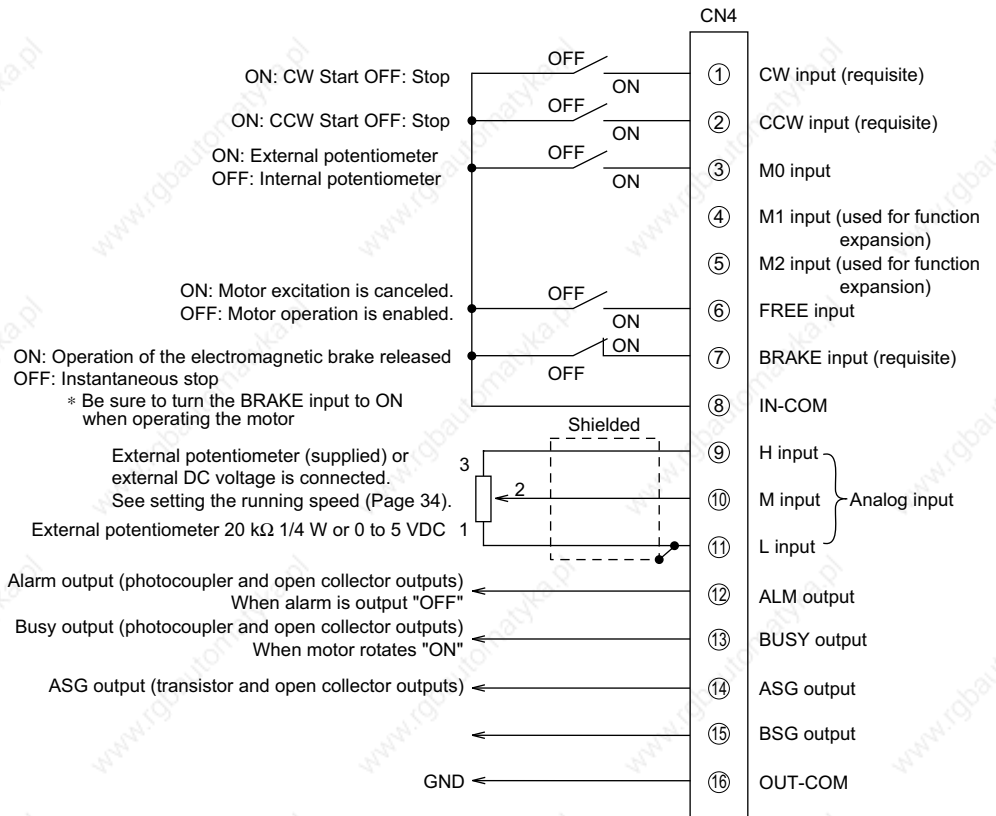
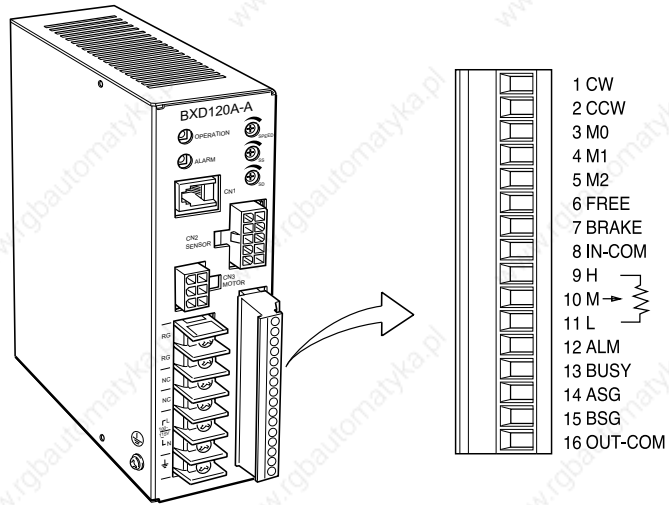

• Input signal

The CW, CCW, M0, M1, M2, FREE and BRAKE inputs are photocoupler inputs.

Internal resistor: 2.3 kΩ Internal voltage: +15 V

The M1 and M2 inputs are connected when using the system upgrading tool (**OPX-1A**).

• Output signal

ALM and BUSY outputs are photocoupler and open collector outputs.

ASG and BSG output are transistor and open collector outputs.

External operating conditions:

ALM and BUSY outputs: 4.5 to 26.4 VDC without exceeding 40 mA

ASG and BSG outputs: 4.5 to 26.4 VDC without exceeding 20 mA

External potentiometer connection

Optional external potentiometer is connected as below.

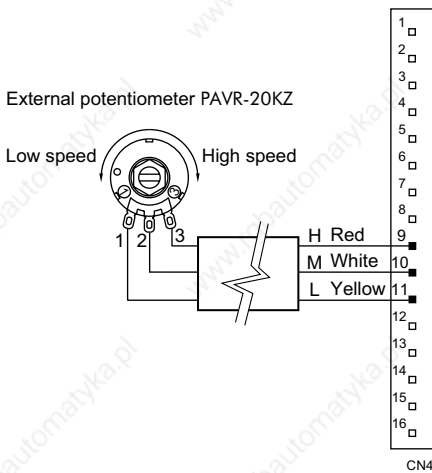

To connect the external potentiometer, use the attached external potentiometer and the signal cable [1 m (3.3 ft.)] for connection of the external potentiometer.

1. Connect the red lead wire of the signal cable for connection of the external potentiometer (hereinafter referred to as "signal cable") to the terminal 3 of the external potentiometer and input terminal H.
2. Connect the white lead wire of the signal cable to the terminal 2 of the external potentiometer and input terminal M.
3. Connect the yellow lead wire of the signal cable to the terminal 1 of the external potentiometer and input terminal L.
4. Connect the shielded cable of the signal cable to the input terminal L. (Make sure that the shielded cable of the signal cable does not touch other terminals).

Note

- The external DC power supply voltage must not exceed 5 VDC. Otherwise, the driver may be damaged.
- When connecting the external DC power supply, sufficient care must be taken not to mistake power polarity. Connection with incorrect polarity may damage the driver

External DC power supply connection

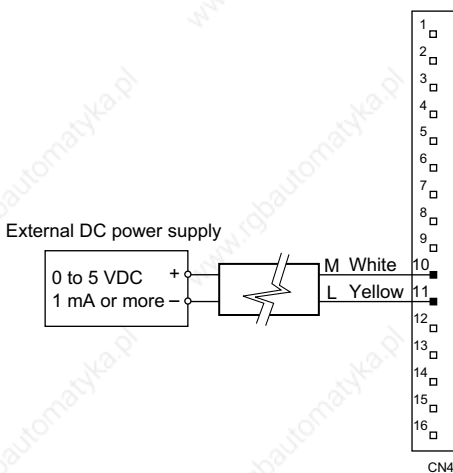

For external DC voltage, use the DC power supply (0 to 5 VDC) having the primary and secondary sides provided with reinforced insulation.

1. Connect the lead wire of the signal cable for connection of the external potentiometer (hereinafter referred to as "signal cable") to the positive terminal of the external DC power supply and input terminal M.
2. Connect the lead wire of the signal cable to the negative terminal of the external DC power supply and input terminal L.
3. Connect the shielded cable of the signal cable to the input terminal L. (Make sure that the shielded cable on the external potentiometer side does not touch other terminals.)

Input impedance between input M and input L is about 15 kΩ.

Input L is connected with the IN-COM inside the driver.

Photocoupler state

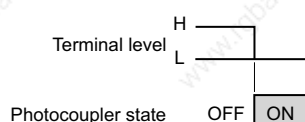

Note

- If both CW and CCW inputs are turned ON simultaneously, the motor stops after deceleration.
- If the brake input is turned OFF concurrently as the CW or CCW input is turned OFF, brake is applied to stop the operation.

Input signals and output signals

Input signal

All input signals of the driver are photocoupler inputs.

The signal state represents the “ON: Carrying current” or “OFF: Not carrying current” state of the internal photocoupler rather than the voltage level of the signal.

Driver internal circuit

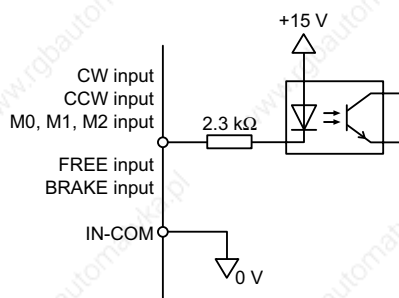

• CW input

When the brake input is ON, motor operation is enabled (See the description of brake input). If the CW input is turned ON, acceleration and operation are performed in the clockwise direction for the time set on the slow start time setter.

If it is turned OFF, deceleration takes place and the operation stops at the time set on the slow start time setter.

• CCW input

When the brake input is ON, motor operation is enabled (See the description of brake input). If the CCW input is turned ON, acceleration and operation are performed in the clockwise direction for the time set on the slow start time setter.

If it is turned OFF, deceleration takes place and the operation stops at the time set on the slow start time setter.

• Rotation direction of the gear output shaft

Rotation direction is shown as viewed from the flange surface of the motor.

Depending on the gearhead ratio, the rotation direction of the gear output shaft is as follows:

Gear ratio	Frame size			
	60 mm (2.32 in.)	80 mm (3.15 in.)	90 mm (3.54 in.)	104 mm (4.09 in.)
5	Same direction			
10				
15				
20	Same direction		Opposite direction	
30	Opposite direction			
50				
100	Opposite direction		Same direction	
200	Same direction			

• Brake input and ACL input

If the brake input and driver protection functions have activated during normal times, they will work as ACL input.

• Normal times (Brake input)

Function will be activated as brake input function (Signal name “BRAKE” is indicated on the right of the driver).

When the brake input is ON, the motor is enabled.

If it is OFF, brake is applied to the running motor to stop it.

To start motor operation, be sure to set the brake input to ON.

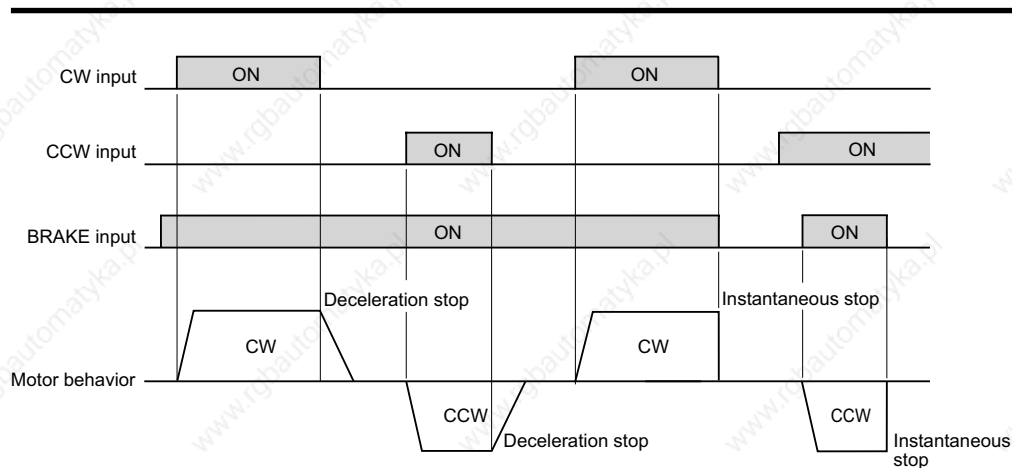

• **Activation of protection function (ACL input)**

The function is performed as ACL (Alarm Clear) input. The protection function is reset and the driver restarts.

This is used to reset the protection function when power is applied.

However, if protection functions for overcurrent, EEPROM data failure, system failure and encoder failure have activated, resetting will be disabled. Turn on the power again to perform resetting.

If one shot (0.5 sec.) is input to ACL input, the driver will be restarted.

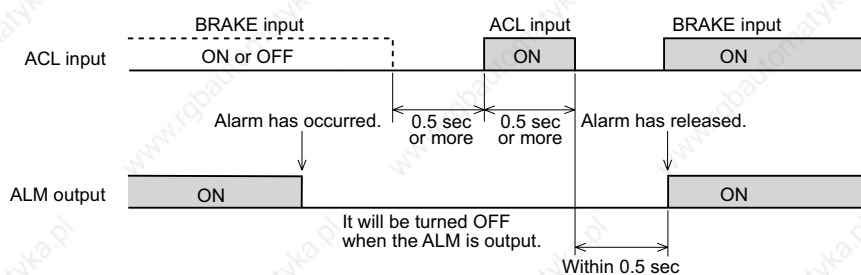

You can reset the protection function by cycling on the power supply.

Be sure to turn on power again after removing the cause for the operation of protection function; then reset ALM output.

For the output conditions of the protection function, see the description on page 30, 31.

• **FREE input**

Warning • Do not turn ON the FREE input when the position is held in the vertical direction. Otherwise, the holding force of the motor and electromagnetic brake will be lost, causing personal injury and equipment damage.

If FREE input is turned ON, motor excitation will be canceled, and the electromagnetic brake* will be released.

When FREE input is turned OFF, the driver excites the motor and activates the electromagnetic brake*.

The FREE input function takes precedence, independently of other inputs.

Even if a protection function activates, the FREE input function works.

* The electromagnetic brake refers to the case where the motor equipped with an electromagnetic brake.

• **M0 input**

Switch the speed setting in motor startup to the external or internal potentiometer. Turning ON of the M0 input enables the external potentiometer or external DC voltage setting speed. Turning OFF of the M0 input enables the setting speed of the internal potentiometer. Switching of the M0 input allows two-speed switching operation according to the external potentiometer or a combined use of external DC voltage.

The M1 and M2 inputs are connected when using the system upgrade tool (**OPX-1A**). Do not make a connection if you do not use the external potentiometer.

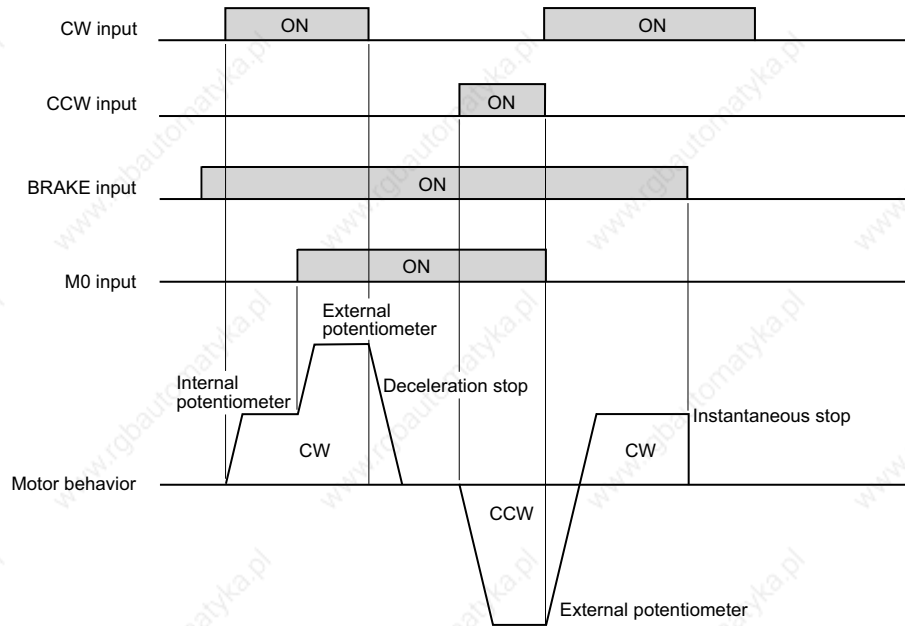

■ **Output signal**

The signal state represents the “ON: Carrying current” or “OFF: Not carrying current” state of the internal photocoupler rather than the voltage level of the signal.

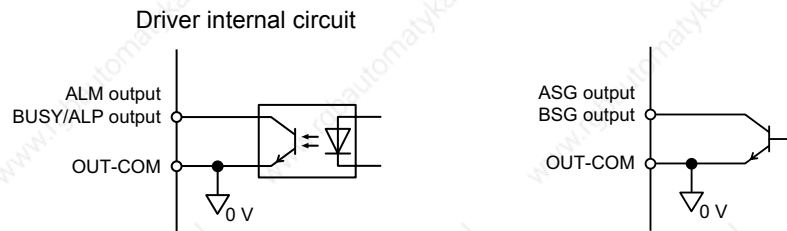
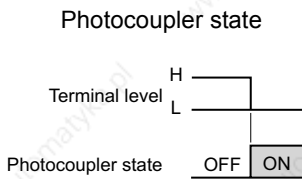

• **ALM output: photocoupler and open collector outputs**

⚠ Warning • When the driver’s protection function is triggered, first remove the cause and then clear the protection function. Continuing the operation without removing the cause of the problem may cause malfunction of the motor, leading to injury or damage to equipment.

When the protection function has activated, the ALM (Alarm) output is turned off to stop the motor.

If the electromagnetic brake is not supplied, stop is provided by inertia. When the electromagnetic brake is supplied, stop is provided by application of the electromagnetic brake. In this case, you can confirm the type of the activated protection function by counting the ALARM LED flashings [After flashing by the specified number of times (LED is on for 0.25 sec. and off for 0.25 sec.), the LED repeats flashing at intervals of 1.25 sec.].

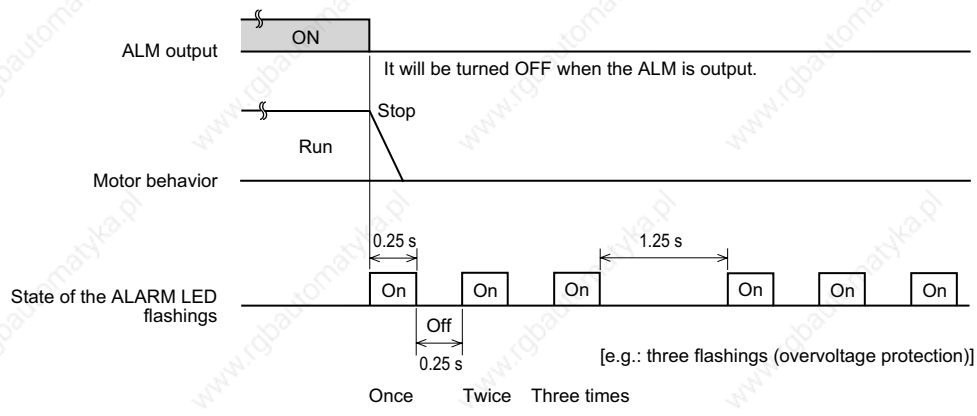

Protection function	Number of times of the ALARM LED flashings	Assumed causes
Overload protection	2 times	Load in excess of the rated torque is applied to the motor for about five seconds or more.
Overvoltage protection	3 times	Primary voltage of the driver inverter has exceeded the upper limit of voltage specification range.
Excessive displacement	4 times	The motor during operation in the position control mode* cannot follow the command.
Overcurrent protection	5 times	Excessive current has flown to driver inverter power element.
Excessive speed	6 times	The speed has exceeded 4000 r/min on the motor shaft.
EEPROM data error	7 times	The parameter has been damaged.
Encoder failure	8 times	A trouble has occurred to the feedback signal of the encoder.
Low voltage protection	9 times	Power supply voltage has reduced below the specified voltage range.

* The position control mode is enabled when the system upgrading tool (**OPX-1A**) is connected.

- **Resetting the protection function**
Reset any of the protection functions via the ACL input or by turning the power off and back on again only after removing the cause of the problem and ensuring safety.
One-shot ACL input (0.5 sec.) will restart the driver.
However, if protection functions for overcurrent, EEPROM data failure and encoder failure have activated, resetting will be disabled. Turn on the power again to perform resetting.
Wait at least 30 seconds after turning off the power before turning it back on again.

• **BUSY output and ALP output: photocoupler and open collector outputs**

If the BUSY output and driver protection functions have activated during normal times, they will work as ALP output.

• Normal times (BUSY output)

Function will be activated as BUSY output.

When the motor is running, the following output will be given:

If CW or CCW input and BRAKE input are turned ON simultaneously, the BUSY output will be turned ON.

It will be turned OFF when the motor has stopped by deceleration.

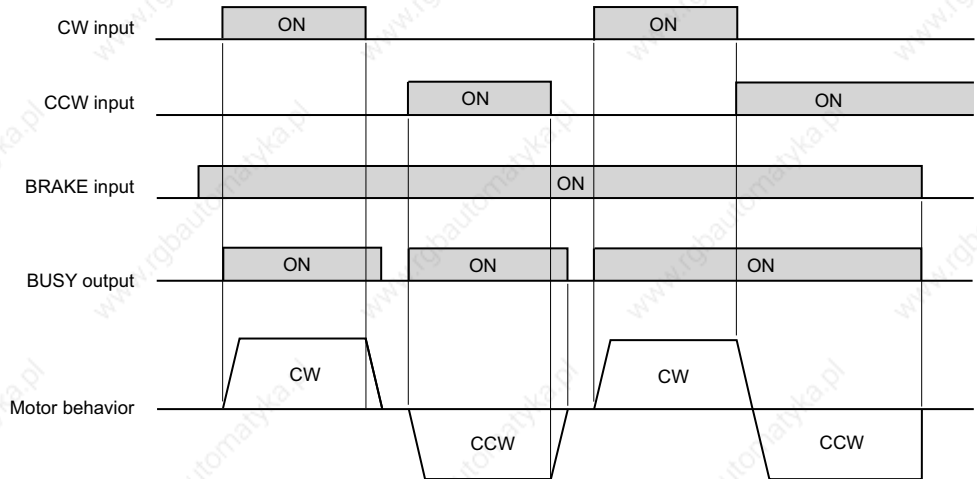

• Activation of protection function (ALP output)

The function is performed as ALP (Alarm Pulse) output, and the causes for the protection function having been activated are conveyed to the controller in terms of the number of pulses. If one shot (0.1 sec. or more) is given to the CW input, the number of ALARM LED flashings in response to the activation of the protection function and the pulses (5 Hz) corresponding to the number of ALARM LED flashings are output. The causes for the protection function having been activated is identified by the controller counting the output pulses.

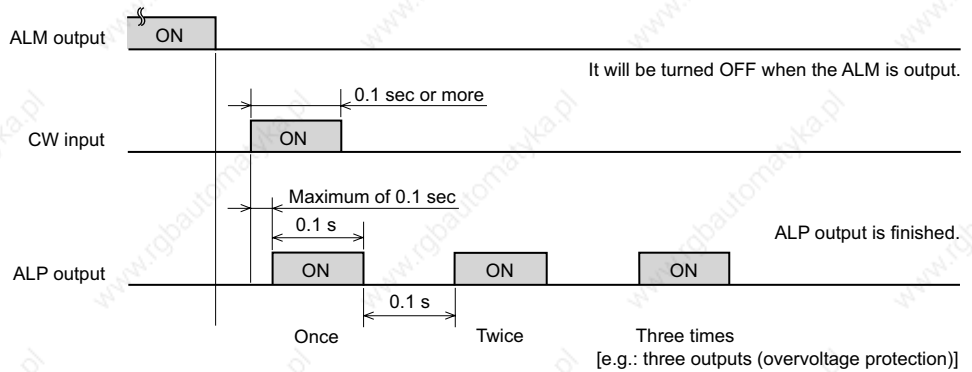

• **ASG output and BSG output: Transistor and open collector outputs**

Outputs feedback pulses from the encoder (500 p/r).

Note

When you want to the encoder feedback pulses, count both the ASG output and BSG output in the phase difference mode of the up/down counter.

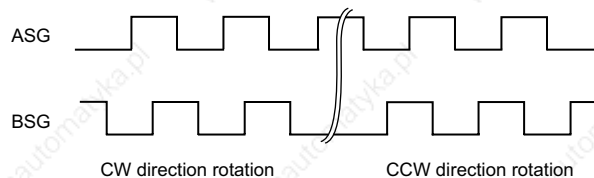

Running

Setting the motor running speed and running operation are as follows.

Setting the running speed

The motor's running speed can be set using the driver's internal potentiometer, external potentiometer or an external DC voltage.

The motor speed range is from 30 to 3000 r/min.

Two running speeds can be set by combining the internal potentiometer and external potentiometer, or the internal potentiometer and external DC voltage.

■Setting by internal potentiometer

Use a precision screw-driver for this adjustment. Clockwise rotation will increase the set speed. The speed is set to 0 r/min at time of shipment.

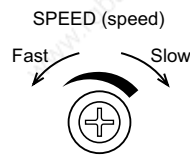
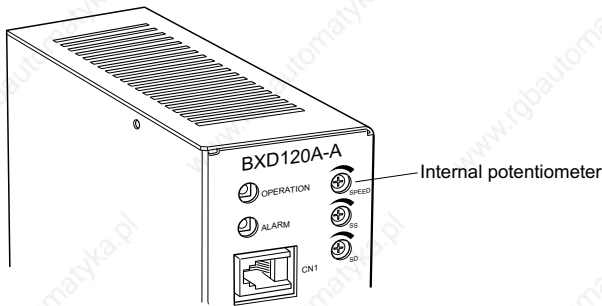

■Setting by external potentiometer

To drive the motor at the speed set on the external potentiometer, turn on the M0 input. Clockwise rotation will increase the set speed.

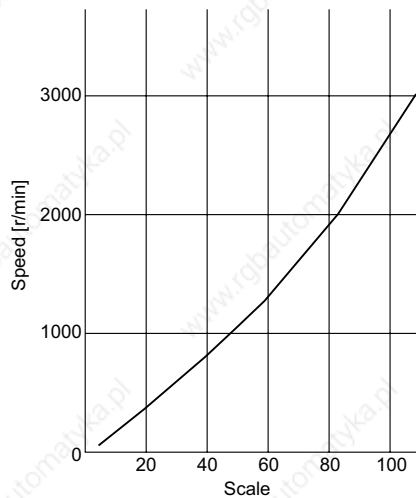

External potentiometer scale-speed characteristics (typical value)

■Setting by external DC voltage

To drive the motor set at the external DC voltage, turn on the M0 input.

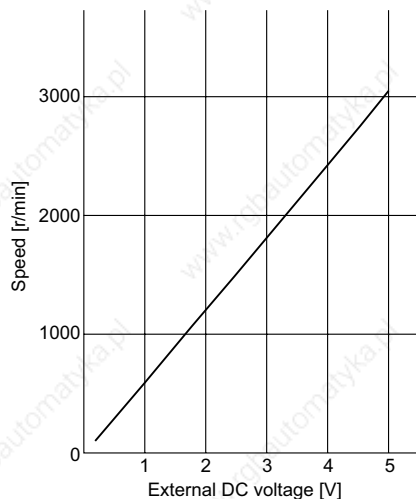

External DC voltage-speed characteristics

■How to set the slow start and slowdown time

You can set the slow start time (acceleration time) and slowdown time (deceleration time) separately when you want to start and stop the motor.

When the slow start and slowdown time has been set, it is valid to any of the setting speeds by the internal potentiometer, external potentiometer and external DC voltage.

Use a precision screw-driver for this adjustment.

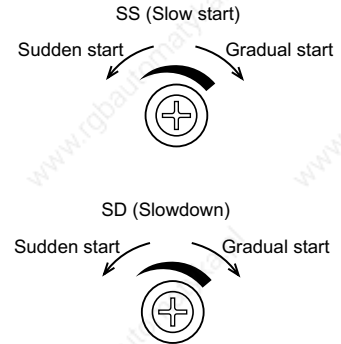
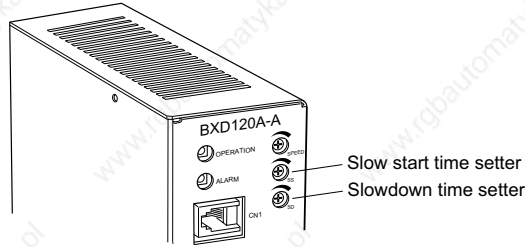

• How to set the slow start time

The slow start time setter (SS) is used to set the time required from the start of motor operation to attainment of the set speed.

Turn the setter in the clockwise direction, and the time will be prolonged.

Time setting range is from 0 to 15 sec. (Time is set to 0 sec. at the time of shipment).

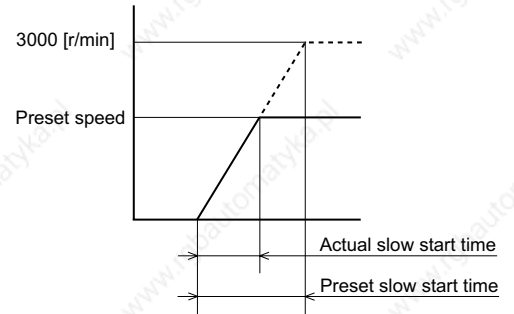

• How to set the slowdown time

The slowdown time setter (SD) is used to set the time required from the set speed to the stop of motor operation.

Turn the setter in the clockwise direction, and the time will be prolonged.

Time setting range is from 0 to 15 sec. (Time is set to 0 sec. at the time of shipment).

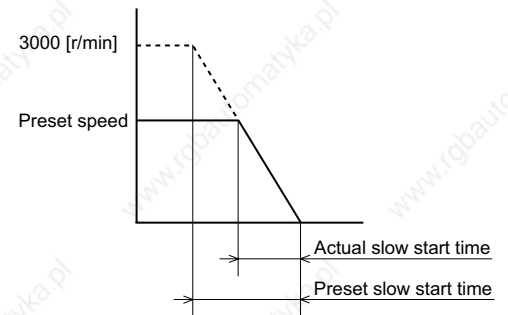

Note

When you have changed the rotation direction, the speed is decelerated and accelerated in conformity to the slow start setting time.

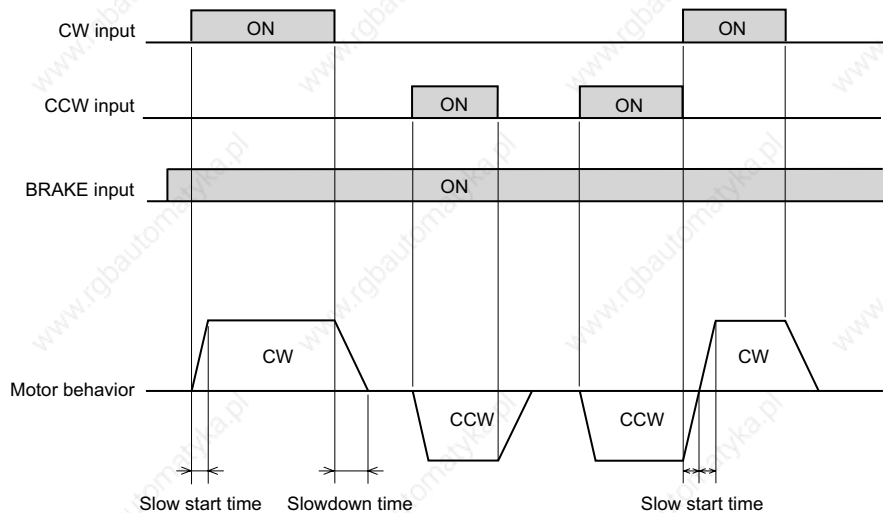

■ Changing the speed

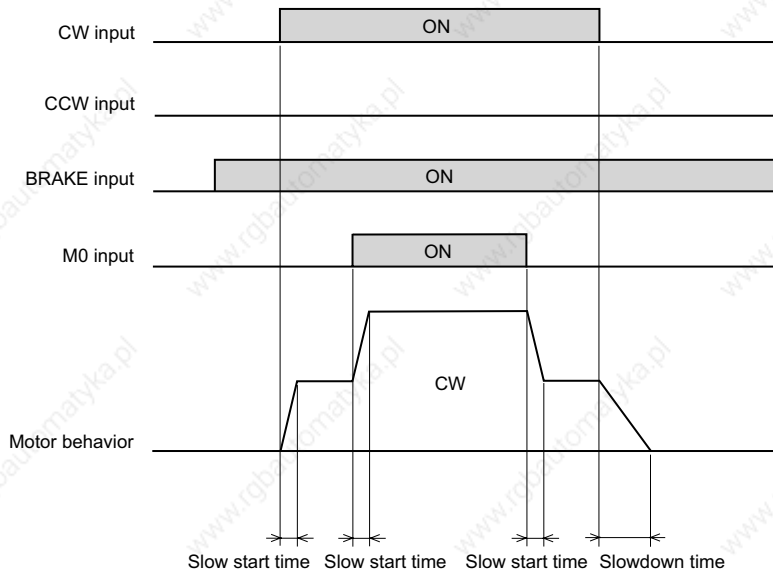

Note

When the speed of rotation is changed over to the low speed by the M0 input, the speed is reduced according to slow start setting time, not according to slowdown setting time.

Inspection

Note

- To prevent the encoder from being damaged, never measure the insulation resistance or dielectric strength of the encoder as an independent unit.
- Semiconducting elements are used for the driver. Carefully handle the driver, because the driver may be damaged by static electricity.

It is recommended to check the following four items after motor operation. If any failure is found, stop the operation, and please contact your local sales office.

Inspection items

- Check if the motor and gearhead installation screws are loosened or not.
- Check if abnormal noise is produced from the motor bearing section (ball bearing).
- Check if abnormal noise is produced from the gearhead bearing (ball bearing) and gear meshing section.
- Check if the motor/gearhead output shaft and load shaft are misaligned or not.
- Check if the motor cable or encoder cable are damaged or stressed. Also check if the connections with the driver are loosened.
- Check if the driver opening is clogged or not.
- Check if the driver installation screw is loosened or not.
- Check if the driver internal power element smoothing capacitor have abnormal smell or other failures.

Troubleshooting and remedial actions

During motor running, the motor and driver may not operate correctly due to speed setting error or connection error. If normal motor operation cannot be ensured, see the following description and take appropriate countermeasures. If normal operation cannot be ensured even after that, please contact your local sales office.

Phenomenon	Possible cause	Remedial action
The motor fails to turn.	BRAKE input turned OFF.	Turn on the BRAKE input.
	FREE input turned ON.	Turn off the FREE input.
	Both of CW input and CCW input turned OFF.	Turn on the CW input or CCW input.
	Both of CW input and CCW input turned ON.	Turn on either of the CW input or CCW input.
	The internal potentiometer is not adjusted.	Turn the internal potentiometer slightly in the clockwise direction. The speed is set to 0 r/min at time of shipment.
	M0 input is not turned OFF.	When the M0 input is off, the internal potentiometer is selected.
	The external potentiometer contact is faulty.	Check for connection of the external potentiometer.
	M0 input is not turned ON.	When the M0 input is on, the external potentiometer is selected.
	M1 input and M2 input is turned ON. The external DC voltage contact is faulty.	Turn off the M1 input and M2 input. Check for connection of the external DC voltage.
The motor is driven opposite of the specified direction.	Incorrect CW/CCW input or faulty connection.	The motors driven in the CW direction when the CW input is turned on and CCW direction when the CCW input is turned on.
	Speed reduction ratios 30:1, 50:1 and 100:1 are used in the combination type.	When speed reduction ratios 30:1, 50:1 and 100:1 are used in the combination type, drive direction is opposite to that of the motor. Reverse the CW/CCW input operation.
Unstable motor operation with big vibration.	The motor (gearhead) output shaft and load shaft are not aligned with each other.	Make sure that the motor (gearhead) output shaft and load shaft are connected in an appropriate manner.
	Affected by noise.	Check for running only with the motor, driver and controller required for running. If noise influence has been confirmed, take the appropriate measures such as separation from noise generating source, re-connection of wiring, replacement of the signal cable by a shielded cable, and installation of a Ferrite core.
The motor fails to stop instantaneously.	Turn OFF the set CW input or CCW input to stop the motor.	To stop the motor instantaneously, turn off the BRAKE input. If the motor does not stop instantaneously after that, load inertia may be excessive. Increase friction load or reduce load inertia, and check the result.

Alarm display and details

When the driver's ALARM LED is flashing, check the number of flashes and take an appropriate measure according to the table below.

The ALARM LED's flashing pattern is as shown in the figure below:

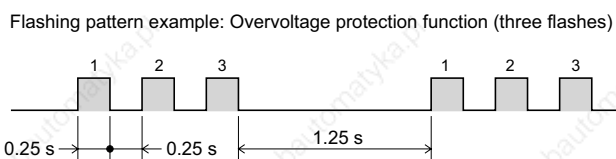

Number of times of the ALARM LED flashings	Protection function	Remedial action
2 times	Overload protection	Re-examine the load.
3 times	Overvoltage protection	When it has occurred to slow start/slowdown of the motor, reduce the load inertia or prolong slow start/slowdown time. Or connect the optional regeneration unit (available at extra cost). If this trouble has occurred in the gravitational application, reduce the load or speed. Or connect the optional regeneration unit (available at extra cost).
4 times	Excessive displacement	Reduce load inertia and load torque or prolong the slow start and slowdown time.
5 times	Overcurrent protection	Any one of motor cable, motor winding and driver output element is short circuited.
6 times	Excessive speed	Reduce the motor speed below 3000 r/min.
7 times	EEPROM data error Encoder failure	Turn on the driver power supply again. If the problem cannot be solved by it, contact our branch office or sales office from which you purchased our product, and request the product to be repaired.
8 times	Low voltage	Check the encoder cable for connection.
9 times	Protection	Check the power voltage.

* Turn on the driver power supply again. If the problem cannot be solved by it, contact our branch office or sales office from which you purchased our product, and request the product to be repaired.

Appendix

Option (sold separately)

■Data setter OPX-1A (Supplied with modular cable)

This data setter provides a substantial extension of the **BX** series functions.

It allows digital setting of the speed in eight steps, positioning operation (setting of movements at 6 points) and mechanical home position resetting. It also has a great variety of additional functions including driver data copying function and operation monitoring function.

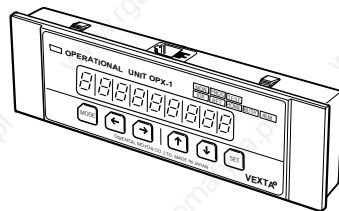

■Regeneration unit (Supplied with two mounting screws)

EPRC-400P (for BX230, BX460, BX5120)

RGB100 (for BX6200, BX6400)

This regeneration unit consumes and discharges regeneration energy generated during gravitational operation or sudden stop of large load inertial, thereby protecting the driver.

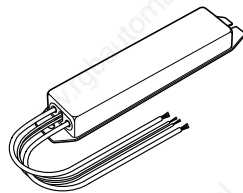

■Extension cable and movable cable

We have available the junction cable and movable cable required to extend the distance between the motor and driver. These cables for motor cable and encoder cable are available as one set.

Model		Length m (ft.)
Junction cable	Movable cable	
CC01SBF	CC01SBR	1 (3.3)
CC02SBF	CC02SBR	2 (6.6)
CC03SBF	CC03SBR	3 (9.8)
CC05SBF	CC05SBR	5 (16.4)
CC07SBF	CC07SBR	7 (23.0)
CC10SBF	CC10SBR	10 (32.8)
CC15SBF	CC15SBR	15 (49.2)
CC20SBF	CC20SBR	20 (65.6)

• For motor cable

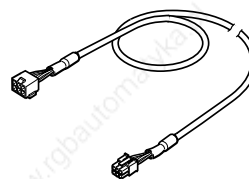

• For encoder cable

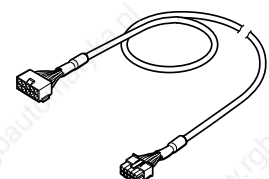

■DIN rail mounting plate (Supplied with three mounting screws)

Plate for mounting the driver to a DIN rail [35 mm (1.38 in.)].

Model: **PADP01**

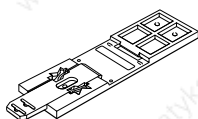

- Unauthorized reproduction or copying of all or part of this Operating Manual is prohibited. If a new copy is required to replace an original manual that has been damaged or lost, please contact your nearest branch or sales office.
- This Operating Manual is subject to change without prior notice for the purpose of product improvement or changes in specifications, or to improve its general content.
- While we make every effort to offer accurate information in the manual, we welcome your input. Should you find unclear descriptions, errors or omissions, please contact the nearest office.
-  **ORIENTAL MOTOR**, and **VEXTA** are trademarks of Oriental Motor Co., Ltd., and are registered in Japan and other countries. Other product names and company names mentioned in this manual may be trademarks or registered trademarks of their respective companies and are hereby acknowledged. The third-party products mentioned in this manual are recommended products, and references to their names shall not be construed as any form of performance guarantee. Oriental Motor is not liable whatsoever for the performance of these third-party products.

© Copyright ORIENTAL MOTOR CO., LTD. 2005

- Please contact your nearest ORIENTAL MOTOR office for further information.

ORIENTAL MOTOR U.S.A. CORP.

Technical Support Line Tel:(800)468-3982
Available from 7:30 AM to 5:00 PM, P.S.T.
E-mail: techsupport@orientalmotor.com
www.orientalmotor.com

ORIENTAL MOTOR (EUROPA) GmbH

Headquarters and Düsseldorf Office
Tel:0211-5206700 Fax:0211-52067099

Munich Office

Tel:08131-59880 Fax:08131-598888

Hamburg Office

Tel:040-76910443 Fax:040-76910445

ORIENTAL MOTOR (UK) LTD.

Tel:01256-347090 Fax:01256-347099

ORIENTAL MOTOR (FRANCE) SARL

Tel:01 47 86 97 50 Fax:01 47 82 45 16

ORIENTAL MOTOR ITALIA s.r.l.

Tel:02-93906346 Fax:02-93906348

TAIWAN ORIENTAL MOTOR CO., LTD.

Tel:(02)8228-0707 Fax:(02)8228-0708

SINGAPORE ORIENTAL MOTOR PTE. LTD.

Tel:(6745)7344 Fax:(6745)9405

ORIENTAL MOTOR (MALAYSIA) SDN. BHD.

Tel:(03)79545778 Fax:(03)79541528

INA ORIENTAL MOTOR CO., LTD.

KOREA

Tel:(032)822-2042~3 Fax:(032)819-8745

ORIENTAL MOTOR CO., LTD.

Headquarters Tokyo, Japan
Tel:(03)3835-0684 Fax:(03)3835-1890