

Delem		Luchthavenweg 42, 5657 EB Eindhoven, the NETHERLANDS	
EXPLODED VIEW			
DA69 VAO-1 STANDARD			
Format	Number	Issue	
A3	8028-504	B	
See drawing 9065-901 for viewing angle options information		Date	14-04-1998
Note B	Redrawn HNF	Date 29-10-2001	
Descr:ipt Lon Update Lay-Out			
Note A	Redrawn MI	Date 14-09-1998	
Description			
Measures in mm, unless otherwise specified		Drawn MI	
No unauthorized copying allowed Scale			

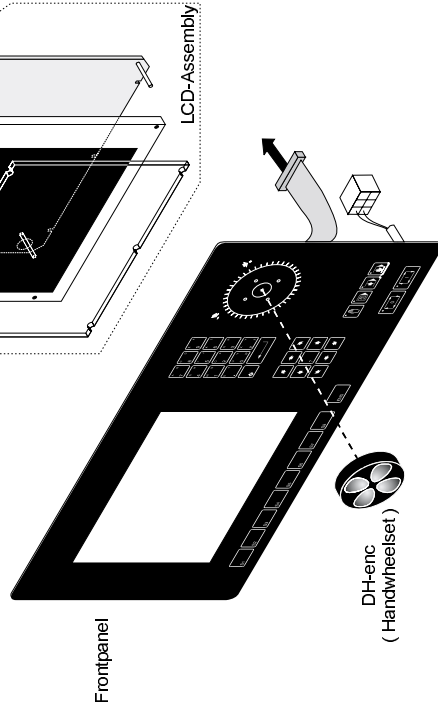

Delem		Luchthavenweg 42, 5657 EB Eindhoven, the NETHERLANDS	
EXPLODED VIEW			
DA69 VAO-2 STANDARD			
Format	Number	Issue	
A3	8028-505	B	
Note	Redrawn	Date	
B	HNF	29-10-2001	
Description			
Update Lay-Out			
Note	Redrawn	Date	
A	MI	14-09-1998	
Description			
Measures in mm, unless otherwise specified			
Drawn	MI	Date	
		14-04-1998	
No unauthorized copying allowed Scale			

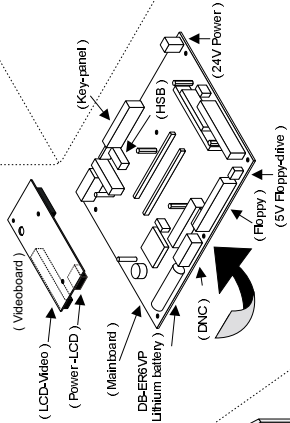
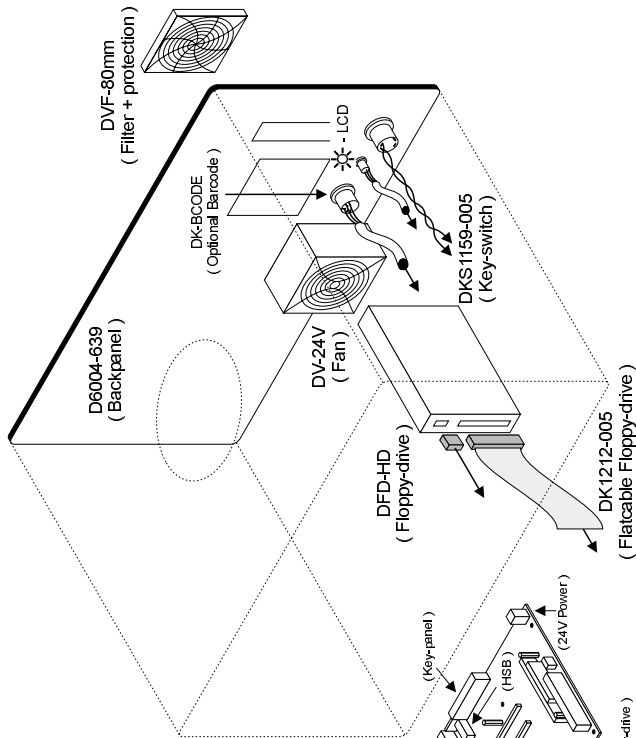
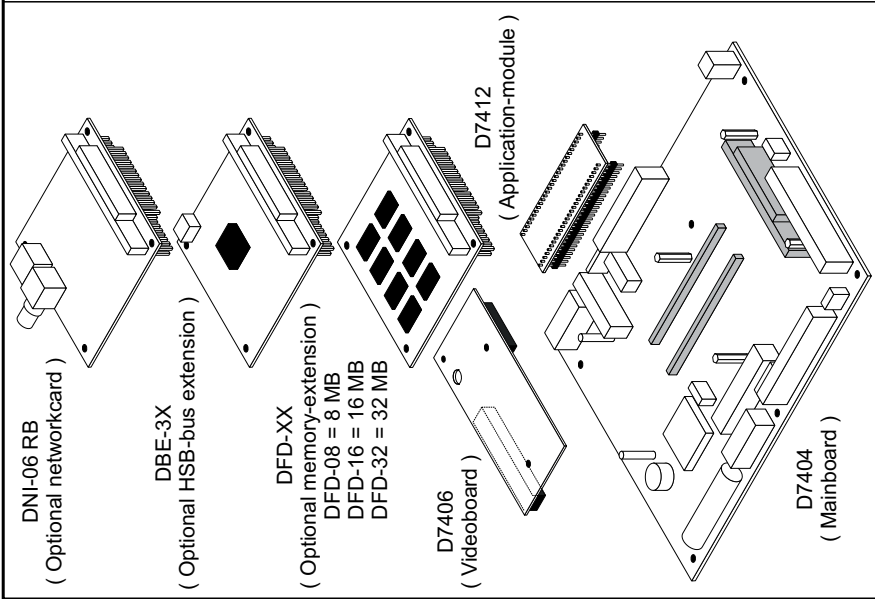
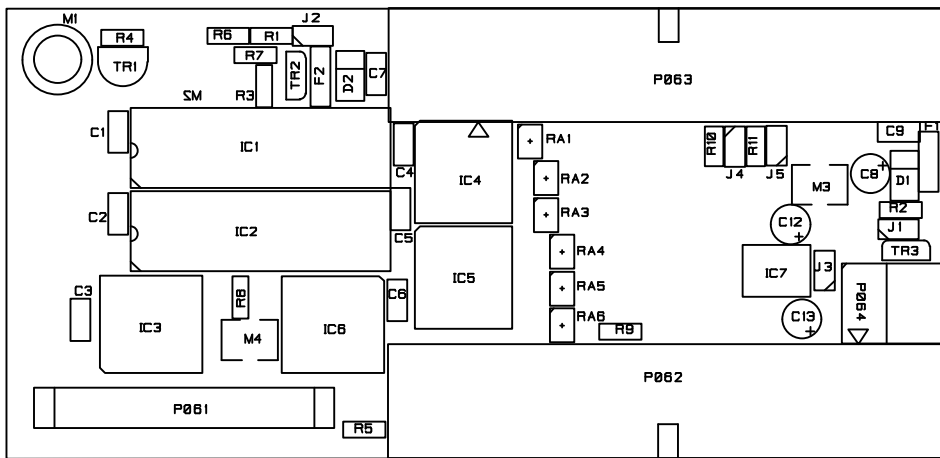

Note	Redraw	Date
		02-04-98
Description Issue A -> B		
Note	Redraw	Date
		01-10-97
Description Issue - -> A		
Measures in mm, unless otherwise specified		Drawn
		HM
		Date
		16-04-96

Del em Luchthavenweg 42.5657 EB Eindhoven, the NETHERLANDS		
LCD INTERFACE COMP.OPST.		
		301/B
Format	Number	Issue
A4	7406-201	B
No unauthorized copying allowed		

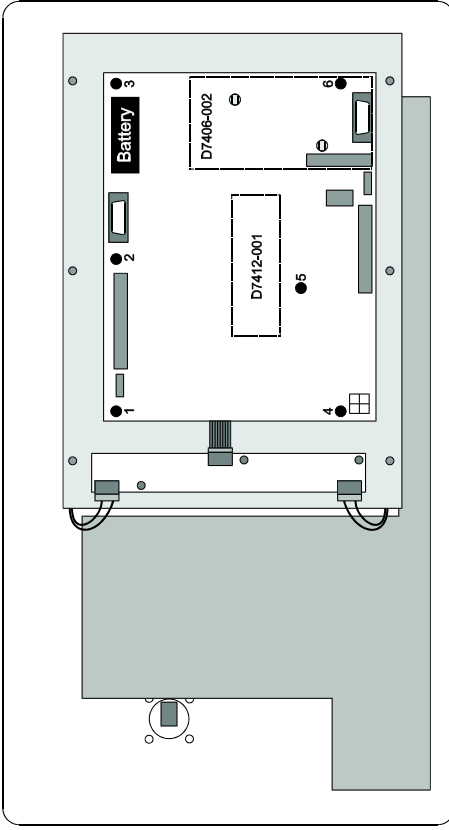

Disconnect all connectors, remove all other boards from Mainboard, and unscrew 1 - 6 to exchange D7404-008 (Mainboard)

EXCHANGING D7404-008 (Mainboard DA69)

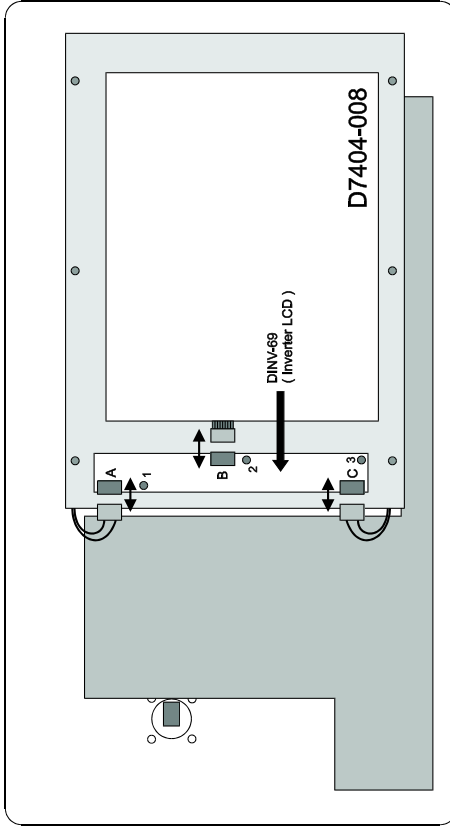

Disconnect A, B and C & Unscrew 1, 2 and 3 to exchange DINV-69 (Inverter LCD)

EXCHANGING DINV-69 (Inverter LCD)

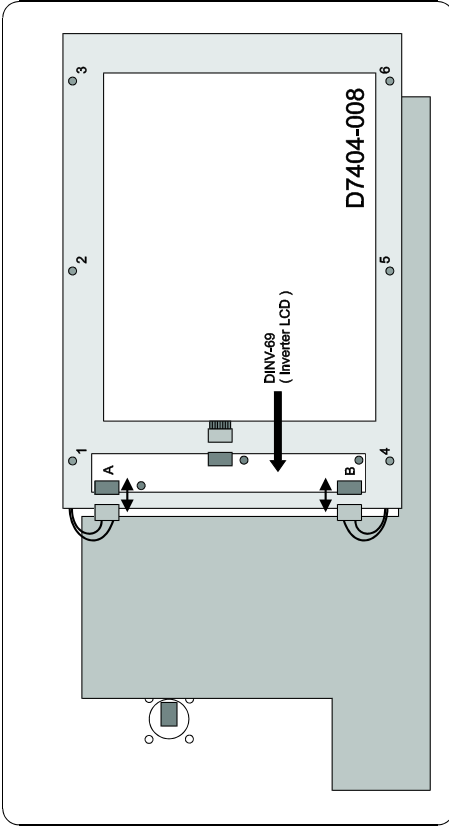

Disconnect A and B & Unscrew 1 - 6 to remove LCD-assembly from frontpanel

BACKVIEW

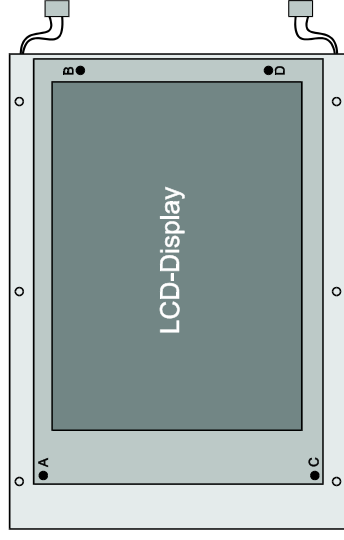

Unscrew A - D to exchange LCD-Display

FRONTVIEW

EXCHANGING DLCD-69 (VGA-LCD Display)

Note	Redrawn	Date
Description		
Note	Redrawn	Date
Description		
Measures in mm, unless otherwise specified	Drawn	Date
	MI	10-03-1998

Delem Luchthavenweg 42, 5657 EB Eindhoven, The NETHERLANDS		
DA69 LCD-EXCHANGE NOTE		
Format	Number	Issue
A3	9055-501/-	-
No unauthorized copying allowed Scale		

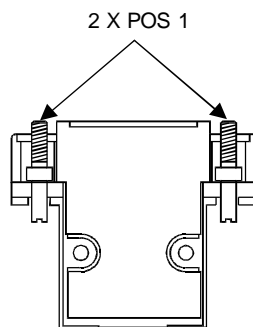
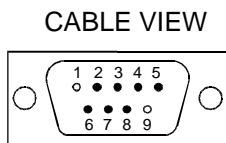

pin 2 PC RXD TO pin 3 CNC TXD
pin 3 PC TXD TO pin 2 CNC RXD
pin 7 PC RTS TO pin 8 CNC CTS
pin 5 PC 0V TO pin 5 CNC 0V
pin 7 CNC RTS TO pin 8 PC CTS
pin 4 CNC DTR TO pin 6 CNC DSR
pin 4 PC DTR TO pin 6 PC DSR

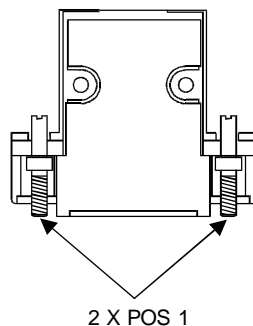
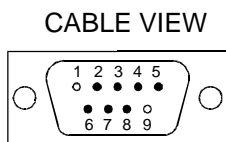

VERSIE	LENGTE
001	4 mtr
002	6 mtr
003	9 mtr
004	12 mtr

FEMALE

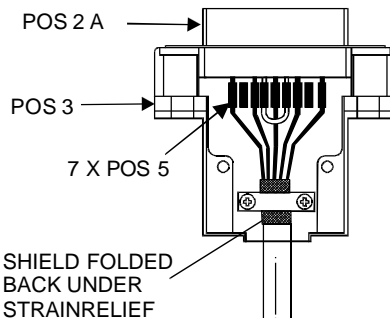

POS 4

SHIELD FOLDED
BACK UNDER
STRAINRELIEF

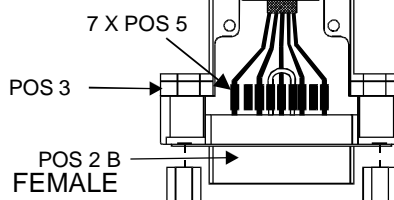

MOUNT TWO
COUPLING NUTS

9 POLE
MALE

25 POLE
FEMALE

POS 6

Note	Redrawn	Date
Description -		
Note	Redrawn	Date
Description -		
Measures in mm, unless otherwise specified	Drawn VW	Date 28-01-1997

Delem

Luchthavenweg 42, 5657 EB
Eindhoven, the NETHERLANDS

SERIAL INTERFACE CABLE 2 X SUB-D
9-/25-POLE

Format A4	Number 1130-201	Issue -
---------------------	--------------------	------------

No unauthorized copying allowed | Scale