

Automation PC 810

User's Manual

Version: **1.50 (August 2013)**

Model no.: **MAAPC800-ENG**

All information contained in this manual is current as of its creation/publication. B&R reserves the right to change the contents of this manual without notice. The information contained herein is believed to be accurate as of the date of publication; however, Bernecker + Rainer Industrie-Elektronik Ges.m.b.H. makes no warranty, expressed or implied, with regard to the products or documentation contained within this manual. In addition, Bernecker + Rainer Industrie-Elektronik Ges.m.b.H. shall not be liable for any incidental or consequential damages in connection with or arising from the furnishing, performance or use of the product(s) in this documentation. Software names, hardware names and trademarks are registered by their respective companies.

Chapter 1: General information

Chapter 2: Technical data

Chapter 3: Installation

Chapter 4: Software

Chapter 5: Standards and certifications

Chapter 6: Accessories

Chapter 7: Maintenance and service

Appendix A

Chapter 1 General information.....	14
1 Manual history.....	14
2 Safety notices.....	19
2.1 Intended use.....	19
2.2 Protection against electrostatic discharge.....	19
2.2.1 Packaging.....	19
2.2.2 Guidelines for proper ESD handling.....	19
2.3 Policies and procedures.....	19
2.4 Transport and storage.....	20
2.5 Installation.....	20
2.6 Operation.....	20
2.6.1 Protection against touching electrical parts.....	20
2.6.2 Environmental conditions - Dust, humidity, aggressive gases.....	20
2.6.3 Viruses and dangerous programs.....	20
2.7 Environmentally friendly disposal.....	21
2.7.1 Separation of materials.....	21
3 Organization of safety notices.....	22
4 Guidelines.....	22
5 Overview.....	23
Chapter 2 Technical data.....	27
1 Introduction.....	27
1.1 Features.....	28
1.2 System components / configuration.....	28
1.3 Configuration - Base system.....	29
1.4 Configuration - Optional components.....	30
2 Complete system.....	31
2.1 Temperature specifications.....	31
2.1.1 Maximum ambient temperature.....	32
2.1.2 Minimum ambient temperature.....	37
2.1.3 Temperature monitoring.....	37
2.1.4 Temperature sensor locations.....	38
2.2 Humidity specifications.....	39
2.3 Power management.....	40
2.3.1 Supply voltage block diagram.....	40
2.3.2 Power calculation with 5PC810.SX01-00 revision < D0.....	41
2.3.3 Power calculation with 5PC810.SX01-00 revision < D0.....	42
2.3.4 Power calculation with 5PC810.SX02-00 revision < D0.....	43
2.3.5 Power calculation with 5PC810.SX02-00 revision < D0.....	44
2.3.6 Power calculation with 5PC810.SX03-00.....	45
2.3.7 Power calculation with 5PC810.SX05-00.....	46
2.4 Serial number sticker.....	47
2.5 Block diagrams.....	49
2.5.1 System unit 5PC810.SX01-00 and bus unit 5PC810.BX01-00.....	49
2.5.2 System unit 5PC810.SX01-00 and bus unit 5PC810.BX01-01.....	50
2.5.3 System unit 5PC810.SX02-00 and bus unit 5PC810.BX02-00.....	51
2.5.4 System unit 5PC810.SX02-00 and bus unit 5PC810.BX02-01.....	52
2.5.5 System unit 5PC810.SX03-00 and bus unit 5PC810.BX03-00.....	53
2.5.6 System unit 5PC810.SX05-00 and bus unit 5PC810.BX05-00.....	54
2.5.7 System unit 5PC810.SX05-00 and bus unit 5PC810.BX05-01.....	55
2.5.8 System unit 5PC810.SX05-00 and bus unit 5PC810.BX05-02.....	56
2.6 Device interfaces.....	57
2.6.1 +24 VDC supply voltage.....	57
2.6.2 COM1 serial interface.....	58
2.6.3 COM2 serial interface.....	58
2.6.4 Monitor/Panel interface - SDL (Smart Display Link / DVI).....	59
2.6.5 Ethernet 1 (ETH1).....	61

2.6.6 Ethernet 2 (ETH2).....	62
2.6.7 USB interfaces (USB1, 2, 3, 4, 5).....	63
2.6.8 MIC, Line IN, Line OUT.....	64
2.6.9 Add-on interface slot.....	64
2.6.10 Add-on UPS slot.....	65
2.6.11 AP Link slot.....	65
2.6.12 Card slots (PCI / PCIe).....	66
2.6.13 LED status indicators.....	68
2.6.14 CMOS profile switch.....	68
2.6.15 Power button.....	69
2.6.16 Reset button.....	69
2.6.17 Battery.....	70
2.6.18 Hardware security key (dongle).....	71
2.6.19 CompactFlash slot 1.....	72
2.6.20 CompactFlash slot 2.....	72
2.6.21 Slide-in slot 1.....	73
2.6.22 Slide-in slot 2.....	73
2.6.23 Slide-in compact slot.....	74
3 Individual components.....	75
3.1 System units.....	75
3.1.1 5PC810.SX01-00.....	75
3.1.2 5PC810.SX02-00.....	82
3.1.3 5PC810.SX03-00.....	89
3.1.4 5PC810.SX05-00.....	96
3.2 Bus units.....	103
3.2.1 General information.....	103
3.2.2 Order data.....	104
3.2.3 Technical data.....	104
3.3 945GME CPU boards.....	106
3.3.1 General information.....	106
3.3.2 Order data.....	106
3.3.3 5PC800.B945-0x - Technical data.....	107
3.3.4 5PC800.B945-1x - Technical data.....	107
3.4 Heat sinks.....	109
3.4.1 Order data.....	109
3.4.2 Technical data.....	109
3.5 Main memory.....	111
3.5.1 General information.....	111
3.5.2 Order data.....	111
3.5.3 Technical data.....	111
3.6 Drives.....	112
3.6.1 5AC801.HDDI-00.....	112
3.6.2 5AC801.HDDI-01.....	114
3.6.3 5AC801.HDDI-02.....	116
3.6.4 5AC801.HDDI-03.....	118
3.6.5 5AC801.HDDI-04.....	120
3.6.6 5AC801.SSDI-00.....	122
3.6.7 5AC801.SSDI-01.....	126
3.6.8 5AC801.SSDI-02.....	128
3.6.9 5AC801.SSDI-03.....	130
3.6.10 5AC801.SSDI-04.....	132
3.6.11 5MMSSD.0060-00.....	134
3.6.12 5MMSSD.0060-01.....	136
3.6.13 5MMSSD.0128-01.....	138
3.6.14 5MMSSD.0180-00.....	140
3.6.15 5AC801.ADAS-00.....	142
3.6.16 5AC801.HDDS-00.....	143

3.6.17 5AC801.DVDS-00.....	145
3.6.18 5AC801.DVRS-00.....	147
3.6.19 5ACPCI.RAIC-01.....	150
3.6.20 5ACPCI.RAIC-02.....	153
3.6.21 5ACPCI.RAIC-03.....	155
3.6.22 5ACPCI.RAIC-04.....	158
3.6.23 5ACPCI.RAIC-05.....	160
3.6.24 5ACPCI.RAIC-06.....	163
3.6.25 5MMHDD.0250-00.....	166
3.6.26 5MMHDD.0500-00.....	168
3.7 Fan kit.....	170
3.7.1 5PC810.FA01-00.....	170
3.7.2 5PC810.FA02-01.....	171
3.7.3 5PC810.FA03-00.....	172
3.7.4 5PC810.FA05-00.....	173
3.8 AP Link cards.....	175
3.8.1 5AC801.SDL0-00.....	175
3.8.2 5AC801.RDYR-00.....	177
3.9 Ready relay.....	178
3.9.1 5AC801.RDYR-01.....	178
3.9.2 General information.....	178
3.9.3 Order data.....	178
3.9.4 Pinout.....	178
3.9.5 Contents of delivery.....	179
3.10 Add-on interfaces (IF option).....	180
3.10.1 General information.....	180
3.10.2 5AC600.CANI-00.....	180
3.10.3 5AC600.485I-00.....	183
Chapter 3 Installation.....	186
1 Installation.....	186
1.1 Procedure.....	186
1.2 Important installation information.....	186
1.3 Mounting orientation.....	187
1.3.1 Vertical mounting orientation.....	187
1.3.2 Horizontal mounting orientation.....	187
1.4 Spacing for air circulation.....	188
2 Cable connections.....	189
3 Grounding concept.....	190
4 General instructions for performing temperature testing.....	191
4.1 Procedure.....	191
4.2 Evaluating temperatures in Windows operating systems.....	191
4.2.1 Evaluating with the B&R Control Center.....	191
4.2.2 Evaluating with the BurnInTest tool from Passmark.....	192
4.3 Evaluating temperatures in operating systems other than Windows.....	194
4.4 Evaluating the measurement results.....	194
5 Connection examples.....	195
5.1 Selecting display units.....	195
5.2 One Automation Panel 900 system via onboard DVI.....	196
5.2.1 Base system requirements.....	196
5.2.2 Link modules.....	196
5.2.3 Cables.....	196
5.2.4 Possible Automation Panel devices, resolutions and segment lengths.....	197
5.2.5 BIOS settings.....	197
5.3 One Automation Panel 900 system via onboard SDL.....	198
5.3.1 Base system requirements.....	198
5.3.2 Link modules.....	198

5.3.3 Cables.....	198
5.3.4 Settings in BIOS.....	199
5.4 One Automation Panel 800 system via onboard SDL.....	200
5.4.1 Base system requirements.....	200
5.4.2 Cables.....	200
5.4.3 Settings in BIOS.....	201
5.5 One AP900 and one AP800 via onboard SDL.....	202
5.5.1 Base system requirements.....	202
5.5.2 Link modules.....	202
5.5.3 Cables.....	202
5.5.4 Settings in BIOS.....	203
5.6 Four Automation Panel 900 systems via onboard SDL.....	204
5.6.1 Base system requirements.....	204
5.6.2 Link modules.....	204
5.6.3 Cables.....	205
5.6.4 Settings in BIOS.....	206
5.7 One Automation Panel 900 via SDL AP Link.....	207
5.7.1 Base system requirements.....	207
5.7.2 Link modules.....	207
5.7.3 Cables.....	207
5.7.4 Settings in BIOS.....	208
5.8 Four Automation Panel 900 units via SDL AP Link.....	209
5.8.1 Base system requirements.....	209
5.8.2 Link modules.....	210
5.8.3 Cables.....	210
5.8.4 Settings in BIOS.....	211
5.9 Two Automation Panel 900 systems via onboard SDL and SDL AP Link.....	212
5.9.1 Base system requirements.....	212
5.9.2 Link modules.....	212
5.9.3 Cables.....	213
5.9.4 Settings in BIOS.....	213
5.10 Eight Automation Panel 900 units via onboard SDL and SDL AP Link.....	214
5.10.1 Base system requirements.....	214
5.10.2 Link modules.....	215
5.10.3 Cables.....	215
5.10.4 Settings in BIOS.....	216
5.11 Six AP900 and two AP800 units via onboard SDL and SDL AP Link.....	217
5.11.1 Base system requirements.....	217
5.11.2 Link modules.....	218
5.11.3 Cables.....	218
5.11.4 Settings in BIOS.....	219
6 Connecting peripheral USB devices.....	220
6.1 Locally on the APC810.....	220
6.2 Remote connection to Automation Panel 900 via DVI.....	221
6.3 Remote connection to Automation Panel 800 / 900 via SDL.....	221
7 Configuring a SATA RAID set.....	222
7.1 Create RAID set.....	223
7.2 Create RAID set - Striped.....	223
7.3 Create RAID set - Mirrored.....	224
7.4 Delete RAID set.....	224
7.5 Rebuild mirrored set.....	225
7.6 Resolve conflicts.....	225
7.7 Low level format.....	226
8 Known problems / issues.....	227
Chapter 4 Software.....	228
1 BIOS options.....	228

1.1 General information.....	228
1.2 BIOS setup and boot procedure.....	228
1.2.1 BIOS Setup keys.....	230
1.3 Main.....	231
1.4 Advanced.....	232
1.4.1 ACPI configuration.....	233
1.4.2 PCI configuration.....	234
1.4.3 PCI Express configuration.....	237
1.4.4 Graphics configuration.....	239
1.4.5 CPU configuration.....	241
1.4.6 Chipset settings.....	242
1.4.7 I/O interface configuration.....	243
1.4.8 Clock configuration.....	243
1.4.9 IDE configuration.....	244
1.4.10 USB configuration.....	249
1.4.11 Keyboard/Mouse configuration.....	250
1.4.12 Remote access configuration.....	251
1.4.13 CPU board monitor.....	253
1.4.14 Baseboard/Panel features.....	254
1.5 Boot.....	258
1.6 Security.....	259
1.6.1 Hard disk security user password.....	260
1.6.2 Hard disk security master password.....	261
1.7 Power.....	261
1.8 Exit.....	263
1.9 BIOS default settings.....	264
1.9.1 Main.....	264
1.9.2 Advanced.....	264
1.9.3 Boot.....	269
1.9.4 Security.....	269
1.9.5 Power.....	269
1.10 BIOS error signals (beep codes).....	270
1.11 Allocation of resources.....	271
1.11.1 RAM address assignment.....	271
1.11.2 I/O address assignments.....	271
1.11.3 Interrupt assignments in PIC mode.....	271
1.11.4 Interrupt assignments in APIC mode.....	272
2 Upgrade information.....	276
2.1 BIOS upgrade.....	276
2.1.1 Important information.....	276
2.1.2 Procedure with MS-DOS.....	277
2.2 Firmware upgrade.....	279
2.2.1 Procedure.....	279
2.2.2 Possible upgrade problems and software dependencies (for V1.00).....	280
2.3 Creating an MS-DOS boot diskette in Windows XP.....	282
2.4 Creating a bootable USB flash drive for B&R upgrade files.....	284
2.4.1 Requirements.....	284
2.4.2 Procedure.....	284
2.4.3 How to access MS-DOS.....	284
2.5 Creating a bootable CompactFlash card for B&R upgrade files.....	285
2.5.1 Requirements.....	285
2.5.2 Procedure.....	285
2.5.3 How to access MS-DOS.....	285
2.6 Upgrade problems.....	285
3 Microsoft DOS.....	286
3.1 Order data.....	286
3.2 Known problems.....	286

3.3 Resolutions and color depths.....	286
4 Windows XP Professional.....	287
4.1 Order data.....	287
4.2 Overview.....	287
4.3 Installation.....	287
4.3.1 Installation on a PCI SATA RAID controller - 5ACPCI.RAIC-03, 5ACPCI.RAIC-05, 5ACPCI.RAIC-06.....	288
4.3.2 For variants with 5 PCI slots.....	288
4.4 Drivers.....	288
5 Windows 7.....	289
5.1 General information.....	289
5.2 Order data.....	289
5.3 Overview.....	289
5.4 Installation.....	290
5.4.1 Installation on a PCI SATA RAID controller - 5ACPCI.RAIC-03, 5ACPCI.RAIC-05, 5ACPCI.RAIC-06.....	290
5.4.2 For variants with 5 PCI slots.....	290
5.5 Special considerations, limitations.....	291
5.6 Drivers.....	291
6 Windows XP Embedded.....	292
6.1 General information.....	292
6.2 Order data.....	292
6.3 Overview.....	292
6.4 Features with FP2007 (Feature Pack 2007).....	292
6.5 Installation.....	293
6.6 Drivers.....	293
6.6.1 Touch screen driver.....	293
7 Windows Embedded Standard 2009.....	294
7.1 General information.....	294
7.2 Order data.....	294
7.3 Overview.....	294
7.4 Features with WES2009 (Windows Embedded Standard 2009).....	294
7.5 Installation.....	295
7.6 Drivers.....	295
7.6.1 Touch screen driver.....	295
8 Windows Embedded Standard 7.....	296
8.1 General information.....	296
8.2 Order data.....	296
8.3 Overview.....	297
8.4 Features with WES7 (Windows Embedded Standard 7).....	297
8.5 Installation.....	297
8.6 Drivers.....	298
8.6.1 Touch screen driver.....	298
9 Windows CE.....	299
9.1 General information.....	299
9.2 Order data.....	299
9.3 Overview.....	299
9.4 Windows CE 6.0 features.....	299
9.5 Requirements.....	300
9.6 Installation.....	300
9.7 B&R Embedded OS Installer.....	300
10 Automation Runtime.....	301
10.1 General information.....	301
10.2 Order data.....	301
10.3 Automation Runtime Windows (ARwin).....	301
10.4 Automation Runtime Embedded (ARemb).....	301
11 B&R Automation Device Interface (ADI) - Control Center.....	302
11.1 Functions.....	302

11.2 Installation.....	303
11.3 SDL Equalizer settings.....	304
11.4 UPS configuration.....	305
11.4.1 Installing the UPS service for the B&R add-on UPS.....	305
11.4.2 Displaying UPS default values.....	305
11.4.3 Changing UPS battery settings.....	306
11.4.4 Updating UPS battery settings.....	307
11.4.5 Saving UPS battery settings.....	308
11.4.6 Configuring UPS system settings.....	308
11.4.7 Changing additional UPS settings.....	309
11.4.8 Procedure following power failure.....	311
12 B&R Automation Device Interface (ADI) Development Kit.....	312
13 B&R Automation Device Interface (ADI) .NET SDK.....	314
14 B&R Key Editor.....	316
Chapter 5 Standards and certifications.....	318
1 Standards and guidelines.....	318
1.1 CE mark.....	318
1.2 EMC directive.....	318
1.3 Low voltage directive.....	318
2 Certifications.....	319
2.1 UL certification.....	319
2.2 Certifications for use in potentially explosive environments.....	319
2.2.1 UL Haz. Loc. Certifications.....	319
2.2.2 ATEX certification.....	319
2.2.3 Requirements for use in potentially explosive environments.....	320
2.3 GL certification (Germanischer Lloyd).....	321
Chapter 6 Accessories.....	324
1 Replacement CMOS batteries.....	324
1.1 0AC201.91 / 4A0006.00-000.....	324
1.1.1 General information.....	324
1.1.2 Order data.....	324
1.1.3 Technical data.....	324
2 Power connectors.....	326
2.1 0TB103.9x.....	326
2.1.1 General information.....	326
2.1.2 Order data.....	326
2.1.3 Technical data.....	326
3 Replacement fan.....	327
3.1 General information.....	327
3.2 Order data.....	327
4 DVI/Monitor adapter.....	328
4.1 5AC900.1000-00.....	328
4.2 General information.....	328
4.3 Order data.....	328
5 CompactFlash cards.....	329
5.1 General information.....	329
5.2 General information.....	329
5.2.1 Flash technology.....	329
5.2.2 Wear leveling.....	329
5.2.3 ECC error correction.....	329
5.2.4 S.M.A.R.T. support.....	329
5.2.5 Maximum reliability.....	330
5.3 5CFCRD.xxxx-06.....	331
5.3.1 General information.....	331
5.3.2 Order data.....	331

5.3.3	Technical data.....	331
5.3.4	Temperature humidity diagram.....	333
5.3.5	Dimensions.....	333
5.3.6	Benchmark.....	334
5.4	5CFCRD.xxxx-04.....	335
5.4.1	General information.....	335
5.4.2	Order data.....	335
5.4.3	Technical data.....	335
5.4.4	Temperature humidity diagram.....	337
5.4.5	Dimensions.....	337
5.4.6	Benchmark.....	338
5.5	5CFCRD.xxxx-03.....	339
5.5.1	General information.....	339
5.5.2	Order data.....	339
5.5.3	Technical data.....	339
5.5.4	Temperature humidity diagram.....	341
5.5.5	Dimensions.....	341
5.6	Known problems/issues.....	342
6	USB media drive.....	343
6.1	5MD900.USB2-01.....	343
6.1.1	General information.....	343
6.1.2	Order data.....	343
6.1.3	Interfaces.....	343
6.1.4	Technical data.....	343
6.1.5	Dimensions.....	345
6.1.6	Dimensions with front cover.....	346
6.1.7	Cutout installation.....	346
6.1.8	Contents of delivery.....	346
6.1.9	Installation.....	346
6.2	5MD900.USB2-02.....	348
6.2.1	General information.....	348
6.2.2	Order data.....	348
6.2.3	Interfaces.....	348
6.2.4	Technical data.....	348
6.2.5	Dimensions.....	350
6.2.6	Dimensions with front cover.....	350
6.2.7	Cutout installation.....	351
6.2.8	Contents of delivery.....	351
6.2.9	Installation.....	351
6.3	5A5003.03.....	352
6.3.1	General information.....	352
6.3.2	Order data.....	352
6.3.3	Technical data.....	352
6.3.4	Dimensions.....	352
6.3.5	Contents of delivery.....	352
6.3.6	Installation.....	353
7	USB flash drives.....	354
7.1	5MMUSB.2048-00.....	354
7.1.1	General information.....	354
7.1.2	Order data.....	354
7.1.3	Technical data.....	354
7.1.4	Temperature humidity diagram.....	355
7.2	5MMUSB.xxxx-01.....	356
7.2.1	General information.....	356
7.2.2	Order data.....	356
7.2.3	Technical data.....	356
7.2.4	Temperature humidity diagram.....	357

8 HMI Drivers & Utilities DVD.....	358
8.1 5SWHMI.0000-00.....	358
8.1.1 General information.....	358
8.1.2 Order data.....	358
8.1.3 Contents (V2.10).....	358
9 Uninterruptible power supply.....	361
9.1 Features.....	361
9.2 Requirements.....	361
9.3 5AC600.UPSI-00.....	362
9.3.1 General information.....	362
9.3.2 Order data.....	362
9.3.3 Technical data.....	362
9.3.4 Installation.....	362
9.4 5AC600.UPSB-00.....	364
9.4.1 General information.....	364
9.4.2 Order data.....	364
9.4.3 Technical data.....	364
9.4.4 Temperature/Service life diagram up to 20% battery capacity.....	365
9.4.5 Deep discharge cycles.....	365
9.4.6 Dimensions.....	366
9.4.7 Drilling template.....	366
9.4.8 Installation instructions.....	366
9.5 5CAUPS.00xx-00.....	367
9.5.1 General information.....	367
9.5.2 Order data.....	367
9.5.3 Technical data.....	367
9.6 5AC600.UPSF-00.....	368
9.6.1 General information.....	368
9.6.2 Order data.....	368
9.7 5AC600.UPSF-01.....	368
9.7.1 General information.....	368
9.7.2 Order data.....	368
10 Line filter.....	369
10.1 5AC804.MFLT-00.....	369
10.1.1 General information.....	369
10.1.2 Order data.....	369
10.1.3 Technical data.....	369
10.1.4 Dimensions.....	370
10.1.5 Drilling template.....	370
10.1.6 Connecting to the end device.....	370
11 PCI plug-in cards.....	371
11.1 5ACPCI.ETH1-01.....	371
11.1.1 General information.....	371
11.1.2 Order data.....	371
11.1.3 Technical data.....	371
11.1.4 Driver support.....	372
11.1.5 Dimensions.....	373
11.2 5ACPCI.ETH3-01.....	374
11.2.1 General information.....	374
11.2.2 Order data.....	374
11.2.3 Technical data.....	374
11.2.4 Driver support.....	375
11.2.5 Dimensions.....	376
12 Cables.....	377
12.1 DVI cables.....	377
12.1.1 5CADVI.0xxx-00.....	377
12.2 SDL cables.....	380

12.2.1 5CASDL.0xxx-00.....	380
12.3 SDL cables with 45° male connector.....	383
12.3.1 5CASDL.0xxx-01.....	383
12.4 SDL flex cables.....	386
12.4.1 5CASDL.0xxx-03.....	386
12.5 SDL flex cables with extender.....	389
12.5.1 5CASDL.0xx0-13.....	389
12.6 USB cables.....	393
12.6.1 5CAUSB.00xx-00.....	393
12.7 RS232 cables.....	394
12.7.1 9A0014.xx.....	394
12.8 Internal supply cable.....	396
12.8.1 5CAMSC.0001-00.....	396
13 HDD replacement disk tray.....	397
13.1 5AC801.FRAM-00.....	397
13.1.1 General information.....	397
13.1.2 Order data.....	397
13.1.3 Technical data.....	397
13.1.4 Dimensions.....	398

Chapter 7 Maintenance and service.....399

1 Changing the battery.....	399
1.1 Battery status evaluation.....	399
1.2 Procedure.....	399
2 Replacing a CompactFlash card.....	401
3 Installing and replacing slide-in compact drives.....	402
3.1 Procedure.....	402
4 Installing and replacing slide-in drives.....	403
4.1 Procedure.....	403
5 Installing a slide-in compact adapter.....	404
5.1 Procedure.....	404
6 Installing and replacing fan kits.....	406
6.1 Procedure.....	406
7 Installing the UPS module.....	408
7.1 Installation without installed add-on interface module.....	408
7.1.1 1-slot APC810.....	408
7.1.2 2- and 3-slot APC810.....	410
7.1.3 5-slot APC810.....	412
7.2 Installation with installed add-on interface module.....	414
7.2.1 1-slot APC810.....	414
7.2.2 2- and 3-slot APC810.....	416
7.2.3 5-slot APC810.....	418
8 Installing the UPS fuse kit on the battery unit.....	420
8.1 Procedure.....	420
9 Installing the side cover.....	422
9.1 1-slot APC810.....	422
9.2 2- and 3-slot APC810.....	422
9.3 5-slot APC810.....	423
10 AP Link installation.....	424
10.1 Procedure.....	424
11 Replacing a PCI SATA RAID hard disk in a RAID 1 set.....	425
11.1 Procedure.....	425
12 Installing the HDD replacement disk tray.....	427
12.1 Procedure.....	427
13 Installing the ready relay /2 in the add-on UPS slot.....	428
13.1 Procedure.....	428

Appendix A	430
1 Maintenance Controller Extended (MTCX).....	430
1.1 Temperature monitoring - Fan control.....	430
2 Connecting an external device to the mainboard.....	432

Chapter 1 • General information

1 Manual history

Version	Date	Change
0.10 Preliminary	20-Nov-07	<ul style="list-style-type: none"> • First version
0.20 Preliminary	11-Jan-08	<ul style="list-style-type: none"> • Modified brief description text for system units. • Modified text to read 945GME (instead of 945GM). • Removed 256 MB main memory. • Updated 5AC801.ADAS-00 and 5AC801.HDDS-00. • Updated accessories. • Updated 5AC801.RDYR-00 ready relay, SATA RAID controller, fan kit, IF options and replacement fan filter. • Updated BIOS description.
0.30 Preliminary	31-Jan-08	<ul style="list-style-type: none"> • Correct mistake regarding configuration. • Updated BIOS default profiles. • Modified model number and name from APC810 to APC800. • Updated technical data for the complete system. • Updated connection examples. • Updated problems and properties of the first production batch.
0.40 Preliminary	11-Apr-08	<ul style="list-style-type: none"> • Revised problems and properties of the first production batch. • Updated section "Temperature sensor locations" in chapter "Appendix A". • Updated section "Temperature specifications" on page 31. • Updated 1-slot system unit. • Updated content (especially in the chapter "Maintenance and service" chapter). • Revised BIOS description for Version 1.10.
0.41 Preliminary	09-May-08	<ul style="list-style-type: none"> • Corrected images for "Ambient temperatures with and without a fan kit". • Updated measurement specifications of 1- and 2-slot complete systems to include the 5AC801.HS00-01 heat sink. • Updated "Power management" section. • Updated serial number sticker information. • Updated "Automation PC 810 with Windows XP Professional and Windows XP embedded" section. • Updated "Automation Device Interface (ADI)" section. • Updated 5-slot variant. • Updated drilling templates 5-card variant. • Updated section "Connecting peripheral USB devices" on page 220. • Updated index.
0.42 Preliminary	29-May-08	<ul style="list-style-type: none"> • Added information about mounting orientation (vertical, horizontal) in 3 "Installation". • Updated ambient temperature specifications with and without a fan kit for each mounting orientation (vertical, horizontal). • Corrected error (fan kit model numbers) in Figure 2 "Configuration - Optional components" on page 30. • Corrected error (pinout) in Table 18 "Supply voltage connection 24 VDC" on page 57. • Revised slide-in slot 2 description. • Updated 5AC801.DVDS-00 slide-in DVD burner. • Updated fan kit for the 5-slot variant (5PC810.FA05-00). • Updated real-time clock (RTC) specifications.
1.00	10-Jul-08	<ul style="list-style-type: none"> • Corrected spelling and sentence structure errors. • Updated block diagrams for all system units with relation to the bus unit ("Block diagrams" on page 49). • Updated description of the 5AC600.485I-00 add-on interface module.

Table 1: Manual history

Version	Date	Change
1.10	12-Sep-08	<ul style="list-style-type: none"> • Corrected spelling and sentence structure errors. • Updated starting current values (due to new power supply). • Updated 5ACPCI.ETH1-01 and 5ACPCI.ETH3-01 PCI Ethernet cards. • Updated power consumption from 1..5 A to 1..6 A. • Updated manual to the maximum value of 130 W. • Added new "Standards and certifications" chapter. • Updated humidity specifications in "Humidity specifications" on page 39. • Explained user ID in further detail. • Updated model number for Windows XP with SP3 (5SWWXP.0600-ENG, 5SWWXP.0600-GER, 5SWWXP.0600-MUL). • Added minimum ambient temperature specifications. • Added 5CAMSC.0001-00 internal supply cable (for external consumers on the PCI slot). • Moved SATA RAID controller configuration from "Software" to "Commissioning". • Corrected errors for 5PC810.FA05-00 (see "5PC810.FA05-00" on page 173). • Modified BIOS settings (new BIOS version). • Updated information about creating a bootable MS-DOS diskette. • Updated information about creating a bootable USB flash drive. • Updated B&R Key Editor description. • Updated HMI Drivers & Utilities DVD. • Revised description for operating the RS232/422/485 add-on interface module as an RS485 interface. • Updated ADI Control Center. • Updated glossary. • Updated information about removing the 5PC810.SX01-00 and 5PC810.SX05-00 side cover. • Updated information about installing the UPS module (with and without add-on interface module). • Corrected model number errors for 3-phase 40 A power supply (0PS340.1). • Updated 5-slot bus unit. • Corrected temperature humidity diagrams. • Updated add-on interface slot. • Updated description "Connecting an external device to the mainboard" on page 432. • Updated description "AP Link installation" on page 424. • Corrected power supply fuse from 10 A to 15 A in "+24 VDC supply voltage" on page 57. • Updated CMOS profile switch position 2 in "CMOS profile switch" on page 68. • Corrected service life and revolution speed of the 5PC810.FA01-00 fan kit. • Updated temperature monitoring and fan control, see "Temperature monitoring - Fan control" on page 430.

Table 1: Manual history

Version	Date	Change
1.20	14-Oct-09	<ul style="list-style-type: none"> • Updated topology images. • Corrected maximum ambient temperature for the 5AC800.B945-02 system unit in the figure Maximale Umgebungstemperatur ohne Lüfter Kit. • Modified the description of the CMOS battery status in Table 211 "945GME Advanced - Baseboard monitor - Configuration options" on page 256. • Added HDD replacement tray to accessories in "5AC801.FRAM-00" on page 397 and corresponding installation in 7 "Maintenance and service". • Corrected error in figure and table index. • Corrected error in temperature humidity diagram for the 5ACPCI.RAIC-03 and 5ACPCI.RAIC-04 SATA RAID hard disks. • Modified ADI Development Kit. • Added table for the maximum ambient temperature of heat sinks 5AC801.HS00-00 > Rev. D0 and 5AC801.HS00-01 > Rev. D0. • Updated PCIE port (ETH2) and PCIE port (ETH1) BIOS description. • Discontinued 9S0000.08-010, 9S0000.08-020 and 9S0000.09-090. • Updated information regarding firmware upgrades. • Added CMOS profile 3 (5PC820.SX01-00). Additional information about this CMOS profile can be found in the APC820 user's manual. • Updated section "Environmentally friendly disposal" in chapter 1 "General information". • Added new 5PC810.FA02-01 for 2-slot APC810 variants. • Added PCI bus type for bus units. • Updated BIOS default settings for FDC/LPT/COM ports. • Removed content of delivery for USB flash drives. • Updated image for Silicon Systems CompactFlash. • Corrected L2 cache of 5PC800.B945-00 CPU board to 2 MB. • Updated B&R CompactFlash cards. • Revised technical data for Silicon Systems CF cards. • Updated section 1.11 "Allocation of resources" on page 271. • Updated section 4.3.1 "Installation on a PCI SATA RAID controller - 5ACPCI.RAIC-03, 5ACPCI.RAIC-05, 5ACPCI.RAIC-06" on page 288. • Updated new "5AC801.SSDI-00" on page 122. • Updated BIOS settings to V1.14. • Removed "CPU board software versions" and "Automation Panel Link software versions" tables from section "BIOS upgrade". • Modified dimensions for slide-in and slide-in compact devices. The new dimensions are based on all of the mechanical features of the devices. • Updated mechanical properties for products 5AC801.DVDS-00 and 5AC801.DVRS-00. • Updated operating systems 5SWWXP.0500-GER, 5SWWXP.0500-ENG and 5SWWXP.0500-MUL. • Removed section 9.4 "Creating a bootable USB flash drive". • In chapter 4 "Software", updated and moved sections "BIOS upgrade", "Firmware upgrade" and "Creating an MS-DOS boot diskette in Windows XP" to section 2 "Upgrade information". • In chapter 4 "Software", updated section "Creating a bootable USB flash drive for B&R upgrade files" on page 284. • In chapter 4 "Software", updated section 2.5 "Creating a bootable CompactFlash card for B&R upgrade files" on page 285. • Added specifications for possible resolutions to the technical data of the CPU boards. • Updated section 1.10 "BIOS error signals (beep codes)" on page 270 in 4 "Software". • Modified Windows XP Professional installation text. • Changed section "Temperature sensor locations". • Updated information about B&R Key Editor. • Updated section 3 "Microsoft DOS" on page 286. • Corrected chipset for technical data of the CPU board in section "945GME CPU boards" on page 106. • Corrected Table 92 "5AC801.ADAS-00 - Technical data" on page 142. • Updated information in "RS422 - Bus length and cable type" on page 184. • Corrected Table 183 "Link modules" on page 218. • Updated hex range in Table 239 "RAM address assignment" on page 271. • Replaced 0AC201.9 replacement CMOS batteries with 0AC201.91. • Updated 5PC800.B945-05 CPU board. • Revised section 2.2 "Humidity specifications" on page 39.

Table 1: Manual history

Version	Date	Change
1.30	12-Jul-10	<ul style="list-style-type: none"> Updated system unit 5PC810.SX03-00, bus unit 5PC810.BX03-00, fan kit 5PC810.FA03-00 and replacement fan 5AC801.FA03-00. Updated section 7 "Windows Embedded Standard 2009" on page 294. Updated section 11 "B&R Automation Device Interface (ADI) - Control Center" on page 302. 5 "Standards and certifications" on page 318 revised. Added B&R 16 GB CompactFlash card 5CFCRD.016G-04. Updated section "Known problems / issues" on page 227 to include additional information. Updated section "Cables" on page 377 in chapter 6 "Accessories". Added B&R ID codes for system units. Updated section 9 "Windows CE" on page 299. Updated B&R USB flash drive in 6 "Accessories" on page 324. Added CPU boards 5PC800.B945-10, 5PC800.B945-11, 5PC800.B945-12, 5PC800.B945-13, and 5PC800.B945-14. Updated technical data "Remanent variables for AR (Automation Runtime) in power fail mode" for APC810 system units.
1.31	14-Nov-10	<ul style="list-style-type: none"> Updated 5AC801.RDYR-01 ready relay in chapter 6 "Accessories". Updated section 13 "Installing the ready relay /2 in the add-on UPS slot" on page 428 in chapter 7 "Maintenance and service".
1.32	02-Nov-10	<ul style="list-style-type: none"> "5AC801.HDDI-03" on page 118 updated. "5ACPCI.RAIC-05" on page 160 updated. "5MMHDD.0250-00" on page 166 updated. Revised "Configuration - Optional components" on page 30. Updated 5AC801.HDDI-03, 5ACPCI.RAIC-05 and 5MMHDD.0250-00 in sections 2.1 "Temperature specifications" and 2.2 "Humidity specifications" on page 39.
1.33	20-May-11	<ul style="list-style-type: none"> Updated sections "Windows Embedded Standard 7" on page 296, "B&R Automation Device Interface (ADI) .NET SDK" on page 314, "Automation Runtime" on page 301 and "B&R Automation Runtime dongle". Updated BIOS version (1.14 -> 1.17). Revised sections "B&R Automation Device Interface (ADI) - Control Center" on page 302, "B&R Key Editor" on page 316, "HMI Drivers & Utilities DVD" on page 358 and "B&R Automation Device Interface (ADI) Development Kit" on page 312. Updated bus unit 5PC810.BX05-02. Corrected chipset information "945GME CPU boards" on page 106. Revised "Configuration - Optional components" on page 30.
1.34	11-Jul-11	<ul style="list-style-type: none"> Updated USB5 in heading ("USB interfaces (USB1, 2, 3, 4, 5)" on page 63). Updated 5AC801.HDDI-03 in Table 44 "Slide-in compact slot" on page 74. Updated "Charge duration when battery low" entry in Table 287 "5AC600.UPSB-00, 5AC600.UPSB-00 - Technical data" on page 364. Revised sections "B&R Automation Device Interface (ADI) - Control Center" on page 302, "B&R Automation Device Interface (ADI) Development Kit" on page 312 and "B&R Automation Device Interface (ADI) .NET SDK" on page 314. Updated information regarding "Special considerations for the 5PCI slot variant" in "Windows XP Professional" on page 287 and "Windows 7" on page 289. Corrected information on "Windows XP mode" in section "Features with WES7 (Windows Embedded Standard 7)" on page 297. Revised reference to external UPS 24 VDC in section "Uninterruptible power supply" on page 361.
1.40	23-Jan-12	<ul style="list-style-type: none"> Revised section "CompactFlash cards". Moved section "B&R Automation Device Interface (ADI) Development Kit" to 4 "Software". Moved section "Temperature sensor locations" to 2 "Technical data". Removed drilling templates section from the "Installation" chapter and updated drilling templates for the system units in chapter 2 "Technical data", section 2 "Complete system" on page 31. Revised section "Connection examples" on page 195. Removed "Cable lengths and resolutions for SDL transmission" in section "AP Link cards" on page 175. Added new CompactFlash cards 5CFCRD.xxxx-06 in 6 "Accessories". Discontinued CompactFlash cards 5CFCRD.xxxx-04. Removed section "B&R Automation Runtime dongle" and updated the order data in section "Automation Runtime" on page 301. Updated BIOS version (1.17 -> 1.18). Revised entire manual according to current formatting standards.
1.41	25-Jun-12	<ul style="list-style-type: none"> Updated information about the Automation Device Interface and B&R Key Editor. Updated section "Card slots (PCI / PCIe)" on page 66 to include information regarding using 64-bit PCI cards. Updated section "Cable lengths and resolutions for SDL transmission" on page 59. Updated information regarding "PCI to PCI bridge" in 3.2.3 "Technical data" for the bus units. Updated information regarding "PCIe to SATA bridge" in section "Slide-in slot 2" on page 73. Moved ready relay 5AC801.RDYR-01 to section "Ready relay".

Table 1: Manual history

General information • Manual history

Version	Date	Change
1.45	01-Oct-12	<ul style="list-style-type: none"> Modified "Organization of safety notices" on page 22, updated descriptions for cautions and warnings. Added SSD drives "5AC801.SSDI-01" on page 126 and "5AC801.SSDI-02" on page 128. Updated section "General instructions for performing temperature testing" on page 191. Updated Windows 7 Service Pack 1 (see "Windows 7" on page 289). Updated Windows Embedded Standard 7 Service Pack 1 (see "Windows Embedded Standard 7" on page 296). Updated "B&R Automation Device Interface (ADI) - Control Center" on page 302. Updated "B&R Automation Device Interface (ADI) Development Kit" on page 312 to version 3.40. Updated "B&R Automation Device Interface (ADI) .NET SDK" on page 314 to version 1.80. Updated "B&R Key Editor" on page 316 to version 3.30. Updated technical data for CPU boards, see "945GME CPU boards" on page 106.
1.46	21-Nov-12	<ul style="list-style-type: none"> Updated B&R CompactFlash card 5CFCRD.032G-06, see "5CFCRD.xxxx-06" on page 331. Revised technical data for UPS cables, see "5CAUPS.00xx-00" on page 367.
1.47	14-Mar-13	<ul style="list-style-type: none"> Updated the following drives: "5AC801.HDDI-04" on page 120, "5ACPCI.RAIC-06" on page 163, "5MMHDD.0500-00" on page 168. Revised order data for system units "5PC810.SX01-00" on page 75, "5PC810.SX02-00" on page 82, "5PC810.SX03-00" on page 89 and "5PC810.SX05-00" on page 96. Revised general information regarding drives "5ACPCI.RAIC-01" on page 150, "5ACPCI.RAIC-05" on page 160 and "5MMHDD.0250-00" on page 166. Corrected spelling and sentence structure errors.
1.48	15-May-13	<ul style="list-style-type: none"> 5 "Standards and certifications" on page 318 revised. Revised information regarding certifications in technical data of individual components. Updated line filter "5AC804.MFLT-00" on page 369. Updated add-on fuse kit "5AC600.UPSF-00" on page 368 and replacement fuses "5AC600.UPSF-01" on page 368 for the UPS battery unit. Updated slide-in compact drive "5AC801.SSDI-03" on page 130. Updated replacement SSDs "5MMSSD.0060-00" on page 134, "5MMSSD.0060-01" on page 136 and "5MMSSD.0180-00" on page 140.
1.50	19-Aug-13	<ul style="list-style-type: none"> Updated B&R USB flash drive 5MMUSB.4096-01, see "USB flash drives" on page 354. Updated slide-in compact drive "5AC801.SSDI-04" on page 132. Updated replacement SSD "5MMSSD.0128-01" on page 138. Updated tightening torque of locating screws in section "Cables" on page 377. Updated sections "B&R Automation Device Interface (ADI) Development Kit" on page 312 and "B&R Automation Device Interface (ADI) .NET SDK" on page 314. Revised description of ready relay "5AC801.RDYR-00" on page 177 and "5AC801.RDYR-01" on page 178.

Table 1: Manual history

2 Safety notices

2.1 Intended use

Programmable logic controllers (PLCs), operating/monitoring devices (industrial PCs, Power Panels, Mobile Panels, etc.), and B&R uninterruptible power supplies have been designed, developed, and manufactured for conventional use in industrial environments. They were not designed, developed and manufactured for any use involving serious risks or hazards that could lead to death, injury, serious physical damage or loss of any kind without the implementation of exceptionally stringent safety precautions. In particular, such risks and hazards include the use of these devices to monitor nuclear reactions in nuclear power plants, their use in flight control or flight safety systems as well as in the control of mass transportation systems, medical life support systems or weapons systems.

2.2 Protection against electrostatic discharge

Electrical components that can be damaged by electrostatic discharge (ESD) must be handled accordingly.

2.2.1 Packaging

- **Electrical components with a housing**
...Do not require special ESD packaging but must be handled properly (see "Electrical components with a housing").
- **Electrical components without a housing**
...Must be protected by ESD-suitable packaging.

2.2.2 Guidelines for proper ESD handling

Electrical components with a housing

- Do not touch the connector contacts on connected cables.
- Do not touch the contact tips on circuit boards.

Electrical components without a housing

The following applies in addition to the points listed under "Electrical components with a housing":

- Any persons handling electrical components or devices with installed electrical components must be grounded.
- Components may only be touched on their narrow sides or front plate.
- Components should always be stored in a suitable medium (ESD packaging, conductive foam, etc.). Metallic surfaces are not suitable storage surfaces!
- Components should not be subjected to electrostatic discharge (e.g. through the use of charged plastics).
- Ensure a minimum distance of 10 cm from monitors and TV sets.
- Measurement devices and equipment must be grounded.
- Measurement probes on potential-free measurement devices must be discharged on sufficiently grounded surfaces before taking measurements.

Individual components

- ESD protective measures for individual components are thoroughly integrated at B&R (conductive floors, footwear, arm bands, etc.).
- These increased ESD protective measures for individual components are not necessary for customers handling B&R products.

2.3 Policies and procedures

Electronic devices are never completely failsafe. If the programmable control system, operating/monitoring device or uninterruptible power supply fails, the user is responsible for ensuring that other connected devices, e.g. motors, are brought to a secure state.

When using programmable logic controllers or operating/monitoring devices as control systems together with a Soft PLC (e.g. B&R Automation Runtime or comparable product) or Slot PLC (e.g. B&R LS251 or comparable product), safety precautions relevant to industrial control systems (e.g. the provision of safety devices such as emergency stop circuits, etc.) must be observed in accordance with applicable national and international regulations. The same applies for all other devices connected to the system, such as drives.

All tasks such as the installation, commissioning and servicing of devices are only permitted to be carried out by qualified personnel. Qualified personnel are those familiar with the transport, mounting, installation, commissioning and operation of devices who also have the appropriate qualifications (e.g. IEC 60364). National accident prevention regulations must be observed.

The safety notices, connection descriptions (type plate and documentation) and limit values listed in the technical data are to be read carefully before installation and commissioning and must be observed.

2.4 Transport and storage

During transport and storage, devices must be protected against undue stress (mechanical loads, temperature, humidity, aggressive atmospheres, etc.).

2.5 Installation

- Installation must be performed according to this documentation using suitable equipment and tools.
- Devices may only be installed by qualified personnel without voltage applied. Before installation, voltage to the control cabinet must be switched off and prevented from being switched on again.
- General safety guidelines and national accident prevention regulations must be observed.
- Electrical installation must be carried out according to applicable guidelines (e.g. line cross sections, fuses, protective ground connections).

2.6 Operation

2.6.1 Protection against touching electrical parts

To operate programmable logic controllers, operating/monitoring devices or uninterruptible power supplies, it is necessary for certain parts to carry dangerous voltage levels over 42 VDC. Touching one of these parts can result in a life-threatening electric shock. This could lead to death, severe injury or damage to equipment.

Before turning on the programmable logic controller, operating/monitoring devices or the uninterruptible power supply, the housing must be properly grounded (PE rail). Ground connections must be established even when testing or operating operating/monitoring devices or the uninterruptible power supply for a short time!

Before turning the device on, all parts that carry voltage must be securely covered. During operation, all covers must remain closed.

2.6.2 Environmental conditions - Dust, humidity, aggressive gases

The use of operating/monitoring devices (e.g. industrial PCs, Power Panels, Mobile Panels, etc.) and uninterruptible power supplies in very dusty environments should be avoided. Dust collection on the devices can affect functionality and may prevent sufficient cooling, especially in systems with active cooling systems (fans).

The presence of aggressive gases can also lead to malfunctions. When combined with high temperature and humidity, aggressive gases – e.g. with sulfur, nitrogen and chlorine components – can induce chemical reactions that can damage electronic components very quickly. Signs of the presence of aggressive gases are blackened copper surfaces and cable ends on existing equipment.

For operation in dusty or humid conditions, correctly installed (e.g. cutout installations) operating/monitoring devices like the Automation Panel or Power Panel are protected on the front. The back of all devices must be protected from dust and humidity and cleaned at suitable intervals.

2.6.3 Viruses and dangerous programs

This system is subject to potential risk each time data is exchanged or software is installed from a data medium (e.g. diskette, CD-ROM, USB flash drive, etc.), a network connection or the Internet. The user is responsible for assessing these dangers, implementing preventive measures such as virus protection programs, firewalls, etc. and making sure that software is only obtained from trusted sources.

2.7 Environmentally friendly disposal

All B&R programmable controllers, operating/monitoring devices and uninterruptible power supplies are designed to inflict as little harm as possible on the environment.

2.7.1 Separation of materials

It is necessary to separate different materials so the device can undergo an environmentally friendly recycling process.

Component	Disposal
Programmable logic controllers Operating/monitoring devices Uninterruptible power supply Batteries and rechargeable batteries Cables	Electronics recycling
Cardboard box / paper packaging	Paper / cardboard recycling
Plastic packaging	Plastic recycling

Table 2: Environmentally friendly separation of materials

Disposal must comply with applicable legal regulations.

3 Organization of safety notices

Safety notices in this manual are organized as follows:

Safety notice	Description
Danger!	Disregarding these safety guidelines and notices can be life-threatening.
Warning!	Disregarding these safety guidelines and notices can result in severe injury or substantial damage to equipment.
Caution!	Disregarding these safety guidelines and notices can result in injury or damage to equipment.
Information:	This information is important for preventing errors.

Table 3: Description of the safety notices used in this documentation

4 Guidelines

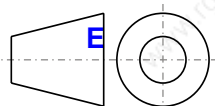

European dimension standards apply to all dimension diagrams in this document.

All dimensions are specified in mm.

Range of nominal sizes	General tolerance according to DIN ISO 2768 (medium)
Up to 6 mm	± 0.1 mm
For 6 to 30 mm	± 0.2 mm
For 30 to 120 mm	± 0.3 mm
For 120 to 400 mm	± 0.5 mm
For 400 to 1000 mm	± 0.8 mm

Table 4: Range of nominal sizes

5 Overview

Product ID	Short description	on page
Accessories		
5AC801.FA01-00	APC810 replacement fan filter for 5PC810.SX01-00; 5 pcs.	327
5AC801.FA02-00	APC810 replacement fan filter for 5PC810.SX02-00; 5 pcs.	327
5AC801.FA03-00	APC810 replacement fan filter for 5PC810.SX03-00; 5 pcs.	327
5AC801.FA05-00	APC810 replacement fan filter for 5PC810.SX05-00; 5 pcs.	327
5AC801.FRAME-00	APC810 SATA hard disk replacement tray	397
5AC801.RDYR-01	Ready relay for APC810 for installation on an add-on UPS slot	178
5AC804.MFLT-00	Line filter	369
5ACPCI.ETH1-01	PCI Ethernet card 1x 10/100	371
5ACPCI.ETH3-01	PCI Ethernet card 3x 10/100	374
5CAMSC.0001-00	Internal supply cable	396
Automation Panel Link interfaces		
5AC801.RDYR-00	APC810 ready relay	177
5AC801.SDL0-00	Smart Display Link/DVI-D transmitter	175
Automation Runtime		
1A4600.10	B&R Automation Runtime ARwin, incl. license sticker and copy protection	301
1A4600.10-2	B&R Automation Runtime ARwin, ARNC0	301
1A4600.10-3	B&R Automation Runtime ARwin+PVIControls incl. license sticker and copy protection	301
1A4600.10-4	B&R Automation Runtime ARwin+ARNC0+PVIControls	301
1A4601.06	B&R Automation Runtime ARemb, incl. license sticker and copy protection	301
1A4601.06-2	B&R Automation Runtime ARemb, ARNC0	301
Batteries		
0AC201.91	Lithium batteries 4 pcs., 3 V / 950 mAh button cell We hereby state that the lithium cells contained in this shipment qualify as "partly regulated". Handle with care. If the package is damaged, inspect the cells, repack intact cells and protect the cells against short circuit. For emergency information, call RENATA SA at +41 61 319 28 27.	324
4A0006.00-000	Lithium battery, 3 V / 950 mAh, button cell	324
Bus units		
5PC810.BX01-00	APC810 bus, 1 PCI	104
5PC810.BX01-01	APC810 bus, 1 PCI Express (x4)	104
5PC810.BX02-00	APC810 bus, 2 PCI	104
5PC810.BX02-01	APC810 bus, 1 PCI, 1 PCI Express (x4)	104
5PC810.BX03-00	APC810 bus, 2 PCI, 1 PCI Express (x4)	104
5PC810.BX05-00	APC810 bus, 4 PCI, 1 PCI Express (x1)	104
5PC810.BX05-01	APC810 bus, 2 PCI, 3 PCI Express (x1)	104
5PC810.BX05-02	APC810 bus, 5 PCI	104
CPU boards		
5PC800.B945-00	Intel Core Duo L2400 CPU board, 1.66 GHz, dual core, 667 MHz FSB, 2 MB L2 cache; 945GME chipset; 2 slots for SO-DIMM DDR2 modules (max. total of 3 GB), Realtek RTL8111B Ethernet controller	106
5PC800.B945-01	Intel Core2 Duo L7400 CPU board, 1.5 GHz, dual core, 667 MHz FSB, 2 MB L2 cache; 945GME chipset; 4 slots for SO-DIMM DDR2 modules (max. total of 3 GB), Realtek RTL8111B Ethernet controller	106
5PC800.B945-02	Intel Core2 Duo U7500 CPU board, 1.06 GHz, dual core, 533 MHz FSB, 2 MB L2 cache; 945GME chipset; 2 slots for SO-DIMM DDR2 modules (max. total of 3 GB), Realtek RTL8111B Ethernet controller	106
5PC800.B945-03	Intel Celeron M 423 CPU board, 1.06 GHz, single core, 533 MHz FSB, 1 MB L2 cache; 945GME chipset; 2 slots for SO-DIMM DDR2 modules (max. total of 3 GB), Realtek RTL8111B Ethernet controller	106
5PC800.B945-04	Intel Core2 Duo T7400 CPU board, 2.16 GHz, dual core, 667 MHz FSB, 2 MB L2 cache; 945GME chipset; 4 slots for SO-DIMM DDR2 modules (max. total of 3 GB), Realtek RTL8111B Ethernet controller	106
5PC800.B945-05	Intel Atom N270 CPU board, 1.6 GHz, single core, 533 MHz FSB, 512 kB L2 cache; 945GME chipset; 2 slots for SO-DIMM DDR2 modules (max. total of 3 GB), Realtek RTL8111C Ethernet controller	106
5PC800.B945-10	Intel Core Duo L2400 CPU board, 1.66 GHz, dual core, 667 MHz FSB, 2 MB L2 cache; 945GME chipset; 2 slots for SO-DIMM DDR2 modules (max. total of 3 GB), Realtek RTL8111C Ethernet controller	106
5PC800.B945-11	Intel Core2 Duo L7400 CPU board, 1.5 GHz, dual core, 667 MHz FSB, 4 MB L2 cache; 945GME chipset; 2 slots for SO-DIMM DDR2 modules (max. total of 3 GB), Realtek RTL8111C Ethernet controller	106
5PC800.B945-12	Intel Core2 Duo U7500 CPU board, 1.06 GHz, dual core, 533 MHz FSB, 2 MB L2 cache; 945GME chipset; 2 slots for SO-DIMM DDR2 modules (max. total of 3 GB), Realtek RTL8111C Ethernet controller	106
5PC800.B945-13	Intel Celeron M 423 CPU board, 1.06 GHz, single core, 533 MHz FSB, 1 MB L2 cache; 945GME chipset; 2 slots for SO-DIMM DDR2 modules (max. total of 3 GB), Realtek RTL8111C Ethernet controller	106
5PC800.B945-14	Intel Core2 Duo T7400 CPU board, 2.16 GHz, dual core, 667 MHz FSB, 4 MB L2 cache; 945GME chipset; 2 slots for SO-DIMM DDR2 modules (max. total of 3 GB), Realtek RTL8111C Ethernet controller	106
CompactFlash		
5CFCRD.0064-03	CompactFlash 64 MB Western Digital (SLC)	339
5CFCRD.0128-03	CompactFlash 128 MB Western Digital (SLC)	339
5CFCRD.016G-04	CompactFlash 16 GB B&R (SLC)	335
5CFCRD.016G-06	CompactFlash 16 GB B&R (SLC)	331
5CFCRD.0256-03	CompactFlash 256 MB Western Digital (SLC)	339
5CFCRD.032G-06	CompactFlash 32 GB B&R (SLC)	331
5CFCRD.0512-03	CompactFlash 512 MB Western Digital (SLC)	339
5CFCRD.0512-04	CompactFlash 512 MB B&R (SLC)	335
5CFCRD.0512-06	CompactFlash 512 MB B&R (SLC)	331
5CFCRD.1024-03	CompactFlash 1 GB Western Digital (SLC)	339
5CFCRD.1024-04	CompactFlash 1 GB B&R (SLC)	335
5CFCRD.1024-06	CompactFlash 1 GB B&R (SLC)	331
5CFCRD.2048-03	CompactFlash 2 GB Western Digital (SLC)	339
5CFCRD.2048-04	CompactFlash 2 GB B&R (SLC)	335
5CFCRD.2048-06	CompactFlash 2 GB B&R (SLC)	331

General information • Overview

Product ID	Short description	on page
5CFCRD.4096-03	CompactFlash 4 GB Western Digital (SLC)	339
5CFCRD.4096-04	CompactFlash 4 GB B&R (SLC)	335
5CFCRD.4096-06	CompactFlash 4 GB B&R (SLC)	331
5CFCRD.8192-03	CompactFlash 8 GB Western Digital (SLC)	339
5CFCRD.8192-04	CompactFlash 8 GB B&R (SLC)	335
5CFCRD.8192-06	CompactFlash 8 GB B&R (SLC)	331
DVI cable		
5CADVI.0018-00	DVI-D cable, 1.8 m	377
5CADVI.0050-00	DVI-D cable, 5 m	377
5CADVI.0100-00	DVI-D cable, 10 m	377
Drives		
5AC801.ADAS-00	SATA hard disk adapter for operating a slide-in compact hard disk in a slide-in slot	142
5AC801.DVDS-00	DVD-ROM SATA slide-in drive	145
5AC801.DVRS-00	DVD-R/RW DVD+R/RW SATA slide-in drive	147
5AC801.HDDI-00	40 GB SATA slide-in compact hard disk; 24/7 operation with extended temperature range. Note: please see the manual for information about using this hard disk	112
5AC801.HDDI-01	80 GB slide-in compact SATA hard disk; 24/7 operation with extended temperature range. Note: Please see the manual for information about using this hard disk.	114
5AC801.HDDI-02	160 GB SATA hard disk, slide-in compact, 24/7 operation with extended temperature range. Note: please see the manual for information about using this hard disk	116
5AC801.HDDI-03	250 GB slide-in compact SATA hard disk, 24/7 operation. Note: please see the manual for information about using this hard disk	118
5AC801.HDDI-04	500 GB SATA hard disk, slide-in compact, 24/7 operation Note: please see the manual for information about using this hard disk	120
5AC801.HDDS-00	40 GB SATA slide-in hard disk; 24/7 operation with extended temperature range. Note: please see the manual for information about using this hard disk	143
5AC801.SSDI-00	32 GB SATA SSD (SLC), slide-in compact	122
5AC801.SSDI-01	60 GB SATA slide-in compact SSD (MLC)	126
5AC801.SSDI-02	180 GB SATA slide-in compact SSD (MLC)	128
5AC801.SSDI-03	60 GB SATA slide-in compact SSD (MLC)	130
5AC801.SSDI-04	128 GB SATA SSD (MLC), slide-in compact	132
5ACPCI.RAIC-01	PCI RAID system SATA 2x 60 GB; Note: Please see the manual for information about using this hard disk.	150
5ACPCI.RAIC-02	60 GB SATA hard disk replacement part for 5ACPCI.RAIC-01; Note: Please see the manual for information about using this hard disk.	153
5ACPCI.RAIC-03	PCI RAID system SATA 2x 160 GB; note: Please see the manual for information about using this hard disk.	155
5ACPCI.RAIC-04	160 GB SATA hard disk, replacement part for 5ACPCI.RAIC-03; note: Please see the manual for information about using this hard disk.	158
5ACPCI.RAIC-05	PCI RAID system SATA 2x 250 GB; note: please see the manual for information about using this hard disk	160
5ACPCI.RAIC-06	PCI RAID system SATA 2x 500 GB; note: please see the manual for information about using this hard disk	163
5MMHDD.0250-00	250 GB SATA hard disk; replacement for 5AC801.HDDI-03 and 5ACPCI.RAIC-05; note: please see the manual for information about using this hard disk	166
5MMHDD.0500-00	500 GB SATA hard disk; replacement for 5AC801.HDDI-04, 5AC901.CHDD-01 and 5ACPCI.RAIC-06; note: please see the manual for information about using this hard disk	168
5MMSSD.0060-00	60 GB SATA SSD (MLC); replacement for 5AC801.SSDI-01 and 5AC901.CSSD-01; SSD for 5PP5IO.GMAC-00; note: please see the manual for information about using this SSD	134
5MMSSD.0060-01	60 GB SATA SSD (MLC); replacement for 5AC801.SSDI-03 and 5AC901.CSSD-03; SSD for 5PP5IO.GMAC-00; note: please see the manual for information about using this SSD	136
5MMSSD.0128-01	128 GB SATA SSD (MLC); replacement for 5AC801.SSDI-04 and 5AC901.CSSD-04; SSD for 5PP5IO.GMAC-00; note: please see the manual for information about using this SSD	138
5MMSSD.0180-00	180 GB SATA SSD (MLC); replacement part for 5AC801.SSDI-02 and 5AC901.CSSD-02; SSD for 5PP5IO.GMAC-00; note: please see the manual for information about using this SSD	140
Fan kits		
5PC810.FA01-00	APC810 fan kit for 5PC810.SX01-00 system unit	170
5PC810.FA02-00	APC810 fan kit for 5PC810.SX02-00 system unit	171
5PC810.FA02-01	APC810 fan kit for 5PC810.SX02-00 (revisions > D0)	171
5PC810.FA03-00	APC810 fan kit for 5PC810.SX03-00 system unit	172
5PC810.FA05-00	APC810 fan kit for 5PC810.SX05-00 system unit	173
Kühlkörper		
5AC801.HS00-00	APC810 heat sink for CPU boards with L2400, L7400, U7500 or Celeron M 423 dual-core processor	109
5AC801.HS00-01	APC810 heat sink for CPU boards with T7400, T9400 or P8400 dual-core processor	109
5AC801.HS00-02	APC810 heat sink for CPU board with Atom processor N270	109
MS-DOS		
9S0000.01-010	OEM Microsoft MS-DOS 6.22, German floppy disks, only supplied together with a new PC	286
9S0000.01-020	OEM Microsoft MS-DOS 6.22, English floppy disks, only supplied together with a new PC	286
Main memory		
5MMDDR.0512-01	SO-DIMM DDR2 RAM 512 MB PC2-5300	111
5MMDDR.1024-01	SO-DIMM DDR2 RAM 1024 MB PC2-5300	111
5MMDDR.2048-01	SO-DIMM DDR2 RAM 2048 MB PC2-5300	111
Miscellaneous		
5AC900.1000-00	DVI (male connector) to CRT (female connector) adapter. For connecting a standard monitor to a DVI-I interface.	328
Other		
5SWHMI.0000-00	HMI Drivers & Utilities DVD	358
RS232 cable		
9A0014.02	RS232 extension cable for remote operation of a display unit with touch screen, 1.8 m	394
9A0014.05	RS232 extension cable for remote operation of a display unit with touch screen, 5 m	394
9A0014.10	RS232 extension cable for remote operation of a display unit with touch screen, 10 m	394

Product ID	Short description	on page
SDL cable - 45° connector		
5CASDL.0018-01	SDL cable with 45° male connector, 1.8 m	383
5CASDL.0050-01	SDL cable with 45° male connector, 5 m	383
5CASDL.0100-01	SDL cable with 45° male connector, 10 m	383
5CASDL.0150-01	SDL cable with 45° male connector, 15 m	383
SDL cables		
5CASDL.0018-00	SDL cable, 1.8 m	380
5CASDL.0050-00	SDL cable, 5 m	380
5CASDL.0100-00	SDL cable, 10 m	380
5CASDL.0150-00	SDL cable, 15 m	380
5CASDL.0200-00	SDL cable, 20 m	380
5CASDL.0250-00	SDL cable, 25 m	380
5CASDL.0300-00	SDL cable, 30 m	380
SDL flex cable		
5CASDL.0018-03	SDL flex cable, 1.8 m	386
5CASDL.0050-03	SDL flex cable, 5 m	386
5CASDL.0100-03	SDL flex cable, 10 m	386
5CASDL.0150-03	SDL flex cable, 15 m	386
5CASDL.0200-03	SDL flex cable, 20 m	386
5CASDL.0250-03	SDL flex cable, 25 m	386
5CASDL.0300-03	SDL flex cable, 30 m	386
5CASDL.0300-13	SDL flex cable with extender, 30 m	389
5CASDL.0400-13	SDL flex cable with extender, 40 m	389
5CASDL.0430-13	SDL flex cable with extender, 43 m	389
Serial adapters		
5AC600.485I-00	RS232/422/485 interface, for installation in an APC620, APC810 or PPC700	183
5AC600.CANI-00	CAN interface; for installation in an APC620, APC810 or PPC700	180
Systemeinheiten		
5PC810.SX01-00	APC810 system unit, 1 slot (PCI Express, PCI, depending on bus); 1 compact slide-in slot; Smart Display Link/DVI/Monitor, 2x RS232, 5x USB 2.0, 2x ETH 10/100/1000, 24 VDC (order 0TB103.9 screw clamp or 0TB103.91 cage clamp terminals separately)	75
5PC810.SX02-00	APC810 system unit, 2 slots (PCI Express, PCI, depending on bus); 1 slot for Automation Panel Link transmitter; 1 slide-in compact and 1 slide-in slot; Smart Display Link/DVI/Monitor, 2x RS232, 5x USB 2.0, 2x ETH 10/100/1000, 24 VDC (order 0TB103.9 screw clamp or 0TB103.91 cage clamp terminals separately)	82
5PC810.SX03-00	APC810 system unit, 3 slots (PCI Express, PCI, depending on bus); 1 slot for Automation Panel Link transmitter; 1 slide-in compact and 1 slide-in slot; Smart Display Link/DVI/Monitor, 2x RS232, 5x USB 2.0, 2x ETH 10/100/1000, AC97 sound, 24 VDC (order 0TB103.9 screw clamp or 0TB103.91 cage clamp terminals separately)	89
5PC810.SX05-00	APC810 system unit, 5 slots (PCI Express, PCI, depending on bus); 1 slot for Automation Panel Link transmitter; 1 slide-in compact and 2 slide-in slots; Smart Display Link/DVI/Monitor, 2x RS232, 5x USB 2.0, 2x ETH 10/100/1000, 24 VDC (order 0TB103.9 screw clamp or 0TB103.91 cage clamp terminals separately)	96
Terminal blocks		
0TB103.9	Connector, 24 VDC, 3-pin female, 3.31 mm ² screw clamp, protected against vibration by the screw flange	326
0TB103.91	Connector, 24 VDC, 3-pin female, 3.31 mm ² cage clamp, protected against vibration by the screw flange	326
USB accessories		
5A5003.03	Front cover, for remote CD-ROM drive 5A5003.02 and USB 2.0 drive combination 5MD900.USB2-00, 5MD900.USB2-01 and 5MD900.USB2-02	352
5MD900.USB2-01	USB 2.0 drive combination, consists of DVD-R/RW DVD+R/RW, FDD, CompactFlash slot (Type II), USB connection (Type A on front, Type B on back); 24 VDC, (order screw clamp 0TB103.9 or cage clamp 0TB103.91 separately)	343
5MD900.USB2-02	USB 2.0 drive combination, consists of DVD-R/RW DVD+R/RW, CompactFlash slot (Type II), USB connection (Type A on the front, Type B on the back); 24V DC (order screw clamp terminal 0TB103.9 or cage clamp terminal 0TB103.91 separately)	348
5MMUSB.2048-00	USB 2.0 flash drive, 2048 MB	354
5MMUSB.2048-01	USB 2.0 flash drive, 2048 MB, B&R	356
5MMUSB.4096-01	USB 2.0 flash drive, 4096 MB, B&R	356
USB cable		
5CAUSB.0018-00	USB 2.0 connection cable type A - type B, 1.8 m	393
5CAUSB.0050-00	USB 2.0 connection cable type A - type B, 5 m	393
Uninterruptible power supplies		
5AC600.UPSB-00	Battery unit 5 Ah; for APC620, APC810 or PPC800 UPS	364
5AC600.UPSF-00	UPS fuse kit for battery unit 5AC600.UPSB-00 up to revision D0.	368
5AC600.UPSF-01	UPS fuse, 5 pcs.	368
5AC600.UPSI-00	UPS module for APC620, APC810, PPC800; for system units 5PC600.SX01-00 (beginning with rev. H0), 5PC600.SX02-00 (beginning with rev. G0), 5PC600.SX02-01 (beginning with rev. H0), 5PC600.SX05-00 (beginning with rev. F0), 5PC600.SX05-01 (beginning with rev. F0), 5PC600.SF03-00 (beginning with rev. A0), 5PC810.SX*, 5PC820.1505-00, 5PC820.1906-00. Order cable (5CAUPS.0005-00 or 5CAUPS.0030-00) and battery unit (5AC600.UPSB-00) separately.	362
5CAUPS.0005-00	UPS cable 0.5 m; for UPS 5AC600.UPSI-00	367
5CAUPS.0030-00	UPS cable 3 m; for UPS 5AC600.UPSI-00	367
Windows 7 Professional/Ultimate		
5SWWI7.0100-ENG	Microsoft OEM Windows 7 Professional 32-bit, DVD, English. Only available with a new device.	289
5SWWI7.0100-GER	Microsoft OEM Windows 7 Professional 32-bit, DVD, German. Only available with a new device.	289
5SWWI7.0200-ENG	Microsoft OEM Windows 7 Professional 64-bit, DVD, English. Only available with a new device.	289
5SWWI7.0200-GER	Microsoft OEM Windows 7 Professional 64-bit, DVD, German. Only available with a new device.	289
5SWWI7.0300-MUL	Microsoft OEM Windows 7 Ultimate 32-bit, DVD, multilingual. Only available with a new device.	289
5SWWI7.0400-MUL	Microsoft OEM Windows 7 Ultimate 64-bit, DVD, multilingual. Only available with a new device.	289

General information • Overview

Product ID	Short description	on page
5SWWI7.1100-ENG	Microsoft OEM Windows 7 Professional 32-bit, Service Pack 1, DVD, English. Only available with a new device.	289
5SWWI7.1100-GER	Microsoft OEM Windows 7 Professional 32-bit, Service Pack 1, DVD, German. Only available with a new device.	289
5SWWI7.1200-ENG	Microsoft OEM Windows 7 Professional 64-bit, Service Pack 1, DVD, English. Only available with a new device.	289
5SWWI7.1200-GER	Microsoft OEM Windows 7 Professional 64-bit, Service Pack 1, DVD, German. Only available with a new device.	289
5SWWI7.1300-MUL	Microsoft OEM Windows 7 Ultimate 32-bit, Service Pack 1, DVD, multilingual. Only available with a new device.	289
5SWWI7.1400-MUL	Microsoft OEM Windows 7 Ultimate 64-bit, Service Pack 1, DVD, multilingual. Only available with a new device.	289
Windows CE 6.0		
5SWWCE.0826-ENG	Microsoft OEM Windows CE 6.0 Professional, English; for APC810 with 945GME chipset; order CompactFlash separately (at least 128 MB).	299
Windows Embedded Standard 2009		
5SWWXP.0726-ENG	Microsoft OEM Windows Embedded Standard 2009, English; for APC810 with 945GME chipset; order CompactFlash separately (at least 1 GB).	294
Windows Embedded Standard 7		
5SWWI7.1526-ENG	Microsoft OEM Windows Embedded Standard 7 32-bit, Service Pack 1, English; for APC810 with 945GME chipset; order CompactFlash separately (at least 16 GB)	296
5SWWI7.1626-ENG	Microsoft OEM Windows Embedded Standard 7 64-bit, Service Pack 1, English; for APC810 with 945GME chipset; order CompactFlash separately (at least 16 GB)	296
5SWWI7.1726-MUL	Microsoft OEM Windows Embedded Standard 7 Premium 32-bit, Service Pack 1, multilingual; for APC810 with 945GME chipset; order CompactFlash separately (at least 16 GB)	296
5SWWI7.1826-MUL	Microsoft OEM Windows Embedded Standard 7 Premium 64-bit, Service Pack 1, multilingual; for APC810 with 945GME chipset; order CompactFlash separately (at least 16 GB)	296
Windows XP Embedded		
5SWWXP.0426-ENG	Microsoft OEM Windows XP Embedded Feature Pack 2007, English; for APC810 with 945GME chipset; order CompactFlash separately (at least 512 MB)	292
Windows XP Professional		
5SWWXP.0500-ENG	Microsoft OEM Windows XP Professional Service Pack 2c, CD, English. Only available with a new device.	287
5SWWXP.0500-GER	Microsoft OEM Windows XP Professional Service Pack 2c, CD, German. Only available with a new device.	287
5SWWXP.0500-MUL	Microsoft OEM Windows XP Professional Service Pack 2c, CD, multilingual. Only available with a new device.	287
5SWWXP.0600-ENG	Microsoft OEM Windows XP Professional Service Pack 3, CD, English. Only available with a new device.	287
5SWWXP.0600-GER	Microsoft OEM Windows XP Professional Service Pack 3, CD, German. Only available with a new device.	287
5SWWXP.0600-MUL	Microsoft OEM Windows XP Professional Service Pack 3, CD, multilingual. Only available with a new device.	287

Chapter 2 • Technical data

1 Introduction

The APC810 is a logical step forward from the successful APC620 product series. Based on the latest Intel® Core™2 Duo technology, the APC810 offers the highest level of performance for any application that requires maximum computing power.

The APC810 saves space in the control cabinet, with drive bays (DVD, HDD) and two CompactFlash slots protected behind a cover on the front of the device. Modular plug-in technology makes it easy for the user to replace drives. All connections and interfaces are located on the top of the housing so that installation depth is not increased by protruding connectors. Different APC810 sizes with one, two, three or five slots for PCI and/or PCI Express cards ensure the optimum design for any type of installation – a perfect fit that doesn't waste valuable space in the control cabinet.



1.1 Features

- Latest processor technology – Core Duo, Core 2 Duo, Celeron M and Atom N270
- Up to 3 GB main memory (dual-channel memory support)
- 2 CompactFlash slots (type I)
- 1, 2, 3 or 5 card slots (for PCI / PCI Express (PCIe) cards)
- SATA drives (slide-in and slide-in compact slots)
- 5x USB 2.0
- 2x Ethernet 10/100/1000 Mbit interfaces
- 2x RS232 interface, modem-compatible
- 24 VDC supply voltage
- Fan-free operation¹⁾
- BIOS (AMI)
- Real-time clock (RTC, battery-backed)
- 512 kB SRAM (battery-backed)
- Possibility to connect various display devices to the "Monitor/Panel" video output (supports RGB, DVI and SDL - Smart Display Link - signals)
- 2nd graphics line by installing the optional AP Link card
- Easy slide-in drive replacement (SATA hot plugging)
- Optional installation of the add-on UPS module
- Optional CAN interface
- Optional RS232/422/485 interface
- Optional RAID controller (requires an open PCI slot)

1.2 System components / configuration

The APC810 system can be assembled to meet individual requirements and operating conditions.

The following components are absolutely essential for operation:

- System unit
- Bus unit
- CPU board
- Heat sink
- Main memory
- Drive (mass storage device such as CompactFlash card or hard disk) for the operating system
- Software

¹⁾ Depends on the device configuration and ambient temperature.

1.3 Configuration - Base system









Base system configuration					
System unit Select one					
A system unit consists of a housing and mainboard. Variants: Card slots (1, 2, 3 or 5) Slide-in slots (0, 1 or 2) AP Link slot (0 or 1) Example: (2 / 1 / 1) = 2 card slots, 1 slide-in slot, 1 AP Link slot					
	5PC810.SX01-00 (1 / 0 / 0)	5PC810.SX02-00 (2 / 1 / 1)	5PC810.SX03-00 (3 / 1 / 1)	5PC810.SX05-00 (5 / 2 / 1)	
	↓ ↓ ↓ ↓ ↓				
	Bus unit Select one				
		5PC810.BX01-00 (1 PCI) 5PC810.BX01-01 (1 PCIe)	5PC810.BX02-00 (2 PCI) 5PC810.BX02-01 (1 PCI / 1 PCIe)	5PC810.BX03-00 (2 PCI / 1 PCIe)	5PC810.BX05-00 (4 PCI / 1 PCIe) 5PC810.BX05-01 (2 PCI / 3 PCIe) 5PC810.BX05-02 (5 PCI)
CPU board - Heat sink - Main memory					
CPU board Select one					
	5PC800.B945-00 = -10 5PC800.B945-01 = -11 5PC800.B945-02 = -12 5PC800.B945-03 = -13	5PC800.B945-04 = -14	5PC800.B945-05		
Heat sinks Select one ↓ ↓ ↓					
	5AC801.HS00-00	5AC801.HS00-01	5AC801.HS00-02		
Main memory Select one or two (max. 3 GB can be used) ↓					
	5MMDDR.0512-01 - 512 MB 5MMDDR.1024-01 - 1 GB 5MMDDR.2048-01 - 2 GB				

Figure 1: Base system configuration

1.4 Configuration - Optional components











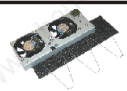

Configuration - Drives, software, accessories			
System unit	Select one		
A system unit consists of a housing and mainboard. Variants: Card slots (1, 2, 3 or 5) Slide-in slots (0, 1 or 2) AP Link slot (0 or 1) Example: (2 / 1 / 1) = 2 card slots, 1 slide-in slot, 1 AP Link slot	 5PC810.SX01-00 (1 / 0 / 0)	 5PC810.SX02-00 (2 / 1 / 1)	 5PC810.SX03-00 (3 / 1 / 1)
Fan kit	Select one		
	5PC810.FA01-00	5PC810.FA02-01	5PC810.FA03-00
Slide-in compact drive	Select one		
	5AC801.HDDI-00 (40 GB) 5AC801.HDDI-04 (500 GB) 5AC801.SSDI-00 (32 GB)	5AC801.SSDI-01 (60 GB) 5AC801.SSDI-02 (180 GB) 5AC801.SSDI-03 (60 GB)	
CompactFlash	Select one or two		
	5CFCRD.0512-06, 5CFCRD.1024-06, 5CFCRD.2048-06, 5CFCRD.4096-06, 5CFCRD.8192-06, 5CFCRD.016G-06 5CFCRD.032G-06	5CFCRD.0064-03, 5CFCRD.0128-03, 5CFCRD.0256-03, 5CFCRD.0512-03, 5CFCRD.1024-03, 5CFCRD.2048-03, 5CFCRD.4096-03, 5CFCRD.8192-03	
Slide-in drive	Not possible	1 possible	2 possible
		5AC801.HDDS-00 (40 GB) 5AC801.DVDS-00 (DVD drive) 5AC801.ADAS-00 (adapter) 5AC801.DVRS-00 (DVD writer)	
AP Link card		Select one	
		5AC801.SDL0-00 (for 2nd graphics line) 5AC801.RDYR-00 (ready relay)	
RAID system	Select one		
	5ACPCI.RAIC-06 (2x 500 GB, uses 1 PCI slot) 5MMHDD.0500-00 (Replacement SATA-HDD 500 GB)		
Interface option	Select one		
	5AC600.CANI-00 (CAN) 5AC600.485I-00 (combined RS232/RS422/RS485)		
UPS module + battery	Select one		
	5AC600.UPSI-00 (add-on UPS module) + 5AC600.UPSB-00 (UPS battery unit) Connection cable: 5CAUPS.0005-00 (0.5 meters) or 5CAUPS.0030-00 (3 meters)		
Terminal blocks	Select one		
	0TB103.9 (screw clamps) 0TB103.91 (cage clamps)		
Software	Select one		
	Windows XP 5SWWXP.0500-ENG 5SWWXP.0500-GER 5SWWXP.0500-MUL Windows XP Embedded 5SWWXP.0600-ENG 5SWWXP.0600-GER 5SWWXP.0600-MUL Windows CE 5SWWCE.0826-ENG Windows 7 5SWWI7.1200-ENG 5SWWI7.1200-GER 5SWWI7.1400-MUL	Windows Embedded Standard 2009 5SWWXP.0726-ENG Windows Embedded Standard 7 5SWWI7.1526-ENG 5SWWI7.1626-ENG 5SWWI7.1726-MUL 5SWWI7.1826-MUL Windows XP Embedded 5SWWXP.0426-ENG	Automation Runtime 1A4601.06 1A4601.06-2 1A4600.10 1A4600.10-2 1A4600.10-3 1A4600.10-4 Microsoft DOS 9S0000.01-010 9S0000.01-020

Figure 2: Configuration - Optional components

2 Complete system

2.1 Temperature specifications

CPU boards can be combined with various other components such as drives, main memory, additional insert cards, etc. depending on the system unit and fan kit. The many different configurations possible result in varying maximum ambient temperatures, which can be seen in the following tables in this section.

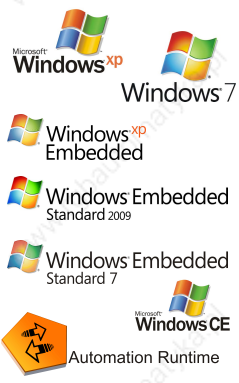
Information:

The maximum specified ambient temperatures for operation with and without a fan kit have been determined under worst-case conditions. Experience has shown that higher ambient temperatures can be reached in typical applications, e.g. those in Microsoft Windows. Testing and evaluation must be performed on-site by the user (temperatures can be read in BIOS or with the B&R Control Center).

Information regarding worst-case conditions

- Thermal Analysis Tool (TAT V2.02) from Intel for simulating a 100% processor load
- BurnInTest tool (BurnInTest V4.0 Pro from Passmark Software) for simulating a 100% load on the interface via loop back adapters (serial interfaces, add-on and slide-in drives, USB ports, audio outputs)
- Maximum system expansion and power consumption

What must be considered when determining the maximum ambient temperature?

- Operating the Ethernet interfaces (ETH1/ETH2) in 10/100 Mbit or 1 Gbit mode
- Operating the complete system with or without fan kit
- The revision of the heat sink being used

2.1.1 Maximum ambient temperature

2.1.1.1 Maximum ambient temperature without a fan kit

Information:

- There is a difference when operating ETH2 in "up to 100 Mbit" or "up to 1 Gbit" mode.
- Operation without a fan kit is permitted **ONLY** when installed vertically (see "Mounting orientation" on page 187).
- The specifications in the following table are only valid for system units with heat sinks 5AC801.HS00-00 < Rev. D0 and 5AC801.HS00-01 < Rev. D0.

All temperature values in degrees Celsius (°C) at 500 m above sea level.

The maximum ambient temperature is typically derated by 1°C per 1000 meters (starting at 500 meters above sea level).

	ETH1: Up to 100 Mbit operation ETH2: Up to 100 Mbit operation					ETH1: Up to 100 Mbit operation ETH2: Up to 1 Gbit operation					Temperature limits	Location of sensor(s)		
	L2400 5PC800.B945-00	L7400 5PC800.B945-01	U7500 5PC800.B945-02	M 423 5PC800.B945-03	T7400 5PC800.B945-04	L2400 5PC800.B945-00	L7400 5PC800.B945-01	U7500 5PC800.B945-02	M 423 5PC800.B945-03	T7400 5PC800.B945-04				
Maximum ambient temperature	35	35	35	45	-	30	30	30	40	-				
What else can also be operated at the max. ambient temperature, or are there any limits?														
Slide-in compact drives	Onboard CompactFlash ¹⁾	✓	✓	✓	✓		✓	✓	✓	✓		80	I/O	
	5AC801.HDDI-00	✓	✓	✓	✓		✓	✓	✓	✓		80		
	5AC801.HDDI-01	✓	✓	✓	✓		✓	✓	✓	✓		80		
	5AC801.HDDI-02	✓	✓	✓	✓		✓	✓	✓	✓		80		
	5AC801.HDDI-03	✓	✓	✓	✓		✓	✓	✓	✓		60		
	5AC801.HDDI-04	✓	✓	✓	✓		✓	✓	✓	✓		60		
	5AC801.SSDI-00	✓	✓	✓	✓		✓	✓	✓	✓		70		
	5AC801.SSDI-01	✓	✓	✓	✓		✓	✓	✓	✓		70		
	5AC801.SSDI-02	✓	✓	✓	✓		✓	✓	✓	✓		70		
	5AC801.SSDI-03	✓	✓	✓	✓		✓	✓	✓	✓		70		
5AC801.SSDI-04	✓	✓	✓	✓		✓	✓	✓	✓		70			
Slide-in drives	5AC801.HDDS-00	✓	✓	✓	✓		✓	✓	✓	✓		80	Slide-in drive	
	5AC801.DVDS-00	✓	✓	✓	40		✓	✓	✓	✓		50		
	5AC801.DVRS-00	✓	✓	✓	40		✓	✓	✓	✓		50		
Main memory	5MMDDR.0512-01	✓	✓	✓	✓		✓	✓	✓	✓		-	-	
	5MMDDR.1024-01	✓	✓	✓	✓		✓	✓	✓	✓		-		
	5MMDDR.2048-01	✓	✓	✓	✓		✓	✓	✓	✓		-		
System units	5PC810.SX01-00	✓	✓	✓	✓		✓	✓	✓	✓		80	Power supply	
	5PC810.SX02-00	✓	✓	✓	✓		✓	✓	✓	✓		80		
	5PC810.SX03-00	✓	✓	✓	✓		✓	✓	✓	✓		80		
	5PC810.SX05-00	✓	✓	✓	✓		✓	✓	✓	✓		80		
Additional insert cards Interfaces / AP Link	5AC600.CANI-00	✓	✓	✓	✓		✓	✓	✓	✓		-	-	
	5AC600.485I-00	✓	✓	✓	✓		✓	✓	✓	✓		-		
	5AC801.SDL0-00	✓	✓	✓	✓		✓	✓	✓	✓		-		
	5AC801.RDYR-00	✓	✓	✓	✓		✓	✓	✓	✓		-		
	5ACPCI.RAIC-01 (24 hours / standard)	30/ ✓	30/ ✓	30/ ✓	30/ 40		✓	✓	✓	✓	30/ ✓			-
	5ACPCI.RAIC-03 (24 hours / standard)	✓	✓	✓	✓		✓	✓	✓	✓		-		
5ACPCI.RAIC-05 (24 hours / standard)	✓	✓	✓	✓		✓	✓	✓	✓		-			
5ACPCI.RAIC-06 (24 hours / standard)	✓	✓	✓	✓		✓	✓	✓	✓		-			

1) Only possible with a CompactFlash card from B&R that is compatible with the device.

Table 5: Ambient temperature without a fan kit

Information:

- There is a difference when operating ETH1 and ETH2 in "up to 100 Mbit" or "up to 1 Gbit" mode.
- Operation without a fan kit is permitted **ONLY** when installed vertically (see "Mounting orientation" on page 187).
- The specifications in the following table are only valid for system units with heat sinks 5AC801.HS00-00 ≥ Rev. D0 and 5AC801.HS00-01 ≥ Rev. D0.

All temperature values in degrees Celsius (°C) at 500 m above sea level.

The maximum ambient temperature is typically derated by 1°C per 1000 meters (starting at 500 meters above sea level).

	ETH1: Up to 100 Mbit operation ETH2: Up to 100 Mbit operation					ETH1: Up to 100 Mbit operation ETH2: Up to 1 Gbit operation					Temperature limits	Location of sensor(s)
	L2400	L7400	U7500	M 423	T7400	L2400	L7400	U7500	M 423	T7400		
Maximum ambient temperature	35	35	45	45	-	30	30	40	40	-		
What else can also be operated at the max. ambient temperature, or are there any limits?												
Slide-in compact drives	Onboard CompactFlash ¹⁾	✓	✓	✓	✓	✓	✓	✓	✓	✓	80	I/O
	5AC801.HDDI-00	✓	✓	✓	✓	✓	✓	✓	✓	✓	80	
	5AC801.HDDI-01	✓	✓	✓	✓	✓	✓	✓	✓	✓	80	
	5AC801.HDDI-02	✓	✓	✓	✓	✓	✓	✓	✓	✓	80	
	5AC801.HDDI-03	✓	✓	✓	✓	✓	✓	✓	✓	✓	60	
	5AC801.HDDI-04	✓	✓	✓	✓	✓	✓	✓	✓	✓	60	
	5AC801.SSDI-00	✓	✓	✓	✓	✓	✓	✓	✓	✓	70	
	5AC801.SSDI-01	✓	✓	✓	✓	✓	✓	✓	✓	✓	70	
	5AC801.SSDI-02	✓	✓	✓	✓	✓	✓	✓	✓	✓	70	
Slide-in drives	5AC801.HDDS-00	✓	✓	✓	✓	✓	✓	✓	✓	✓	80	Slide-in drive
	5AC801.DVDS-00	✓	✓	40	40	✓	✓	✓	✓	✓	50	
	5AC801.DVRS-00	✓	✓	40	40	✓	✓	✓	✓	✓	50	
Main memory	5MMDDR.0512-01	✓	✓	✓	✓	✓	✓	✓	✓	✓	-	-
	5MMDDR.1024-01	✓	✓	✓	✓	✓	✓	✓	✓	✓	-	
	5MMDDR.2048-01	✓	✓	✓	✓	✓	✓	✓	✓	✓	-	
System units	5PC810.SX01-00	✓	✓	✓	✓	✓	✓	✓	✓	✓	80	Power supply
	5PC810.SX02-00	✓	✓	✓	✓	✓	✓	✓	✓	✓	80	
	5PC810.SX03-00	✓	✓	✓	✓	✓	✓	✓	✓	✓	80	
	5PC810.SX05-00	✓	✓	✓	✓	✓	✓	✓	✓	✓	80	
Additional insert cards Interfaces / AP Link	5AC600.CANI-00	✓	✓	✓	✓	✓	✓	✓	✓	✓	-	-
	5AC600.485I-00	✓	✓	✓	✓	✓	✓	✓	✓	✓	-	
	5AC801.SDL0-00	✓	✓	✓	✓	✓	✓	✓	✓	✓	-	
	5AC801.RDYR-00	✓	✓	✓	✓	✓	✓	✓	✓	✓	-	
	5ACPCI.RAIC-01 (24 hours / standard)	30/	30/	30/	30/	✓	✓	✓	✓	30/	-	
	5ACPCI.RAIC-03 (24 hours / standard)	✓	✓	✓	✓	✓	✓	✓	✓	✓	-	
	5ACPCI.RAIC-05 (24 hours / standard)	✓	✓	✓	✓	✓	✓	✓	✓	✓	-	
5ACPCI.RAIC-06 (24 hours / standard)	✓	✓	✓	✓	✓	✓	✓	✓	✓	-		

1) Only possible with a CompactFlash card from B&R that is compatible with the device.

Table 6: Ambient temperature without a fan kit

Information:

- There is no difference when operating ETH1 and ETH2 in "up to 100 Mbit" or "up to 1 Gbit" mode.
- Operation without a fan kit is permitted ONLY when installed vertically (1.3 "Mounting orientation" on page 187).
- The specifications in the following table are only valid for system units with heat sinks 5AC801.HS00-00 ≥ Rev. D0 and 5AC801.HS00-01 ≥ Rev. D0 and the CPU board 5PC800.B945-05 with heat sink 5AC801.HS00-02.

		L2400	L7400	U7500	M 423	T7400	N270		
		5PC800.B945-10	5PC800.B945-11	5PC800.B945-12	5PC800.B945-13	5PC800.B945-14	5PC800.B945-05		
All temperature values in degrees Celsius (°C) at 500 m above sea level.									
The maximum ambient temperature is typically derated by 1°C per 1000 meters (starting at 500 meters above sea level).									
Maximum ambient temperature		35	35	45	45	-	50	Temperature limits	Location of sensor(s)
What else can also be operated at the max. ambient temperature, or are there any limits?									
Slide-in compact drives	Onboard CompactFlash ¹⁾	✓	✓	✓	✓		✓	80	I/O
	5AC801.HDDI-00	✓	✓	✓	✓		✓	80	
	5AC801.HDDI-01	✓	✓	✓	✓		✓	80	
	5AC801.HDDI-02	✓	✓	✓	✓		✓	80	
	5AC801.HDDI-03	✓	✓	✓	✓		45	60	
	5AC801.HDDI-04	✓	✓	✓	✓		45	60	
	5AC801.SSDI-00	✓	✓	✓	✓		✓	70	
	5AC801.SSDI-01	✓	✓	✓	✓		✓	70	
	5AC801.SSDI-02	✓	✓	✓	✓		✓	70	
	5AC801.SSDI-03	✓	✓	✓	✓		✓	70	
Slide-in drives	5AC801.HDDS-00	✓	✓	✓	✓		✓	80	Slide-in drive
	5AC801.DVDS-00	✓	✓	40	40		40	50	
	5AC801.DVRS-00	✓	✓	40	40		40	50	
Main memory	5MMDDR.0512-01	✓	✓	✓	✓		✓	-	-
	5MMDDR.1024-01	✓	✓	✓	✓		✓	-	
	5MMDDR.2048-01	✓	✓	✓	✓		✓	-	
System units	5PC810.SX01-00	✓	✓	✓	✓		✓	80	Power supply
	5PC810.SX02-00	✓	✓	✓	✓		✓	80	
	5PC810.SX03-00	✓	✓	✓	✓		✓	80	
	5PC810.SX05-00	✓	✓	✓	✓		✓	80	
Additional insert cards Interfaces / AP Link	5AC600.CANI-00	✓	✓	✓	✓		✓	-	-
	5AC600.4851-00	✓	✓	✓	✓		✓	-	
	5AC801.SDL0-00	✓	✓	✓	✓		✓	-	
	5AC801.RDYR-00	✓	✓	✓	✓		✓	-	
	5ACPCI.RAIC-01 (24 hours / standard)	30/✓	30/✓	30/✓	30/40		30/40	-	
	5ACPCI.RAIC-03 (24 hours / standard)	✓	✓	✓	✓		✓	-	
	5ACPCI.RAIC-05 (24 hours / standard)	✓	✓	✓	✓		45	-	
5ACPCI.RAIC-06 (24 hours / standard)	✓	✓	✓	✓		45	-		

1) Only possible with a CompactFlash card from B&R that is compatible with the device.

Table 7: Ambient temperature without a fan kit

2.1.1.2 Maximum ambient temperature with a fan kit

Information:

- There is a difference when operating ETH1 and ETH2 in "up to 100 Mbit" or "up to 1 Gbit" mode.
- Vertical and horizontal (minus 5°C) mounting orientations are permitted (see "Mounting orientation" on page 187).

All temperature values in degrees Celsius (°C) at 500 m above sea level.

The maximum ambient temperature is typically derated by 1°C per 1000 meters (starting at 500 meters above sea level).

		ETH1: Up to 100 Mbit operation ETH2: Up to 100 Mbit operation					ETH1: Up to 100 Mbit operation ETH2: Up to 1 Gbit operation						
		L2400	L7400	U7500	M 423	T7400	L2400	L7400	U7500	M 423	T7400		
		5PC800.B945-00	5PC800.B945-01	5PC800.B945-02	5PC800.B945-03	5PC800.B945-04	5PC800.B945-00	5PC800.B945-01	5PC800.B945-02	5PC800.B945-03	5PC800.B945-04		
Maximum ambient temperature		55	55	55	55	55	50	50	50	50	45		
What else can also be operated at the max. ambient temperature, or are there any limits?												Temperature limits	Location of sensor(s)
Slide-in compact drives	Onboard CompactFlash ¹⁾	✓	✓	✓	✓	✓	✓	✓	✓	✓	✓	80	I/O
	5AC801.HDDI-00	✓	✓	✓	✓	✓	✓	✓	✓	✓	✓	80	
	5AC801.HDDI-01	✓	✓	✓	✓	✓	✓	✓	✓	✓	✓	80	
	5AC801.HDDI-02	✓	✓	✓	✓	✓	✓	✓	✓	✓	✓	80	
	5AC801.HDDI-03	50	50	50	50	50	✓	✓	✓	✓	✓	60	
	5AC801.HDDI-04	50	50	50	50	50	✓	✓	✓	✓	✓	60	
	5AC801.SSDI-00	✓	✓	✓	✓	✓	✓	✓	✓	✓	✓	70	
	5AC801.SSDI-01	✓	✓	✓	✓	✓	✓	✓	✓	✓	✓	70	
	5AC801.SSDI-02	✓	✓	✓	✓	✓	✓	✓	✓	✓	✓	70	
	5AC801.SSDI-03	✓	✓	✓	✓	✓	✓	✓	✓	✓	✓	70	
Slide-in drives	5AC801.HDDS-00	✓	✓	✓	✓	✓	✓	✓	✓	✓	✓	80	Slide-in drive
	5AC801.DVDS-00	50	50	50	50	50	✓	✓	✓	✓	✓	50	
	5AC801.DVRS-00	50	50	50	50	50	✓	✓	✓	✓	✓	50	
	5AC801.DVRS-00	50	50	50	50	50	✓	✓	✓	✓	✓	50	
Main memory	5MMDR.0512-01	✓	✓	✓	✓	✓	✓	✓	✓	✓	✓	-	-
	5MMDR.1024-01	✓	✓	✓	✓	✓	✓	✓	✓	✓	✓	-	
	5MMDR.2048-01	✓	✓	✓	✓	✓	✓	✓	✓	✓	✓	-	
System units	5PC810.SX01-00	✓	✓	✓	✓	✓	✓	✓	✓	✓	✓	80	Power supply
	5PC810.SX02-00	✓	✓	✓	✓	✓	✓	✓	✓	✓	✓	80	
	5PC810.SX03-00	✓	✓	✓	✓	✓	✓	✓	✓	✓	✓	80	
	5PC810.SX05-00	✓	✓	✓	✓	✓	✓	✓	✓	✓	✓	80	
Additional insert cards Interfaces / AP Link	5AC600.CANI-00	✓	✓	✓	✓	✓	✓	✓	✓	✓	✓	-	-
	5AC600.485I-00	✓	✓	✓	✓	✓	✓	✓	✓	✓	✓	-	
	5AC801.SDL0-00	✓	✓	✓	✓	✓	✓	✓	✓	✓	✓	-	
	5AC801.RDYR-00	✓	✓	✓	✓	✓	✓	✓	✓	✓	✓	-	
	5ACPCI.RAIC-01 (24 hours / standard)	30/40	30/40	30/40	30/40	30/40	30/40	30/40	30/40	30/40	30/40	-	
	5ACPCI.RAIC-03 (24 hours / standard)	✓	✓	✓	✓	✓	✓	✓	✓	✓	✓	-	
	5ACPCI.RAIC-05 (24 hours / standard)	50	50	50	50	50	✓	✓	✓	✓	✓	-	
	5ACPCI.RAIC-06 (24 hours / standard)	50	50	50	50	50	✓	✓	✓	✓	✓	-	

1) Only possible with a CompactFlash card from B&R that is compatible with the device.

Table 8: Ambient temperature with a fan kit

Information:

- There is no difference when operating ETH1 and ETH2 in "up to 100 Mbit" or "up to 1 Gbit" mode.
- Vertical and horizontal (minus 5°C) mounting orientations are permitted (see "Mounting orientation" on page 187).
- The specifications in the following table are only valid for system units with heat sinks 5AC801.HS00-00 ≥ Rev. D0 and 5AC801.HS00-01 ≥ Rev. D0 and the CPU board 5PC800.B945-05 with heat sink 5AC801.HS00-02.

All temperature values in degrees Celsius (°C) at 500 m above sea level.

The maximum ambient temperature is typically derated by 1°C per 1000 meters (starting at 500 meters above sea level).

		L2400 5PC800.B945-10	L7400 5PC800.B945-11	U7500 5PC800.B945-12	M 423 5PC800.B945-13	T7400 5PC800.B945-14	N270 5PC800.B945-05	Temperature limits	Location of sensor(s)
Maximum ambient temperature		55	55	55	55	55	60		
What else can also be operated at the max. ambient temperature, or are there any limits?									
Slide-in compact drives	Onboard CompactFlash ¹⁾	✓	✓	✓	✓	✓	✓	80	I/O
	5AC801.HDDI-00	✓	✓	✓	✓	✓	✓	80	
	5AC801.HDDI-01	✓	✓	✓	✓	✓	✓	80	
	5AC801.HDDI-02	✓	✓	✓	✓	✓	✓	80	
	5AC801.HDDI-03	50	50	50	50	50	50	60	
	5AC801.HDDI-04	50	50	50	50	50	50	60	
	5AC801.SSDI-00	✓	✓	✓	✓	✓	✓	70	
	5AC801.SSDI-01	✓	✓	✓	✓	✓	✓	70	
	5AC801.SSDI-02	✓	✓	✓	✓	✓	✓	70	
Slide-in drives	5AC801.HDDS-00	✓	✓	✓	✓	✓	✓	80	Slide-in drive
	5AC801.DVDS-00	50	50	50	50	50	50	50	
	5AC801.DVRS-00	50	50	50	50	50	50	50	
Main memory	5MMDDR.0512-01	✓	✓	✓	✓	✓	✓	-	-
	5MMDDR.1024-01	✓	✓	✓	✓	✓	✓	-	
	5MMDDR.2048-01	✓	✓	✓	✓	✓	✓	-	
System units	5PC810.SX01-00	✓	✓	✓	✓	✓	✓	80	Power supply
	5PC810.SX02-00	✓	✓	✓	✓	✓	✓	80	
	5PC810.SX03-00	✓	✓	✓	✓	✓	✓	80	
	5PC810.SX05-00	✓	✓	✓	✓	✓	✓	80	
Additional insert cards Interfaces / AP Link	5AC600.CANI-00	✓	✓	✓	✓	✓	✓	-	-
	5AC600.4851-00	✓	✓	✓	✓	✓	✓	-	
	5AC801.SDL0-00	✓	✓	✓	✓	✓	✓	-	
	5AC801.RDYR-00	✓	✓	✓	✓	✓	✓	-	
	5ACPCI.RAIC-01 (24 hours / standard)	30/ 40	30/ 40	30/ 40	30/ 40	30/ 40	30/ 40	-	
	5ACPCI.RAIC-03 (24 hours / standard)	✓	✓	✓	✓	✓	✓	-	
	5ACPCI.RAIC-05 (24 hours / standard)	50	50	50	50	50	50	-	
5ACPCI.RAIC-06 (24 hours / standard)	50	50	50	50	50	50	-		

1) Only possible with a CompactFlash card from B&R that is compatible with the device.

Table 9: Ambient temperature with a fan kit

2.1.1.3 How is the maximum ambient temperature determined?

1. The CPU board is selected (i.e. operation with or without a fan kit).
2. The "Maximum ambient temperature" row shows the maximum ambient temperature for the complete system, including the respective CPU board.

Information:

Maximum temperature data is for operation at 500 meters. The maximum ambient temperature is typically derated by 1°C per 1000 meters (starting at 500 meters above sea level).

3. Incorporating additional drives (add-on, slide-in), main memory, additional insert cards, etc. can change the temperature limits of an APC810 system.

If there is a "✓" next to the component, it can be used at the maximum ambient temperature of the complete system without problems.

If there is a specific temperature, for example "35", next to the component, then the ambient temperature of the complete APC810 system cannot exceed this temperature.

2.1.2 Minimum ambient temperature

For systems containing one of the following components, the minimum ambient temperature is +5°C: 5AC801.DVDS-00, 5AC801.DVRS-00, 5ACPCI.RAIC-01 and 5ACPCI.RAIC-02. If none of these components are used, then the minimum ambient temperature is 0°C.

2.1.3 Temperature monitoring

Sensors monitor temperature values at various places in the APC810 (CPU, board, board I/O, board ETH2, board power supply, ETH2 controller, power supply and slide-in drives 1/2). The location of the temperature sensors can be seen in Figure 3 "Temperature sensor locations" on page 38. The values listed in the table represent the defined maximum temperature²⁾ for the respective measurement point. An alarm is not triggered if this temperature is exceeded. These temperatures can be read in BIOS ("Advanced" - Baseboard/Panel features - Baseboard monitor) or in approved Microsoft operating systems via the B&R Control Center.

In addition, the hard disks for APC810 systems available from B&R are equipped with S.M.A.R.T, or Self-Monitoring, Analysis, and Reporting Technology. This makes it possible to read various parameters, e.g. temperature, using software (such as HDD Thermometer, a freeware program) on approved Microsoft operating systems (except Windows CE).

²⁾ The temperature measured approximates the immediate ambient temperature but may also be influenced by neighboring components.

2.1.4 Temperature sensor locations

Sensors indicate temperature values at different locations in the APC810 (CPU, board I/O, slide-in drive, etc). The temperatures³⁾ can be read in BIOS (Advanced - CPU monitor) or in Microsoft Windows operating systems via the B&R Control Center⁴⁾.

For applications that don't use Windows, the temperatures can be evaluated using the B&R implementation guide. In addition to the implementation guide, there are also programs available in MS-DOS.

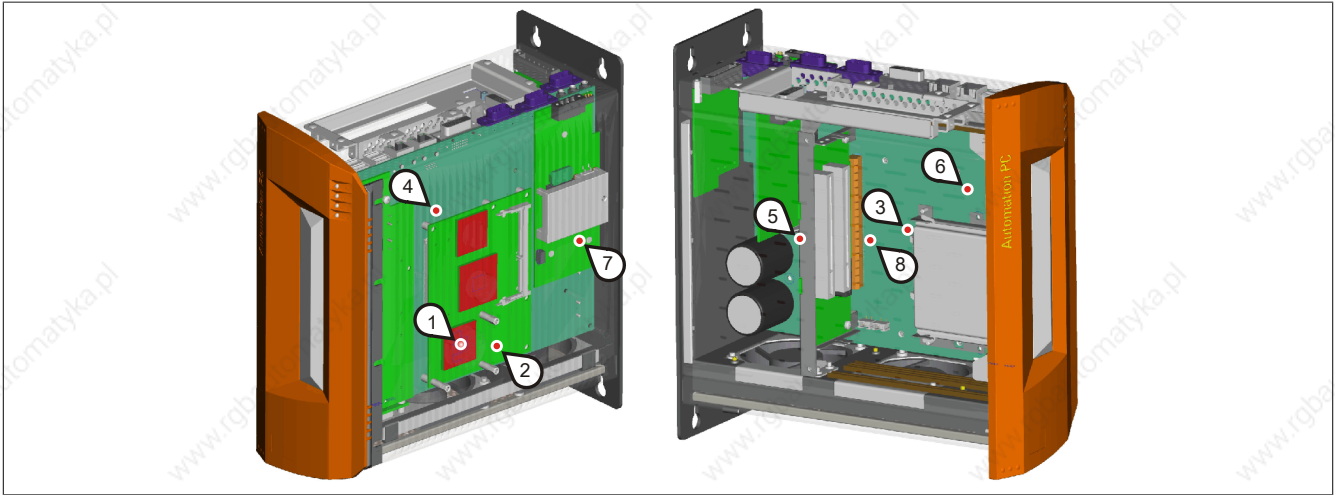

Figure 3: Temperature sensor locations

Position	Measurement point for	Measurement	Max. specified
1	CPU	Ambient temperature of the processor (sensor integrated in the processor)	100°C
2	Board	CPU board temperature (sensor integrated on the CPU board)	85°C
3	Board I/O	Board temperature in the I/O area (sensor on the baseboard)	85°C
4	Board ETH2	Baseboard temperature near the ETH2 controller (sensor on the baseboard)	80°C
5	Board power supply	Board power supply temperature (sensor on the mainboard)	80°C
6	ETH2 controller	ETH2 controller temperature (sensor in the ETH2 controller)	125°C
7	Power supply	Power supply temperature (sensor on the power supply)	80°C
8	Slide-in drive 1	Slide-in drive 1 temperature (sensor integrated in the slide-in slot)	Depends on the drive
8	Slide-in drive 2	Slide-in drive 2 temperature (sensor integrated in the slide-in slot)	Depends on the drive

Table 10: Temperature sensor locations

³⁾ The temperature measured approximates the immediate ambient temperature but can be influenced by neighboring components.

⁴⁾ The ADI driver that includes the B&R Control Center is available in the Downloads section of the B&R website (www.br-automation.com).

2.2 Humidity specifications

The following table lists the minimum and maximum relative humidity values for the individual components that are relevant for the humidity limitations of a complete system. The lowest and highest common values are always used when establishing these limits.

Component		Operation	Storage / Transport
945GME COM Express CPU boards		10 to 90%	5 to 95%
System units (all models)		5 to 90%	5 to 95%
Main memory for CPU boards		10 to 90%	5 to 95%
Slide-in compact drives	5AC801.HDDI-00	5 to 90%	5 to 95%
	5AC801.HDDI-01	5 to 90%	5 to 95%
	5AC801.HDDI-02	8 to 80%	5 to 95%
	5AC801.HDDI-03	5 to 95%	5 to 95%
	5AC801.HDDI-04	5 to 95%	5 to 95%
	5AC801.SSDI-00	5 to 95%	5 to 95%
	5AC801.SSDI-01	5 to 95%	5 to 95%
	5AC801.SSDI-02	5 to 95%	5 to 95%
	5AC801.SSDI-03	8 to 95%	8 to 95%
Slide-in drives	5AC801.HDDS-00	5 to 90%	5 to 90%
	5AC801.DVDS-00	8 to 90%	5 to 95%
	5AC801.DVRS-00	8 to 90%	5 to 95%
	5AC801.HDDS-00	5 to 90%	5 to 90%
Additional insert cards	5AC600.CANI-00	5 to 90%	5 to 95%
	5AC600.485I-00	5 to 90%	5 to 95%
	5AC801.SDL0-00	5 to 90%	5 to 95%
	5AC801.RDYR-00	5 to 90%	5 to 95%
	5ACPCI.RAIC-01 (24 hours / standard)	5 to 90%	5 to 95%
	5ACPCI.RAIC-02 (24 hours / standard)	5 to 90%	5 to 95%
	5ACPCI.RAIC-03 (24 hours / standard)	8 to 90%	5 to 95%
	5ACPCI.RAIC-04 (24 hours / standard)	8 to 90%	5 to 95%
	5ACPCI.RAIC-05 (24 hours / standard)	5 to 95%	5 to 95%
	5ACPCI.RAIC-06 (24 hours / standard)	5 to 95%	5 to 95%
	5MMHDD.0250-00 (24 hours / standard)	5 to 95%	5 to 95%
	5MMHDD.0500-00 (24 hours / standard)	5 to 95%	5 to 95%
	Accessories	5CFCRD.xxxx-06 CompactFlash cards	85%
5CFCRD.xxxx-04 CompactFlash cards		85%	85%
5CFCRD.xxxx-03 CompactFlash cards		8 to 95%	8 to 95%
5MMUSB.2048-00 flash drive		10 to 90%	5 to 90%
5MMUSB.xxxx-01 flash drive		85%	85%
5MD900.USB2-01 USB media drive		20 to 80%	5 to 90%

Table 11: Overview of humidity specifications for individual components

The specifications listed correspond to the relative humidity at an ambient temperature of 30°C. More detailed information about specific temperature-dependent humidity values can be found in the technical data for the individual components.

2.3 Power management

2.3.1 Supply voltage block diagram

The following block diagram illustrates the simplified structure of the APC810 supply voltage for system units.

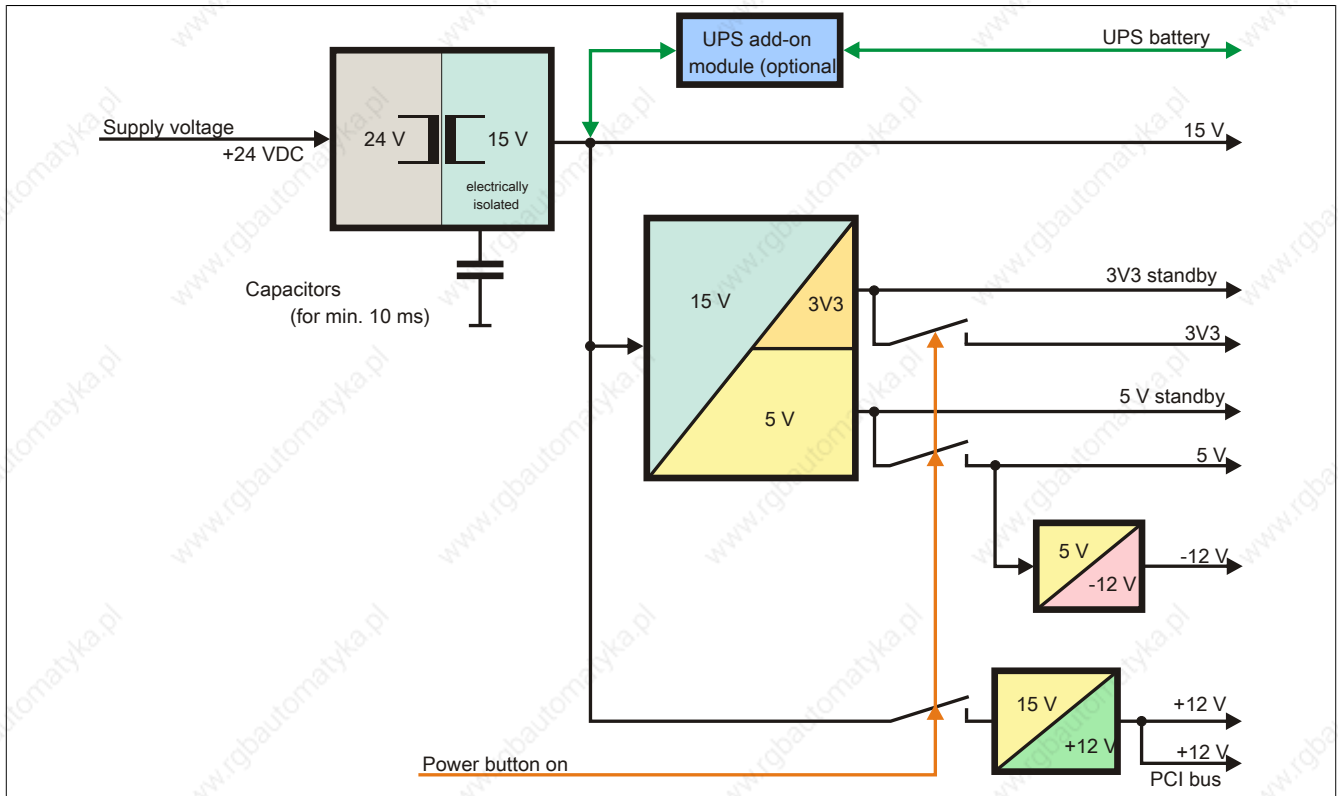

Figure 4: Supply voltage for system units

Description

15 V is generated from the supply voltage using a DC-to-DC converter. This electrically isolated 15 V supplies additional DC-to-DC converters that generate the remaining voltage.

After the system is turned on (e.g. using the power button), the 3V3 and 5 V voltages are applied to the bus. At the 5 V output, another DC-to-DC converter generates -12 V and applies this to the bus. An additional DC-to-DC converter generates +12 V.

The optional add-on UPS (with battery unit) is supplied with 15 V and provides an uninterrupted power supply of the 15 V bus during a power failure.

2.3.2 Power calculation with 5PC810.SX01-00 revision < D0

Information:		CPU board						Current system
		5PC800.B945-00 5PC800.B945-10	5PC800.B945-01 5PC800.B945-11	5PC800.B945-02 5PC800.B945-12	5PC800.B945-03 5PC800.B945-13	5PC800.B945-04 5PC800.B945-14	5PC800.B945-05	
All values in watts The values for the suppliers are maximum values. The values for the consumers are average maximum values, but not peak values.								Enter values in this column
		Total power supply power (maximum)						130
		Maximum possible at +12V						75
+12 V	Add-on UPS module, optional	7.5	7.5	7.5	7.5	7.5		
	CPU board, permanent consumers	26	30	18	14	43	11	
	512 MB RAM, max. 2 with 1.5 W each							
	1024 MB RAM, max. 2 with 2.5 W each							
	2048 MB RAM, max. 2 with 3 W each							
	Fan kit, optional	1.8	1.8	1.8	1.8	1.8	1.8	
	External consumers, optional (via mainboard)	10	10	10	10	10	10	
	PCI card limit, optional (max. 3 W without fan kit, max. 6 W with fan kit) ¹⁾							
PCIe x1 card limit, optional (max. 3 W without fan kit, max. 20 W with fan kit) ¹⁾								
		Consumers +12 V ∑						
		Maximum possible at +5V						65
+5 V	System unit, permanent consumers	4	4	4	4	4	4	
	Hard disk (slide-in compact)	4	4	4	4	4	4	
	USB peripherals USB2 and USB4 with 2.5 W each							
	USB peripherals USB1, USB3 and USB5 with 5 W each							
	Interface option (add-on interface), optional	0.5	0.5	0.5	0.5	0.5	0.5	
	External consumers, optional (via mainboard)	5	5	5	5	5	5	
PCI card limit, optional (max. 3 W without fan kit, max. 20 W with fan kit) ¹⁾								
		Maximum possible at -12V						1.2
-12 V	PCI card limit, optional (max. 1.2 W with or without fan kit) ¹⁾							
			Consumers -12 V ∑					
		Consumers +5 V ∑						
		Maximum possible at 3V3						40
3V3	System unit, permanent consumers	4	4	4	4	4	4	
	CompactFlash, 1 W each							
	Interface option (add-on interface), optional	0.25	0.25	0.25	0.25	0.25	0.25	
	PCI card limit, optional (max. 3 W without fan kit, max. 15 W with fan kit) ¹⁾							
	PCIe x1 card limit, optional (max. 3 W without fan kit, max. 10 W with fan kit) ¹⁾							
		Consumers 3V3 ∑						
		Consumers ∑						

1) The total performance of one PCI/PCIe card per PCI slot (= sum of the power consumption for each voltage range) may not exceed the limits stated for operation with or without a fan kit.

Table 12: 1-slot APC variant - Power calculation table

2.3.3 Power calculation with 5PC810.SX01-00 revision < D0

Information:		CPU board						Current system
		5PC800.B945-00 5PC800.B945-10	5PC800.B945-01 5PC800.B945-11	5PC800.B945-02 5PC800.B945-12	5PC800.B945-03 5PC800.B945-13	5PC800.B945-04 5PC800.B945-14	5PC800.B945-05	
All values in watts The values for the suppliers are maximum values. The values for the consumers are average maximum values, but not peak values.								Enter values in this column
		Total power supply power (maximum)						85
		Maximum possible at +12V						75
+12 V	Add-on UPS module, optional	7.5	7.5	7.5	7.5	7.5		
	CPU board, permanent consumers	26	30	18	14	43	11	
	512 MB RAM, max. 2 with 1.5 W each							
	1024 MB RAM, max. 2 with 2.5 W each							
	2048 MB RAM, max. 2 with 3 W each							
	Fan kit, optional	1.8	1.8	1.8	1.8	1.8	1.8	
	External consumers, optional (via mainboard)	10	10	10	10	10	10	
	PCI card limit, optional (max. 3 W without fan kit, max. 6 W with fan kit) ¹⁾							
	PCIe x1 card limit, optional (max. 3 W without fan kit, max. 20 W with fan kit) ¹⁾							
	Consumers +12 V ∑							
		Maximum possible at +5V						65
+5 V	System unit, permanent consumers	4	4	4	4	4	4	
	Hard disk (slide-in compact)	4	4	4	4	4	4	
	USB peripherals USB2 and USB4 with 2.5 W each							
	USB peripherals USB1, USB3 and USB5 with 5 W each							
	Interface option (add-on interface), optional	0.5	0.5	0.5	0.5	0.5	0.5	
	External consumers, optional (via mainboard)	5	5	5	5	5	5	
PCI card limit, optional (max. 3 W without fan kit, max. 20 W with fan kit) ¹⁾								
Maximum possible at -12V							1.2	
-12 V	PCI card limit, optional (max. 1.2 W with or without fan kit) ¹⁾							
Consumers -12 V ∑								
Consumers +5 V ∑								
		Maximum possible at 3V3						40
3V3	System unit, permanent consumers	4	4	4	4	4	4	
	CompactFlash, 1 W each							
	Interface option (add-on interface), optional	0.25	0.25	0.25	0.25	0.25	0.25	
	PCI card limit, optional (max. 3 W without fan kit, max. 15 W with fan kit) ¹⁾							
	PCIe x1 card limit, optional (max. 3 W without fan kit, max. 10 W with fan kit) ¹⁾							
Consumers 3V3 ∑								
Consumers ∑								

1) The total performance of one PCI/PCIe card per PCI slot (= sum of the power consumption for each voltage range) may not exceed the limits stated for operation with or without a fan kit.

Table 13: 1-slot APC variant - Power calculation table

2.3.4 Power calculation with 5PC810.SX02-00 revision < D0

Information:		CPU board						Current system
		5PC800.B945-00 5PC800.B945-10	5PC800.B945-01 5PC800.B945-11	5PC800.B945-02 5PC800.B945-12	5PC800.B945-03 5PC800.B945-13	5PC800.B945-04 5PC800.B945-14	5PC800.B945-05	
All values in watts The values for the suppliers are maximum values. The values for the consumers are average maximum values, but not peak values.								Enter values in this column
		Total power supply power (maximum)						130
		Maximum possible at +12V						75
+12 V	Add-on UPS module, optional	7.5	7.5	7.5	7.5	7.5		
	CPU board, permanent consumers	26	30	18	14	43	11	
	512 MB RAM, max. 2 with 1.5 W each							
	1024 MB RAM, max. 2 with 2.5 W each							
	2048 MB RAM, max. 2 with 3 W each							
	Fan kit, optional	1.8	1.8	1.8	1.8	1.8	1.8	
	External consumers, optional (via mainboard)	10	10	10	10	10	10	
	PCI card limit, optional (max. 3 W without fan kit, max. 6 W with fan kit) ¹⁾							
PCIe x1 card limit, optional (max. 3 W without fan kit, max. 20 W with fan kit) ¹⁾								
		Consumers +12 V ∑						
		Maximum possible at +5V						65
+5 V	System unit, permanent consumers	4	4	4	4	4	4	
	Hard disk (slide-in compact)	4	4	4	4	4	4	
	Slide-in drive (hard disk, DVD-ROM, etc.)	4	4	4	4	4	4	
	USB peripherals USB2 and USB4 with 2.5 W each							
	USB peripherals USB1, USB3 and USB5 with 5 W each							
	Interface option (add-on interface), optional	0.5	0.5	0.5	0.5	0.5	0.5	
	Graphics adapter (AP Link), optional	5	5	5	5	5	5	
	External consumers, optional (via mainboard)	5	5	5	5	5	5	
PCI card limit, optional (max. 3 W without fan kit, max. 20 W with fan kit) ¹⁾								
		Maximum possible at -12V						1.2
-12 V	PCI card limit, optional (max. 1.2 W with or without fan kit) ¹⁾							
			Consumers -12 V ∑					
		Consumers +5 V ∑						
		Maximum possible at 3V3						40
3V3	System unit, permanent consumers	4	4	4	4	4	4	
	CompactFlash, 1 W each							
	Interface option (add-on interface), optional	0.25	0.25	0.25	0.25	0.25	0.25	
	Graphics adapter (AP Link), optional	1.5	1.5	1.5	1.5	1.5	1.5	
	PCI card limit, optional (max. 3 W without fan kit, max. 15 W with fan kit) ¹⁾							
	PCIe x1 card limit, optional (max. 3 W without fan kit, max. 10 W with fan kit) ¹⁾							
		Consumers 3V3 ∑						
		Consumers ∑						

1) The total performance of one PCI/PCIe card per PCI slot (= sum of the power consumption for each voltage range) may not exceed the limits stated for operation with or without a fan kit.

Table 14: 2-slot APC variant - Power calculation table

2.3.5 Power calculation with 5PC810.SX02-00 revision < D0

Information:		CPU board						Current system
		5PC800.B945-00 5PC800.B945-10	5PC800.B945-01 5PC800.B945-11	5PC800.B945-02 5PC800.B945-12	5PC800.B945-03 5PC800.B945-13	5PC800.B945-04 5PC800.B945-14	5PC800.B945-05	
All values in watts The values for the suppliers are maximum values. The values for the consumers are average maximum values, but not peak values.								Enter values in this column
		Total power supply power (maximum)						85
		Maximum possible at +12V						75
+12 V	Add-on UPS module, optional	7.5	7.5	7.5	7.5	7.5	7.5	
	CPU board, permanent consumers	26	30	18	14	43	11	
	512 MB RAM, max. 2 with 1.5 W each							
	1024 MB RAM, max. 2 with 2.5 W each							
	2048 MB RAM, max. 2 with 3 W each							
	Fan kit, optional	1.8	1.8	1.8	1.8	1.8	1.8	
	External consumers, optional (via mainboard)	10	10	10	10	10	10	
	PCI card limit, optional (max. 3 W without fan kit, max. 6 W with fan kit) ¹⁾							
PCIe x1 card limit, optional (max. 3 W without fan kit, max. 20 W with fan kit) ¹⁾								
		Consumers +12 V ∑						
		Maximum possible at +5V						65
+5 V	System unit, permanent consumers	4	4	4	4	4	4	
	Hard disk (slide-in compact)	4	4	4	4	4	4	
	Slide-in drive (hard disk, DVD-ROM, etc.)	4	4	4	4	4	4	
	USB peripherals USB2 and USB4 with 2.5 W each							
	USB peripherals USB1, USB3 and USB5 with 5 W each							
	Interface option (add-on interface), optional	0.5	0.5	0.5	0.5	0.5	0.5	
	Graphics adapter (AP Link), optional	5	5	5	5	5	5	
	External consumers, optional (via mainboard)	5	5	5	5	5	5	
PCI card limit, optional (max. 3 W without fan kit, max. 20 W with fan kit) ¹⁾								
		Maximum possible at -12V						1.2
-12 V	PCI card limit, optional (max. 1.2 W with or without fan kit) ¹⁾							
		Consumers -12 V ∑						
		Consumers +5 V ∑						
		Maximum possible at 3V3						40
3V3	System unit, permanent consumers	4	4	4	4	4	4	
	CompactFlash, 1 W each							
	Interface option (add-on interface), optional	0.25	0.25	0.25	0.25	0.25	0.25	
	Graphics adapter (AP Link), optional	1.5	1.5	1.5	1.5	1.5	1.5	
	PCI card limit, optional (max. 3 W without fan kit, max. 15 W with fan kit) ¹⁾							
	PCIe x1 card limit, optional (max. 3 W without fan kit, max. 10 W with fan kit) ¹⁾							
		Consumers 3V3 ∑						
		Consumers ∑						

1) The total performance of one PCI/PCIe card per PCI slot (= sum of the power consumption for each voltage range) may not exceed the limits stated for operation with or without a fan kit.

Table 15: 2-slot APC variant - Power calculation table

2.3.6 Power calculation with 5PC810.SX03-00

Information:		CPU board						Current system
		5PC800.B945-00 5PC800.B945-10	5PC800.B945-01 5PC800.B945-11	5PC800.B945-02 5PC800.B945-12	5PC800.B945-03 5PC800.B945-13	5PC800.B945-04 5PC800.B945-14	5PC800.B945-05	
All values in watts The values for the suppliers are maximum values. The values for the consumers are average maximum values, but not peak values.								Enter values in this column
		Total power supply power (maximum)						130
		Maximum possible at +12V						75
+12 V	Add-on UPS module, optional	7.5	7.5	7.5	7.5	7.5	7.5	
	CPU board, permanent consumers	26	30	18	14	43	11	
	512 MB RAM, max. 2 with 1.5 W each							
	1024 MB RAM, max. 2 with 2.5 W each							
	2048 MB RAM, max. 2 with 3 W each							
	Fan kit, optional	3.7	3.7	3.7	3.7	3.7	3.7	
	External consumers, optional (via mainboard)	10	10	10	10	10	10	
	PCI card limit, optional (max. 3 W without fan kit, max. 6 W with fan kit) ¹⁾							
PCIe x1 card limit, optional (max. 3 W without fan kit, max. 20 W with fan kit) ¹⁾								
		Consumers +12 V ∑						
		Maximum possible at +5V						65
+5 V	System unit, permanent consumers	4	4	4	4	4	4	
	Hard disk (slide-in compact)	4	4	4	4	4	4	
	Slide-in drive (hard disk, DVD-ROM, etc.)	4	4	4	4	4	4	
	USB peripherals USB2 and USB4 with 2.5 W each							
	USB peripherals USB1, USB3 and USB5 with 5 W each							
	Interface option (add-on interface), optional	0.5	0.5	0.5	0.5	0.5	0.5	
	Graphics adapter (AP Link), optional	5	5	5	5	5	5	
	External consumers, optional (via mainboard)	5	5	5	5	5	5	
PCI card limit, optional (max. 3 W without fan kit, max. 20 W with fan kit) ¹⁾								
		Maximum possible at -12V						1.2
-12 V	PCI card limit, optional (max. 1.2 W with or without fan kit) ¹⁾							
			Consumers -12 V ∑					
		Consumers +5 V ∑						
		Maximum possible at 3V3						40
3V3	System unit, permanent consumers	4	4	4	4	4	4	
	CompactFlash, 1 W each							
	Interface option (add-on interface), optional	0.25	0.25	0.25	0.25	0.25	0.25	
	Graphics adapter (AP Link), optional	1.5	1.5	1.5	1.5	1.5	1.5	
	PCI card limit, optional (max. 3 W without fan kit, max. 15 W with fan kit) ¹⁾							
	PCIe x1 card limit, optional (max. 3 W without fan kit, max. 10 W with fan kit) ¹⁾							
		Consumers 3V3 ∑						
		Consumers ∑						

1) The total performance of one PCI/PCIe card per PCI slot (= sum of the power consumption for each voltage range) may not exceed the limits stated for operation with or without a fan kit.

Table 16: 3-slot APC variant - Power calculation table

2.3.7 Power calculation with 5PC810.SX05-00

Information:		CPU board						Current system
		5PC800.B945-00 5PC800.B945-10	5PC800.B945-01 5PC800.B945-11	5PC800.B945-02 5PC800.B945-12	5PC800.B945-03 5PC800.B945-13	5PC800.B945-04 5PC800.B945-14	5PC800.B945-05	
All values in watts The values for the suppliers are maximum values. The values for the consumers are average maximum values, but not peak values.								Enter values in this column
		Total power supply power (maximum)						130
		Maximum possible at +12V						75
+12 V	Add-on UPS module, optional	7.5	7.5	7.5	7.5	7.5	7.5	
	CPU board, permanent consumers	26	30	18	14	43	11	
	512 MB RAM, max. 2 with 1.5 W each							
	1024 MB RAM, max. 2 with 2.5 W each							
	2048 MB RAM, max. 2 with 3 W each							
	Fan kit, optional	2.8	2.8	2.8	2.8	2.8	2.8	
	External consumers, optional (via mainboard)	10	10	10	10	10	10	
	PCI card limit, optional (max. 3 W without fan kit, max. 6 W with fan kit) ¹⁾							
	PCIe x1 card limit, optional (max. 3 W without fan kit, max. 20 W with fan kit) ¹⁾							
	Consumers +12 V ∑							
		Maximum possible at +5V						65
+5 V	System unit, permanent consumers	4	4	4	4	4	4	
	Hard disk (slide-in compact)	4	4	4	4	4	4	
	Slide-in drive (hard disk, DVD-ROM, etc.)	4	4	4	4	4	4	
	USB peripherals USB2 and USB4 with 2.5 W each							
	USB peripherals USB1, USB3 and USB5 with 5 W each							
	Interface option (add-on interface), optional	0.5	0.5	0.5	0.5	0.5	0.5	
	Graphics adapter (AP Link), optional	5	5	5	5	5	5	
	External consumers, optional (via mainboard)	5	5	5	5	5	5	
	PCI card limit, optional (max. 3 W without fan kit, max. 20 W with fan kit) ¹⁾							
	Consumers +5 V ∑							
		Maximum possible at -12V						1.2
-12 V	PCI card limit, optional (max. 1.2 W with or without fan kit) ¹⁾							
Consumers -12 V ∑								
		Maximum possible at 3V3						40
3V3	System unit, permanent consumers	4	4	4	4	4	4	
	CompactFlash, 1 W each							
	Interface option (add-on interface), optional	0.25	0.25	0.25	0.25	0.25	0.25	
	Graphics adapter (AP Link), optional	1.5	1.5	1.5	1.5	1.5	1.5	
	PCI card limit, optional (max. 3 W without fan kit, max. 15 W with fan kit) ¹⁾							
	PCIe x1 card limit, optional (max. 3 W without fan kit, max. 10 W with fan kit) ¹⁾							
Consumers 3V3 ∑								
Consumers ∑								

¹⁾ The total performance of one PCI/PCIe card per PCI slot (= sum of the power consumption for each voltage range) may not exceed the limits stated for operation with or without a fan kit.

Table 17: 5-slot APC variant - Power calculation table

2.4 Serial number sticker

A unique serial number sticker with a barcode (Code 128) is affixed to each B&R device for identification purposes. This serial number represents all of the individual components built into the system (model number, name, revision, serial number, delivery date and duration of warranty).



Figure 5: Serial number sticker (front)

A sticker with detailed information about the installed components can also be found on the back of the mounting plate.

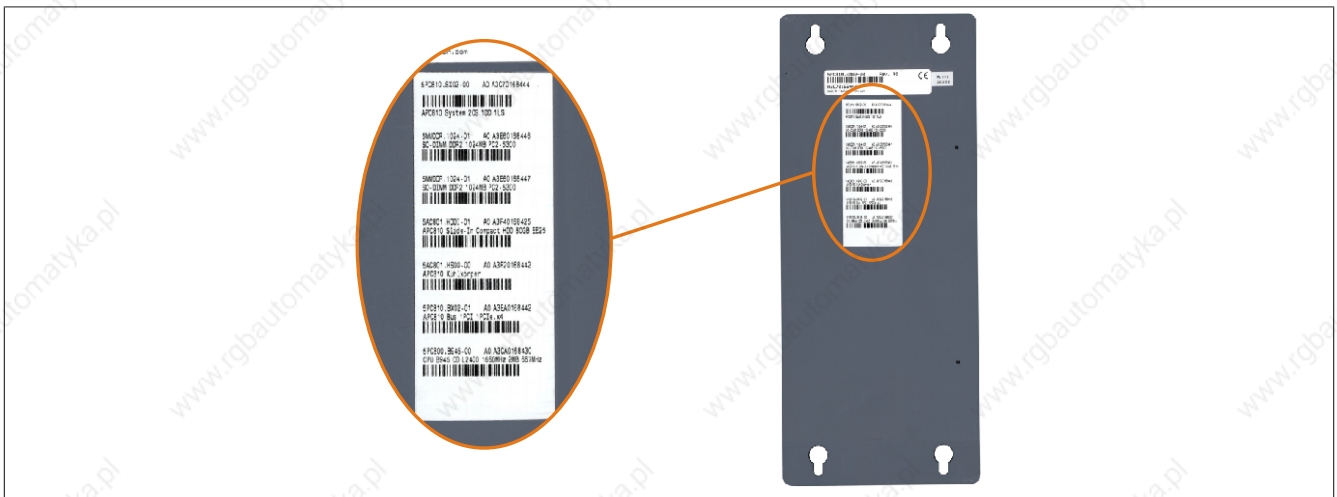

Figure 6: Serial number sticker (back)

This information can also be found on the B&R website by entering the serial number of the complete system in the search field tab (after selecting the "Serial number" option) at the top of the homepage www.br-automation.com. The search provides a detailed list of the installed components.

The screenshot shows the B&R website interface. At the top, there is a search bar with the serial number "A3C70168444" entered. Below the search bar, there are tabs for "Website", "Materialnummer", and "Serialnummer". The "Serialnummer" tab is selected. On the left side, there is a navigation menu with "Produkte" selected. The main content area shows the search results for the serial number "A3C70168444". The results include a table with columns: SERIAL, MATERIAL, REVISION, LIEFERUNG, and GEWÄHRLEISTUNGSENDE. The table lists several components, including Automation PC 810, 5PC810.SX02-00, 5MMDDR.1024-01, 5AC801.HDDI-01, 5AC801.HS00-00, 5PC810.BX02-01, and 5PC800.B945-00.

Serial number entered here
e.g. A3C70168444

Switching to the option
"Serial number"

List of installed
components shown after
searching for a serial number

SERIAL	MATERIAL	REVISION	LIEFERUNG	GEWÄHRLEISTUNGSENDE
A3C70168444	5PC810.SX02-00	A0	*NV	*N/A
A3E60168446	5MMDDR.1024-01	A0	*NV	*N/A
A3E60168447	5MMDDR.1024-01	A0	*NV	*N/A
A3F40168425	5AC801.HDDI-01	A0	*NV	*N/A
A3F20168442	5AC801.HS00-00	A0	*NV	*N/A
A3EA0168442	5PC810.BX02-01	A0	*NV	*N/A
A3CA0168430	5PC800.B945-00	A0	*NV	*N/A

Figure 7: A3C70168444 - Example of serial number search

2.5 Block diagrams

The following block diagrams show the simplified structure of system units with a CPU board in relation to the various bus units.

2.5.1 System unit 5PC810.SX01-00 and bus unit 5PC810.BX01-00

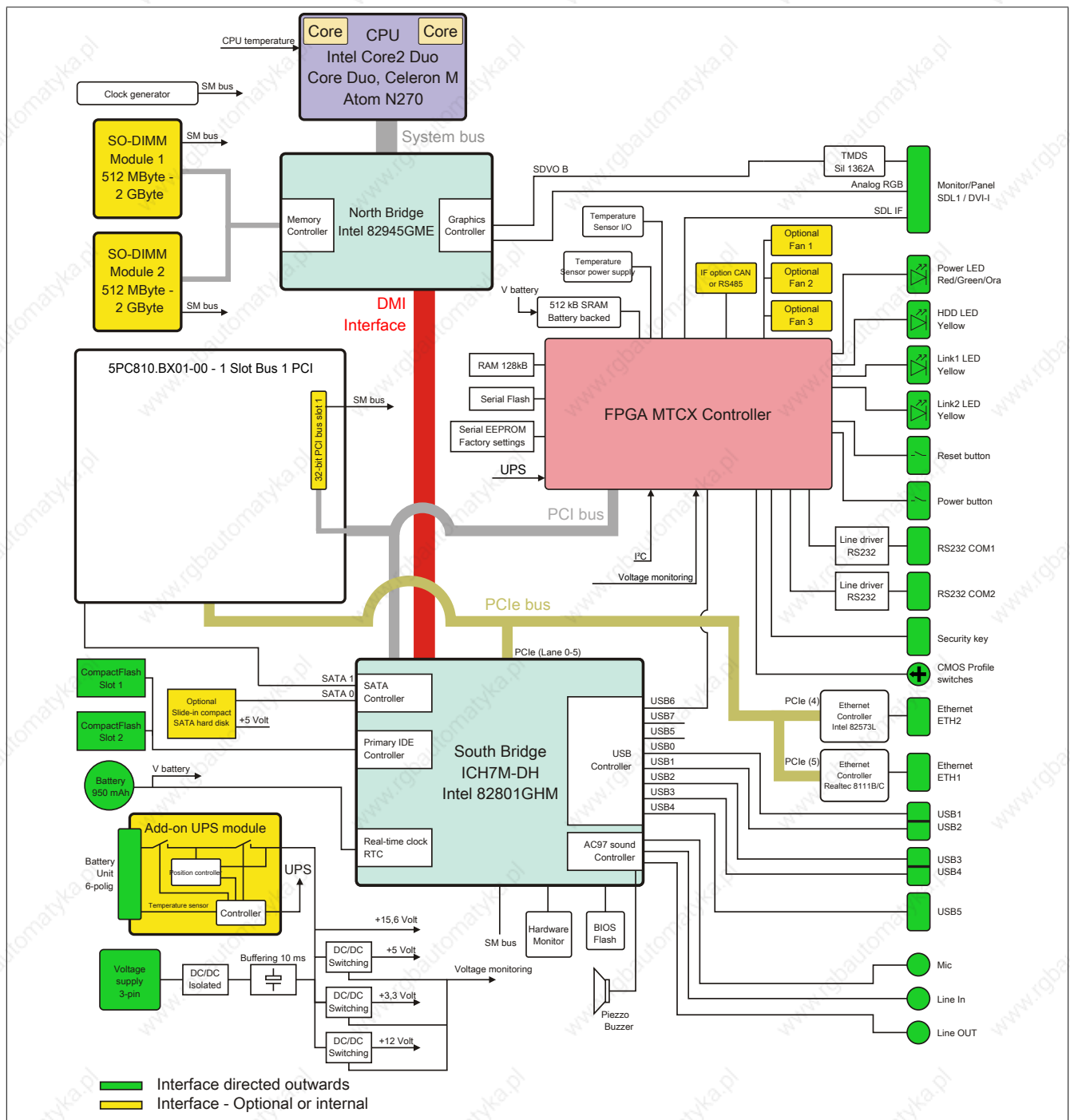

Figure 8: 5PC810.SX01-00 + 5PC810.BX01-00 - Block diagram

2.5.2 System unit 5PC810.SX01-00 and bus unit 5PC810.BX01-01

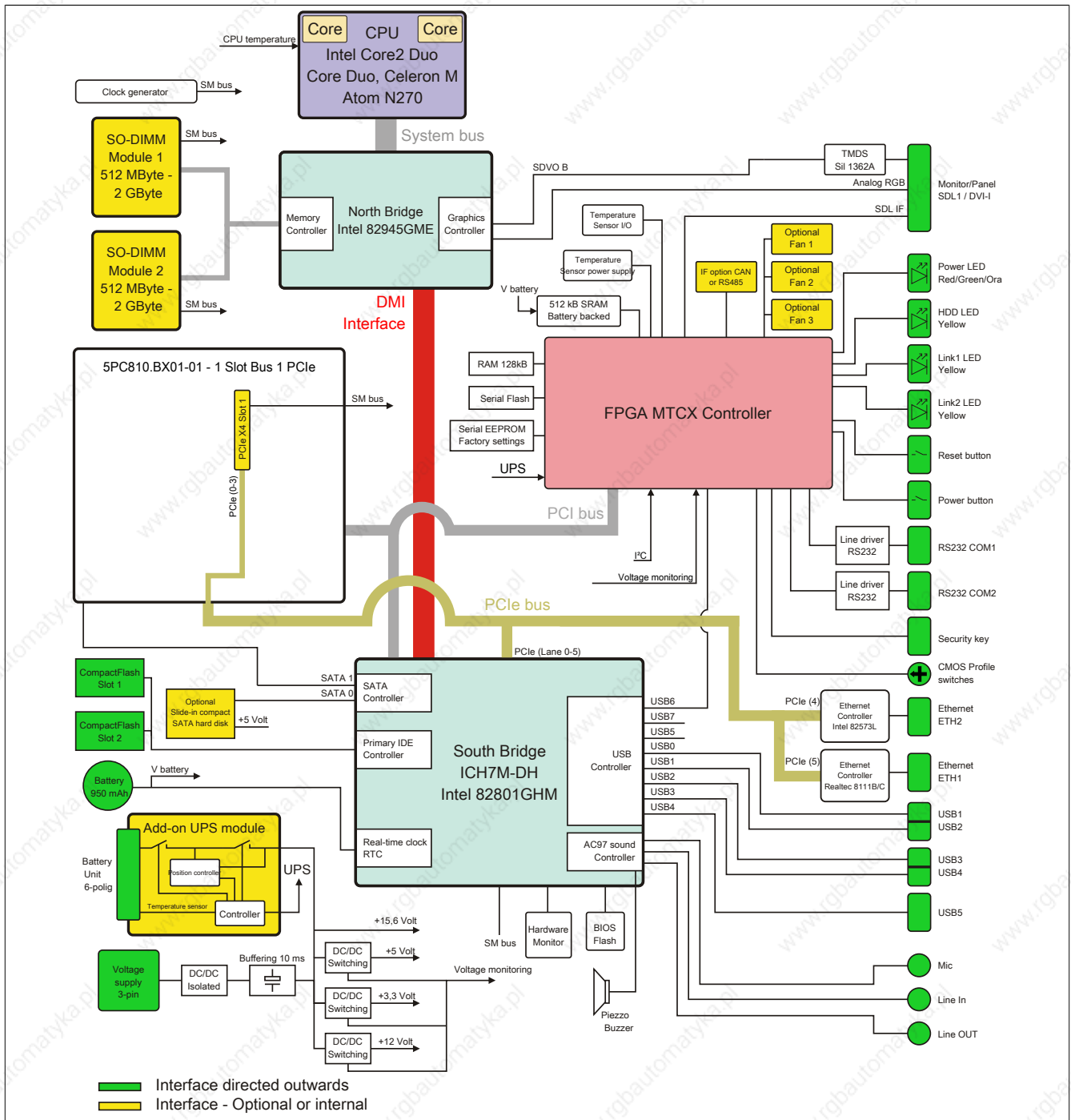

Figure 9: 5PC810.SX01-00 + 5PC810.BX01-01 - Block diagram

2.5.3 System unit 5PC810.SX02-00 and bus unit 5PC810.BX02-00

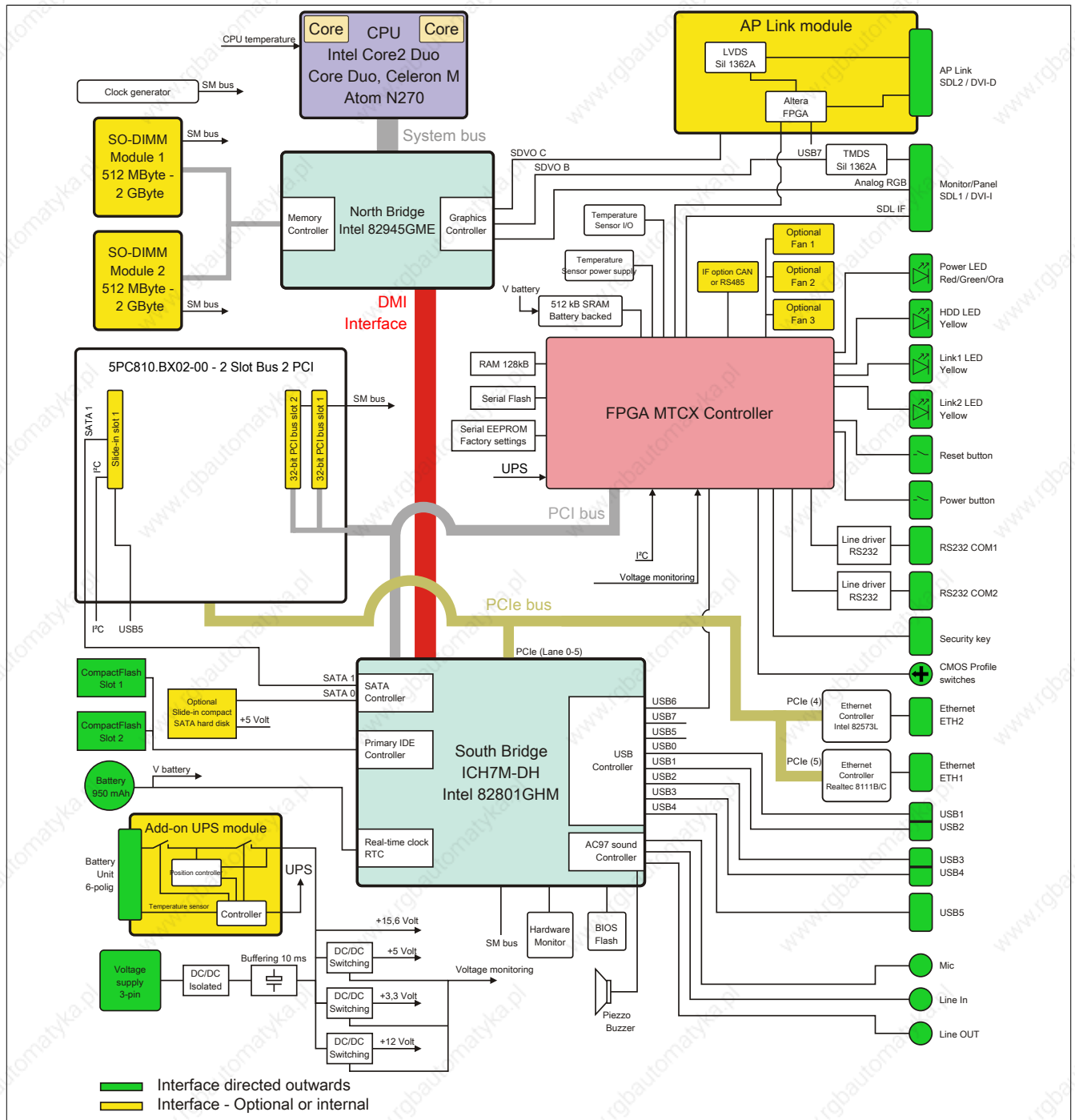

Figure 10: 5PC810.SX02-00 + 5PC810.BX02-00 - Block diagram

2.5.4 System unit 5PC810.SX02-00 and bus unit 5PC810.BX02-01

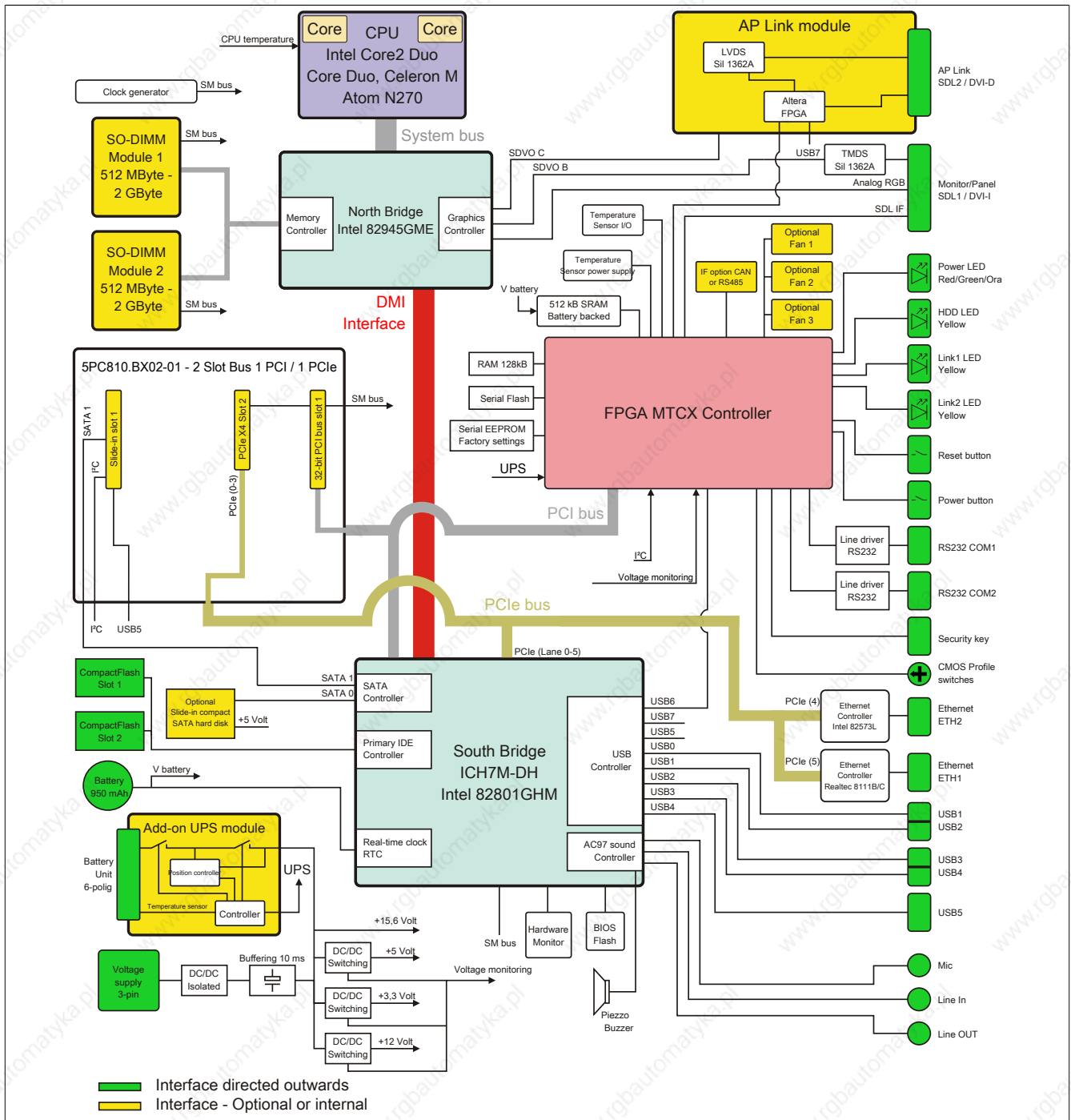

Figure 11: 5PC810.SX02-00 + 5PC810.BX02-01 - Block diagram

2.5.5 System unit 5PC810.SX03-00 and bus unit 5PC810.BX03-00

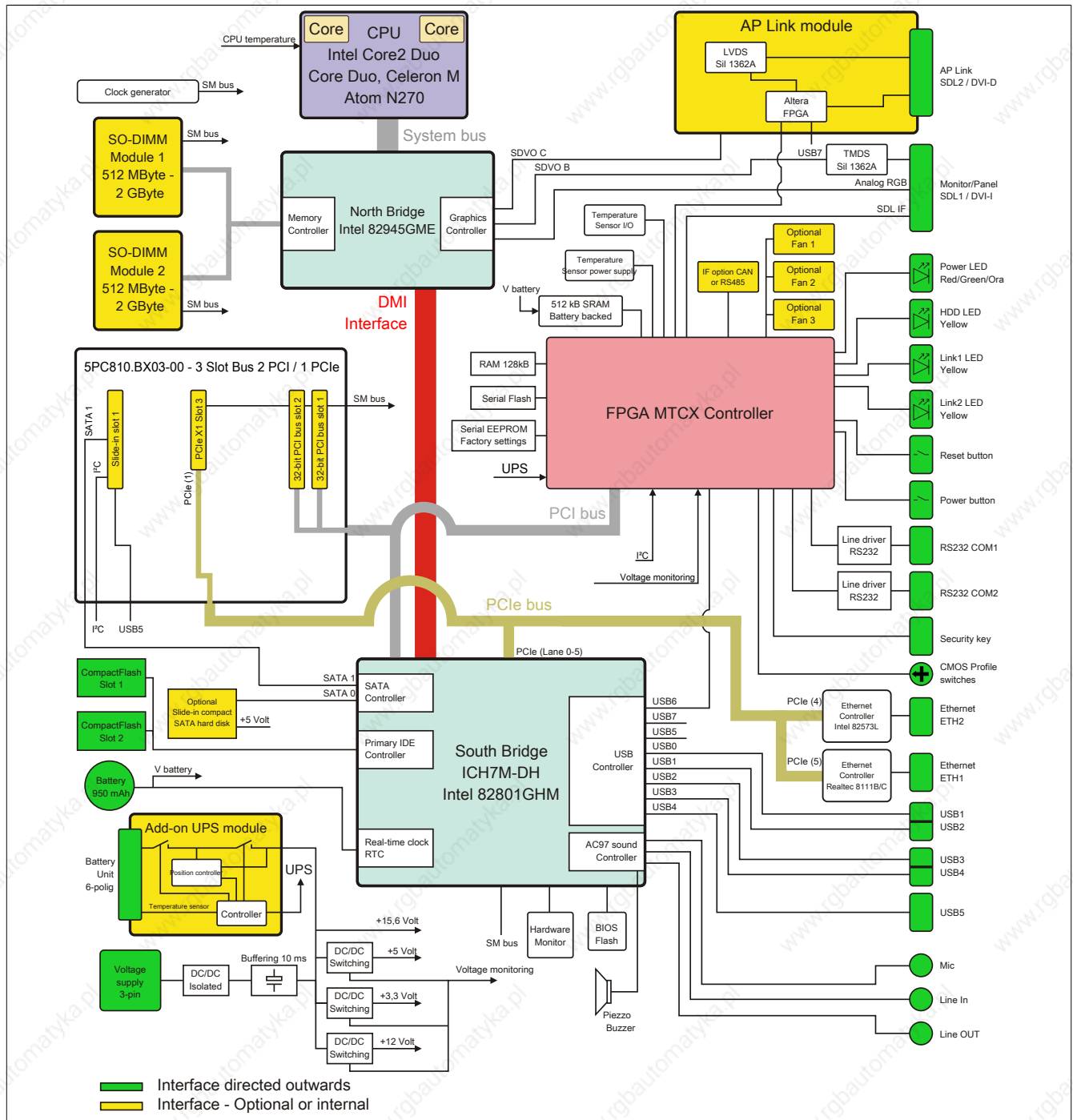

Figure 12: 5PC810.SX03-00 + 5PC810.BX03-00 - Block diagram

2.5.6 System unit 5PC810.SX05-00 and bus unit 5PC810.BX05-00

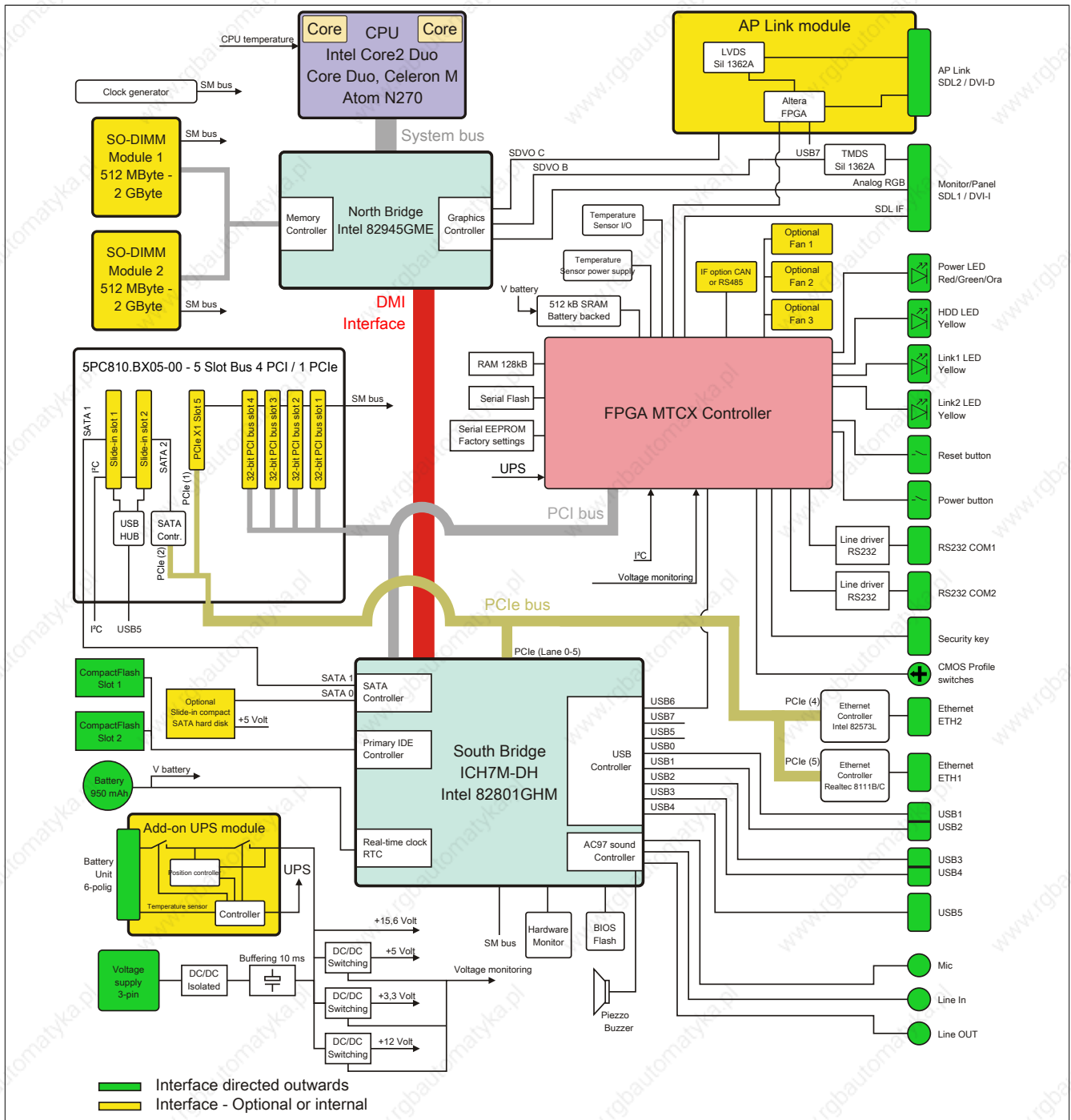

Figure 13: 5PC810.SX05-00 + 5PC810.BX05-00 - Block diagram

2.5.7 System unit 5PC810.SX05-00 and bus unit 5PC810.BX05-01

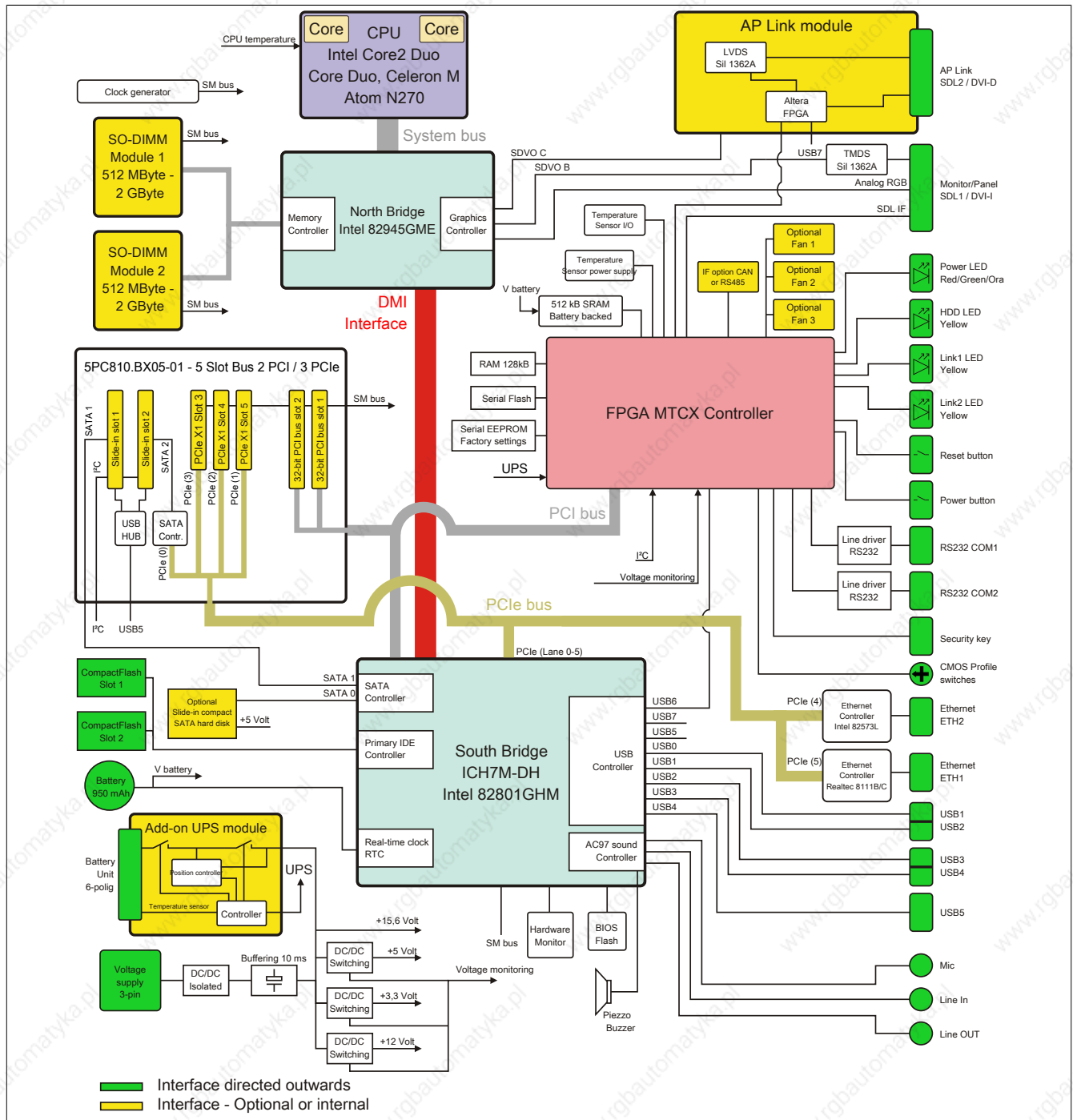

Figure 14: 5PC810.SX05-00 + 5PC810.BX05-01 - Block diagram

2.5.8 System unit 5PC810.SX05-00 and bus unit 5PC810.BX05-02

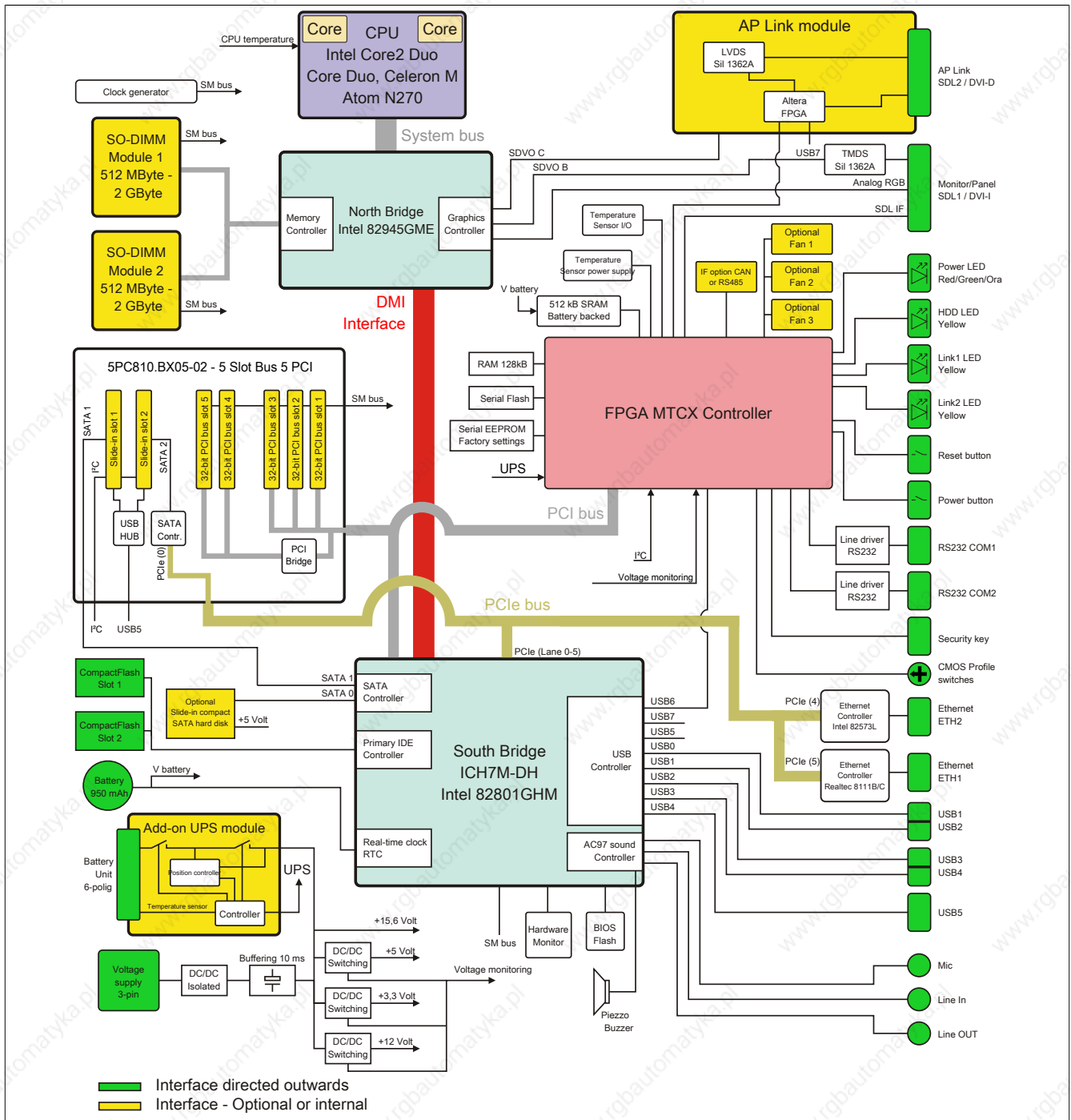

Figure 15: 5PC810.SX05-00 + 5PC810.BX05-02 - Block diagram

2.6 Device interfaces

2.6.1 +24 VDC supply voltage

The 3-pin male connector required for the supply voltage connection is not included in delivery. It can be ordered from B&R using model number 0TB103.9 (screw clamp) or 0TB103.91 (cage clamp).

The pinout is listed in the following table and printed on the APC810 housing. The supply voltage is protected internally by a soldered fuse (15 A, fast-acting) to prevent damage to the device in the event of an overload (fuse replacement necessary) or if the voltage supply is connected incorrectly (reverse polarity protection - fuse replacement not necessary). The device must be returned to B&R for repairs if the fuse is blown in the event of an error.

Supply voltage	
Protected against reverse polarity	
Pin	Description
1	-
2	Functional ground
3	+
Model number	Short description
Terminal blocks	
0TB103.9	Male connector 24 V 5.08 3-pin screw clamp
0TB103.91	Male connector 24 V 5.08 3-pin cage clamp

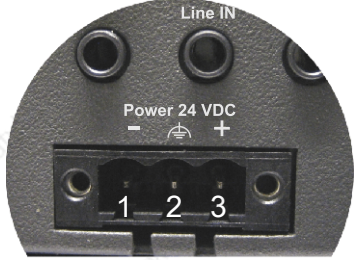

Table 18: Supply voltage connection 24 VDC

2.6.1.1 Grounding

Caution!

The functional ground (pin 2) must be connected to ground (e.g. control cabinet) using the shortest possible path. Using the largest possible conductor cross section on the supply connector is recommended.

The ground connection is located on the bottom of the APC810 system.



The M4 self-locking nut can be used, for example, to fasten a copper strip to a central grounding point in the control cabinet or system where the APC810 is installed. The largest possible conductor cross section should be used (at least 2.5 mm²).

2.6.2 COM1 serial interface

COM1 serial interface ¹⁾	
RS232	
Type	RS232, modem-capable, not electrically isolated
UART	16550-compatible, 16-byte FIFO
Transfer rate	Max. 115 kbit/s
Bus length	Max. 15 m
Pin	Assignment
1	DCD
2	RXD
3	TXD
4	DTR
5	GND
6	DSR
7	RTS
8	CTS
9	RI

9-pin male DSUB connector

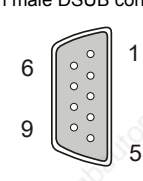

Table 19: COM1 - Pinout

1) The interfaces, etc. available on the device or module have been numbered as such for easy identification. This numbering may differ from that used by the particular operating system.

2.6.3 COM2 serial interface

COM2 serial interface ¹⁾	
RS232	
Type	RS232, modem-capable, not electrically isolated
UART	16550-compatible, 16-byte FIFO
Transfer rate	Max. 115 kbit/s
Bus length	Max. 15 m
Pin	Assignment
1	DCD
2	RXD
3	TXD
4	DTR
5	GND
6	DSR
7	RTS
8	CTS
9	RI

9-pin male DSUB connector

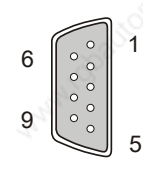

Table 20: COM2 - Pinout

1) The interfaces, etc. available on the device or module have been numbered as such for easy identification. This numbering may differ from that used by the particular operating system.

2.6.4 Monitor/Panel interface - SDL (Smart Display Link / DVI)

Monitor/Panel interface - SDL (Smart Display Link) / DVI	
The following is an overview of the video signals available on the monitor/panel output. For details, see the technical data for the CPU board being used.	
CPU board	Video signals with all system unit variants
5PC800.B945-00 = -10	RGB, DVI, SDL
5PC800.B945-01 = -11	RGB, DVI, SDL
5PC800.B945-02 = -12	RGB, DVI, SDL
5PC800.B945-03 = -13	RGB, DVI, SDL
5PC800.B945-04 = -14	RGB, DVI, SDL
5PC800.B945-05	RGB, DVI, SDL



Table 21: Monitor/Panel interface - RGB, DVI, SDL

2.6.4.1 Pinout

Pin	Assignment	Description	Pin	Assignment	Description
1	TMDS data 2-	DVI lane 2 (negative)	16	HPD	Hot plug detect
2	TMDS data 2+	DVI lane 2 (positive)	17	TMDS data 0-	DVI lane 0 (negative)
3	TMDS data 2/4 SHIELD	Shield for data pair 2 and 4	18	TMDS data 0+	DVI lane 0 (positive)
4	SDL-	SDL lane (negative)	19	TMDS Data 0/ XUSB1 SHIELD	Shield for data pair 0 and USB1
5	SDL+	SDL lane (positive)	20	XUSB1-	USB lane 1 (negative)
6	DDC clock	DDC-based control signal (clock)	21	XUSB1+	USB lane 1 (positive)
7	DDC data	DDC-based control signal (data)	22	TMDS clock shield	Shield for clock pair
8	NC	Not connected	23	TMDS clock+	DVI clock (positive)
9	TMDS data 1-	DVI lane 1 (negative)	24	TMDS clock -	DVI clock (negative)
10	TMDS DATA 1+	DVI lane 1 (negative) HDMI clock (positive)	C1	ANALOG RED	Analog red
11	TMDS DATA 1/ XUSB0 SHIELD	Shield for data pair 1 and USB0	C2	ANALOG GREEN	Analog green
12	XUSB0-	USB lane 0 (negative)	C3	ANALOG BLUE	Analog blue
13	XUSB0+	USB lane 0 (positive)	C4	ANALOG HORZ SYNC	Analog horizontal synchronization
14	+5 V power ¹⁾	+5 V power supply	C5	ANALOG GND	Analog ground (return for R, G and B signals)
15	Ground (return for +5 V, HSync and VSync)	Ground			

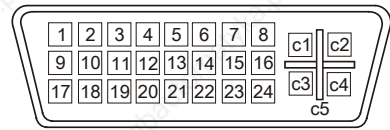

Table 22: DVI interface - Pinout

- 1) Protected internally by a multifuse.

2.6.4.2 Cable lengths and resolutions for SDL transmission

The following table lists the relationship between segment lengths and maximum resolution depending on the SDL cable being used:

SDL cables Segment length [m]	Resolution					
	VGA 640 x 480	SVGA 800 x 600	XGA 1024 x 768	SXGA 1280 x 1024	UXGA 1600 x 1200	FHD 1920 x 1080
1.8	5CASDL.0018-00	5CASDL.0018-00	5CASDL.0018-00	5CASDL.0018-00	5CASDL.0018-00	5CASDL.0018-00
	5CASDL.0018-01	5CASDL.0018-01	5CASDL.0018-01	5CASDL.0018-01	5CASDL.0018-01	5CASDL.0018-01
	5CASDL.0018-03	5CASDL.0018-03	5CASDL.0018-03	5CASDL.0018-03	5CASDL.0018-03	5CASDL.0018-03
5	5CASDL.0050-00	5CASDL.0050-00	5CASDL.0050-00	5CASDL.0050-00	5CASDL.0050-00	5CASDL.0050-00
	5CASDL.0050-01	5CASDL.0050-01	5CASDL.0050-01	5CASDL.0050-01	5CASDL.0050-01	5CASDL.0050-01
	5CASDL.0050-03	5CASDL.0050-03	5CASDL.0050-03	5CASDL.0050-03	5CASDL.0050-03	5CASDL.0050-03
10	5CASDL.0100-00	5CASDL.0100-00	5CASDL.0100-00	5CASDL.0100-00	5CASDL.0100-00	5CASDL.0100-00
	5CASDL.0100-01	5CASDL.0100-01	5CASDL.0100-01	5CASDL.0100-01	5CASDL.0100-01	5CASDL.0100-01
	5CASDL.0100-03	5CASDL.0100-03	5CASDL.0100-03	5CASDL.0100-03	5CASDL.0100-03	5CASDL.0100-03
15	5CASDL.0150-00	5CASDL.0150-00	5CASDL.0150-00	5CASDL.0150-00	-	-
	5CASDL.0150-01	5CASDL.0150-01	5CASDL.0150-01	5CASDL.0150-01	-	-
	5CASDL.0150-03	5CASDL.0150-03	5CASDL.0150-03	5CASDL.0150-03	-	5CASDL.0150-03
20	5CASDL.0200-00	5CASDL.0200-00	5CASDL.0200-00	5CASDL.0200-00	-	-
	5CASDL.0200-03	5CASDL.0200-03	5CASDL.0200-03	5CASDL.0200-03	-	5CASDL.0200-03
25	5CASDL.0250-00	5CASDL.0250-00	5CASDL.0250-00	-	-	-
	5CASDL.0250-03	5CASDL.0250-03	5CASDL.0250-03	-	-	-
30	5CASDL.0300-00	5CASDL.0300-00	-	-	-	-
	5CASDL.0300-03	5CASDL.0300-03	5CASDL.0300-13	5CASDL.0300-13	-	5CASDL.0300-13
40	5CASDL.0400-13	5CASDL.0400-13	5CASDL.0400-13	5CASDL.0400-13	-	5CASDL.0400-13

Table 23: Cable lengths and resolutions for SDL transmission

2.6.4.3 Cable lengths and resolutions for DVI transmission

The following table lists the relationship between segment lengths and maximum resolution depending on the DVI cable being used:

DVI cables Segment length [m]	Resolution					
	VGA 640 x 480	SVGA 800 x 600	XGA 1024 x 768	SXGA 1280 x 1024	UXGA 1600 x 1200	FHD 1920 x 1080
1.8	5CADVI.0018-00	5CADVI.0018-00	5CADVI.0018-00	5CADVI.0018-00	5CADVI.0018-00	5CADVI.0018-00
5	5CADVI.0050-00	5CADVI.0050-00	5CADVI.0050-00	5CADVI.0050-00	5CADVI.0050-00	5CADVI.0050-00

Table 24: Cable lengths and resolutions for DVI transmission

2.6.5 Ethernet 1 (ETH1)

This Ethernet controller is integrated in the CPU board and connected to external devices via the system unit.

Ethernet 1 connection (ETH1 ¹⁾)		
Controller	Realtek RTL8111B/C ²⁾	
Cabling	S/STP (Cat 5e)	
Transfer rate	10/100/1000 Mbit/s ³⁾	
Cable length	Max. 100 m (min. Cat 5e)	
Speed LED	On	Off
Green	100 Mbit/s	10 Mbit/s ⁴⁾
Orange	1000 Mbit/s	-
Link LED	On	Off
Orange	Link (Ethernet network connection available)	Activity (blinking - data transfer in progress)

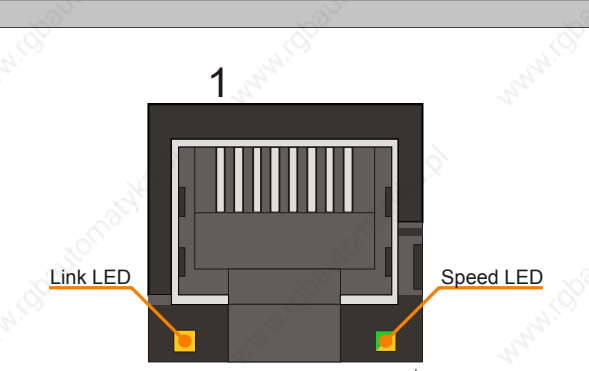

Table 25: Ethernet interface (ETH1)

- 1) The interfaces, etc. available on the device or module have been numbered as such for easy identification. This numbering may differ from that used by the particular operating system.
- 2) The Realtek 8111B is integrated in CPU boards 5PC800.B945-00, -01, -02, -03 and -04.
The Realtek 8111C is integrated in CPU boards 5PC800.B945-05 and 5PC800.B945-10, -11, -12, -13 and -14.
- 3) Switching takes place automatically.
- 4) The 10 Mbit/s transfer speed / connection only exists if the Link LED is also lit at the same time.

Important information regarding transfer speed

Due to thermal factors, operation of the ETH1 in 1000 Mbit/s mode with the CPU boards 5PC800.B945-00, -01, -02, -03 and -04 is only permitted with use of a fan kit or heat sinks (5AC801.HS00-00, 5AC801.HS00-01) for Rev. D0 and higher (see "Temperature specifications" on page 31). This limitation does not apply to CPU boards 5PC800.B945-10, -11, -12, -13 and -14 with heat sinks 5AC801.HS00-00 and 5AC801.HS00-01 or CPU board 5PC800.B945-05 with heat sink 5AC801.HS00-02.

Driver support

A special driver is required in order to operate the Realtek RTL8111B/C Ethernet controller. Drivers for approved operating systems are available in the Downloads section of the B&R website (www.br-automation.com).

Information:

Required drivers can only be downloaded from the B&R website, not from manufacturer websites.

2.6.6 Ethernet 2 (ETH2)

This Ethernet controller is integrated in the mainboard and connected to external devices via the system unit.

Ethernet 2 connection (ETH2 ¹⁾)		
Controller	Intel 82573L	
Cabling	S/STP (Cat 5e)	
Transfer rate	10/100/1000 Mbit/s ²⁾	
Cable length	Max. 100 m (min. Cat 5e)	
Speed LED	On	Off
Green	100 Mbit/s	10 Mbit/s ³⁾
Orange	1000 Mbit/s	-
Link LED	On	Off
Orange	Link (Ethernet network connection available)	Activity (blinking - data transfer in progress)

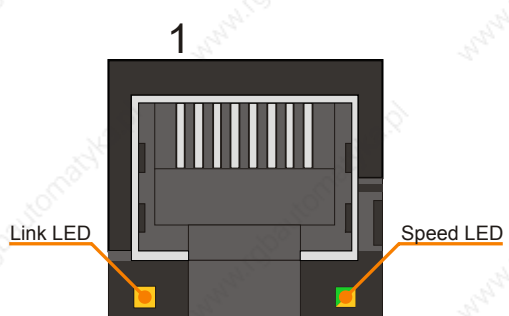

Table 26: Ethernet interface (ETH2)

- 1) The interfaces, etc. available on the device or module have been numbered as such for easy identification. This numbering may differ from that used by the particular operating system.
- 2) Switching takes place automatically.
- 3) The 10 Mbit/s transfer speed / connection only exists if the Link LED is also lit at the same time.

Driver support

A special driver is required in order to operate the Intel 82573L Ethernet controller. Drivers for approved operating systems are available in the Downloads section of the B&R website (www.br-automation.com).

Information:

Required drivers can only be downloaded from the B&R website, not from manufacturer websites.

2.6.7 USB interfaces (USB1, 2, 3, 4, 5)

The APC810 features a USB 2.0 (Universal Serial Bus) host controller with multiple USB ports, 5 of which are accessible externally for easy user access.

Warning!

Peripheral USB devices can be connected to the USB ports on this device. Due to the vast number of USB devices available on the market, B&R cannot guarantee their performance. B&R does ensure the performance of all USB devices that they provide.

Information:

For additional information, please see 3 "Installation", section "Connecting peripheral USB devices" on page 220.

Caution!

Because this interface is designed according to general PC specifications, extreme care should be exercised with regard to EMC, cable routing, etc.

USB1,2,3,4

Universal Serial Bus (USB1, USB2, USB3, USB4 ¹⁾)	
Type	USB 2.0
Design	Type A
Transfer rate	Low speed (1.5 Mbit/s), full speed (12 Mbit/s), high speed (480 Mbit/s)
Current load ²⁾ USB1, USB3 USB2, USB4	Max. 1 A Max. 500 mA
Cable length	Max. 5 m (without hub)

4 x USB type A, female

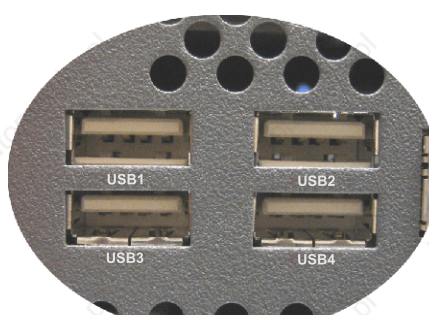

Table 27: USB1, USB2, USB3 and USB4 interfaces

- 1) The interfaces, etc. available on the device or module have been numbered as such for easy identification. This numbering may differ from that used by the particular operating system.
- 2) Each USB port is protected by a maintenance-free "USB current-limiting circuit breaker" (max. 500 mA or 1 A).

USB5

Universal Serial Bus (USB5) ¹⁾	
Type	USB 2.0
Design	Type A
Transfer rate	Low speed (1.5 Mbit/s), full speed (12 Mbit/s), high speed (480 Mbit/s)
Power supply ²⁾ USB5	Max. 1 A
Cable length	Max. 5 m (without hub)

1 x USB type A, female



Table 28: USB5 interface

- 1) The interfaces, etc. available on the device or module have been numbered as such for easy identification. This numbering may differ from that used by the particular operating system.
- 2) Each USB port is protected by a maintenance-free "USB current-limiting circuit breaker" (max. 1 A).

2.6.8 MIC, Line IN, Line OUT

All APC810 systems include an AC97-compatible sound chip (Rev 2.2) with access to MIC, Line IN and Line OUT channels from the outside.

MIC, Line IN, Line OUT		
Controller	Realtek AC97, Rev. 2.2	3.5 mm jack, female
MIC	Connection of a mono microphone with a 3.5 mm jack	
Line IN	Stereo Line IN signals supplied via a 3.5 mm jack	
Line OUT	Connection of a stereo playback device (e.g. amplifier) via a 3.5 mm jack	
		

Table 29: MIC, Line IN, Line OUT

Driver support

A special driver is required in order to operate the audio controller. Drivers for approved operating systems are available in the Downloads section of the B&R website (www.br-automation.com).

Information:

Required drivers can only be downloaded from the B&R website, not from manufacturer websites.

2.6.9 Add-on interface slot

An optional add-on interface (e.g. CAN, RS485) can be installed here. See also "Add-on interfaces (IF option)" on page 180.

Add-on interface slot	
Model number	Short description
	Serial port adapter
5AC600.CANI-00	Add-on CAN interface
5AC600.458I-00	Add-on RS232/422/458 interface
	

Table 30: Add-on interface slot

2.6.10 Add-on UPS slot

An optional Automation PC add-on UPS module or the APC810 ready relay /2 can be installed in this slot.

Add-on UPS slot	
Pinout with installed add-on UPS module	
1	+
2	+
3	-
4	-
5	NTC (for battery temperature measurement)
6	NTC (for battery temperature measurement)
Model number	Short description
Uninterruptible power supply	
5AC600.UPSI-00	Add-on UPS module
5AC600.UPSB-00	Battery unit 5 Ah
5CAUPS.0005-00	UPS cable 0.5 m
5CAUPS.0030-00	UPS cable 3 m
APC810 ready relay	
5AC801.RDYR-01	APC810 ready relay /2

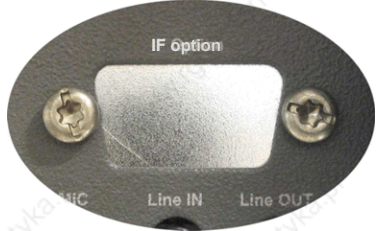
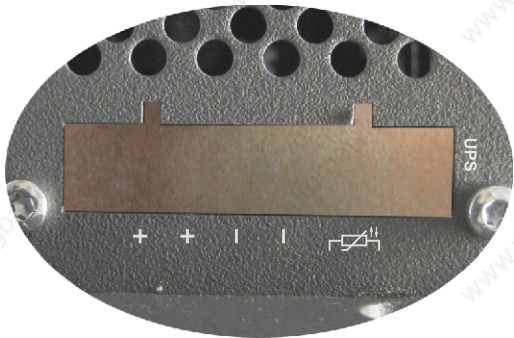



Table 31: Add-on UPS slot (with and without installed UPS)

For additional information about the UPS module, see chapter 6 "Accessories", section 361.

2.6.11 AP Link slot

When connected with the 5AC801.SDL0-00 AP Link card, it is possible to implement a second graphics line with DVI and SDL, but without RGB signals. In addition, the 5AC801.RDYR-00 ready relay can also be installed in the APC810.

Information:

AP Link cards can only be installed with system units 5PC810.SX02-00, 5PC810.SX03-00 and 5PC810.SX05-00.

2.6.12 Card slots (PCI / PCIe)

Standard PCI 2.2 half-size cards or PCI Express (PCIe) half-size cards can be installed depending on the type of bus unit. They cannot exceed the following dimensions.

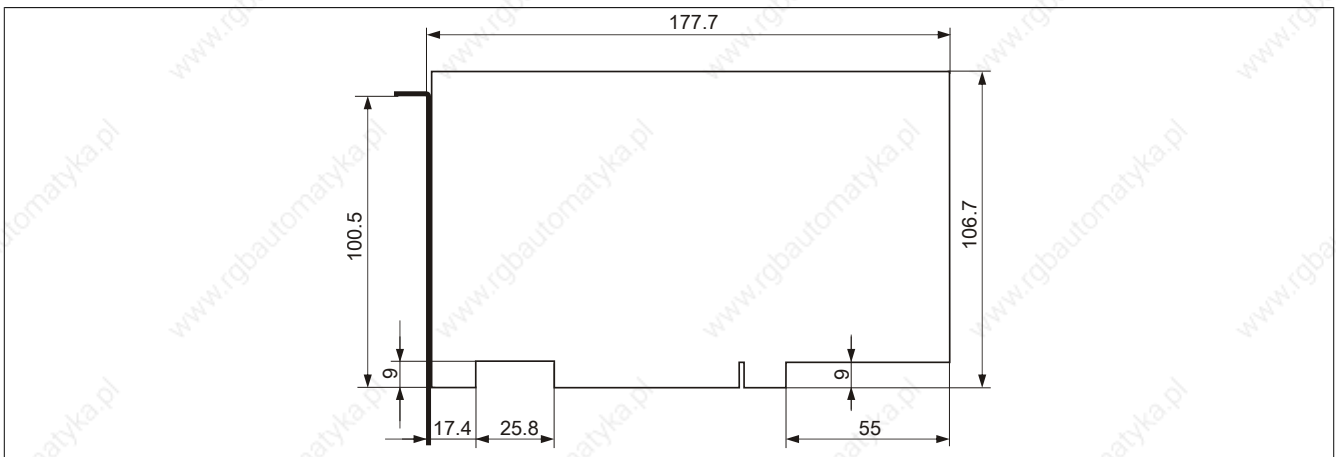

Figure 16: Standard half-size 32-bit PCI card - Dimensions

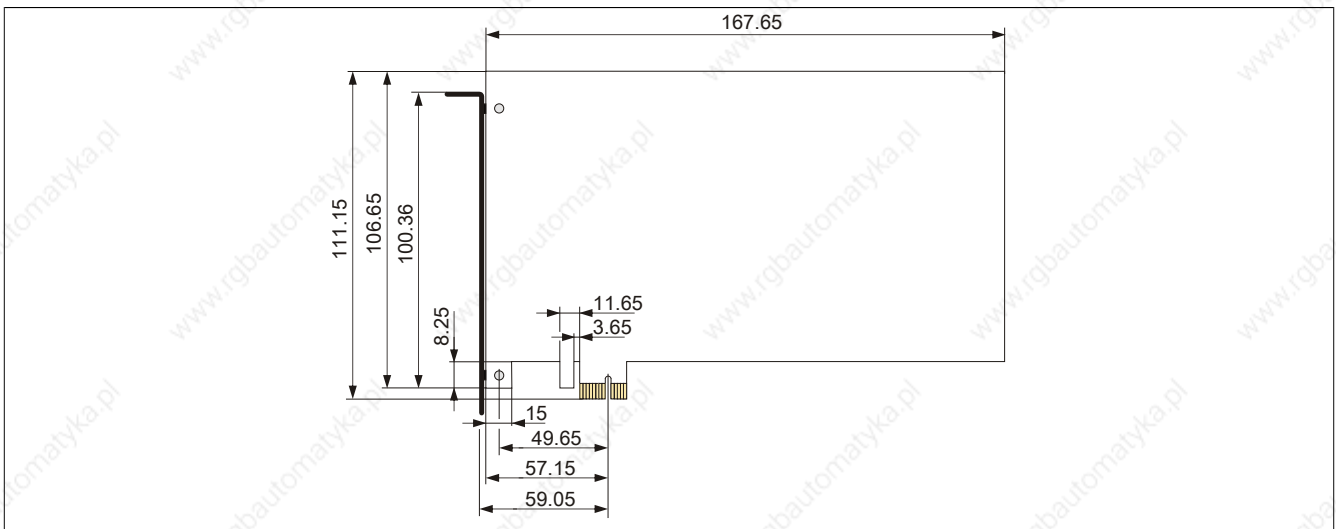
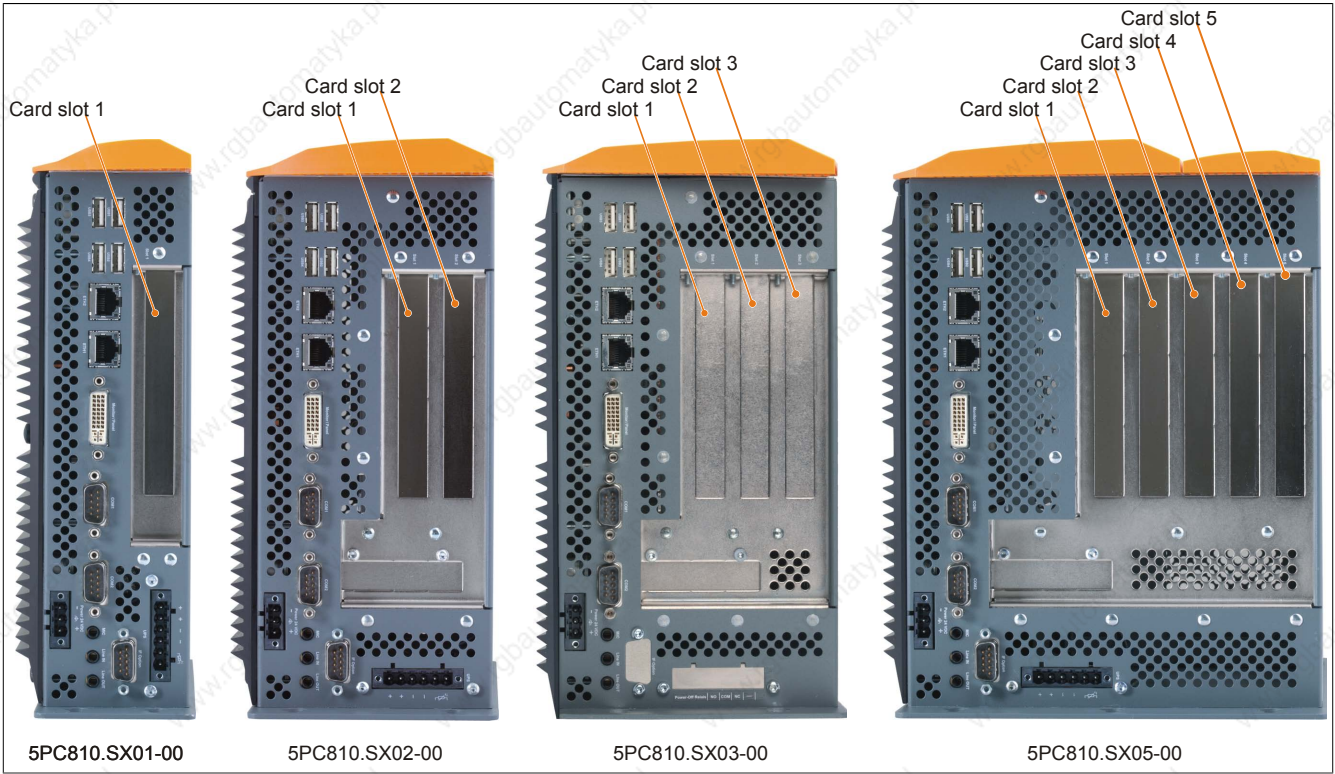

Figure 17: Standard half-size PCIe card - Dimensions

Due to mechanical limitations, a 64-bit PCI card cannot be inserted in every system unit or card slot. The following table provides an overview of the slots where 64-bit cards can be inserted.

System unit	Bus unit	Card slot 1	Card slot 2	Card slot 3	Card slot 4	Card slot 5
5PC810.SX01-00	5PC810.BX01-00	32-bit PCI				
	5PC810.BX01-01	PCIe				
5PC810.SX02-00	5PC810.BX02-00	32-bit and 64-bit PCI	32-bit PCI			
	5PC810.BX02-01	32-bit and 64-bit PCI	PCIe			
5PC810.SX03-00	5PC810.BX03-00	32-bit and 64-bit PCI	32-bit PCI	PCIe		
5PC810.SX05-00	5PC810.BX05-00	32-bit and 64-bit PCI	32-bit and 64-bit PCI	32-bit and 64-bit PCI	32-bit PCI	PCIe
	5PC810.BX05-01	32-bit and 64-bit PCI	32-bit and 64-bit PCI	PCIe	PCIe	PCIe
	5PC810.BX05-02	32-bit and 64-bit PCI	32-bit and 64-bit PCI	32-bit and 64-bit PCI	32-bit and 64-bit PCI	32-bit and 64-bit PCI

Table 32: Overview of 64-bit cards



2.6.13 LED status indicators

LED status indicators are integrated in the system unit behind the orange front cover.

LED status indicators			
LED	Color	Status	Description
Power	Green	On	Supply voltage OK
	Red	On	System in standby mode (S5: Soft-off mode, S4: Hibernation mode -suspend-to-disk or S3: Suspend-to-RAM)
	Orange ¹⁾	On	Supply voltage not OK, system operating on battery power
HDD	Yellow	On	Indicates IDE drive access (CF, HDD, CD, etc.)
Link1	Yellow	On	Indicates an active SDL connection on the male monitor/panel connector
		Blinking	Indicates that an active SDL connection has been interrupted by a loss of power to the display unit
Link2	Yellow	On	Indicates an active SDL connection on the AP Link.
		Blinking	Indicates that an active SDL connection on the AP Link has been interrupted by a loss of power to the display unit



Table 33: LED status indicators - Data

1) Only lit when an add-on UPS module is installed.

The light for the LED status indicators is fed to the front cover via fiber optic lines.



Figure 18: LED status indicators - Front

2.6.14 CMOS profile switch

CMOS profile switch	
Different BIOS default value profiles can be specified using the 16-position CMOS profile switch.	
Switch position	Description
0	Profile 0: Reserved for default profile
1	Profile 1: Optimized for system units 5PC810.SX01-00, 5PC810.SX02-00 and 5PC810.SX03-00
2	Profile 2: Optimized for 5PC810.SX05-00 system unit
3	Profile 3: Optimized for system units 5PC820.SX01-00 and 5PC820.SX01-01
4	Profile 4: Reserved
5	Profile 5: Optimized for system units 5PC820.1505-00 and 5PC820.1906-00



Table 34: CMOS profile switch

Information:

The factory default switch position represents the optimal BIOS default values for this system and should therefore not be changed.

The position of the CMOS profile switch is displayed in BIOS Setup and in the B&R ADI Control Center (among other places).

2.6.15 Power button

The power button provides a wide range of ATX power supply functions.

Power button	
<p>The power button can be pressed with a pointed object (e.g. paper clip or tip of a pen).</p> <p>The power button acts like the on/off switch on a normal desktop PC with an ATX power supply:</p> <p>Press and release ... Switches on the APC810 or shuts down the operating system and switches off the APC810</p> <p>Press and hold ... Switches off the ATX power supply without shutting down the APC810 (data could be lost!)</p> <p>Pressing the power button does not reset the MTCX processor.</p>	

Table 35: Power button

2.6.16 Reset button

Information:

With MTCX PX32 firmware \geq V00.11 and higher, the reset button is only triggered by edges. This means that the device boots even when the reset button is pressed. With MTCX PX32 firmware $<$ V00.11, the system does not start after pressing (ca. 10 seconds) and releasing the reset button.

Reset button	
<p>The reset button can be pressed with a pointed object (e.g. paper clip or tip of a pen).</p> <p>Pushing the reset button triggers a hardware and PCI reset. The APC810 is restarted (cold restart).</p> <p>Pressing the reset button does not reset the MTCX processor.</p>	

Table 36: Reset button

Warning!

A system reset can result in lost data!

2.6.17 Battery

The lithium battery (3 V, 950 mAh) buffers the internal real-time clock (RTC), individually stored BIOS settings as well as data stored in SRAM on interface cards. It is located behind the black cover on the front of the device. The battery's buffer lifespan is at least 2½ years (at 50°C, 8.5 µA for the components being supplied and a self-discharge of 40%). The battery has a limited service life and should be replaced regularly (after the specified service life at the latest).

Battery	
Battery	
Type	Renata 950 mAh
Removable	Yes, accessible from the outside
Service life	2½ years ¹⁾
Model number	Short description
	Batteries
0AC201.91	Lithium batteries, 4 pcs., 3 V, 950 mAh, button cell
4A0006.00-000	Lithium battery, 1 pc., 3 V / 950 mAh, button cell



Table 37: Battery

1) At 50°C, 8.5 µA of the supplied components and a self-discharge of 40%.

Battery status evaluation

The status of the battery is determined immediately after the device is started and subsequently checked by the system every 24 hours. During this measurement, the battery is subjected to a brief load (approximately 1 second) and then evaluated. Once determined, the battery status is displayed in BIOS (under Advanced -> OEM features -> System board features -> Voltage values) and in the B&R Control Center (ADI driver); it can also be read in a customer application using the ADI library.

Battery status	Description
N/A	The hardware or firmware being used is too old and does not support reading the battery status.
GOOD	Data buffering is intact.
BAD	From the point when battery capacity is recognized as insufficient (BAD), data buffering is intact for approximately another 500 hours.

Table 38: Battery status

From the point when battery capacity is recognized as insufficient, data buffering is intact for approximately another 500 hours. When replacing the battery, data is buffered for approximately 10 minutes by a gold leaf capacitor.

2.6.18 Hardware security key (dongle)

B&R recommends a hardware security key (dongle) based on the DS1425 from MAXIM (formerly Dallas Semiconductors) for software copy protection.

Hardware security key

A hardware security key (dongle) can be inserted behind the black cover.



Table 39: Hardware security key

Warning!

Turn off power before removing or adding the hardware security key.

2.6.19 CompactFlash slot 1

This CompactFlash slot is a fixed part of an APC810 system and internally connected with the chipset via IDE PATA. Type I CompactFlash cards are supported.

CompactFlash slot (CF1)	
Connection	PATA master
CompactFlash Type	Type I
Model number	Short description
CompactFlash	
5CFCRD.0512-06	CompactFlash 512 MB B&R
5CFCRD.1024-06	CompactFlash 1024 MB B&R
5CFCRD.2048-06	CompactFlash 2048 MB B&R
5CFCRD.4096-06	CompactFlash 4096 MB B&R
5CFCRD.8192-06	CompactFlash 8192 MB B&R
5CFCRD.016G-06	CompactFlash 16 GB B&R
5CFCRD.032G-06	CompactFlash 32 GB B&R
5CFCRD.0064-03	CompactFlash 64 MB WD
5CFCRD.0128-03	CompactFlash 128 MB WD
5CFCRD.0256-03	CompactFlash 256 MB WD
5CFCRD.0512-03	CompactFlash 512 MB WD
5CFCRD.1024-03	CompactFlash 1024 MB WD
5CFCRD.2048-03	CompactFlash 2048 MB WD
5CFCRD.4096-03	CompactFlash 4096 MB WD
5CFCRD.8192-03	CompactFlash 8192 MB WD



Table 40: CompactFlash slot (CF1)

Warning!

Power must be turned off before inserting or removing CompactFlash cards.

2.6.20 CompactFlash slot 2

This CompactFlash slot is a fixed part of an APC810 system and internally connected with the chipset via IDE PATA. Type I CompactFlash cards are supported.

CompactFlash slot (CF2)	
Connection	PATA slave
CompactFlash Type	Type I
Model number	Short description
CompactFlash	
5CFCRD.0512-06	CompactFlash 512 MB B&R
5CFCRD.1024-06	CompactFlash 1024 MB B&R
5CFCRD.2048-06	CompactFlash 2048 MB B&R
5CFCRD.4096-06	CompactFlash 4096 MB B&R
5CFCRD.8192-06	CompactFlash 8192 MB B&R
5CFCRD.016G-06	CompactFlash 16 GB B&R
5CFCRD.032G-06	CompactFlash 32 GB B&R
5CFCRD.0064-03	CompactFlash 64 MB WD
5CFCRD.0128-03	CompactFlash 128 MB WD
5CFCRD.0256-03	CompactFlash 256 MB WD
5CFCRD.0512-03	CompactFlash 512 MB WD
5CFCRD.1024-03	CompactFlash 1024 MB WD
5CFCRD.2048-03	CompactFlash 2048 MB WD
5CFCRD.4096-03	CompactFlash 4096 MB WD
5CFCRD.8192-03	CompactFlash 8192 MB WD



Table 41: CompactFlash slot (CF2)

Warning!

Power must be turned off before inserting or removing CompactFlash cards.

2.6.21 Slide-in slot 1

The internal connection between slide-in slot 1 and the chipset is made via SATA I and USB.

Slide-in slot 1	
Connection	SATA I and USB
Model number	Short description
Drives	
5AC801.ADAS-00	SATA hard disk adapter for operating a slide-in compact hard disk in a slide-in slot
5AC801.HDDS-00	40 GB SATA slide-in hard disk; 24/7 operation with extended temperature range. Note: Please see the manual for information about using this hard disk.
5AC801.DVRS-00	DVD-R/RW DVD+R/RW SATA slide-in drive
5AC801.DVDS-00	DVD-ROM SATA slide-in drive



Table 42: Slide-in slot 1

Information:

The SATA I interface allows disks to be replaced during operation (hot plugging). In order to take advantage of this capability, this feature must be supported by the operating system.

2.6.22 Slide-in slot 2

The internal connection between slide-in slot 2 and the chipset is made via a PCIe to SATA bridge (SiL 3531) and USB.

Slide-in slot 2	
Connection	PCIe to SATA Bridge (SiL 3531) and USB
Model number	Short description
Drives	
5AC801.HDDS-00	40 GB SATA slide-in hard disk; 24/7 operation with extended temperature range. Note: Please see the manual for information about using this hard disk.
5AC801.DVRS-00	DVD-R/RW DVD+R/RW SATA slide-in drive
5AC801.DVDS-00	DVD-ROM SATA slide-in drive



Table 43: Slide-in slot 2

Information:

The APC810 slide-in compact adapter 5AC801.ADAS-00 can only be inserted into slide-in slot 1 for mechanical reasons (so that the front door can be closed).

Information:

The SATA I interface allows disks to be replaced during operation (hot plugging). In order to take advantage of this capability, this feature must be supported by the operating system.

Information:

The required drivers are available for the operating system being used and can be downloaded from the B&R website.

2.6.23 Slide-in compact slot

The internal connection between the slide-in compact slot and the chipset is made via SATA I.

Slide-in compact slot	
Connection	SATA I
Model number	Short description
Drives	
5AC801.HDDI-00	40 GB SATA hard disk, slide-in compact, 24/7 operation with extended temperature range. Note: Please see the manual for information about using this hard disk.
5AC801.HDDI-03	250 GB SATA hard disk, slide-in compact, 24/7 operation. Note: Please see the manual for information about using this hard disk.
5AC801.HDDI-04	500 GB SATA hard disk, slide-in compact, 24/7 operation. Note: Please see the manual for information about using this hard disk.
5AC801.SSDI-00	32 GB SATA SSD (SLC), slide-in compact
5AC801.SSDI-01	60 GB SATA SSD (MLC), slide-in compact
5AC801.SSDI-02	180 GB SATA SSD (MLC), slide-in compact
5AC801.SSDI-03	60 GB SATA SSD (MLC), slide-in compact
5AC801.SSDI-04	128 GB SATA SSD (MLC), slide-in compact



Table 44: Slide-in compact slot

Information:

The SATA I interface allows disks to be replaced during operation (hot plugging). In order to take advantage of this capability, this feature must be supported by the operating system.

For information about installing/replacing a slide-in compact drive, see "Procedure" on page 402.

3 Individual components

3.1 System units

The system unit unites all of the individual components into one compact device. It consists of a housing and an integrated mainboard. Interfaces are easily accessible either on top of the device or behind the orange cover on the front. System units either have 1, 2, 3 or 5 card slots.

3.1.1 5PC810.SX01-00

3.1.1.1 General information

- Slot for a bus unit with 1 PCI or 1 PCIe slot
- 512 kB SRAM onboard
- Insert for 1 slide-in compact drive

3.1.1.2 Order data

Model number	Short description	Figure
	System units	
5PC810.SX01-00	APC810 system unit, 1 slot (PCI Express, PCI, depending on bus); 1 compact slide-in slot; Smart Display Link/DVI/Monitor, 2x RS232, 5x USB 2.0, 2x ETH 10/100/1000, 24 VDC (order 0TB103.9 screw clamp or 0TB103.91 cage clamp terminals separately)	
	Required accessories	
	Bus units	
5PC810.BX01-00	APC810 bus, 1 PCI	
5PC810.BX01-01	APC810 bus, 1 PCI Express (x4)	
	CPU boards	
5PC800.B945-05	Intel Atom N270 CPU board, 1.6 GHz, single core, 533 MHz FSB, 512 kB L2 cache; 945GME chipset; 2 slots for SO-DIMM DDR2 modules (max. total of 3 GB), Realtek RTL8111C Ethernet controller	
5PC800.B945-10	Intel Core2 Duo L2400 CPU board, 1.66 GHz, dual core, 667 MHz FSB, 2 MB L2 cache; 945GME chipset; 2 slots for SO-DIMM DDR2 modules (max. total of 3 GB), Realtek RTL8111C Ethernet controller	
5PC800.B945-11	Intel Core2 Duo L7400 CPU board, 1.5 GHz, dual core, 667 MHz FSB, 2 MB L2 cache; 945GME chipset; 4 slots for SO-DIMM DDR2 modules (max. total of 3 GB), Realtek RTL8111C Ethernet controller	
5PC800.B945-12	Intel Core2 Duo U7500 CPU board, 1.06 GHz, dual core, 533 MHz FSB, 2 MB L2 cache; 945GME chipset; 2 slots for SO-DIMM DDR2 modules (max. total of 3 GB), Realtek RTL8111C Ethernet controller	
5PC800.B945-13	Intel Celeron M 423 CPU board, 1.06 GHz, single core, 533 MHz FSB, 1 MB L2 cache; 945GME chipset; 2 slots for SO-DIMM DDR2 modules (max. total of 3 GB), Realtek RTL8111C Ethernet controller	
5PC800.B945-14	Intel Core2 Duo T7400 CPU board, 2.16 GHz, dual core, 667 MHz FSB, 2 MB L2 cache; 945GME chipset; 4 slots for SO-DIMM DDR2 modules (max. total of 3 GB), Realtek RTL8111C Ethernet controller	
	Terminal blocks	
0TB103.9	Connector, 24 VDC, 3-pin female, 3.31 mm ² screw clamp, protected against vibration by the screw flange	
0TB103.91	Connector, 24 VDC, 3-pin female, 3.31 mm ² cage clamp, protected against vibration by the screw flange	
	Main memory	
5MMDDR.0512-01	SO-DIMM DDR2 RAM 512 MB PC2-5300	
5MMDDR.1024-01	SO-DIMM DDR2 RAM 1024 MB PC2-5300	
5MMDDR.2048-01	SO-DIMM DDR2 RAM 2048 MB PC2-5300	
	Heat sinks	
5AC801.HS00-00	APC810 heat sink for CPU boards with L2400, L7400, U7500 or Celeron M 423 dual-core processor	
5AC801.HS00-01	APC810 heat sink for CPU boards with T7400, T9400 or P8400 dual-core processor	
5AC801.HS00-02	APC810 heat sink for CPU board with Atom processor N270	
	Optional accessories	
	Drives	

Table 45: 5PC810.SX01-00 - Order data

Model number	Short description	Figure
5AC801.HDDI-00	40 GB slide-in compact SATA hard disk, 24/7 operation with extended temperature range. Note: Please see the manual for information about using this hard disk.	
5AC801.HDDI-04	500 GB slide-in compact SATA hard disk; 24/7 operation. Note: Please see the manual for information about using this hard disk.	
5AC801.SSDI-00	32 GB SATA SSD (SLC), slide-in compact	
5AC801.SSDI-03	60 GB SATA SSD (MLC), slide-in compact	
5AC801.SSDI-04	128 GB SATA SSD (MLC), slide-in compact	
5ACPCI.RAIC-06	PCI RAID system SATA 2x 500 GB; Note: Please see the manual for information about using this hard disk.	
Fan kit		
5PC810.FA01-00	APC810 fan kit for 5PC810.SX01-00 system unit	
Serial port adapter		
5AC600.485I-00	RS232/422/485 interface, for installation in an APC620, APC810 or PPC700	
5AC600.CANI-00	CAN interface; for installation in an APC620, APC810 or PPC700	
Uninterruptible power supply		
5AC600.UPSI-00	UPS module for APC620, APC810, PPC800; for system units 5PC600.SX01-00 (starting with Rev. H0), 5PC600.SX02-00 (starting with Rev. G0), 5PC600.SX02-01 (starting with Rev. H0), 5PC600.SX05-00 (starting with Rev. F0), 5PC600.SX05-01 (starting with Rev. F0), 5PC600.SF03-00 (starting with Rev. A0), 5PC810.SX*. 5PC820.1505-00, 5PC820.1906-00. Order cable (5CAUPS.0005-00 or 5CAUPS.0030-00) and battery unit (5AC600.UPSB-00) separately	
Accessories		
5ACPCI.ETH1-01	PCI Ethernet card 1x 10/100	
5ACPCI.ETH3-01	PCI Ethernet card 3x 10/100	

Table 45: 5PC810.SX01-00 - Order data

3.1.1.3 Interfaces

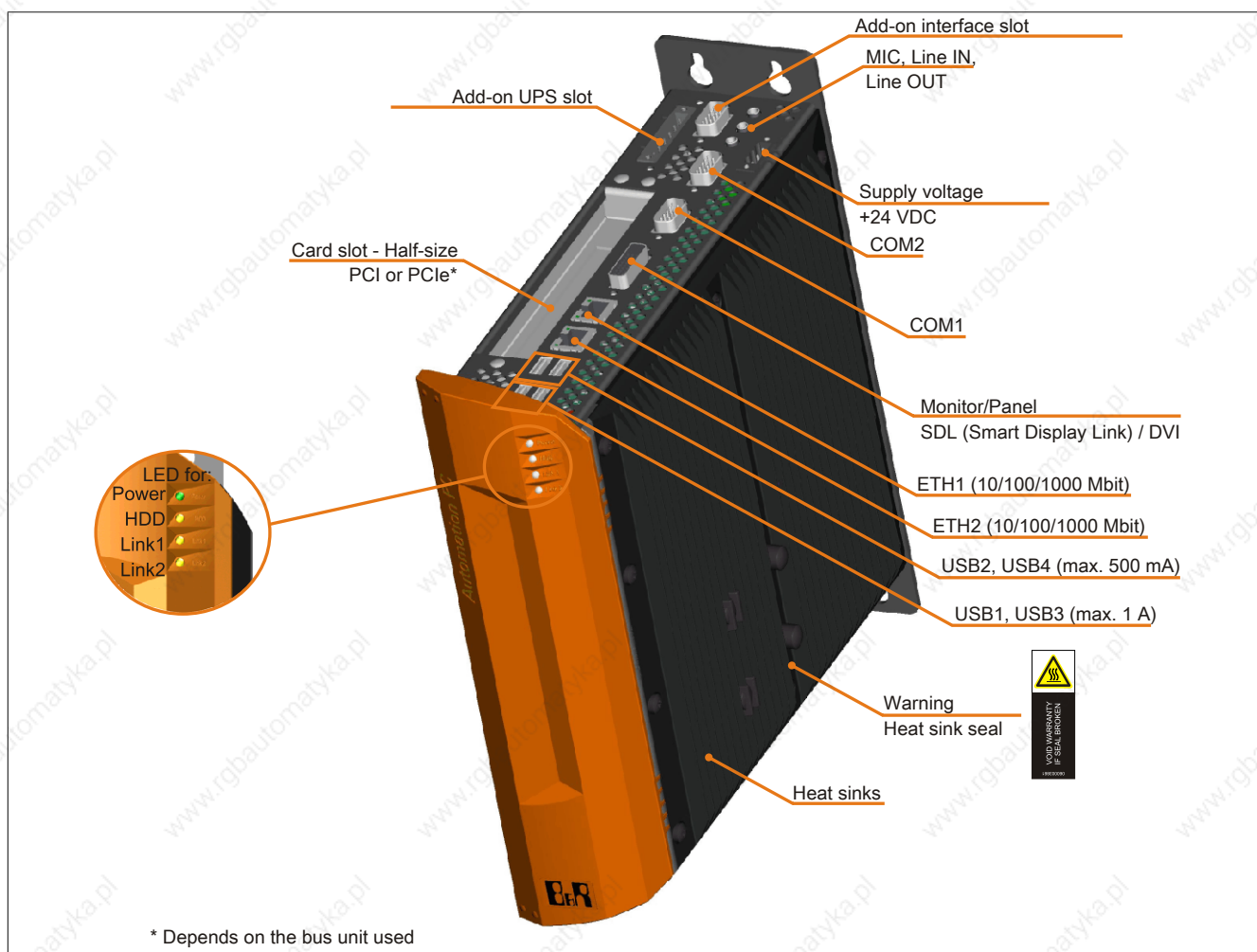

Figure 19: 5PC810.SX01-00 - Interfaces on top

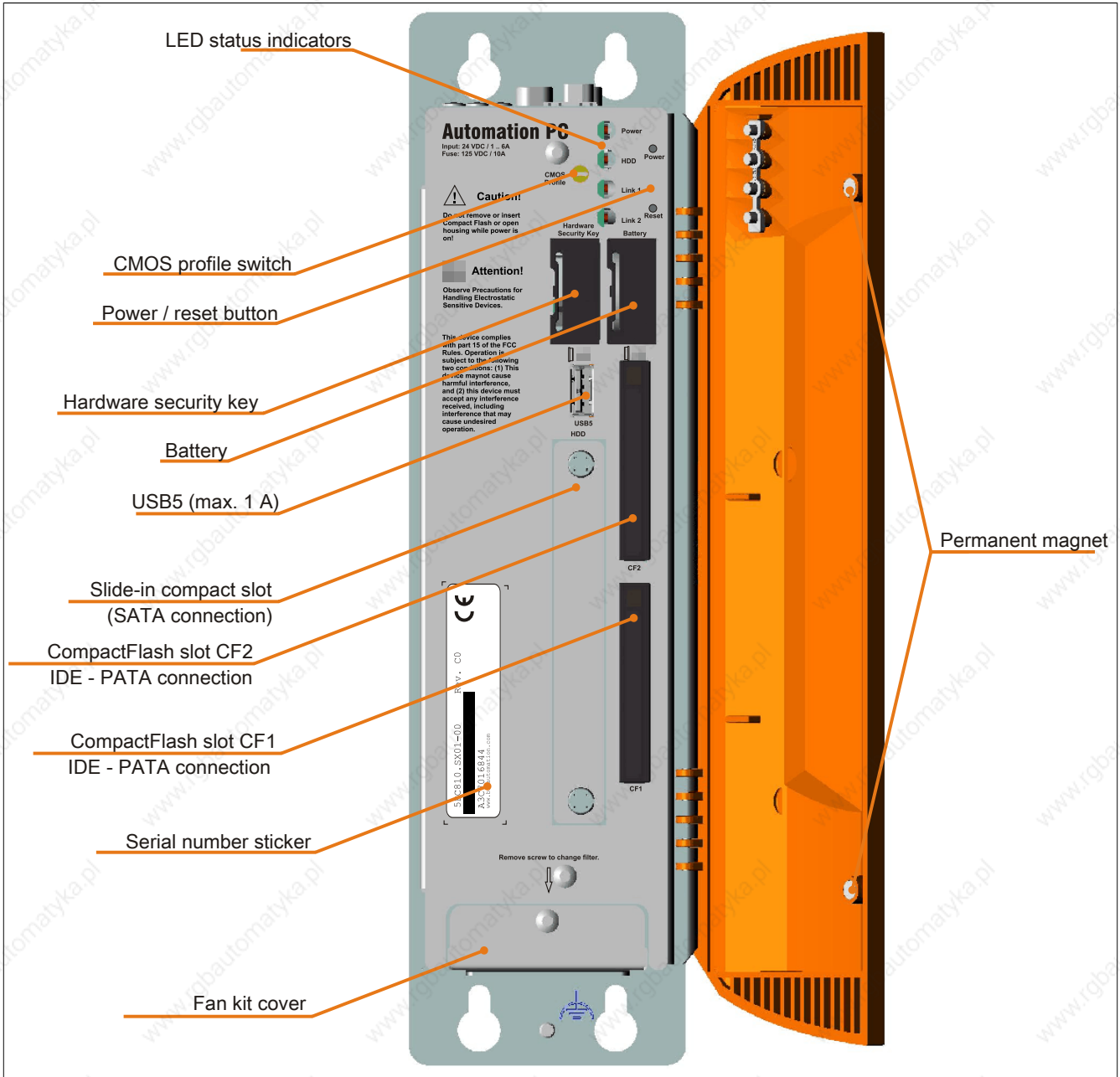

Figure 20: 5PC810.SX01-00 - Interfaces on front

3.1.1.4 Technical data

Product ID	5PC810.SX01-00
General information	
Dongle port	Yes
Cooling	Passive via heat sink and optionally supported with an active fan kit ¹⁾
LEDs	Power, HDD, Link 1, Link 2
B&R ID code	\$A3ED
Battery	
Type	Renata 950 mAh
Service life	2½ years ²⁾
Removable	Yes, accessible behind the orange front door
Design	Lithium ion
Power button	Yes
Reset button	Yes
Buzzer	Yes
Certification	
CE	Yes
cULus	Yes
cULus HazLoc Class 1 Division 2	Yes
ATEX Zone 22	Yes
GL	Yes

Table 46: 5PC810.SX01-00 - Technical data

Technical data • Individual components

Product ID	5PC810.SX01-00
Controller	
Boot loader	BIOS
Real-time clock Battery-buffered	Yes
Power failure logic Controller Buffer time	MTCX ³⁾ 10 ms
Graphics Controller	Depends on the CPU board being used
SRAM Size Battery-buffered Remanent variables in power failure mode	512 kB Yes 192 kB (e.g. for Automation Runtime, see AS help documentation)
Memory Type Size	Depends on the CPU board being used Depends on the CPU board being used
Interfaces	
COM1 Type Design UART Max. baud rate	RS232, modem-capable, not electrically isolated 9-pin male DSUB connector 16550-compatible, 16-byte FIFO 115 kbit/s
COM2 Type Design UART Max. baud rate	RS232, modem-capable, not electrically isolated 9-pin male DSUB connector 16550-compatible, 16-byte FIFO 115 kbit/s
CompactFlash slot 1 Quantity Type	1 Type I
CompactFlash slot 2 Quantity Type	1 Type I
USB Quantity Type Design Transfer rate Current load	5 USB 2.0 Type A Low speed (1.5 Mbit/s), full speed (12 Mbit/s), high speed (480 Mbit/s) Max. 500 mA or 1 A per connection
Ethernet Quantity Design Transfer rate Max. baud rate	2 Shielded RJ45 port 10/100/1000 Mbit/s 1 Gbit/s
Monitor/Panel interface Design Type	Female DVI-I connector SDL / DVI / Monitor
CAN Note	Optional
Audio Type Inputs Outputs	AC97 sound ⁴⁾ Microphone, Line IN Line OUT
Add-on interface slot Quantity	1
Inserts	
PCI / PCIe slots Quantity	1 PCI slot or 1 PCIe slot ⁵⁾
Slide-in drives	No
Slide-in compact drives	1
Automation Panel Link slot	No
Add-on UPS slot	Yes
Insert for fan kit	Yes
Electrical characteristics	
Nominal voltage	24 VDC ±25%
Nominal current	6 A
Starting current	Typ. 7 A, max. 50 A for <300 µs
Electrical isolation	Yes
Operating conditions	
Protection in accordance with EN 60529	IP20
Environmental conditions	
Temperature Operation Storage Transport	Component-dependent -20 to 60°C -20 to 60°C

Table 46: 5PC810.SX01-00 - Technical data

Product ID	5PC810.SX01-00
Relative humidity	
Operation	Component-dependent
Storage	Component-dependent
Transport	Component-dependent
Vibration ⁶⁾	
Operation (continuous)	2 to 9 Hz: 1.75 mm amplitude / 9 to 200 Hz: 0.5 g
Operation (occasional)	2 to 9 Hz: 3.5 mm amplitude / 9 to 200 Hz: 1 g
Storage	2 to 8 Hz: 7.5 mm amplitude / 8 to 200 Hz: 2 g / 200 to 500 Hz: 4 g
Transport	2 to 8 Hz: 7.5 mm amplitude / 8 to 200 Hz: 2 g / 200 to 500 Hz: 4 g
Shock ⁶⁾	
Operation	15 g, 11 ms
Storage	30 g, 15 ms
Transport	30 g, 15 ms
Altitude	
Operation	Max. 3000 m (component-dependent) ⁷⁾
Mechanical characteristics	
Housing ⁸⁾	
Material	Galvanized plate, plastic
Front cover	Colored orange plastic (similar to Pantone 144CV)
Paint	Light gray (similar to Pantone 427CV), dark gray (similar to Pantone 432CV)
Dimensions	
Width	81.3 mm with heat sink 5AC801.HS00-00 and 5AC801.HS00-02 96.5 mm with heat sink 5AC801.HS00-01
Height	270 mm
Depth	252.7 mm
Weight	Approx. 2200g (component-dependent)

Table 46: 5PC810.SX01-00 - Technical data

- 1) A fan kit is absolutely necessary for the APC810 GM45.
- 2) At 50°C, 8.5 µA of the supplied components and a self-discharge of 40%.
- 3) Maintenance Controller Extended.
- 4) No longer supported by the GM45 chipset.
- 5) The PCI and PCIe slots available depend on the 5PC810.BX01-00 and 5PC810.BX01-01 bus unit being used.
- 6) Maximum values unless specified otherwise by another individual component.
- 7) The maximum ambient temperature is typically derated by 1°C per 1000 meters (starting at 500 meters above sea level).
- 8) There may be visible deviations in the color and surface appearance depending on the process or batch.

3.1.1.5 Dimensions

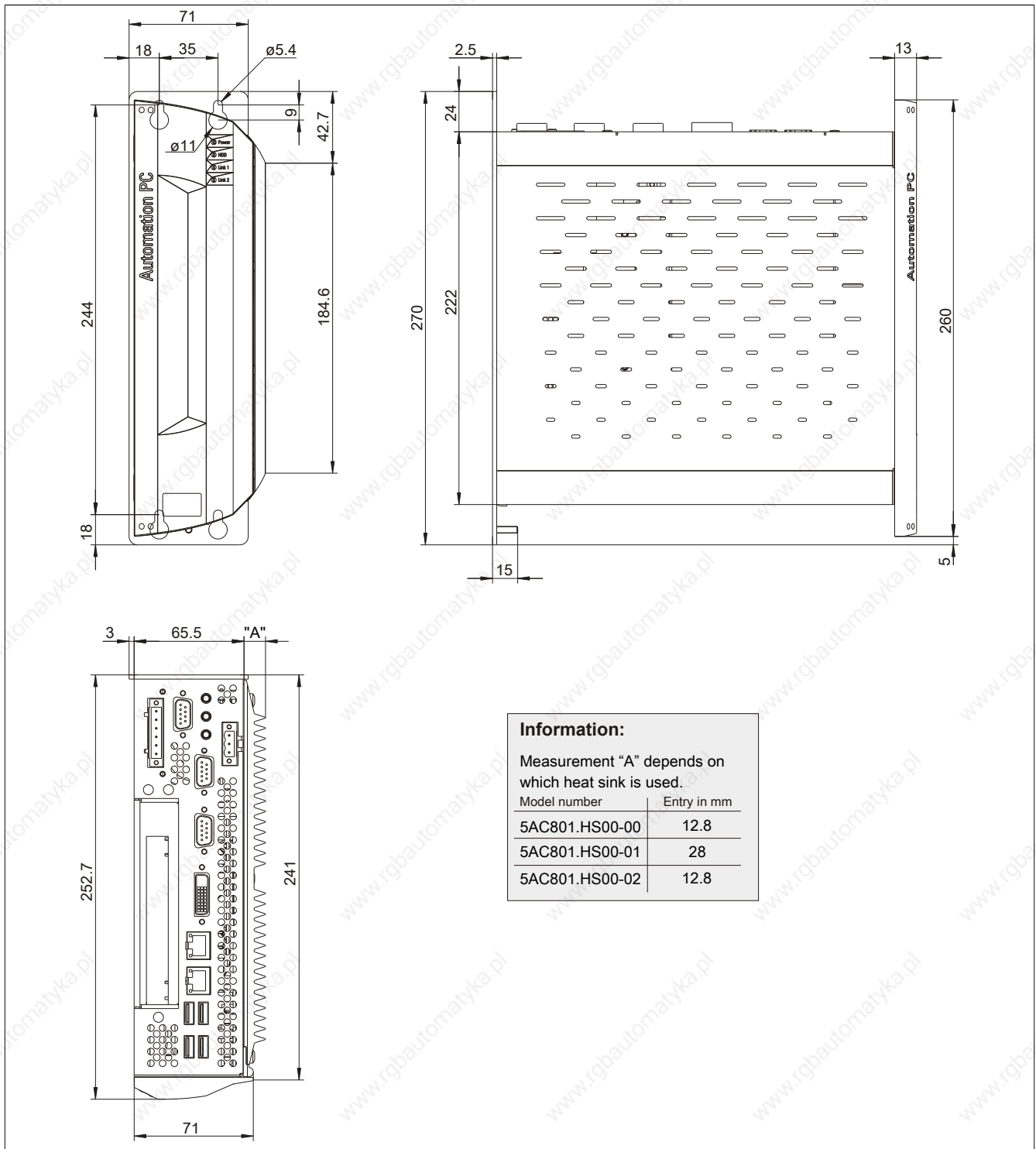

Figure 21: 5PC810.SX01-00 - Dimensions

3.1.1.6 Drilling template

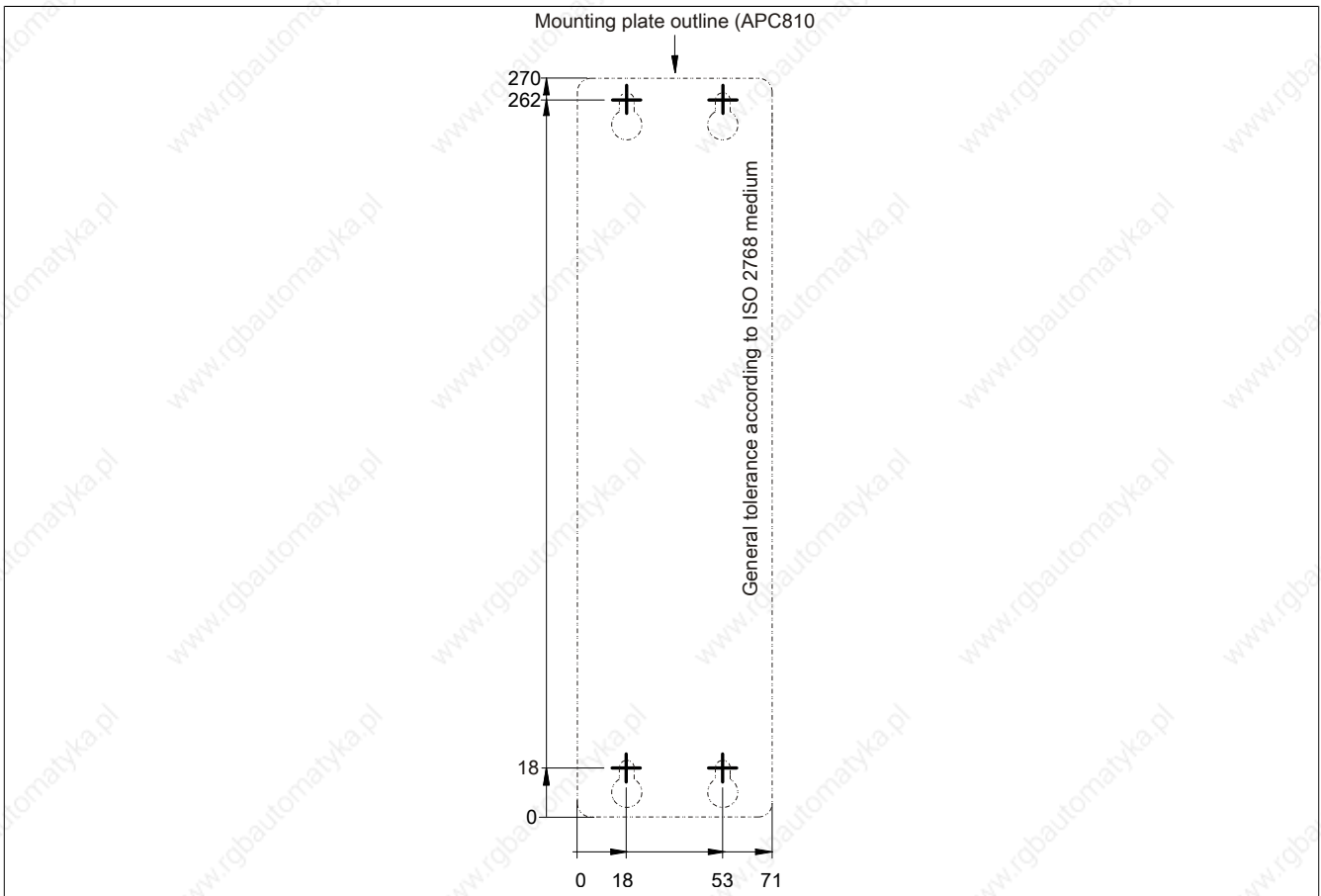

Figure 22: 5PC810.SX01-00 - Drilling template

3.1.2 5PC810.SX02-00

3.1.2.1 General information

- Slot for a bus unit with 2 PCI slots or 1 PCI and 1 PCIe slots
- 512 kB SRAM onboard
- Insert for 1 slide-in compact drive and 1 slide-in drive
- Automation Panel Link slot for connecting Automation Panels via SDL

3.1.2.2 Order data

Model number	Short description	Figure
System units		
5PC810.SX02-00	APC810 system unit, 2 slots (PCI Express, PCI, depending on bus); 1 slot for Automation Panel Link transmitter; 1 slide-in compact and 1 slide-in slot; Smart Display Link/DVI/Monitor, 2x RS232, 5x USB 2.0, 2x ETH 10/100/1000, 24 VDC (order 0TB103.9 screw clamp or 0TB103.91 cage clamp terminals separately)	
Required accessories		
Bus units		
5PC810.BX02-00	APC810 bus, 2 PCI	
5PC810.BX02-01	APC810 bus, 1 PCI, 1 PCI Express (x4)	
CPU boards		
5PC800.B945-05	Intel Atom N270 CPU board, 1.6 GHz, single core, 533 MHz FSB, 512 kB L2 cache; 945GME chipset; 2 slots for SO-DIMM DDR2 modules (max. total of 3 GB), Realtek RTL8111C Ethernet controller	
5PC800.B945-10	Intel Core Duo L2400 CPU board, 1.66 GHz, dual core, 667 MHz FSB, 2 MB L2 cache; 945GME chipset; 2 slots for SO-DIMM DDR2 modules (max. total of 3 GB), Realtek RTL8111C Ethernet controller	
5PC800.B945-11	Intel Core2 Duo L7400 CPU board, 1.5 GHz, dual core, 667 MHz FSB, 2 MB L2 cache; 945GME chipset; 4 slots for SO-DIMM DDR2 modules (max. total of 3 GB), Realtek RTL8111C Ethernet controller	
5PC800.B945-12	Intel Core2 Duo U7500 CPU board, 1.06 GHz, dual core, 533 MHz FSB, 2 MB L2 cache; 945GME chipset; 2 slots for SO-DIMM DDR2 modules (max. total of 3 GB), Realtek RTL8111C Ethernet controller	
5PC800.B945-13	Intel Celeron M 423 CPU board, 1.06 GHz, single core, 533 MHz FSB, 1 MB L2 cache; 945GME chipset; 2 slots for SO-DIMM DDR2 modules (max. total of 3 GB), Realtek RTL8111C Ethernet controller	
5PC800.B945-14	Intel Core2 Duo T7400 CPU board, 2.16 GHz, dual core, 667 MHz FSB, 2 MB L2 cache; 945GME chipset; 4 slots for SO-DIMM DDR2 modules (max. total of 3 GB), Realtek RTL8111C Ethernet controller	
Terminal blocks		
0TB103.9	Connector, 24 VDC, 3-pin female, 3.31 mm ² screw clamp, protected against vibration by the screw flange	
0TB103.91	Connector, 24 VDC, 3-pin female, 3.31 mm ² cage clamp, protected against vibration by the screw flange	
Main memory		
5MMDDR.0512-01	SO-DIMM DDR2 RAM 512 MB PC2-5300	
5MMDDR.1024-01	SO-DIMM DDR2 RAM 1024 MB PC2-5300	
5MMDDR.2048-01	SO-DIMM DDR2 RAM 2048 MB PC2-5300	
Heat sinks		
5AC801.HS00-00	APC810 heat sink for CPU boards with L2400, L7400, U7500 or Celeron M 423 dual-core processor	
5AC801.HS00-01	APC810 heat sink for CPU boards with T7400, T9400 or P8400 dual-core processor	
5AC801.HS00-02	APC810 heat sink for CPU board with Atom processor N270	
Optional accessories		
Automation Panel Link insert cards		
5AC801.RDYR-00	APC810 ready relay	
5AC801.SDL0-00	Smart Display Link/DVI-D transmitter	
Drives		
5AC801.ADAS-00	SATA hard disk adapter for operating a slide-in compact hard disk in a slide-in slot	
5AC801.DVDS-00	DVD-ROM SATA slide-in drive	
5AC801.DVRS-00	DVD-R/RW DVD+R/RW SATA drive, slide-in	
5AC801.HDDI-00	40 GB slide-in compact SATA hard disk, 24/7 operation with extended temperature range. Note: Please see the manual for information about using this hard disk.	

Table 47: 5PC810.SX02-00 - Order data

Model number	Short description	Figure
5AC801.HDDI-04	500 GB slide-in compact SATA hard disk; 24/7 operation. Note: Please see the manual for information about using this hard disk.	
5AC801.HDDS-00	40 GB slide-in SATA hard disk; 24/7 operation with extended temperature range. Note: Please see the manual for information about using this hard disk.	
5AC801.SSDI-00	32 GB SATA SSD (SLC), slide-in compact	
5AC801.SSDI-03	60 GB SATA SSD (MLC), slide-in compact	
5AC801.SSDI-04	128 GB SATA SSD (MLC), slide-in compact	
5ACPCI.RAIC-06	PCI RAID system SATA 2x 500 GB; Note: Please see the manual for information about using this hard disk.	
Fan kit		
5PC810.FA02-01	APC810 fan kit for 5PC810.SX02-00 (revisions > D0)	
Serial port adapter		
5AC600.485I-00	RS232/422/485 interface, for installation in an APC620, APC810 or PPC700	
5AC600.CANI-00	CAN interface; for installation in an APC620, APC810 or PPC700	
Uninterruptible power supply		
5AC600.UPSI-00	UPS module for APC620, APC810, PPC800; for system units 5PC600.SX01-00 (starting with Rev. H0), 5PC600.SX02-00 (starting with Rev. G0), 5PC600.SX02-01 (starting with Rev. H0), 5PC600.SX05-00 (starting with Rev. F0), 5PC600.SX05-01 (starting with Rev. F0), 5PC600.SF03-00 (starting with Rev. A0), 5PC810.SX*. 5PC820.1505-00, 5PC820.1906-00. Order cable (5CAUPS.0005-00 or 5CAUPS.0030-00) and battery unit (5AC600.UPSB-00) separately	
Accessories		
5ACPCI.ETH1-01	PCI Ethernet card 1x 10/100	
5ACPCI.ETH3-01	PCI Ethernet card 3x 10/100	

Table 47: 5PC810.SX02-00 - Order data

3.1.2.3 Interfaces

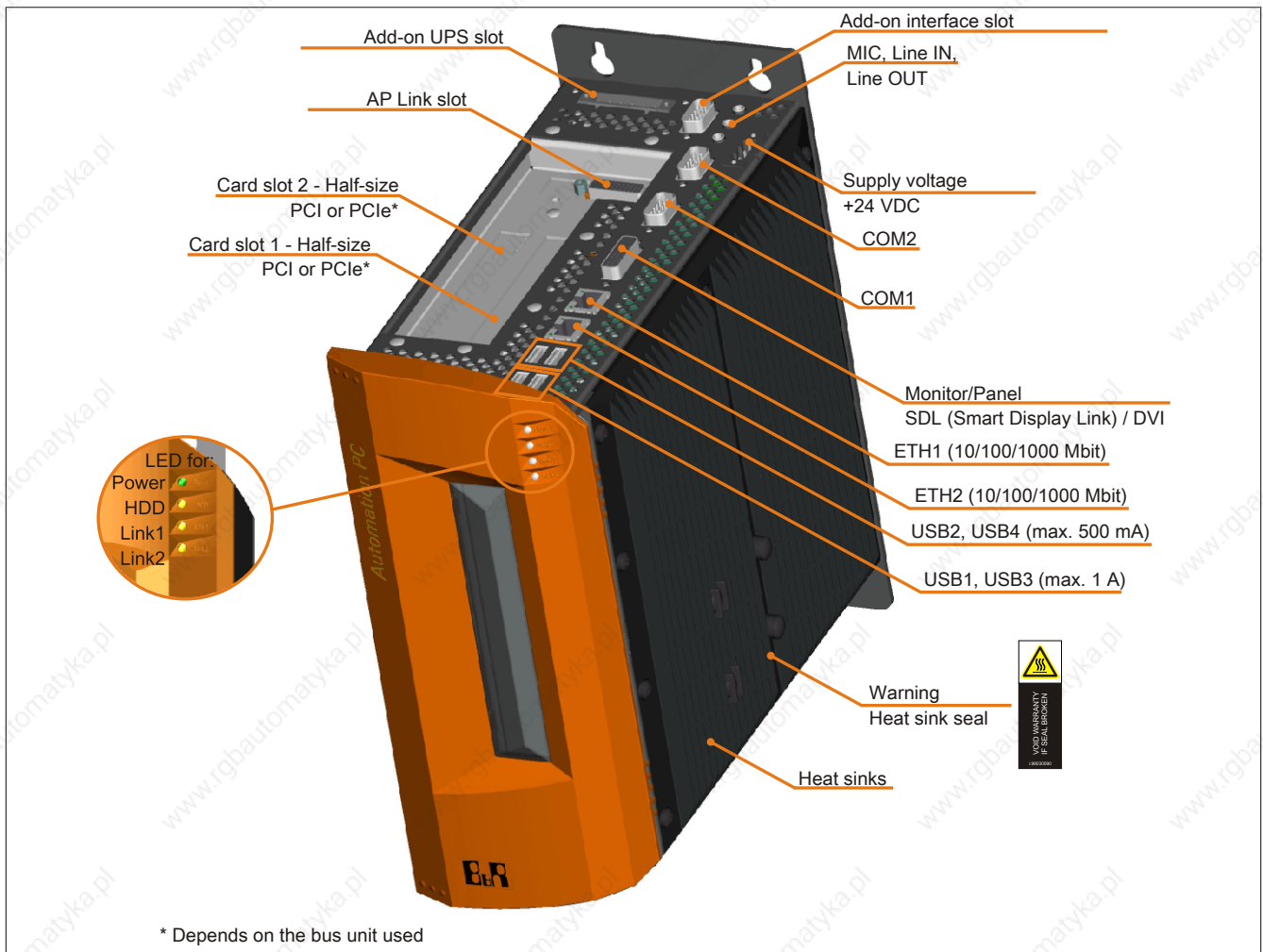

Figure 23: 5PC810.SX02-00 - Interfaces on top

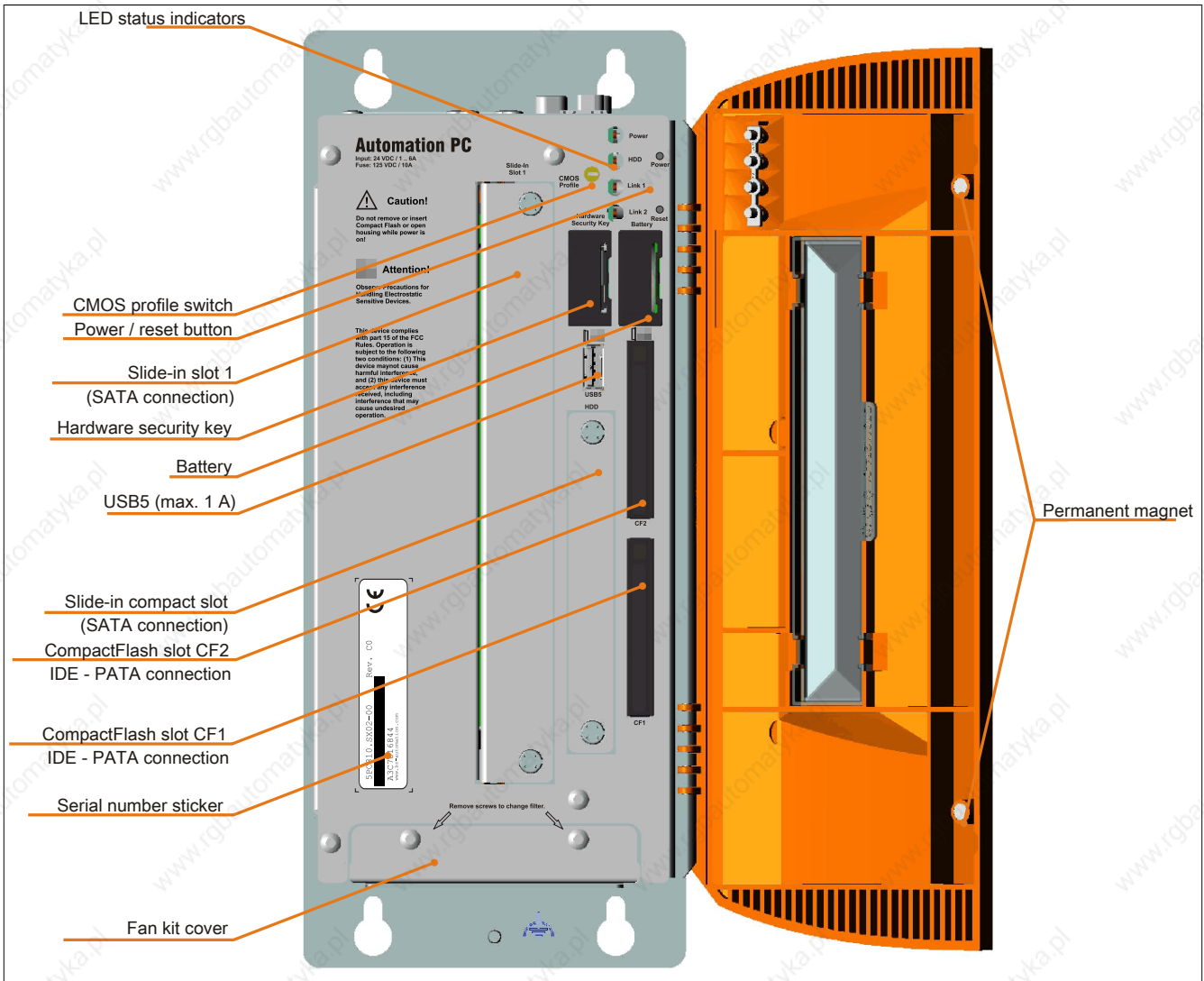

Figure 24: 5PC810.SX02-00 - Interfaces on front

3.1.2.4 Technical data

Product ID	5PC810.SX02-00
General information	
Dongle port	Yes
Cooling	Passive via heat sink and optionally supported with an active fan kit ¹⁾
LEDs	Power, HDD, Link 1, Link 2
B&R ID code	\$A3C7
Battery	
Type	Renata 950 mAh
Service life	2½ years ²⁾
Removable	Yes, accessible behind the orange front door
Design	Lithium ion
Power button	Yes
Reset button	Yes
Buzzer	Yes
Certification	
CE	Yes
cULus	Yes
cULus HazLoc Class 1 Division 2	Yes
ATEX Zone 22	Yes
GL	Yes
Controller	
Boot loader	BIOS
Real-time clock	
Battery-buffered	Yes
Power failure logic	
Controller	MTCX ³⁾
Buffer time	10 ms

Table 48: 5PC810.SX02-00 - Technical data

Product ID	5PC810.SX02-00
Graphics Controller	Depends on the CPU board being used
SRAM Size Battery-buffered Remanent variables in power failure mode	512 kB Yes 192 kB (e.g. for Automation Runtime, see AS help documentation)
Memory Type Size	Depends on the CPU board being used Depends on the CPU board being used
Interfaces	
COM1 Type Design UART Max. baud rate	RS232, modem-capable, not electrically isolated 9-pin male DSUB connector 16550-compatible, 16-byte FIFO 115 kbit/s
COM2 Type Design UART Max. baud rate	RS232, modem-capable, not electrically isolated 9-pin male DSUB connector 16550-compatible, 16-byte FIFO 115 kbit/s
CompactFlash slot 1 Quantity Type	1 Type I
CompactFlash slot 2 Quantity Type	1 Type I
USB Quantity Type Design Transfer rate Current load	5 USB 2.0 Type A Low speed (1.5 Mbit/s), full speed (12 Mbit/s), high speed (480 Mbit/s) Max. 500 mA or 1 A per connection
Ethernet Quantity Design Transfer rate Max. baud rate	2 Shielded RJ45 port 10/100/1000 Mbit/s 1 Gbit/s
Monitor/Panel interface Design Type	Female DVI-I connector SDL / DVI / Monitor
CAN Note	Optional
Audio Type Inputs Outputs	AC97 sound ⁴⁾ Microphone, Line IN Line OUT
Add-on interface slot Quantity	1
Inserts	
PCI / PCIe slots Quantity	2 PCI slots, or 1 PCI and 1 PCIe slot ⁵⁾
Slide-in drives	1
Slide-in compact drives	1
Automation Panel Link slot	Yes
Add-on UPS slot	Yes
Insert for fan kit	Yes
Electrical characteristics	
Nominal voltage	24 VDC ±25%
Nominal current	6 A
Starting current	Typ. 7 A, max. 50 A for <300 µs
Electrical isolation	Yes
Operating conditions	
Protection in accordance with EN 60529	IP20
Environmental conditions	
Temperature Operation Storage Transport	Component-dependent -20 to 60°C -20 to 60°C
Relative humidity Operation Storage Transport	Component-dependent Component-dependent Component-dependent

Table 48: 5PC810.SX02-00 - Technical data

Technical data • Individual components

Product ID	5PC810.SX02-00
Vibration ⁶⁾	
Operation (continuous)	2 to 9 Hz: 1.75 mm amplitude / 9 to 200 Hz: 0.5 g
Operation (occasional)	2 to 9 Hz: 3.5 mm amplitude / 9 to 200 Hz: 1 g
Storage	2 to 8 Hz: 7.5 mm amplitude / 8 to 200 Hz: 2 g / 200 to 500 Hz: 4 g
Transport	2 to 8 Hz: 7.5 mm amplitude / 8 to 200 Hz: 2 g / 200 to 500 Hz: 4 g
Shock ⁶⁾	
Operation	15 g, 11 ms
Storage	30 g, 15 ms
Transport	30 g, 15 ms
Altitude	
Operation	Max. 3000 m (component-dependent) ⁷⁾
Mechanical characteristics	
Housing ⁸⁾	
Material	Galvanized plate, plastic
Front cover	Colored orange plastic (similar to Pantone 144CV)
Paint	Light gray (similar to Pantone 427CV), dark gray (similar to Pantone 432CV)
Dimensions	
Width	120.8 mm with heat sink 5AC801.HS00-00 and 5AC801.HS00-02 136 mm with heat sink 5AC801.HS00-01
Height	270 mm
Depth	254.6 mm
Weight	Approx. 2800g (component-dependent)

Table 48: 5PC810.SX02-00 - Technical data

- 1) A fan kit is absolutely necessary for the APC810 GM45.
- 2) At 50°C, 8.5 µA of the supplied components and a self-discharge of 40%.
- 3) Maintenance Controller Extended.
- 4) No longer supported by the GM45 chipset.
- 5) The PCI and PCIe slots available depend on the 5PC810.BX02-00 and 5PC810.BX02-01 bus unit being used.
- 6) Maximum values unless specified otherwise by another individual component.
- 7) The maximum ambient temperature is typically derated by 1°C per 1000 meters (starting at 500 meters above sea level).
- 8) There may be visible deviations in the color and surface appearance depending on the process or batch.

3.1.2.5 Dimensions

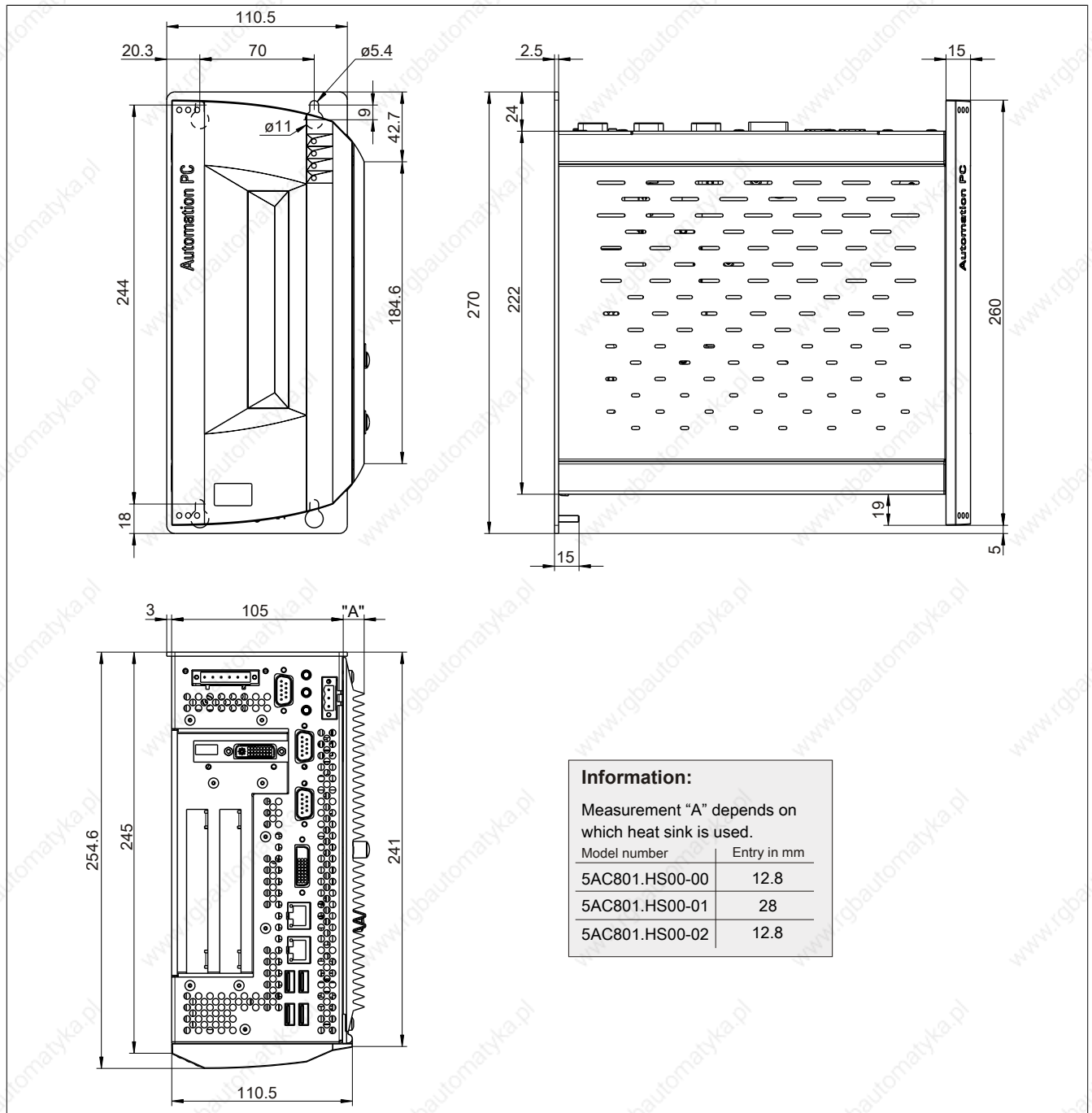

Figure 25: 5PC810.SX02-00 - Dimensions

3.1.2.6 Drilling template

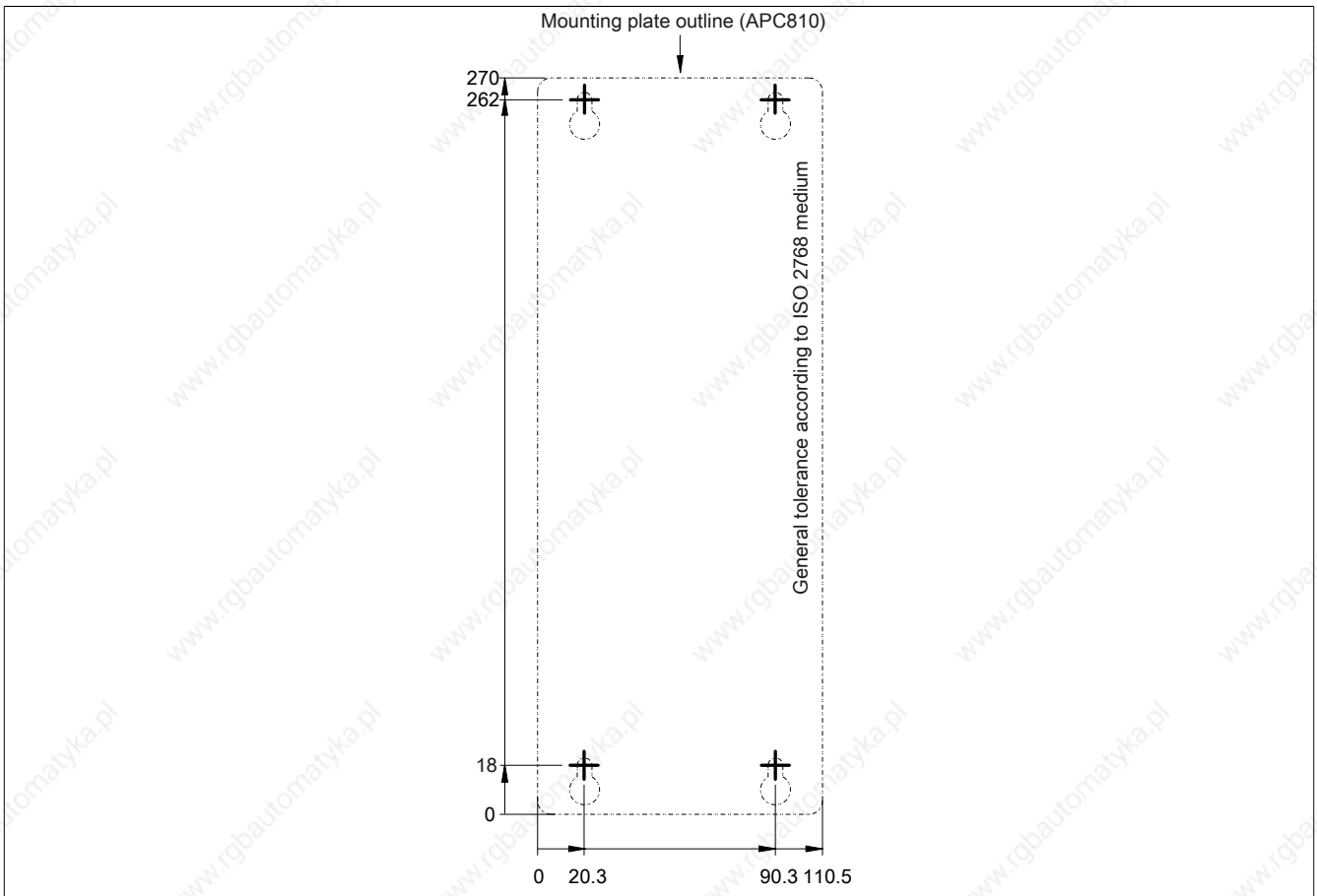

Figure 26: 5PC810.SX02-00 - Drilling template

3.1.3 5PC810.SX03-00

3.1.3.1 General information

- Slot for a bus unit with 2 PCI and 1 PCIe slots
- 512 kB SRAM onboard
- Insert for 1 slide-in compact drive and 1 slide-in drive
- Automation Panel Link slot for connecting Automation Panels via SDL

3.1.3.2 Order data

Model number	Short description	Figure
System units		
5PC810.SX03-00	APC810 system unit, 3 slots (PCI Express, PCI, depending on bus); 1 slot for Automation Panel Link transmitter; 1 slide-in compact and 1 slide-in slot; Smart Display Link/ DVI/Monitor, 2x RS232, 5x USB 2.0, 2x ETH 10/100/1000, AC97 sound, 24 VDC (order OTB103.9 screw clamp or OTB103.91 cage clamp terminals separately)	
Required accessories		
Bus units		
5PC810.BX03-00	APC810 bus, 2 PCI, 1 PCI Express (x4)	
CPU boards		
5PC800.B945-05	Intel Atom N270 CPU board, 1.6 GHz, single core, 533 MHz FSB, 512 kB L2 cache; 945GME chipset; 2 slots for SO-DIMM DDR2 modules (max. total of 3 GB), Realtek RTL8111C Ethernet controller	
5PC800.B945-10	Intel Core Duo L2400 CPU board, 1.66 GHz, dual core, 667 MHz FSB, 2 MB L2 cache; 945GME chipset; 2 slots for SO-DIMM DDR2 modules (max. total of 3 GB), Realtek RTL8111C Ethernet controller	
5PC800.B945-11	Intel Core2 Duo L7400 CPU board, 1.5 GHz, dual core, 667 MHz FSB, 2 MB L2 cache; 945GME chipset; 4 slots for SO-DIMM DDR2 modules (max. total of 3 GB), Realtek RTL8111C Ethernet controller	
5PC800.B945-12	Intel Core2 Duo U7500 CPU board, 1.06 GHz, dual core, 533 MHz FSB, 2 MB L2 cache; 945GME chipset; 2 slots for SO-DIMM DDR2 modules (max. total of 3 GB), Realtek RTL8111C Ethernet controller	
5PC800.B945-13	Intel Celeron M 423 CPU board, 1.06 GHz, single core, 533 MHz FSB, 1 MB L2 cache; 945GME chipset; 2 slots for SO-DIMM DDR2 modules (max. total of 3 GB), Realtek RTL8111C Ethernet controller	
5PC800.B945-14	Intel Core2 Duo T7400 CPU board, 2.16 GHz, dual core, 667 MHz FSB, 2 MB L2 cache; 945GME chipset; 4 slots for SO-DIMM DDR2 modules (max. total of 3 GB), Realtek RTL8111C Ethernet controller	
Terminal blocks		
OTB103.9	Connector, 24 VDC, 3-pin female, 3.31 mm ² screw clamp, protected against vibration by the screw flange	
OTB103.91	Connector, 24 VDC, 3-pin female, 3.31 mm ² cage clamp, protected against vibration by the screw flange	
Main memory		
5MMDDR.0512-01	SO-DIMM DDR2 RAM 512 MB PC2-5300	
5MMDDR.1024-01	SO-DIMM DDR2 RAM 1024 MB PC2-5300	
5MMDDR.2048-01	SO-DIMM DDR2 RAM 2048 MB PC2-5300	
Heat sinks		
5AC801.HS00-00	APC810 heat sink for CPU boards with L2400, L7400, U7500 or Celeron M 423 dual-core processor	
5AC801.HS00-01	APC810 heat sink for CPU boards with T7400, T9400 or P8400 dual-core processor	
5AC801.HS00-02	APC810 heat sink for CPU board with Atom processor N270	
Optional accessories		
Automation Panel Link insert cards		
5AC801.RDYR-00	APC810 ready relay	
5AC801.SDL0-00	Smart Display Link/DVI-D transmitter	
Drives		
5AC801.ADAS-00	SATA hard disk adapter for operating a slide-in compact hard disk in a slide-in slot	
5AC801.DVDS-00	DVD-ROM SATA slide-in drive	
5AC801.DVRS-00	DVD-R/RW DVD+R/RW SATA drive, slide-in	
5AC801.HDDI-00	40 GB slide-in compact SATA hard disk, 24/7 operation with extended temperature range. Note: Please see the manual for information about using this hard disk.	

Table 49: 5PC810.SX03-00 - Order data

Model number	Short description	Figure
5AC801.HDDI-04	500 GB slide-in compact SATA hard disk; 24/7 operation. Note: Please see the manual for information about using this hard disk.	
5AC801.HDDS-00	40 GB slide-in SATA hard disk; 24/7 operation with extended temperature range. Note: Please see the manual for information about using this hard disk.	
5AC801.SSDI-00	32 GB SATA SSD (SLC), slide-in compact	
5AC801.SSDI-03	60 GB SATA SSD (MLC), slide-in compact	
5AC801.SSDI-04	128 GB SATA SSD (MLC), slide-in compact	
5ACPCI.RAIC-06	PCI RAID system SATA 2x 500 GB; Note: Please see the manual for information about using this hard disk.	
Fan kit		
5PC810.FA03-00	APC810 fan kit for 5PC810.SX03-00 system unit	
Serial port adapter		
5AC600.485I-00	RS232/422/485 interface, for installation in an APC620, APC810 or PPC700	
5AC600.CANI-00	CAN interface; for installation in an APC620, APC810 or PPC700	
Uninterruptible power supply		
5AC600.UPSI-00	UPS module for APC620, APC810, PPC800; for system units 5PC600.SX01-00 (starting with Rev. H0), 5PC600.SX02-00 (starting with Rev. G0), 5PC600.SX02-01 (starting with Rev. H0), 5PC600.SX05-00 (starting with Rev. F0), 5PC600.SX05-01 (starting with Rev. F0), 5PC600.SF03-00 (starting with Rev. A0), 5PC810.SX*. 5PC820.1505-00, 5PC820.1906-00. Order cable (5CAUPS.0005-00 or 5CAUPS.0030-00) and battery unit (5AC600.UPSB-00) separately	
Accessories		
5ACPCI.ETH1-01	PCI Ethernet card 1x 10/100	
5ACPCI.ETH3-01	PCI Ethernet card 3x 10/100	

Table 49: 5PC810.SX03-00 - Order data

3.1.3.3 Interfaces

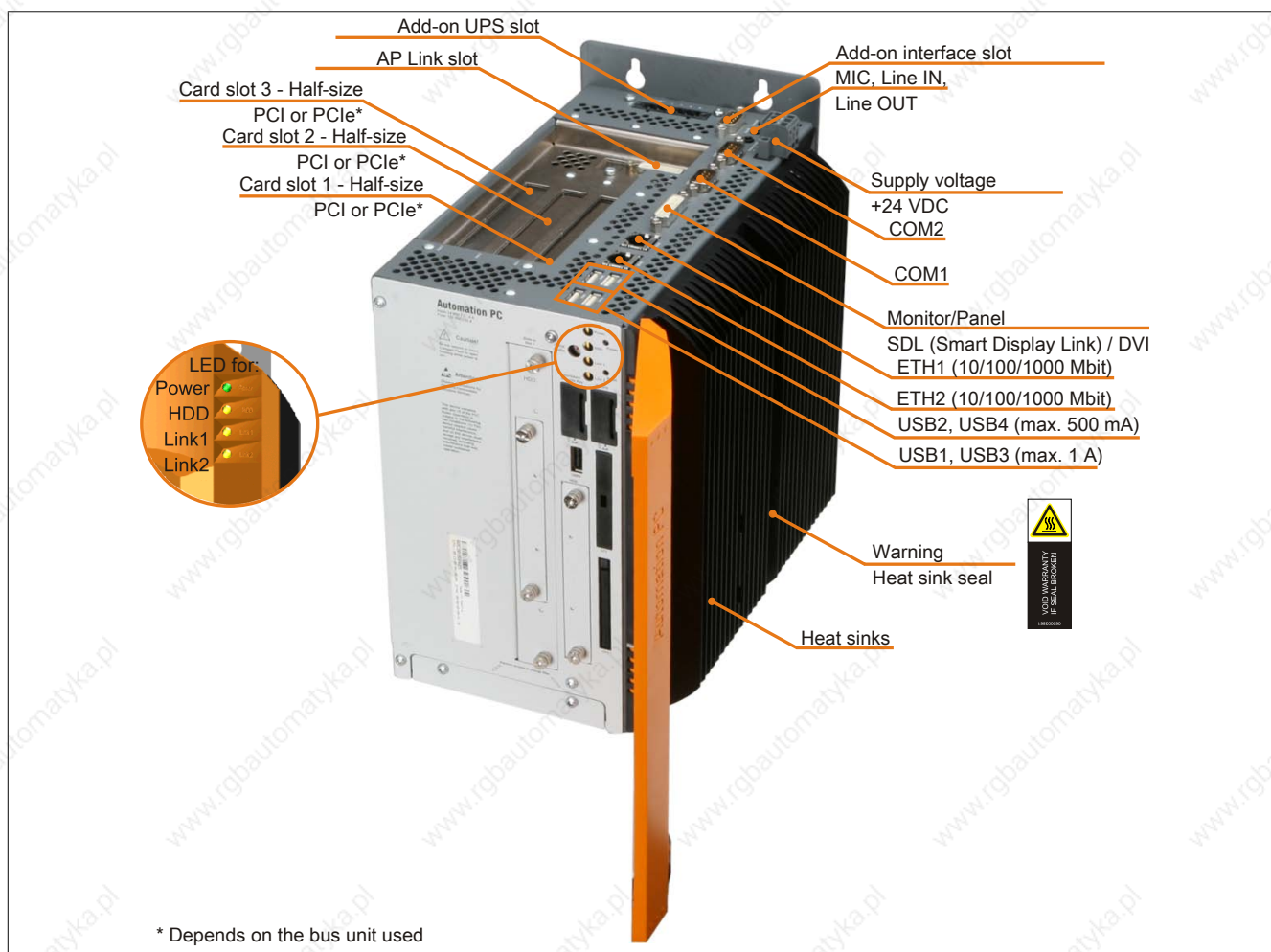

Figure 27: 5PC810.SX03-00 - Interfaces on top

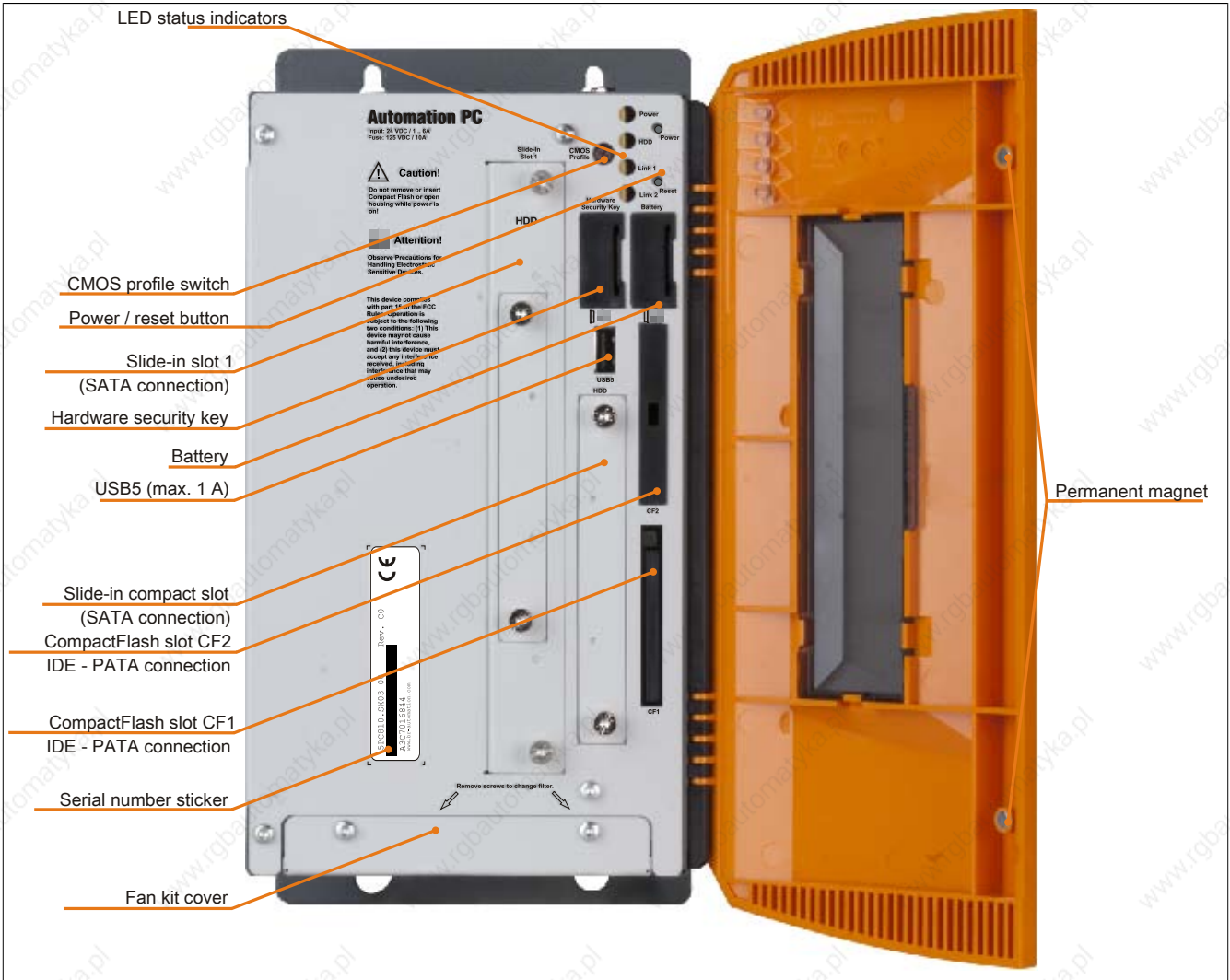

Figure 28: 5PC810.SX03-00 - Interfaces on front

3.1.3.4 Technical data

Product ID	5PC810.SX03-00
General information	
Dongle port	Yes
Cooling	Passive via heat sink and optionally supported with an active fan kit ¹⁾
LEDs	Power, HDD, Link 1, Link 2
B&R ID code	\$B2C3
Battery	
Type	Renata 950 mAh
Service life	2½ years ²⁾
Removable	Yes, accessible behind the orange front door
Design	Lithium ion
Power button	Yes
Reset button	Yes
Buzzer	Yes
Certification	
CE	Yes
cULus	Yes
Controller	
Boot loader	BIOS
Real-time clock	
Battery-buffered	Yes
Power failure logic	
Controller	MTCX ³⁾
Buffer time	10 ms
Graphics	
Controller	Depends on the CPU board being used

Table 50: 5PC810.SX03-00 - Technical data

Technical data • Individual components

Product ID	5PC810.SX03-00
SRAM	
Size	512 kB
Battery-buffered	Yes
Remanent variables in power failure mode	192 kB (e.g. for Automation Runtime, see AS help documentation)
Memory	
Type	Depends on the CPU board being used
Size	Depends on the CPU board being used
Interfaces	
COM1	
Type	RS232, modem-capable, not electrically isolated
Design	9-pin male DSUB connector
UART	16550-compatible, 16-byte FIFO
Max. baud rate	115 kbit/s
COM2	
Type	RS232, modem-capable, not electrically isolated
Design	9-pin male DSUB connector
UART	16550-compatible, 16-byte FIFO
Max. baud rate	115 kbit/s
CompactFlash slot 1	
Quantity	1
Type	Type I
CompactFlash slot 2	
Quantity	1
Type	Type I
USB	
Quantity	5
Type	USB 2.0
Design	Type A
Transfer rate	Low speed (1.5 Mbit/s), full speed (12 Mbit/s), high speed (480 Mbit/s)
Current load	Max. 500 mA or 1 A per connection
Ethernet	
Quantity	2
Design	Shielded RJ45 port
Transfer rate	10/100/1000 Mbit/s
Max. baud rate	1 Gbit/s
Monitor/Panel interface	
Design	Female DVI-I connector
Type	SDL / DVI / Monitor
CAN	
Note	Optional
Audio	
Type	AC97 sound ⁴⁾
Inputs	Microphone, Line IN
Outputs	Line OUT
Add-on interface slot	
Quantity	1
Inserts	
PCI / PCIe slots	
Quantity	2 PCI and 1 PCIe slot ⁵⁾
Slide-in drives	1
Slide-in compact drives	1
Automation Panel Link slot	Yes
Add-on UPS slot	Yes
Insert for fan kit	Yes
Electrical characteristics	
Nominal voltage	24 VDC ±25%
Nominal current	6 A
Starting current	Typ. 7 A, max. 50 A for <300 µs
Electrical isolation	Yes
Operating conditions	
Protection in accordance with EN 60529	IP20
Environmental conditions	
Temperature	
Operation	Component-dependent
Storage	-20 to 60°C
Transport	-20 to 60°C
Relative humidity	
Operation	Component-dependent
Storage	Component-dependent
Transport	Component-dependent
Vibration ⁶⁾	
Operation (continuous)	2 to 9 Hz: 1.75 mm amplitude / 9 to 200 Hz: 0.5 g
Operation (occasional)	2 to 9 Hz: 3.5 mm amplitude / 9 to 200 Hz: 1 g
Storage	2 to 8 Hz: 7.5 mm amplitude / 8 to 200 Hz: 2 g / 200 to 500 Hz: 4 g
Transport	2 to 8 Hz: 7.5 mm amplitude / 8 to 200 Hz: 2 g / 200 to 500 Hz: 4 g

Table 50: 5PC810.SX03-00 - Technical data

Product ID	5PC810.SX03-00
Shock ⁶⁾	
Operation	15 g, 11 ms
Storage	30 g, 15 ms
Transport	30 g, 15 ms
Altitude	
Operation	Max. 3000 m (component-dependent) ⁷⁾
Mechanical characteristics	
Housing ⁸⁾	
Material	Galvanized plate, plastic
Front cover	Colored orange plastic (similar to Pantone 144CV)
Paint	Light gray (similar to Pantone 427CV), dark gray (similar to Pantone 432CV)
Dimensions	
Width	140.8 mm with heat sink 5AC801.HS00-00 and 5AC801.HS00-02 156.5 mm with heat sink 5AC801.HS00-01
Height	270 mm
Depth	254,6 mm
Weight	Approx. 3200g (component-dependent)

Table 50: 5PC810.SX03-00 - Technical data

- 1) A fan kit is absolutely necessary for the APC810 GM45.
- 2) At 50°C, 8.5 µA of the supplied components and a self-discharge of 40%.
- 3) Maintenance Controller Extended.
- 4) No longer supported by the GM45 chipset.
- 5) Bus unit 5PC810.BX03-00 with 2 PCI and 1 PCIe slots can be used.
- 6) Maximum values unless specified otherwise by another individual component.
- 7) The maximum ambient temperature is typically derated by 1°C per 1000 meters (starting at 500 meters above sea level).
- 8) There may be visible deviations in the color and surface appearance depending on the process or batch.

3.1.3.5 Dimensions

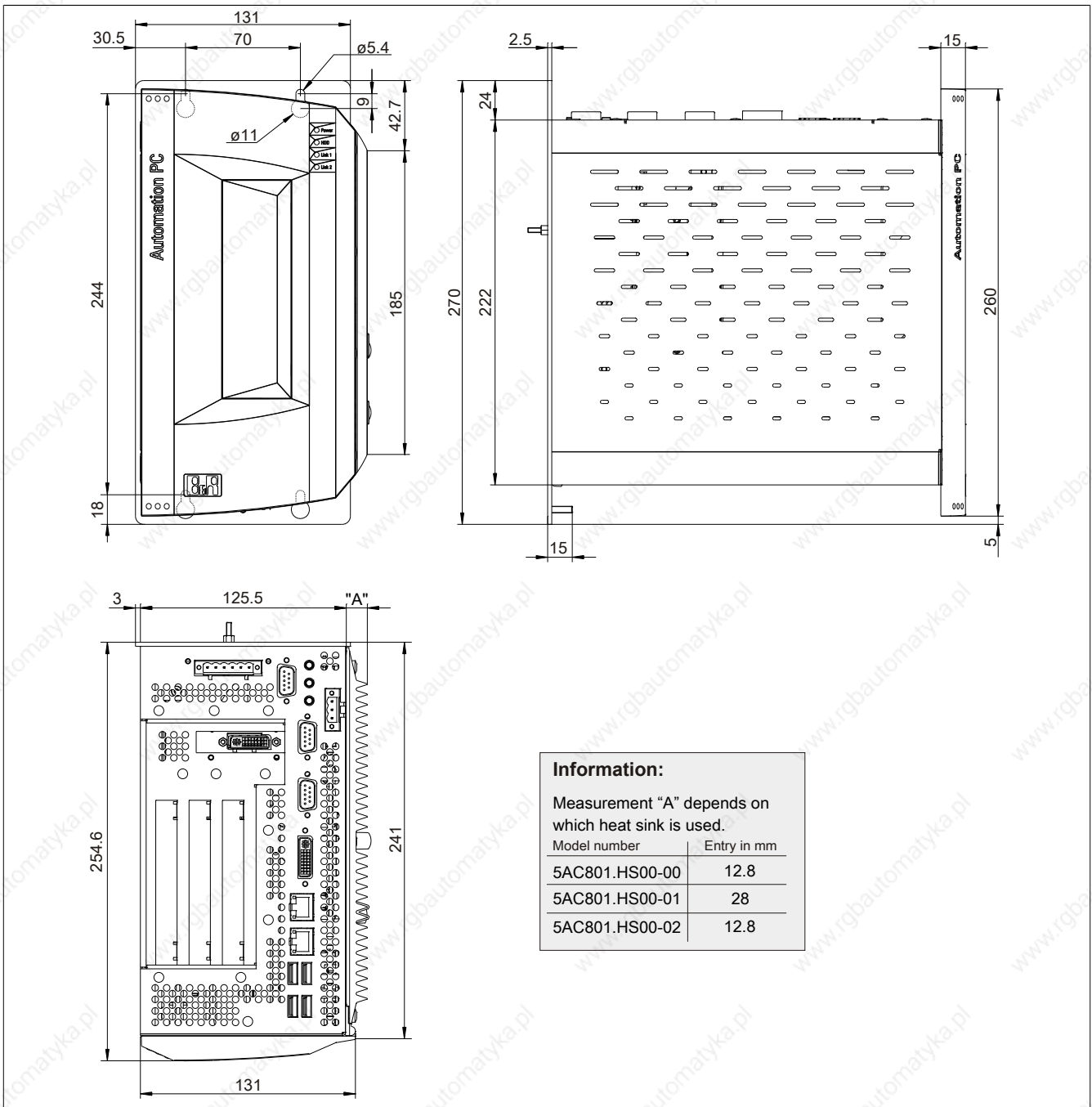

Figure 29: 5PC810.SX03-00 - Dimensions

3.1.3.6 Drilling template

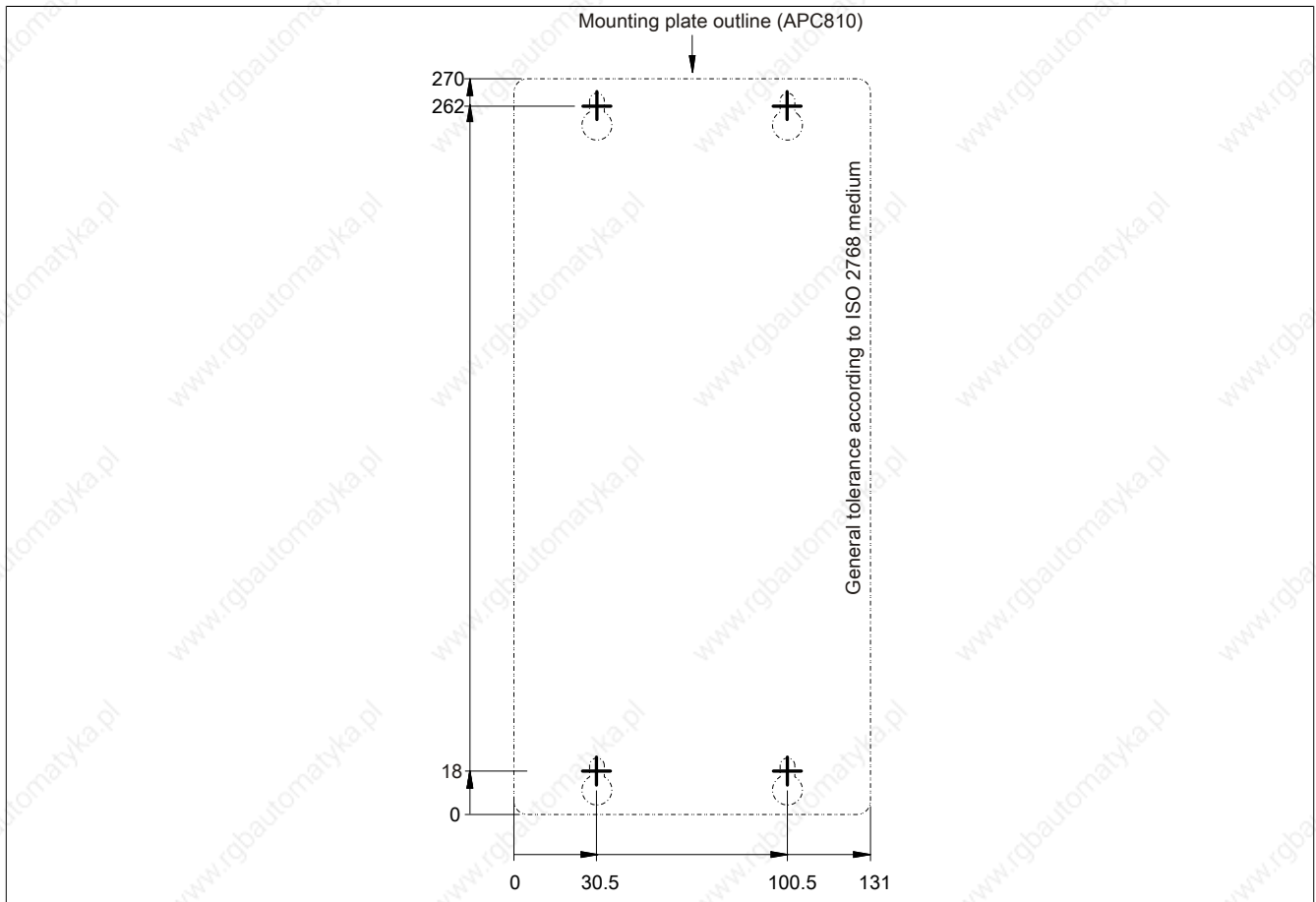

Figure 30: 5PC810.SX03-00 - Drilling template

3.1.4 5PC810.SX05-00

3.1.4.1 General information

- Slot for a bus unit with 4 PCI and 1 PCIe slots, 2 PCI and 3 PCIe slots or 5 PCI slots
- 512 kB SRAM onboard
- Insert for 1 slide-in compact drive and 2 slide-in drives
- Automation Panel Link slot for connecting Automation Panels via SDL

3.1.4.2 Order data

Model number	Short description	Figure
	System units	
5PC810.SX05-00	APC810 system unit, 5 slots (PCI Express, PCI, depending on bus); 1 slot for Automation Panel Link transmitter; 1 slide-in compact and 2 slide-in slots; Smart Display Link/ DVI/Monitor, 2x RS232, 5x USB 2.0, 2x ETH 10/100/1000, 24 VDC (order 0TB103.9 screw clamp or 0TB103.91 cage clamp terminals separately)	
	Required accessories	
	Bus units	
5PC810.BX05-00	APC810 bus, 4 PCI, 1 PCI Express (x1)	
5PC810.BX05-01	APC810 bus, 2 PCI, 3 PCI Express (x1)	
5PC810.BX05-02	APC810 bus, 5 PCI	
	CPU boards	
5PC800.B945-05	Intel Atom N270 CPU board, 1.6 GHz, single core, 533 MHz FSB, 512 kB L2 cache; 945GME chipset; 2 slots for SO-DIMM DDR2 modules (max. total of 3 GB), Realtek RTL8111C Ethernet controller	
5PC800.B945-10	Intel Core Duo L2400 CPU board, 1.66 GHz, dual core, 667 MHz FSB, 2 MB L2 cache; 945GME chipset; 2 slots for SO-DIMM DDR2 modules (max. total of 3 GB), Realtek RTL8111C Ethernet controller	
5PC800.B945-11	Intel Core2 Duo L7400 CPU board, 1.5 GHz, dual core, 667 MHz FSB, 2 MB L2 cache; 945GME chipset; 4 slots for SO-DIMM DDR2 modules (max. total of 3 GB), Realtek RTL8111C Ethernet controller	
5PC800.B945-12	Intel Core2 Duo U7500 CPU board, 1.06 GHz, dual core, 533 MHz FSB, 2 MB L2 cache; 945GME chipset; 2 slots for SO-DIMM DDR2 modules (max. total of 3 GB), Realtek RTL8111C Ethernet controller	
5PC800.B945-13	Intel Celeron M 423 CPU board, 1.06 GHz, single core, 533 MHz FSB, 1 MB L2 cache; 945GME chipset; 2 slots for SO-DIMM DDR2 modules (max. total of 3 GB), Realtek RTL8111C Ethernet controller	
5PC800.B945-14	Intel Core2 Duo T7400 CPU board, 2.16 GHz, dual core, 667 MHz FSB, 2 MB L2 cache; 945GME chipset; 4 slots for SO-DIMM DDR2 modules (max. total of 3 GB), Realtek RTL8111C Ethernet controller	
	Terminal blocks	
0TB103.9	Connector, 24 VDC, 3-pin female, 3.31 mm ² screw clamp, protected against vibration by the screw flange	
0TB103.91	Connector, 24 VDC, 3-pin female, 3.31 mm ² cage clamp, protected against vibration by the screw flange	
	Main memory	
5MMDDR.0512-01	SO-DIMM DDR2 RAM 512 MB PC2-5300	
5MMDDR.1024-01	SO-DIMM DDR2 RAM 1024 MB PC2-5300	
5MMDDR.2048-01	SO-DIMM DDR2 RAM 2048 MB PC2-5300	
	Heat sinks	
5AC801.HS00-00	APC810 heat sink for CPU boards with L2400, L7400, U7500 or Celeron M 423 dual-core processor	
5AC801.HS00-01	APC810 heat sink for CPU boards with T7400, T9400 or P8400 dual-core processor	
5AC801.HS00-02	APC810 heat sink for CPU board with Atom processor N270	
	Optional accessories	
	Automation Panel Link insert cards	
5AC801.RDYR-00	APC810 ready relay	
5AC801.SDLO-00	Smart Display Link/DVI-D transmitter	
	Drives	
5AC801.ADAS-00	SATA hard disk adapter for operating a slide-in compact hard disk in a slide-in slot	
5AC801.DVDS-00	DVD-ROM SATA slide-in drive	
5AC801.DVRS-00	DVD-R/RW DVD+R/RW SATA drive, slide-in	

Table 51: 5PC810.SX05-00 - Order data

Model number	Short description	Figure
5AC801.HDDI-00	40 GB slide-in compact SATA hard disk, 24/7 operation with extended temperature range. Note: Please see the manual for information about using this hard disk.	
5AC801.HDDI-04	500 GB slide-in compact SATA hard disk; 24/7 operation. Note: Please see the manual for information about using this hard disk.	
5AC801.HDDS-00	40 GB slide-in SATA hard disk; 24/7 operation with extended temperature range. Note: Please see the manual for information about using this hard disk.	
5AC801.SSDI-00	32 GB SATA SSD (SLC), slide-in compact	
5AC801.SSDI-03	60 GB SATA SSD (MLC), slide-in compact	
5AC801.SSDI-04	128 GB SATA SSD (MLC), slide-in compact	
5ACPCI.RAIC-06	PCI RAID system SATA 2x 500 GB; Note: Please see the manual for information about using this hard disk.	
Fan kit		
5PC810.FA05-00	APC810 fan kit for 5PC810.SX05-00 system unit	
Serial port adapter		
5AC600.485I-00	RS232/422/485 interface, for installation in an APC620, APC810 or PPC700	
5AC600.CANI-00	CAN interface; for installation in an APC620, APC810 or PPC700	
Uninterruptible power supply		
5AC600.UPSI-00	UPS module for APC620, APC810, PPC800; for system units 5PC600.SX01-00 (starting with Rev. H0), 5PC600.SX02-00 (starting with Rev. G0), 5PC600.SX02-01 (starting with Rev. H0), 5PC600.SX05-00 (starting with Rev. F0), 5PC600.SX05-01 (starting with Rev. F0), 5PC600.SF03-00 (starting with Rev. A0), 5PC810.SX*. 5PC820.1505-00, 5PC820.1906-00. Order cable (5CAUPS.0005-00 or 5CAUPS.0030-00) and battery unit (5AC600.UPSB-00) separately	
Accessories		
5ACPCI.ETH1-01	PCI Ethernet card 1x 10/100	
5ACPCI.ETH3-01	PCI Ethernet card 3x 10/100	

Table 51: 5PC810.SX05-00 - Order data

3.1.4.3 Interfaces

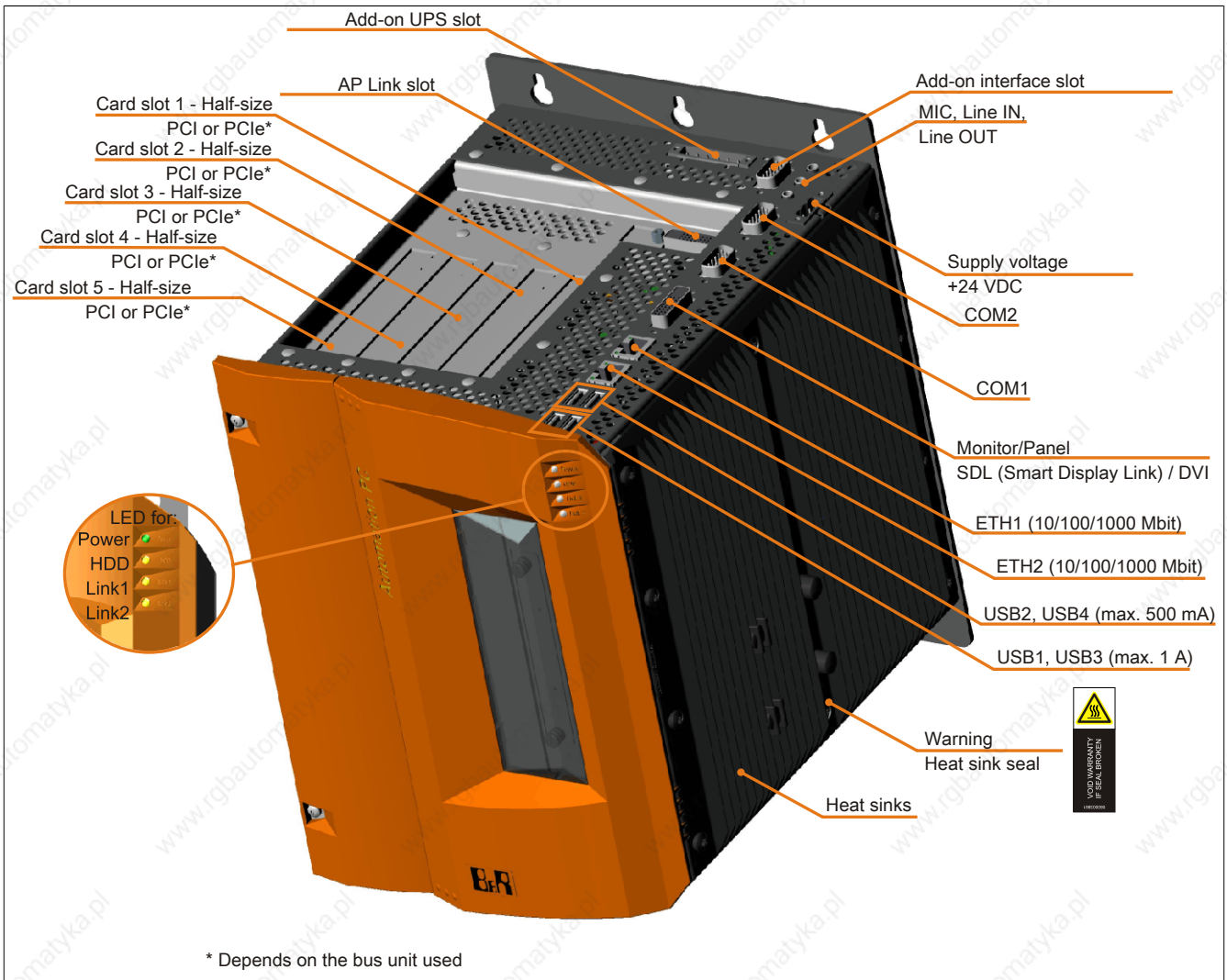

Figure 31: 5PC810.SX05-00 - Interfaces on top

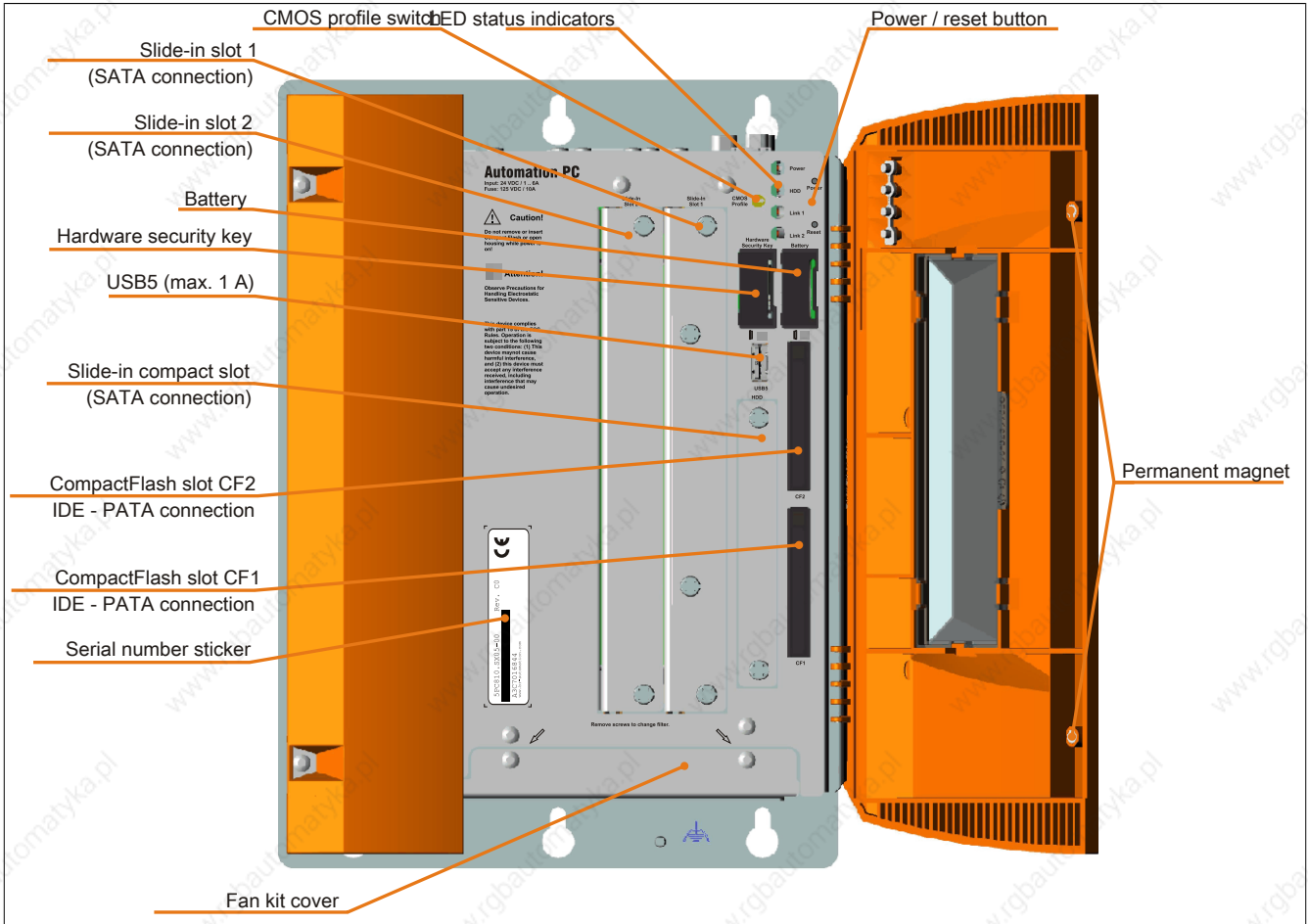

Figure 32: 5PC810.SX05-00 - Interfaces on front

3.1.4.4 Technical data

Product ID	5PC810.SX05-00
General information	
Dongle port	Yes
Cooling	Passive via heat sink and optionally supported with an active fan kit ¹⁾
LEDs	Power, HDD, Link 1, Link 2
B&R ID code	\$A3EE
Battery	
Type	Renata 950 mAh
Service life	2½ years ²⁾
Removable	Yes, accessible behind the orange front door
Design	Lithium ion
Power button	Yes
Reset button	Yes
Buzzer	Yes
Certification	
CE	Yes
cULus	Yes
Controller	
Boot loader	BIOS
Real-time clock	
Battery-buffered	Yes
Power failure logic	
Controller	MTCX ³⁾
Buffer time	10 ms
Graphics	
Controller	Depends on the CPU board being used
SRAM	
Size	512 kB
Battery-buffered	Yes
Remanent variables in power failure mode	192 kB (e.g. for Automation Runtime, see AS help documentation)
Memory	
Type	Depends on the CPU board being used
Size	Depends on the CPU board being used

Table 52: 5PC810.SX05-00 - Technical data

Technical data • Individual components

Product ID	5PC810.SX05-00
Interfaces	
COM1 Type Design UART Max. baud rate	RS232, modem-capable, not electrically isolated 9-pin male DSUB connector 16550-compatible, 16-byte FIFO 115 kbit/s
COM2 Type Design UART Max. baud rate	RS232, modem-capable, not electrically isolated 9-pin male DSUB connector 16550-compatible, 16-byte FIFO 115 kbit/s
CompactFlash slot 1 Quantity Type	1 Type I
CompactFlash slot 2 Quantity Type	1 Type I
USB Quantity Type Design Transfer rate Current load	5 USB 2.0 Type A Low speed (1.5 Mbit/s), full speed (12 Mbit/s), high speed (480 Mbit/s) Max. 500 mA or 1 A per connection
Ethernet Quantity Design Transfer rate Max. baud rate	2 Shielded RJ45 port 10/100/1000 Mbit/s 1 Gbit/s
Monitor/Panel interface Design Type	Female DVI-I connector SDL / DVI / Monitor
CAN Note	Optional
Audio Type Inputs Outputs	AC97 sound ⁴⁾ Microphone, Line IN Line OUT
Add-on interface slot Quantity	1
Inserts	
PCI / PCIe slots Quantity	4 PCI slots and 1 PCIe slots or 2 PCI slots and 3 PCIe slots or 5 PCI slots ⁵⁾
Slide-in drives	2
Slide-in compact drives	1
Automation Panel Link slot	Yes
Add-on UPS slot	Yes
Insert for fan kit	Yes
Electrical characteristics	
Nominal voltage	24 VDC ±25%
Nominal current	6 A
Starting current	Typ. 7 A, max. 50 A for <300 µs
Electrical isolation	Yes
Operating conditions	
Protection in accordance with EN 60529	IP20
Environmental conditions	
Temperature Operation Storage Transport	Component-dependent -20 to 60°C -20 to 60°C
Relative humidity Operation Storage Transport	Component-dependent Component-dependent Component-dependent
Vibration ⁶⁾ Operation (continuous) Operation (occasional) Storage Transport	2 to 9 Hz: 1.75 mm amplitude / 9 to 200 Hz: 0.5 g 2 to 9 Hz: 3.5 mm amplitude / 9 to 200 Hz: 1 g 2 to 8 Hz: 7.5 mm amplitude / 8 to 200 Hz: 2 g / 200 to 500 Hz: 4 g 2 to 8 Hz: 7.5 mm amplitude / 8 to 200 Hz: 2 g / 200 to 500 Hz: 4 g
Shock ⁶⁾ Operation Storage Transport	15 g, 11 ms 30 g, 15 ms 30 g, 15 ms

Table 52: 5PC810.SX05-00 - Technical data

Product ID	5PC810.SX05-00
Altitude Operation	Max. 3000 m (component-dependent) ⁷⁾
Mechanical characteristics	
Housing ⁸⁾	
Material	Galvanized plate, plastic
Front cover	Colored orange plastic (similar to Pantone 144CV)
Paint	Light gray (similar to Pantone 427CV), dark gray (similar to Pantone 432CV)
Dimensions	
Width	201.7 mm with heat sink 5AC801.HS00-00 and 5AC801.HS00-02 216.9 mm with heat sink 5AC801.HS00-01
Height	270 mm
Depth	254.5 mm
Weight	Approx. 3900g (component-dependent)

Table 52: 5PC810.SX05-00 - Technical data

- 1) A fan kit is absolutely necessary for the APC810 GM45.
- 2) At 50°C, 8.5 µA of the supplied components and a self-discharge of 40%.
- 3) Maintenance Controller Extended.
- 4) No longer supported by the GM45 chipset.
- 5) The PCI and PCIe slots available depend on the 5PC810.BX05-00, 5PC810.BX05-01 and 5PC810.BX05-02 bus unit being used.
- 6) Maximum values unless specified otherwise by another individual component.
- 7) The maximum ambient temperature is typically derated by 1°C per 1000 meters (starting at 500 meters above sea level).
- 8) There may be visible deviations in the color and surface appearance depending on the process or batch.

3.1.4.5 Dimensions

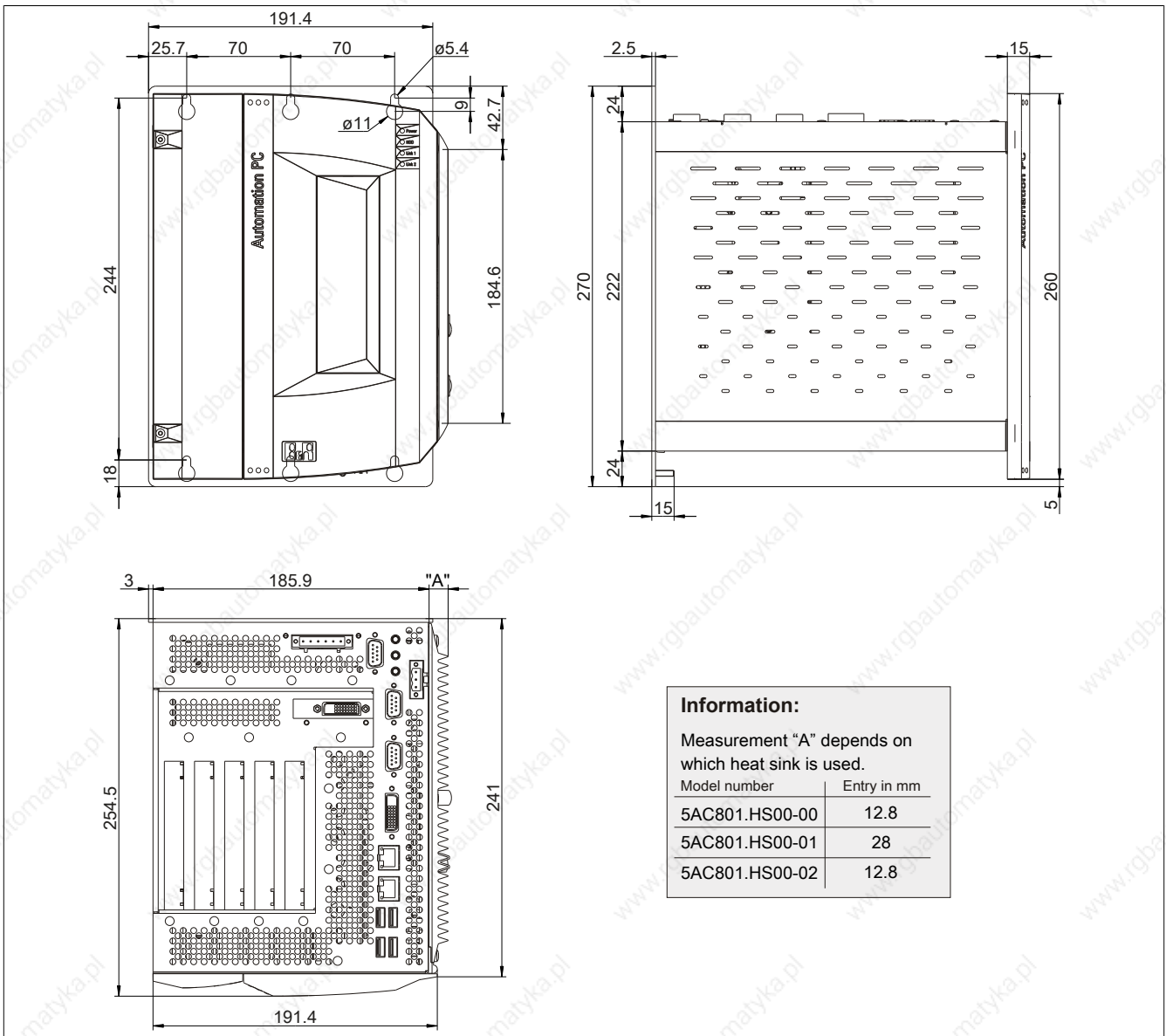

Figure 33: 5PC810.SX05-00 - Dimensions

3.1.4.6 Drilling template

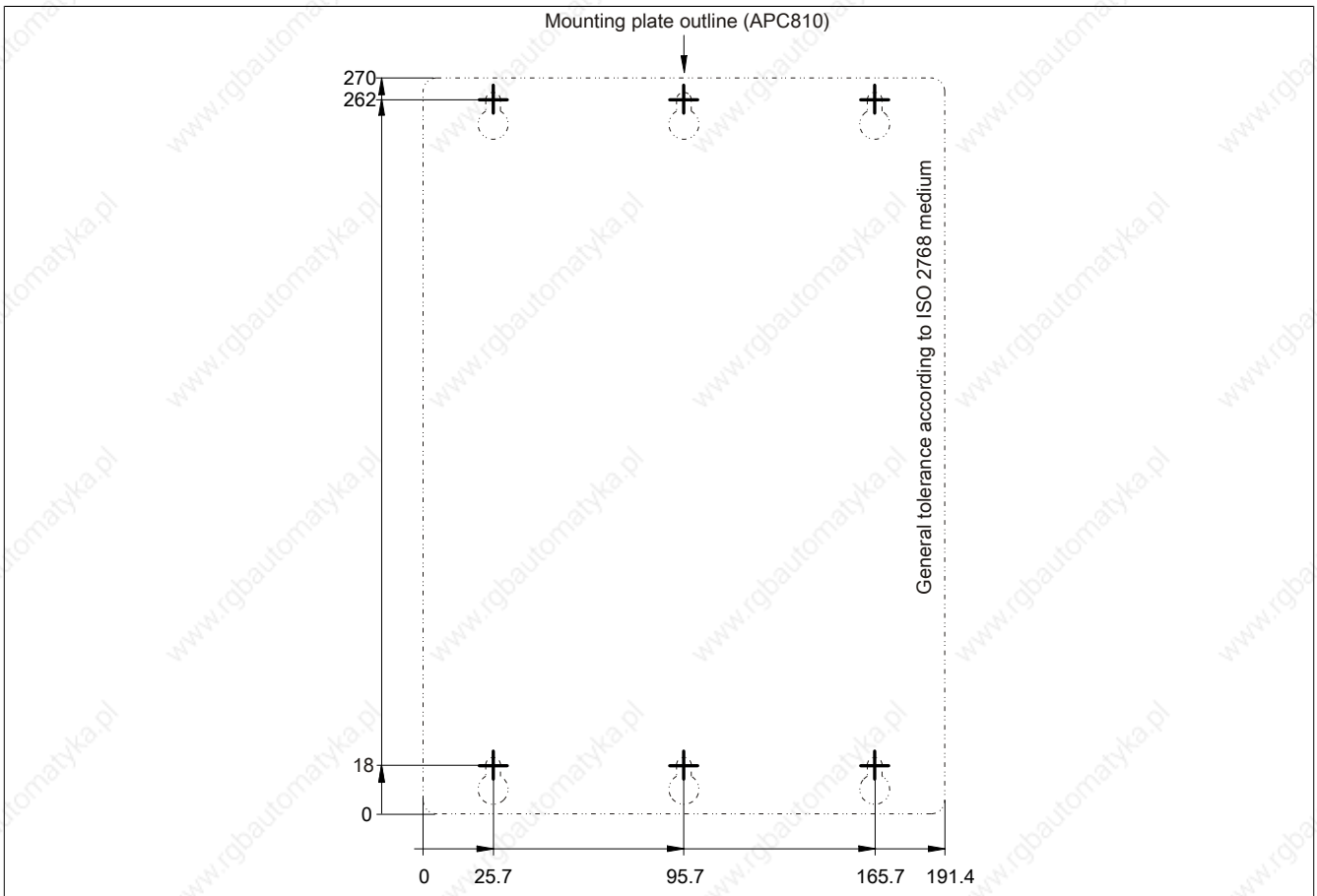

Figure 34: 5PC810.SX05-00 - Drilling template

3.2 Bus units

3.2.1 General information

Bus units are compatible with system units with 1, 2, 3 or 5 card slots and provide support for PCI and/or PCI Express.

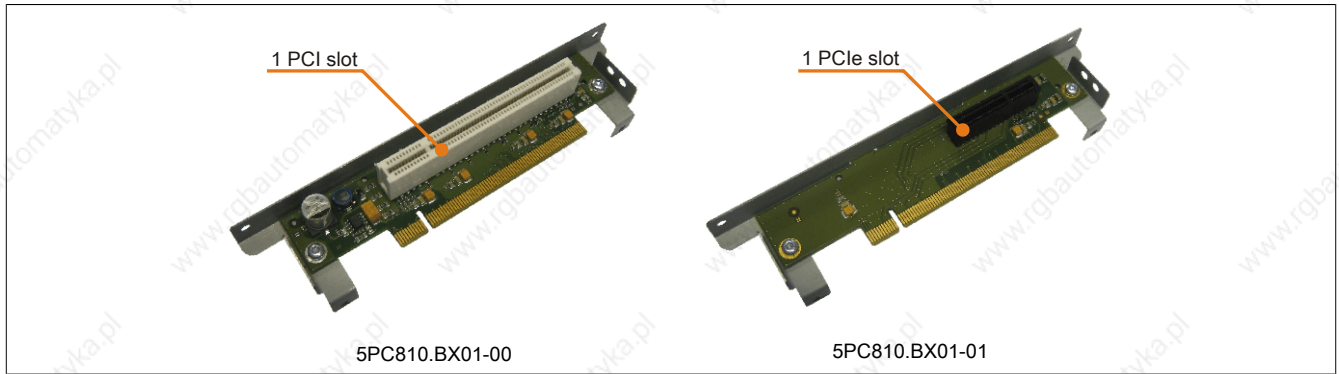

Figure 35: 1-slot bus units

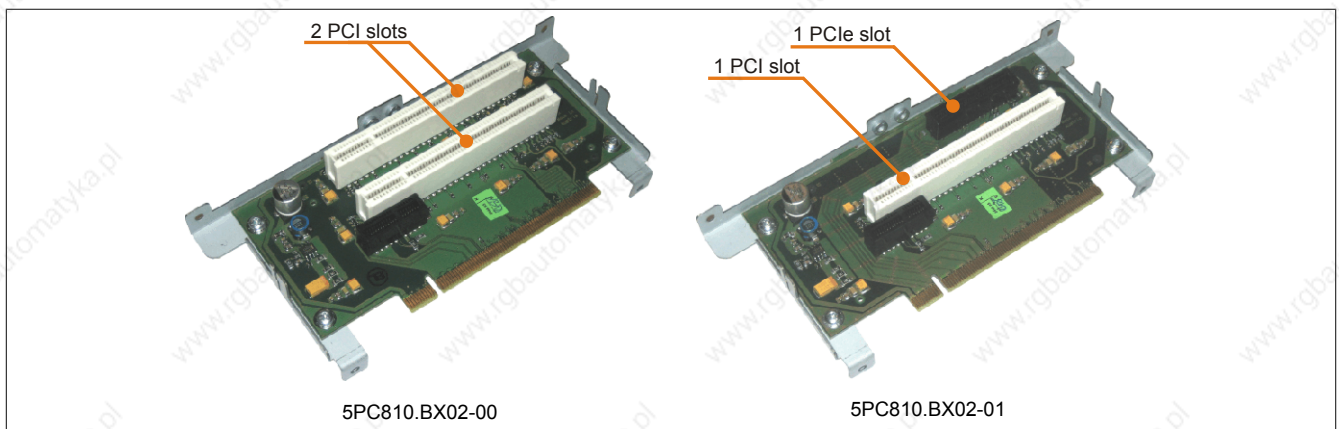

Figure 36: 2-slot bus units

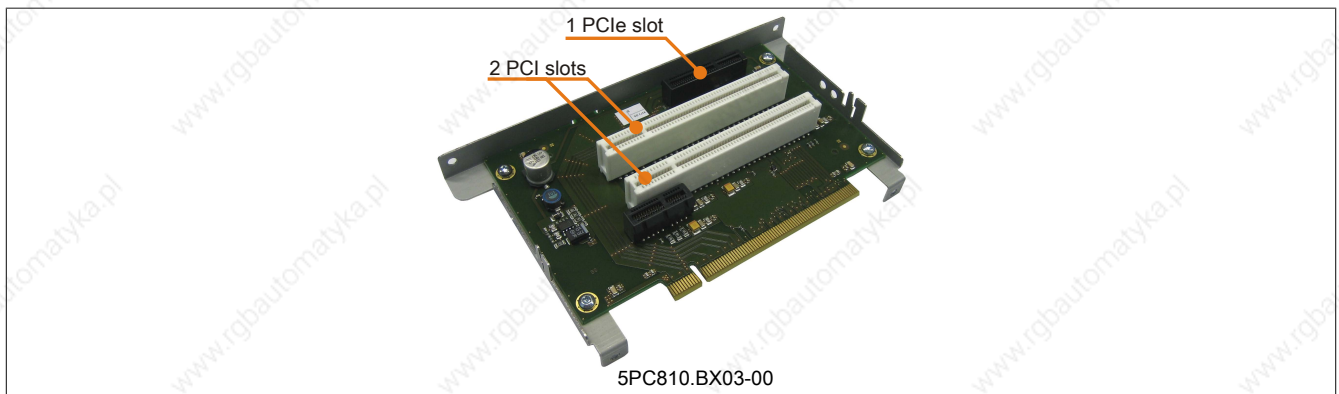

Figure 37: 3-slot bus units

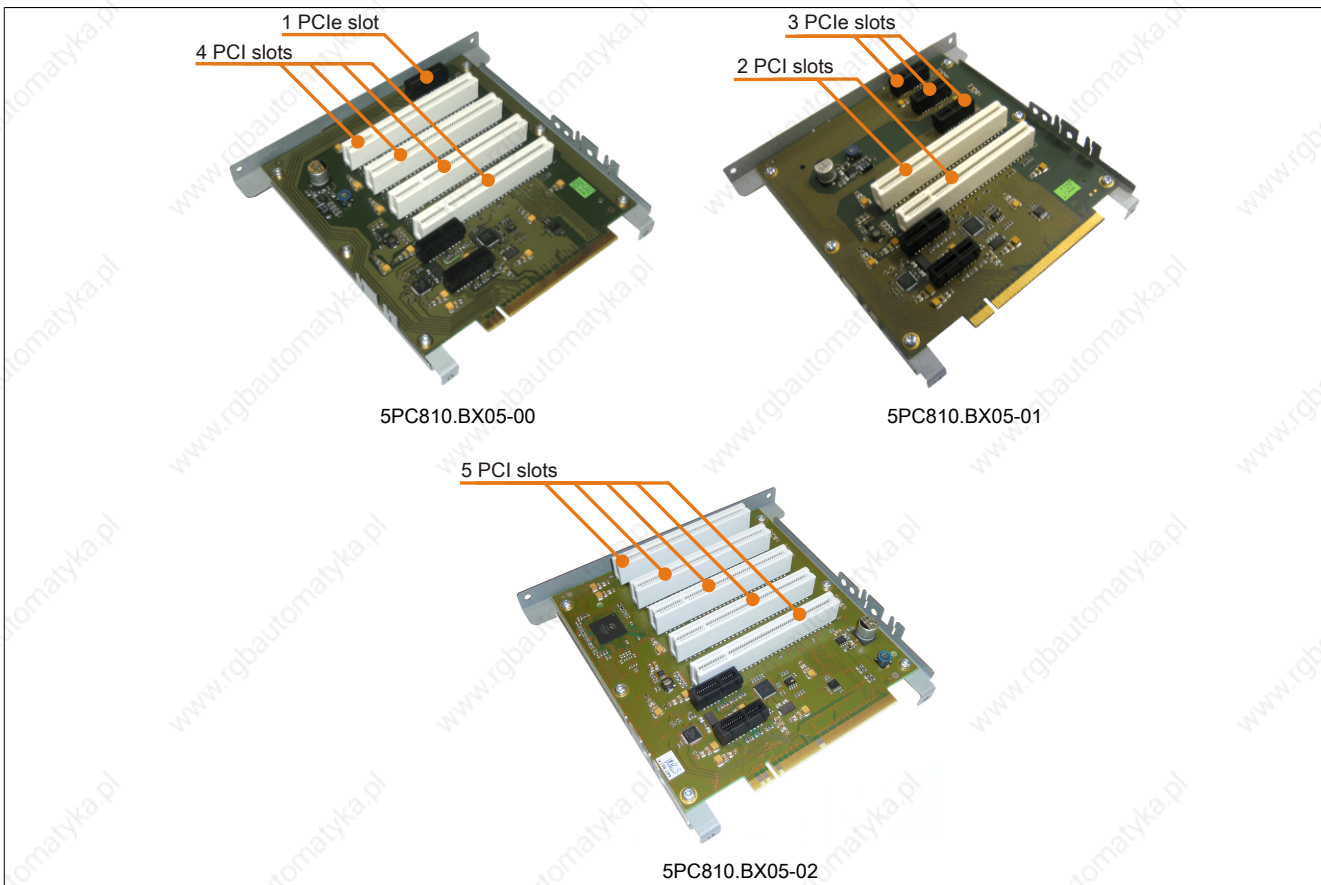

Figure 38: 5-slot bus units

3.2.2 Order data

Model number	Short description	Figure
Bus units		
5PC810.BX01-00	APC810 bus, 1 PCI	
5PC810.BX01-01	APC810 bus, 1 PCI Express (x4)	
5PC810.BX02-00	APC810 bus, 2 PCI	
5PC810.BX02-01	APC810 bus, 1 PCI, 1 PCI Express (x4)	
5PC810.BX03-00	APC810 bus, 2 PCI, 1 PCI Express (x4)	
5PC810.BX05-00	APC810 bus, 4 PCI, 1 PCI Express (x1)	
5PC810.BX05-01	APC810 bus, 2 PCI, 3 PCI Express (x1)	
5PC810.BX05-02	APC810 bus, 5 PCI	

Table 53: 5PC810.BX01-00, 5PC810.BX01-01, 5PC810.BX02-00, 5PC810.BX02-01, 5PC810.BX03-00, 5PC810.BX05-00, 5PC810.BX05-01, 5PC810.BX05-02 - Order data

3.2.3 Technical data

Product ID	5PC810.BX01-00	5PC810.BX01-01	5PC810.BX02-00	5PC810.BX02-01	5PC810.BX03-00	5PC810.BX05-00	5PC810.BX05-01	5PC810.BX05-02
General information								
Certification								
CE	Yes							
cULus HazLoc Class 1 Division 2	Yes	-	Yes	-	-	-	-	-
ATEX Zone 22	Yes	-	Yes	-	-	-	-	-
GL	Yes	Yes	Yes	Yes	-	-	-	-
Inserts								
PCI slots								
Quantity	1	-	2	1	2	4	2	5
Type	32-bit	-	32-bit	32-bit	32-bit	32-bit	32-bit	32-bit
Design	PCI half-size	-	PCI half-size	PCI half-size	PCI half-size	PCI half-size	PCI half-size	PCI half-size
Standard	2.2 ¹⁾	-	2.2 ¹⁾	2.2 ¹⁾	2.2 ¹⁾	2.2 ¹⁾	2.2 ¹⁾	2.2 ¹⁾
Bus speed	33 MHz	-	33 MHz	33 MHz	33 MHz	33 MHz	33 MHz	33 MHz
PCI to PCI bridge	-	-	-	-	-	-	-	Yes, slots 4 and 5

Table 54: 5PC810.BX01-00, 5PC810.BX01-01, 5PC810.BX02-00, 5PC810.BX02-01, 5PC810.BX03-00, 5PC810.BX05-00, 5PC810.BX05-01, 5PC810.BX05-02 - Technical data

Product ID	5PC810. BX01-00	5PC810. BX01-01	5PC810. BX02-00	5PC810. BX02-01	5PC810. BX03-00	5PC810. BX05-00	5PC810. BX05-01	5PC810. BX05-02
PCIe slots	-	1	-	1	1	1	3	-
Quantity	-	1	-	1	1	1	3	-
Design	-	PCIe half-size	-	PCIe half-size	PCIe half-size	PCIe half-size	PCIe half-size	-
Standard	-	1.0 a	-	1.0 a	1.0 a	1.0 a	1.0 a	-
Bus speed	-	x4 (10 GB/s)	-	x4 (10 GB/s)	x4 (10 GB/s)	x1 (2.5 GB/s)	x1 (2.5 GB/s)	-

Table 54: 5PC810.BX01-00, 5PC810.BX01-01, 5PC810.BX02-00, 5PC810.BX02-01, 5PC810.BX03-00, 5PC810.BX05-00, 5PC810.BX05-01, 5PC810.BX05-02 - Technical data

- 1) Due to mechanical limitations, a 64-bit PCI card cannot be inserted in every system unit or card slot. A table in the user's manual provides an overview of the slots where 64-bit cards can be inserted.

3.3 945GME CPU boards

3.3.1 General information

- AMI BIOS
- Intel® 945GME chipset
- 2x DDR2 memory slot
- Dual-channel memory
- Intel® GMA 950
- Gigabit Ethernet

3.3.2 Order data

Model number	Short description	Figure
CPU boards		
5PC800.B945-00	Intel Core Duo L2400 CPU board, 1.66 GHz, dual core, 667 MHz FSB, 2 MB L2 cache; 945GME chipset; 2 slots for SO-DIMM DDR2 modules (max. total of 3 GB), Realtek RTL8111B Ethernet controller	
5PC800.B945-01	Intel Core2 Duo L7400 CPU board, 1.5 GHz, dual core, 667 MHz FSB, 2 MB L2 cache; 945GME chipset; 2 slots for SO-DIMM DDR2 modules (max. total of 3 GB), Realtek RTL8111B Ethernet controller	
5PC800.B945-02	Intel Core2 Duo U7500 CPU board, 1.06 GHz, dual core, 533 MHz FSB, 2 MB L2 cache; 945GME chipset; 2 slots for SO-DIMM DDR2 modules (max. total of 3 GB), Realtek RTL8111B Ethernet controller	
5PC800.B945-03	Intel Celeron M 423 CPU board, 1.06 GHz, single core, 533 MHz FSB, 1 MB L2 cache; 945GME chipset; 2 slots for SO-DIMM DDR2 modules (max. total of 3 GB), Realtek RTL8111B Ethernet controller	
5PC800.B945-04	Intel Core2 Duo T7400 CPU board, 2.16 GHz, dual core, 667 MHz FSB, 2 MB L2 cache; 945GME chipset; 4 slots for SO-DIMM DDR2 modules (max. total of 3 GB), Realtek RTL8111B Ethernet controller	
5PC800.B945-05	Intel Atom N270 CPU board, 1.6 GHz, single core, 533 MHz FSB, 512 kB L2 cache; 945GME chipset; 2 slots for SO-DIMM DDR2 modules (max. total of 3 GB), Realtek RTL8111C Ethernet controller	
Required accessories		
Main memory		
5MMDDR.0512-01	SO-DIMM DDR2 RAM 512 MB PC2-5300	
5MMDDR.1024-01	SO-DIMM DDR2 RAM 1024 MB PC2-5300	
5MMDDR.2048-01	SO-DIMM DDR2 RAM 2048 MB PC2-5300	

Table 55: 5PC800.B945-00, 5PC800.B945-01, 5PC800.B945-02, 5PC800.B945-03, 5PC800.B945-04, 5PC800.B945-05 - Order data

Model number	Short description	Figure
CPU boards		
5PC800.B945-10	Intel Core Duo L2400 CPU board, 1.66 GHz, dual core, 667 MHz FSB, 2 MB L2 cache; 945GME chipset; 2 slots for SO-DIMM DDR2 modules (max. total of 3 GB), Realtek RTL8111C Ethernet controller	
5PC800.B945-11	Intel Core2 Duo L7400 CPU board, 1.5 GHz, dual core, 667 MHz FSB, 4 MB L2 cache; 945GME chipset; 2 slots for SO-DIMM DDR2 modules (max. total of 3 GB), Realtek RTL8111C Ethernet controller	
5PC800.B945-12	Intel Core2 Duo U7500 CPU board, 1.06 GHz, dual core, 533 MHz FSB, 2 MB L2 cache; 945GME chipset; 2 slots for SO-DIMM DDR2 modules (max. total of 3 GB), Realtek RTL8111C Ethernet controller	
5PC800.B945-13	Intel Celeron M 423 CPU board, 1.06 GHz, single core, 533 MHz FSB, 1 MB L2 cache; 945GME chipset; 2 slots for SO-DIMM DDR2 modules (max. total of 3 GB), Realtek RTL8111C Ethernet controller	
5PC800.B945-14	Intel Core2 Duo T7400 CPU board, 2.16 GHz, dual core, 667 MHz FSB, 4 MB L2 cache; 945GME chipset; 2 slots for SO-DIMM DDR2 modules (max. total of 3 GB), Realtek RTL8111C Ethernet controller	
Required accessories		
Main memory		
5MMDDR.0512-01	SO-DIMM DDR2 RAM 512 MB PC2-5300	
5MMDDR.1024-01	SO-DIMM DDR2 RAM 1024 MB PC2-5300	
5MMDDR.2048-01	SO-DIMM DDR2 RAM 2048 MB PC2-5300	

Table 56: 5PC800.B945-10, 5PC800.B945-11, 5PC800.B945-12, 5PC800.B945-13, 5PC800.B945-14 - Order data

3.3.3 5PC800.B945-0x - Technical data

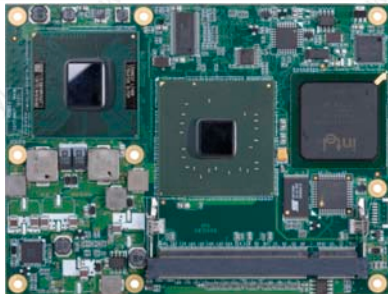
Product ID	5PC800.B945-00	5PC800.B945-01	5PC800.B945-02	5PC800.B945-03	5PC800.B945-04	5PC800.B945-05
General information						
Certification	Yes					
CE	Yes					
cULus	-	-	-	-	-	Yes
GL	-	-	-	-	-	Yes
Controller						
Boot loader	Embedded AMI BIOS					
Processor	Intel® Core™ Duo L2400, Intel® Core™ Duo L7400, Intel® Core™ Duo U7500, Intel® Celeron® M 423, Intel® Core™ Duo T7400, Intel® Atom™ N270					
Type	Intel® Core™ Duo L2400	Intel® Core™ Duo L7400	Intel® Core™ Duo U7500	Intel® Celeron® M 423	Intel® Core™ Duo T7400	Intel® Atom™ N270
Clock frequency	1660 MHz	1500 MHz	1060 MHz	1060 MHz	2160 MHz	1660 MHz
Number of cores	2	2	2	1	2	1
Architectures	65 nm	65 nm	65 nm	65 nm	65 nm	45 nm
L1 cache	32 kB	32 kB	32 kB	32 kB	32 kB	24 kB
L2 cache	2 MB	4 MB	2 MB	1 MB	4 MB	512 kB
External bus	667 MHz	667 MHz	533 MHz	533 MHz	667 MHz	533 MHz
Intel® 64 Architecture	No	Yes	Yes	No	Yes	No
Intel® Virtualization Technology (VT-x)	Yes	Yes	Yes	No	Yes	No
Enhanced Intel SpeedStep® Technology	Yes	Yes	Yes	No	Yes	Yes
Chipset	Intel® 945GME Intel® 82801 GHM (ICH7M-DH)					
Real-time clock	At 25°C: typ. 12 ppm (1 seconds) per day					
Accuracy	Yes					
Battery-buffered	Yes					
Memory socket	DDR2					
Type	Max. 3 GB					
Size						
Graphics	Intel® Graphics Media Accelerator 950					
Controller	Up to 224 MB ¹⁾					
Memory	Max. 32-bit					
Color depth						
Resolution	2x Intel-compliant SDVO ports, 1920 x 1080					
DVI	400 MHz RAMDAC, resolutions up to 2048 x 1536 @ 75 Hz (QXGA) and 1920 x 1080 @ 85 Hz (HDTV)					
RGB						
Mass memory management	2x SATA, 1x IDE					
Power management	ACPI 2.0, S3 Support (suspend to RAM)					

Table 57: 5PC800.B945-00, 5PC800.B945-01, 5PC800.B945-02, 5PC800.B945-03, 5PC800.B945-04, 5PC800.B945-05 - Technical data

1) Allocated in main memory.

3.3.4 5PC800.B945-1x - Technical data

Product ID	5PC800.B945-10	5PC800.B945-11	5PC800.B945-12	5PC800.B945-13	5PC800.B945-14
General information					
Certification	Yes				
CE	Yes				
cULus	Yes				
Controller					
Boot loader	Embedded AMI BIOS				
Processor	Intel® Core™ Duo L2400, Intel® Core™ Duo L7400, Intel® Core™ Duo U7500, Intel® Celeron® M 423, Intel® Core™ Duo T7400				
Type	Intel® Core™ Duo L2400	Intel® Core™ Duo L7400	Intel® Core™ Duo U7500	Intel® Celeron® M 423	Intel® Core™ Duo T7400
Clock frequency	1660 MHz	1500 MHz	1060 MHz	1060 MHz	2160 MHz
Number of cores	2	2	2	1	2
Architectures	65 nm				
L1 cache	32 kB				
L2 cache	2 MB	4 MB	2 MB	1 MB	4 MB
External bus	667 MHz	667 MHz	533 MHz	533 MHz	667 MHz
Intel® 64 Architecture	No	Yes	Yes	No	Yes
Intel® Virtualization Technology (VT-x)	Yes	Yes	Yes	No	Yes
Enhanced Intel SpeedStep® Technology	Yes	Yes	Yes	No	Yes
Chipset	Intel® 945GME Intel® 82801 GHM (ICH7M-DH)				
Real-time clock	At 25°C: typ. 12 ppm (1 seconds) per day				
Accuracy	Yes				
Battery-buffered	Yes				

Table 58: 5PC800.B945-10, 5PC800.B945-11, 5PC800.B945-12, 5PC800.B945-13, 5PC800.B945-14 - Technical data

Technical data • Individual components

Product ID	5PC800.B945-10	5PC800.B945-11	5PC800.B945-12	5PC800.B945-13	5PC800.B945-14
Memory socket					
Type	DDR2				
Size	Max. 3 GB				
Graphics					
Controller	Intel® Graphics Media Accelerator 950				
Memory	Up to 224 MB ¹⁾				
Color depth	Max. 32-bit				
Resolution					
DVI	2x Intel-compliant SDVO ports, 1920 x 1080				
RGB	400 MHz RAMDAC, resolutions up to 2048 x 1536 @ 75 Hz (QXGA) and 1920 x 1080 @ 85 Hz (HDTV)				
Mass memory management	2x SATA, 1x IDE				
Power management	ACPI 2.0, S3 Support (suspend to RAM)				

Table 58: 5PC800.B945-10, 5PC800.B945-11, 5PC800.B945-12, 5PC800.B945-13, 5PC800.B945-14 - Technical data

- 1) Allocated in main memory.

3.4 Heat sinks

3.4.1 Order data

Model number	Short description	Figure
Heat sinks		
5AC801.HS00-00	APC810 heat sink for CPU boards with L2400, L7400, U7500 or Celeron M 423 dual-core processor	
5AC801.HS00-01	APC810 heat sink for CPU boards with T7400, T9400 or P8400 dual-core processor	
5AC801.HS00-02	APC810 heat sink for CPU board with Atom processor N270	
Required accessories		
CPU boards		
5PC800.B945-00	Intel Core Duo L2400 CPU board, 1.66 GHz, dual core, 667 MHz FSB, 2 MB L2 cache; 945GME chipset; 2 slots for SO-DIMM DDR2 modules (max. total of 3 GB), Realtek RTL8111B Ethernet controller	
5PC800.B945-01	Intel Core2 Duo L7400 CPU board, 1.5 GHz, dual core, 667 MHz FSB, 2 MB L2 cache; 945GME chipset; 4 slots for SO-DIMM DDR2 modules (max. total of 3 GB), Realtek RTL8111B Ethernet controller	
5PC800.B945-02	Intel Core2 Duo U7500 CPU board, 1.06 GHz, dual core, 533 MHz FSB, 2 MB L2 cache; 945GME chipset; 2 slots for SO-DIMM DDR2 modules (max. total of 3 GB), Realtek RTL8111B Ethernet controller	
5PC800.B945-03	Intel Celeron M 423 CPU board, 1.06 GHz, single core, 533 MHz FSB, 1 MB L2 cache; 945GME chipset; 2 slots for SO-DIMM DDR2 modules (max. total of 3 GB), Realtek RTL8111B Ethernet controller	
5PC800.B945-04	Intel Core2 Duo T7400 CPU board, 2.16 GHz, dual core, 667 MHz FSB, 2 MB L2 cache; 945GME chipset; 4 slots for SO-DIMM DDR2 modules (max. total of 3 GB), Realtek RTL8111B Ethernet controller	
5PC800.B945-05	Intel Atom N270 CPU board, 1.6 GHz, single core, 533 MHz FSB, 512 kB L2 cache; 945GME chipset; 2 slots for SO-DIMM DDR2 modules (max. total of 3 GB), Realtek RTL8111C Ethernet controller	
5PC800.B945-10	Intel Core Duo L2400 CPU board, 1.66 GHz, dual core, 667 MHz FSB, 2 MB L2 cache; 945GME chipset; 2 slots for SO-DIMM DDR2 modules (max. total of 3 GB), Realtek RTL8111C Ethernet controller	
5PC800.B945-11	Intel Core2 Duo L7400 CPU board, 1.5 GHz, dual core, 667 MHz FSB, 2 MB L2 cache; 945GME chipset; 4 slots for SO-DIMM DDR2 modules (max. total of 3 GB), Realtek RTL8111C Ethernet controller	
5PC800.B945-12	Intel Core2 Duo U7500 CPU board, 1.06 GHz, dual core, 533 MHz FSB, 2 MB L2 cache; 945GME chipset; 2 slots for SO-DIMM DDR2 modules (max. total of 3 GB), Realtek RTL8111C Ethernet controller	
5PC800.B945-13	Intel Celeron M 423 CPU board, 1.06 GHz, single core, 533 MHz FSB, 1 MB L2 cache; 945GME chipset; 2 slots for SO-DIMM DDR2 modules (max. total of 3 GB), Realtek RTL8111C Ethernet controller	
5PC800.B945-14	Intel Core2 Duo T7400 CPU board, 2.16 GHz, dual core, 667 MHz FSB, 2 MB L2 cache; 945GME chipset; 4 slots for SO-DIMM DDR2 modules (max. total of 3 GB), Realtek RTL8111C Ethernet controller	

Table 59: 5AC801.HS00-00, 5AC801.HS00-01, 5AC801.HS00-02 - Order data

3.4.2 Technical data

Product ID	5AC801.HS00-00	5AC801.HS00-01	5AC801.HS00-02
General information			
Ideal for CPU boards	5PC800.B945-00 = -10 5PC800.B945-01 = -11 5PC800.B945-02 = -12 5PC800.B945-03 = -13	5PC800.B945-04 = -14	5PC800.B945-05
Certification		Yes	
CE	-	-	Yes
GL	-	-	-
cULus HazLoc Class 1 Division 2	-	Yes	-
ATEX Zone 22	-	Yes	-
Mechanical characteristics			
Materials	Aluminum, black-coated with copper heat pipes		

Table 60: 5AC801.HS00-00, 5AC801.HS00-01, 5AC801.HS00-02 - Technical data

Technical data • Individual components

Product ID	5AC801.HS00-00	5AC801.HS00-01	5AC801.HS00-02
Dimensions			
Width		228.7 mm	
Height		218 mm	
Depth	12.8 mm	28 mm	12.8 mm
Weight	Approx. 1700 g	Approx. 2000 g	Approx. 1700 g

Table 60: 5AC801.HS00-00, 5AC801.HS00-01, 5AC801.HS00-02 - Technical data

3.5 Main memory

3.5.1 General information

These 200-pin DDR2 main memory modules operate at 677 MHz and are available in sizes of 512 MB, 1 GB and 2 GB.

If two RAM modules with the same size (e.g. 1 GB) are inserted, then dual-channel memory technology is supported. This technology is not supported if two modules of different sizes (e.g. 1 GB and 2 GB) are inserted.

If two 2 GB modules are inserted, only 3 GB of main memory can be used.

3.5.2 Order data

Model number	Short description	Figure
	Main memory	
5MMDDR.0512-01	SO-DIMM DDR2 RAM 512 MB PC2-5300	
5MMDDR.1024-01	SO-DIMM DDR2 RAM 1024 MB PC2-5300	
5MMDDR.2048-01	SO-DIMM DDR2 RAM 2048 MB PC2-5300	

Table 61: 5MMDDR.0512-01, 5MMDDR.1024-01, 5MMDDR.2048-01 - Order data

3.5.3 Technical data

Product ID	5MMDDR.0512-01	5MMDDR.1024-01	5MMDDR.2048-01
General information			
Type	SO-DIMM DDR2 SDRAM		
Memory size	512 MB	1 GB	2 GB
Construction	200-pin		
Organization	64M x 64-bit	128M x 64-bit	256M x 64-bit
Velocity	DDR2-667 (PC2-5300)		
Certification			
CE		Yes	
cULus		Yes	
GL		Yes	

Table 62: 5MMDDR.0512-01, 5MMDDR.1024-01, 5MMDDR.2048-01 - Technical data

Information:

A main memory module can only be replaced at B&R.

3.6 Drives

3.6.1 5AC801.HDDI-00

3.6.1.1 General information

This 40 GB slide-in compact hard disk is specified for 24-hour operation, features an extended temperature range and can be used in APC810 and PPC800 system units.

When used in an APC810

When inserted in the slide-in compact slot, the slide-in compact drive is accessed internally via SATA.

3.6.1.2 Order data

Model number	Short description	Figure
	Drives	
5AC801.HDDI-00	40 GB SATA slide-in compact hard disk; 24/7 operation with extended temperature range. Note: please see the manual for information about using this hard disk	

Table 63: 5AC801.HDDI-00 - Order data

3.6.1.3 Technical data

Information:

The following characteristics, features and limit values only apply to this individual component and can deviate from those specified for the complete system. For the complete system in which this individual component is used, refer to the data given specifically for that device.

Product ID	5AC801.HDDI-00
General information	
Certification	
CE	Yes
cULus	Yes
GL	Yes
Hard disk drive	
Capacity	40 GB
Number of heads	1
Number of sectors	78,140,160
Bytes per sector	512
Cache	8 MB
Speed	5400 rpm ±1%
Startup time	Typ. 3 s (from 0 rpm to read access)
MTBF	750,000 POH ¹⁾
S.M.A.R.T. support	Yes
Interface	SATA
Access time	5.6 ms
Data transfer rate	
Internal	Max. 450 Mbit/s
To/From host	Max. 150 MB/s (Ultra DMA mode 5)
Positioning time	
Minimum (track to track)	1 ms
Nominal (read only)	12.5 ms
Maximum (read only)	23 ms

Table 64: 5AC801.HDDI-00 - Technical data

Product ID	5AC801.HDDI-00
Environmental conditions	
Temperature ²⁾	
Operation ³⁾	-30 to 85°C
24-hour operation ⁴⁾	-30 to 85°C
Storage	-40 to 95°C
Transport	-40 to 95°C
Relative humidity ⁵⁾	
Operation	5 to 90%, non-condensing
Storage	5 to 95%, non-condensing
Transport	5 to 95%, non-condensing
Vibration	
Operation	5 to 500 Hz: 2 g; no unrecoverable errors
Storage	5 to 500 Hz: 5 g; no unrecoverable errors
Transport	5 to 500 Hz: 5 g; no unrecoverable errors
Shock	
Operation	300 g and 2 ms duration; no unrecoverable errors 150 g and 11 ms duration; no unrecoverable errors
Storage	800 g and 2 ms duration; no unrecoverable errors
Transport	400 g and 0.5 ms duration; no unrecoverable errors 800 g and 2 ms duration; no unrecoverable errors 400 g and 0.5 ms duration; no unrecoverable errors
Altitude	
Operation	-300 to 5000 m
Storage	-300 to 12192 m
Mechanical characteristics	
Installation	Fixed ⁶⁾
Dimensions	
Width	13 mm
Height	98 mm
Depth	105 mm
Weight	134 g
Manufacturer information	
Manufacturer	Seagate
Manufacturer product ID	ST940817SM

Table 64: 5AC801.HDDI-00 - Technical data

- 1) With 8760 POH (power-on hours) per year and 70°C surface temperature.
- 2) Temperature values at an elevation of 305 meters. The temperature specification must be reduced linearly by 1°C every 305 meters. The temperature increase and decrease can be a maximum of 20°C per hour.
- 3) Standard operation refers to 333 POH (power-on hours) per month.
- 4) 24-hour operation refers to 732 POH (power-on hours) per month.
- 5) Humidity gradient: Maximum 15% per hour.
- 6) Slide-in compact installation.

3.6.1.4 Temperature humidity diagram

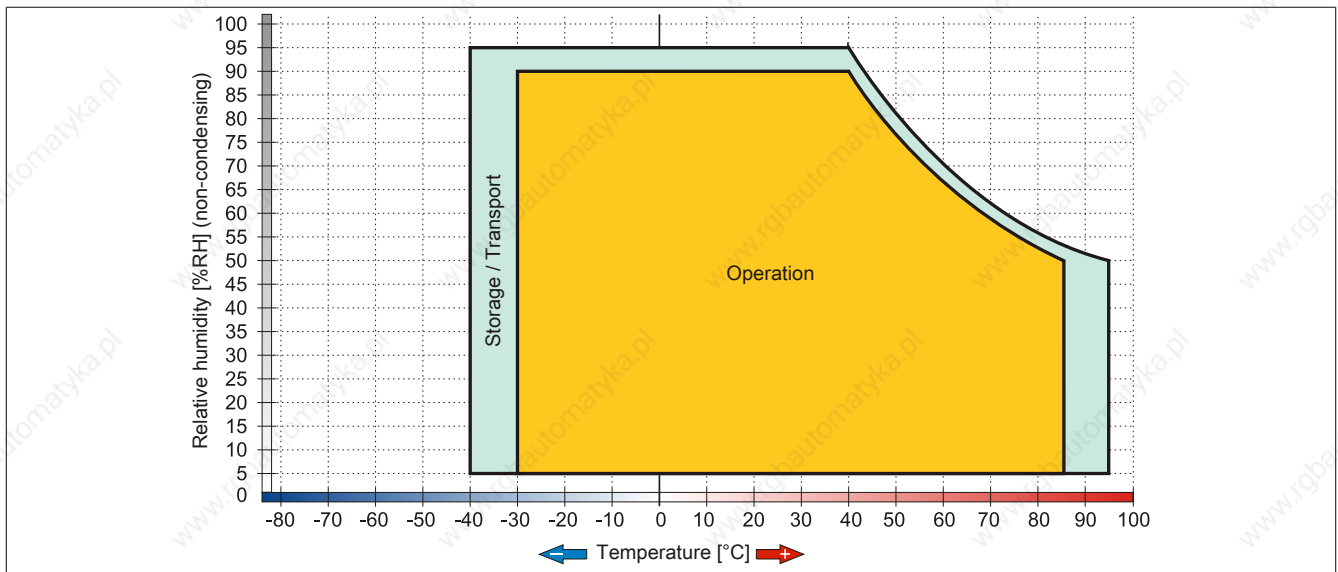

Figure 39: 5AC801.HDDI-00 - Temperature humidity diagram

3.6.2 5AC801.HDDI-01

3.6.2.1 General information

This 80 GB slide-in compact hard disk is specified for 24-hour operation, features an extended temperature range and can be used in APC810 and PPC800 system units.

When used in an APC810

When inserted in the slide-in compact slot, the slide-in compact drive is accessed internally via SATA.

3.6.2.2 Order data

Model number	Short description	Figure
	Drives	
5AC801.HDDI-01	80 GB slide-in compact SATA hard disk; 24/7 operation with extended temperature range. Note: Please see the manual for information about using this hard disk.	

Table 65: 5AC801.HDDI-01 - Order data

3.6.2.3 Technical data

Product ID	5AC801.HDDI-01
General information	
Certification	
CE	Yes
cULus	Yes
Hard disk drive	
Capacity	80 GB
Number of heads	2
Number of sectors	156,301,488
Bytes per sector	512
Cache	8 MB
Speed	5400 rpm \pm 1%
Startup time	Typ. 3 s (from 0 rpm to read access)
MTBF	750,000 POH ¹⁾
S.M.A.R.T. support	Yes
Interface	SATA
Access time	5.6 ms
Data transfer rate	
Internal	Max. 450 Mbit/s
To/From host	Max. 150 MB/s (Ultra DMA mode 5)
Positioning time	
Minimum (track to track)	1 ms
Nominal (read only)	12.5 ms
Maximum (read only)	23 ms
Environmental conditions	
Temperature ²⁾	
Operation ³⁾	-30 to 85°C
24-hour operation ⁴⁾	-30 to 85°C
Storage	-40 to 95°C
Transport	-40 to 95°C
Relative humidity ⁵⁾	
Operation	5 to 90%, non-condensing
Storage	5 to 95%, non-condensing
Transport	5 to 95%, non-condensing
Vibration	
Operation	5 to 500 Hz: 2 g; no unrecoverable errors
Storage	5 to 500 Hz: 5 g; no unrecoverable errors
Transport	5 to 500 Hz: 5 g; no unrecoverable errors

Table 66: 5AC801.HDDI-01 - Technical data

Product ID	5AC801.HDDI-01
Shock	
Operation	300 g and 2 ms duration; no unrecoverable errors
Storage	150 g and 11 ms duration; no unrecoverable errors
Transport	300 g and 2 ms duration; no unrecoverable errors
Transport	150 g and 11 ms duration; no unrecoverable errors
Altitude	
Operation	-300 to 5000 m
Storage	-300 to 12192 m
Mechanical characteristics	
Installation	Fixed ⁶⁾
Dimensions	
Width	13 mm
Height	98 mm
Depth	105 mm
Weight	133 g
Manufacturer information	
Manufacturer	Seagate
Manufacturer product ID	ST980817SM

Table 66: 5AC801.HDDI-01 - Technical data

- 1) With 8760 POH (power on hours) per year and 70°C surface temperature.
- 2) Temperature values at an elevation of 305 meters. The temperature specification must be reduced linearly by 1°C every 305 meters. The temperature increase and decrease can be a maximum of 20°C per hour.
- 3) Standard operation refers to 333 POH (power-on hours) per month.
- 4) 24-hour operation refers to 732 POH (power-on hours) per month.
- 5) Humidity gradient: Maximum 15% per hour.
- 6) Slide-in compact installation.

3.6.2.4 Temperature humidity diagram

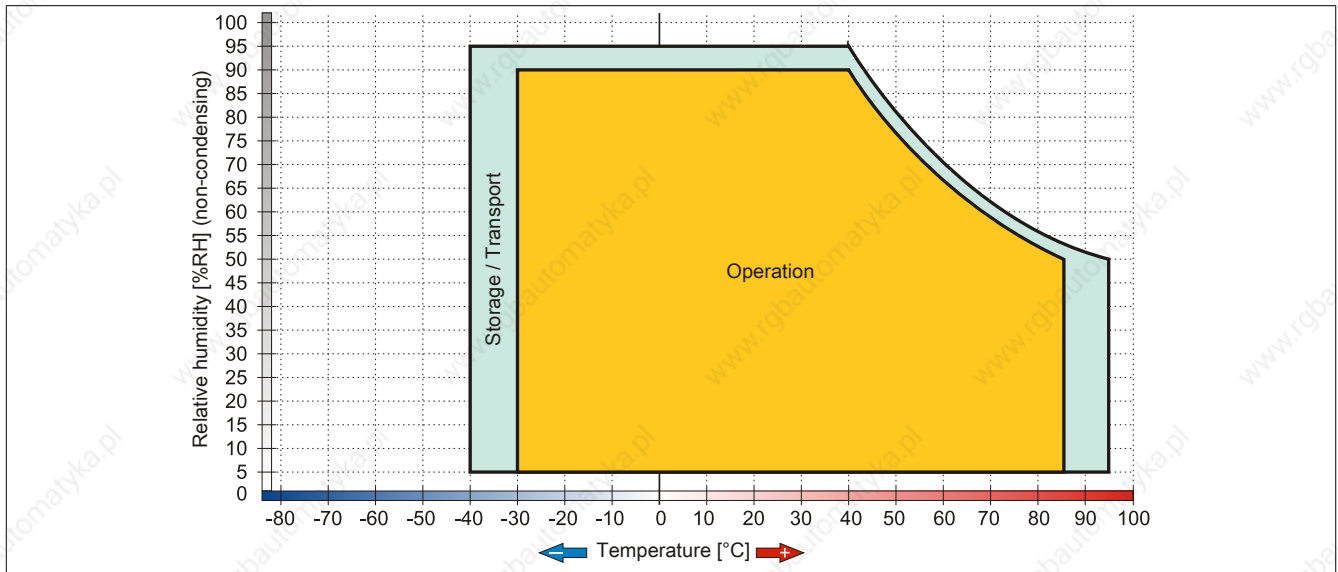

Figure 40: 5AC801.HDDI-01 - Temperature humidity diagram

3.6.3 5AC801.HDDI-02

3.6.3.1 General information

This 160 GB slide-in compact hard disk is specified for 24-hour operation, features an extended temperature range and can be used in APC810 and PPC800 system units.

When used in a APC810

When inserted in the slide-in compact slot, the slide-in compact drive is accessed internally via SATA.

3.6.3.2 Order data

Model number	Short description	Figure
	Drives	
5AC801.HDDI-02	160 GB SATA hard disk, slide-in compact, 24/7 operation with extended temperature range. Note: please see the manual for information about using this hard disk	

Table 67: 5AC801.HDDI-02 - Order data

3.6.3.3 Technical data

Information:

The following characteristics, features and limit values only apply to this individual component and can deviate from those specified for the complete system. For the complete system in which this individual component is used, refer to the data given specifically for that device.

Product ID	5AC801.HDDI-02
General information	
Certification	
CE	Yes
GL	Yes
Hard disk drive	
Capacity	160 GB
Number of heads	3
Number of sectors	312,581,808
Bytes per sector	512
Cache	8 MB
Speed	5400 rpm \pm 1%
Startup time	Typ. 4 s (from 0 rpm to read access)
MTBF	300,000 POH ¹⁾
S.M.A.R.T. support	Yes
Interface	SATA
Access time	12 ms
Data transfer rate	
Internal	Max. 84.6 Mbit/s
To/From host	Max. 150 MB/s (Ultra DMA mode 5)
Positioning time	
Minimum (track to track)	1.5 ms
Nominal (read only)	12 ms
Maximum (read only)	22 ms
Environmental conditions	
Temperature ²⁾	
Operation	-15 to 80°C
24-hour operation ³⁾	-15 to 80°C
Storage	-40 to 95°C
Transport	-40 to 95°C

Table 68: 5AC801.HDDI-02 - Technical data

Product ID	5AC801.HDDI-02
Relative humidity ⁴⁾	
Operation	8 to 90%, non-condensing ⁵⁾
Storage	5 to 95%, non-condensing ⁶⁾
Transport	5 to 95%, non-condensing ⁶⁾
Vibration	
Operation	5 to 500 Hz: 1 g; no unrecoverable errors
Storage	5 to 500 Hz: 5 g, no damage
Transport	5 to 500 Hz: 5 g, no damage
Shock	
Operation	325 g and 2 ms duration; no unrecoverable errors
Storage	900 g, 1 ms; no damage
Transport	120 g, 11 ms; no damage
Transport	900 g, 1 ms; no damage
Transport	120 g, 11 ms; no damage
Altitude	
Operation	-300 to 3000 m
Storage	-300 to 12192 m
Mechanical characteristics	
Installation	Fixed ⁷⁾
Dimensions	
Width	13 mm
Height	98 mm
Depth	105 mm
Weight	135 g
Manufacturer information	
Manufacturer	Fujitsu
Manufacturer product ID	MHY2160BH-ESW

Table 68: 5AC801.HDDI-02 - Technical data

- 1) With 8760 POH (power-on hours) per year and 70°C surface temperature.
- 2) Standard operation refers to 333 POH (power-on hours) per month.
- 3) 24-hour operation refers to 732 POH (power-on hours) per month.
- 4) Humidity gradient: Maximum 15% per hour.
- 5) Maximum humidity at 29°C.
- 6) Maximum humidity at 40°C.
- 7) Slide-in compact installation.

3.6.3.4 Temperature humidity diagram

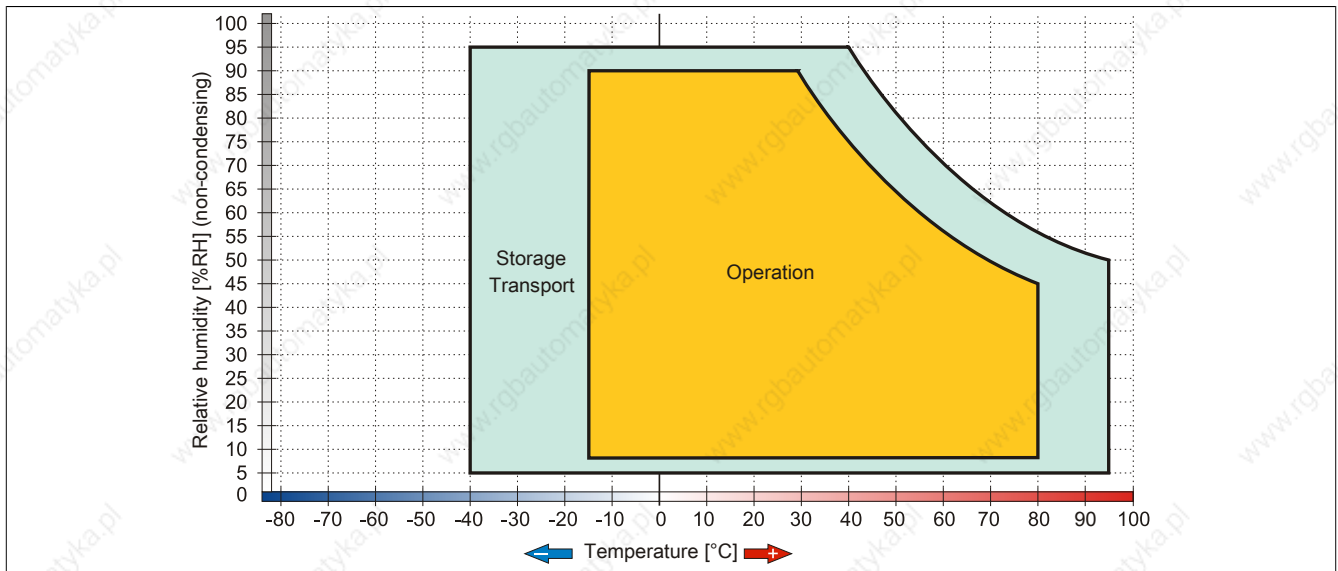

Figure 41: 5AC801.HDDI-02 - Temperature humidity diagram

3.6.4 5AC801.HDDI-03

3.6.4.1 General information

This 250 GB slide-in compact hard disk is specified for 24-hour operation and can be used in APC810 and PPC800 system units.

When used in an APC810

When inserted in the slide-in compact slot, the slide-in compact drive is accessed internally via SATA.

3.6.4.2 Order data

Model number	Short description	Figure
	Drives	
5AC801.HDDI-03	250 GB slide-in compact SATA hard disk, 24/7 operation. Note: please see the manual for information about using this hard disk	
	Optional accessories	
	Drives	
5MMHDD.0250-00	250 GB SATA hard disk; replacement for 5AC801.HDDI-03 and 5ACPCI.RAIC-05; note: please see the manual for information about using this hard disk	

Table 69: 5AC801.HDDI-03 - Order data

3.6.4.3 Technical data

Information:

The following characteristics, features and limit values only apply to this individual component and can deviate from those specified for the complete system. For the complete system in which this individual component is used, refer to the data given specifically for that device.

Product ID	5AC801.HDDI-03
General information	
Certification	
CE	Yes
cULus	Yes
cULus HazLoc Class 1 Division 2	Yes
ATEX Zone 22	Yes
GL	Yes
Hard disk drive	
Capacity	250 GB
Number of heads	1
Number of sectors	488,397,168
Bytes per sector	512
Cache	8 MB
Speed	5400 rpm ±0.2%
Startup time	Typ. 3.6 s (from 0 rpm to read access)
MTBF	550,000 POH ¹⁾
S.M.A.R.T. support	Yes
Interface	SATA
Access time	5.56 ms
Supported transfer modes	SATA 1.0, Serial ATA Revision 2.6 PIO mode 0-4, multiword DMA mode 0-2, UDMA mode 0-6
Data transfer rate	
Internal	Max. 1175 Mbit/s
To/From host	Max. 150 MB/s (SATA I), max. 300 MB/s (SATA II)
Positioning time	
Minimum (track to track)	1 ms
Nominal (read only)	14 ms
Maximum (read only)	30 ms

Table 70: 5AC801.HDDI-03 - Technical data

Product ID	5AC801.HDDI-03
Environmental conditions	
Temperature ²⁾	
Operation ³⁾	0 to 60°C
24-hour operation ⁴⁾	0 to 60°C
Storage	-40 to 70°C
Transport	-40 to 70°C
Relative humidity ⁵⁾	
Operation	5 to 95%, non-condensing
Storage	5 to 95%, non-condensing
Transport	5 to 95%, non-condensing
Vibration	
Operation	5 to 500 Hz: 0.5 g; no unrecoverable errors
Storage	5 to 500 Hz: 5 g; no unrecoverable errors
Transport	5 to 500 Hz: 5 g; no unrecoverable errors
Shock	
Operation	350 g and 2 ms duration; no unrecoverable errors
Storage	800 g and 2 ms duration; no unrecoverable errors
	1000 g and 1 ms duration; no unrecoverable errors
Transport	600 g and 0.5 ms duration; no unrecoverable errors
	800 g and 2 ms duration; no unrecoverable errors
	1000 g and 1 ms duration; no unrecoverable errors
	600 g and 0.5 ms duration; no unrecoverable errors
Altitude	
Operation	-300 to 3048 m
Storage	-300 to 12192 m
Mechanical characteristics	
Installation	Fixed ⁶⁾
Dimensions	
Width	13 mm
Height	98 mm
Depth	105 mm
Weight	134 g
Manufacturer information	
Manufacturer	Seagate
Manufacturer product ID	ST9250315AS

Table 70: 5AC801.HDDI-03 - Technical data

- 1) With 8760 POH (power-on hours) per year and 25°C surface temperature.
- 2) Temperature values at an elevation of 305 meters. The temperature specification must be reduced linearly by 1°C every 305 meters. The temperature increase and decrease can be a maximum of 20°C per hour.
- 3) Standard operation refers to 333 POH (power-on hours) per month.
- 4) 24-hour operation refers to 732 POH (power-on hours) per month.
- 5) Humidity gradient: Maximum 30% per hour.
- 6) Slide-in compact installation.

3.6.4.4 Temperature humidity diagram

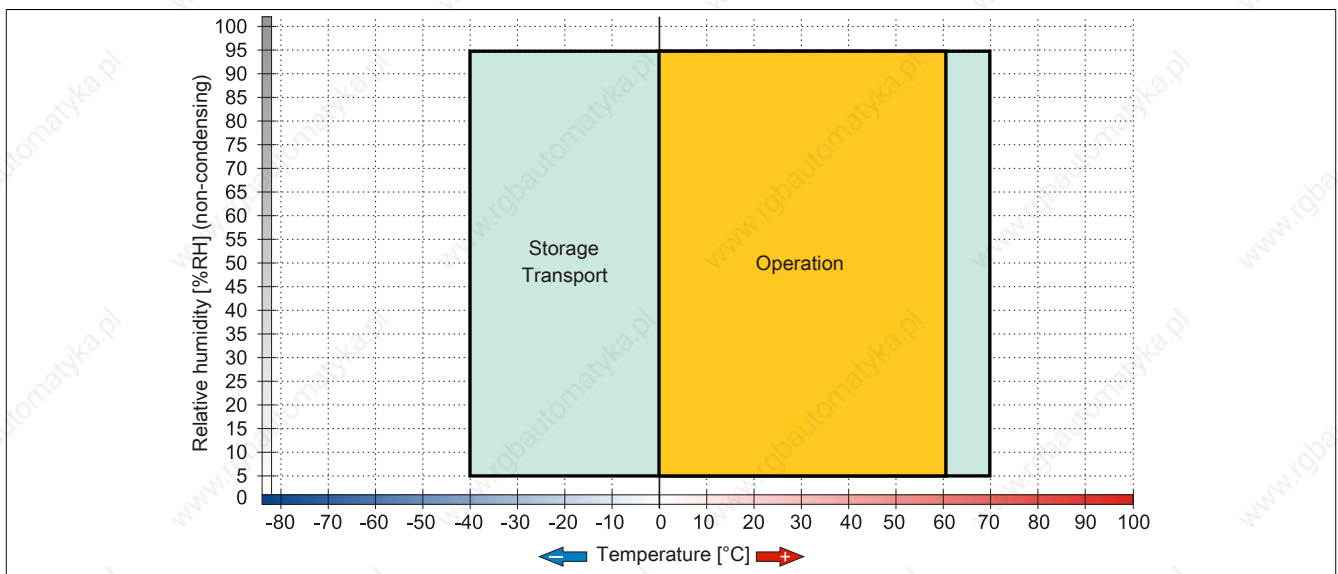

Figure 42: 5AC801.HDDI-03 - Temperature humidity diagram

3.6.5 5AC801.HDDI-04

3.6.5.1 General information

This 500 GB slide-in compact hard disk is specified for 24-hour operation and can be used in APC810 and PPC800 system units.

- 500 GB hard disk
- Slide-in compact
- Specified for 24-hour operation
- S.M.A.R.T. support

When used in an APC810

When inserted in the slide-in compact slot, the slide-in compact drive is accessed internally via SATA.

3.6.5.2 Order data

Model number	Short description	Figure
	Drives	
5AC801.HDDI-04	500 GB SATA hard disk, slide-in compact, 24/7 operation Note: please see the manual for information about using this hard disk	
	Optional accessories	
	Drives	
5MMHDD.0500-00	500 GB SATA hard disk; replacement for 5AC801.HDDI-04, 5AC901.CHDD-01 and 5ACPCI.RAIC-06; note: please see the manual for information about using this hard disk	

Table 71: 5AC801.HDDI-04 - Order data

3.6.5.3 Technical data

Information:

The following characteristics, features and limit values only apply to this accessory and can deviate from those specified for the complete system. The data specifications for the complete system take precedence over those of individual components.

Product ID	5AC801.HDDI-04
General information	
Certification	
CE	Yes
cULus	Yes
GL	Yes
Hard disk drive	
Capacity	500 GB
Number of heads	2
Number of sectors	976,773,168
Bytes per sector	512 (logical) / 4096 (physical)
Cache	16 MB
Speed	5400 rpm ±0.2%
Startup time	Typ. 3.5 s (from 0 rpm to read access)
Service life	5 years
MTBF	1,000,000 POH ¹⁾
S.M.A.R.T. support	Yes
Interface	SATA
Access time	5.5 ms
Supported transfer modes	SATA II
Data transfer rate	
Internal	Max. 147 MB/s
To/From host	Max. 150 MB/s (SATA I), max. 300 MB/s (SATA II)
Positioning time	
Nominal (read only)	11 ms
Maximum (read only)	21 ms
Environmental conditions	
Temperature ²⁾	
Operation ³⁾	0 to 60°C
24-hour operation ⁴⁾	0 to 60°C
Storage	-40 to 70°C
Transport	-40 to 70°C

Table 72: 5AC801.HDDI-04 - Technical data

Product ID	5AC801.HDDI-04
Relative humidity ⁵⁾	
Operation	5 to 95%, non-condensing
Storage	5 to 95%, non-condensing
Transport	5 to 95%, non-condensing
Vibration	
Operation (continuous)	5 to 500 Hz: 0.25 g; no unrecoverable errors
Operation (occasional)	5 to 500 Hz: 0.5 g; no unrecoverable errors
Storage	10 to 500 Hz: 5 g; no unrecoverable errors
Transport	10 to 500 Hz: 5 g; no unrecoverable errors
Shock	
Operation	400 g and 2 ms duration; no unrecoverable errors
Storage	1000 g and 2 ms duration; no unrecoverable errors
Transport	1000 g and 2 ms duration; no unrecoverable errors
Altitude	
Operation	-305 to 3048 m
Storage	-305 to 12192 m
Mechanical characteristics	
Installation	Fixed ⁶⁾
Dimensions	
Width	13 mm
Height	98 mm
Depth	105 mm
Weight	134 g
Manufacturer information	
Manufacturer	Western Digital
Manufacturer product ID	WD5000LUCT

Table 72: 5AC801.HDDI-04 - Technical data

- 1) With 8760 POH (power-on hours) per year and 25°C surface temperature.
- 2) Temperature values at an elevation of 305 meters. The temperature specification must be reduced linearly by 1°C every 305 meters. The temperature increase and decrease can be a maximum of 20°C per hour.
- 3) Standard operation refers to 333 POH (power-on hours) per month.
- 4) 24-hour operation refers to 732 POH (power-on hours) per month.
- 5) Humidity gradient: Maximum 20% per hour.
- 6) Slide-in compact installation.

3.6.5.4 Temperature humidity diagram

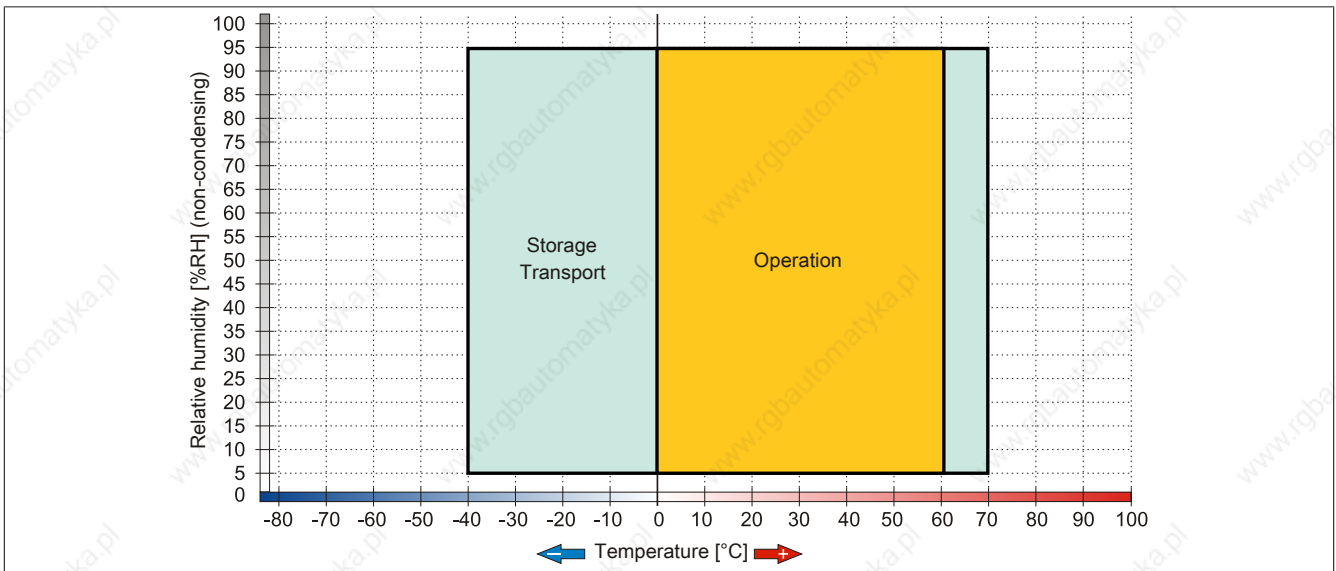

Figure 43: 5AC801.HDDI-04 - Temperature humidity diagram

3.6.6 5AC801.SSDI-00

3.6.6.1 General information

This 32 GB slide-in compact SSD (solid-state drive) is based on single-level cell (SLC) technology and can be used in APC810 and PPC800 system units.

When used in an APC810

Information:

The slide-in compact SSD cannot be used with the 5AC801.ADAS-00 adapter in slide-in slot 2 of the 5-slot variant of the APC810.

When inserted in the slide-in compact slot, the slide-in compact drive is accessed internally via SATA.

3.6.6.2 Order data

Model number	Short description	Figure
5AC801.SSDI-00	32 GB SATA SSD (SLC), slide-in compact	

Table 73: 5AC801.SSDI-00 - Order data

3.6.6.3 Technical data

Caution!

A sudden loss of power may result in data loss! In very rare cases, the mass storage device may also become damaged.

To prevent damage and loss of data, the use of a UPS device is recommended.

Information:

The following characteristics, features and limit values only apply to this individual component and can deviate from those specified for the complete system. For the complete system in which this individual component is used, refer to the data given specifically for that device.

Product ID	5AC801.SSDI-00
General information	
Certification	
CE	Yes
cULus	Yes
GL	Yes
Solid state drive	
Capacity	32 GB
Data reliability	<1 unrecoverable error in 10 ¹⁵ bit read accesses
MTBF	2,000,000 hours
Power on/off cycles	50,000
S.M.A.R.T. support	Yes
Interface	SATA
Maintenance	None
Continuous reading	Max. 250 MB/s
Continuous writing	Max. 170 MB/s

Table 74: 5AC801.SSDI-00 - Technical data

Product ID	5AC801.SSDI-00
IOPS ¹⁾	
4k read	35,000
4k write	3,300
Endurance	
Guaranteed data volume	
Guaranteed	700 TB
Results for 5 years	350 GB/day
SLC flash	Yes
Wear leveling	Static
Error correction coding (ECC)	Yes
Compatibility	SATA revision 2.6 compliant, compatible with SATA 1.5 Gbit/s and 3 Gbit/s interface rates ATA/ATAPI-7 SSD Enhanced SMART ATA feature set Native Command Queuing (NCQ)
Environmental conditions	
Temperature	
Operation	0 to 70°C
Storage	-55 to 95°C
Transport	-55 to 95°C
Relative humidity	
Operation	5 to 95%, non-condensing
Storage	5 to 95%, non-condensing
Transport	5 to 95%, non-condensing
Vibration	
Operation	7 to 800 Hz: 2.17 g
Storage	10 to 500 Hz: 3.13 g
Transport	10 to 500 Hz: 3.13 g
Shock	
Operation	1000 g, 0.5 ms
Storage	1000 g, 0.5 ms
Transport	1000 g, 0.5 ms
Altitude	
Operation	-300 to 12192 m
Storage	-300 to 12192 m
Transport	-300 to 12192 m
Mechanical characteristics	
Installation	Fixed ²⁾
Dimensions	
Width	13 mm
Height	98 mm
Depth	105 mm
Weight	118 g
Manufacturer information	
Manufacturer	Intel
Manufacturer product ID	SSDSA2SH032G1

Table 74: 5AC801.SSDI-00 - Technical data

- 1) IOPS: Random read and write input/output operations per second.
- 2) Slide-in compact installation.

3.6.6.4 Temperature humidity diagram

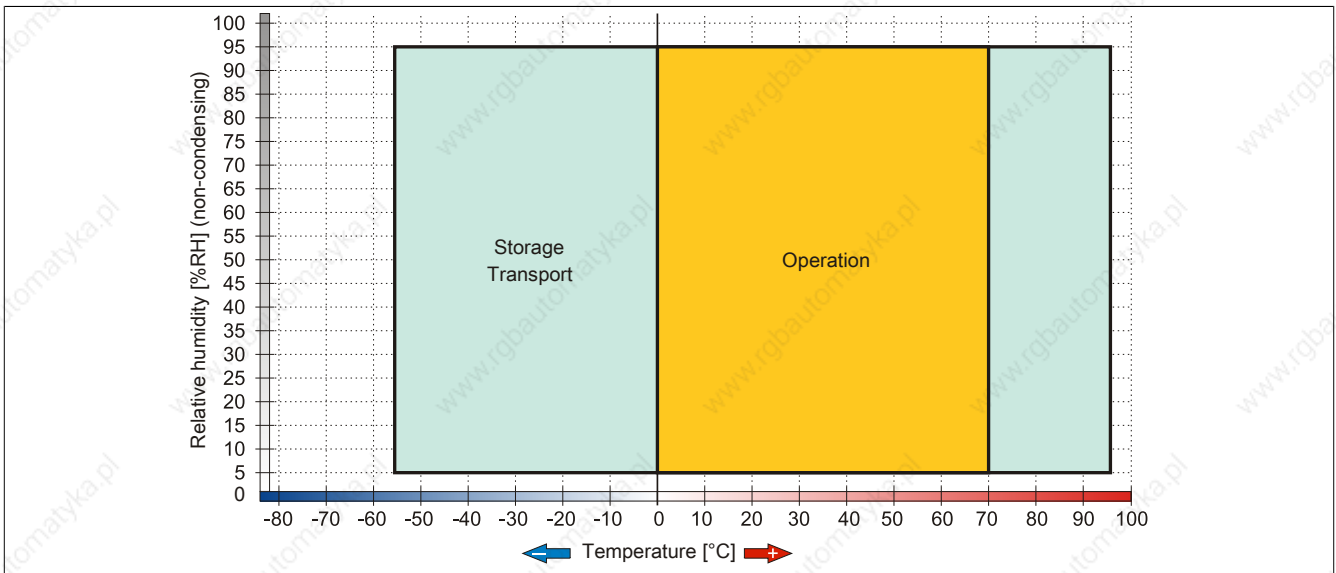

Figure 44: 5AC801.SSDI-00 - Temperature humidity diagram

3.6.6.5 Benchmark

The following two benchmarks show a comparison of the Intel solid-state drive (5AC801.SSDI-00) and the Seagate hard disk (5AC801.HDDI-00) for cyclic reading and writing.

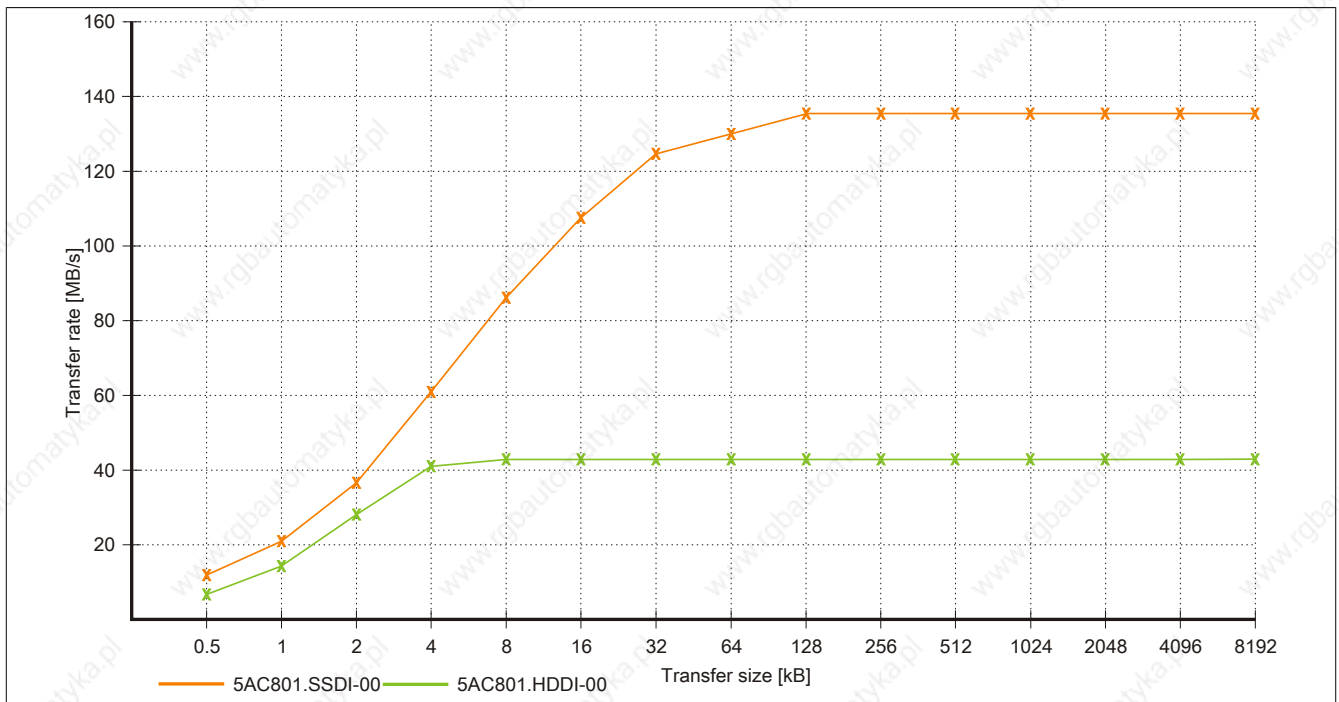

Figure 45: 5AC801.SSDI-00 - ATTO disk benchmark v2.34 - Cyclic read

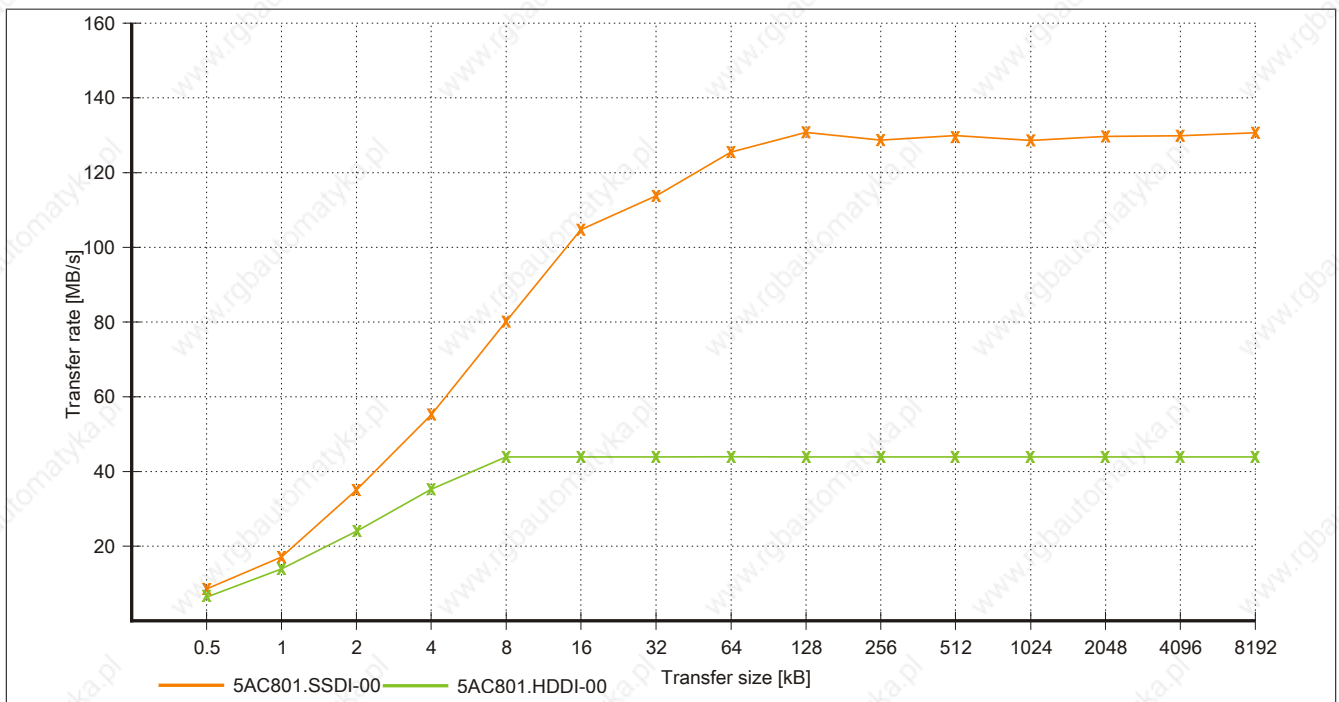

Figure 46: 5AC801.SSDI-00 - ATTO disk benchmark v2.34 - Cyclic write

3.6.7 5AC801.SSDI-01

3.6.7.1 General information

This 60 GB slide-in compact SSD (solid-state drive) is based on multi-level cell (MLC) technology and can be used in APC810 and PPC800 system units.

When used in an APC810

Information:

The slide-in compact SSD cannot be used with the 5AC801.ADAS-00 adapter in slide-in slot 2 of the 5-slot variant of the APC810.

When inserted in the slide-in compact slot, the slide-in compact drive is accessed internally via SATA.

3.6.7.2 Order data

Model number	Short description	Figure
	Drives	
5AC801.SSDI-01	60 GB SATA slide-in compact SSD (MLC)	
	Optional accessories	
	Drives	
5MMSSD.0060-00	60 GB SATA SSD (MLC); replacement for 5AC801.SSDI-01 and 5AC901.CSSD-01; SSD for 5PP5IO.GMAC-00; note: please see the manual for information about using this SSD	

Table 75: 5AC801.SSDI-01 - Order data

3.6.7.3 Technical data

Caution!

A sudden loss of power may result in data loss! In very rare cases, the mass storage device may also become damaged.

To prevent damage and loss of data, the use of a UPS device is recommended.

Information:

The following characteristics, features and limit values only apply to this accessory and can deviate from those specified for the complete system. The data specifications for the complete system take precedence over those of individual components.

Product ID	5AC801.SSDI-01
General information	
Certification	
CE	Yes
cULus	Yes
GL	Yes
Solid state drive	
Capacity	60 GB
Data reliability	<1 unrecoverable error in 10 ¹⁶ bit read accesses
MTBF	1,200,000 hours
S.M.A.R.T. support	Yes
Interface	SATA
Maintenance	None
Continuous reading	Max. 550 MB/s with SATA 6 Gbit/s Max. 280 MB/s with SATA 3 Gbit/s
Continuous writing	Max. 475 MB/s with SATA 6 Gbit/s Max. 245 MB/s with SATA 3 Gbit/s

Table 76: 5AC801.SSDI-01 - Technical data

Product ID	5AC801.SSDI-01
IOPS ¹⁾	15,000
4k read	
4k write	
Typical	23,000
Maximum	80,000
Endurance	
MLC flash	Yes
Compatibility	SATA 3.0 compliant ACS-2 SSD Enhanced SMART ATA feature set Native Command Queuing (NCQ)
Environmental conditions	
Temperature	
Operation	0 to 70°C
Storage	-55 to 95°C
Transport	-55 to 95°C
Relative humidity	
Operation	5 to 95%, non-condensing
Storage	5 to 95%, non-condensing
Transport	5 to 95%, non-condensing
Vibration	
Operation	5 to 700 Hz: 2.17 g
Storage	5 to 800 Hz: 3.13 g
Transport	5 to 800 Hz: 3.13 g
Shock	
Operation	1500 g, 0.5 ms
Storage	1500 g, 0.5 ms
Transport	1500 g, 0.5 ms
Altitude	
Operation	-300 to 12192 m
Storage	-300 to 12192 m
Transport	-300 to 12192 m
Mechanical characteristics	
Installation	Fixed ²⁾
Dimensions	
Width	13 mm
Height	98 mm
Depth	105 mm
Weight	118 g
Manufacturer information	
Manufacturer	Intel
Manufacturer product ID	SSDSC2CW060A3

Table 76: 5AC801.SSDI-01 - Technical data

- 1) IOPS: Random read and write input/output operations per second.
- 2) Slide-in compact installation.

3.6.7.4 Temperature humidity diagram

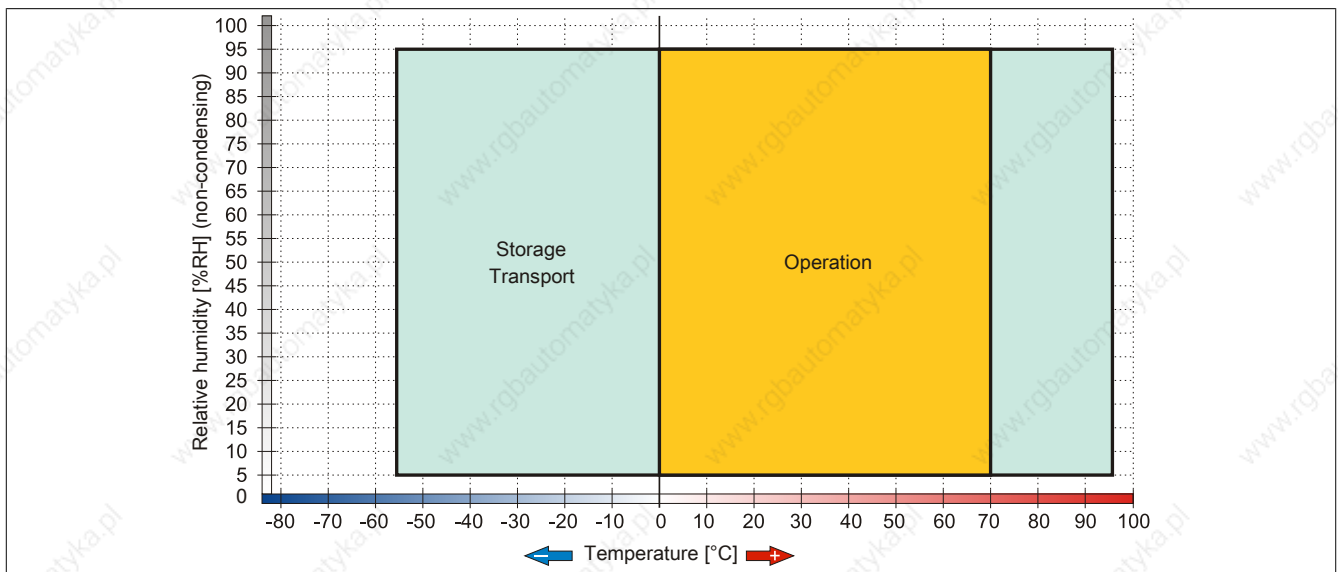

Figure 47: 5AC801.SSDI-01 - Temperature humidity diagram

3.6.8 5AC801.SSDI-02

3.6.8.1 General information

This 180 GB slide-in compact SSD (solid-state drive) is based on multi-level cell (MLC) technology and can be used in APC810 and PPC800 system units.

When used in an APC810

Information:

The slide-in compact SSD cannot be used with the 5AC801.ADAS-00 adapter in slide-in slot 2 of the 5-slot variant of the APC810.

When inserted in the slide-in compact slot, the slide-in compact drive is accessed internally via SATA.

3.6.8.2 Order data

Model number	Short description	Figure
	Drives	
5AC801.SSDI-02	180 GB SATA slide-in compact SSD (MLC)	
	Optional accessories	
	Drives	
5MMSSD.0180-00	180 GB SATA SSD (MLC); replacement part for 5AC801.SSDI-02 and 5AC901.CSSD-02; SSD for 5PP5IO.GMAC-00; note: please see the manual for information about using this SSD	

Table 77: 5AC801.SSDI-02 - Order data

3.6.8.3 Technical data

Caution!

A sudden loss of power may result in data loss! In very rare cases, the mass storage device may also become damaged.

To prevent damage and loss of data, the use of a UPS device is recommended.

Information:

The following characteristics, features and limit values only apply to this accessory and can deviate from those specified for the complete system. The data specifications for the complete system take precedence over those of individual components.

Product ID	5AC801.SSDI-02
General information	
Certification	
CE	Yes
cULus	Yes
GL	Yes
Solid state drive	
Capacity	180 GB
Data reliability	<1 unrecoverable error in 10 ¹⁶ bit read accesses
MTBF	1,200,000 hours
S.M.A.R.T. support	Yes
Interface	SATA
Maintenance	None
Continuous reading	Max. 550 MB/s with SATA 6 Gbit/s Max. 280 MB/s with SATA 3 Gbit/s
Continuous writing	Max. 520 MB/s with SATA 6 Gbit/s Max. 260 MB/s with SATA 3 Gbit/s

Table 78: 5AC801.SSDI-02 - Technical data

Product ID	5AC801.SSDI-02
IOPS ¹⁾	
4k read	50,000
4k write	
Typical	60,000
Maximum	80,000
Endurance	
MLC flash	Yes
Compatibility	SATA 3.0 compliant ACS-2 SSD Enhanced SMART ATA feature set Native Command Queuing (NCQ)
Environmental conditions	
Temperature	
Operation	0 to 70°C
Storage	-55 to 95°C
Transport	-55 to 95°C
Relative humidity	
Operation	5 to 95%, non-condensing
Storage	5 to 95%, non-condensing
Transport	5 to 95%, non-condensing
Vibration	
Operation	5 to 700 Hz: 2.17 g
Storage	5 to 800 Hz: 3.13 g
Transport	5 to 800 Hz: 3.13 g
Shock	
Operation	1500 g, 0.5 ms
Storage	1500 g, 0.5 ms
Transport	1500 g, 0.5 ms
Altitude	
Operation	-300 to 12192 m
Storage	-300 to 12192 m
Transport	-300 to 12192 m
Mechanical characteristics	
Installation	Fixed ²⁾
Dimensions	
Width	13 mm
Height	98 mm
Depth	105 mm
Weight	118 g
Manufacturer information	
Manufacturer	Intel
Manufacturer product ID	SSDSC2CW180A3

Table 78: 5AC801.SSDI-02 - Technical data

- 1) IOPS: Random read and write input/output operations per second.
- 2) Slide-in compact installation.

3.6.8.4 Temperature humidity diagram

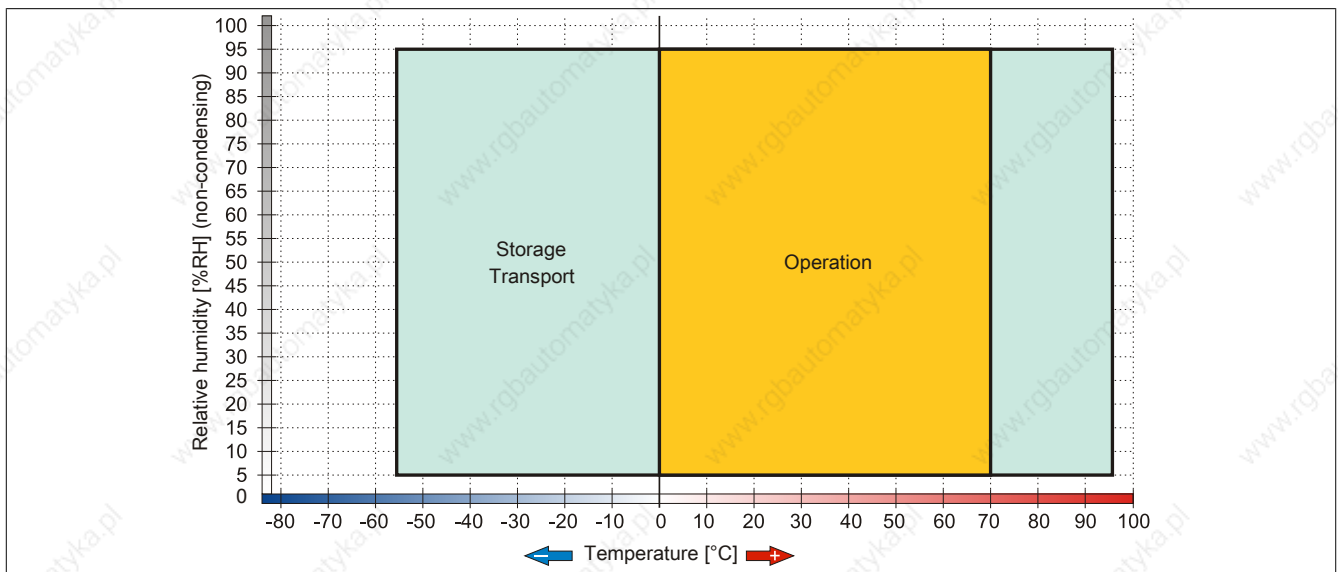

Figure 48: 5AC801.SSDI-02 - Temperature humidity diagram

3.6.9 5AC801.SSDI-03

3.6.9.1 General information

This 60 GB slide-in compact SSD (solid-state drive) is based on multi-level cell (MLC) technology and can be used in APC810 and PPC800 system units.

When used in an APC810

Information:

The slide-in compact SSD cannot be used with the 5AC801.ADAS-00 adapter in slide-in slot 2 of the 5-slot variant of the APC810.

When inserted in the slide-in compact slot, the slide-in compact drive is accessed internally via SATA.

3.6.9.2 Order data

Model number	Short description	Figure
	Drives	
5AC801.SSDI-03	60 GB SATA slide-in compact SSD (MLC)	
	Optional accessories	
	Drives	
5MMSSD.0060-01	60 GB SATA SSD (MLC); replacement for 5AC801.SSDI-03 and 5AC901.CSSD-03; SSD for 5PP5IO.GMAC-00; note: please see the manual for information about using this SSD	

Table 79: 5AC801.SSDI-03 - Order data

3.6.9.3 Technical data

Caution!

A sudden loss of power may result in data loss! In very rare cases, the mass storage device may also become damaged.

To prevent damage and loss of data, the use of a UPS device is recommended.

Information:

The following characteristics, features and limit values only apply to this accessory and can deviate from those specified for the complete system. The data specifications for the complete system take precedence over those of individual components.

Product ID	5AC801.SSDI-03
General information	
Certification	
CE	Yes
cULus	Yes
GL	Yes
Solid state drive	
Capacity	60 GB
Data reliability	<1 unrecoverable error in 10 ¹⁵ bit read accesses
MTBF	1,500,000 hours
S.M.A.R.T. support	Yes
Interface	SATA
Maintenance	None
Continuous reading	Max. 510 MB/s
Continuous writing	Max. 430 MB/s
IOPS ¹⁾	
4k read	Max. 60,000 (random)
4k write	Max. 25,000 (random)
Endurance	
MLC flash	Yes
Compatibility	SATA 3.0 compliant ACS-2 SSD Enhanced SMART ATA feature set Native Command Queuing (NCQ)

Table 80: 5AC801.SSDI-03 - Technical data

Product ID	5AC801.SSDI-03
Environmental conditions	
Temperature	
Operation	0 to 70°C
Storage	-40 to 95°C
Transport	-40 to 95°C
Relative humidity	
Operation	8 to 95%, non-condensing
Storage	8 to 95%, non-condensing
Transport	8 to 95%, non-condensing
Vibration	
Operation	10 to 2000 Hz: 20 g
Storage	10 to 2000 Hz: 20 g
Transport	10 to 2000 Hz: 20 g
Shock	
Operation	1500 g, 0.5 ms
Storage	1500 g, 0.5 ms
Transport	1500 g, 0.5 ms
Altitude	
Operation	-300 to 12192 m
Storage	-300 to 12192 m
Transport	-300 to 12192 m
Mechanical characteristics	
Installation	Fixed ²⁾
Dimensions	
Width	13 mm
Height	98 mm
Depth	105 mm
Weight	118 g
Manufacturer information	
Manufacturer	Toshiba
Manufacturer product ID	THNSNH060GBST

Table 80: 5AC801.SSDI-03 - Technical data

- 1) IOPS: Random read and write input/output operations per second.
- 2) Slide-in compact installation.

3.6.9.4 Temperature humidity diagram

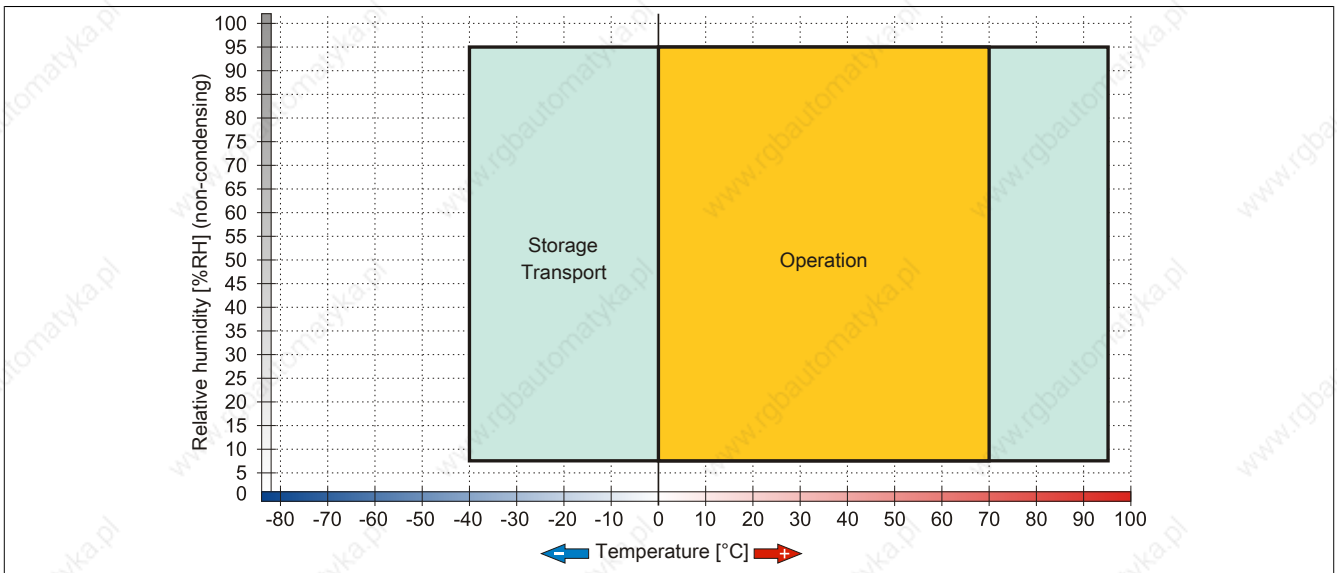

Figure 49: 5AC801.SSDI-03 - Temperature humidity diagram

3.6.10 5AC801.SSDI-04

3.6.10.1 General information

This 128 GB slide-in compact SSD (solid-state drive) is based on multi-level cell (MLC) technology and can be used in APC810 and PPC800 system units.

When used in an APC810

Information:

The slide-in compact SSD cannot be used with the 5AC801.ADAS-00 adapter in slide-in slot 2 of the 5-slot variant of the APC810.

When inserted in the slide-in compact slot, the slide-in compact drive is accessed internally via SATA.

3.6.10.2 Order data

Model number	Short description	Figure
	Drives	
5AC801.SSDI-04	128 GB SATA SSD (MLC), slide-in compact	
	Optional accessories	
	Drives	
5MMSSD.0128-01	128 GB SATA SSD (MLC); replacement for 5AC801.SSDI-04 and 5AC901.CSSD-04; SSD for 5PP510.GMAC-00; note: please see the manual for information about using this SSD	

Table 81: 5AC801.SSDI-04 - Order data

3.6.10.3 Technical data

Caution!

A sudden loss of power may result in data loss! In very rare cases, the mass storage device may also become damaged.

To prevent damage and loss of data, the use of a UPS device is recommended.

Information:

The following characteristics, features and limit values only apply to this accessory and can deviate from those specified for the complete system. The data specifications for the complete system take precedence over those of individual components.

Product ID	5AC801.SSDI-04
General information	
Certification	
CE	Yes
cULus	Yes
GL	Yes
Solid state drive	
Capacity	128 GB
Data reliability	<1 unrecoverable error in 10 ¹⁵ bit read accesses
MTBF	1,500,000 hours
S.M.A.R.T. support	Yes
Interface	SATA
Maintenance	None
Continuous reading	Max. 510 MB/s
Continuous writing	Max. 450 MB/s
IOPS ¹⁾	
4k read	Max. 80,000 (random)
4k write	Max. 35,000 (random)

Table 82: 5AC801.SSDI-04 - Technical data

Product ID	5AC801.SSDI-04
Endurance	
MLC flash	Yes
Compatibility	SATA 3.0 compliant ACS-2 SSD Enhanced SMART ATA feature set Native Command Queuing (NCQ)
Environmental conditions	
Temperature	
Operation	0 to 70°C
Storage	-40 to 95°C
Transport	-40 to 95°C
Relative humidity	
Operation	8 to 95%, non-condensing
Storage	8 to 95%, non-condensing
Transport	8 to 95%, non-condensing
Vibration	
Operation	10 to 2000 Hz: 20 g
Storage	10 to 2000 Hz: 20 g
Transport	10 to 2000 Hz: 20 g
Shock	
Operation	1500 g, 0.5 ms
Storage	1500 g, 0.5 ms
Transport	1500 g, 0.5 ms
Altitude	
Operation	-300 to 12192 m
Storage	-300 to 12192 m
Transport	-300 to 12192 m
Mechanical characteristics	
Installation	Fixed ²⁾
Dimensions	
Width	13 mm
Height	98 mm
Depth	105 mm
Weight	118 g
Manufacturer information	
Manufacturer	Toshiba
Manufacturer product ID	THNSNH128GBST

Table 82: 5AC801.SSDI-04 - Technical data

- 1) IOPS: Random read and write input/output operations per second.
- 2) Slide-in compact installation.

3.6.10.4 Temperature humidity diagram

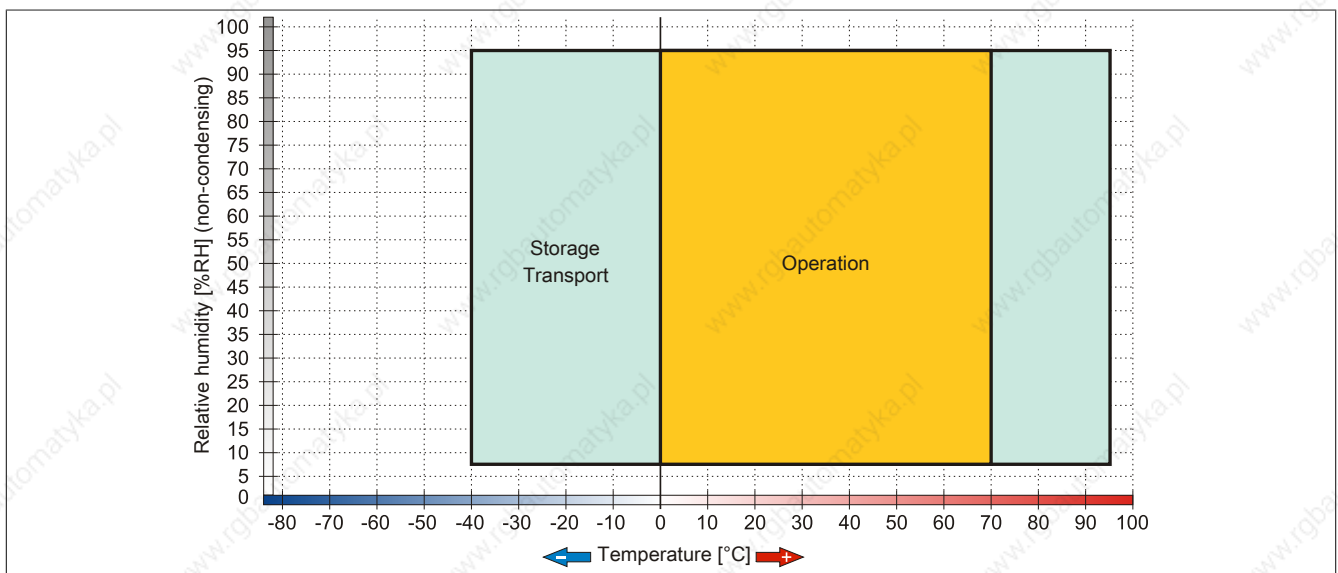

Figure 50: 5AC801.SSDI-04 - Temperature humidity diagram

3.6.11 5MMSSD.0060-00

3.6.11.1 General information

This 60 GB slide-in compact SSD (solid-state drive) is based on multi-level cell (MLC) technology and can be used as a replacement or accessory part.

- Replacement for 5AC801.SSDI-01 or 5AC901.CSSD-01 SSD drives
- Accessory for the APC510 (optional SSD for I/O board)

3.6.11.2 Order data

Model number	Short description	Figure
	Drives	
5MMSSD.0060-00	60 GB SATA SSD (MLC); replacement for 5AC801.SSDI-01 and 5AC901.CSSD-01; SSD for 5PP5IO.GMAC-00; note: please see the manual for information about using this SSD	

Table 83: 5MMSSD.0060-00 - Order data

3.6.11.3 Technical data

Caution!

A sudden loss of power may result in data loss! In very rare cases, the mass storage device may also become damaged.

To prevent damage and loss of data, the use of a UPS device is recommended.

Information:

The following characteristics, features and limit values only apply to this accessory and can deviate from those specified for the complete system. The data specifications for the complete system take precedence over those of individual components.

Product ID	5MMSSD.0060-00
General information	
Certification	
CE	Yes
cULus	Yes
Solid state drive	
Capacity	60 GB
Data reliability	<1 unrecoverable error in 10 ¹⁶ bit read accesses
MTBF	1,200,000 hours
S.M.A.R.T. support	Yes
Interface	SATA
Maintenance	None
Continuous reading	Max. 550 MB/s with SATA 6 Gbit/s Max. 280 MB/s with SATA 3 Gbit/s
Continuous writing	Max. 475 MB/s with SATA 6 Gbit/s Max. 245 MB/s with SATA 3 Gbit/s
IOPS ¹⁾	
4k read	15,000
4k write	
Typical	23,000
Maximum	80,000
Endurance	
MLC flash	Yes
Compatibility	SATA 3.0 compliant ACS-2 SSD Enhanced SMART ATA feature set Native Command Queuing (NCQ)

Table 84: 5MMSSD.0060-00 - Technical data

Product ID	5MMSSD.0060-00
Environmental conditions	
Temperature	
Operation	0 to 70°C
Storage	-55 to 95°C
Transport	-55 to 95°C
Relative humidity	
Operation	5 to 95%, non-condensing
Storage	5 to 95%, non-condensing
Transport	5 to 95%, non-condensing
Vibration	
Operation	5 to 700 Hz: 2.17 g
Storage	5 to 800 Hz: 3.13 g
Transport	5 to 800 Hz: 3.13 g
Shock	
Operation	1500 g, 0.5 ms
Storage	1500 g, 0.5 ms
Transport	1500 g, 0.5 ms
Altitude	
Operation	-300 to 12192 m
Storage	-300 to 12192 m
Transport	-300 to 12192 m
Mechanical characteristics	
Dimensions	
Width	9.5 mm
Height	69 mm
Depth	100 mm
Weight	78 g
Manufacturer information	
Manufacturer	Intel
Manufacturer product ID	SSDSC2CW060A3

Table 84: 5MMSSD.0060-00 - Technical data

1) IOPS: Random read and write input/output operations per second.

3.6.11.4 Temperature humidity diagram

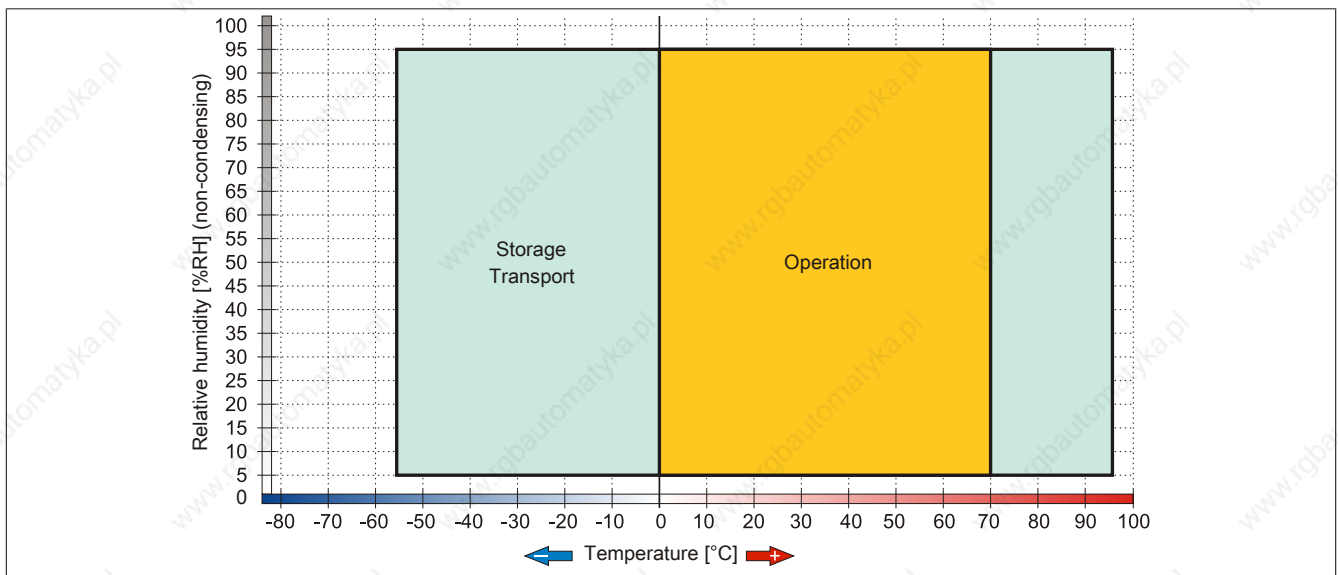

Figure 51: 5MMSSD.0060-00 - Temperature humidity diagram

3.6.12 5MMSSD.0060-01

3.6.12.1 General information

This 60 GB slide-in compact SSD (solid-state drive) is based on multi-level cell (MLC) technology and can be used as a replacement or accessory part.

- Replacement for 5AC801.SSDI-03 or 5AC901.CSSD-03 SSD drives
- Accessory for the APC510 (optional SSD for I/O board)

3.6.12.2 Order data

Model number	Short description	Figure
	Drives	
5MMSSD.0060-01	60 GB SATA SSD (MLC); replacement for 5AC801.SSDI-03 and 5AC901.CSSD-03; SSD for 5PP51O.GMAC-00; note: please see the manual for information about using this SSD	

Table 85: 5MMSSD.0060-01 - Order data

3.6.12.3 Technical data

Caution!

A sudden loss of power may result in data loss! In very rare cases, the mass storage device may also become damaged.

To prevent damage and loss of data, the use of a UPS device is recommended.

Information:

The following characteristics, features and limit values only apply to this accessory and can deviate from those specified for the complete system. The data specifications for the complete system take precedence over those of individual components.

Product ID	5MMSSD.0060-01
General information	
Certification	
CE	Yes
cULus	Yes
Solid state drive	
Capacity	60 GB
Data reliability	<1 unrecoverable error in 10 ¹⁵ bit read accesses
MTBF	1,500,000 hours
S.M.A.R.T. support	Yes
Interface	SATA
Maintenance	None
Continuous reading	Max. 510 MB/s
Continuous writing	Max. 430 MB/s
IOPS ¹⁾	
4k read	Max. 60,000 (random)
4k write	Max. 25,000 (random)
Endurance	
MLC flash	Yes
Compatibility	SATA 3.0 compliant ACS-2 SSD Enhanced SMART ATA feature set Native Command Queuing (NCQ)
Environmental conditions	
Temperature	
Operation	0 to 70°C
Storage	-40 to 95°C
Transport	-40 to 95°C
Relative humidity	
Operation	8 to 95%, non-condensing
Storage	8 to 95%, non-condensing
Transport	8 to 95%, non-condensing

Table 86: 5MMSSD.0060-01 - Technical data

Product ID	5MMSSD.0060-01
Vibration	
Operation	10 to 2000 Hz: 20 g
Storage	10 to 2000 Hz: 20 g
Transport	10 to 2000 Hz: 20 g
Shock	
Operation	1500 g, 0.5 ms
Storage	1500 g, 0.5 ms
Transport	1500 g, 0.5 ms
Altitude	
Operation	-300 to 12192 m
Storage	-300 to 12192 m
Transport	-300 to 12192 m
Mechanical characteristics	
Dimensions	
Width	9.5 mm
Height	69 mm
Depth	100 mm
Weight	78 g
Manufacturer information	
Manufacturer	Toshiba
Manufacturer product ID	THNSNH060GBST

Table 86: 5MMSSD.0060-01 - Technical data

- 1) IOPS: Random read and write input/output operations per second.

3.6.12.4 Temperature humidity diagram

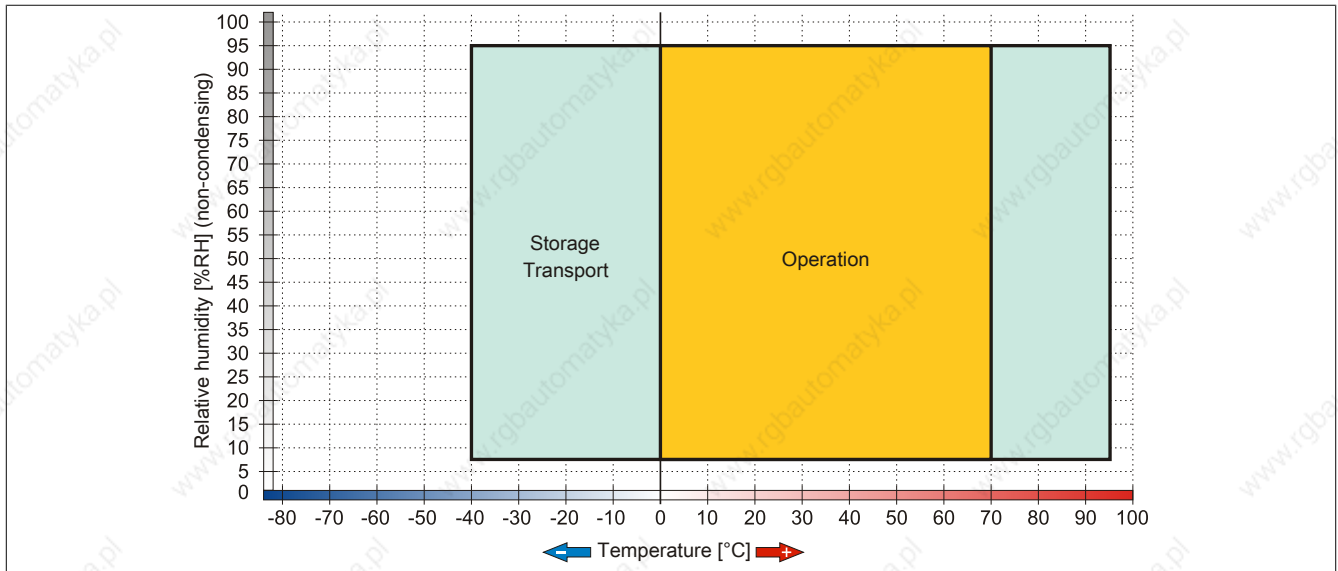

Figure 52: 5MMSSD.0060-01 - Temperature humidity diagram

3.6.13 5MMSSD.0128-01

3.6.13.1 General information

This 128 GB slide-in compact SSD (solid-state drive) is based on multi-level cell (MLC) technology and can be used as a replacement or accessory part.

- Replacement for 5AC801.SSDI-04 or 5AC901.CSSD-04 SSD drives
- Accessory for the APC510 (optional SSD for I/O board)

3.6.13.2 Order data

Model number	Short description	Figure
	Drives	
5MMSSD.0128-01	128 GB SATA SSD (MLC); replacement for 5AC801.SSDI-04 and 5AC901.CSSD-04; SSD for 5PP510.GMAC-00; note: please see the manual for information about using this SSD	

Table 87: 5MMSSD.0128-01 - Order data

3.6.13.3 Technical data

Caution!

A sudden loss of power may result in data loss! In very rare cases, the mass storage device may also become damaged.

To prevent damage and loss of data, the use of a UPS device is recommended.

Information:

The following characteristics, features and limit values only apply to this accessory and can deviate from those specified for the complete system. The data specifications for the complete system take precedence over those of individual components.

Product ID	5MMSSD.0128-01
General information	
Certification	
CE	Yes
cULus	Yes
Solid state drive	
Capacity	128 GB
Data reliability	<1 unrecoverable error in 10 ¹⁵ bit read accesses
MTBF	1,500,000 hours
S.M.A.R.T. support	Yes
Interface	SATA
Maintenance	None
Continuous reading	Max. 510 MB/s
Continuous writing	Max. 450 MB/s
IOPS ¹⁾	
4k read	Max. 80,000 (random)
4k write	Max. 35,000 (random)
Endurance	
MLC flash	Yes
Compatibility	SATA 3.0 compliant ACS-2 SSD Enhanced SMART ATA feature set Native Command Queuing (NCQ)
Environmental conditions	
Temperature	
Operation	0 to 70°C
Storage	-40 to 95°C
Transport	-40 to 95°C

Table 88: 5MMSSD.0128-01 - Technical data

Product ID	5MMSSD.0128-01
Relative humidity	
Operation	8 to 95%, non-condensing
Storage	8 to 95%, non-condensing
Transport	8 to 95%, non-condensing
Vibration	
Operation	10 to 2000 Hz: 20 g
Storage	10 to 2000 Hz: 20 g
Transport	10 to 2000 Hz: 20 g
Shock	
Operation	1500 g, 0.5 ms
Storage	1500 g, 0.5 ms
Transport	1500 g, 0.5 ms
Altitude	
Operation	-300 to 12192 m
Storage	-300 to 12192 m
Transport	-300 to 12192 m
Mechanical characteristics	
Dimensions	
Width	9.5 mm
Height	69 mm
Depth	100 mm
Weight	78 g
Manufacturer information	
Manufacturer	Toshiba
Manufacturer product ID	THNSNH128GBST

Table 88: 5MMSSD.0128-01 - Technical data

1) IOPS: Random read and write input/output operations per second.

3.6.13.4 Temperature humidity diagram

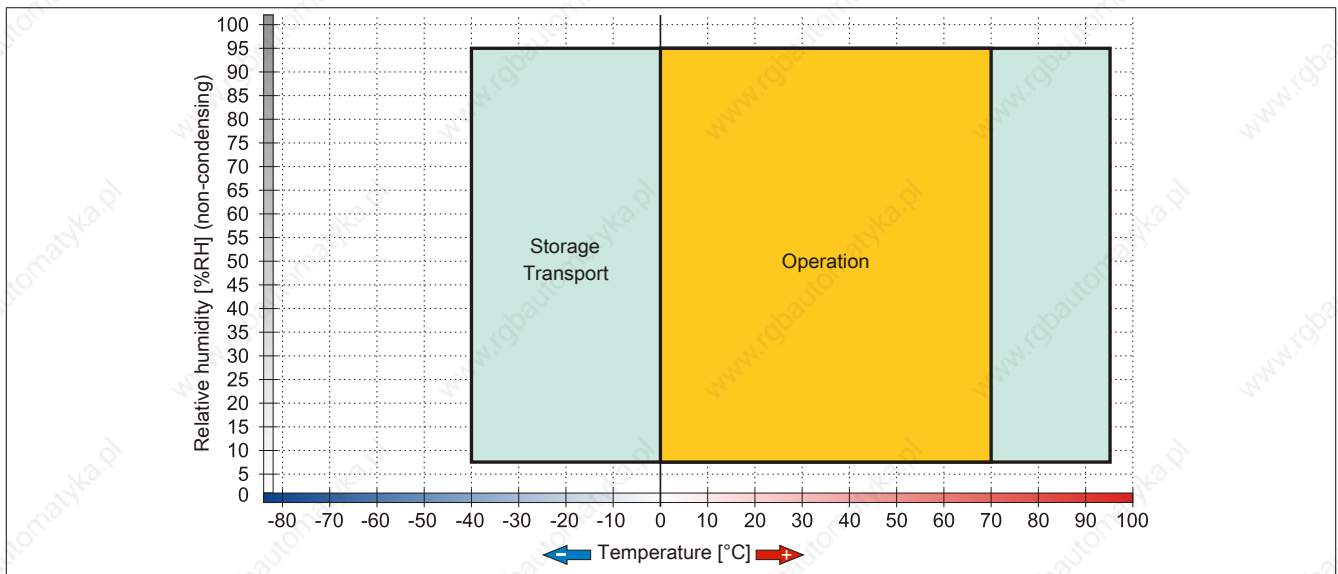

Figure 53: 5MMSSD.0128-01 - Temperature humidity diagram

3.6.14 5MMSSD.0180-00

3.6.14.1 General information

This 180 GB slide-in compact SSD (solid-state drive) is based on multi-level cell (MLC) technology and can be used as a replacement or accessory part.

- Replacement for 5AC801.SSDI-02 or 5AC901.CSSD-02 SSD drives
- Accessory for the APC510 (optional SSD for I/O board)

3.6.14.2 Order data

Model number	Short description	Figure
	Drives	
5MMSSD.0180-00	180 GB SATA SSD (MLC); replacement part for 5AC801.SSDI-02 and 5AC901.CSSD-02; SSD for 5PP5IO.GMAC-00; note: please see the manual for information about using this SSD	

Table 89: 5MMSSD.0180-00 - Order data

3.6.14.3 Technical data

Caution!

A sudden loss of power may result in data loss! In very rare cases, the mass storage device may also become damaged.

To prevent damage and loss of data, the use of a UPS device is recommended.

Information:

The following characteristics, features and limit values only apply to this accessory and can deviate from those specified for the complete system. The data specifications for the complete system take precedence over those of individual components.

Product ID	5MMSSD.0180-00
General information	
Certification	
CE	Yes
cULus	Yes
Solid state drive	
Capacity	180 GB
Data reliability	<1 unrecoverable error in 10 ¹⁶ bit read accesses
MTBF	1,200,000 hours
S.M.A.R.T. support	Yes
Interface	SATA
Maintenance	None
Continuous reading	Max. 550 MB/s with SATA 6 Gbit/s Max. 280 MB/s with SATA 3 Gbit/s
Continuous writing	Max. 520 MB/s with SATA 6 Gbit/s Max. 260 MB/s with SATA 3 Gbit/s
IOPS ¹⁾	
4k read	50,000
4k write	
Typical	60,000
Maximum	80,000
Endurance	
MLC flash	Yes
Compatibility	SATA 3.0 compliant ACS-2 SSD Enhanced SMART ATA feature set Native Command Queuing (NCQ)

Table 90: 5MMSSD.0180-00 - Technical data

Product ID	5MMSSD.0180-00
Environmental conditions	
Temperature	
Operation	0 to 70°C
Storage	-55 to 95°C
Transport	-55 to 95°C
Relative humidity	
Operation	5 to 95%, non-condensing
Storage	5 to 95%, non-condensing
Transport	5 to 95%, non-condensing
Vibration	
Operation	5 to 700 Hz: 2.17 g
Storage	5 to 800 Hz: 3.13 g
Transport	5 to 800 Hz: 3.13 g
Shock	
Operation	1500 g, 0.5 ms
Storage	1500 g, 0.5 ms
Transport	1500 g, 0.5 ms
Altitude	
Operation	-300 to 12192 m
Storage	-300 to 12192 m
Transport	-300 to 12192 m
Mechanical characteristics	
Dimensions	
Width	9.5 mm
Height	69 mm
Depth	100 mm
Weight	78 g
Manufacturer information	
Manufacturer	Intel
Manufacturer product ID	SSDSC2CW180A3

Table 90: 5MMSSD.0180-00 - Technical data

1) IOPS: Random read and write input/output operations per second.

3.6.14.4 Temperature humidity diagram

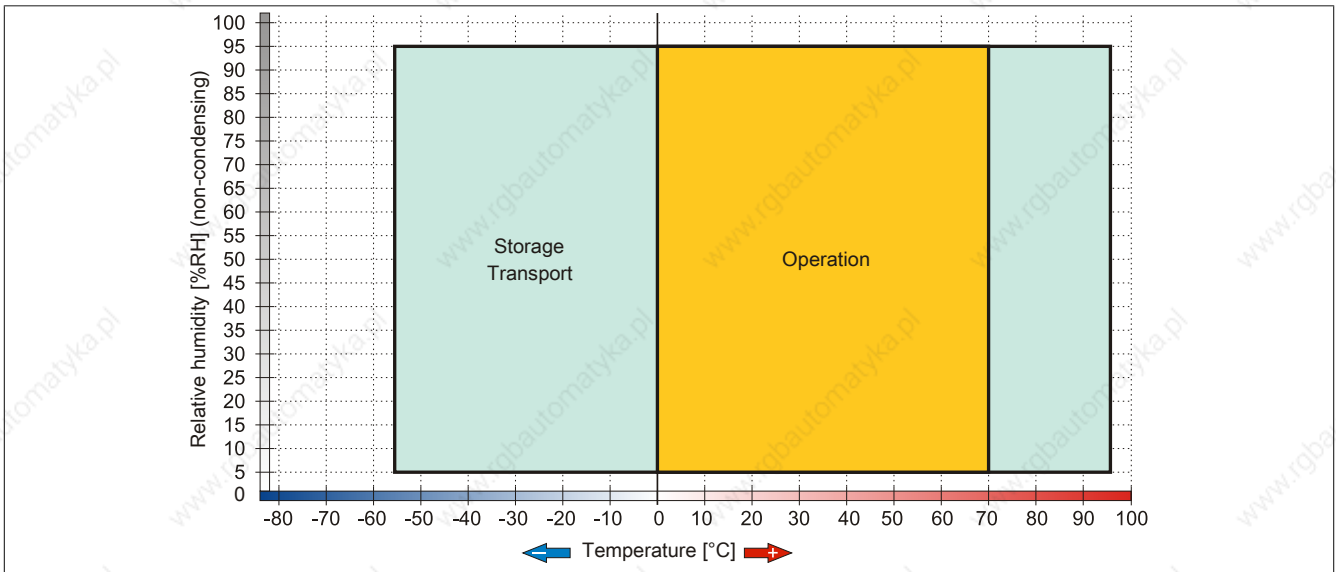

Figure 54: 5MMSSD.0180-00 - Temperature humidity diagram

3.6.15 5AC801.ADAS-00

3.6.15.1 General information

The hard disk adapter is a slide-in adapter that allows slide-in compact drives to be installed and operated on a B&R Industrial PC. This adapter can be used in APC810 and PPC800 system units with a slide-in drive slot.

When used in an APC810

Information:

The slide-in compact adapter can only be inserted into slide-in slot 1 for mechanical reasons (closing the front door).

3.6.15.2 Order data

Model number	Short description	Figure
	Drives	
5AC801.ADAS-00	SATA hard disk adapter for operating a slide-in compact hard disk in a slide-in slot	

Table 91: 5AC801.ADAS-00 - Order data

3.6.15.3 Technical data

Product ID	5AC801.ADAS-00	
General information		
Certification		
CE		Yes
cULus		Yes
GL		Yes
Mechanical characteristics		
Dimensions		
Width		22 mm
Height		172.5 mm
Depth		150 mm
Weight		328 g

Table 92: 5AC801.ADAS-00 - Technical data

3.6.16 5AC801.HDDS-00

3.6.16.1 General information

This 160 GB hard disk is specified for 24-hour operation, features an extended temperature range and can be used in APC810 and PPC800 system units with a slide-in drive slot.

Information:

A slide-in drive can be inserted or removed at any time.

When used in an APC810

When inserted in slide-in slot 1 or slide-in drive 2, the slide-in drive is accessed internally via SATA and USB.

3.6.16.2 Order data

Model number	Short description	Figure
5AC801.HDDS-00	Drives 40 GB SATA slide-in hard disk; 24/7 operation with extended temperature range. Note: please see the manual for information about using this hard disk	

Table 93: 5AC801.HDDS-00 - Order data

3.6.16.3 Technical data

Information:

The following characteristics, features and limit values only apply to this individual component and can deviate from those specified for the complete system. For the complete system in which this individual component is used, refer to the data given specifically for that device.

Product ID	5AC801.HDDS-00
General information	
Certification	
CE	Yes
cULus	Yes
GL	Yes
Hard disk drive	
Capacity	40 GB
Number of heads	1
Number of sectors	78,140,160
Bytes per sector	512
Cache	8 MB
Speed	5400 rpm ±1%
Startup time	Typ. 3 s (from 0 rpm to read access)
MTBF	750,000 POH ¹⁾
S.M.A.R.T. support	Yes
Interface	SATA
Access time	5.6 ms
Data transfer rate	
Internal	Max. 450 Mbit/s
To/From host	Max. 150 MB/s (Ultra DMA mode 5)
Positioning time	
Minimum (track to track)	1 ms
Nominal (read only)	12.5 ms
Maximum (read only)	23 ms

Table 94: 5AC801.HDDS-00 - Technical data

Product ID	5AC801.HDDS-00
Environmental conditions	
Temperature ²⁾	
Operation ³⁾	-30 to 85°C
24-hour operation ⁴⁾	-30 to 85°C
Storage	-40 to 95°C
Transport	-40 to 95°C
Relative humidity ⁵⁾	
Operation	5 to 90%, non-condensing
Storage	5 to 95%, non-condensing
Transport	5 to 95%, non-condensing
Vibration	
Operation	5 to 500 Hz: 2 g; no unrecoverable errors
Storage	5 to 500 Hz: 5 g; no unrecoverable errors
Transport	5 to 500 Hz: 5 g; no unrecoverable errors
Shock	
Operation	300 g and 2 ms duration; no unrecoverable errors 150 g and 11 ms duration; no unrecoverable errors
Storage	800 g and 2 ms duration; no unrecoverable errors
Transport	400 g and 0.5 ms duration; no unrecoverable errors 800 g and 2 ms duration; no unrecoverable errors 400 g and 0.5 ms duration; no unrecoverable errors
Altitude	
Operation	-300 to 5000 m
Storage	-300 to 12192 m
Mechanical characteristics	
Installation	Fixed ⁶⁾
Dimensions	
Width	22 mm
Height	172.5 mm
Depth	150 mm
Weight	387 g
Manufacturer information	
Manufacturer	Seagate
Manufacturer product ID	ST940817SM

Table 94: 5AC801.HDDS-00 - Technical data

- 1) With 8760 POH (power-on hours) per year and 70°C surface temperature.
- 2) Temperature values at an elevation of 305 meters. The temperature specification must be reduced linearly by 1°C every 305 meters. The temperature increase and decrease can be a maximum of 20°C per hour.
- 3) Standard operation refers to 333 POH (power-on hours) per month.
- 4) 24-hour operation refers to 732 POH (power-on hours) per month.
- 5) Humidity gradient: Maximum 15% per hour.
- 6) Slide-in compact installation.

3.6.16.4 Temperature humidity diagram

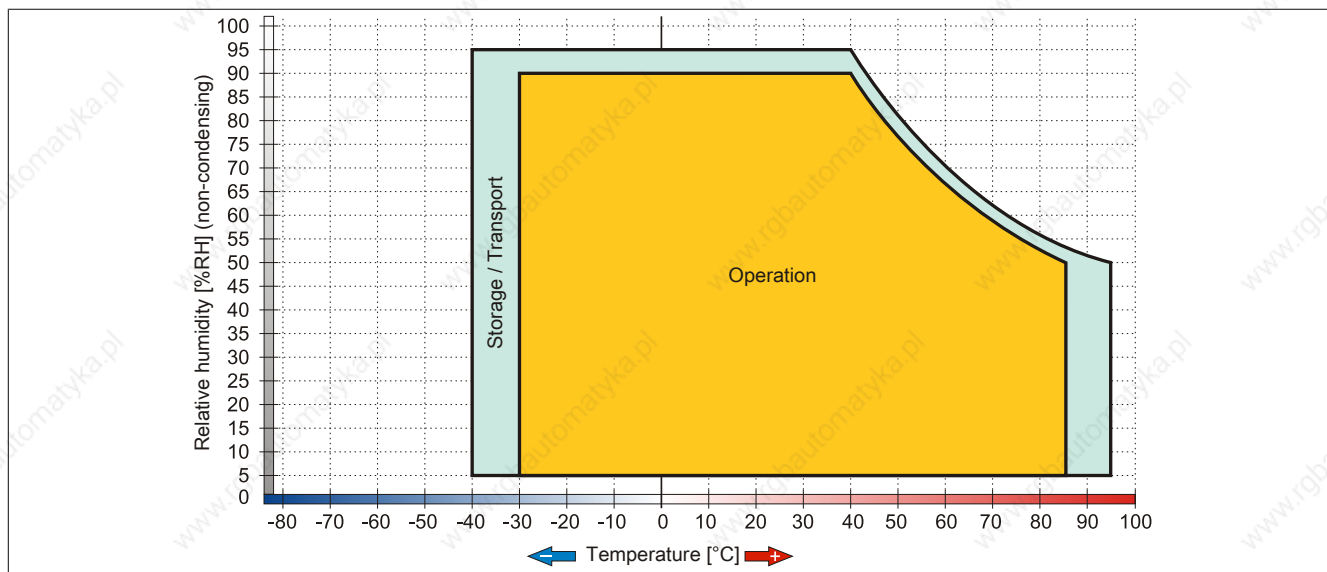

Figure 55: 5AC801.HDDS-00 - Temperature humidity diagram

3.6.17 5AC801.DVDS-00

3.6.17.1 General information

The DVD-ROM slide-in drive can be used in APC810 and PPC800 system units with a slide-in drive slot.

Information:

A slide-in drive can be inserted or removed at any time.

When used in an APC810

When inserted in slide-in slot 1 or slide-in drive 2, the slide-in drive is referred to internally as SATA and USB.

3.6.17.2 Order data

Model number	Short description	Figure
5AC801.DVDS-00	DVD-ROM SATA slide-in drive	

Table 95: 5AC801.DVDS-00 - Order data

3.6.17.3 Technical data

Information:

The following characteristics, features and limit values only apply to this individual component and can deviate from those specified for the complete system. For the complete system in which this individual component is used, refer to the data given specifically for that device.

Product ID	5AC801.DVDS-00
General information	
Certification	
CE	Yes
cULus	Yes
GL	Yes
CD / DVD drive	
Data transfer rate	Max. 1.5 Gbit/s
Speed	Max. 5090 rpm ±1%
Noise level	Approx. 45 dBA in a distance of 50 cm (full read access)
Compatible formats	CD-DA, CD-ROM mode 1/mode 2 CD-ROM XA mode 2 (form 1, form 2) Photo CD (single/multi-session) Enhanced CD, CD text DVD-ROM, DVD-Video (dual layer), DVD-R (single/multi-border), DVD-R DL (single/multi-border), DVD-RW (single/multi-border), DVD+R (single/multi-session), DVD+R DL (single/multi-session), DVD+RW (single/multi-session), DVD-RAM (4.7 GB, 2.6 GB)
Laser class	Class 1 laser
Service life	60000 POH (power-on hours)
Interface	SATA
Startup time	
CD	Max. 19 seconds (from 0 rpm to read access)
DVD	Max. 19 seconds (from 0 rpm to read access)
Access time	
CD	Average of 130 ms
DVD	Average of 140 ms

Table 96: 5AC801.DVDS-00 - Technical data

Product ID	5AC801.DVDS-00
Readable media CD DVD	CD-ROM (12 cm, 8 cm), CD-A CD-R, CD-RW DVD-ROM, DVD-R, DVD-R DL, DVD-RW, DVD+R DVD+R DL, DVD+RW, DVD-RAM
Read speed CD DVD	24x 8x
Environmental conditions	
Temperature ¹⁾ Operation Storage Transport	5 to 55°C ²⁾ -20 to 60°C -40 to 65°C
Relative humidity Operation Storage Transport	8 to 80%, non-condensing 5 to 95%, non-condensing 5 to 95%, non-condensing
Vibration Operation Storage Transport	5 to 500 Hz: 0.2 g 5 to 500 Hz: 2 g 5 to 500 Hz: 2 g
Shock Operation Storage Transport	5 g and 11 ms duration 60 g and 11 ms duration 200 g and 2 ms duration 60 g and 11 ms duration 200 g and 2 ms duration
Mechanical characteristics	
Dimensions Width Height Depth	22 mm 172.5 mm 150 mm
Weight	455 g

Table 96: 5AC801.DVDS-00 - Technical data

- 1) Temperature data is for operation at 500 meters. The maximum ambient temperature is typically derated by 1°C per 1000 meters (starting at 500 meters above sea level).
- 2) Drive surface temperature.

3.6.17.4 Temperature humidity diagram

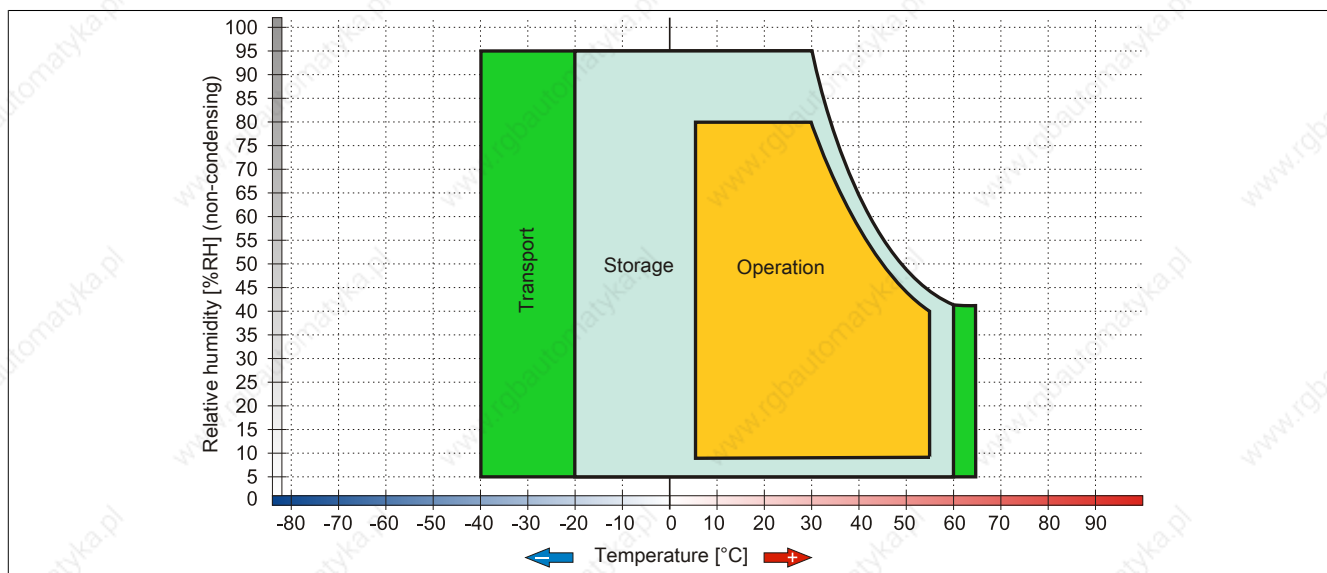

Figure 56: 5AC801.DVDS-00 - Temperature humidity diagram

3.6.17.5 Hot plugging

Hardware revision B0 of the 5AC801.DVDS-00 slide-in DVD-ROM does not offer SATA hot plugging functionality. Hot plugging is possible for other hardware revisions.

3.6.18 5AC801.DVRS-00

3.6.18.1 General information

The DVD-R/RW slide-in drive can be used in APC810 and PPC800 system units with a slide-in drive slot.

Information:

A slide-in drive can be inserted or removed at any time.

When used in an APC810

When inserted in slide-in slot 1 or slide-in drive 2, the slide-in drive is referred to internally as SATA and USB.

3.6.18.2 Order data

Model number	Short description	Figure
	Drives	
5AC801.DVRS-00	DVD-R/RW DVD+R/RW SATA slide-in drive	
	Optional accessories	
	Other	
5SWUTI.0000-00	OEM Nero CD-RW Software, only available with a CD writer.	

Table 97: 5AC801.DVRS-00 - Order data

3.6.18.3 Technical data

Information:

The following characteristics, features and limit values only apply to this individual component and can deviate from those specified for the complete system. For the complete system in which this individual component is used, refer to the data given specifically for that device.

Product ID	5AC801.DVRS-00
General information	
Certification	
CE	Yes
cULus	Yes
GL	Yes
CD / DVD drive	
Data buffer capacity	2 MB
Data transfer rate	Max. 33.3 MB/s
Speed	Max. 5160 rpm ±1%
Noise level	Approx. 45 dBA in a distance of 50 cm (full read access)
Compatible formats	CD-DA, CD-ROM mode 1/mode 2 CD-ROM XA mode 2 (form 1, form 2) Photo CD (single-/multi-session), Enhanced CD, CD text DVD-ROM, DVD-R, DVD-R (dual layer), DVD-RW, DVD-Video DVD-RAM (4.7GB, 2.6GB) DVD+R, DVD+R (dual layer), DVD+RW
Laser class	Class 1 laser
Service life	60000 POH (power-on hours)
Interface	SATA
Startup time	
CD	Max. 14 seconds (from 0 rpm to read access)
DVD	Max. 15 seconds (from 0 rpm to read access)
Access time	
CD	On average 140 ms (24x)
DVD	On average 150 ms (8x)

Table 98: 5AC801.DVRS-00 - Technical data

Technical data • Individual components

Product ID	5AC801.DVRS-00
Readable media CD DVD	CD/CD-ROM (12 cm, 8 cm), CD-R, CD-RW DVD-ROM, DVD-R, DVD-R (dual layer), DVD-RW, DVD-RAM, DVD+R, DVD+R (dual layer), DVD+RW, DVD-RAM
Writable media CD DVD	CD-R, CD-RW DVD-R/RW, DVD-R (dual layer), DVD-RAM (4.7 GB), DVD+R/RW, DVD+R (dual layer)
Read speed CD DVD	24x 8x
Write speed CD-R CD-RW DVD+R DVD+R (dual layer) DVD+RW DVD-R DVD-R (dual layer) DVD-RAM ¹⁾ DVD-RW	24x, 16x, 10x and 4x 24x, 16x, 10x and 4x 8x, 4x and 2.4x 6x, 4x and 2.4x 4x and 2x 8x, 4x and 2x 6x, 4x and 2x 5x, 3x and 2x 6x, 4x and 2x
Write methods CD DVD	Disk at once, session at once, packet write, track at once Disk at once, incremental, overwrite, sequential, multi-session
Environmental conditions	
Temperature ²⁾ Operation Storage Transport	5 to 55°C ³⁾ -20 to 60°C -40 to 65°C
Relative humidity Operation Storage Transport	8 to 80%, non-condensing 5 to 95%, non-condensing 5 to 95%, non-condensing
Vibration Operation Storage Transport	5 to 500 Hz: 0.2 g 5 to 500 Hz: 2 g 5 to 500 Hz: 2 g
Shock Operation Storage Transport	At max. 5 g and 11 ms duration At max. 60 g and 11 ms duration At max. 200 g and 2 ms duration At max. 60 g and 11 ms duration At max. 200 g and 2 ms duration
Mechanical characteristics	
Dimensions Width Height Depth	22 mm 172.5 mm 150 mm
Weight	400 g

Table 98: 5AC801.DVRS-00 - Technical data

- 1) RAM drivers are not provided by the manufacturer. Support of RAM function by "Nero" burning software (model number 5SWUT1.0000-00) or other burning software packages or drivers from third-party providers.
- 2) Temperature specifications refer to operation at 500 meters. The maximum ambient temperature is typically derated by 1°C per 1000 meters (starting at 500 meters above sea level).
- 3) Drive surface temperature.

3.6.18.4 Temperature humidity diagram

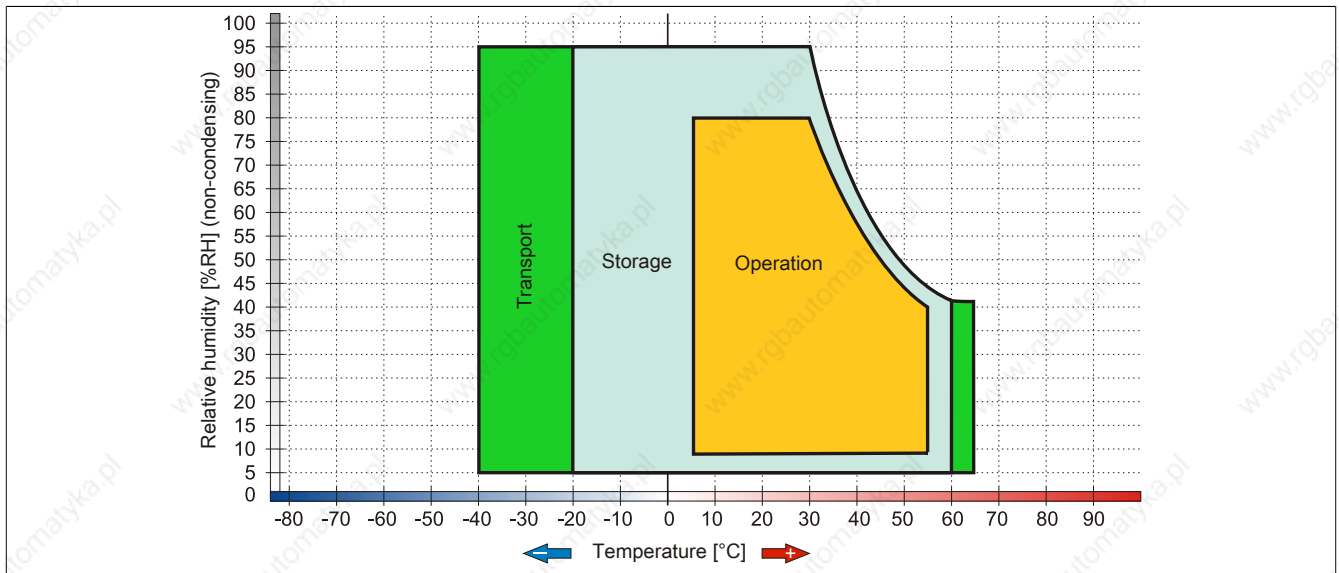

Figure 57: 5AC801.DVRS-00 - Temperature humidity diagram

3.6.19 5ACPCI.RAIC-01

3.6.19.1 General information

This SATA RAID controller supports RAID level 0 and 1 and can be inserted in a PCI slot. The hard disks that are used are specified for 24-hour operation (24x7).

- SATA RAID controller
- RAID level 0 (striped) and 1 (mirrored)
- 2 SATA hard disk drives (suitable for 24-hour operation)
- Only requires 1 PCI slot
- Transfer rates up to 150 MB/s



Figure 58: PCI SATA RAID controller

Information:

The PCI SATA RAID controller cannot be used in place of a universal power supply (UPS). If the operating system is not shut down properly, then this will be detected as an error state (with RAID 1 sets) at the next system startup and a complete rebuild is performed. This generally takes at least 50 minutes (configurable) to complete.

3.6.19.2 Order data

Model number	Short description	Figure
5ACPCI.RAIC-01	Drives PCI RAID system SATA 2x 60 GB; Note: Please see the manual for information about using this hard disk.	
	Optional accessories	
	Drives	
5ACPCI.RAIC-02	60 GB SATA hard disk replacement part for 5ACPCI.RAIC-01; Note: Please see the manual for information about using this hard disk.	

Table 99: 5ACPCI.RAIC-01 - Order data

3.6.19.3 Technical data

Information:

The following characteristics, features and limit values only apply to this individual component and can deviate from those specified for the complete system. For the complete system in which this individual component is used, refer to the data given specifically for that device.

Product ID	5ACPCI.RAIC-01
General information	
Number of hard disks	2
Certification	
CE	Yes
cULus	Yes
Controller	
Type	Sil 3512 SATA link
Specification	Serial ATA 1.0
Data transfer rate	Max. 1.5 Gbit/s (150 MB/s)
RAID level	Supports RAID 0, 1
BIOS extension ROM requirements	Approx. 32 kB
Hard disk drive	
Capacity	60 GB
Number of heads	3
Number of sectors	117,210,240
Bytes per sector	512
Cache	8 MB
Speed	7200 rpm ±1%
Startup time	Typ. 4 s (from 0 rpm to read access)
Service life	5 years
S.M.A.R.T. support	Yes
Access time	4.2 ms
Supported transfer modes	SATA 1.0, PIO mode 0-4, multiword DMA mode 0-2, UDMA 0-5
Data transfer rate	
Internal	Max. 539 Mbit/s
To/From host	Max. 150 MB/s
Positioning time	
Minimum (track to track)	1.5 ms
Nominal (read only)	10.5 ms
Maximum (read only)	22 ms
Electrical characteristics	
Power consumption	0.3A at 3.3V (PCI bus) 1A at 5V (PCI bus)
Environmental conditions	
Temperature ¹⁾	
Operation ²⁾	5 to 55°C
24-hour operation ³⁾	5 to 40°C
Storage	-40 to 70°C
Transport	-40 to 70°C
Relative humidity	
Operation	5 to 90%, non-condensing
Storage	5 to 95%, non-condensing
Transport	5 to 95%, non-condensing
Vibration ⁴⁾	
Operation (continuous)	5 to 500 Hz: 0.125 g (1.225 m/s ² 0-peak) duration 1 octave pe minute; no damage
Operation (occasional)	5 to 500 Hz: 0.25 g (2.45 m/s ² 0-peak) duration 1 octave pe minute; no damage
Storage	At max. 5 to 500 Hz and 5 g (49 m/s ² 0-peak) duration 0.5 octave per minute; no damage
Transport	At max. 5 to 500 Hz and 5 g (49 m/s ² 0-peak) duration 0.5 octave per minute; no damage
Shock	
Operation	At max. 125 g (1226 m/s ² 0-peak) and 2 ms duration; no unrecoverable errors
Storage	At max. 400 g (3924 m/s ² 0-peak) and 2 ms duration; no damage At max. 450 g (4424 m/s ² 0-peak) and 1 ms duration; no damage At max. 200 g (1962 m/s ² 0-peak) and 0.5 ms duration; no damage
Transport	At max. 400 g (3924 m/s ² 0-peak) and 2 ms duration; no damage At max. 450 g (4424 m/s ² 0-peak) and 1 ms duration; no damage At max. 200 g (1962 m/s ² 0-peak) and 0.5 ms duration; no damage
Altitude	
Operation	-300 to 3048 m
Storage	-300 to 12192 m
Mechanical characteristics	
Installation ⁵⁾	Fixed
Dimensions	
Width	70 mm
Length	100 mm
Height	9.5 mm

Table 100: 5ACPCI.RAIC-01 - Technical data

Product ID	5ACPCI.RAIC-01
Weight	350 g
Manufacturer information	
Manufacturer	Seagate
Manufacturer product ID	Momentum 7200.1 ST96023AS

Table 100: 5ACPCI.RAIC-01 - Technical data

- 1) Temperature values at an elevation of 305 meters. The temperature specification must be reduced linearly by 1°C every 305 meters. The temperature increase and decrease can be a maximum of 3°C per minute.
- 2) Standard operation refers to 333 POH (power-on hours) per month.
- 3) 24-hour operation refers to 732 POH (power-on hours) per month.
- 4) Operation in areas prone to vibration and shock can affect performance negatively (reduction of transfer rate).
- 5) Installed in PCI slot.

3.6.19.4 Temperature humidity diagram

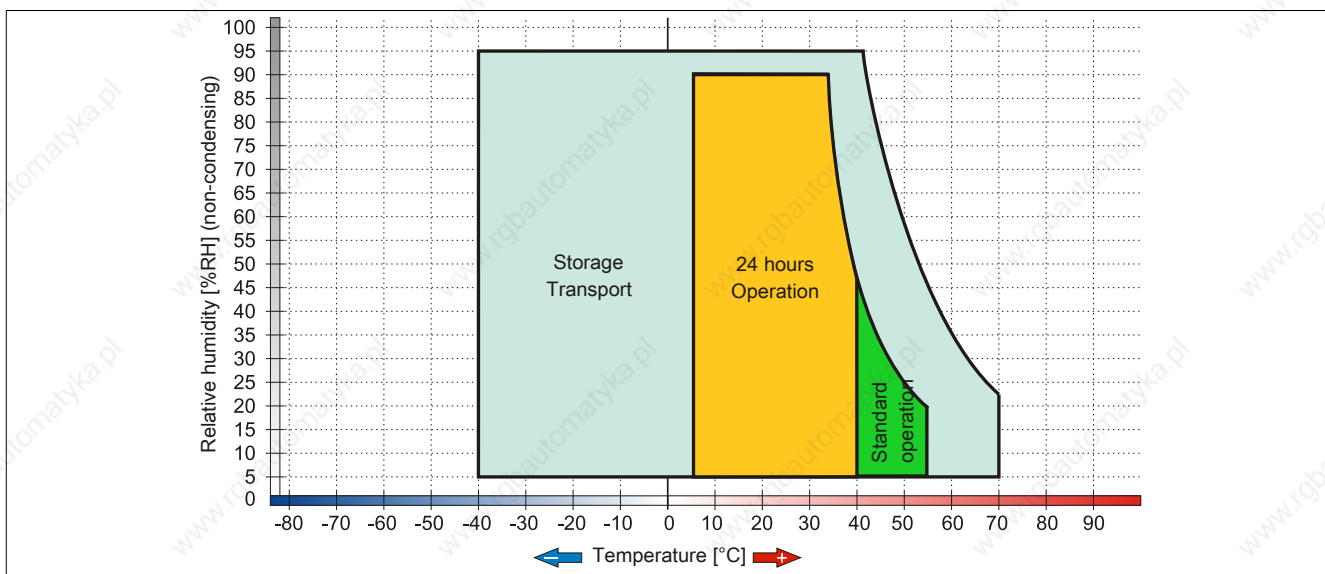

Figure 59: 5ACPCI.RAIC-01 - Temperature humidity diagram

3.6.19.5 Driver support

Special drivers are necessary for operating the PCI SATA RAID controller. Drivers for supported and approved operating systems are available in the Downloads section of the B&R website (www.br-automation.com).

.NET-based SATA Raid™ serial ATA RAID management software can also be found on the B&R website.

Information:

Required drivers can only be downloaded from the B&R website, not from manufacturer websites.

3.6.19.6 Configuration

For information about configuring a SATA RAID set, see 3 "Installation", section 7 "Configuring a SATA RAID set" on page 222.

3.6.19.7 Replacing a HDD

A hard drive can be easily replaced in the event of an error when using the RAID1 (mirroring) configuration without having to reinstall the system. The replacement SATA HDD 60GB 5ACPCI.RAIC-02 is available as a replacement part for a HDD.

For instructions on replacing the drive, see chapter 7 "Maintenance and service", section 11 "Replacing a PCI SATA RAID hard disk in a RAID 1 set" on page 425.

3.6.20 5ACPCI.RAIC-02

3.6.20.1 General information

This hard disk can be used as a replacement for a HDD used with the 5ACPCI.RAIC-01 PCI SATA RAID controller.

3.6.20.2 Order data

Model number	Short description	Figure
5ACPCI.RAIC-02	Drives 60 GB SATA hard disk replacement part for 5ACPCI.RAIC-01; Note: Please see the manual for information about using this hard disk.	

Table 101: 5ACPCI.RAIC-02 - Order data

3.6.20.3 Technical data

Information:

The following characteristics, features and limit values only apply to this individual component and can deviate from those specified for the complete system. For the complete system in which this individual component is used, refer to the data given specifically for that device.

Product ID	5ACPCI.RAIC-02
General information	
Certification	
CE	Yes
cULus	Yes
Hard disk drive	
Capacity	60 GB
Number of heads	3
Number of sectors	117,210,240
Bytes per sector	512
Cache	8 MB
Speed	7200 rpm ±1%
Startup time	Typ. 4 s (from 0 rpm to read access)
Service life	5 years
S.M.A.R.T. support	Yes
Access time	4.2 ms
Supported transfer modes	SATA 1.0, PIO mode 0-4, multiword DMA mode 0-2, UDMA 0-5
Data transfer rate	
Internal	Max. 539 Mbit/s
To/From host	Max. 150 MB/s
Positioning time	
Minimum (track to track)	1.5 ms
Nominal (read only)	10.5 ms
Maximum (read only)	22 ms
Environmental conditions	
Temperature ¹⁾	
Operation ²⁾	5 to 55°C
24-hour operation ³⁾	5 to 40°C
Storage	-40 to 70°C
Transport	-40 to 70°C
Relative humidity	
Operation	5 to 90%, non-condensing
Storage	5 to 95%, non-condensing
Transport	5 to 95%, non-condensing
Vibration ⁴⁾	
Operation (continuous)	5 to 500 Hz: 0.125 g (1.225 m/s ² 0-peak) duration 1 octave pe minute; no damage
Operation (occasional)	5 to 500 Hz: 0.25 g (2.45 m/s ² 0-peak) duration 1 octave pe minute; no damage
Storage	At max. 5 to 500 Hz and 5 g (49 m/s ² 0-peak) duration 0.5 octave per minute; no damage
Transport	At max. 5 to 500 Hz and 5 g (49 m/s ² 0-peak) duration 0.5 octave per minute; no damage

Table 102: 5ACPCI.RAIC-02 - Technical data

Product ID	5ACPCI.RAIC-02
Shock	At max. 125 g (1226 m/s ² 0-peak) and 2 ms duration; no unrecoverable errors
Operation	At max. 400 g (3924 m/s ² 0-peak) and 2 ms duration; no damage
Storage	At max. 450 g (4424 m/s ² 0-peak) and 1 ms duration; no damage
Transport	At max. 200 g (1962 m/s ² 0-peak) and 0.5 ms duration; no damage
	At max. 400 g (3924 m/s ² 0-peak) and 2 ms duration; no damage
	At max. 450 g (4424 m/s ² 0-peak) and 1 ms duration; no damage
	At max. 200 g (1962 m/s ² 0-peak) and 0.5 ms duration; no damage
Altitude	
Operation	-300 to 3048 m
Storage	-300 to 12192 m
Mechanical characteristics	
Dimensions	
Width	70 mm
Length	100 mm
Height	9.5 mm
Weight	350 g
Manufacturer information	
Manufacturer	Seagate
Manufacturer product ID	Momentum 7200.1 ST96023AS

Table 102: 5ACPCI.RAIC-02 - Technical data

- 1) Temperature values at an elevation of 305 meters. The temperature specification must be reduced linearly by 1°C every 305 meters. The temperature increase and decrease can be a maximum of 3°C per minute.
- 2) Standard operation refers to 333 POH (power-on hours) per month.
- 3) 24-hour operation refers to 732 POH (power-on hours) per month.
- 4) Operation in areas prone to vibration and shock can affect performance negatively (reduction of transfer rate).

3.6.20.4 Temperature humidity diagram

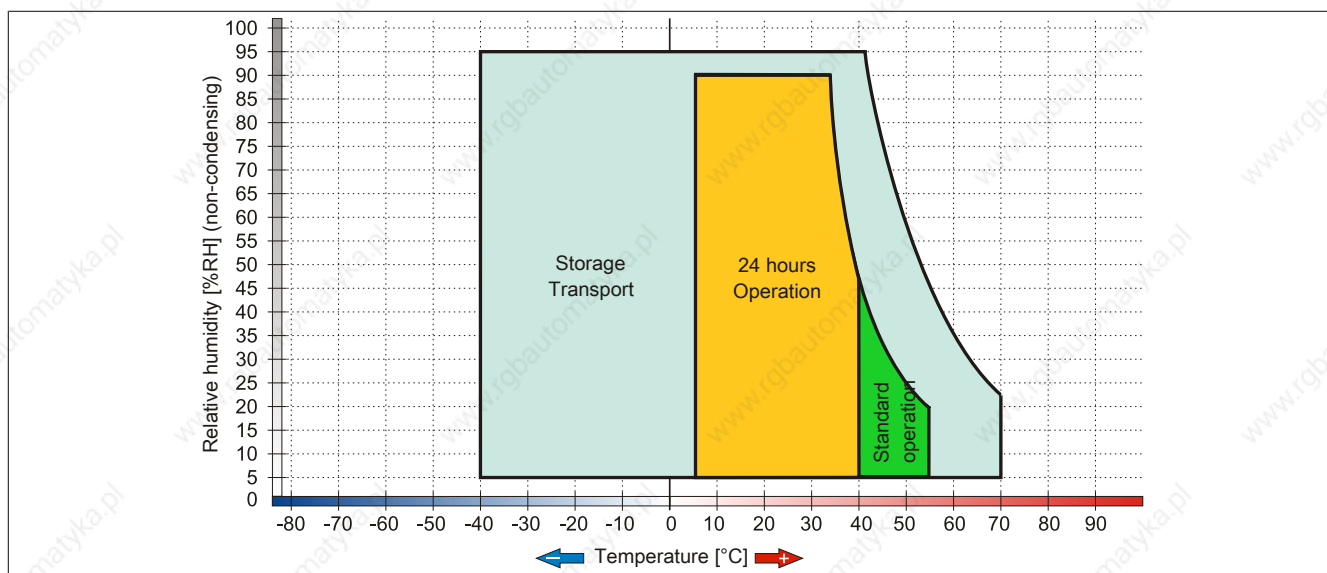

Figure 60: 5ACPCI.RAIC-02 - Temperature humidity diagram

3.6.21 5ACPCI.RAIC-03

3.6.21.1 General information

This SATA RAID controller supports RAID level 0 and 1 and can be inserted in a PCI slot. The hard disks being used are specified for 24-hour operation and also feature an extended temperature range.

- SATA RAID controller
- RAID level 0 (striped) and 1 (mirrored)
- 2 SATA hard disk drives (suitable for 24-hour operation)
- Only requires 1 PCI slot
- Transfer rates up to 150 MB/s



Figure 61: PCI SATA RAID controller

Information:

The PCI SATA RAID controller cannot be used in place of a universal power supply (UPS). If the operating system is not shut down properly, then this will be detected as an error state (with RAID 1 sets) at the next system startup and a complete rebuild is performed. If 160 GB of memory are used, this generally takes approximately 160 minutes (configurable) to complete.

3.6.21.2 Order data

Model number	Short description	Figure
5ACPCI.RAIC-03	Drives PCI RAID system SATA 2x 160 GB; note: Please see the manual for information about using this hard disk.	
	Optional accessories	
	Drives	
5ACPCI.RAIC-04	160 GB SATA hard disk, replacement part for 5ACPCI.RAIC-03; note: Please see the manual for information about using this hard disk.	

Table 103: 5ACPCI.RAIC-03 - Order data

3.6.21.3 Technical data

Information:

The following characteristics, features and limit values only apply to this individual component and can deviate from those specified for the complete system. For the complete system in which this individual component is used, refer to the data given specifically for that device.

Product ID	5ACPCI.RAIC-03
General information	
Number of hard disks	2
Certification CE	Yes
Controller	
Type	Sil 3512 SATA link
Specification	Serial ATA 1.0
Data transfer rate	Max. 1.5 Gbit/s (150 MB/s)
RAID level	Supports RAID 0, 1
BIOS extension ROM requirements	Approx. 32 kB
Hard disk drive	
Capacity	160 GB
Number of heads	3
Number of sectors	312,581,808
Bytes per sector	512
Cache	8 MB
Speed	5400 rpm \pm 1%
Startup time	Typ. 4 s (from 0 rpm to read access)
Service life	5 years
S.M.A.R.T. support	Yes
Access time	5.56 ms
Supported transfer modes	SATA 1.0, PIO mode 0-4, multiword DMA mode 0-2, UDMA 0-5
Data transfer rate	
Internal	Max. 84.6 Mbit/s
To/From host	Max. 150 MB/s
Positioning time	
Minimum (track to track)	1.5 ms
Nominal (read only)	12 ms
Maximum (read only)	22 ms
Electrical characteristics	
Power consumption	0.3A at 3.3V (PCI bus) 1A at 5V (PCI bus)
Environmental conditions	
Temperature ¹⁾	
Operation ²⁾	-15 to 80°C
24-hour operation ³⁾	-15 to 80°C
Storage	-40 to 95°C
Transport	-40 to 95°C
Relative humidity	
Operation	8 to 90%, non-condensing ⁴⁾
Storage	5 to 95%, non-condensing ⁵⁾
Transport	5 to 95%, non-condensing ⁵⁾
Vibration ⁶⁾	
Operation (continuous)	5 to 500 Hz: max. 0.125 g; duration 1 octave per minute; no unrecoverable errors
Operation (occasional)	5 to 500 Hz: max. 0.25 g; duration 1 octave per minute; no unrecoverable errors
Storage	5 to 500 Hz: max. 5 g; duration 0.5 octaves per minute; no damage
Transport	5 to 500 Hz: max. 5 g; duration 0.5 octaves per minute; no damage
Shock	
Operation	Max. 125 g, 2 ms; no unrecoverable errors
Storage	Max. 400 g, 2 ms; no damage Max. 450 g, 1 ms; no damage Max. 200 g, 0.5 ms; no damage
Transport	Max. 400 g, 2 ms; no damage Max. 450 g, 1 ms; no damage Max. 200 g, 0.5 ms; no damage
Altitude	
Operation	-300 to 3048 m
Storage	-300 to 12192 m
Mechanical characteristics	
Installation ⁷⁾	Fixed
Dimensions	
Width	70 mm
Length	100 mm
Height	9.5 mm

Table 104: 5ACPCI.RAIC-03 - Technical data

Product ID	5ACPCI.RAIC-03
Weight	350 g
Manufacturer information	
Manufacturer	Fujitsu
Manufacturer product ID	M120-ESW MHY2160BH-ESW

Table 104: 5ACPCI.RAIC-03 - Technical data

- 1) Temperature values at an elevation of 305 meters. The temperature specification must be reduced linearly by 1°C every 305 meters. The temperature increase and decrease can be a maximum of 3°C per minute.
- 2) Standard operation refers to 333 POH (power-on hours) per month.
- 3) 24-hour operation refers to 732 POH (power-on hours) per month.
- 4) Maximum humidity at 29°C.
- 5) Maximum humidity at 40°C.
- 6) Operation in areas prone to vibration and shock can affect performance negatively (reduction of transfer rate).
- 7) Installed in PCI slot.

3.6.21.4 Temperature humidity diagram

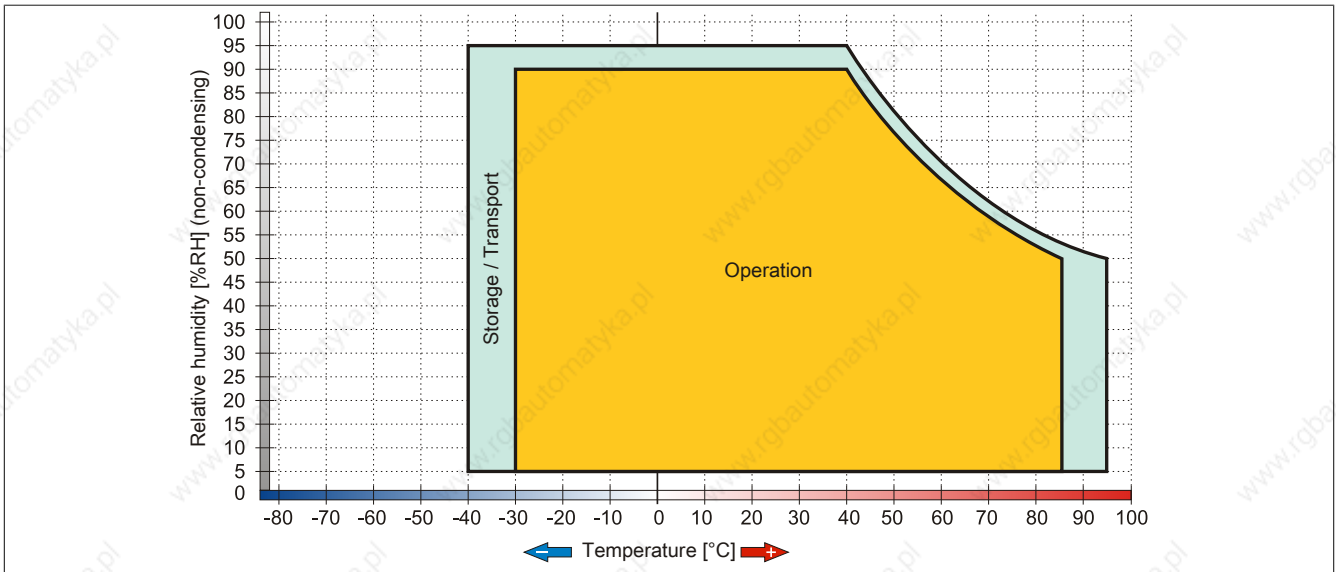

Figure 62: 5ACPCI.RAIC-03 - Temperature humidity diagram

3.6.21.5 Driver support

Special drivers are necessary for operating the PCI SATA RAID controller. Drivers for supported and approved operating systems are available in the Downloads section of the B&R website (www.br-automation.com).

.NET-based SATA Raid™ serial ATA RAID management software can also be found on the B&R website.

Information:

Required drivers can only be downloaded from the B&R website, not from manufacturer websites.

3.6.21.6 Configuration

For information about configuring a SATA RAID set, see 3 "Installation", section 7 "Configuring a SATA RAID set" on page 222.

3.6.21.7 Replacing a HDD

A hard drive can be easily replaced in the event of an error when using the RAID1 (mirroring) configuration without having to reinstall the system. The 160 GB 5ACPCI.RAIC-04 SATA HDD is available as a replacement hard disk.

For instructions on replacing the drive, see 7 "Maintenance and service", section 11 "Replacing a PCI SATA RAID hard disk in a RAID 1 set" on page 425.

3.6.22 5ACPCI.RAIC-04

3.6.22.1 General information

This hard disk can be used as a replacement for a HDD used with the 5ACPCI.RAIC-03 PCI SATA RAID controller.

3.6.22.2 Order data

Model number	Short description	Figure
5ACPCI.RAIC-04	Drives 160 GB SATA hard disk, replacement part for 5ACPCI.RAIC-03; note: Please see the manual for information about using this hard disk.	

Table 105: 5ACPCI.RAIC-04 - Order data

3.6.22.3 Technical data

Information:

The following characteristics, features and limit values only apply to this individual component and can deviate from those specified for the complete system. For the complete system in which this individual component is used, refer to the data given specifically for that device.

Product ID	5ACPCI.RAIC-04
General information	
Certification CE	Yes
Hard disk drive	
Capacity	160 GB
Number of heads	3
Number of sectors	312,581,808
Bytes per sector	512
Cache	8 MB
Speed	5400 rpm \pm 1%
Startup time	Typ. 4 s (from 0 rpm to read access)
Service life	5 years
S.M.A.R.T. support	Yes
Access time	5.56 ms
Supported transfer modes	SATA 1.0, PIO mode 0-4, multiword DMA mode 0-2, UDMA 0-5
Data transfer rate	
Internal	Max. 84.6 Mbit/s
To/From host	Max. 150 MB/s
Positioning time	
Minimum (track to track)	1.5 ms
Nominal (read only)	12 ms
Maximum (read only)	22 ms
Electrical characteristics	
Power consumption	0.3A at 3.3V (PCI bus) 1A at 5V (PCI bus)
Environmental conditions	
Temperature ¹⁾	
Operation ²⁾	-15 to 80°C
24-hour operation ³⁾	-15 to 80°C
Storage	-40 to 95°C
Transport	-40 to 95°C
Relative humidity	
Operation	8 to 90%, non-condensing ⁴⁾
Storage	5 to 95%, non-condensing ⁵⁾
Transport	5 to 95%, non-condensing ⁵⁾
Vibration ⁶⁾	
Operation (continuous)	5 to 500 Hz: max. 0.125 g; duration 1 octave per minute; no unrecoverable errors
Operation (occasional)	5 to 500 Hz: max. 0.25 g; duration 1 octave per minute; no unrecoverable errors
Storage	5 to 500 Hz: max. 5 g; duration 0.5 octaves per minute; no damage
Transport	5 to 500 Hz: max. 5 g; duration 0.5 octaves per minute; no damage

Table 106: 5ACPCI.RAIC-04 - Technical data

Product ID	5ACPCI.RAIC-04
Shock	Max. 125 g, 2 ms; no unrecoverable errors
Operation	Max. 400 g, 2 ms; no damage
Storage	Max. 450 g, 1 ms; no damage
Transport	Max. 200 g, 0.5 ms; no damage
Altitude	Max. 400 g, 2 ms; no damage
Operation	Max. 450 g, 1 ms; no damage
Storage	Max. 200 g, 0.5 ms; no damage
Mechanical characteristics	
Dimensions	
Width	70 mm
Length	100 mm
Height	9.5 mm
Weight	350 g
Manufacturer information	
Manufacturer	Fujitsu
Manufacturer product ID	M120-ESW MHY2160BH-ESW

Table 106: 5ACPCI.RAIC-04 - Technical data

- 1) Temperature values at an elevation of 305 meters. The temperature specification must be reduced linearly by 1°C every 305 meters. The temperature increase and decrease can be a maximum of 3°C per minute.
- 2) Standard operation refers to 333 POH (power-on hours) per month.
- 3) 24-hour operation refers to 732 POH (power-on hours) per month.
- 4) Maximum humidity at 29°C.
- 5) Maximum humidity at 40°C.
- 6) Operation in areas prone to vibration and shock can affect performance negatively (reduction of transfer rate).

3.6.22.4 Temperature humidity diagram

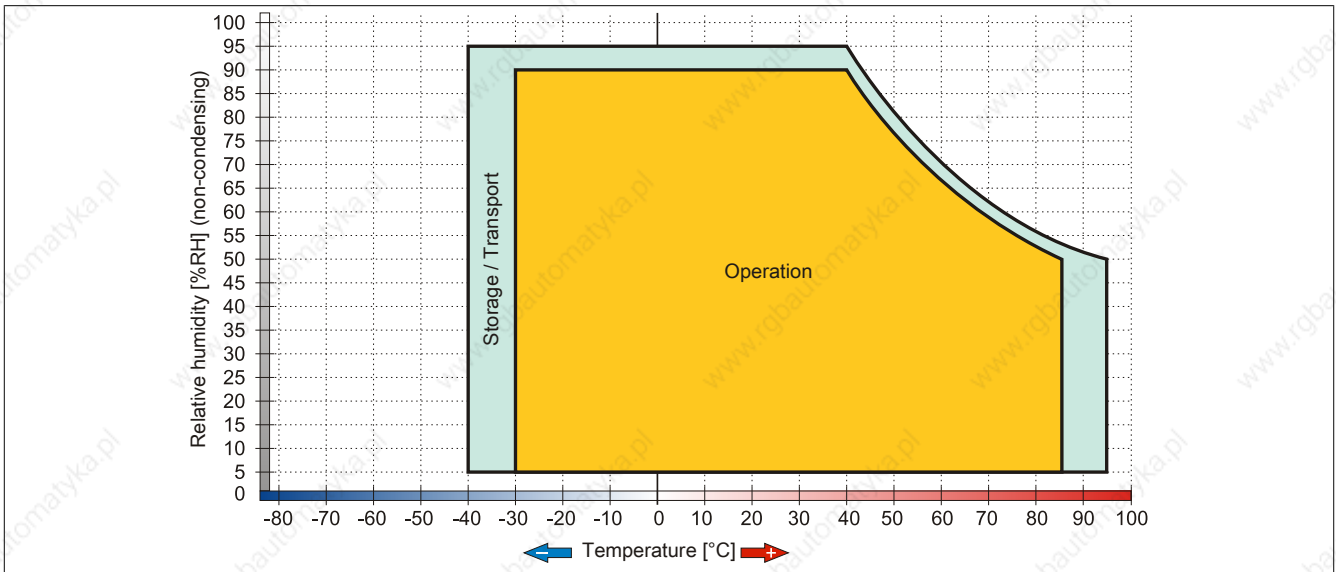

Figure 63: 5ACPCI.RAIC-04 - Temperature humidity diagram

3.6.23 5ACPCI.RAIC-05

3.6.23.1 General information

This SATA RAID controller supports RAID level 0 and 1 and can be inserted in a PCI slot. The 250 GB hard disks that are used are specified for 24-hour operation (24x7).

- SATA RAID controller
- RAID level 0 (striped) and 1 (mirrored)
- 2 SATA hard disk drives (suitable for 24-hour operation)
- Only requires 1 PCI slot
- Transfer rates up to 150 MB/s



Figure 64: PCI SATA RAID controller

Information:

The PCI SATA RAID controller cannot be used in place of a universal power supply (UPS). If the operating system is not shut down properly, then this will be detected as an error state (with RAID 1 sets) at the next system startup and a complete rebuild is performed. If 250 GB of memory are used, this generally takes approximately 250 minutes (configurable) to complete.

3.6.23.2 Order data

Model number	Short description	Figure
5ACPCI.RAIC-05	Drives PCI RAID system SATA 2x 250 GB; note: please see the manual for information about using this hard disk	
	Optional accessories	
	Drives	
5MMHDD.0250-00	250 GB SATA hard disk; replacement for 5AC801.HDDI-03 and 5ACPCI.RAIC-05; note: please see the manual for information about using this hard disk	

Table 107: 5ACPCI.RAIC-05 - Order data

3.6.23.3 Technical data

Product ID	5ACPCI.RAIC-05
General information	
Number of hard disks	2
Certification	
CE	Yes
cULus	Yes
Controller	
Type	Sil 3512 SATA link
Specification	Serial ATA 1.0
Data transfer rate	Max. 1.5 Gbit/s (150 MB/s)
RAID level	Supports RAID 0, 1
BIOS extension ROM requirements	Approx. 32 kB
Hard disk drive	
Capacity	250 GB
Number of heads	1
Number of sectors	488,397,168
Bytes per sector	512
Cache	8 MB
Speed	5400 rpm ±0.2%
Startup time	Typ. 3.6 s (from 0 rpm to read access)
S.M.A.R.T. support	Yes
Access time	5.56 ms
Supported transfer modes	SATA 1.0, Serial ATA Revision 2.6 PIO mode 0-4, multiword DMA mode 0-2, UDMA mode 0-6
Data transfer rate	
Internal	Max. 1175 Mbit/s
To/From host	Max. 150 MB/s
Positioning time	
Minimum (track to track)	1 ms
Nominal (read only)	14 ms
Maximum (read only)	30 ms
Electrical characteristics	
Power consumption	0.3A at 3.3V (PCI bus) 1A at 5V (PCI bus)
Environmental conditions	
Temperature ¹⁾	
Operation ²⁾	0 to 60°C
24-hour operation ³⁾	0 to 60°C
Storage	-40 to 70°C
Transport	-40 to 70°C
Relative humidity ⁴⁾	
Operation	5 to 95%, non-condensing
Storage	5 to 95%, non-condensing
Transport	5 to 95%, non-condensing
Vibration ⁵⁾	
Operation (continuous)	5 to 500 Hz: max. 0.125 g; duration 1 octave per minute; no unrecoverable errors
Operation (occasional)	5 to 500 Hz: max. 0.25 g; duration 1 octave per minute; no unrecoverable errors
Storage	5 to 500 Hz: 5 g; duration 0.5 octaves per minute; no damage
Transport	5 to 500 Hz: 5 g; duration 0.5 octaves per minute; no damage
Shock ⁵⁾	
Operation	Max. 125 g, 2 ms; no unrecoverable errors
Storage	Max. 400 g, 2 ms; no damage Max. 500 g, 1 ms; no damage Max. 300 g, 0.5 ms; no damage
Transport	Max. 400 g, 2 ms; no damage Max. 500 g, 1 ms; no damage Max. 300 g, 0.5 ms; no damage
Altitude	
Operation	- 300 to 3048 m
Storage	- 300 to 12192 m
Mechanical characteristics	
Installation	Fixed ⁶⁾
Weight	350 g
Manufacturer information	
Manufacturer	Seagate
Manufacturer product ID	ST9250315AS

Table 108: 5ACPCI.RAIC-05 - Technical data

- 1) Temperature values at an elevation of 305 meters. The temperature specification must be reduced linearly by 1°C every 305 meters. The temperature increase and decrease can be a maximum of 20°C per hour.
- 2) Standard operation refers to 333 POH (power-on hours) per month.
- 3) 24-hour operation refers to 732 POH (power-on hours) per month.
- 4) Humidity gradient: Maximum 30% per hour.
- 5) Operation in areas prone to vibration and shock can affect performance negatively (reduction of transfer rate).
- 6) Installed in PCI slot.

3.6.23.4 Temperature humidity diagram

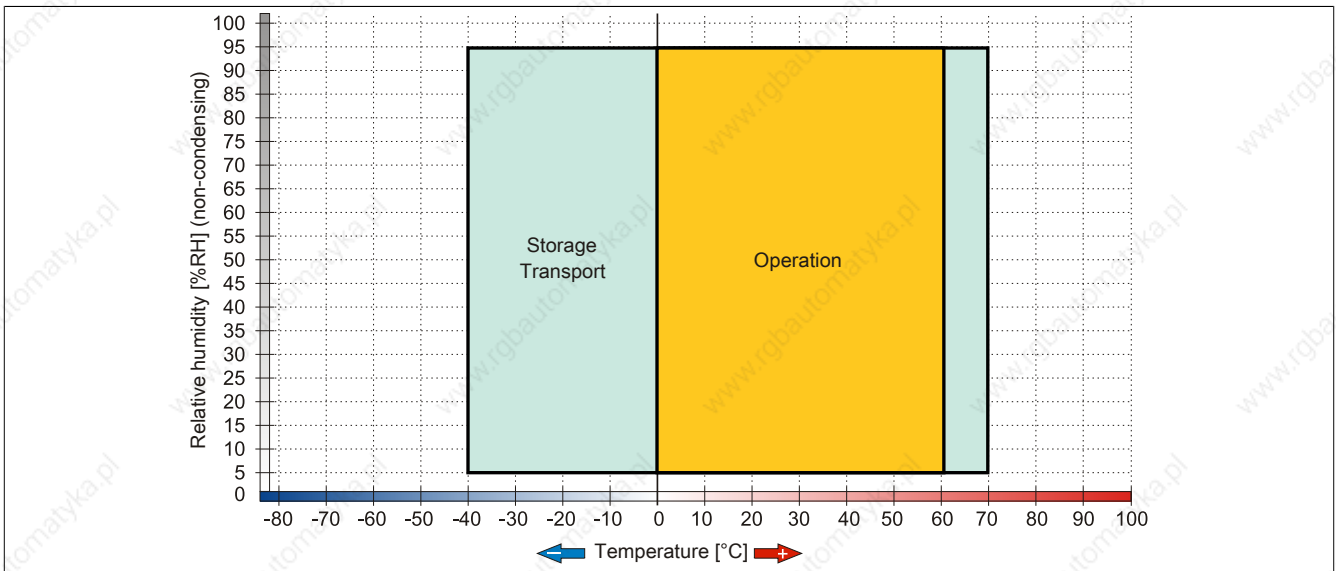

Figure 65: 5ACPCI.RAIC-05 - Temperature humidity diagram

3.6.23.5 Driver support

Special drivers are necessary for operating the PCI SATA RAID controller. Drivers for supported and approved operating systems are available in the Downloads section of the B&R website (www.br-automation.com).

.NET-based SATA Raid™ serial ATA RAID management software can also be found on the B&R website.

Information:

Required drivers can only be downloaded from the B&R website, not from manufacturer websites.

3.6.23.6 Configuration

For information about configuring a SATA RAID set, see 3 "Installation", section 7 "Configuring a SATA RAID set" on page 222.

3.6.23.7 Replacing a HDD

A hard drive can be easily replaced in the event of an error when using the RAID1 (mirroring) configuration without having to reinstall the system. The 250 GB 5MMHDD.0250-00 SATA HDD is available as a replacement hard disk.

For information about performing a replacement, see "Replacing a PCI SATA RAID hard disk in a RAID 1 set" on page 425.

3.6.24 5ACPCI.RAIC-06

3.6.24.1 General information

This SATA RAID controller supports RAID level 0 and 1 and can be inserted in a PCI slot. The 500 GB hard disks that are used are specified for 24-hour operation (24x7).

- SATA RAID controller
- RAID level 0 (striped) and 1 (mirrored)
- 2x 500 GB SATA hard disks (suitable for 24-hour operation)
- Only requires 1 PCI slot
- Transfer rates up to 150 MB/s



Figure 66: PCI SATA RAID controller

Information:

The PCI SATA RAID controller cannot be used in place of a universal power supply (UPS). If the operating system is not shut down properly, then this will be detected as an error state (with RAID 1 sets) at the next system startup and a complete rebuild is performed. If 500 GB of memory are used, this generally takes approximately 500 minutes (configurable) to complete.

3.6.24.2 Order data

Model number	Short description	Figure
	Drives	
5ACPCI.RAIC-06	PCI RAID system SATA 2x 500 GB; note: please see the manual for information about using this hard disk	
	Optional accessories	
	Drives	
5MMHDD.0500-00	500 GB SATA hard disk; replacement for 5AC801.HDDI-04, 5AC901.CHDD-01 and 5ACPCI.RAIC-06; note: please see the manual for information about using this hard disk	

Table 109: 5ACPCI.RAIC-06 - Order data

3.6.24.3 Technical data

Information:

The following characteristics, features and limit values only apply to this accessory and can deviate from those specified for the complete system. The data specifications for the complete system take precedence over those of individual components.

Product ID	5ACPCI.RAIC-06
General information	
Capacity	2x 500 GB
Number of hard disks	2
Certification	
CE	Yes
cULus	Yes
Controller	
Type	Sil 3512 SATA link
Specification	Serial ATA 1.0
Data transfer rate	Max. 1.5 Gbit/s (150 MB/s)
RAID level	Supports RAID 0, 1
BIOS extension ROM requirements	Approx. 32 kB
Hard disk drive ¹⁾	
Capacity	500 GB
Number of heads	2
Number of sectors	976,773,168
Bytes per sector	512 (logical) / 4096 (physical)
Cache	16 MB
Speed	5400 rpm ±0.2%
Startup time	Typ. 3.5 s (from 0 rpm to read access)
Service life	5 years
MTBF	1,000,000 POH ²⁾
S.M.A.R.T. support	Yes
Interface	SATA
Access time	5.5 ms
Supported transfer modes	SATA II
Data transfer rate	
Internal	Max. 147 MB/s
To/From host	Max. 150 MB/s (SATA I), max. 300 MB/s (SATA II)
Positioning time	
Nominal (read only)	11 ms
Maximum (read only)	21 ms
Environmental conditions	
Temperature ³⁾	
Operation ⁴⁾	0 to 60°C
24-hour operation ⁵⁾	0 to 60°C
Storage	-40 to 70°C
Transport	-40 to 70°C
Relative humidity ⁶⁾	
Operation	5 to 95%, non-condensing
Storage	5 to 95%, non-condensing
Transport	5 to 95%, non-condensing
Vibration ⁷⁾	
Operation (continuous)	5 to 500 Hz: 0.125 g; no unrecoverable errors
Operation (occasional)	5 to 500 Hz: 0.25 g; no unrecoverable errors
Storage	10 to 500 Hz: 5 g; no unrecoverable errors
Transport	10 to 500 Hz: 5 g; no unrecoverable errors
Shock	
Operation	200 g and 2 ms duration; no unrecoverable errors
Storage	1000 g and 2 ms duration; no unrecoverable errors
Transport	1000 g and 2 ms duration; no unrecoverable errors
Altitude	
Operation	-305 to 3048 m
Storage	-305 to 12192 m
Mechanical characteristics	
Installation	Fixed ⁸⁾
Weight	350 g
Manufacturer information	
Manufacturer	Western Digital
Manufacturer product ID	WD5000LUCT

Table 110: 5ACPCI.RAIC-06 - Technical data

- 1) Technical data for a hard disk.
- 2) With 8760 POH (power-on hours) per year and 25°C surface temperature.
- 3) Temperature values at an elevation of 305 meters. The temperature specification must be reduced linearly by 1°C every 305 meters. The temperature increase and decrease can be a maximum of 20°C per hour.

- 4) Standard operation refers to 333 POH (power-on hours) per month.
- 5) 24-hour operation refers to 732 POH (power-on hours) per month.
- 6) Humidity gradient: Maximum 20% per hour.
- 7) Operation in areas prone to vibration and shock can affect performance negatively (reduction of transfer rate).
- 8) Installed in PCI slot.

3.6.24.4 Temperature humidity diagram

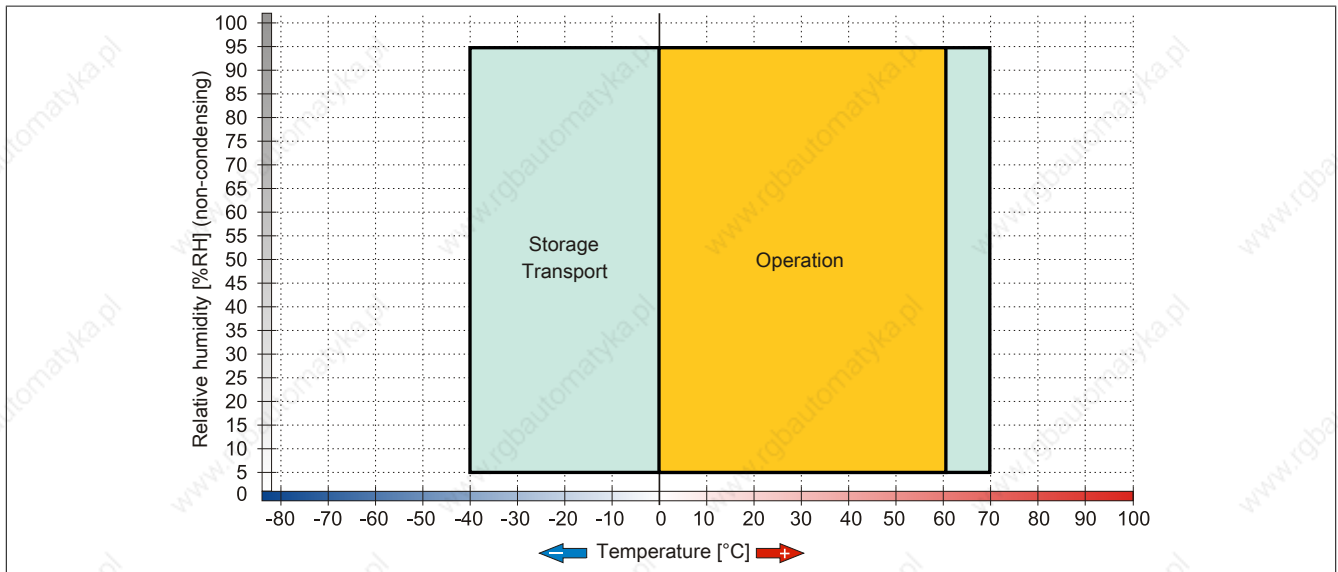

Figure 67: 5ACPCI.RAIC-06 - Temperature humidity diagram

3.6.24.5 Driver support

Special drivers are necessary for operating the PCI SATA RAID controller. Drivers for supported and approved operating systems are available in the Downloads section of the B&R website (www.br-automation.com).

.NET-based SATA Raid™ serial ATA RAID management software can also be found on the B&R website.

Information:

Required drivers can only be downloaded from the B&R website, not from manufacturer websites.

3.6.24.6 Configuration

For information about configuring a SATA RAID set, see 3 "Installation", section 7 "Configuring a SATA RAID set" on page 222.

3.6.24.7 Replacing a HDD

A hard drive can be easily replaced in the event of an error when using the RAID1 (mirroring) configuration without having to reinstall the system. The 500 GB 5MMHDD.0500-00 SATA HDD is available as a replacement hard disk.

For information about performing a replacement, see "Replacing a PCI SATA RAID hard disk in a RAID 1 set" on page 425.

3.6.25 5MMHDD.0250-00

3.6.25.1 General information

This 250 GB hard disk can be used as a replacement part or accessory.

- 250 GB hard disk
- Replacement hard disk for a 5AC801.HDDI-03 hard disk or a 5ACPCI.RAIC-05 RAID controller
- APC510 accessory (optional hard disk for the I/O board)
- Specified for 24-hour operation
- S.M.A.R.T. support

3.6.25.2 Order data

Model number	Short description	Figure
	Drives	
5MMHDD.0250-00	250 GB SATA hard disk; replacement for 5AC801.HDDI-03 and 5ACPCI.RAIC-05; note: please see the manual for information about using this hard disk	

Table 111: 5MMHDD.0250-00 - Order data

3.6.25.3 Technical data

Information:

The following characteristics, features and limit values only apply to this individual component and can deviate from those specified for the complete system. For the complete system in which this individual component is used, refer to the data given specifically for that device.

Product ID	5MMHDD.0250-00
General information	
Certification	
CE	Yes
cULus	Yes
Hard disk drive	
Capacity	250 GB
Number of heads	1
Number of sectors	488,397,168
Bytes per sector	512
Cache	8 MB
Speed	5400 rpm \pm 0.2%
Startup time	Typ. 3.6 s (from 0 rpm to read access)
MTBF	550,000 POH ¹⁾
S.M.A.R.T. support	Yes
Interface	SATA
Access time	5.56 ms
Supported transfer modes	SATA 1.0, Serial ATA Revision 2.6 PIO mode 0-4, multiword DMA mode 0-2, UDMA mode 0-6
Data transfer rate	
Internal	Max. 1175 Mbit/s
To/From host	Max. 150 MB/s (SATA I), max. 300 MB/s (SATA II)
Positioning time	
Minimum (track to track)	1 ms
Nominal (read only)	14 ms
Maximum (read only)	30 ms
Environmental conditions	
Temperature ²⁾	
Operation ³⁾	0 to 60°C
24-hour operation ⁴⁾	0 to 60°C
Storage	-40 to 70°C
Transport	-40 to 70°C

Table 112: 5MMHDD.0250-00 - Technical data

Product ID	5MMHDD.0250-00
Relative humidity ⁵⁾ Operation Storage Transport	5 to 95%, non-condensing 5 to 95%, non-condensing 5 to 95%, non-condensing
Vibration Operation Storage Transport	5 to 500 Hz: 0.5 g; no unrecoverable errors 5 to 500 Hz: 5 g; no unrecoverable errors 5 to 500 Hz: 5 g; no unrecoverable errors
Shock Operation Storage Transport	350 g and 2 ms duration; no unrecoverable errors 800 g and 2 ms duration; no unrecoverable errors 1000 g and 1 ms duration; no unrecoverable errors 600 g and 0.5 ms duration; no unrecoverable errors 800 g and 2 ms duration; no unrecoverable errors 1000 g and 1 ms duration; no unrecoverable errors 600 g and 0.5 ms duration; no unrecoverable errors
Altitude Operation Storage	-300 to 3048 m -300 to 12192 m
Mechanical characteristics	
Dimensions Width Height Depth	9.5 mm 69 mm 100 mm
Weight	100 g
Manufacturer information	
Manufacturer	Seagate
Manufacturer product ID	ST9250315AS

Table 112: 5MMHDD.0250-00 - Technical data

- 1) With 8760 POH (power-on hours) per year and 25°C surface temperature.
- 2) Temperature values at an elevation of 305 meters. The temperature specification must be reduced linearly by 1°C every 305 meters. The temperature increase and decrease can be a maximum of 20°C per hour.
- 3) Standard operation refers to 333 POH (power-on hours) per month.
- 4) 24-hour operation refers to 732 POH (power-on hours) per month.
- 5) Humidity gradient: Maximum 30% per hour.

3.6.25.4 Temperature humidity diagram

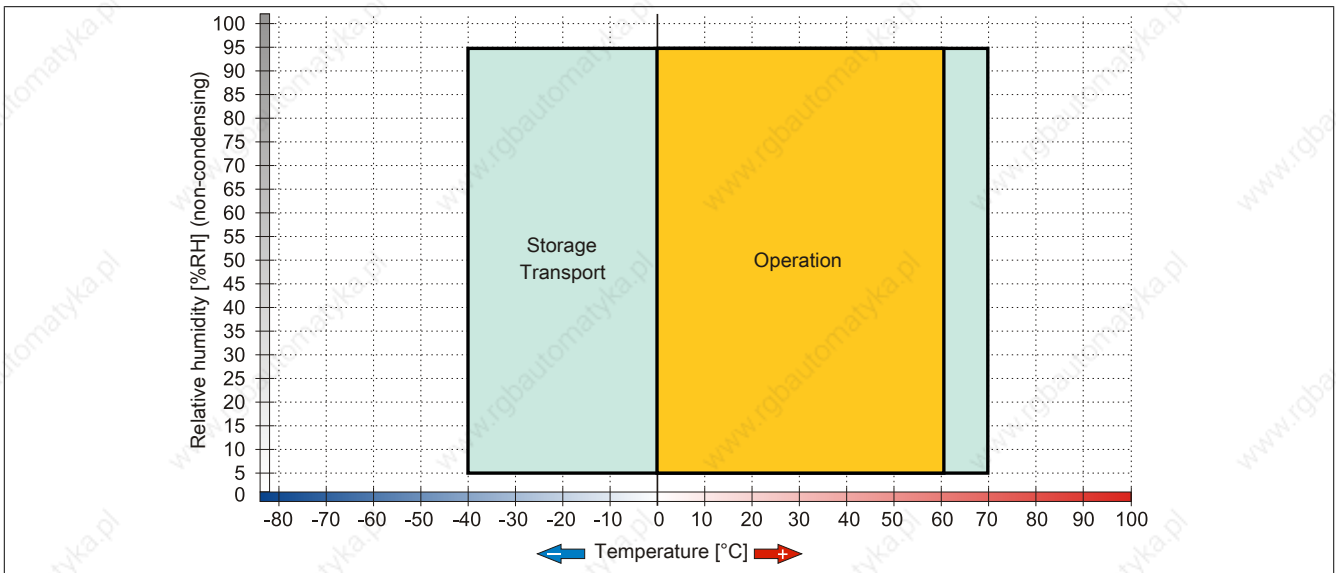

Figure 68: 5MMHDD.0250-00 - Temperature humidity diagram

3.6.26 5MMHDD.0500-00

3.6.26.1 General information

This 500 GB hard disk can be used as a replacement part or accessory.

- 500 GB hard disk
- Replacement hard disk for a 5AC801.HDDI-04 / 5AC901.CHDD-01 hard disk or a 5ACPCI.RAIC-05 RAID controller
- APC510 accessory (optional hard disk for the I/O board)
- Specified for 24-hour operation
- S.M.A.R.T. support

3.6.26.2 Order data

Model number	Short description	Figure
5MMHDD.0500-00	Drives 500 GB SATA hard disk; replacement for 5AC801.HDDI-04, 5AC901.CHDD-01 and 5ACPCI.RAIC-06; note: please see the manual for information about using this hard disk	

Table 113: 5MMHDD.0500-00 - Order data

3.6.26.3 Technical data

Information:

The following characteristics, features and limit values only apply to this accessory and can deviate from those specified for the complete system. The data specifications for the complete system take precedence over those of individual components.

Product ID	5MMHDD.0500-00
General information	
Certification	
CE	Yes
cULus	Yes
Hard disk drive	
Capacity	500 GB
Number of heads	2
Number of sectors	976,773,168
Bytes per sector	512 (logical) / 4096 (physical)
Cache	16 MB
Speed	5400 rpm \pm 0.2%
Startup time	Typ. 3.5 s (from 0 rpm to read access)
Service life	5 years
MTBF	1,000,000 POH ¹⁾
S.M.A.R.T. support	Yes
Interface	SATA
Access time	5.5 ms
Supported transfer modes	SATA II
Data transfer rate	
Internal	Max. 147 MB/s
To/From host	Max. 150 MB/s (SATA I), max. 300 MB/s (SATA II)
Positioning time	
Nominal (read only)	11 ms
Maximum (read only)	21 ms

Table 114: 5MMHDD.0500-00 - Technical data

Product ID	5MMHDD.0500-00
Environmental conditions	
Temperature ²⁾	
Operation ³⁾	0 to 60°C
24-hour operation ⁴⁾	0 to 60°C
Storage	-40 to 70°C
Transport	-40 to 70°C
Relative humidity ⁵⁾	
Operation	5 to 95%, non-condensing
Storage	5 to 95%, non-condensing
Transport	5 to 95%, non-condensing
Vibration	
Operation (continuous)	5 to 500 Hz: 0.25 g; no unrecoverable errors
Operation (occasional)	5 to 500 Hz: 0.5 g; no unrecoverable errors
Storage	10 to 500 Hz: 5 g; no unrecoverable errors
Transport	10 to 500 Hz: 5 g; no unrecoverable errors
Shock	
Operation	400 g and 2 ms duration; no unrecoverable errors
Storage	1000 g and 2 ms duration; no unrecoverable errors
Transport	1000 g and 2 ms duration; no unrecoverable errors
Altitude	
Operation	-305 to 3048 m
Storage	-305 to 12192 m
Mechanical characteristics	
Dimensions	
Width	7 mm
Height	69 mm
Depth	100 mm
Weight	100 g
Manufacturer information	
Manufacturer	Western Digital
Manufacturer product ID	WD5000LUCT

Table 114: 5MMHDD.0500-00 - Technical data

- 1) With 8760 POH (power-on hours) per year and 25°C surface temperature.
- 2) Temperature values at an elevation of 305 meters. The temperature specification must be reduced linearly by 1°C every 305 meters. The temperature increase and decrease can be a maximum of 20°C per hour.
- 3) Standard operation refers to 333 POH (power-on hours) per month.
- 4) 24-hour operation refers to 732 POH (power-on hours) per month.
- 5) Humidity gradient: Maximum 20% per hour.

3.6.26.4 Temperature humidity diagram

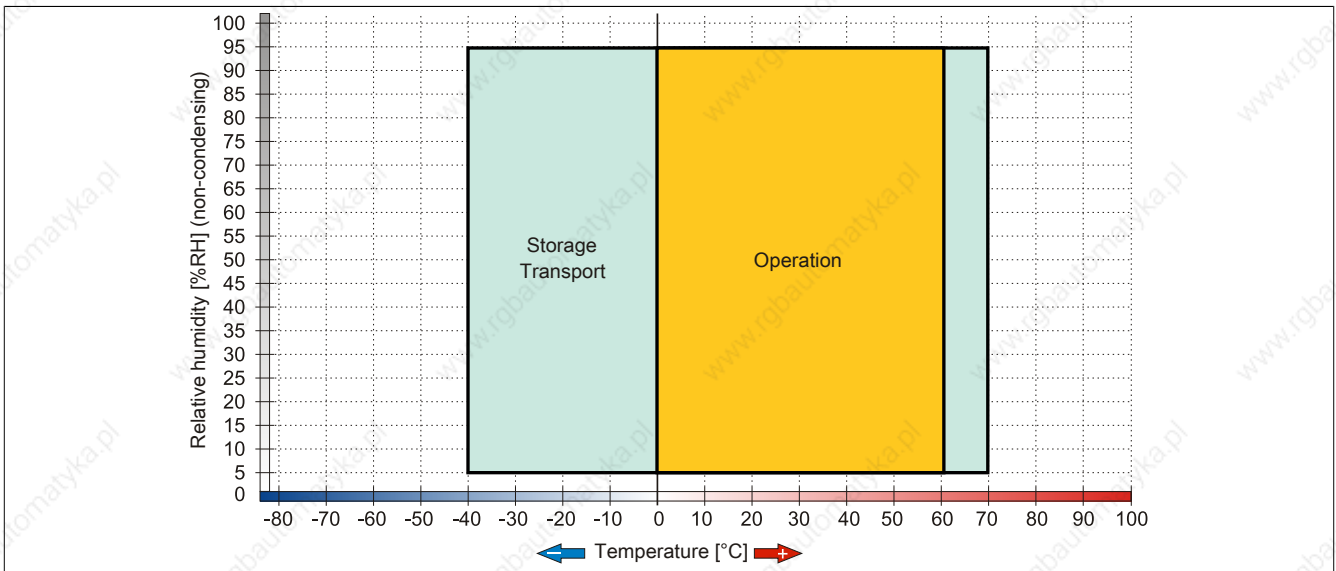

Figure 69: 5MMHDD.0500-00 - Temperature humidity diagram

3.7 Fan kit

Information:

Fans are necessary when using components that must work within certain temperature limits, e.g. RAID controllers, DVD combos and PCI cards.

Fan and dust filters are subject to wear and must be checked with appropriate frequency and cleaned or replaced when not functioning properly (e.g. due to dirt and grime).

For additional information about when fans are switched on, see Appendix A.

3.7.1 5PC810.FA01-00

3.7.1.1 General information

This fan kit is an optional addition for 1-slot system units.

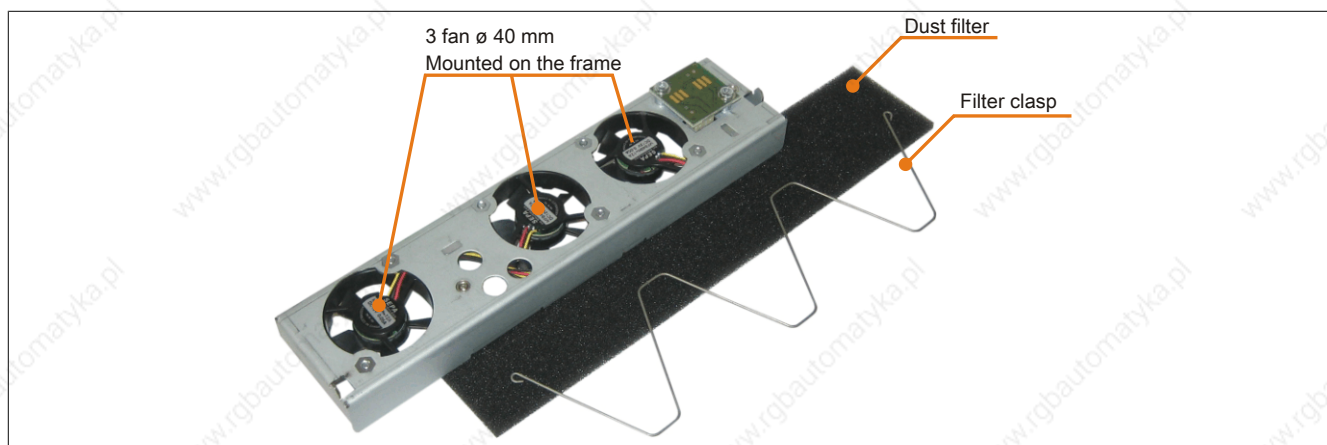

Figure 70: 5PC810.FA01-00 - Fan kit

3.7.1.2 Order data

Model number	Short description	Figure
	Fan kits	
5PC810.FA01-00	APC810 fan kit for 5PC810.SX01-00 system unit	
	Optional accessories	
	Accessories	
5AC801.FA01-00	APC810 replacement fan filter for 5PC810.SX01-00; 5 pcs.	

Table 115: 5PC810.FA01-00 - Order data

3.7.1.3 Technical data

Product ID	5PC810.FA01-00	
General information		
Number of fans	3	
Speed	Max. 6100 rpm	
Noise level	21 dB	
Service life	29,000 hours at 70°C 95,000 hours at 20°C	
Type	Double ball bearings	
Certification		
CE	Yes	
cULus HazLoc Class 1 Division 2	Yes	
ATEX Zone 22	Yes	
GL	Yes	

Table 116: 5PC810.FA01-00 - Technical data

Product ID	5PC810.FA01-00
Mechanical characteristics	
Dimensions	
Fan	
Width	40 mm
Height	40 mm
Depth	10 mm

Table 116: 5PC810.FA01-00 - Technical data

For information about installing/replacing fan kits, see chapter "Maintenance and service", section 6 "Installing and replacing fan kits" on page 406.

3.7.2 5PC810.FA02-01

3.7.2.1 General information

These fan kits are an optional addition for 2-slot system units.

The only difference between the 5PC810.5A02-01 and the 5PC810.FA02-00 fan kit is that additional guide elements have been integrated that are similar to the fan kits for the 1-slot and 5-slot models. This makes it easier to install or replace the fan kit. Starting with Revision D0, only the 5PC810.5A02-01 fan kit can be installed for the 5PC810.SX02-00 system unit.

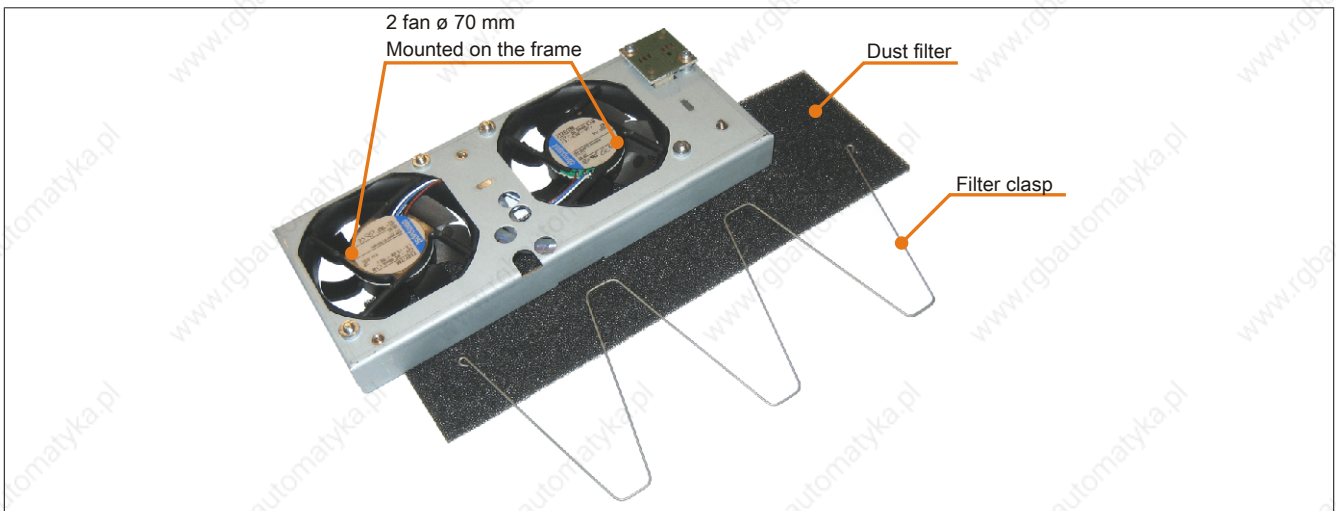

Figure 71: 5PC810.FA02-00 and 5PC810.FA02-01 - Fan kit

3.7.2.2 Order data

Model number	Short description	Figure
	Fan kits	
5PC810.FA02-00	APC810 fan kit for 5PC810.SX02-00 system unit	
5PC810.FA02-01	APC810 fan kit for 5PC810.SX02-00 (revisions > D0)	
	Optional accessories	
	Accessories	
5AC801.FA02-00	APC810 replacement fan filter for 5PC810.SX02-00; 5 pcs.	

Table 117: 5PC810.FA02-00, 5PC810.FA02-01 - Order data

3.7.2.3 Technical data

Product ID	5PC810.FA02-00	5PC810.FA02-01
General information		
Number of fans	2	
Speed	Max. 4300 rpm ±12.5%	
Noise level	32 dB	
Service life	60,000 hours (at 40°C)	
Type	Double ball bearings	

Table 118: 5PC810.FA02-00, 5PC810.FA02-01 - Technical data

Technical data • Individual components

Product ID	5PC810.FA02-00	5PC810.FA02-01
Certification		
CE		Yes
cULus HazLoc Class 1 Division 2	-	Yes
ATEX Zone 22	-	Yes
GL	-	Yes
Mechanical characteristics		
Dimensions		
Fan		
Width		70 mm
Height		70 mm
Depth		15 mm

Table 118: 5PC810.FA02-00, 5PC810.FA02-01 - Technical data

For information about installing/replacing fan kits, see chapter "Maintenance and service", section 6 "Installing and replacing fan kits" on page 406.

3.7.3 5PC810.FA03-00

3.7.3.1 General information

This fan kit is an optional addition for 3-slot system units.

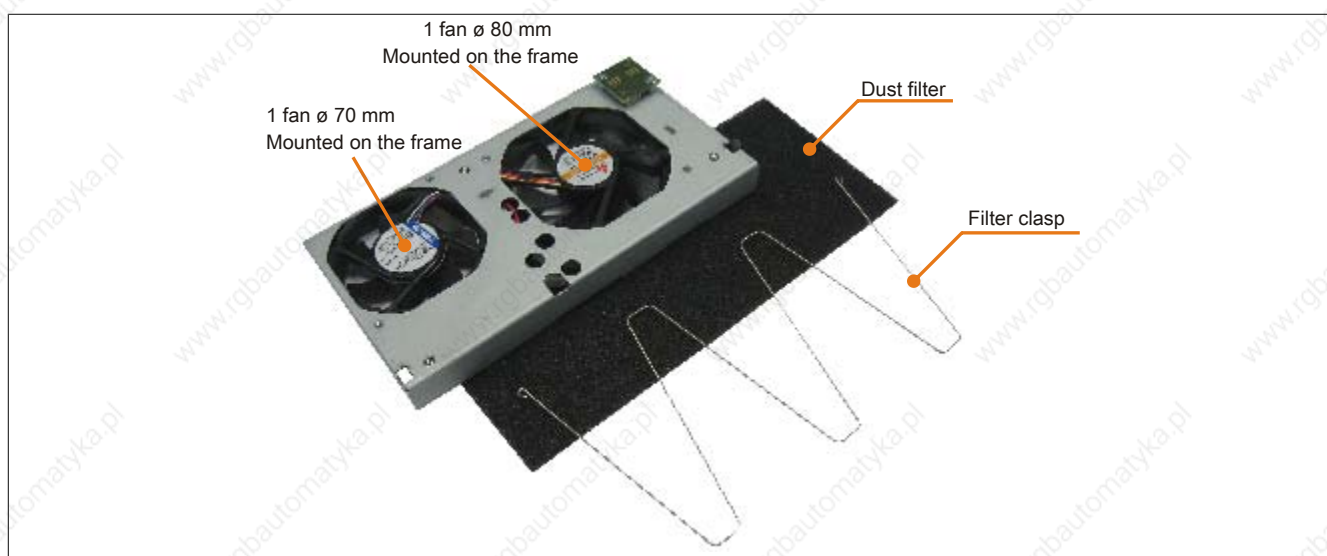

Figure 72: 5PC810.FA03-00 - Fan kit

3.7.3.2 Order data

Model number	Short description	Figure
	Fan kits	
5PC810.FA03-00	APC810 fan kit for 5PC810.SX03-00 system unit	
	Optional accessories	
	Accessories	
5AC801.FA03-00	APC810 replacement fan filter for 5PC810.SX03-00; 5 pcs.	

Table 119: 5PC810.FA03-00 - Order data

3.7.3.3 Technical data

Product ID	5PC810.FA03-00
General information	
Number of fans	2
Speed	Fan 1: Max. 4300 rpm \pm 12.5% Fan 2: Max. 3200 rpm \pm 10%

Table 120: 5PC810.FA03-00 - Technical data

Product ID	5PC810.FA03-00
Noise level	Fan 1: 32 dB Fan 2: 33 dB
Service life	Fan 1: 60,000 hours (at 40°C) Fan 2: 75,000 hours (at 40°C)
Type	Double ball bearings
Certification CE	Yes
Mechanical characteristics	
Dimensions	
Fan	
Width	Fan 1: 70 mm Fan 2: 80 mm
Height	Fan 1: 70 mm Fan 2: 80 mm
Depth	Fan 1: 15 mm Fan 2: 15 mm

Table 120: 5PC810.FA03-00 - Technical data

For information about installing/replacing fan kits, see chapter "Maintenance and service", section 6 "Installing and replacing fan kits" on page 406.

3.7.4 5PC810.FA05-00

3.7.4.1 General information

This fan kit is an optional addition for 5-slot system units.

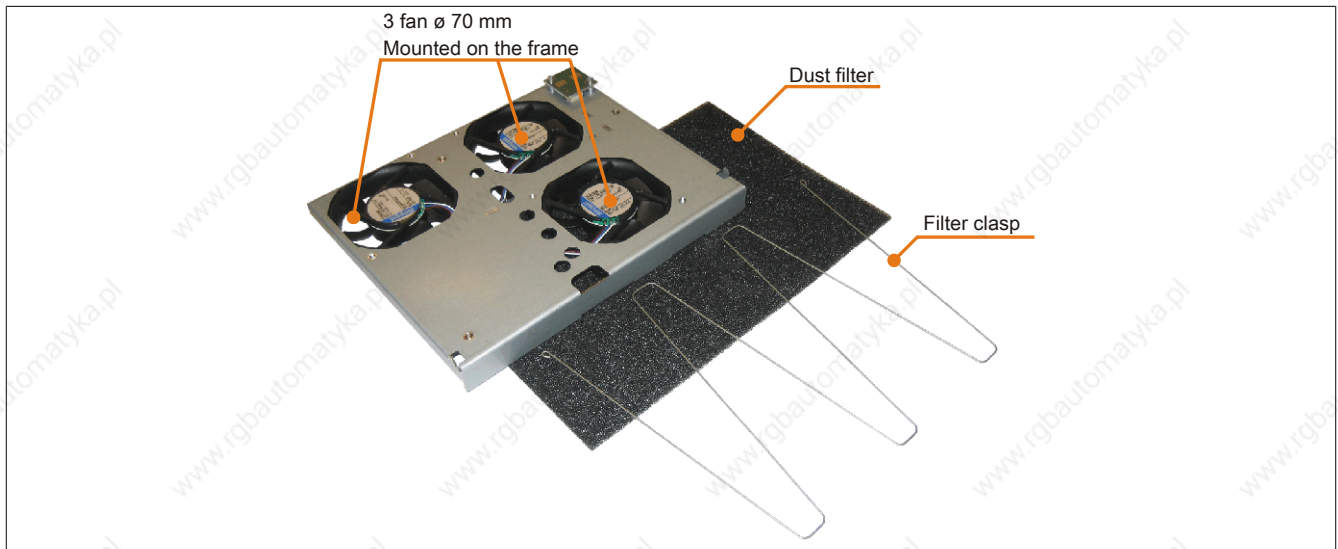

Figure 73: 5PC810.FA05-00 - Fan kit

3.7.4.2 Order data

Model number	Short description	Figure
	Fan kits	
5PC810.FA05-00	APC810 fan kit for 5PC810.SX05-00 system unit	
	Optional accessories	
	Accessories	
5AC801.FA05-00	APC810 replacement fan filter for 5PC810.SX05-00; 5 pcs.	

Table 121: 5PC810.FA05-00 - Order data

3.7.4.3 Technical data

Product ID	5PC810.FA05-00
General information	
Number of fans	3
Speed	Max. 4300 rpm \pm 10%
Noise level	32 dB
Service life	60,000 hours (at 40°C)
Type	Double ball bearings
Certification CE	Yes
Mechanical characteristics	
Dimensions	
Fan	
Width	70 mm
Height	70 mm
Depth	15 mm

Table 122: 5PC810.FA05-00 - Technical data

For information about installing/replacing fan kits, see chapter "Maintenance and service", section 6 "Installing and replacing fan kits" on page 406.

3.8 AP Link cards

AP Link cards can be installed in the APC810 system units 5PC810.SX02-00, 5PC810.SX03-00 and 5PC810.SX05-00.

3.8.1 5AC801.SDL0-00

3.8.1.1 General information

A second graphics line can be created using an AP Link graphics adapter card. This makes it possible to transfer DVI and SDL signals. RGB signals are not supported. Details can be found in the technical data for the CPU board being used.

Information:

It is only possible to install AP Link SDL transmitters when using the 5PC810.SX02-00, 5PC810.SX03-00 and 5PC810.SX05-00 system units.

For additional information about installing the AP Link SDL transmitter, please see "AP Link installation" on page 424.

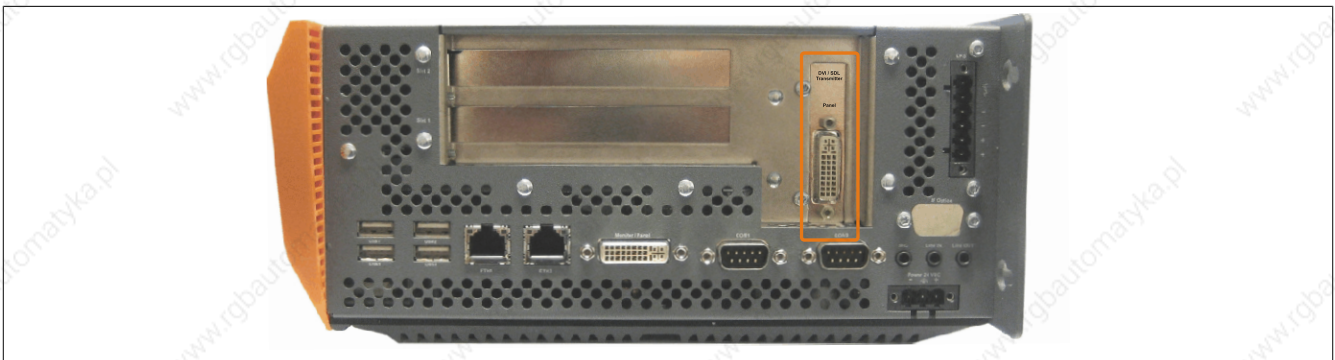

Figure 74: 5PC810.SX02-00 - Installation example in system unit

3.8.1.2 Order data

Model number	Short description	Figure
5AC801.SDL0-00	Automation Panel Link interfaces Smart Display Link/DVI-D transmitter	

Table 123: 5AC801.SDL0-00 - Order data

3.8.1.3 Technical data

Product ID	5AC801.SDL0-00
General information	
Certification	
CE	Yes
GL	Yes
Interfaces	
Monitor/Panel interface	
Design	Female DVI-D connector
Type	SDL/DVI

Table 124: 5AC801.SDL0-00 - Technical data

3.8.1.4 Pinout

Pin	Assignment	Description	Pin	Assignment	Description
1	TMDS data 2-	DVI lane 2 (negative)	16	HPD	Hot plug detect
2	TMDS data 2+	DVI lane 2 (positive)	17	TMDS data 0-	DVI lane 0 (negative)
3	TMDS data 2/4 SHIELD	Shield for data pair 2 and 4	18	TMDS data 0+	DVI lane 0 (positive)
4	SDL-	SDL lane (negative)	19	TMDS Data 0/ XUSB1 SHIELD	Shield for data pair 0 and USB1
5	SDL+	SDL lane (positive)	20	XUSB1-	USB lane 1 (negative)
6	DDC clock	DDC-based control signal (clock)	21	XUSB1+	USB lane 1 (positive)
7	DDC data	DDC-based control signal (data)	22	TMDS clock shield	Shield for clock pair
8	NC	Not connected	23	TMDS clock+	DVI clock (positive)
9	TMDS data 1-	DVI lane 1 (negative)	24	TMDS clock -	DVI clock (negative)
10	TMDS DATA 1+	DVI lane 1 (negative) HDMI clock (positive)	C1	NC	Not connected
11	TMDS DATA 1/ XUSB0 SHIELD	Shield for data pair 1 and USB0	C2	NC	Not connected
12	XUSB0-	USB lane 0 (negative)	C3	NC	Not connected
13	XUSB0+	USB lane 0 (positive)	C4	NC	Not connected
14	+5 V power ¹⁾	+5 V power supply	C5	NC	Not connected
15	Ground (return for +5 V, HSync and VSync)	Ground			

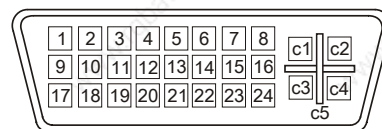

Table 125: DVI interface - Pinout

1) Protected internally by a multifuse.

3.8.1.5 Cable lengths and resolutions for SDL transmission

The following table lists the relationship between segment lengths and maximum resolution depending on the SDL cable being used:

SDL cables Segment length [m]	Resolution					
	VGA 640 x 480	SVGA 800 x 600	XGA 1024 x 768	SXGA 1280 x 1024	UXGA 1600 x 1200	FHD 1920 x 1080
1.8	5CASDL.0018-00	5CASDL.0018-00	5CASDL.0018-00	5CASDL.0018-00	5CASDL.0018-00	5CASDL.0018-00
	5CASDL.0018-01	5CASDL.0018-01	5CASDL.0018-01	5CASDL.0018-01	5CASDL.0018-01	5CASDL.0018-01
	5CASDL.0018-03	5CASDL.0018-03	5CASDL.0018-03	5CASDL.0018-03	5CASDL.0018-03	5CASDL.0018-03
5	5CASDL.0050-00	5CASDL.0050-00	5CASDL.0050-00	5CASDL.0050-00	5CASDL.0050-00	5CASDL.0050-00
	5CASDL.0050-01	5CASDL.0050-01	5CASDL.0050-01	5CASDL.0050-01	5CASDL.0050-01	5CASDL.0050-01
	5CASDL.0050-03	5CASDL.0050-03	5CASDL.0050-03	5CASDL.0050-03	5CASDL.0050-03	5CASDL.0050-03
10	5CASDL.0100-00	5CASDL.0100-00	5CASDL.0100-00	5CASDL.0100-00	5CASDL.0100-00	5CASDL.0100-00
	5CASDL.0100-01	5CASDL.0100-01	5CASDL.0100-01	5CASDL.0100-01	5CASDL.0100-01	5CASDL.0100-01
	5CASDL.0100-03	5CASDL.0100-03	5CASDL.0100-03	5CASDL.0100-03	5CASDL.0100-03	5CASDL.0100-03
15	5CASDL.0150-00	5CASDL.0150-00	5CASDL.0150-00	5CASDL.0150-00	-	-
	5CASDL.0150-01	5CASDL.0150-01	5CASDL.0150-01	5CASDL.0150-01	-	-
	5CASDL.0150-03	5CASDL.0150-03	5CASDL.0150-03	5CASDL.0150-03	-	5CASDL.0150-03
20	5CASDL.0200-00	5CASDL.0200-00	5CASDL.0200-00	5CASDL.0200-00	-	-
	5CASDL.0200-03	5CASDL.0200-03	5CASDL.0200-03	5CASDL.0200-03	-	5CASDL.0200-03
	5CASDL.0250-00	5CASDL.0250-00	5CASDL.0250-00	-	-	-
25	5CASDL.0250-03	5CASDL.0250-03	5CASDL.0250-03	-	-	-
	5CASDL.0300-00	5CASDL.0300-00	-	-	-	-
30	5CASDL.0300-03	5CASDL.0300-03	5CASDL.0300-13	5CASDL.0300-13	-	5CASDL.0300-13
	5CASDL.0400-13	5CASDL.0400-13	5CASDL.0400-13	5CASDL.0400-13	-	5CASDL.0400-13

Table 126: Cable lengths and resolutions for SDL transmission

3.8.2 5AC801.RDYR-00

3.8.2.1 General information

Since the 5AC801.RDYR-00 ready relay switches the relay contacts as soon as the B&R Automation PC 810 has booted and is supplied internally with all voltages, it is possible to connect additional devices to the relay that will also be switched on.

The 5AC801.RDYR-00 ready relay can only be installed in an AP Link slot.

Information:

It is only possible to install the ready relay when using the 5PC810.SX02-00, 5PC810.SX03-00 and 5PC810.SX05-00 system units.

For additional information about installing the ready relay, see "AP Link installation" on page 424.



Figure 75: Installation example with the 5PC810.SX02-00 system unit

3.8.2.2 Order data

Model number	Short description	Figure
	Automation Panel Link interfaces	
5AC801.RDYR-00	APC810 ready relay	
	Required accessories	
	Terminal blocks	
0TB704.9	Accessory terminal block, 4-pin, screw clamps 2.5 mm ²	
0TB704.91	Accessory terminal block, 4-pin, cage clamp 2.5 mm ²	

Table 127: 5AC801.RDYR-00 - Order data

3.8.2.3 Pinout

Ready relay - Pinout		
Pin	Assignment	
1	Normally open contact	
2	Root	
3	Normally closed contact	
4	NC	

Table 128: 5AC801.RDYR-00 ready relay - Pinout

3.9 Ready relay

3.9.1 5AC801.RDYR-01

3.9.2 General information

Since the 5AC801.RDYR-01 ready relay switches the relay contacts as soon as the B&R Automation PC 810 has booted and is supplied internally with all voltages, it is possible to connect additional devices to the relay that will also be switched on.

The 5AC801.RDYR-01 ready relay can only be used in the add-on UPS slot on the APC810 (this slot must be available for this purpose).

The information sheet included in delivery explains how to attach the labels to the Automation PC 810.

Information:

For information about installing the ready relay, see chapter 7 "Maintenance and service", section 13 "Installing the ready relay /2 in the add-on UPS slot" on page 428.

3.9.3 Order data

Model number	Short description	Figure
	Accessories	
5AC801.RDYR-01	Ready relay for APC810 for installation on an add-on UPS slot	

Table 129: 5AC801.RDYR-01 - Order data

3.9.4 Pinout

Pin	Assignment	Description	Figure
1	-	Not connected	
2	-	Not connected	
3	NO	Normally open	
4	COM	Change-over contact	
5	NC	Normally closed	
6	-	Not connected	

Table 130: 5AC801.RDYR-01 - Pinout

3.9.5 Contents of delivery

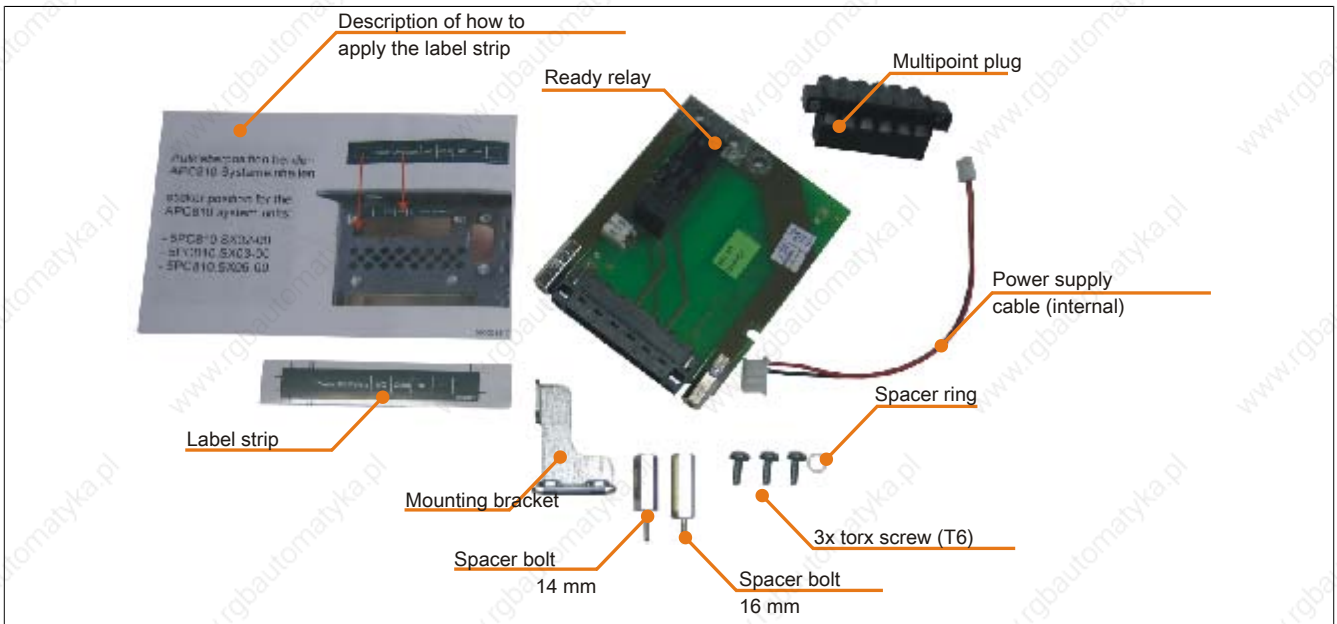

Figure 76: 5AC801.RDYR-01 - Contents of delivery

3.10 Add-on interfaces (IF option)

3.10.1 General information

An additional interface (CAN or combined RS232/422/485) can be installed in the APC810's IF optional slot.

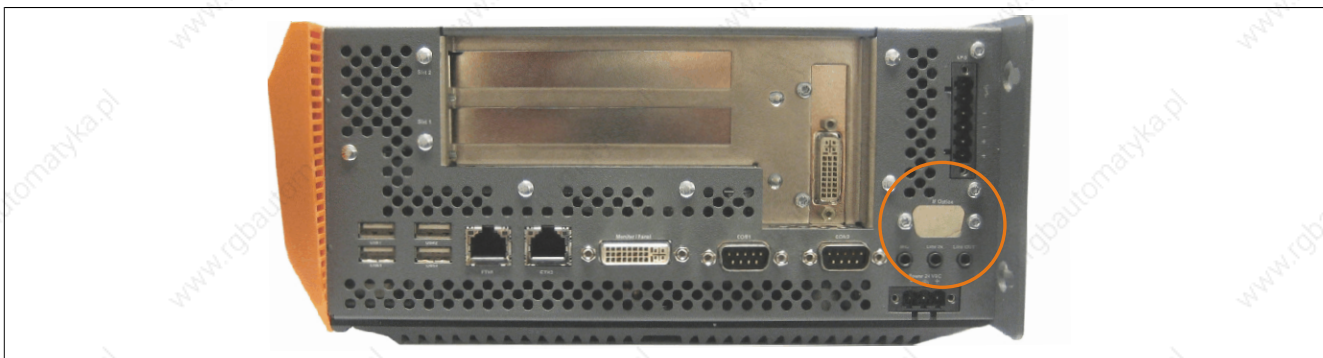

Figure 77: Add-on interfaces (IF option)

Information:

An add-on interface drive can be inserted, removed or replaced at any time.

Information:

Turn off power before inserting or removing an add-on interface.

3.10.2 5AC600.CANI-00

3.10.2.1 General information

The add-on CAN interface is equipped with an Intel 82527 CAN controller that conforms to the CAN 2.0 specification, Part A/B. The CAN controller can trigger an NMI (non-maskable interrupt).

3.10.2.2 Order data

Model number	Short description	Figure
	Serial adapters	
5AC600.CANI-00	CAN interface; for installation in an APC620, APC810 or PPC700	

Table 131: 5AC600.CANI-00 - Order data

3.10.2.3 Technical data

Product ID	5AC600.CANI-00
General information	
Certification	
CE	Yes
cULus	Yes
Interfaces	
CAN	
Quantity	1
Controller	Bosch CC770 (compatible with Intel 82527 CAN controller)
Design	9-pin male DSUB connector
Terminating resistor	
Type	Can be enabled or disabled using a sliding switch
Default setting	Disabled

Table 132: 5AC600.CANI-00 - Technical data

3.10.2.4 Pinout

Add-on CAN		9-pin male DSUB connector
Type	Electrically isolated	
Transfer rate	Max. 500 kbit/s	
Bus length	Max. 1000 meters	
Pin	Assignment	
1	NC	
2	CAN low	
3	GND	
4	NC	
5	NC	
6	Reserved	
7	CAN high	
8	NC	
9	NC	

Table 133: CAN - Pinout

3.10.2.5 I/O address and IRQ

Resource	Default setting	Additional setting options
I/O address	384h / 385h	-
IRQ	IRQ10	NMI ¹

Table 134: Add-on CAN - I/O address and IRQ

1 NMI = Non-maskable interrupt.

The IRQ setting can be changed in BIOS Setup. It is possible for conflicts with other resources to occur when changing this setting.

I/O address	Register	Function
384h	Address register	Defines the register number to access.
385h	Data registers	Access to the register defined in the address register.

3.10.2.6 Bus length and cable type

The type of cable used depends largely on the required bus length and the number of nodes. The bus length is mainly determined by the bit rate. In accordance with CiA (CAN in Automation) the maximum bus length is 1000 meters.

The following bus lengths are permitted with a maximum oscillator tolerance of 0.121%:

Distance [m]	Transfer rate [kbit/s]
≤1000	Typ. 50
≤200	Typ. 250
≤60	Typ. 500

Table 135: CAN - Bus length and transfer rate

The material used for the cable should preferably have all or most of the following properties in order to achieve an optimal transfer rate.

CAN cables	Property
Signal lines	<ul style="list-style-type: none"> Cable cross section: 2x 0.25 mm² (24AWG/19), tinned Cu stranded wire Wire insulation: PE Conductor resistance: ≤ 82 Ω / km Stranding: Wires stranded in pairs Shield: Paired shield with aluminum foil
Grounding line	<ul style="list-style-type: none"> Cable cross section: 1x 0.34 mm² (22AWG/19), tinned Cu stranded wire Wire insulation: PE Conductor resistance: ≤ 59 Ω / km
Outer sheathing	<ul style="list-style-type: none"> Materials: PUR mixture Features: Halogen-free Cable shielding: From tinned copper wires

Table 136: CAN - Cable requirements

3.10.2.7 Terminating resistor

CAN networks are cabled using a bus structure where both ends of the bus are equipped with terminating resistors. The add-on CAN interface has an integrated terminating resistor (factory setting: disabled with the setting "Off").

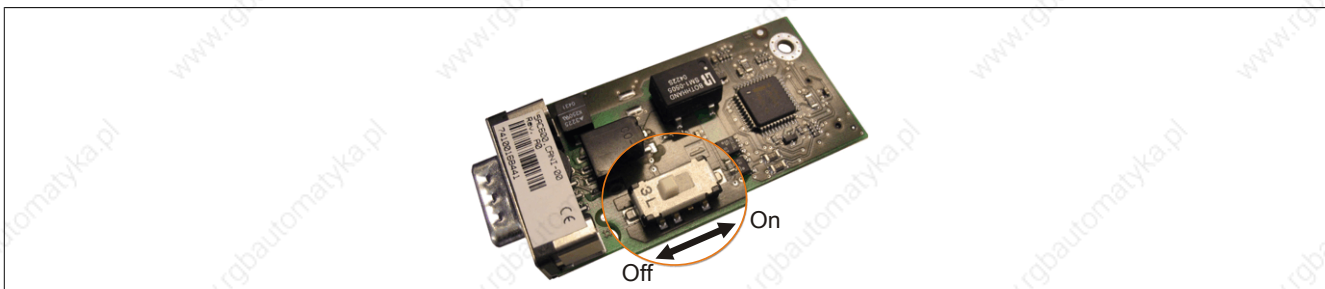

Figure 78: 5AC600.CANI-00 - Terminating resistor for add-on CAN interface

3.10.2.8 Contents of delivery

The screws included in the mounting kit are used for installation.

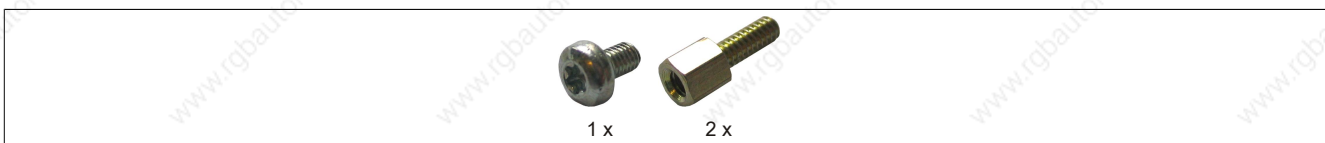

Figure 79: 5AC600.CANI-00 - Contents of delivery / mounting material

3.10.2.9 Driver support

Due to the dual core processors, driver version 2.36 of INACAN.SYS included in the PVI 2.6.0.3105 installer is required for operation.

Information:

Required drivers can only be downloaded from the B&R website, not from manufacturer websites.

3.10.3 5AC600.485I-00

3.10.3.1 General information

This serial interface is a combined RS232/RS422/RS485 interface. The operating mode (RS232/RS422/RS485) is selected automatically depending on the electrical connection.

3.10.3.2 Order data

Model number	Short description	Figure
5AC600.485I-00	Serial adapters RS232/422/485 interface, for installation in an APC620, APC810 or PPC700	

Table 137: 5AC600.485I-00 - Order data

3.10.3.3 Technical data

Product ID	5AC600.485I-00
General information	
Certification	
CE	Yes
cULus	Yes
GL	Yes
Interfaces	
COM1	
Type	RS232, not modem-capable, electrically isolated
Design	9-pin male DSUB connector
Max. baud rate	115 kbit/s

Table 138: 5AC600.485I-00 - Technical data

3.10.3.4 Pinout

Add-on RS232/422/485			9-pin male DSUB connector
	RS232	RS422/485	
Type	RS232 not modem compatible; Electrically isolated		
UART	16550-compatible, 16-byte FIFO		
Transfer rate	Max. 115 kbit/s		
Bus length	Max. 15 meters	Max. 1200 meters	
Pin	RS232 - Pinout	RS422 - Pinout	
1	NC	TXD\	
2	RXD	NC	
3	TXD	NC	
4	NC	TXD	
5	GND	GND	
6	NC	RXD\	
7	RTS	NC	
8	CTS	NC	
9	NC	RXD	

Table 139: RS232/RS422 - Pinout

3.10.3.5 I/O address and IRQ

Resource	Default setting	Additional setting options
I/O address	2E8h	238, 2F8, 338, 3E8, 3F8
IRQ	IRQ10	IRQ 3, 4, 5, 7, 11, 12

Table 140: Add-on RS232/422/485 - I/O address and IRQ

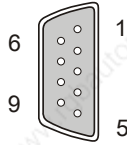
Setting for the I/O address and IRQ can be changed in BIOS Setup ("Advanced" - "Baseboard / Panel features" - "Legacy devices", "COM E"). It is possible for conflicts with other resources to occur when changing this setting.

3.10.3.6 RS232 - Bus length and cable type

The maximum transfer rate of 115 kbit/s depends on the type of cable being used.

Distance [m]	Transfer rate [kbit/s]
≤15	Typ. 64
≤10	Typ. 115
≤5	Typ. 115

Table 141: RS232 - Bus length and transfer rate

The material used for the cable should preferably have all or most of the following properties in order to achieve an optimal transfer rate.

RS232 cables	
Signal lines	4x 0.16 mm ² (26AWG), tinned Cu stranded wire
Cable cross section	PE
Wire insulation	≤ 82 Ω / km
Conductor resistance	Wires stranded in pairs
Stranding	Paired shield with aluminum foil
Shield	
Grounding line	1x 0.34 mm ² (22AWG/19), tinned Cu stranded wire
Cable cross section	PE
Wire insulation	≤ 59 Ω / km
Conductor resistance	
Outer sheathing	
Materials	PUR mixture
Features	Halogen-free
Cable shielding	From tinned copper wires

Table 142: RS232 - Cable requirements

3.10.3.7 RS422 - Bus length and cable type

The RTS line must be switched on to switch the transmitter to active.

The maximum transfer rate of 115 kbit/s depends on the type of cable being used.

Distance [m]	Transfer rate [kbit/s]
1200	Typ. 115

Table 143: RS422 - Bus length and transfer rate

The material used for the cable should preferably have all or most of the following properties in order to achieve an optimal transfer rate.

RS422 cables	Property
Signal lines	4x 0.25 mm ² (24AWG/19), tinned Cu stranded wire
Cable cross section	PE
Wire insulation	≤ 82 Ω / km wires
Conductor resistance	stranded in pairs
Stranding	Paired shield with aluminum foil
Shield	
Grounding line	1x 0.34 mm ² (22AWG/19), tinned Cu stranded wire
Cable cross section	PE
Wire insulation	≤ 59 Ω / km
Conductor resistance	
Outer sheathing	
Materials	PUR mixture
Features	Halogen-free
Cable shielding	From tinned copper wires

Table 144: RS422 - Cable requirements

3.10.3.8 When operated as an RS485 interface

When operated in this mode, the pins of the RS422 default interface (1, 4, 6 and 9) must be used. Pins should be connected as shown.

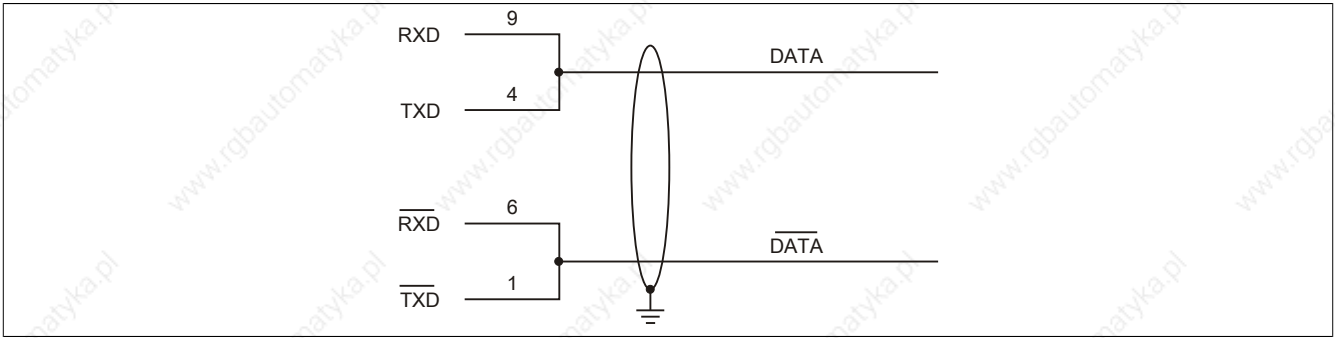

Figure 80: Add-on RS232/422/485 interface - Operated in RS485 mode

The RTS line must be switched by the driver for each transmission or reception; there is no automatic switch-back mechanism. This cannot be configured in Windows.

The voltage drop resulting from long cable lengths can lead to greater potential differences between bus stations, which can hinder communication. This can be improved by running ground wire with the others.

The line ends of the RS485 interface should (at least for longer line lengths or larger transfer rates) be closed. Normally a passive terminator can be used on the bus ends by connecting each of the signal lines with a 120 Ω resistor.

3.10.3.9 RS485 - Bus length and cable type

The maximum transfer rate of 115 kbit/s depends on the type of cable being used.

Distance [m]	Transfer rate [kbit/s]
1200	Typ. 115

Table 145: RS485 - Bus length and transfer rate

The material used for the cable should preferably have all or most of the following properties in order to achieve an optimal transfer rate.

RS485 cables	Property
Signal lines	
Cable cross section	4x 0.25 mm ² (24AWG/19), tinned Cu stranded wire
Wire insulation	PE
Conductor resistance	≤ 82 Ω / km
Stranding	Wires stranded in pairs
Shield	Paired shield with aluminum foil
Grounding line	
Cable cross section	1x 0.34 mm ² (22AWG/19), tinned Cu stranded wire
Wire insulation	PE
Conductor resistance	≤ 59 Ω / km
Outer sheathing	
Materials	PUR mixture
Features	Halogen-free
Cable shielding	From tinned copper wires

Table 146: RS422 - Cable requirements

3.10.3.10 Contents of delivery

The screws included in the mounting kit are used for installation.

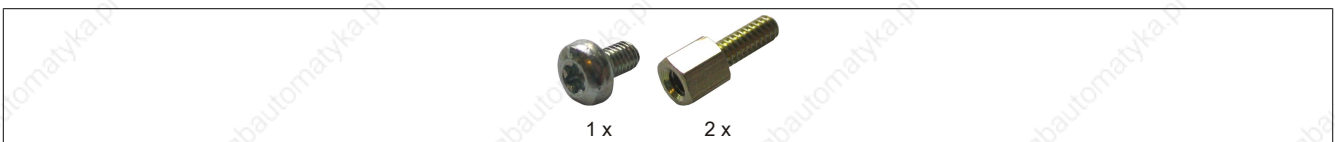

Figure 81: 5AC600.485I-00 - Contents of delivery / mounting material

Chapter 3 • Installation

1 Installation

Devices are installed using the mounting plates found on the housing. These plates are designed for M5 screws.

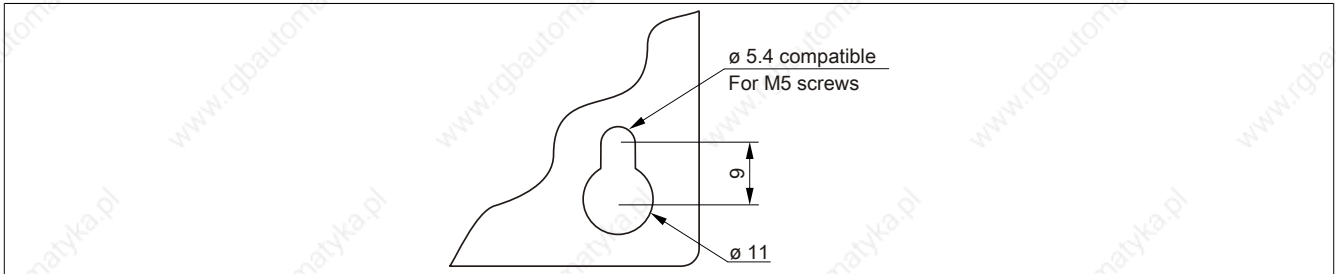

Figure 82: Mounting plates

The exact position of the mounting holes is illustrated in the drilling templates in 2 "Technical data", section "Individual components" on page 75.

1.1 Procedure

1. Drill the necessary holes in the control cabinet. The exact position of the mounting holes is illustrated in the drilling templates.
2. Mount the B&R Industrial PC to the control cabinet using M5 screws.

1.2 Important installation information

- Environmental conditions must be taken into consideration.
- This device must be mounted to a flat surface.
- This device is only certified for operation in closed rooms.
- This device must not be subjected to direct sunlight.
- Ventilation holes must not be covered.
- This device must be mounted in one of the approved orientations.
- The wall or control cabinet must be able to withstand four times the total weight of the device.
- The flex radius of connected cables (DVI, SDL, USB, etc.) must not be exceeded.

1.3 Mounting orientation

The APC810 must be mounted as described in the following sections.

1.3.1 Vertical mounting orientation

APC810 systems with or without a fan kit can be mounted in this orientation.

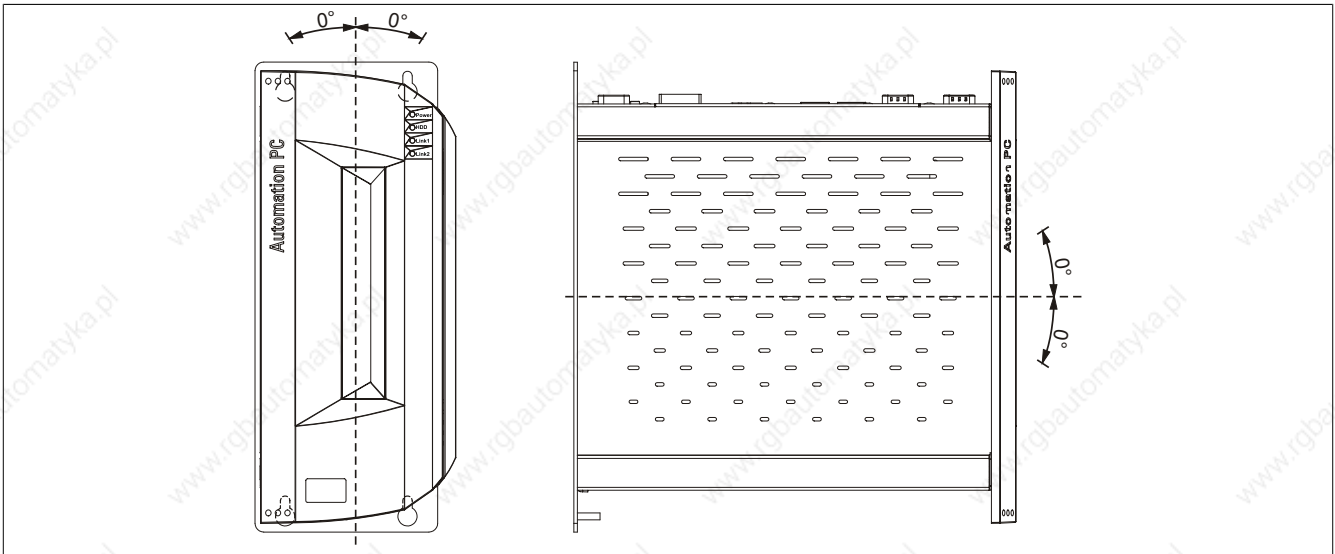

Figure 83: Vertical mounting orientation

In order to facilitate natural air circulation, devices must be mounted according to the spacing indicated in the section "Spacing for air circulation" on page 188.

1.3.2 Horizontal mounting orientation

Operation in the horizontal mounting orientation (heat sink on top) requires the use of a fan kit. The maximum ambient temperature specification must be reduced by 5°C.

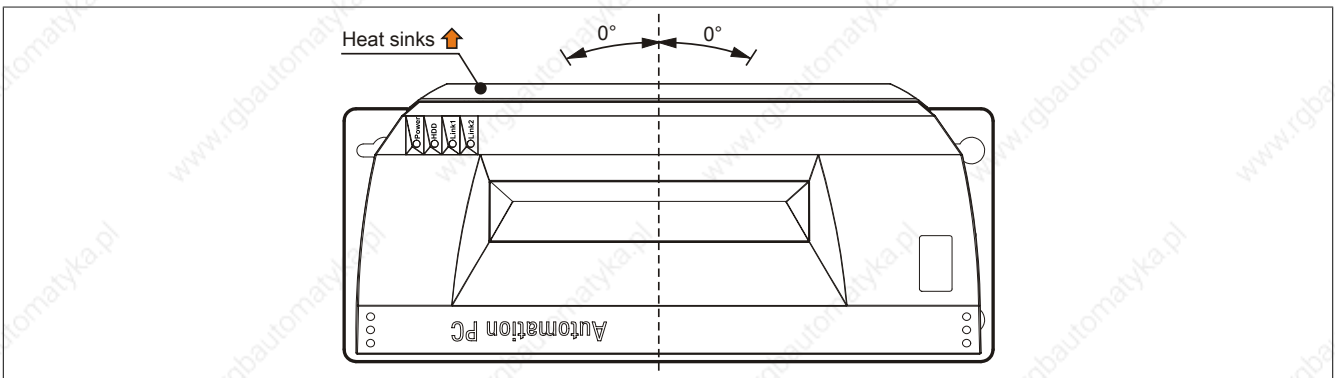

Figure 84: Horizontal mounting orientation

In order to facilitate natural air circulation, devices must be mounted according to the spacing indicated in the section "Spacing for air circulation" on page 188.

1.4 Spacing for air circulation

In order to guarantee sufficient air circulation, allow the specified amount of space above, below, to the side and behind the Automation PC 810 devices. The minimum specified spacing is indicated in the following diagram. This applies to all Automation PC 810 variants.

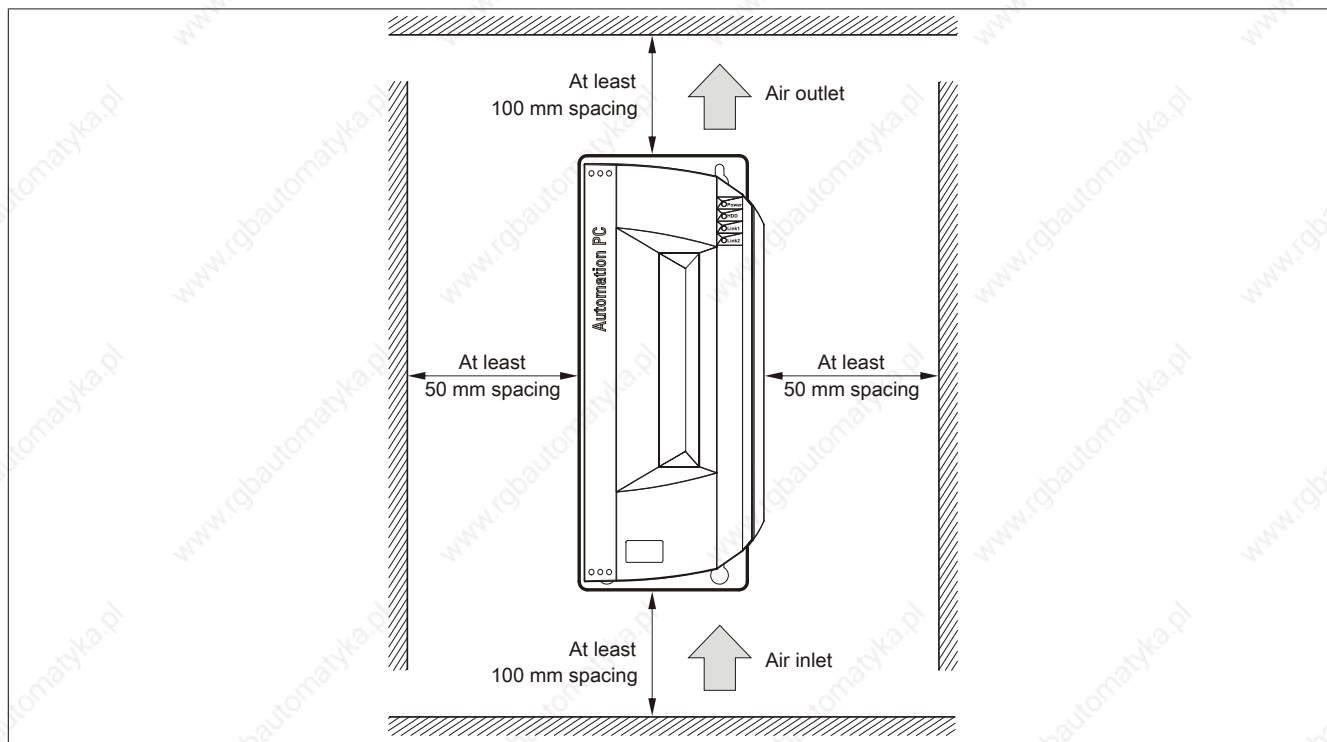

Figure 85: Standard mounting - Spacing

These defined distances are valid for both the vertical and horizontal mounting orientations for the APC810.

Information:

The spacing specifications for air circulation are based on the worst-case scenario for operation at the maximum specified ambient temperature (see "Temperaturangaben" in the chapter "Technical data").

If the spacing specifications for air circulation cannot be adhered to, then the maximum specified temperatures for the temperature sensors (see "Temperatursensorpositionen" in the chapter "Technical data") must be monitored by the user and appropriate measures taken if they are exceeded.

2 Cable connections

Flex radius specifications must be taken into account when installing or connecting cables.

Information:

The maximum torque for the locating screws is 0.5 Nm.

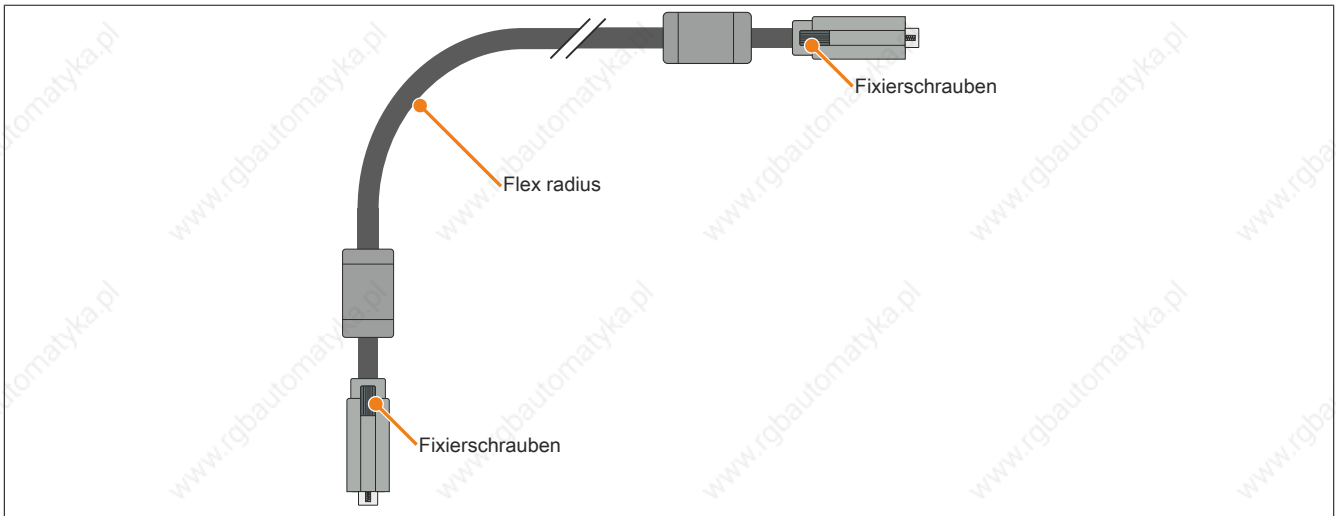

Figure 86: Flex radius - Cable connection

Information:

The specified flex radius can be found in the Automation Panel 800 or Automation Panel 900 user's manual, which can be downloaded as a PDF file from the B&R website at www.br-automation.com.

3 Grounding concept

Functional ground is a current path of low impedance between electrical circuits and ground. It is used, for example, to improve immunity to disturbances and not necessarily as a protective measure. It therefore serves only to deflect disturbances, not to provide any kind of protection against electric shock.

The functional ground on the device has 2 connections:

- Supply voltage
- Ground connection

To guarantee safe conductance of electric disturbances, the following points should be observed:

- The device should be connected to the central grounding point in the control cabinet using the shortest route possible.
- A cable with a minimum cross section of 2.5 mm^2 per connection should be used. If a cable with wire end sleeves is connected to the 0TB103.9 or 0TB103.91 terminal block, then a cable with maximum 1.5 mm^2 per connection is possible.
- Note the line shielding concept; all connected data cables are used as shielded lines.

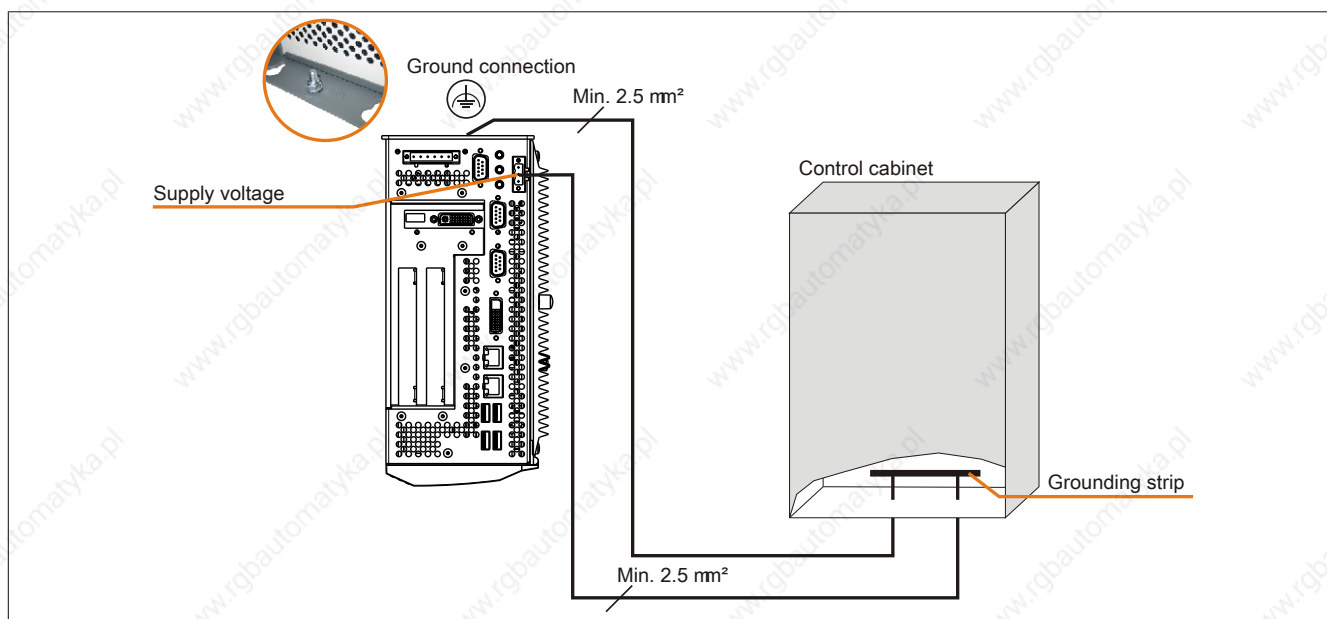

Figure 87: Grounding concept

4 General instructions for performing temperature testing

The purpose of these instructions is to explain general procedures for performing application-specific temperature testing on B&R Industrial PCs and Power Panels. Nevertheless, these instructions are meant to serve only as a guideline.

4.1 Procedure

In order to obtain accurate results, the testing conditions should match the conditions in the field. This means that for the duration of the temperature tests, the target application should be running, the PC should be installed in the control cabinet that will be used, etc.

In addition, a temperature sensor should be installed for the device being tested to provide live monitoring of the ambient temperature. In order to obtain accurate measurements, this sensor should be installed at a distance of 5 to 10 cm from the B&R Industrial PC near the air intake (not near the exhaust).

All B&R Industrial PCs and Power Panels are equipped with internal temperature sensors. These are installed in different locations for each series. The number of sensors and the temperature limits also vary from series to series.

For information about the locations of temperature sensors and the maximum specified values, please see section "Temperatursensorpositionen" in chapter 2 "Technical data".

To ensure that the thermal situation is evaluated reliably, a minimum of 8 hours is recommended for testing.

4.2 Evaluating temperatures in Windows operating systems

4.2.1 Evaluating with the B&R Control Center

The B&R Control Center can be used to evaluate the temperatures. Temperatures can be viewed on the "Temperatures" property page. The B&R Control Center is available at no cost in the Downloads section of the B&R website (www.br-automation.com). The B&R Control Center uses the B&R Automation Device Interface (ADI).

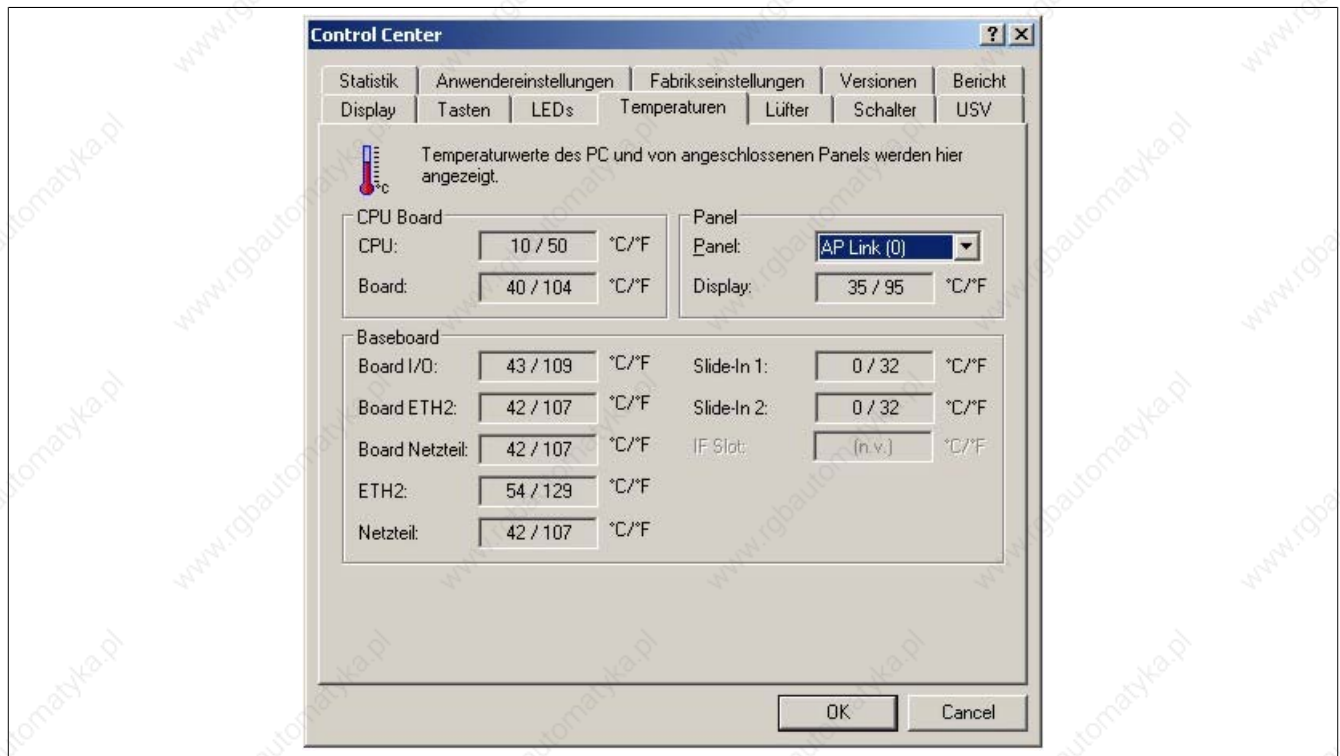

A separate application can be developed if it is necessary to collect historical data.

Information:

Software development kits such as the ADI .NET SDK are available on the B&R website (www.br-automation.com).

4.2.2 Evaluating with the BurnInTest tool from Passmark

If a separate application is not created or used to evaluate the temperature, then B&R recommends using the BurnInTest software tool from Passmark.

Standard and Professional versions of BurnInTest are available. In addition to the software package, there are also various loopback plugs (serial, parallel, USB, etc.) and test CDs/DVDs available. The exact software and loopback plugs used will determine the corresponding load that can be generated on the system and peripheral devices.

Information:

Loopback plugs are also available from Passmark. More information is available at www.passmark.com.

The following screenshots are based on Passmark BurnInTest Pro V4 and a 2-slot APC810 with DVD.

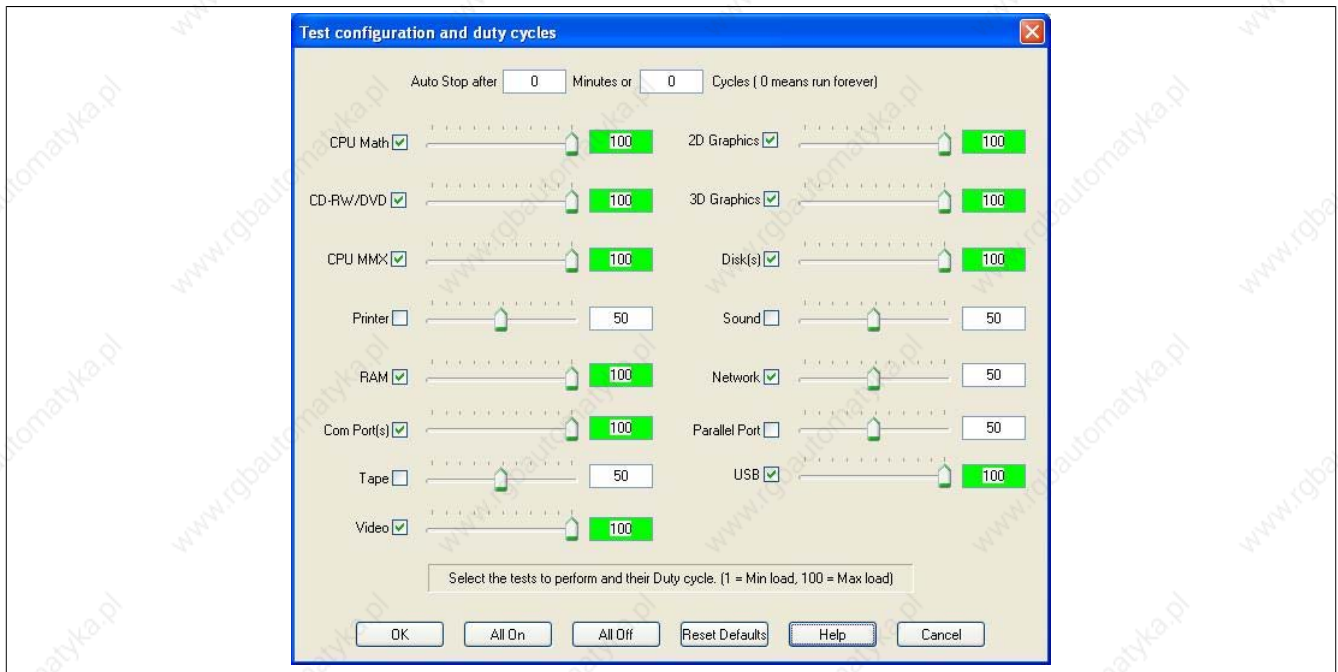

Figure 88: Settings for Passmark BurnInTest Pro V4 and a 2-slot APC810 with DVD

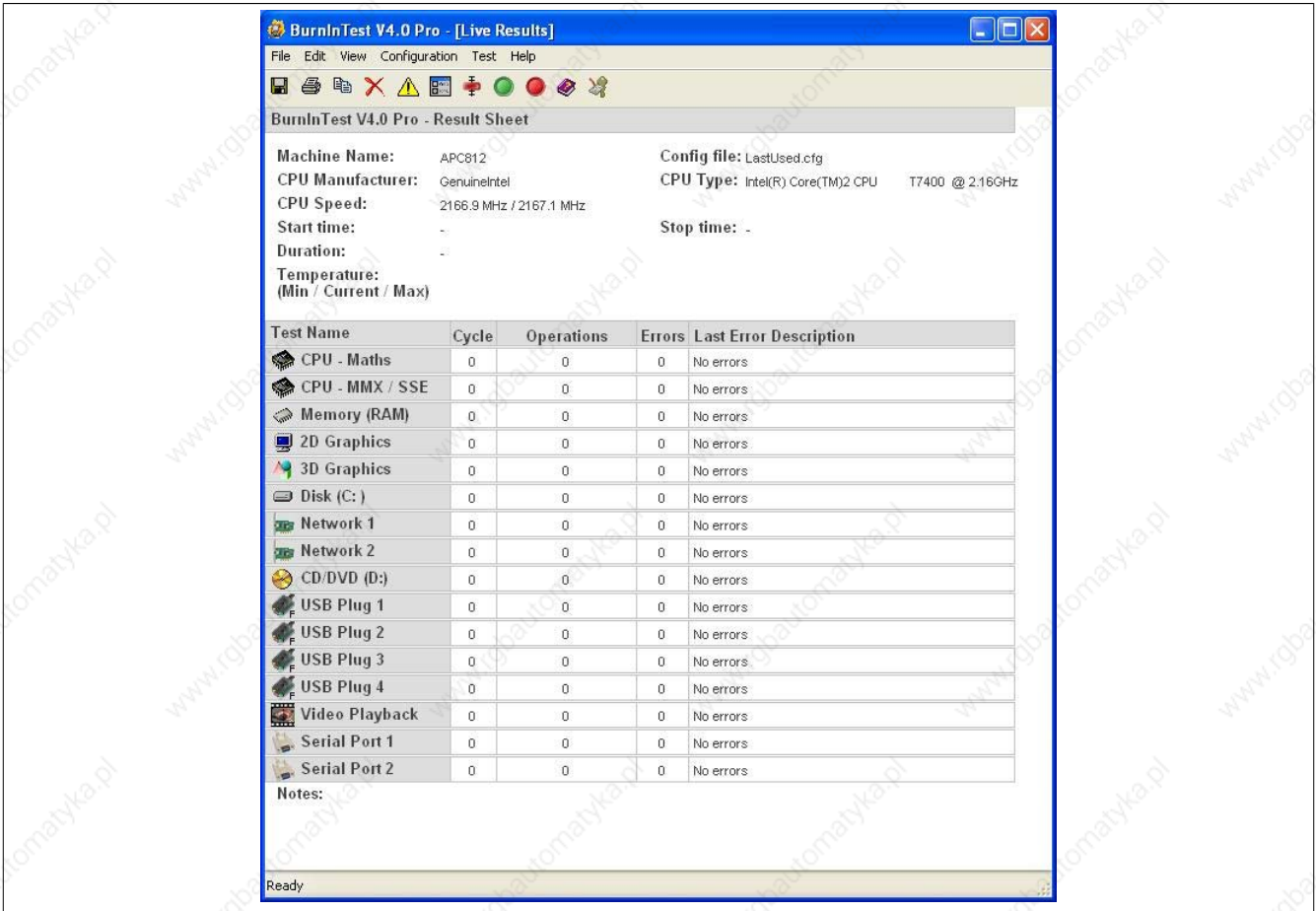

Figure 89: Test overview of a 2-slot APC810 with DVD

The respective test properties may need to be fine-tuned depending on the availability of a loopback plug and DVDs.

Information:

USB flash drives can also be used if a USB loopback plug is not available. The USB flash drives must be detected as formatted drives in Windows. The test USB must then be deselected, and the USB flash drives must be configured as the testing device in the disk properties.



Information:

Serial loopback plugs are relatively easy to create. Simply connect several pins on the serial interface with wires.

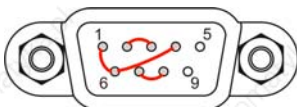

4.3 Evaluating temperatures in operating systems other than Windows

For applications that don't use Windows, temperatures can be evaluated with the help of the B&R implementation guide. In addition to the implementation guide, there are also programs available in MS-DOS.

The implementation guide only describes device-specific functions and not the main functions of the example programs.

If code from the example programs is used, it is important to observe the notes in the implementation guide regarding TODO statements, I/O access functions, etc.

Information:

Example programs and implementation guides for all B&R Industrial PCs and Power Panels are available at no cost from the B&R website (www.br-automation.com).

4.4 Evaluating the measurement results

The maximum temperature value recorded by each sensor must not exceed the temperature limits specified in the user's manuals.

If the temperature tests cannot be performed in a climate-controlled chamber, they can still be performed in an office environment. In this case, however, it is necessary to measure the ambient temperature. Experience at B&R has shown that values measured on passive systems (systems without a fan kit) can be projected linearly based on the ambient temperature. In order to be able to project the temperature values for systems with a fan kit, the fans must be running. It is also important to take values such as speed into consideration.

If the temperature tests are performed in a climate-controlled chamber with fans, the fans will cool the devices and skew the results. Measurement results for passive devices would therefore be unusable in this case. In order to obtain accurate results in climate-controlled chambers with fans, the fans must be turned off and the device must be allowed to run for a sufficient amount of time (several hours) before beginning the test.

Example using a 2-slot APC810

The following example is only valid if the instructions for installation and mounting orientation provided in the user's manual are observed.

Temperature sensor	Measured temperature	Projected temperature	
Ambient temperature	20°C	35°C	45°C
CPU	48°C	63°C	73°C
CPU board	51°C	66°C	76°C
Board I/O	51°C	66°C	76°C
Board ETH2	52°C	67°C	77°C
Board power supply	51°C	66°C	76°C
ETH2	65°C	80°C	90°C
Power supply	51°C	66°C	76°C

Table 147: Evaluation example using a 2-slot APC810

5 Connection examples

The following examples provide an overview of the configuration options for connecting Automation Panel 800 and Automation Panel 900 and/or Automation Panel 800 devices with the APC810. The following questions will be answered:

- How are Automation Panel 900 devices connected to the monitor/panel output of the APC810? What needs to be considered?
- How are Automation Panel 800 devices connected to the monitor/panel output of the APC810? What needs to be considered?
- How are Automation Panel 900 devices connected simultaneously to the monitor/panel output on the APC810's optional SDL AP Link? What needs to be considered?
- What are the "display clone" and "extended desktop" modes?
- How many Automation Panel 900 devices can be connected per line?
- How many Automation Panel 900 devices can be connected to an Automation Panel 800 device per line?
- How are the connected devices numbered internally?
- Are there limitations to the segment length? If so, what are they?
- What cables and link modules are needed?
- Do BIOS settings have to be changed for a specific configuration?

5.1 Selecting display units

In order to connect an Automation Panel 800 and an Automation Panel 900 on the same line, the devices must have the same display type. The following table lists the AP900 devices that can be connected on the same line with an AP800 device.

Automation Panel 800	Automation Panel 900
5AP820.1505-00	5AP920.1505-01 5AP951.1505-01 5AP980.1505-01 5AP981.1505-01
5AP880.1505-00	5AP920.1505-01 5AP951.1505-01 5AP980.1505-01 5AP981.1505-01

Table 148: Selecting display units

5.2 One Automation Panel 900 system via onboard DVI

An Automation Panel 900 with max. SXGA resolution is connected to the integrated DVI interface (onboard). As an alternative, an office TFT with a DVI interface or analog monitor (using adapter 5AC900.1000-00) can also be used. A separate cable is used for both the touch screen and USB data. If USB devices are to be operated on the Automation Panel 900, the maximum distance is 5 meters. USB devices can only be connected directly to the Automation Panel (i.e. without a hub).

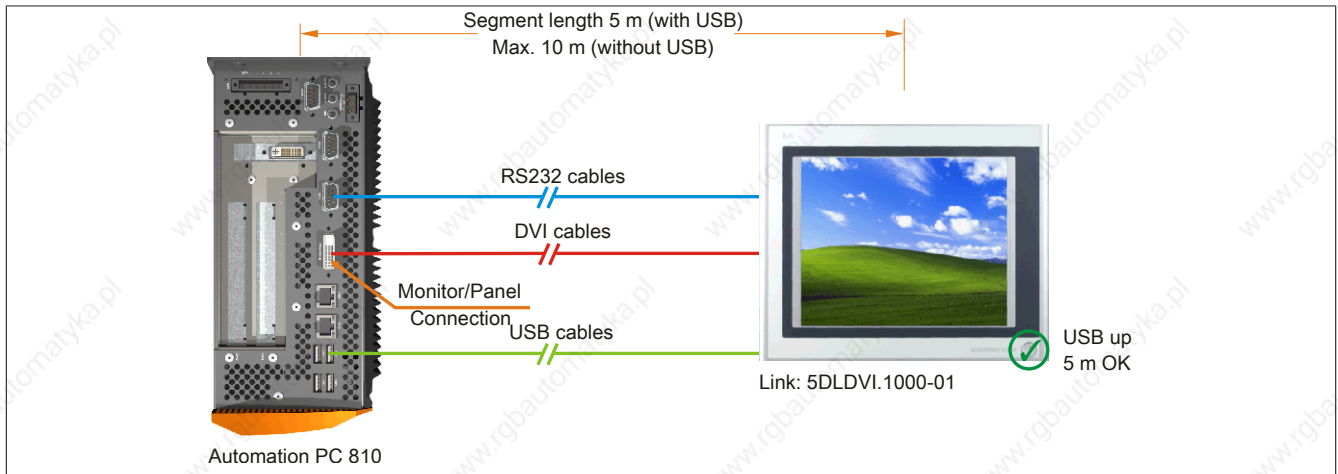

Figure 90: One Automation Panel 900 system via onboard DVI

5.2.1 Base system requirements

The following table lists the possible APC810 system unit and CPU board combinations necessary to implement the configuration shown in the figure above. If a combination results in a limitation of the maximum resolution, this is also indicated (e.g. when connecting a non-B&R Automation Panel 900 device).

CPU board	With system unit				Limitation Resolution
	5PC810.SX01-00	5PC810.SX02-00	5PC810.SX03-00	5PC810.SX05-00	
5PC800.B945-00 5PC800.B945-10	✓	✓	✓	✓	Max. SXGA
5PC800.B945-01 5PC800.B945-11	✓	✓	✓	✓	Max. SXGA
5PC800.B945-02 5PC800.B945-12	✓	✓	✓	✓	Max. SXGA
5PC800.B945-03 5PC800.B945-13	✓	✓	✓	✓	Max. SXGA
5PC800.B945-04 5PC800.B945-14	✓	✓	✓	✓	Max. SXGA
5PC800.B945-05	✓	✓	✓	✓	Max. SXGA

Table 149: Possible system unit and CPU board combinations

5.2.2 Link modules

Information:

A corresponding Link module must be selected for each device used.

Model number	Description	Note
5DL DVI.1000-01	Automation Panel Link DVI receiver Connections for DVI-D, RS232 and USB 2.0 (Type B); 24 VDC (order screw clamp 0TB103.9 or cage clamp 0TB103.91 separately)	For Automation Panel 900

Table 150: Link modules

5.2.3 Cables

Select one Automation Panel 900 cable each from the 3 required types.

Model number	Description	Length
5CADVI.0018-00	DVI-D cable, 1.8 m	1.8 m ±50 mm
5CADVI.0050-00	DVI-D cable, 5 m	5 m ±80 mm
5CADVI.0100-00	DVI-D cable, 10 m	10 m ±100 mm
9A0014.02	RS232 extension cable for remote operation of a display unit with touch screen, 1.8 m	1.8 m ±50 mm

Table 151: Cables for DVI configurations

Model number	Description	Length
9A0014.05	RS232 extension cable for remote operation of a display unit with touch screen, 5 m	5 m ±80 mm
9A0014.10	RS232 extension cable for remote operation of a display unit with touch screen, 10 m	10 m ±100 mm
5CAUSB.0018-00	USB 2.0 connection cable Type A - Type B, 1.8 m	1.8 m ±30 mm
5CAUSB.0050-00	USB 2.0 connection cable Type A - Type B, 5 m	5 m ±50 mm

Table 151: Cables for DVI configurations

Information:

Detailed technical data about cables can be found in the Automation Panel 900 user's manual. This can be downloaded as a PDF file from the B&R website at www.br-automation.com.

5.2.4 Possible Automation Panel devices, resolutions and segment lengths

The following Automation Panel 900 devices can be used. In rare cases, segment length is limited by the resolution.

Model number	Diagonal	Resolution	Touch screen	Keys	Max. segment length
5AP920.1043-01	10.4"	VGA	✓	-	5 m / 10 m ¹⁾
5AP920.1214-01	12.1"	SVGA	✓	-	5 m / 10 m ¹⁾
5AP920.1505-01	15.0"	XGA	✓	-	5 m / 10 m ¹⁾
5AP920.1706-01	17.0"	SXGA	✓	-	5 m / 10 m ¹⁾
5AP920.1906-01	19.0"	SXGA	✓	-	5 m / 10 m ¹⁾

Table 152: Possible Automation Panel devices, resolutions and segment lengths

- 1) USB support is not possible on the Automation Panel 900 in these cases since USB is limited to 5 m.

Information:

When transferring data via DVI, it is not possible to read statistical values from Automation Panel 900 devices.

5.2.5 BIOS settings

No special BIOS settings are necessary for operation.

5.3 One Automation Panel 900 system via onboard SDL

An Automation Panel 900 is connected to the integrated SDL interface (onboard) via an SDL cable. USB devices can only be connected directly to the Automation Panel (i.e. without a hub).

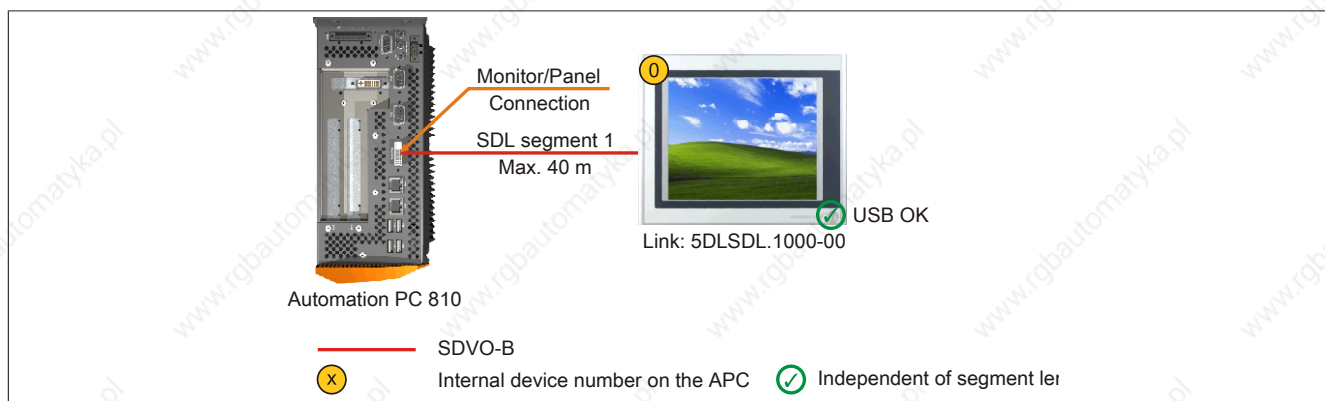

Figure 91: One Automation Panel 900 system via onboard SDL

5.3.1 Base system requirements

The following table lists the possible APC810 system unit and CPU board combinations necessary to implement the configuration shown in the figure above. If a combination results in a limitation of the maximum resolution, this is also indicated (e.g. when connecting a non-B&R Automation Panel 900 device).

CPU board	With system unit				Limitation Resolution
	5PC810.SX01-00	5PC810.SX02-00	5PC810.SX03-00	5PC810.SX05-00	
5PC800.B945-00 5PC800.B945-10	✓	✓	✓	✓	Max. UXGA
5PC800.B945-01 5PC800.B945-11	✓	✓	✓	✓	Max. UXGA
5PC800.B945-02 5PC800.B945-12	✓	✓	✓	✓	Max. UXGA
5PC800.B945-03 5PC800.B945-13	✓	✓	✓	✓	Max. UXGA
5PC800.B945-04 5PC800.B945-14	✓	✓	✓	✓	Max. UXGA
5PC800.B945-05	✓	✓	✓	✓	Max. UXGA

Table 153: Possible system unit and CPU board combinations

5.3.2 Link modules

Information:

A corresponding Link module must be selected for each device used.

Model number	Description	Note
5DLSDL.1000-00	Automation Panel Link SDL receiver Connection for SDL In; transmission of display, touch screen, USB 1.1, matrix key and service data; 24 VDC (order screw clamp 0TB103.9 or cage clamp 0TB103.91 separately)	For Automation Panel 900

Table 154: Link modules

5.3.3 Cables

Select an Automation Panel 900 cable from the following table.

Model number	Description	Length
5CASDL.0018-00	SDL cable, 1.8 m	1.8 m ±30 mm
5CASDL.0050-00	SDL cable, 5 m	5 m ±30 mm
5CASDL.0100-00	SDL cable, 10 m	10 m ±50 mm
5CASDL.0150-00	SDL cable, 15 m	15 m ±100 mm
5CASDL.0200-00	SDL cable, 20 m	20 m ±100 mm
5CASDL.0250-00	SDL cable, 25 m	25 m ±100 mm
5CASDL.0300-00	SDL cable, 30 m	30 m ±100 mm
5CASDL.0018-03	SDL flex cable, 1.8 m	1.8 m ±20 mm
5CASDL.0050-03	SDL flex cable, 5 m	5 m ±45 mm
5CASDL.0100-03	SDL flex cable, 10 m	10 m ±90 mm

Table 155: Cables for SDL configurations

Model number	Description	Length
5CASDL.0150-03	SDL flex cable, 15 m	15 m ±135 mm
5CASDL.0200-03	SDL flex cable, 20 m	20 m ±180 mm
5CASDL.0250-03	SDL flex cable, 25 m	25 m ±225 mm
5CASDL.0300-03	SDL flex cable, 30 m	30 m ±270 mm
5CASDL.0300-13	SDL flex cable with extender, 30 m	30 m ±280 mm
5CASDL.0400-13	SDL flex cable with extender, 40 m	40 m ±380 mm
5CASDL.0430-13	SDL flex cable with extender, 43 m	43 m ±410 mm
5CASDL.0018-01	SDL cable with 45° male connector, 1.8 m	1.8 m ±30 mm
5CASDL.0050-01	SDL cable with 45° male connector, 5 m	5 m ±50 mm
5CASDL.0100-01	SDL cable with 45° male connector, 10 m	10 m ±100 mm
5CASDL.0150-01	SDL cable with 45° male connector, 15 m	15 m ±100 mm

Table 155: Cables for SDL configurations

Information:

Detailed technical data about cables can be found in the Automation Panel 900 user's manual. This can be downloaded as a PDF file from the B&R website at www.br-automation.com.

5.3.3.1 Cable lengths and resolutions for SDL transmission

The following table lists the relationship between segment lengths and maximum resolution depending on the SDL cable being used:

SDL cables Segment length [m]	Resolution					
	VGA 640 x 480	SVGA 800 x 600	XGA 1024 x 768	SXGA 1280 x 1024	UXGA 1600 x 1200	FHD 1920 x 1080
1.8	5CASDL.0018-00	5CASDL.0018-00	5CASDL.0018-00	5CASDL.0018-00	5CASDL.0018-00	5CASDL.0018-00
	5CASDL.0018-01	5CASDL.0018-01	5CASDL.0018-01	5CASDL.0018-01	5CASDL.0018-01	5CASDL.0018-01
	5CASDL.0018-03	5CASDL.0018-03	5CASDL.0018-03	5CASDL.0018-03	5CASDL.0018-03	5CASDL.0018-03
5	5CASDL.0050-00	5CASDL.0050-00	5CASDL.0050-00	5CASDL.0050-00	5CASDL.0050-00	5CASDL.0050-00
	5CASDL.0050-01	5CASDL.0050-01	5CASDL.0050-01	5CASDL.0050-01	5CASDL.0050-01	5CASDL.0050-01
	5CASDL.0050-03	5CASDL.0050-03	5CASDL.0050-03	5CASDL.0050-03	5CASDL.0050-03	5CASDL.0050-03
10	5CASDL.0100-00	5CASDL.0100-00	5CASDL.0100-00	5CASDL.0100-00	5CASDL.0100-00	5CASDL.0100-00
	5CASDL.0100-01	5CASDL.0100-01	5CASDL.0100-01	5CASDL.0100-01	5CASDL.0100-01	5CASDL.0100-01
	5CASDL.0100-03	5CASDL.0100-03	5CASDL.0100-03	5CASDL.0100-03	5CASDL.0100-03	5CASDL.0100-03
15	5CASDL.0150-00	5CASDL.0150-00	5CASDL.0150-00	5CASDL.0150-00	-	-
	5CASDL.0150-01	5CASDL.0150-01	5CASDL.0150-01	5CASDL.0150-01	-	-
	5CASDL.0150-03	5CASDL.0150-03	5CASDL.0150-03	5CASDL.0150-03	-	5CASDL.0150-03
20	5CASDL.0200-00	5CASDL.0200-00	5CASDL.0200-00	5CASDL.0200-00	-	-
	5CASDL.0200-01	5CASDL.0200-01	5CASDL.0200-01	5CASDL.0200-01	-	-
	5CASDL.0200-03	5CASDL.0200-03	5CASDL.0200-03	5CASDL.0200-03	-	5CASDL.0200-03
25	5CASDL.0250-00	5CASDL.0250-00	5CASDL.0250-00	-	-	-
	5CASDL.0250-01	5CASDL.0250-01	5CASDL.0250-01	-	-	-
	5CASDL.0250-03	5CASDL.0250-03	5CASDL.0250-03	-	-	-
30	5CASDL.0300-00	5CASDL.0300-00	-	-	-	-
	5CASDL.0300-01	5CASDL.0300-01	-	-	-	-
	5CASDL.0300-03	5CASDL.0300-03	5CASDL.0300-13	5CASDL.0300-13	-	5CASDL.0300-13
40	5CASDL.0400-13	5CASDL.0400-13	5CASDL.0400-13	5CASDL.0400-13	-	5CASDL.0400-13

Table 156: Cable lengths and resolutions for SDL transmission

5.3.4 Settings in BIOS

No special BIOS settings are necessary for operation.

For detailed information, see the user's manual for the B&R Industrial PC being used.

Touch screen functionality

COM C must be enabled in BIOS in order to operate the panel touch screen connected to the monitor/panel interface ("Advanced - Baseboard/Panel features - Legacy devices").

5.4 One Automation Panel 800 system via onboard SDL

An Automation Panel 800 is connected to the integrated SDL interface (onboard) via an SDL cable. USB devices can only be connected directly to the extension keyboard (without a hub).

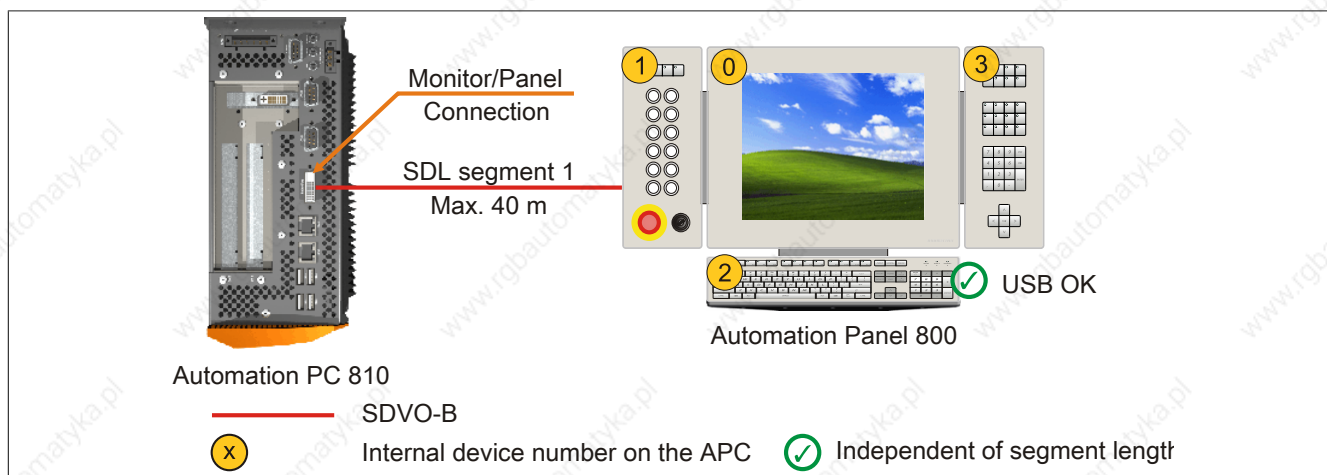

Figure 92: One Automation Panel 800 system via onboard SDL

5.4.1 Base system requirements

The following table lists the possible APC810 system unit and CPU board combinations necessary to implement the configuration shown in the figure above. If a combination results in a limitation of the maximum resolution, this is also indicated (e.g. when connecting a non-B&R Automation Panel 900 device).

CPU board	With system unit				Limitation Resolution
	5PC810.SX01-00	5PC810.SX02-00	5PC810.SX03-00	5PC810.SX05-00	
5PC800.B945-00 5PC800.B945-10	✓	✓	✓	✓	Max. UXGA
5PC800.B945-01 5PC800.B945-11	✓	✓	✓	✓	Max. UXGA
5PC800.B945-02 5PC800.B945-12	✓	✓	✓	✓	Max. UXGA
5PC800.B945-03 5PC800.B945-13	✓	✓	✓	✓	Max. UXGA
5PC800.B945-04 5PC800.B945-14	✓	✓	✓	✓	Max. UXGA
5PC800.B945-05	✓	✓	✓	✓	Max. UXGA

Table 157: Possible system unit and CPU board combinations

5.4.2 Cables

Select an Automation Panel 800 SDL cable from the following table.

Model number	Description	Length
5CASDL.0018-20	SDL flex cable for the Automation Panel 800, 1.8 m	1.8 m ±20 mm
5CASDL.0050-20	SDL flex cable for the Automation Panel 800, 5 m	5 m ±45 mm
5CASDL.0100-20	SDL flex cable for the Automation Panel 800, 10 m	10 m ±90 mm
5CASDL.0150-20	SDL flex cable for the Automation Panel 800, 15 m	15 m ±135 mm
5CASDL.0200-20	SDL flex cable for the Automation Panel 800, 20 m	20 m ±180 mm
5CASDL.0250-20	SDL flex cable for the Automation Panel 800, 25 m	25 m ±230 mm
5CASDL.0300-30	SDL flex cable with extender for the Automation Panel 800, 30 m	30 m ±280 mm
5CASDL.0400-30	SDL flex cable with extender for the Automation Panel 800, 40 m	40 m ±380 mm

Table 158: Cables for SDL configurations

Information:

Detailed technical data about cables can be found in the Automation Panel 800 user's manual. This can be downloaded as a PDF file from the B&R website at www.br-automation.com.

5.4.2.1 Cable lengths and resolutions for SDL transmission

The following table lists the relationship between segment lengths and maximum resolution depending on the SDL cable being used:

Cables Segment length [m]	Resolution
	XGA 1024 x 768
1.8	5CASDL.0018-20
5	5CASDL.0050-20
10	5CASDL.0100-20
15	5CASDL.0150-20
20	5CASDL.0200-20
25	5CASDL.0250-20
30	5CASDL.0300-30
40	5CASDL.0400-30

Table 159: Cable lengths and resolutions for SDL transmission

5.4.3 Settings in BIOS

No special BIOS settings are necessary for operation.

For detailed information, see the user's manual for the B&R Industrial PC being used.

Touch screen functionality

COM C must be enabled in BIOS in order to operate the panel touch screen connected to the monitor/panel interface ("Advanced - Baseboard/Panel features - Legacy devices").

5.5 One AP900 and one AP800 via onboard SDL

An Automation Panel 900 and an Automation Panel 800 are connected to the integrated SDL interface (onboard) via SDL.

USB is supported up to a maximum distance (segment 1 + segment 2) of 30 m on the two displays. Past a distance of 30 m, USB is only available on the first display (front and back) up to 40 m. USB devices can only be connected directly to the Automation Panel 900 or extension keyboard (without a hub).

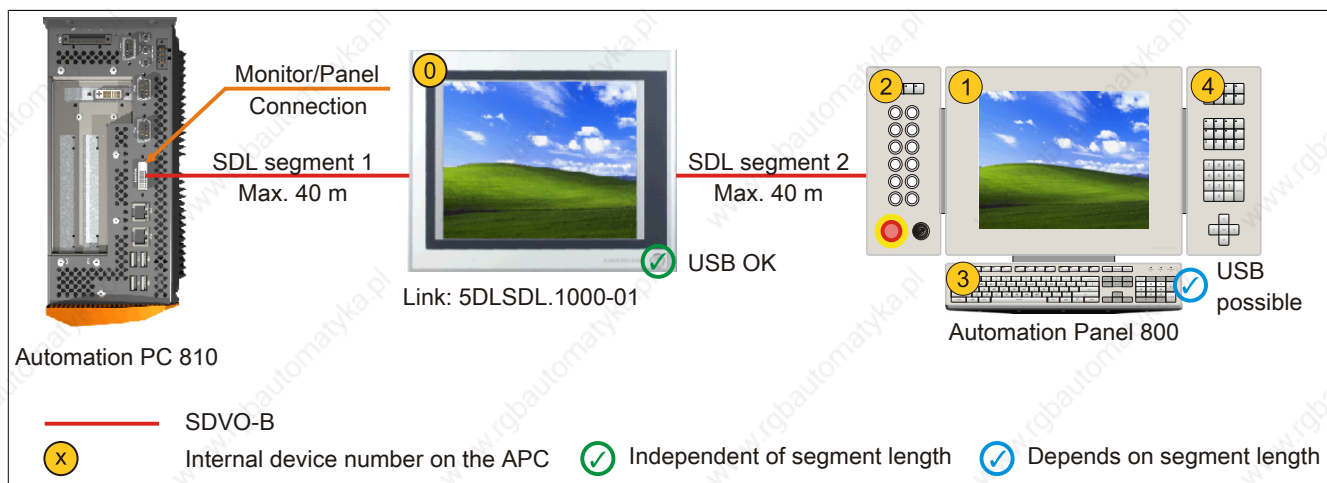

Figure 93: One AP900 system and one AP800 system via onboard SDL

5.5.1 Base system requirements

The following table lists the possible APC810 system unit and CPU board combinations necessary to implement the configuration shown in the figure above. If a combination results in a limitation of the maximum resolution, this is also indicated (e.g. when connecting a non-B&R Automation Panel 900 device).

CPU board	With system unit				Limitation Resolution
	5PC810.SX01-00	5PC810.SX02-00	5PC810.SX03-00	5PC810.SX05-00	
5PC800.B945-00 5PC800.B945-10	✓	✓	✓	✓	Max. UXGA
5PC800.B945-01 5PC800.B945-11	✓	✓	✓	✓	Max. UXGA
5PC800.B945-02 5PC800.B945-12	✓	✓	✓	✓	Max. UXGA
5PC800.B945-03 5PC800.B945-13	✓	✓	✓	✓	Max. UXGA
5PC800.B945-04 5PC800.B945-14	✓	✓	✓	✓	Max. UXGA
5PC800.B945-05	✓	✓	✓	✓	Max. UXGA

Table 160: Possible system unit and CPU board combinations

5.5.2 Link modules

Information:

A corresponding Link module must be selected for each device used.

Model number	Description	Note
5DLSDL.1000-01	Automation Panel Link SDL transceiver Connections for SDL In and SDL Out; transmission of display, touch screen, USB 1.1, matrix key and service data; 24 VDC (order screw clamp 0TB103.9 or cage clamp 0TB103.91 separately)	For Automation Panel 900

Table 161: Link modules

5.5.3 Cables

For a selection of SDL cables for connecting the AP900 display to an AP900 display, see "Cables" on page 198.

For a selection of SDL cables for connecting the AP800 display to an AP900 display, see "Cables" on page 200.

Information:

For detailed information regarding cables, see the chapter "Accessories".

5.5.4 Settings in BIOS

No special BIOS settings are necessary for operation.

For detailed information, see the user's manual for the B&R Industrial PC being used.

Touch screen functionality

COM C must be enabled in BIOS in order to operate the panel touch screen connected to the monitor/panel interface ("Advanced - Baseboard/Panel features - Legacy devices").

5.6 Four Automation Panel 900 systems via onboard SDL

An Automation Panel 900 is connected to the integrated SDL interface (onboard) via an SDL cable. Up to three other Automation Panels of the same type are connected to this Automation Panel and operated via SDL. All four of the panels show the same content (display clone).

USB is supported up to a maximum distance (SDL segment 1 + SDL segment 2) of 30 m on the first two panels (front and back). Past a distance of 30 m, USB is only available for the first panel (front and back). USB devices can only be connected directly to the Automation Panel (i.e. without a hub).

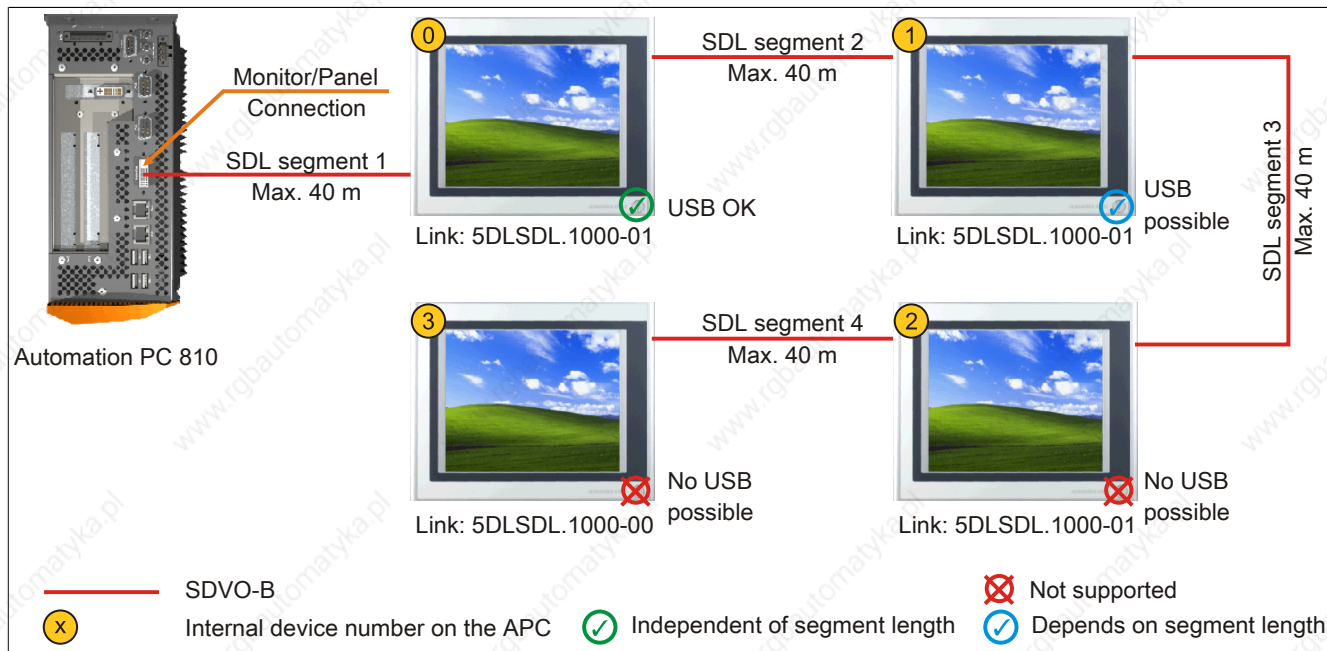

Figure 94: Four Automation Panel 900 systems via onboard SDL

5.6.1 Base system requirements

The following table lists the possible APC810 system unit and CPU board combinations necessary to implement the configuration shown in the figure above. If a combination results in a limitation of the maximum resolution, this is also indicated (e.g. when connecting a non-B&R Automation Panel 900 device).

CPU board	With system unit				Limitation Resolution
	5PC810.SX01-00	5PC810.SX02-00	5PC810.SX03-00	5PC810.SX05-00	
5PC800.B945-00 5PC800.B945-10	✓	✓	✓	✓	Max. UXGA
5PC800.B945-01 5PC800.B945-11	✓	✓	✓	✓	Max. UXGA
5PC800.B945-02 5PC800.B945-12	✓	✓	✓	✓	Max. UXGA
5PC800.B945-03 5PC800.B945-13	✓	✓	✓	✓	Max. UXGA
5PC800.B945-04 5PC800.B945-14	✓	✓	✓	✓	Max. UXGA
5PC800.B945-05	✓	✓	✓	✓	Max. UXGA

Table 162: Possible system unit and CPU board combinations

5.6.2 Link modules

Information:

A corresponding Link module must be selected for each device used.

Model number	Description	Note
5DLSDL.1000-00	Automation Panel Link SDL receiver Connection for SDL In; transmission of display, touch screen, USB 1.1, matrix key and service data; 24 VDC (order screw clamp 0TB103.9 or cage clamp 0TB103.91 separately)	For Automation Panel 900
5DLSDL.1000-01	Automation Panel Link SDL transceiver Connections for SDL In and SDL Out; transmission of display, touch screen, USB 1.1, matrix key and service data; 24 VDC (order screw clamp 0TB103.9 or cage clamp 0TB103.91 separately)	For Automation Panel 900

Table 163: Link modules

5.6.3 Cables

Select an Automation Panel 900 cable from the following table.

Model number	Description	Length
5CASDL.0018-00	SDL cable, 1.8 m	1.8 m ±30 mm
5CASDL.0050-00	SDL cable, 5 m	5 m ±30 mm
5CASDL.0100-00	SDL cable, 10 m	10 m ±50 mm
5CASDL.0150-00	SDL cable, 15 m	15 m ±100 mm
5CASDL.0200-00	SDL cable, 20 m	20 m ±100 mm
5CASDL.0250-00	SDL cable, 25 m	25 m ±100 mm
5CASDL.0300-00	SDL cable, 30 m	30 m ±100 mm
5CASDL.0018-03	SDL flex cable, 1.8 m	1.8 m ±20 mm
5CASDL.0050-03	SDL flex cable, 5 m	5 m ±45 mm
5CASDL.0100-03	SDL flex cable, 10 m	10 m ±90 mm
5CASDL.0150-03	SDL flex cable, 15 m	15 m ±135 mm
5CASDL.0200-03	SDL flex cable, 20 m	20 m ±180 mm
5CASDL.0250-03	SDL flex cable, 25 m	25 m ±225 mm
5CASDL.0300-03	SDL flex cable, 30 m	30 m ±270 mm
5CASDL.0300-13	SDL flex cable with extender, 30 m	30 m ±280 mm
5CASDL.0400-13	SDL flex cable with extender, 40 m	40 m ±380 mm
5CASDL.0430-13	SDL flex cable with extender, 43 m	43 m ±410 mm
5CASDL.0018-01	SDL cable with 45° male connector, 1.8 m	1.8 m ±30 mm
5CASDL.0050-01	SDL cable with 45° male connector, 5 m	5 m ±50 mm
5CASDL.0100-01	SDL cable with 45° male connector, 10 m	10 m ±100 mm
5CASDL.0150-01	SDL cable with 45° male connector, 15 m	15 m ±100 mm

Table 164: Cables for SDL configurations

Information:

Detailed technical data about cables can be found in the Automation Panel 900 user's manual. This can be downloaded as a PDF file from the B&R website at www.br-automation.com.

5.6.3.1 Cable lengths and resolutions for SDL transmission

The following table lists the relationship between segment lengths and maximum resolution depending on the SDL cable being used:

SDL cables Segment length [m]	Resolution					
	VGA 640 x 480	SVGA 800 x 600	XGA 1024 x 768	SXGA 1280 x 1024	UXGA 1600 x 1200	FHD 1920 x 1080
1.8	5CASDL.0018-00	5CASDL.0018-00	5CASDL.0018-00	5CASDL.0018-00	5CASDL.0018-00	5CASDL.0018-00
	5CASDL.0018-01	5CASDL.0018-01	5CASDL.0018-01	5CASDL.0018-01	5CASDL.0018-01	5CASDL.0018-01
	5CASDL.0018-03	5CASDL.0018-03	5CASDL.0018-03	5CASDL.0018-03	5CASDL.0018-03	5CASDL.0018-03
5	5CASDL.0050-00	5CASDL.0050-00	5CASDL.0050-00	5CASDL.0050-00	5CASDL.0050-00	5CASDL.0050-00
	5CASDL.0050-01	5CASDL.0050-01	5CASDL.0050-01	5CASDL.0050-01	5CASDL.0050-01	5CASDL.0050-01
	5CASDL.0050-03	5CASDL.0050-03	5CASDL.0050-03	5CASDL.0050-03	5CASDL.0050-03	5CASDL.0050-03
10	5CASDL.0100-00	5CASDL.0100-00	5CASDL.0100-00	5CASDL.0100-00	5CASDL.0100-00	5CASDL.0100-00
	5CASDL.0100-01	5CASDL.0100-01	5CASDL.0100-01	5CASDL.0100-01	5CASDL.0100-01	5CASDL.0100-01
	5CASDL.0100-03	5CASDL.0100-03	5CASDL.0100-03	5CASDL.0100-03	5CASDL.0100-03	5CASDL.0100-03
15	5CASDL.0150-00	5CASDL.0150-00	5CASDL.0150-00	5CASDL.0150-00	-	-
	5CASDL.0150-01	5CASDL.0150-01	5CASDL.0150-01	5CASDL.0150-01	-	-
	5CASDL.0150-03	5CASDL.0150-03	5CASDL.0150-03	5CASDL.0150-03	-	5CASDL.0150-03
20	5CASDL.0200-00	5CASDL.0200-00	5CASDL.0200-00	5CASDL.0200-00	-	-
	5CASDL.0200-03	5CASDL.0200-03	5CASDL.0200-03	5CASDL.0200-03	-	5CASDL.0200-03
	5CASDL.0250-00	5CASDL.0250-00	5CASDL.0250-00	-	-	-
25	5CASDL.0250-03	5CASDL.0250-03	5CASDL.0250-03	-	-	-
	5CASDL.0300-00	5CASDL.0300-00	-	-	-	-
	5CASDL.0300-03	5CASDL.0300-03	5CASDL.0300-13	5CASDL.0300-13	-	5CASDL.0300-13
40	5CASDL.0400-13	5CASDL.0400-13	5CASDL.0400-13	5CASDL.0400-13	-	5CASDL.0400-13

Table 165: Cable lengths and resolutions for SDL transmission

5.6.4 Settings in BIOS

No special BIOS settings are necessary for operation.

For detailed information, see the user's manual for the B&R Industrial PC being used.

Touch screen functionality

COM C must be enabled in BIOS in order to operate the panel touch screen connected to the monitor/panel interface ("Advanced - Baseboard/Panel features - Legacy devices").

5.7 One Automation Panel 900 via SDL AP Link

An Automation Panel 900 unit is connected to the optional SDL transmitter (AP Link) via an SDL cable. USB devices can only be connected directly to the Automation Panel (i.e. without a hub).

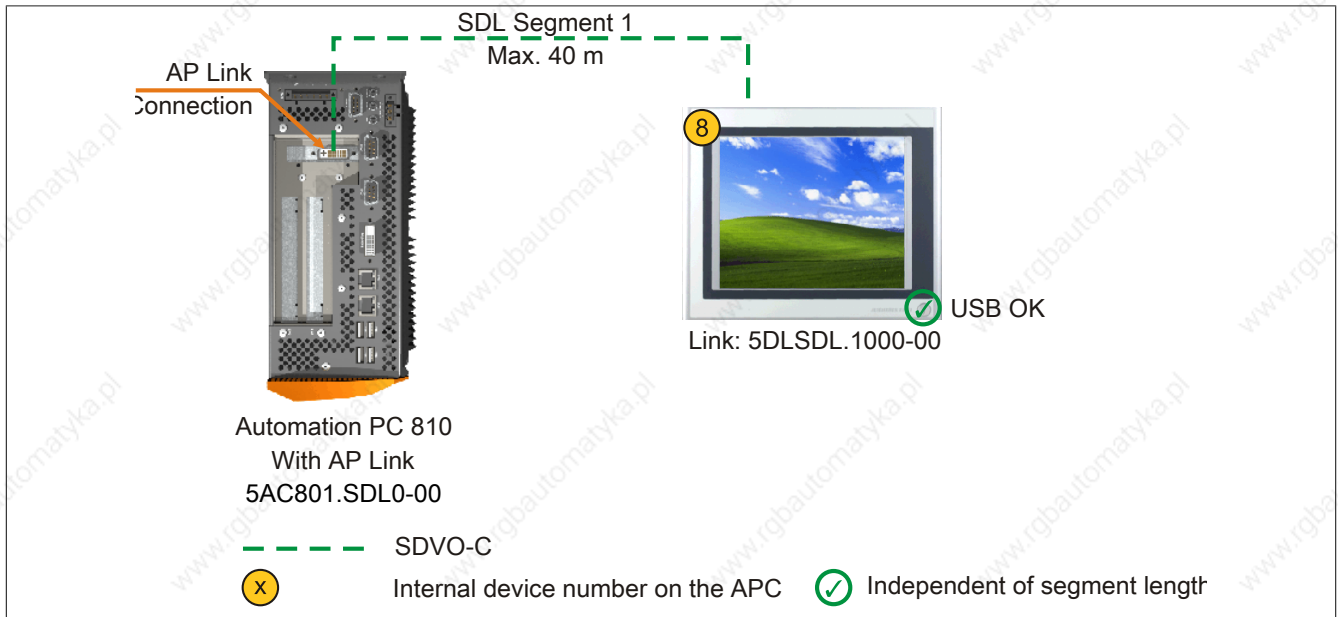

Figure 95: One Automation Panel 900 system via SDL AP Link

5.7.1 Base system requirements

The following table lists the possible APC810 system unit and CPU board combinations necessary to implement the configuration shown in the figure above. If a combination results in a limitation of the maximum resolution, this is also indicated (e.g. when connecting a non-B&R Automation Panel 900 device).

CPU board	With system unit				Limitation Resolution
	5PC810.SX01-00 ¹⁾	5PC810.SX02-00	5PC810.SX03-00	5PC810.SX05-00	
5PC800.B945-00 5PC800.B945-10	-	✓	✓	✓	Max. UXGA
5PC800.B945-01 5PC800.B945-11	-	✓	✓	✓	Max. UXGA
5PC800.B945-02 5PC800.B945-12	-	✓	✓	✓	Max. UXGA
5PC800.B945-03 5PC800.B945-13	-	✓	✓	✓	Max. UXGA
5PC800.B945-04 5PC800.B945-14	-	✓	✓	✓	Max. UXGA
5PC800.B945-05	-	✓	✓	✓	Max. UXGA

Table 166: Possible system unit and CPU board combinations

1) AP Link cannot be installed.

5.7.2 Link modules

Information:

A corresponding Link module must be selected for each device used.

Model number	Description	Note
5DLSDL.1000-00	Automation Panel Link SDL receiver Connection for SDL In; transmission of display, touch screen, USB 1.1, matrix key and service data; 24 VDC (order screw clamp 0TB103.9 or cage clamp 0TB103.91 separately)	For Automation Panel 900
5AC801.SDL0-00	APC810 AP Link SDL transmitter Automation Panel SDL link transmitter	For Automation PC 810

Table 167: Link modules

5.7.3 Cables

Select an Automation Panel 900 cable from the following table.

Model number	Description	Length
5CASDL.0018-00	SDL cable, 1.8 m	1.8 m ±30 mm
5CASDL.0050-00	SDL cable, 5 m	5 m ±30 mm
5CASDL.0100-00	SDL cable, 10 m	10 m ±50 mm
5CASDL.0150-00	SDL cable, 15 m	15 m ±100 mm
5CASDL.0200-00	SDL cable, 20 m	20 m ±100 mm
5CASDL.0250-00	SDL cable, 25 m	25 m ±100 mm
5CASDL.0300-00	SDL cable, 30 m	30 m ±100 mm
5CASDL.0018-03	SDL flex cable, 1.8 m	1.8 m ±20 mm
5CASDL.0050-03	SDL flex cable, 5 m	5 m ±45 mm
5CASDL.0100-03	SDL flex cable, 10 m	10 m ±90 mm
5CASDL.0150-03	SDL flex cable, 15 m	15 m ±135 mm
5CASDL.0200-03	SDL flex cable, 20 m	20 m ±180 mm
5CASDL.0250-03	SDL flex cable, 25 m	25 m ±225 mm
5CASDL.0300-03	SDL flex cable, 30 m	30 m ±270 mm
5CASDL.0300-13	SDL flex cable with extender, 30 m	30 m ±280 mm
5CASDL.0400-13	SDL flex cable with extender, 40 m	40 m ±380 mm
5CASDL.0430-13	SDL flex cable with extender, 43 m	43 m ±410 mm
5CASDL.0018-01	SDL cable with 45° male connector, 1.8 m	1.8 m ±30 mm
5CASDL.0050-01	SDL cable with 45° male connector, 5 m	5 m ±50 mm
5CASDL.0100-01	SDL cable with 45° male connector, 10 m	10 m ±100 mm
5CASDL.0150-01	SDL cable with 45° male connector, 15 m	15 m ±100 mm

Table 168: Cables for SDL configurations

Information:

Detailed technical data about cables can be found in the Automation Panel 900 user's manual. This can be downloaded as a PDF file from the B&R website at www.br-automation.com.

5.7.3.1 Cable lengths and resolutions for SDL transmission

The following table lists the relationship between segment lengths and maximum resolution depending on the SDL cable being used:

SDL cables Segment length [m]	Resolution					
	VGA 640 x 480	SVGA 800 x 600	XGA 1024 x 768	SXGA 1280 x 1024	UXGA 1600 x 1200	FHD 1920 x 1080
1.8	5CASDL.0018-00	5CASDL.0018-00	5CASDL.0018-00	5CASDL.0018-00	5CASDL.0018-00	5CASDL.0018-00
	5CASDL.0018-01	5CASDL.0018-01	5CASDL.0018-01	5CASDL.0018-01	5CASDL.0018-01	5CASDL.0018-01
	5CASDL.0018-03	5CASDL.0018-03	5CASDL.0018-03	5CASDL.0018-03	5CASDL.0018-03	5CASDL.0018-03
5	5CASDL.0050-00	5CASDL.0050-00	5CASDL.0050-00	5CASDL.0050-00	5CASDL.0050-00	5CASDL.0050-00
	5CASDL.0050-01	5CASDL.0050-01	5CASDL.0050-01	5CASDL.0050-01	5CASDL.0050-01	5CASDL.0050-01
	5CASDL.0050-03	5CASDL.0050-03	5CASDL.0050-03	5CASDL.0050-03	5CASDL.0050-03	5CASDL.0050-03
10	5CASDL.0100-00	5CASDL.0100-00	5CASDL.0100-00	5CASDL.0100-00	5CASDL.0100-00	5CASDL.0100-00
	5CASDL.0100-01	5CASDL.0100-01	5CASDL.0100-01	5CASDL.0100-01	5CASDL.0100-01	5CASDL.0100-01
	5CASDL.0100-03	5CASDL.0100-03	5CASDL.0100-03	5CASDL.0100-03	5CASDL.0100-03	5CASDL.0100-03
15	5CASDL.0150-00	5CASDL.0150-00	5CASDL.0150-00	5CASDL.0150-00	-	-
	5CASDL.0150-01	5CASDL.0150-01	5CASDL.0150-01	5CASDL.0150-01	-	-
	5CASDL.0150-03	5CASDL.0150-03	5CASDL.0150-03	5CASDL.0150-03	-	5CASDL.0150-03
20	5CASDL.0200-00	5CASDL.0200-00	5CASDL.0200-00	5CASDL.0200-00	-	-
	5CASDL.0200-03	5CASDL.0200-03	5CASDL.0200-03	5CASDL.0200-03	-	5CASDL.0200-03
25	5CASDL.0250-00	5CASDL.0250-00	5CASDL.0250-00	-	-	-
	5CASDL.0250-03	5CASDL.0250-03	5CASDL.0250-03	-	-	-
30	5CASDL.0300-00	5CASDL.0300-00	-	-	-	-
	5CASDL.0300-03	5CASDL.0300-03	5CASDL.0300-13	5CASDL.0300-13	-	5CASDL.0300-13
40	5CASDL.0400-13	5CASDL.0400-13	5CASDL.0400-13	5CASDL.0400-13	-	5CASDL.0400-13

Table 169: Cable lengths and resolutions for SDL transmission

5.7.4 Settings in BIOS

No special BIOS settings are necessary for operation.

For detailed information, see the user's manual for the B&R Industrial PC being used.

Touch screen functionality

COM D must be enabled in BIOS in order to operate the panel touch screen connected to the AP Link interface ("Advanced - Baseboard / Panel features - Legacy devices").

5.8 Four Automation Panel 900 units via SDL AP Link

An Automation Panel 900 unit is connected to the optional SDL transmitter (AP Link) via an SDL cable. Three other Automation Panels of the same type are connected to this Automation Panel and operated via SDL. All four of the panels show the same content (display clone).

USB is supported up to a maximum distance (SDL segment 1 + SDL segment 2) of 30 m on the first two panels (front and back). Past a distance of 30 m, USB is only available for the first panel (front and back). USB devices can only be connected directly to the Automation Panel (i.e. without a hub).

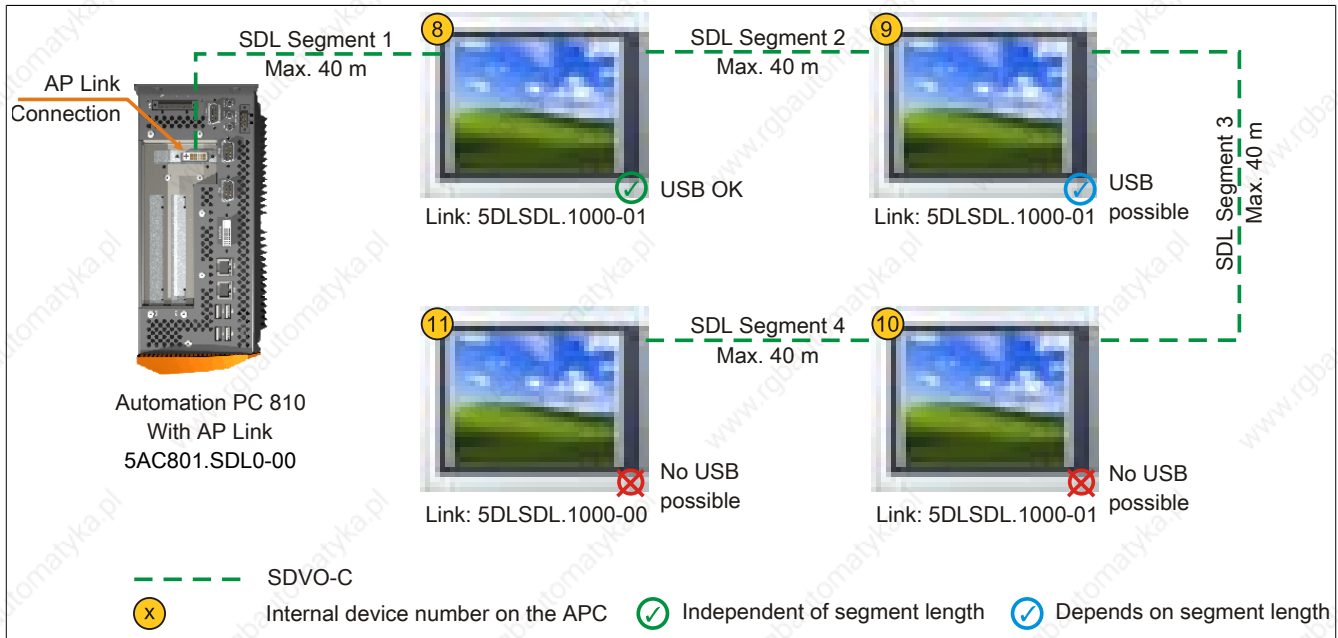

Figure 96: Four Automation Panel 900 systems via SDL AP Link

5.8.1 Base system requirements

The following table lists the possible APC810 system unit and CPU board combinations necessary to implement the configuration shown in the figure above. If a combination results in a limitation of the maximum resolution, this is also indicated (e.g. when connecting a non-B&R Automation Panel 900 device).

CPU board	With system unit				Limitation Resolution
	5PC810.SX01-00 ¹⁾	5PC810.SX02-00	5PC810.SX03-00	5PC810.SX05-00	
5PC800.B945-00 5PC800.B945-10	-	✓	✓	✓	Max. UXGA
5PC800.B945-01 5PC800.B945-11	-	✓	✓	✓	Max. UXGA
5PC800.B945-02 5PC800.B945-12	-	✓	✓	✓	Max. UXGA
5PC800.B945-03 5PC800.B945-13	-	✓	✓	✓	Max. UXGA
5PC800.B945-04 5PC800.B945-14	-	✓	✓	✓	Max. UXGA
5PC800.B945-05	-	✓	✓	✓	Max. UXGA

Table 170: Possible system unit and CPU board combinations

1) AP Link cannot be installed.

5.8.2 Link modules

Information:

A corresponding Link module must be selected for each device used.

Model number	Description	Note
5DLSDL.1000-00	Automation Panel Link SDL receiver Connection for SDL In; transmission of display, touch screen, USB 1.1, matrix key and service data; 24 VDC (order screw clamp OTB103.9 or cage clamp OTB103.91 separately)	For Automation Panel 900
5DLSDL.1000-01	Automation Panel Link SDL transceiver Connections for SDL In and SDL Out; transmission of display, touch screen, USB 1.1, matrix key and service data; 24 VDC (order screw clamp OTB103.9 or cage clamp OTB103.91 separately)	For Automation Panel 900
5AC801.SDL0-00	APC810 AP Link SDL transmitter Automation Panel SDL link transmitter	For Automation PC 810

Table 171: Link modules

5.8.3 Cables

Select an Automation Panel 900 cable from the following table.

Model number	Description	Length
5CASDL.0018-00	SDL cable, 1.8 m	1.8 m ±30 mm
5CASDL.0050-00	SDL cable, 5 m	5 m ±30 mm
5CASDL.0100-00	SDL cable, 10 m	10 m ±50 mm
5CASDL.0150-00	SDL cable, 15 m	15 m ±100 mm
5CASDL.0200-00	SDL cable, 20 m	20 m ±100 mm
5CASDL.0250-00	SDL cable, 25 m	25 m ±100 mm
5CASDL.0300-00	SDL cable, 30 m	30 m ±100 mm
5CASDL.0018-03	SDL flex cable, 1.8 m	1.8 m ±20 mm
5CASDL.0050-03	SDL flex cable, 5 m	5 m ±45 mm
5CASDL.0100-03	SDL flex cable, 10 m	10 m ±90 mm
5CASDL.0150-03	SDL flex cable, 15 m	15 m ±135 mm
5CASDL.0200-03	SDL flex cable, 20 m	20 m ±180 mm
5CASDL.0250-03	SDL flex cable, 25 m	25 m ±225 mm
5CASDL.0300-03	SDL flex cable, 30 m	30 m ±270 mm
5CASDL.0300-13	SDL flex cable with extender, 30 m	30 m ±280 mm
5CASDL.0400-13	SDL flex cable with extender, 40 m	40 m ±380 mm
5CASDL.0430-13	SDL flex cable with extender, 43 m	43 m ±410 mm
5CASDL.0018-01	SDL cable with 45° male connector, 1.8 m	1.8 m ±30 mm
5CASDL.0050-01	SDL cable with 45° male connector, 5 m	5 m ±50 mm
5CASDL.0100-01	SDL cable with 45° male connector, 10 m	10 m ±100 mm
5CASDL.0150-01	SDL cable with 45° male connector, 15 m	15 m ±100 mm

Table 172: Cables for SDL configurations

Information:

Detailed technical data about cables can be found in the Automation Panel 900 user's manual. This can be downloaded as a PDF file from the B&R website at www.br-automation.com.

5.8.3.1 Cable lengths and resolutions for SDL transmission

The following table lists the relationship between segment lengths and maximum resolution depending on the SDL cable being used:

SDL cables Segment length [m]	Resolution					
	VGA 640 x 480	SVGA 800 x 600	XGA 1024 x 768	SXGA 1280 x 1024	UXGA 1600 x 1200	FHD 1920 x 1080
1.8	5CASDL.0018-00	5CASDL.0018-00	5CASDL.0018-00	5CASDL.0018-00	5CASDL.0018-00	5CASDL.0018-00
	5CASDL.0018-01	5CASDL.0018-01	5CASDL.0018-01	5CASDL.0018-01	5CASDL.0018-01	5CASDL.0018-01
	5CASDL.0018-03	5CASDL.0018-03	5CASDL.0018-03	5CASDL.0018-03	5CASDL.0018-03	5CASDL.0018-03
5	5CASDL.0050-00	5CASDL.0050-00	5CASDL.0050-00	5CASDL.0050-00	5CASDL.0050-00	5CASDL.0050-00
	5CASDL.0050-01	5CASDL.0050-01	5CASDL.0050-01	5CASDL.0050-01	5CASDL.0050-01	5CASDL.0050-01
	5CASDL.0050-03	5CASDL.0050-03	5CASDL.0050-03	5CASDL.0050-03	5CASDL.0050-03	5CASDL.0050-03
10	5CASDL.0100-00	5CASDL.0100-00	5CASDL.0100-00	5CASDL.0100-00	5CASDL.0100-00	5CASDL.0100-00
	5CASDL.0100-01	5CASDL.0100-01	5CASDL.0100-01	5CASDL.0100-01	5CASDL.0100-01	5CASDL.0100-01
	5CASDL.0100-03	5CASDL.0100-03	5CASDL.0100-03	5CASDL.0100-03	5CASDL.0100-03	5CASDL.0100-03
15	5CASDL.0150-00	5CASDL.0150-00	5CASDL.0150-00	5CASDL.0150-00	-	-
	5CASDL.0150-01	5CASDL.0150-01	5CASDL.0150-01	5CASDL.0150-01	-	-
	5CASDL.0150-03	5CASDL.0150-03	5CASDL.0150-03	5CASDL.0150-03	-	5CASDL.0150-03
20	5CASDL.0200-00	5CASDL.0200-00	5CASDL.0200-00	5CASDL.0200-00	-	-
	5CASDL.0200-01	5CASDL.0200-01	5CASDL.0200-01	5CASDL.0200-01	-	-
	5CASDL.0200-03	5CASDL.0200-03	5CASDL.0200-03	5CASDL.0200-03	-	5CASDL.0200-03

Table 173: Cable lengths and resolutions for SDL transmission

SDL cables Segment length [m]	Resolution					
	VGA 640 x 480	SVGA 800 x 600	XGA 1024 x 768	SXGA 1280 x 1024	UXGA 1600 x 1200	FHD 1920 x 1080
25	5CASDL.0250-00	5CASDL.0250-00	5CASDL.0250-00	-	-	-
	5CASDL.0250-03	5CASDL.0250-03	5CASDL.0250-03	-	-	-
30	5CASDL.0300-00	5CASDL.0300-00	-	-	-	-
	5CASDL.0300-03	5CASDL.0300-03	5CASDL.0300-13	5CASDL.0300-13	-	5CASDL.0300-13
40	5CASDL.0400-13	5CASDL.0400-13	5CASDL.0400-13	5CASDL.0400-13	-	5CASDL.0400-13

Table 173: Cable lengths and resolutions for SDL transmission

5.8.4 Settings in BIOS

No special BIOS settings are necessary for operation.

For detailed information, see the user's manual for the B&R Industrial PC being used.

Touch screen functionality

COM D must be enabled in BIOS in order to operate the panel touch screen connected to the AP Link interface ("Advanced - Baseboard / Panel features - Legacy devices").

5.9 Two Automation Panel 900 systems via onboard SDL and SDL AP Link

An Automation Panel 900 (max. UXGA) is connected to the integrated SDL interface (onboard) via an SDL cable. A second Automation Panel 900 (max. UXGA) is connected to the optional SDL transmitter (AP Link) via an SDL cable. The Automation Panels show different content (extended desktop) and can be different types.

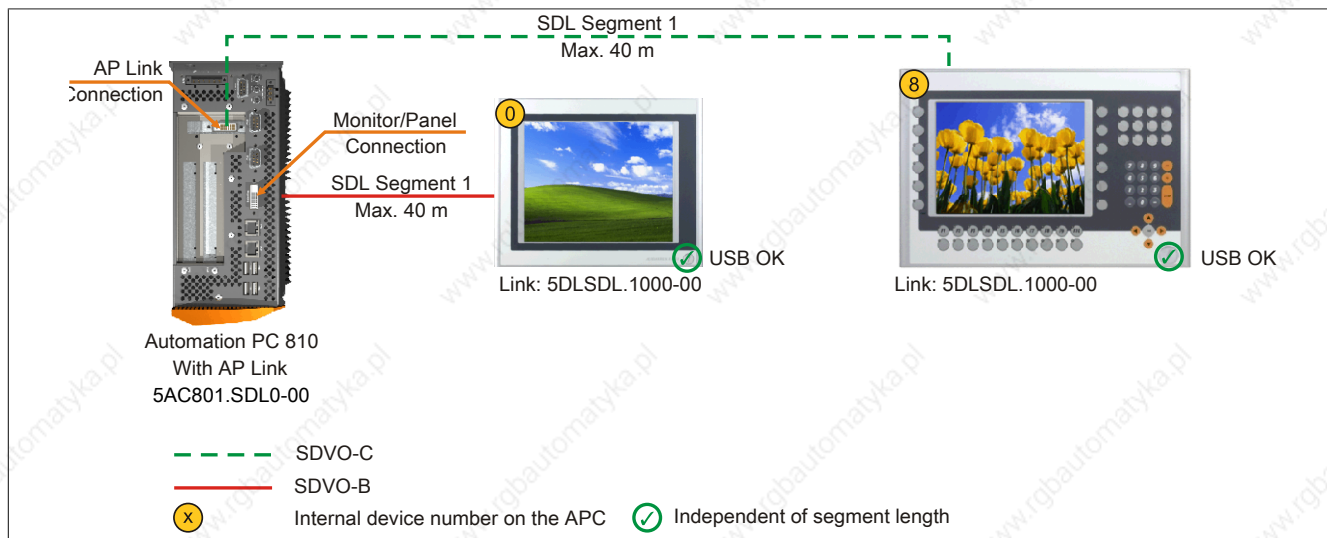

Figure 97: Two Automation Panel 900 systems via onboard SDL and SDL AP Link

5.9.1 Base system requirements

The following table lists the possible APC810 system unit and CPU board combinations necessary to implement the configuration shown in the figure above. If a combination results in a limitation of the maximum resolution, this is also indicated (e.g. when connecting a non-B&R Automation Panel 900 device).

CPU board	With system unit				Limitation Resolution
	5PC810.SX01-00 ¹⁾	5PC810.SX02-00	5PC810.SX03-00	5PC810.SX05-00	
5PC800.B945-00 5PC800.B945-10	-	✓	✓	✓	Max. UXGA
5PC800.B945-01 5PC800.B945-11	-	✓	✓	✓	Max. UXGA
5PC800.B945-02 5PC800.B945-12	-	✓	✓	✓	Max. UXGA
5PC800.B945-03 5PC800.B945-13	-	✓	✓	✓	Max. UXGA
5PC800.B945-04 5PC800.B945-14	-	✓	✓	✓	Max. UXGA
5PC800.B945-05	-	✓	✓	✓	Max. UXGA

Table 174: Possible system unit and CPU board combinations

1) AP Link cannot be installed.

5.9.2 Link modules

Information:

A corresponding Link module must be selected for each device used.

Model number	Description	Note
5DLSDL.1000-00	Automation Panel Link SDL receiver Connection for SDL In; transmission of display, touch screen, USB 1.1, matrix key and service data; 24 VDC (order screw clamp 0TB103.9 or cage clamp 0TB103.91 separately)	For Automation Panel 900
5AC801.SDL0-00	APC810 AP Link SDL transmitter Automation Panel SDL link transmitter	For Automation PC 810

Table 175: Link modules

5.9.3 Cables

Select an Automation Panel 900 cable from the following table.

Model number	Description	Length
5CASDL.0018-00	SDL cable, 1.8 m	1.8 m ±30 mm
5CASDL.0050-00	SDL cable, 5 m	5 m ±30 mm
5CASDL.0100-00	SDL cable, 10 m	10 m ±50 mm
5CASDL.0150-00	SDL cable, 15 m	15 m ±100 mm
5CASDL.0200-00	SDL cable, 20 m	20 m ±100 mm
5CASDL.0250-00	SDL cable, 25 m	25 m ±100 mm
5CASDL.0300-00	SDL cable, 30 m	30 m ±100 mm
5CASDL.0018-03	SDL flex cable, 1.8 m	1.8 m ±20 mm
5CASDL.0050-03	SDL flex cable, 5 m	5 m ±45 mm
5CASDL.0100-03	SDL flex cable, 10 m	10 m ±90 mm
5CASDL.0150-03	SDL flex cable, 15 m	15 m ±135 mm
5CASDL.0200-03	SDL flex cable, 20 m	20 m ±180 mm
5CASDL.0250-03	SDL flex cable, 25 m	25 m ±225 mm
5CASDL.0300-03	SDL flex cable, 30 m	30 m ±270 mm
5CASDL.0300-13	SDL flex cable with extender, 30 m	30 m ±280 mm
5CASDL.0400-13	SDL flex cable with extender, 40 m	40 m ±380 mm
5CASDL.0430-13	SDL flex cable with extender, 43 m	43 m ±410 mm
5CASDL.0018-01	SDL cable with 45° male connector, 1.8 m	1.8 m ±30 mm
5CASDL.0050-01	SDL cable with 45° male connector, 5 m	5 m ±50 mm
5CASDL.0100-01	SDL cable with 45° male connector, 10 m	10 m ±100 mm
5CASDL.0150-01	SDL cable with 45° male connector, 15 m	15 m ±100 mm

Table 176: Cables for SDL configurations

Information:

Detailed technical data about cables can be found in the Automation Panel 900 user's manual. This can be downloaded as a PDF file from the B&R website at www.br-automation.com.

5.9.3.1 Cable lengths and resolutions for SDL transmission

The following table lists the relationship between segment lengths and maximum resolution depending on the SDL cable being used:

SDL cables Segment length [m]	Resolution					
	VGA 640 x 480	SVGA 800 x 600	XGA 1024 x 768	SXGA 1280 x 1024	UXGA 1600 x 1200	FHD 1920 x 1080
1.8	5CASDL.0018-00	5CASDL.0018-00	5CASDL.0018-00	5CASDL.0018-00	5CASDL.0018-00	5CASDL.0018-00
	5CASDL.0018-01	5CASDL.0018-01	5CASDL.0018-01	5CASDL.0018-01	5CASDL.0018-01	5CASDL.0018-01
	5CASDL.0018-03	5CASDL.0018-03	5CASDL.0018-03	5CASDL.0018-03	5CASDL.0018-03	5CASDL.0018-03
5	5CASDL.0050-00	5CASDL.0050-00	5CASDL.0050-00	5CASDL.0050-00	5CASDL.0050-00	5CASDL.0050-00
	5CASDL.0050-01	5CASDL.0050-01	5CASDL.0050-01	5CASDL.0050-01	5CASDL.0050-01	5CASDL.0050-01
	5CASDL.0050-03	5CASDL.0050-03	5CASDL.0050-03	5CASDL.0050-03	5CASDL.0050-03	5CASDL.0050-03
10	5CASDL.0100-00	5CASDL.0100-00	5CASDL.0100-00	5CASDL.0100-00	5CASDL.0100-00	5CASDL.0100-00
	5CASDL.0100-01	5CASDL.0100-01	5CASDL.0100-01	5CASDL.0100-01	5CASDL.0100-01	5CASDL.0100-01
	5CASDL.0100-03	5CASDL.0100-03	5CASDL.0100-03	5CASDL.0100-03	5CASDL.0100-03	5CASDL.0100-03
15	5CASDL.0150-00	5CASDL.0150-00	5CASDL.0150-00	5CASDL.0150-00	-	-
	5CASDL.0150-01	5CASDL.0150-01	5CASDL.0150-01	5CASDL.0150-01	-	-
	5CASDL.0150-03	5CASDL.0150-03	5CASDL.0150-03	5CASDL.0150-03	-	5CASDL.0150-03
20	5CASDL.0200-00	5CASDL.0200-00	5CASDL.0200-00	5CASDL.0200-00	-	-
	5CASDL.0200-03	5CASDL.0200-03	5CASDL.0200-03	5CASDL.0200-03	-	5CASDL.0200-03
25	5CASDL.0250-00	5CASDL.0250-00	5CASDL.0250-00	-	-	-
	5CASDL.0250-03	5CASDL.0250-03	5CASDL.0250-03	-	-	-
30	5CASDL.0300-00	5CASDL.0300-00	-	-	-	-
	5CASDL.0300-03	5CASDL.0300-03	5CASDL.0300-13	5CASDL.0300-13	-	5CASDL.0300-13
40	5CASDL.0400-13	5CASDL.0400-13	5CASDL.0400-13	5CASDL.0400-13	-	5CASDL.0400-13

Table 177: Cable lengths and resolutions for SDL transmission

5.9.4 Settings in BIOS

No special BIOS settings are necessary for operation.

For detailed information, see the user's manual for the B&R Industrial PC being used.

Touch screen functionality

COM C must be enabled in BIOS in order to operate the panel touch screen connected to the monitor/panel or AP Link interface ("Advanced - Baseboard / Panel features - Legacy devices").

5.10 Eight Automation Panel 900 units via onboard SDL and SDL AP Link

Four Automation Panel 900 units (max. UXGA) are connected to the integrated SDL interface (onboard) via SDL. Four additional Automation Panel 900 units (max. UXGA) are connected to the optional SDL transmitter (AP Link). The Automation Panels in each line must be the same type. The two lines show different content (extended desktop), but panels in the same line show the same content (display clone).

USB is supported up to a maximum distance (SDL segment 1 + SDL segment 2) of 30 m on the first two panels (front and back) on both lines. Past a distance of 30 m, USB is only available for the first panel on each line. USB devices can only be connected directly to the Automation Panel (without hub).

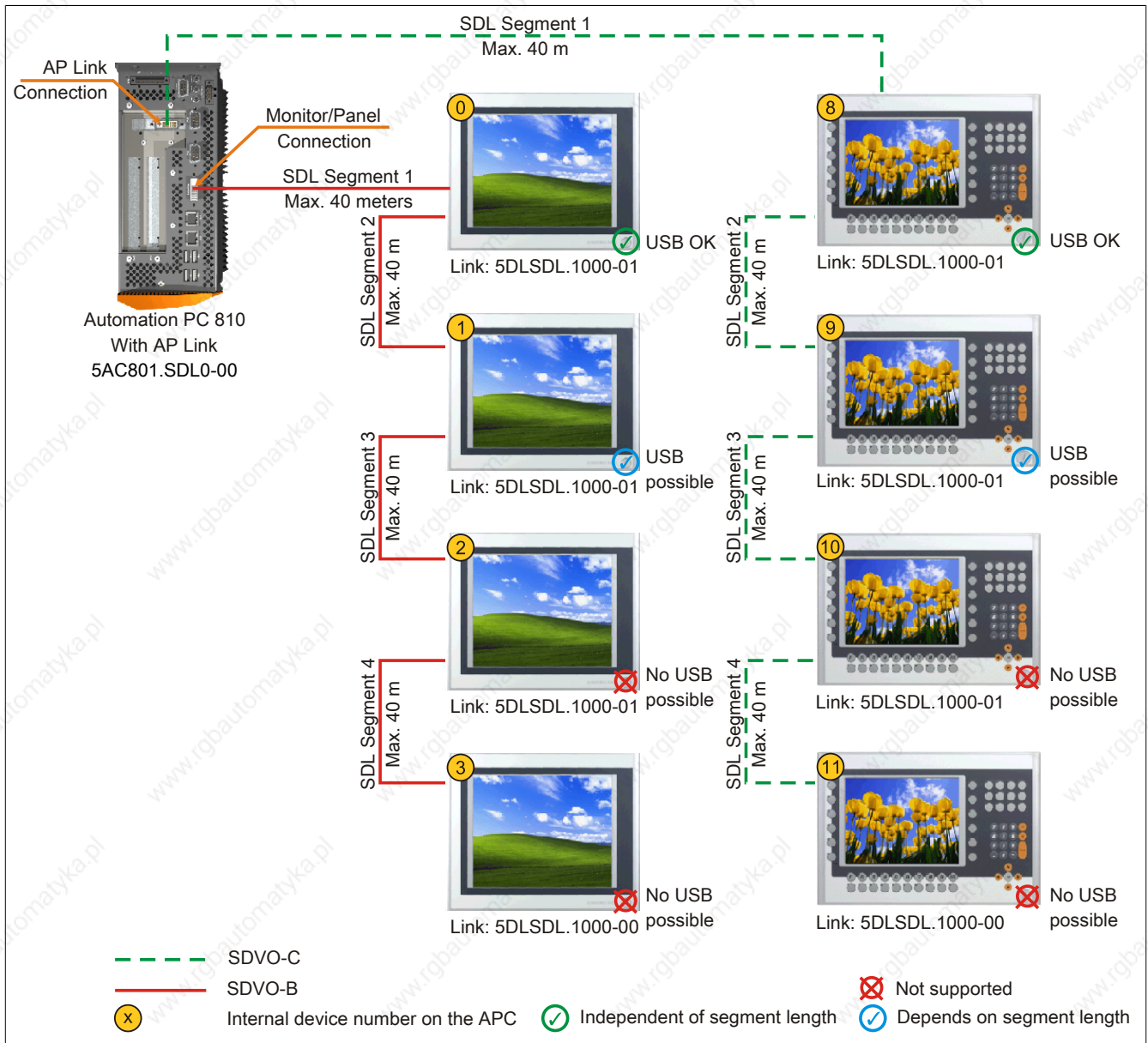

Figure 98: Eight Automation Panel 900 systems via onboard SDL and SDL AP Link

5.10.1 Base system requirements

The following table lists the possible APC810 system unit and CPU board combinations necessary to implement the configuration shown in the figure above. If a combination results in a limitation of the maximum resolution, this is also indicated (e.g. when connecting a non-B&R Automation Panel 900 device).

CPU board	With system unit				Limitation Resolution
	5PC810.SX01-00 ¹⁾	5PC810.SX02-00	5PC810.SX03-00	5PC810.SX05-00	
5PC800.B945-00	-	✓	✓	✓	Max. UXGA
5PC800.B945-10	-	✓	✓	✓	Max. UXGA
5PC800.B945-01	-	✓	✓	✓	Max. UXGA
5PC800.B945-11	-	✓	✓	✓	Max. UXGA

Table 178: Possible system unit and CPU board combinations

CPU board	With system unit				Limitation Resolution
	5PC810.SX01-00 ¹⁾	5PC810.SX02-00	5PC810.SX03-00	5PC810.SX05-00	
5PC800.B945-02 5PC800.B945-12	-	✓	✓	✓	Max. UXGA
5PC800.B945-03 5PC800.B945-13	-	✓	✓	✓	Max. UXGA
5PC800.B945-04 5PC800.B945-14	-	✓	✓	✓	Max. UXGA
5PC800.B945-05	-	✓	✓	✓	Max. UXGA

Table 178: Possible system unit and CPU board combinations

1) AP Link cannot be installed.

5.10.2 Link modules

Information:

A corresponding Link module must be selected for each device used.

Model number	Description	Note
5DLSDL.1000-00	Automation Panel Link SDL receiver Connection for SDL In; transmission of display, touch screen, USB 1.1, matrix key and service data; 24 VDC (order screw clamp 0TB103.9 or cage clamp 0TB103.91 separately)	For Automation Panel 900
5DLSDL.1000-01	Automation Panel Link SDL transceiver Connections for SDL In and SDL Out; transmission of display, touch screen, USB 1.1, matrix key and service data; 24 VDC (order screw clamp 0TB103.9 or cage clamp 0TB103.91 separately)	For Automation Panel 900
5AC801.SDL0-00	APC810 AP Link SDL transmitter Automation Panel SDL link transmitter	For Automation PC 810

Table 179: Link modules

5.10.3 Cables

Select an Automation Panel 900 cable from the following table.

Model number	Description	Length
5CASDL.0018-00	SDL cable, 1.8 m	1.8 m ±30 mm
5CASDL.0050-00	SDL cable, 5 m	5 m ±30 mm
5CASDL.0100-00	SDL cable, 10 m	10 m ±50 mm
5CASDL.0150-00	SDL cable, 15 m	15 m ±100 mm
5CASDL.0200-00	SDL cable, 20 m	20 m ±100 mm
5CASDL.0250-00	SDL cable, 25 m	25 m ±100 mm
5CASDL.0300-00	SDL cable, 30 m	30 m ±100 mm
5CASDL.0018-03	SDL flex cable, 1.8 m	1.8 m ±20 mm
5CASDL.0050-03	SDL flex cable, 5 m	5 m ±45 mm
5CASDL.0100-03	SDL flex cable, 10 m	10 m ±90 mm
5CASDL.0150-03	SDL flex cable, 15 m	15 m ±135 mm
5CASDL.0200-03	SDL flex cable, 20 m	20 m ±180 mm
5CASDL.0250-03	SDL flex cable, 25 m	25 m ±225 mm
5CASDL.0300-03	SDL flex cable, 30 m	30 m ±270 mm
5CASDL.0300-13	SDL flex cable with extender, 30 m	30 m ±280 mm
5CASDL.0400-13	SDL flex cable with extender, 40 m	40 m ±380 mm
5CASDL.0430-13	SDL flex cable with extender, 43 m	43 m ±410 mm
5CASDL.0018-01	SDL cable with 45° male connector, 1.8 m	1.8 m ±30 mm
5CASDL.0050-01	SDL cable with 45° male connector, 5 m	5 m ±50 mm
5CASDL.0100-01	SDL cable with 45° male connector, 10 m	10 m ±100 mm
5CASDL.0150-01	SDL cable with 45° male connector, 15 m	15 m ±100 mm

Table 180: Cables for SDL configurations

Information:

Detailed technical data about cables can be found in the Automation Panel 900 user's manual. This can be downloaded as a PDF file from the B&R website at www.br-automation.com.

5.10.3.1 Cable lengths and resolutions for SDL transmission

The following table lists the relationship between segment lengths and maximum resolution depending on the SDL cable being used:

SDL cables Segment length [m]	Resolution					
	VGA 640 x 480	SVGA 800 x 600	XGA 1024 x 768	SXGA 1280 x 1024	UXGA 1600 x 1200	FHD 1920 x 1080
1.8	5CASDL.0018-00	5CASDL.0018-00	5CASDL.0018-00	5CASDL.0018-00	5CASDL.0018-00	5CASDL.0018-00
	5CASDL.0018-01	5CASDL.0018-01	5CASDL.0018-01	5CASDL.0018-01	5CASDL.0018-01	5CASDL.0018-01
	5CASDL.0018-03	5CASDL.0018-03	5CASDL.0018-03	5CASDL.0018-03	5CASDL.0018-03	5CASDL.0018-03
5	5CASDL.0050-00	5CASDL.0050-00	5CASDL.0050-00	5CASDL.0050-00	5CASDL.0050-00	5CASDL.0050-00
	5CASDL.0050-01	5CASDL.0050-01	5CASDL.0050-01	5CASDL.0050-01	5CASDL.0050-01	5CASDL.0050-01
	5CASDL.0050-03	5CASDL.0050-03	5CASDL.0050-03	5CASDL.0050-03	5CASDL.0050-03	5CASDL.0050-03
10	5CASDL.0100-00	5CASDL.0100-00	5CASDL.0100-00	5CASDL.0100-00	5CASDL.0100-00	5CASDL.0100-00
	5CASDL.0100-01	5CASDL.0100-01	5CASDL.0100-01	5CASDL.0100-01	5CASDL.0100-01	5CASDL.0100-01
	5CASDL.0100-03	5CASDL.0100-03	5CASDL.0100-03	5CASDL.0100-03	5CASDL.0100-03	5CASDL.0100-03
15	5CASDL.0150-00	5CASDL.0150-00	5CASDL.0150-00	5CASDL.0150-00	-	-
	5CASDL.0150-01	5CASDL.0150-01	5CASDL.0150-01	5CASDL.0150-01	-	-
	5CASDL.0150-03	5CASDL.0150-03	5CASDL.0150-03	5CASDL.0150-03	-	5CASDL.0150-03
20	5CASDL.0200-00	5CASDL.0200-00	5CASDL.0200-00	5CASDL.0200-00	-	-
	5CASDL.0200-03	5CASDL.0200-03	5CASDL.0200-03	5CASDL.0200-03	-	5CASDL.0200-03
	5CASDL.0250-00	5CASDL.0250-00	5CASDL.0250-00	-	-	-
25	5CASDL.0250-03	5CASDL.0250-03	5CASDL.0250-03	-	-	-
	5CASDL.0300-00	5CASDL.0300-00	-	-	-	-
	5CASDL.0300-03	5CASDL.0300-03	5CASDL.0300-13	5CASDL.0300-13	-	5CASDL.0300-13
40	5CASDL.0400-13	5CASDL.0400-13	5CASDL.0400-13	5CASDL.0400-13	-	5CASDL.0400-13

Table 181: Cable lengths and resolutions for SDL transmission

5.10.4 Settings in BIOS

No special BIOS settings are necessary for operation.

For detailed information, see the user's manual for the B&R Industrial PC being used.

Touch screen functionality

COM C must be enabled in BIOS in order to operate the panel touch screen connected to the monitor/panel or AP Link interface ("Advanced - Baseboard / Panel features - Legacy devices").

5.11 Six AP900 and two AP800 units via onboard SDL and SDL AP Link

Three Automation Panel 900 (max. UXGA) units and one Automation Panel 800 are connected to the integrated SDL interface (onboard) via SDL. In addition, three Automation Panel 900 (max. UXGA) units and one Automation Panel 800 are operated on the optional SDL transmitter. The Automation Panels in each line must be of the same type. The two lines show different content (extended desktop), but displays in the same line show the same content (display clone).

USB is supported up to a maximum distance (segment 1 + segment 2) of 30 m on the first two displays. Past a distance of 30 m, USB is only available on the first display (front and back) up to 40 m. USB devices can only be connected directly to Automation Panel 900 devices (without a hub).

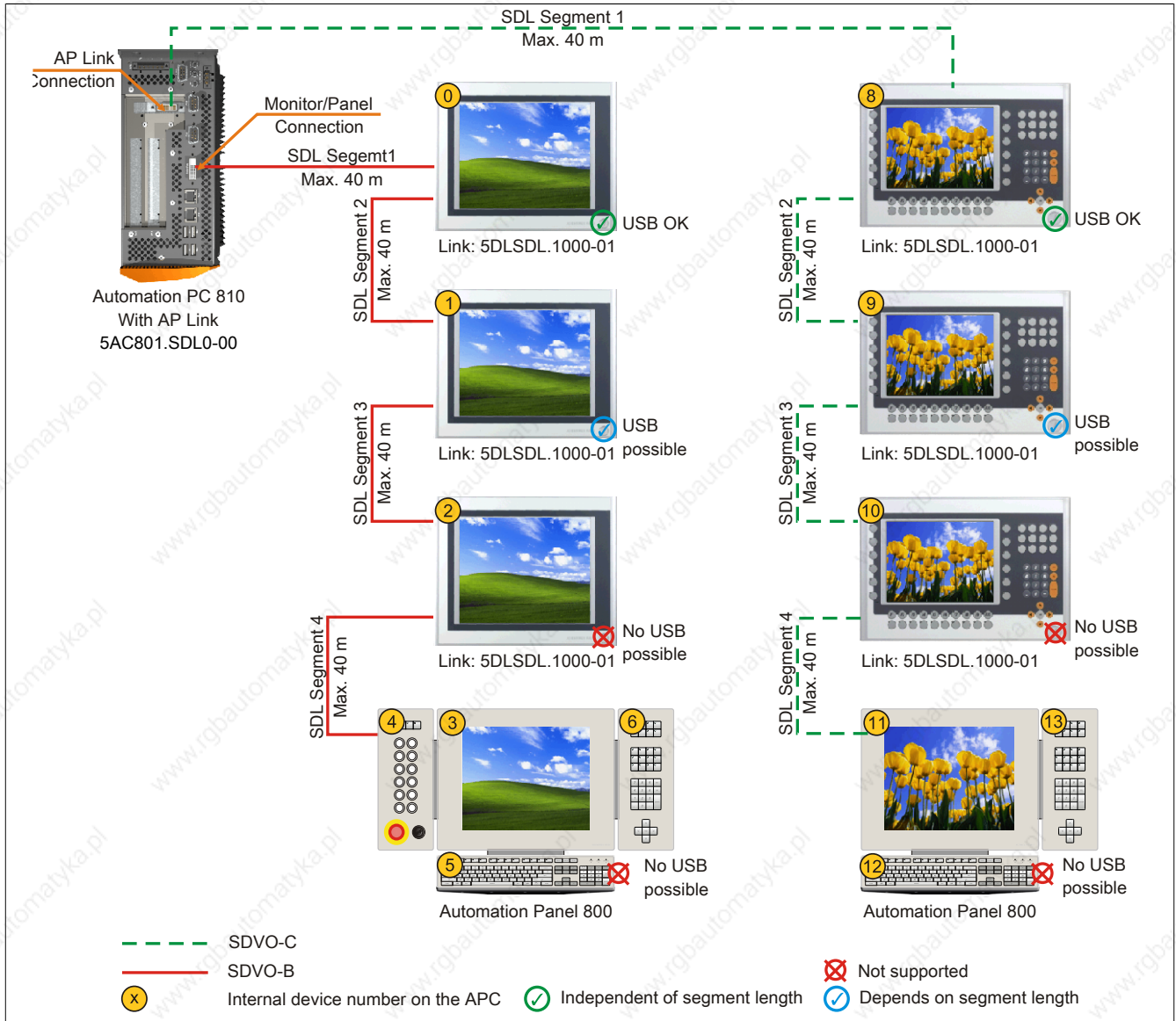

Figure 99: Six AP900 and two AP800 systems via onboard SDL and SDL AP Link

5.11.1 Base system requirements

The following table lists the possible APC810 system unit and CPU board combinations necessary to implement the configuration shown in the figure above. If a combination results in a limitation of the maximum resolution, this is also indicated (e.g. when connecting a non-B&R Automation Panel 900 device).

In order to connect an Automation Panel 800 and an Automation Panel 900 on the same line, the devices must have the same display type.

CPU board	With system unit				Limitation Resolution
	5PC810.SX01-00 ¹⁾	5PC810.SX02-00	5PC810.SX03-00	5PC810.SX05-00	
5PC800.B945-00 5PC800.B945-10	-	✓	✓	✓	Max. UXGA
5PC800.B945-01 5PC800.B945-11	-	✓	✓	✓	Max. UXGA
5PC800.B945-02 5PC800.B945-12	-	✓	✓	✓	Max. UXGA
5PC800.B945-03 5PC800.B945-13	-	✓	✓	✓	Max. UXGA
5PC800.B945-04 5PC800.B945-14	-	✓	✓	✓	Max. UXGA
5PC800.B945-05	-	✓	✓	✓	Max. UXGA

Table 182: Possible system unit and CPU board combinations

1) AP Link cannot be installed.

5.11.2 Link modules

Information:

A corresponding Link module must be selected for each device used.

Model number	Description	Note
5DLSDL.1000-01	Automation Panel Link SDL transceiver Connections for SDL In and SDL Out; transmission of display, touch screen, USB 1.1, matrix key and service data; 24 VDC (order screw clamp 0TB103.9 or cage clamp 0TB103.91 separately)	For Automation Panel 900
5AC801.SDL0-00	APC810 AP Link SDL transmitter Automation Panel SDL link transmitter	For Automation PC 810

Table 183: Link modules

5.11.3 Cables

For a selection of SDL cables for connecting the AP900 display to an AP900 display, see "Cables" on page 198.

For a selection of SDL cables for connecting the AP800 display to an AP900 display, see "Cables" on page 200.

Information:

For detailed information regarding cables, see the chapter "Accessories".

5.11.3.1 Cable lengths and resolutions for SDL transmission

The following table lists the relationship between segment lengths and maximum resolution depending on the SDL cable being used:

Cables Segment length [m]	Resolution				
	VGA 640 x 480	SVGA 800 x 600	XGA 1024 x 768	SXGA 1280 x 1024	UXGA 1600 x 1200
1.8	-	-	5CASDL.0018-00	-	-
	-	-	5CASDL.0018-01	-	-
	-	-	5CASDL.0018-20	-	-
	-	-	5CASDL.0018-03	-	-
5	-	-	5CASDL.0050-00	-	-
	-	-	5CASDL.0050-01	-	-
	-	-	5CASDL.0050-20	-	-
	-	-	5CASDL.0050-03	-	-
10	-	-	5CASDL.0100-00	-	-
	-	-	5CASDL.0100-01	-	-
	-	-	5CASDL.0100-20	-	-
	-	-	5CASDL.0100-03	-	-
15	-	-	5CASDL.0150-00	-	-
	-	-	5CASDL.0150-01	-	-
	-	-	5CASDL.0150-20	-	-
	-	-	5CASDL.0150-03	-	-
20	-	-	5CASDL.0200-00	-	-
	-	-	5CASDL.0200-20	-	-
	-	-	5CASDL.0200-03	-	-
25	-	-	5CASDL.0250-00	-	-
	-	-	5CASDL.0250-20	-	-
	-	-	5CASDL.0250-03	-	-

Table 184: Segment lengths, resolutions and SDL cables

Cables Segment length [m]	Resolution				
	VGA 640 x 480	SVGA 800 x 600	XGA 1024 x 768	SXGA 1280 x 1024	UXGA 1600 x 1200
30	-	-	5CASDL.0300-10	-	-
	-	-	5CASDL.0300-13	-	-
	-	-	5CASDL.0300-30	-	-
40	-	-	5CASDL.0400-10	-	-
	-	-	5CASDL.0400-13	-	-
	-	-	5CASDL.0400-30	-	-

Table 184: Segment lengths, resolutions and SDL cables

5.11.4 Settings in BIOS

No special BIOS settings are necessary for operation.

For detailed information, see the user's manual for the B&R Industrial PC being used.

Touch screen functionality

COM C must be enabled in BIOS in order to operate the panel touch screen connected to the monitor/panel or AP Link interface ("Advanced - Baseboard / Panel features - Legacy devices").

6 Connecting peripheral USB devices

Warning!

Peripheral USB devices can be connected to the USB ports on this device. Due to the vast number of USB devices available on the market, B&R cannot guarantee that they will all work. B&R does ensure the performance of all USB devices that they provide.

6.1 Locally on the APC810

Many different peripheral USB devices can be connected to the 5 USB ports on this device. USB ports USB1, USB3 and USB5 can each handle a load of 1 A, and USB ports USB2 and USB4 can each handle a load of 500 mA. The maximum transfer rate is USB 2.0.



Figure 100: Local connection of USB peripheral devices on the APC810

6.2 Remote connection to Automation Panel 900 via DVI

Many different peripheral USB devices can be connected to the 2 or 3 USB ports on the Automation Panel 900. These can each handle a load of 500 mA. The maximum transfer rate is USB 2.0.

Information:

Only end devices (not hubs) can be connected to the Automation Panel 900.



Figure 101: Remote connection of USB peripheral devices on the APC900 via DVI

6.3 Remote connection to Automation Panel 800 / 900 via SDL

Many different peripheral USB devices can be connected to the 2 or 3 USB ports on Automation Panel 900 or the USB interfaces on Automation Panel 800 devices. These can each handle a load of 500 mA. The maximum transfer rate is USB 1.1.

Information:

Only end devices (no hubs) can be connected to the Automation Panel 800 / 900.



Figure 102: Remote connection of USB peripheral devices on the APC800/900 via SDL

7 Configuring a SATA RAID set

Information:

The following software description is valid for PCI SATA controllers 5ACPCI.RAIC-01, 5ACPCI.RAIC-03, 5ACPCI.RAIC-05 and 5ACPCI.RAIC-06.

The "RAID Configuration Utility" in BIOS must be started in order to make the necessary settings. After POST, pressing <Ctrl+S> or <F4> opens the RAID BIOS.

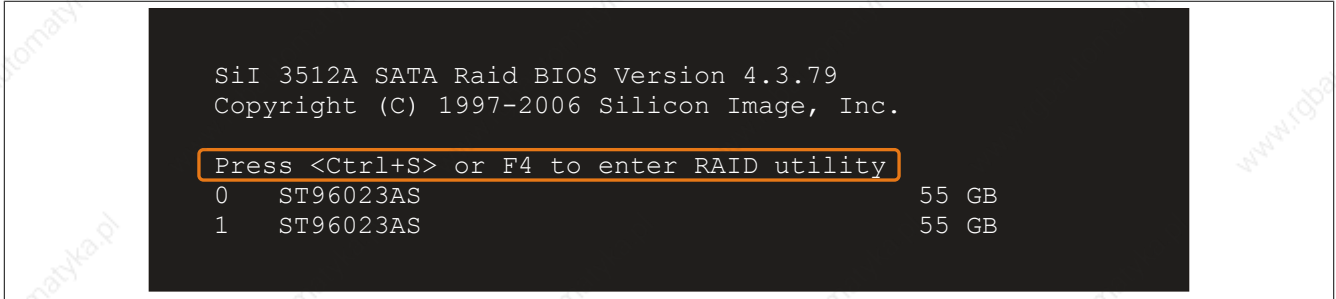

Figure 103: Open the RAID Configuration Utility

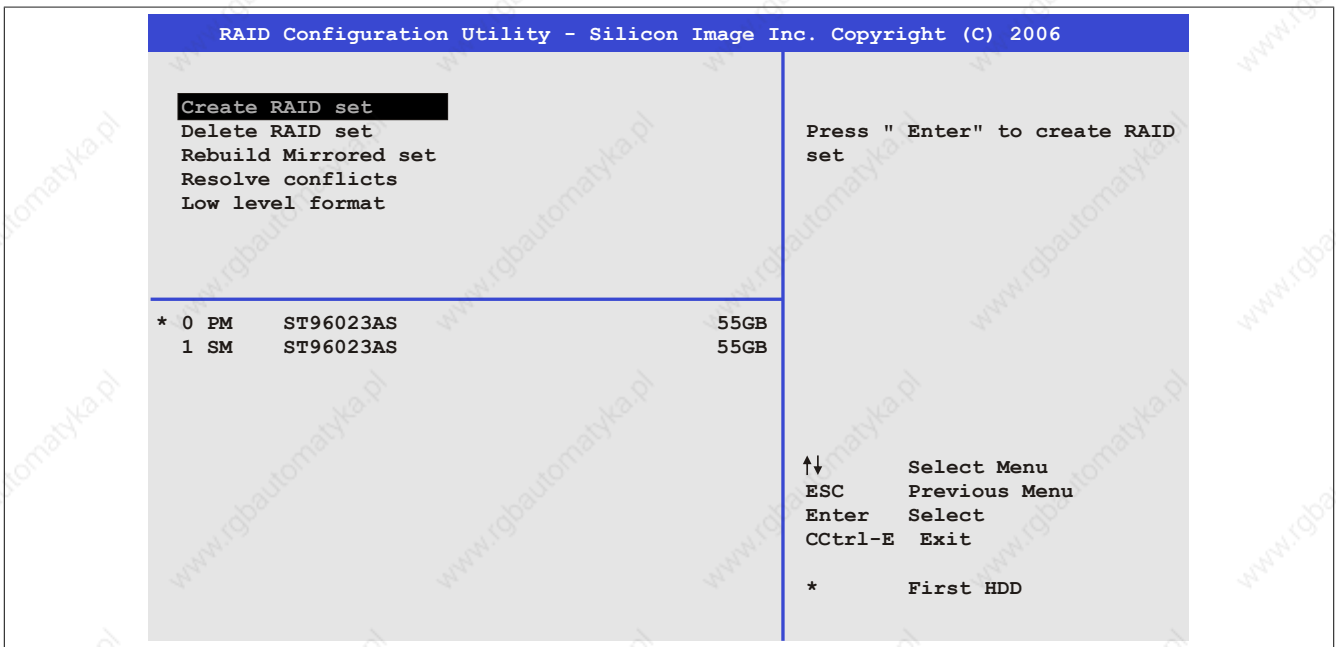

Figure 104: RAID Configuration Utility - Menu

The following keys can be used once inside BIOS Setup:

Key	Function
Cursor ↑	Moves to the previous item
Cursor ↓	Moves to the next item
Enter	Selects an item or opens a submenu
ESC	Returns to the previous menu
Ctrl+E	Saves any changed settings and exits setup

Table 185: BIOS-relevant keys in the RAID Configuration Utility

7.1 Create RAID set

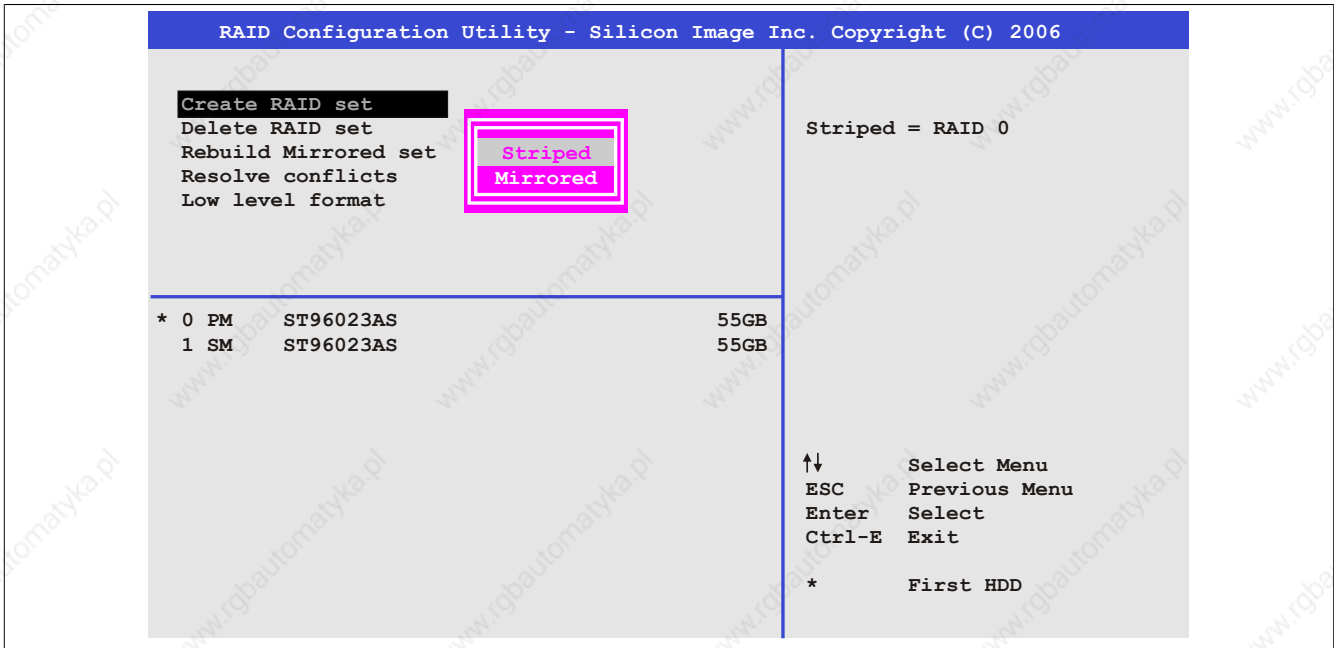

Figure 105: RAID Configuration Utility - Menu

The RAID system can be set up as "Striped" = RAID0 or "Mirrored" = RAID1 using the "Create RAID set" menu option.

7.2 Create RAID set - Striped

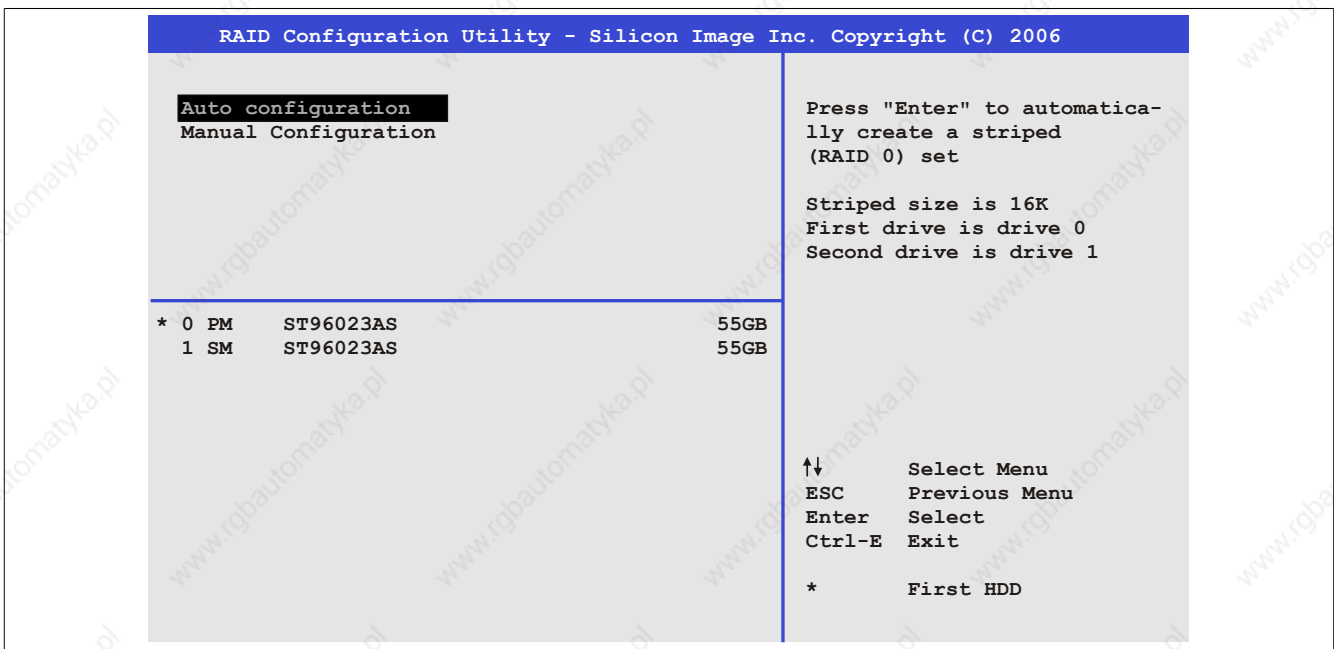

Figure 106: RAID Configuration Utility - Create RAID set - Striped

"Auto configuration"

Auto configuration optimizes all settings.

"Manual configuration"

Allows the first and second HDD to be specified as well as the "Chunk size" (= block size, application-dependent).

7.3 Create RAID set - Mirrored

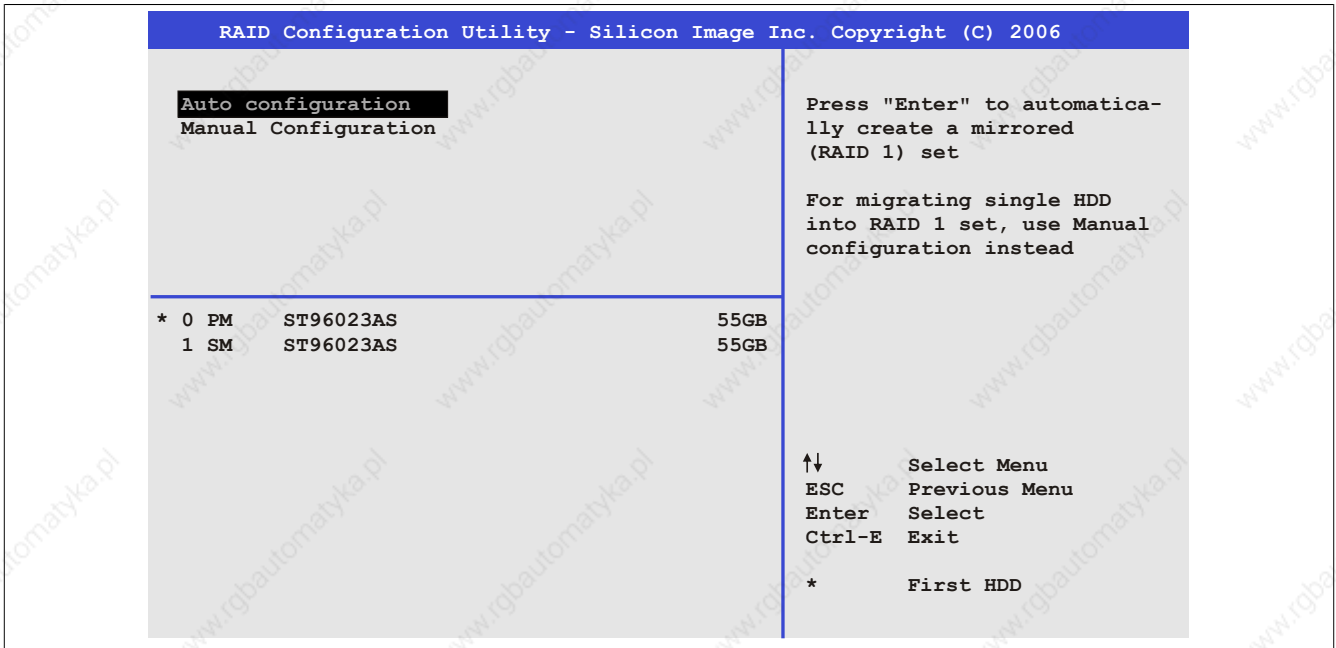

Figure 107: RAID Configuration Utility - Create RAID set - Mirrored

"Auto configuration"

Auto configuration optimizes all settings.

"Manual configuration"

Allows the "Source" and "Target" HDD to be specified as well as whether a rebuild (mirror) should be performed immediately (takes approx. 50 minutes).

7.4 Delete RAID set

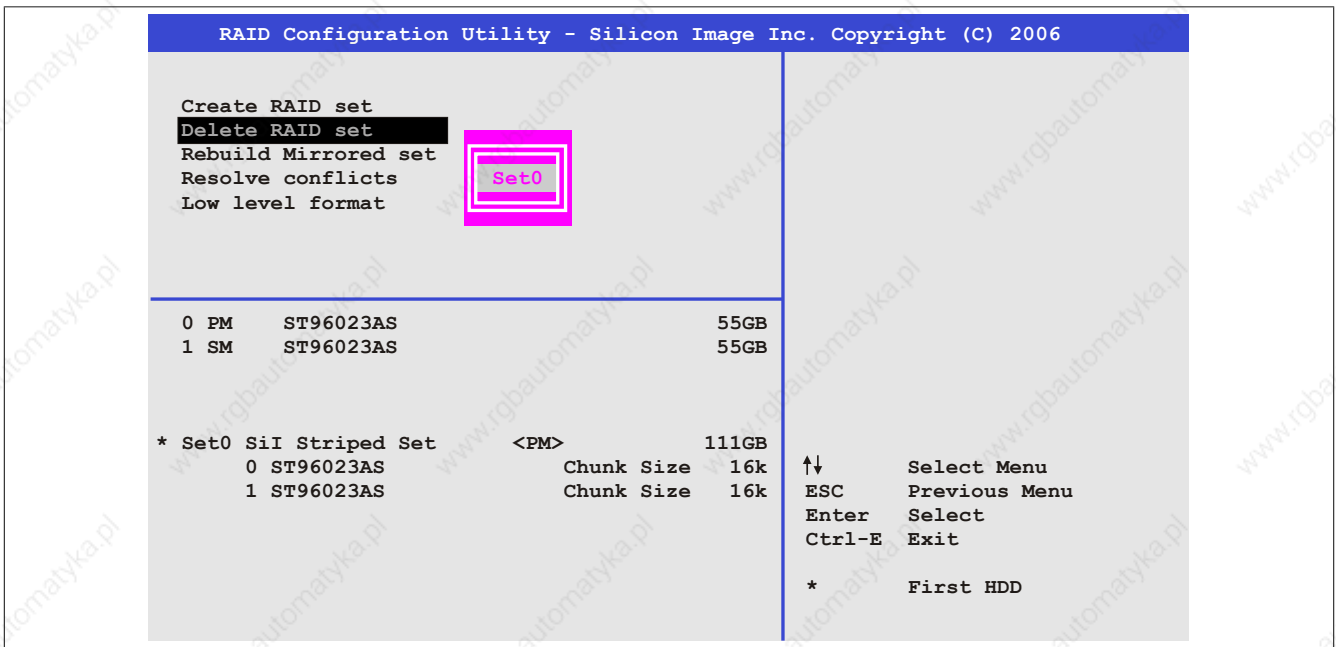

Figure 108: RAID Configuration Utility - Delete RAID set

An existing RAID set can be deleted using the "Delete RAID set" menu option.

7.5 Rebuild mirrored set

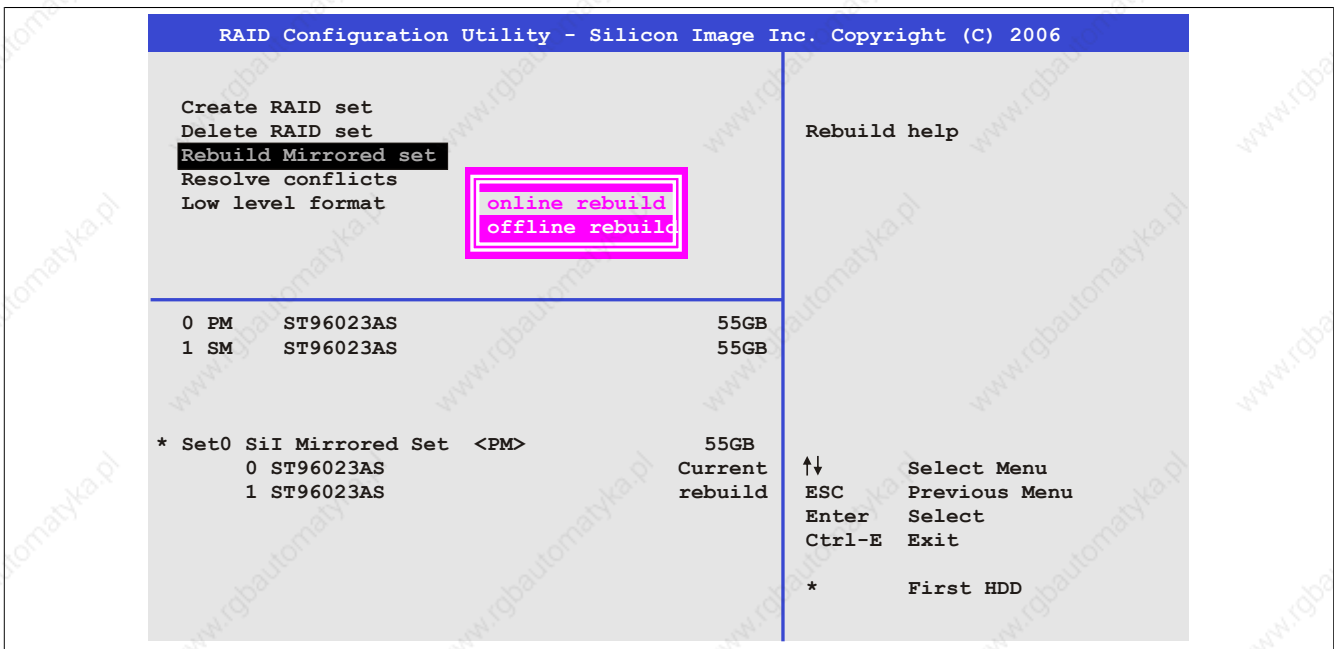

Figure 109: RAID Configuration Utility - Rebuild mirrored set

The "Rebuild mirrored set" menu option can be used to restart a rebuild procedure in a RAID 1 set if an error occurs, if a rebuild procedure was interrupted or if a hard disk was replaced.

If "Online rebuild" is selected, then the rebuild is executed during operation after the system is booted. The installed SATA RAID configuration program may display an event pop-up message: `SATA Raid detected a new event` before restarting the rebuild. The entire rebuild takes approximately 50 minutes.

If "Offline rebuild" is selected, then a rebuild is performed immediately before the operating system is started (duration depends on the respective memory size).

7.6 Resolve conflicts

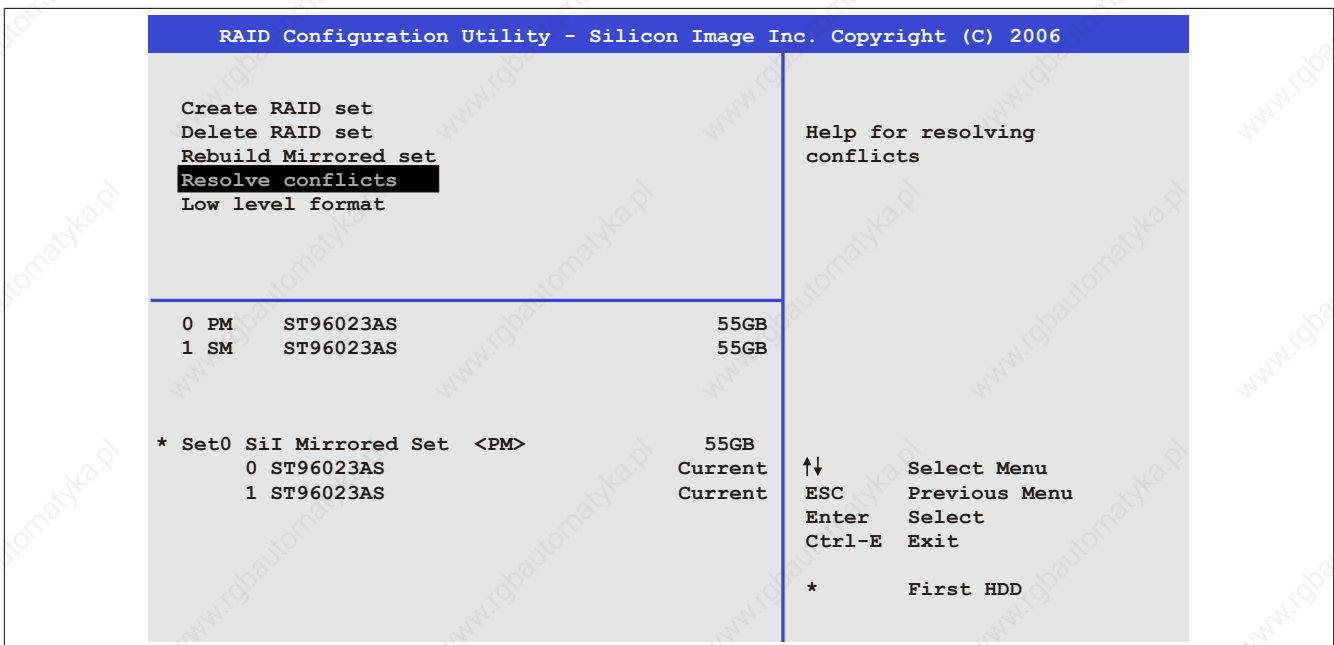

Figure 110: RAID Configuration Utility - Resolve conflicts

Conflicts in a RAID set can be resolved using the "Resolve conflicts" menu option. This function is only available if the status of the hard disk is "Conflict".

7.7 Low level format



Figure 111: RAID Configuration Utility - Low level format

Individual hard disks can be configured using the "Low level format" menu option. This can only be done if a RAID set is not configured. A low level format of a hard disk takes approx. 40 minutes.

8 Known problems / issues

The following points listed are known as of 07-May-08 in the first production lot of APC800 devices:

- The hardware security key interface is supported beginning with MTCX FPGA version 00.06 and higher.
- The status indicator of the Link or Activity LED for the ETH1 interface did not function correctly. However, this did not affect the network connection. The status indicator functions correctly beginning with hardware revisions 5PC810.SX92-00 (revision B0) and 5PC800.B945-0x (revision B0).
- It was sporadically possible that the ETH2 interface was not initialized during startup and would therefore not function. The problem could be corrected by a reset or warm restart (Ctrl+Alt+Del). This problem is corrected in MTCX FPGA version 00.03.
- First Boot Agent Windows XP embedded and built-in SATA HDD drive: The BIOS setting "Legacy IDE channels" under "Advanced - IDE configuration" must be set to "PATA only" before inserting a CompactFlash card with a Windows XP embedded image and executing the First Boot Agent. Alternatively, the SATA drive can be removed first.
- When using two graphic lines, the Windows XP graphics driver assigns the labels "Digital display" to the monitor/panel connector and "Digital display 2" to the AP Link connector. In "extended desktop" mode, the following behavior is observed: If the cable for the digital display device on the monitor/panel interface is disconnected, digital display 2 become the primary display automatically, with the graphics driver settings also switching over accordingly. The next time the system is rebooted, the image content is routed from the monitor/panel interface to the AP Link interface. If the "SDVO/DVI Hot plugging support" option is set to "Enabled" in BIOS (found under "Advanced - Graphics - Configuration"), then the image content is automatically routed from the disconnected monitor/panel interface to the second graphics line on the AP Link interface.
- Special features of "quick switching": If the APC810 is in standby mode, i.e. the Power LED is red (e.g. during Windows XP shutdown), then buffering takes a little more time due to the capacitors and lower power consumption. If the "Power loss control" option is set to "Power on" or "Last state" in BIOS, then the system might not restart because a power off/on was not detected. To make sure that these system units will restart after a power off/on, the cutoff time should be set to at least 10 seconds.
- With MTCX PX32 firmware \geq V00.11 and higher, the reset button is only triggered by edges. This means that the device boots even when the reset button is pressed. With MTCX PX32 firmware $<$ V00.11, the system does not start after pressing (ca. 10 seconds) and releasing the reset button.
- Hardware revision B0 of the 5AC801.DVDS-00 slide-in DVD-ROM does not offer SATA hot plugging functionality. Hot plugging is possible for other hardware revisions.
- Using two different types of CompactFlash cards can cause problems with Automation PCs and Panel PCs. For example, it is possible that one of the two cards is not detected during system startup. This is caused by different startup speeds. CompactFlash cards with older technology require significantly more time during system startup than CompactFlash cards with newer technology. This behavior occurs near the end of the time frame provided for startup. The problem described can occur because the startup time for the CompactFlash cards fluctuates due to the different components being used. Depending on the CompactFlash cards being used, this error may occur never, sometimes or always.
- During daisy chain operation of multiple AP800/AP900 devices via SDL, it is possible that the touch controller status shows a red "X" in the Control Center applet for the touch screen driver when the touch controller is detected. The functionality of the touch system is not affected by this. This can be avoided by setting a panel locking time of 50 ms. The panel locking time can be configured with the B&R Key Editor.

Chapter 4 • Software

1 BIOS options

Information:

The following diagrams, BIOS menu items and their descriptions refer to BIOS version 1.18. It is therefore possible that these diagrams and BIOS descriptions will not correspond with the BIOS version actually installed.

1.1 General information

BIOS is an acronym for "Basic Input/Output System". It is the most basic standardized interface between the user and the system (hardware). The BIOS system used in this B&R Industrial PC was developed by American Megatrends Inc.

The BIOS Setup utility can be used to modify basic system configuration settings. These settings are stored in CMOS and EEPROM memory (as a backup).

CMOS data is buffered by a battery (if present) and continues to remain stored on the B&R Industrial PC even when the power is turned off (no 24 VDC supply).

1.2 BIOS setup and boot procedure

BIOS is immediately activated when switching on the power supply or pressing the power button on the B&R Industrial PC. The system checks if the setup data from EEPROM memory is "OK". If the data is "OK", then it is transferred to CMOS. If the data is "Not OK", then the CMOS data is checked to see whether it is valid. An error message is output if the CMOS data contains errors, and the boot procedure can be continued by pressing <F1>. To prevent an error message from appearing at each restart, the BIOS Setup utility can be opened by pressing . The settings can then be re-saved.

BIOS reads the system configuration information, checks and configures the system with the Power-On Self-Test (POST).

When these "preliminaries" are finished, BIOS looks for an operating system on the available data storage devices (hard drive, floppy drive, etc.). BIOS then launches the operating system and hands over to it the control of system operations.

To enter BIOS Setup, the key must be pressed after the USB controller has been initialized as soon as the following message appears on the screen (during POST): "Press DEL to run SETUP".

```
AMIBIOS (C) 2003 American Megatrends, Inc.  
[APC2R118] Bernecker + Rainer Industrie-Elektronik H1.18  
Serial Number : 133453  
CPU : Intel(R) Core(TM)2 CPU          T7400 @ 2.16GHz  
Speed : 2.16 Ghz  
Press DEL to run Setup  
Press F11 for BIOS POPUP  
The MCH is operating with DDR2-677/CL5 in Dual-Channel Interleaved Mode  
Initializing USB Controllers .. Done  
2048MB OK  
USB Device(s): 1 Keyboard, 1 Hub  
Auto-Detecting Sec Master..IDE Hard Disk  
Auto-Detecting Sec Slave...IDE Hard Disk  
Sec Master: SILICONSYSTEMS INC 4GB 240-0230  
Sec Slave : SILICONSYSTEMS INC 4GB 240-0230  
Auto-Detecting USB Mass Storage Devices ..  
00 USB mass storage devices found an configured.
```

Figure 112: Boot screen

1.2.1 BIOS Setup keys

The following keys are enabled during POST:

Information:

Key signals from USB keyboards will only be registered after the USB controller has been initialized.

Keys	Function
Del	Opens the main BIOS Setup screen
F12	Network boot
F11	Opens the boot menu. This lists all bootable devices that are connected to the system. Selecting a device with cursor ↑, cursor ↓ and the pressing <ENTER> will boot from that device.
	
<Pause>	Pauses POST. Pressing any other key resumes POST.

Table 186: BIOS-relevant keys for POST

The following keys can be used once inside BIOS Setup:

Key	Function
F1	Opens general help information
Cursor ↑	Moves to the previous item
Cursor ↓	Moves to the next item
Cursor ←	Moves to the previous item
Cursor →	Moves to the next item
+/-	Changes the setting for the selected function
Enter	Changes to the selected screen
Page ↑	Changes to the previous page
Page ↓	Changes to the next page
Pos 1	Jumps to the first BIOS menu item or object
End	Jumps to the last BIOS menu item or object
F2 / F3	Changes the colors of BIOS Setup
F7	Resets any changes
F9	Loads and configures CMOS default values for all BIOS settings
F10	Saves and exits
ESC	Exits a submenu

Table 187: BIOS-relevant keys

1.3 Main

The main BIOS Setup screen appears immediately after the button is pressed during startup.

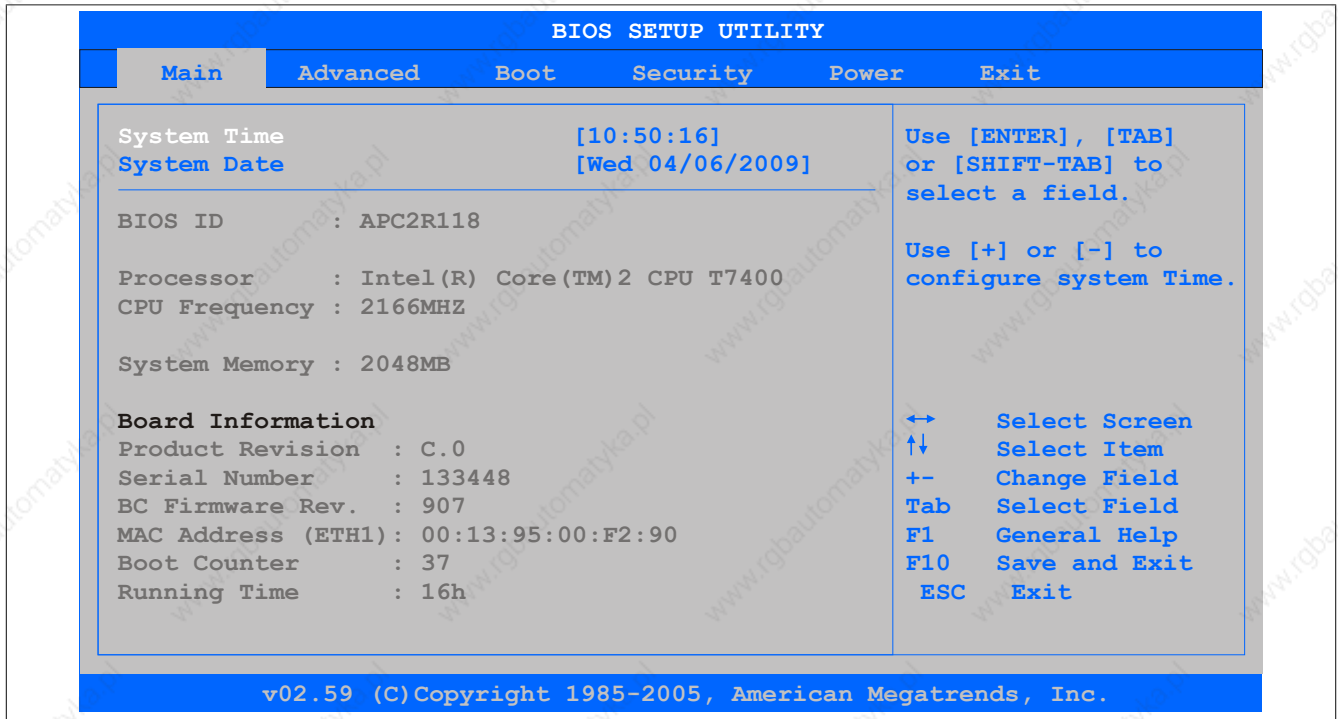

Figure 113: 945GME BIOS Main menu

BIOS setting	Function	Configuration options	Effect
System time	The currently configured system time setting. This is buffered by the CMOS battery when the system is switched off.	Changes the system time	Sets the system time in the format Hour:Minute:Second (hh:mm:ss)
System date	The currently configured system date. This is buffered by the CMOS battery when the system is switched off.	Changes the system date	Sets the system date in the format Month:Day:Year (mm:dd:yyyy)
BIOS ID	Displays the BIOS version	None	-
Processor	Displays the processor type	None	-
CPU frequency	Displays the processor frequency	None	-
System memory	Displays the system memory size	None	-
Product revision	Displays the hardware revision of the CPU board	None	-
Serial number	Displays the serial number of the CPU board	None	-
BC firmware rev.	Displays the firmware revision of the CPU board controller	None	-
MAC address (ETH1)	Displays the assigned MAC address for the ETH1 interface	None	-
Boot counter	Displays the boot counter; each restart increases the counter by one (max. 16777215)	None	-
Running time	Displays the runtime in hours (max. 65535)	None	-

Table 188: 945GME Main menu - Configuration options

1.4 Advanced

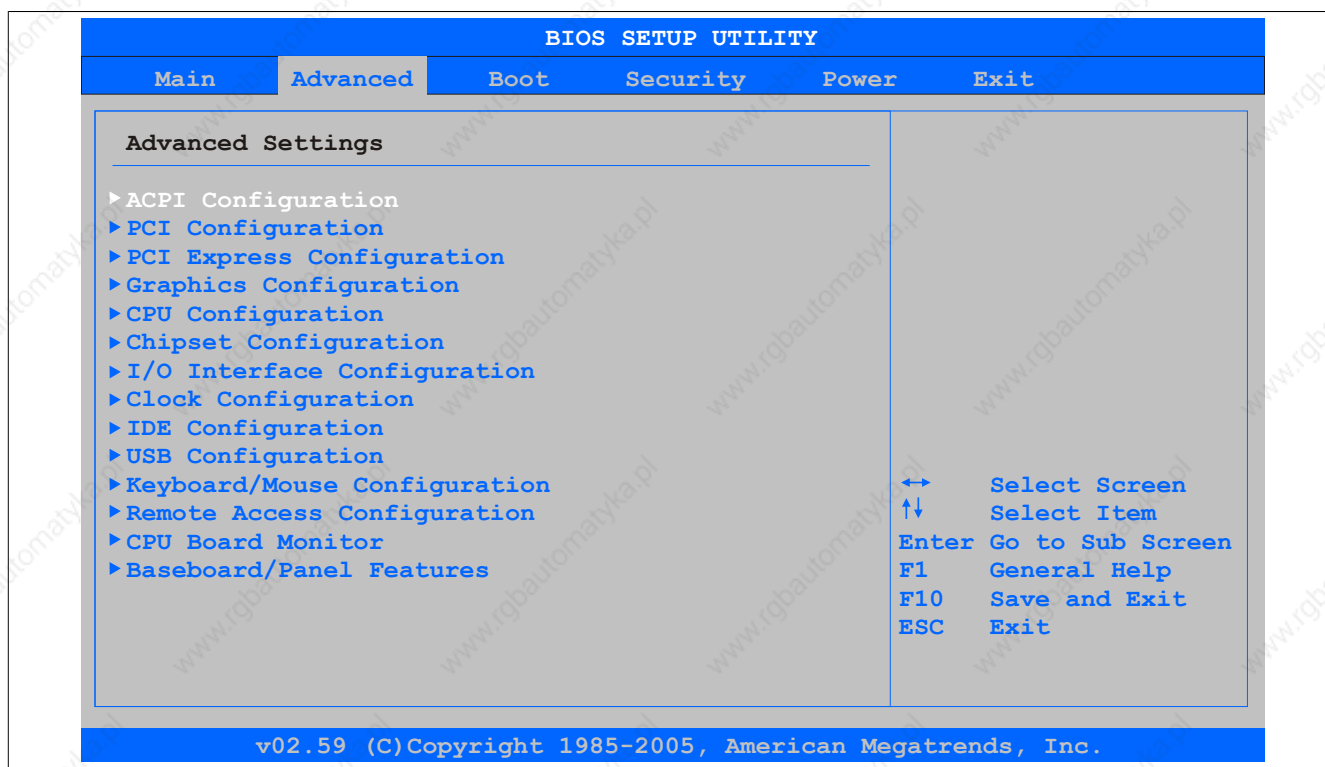

Figure 114: 945GME Advanced menu

BIOS setting	Function	Configuration options	Effect
ACPI configuration	Configures ACPI devices	Enter	Opens the submenu See "ACPI configuration" on page 233
PCI configuration	Configures PCI devices	Enter	Opens the submenu See "PCI configuration" on page 234
PCI Express configuration	Configures PCI Express settings	Enter	Opens the submenu See "PCI Express configuration" on page 237
Graphics configuration	Configures graphics settings	Enter	Opens the submenu See "Graphics configuration" on page 239
CPU configuration	Configures CPU settings	Enter	Opens the submenu See "CPU configuration" on page 241
Chipset configuration	Configures chipset settings	Enter	Opens the submenu See "Chipset settings" on page 242
I/O interface configuration	Configures I/O device settings	Enter	Opens the submenu See "I/O interface configuration" on page 243
Clock configuration	Configures clock settings	Enter	Opens the submenu See "Clock configuration" on page 243
IDE configuration	Configures IDE functions	Enter	Opens the submenu See "IDE configuration" on page 244
USB configuration	Configures USB settings	Enter	Opens the submenu See "USB configuration" on page 249
Keyboard/Mouse configuration	Configures keyboard/mouse settings	Enter	Opens the submenu See "Keyboard/Mouse configuration" on page 250
Remote access configuration	Configures remote access settings	Enter	Opens the submenu See "Remote access configuration" on page 251
CPU board monitor	Displays the current voltages and temperature of the processor in use	Enter	Opens the submenu See "CPU board monitor" on page 253
Baseboard/Panel features	Displays and configures device-specific settings	Enter	Opens the submenu See "Baseboard/Panel features" on page 254

Table 189: 945GME Advanced menu - Configuration options

1.4.1 ACPI configuration

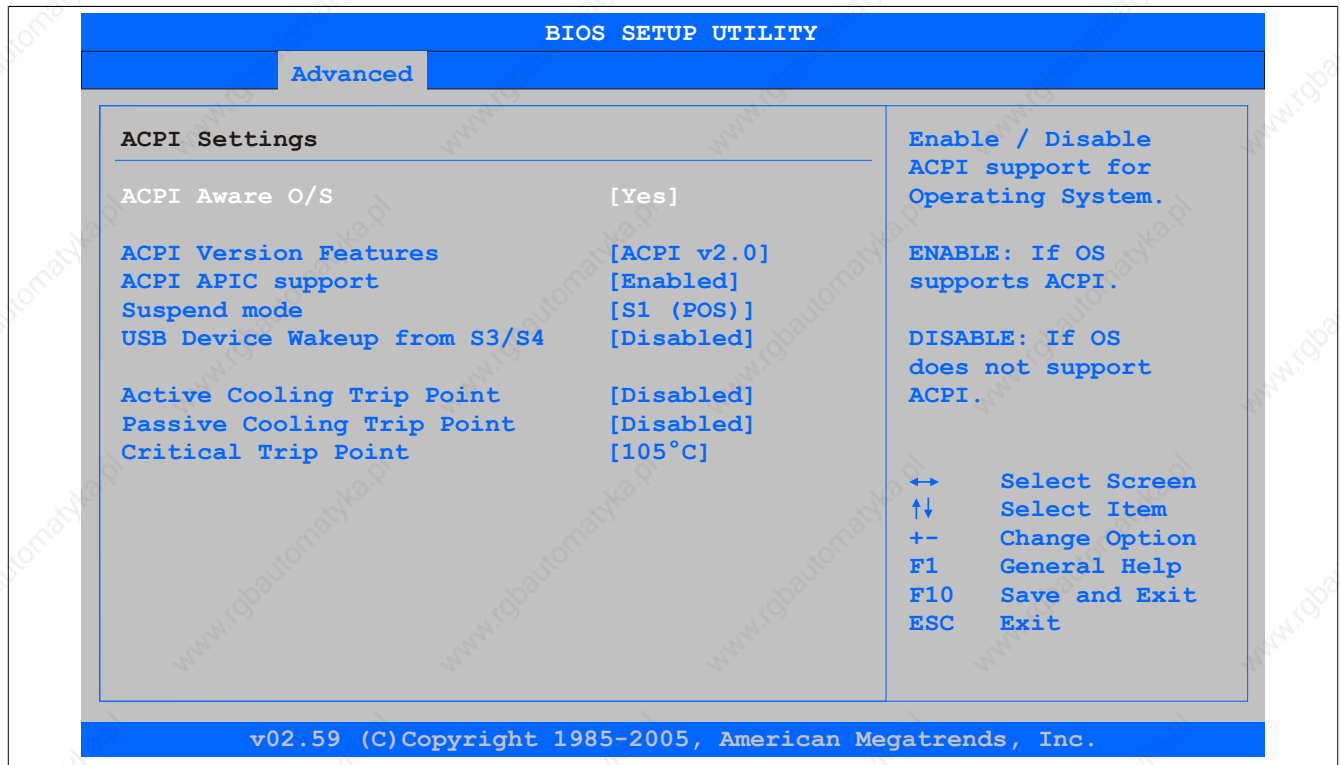

Figure 115: 945GME Advanced - ACPI configuration

BIOS setting	Function	Configuration options	Effect
ACPI aware O/S	This function determines if the operating system supports the ACPI function (Advanced Configuration and Power Interface).	Yes	The operating system supports ACPI.
		No	The operating system does not support ACPI.
ACPI version features	Option for setting the power option specifications to be supported. The ACPI functions must be supported by the drivers and operating systems being used.	ACPI v1.0	Uses ACPI functions in accordance with v1.0
		ACPI v2.0	Uses ACPI functions in accordance with v2.0
		ACPI v3.0	Uses ACPI functions in accordance with v3.0
ACPI APIC support	This option controls the support of the advanced programmable interrupt controller in the processor.	Enabled	Enables this function
		Disabled	Disables the function
Suspend mode	Selects the ACPI status to be used when Suspend mode is enabled	S1 (POS)	Sets S1 as Suspend mode. Only a few functions are disabled and are available again at the touch of a button
		S3 (STR)	Sets S3 as Suspend mode. The current state of the operating system is written to RAM, which is then the only component to receive power.
USB device wakeup from S3/S4	This options makes it possible for activity on a connected USB device to wake the system up from the S3/S4 standby mode.	Enabled	Enables this function
		Disabled	Disables this function
Active cooling trip point	This function can be used to switch on an optional CPU fan via the operating system when the CPU reaches the set temperature.	Disabled	Disables this function
		50°C, 60°C, 70°C, 80°C, 90°C	Temperature setting for the active cooling trip point. Configurable in increments of 10 degrees.
Passive cooling trip point	This function can be used to set a CPU temperature at which the operating system reduces the CPU speed.	Disabled	Disables this function
		50°C, 60°C, 70°C, 80°C, 90°C	Temperature setting for the passive cooling trip point. Configurable in increments of 10 degrees.
Critical trip point	Option for configuring a CPU temperature at which the operating system automatically shuts down	80°C, 85°C, 90°C, 95°C, 100°C, 105°C, 110°C	Temperature setting for the critical trip point. Configurable in increments of 5 degrees.

Table 190: 945GME Advanced - ACPI configuration - Configuration options

1.4.2 PCI configuration

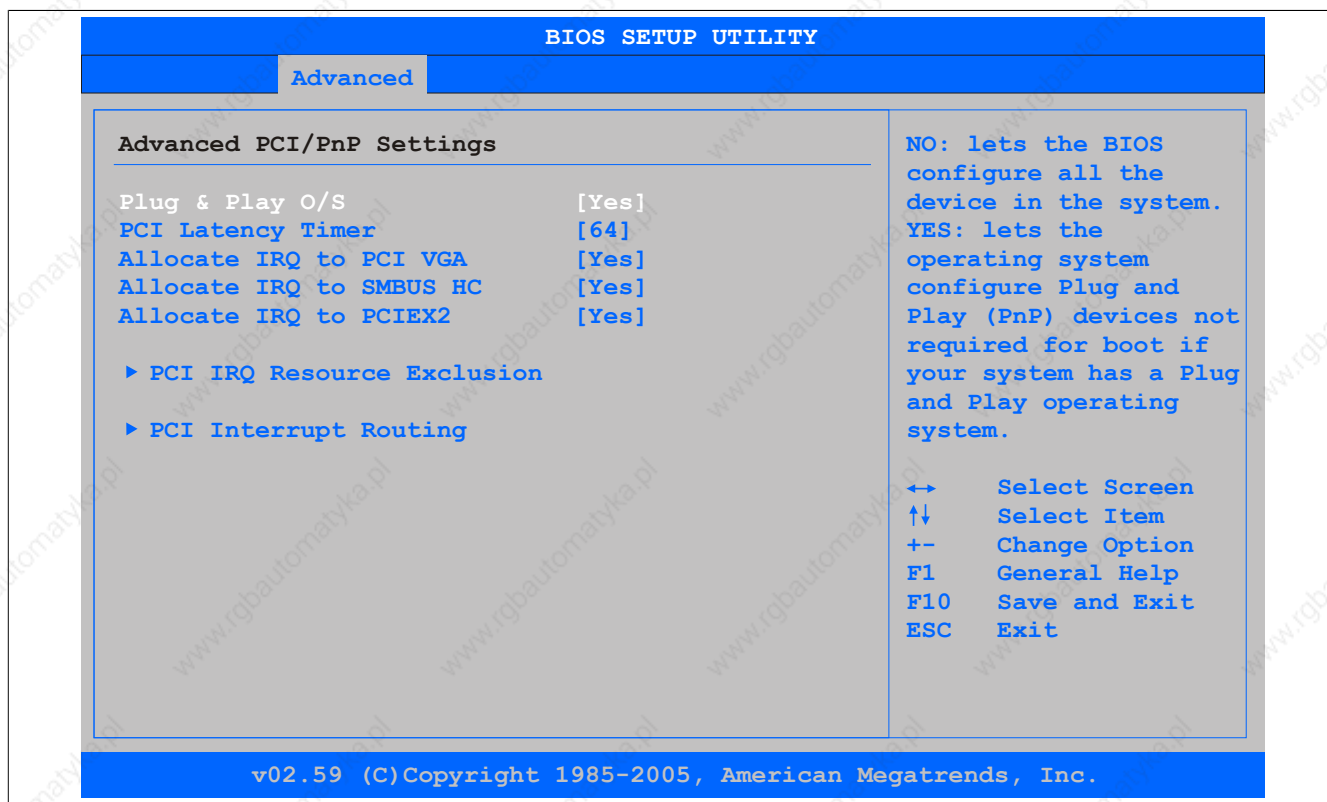

Figure 116: 945GME Advanced - PCI configuration

BIOS setting	Function	Configuration options	Effect
Plug & Play O/S	Informs BIOS if the operating system is capable of handling plug and play	Yes	Resource allocation handled by the operating system
		No	Resource allocation handled by BIOS
PCI latency timer	Option for controlling how long (in PCI ticks) one PCI bus card can continue to use the master after another PCI card has requested access	32, 64, 96, 128, 160, 192, 224, 248	Manually sets the value in PCI ticks
Allocate IRQ to PCI VGA	This function is used to determine if an interrupt is assigned to the PCI VGA.	Yes	Interrupt assigned automatically
		No	Interrupt not assigned
Allocate IRQ to SMBUS HC	This function is used to set whether the SM (system management) bus controller is assigned a PCI interrupt.	Yes	PCI interrupt assigned automatically
		No	Interrupt not assigned
Allocate IRQ to PCIEX2	This function is used to whether the PCIEX2 is assigned a PCI interrupt	Yes	PCI interrupt assigned automatically
		No	Interrupt not assigned
PCI IRQ resource exclusion	Configures the PCI IRQ resource settings for ISA Legacy devices	Enter	Opens the submenu See "PCI IRQ resource exclusion" on page 235
PCI interrupt routing	Configures PCI interrupt routing	Enter	Opens the submenu See "PCI interrupt routing" on page 236

Table 191: 945GME Advanced - PCI configuration - Configuration options

1.4.2.1 PCI IRQ resource exclusion

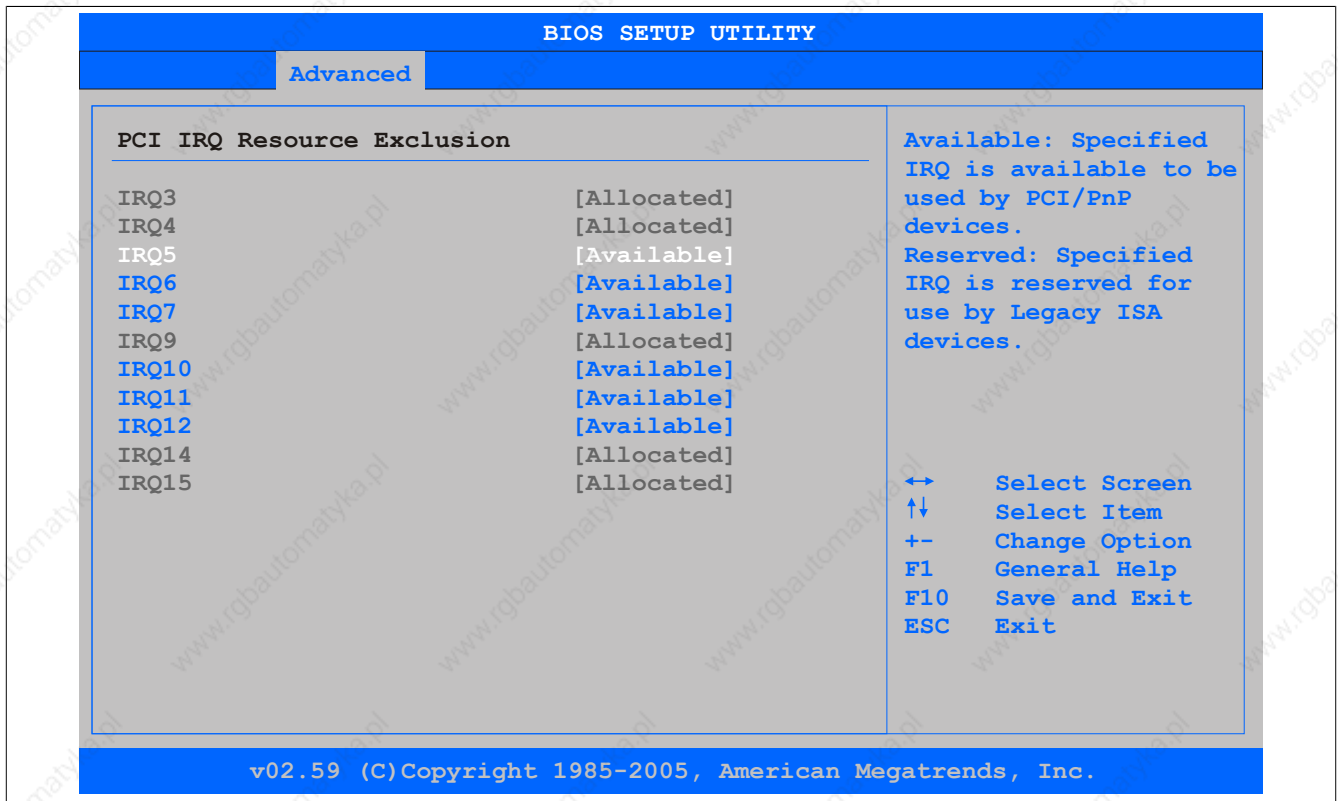

Figure 117: 945GME Advanced - PCI IRQ resource exclusion

BIOS setting	Function	Configuration options	Effect
IRQx	IRQ interrupt routing for Legacy ISA devices	Allocated	Allocated by the system - cannot be used
		Available	Available - can be used
		Reserved	Reserved - cannot be used

Table 192: 945GME Advanced - PCI IRQ resource exclusion - Configuration options

1.4.2.2 PCI interrupt routing

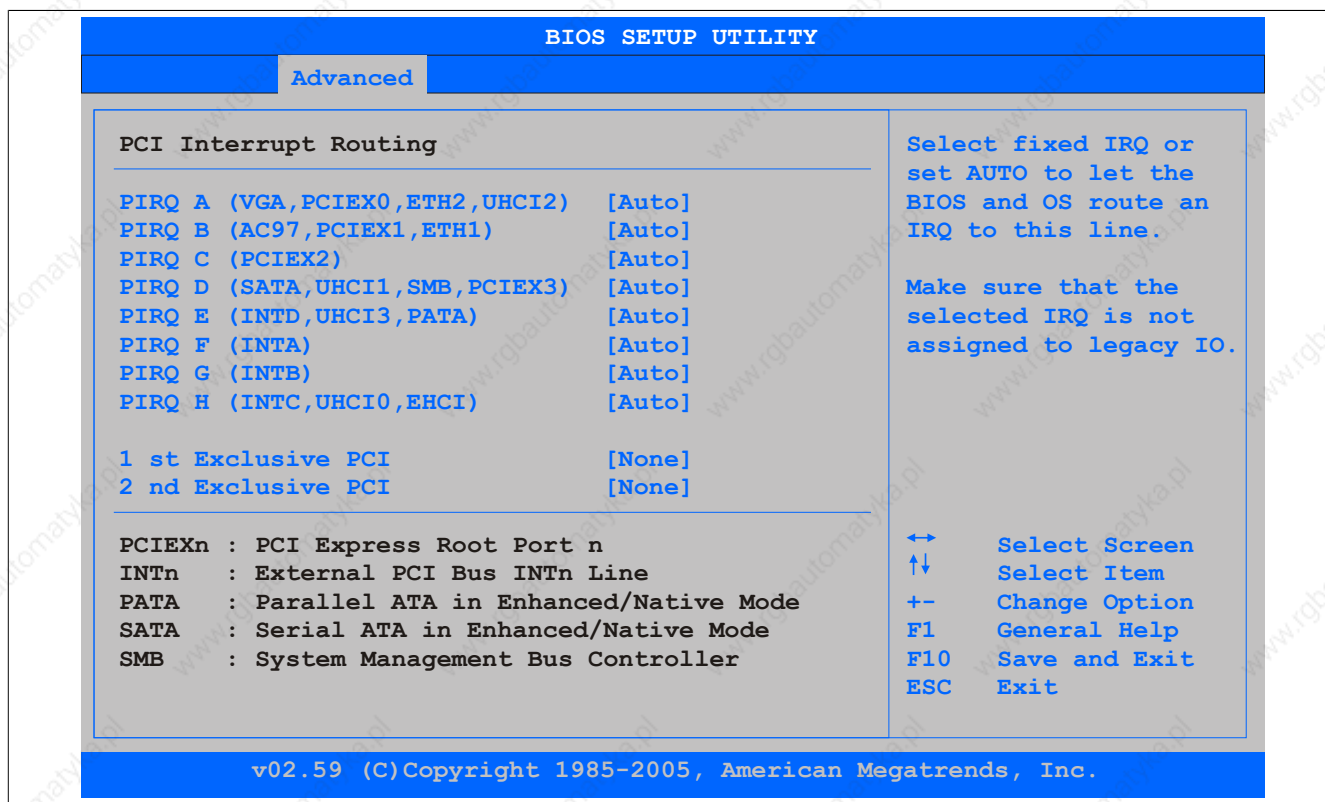

Figure 118: 945GME Advanced - PCI interrupt routing

BIOS setting	Function	Configuration options	Effect
PIRQ A (VGA, PCIEX0, ETH2, UHCI2)	Option for configuring PIRQ A	Auto	Automatic assignment by BIOS and the operating system
		5,6,7,9,10,11,12	Manual assignment
PIRQ B (AC97, PCIEX1, ETH1)	Option for configuring PIRQ B	Auto	Automatic assignment by BIOS and the operating system
		5,6,7,9,10,11,12	Manual assignment
PIRQ C (PCIEX2)	Option for configuring PIRQ C	Auto	Automatic assignment by BIOS and the operating system
		5,6,7,9,10,11,12	Manual assignment
PIRQ D (SATA, UHCI1, SMB, PCIEX3)	Option for configuring PIRQ D	Auto	Automatic assignment by BIOS and the operating system
		5,6,7,9,10,11,12	Manual assignment
PIRQ E (INTD, UHCI3, PATA)	Option for configuring PIRQ E	Auto	Automatic assignment by BIOS and the operating system
		5,6,7,9,10,11,12	Manual assignment
PIRQ F (INTA)	Option for configuring PIRQ F	Auto	Automatic assignment by BIOS and the operating system
		5,6,7,9,10,11,12	Manual assignment
PIRQ G (INTB)	Option for configuring PIRQ G	Auto	Automatic assignment by BIOS and the operating system
		5,6,7,9,10,11,12	Manual assignment
PIRQ H (INTC, UHCI0, EHCI)	Option for configuring PIRQ H	Auto	Automatic assignment by BIOS and the operating system
		5,6,7,9,10,11,12	Manual assignment
1st exclusive PCI	This option is used to determine if the IRQ listed under PIRQ x is handled exclusively (no IRQ sharing). Information: This is only displayed if a PIRQ is configured manually (e.g. 5).	None x	No interrupt assigned Assigns the PIRQ as the 1st exclusive PCI IRQ

Table 193: 945GME Advanced - PCI interrupt routing - Configuration options

BIOS setting	Function	Configuration options	Effect
2nd Exclusive PCI	<p>This option is used to determine if the IRQ listed under PIRQ x is handled exclusively (no IRQ sharing).</p> <p>Information:</p> <p>This is only displayed if two PIRQs are configured manually.</p>	<p>None</p> <p>x</p>	<p>No interrupt assigned</p> <p>Assigns the PIRQ as the 2nd exclusive PCI IRQ.</p>

Table 193: 945GME Advanced - PCI interrupt routing - Configuration options

1.4.3 PCI Express configuration

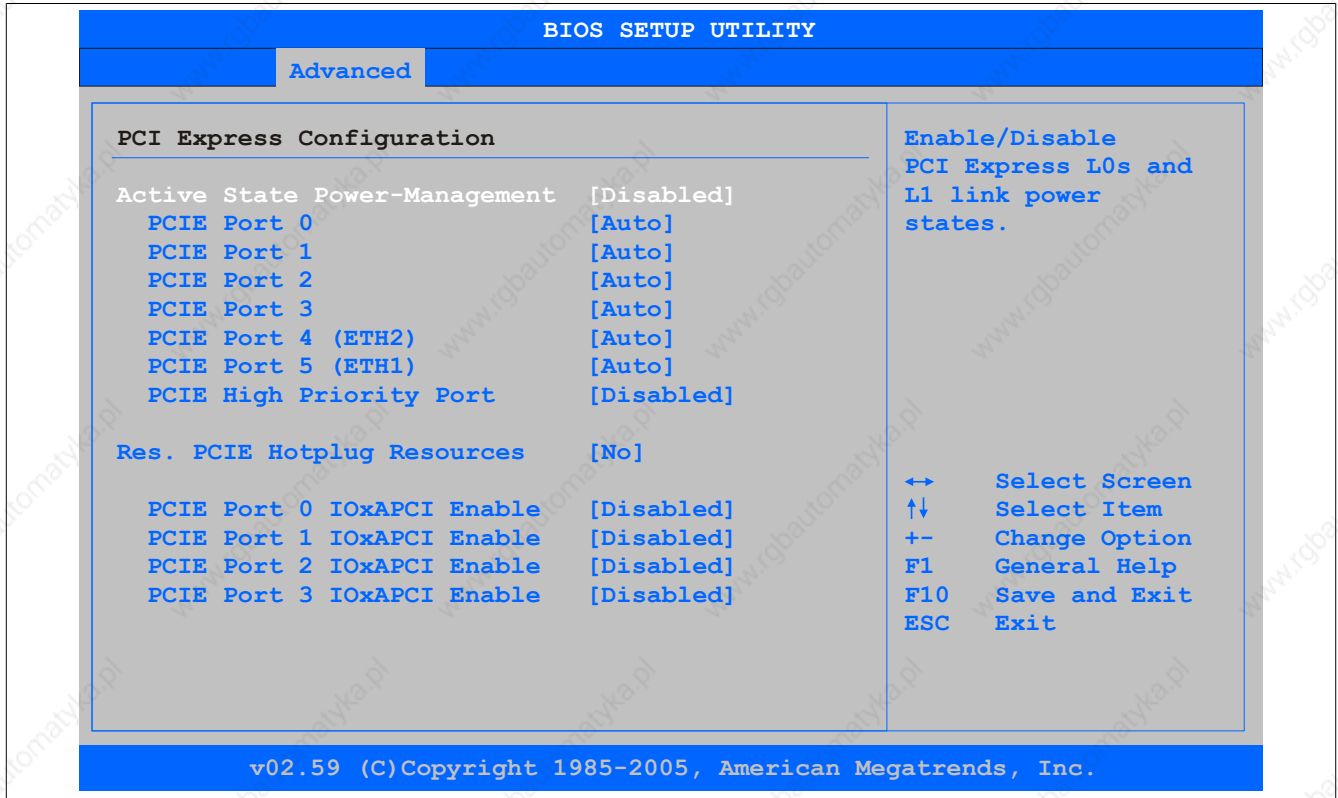

Figure 119: 945GME Advanced - PCI Express configuration

BIOS setting	Function	Configuration options	Effect
Active state power management	Option for configuring a power saving function (L0s/L1) for PCIe slots if they do not require full power	Enabled	Enables this function
		Disabled	Disables this function
PCIE port 0	<p>This option enables or disables the PCI Express interface function.</p> <p>Information:</p> <p>If no PCI Express devices are being used, this option should be disabled.</p>	Auto	Automatic assignment by BIOS and the operating system
		Enabled	Enables this function
		Disabled	Disables this function
PCIE port 1	<p>This option enables or disables the PCI Express interface function.</p> <p>Information:</p> <p>If no PCI Express devices are being used, this option should be disabled.</p>	Auto	Automatic assignment by BIOS and the operating system
		Enabled	Enables this function
		Disabled	Disables this function
PCIE port 2	<p>This option enables or disables the PCI Express interface function.</p> <p>Information:</p> <p>If no PCI Express devices are being used, this option should be disabled.</p>	Auto	Automatic assignment by BIOS and the operating system
		Enabled	Enables this function
		Disabled	Disables this function
PCIE port 3	This option enables or disables the PCI Express interface function.	Auto	Automatic assignment by BIOS and the operating system

Table 194: 945GME Advanced - PCI Express configuration - Configuration options

BIOS setting	Function	Configuration options	Effect
	Information: If no PCI Express devices are being used, this option should be disabled.	Enabled	Enables this function
		Disabled	Disables this function
PCIE Port 4 (ETH2)	This option enables or disables the PCI Express interface function. Information: If no PCI Express devices are being used, this option should be disabled.	Auto	Automatic assignment by BIOS and the operating system
		Enabled	Enables this function
		Disabled	Disables this function
PCIE Port 5 (ETH1)	This option enables or disables the PCI Express interface function. Information: If no PCI Express devices are being used, this option should be disabled.	Auto	Automatic assignment by BIOS and the operating system
		Enabled	Enables this function
		Disabled	Disables this function
PCIE high priority port	This option enables or disables the priority port for PCIE.	Disabled	Disables this function
		Port 0	Enables port 0 as the priority port
		Port 1	Enables port 1 as the priority port
		Port 2	Enables port 2 as the priority port
		Port 3	Enables port 3 as the priority port
		ETH2	Enables ETH2 as the priority port
Res. PCIE hot plugging resource	This option is used to reserve an I/O and memory resource for an unused PCIE port. A PCIE port must be set to "Enabled" and resources must be reserved in order for ExpressCard hot-plugging to be supported on the respective port.	Yes	Resource reserved
		No	Resource not reserved
PCIE port 0 IOxAPCI enable	This option enables or disables the APIC (Advanced Programmable Interrupt Controller) on PCIE port 0. The IRQ resources available to the system are expanded when APIC mode is enabled.	Enabled	Enables this function
		Disabled	Disables this function
PCIE port 1 IOxAPCI enable	This option enables or disables the APIC (Advanced Programmable Interrupt Controller) on PCIE port 1. The IRQ resources available to the system are expanded when APIC mode is enabled.	Enabled	Enables this function
		Disabled	Disables this function
PCIE port 2 IOxAPCI enable	This option enables or disables the APIC (Advanced Programmable Interrupt Controller) on PCIE port 2. The IRQ resources available to the system are expanded when APIC mode is enabled.	Enabled	Enables this function
		Disabled	Disables this function
PCIE port 3 IOxAPCI enable	This option enables or disables the APIC (Advanced Programmable Interrupt Controller) on PCIE port 3. The IRQ resources available to the system are expanded when APIC mode is enabled.	Enabled	Enables this function
		Disabled	Disables this function

Table 194: 945GME Advanced - PCI Express configuration - Configuration options

1.4.4 Graphics configuration

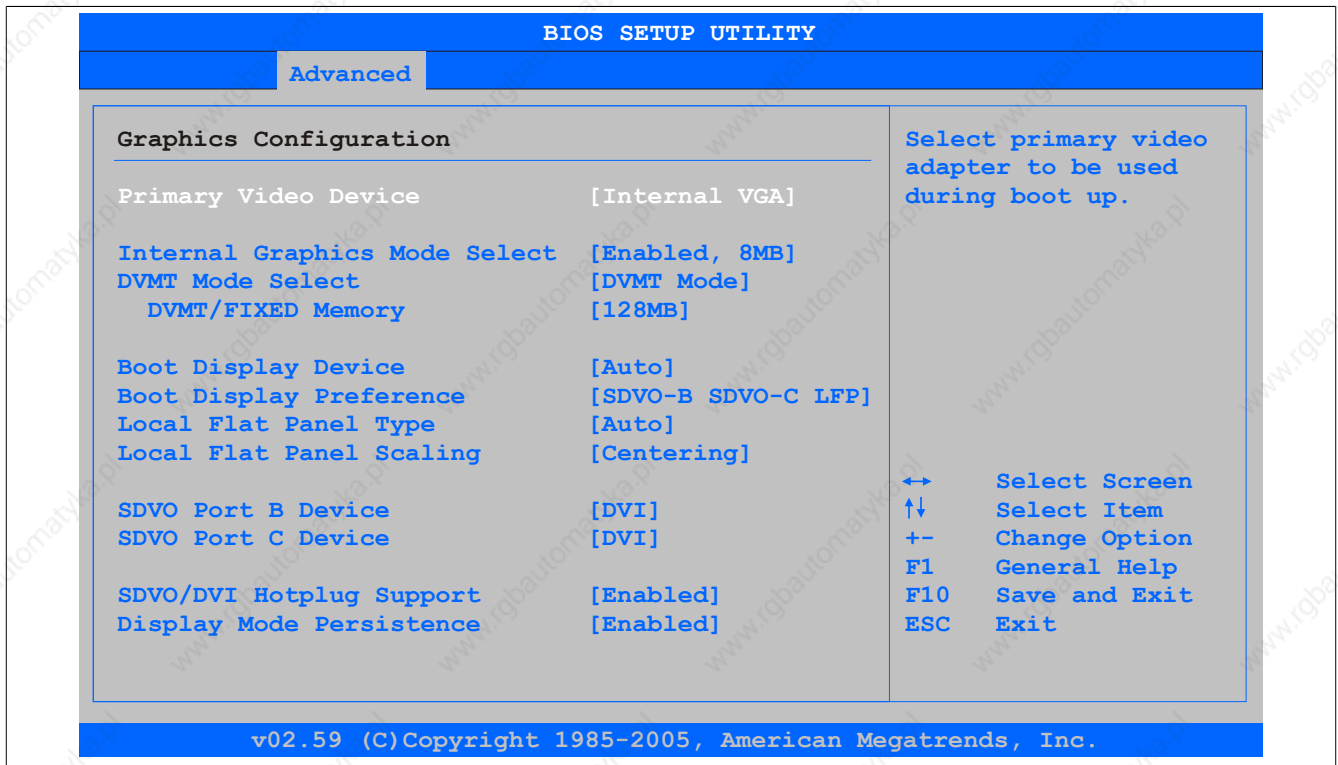

Figure 120: 945GME Advanced - Graphics configuration

BIOS setting	Function	Configuration options	Effect
Primary video device	Option for selecting the primary display device	Internal VGA	Uses the internal graphics chip on the CPU board as the video device (monitor/panel interface)
		PCI / Int. VGA	Uses the graphics chip of a connected graphics card as the display device
Internal graphics mode select	Option for setting the amount of memory used for the internal graphics controller	Disabled	Nothing reserved, disables the graphics controller
		Enabled, 1MB	Provides 1 MB main memory
		Enabled, 8MB	Provides 8 MB main memory
DVMT mode select	Option for determining the DVMT mode (Dynamic Video Memory Technology) of the DVMT graphics driver	Fixed mode	Allocates a fixed amount of memory to the graphics chip, which is then no longer available to the PC
		DVMT mode	Memory consumption controlled dynamically by the DVMT graphics driver. Only the amount of memory that is required is reserved.
		Combo mode	At least 64 MB reserved by the DVMT graphics driver (up to 224 MB possible)
DVMT/FIXED memory	Option for setting the amount of memory used for DVMT mode	64 MB	Allows 64 MB of main memory to be used
		128 MB	Allows 128 MB of main memory to be used
		Maximum DVMT	Allows the remaining available main memory to be used
Boot display device	Determines which video channel should be enabled for a display device during booting	Auto	Automatic selection
		CRT only	Uses only the CRT (Cathode Ray Tube) channel
		SDVO only	Uses only the SDVO (Serial Digital Video Out) channel
		CRT + SDVO	Uses the CRT and SDVO channel
		LFP only	Uses only the LFP (Local Flat Panel) channel
Boot display preference	This option determines the order in which the devices on the connected LFP and SDVO channels should be checked and booted.	LFP SDVO-B SDVO-C	Local Flat Panel - Serial Digital Video B output - Serial Video C output
		LFP SDVO-C SDVO-B	Local Flat Panel - Serial Digital Video C output - Serial Video B output
		SDVO-B SDVO-C LFP	Serial Digital Video B output - Serial Digital Video C output - Local Flat Panel
		SDVO-C SDVO-B LFP	Serial Digital Video C output - Serial Digital Video B output - Local Flat Panel
Local flat panel type	This option can be used to set a predefined profile for the LVDS channel.	Auto	Automatic detection and configuration using the EDID data

Table 195: 945GME Advanced - Graphics configuration - Configuration options

BIOS setting	Function	Configuration options	Effect
		VGA 1x18 (002h)	640 x 480
		VGA 1x18 (013h)	640 x 480
		SVGA 1x18 (004h)	800 x 600
		XGA 1x18 (006h)	1024 x 768
		XGA 2x18 (007h)	1024 x 768
		XGA 1x24 (008h)	1024 x 768
		XGA 2x24 (012h)	1024 x 768
		SXGA 2x24 (00Ah)	1280 x 1024
		SXGA 2x24 (018h)	1280 x 1024
		UXGA 2x24 (00Ch)	1600 x 1200
		Customized EDID 1	User-defined profile
		Customized EDID 2	User-defined profile
		Customized EDID 3	User-defined profile
Local flat panel scaling	Determines the screen content should be output depending on the configured local flat panel type	Centering	Centers the screen contents on the display
		Expand text	Expands text across the entire display
		Expand graphics	Expands graphics across the entire display
		Expand text & graphics	Expands text and graphics across the entire display
SDVO port B device	Option for selecting the display device that is connected to SDVO Port B	None	No display device connected
		DVI	Optimizes video signal output for a DVI-compatible display device
		TV	Optimizes video signal output for a TV-compatible display device
		CRT	Optimizes video signal output for a CRT-compatible display device
		LVDS	Optimizes video signal output for a LVDS-compatible display device
		DVI-analog	Optimizes video signal output for an analog DVI-compatible display device
SDVO port C device	Option for selecting the display device that is connected to SDVO Port A	None	No display device connected
		DVI	Optimizes video signal output for a DVI-compatible display device
		TV	Optimizes video signal output for a TV-compatible display device
		CRT	Optimizes video signal output for a CRT-compatible display device
		LVDS	Optimizes video signal output for a LVDS-compatible display device
		DVI-analog	Optimizes video signal output for an analog DVI-compatible display device
SDVO/DVI hot plugging support	If this option is set to enabled, the Windows XP graphics driver supports "hot plugging" and "configuration mode persistence" for DVI monitors connected to a DVI SDVO transmitter. "Hot plugging" support means that a DVI monitor is detected automatically and enabled if connected while the operating system is running. "Configuration mode persistence" means that a dual DVI configuration, for example, is automatically restored when both DVI monitors are reconnected, even if only one of them was connected and enabled during a previous boot.	Enabled	Enables "Hot plugging" and "Configuration mode persistence" mode
		Disabled	Disables "Hot plugging" and "Configuration mode persistence" mode
Display mode persistence	"Display mode persistence" means that the operating system can remember and restore past display configurations. For example, a dual DVI configuration is automatically restored when both DVI monitors are reconnected, even if only one of them was connected and enabled during a previous boot.	Enabled	Enables this function
		Disabled	Disables this function

Table 195: 945GME Advanced - Graphics configuration - Configuration options

1.4.5 CPU configuration

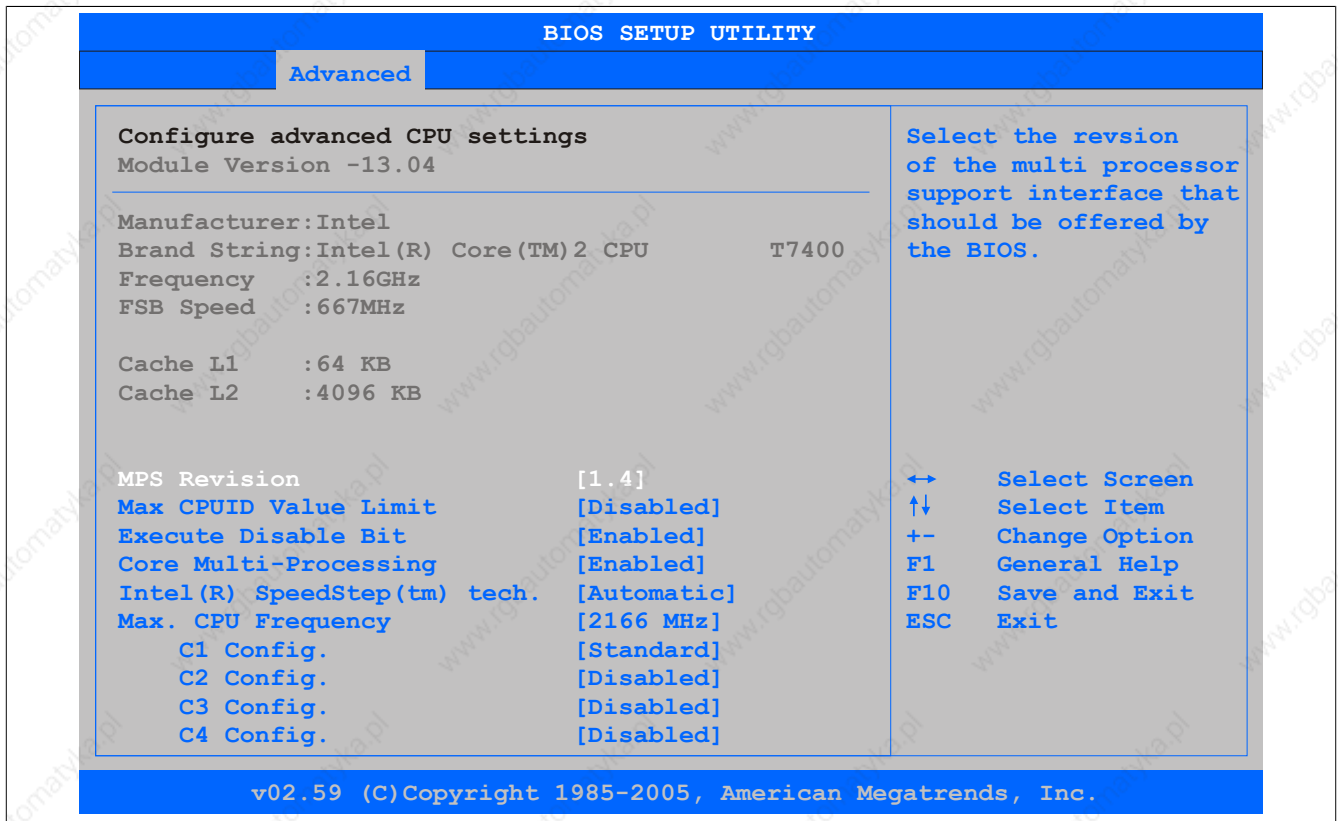

Figure 121: 945GME Advanced - CPU configuration

BIOS setting	Function	Configuration options	Effect
MPS revision	This option supports the use of multiple CPUs (MPS=multiprocessor system).	1.1	Sets MPS support to Revision 1.1
		1.4	Sets MPS support to Revision 1.4
Max CPUID value limit	Option for limiting the CPUID input value. This may be necessary for older operating systems.	Enabled	The processor limits the maximum CPUID input value to 03h if necessary when the the processor supports a higher value.
		Disabled	The processor returns the current maximum value when the CPUID input value is requested.
Execute disable bit	Option for enabling/disabling hardware support for prevention of data execution	Enabled	Enables this function
		Disabled	Disables this function
Core multi-processing	This option can be used to disable a core when using a dual-core processor.	Enabled	Uses both cores in a dual-core processor
		Disabled	Uses only one core in a dual-core processor
Intel(R) Speedster(tm) tech.	Option for controlling the Intel(R) SpeedStep(TM) technology. The processor clock speed is increased or decreased according to the number of calculations that must be made. As a result, the power consumption depends largely on the processor load.	Automatic	The processor speed is regulated by the operating system.
		Maximum speed	The processor speed is set to a maximum.
		Minimum speed	The processor speed is set to a minimum.
		Disabled	Disables SpeedStep technology
Max. CPU frequency	Option for setting the maximum processor speed if the value "Automatic" or "Maximum speed" is set for the option "Intel(R) SpeedStep(tm) tech."	xxxx MHz	Limits the processor speed to the configured value
C1 config	Power management for the Intel Core Duo processor	Standard	Standard C1 support
		Enhanced	Enhanced C1 support
C2 config	Power management for the Intel Core Duo processor	Standard	Standard C2 support
		Enhanced	Enhanced C2 support
		Disabled	Disables C2 support
C3 config	Power management for the Intel Core Duo processor	Standard	Standard C3 support
		Enhanced	Enhanced C3 support
		Disabled	Disables C3 support
C4 config	Power management for the Intel Core Duo processor	Standard	Standard C4 support
		Enhanced	Enhanced C4 support
		Disabled	Disables C4 support

Table 196: 945GME Advanced - CPU configuration - Configuration options

1.4.6 Chipset settings

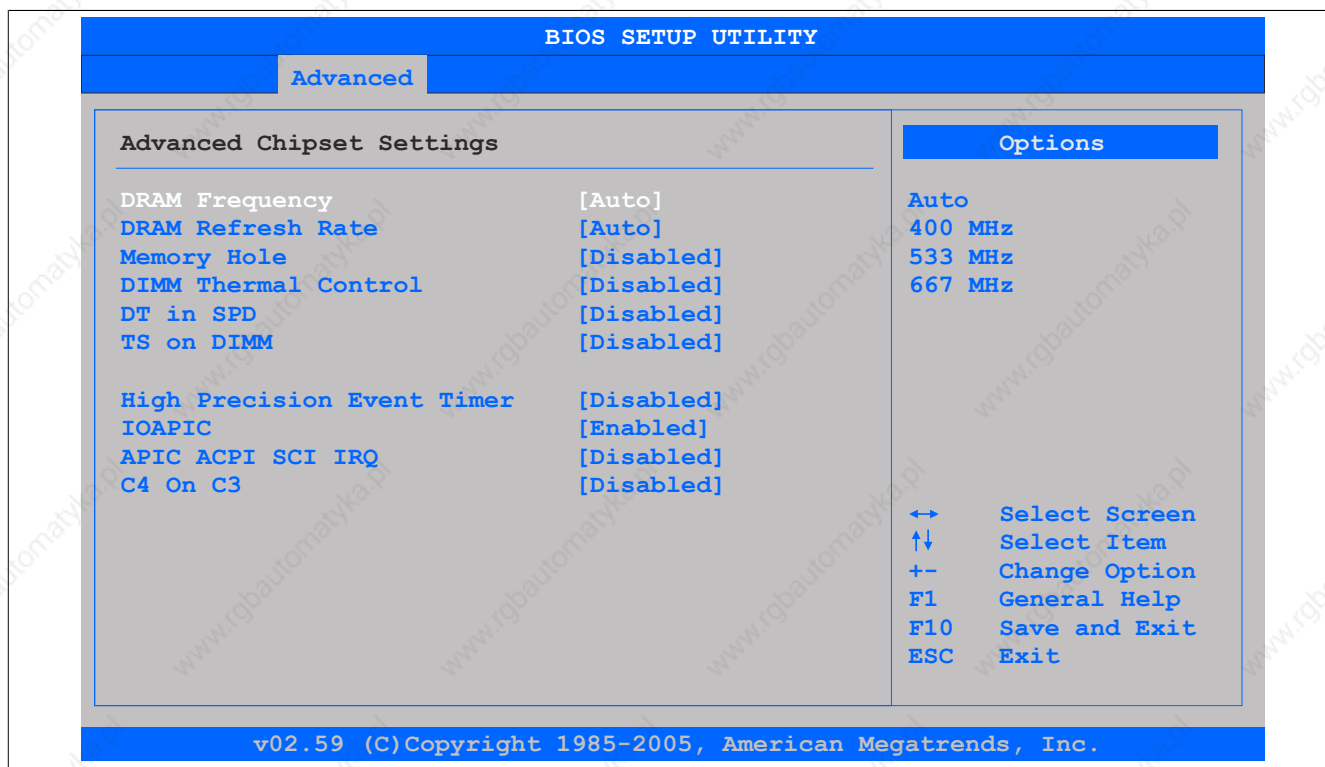

Figure 122: 945GME Advanced - Chipset settings

BIOS setting	Function	Configuration options	Effect
DRAM frequency	Option for setting the RAM frequency	Auto	BIOS sets the frequency automatically.
		400, 533, 667 MHz	The desired clock frequency is set manually.
DRAM refresh rate	Option for configuring the DRAM refresh rate	Auto	Reads the DRAM refresh rate from the SPD data of the DRAM module
		7.8 μs	The DRAM refresh rate is set manually.
		3.9 μs	The DRAM refresh rate is set manually.
Memory hole	Option for ISA cards with a frame buffer. This does not apply to the APC810.	Disabled	Disables this function
		15MB-16MB	Reserves the address range
DIMM thermal control	Option for setting the maximum surface temperature of the DIMM module. The module is cooled by limiting the memory bandwidth if the defined surface temperature is reached.	Disabled 40°C, 50°C, 60°C, 70°C, 80°C, 85°C, 90°C	Surface temperature not limited Temperature limit value for the limitation
DT in SPD	Option to determine whether the GMCH (graphics and memory controller hub) supports DT (delta temperature) in the SPD (serial presence detect) management algorithm of the DIMM module	Enabled	Enables this function
		Disabled	Disables this function
TS on DIMM	Option to determine whether the GMCH (graphics and memory controller hub) supports the TS (thermal sensor) in the thermal management algorithm of the DIMM module	Enabled	Enables this function
		Disabled	Disables this function
High precision event timer	The HPET is a timer inside the PC. It is able to trigger an interrupt with a high degree of accuracy, which allows other programs to better synchronize a variety of applications.	Enabled	Enables this function. This function is recommended for multimedia applications.
		Disabled	Disables this function
IOAPIC	This option is used to enable or disable the APIC (Advanced Programmable Interrupt Controller).	Enabled	The IRQ resources available to the system are expanded when APIC mode is enabled.
		Disabled	Disables this function
APIC ACPI SCI IRQ	This option is used to modify the SCI IRQ when in APIC (Advanced Programmable Interrupt Controller) mode.	Enabled	Uses IRQ20 for SCI
		Disabled	Uses IRQ9 for SCI.
C4 on C3	Fine-tunes the power saving function on an ACPI operating system	Enabled	Brings the processor to C4 if the operating system is initiated in a C3 state
		Disabled	Disables this function

Table 197: 945GME Advanced - Chipset settings - Configuration options

1.4.7 I/O interface configuration

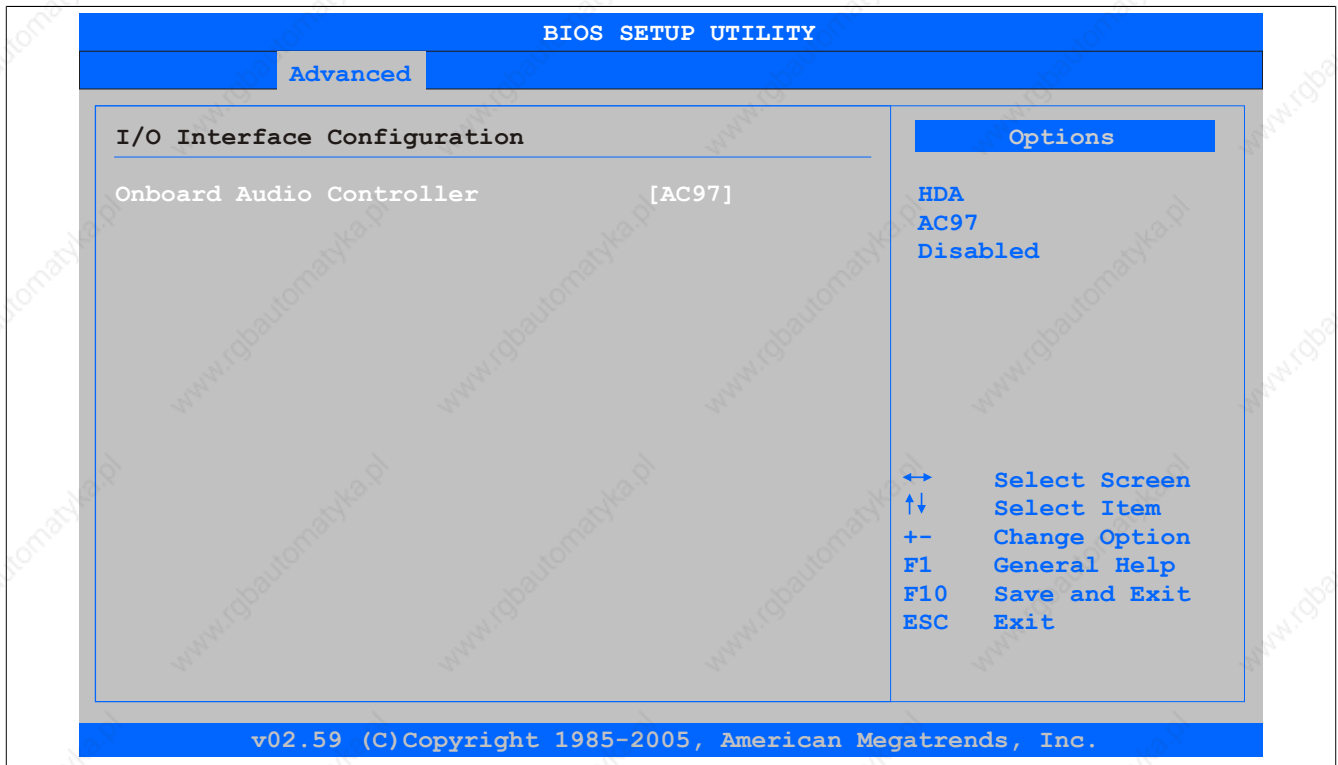

Figure 123: 945GME Advanced - I/O interface configuration

BIOS setting	Function	Configuration options	Effect
Onboard audio controller	Option for selecting or turning off the audio mode	HDA	Enables High Definition Audio sound
		AC97	Enables AC'97 sound
		Disabled	Disables the audio controller

Table 198: 945GME Advanced - I/O interface configuration - Configuration options

1.4.8 Clock configuration

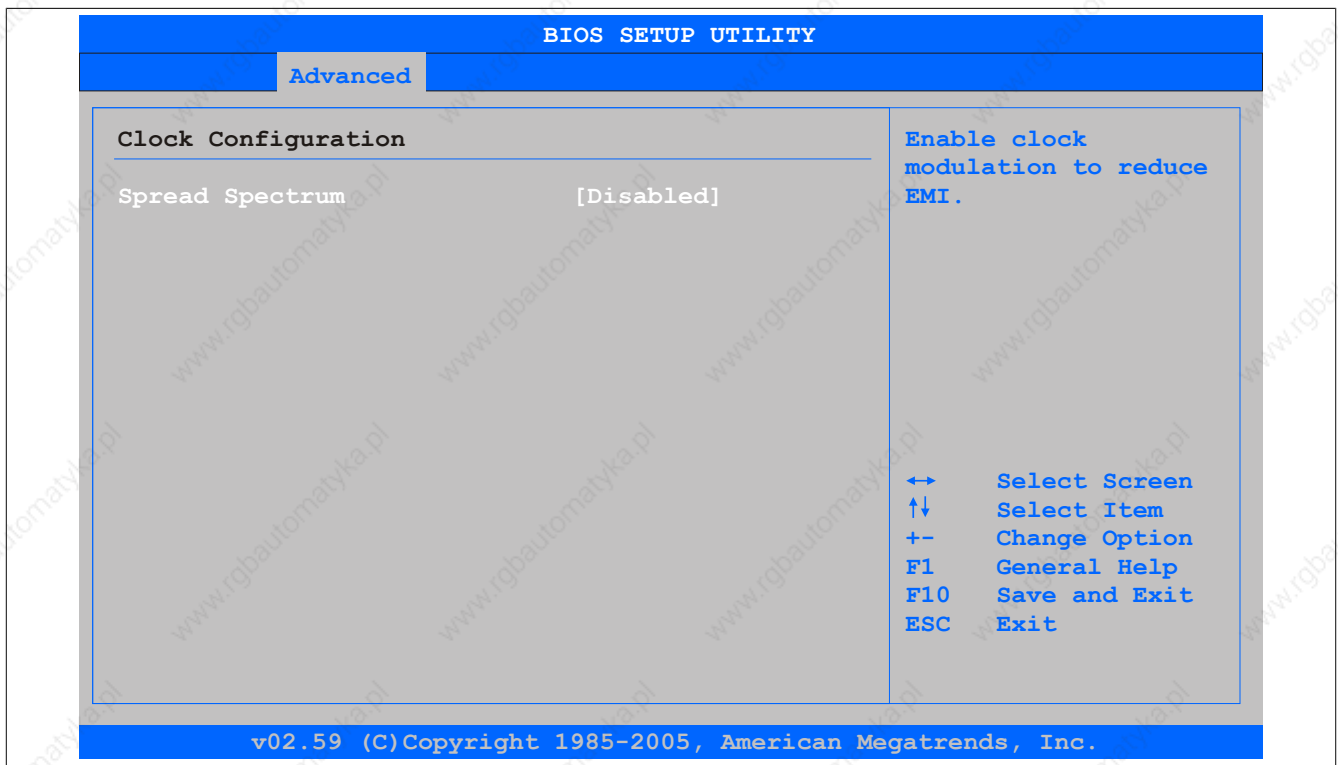

Figure 124: 945GME Advanced - Clock configuration

BIOS setting	Function	Configuration options	Effect
Spread spectrum	This option is used to modulate the cycle frequency to slightly reduce electromagnetic interference	Enabled	Enables this function
		Disabled	Disables this function

Table 199: 945GME Advanced - Clock configuration - Configuration options

1.4.9 IDE configuration

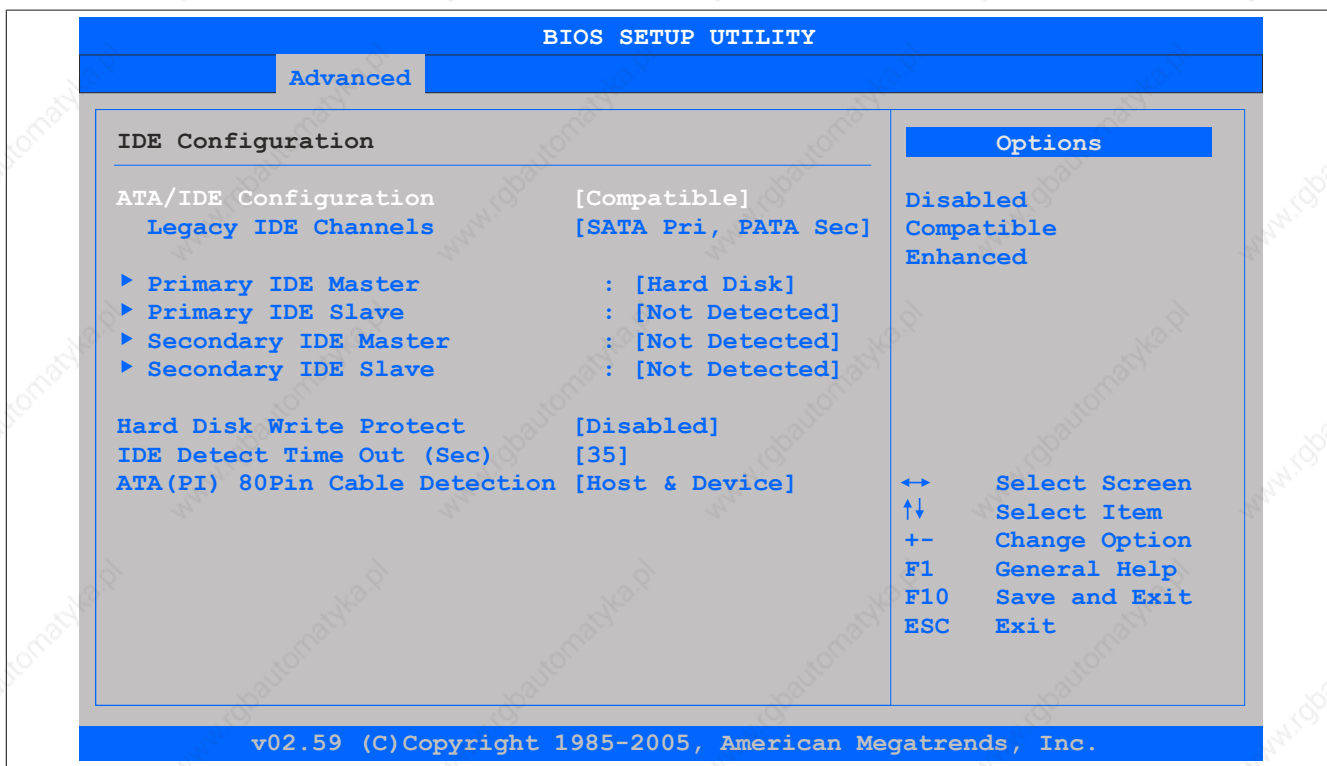

Figure 125: 945GME Advanced - IDE configuration

BIOS setting	Function	Configuration options	Effect
ATA/IDE Configuration	Option for configuring the integrated PATA and SATA controllers	Compatible	Both controllers run in Legacy or Compatible mode.
		Disabled	Disables both controllers
		Enhanced	Both controllers run in Enhanced or Native mode.
Legacy IDE channels ¹⁾	Option for configuring the Legacy IDE channels in Compatible mode.	SATA Pri, PATA Sec	Assigns SATA drives as primary and PATA drives as secondary
		SATA only	Uses SATA drives only
		PATA only	Uses PATA drives only
Configure SATA as ²⁾	Allows the serial ATA connections supported by the southbridge to be defined	IDE	The serial ATA hard drive is used as a parallel ATA physical drive.
		RAID	RAID 0, 1, 5, 10 or Intel® Matrix Storage technology can be configured here with the serial ATA hard drive.
		AHCI	The AHCI setting enables the internal memory driver for SATA functions, which increases the storage performance for random read-write access by allowing the drive itself to determine the sequence of commands.
Configure SATA channels ³⁾	Allows SATA or PATA drives to be configured as primary or secondary devices	Before PATA	Sets the SATA drives as primary devices and PATA as secondary
		Behind PATA	Sets the PATA drives as primary devices and SATA as secondary
AHCI/RAID SATA hot plug ⁴⁾	Allows the configuration of hot plugging support for AHCI/RAID systems	Enabled	Enables hot plugging support
		Disabled	Disables hot plugging support
Primary IDE master	Option for configuring the drive in the system that is connected to the IDE primary master port	Enter	Opens the submenu See "Primary IDE master" on page 245
Primary IDE slave	Option for configuring the drive in the system that is connected to the IDE primary slave port	Enter	Opens the submenu See "Primary IDE slave" on page 246
Secondary IDE master	Option for configuring the drive in the system that is connected to the IDE secondary master port	Enter	Opens the submenu See "Secondary IDE master" on page 247
Secondary IDE slave	Option for configuring the drive in the system that is connected to the IDE secondary slave port	Enter	Opens the submenu See "Secondary IDE slave" on page 248
Hard disk write protect	Option for enabling/disabling write protection for the hard drive	Enabled	Enables this function
		Disabled	Disables this function

Table 200: 945GME Advanced - IDE configuration - Configuration options

BIOS setting	Function	Configuration options	Effect
IDE detect time out (sec)	Configures the time overrun limit for ATA/ATAPI device detection	0, 5, 10, 15, 20, 25, 30, 35	Time setting in seconds
ATA(PI) 80-pin cable detection	Configures whether an 80-pin cable is connected to the drive, to the controller or to both	Host & device	Uses both IDE controllers (motherboard, disk drive)
		Host	Uses the IDE controller on the motherboard
		Device	Uses the IDE controller on the disk drive
<p>Information:</p> <p>This option is not available on the APC810 CPU board. This setting therefore does not apply.</p>			

Table 200: 945GME Advanced - IDE configuration - Configuration options

- 1) These settings are only possible if *ATA/IDE configuration* is set to *Compatible*.
- 2) These settings are only possible if *ATA/IDE configuration* is set to *Enhanced*.
- 3) These settings are only possible if *ATA/IDE configuration* is set to *Enhanced* and *Configure SATA* as is set to *IDE* or *AHCI*.
- 4) These settings are only possible if *ATA/IDE configuration* is set to *Enhanced* and *Configure SATA* as is set to *RAID* or *AHCI*.

1.4.9.1 Primary IDE master

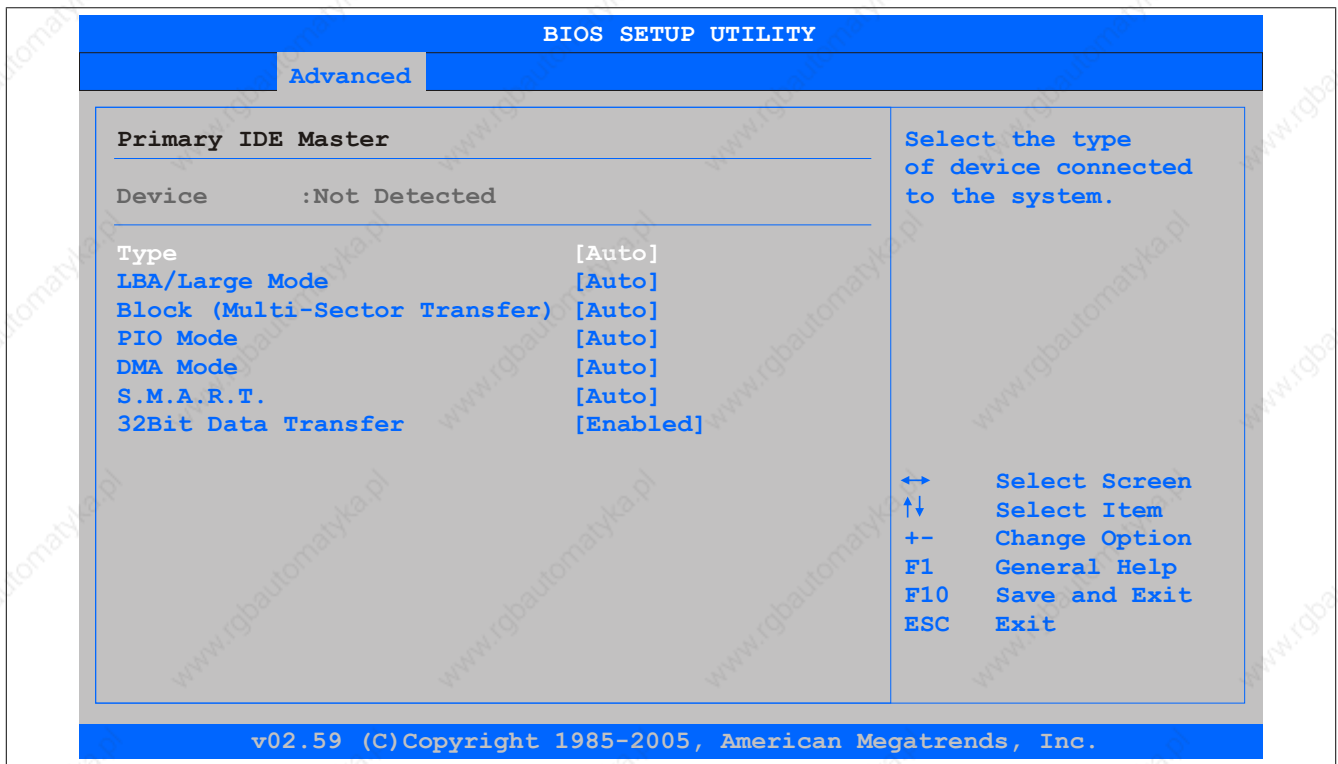

Figure 126: 945GME Advanced - Primary IDE master

BIOS setting	Function	Configuration options	Effect
Type	Configures the type of drive connected to the primary master	Not installed	No drive installed
		Auto	Automatically detects the drive and configures the necessary values
		CD/DVD	CD/DVD drive
		ARMD	ARMD drive (zip drive)
LBA/Large mode	This option enables IDE logical block addressing / large mode	Disabled	Disables this function
		Auto	Automatically enables this function if supported by the system
Block (multi-sector transfer)	This option enables block mode for IDE hard drives. If this option is enabled, the number of blocks per request is read from the configuration sector of the hard drive.	Disabled	Disables this function
		Auto	Automatically enables this function if supported by the system
PIO mode	PIO mode determines the data rate of the hard drive.	Auto	Configures PIO mode automatically
		0, 1, 2, 3, 4	Configures PIO mode manually
<p>Information:</p> <p>This option is not available on the APC810. This setting therefore does not apply.</p>			

Table 201: 945GME Advanced - Primary IDE master - Configuration options

BIOS setting	Function	Configuration options	Effect
DMA mode	Defines the data transfer rate to and from the primary master drive. DMA mode must be enabled activated in the Windows Device Manager in order to guarantee maximum performance. This is only possible when manually setting up the drive.	Auto	Defines the transfer rate automatically
		Disabled	Defines the transfer rate manually
S.M.A.R.T.	Monitoring function for hard drives (Self-Monitoring, Analysis and Reporting Technology)	Auto	Detected and enabled automatically
		Enabled	Enables this function
		Disabled	Disables this function
32 bit data transfer	Enables 32-bit data transfer	Enabled	Enables this function
		Disabled	Disables this function

Table 201: 945GME Advanced - Primary IDE master - Configuration options

1.4.9.2 Primary IDE slave

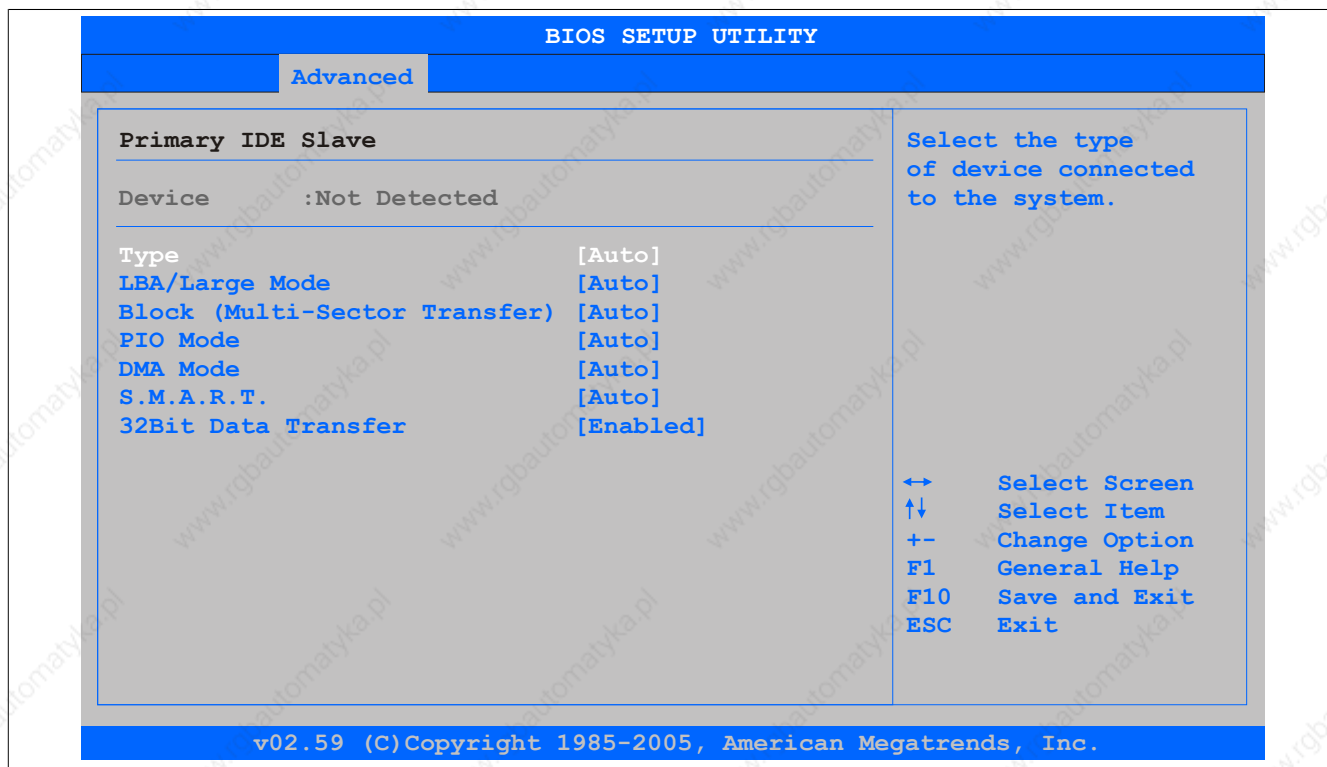

Figure 127: 945GME Advanced - Primary IDE slave

BIOS setting	Function	Configuration options	Effect
Type	Configures the type of drive connected to the primary slave	Not installed	No drive installed
		Auto	Automatically detects the drive and configures the necessary values
		CD/DVD	CD/DVD drive
		ARMD	ARMD drive (zip drive)
LBA/Large mode	This option enables IDE logical block addressing / large mode	Disabled	Disables this function
		Auto	Automatically enables this function if supported by the system
Block (multi-sector transfer)	This option enables block mode for IDE hard drives. If this option is enabled, the number of blocks per request is read from the configuration sector of the hard drive.	Disabled	Disables this function
		Auto	Automatically enables this function if supported by the system
PIO mode	PIO mode determines the data rate of the hard drive.	Auto	Configures PIO mode automatically
		0, 1, 2, 3, 4	Configures PIO mode manually
<p>Information:</p> <p>This option is not available on the APC810. This setting therefore does not apply.</p>			

Table 202: 945GME Advanced - Primary IDE slave - Configuration options

BIOS setting	Function	Configuration options	Effect
DMA mode	The data transfer rate to and from the primary slave drive is defined here. DMA mode must be enabled activated in the Windows Device Manager in order to guarantee maximum performance. This is only possible when manually setting up the drive.	Auto	Defines the transfer rate automatically
		Disabled	Defines the transfer rate manually
S.M.A.R.T.	Monitoring function for hard drives (Self-Monitoring, Analysis and Reporting Technology)	Auto	Detected and enabled automatically
		Enabled	Enables this function
		Disabled	Disables this function
32 bit data transfer	Enables 32-bit data transfer	Enabled	Enables this function
		Disabled	Disables this function

Table 202: 945GME Advanced - Primary IDE slave - Configuration options

1.4.9.3 Secondary IDE master

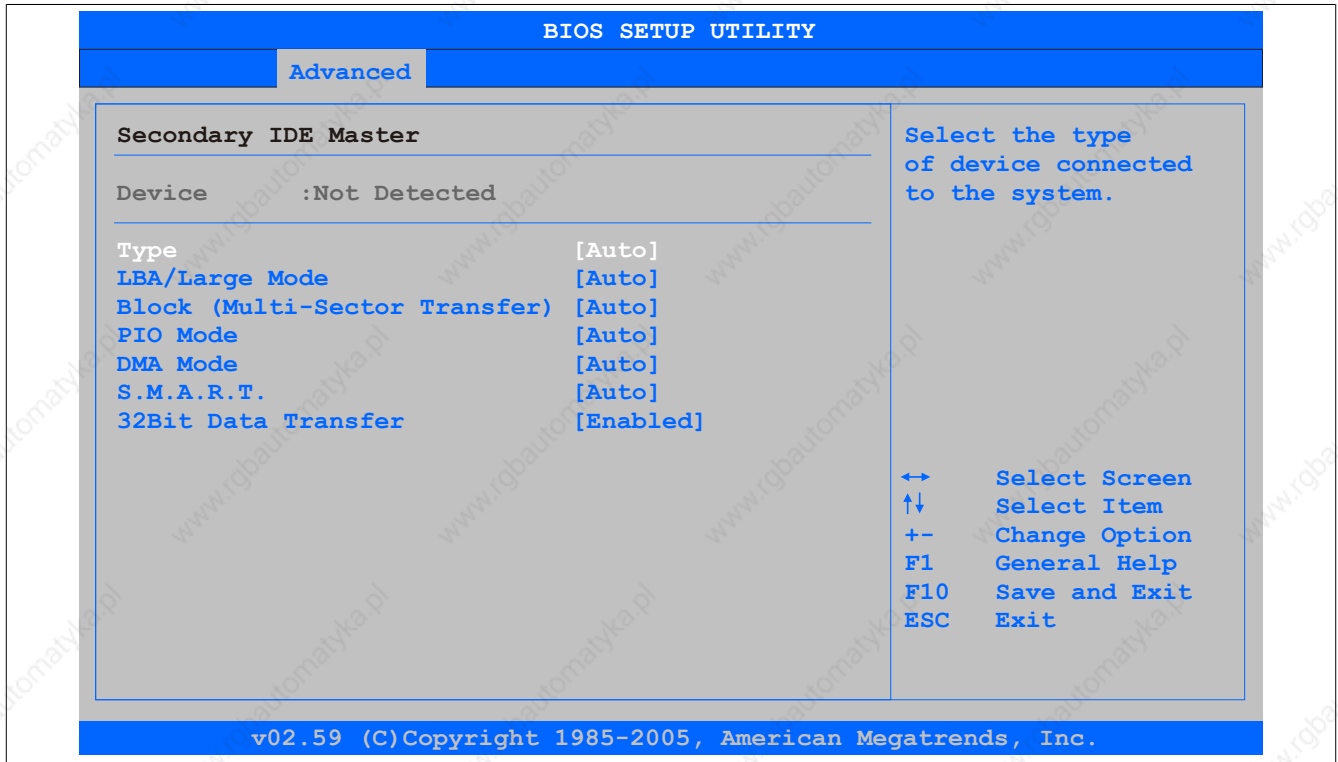

Figure 128: 945GME Advanced - Secondary IDE master

BIOS setting	Function	Configuration options	Effect
Type	Configures the type of drive connected to the secondary master	Not installed	No drive installed
		Auto	Automatically detects the drive and configures the necessary values
		CD/DVD	CD/DVD drive
		ARMD	ARMD drive (zip drive)
LBA/Large mode	This option enables IDE logical block addressing / large mode	Disabled	Disables this function
		Auto	Automatically enables this function if supported by the system
Block (multi-sector transfer)	This option enables block mode for IDE hard drives. If this option is enabled, the number of blocks per request is read from the configuration sector of the hard drive.	Disabled	Disables this function
		Auto	Automatically enables this function if supported by the system
PIO mode	PIO mode determines the data rate of the hard drive.	Auto	Configures PIO mode automatically
		0, 1, 2, 3, 4	Configures PIO mode manually
<p>Information:</p> <p>This option is not available on the APC810. This setting therefore does not apply.</p>			

Table 203: 945GME Advanced - Secondary IDE master - Configuration options

BIOS setting	Function	Configuration options	Effect
DMA mode	The data transfer rate to and from the secondary master drive is defined here. DMA mode must be enabled activated in the Windows Device Manager in order to guarantee maximum performance. This is only possible when manually setting up the drive.	Auto	Defines the transfer rate automatically
		Disabled	Defines the transfer rate manually
S.M.A.R.T.	Monitoring function for hard drives (Self-Monitoring, Analysis and Reporting Technology)	Auto	Detected and enabled automatically
		Enabled	Enables this function
		Disabled	Disables this function
32 bit data transfer	Enables 32-bit data transfer	Enabled	Enables this function
		Disabled	Disables this function

Table 203: 945GME Advanced - Secondary IDE master - Configuration options

1.4.9.4 Secondary IDE slave

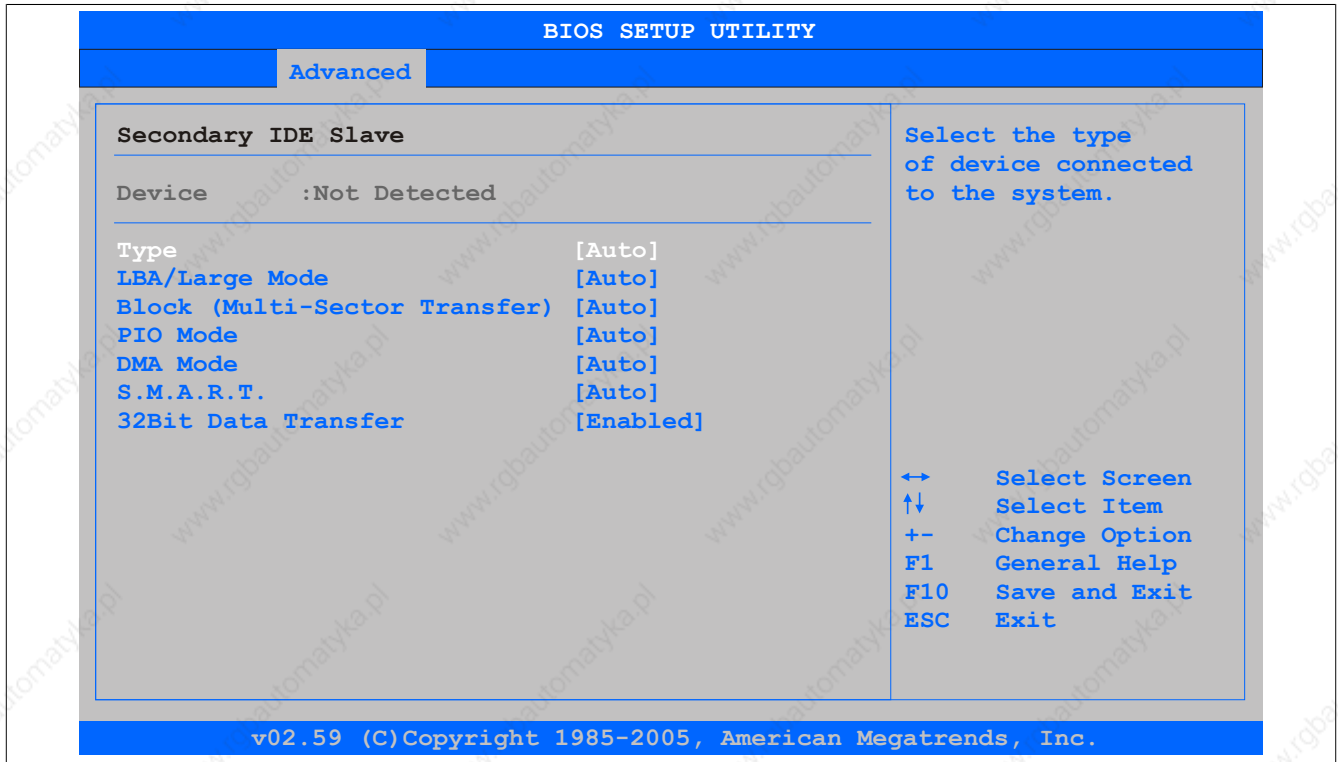

Figure 129: 945GME Advanced - Secondary IDE slave

BIOS setting	Function	Configuration options	Effect
Type	Configures the type of drive connected to the secondary slave	Not installed	No drive installed
		Auto	Automatically detects the drive and configures the necessary values
		CD/DVD	CD/DVD drive
		ARMD	ARMD drive (zip drive)
LBA/Large mode	This option enables IDE logical block addressing / large mode	Disabled	Disables this function
		Auto	Automatically enables this function if supported by the system
Block (multi-sector transfer)	This option enables block mode for IDE hard drives. If this option is enabled, the number of blocks per request is read from the configuration sector of the hard drive.	Disabled	Disables this function
		Auto	Automatically enables this function if supported by the system
PIO mode	PIO mode determines the data rate of the hard drive.	Auto	Configures PIO mode automatically
		0, 1, 2, 3, 4	Configures PIO mode manually
	<p>Information:</p> <p>This option is not available on the APC810. This setting therefore does not apply.</p>		

Table 204: 945GME Advanced - Secondary IDE slave - Configuration options

BIOS setting	Function	Configuration options	Effect
DMA mode	The data transfer rate to and from the secondary slave is defined here. DMA mode must be enabled activated in the Windows Device Manager in order to guarantee maximum performance. This is only possible when manually setting up the drive.	Auto	Defines the transfer rate automatically
		Disabled	Defines the transfer rate manually
S.M.A.R.T.	Monitoring function for hard drives (Self-Monitoring, Analysis and Reporting Technology)	Auto	Detected and enabled automatically
		Enabled	Enables this function
		Disabled	Disables this function
32 bit data transfer	Enables 32-bit data transfer	Enabled	Enables this function
		Disabled	Disables this function

Table 204: 945GME Advanced - Secondary IDE slave - Configuration options

1.4.10 USB configuration

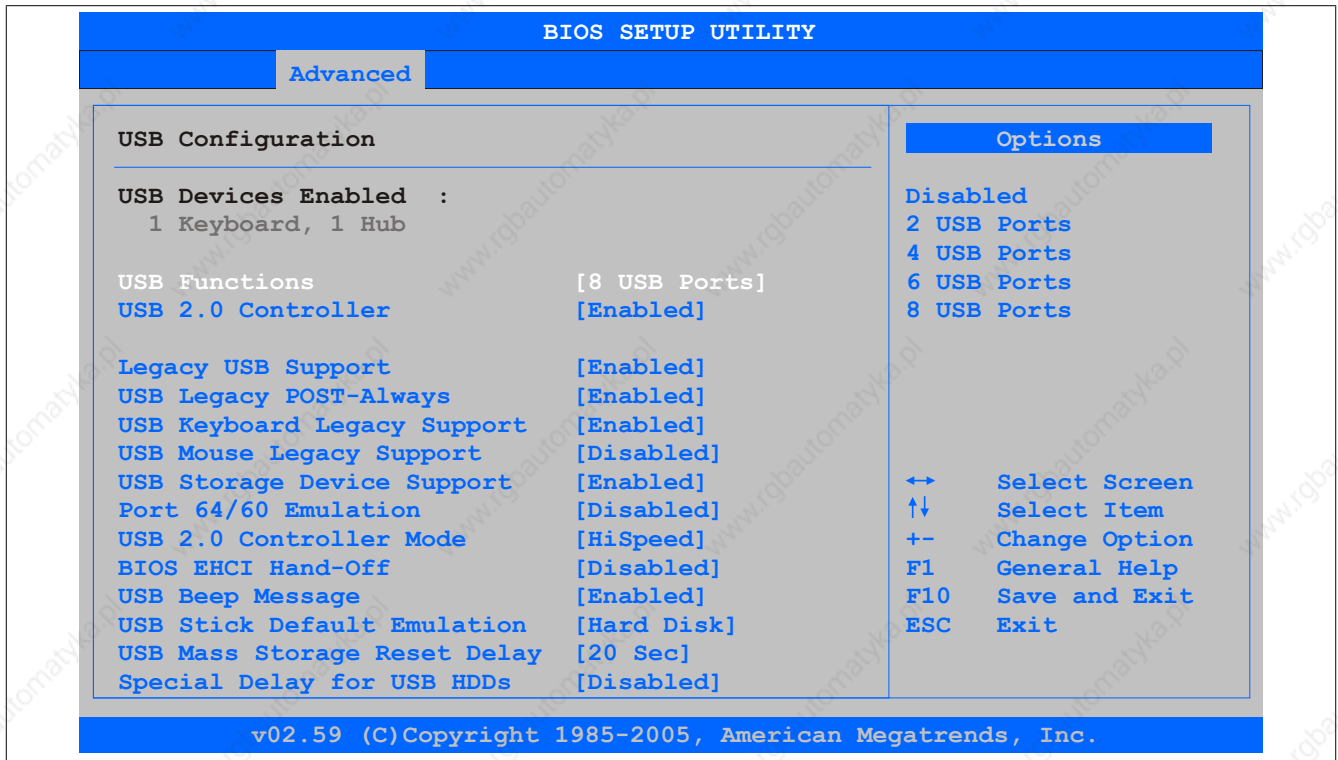

Figure 130: 945GME Advanced - USB configuration

BIOS setting	Function	Configuration options	Effect
USB function	Enables/Disables USB ports USB numbers (USB1, USB3, etc.) are printed on the APC810 housing.	Disabled	Disables the USB port
		2 USB ports	Enables USB1 and USB3
		4 USB ports	Enables USB1, USB2, USB3 and USB4
		6 USB ports	Enables USB1, USB2, USB3, USB4 and USB5
		8 USB ports	Enables USB1, USB2, USB3, USB4, USB5 and USB on an AP via SDL
USB 2.0 controller	Option for enabling or disabling USB 2.0 mode	Enabled	Uses USB 2.0 for all USB ports
		Disabled	Uses USB 1.1 for all USB ports
Legacy USB support	Enables/Disables Legacy USB support. USB ports do not function during startup. USB support is available again after the operating system has started. A USB keyboard is still recognized during POST.	Enabled	Enables this function
		Disabled	Disables this function
		Auto	Automatic enabling
USB Legacy POST-always	Option to enable Legacy USB support during POST (power-on self test) regardless of the setting made for Legacy USB support	Enabled	Allows BIOS Setup to be opened during POST using a USB keyboard
		Disabled	Disables this function
USB keyboard Legacy support	Enables/Disables USB keyboard support	Enabled	Enables this function
		Disabled	Disables this function
USB mouse Legacy support	Enables/Disables USB mouse support	Enabled	Enables this function
		Disabled	Disables this function
USB storage device support	Enables/Disables USB mass storage device support	Enabled	Enables this function
		Disabled	Disables this function
Port 64/60 emulation	Enables/Disables port 64/60 emulation	Enabled	Allows USB keyboard functionality in Windows NT
		Disabled	Allows USB keyboard functionality on all systems except Windows NT

Table 205: 945GME Advanced - USB configuration - Configuration options

BIOS setting	Function	Configuration options	Effect
USB 2.0 controller mode	Configures the USB controller	FullSpeed	12 MBps
		HiSpeed	480 MBps
BIOS EHCI hand-off	Allows support for operating systems to be set up without the fully automatic EHCI function	Enabled	Enables this function
		Disabled	Disables this function
USB beep message	Option for emitting a tone each time a USB device is detected by BIOS during POST	Enabled	Enables this function
		Disabled	Disables this function
USB stick default emulation	Configures how a USB device is to be used	Auto	USB devices with less than 530 MB of memory are simulated as floppy disk drives. Devices with larger memory capacity are simulated as hard drives.
		Hard disk drive	An HDD-formatted drive can be used as an FDD (e.g. zip drive) to start the system.
USB mass storage reset delay	Option for configuring the time that POST waits for USB memory storage devices after the device start command is issued	10 sec, 20 sec, 30 sec, 40 sec	Sets the value manually
Special delay for USB HDDs	Option for setting a boot delay prior to counting the number of USB 2.0 devices in order to allow more time for USB devices that generally take longer to boot (e.g. USB hard disks)	Disabled	Disables this function Doesn't add a boot delay
		1 sec, 2 sec, 3 sec, 4 sec, 5 sec, 7 sec, 10 sec	Adds a boot delay of 1, 2, 3, 4, 5, 7 or 10 seconds

Table 205: 945GME Advanced - USB configuration - Configuration options

1.4.11 Keyboard/Mouse configuration

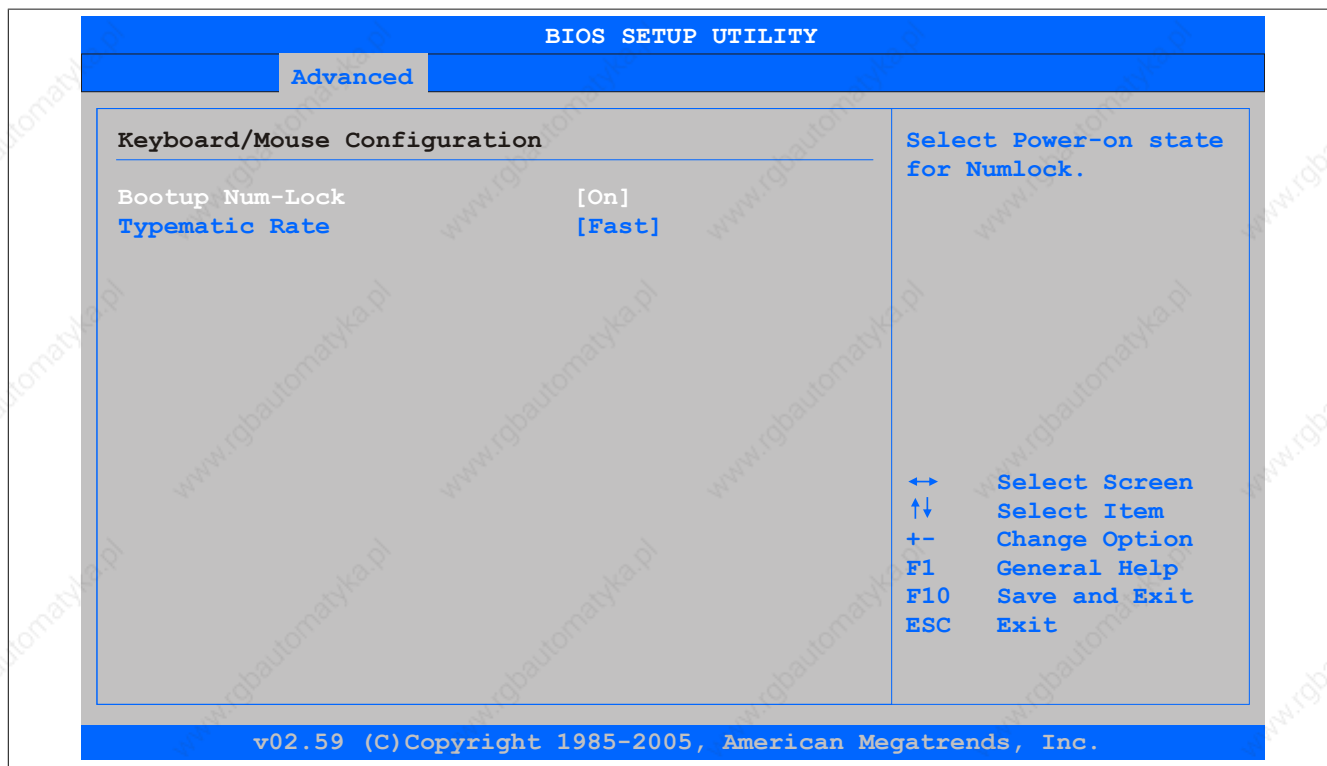

Figure 131: 945GME Advanced - Keyboard/Mouse configuration

BIOS setting	Function	Configuration options	Effect
Bootup Num-lock	Define the state of the NumLock key on the numeric keypad when booting	Off	Only enables the cursor (movement) functions of the numeric keypad
		On	Enables the numeric keypad
Typematic rate	Configures the key repeat function	Slow	Slow key repeat
		Fast	Fast key repeat

Table 206: 945GME Advanced - Keyboard/Mouse configuration - Configuration options

1.4.12 Remote access configuration

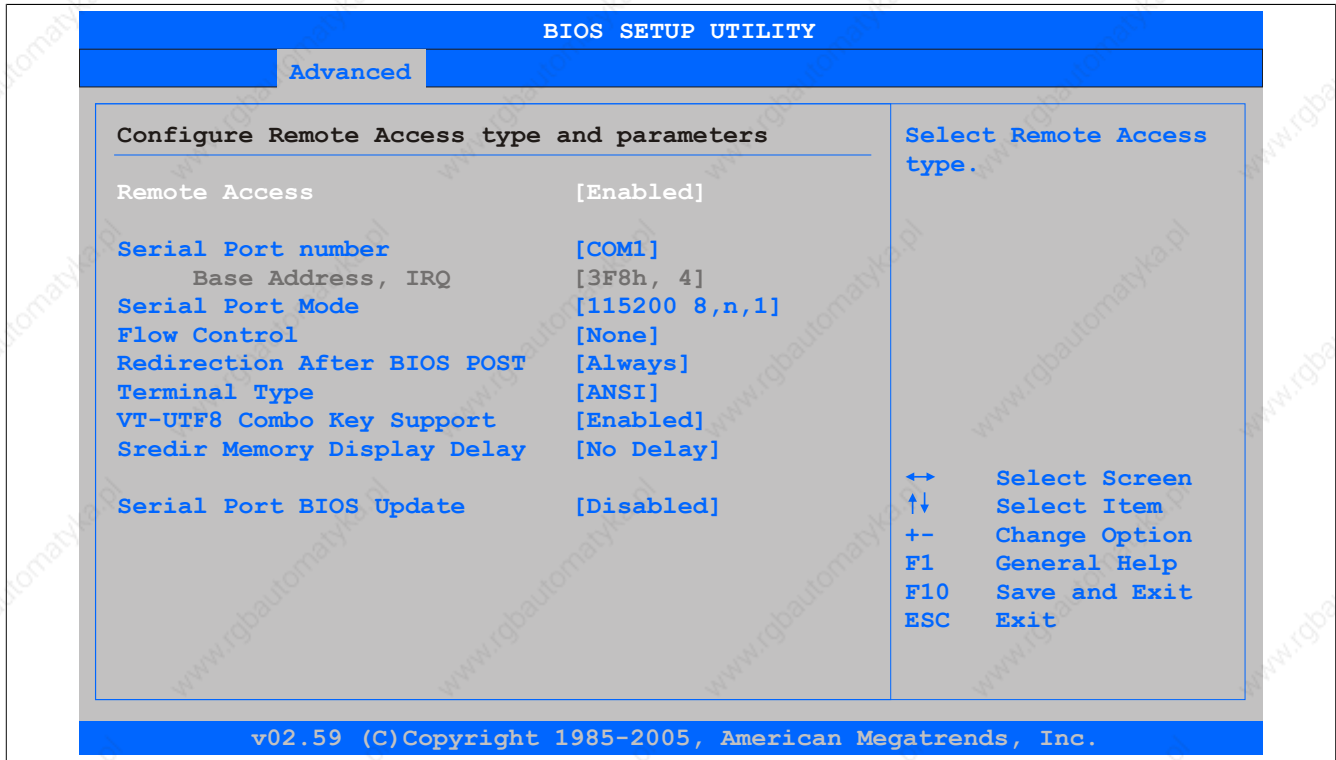

Figure 132: 945GME Advanced - Remote access configuration

BIOS setting	Function	Configuration options	Effect
Remote access	Enables/Disables the remote access function	Enabled	Enables this function
		Disabled	Disables this function
Serial port number	This option is used to configure the serial interface as long as <i>Remote access</i> is not set to "Disabled".	COM1	Enables the COM1 interface as a remote access interface
		COM2	Enables the COM2 interface as a remote access interface
Base address, IRQ	Displays the logical address and interrupt for the serial port as <i>Remote access</i> is not set to "Disabled".	None	-
Serial port Mode	Defines the serial port transfer rate as long as <i>Remote access</i> is not set to "Disabled".	115200 8,n,1 57600 8,n,1 38400 8,n,1 19200 8,n,1 09600 8,n,1	Sets the value manually
Flow control	Determines how the transfer is controlled via the interface Information: The setting must be the same on the terminal and the server.	None	Operates the interface without transfer control
		Hardware	Uses hardware for interface transfer control. This mode must be supported by the cable.
		Software	Uses software for interface transfer control
Redirection After BIOS POST	Configures redirection after startup as long as <i>Remote access</i> is not set to "Disabled"	Disabled	Disables redirection after startup
		Boot loader	Enables redirection during system startup and when charging
		Always	Keeps redirection enabled permanently
Terminal type	Configures the type of connection as long as <i>Remote access</i> is not set to "Disabled".	ANSI, VT100, VT-UTF8	Configures the connection type manually
VT-UTF8 combo key support	This option can be used to enable VT-UTF8 combo key support for ANSI and VT100 interfaces as long as <i>Remote access</i> is not set to "Disabled".	Enabled	Enables this function
		Disabled	Disables this function

Table 207: 945GME Advanced - Remote access configuration - Configuration options

BIOS setting	Function	Configuration options	Effect
Sredir memory display delay	This option can be used to set the memory output delay as long as <i>Remote access</i> is not set to "Disabled" (Sredir -> serial redirection).	No delay	No delay
		Delay 1 sec, Delay 2 sec, Delay 4 sec	Sets the value manually
Serial port BIOS update	Loads updates to the processor via the serial interface during system startup	Enabled	Enables this function
		Disabled	Disables this function
<p>Information:</p> <p>Disabling this option reduced the boot time.</p>			

Table 207: 945GME Advanced - Remote access configuration - Configuration options

1.4.13 CPU board monitor

Information:

The voltage values (e.g. core voltage, battery voltage) displayed on this BIOS Setup screen represent uncalibrated values for informational purposes. They cannot be used to draw any conclusions about hardware alarms or error conditions. The hardware components used have automatic diagnostic functions that can be applied in the event of error.

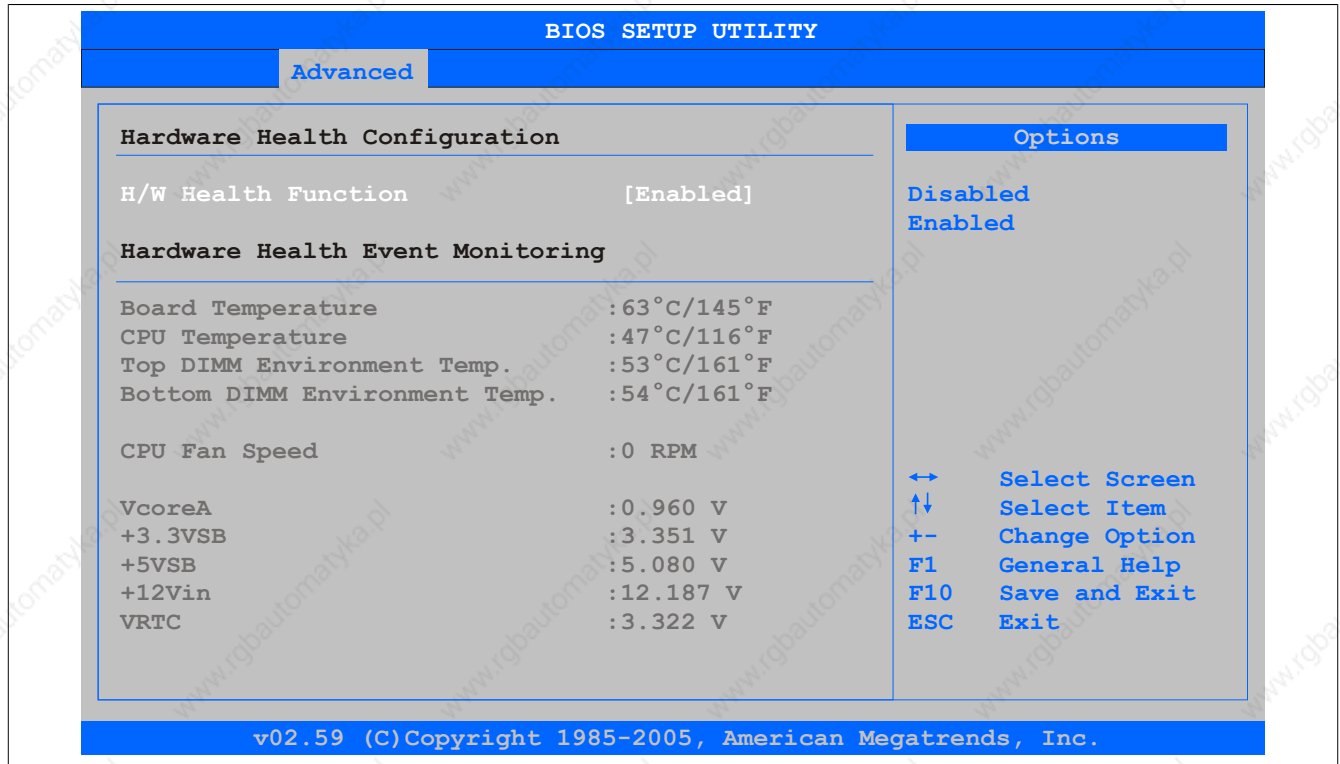

Figure 133: 945GME Advanced - CPU board monitor

BIOS setting	Function	Configuration options	Effect
H/W health function	Option for displaying all values on this screen	Enabled	Displays all values
		Disabled	Displays no value on this screen
Board temperature	Displays the board temperature in degrees Celsius and Fahrenheit	None	-
CPU temperature	Displays the processor's temperature (in degrees Celsius and Fahrenheit)	None	-
Top DIMM environment temp.	Displays the temperature of the first DRAM module	None	-
Bottom DIMM environment temp.	Displays the temperature of the second DRAM module	None	-
CPU fan speed	Displays the speed of the processor fan	None	-
VcoreA	Displays the processor's core voltage A in volts	None	-
+3.3VSB	Displays the current voltage of the 3.3 volt supply	None	-
+5VSB	Displays the current voltage of the 5 volt supply	None	-
+12Vin	Displays the current voltage of the 12 volt supply	None	-
VRTC	Displays the battery voltage in volts	None	-

Table 208: 945GME Advanced - CPU board monitor - Configuration options

1.4.14 Baseboard/Panel features

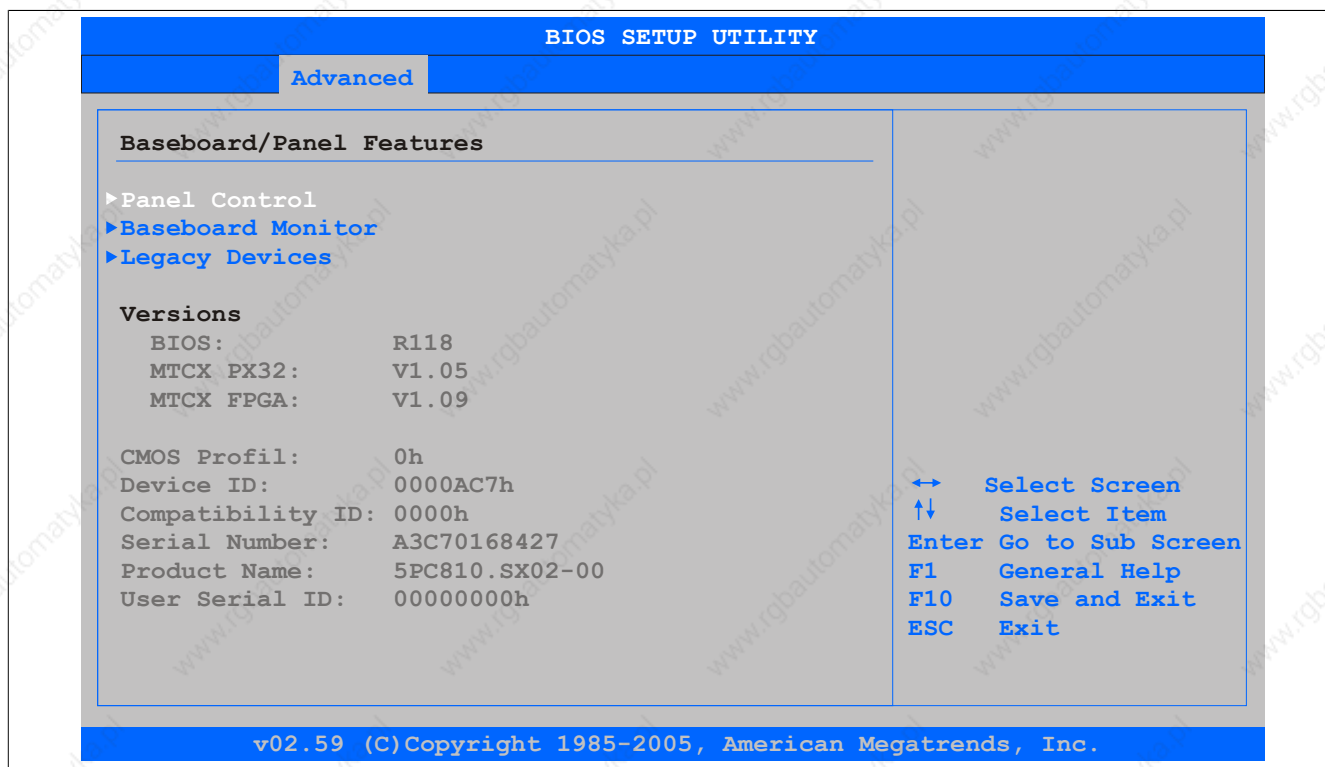

Figure 134: 945GME Advanced - Baseboard/Panel features

BIOS setting	Function	Configuration options	Effect
Panel control	Configures special settings for connected panels (display units)	Enter	Opens the submenu See "Panel control" on page 255
Baseboard monitor	Displays various temperatures and fan speeds	Enter	Opens the submenu See "Baseboard monitor" on page 256
Legacy devices	Configures special settings for interfaces	Enter	Opens the submenu See "Legacy devices" on page 257
BIOS	Displays the BIOS version	None	-
MTCX PX32	Displays the MTCX PX32 firmware version	None	-
MTCX FPGA	Displays the MTCX FPGA firmware version	None	-
CMOS profile	Displays the CMOS profile number	None	-
Device ID	Displays the hexadecimal value of the hardware device ID	None	-
Compatibility ID	Displays the version of the device within the same B&R device ID. This ID is needed for Automation Runtime.	None	-
Serial number	Displays the B&R serial number	None	-
Product name	Displays the B&R model number	None	-
User serial ID	Displays the user serial ID. This 8-digit hexadecimal value can be freely specified by the user (e.g. to give the device a unique ID) and can only be changed using the "B&R Control Center" included with the ADI driver.	None	-

Table 209: 945GME Advanced - Baseboard/Panel features - Configuration options

1.4.14.1 Panel control

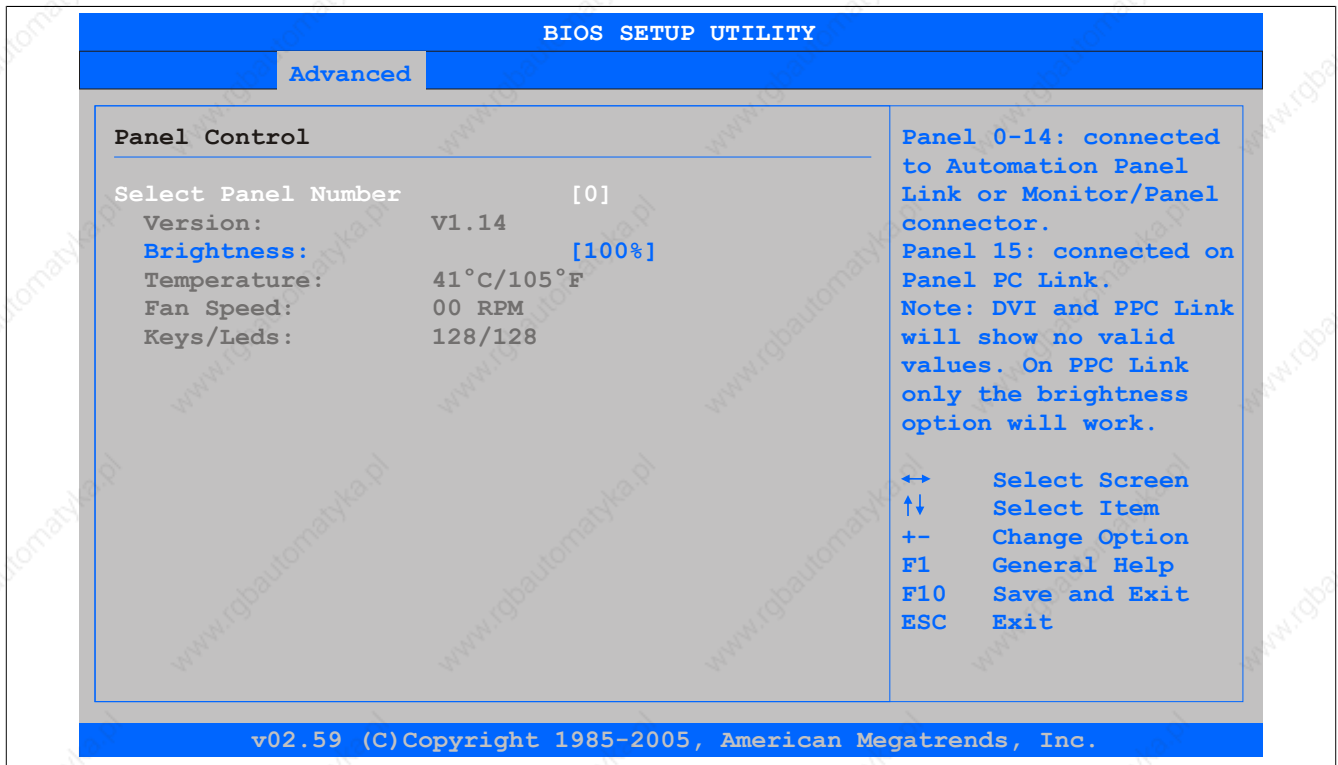

Figure 135: 945GME Advanced - Panel control

BIOS setting	Function	Configuration options	Effect
Select panel number	Selects the panel number for which the values should be displayed and/or changed	0...15	Selects panel 0-15 Panel 15 is specifically intended for Panel PC 800 systems.
Version	Displays the firmware version of the SDLR controller	None	-
Brightness	Sets the brightness of the selected panel	0%, 10%, 20%, 30%, 40%, 50%, 60%, 70%, 80%, 90%, 100%	Sets the brightness (in %) of the selected panel. Changes take effect after saving and restarting the system (e.g. by pressing <F10>).
Temperature	Displays the selected panel's temperature in degrees Celsius and Fahrenheit	None	-
Fan speed	Displays the fan speed for the selected panel	None	-
Keys/LEDs	Displays the available keys and LEDs on the selected panel	None	-

Table 210: 945GME Advanced - Panel control - Configuration options

1.4.14.2 Baseboard monitor

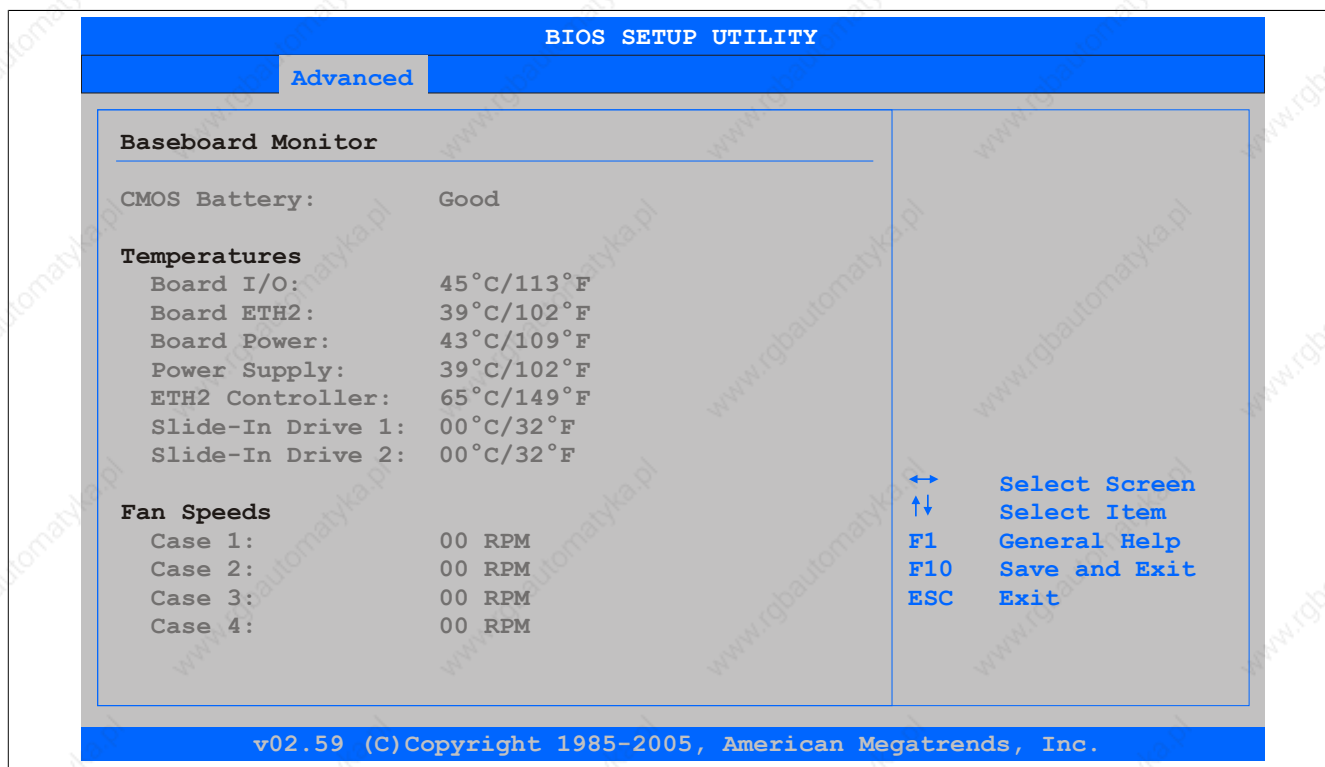

Figure 136: 945GME Advanced - Baseboard monitor

BIOS setting	Function	Configuration options	Effect
CMOS battery	Displays the battery status n.a. - Not available Good - Battery OK Bad - Battery not OK	None	-
Board I/O	Displays the temperature in the I/O area in degrees Celsius and Fahrenheit	None	-
Board ETH2	Displays the temperature in the ETH2 controller chip area in degrees Celsius and Fahrenheit	None	-
Board power	Displays the power supply temperature in degrees Celsius and Fahrenheit	None	-
Power supply	Displays the temperature in the power supply in degrees Celsius and Fahrenheit	None	-
ETH2 controller	Displays the temperature of the ETH2 controller in degrees Celsius and Fahrenheit	None	-
Slide-in drive 1	Displays the temperature of slide-in drive 1 in degrees Celsius and Fahrenheit	None	-
Slide-in drive 2	Displays the temperature of slide-in drive 2 in degrees Celsius and Fahrenheit	None	-
Case 1	Displays the speed of housing fan 1	None	-
Case 2	Displays the speed of housing fan 2	None	-
Case 3	Displays the speed of housing fan 3	None	-
Case 4	Displays the speed of housing fan 4	None	-

Table 211: 945GME Advanced - Baseboard monitor - Configuration options

1.4.14.3 Legacy devices

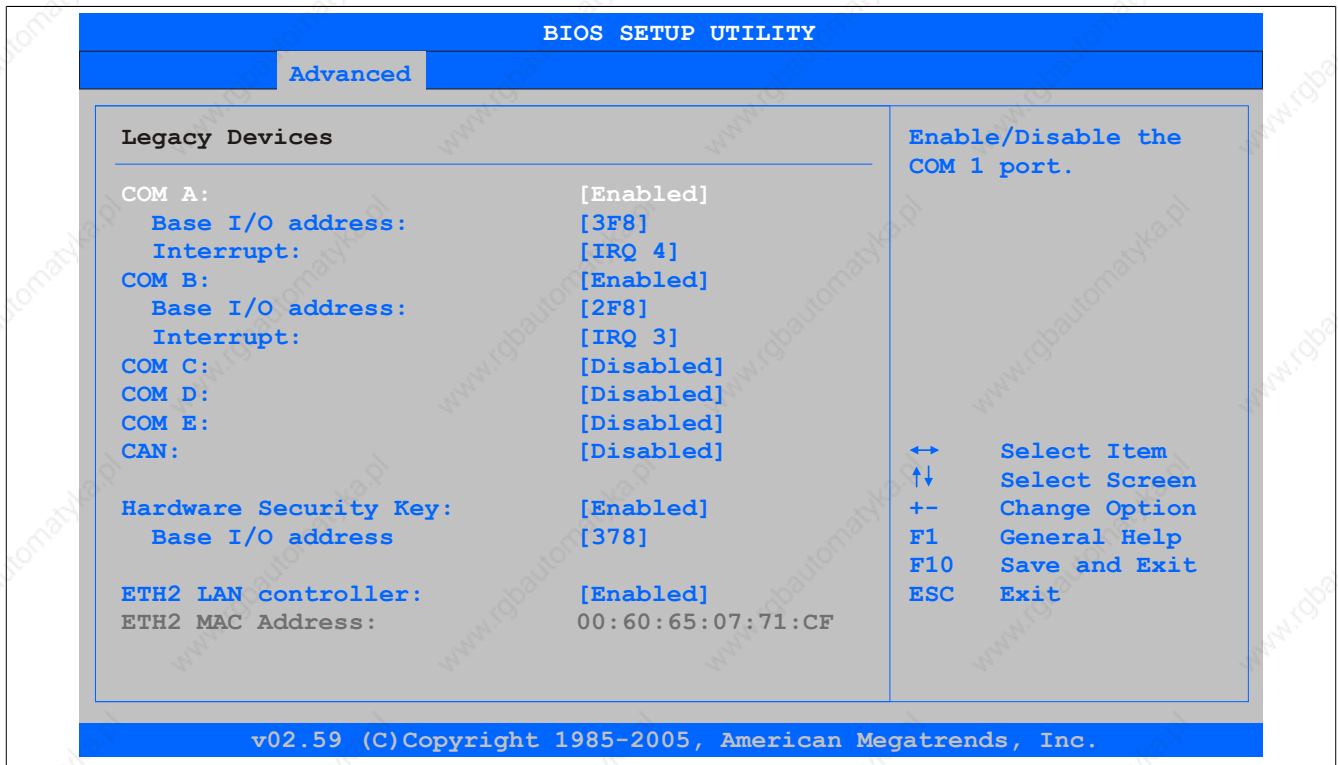

Figure 137: 945GME Advanced - Legacy devices

BIOS setting	Function	Configuration options	Effect
COM A	Settings for the COM1 serial interface	Enabled	Enables the interface
		Disabled	Disables the interface
Base I/O address	Selects the base I/O address of the COM port	238, 2E8, 2F8, 328, 338, 3E8, 3F8	Assigns the selected base I/O address
Interrupt	Selects the interrupt for the COM port	IRQ 3, IRQ 4, IRQ 5, IRQ 6, IRQ 7, IRQ 10, IRQ 11, IRQ 12	Assigns the selected interrupt
COM B	Settings for the COM2 serial interface	Disabled	Disables the interface
		Enabled	Enables the interface
Base I/O address	Selects the base I/O address of the COM port	238, 2E8, 2F8, 328, 338, 3E8, 3F8	Assigns the selected base I/O address
Interrupt	Selects the interrupt for the COM port	IRQ 3, IRQ 4, IRQ 5, IRQ 6, IRQ 7, IRQ 10, IRQ 11, IRQ 12	Assigns the selected interrupt
COM C	Sets the COM port for the touch screen connected to the monitor/panel interface	Enabled	Enables the interface
		Disabled	Disables the interface
Base I/O address	Selects the base I/O address of the COM port	238, 2E8, 2F8, 328, 338, 3E8, 3F8	Assigns the selected base I/O address
Interrupt	Selects the interrupt for the COM port	IRQ 3, IRQ 4, IRQ 5, IRQ 6, IRQ 7, IRQ 10, IRQ 11, IRQ 12	Assigns the selected interrupt
COM D	Sets the COM port for the touch screen connected to the AP Link interface	Enabled	Enables the interface
		Disabled	Disables the interface
Base I/O address	Selects the base I/O address of the COM port	238, 2E8, 2F8, 328, 338, 3E8, 3F8	Assigns the selected base I/O address
Interrupt	Selects the interrupt for the COM port	IRQ 3, IRQ 4, IRQ 5, IRQ 6, IRQ 7, IRQ 10, IRQ 11, IRQ 12	Assigns the selected interrupt
COM E	Configures the COM port of the 5AC600.4851-00 B&R add-on interface (IF option)	Enabled	Enables the interface
		Disabled	Disables the interface
Base I/O address	Selects the base I/O address of the COM port	238, 2E8, 2F8, 328, 338, 3E8, 3F8	Assigns the selected base I/O address
Interrupt	Selects the interrupt for the COM port	IRQ 3, IRQ 4, IRQ 5, IRQ 6, IRQ 7, IRQ 10, IRQ 11, IRQ 12	Assigns the selected interrupt
CAN	Configures the CAN port of the 5AC600.CANI-00 B&R add-on CAN interface (IF option)	Disabled	Disables the interface
		Enabled	Enables the interface
Base I/O address	Displays the base I/O address of the CAN port	None	-
Interrupt	Selects the interrupt for the CAN port	IRQ 10, NMI	Assigns the selected interrupt
Hardware security key	Configures settings for the hardware security key (dongle)	Disabled	Disables the interface
		Enabled	Enables the interface
Base I/O address	Displays the base I/O address of the hardware security interface	278, 378, 3BC	Assigns the base I/O address for the parallel port

Table 212: 945GME Advanced - Legacy devices - Configuration options

BIOS setting	Function	Configuration options	Effect
ETH2 LAN controller	Option for turning the onboard LAN controller (ETH2) on and off	Enabled	Enables the controller
		Disabled	Disables the controller
ETH2 MAC address	Displays the MAC address of the Ethernet 2 controller	None	-

Table 212: 945GME Advanced - Legacy devices - Configuration options

1.5 Boot

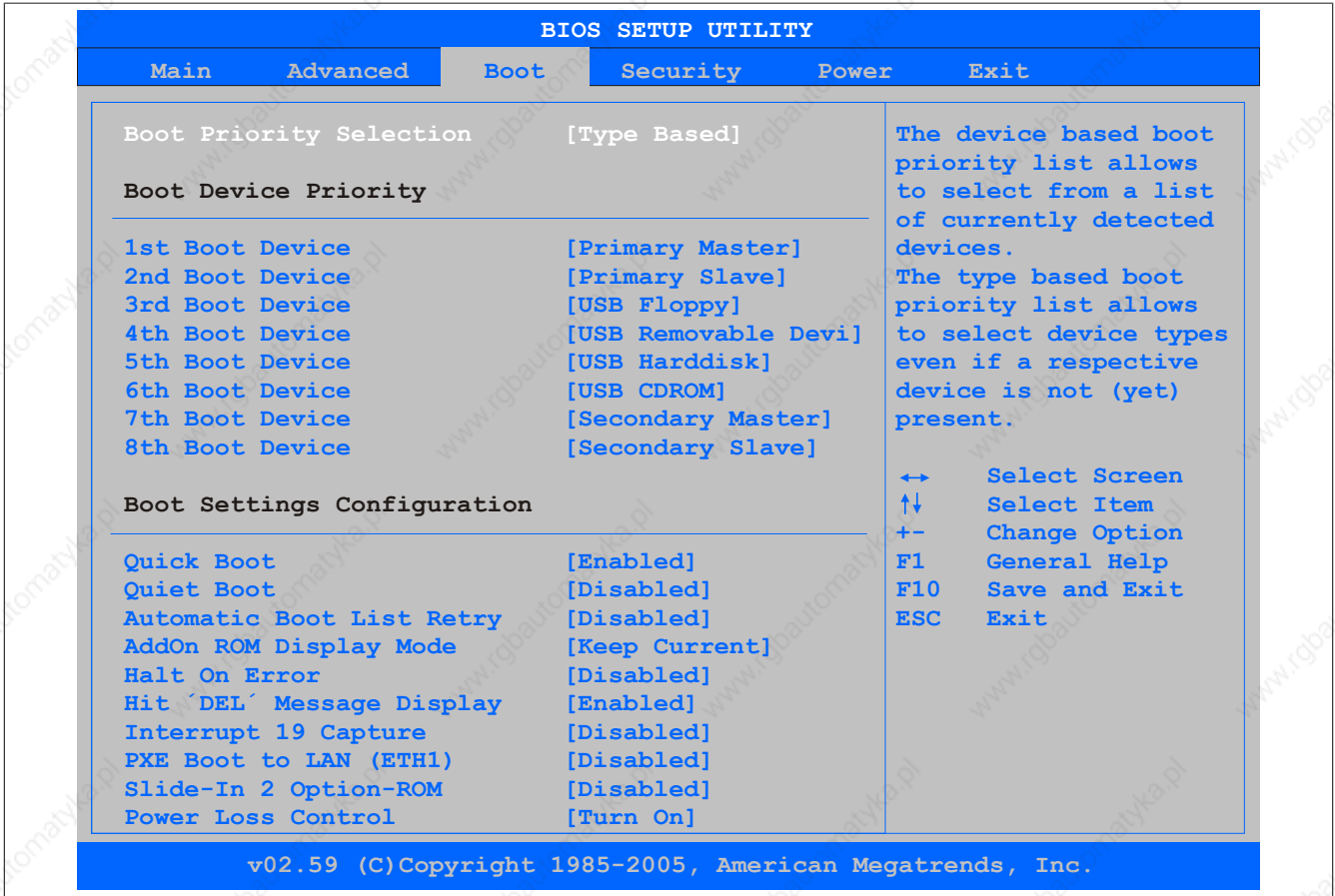

Figure 138: 945GME Boot menu

BIOS setting	Function	Configuration options	Effect
Boot priority selection	Option for determining the method for how drives should be booted	Device based	Only lists devices that are recognized by the system. The order of devices in this list can be changed. Information: It is only possible to use either "Device based" or "Type based". Using both together is not permitted.
		Type based	The boot sequence of a device type list can be changed. It is also possible to add device types that are not connected to this list. Information: It is only possible to use either "Device based" or "Type based". Using both together is not permitted.
1st boot device	Option for selecting drives to be used for booting	Disabled, Primary master, Primary slave, Secondary master, Secondary slave, Legacy floppy, USB floppy, USB hard disk, USB CDROM, USB removable device, Onboard LAN, External LAN, PCI mass storage, PCI SCSI card, Any PCI BEV device, Third master, Third slave, PCI RAID, Local BEV ROM	Specifies the desired boot sequence
2nd boot device			
3rd boot device			
4th boot device			
5th boot device			
6th boot device			
7th boot device			
8th boot device			

Table 213: 945GME Boot menu - Configuration options

BIOS setting	Function	Configuration options	Effect
Quick boot	This function reduces the boot time by skipping some POST procedures.	Enabled	Enables this function
		Disabled	Disables this function
Quiet boot	Determines whether the POST message or the OEM logo (default = black background) is displayed	Enabled	Displays the OEM logo instead of the POST message
		Disabled	Displays the POST message
Automatic boot list retry	This option can be used to attempt to restart the operating system automatically if it fails to start the first time.	Enabled	Enables this function
		Disabled	Disables this function
Add-on ROM display mode	Sets the display mode for the ROM (during the booting procedure)	Force BIOS	Displays an additional part of BIOS
		Keep current	Displays BIOS information
Halt on error	This option determines the system should resume after a startup error during POST .	Enabled	Pauses the system. The system pauses each time an error occurs.
		Disabled	Does not pause the system. All errors are ignored.
Hit 'DEL' message display	Configures settings for the "Hit 'DEL'" message	Enabled	Displays the message
		Disabled	Does not display the message
<p>Information:</p> <p>The message is not displayed if "Quiet boot" is enabled.</p>			
Interrupt 19 capture	This function can be used to include BIOS interruptions.	Enabled	Enables this function
		Disabled	Disables this function
PXE boot to LAN (ETH1)	Enables/disables the function to boot from LAN (ETH1)	Enabled	Enables this function
		Disabled	Disables this function
Slide-in 2 optional ROM	Enables/Disables optional ROM for a slide-in 2 drive	Enabled	Enables this function
		Disabled	Disables this function
Power loss control	Specifies whether the system should be on/off following power loss	Remain off	System remains off
		Turn on	System powered on
		Last state	Enables the previous state

Table 213: 945GME Boot menu - Configuration options

1.6 Security

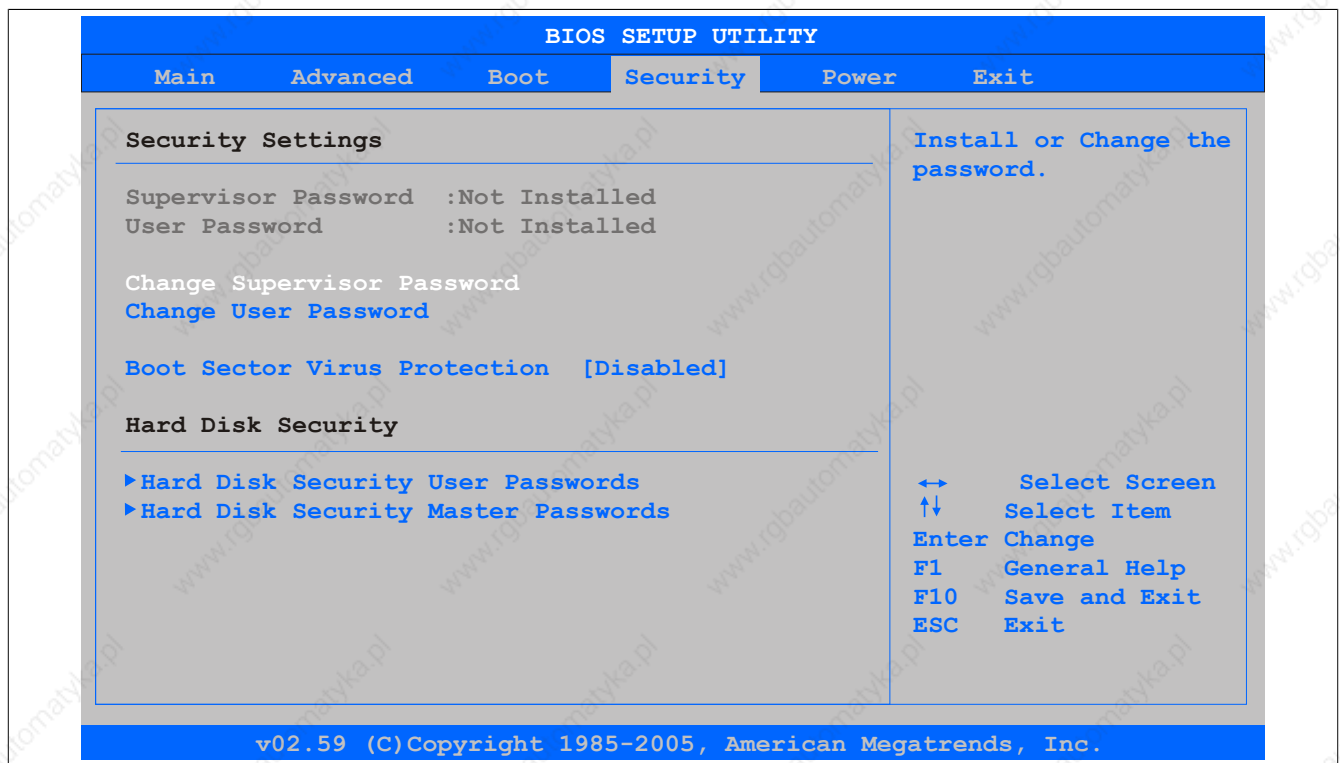

Figure 139: 945GME Security menu

BIOS setting	Function	Configuration options	Effect
Supervisor password	Displays whether a supervisor password has been set	None	-
User password	Displays whether a user password has been set	None	-
Change supervisor password	Function for entering/changing a supervisor password. A supervisor password is necessary to edit all BIOS settings.	Enter	Password entry

Table 214: 945GME Security menu - Configuration options

BIOS setting	Function	Configuration options	Effect
Change user password	Function for entering/changing a user password. The user password allows the user to edit only certain BIOS settings.	Enter	Password entry
Boot sector virus protection	This option is used to issue a warning when the boot sector is accessed by a program or virus.	Enabled	Enables this function
		Disabled	Disables this function
Information: This option only protects the boot sector, not the entire hard drive.			
Hard disk security user passwords	Creates the hard disk security user password	Enter	Opens the submenu See "Hard disk security user password" on page 260
Hard disk security master passwords	Creates the hard disk security master password	Enter	Opens the submenu See "Hard disk security master password" on page 261

Table 214: 945GME Security menu - Configuration options

1.6.1 Hard disk security user password

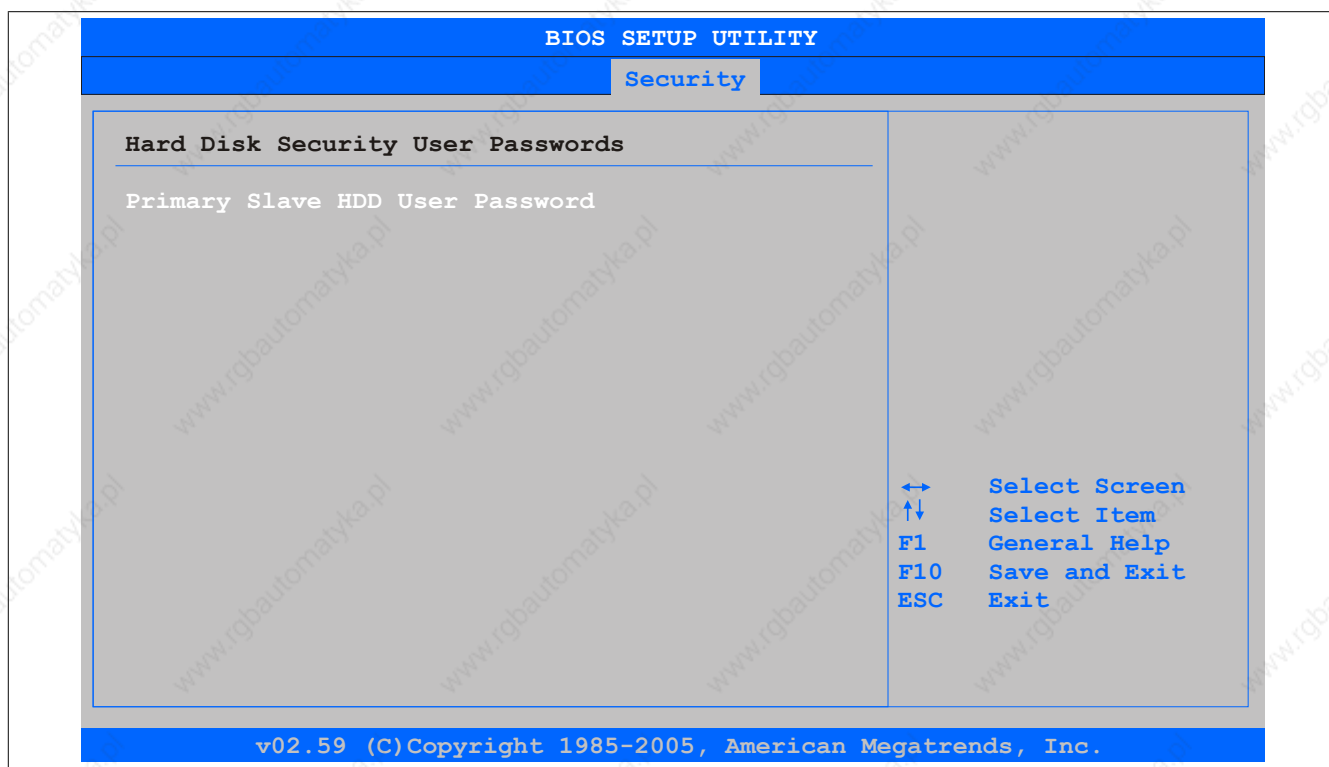

Figure 140: 945GME Security - Hard disk security user password

BIOS setting	Function	Configuration options	Effect
Primary slave HDD user password	This function makes it possible to configure or change the user password for each hard drive without having to reboot the device. The user password allows the user to edit only certain BIOS settings.	Enter	Password entry

Table 215: 945GME Security - Hard disk security user password

1.6.2 Hard disk security master password

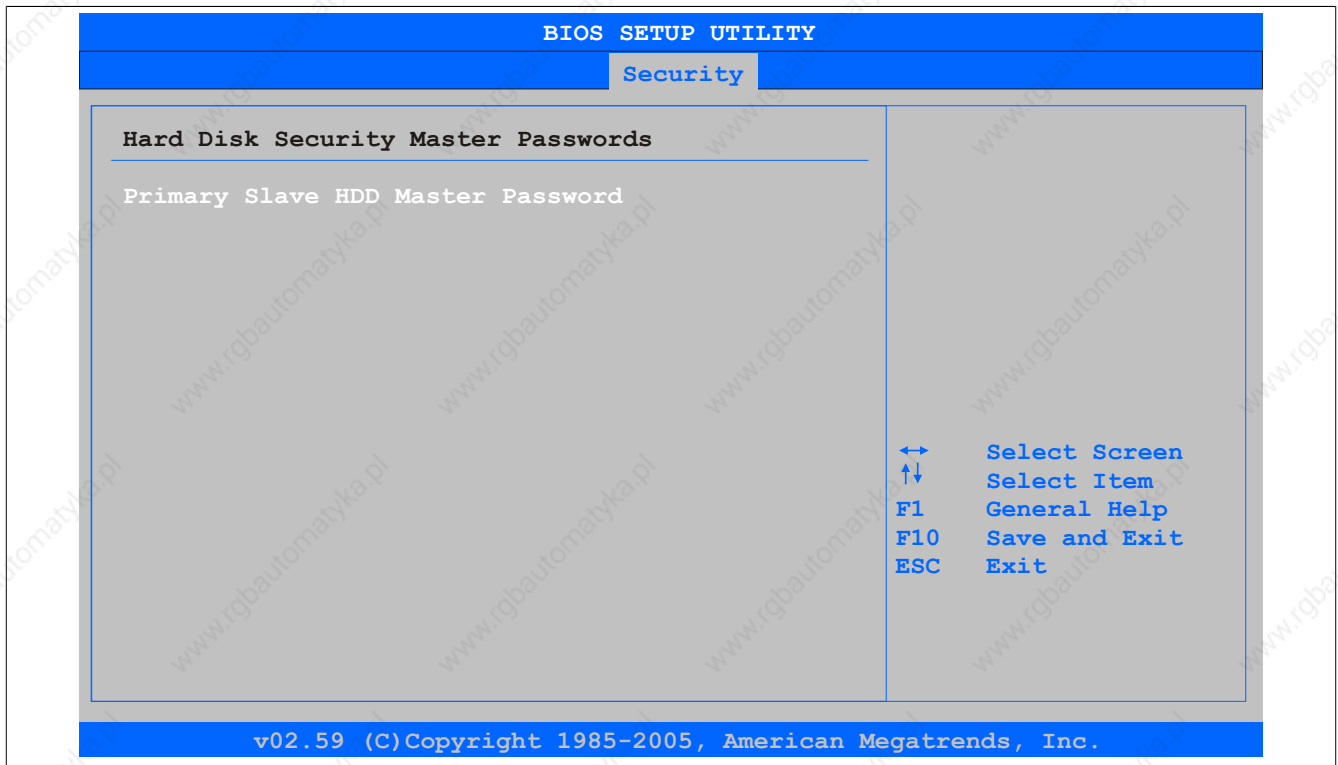

Figure 141: 945GME Security - Hard disk security master password

BIOS setting	Function	Configuration options	Effect
Primary slave HDD master password	This function makes it possible to configure or change the master password for each hard drive without having to reboot the device.	Enter	Password entry

Table 216: 945GME Security - Hard disk security master password

1.7 Power

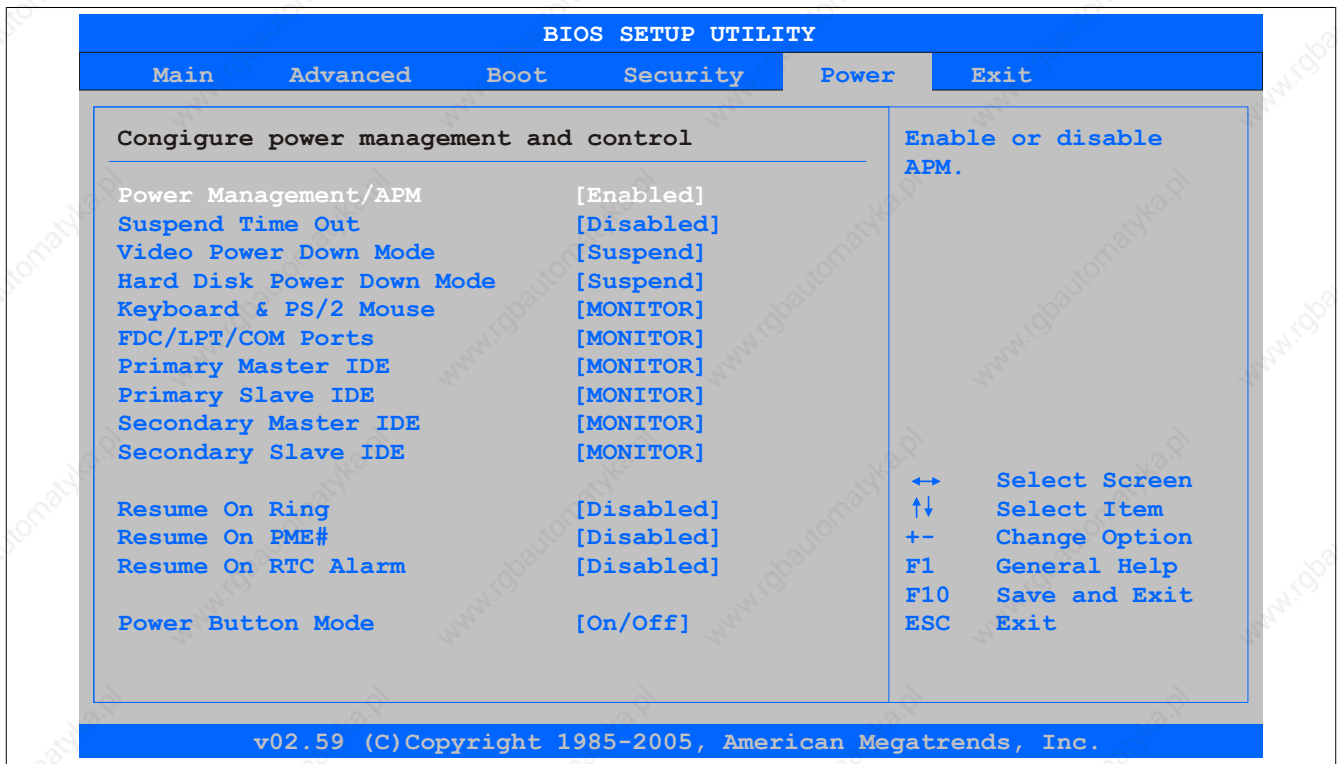

Figure 142: 945GME Power menu

BIOS setting	Function	Configuration options	Effect
Power management/APM	This option enables or disables APM functionality. This is advanced plug and play and power management functionality.	Enabled	Enables this function
		Disabled	Disables this function
Suspend time out	This option can be used to configure how long the system must be inactive before entering suspend mode (all components except the CPU are shut down as far as possible).	1 min, 2 min, 4 min, 8 min, 10 min, 20 min, 30 min, 40 min, 50 min, 60 min	Sets the value manually
		Disabled	Disables this function
Video power down mode	This option can be used to set the energy saving mode for the monitor.	Disabled	Does not switch off the monitor
		Standby	Switches the monitor to standby mode
		Suspend	Switches the monitor to suspend mode
Hard disk power down mode	This option is used to set the energy saving mode for the hard drive	Disabled	Does not switch off the monitor
		Standby	Switches the monitor to standby mode
		Suspend	Switches the monitor to suspend mode
Keyboard & PS/2 mouse	Configures the monitoring of activity during energy saving mode	MONITOR	Returns the system to its normal state from the respective energy saving mode when activity is detected on the keyboard or PS/2 mouse
		IGNORE	Ignores activity
FDC/LPT/COM ports	Configures the monitoring of activity during energy saving mode	MONITOR	Returns the system to its normal state from the respective energy saving mode when activity is detected on the parallel port, serial port 1&2 or the floppy drive port.
		IGNORE	Ignores activity
Primary master IDE	Configures the monitoring of activity during energy saving mode	MONITOR	Returns the system to its normal state from the respective energy saving mode when activity is detected on the IRQ of the respective interface or device
		IGNORE	Ignores activity
Primary slave IDE	Configures the monitoring of activity during energy saving mode	MONITOR	Returns the system to its normal state from the respective energy saving mode when activity is detected on the IRQ of the respective interface or device
		IGNORE	Ignores activity
Secondary master IDE	Configures the monitoring of activity during energy saving mode	MONITOR	Returns the system to its normal state from the respective energy saving mode when activity is detected on the IRQ of the respective interface or device
		IGNORE	Ignores activity
Secondary slave IDE	Configures the monitoring of activity during energy saving mode	MONITOR	Returns the system to its normal state from the respective energy saving mode when activity is detected on the IRQ of the respective interface or device
		IGNORE	Ignores activity
Resume on ring	Returns the PC from energy saving mode when the modem receives an incoming call	Enabled	Enables this function
		Disabled	Disables this function
Resume on PME#	Configures whether the PME wakeup function is enabled or disabled	Enabled	Enables this function
		Disabled	Disables this function
Resume on RTC alarm	This option can be used to enable the alarm and enter the date and time during system startup.	Enabled	Enables this function
		Disabled	Disables this function
Power button mode	This function determines what the power button does.	On/Off	Switches the system on/off
		Suspend	Suppresses this function

Table 217: 945GME Power menu - Configuration options

1.8 Exit

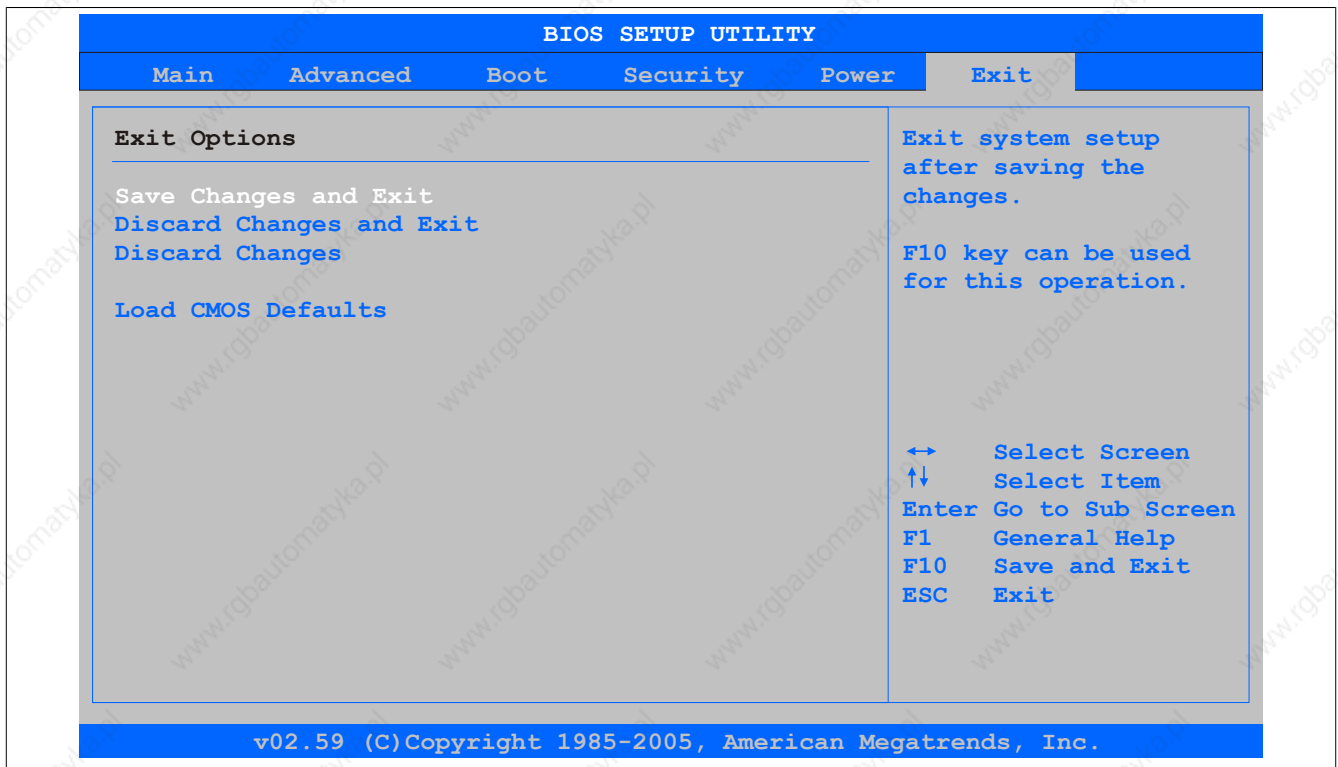

Figure 143: 945GME Exit menu

BIOS setting	Function	Configuration options	Effect
Save changes and exit	Selecting this option closes BIOS Setup. Any changes made are saved to CMOS after confirmation, and the system is rebooted.	OK / Cancel	
Discard changes and exit	Selecting this option closes BIOS Setup without saving any changes made. The start procedure is continued.	OK / Cancel	
Discard changes	This option can be used to reset any settings that may have been made but have been forgotten in the meantime (provided they have not yet been saved).	OK / Cancel	
Load CMOS defaults	This option loads the CMOS default values defined by the DIP switch settings. These values are loaded for all BIOS settings.	OK / Cancel	

Table 218: 855GME (XTX) Exit menu - Configuration options

1.9 BIOS default settings

The various positions of the CMOS profile hex switch can be used to load predefined BIOS profile settings.

Information:

The factory default switch position represents the optimal BIOS default values for this system and should therefore not be changed.

If the "Load setup defaults" function is selected in the main BIOS Setup screen, or if "Exit" is selected (or <F9> is pressed) in the individual setup screens, the following BIOS settings are the optimized values that will be used.

Profile number	Optimized for	Switch position	Note
Profile 0	Reserved	0	
Profile 1	System unit 5PC810.SX01-00 / 5PC810.SX02-00 / 5PC810.SX03-00	1	The default settings for this profile can be found in the APC810 user's manual. This can be downloaded at no cost from the B&R website.
Profile 2	System unit 5PC810.SX05-00	2	
Profile 3	System unit 5PC820.SX01-00 / 5PC820.SX01-01	3	The default settings for this profile can be found in the APC820 user's manual. This can be downloaded at no cost from the B&R website.
Profile 4	Reserved	4	
Profile 5	System unit 5PC820.1505-00 / 5PC820.1906-00	5	The default settings for this profile can be found in the PPC800 user's manual. This can be downloaded at no cost from the B&R website.

Table 219: Profile overview

The following pages provide an overview of the BIOS default settings for the different CMOS profile switch positions. Settings highlighted in yellow are variations from the BIOS default profile (=profile 0).

1.9.1 Main

Setting / Option	Profile 0	Profile 1	Profile 2	My setting
System time	-	-	-	
System date	-	-	-	
BIOS ID	-	-	-	
Processor	-	-	-	
CPU frequency	-	-	-	
System memory	-	-	-	
Product revision	-	-	-	
Serial number	-	-	-	
BC firmware rev.	-	-	-	
MAC address (ETH1)	-	-	-	
Boot counter	-	-	-	
Running time	-	-	-	

Table 220: 945GME Main (Profile setting overview)

1.9.2 Advanced

1.9.2.1 ACPI configuration

Setting / Option	Profile 0	Profile 1	Profile 2	My setting
ACPI aware O/S	Yes	Yes	Yes	
ACPI version features	ACPI v2.0	ACPI v2.0	ACPI v2.0	
ACPI APIC support	Enabled	Enabled	Enabled	
Suspend mode	S1 (POS)	S1 (POS)	S1 (POS)	
USB device wakeup from S3/S4	Disabled	Disabled	Disabled	
Active cooling trip point	Disabled	Disabled	Disabled	
Passive cooling trip point	Disabled	Disabled	Disabled	
Critical trip point	105°C	105°C	105°C	

Table 221: 945GME Advanced - ACPI configuration - Profile setting overview

1.9.2.2 PCI configuration

Setting / Option	Profile 0	Profile 1	Profile 2	My setting
Plug & Play O/S	No	Yes	Yes	
PCI latency timer	64	64	64	
Allocate IRQ to PCI VGA	Yes	Yes	Yes	
Allocate IRQ to SMBUS HC	Yes	Yes	Yes	
Allocate IRQ to PCIEX2	Yes	Yes	Yes	

Table 222: 945GME Advanced - PCI configuration - Profile setting overview

Setting / Option	Profile 0	Profile 1	Profile 2	My setting
PCI IRQ resource exclusion				
IRQ3	Allocated	Allocated	Allocated	
IRQ4	Allocated	Allocated	Allocated	
IRQ5	Available	Available	Available	
IRQ6	Available	Available	Available	
IRQ7	Available	Available	Available	
IRQ9	Allocated	Allocated	Allocated	
IRQ10	Available	Available	Available	
IRQ11	Allocated	Available	Available	
IRQ12	Available	Available	Available	
IRQ14	Allocated	Allocated	Allocated	
IRQ15	Allocated	Allocated	Allocated	
PCI interrupt routing				
PIRQ A (VGA,PCIEX0, ETH2,UHCI2)	Auto	Auto	Auto	
PIRQ B (AC97,PCIEX1, ETH1)	Auto	Auto	Auto	
PIRQ C (PCIEX2)	Auto	Auto	Auto	
PIRQ D (SATA,UHCI1,SMB, PCIEX3)	Auto	Auto	Auto	
PIRQ E (INTD,UHCI3,PATA)	Auto	Auto	Auto	
PIRQ F (INTA)	Auto	Auto	Auto	
PIRQ G (INTB)	Auto	Auto	Auto	
PIRQ H (INTC,UHCI0,EHCI)	Auto	Auto	Auto	
1st Exclusive PCI	-	-	-	
2nd Exclusive PCI	-	-	-	

Table 222: 945GME Advanced - PCI configuration - Profile setting overview

1.9.2.3 PCI Express configuration

Setting / Option	Profile 0	Profile 1	Profile 2	My setting
Active State Power-Management	Disabled	Disabled	Disabled	
PCIe port 0	Auto	Auto	Auto	
PCIe port 1	Auto	Auto	Auto	
PCIe Port 2 (IF slot)	Auto	Auto	Auto	
PCIe port 3	Auto	Auto	Auto	
PCIe Port 4 (ETH2)	Auto	Auto	Auto	
PCIe Port 5 (ETH1)	Auto	Auto	Auto	
PCIe high priority port	Disabled	Disabled	Disabled	
Res. PCIe hot plugging resource	No	No	No	
PCIe Port 0 IOxAPIC enable	Disabled	Disabled	Disabled	
PCIe Port 1 IOxAPIC enable	Disabled	Disabled	Disabled	
PCIe Port 2 IOxAPIC enable	Disabled	Disabled	Disabled	
PCIe Port 3 IOxAPIC enable	Disabled	Disabled	Disabled	

Table 223: 945GME Advanced - PCI Express configuration - Profile setting overview

1.9.2.4 Graphics configuration

Setting / Option	Profile 0	Profile 1	Profile 2	My setting
Primary video device	Internal VGA	Internal VGA	Internal VGA	
Internal graphics mode select	Enabled, 8MB	Enabled, 8MB	Enabled, 8MB	
DVMT mode select	DVMT mode	DVMT mode	DVMT mode	
DVMT/FIXED memory	128 MB	128 MB	128 MB	
Boot display device	Auto	Auto	Auto	
Boot display preference	SDVO-B SDVO-C LFP	SDVO-B SDVO-C LFP	SDVO-B SDVO-C LFP	
Local flat panel type	Auto	Auto	Auto	
Local flat panel scaling	Centering	Centering	Centering	
SDVO port B device	DVI	DVI	DVI	
SDVO port C device	DVI	DVI	DVI	
SDVO/DVI hot plugging support	Enabled	Enabled	Enabled	
Display mode persistence	Enabled	Enabled	Enabled	

Table 224: 945GME Advanced - Graphics configuration - Profile setting overview

1.9.2.5 CPU configuration

Setting / Option	Profile 0	Profile 1	Profile 2	My setting
MPS revision	1.4	1.4	1.4	
Max CPUID value limit	Disabled	Disabled	Disabled	
Execute disable bit	Enabled	Enabled	Enabled	
Core multi-processing	Enabled	Enabled	Enabled	
Intel(R) SpeedStep(tm) tech.	Automatic	Automatic	Automatic	
Max. CPU frequency	xxxx MHz	xxxx MHz	xxxx MHz	
C1 config.	Standard	Standard	Standard	
C2 config.	Disabled	Disabled	Disabled	
C3 config.	Disabled	Disabled	Disabled	
C4 config.	Disabled	Disabled	Disabled	

Table 225: 945GME Advanced - CPU configuration - Profile setting overview

1.9.2.6 Chipset configuration

Setting / Option	Profile 0	Profile 1	Profile 2	My setting
DRAM frequency	Auto	Auto	Auto	
DRAM refresh rate	Auto	Auto	Auto	
Memory hole	Disabled	Disabled	Disabled	
DIMM thermal control	Disabled	Disabled	Disabled	
DT in SPD	Disabled	Disabled	Disabled	
TS on DIMM	Disabled	Disabled	Disabled	
High precision event timer	Disabled	Disabled	Disabled	
IOAPIC	Enabled	Enabled	Enabled	
APIC ACPI SCI IRQ	Disabled	Disabled	Disabled	
C4 on C3	Disabled	Disabled	Disabled	

Table 226: 945GME Advanced - Chipset configuration - Profile setting overview

1.9.2.7 I/O interface configuration

Setting / Option	Profile 0	Profile 1	Profile 3	My setting
Onboard audio controller	AC97	AC97	AC97	

Table 227: 945GME Advanced - I/O interface configuration - Profile setting overview

1.9.2.8 Clock configuration

Setting / Option	Profile 0	Profile 1	Profile 2	My setting
Spread spectrum	Disabled	Disabled	Disabled	

Table 228: 945GME Advanced - Clock configuration - Profile setting overview

1.9.2.9 IDE configuration

Setting / Option	Profile 0	Profile 1	Profile 2	My setting
ATA/IDE Configuration	Compatible	Compatible	Compatible	
Legacy IDE channels	SATA Pri, PATA Sec	SATA Pri, PATA Sec	SATA Pri, PATA Sec	
Configure SATA as	-	-	-	
Configure SATA as Channels	-	-	-	
AHCI/RAID SATA hot plug	-	-	-	
Hard disk write protect	Disabled	Disabled	Disabled	
IDE detect timeout (sec)	35	35	35	
ATA(Pi) 80-pin cable detection	Host & device	Host & device	Host & device	
Primary IDE master				
Type	Auto	Auto	Auto	
LBA/Large mode	Auto	Auto	Auto	
Block (multi-sector transfer)	Auto	Auto	Auto	
PIO mode	Auto	Auto	Auto	
DMA mode	Auto	Auto	Auto	
S.M.A.R.T.	Auto	Auto	Auto	
32Bit data transfer	Enabled	Enabled	Enabled	
Primary IDE slave				
Type	Auto	Auto	Auto	
LBA/Large mode	Auto	Auto	Auto	
Block (multi-sector transfer)	Auto	Auto	Auto	
PIO mode	Auto	Auto	Auto	
DMA mode	Auto	Auto	Auto	
S.M.A.R.T.	Auto	Auto	Auto	
32Bit data transfer	Enabled	Enabled	Enabled	
Secondary IDE master				
Type	Auto	Auto	Auto	
LBA/Large mode	Auto	Auto	Auto	
Block (multi-sector transfer)	Auto	Auto	Auto	
PIO mode	Auto	Auto	Auto	
DMA mode	Auto	Auto	Auto	
S.M.A.R.T.	Auto	Auto	Auto	
32Bit data transfer	Enabled	Enabled	Enabled	
Secondary IDE slave				
Type	Auto	Auto	Auto	
LBA/Large mode	Auto	Auto	Auto	
Block (multi-sector transfer)	Auto	Auto	Auto	
PIO mode	Auto	Auto	Auto	
DMA mode	Auto	Auto	Auto	
S.M.A.R.T.	Auto	Auto	Auto	
32Bit data transfer	Enabled	Enabled	Enabled	

Table 229: 945GME Advanced - IDE configuration - Profile setting overview

1.9.2.10 USB configuration

Setting / Option	Profile 0	Profile 1	Profile 2	My setting
USB function	8 USB ports	8 USB ports	8 USB ports	
USB 2.0 controller	Enabled	Enabled	Enabled	
Legacy USB support	Enabled	Enabled	Enabled	
USB Legacy POST-always	Enabled	Enabled	Enabled	
USB keyboard Legacy support	Enabled	Enabled	Enabled	
USB mouse Legacy support	Disabled	Disabled	Disabled	
USB storage device support	Enabled	Enabled	Enabled	
Port 64/60 emulation	Disabled	Disabled	Disabled	
USB 2.0 controller mode	HiSpeed	HiSpeed	HiSpeed	
BIOS EHCI hand-off	Disabled	Disabled	Disabled	
USB beep message	Enabled	Enabled	Enabled	
USB stick default emulation	Hard disk drive	Hard disk drive	Hard disk drive	
USB mass storage reset delay	20 Sec	20 Sec	20 Sec	

Table 230: 945GME Advanced - USB configuration - Profile setting overview

1.9.2.11 Keyboard/Mouse configuration

Setting / Option	Profile 0	Profile 1	Profile 2	My setting
Bootup Num-lock	On	On	On	
Typematic rate	Fast	Fast	Fast	

Table 231: 945GME Advanced - Keyboard/Mouse configuration - profile setting overview

1.9.2.12 Remote access configuration

Setting / Option	Profile 0	Profile 1	Profile 2	My setting
Remote access	Disabled	Disabled	Disabled	
Serial Port Number	-	-	-	
Base address, IRQ	-	-	-	
Serial port Mode	-	-	-	
Flow control	-	-	-	
Redirection After BIOS POST	-	-	-	
Terminal type	-	-	-	
VT-UTF8 combo key support	-	-	-	
Sredir memory display delay	-	-	-	
Serial port BIOS update	Disabled	Disabled	Disabled	

Table 232: 945GME Advanced - Remote access configuration - Profile setting overview

1.9.2.13 CPU board monitor

Setting / Option	Profile 0	Profile 1	Profile 2	My setting
H/W health function	Enabled	Enabled	Enabled	

Table 233: 945GME Advanced CPU board monitor profile setting overview

1.9.2.14 Baseboard/Panel features

Setting / Option	Profile 0	Profile 1	Profile 2	My setting
Panel control				
Select panel number	-	-	-	
Version	-	-	-	
Brightness	100%	100%	100%	
Temperature	-	-	-	
Fan speed	-	-	-	
Keys/LEDs	-	-	-	
Baseboard monitor				
CMOS battery	-	-	-	
Board I/O	-	-	-	
Board ETH2	-	-	-	
Board power	-	-	-	
Power supply	-	-	-	
Slide-in drive 1	-	-	-	
Slide-in drive 2	-	-	-	
ETH2 controller	-	-	-	
Case 1	-	-	-	
Case 2	-	-	-	
Case 3	-	-	-	
Case 4	-	-	-	
Legacy devices				
COM A	Enabled	Enabled	Enabled	
Base I/O address	3F8	3F8	3F8	
Interrupt	IRQ4	IRQ4	IRQ4	
COM B	Enabled	Enabled	Enabled	
Base I/O address	2F8	2F8	2F8	
Interrupt	IRQ3	IRQ3	IRQ3	
COM C	Enabled	Disabled	Disabled	
Base I/O address	3E8	-	-	
Interrupt	IRQ11	-	-	
COM D	Disabled	Disabled	Disabled	
Base I/O address	-	-	-	
Interrupt	-	-	-	
COM E	Disabled	Disabled	Disabled	
Base I/O address	-	-	-	
Interrupt	-	-	-	
CAN	Disabled	Disabled	Disabled	
Hardware security key	Enabled	Enabled	Enabled	
Base I/O address	378	378	378	
ETH2 LAN Controller	Enabled	Enabled	Enabled	
ETH2 MAC Address	-	-	-	

Table 234: 945GME Advanced - Baseboard/Panel Features profile setting overview

1.9.3 Boot

Setting / Option	Profile 0	Profile 1	Profile 2	My setting
Boot priority selection	Type based	Type based	Type based	
1st boot device	Onboard LAN	Primary master	Primary master	
2nd boot device	Primary master	Primary Slave	Primary Slave	
3rd boot device	Primary Slave	USB floppy	USB floppy	
4th boot device	USB floppy	USB removable device	USB removable device	
5th boot device	USB removable device	USB hard disk	USB hard disk	
6th boot device	USB CDROM	USB CDROM	USB CDROM	
7th boot device	Secondary master	Secondary master	Secondary master	
8th boot device	Secondary slave	Secondary slave	Secondary slave	
Quick boot	Enabled	Enabled	Enabled	
Quiet boot	Disabled	Disabled	Disabled	
Automatic boot list retry	Disabled	Disabled	Disabled	
Add-on ROM display mode	Keep current	Keep current	Keep current	
Halt on error	Disabled	Disabled	Disabled	
Hit "DEL" message display	Enabled	Enabled	Enabled	
Interrupt 19 capture	Disabled	Disabled	Disabled	
PXE boot to LAN (ETH1)	Enabled	Disabled	Disabled	
Slide-in 2 optional ROM	Enabled	Disabled	Enabled	
Power loss control	Turn on	Turn on	Turn on	

Table 235: 945GME Main (Profile setting overview)

1.9.4 Security

Setting / Option	Profile 0	Profile 1	Profile 2	My setting
Supervisor password	-	-	-	
User password	-	-	-	
Boot sector virus protection	Disabled	Disabled	Disabled	
Hard disk security user password	-	-	-	
Hard disk security master password	-	-	-	

Table 236: 945GME Security profile setting overview

1.9.5 Power

Setting / Option	Profile 0	Profile 1	Profile 2	My setting
Power management/APM	Enabled	Enabled	Enabled	
Suspend time out	Disabled	Disabled	Disabled	
Video power down mode	Suspend	Suspend	Suspend	
Hard disk power down mode	Suspend	Suspend	Suspend	
Keyboard & PS/2 mouse	MONITOR	MONITOR	MONITOR	
FDC/LPT/COM ports	MONITOR	MONITOR	MONITOR	
Primary master IDE	MONITOR	MONITOR	MONITOR	
Primary slave IDE	MONITOR	MONITOR	MONITOR	
Secondary master IDE	MONITOR	MONITOR	MONITOR	
Secondary slave IDE	MONITOR	MONITOR	MONITOR	
Resume on ring	Disabled	Disabled	Disabled	
Resume on PME#	Disabled	Disabled	Disabled	
Resume on RTC alarm	Disabled	Disabled	Disabled	
Power button mode	On/Off	On/Off	On/Off	

Table 237: 945GME Power profile setting overview

1.10 BIOS error signals (beep codes)

While the B&R Industrial PC is booting, the following messages and errors can occur with BIOS. These errors are signaled by different beep codes.

Beep code	Description	Necessary user action
1x short	Memory refresh failed	Load BIOS defaults. If the error persists, send the industrial PC to B&R for testing.
2x short	Parity error: POST error (error in one of the hardware testing procedures)	Check that the card has been inserted properly. If the error persists, send the industrial PC to B&R for testing.
3x short	Base 64 kB memory failure: Basic memory error, RAM error within the initial 64 kB	Send the industrial PC to B&R for testing.
4x short	Timer not operational: System timer	Send the industrial PC to B&R for testing.
5x short	Processor error: Defective processor	Send the industrial PC to B&R for testing.
6x short	8042 gate A20 failure: Defective keyboard controller (block 8042/gate A20). The processor cannot switch to protected mode.	Send the industrial PC to B&R for testing.
7x short	Processor exception interrupt error: Virtual mode exception error (CPU generated an interrupt error)	Send the industrial PC to B&R for testing.
8x short	Display memory read/write error: Video memory not accessible, defective graphic card or not installed (not a fatal error)	Check that the graphics card has been inserted correctly, replace if necessary. If the error persists, send the industrial PC to B&R for testing.
9x short	ROM checksum error: ROM BIOS checksum incorrect; defective EPROM, EEPROM or flash ROM component; defective BIOS or incorrectly updated	Send the industrial PC to B&R for testing.
10x short	CMOS shutdown register read/write error: Unable to read/write from/to CMOS	Send the industrial PC to B&R for testing.
11x short	Cache error / external cache bad: Defective L2 cache on the main-board	Send the industrial PC to B&R for testing.

Table 238: 945GME BIOS - POST messages

1.11 Allocation of resources

1.11.1 RAM address assignment

RAM address	Address in hexadecimal	Resource
(TOM - 192 kB) – TOM ¹⁾	N.A.	ACPI reclaim, MPS and NVS area ²⁾
(TOM - 8 MB - 192 kB) – (TOM - 192 kB)	N.A.	VGA frame buffer ³⁾
1024 kB – (TOM - 8 MB - 192 kB)	100000h - N.A.	Extended memory
869 kB – 1024 kB	0E0000h - 0FFFFFFh	Runtime BIOS
832 kB – 869 kB	0D0000h - 0DFFFFh	Upper memory
640 kB – 832 kB	0A0000h - 0CFFFFh	Video memory and BIOS
639 kB – 640 kB	09FC00h - 09FFFFh	Extended BIOS data
0 – 639 kB	000000h - 09FC00h	Conventional memory

Table 239: RAM address assignment

- 1) TOM = Top of memory: Max. installed DRAM.
- 2) Only if ACPI Aware OS is set to "YES" in the setup.
- 3) The VGA frame buffer can be reduced to 1 MB in the setup.

1.11.2 I/O address assignments

I/O address	Resource
0000h - 00FFh	Motherboard resources
0170h - 0177h	Secondary IDE channel
01F0h - 01F7h	Primary IDE channel
0238h - 023Fh	COM5
0278h - 027Fh	Hardware security key (LPT2)
02E8h - 02EFh	COM4
02F8h - 02FFh	COM2
0376h - 0376h	Secondary IDE channel command port
0377h - 0377h	Secondary IDE channel status port
0378h - 037Fh	Hardware security key (LPT1)
0384h - 0385h	CAN controller
03B0h - 03DFh	Video system
03E8h - 03EFh	COM3
03F6h - 03F6h	Primary IDE channel command port
03F7h - 03F7h	Primary IDE channel status port
03F8h - 03FFh	COM1
0480h - 04BFh	Motherboard resources
04D0h - 04D1h	Motherboard resources
0800h - 087Fh	Motherboard resources
0CF8h - 0CFBh	PCI config address register
0CFCh - 0CFFh	PCI config data register
0D00h - FFFFh	PCI / PCI Express bus ¹⁾
4100h - 417Fh	MTCX
FF00h - FF07h	IDE bus master register

Table 240: I/O address assignment

- 1) The BIOS assigns the PCI and PCI Express bus I/O resources from FFF0h downward. Devices that are not compatible with PnP/PCI/PCI Express cannot use the I/O resources in this range.

1.11.3 Interrupt assignments in PIC mode

IRQ	0	1	2	3	4	5	6	7	8	9	10	11	12	13	14	15	NMI	NONE
System timer	•																	
Keyboard		•																
IRQ cascade			•															
COM1 (serial port A)				○	•	○	○	○			○	○	○					
COM2 (serial port B)				•	○	○	○	○			○	○	○					
ACPI ¹⁾										•								
Real-time clock									•									
Coprocessor (FPU)														•				
Primary IDE channel															•			
Secondary IDE channel																•		
B&R	COM3 (COM C)				○	○	○	○			○	○	○					•
	COM4 (COM D)				○	○	○	○			○	○	○					•
	COM5 (COM E)				○	○	○	○			○	○	○					•
	CAN				○	○	○	○			○	○	○				○	•

Table 241: IRQ interrupt assignments in PIC mode

- 1) Advanced Configuration and Power Interface.

- ... Default setting
- ... Optional setting

1.11.4 Interrupt assignments in APIC mode

A total of 23 IRQs are available in APIC (Advanced Programmable Interrupt Controller) mode. Enabling this option is only effective if done before the Windows operating system is installed.

IRQ	0	1	2	3	4	5	6	7	8	9	10	11	12	13	14	15	16	17	18	19	20	21	22	23	NMI	NONE
System timer	●																									
Keyboard		●																								
IRQ cascade			●																							
COM1 (serial port A)				○	●	○	○	○			○	○	○													
COM2 (serial port B)				●	○	○	○	○			○	○	○													
ACPI ¹⁾										●																
Real-time clock									●																	
Coprocessor (FPU)														●												
Primary IDE channel															●											
Secondary IDE channel																●										
B&R	COM3 (COM C)			○	○	○	○	○			○	○	○													●
	COM4 (COM D)			○	○	○	○	○			○	○	○													●
	COM5 (COM E)			○	○	○	○	○			○	○	○													●
	CAN			○	○	○	○	○			○	○	○											○		●
PIRQ A ²⁾																●										
PIRQ B ³⁾																	●									
PIRQ C ⁴⁾																		●								
PIRQ D ⁵⁾																			●							
PIRQ E ⁶⁾																				●						
PIRQ F ⁷⁾																					●					
PIRQ G ⁸⁾																						●				
PIRQ H ⁹⁾																							●			

Table 242: IRQ interrupt assignments in APIC mode

- 1) Advanced Configuration and Power Interface.
- 2) PIRQ A: for PCIe; UHCI host controller 3, VGA controller, PCI Express root port 0, Intel High Definition Audio controller, PCI-EX to SATA bridge
- 3) PIRQ B: for PCIe; AC'97 audio, PCI express root port 1, onboard gigabit LAN controller
- 4) PIRQ C: for PCIe; UHCI host controller 1, SMBus controller, PCI Express root port 3, Serial ATA controller in enhanced/native mode
- 5) PIRQ D: for PCIe, UHCI host controller 3, parallel ATA controller in enhanced/native mode
- 6) PIRQ E: PCI Bus INTD
- 7) PIRQ F: PCI Bus INTA
- 8) PIRQ G: PCI Bus INTB
- 9) PIRQ H: PCI bus INTC, UHCI host controller 0, EHCI host controller

- ... Default setting
- ... Optional setting

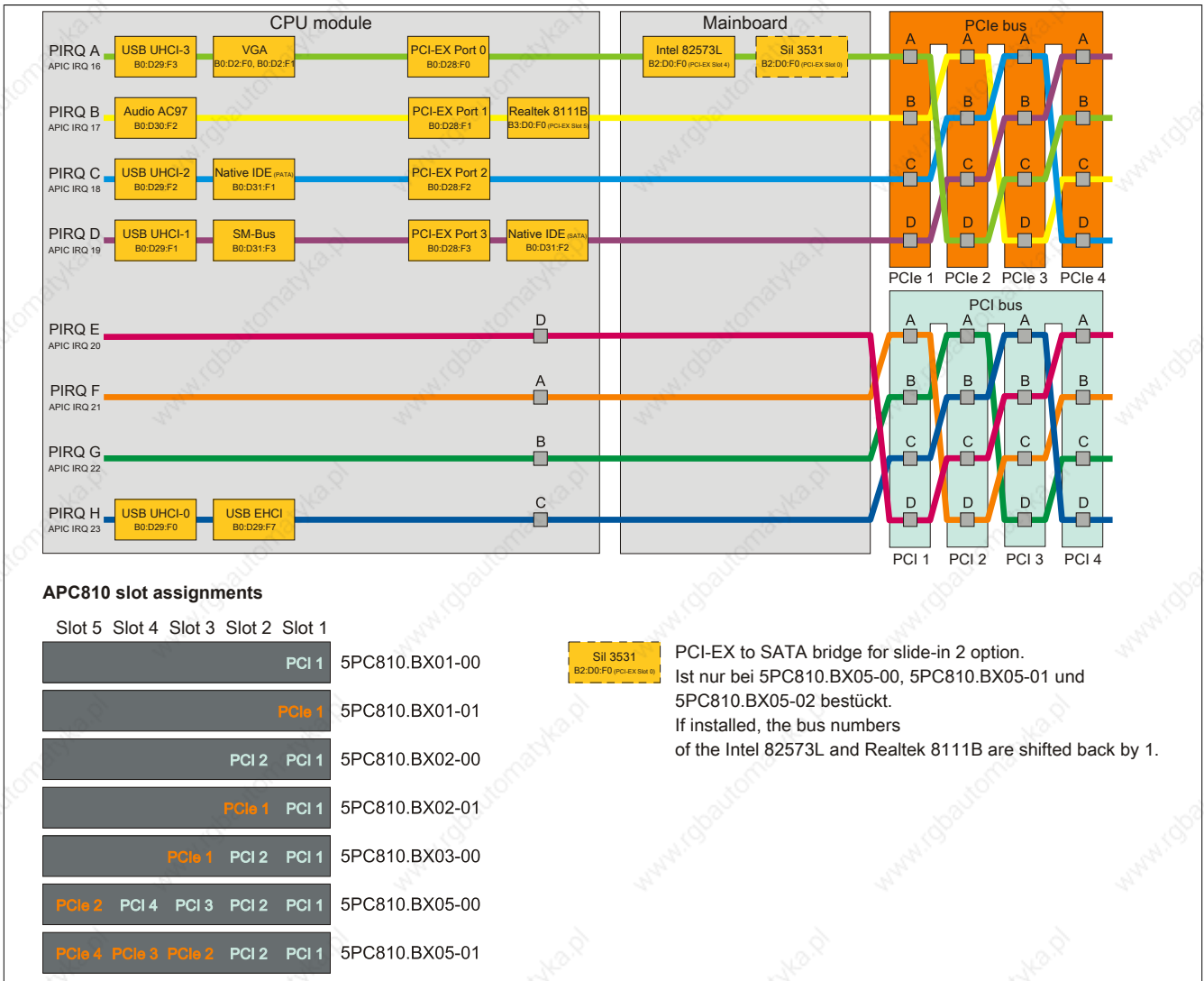

Figure 144: PCI and PCIe routing with enabled 945GME APIC CPU board (COM Express) for BIOS ≤ version 1.12

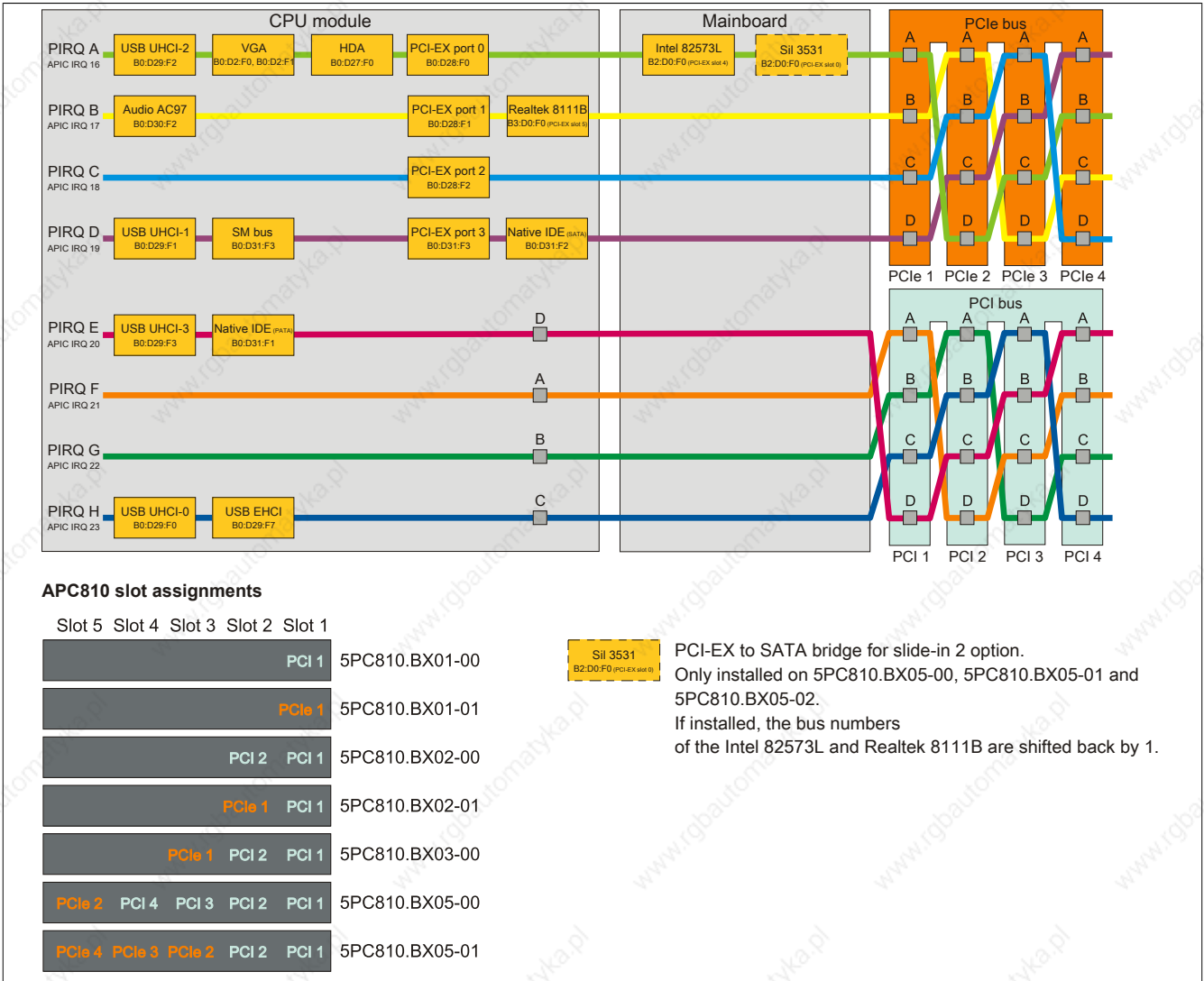

Figure 145: PCI and PCIe routing with enabled 945GME APIC CPU board (COM Express) for BIOS ≥ version 1.14 (bus units 5PC810.BX0x-0x)

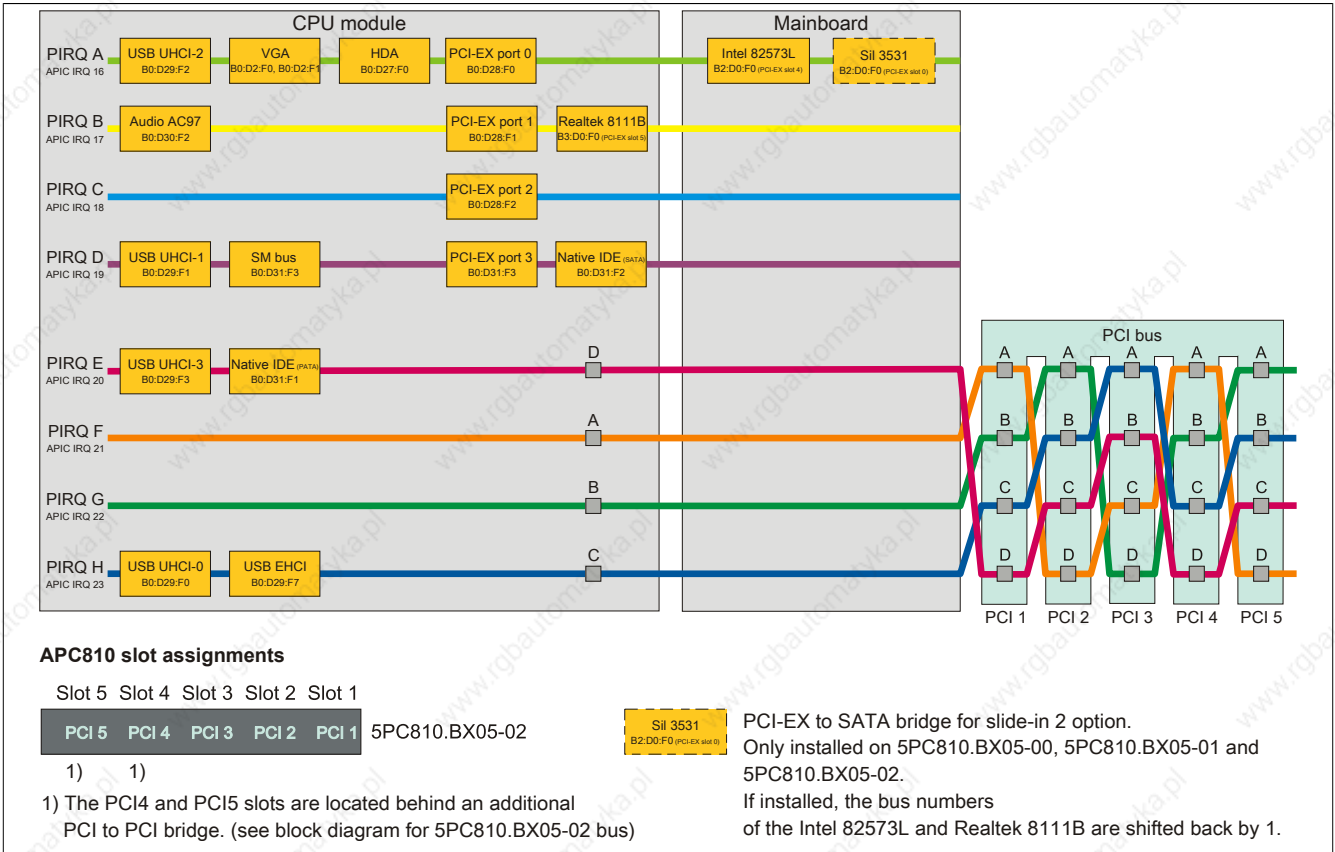

Figure 146: PCI and PCIe routing with enabled 945GME APIC CPU board (COM Express) for BIOS ≥ version 1.14 (bus unit 5PC810.BX05-02)

2 Upgrade information

Warning!

The BIOS and firmware on B&R devices must be kept current. New versions can be downloaded from the B&R website (www.br-automation.com).

2.1 BIOS upgrade

An upgrade may be necessary in order to accomplish the following:

- Updating implemented functions or adding newly implemented functions or components to BIOS Setup (information about changes can be found in the Readme file for the BIOS upgrade).

2.1.1 Important information

Information:

Customized BIOS settings are deleted when upgrading BIOS.

Before starting an upgrade, it helps to determine the various software versions.

2.1.1.1 Which BIOS version and firmware are already installed on the APC810?

This information can be found on the following BIOS Setup page:

- After switching on the APC810, the BIOS Setup screen can be accessed by pressing .
- From the BIOS main menu "Advanced", select "Baseboard/Panel features".

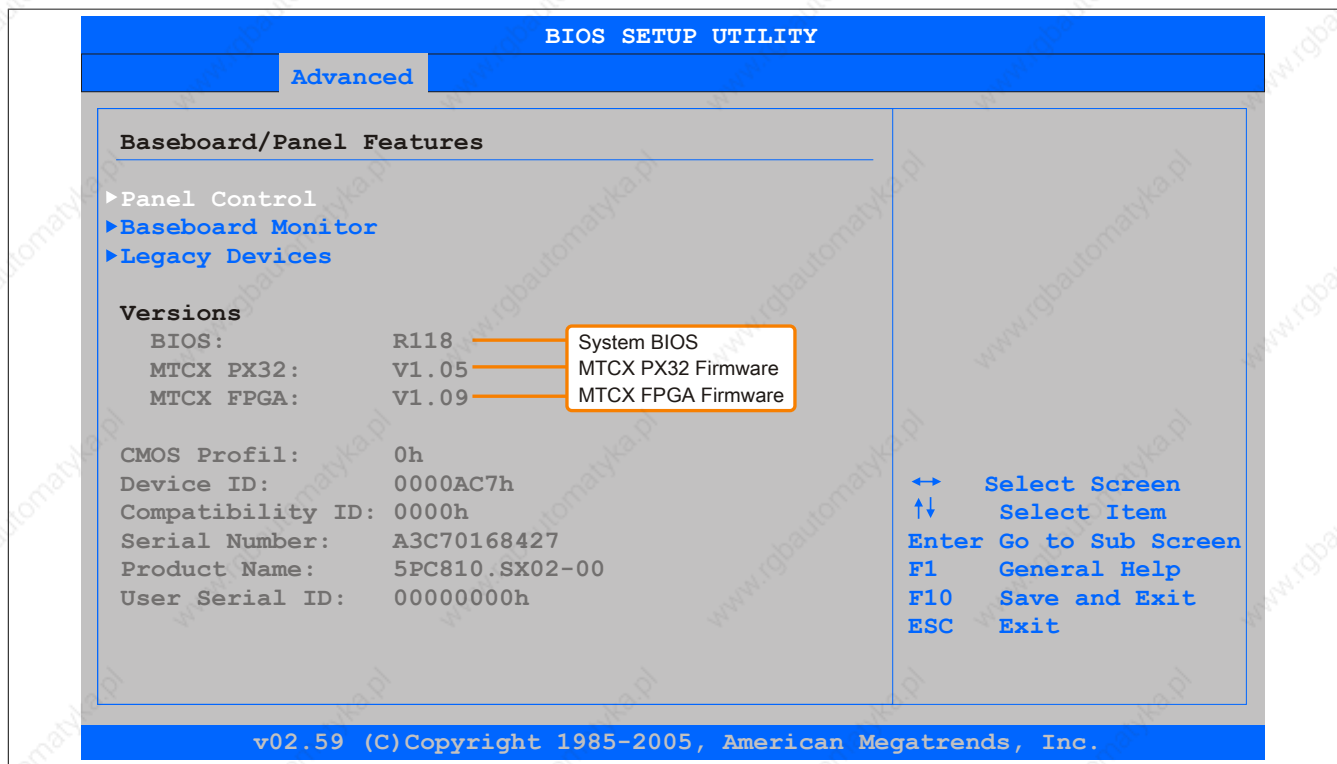

Figure 147: Software version

2.1.1.2 Which firmware is installed on the Automation Panel Link transmitter?

This information can be found on the following BIOS Setup page:

- After switching on the APC810, the BIOS Setup screen can be accessed by pressing .
- From the BIOS main menu "Advanced", select "Baseboard/Panel features" and then "Panel control".

Information:

The version can only be displayed when an Automation Panel with an AP Link SDL transmitter (5AC801.SDL0-00) is connected.

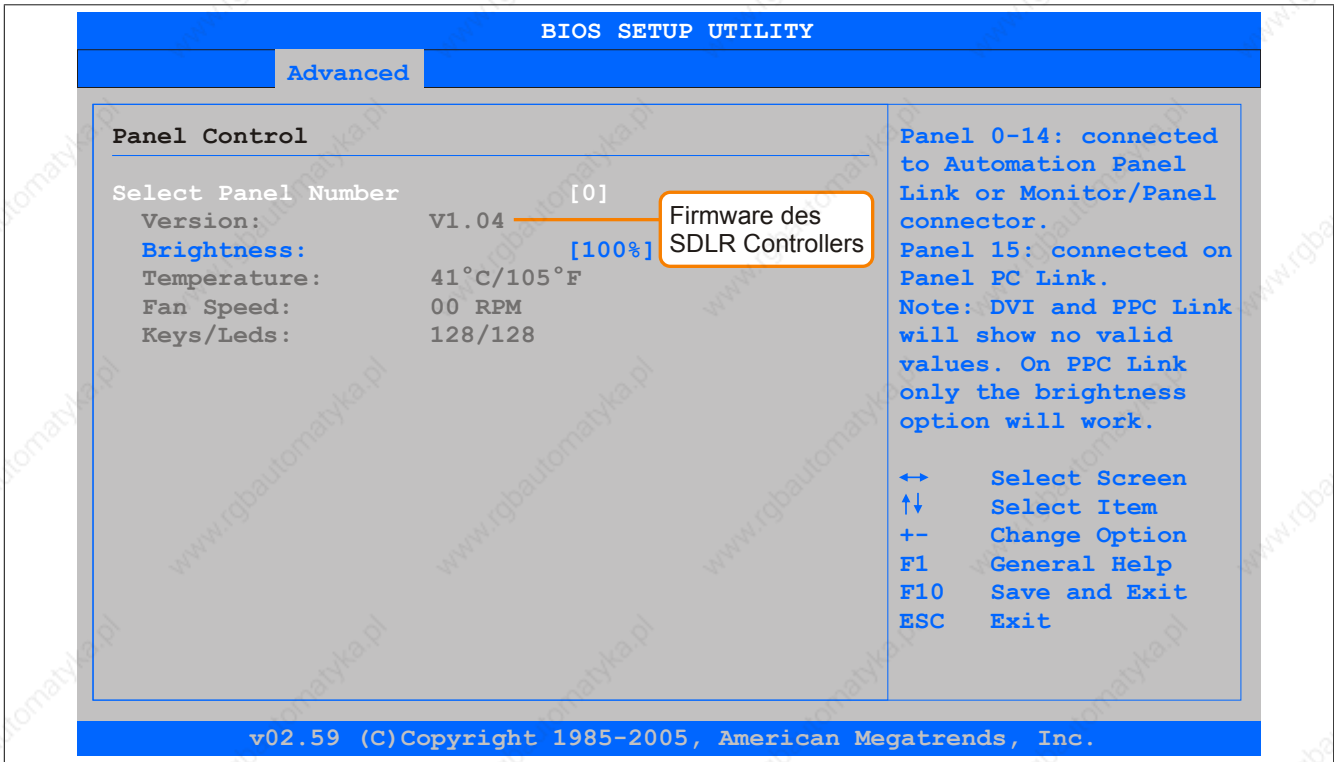

Figure 148: Firmware version of the AP Link SDL transmitter

2.1.2 Procedure with MS-DOS

1. Download the .zip file from the B&R website (www.br-automation.com).
2. Create bootable media.

Information:

In MS-DOS, Win95 and Win98, a blank HD disk can be made bootable by typing "sys a:" or "format a: /s" on the command line.

Information about creating a bootable diskette in Windows XP can be found on page 282.

Information on creating a USB flash drive for a B&R upgrade can be found on page 284.

Information on creating a CompactFlash card for a B&R upgrade can be found on page 285.

3. Copy the contents of the .zip file to the bootable media. If the B&R upgrade was already added when creating the bootable media with the B&R Embedded OS Installer, then this step is not necessary.
4. Connect the bootable media to the B&R device and reboot.
5. The following boot menu will be shown after startup:

```
1. Upgrade AMI BIOS for B945
2. Exit
```

Item 1:

BIOS is automatically upgraded (default after 5 seconds).

Item 2:

Returns to the shell (MS-DOS)

Information:

If a button is not pressed within 5 seconds, then item 1 "Upgrade AMI BIOS for B945" is automatically carried out to update the industrial PC.

6. The system must be rebooted after a successful upgrade.
7. Reboot and press to enter BIOS Setup and load the setup defaults, then select "Save changes and exit".

2.2 Firmware upgrade

The "Firmware upgrade (MTCX, SDLT, SDLR, UPS)" software makes it possible to update the firmware for multiple controllers (MTCX, SDLT, SDLR, UPSI) depending on the APC810 system variant.

The latest firmware upgrade is available in the Downloads section of the B&R website (www.br-automation.com).

2.2.1 Procedure

Proceed as follows to carry out a firmware upgrade:

1. Download the .zip file from the B&R website (www.br-automation.com).
2. Create bootable media.

Information:

In MS-DOS, Win95 and Win98, a blank HD disk can be made bootable by typing "sys a:" or "format a: /s" on the command line.

Information about creating a bootable diskette in Windows XP can be found on page 282.

Information on creating a USB flash drive for a B&R upgrade can be found on page 284.

Information on creating a CompactFlash card for a B&R upgrade can be found on page 285.

3. Copy the contents of the .zip file to the bootable media. If the B&R upgrade was already added when creating the bootable media with the B&R Embedded OS Installer, then this step is not necessary.
4. Connect the bootable media to the B&R device and reboot.
5. The following boot menu will be shown after startup:

Information:

The following boot menu options including descriptions are based on Version 1.00 of the APC800 upgrade (MTCX, SDLR, SDLT, UPSI) disk. In some cases, these descriptions might not match the version you are currently using.

```

1. Upgrade MTCX (APC810) PX32 and FPGA
2. Upgrade SDLT (APC810) only
3. Upgrade SDLR (AP800/AP900) on monitor/panel
3.1 Upgrade SDLR on AP 0 (AP800/AP900)
3.2 Upgrade SDLR on AP 1 (AP800/AP900)
3.3 Upgrade SDLR on AP 2 (AP800/AP900)
3.4 Upgrade SDLR on AP 3 (AP800/AP900)
3.5 Upgrade all SDLR (AP800/AP900)
3.6 Return to main menu
4. Upgrade SDLR (AP800/AP900) on AP link slot
4.1 Upgrade SDLR on AP 8 (AP800/AP900)
4.2 Upgrade SDLR on AP 9 (AP800/AP900)
4.3 Upgrade SDLR on AP 10 (AP800/AP900)
4.4 Upgrade SDLR on AP 11 (AP800/AP900)
4.5 Upgrade all SDLR (AP800/AP900)
4.6 Return to main menu
5. Upgrade add-on UPS (firmware and battery settings)
5.1 Upgrade add-on UPS firmware (5AC600.UPSI-00)
5.2 Upgrade Battery Settings (5AC600.UPSB-00)
5.3 Return to main menu
6. Exit

```

Item 1:

Automatically upgrades the PX32 and FPGA of the MTCX (default after 5 seconds)

Item 2:

Automatically updates the FPGA of the SDLT controller on the AP Link slot

Item 3:

Opens Submenu 1 for upgrading the SDLR controller on the monitor/panel interface

3.1 Upgrade SDLR on AP 0 (AP800/AP900)

Automatically updates the SDLR controller on the Automation Panel 0 interface

3.2 Upgrade SDLR on AP 1 (AP800/AP900)

Automatically updates the SDLR controller on the Automation Panel 1 interface

3.3 Upgrade SDLR on AP 2 (AP800/AP900)

Automatically updates the SDLR controller on the Automation Panel 2 interface

3.4 Upgrade SDLR on AP 3 (AP800/AP900)

Automatically updates the SDLR controller on the Automation Panel 3 interface

3.5 Upgrade all SDLR (AP800/AP900)

Automatically updates all SDLR controllers on all Automation Panels on the monitor/panel interface (default selection after 5 sec)

3.6 Return to main menu

Returns to the main menu

Item 4:

Opens Submenu 2 for upgrading the SDLR controller on the AP Link slot

4.1 Upgrade SDLR on AP 8 (AP800/AP900)

Automatically updates the SDLR controller on the Automation Panel 8 interface

4.2 Upgrade SDLR on AP 9 (AP800/AP900)

Automatically updates the SDLR controller on the Automation Panel 9 interface

4.3 Upgrade SDLR on AP 10 (AP800/AP900)

Automatically updates the SDLR controller on the Automation Panel 10 interface

4.4 Upgrade SDLR on AP 11 (AP800/AP900)

Automatically updates the SDLR controller on the Automation Panel 11 interface

4.5 Upgrade all SDLR (AP800/AP900)

Automatically updates all SDLR controllers on all Automation Panels on the AP Link slot (default selection after 5 sec).

4.6 Return to main menu

Returns to the main menu

Item 5:

Opens Submenu 3 for upgrading the add-on UPS firmware and battery settings

5.1 Upgrade add-on UPS firmware (5AC600.UPSI-00)

Updates the firmware for the add-on UPSI

5.2 Upgrade battery settings (5AC600.UPSB-00)

Automatically updates the battery settings for 5AC600.UPSB-00

5.3 Return to main menu

Returns to the main menu

Item 6:

Returns to the shell (MS-DOS)

Information:

The system must be powered off and back on again after a successful upgrade.

2.2.2 Possible upgrade problems and software dependencies (for V1.00)

- The SDLR firmware can only be updated if an Automation Panel with Automation Panel Link transceiver (5DLSDL.1000-01) and Automation Panel Link receiver (5DLSDL.1000-00) is connected.
- Automation Panel Link transceivers (5DLSDL.1000-01) or Automation Panel Link receivers (5DLSDL.1000-00) with a firmware version less than or equal to V00.10 can no longer be combined with Automation Panel Link transceivers (5DLSDL.1000-01) or Automation Panel Link receivers (5DLSDL.1000-00) with a firmware version greater than or equal to V01.04. Daisy chain mode is not possible with this type of a combination.
- If a UPS (e.g. 5AC600.UPSI-00) + battery unit (e.g. 5AC600.UPSB-00) is connected to the system and ready to be operated, then either the battery must be disconnected or the Power button pushed after upgrading the MTCX or SDLT (to put the system in standby mode) before powering the system off and back on. If this is not done, the firmware upgrade will not work since the UPS is buffering the system.

- The "Legacy mouse support" and "Keyboard controller reset" functions are only provided starting with the MTCX PX32 V00.12 and MTCX FPGA V00.09 combination (included on APC810 MTCX upgrade disk V00.05).

2.3 Creating an MS-DOS boot diskette in Windows XP

1. Insert a blank 1.44 MB HD diskette into the disk drive.
2. Open Windows Explorer.
3. Right-click on the 3½ floppy diskette icon and select "Format".

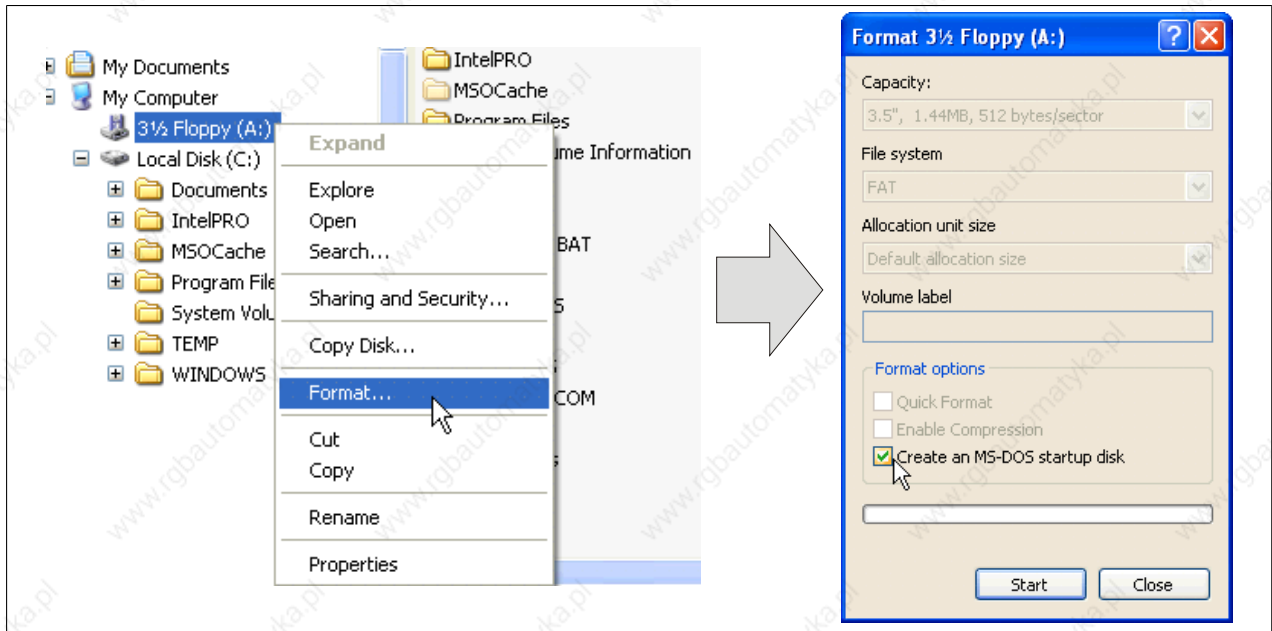

Figure 149: Creating a bootable diskette in Windows XP - Step 1

4. Select the **"Create an MS-DOS startup disk"** option, click on **"Start"** and acknowledge the warning message with **"OK"**.

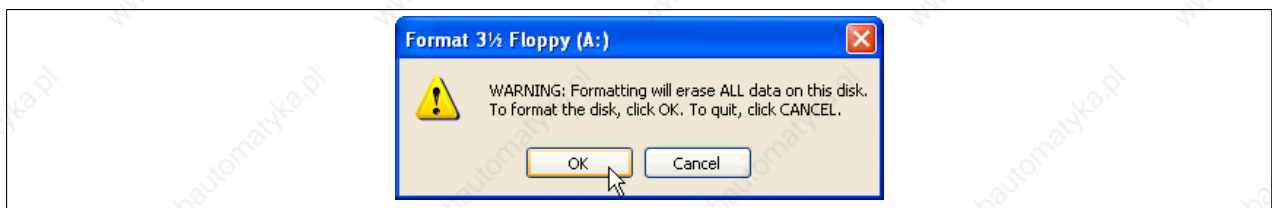

Figure 150: Creating a bootable diskette in Windows XP - Step 2

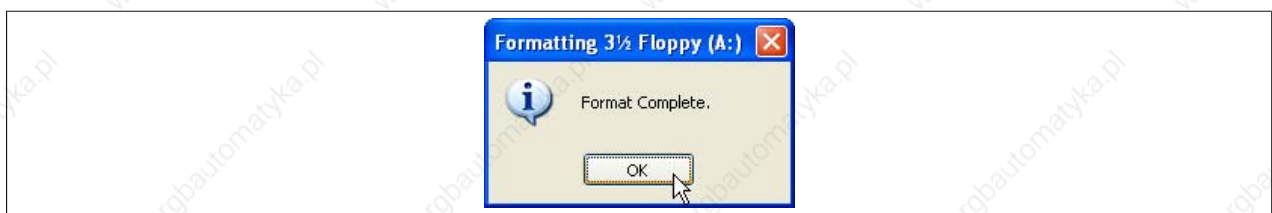

Figure 151: Creating a bootable diskette in Windows XP - Step 3

After creating the startup disk, some of the files must be deleted because of the size of the update.

To do this, all files (hidden system files, etc.) must be visible on the diskette.

In Windows Explorer, go to the "Tools" menu, select "Folder options" and open the "View" tab. Then deselect the option "Hide protected operating system files (Recommended)" (enabled by default) and enable the option "Show hidden files and folders".

before				after			
Name	Size	Type	Date Modified	Name	Size	Type	Date Modified
DISPLAY.SYS	17 KB	System file	6/8/2000 5:00 PM	AUTOEXEC.BAT	0 KB	MS-DOS Batch File	3/22/2006 10:08 AM
EGA2.CPI	58 KB	CPI File	6/8/2000 5:00 PM	COMMAND.COM	91 KB	MS-DOS Application	6/8/2000 5:00 PM
EGA3.CPI	58 KB	CPI File	6/8/2000 5:00 PM	CONFIG.SYS	0 KB	System file	3/22/2006 10:08 AM
EGA.CPI	58 KB	CPI File	6/8/2000 5:00 PM	DISPLAY.SYS	17 KB	System file	6/8/2000 5:00 PM
KEYB.COM	22 KB	MS-DOS Application	6/8/2000 5:00 PM	EGA2.CPI	58 KB	CPI File	6/8/2000 5:00 PM
KEYBOARD.SYS	34 KB	System file	6/8/2000 5:00 PM	EGA3.CPI	58 KB	CPI File	6/8/2000 5:00 PM
KEYBRD2.SYS	32 KB	System file	6/8/2000 5:00 PM	EGA.CPI	58 KB	CPI File	6/8/2000 5:00 PM
KEYBRD3.SYS	31 KB	System file	6/8/2000 5:00 PM	IO.SYS	114 KB	System file	5/15/2001 6:57 PM
KEYBRD4.SYS	13 KB	System file	6/8/2000 5:00 PM	KEYB.COM	22 KB	MS-DOS Application	6/8/2000 5:00 PM
MODE.COM	29 KB	MS-DOS Application	6/8/2000 5:00 PM	KEYBOARD.SYS	34 KB	System file	6/8/2000 5:00 PM
				KEYBRD2.SYS	32 KB	System file	6/8/2000 5:00 PM
				KEYBRD3.SYS	31 KB	System file	6/8/2000 5:00 PM
				KEYBRD4.SYS	13 KB	System file	6/8/2000 5:00 PM
				MODE.COM	29 KB	MS-DOS Application	6/8/2000 5:00 PM
				MSDOS.SYS	1 KB	System file	4/7/2001 1:40 PM

Figure 152: Creating a bootable diskette in Windows XP - Step 4

Name	Size	Type	Date Modified
AUTOEXEC.BAT	0 KB	MS-DOS Batch File	3/22/2006 10:08 AM
COMMAND.COM	91 KB	MS-DOS Application	6/8/2000 5:00 PM
CONFIG.SYS	0 KB	System file	3/22/2006 10:08 AM
DISPLAY.SYS	17 KB	System file	6/8/2000 5:00 PM
EGA2.CPI	58 KB	CPI File	6/8/2000 5:00 PM
EGA3.CPI	58 KB	CPI File	6/8/2000 5:00 PM
EGA.CPI	58 KB	CPI File	6/8/2000 5:00 PM
IO.SYS	114 KB	System file	5/15/2001 6:57 PM
KEYB.COM	22 KB	MS-DOS Application	6/8/2000 5:00 PM
KEYBOARD.SYS	34 KB	System file	6/8/2000 5:00 PM
KEYBRD2.SYS	32 KB	System file	6/8/2000 5:00 PM
KEYBRD3.SYS	31 KB	System file	6/8/2000 5:00 PM
KEYBRD4.SYS	13 KB	System file	6/8/2000 5:00 PM
MODE.COM	29 KB	MS-DOS Application	6/8/2000 5:00 PM
MSDOS.SYS	1 KB	System file	4/7/2001 1:40 PM

Figure 153: Creating a bootable diskette in Windows XP - Step 5

Now all files (selected) except Command.com, IO.sys and MSDOS.sys can be deleted.

2.4 Creating a bootable USB flash drive for B&R upgrade files

When used in connection with a B&R Industrial PC, it is possible to upgrade (e.g. upgrade BIOS) from one of the USB flash drives available from B&R. To do this, the USB flash drive must be prepared accordingly. This is done with the B&R Embedded OS Installer, which can be downloaded at no cost from the B&R website (www.br-automation.com).

2.4.1 Requirements

The following is required to create a bootable USB flash drive:

- B&R USB flash drive
- B&R Industrial PC
- USB media drive
- B&R Embedded OS Installer (V3.00 or higher)

2.4.2 Procedure

1. Connect the USB flash drive to the PC.
2. If the drive list is not refreshed automatically, the list can be updated using the command **Drives > Refresh**.
3. Select the desired USB flash drive in the drive list.
4. Change to the **Action** tab and select **Install a B&R update to a USB flash drive** as the type of action.
5. Enter the path to the MS-DOS operating system files. If the files are part of a .zip archive, then click on the button **From .zip file**. If the files are stored in a directory on the hard drive, then click on the button **From folder**.
6. In the **B&R upgrade** text box, it is also possible to enter the path to the .zip file for the B&R upgrade disk and select the file.
7. Click on the **Start action** button in the toolbar.

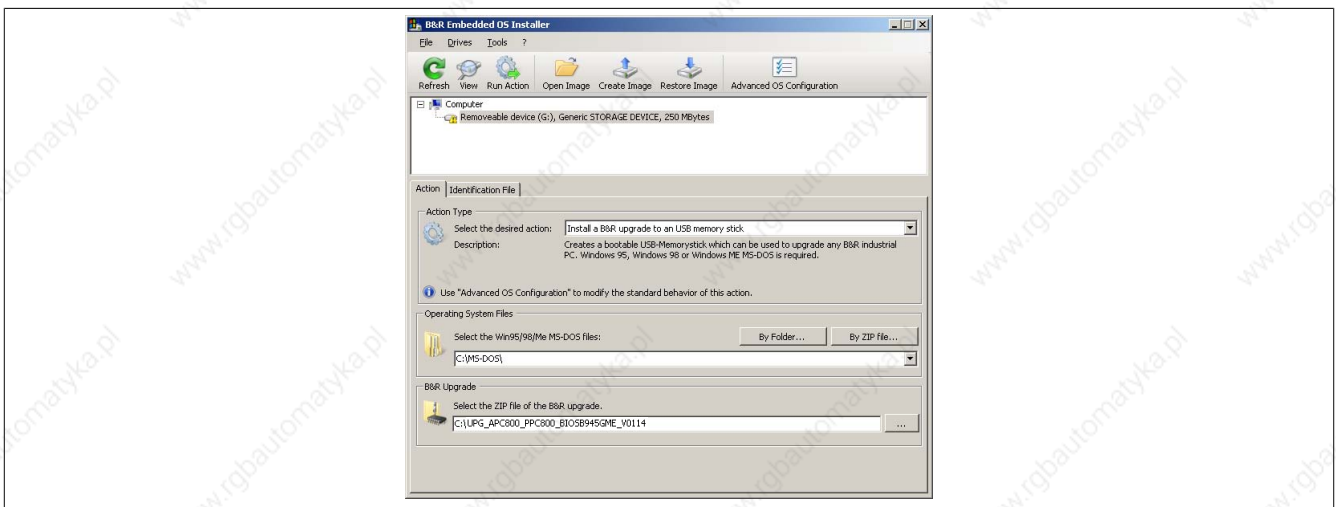

Figure 154: Creating a USB flash drive for B&R upgrade files

2.4.3 How to access MS-DOS

Information on creating an MS-DOS boot diskette can be found in section see "Creating an MS-DOS boot diskette in Windows XP" on page 282. The files from the diskette are then copied to the hard drive.

2.5 Creating a bootable CompactFlash card for B&R upgrade files

When used in connection with a B&R industrial PC, it is possible to upgrade (e.g. upgrade BIOS) from one of the CompactFlash cards available from B&R. To do this, the CompactFlash card must be prepared accordingly. This is done with the B&R Embedded OS Installer, which can be downloaded at no cost from the B&R website (www.br-automation.com).

2.5.1 Requirements

The following peripherals are required for creating a bootable CompactFlash card:

- CompactFlash card
- B&R Industrial PC
- USB media drive
- B&R Embedded OS Installer (at least V3.10)

2.5.2 Procedure

1. Insert the CompactFlash card in the CF slot on the industrial PC.
2. If the drive list is not refreshed automatically, the list can be updated using the command **Drives > Refresh**.
3. Select the desired CompactFlash card from the drive list.
4. Change to the **Action** tab and select **Install a B&R Update to a CompactFlash card** as the type of action.
5. Enter the path to the MS-DOS operating system files. If the files are part of a .zip archive, then click on the button **From .zip file**. If the files are stored in a directory on the hard drive, then click on the button **From folder**.
6. In the **B&R upgrade** text box, it is also possible to enter the path to the .zip file for the B&R upgrade disk and select the file.
7. Click on the **Start action** button in the toolbar.

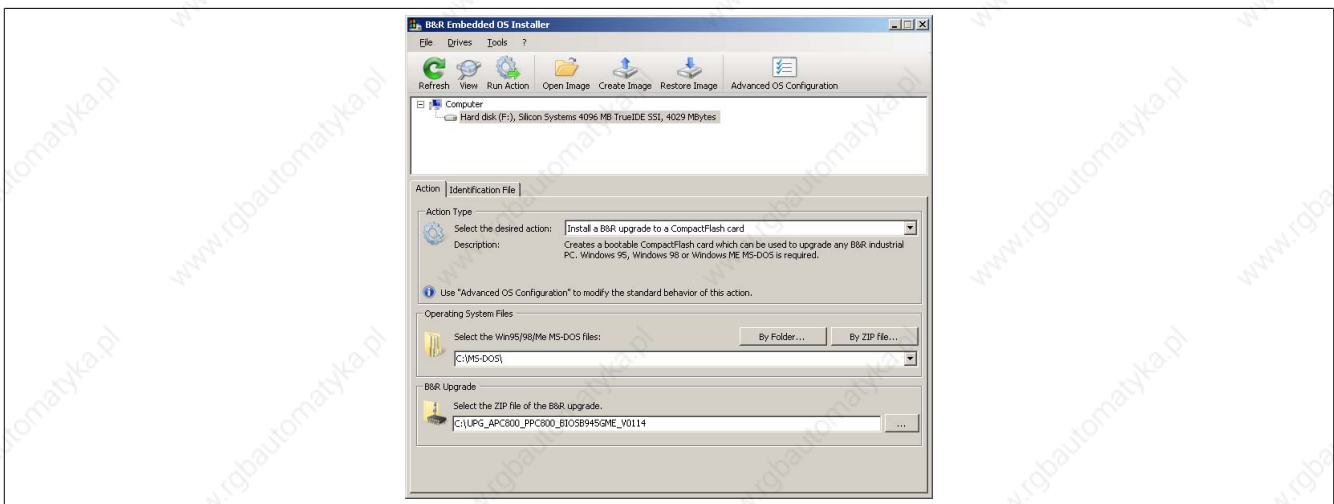

Figure 155: Creating a CompactFlash card for B&R upgrade files

2.5.3 How to access MS-DOS

Information on creating an MS-DOS boot diskette can be found in section see "Creating an MS-DOS boot diskette in Windows XP" on page 282. The files from the diskette are then copied to the hard drive.

2.6 Upgrade problems

Potential upgrade problems are listed in the Readme.txt files on the upgrade disks.

3 Microsoft DOS

3.1 Order data

Model number	Short description	Figure
9S0000.01-010	OEM Microsoft MS-DOS 6.22, German floppy disks, only supplied together with a new PC	
9S0000.01-020	OEM Microsoft MS-DOS 6.22, English floppy disks, only supplied together with a new PC	

Table 243: 9S0000.01-010, 9S0000.01-020 - Order data

3.2 Known problems

Either no drivers are available for the following hardware components or only with limitations:

- AC97 sound is not supported.
- USB 2.0: only USB 1.1 rates can be achieved.
- A second graphics line (for e.g. extended desktop mode) cannot be used.
- Some "ACPI control" functions in BIOS cannot be used.

3.3 Resolutions and color depths

The following table shows the tested resolutions and color depths on the monitor/panel interface with 945GME CPU boards.

Resolutions for DVI	Color depth		
	8-bit	16-bit	24-bit
640 x 480	✓	✓	✓
800 x 600	✓	✓	✓
1024 x 768	✓	✓	✓
1280 x 1024	✓	✓	✓

Table 244: Tested resolutions and color depths for DVI signals

Resolutions for RGB	Color depth		
	8-bit	16-bit	24-bit
640 x 480	✓	✓	✓
800 x 600	✓	✓	✓
1024 x 768	✓	✓	✓
1280 x 1024	✓	✓	✓
1600 x 1200	✓	✓	✓
1920 x 1440	✓	✓	✓

Table 245: Tested resolutions and color depths for RGB signals

4 Windows XP Professional

4.1 Order data

Model number	Short description	Figure
	Windows XP Professional	
5SWWXP.0600-ENG	Microsoft OEM Windows XP Professional Service Pack 3, CD, English. Only available with a new device.	
5SWWXP.0600-GER	Microsoft OEM Windows XP Professional Service Pack 3, CD, German. Only available with a new device.	
5SWWXP.0600-MUL	Microsoft OEM Windows XP Professional Service Pack 3, CD, multilingual. Only available with a new device.	
5SWWXP.0500-ENG	Microsoft OEM Windows XP Professional Service Pack 2c, CD, English. Only available with a new device.	
5SWWXP.0500-GER	Microsoft OEM Windows XP Professional Service Pack 2c, CD, German. Only available with a new device.	
5SWWXP.0500-MUL	Microsoft OEM Windows XP Professional Service Pack 2c, CD, multilingual. Only available with a new device.	

Table 246: 5SWWXP.0600-ENG, 5SWWXP.0600-GER, 5SWWXP.0600-MUL, 5SWWXP.0500-ENG, 5SWWXP.0500-GER, 5SWWXP.0500-MUL - Order data

4.2 Overview

Model number	Edition	Target system	Chipset	Service Pack	Language	Preinstalled	Memory required on the disk	Minimum amount of RAM
5SWWXP.0600-ENG	Professional	APC510 APC511 APC620 APC810 APC820 APC910 PPC700 PPC725 PPC800 PP500	945GME GM45 QM77/HM76 NM10 US15W	SP3	English	Optional	≤ 2.1 GB	128 MB
5SWWXP.0600-GER	Professional	APC510 APC511 APC620 APC810 APC820 APC910 PPC700 PPC725 PPC800 PP500	945GME GM45 QM77/HM76 NM10 US15W	SP3	German	Optional	≤ 2.1 GB	128 MB
5SWWXP.0600-MUL	Professional	APC510 APC511 APC620 APC810 APC820 APC910 PPC700 PPC725 PPC800 PP500	945GME GM45 QM77/HM76 NM10 US15W	SP3	Multilingual	Optional	≤ 2.1 GB	128 MB
5SWWXP.0500-ENG	Professional	APC620 APC810 APC820 PPC700 PPC725 PPC800	945GME GM45	SP2c	English	Optional	≤ 2.1 GB	128 MB
5SWWXP.0500-GER	Professional	APC620 APC810 APC820 PPC700 PPC725 PPC800	945GME GM45	SP2c	German	Optional	≤ 2.1 GB	128 MB
5SWWXP.0500-MUL	Professional	APC620 APC810 APC820 PPC700 PPC725 PPC800	945GME GM45	SP2c	Multilingual	Optional	≤ 2.1 GB	128 MB

4.3 Installation

Upon request, B&R can preinstall the required Windows XP Professional version on the desired mass storage device (e.g. CompactFlash card, etc.). All of the drivers required for operation (graphics, network, etc.) are also installed in this process.

4.3.1 Installation on a PCI SATA RAID controller - 5ACPCI.RAIC-03, 5ACPCI.RAIC-05, 5ACPCI.RAIC-06

The following steps are necessary to install Windows XP Professional on a PCI SATA RAID controller:

1. Download the RAID driver from the B&R website www.br-automation.com and copy the files to a diskette.
2. Connect the media drive (5MD900.USB2-01 or 5MD900.USB2-00) to the USB port.
3. Insert the diskette and Windows XP Professional CD in the media drive and boot from the CD.
4. Press the F6 key during installation to install a third-party SCSI or driver.
5. Press the "s" key when asked about installing an additional drive. Insert the diskette into the floppy drive. Press "Enter" and select the driver.
6. Follow the installation instructions.
7. The installer will copy the files to the Windows XP Professional folder and restart the Automation PC 810.

4.3.2 For variants with 5 PCI slots

The following steps are necessary when installing to a slide-in HDD being operated in slide-in slot 2 (located behind the PCI to SATA bridge) on the APC810:

1. Download the Si3531 SATA driver from the B&R website www.br-automation.com and copy the files to a diskette.
2. Connect the media drive (5MD900.USB2-01 or 5MD900.USB2-00) to the USB port.
3. Insert the diskette and Windows XP Professional CD in the media drive and boot from the CD.
4. Press the F6 key during installation to install a third-party SCSI or driver.
5. Press the "s" key when asked about installing an additional drive. Insert the diskette into the floppy drive. Press "Enter" and select the driver.
6. Follow the installation instructions.
7. The installer will copy the files to the Windows XP Professional folder and restart the Automation PC 810.

Information:

- **Not all USB FDD drives are supported by the Windows XP installer (see Microsoft KB 916196).**
- **Depending on the system, the boot order may have to be changed in BIOS.**

4.4 Drivers

Current drivers for all approved operating systems are available in the Downloads section of the B&R website www.br-automation.com.

Information:

Required drivers can only be downloaded from the B&R website, not from manufacturer websites.

5 Windows 7

5.1 General information

Windows® 7 offers a wealth of innovative features and performance improvements. The 64-bit variants can also exploit the full power of current PC architectures. Faster switching to power saving mode, quicker restores, less memory usage and high-speed detection of USB devices are just a few of the advantages provided by Windows® 7. Both English and German are available in Windows® 7 Professional, while Windows® 7 Ultimate supports up to 35 different languages (up to 36 languages in Service Pack 1). Product activation is not necessary on B&R PCs, which is a huge advantage for simple logistical procedures relating to machine automation.

All of the Windows® operating systems offered by B&R are from the Microsoft Embedded division. This guarantees much longer availability, especially compared to products offered on the consumer market.

5.2 Order data

Model number	Short description	Figure
	Windows 7 Professional/Ultimate	
5SWWI7.0100-ENG	Microsoft OEM Windows 7 Professional 32-bit, DVD, English. Only available with a new device.	
5SWWI7.1100-ENG	Microsoft OEM Windows 7 Professional 32-bit, Service Pack 1, DVD, English. Only available with a new device.	
5SWWI7.0100-GER	Microsoft OEM Windows 7 Professional 32-bit, DVD, German. Only available with a new device.	
5SWWI7.1100-GER	Microsoft OEM Windows 7 Professional 32-bit, Service Pack 1, DVD, German. Only available with a new device.	
5SWWI7.0300-MUL	Microsoft OEM Windows 7 Ultimate 32-bit, DVD, multilingual. Only available with a new device.	
5SWWI7.1300-MUL	Microsoft OEM Windows 7 Ultimate 32-bit, Service Pack 1, DVD, multilingual. Only available with a new device.	
5SWWI7.0200-ENG	Microsoft OEM Windows 7 Professional 64-bit, DVD, English. Only available with a new device.	
5SWWI7.1200-ENG	Microsoft OEM Windows 7 Professional 64-bit, Service Pack 1, DVD, English. Only available with a new device.	
5SWWI7.0200-GER	Microsoft OEM Windows 7 Professional 64-bit, DVD, German. Only available with a new device.	
5SWWI7.1200-GER	Microsoft OEM Windows 7 Professional 64-bit, Service Pack 1, DVD, German. Only available with a new device.	
5SWWI7.0400-MUL	Microsoft OEM Windows 7 Ultimate 64-bit, DVD, multilingual. Only available with a new device.	
5SWWI7.1400-MUL	Microsoft OEM Windows 7 Ultimate 64-bit, Service Pack 1, DVD, multilingual. Only available with a new device.	

Table 247: 5SWWI7.0100-ENG, 5SWWI7.1100-ENG, 5SWWI7.0100-GER, 5SWWI7.1100-GER, 5SWWI7.0300-MUL, 5SWWI7.1300-MUL, 5SWWI7.0200-ENG, 5SWWI7.1200-ENG, 5SWWI7.0200-GER, 5SWWI7.1200-GER, 5SWWI7.0400-MUL, 5SWWI7.1400-MUL - Order data

5.3 Overview

Model number	Edition	Target system	Chipset	Service Pack	Architecture	Language	Preinstalled	Minimum size of the disk	Minimum amount of RAM
5SWWI7.0100-ENG	Professional	APC510 APC511 APC810 APC910 PPC800 PP500	945GME GM45 QM77/HM76 US15W		32-bit	English	Optional	16 GB	1 GB
5SWWI7.1100-ENG	Professional	APC510 APC511 APC810 APC910 PPC800 PP500	945GME GM45 QM77/HM76 NM10 US15W	SP1	32-bit	English	Optional	16 GB	1 GB
5SWWI7.0100-GER	Professional	APC510 APC511 APC810 APC910 PPC800 PP500	945GME GM45 QM77/HM76 US15W		32-bit	German	Optional	16 GB	1 GB
5SWWI7.1100-GER	Professional	APC510 APC511 APC810 APC910 PPC800 PP500	945GME GM45 QM77/HM76 NM10 US15W	SP1	32-bit	German	Optional	16 GB	1 GB

Model number	Edition	Target system	Chipset	Service Pack	Architecture	Language	Preinstalled	Minimum size of the disk	Minimum amount of RAM
5SWWI7.0300-MUL	Ultimate	APC510 APC511 APC810 APC910 PPC800 PP500	945GME GM45 QM77/HM76 US15W		32-bit	Multilingual	Optional	16 GB ¹⁾	1 GB
5SWWI7.1300-MUL	Ultimate	APC510 APC511 APC810 APC910 PPC800 PP500	945GME GM45 QM77/HM76 NM10 US15W	SP1	32-bit	Multilingual	Optional	16 GB ¹⁾	1 GB
5SWWI7.0200-ENG	Professional	APC810 APC910 PPC800	945GME Intel® Core™2 Duo GM45 QM77/HM76		64-bit	English	Optional	20 GB	2 GB
5SWWI7.1200-ENG	Professional	APC810 APC910 PPC800	945GME Intel® Core™2 Duo GM45 QM77/HM76	SP1	64-bit	English	Optional	20 GB	2 GB
5SWWI7.0200-GER	Professional	APC810 APC910 PPC800	945GME Intel® Core™2 Duo GM45 QM77/HM76		64-bit	German	Optional	20 GB	2 GB
5SWWI7.1200-GER	Professional	APC810 APC910 PPC800	945GME Intel® Core™2 Duo GM45 QM77/HM76	SP1	64-bit	German	Optional	20 GB	2 GB
5SWWI7.0400-MUL	Ultimate	APC810 APC910 PPC800	945GME Intel® Core™2 Duo GM45 QM77/HM76		64-bit	Multilingual	Optional	20 GB ¹⁾	2 GB
5SWWI7.1400-MUL	Ultimate	APC810 APC910 PPC800	945GME Intel® Core™2 Duo GM45 QM77/HM76	SP1	64-bit	Multilingual	Optional	20 GB ¹⁾	2 GB

1) The memory used by additional language packs is not taken into account in the minimum size of the disk.

5.4 Installation

Upon request, B&R can preinstall the required Windows 7 version on the desired mass storage device (e.g. CompactFlash card, etc.). All of the drivers required for operation (graphics, network, etc.) are also installed in this process.

5.4.1 Installation on a PCI SATA RAID controller - 5ACPCI.RAIC-03, 5ACPCI.RAIC-05, 5ACPCI.RAIC-06

The following steps are necessary for installing Windows 7 on the PCI SATA RAID controller:

1. Download the RAID driver for Windows 7 from the B&R website at www.br-automation.com and copy the data to a folder on a USB flash drive.
2. Boot using the Windows 7 DVD.
3. Follow the installation steps until a page appears asking "Where do you want to install Windows?".
4. Plug the USB flash drive with the RAID drivers into an available USB port.
5. Click on "Load driver" and navigate to the directory containing the RAID drivers. Then click Next to continue.
6. Remove the USB flash drive.
7. The Windows 7 installation can now be performed as usual.

5.4.2 For variants with 5 PCI slots

The following steps are necessary when installing to a slide-in HDD being operated in the slide-in slot 2 (located behind the PCI to SATA Bridge) on the APC810:

1. Download the SiI3531 SATA driver for Windows 7 from the B&R website at www.br-automation.com and copy the data to a folder on a USB flash drive.
2. Boot using the Windows7 DVD.
3. Follow the installation steps until a page appears asking "Where do you want to install Windows?".
4. Plug the USB flash drive with the RAID drivers into an available USB port.
5. Click on "Load driver" and navigate to the directory containing the RAID drivers. Then click Next to continue.

6. Remove the USB flash drive.
7. The Windows 7 installation can now be performed as usual.

Information:

Depending on the system, the boot order may have to be changed in BIOS.

5.5 Special considerations, limitations

- Windows 7 does not contain a Beep.sys file, which means that an audible signal is no longer sounded (e.g. when pressing a key).
- There is currently no support for the Windows 7 system rating (although this does not apply to PP500, APC510, APC511, APC910 or PPC800 devices with an NM10 chipset).

5.6 Drivers

Current drivers for all approved operating systems are available in the Downloads section of the B&R website www.br-automation.com.

Information:

Required drivers can only be downloaded from the B&R website, not from manufacturer websites.

6 Windows XP Embedded

6.1 General information

Windows XP Embedded is the modular version of the desktop operating system Windows XP Professional. Windows XP Embedded is based on the same binary files as Windows XP Professional and is optimally tailored to the hardware being used. In other words, only the functions and modules required by the respective device are included. Windows XP Embedded is also based on the same reliable code as Windows XP Professional. It provides industry with leading reliability, improvements in security and performance and the latest technology for Web browsing and extensive device support.

6.2 Order data

Model number	Short description	Figure
	Windows XP Embedded	
5SWWXP.0426-ENG	Microsoft OEM Windows XP Embedded Feature Pack 2007, English; for APC810 with 945GME chipset; order CompactFlash separately (at least 512 MB)	
	Required accessories	
	CompactFlash	
5CFCRD.016G-06	CompactFlash 16 GB B&R (SLC)	
5CFCRD.0512-03	CompactFlash 512 MB Western Digital (SLC)	
5CFCRD.1024-03	CompactFlash 1 GB Western Digital (SLC)	
5CFCRD.1024-06	CompactFlash 1 GB B&R (SLC)	
5CFCRD.2048-03	CompactFlash 2 GB Western Digital (SLC)	
5CFCRD.2048-06	CompactFlash 2 GB B&R (SLC)	
5CFCRD.4096-03	CompactFlash 4 GB Western Digital (SLC)	
5CFCRD.4096-06	CompactFlash 4 GB B&R (SLC)	
5CFCRD.8192-03	CompactFlash 8 GB Western Digital (SLC)	
5CFCRD.8192-06	CompactFlash 8 GB B&R (SLC)	

Table 248: 5SWWXP.0426-ENG - Order data

6.3 Overview

Model number	Target system	Chipset	Language	Preinstalled	Minimum size of the disk	Minimum amount of RAM
5SWWXP.0426-ENG	APC810	945GME	English	Yes	512 MB	128 MB

6.4 Features with FP2007 (Feature Pack 2007)

The feature list shows the most important device functions in Windows XP Embedded with Feature Pack 2007 (FP2007).

Function	Present
Enhanced Write Filter (EWF)	✓
File Based Write Filter	✓
Administrator accounts	✓
User accounts	Configurable
Explorer shell	✓
Registry filter	✓
Internet Explorer 6.0 + SP2	✓
Internet information service (IIS)	-
Terminal service	✓
Windows Firewall	✓
MSN Explorer	-
Outlook Express	-
Administrative Tools	✓
Remote Desktop	✓
Remote Assistance	-
.NET Framework	-
ASP.NET	-
Codepages / User locales / Keyboards	✓
Disk Management Service	✓
Windows Installer Service	✓
Class Installer	✓
CoDevice Installer	✓
Media Player	-
DirectX	-
Accessories	✓
Number of fonts	89

Table 249: Device functions in Windows XP Embedded with FP2007

6.5 Installation

Upon request, Windows XP Embedded can be preinstalled by B&R on a suitable CompactFlash card (min. 512 MB). The system is then automatically configured when it is switched on for the first time. This procedure takes approximately 30 minutes, with the device being rebooted a number of times.

6.6 Drivers

All drivers required for operation are preinstalled along with the operating system. If an older version of the driver is still being used, the latest version can be downloaded and installed from the B&R website (www.br-automation.com). It is important that Enhanced Write Filter (EWF) is disabled for this.

6.6.1 Touch screen driver

The touch screen driver must be manually installed in order to operate Automation Panel 800 or Automation Panel 900 touch screen devices. The driver is available in the Downloads section of the B&R website (www.br-automation.com). Be sure to check that the "Enhanced Write Filter (EWF)" is enabled.

Information:

Required drivers can only be downloaded from the B&R website, not from manufacturer websites.

7 Windows Embedded Standard 2009

7.1 General information

Windows® Embedded Standard 2009 is the modular version of Windows® XP Professional. It is used if XP applications should be executed with a minimal operating system size. Together with CompactFlash memory, Windows® Embedded Standard 2009 makes it possible to use the Microsoft desktop operating system in harsh environmental conditions. In addition to the familiar features included in Windows® XP Professional, Windows® Embedded Standard 2009 has been improved with regard to dependability by adding a write filter for individual memory partitions. By protecting individual partitions such as the boot partition, the PC system can be started without problems even after an unexpected power failure. B&R offers complete images for industrial PCs, Power Panel and Mobile Panel devices to make the transition to Windows® Embedded Standard 2009 as easy as possible. In addition to Windows® Embedded Standard 2009, the standard Windows® XP Professional operating system is also available in English, German and a multilingual version.

Windows® Embedded Standard 2009 is based on the same binary files as Windows® XP Professional with Service Pack 3 and is optimally tailored to the hardware being used. In other words, only the functions and modules required by the respective device are included. Windows® Embedded Standard 2009 is also based on the same reliable code as Windows® XP Professional with SP3. It provides industry with leading reliability, security and performance improvements as well as the latest technology for web browsing and extensive device support.

7.2 Order data

Model number	Short description	Figure
	Windows Embedded Standard 2009	
5SWWXP.0726-ENG	Microsoft OEM Windows Embedded Standard 2009, English; for APC810 with 945GME chipset; order CompactFlash separately (at least 1 GB).	
	Required accessories	
	CompactFlash	
5CFCRD.016G-06	CompactFlash 16 GB B&R (SLC)	
5CFCRD.032G-06	CompactFlash 32 GB B&R (SLC)	
5CFCRD.1024-06	CompactFlash 1 GB B&R (SLC)	
5CFCRD.2048-06	CompactFlash 2 GB B&R (SLC)	
5CFCRD.4096-06	CompactFlash 4 GB B&R (SLC)	
5CFCRD.8192-06	CompactFlash 8 GB B&R (SLC)	

Table 250: 5SWWXP.0726-ENG - Order data

7.3 Overview

Model number	Target system	Chipset	Language	Preinstalled	Minimum size of the disk	Minimum amount of RAM
5SWWXP.0726-ENG	APC810	945GME	English	Yes	1 GB	256 MB

7.4 Features with WES2009 (Windows Embedded Standard 2009)

The following list of features shows the most important device functions included in Windows Embedded Standard 2009.

Function	Present
Enhanced Write Filter (EWF)	✓
File-Based Write Filter (FBWF)	✓
Page file	Configurable
Administrator accounts	✓
User accounts	Configurable
Explorer shell	✓
Registry filter	✓
Internet Explorer 7.0	✓
Internet information service (IIS)	-
Terminal service	✓
Windows Firewall	✓
MSN Explorer	-
Outlook Express	-
Administrative Tools	✓
Remote Desktop	✓
Remote Assistance	-
.NET Framework	-
ASP.NET	-

Table 251: Device functions in Windows Embedded Standard 2009

Function	Present
Local network bridge	✓
Codepages / User locales / Keyboards	✓
Disk Management Service	✓
Windows Installer Service	✓
Class Installer	✓
CoDevice Installer	✓
Media Player 6.4	✓
DirectX 9.0c	✓
Accessories	✓
Number of fonts	89

Table 251: Device functions in Windows Embedded Standard 2009

7.5 Installation

Upon request, Windows Embedded Standard 2009 can be preinstalled by B&R on a suitable CompactFlash card (min. 1 GB). The system is then automatically configured when it is switched on for the first time. This procedure takes approximately 10 minutes, with the device being rebooted a number of times.

7.6 Drivers

All drivers required for operation are preinstalled along with the operating system. If an older version of the driver is still being used, the latest version can be downloaded and installed from the B&R website (www.br-automation.com). It is important that Enhanced Write Filter (EWF) is disabled for this.

7.6.1 Touch screen driver

In order to operate Automation Panel 800 or Automation Panel 900 touch screen devices, the touch screen driver must be installed manually or the touch screen interface updated in the device manager. The driver is available in the Downloads section of the B&R website (www.br-automation.com). It is important that Enhanced Write Filter (EWF) is enabled for this.

Information:

Required drivers can only be downloaded from the B&R website, not from manufacturer websites.

8 Windows Embedded Standard 7

8.1 General information

The successor to Windows® XP Embedded is Windows® Embedded Standard 7. As with previous versions, this embedded operating system offers full system support for B&R Industrial PCs. In addition to brand new features that are also included in Windows® 7 Professional, Windows® Embedded Standard 7 includes embedded components such as Enhanced Write Filter, File-Based Write Filter, Registry Filter and USB Boot. Windows® Embedded Standard 7 is available in two different versions. The main difference between them has to do with multilingual support. Windows® Embedded Standard 7 is only available in a single language, whereas Windows® Embedded Standard 7 Premium supports the installation of several languages simultaneously.

With Windows® Embedded Standard 7, Microsoft has made substantial improvements in the area of security. The AppLocker program, available in the premium version, can prevent the execution of unknown or potentially undesired applications that are being installed over a network or from drives that are directly connected. A tiered approach allows the differentiation between scripts (.ps1, .bat, .cmd, .vbs and .js), installation files (.msi, .msp) and libraries (.dll, .ocx). AppLocker can also be configured to record undesired activity and display it in the Event Viewer. Windows® Embedded Standard 7 is available in both a 32-bit and 64-bit version.⁵⁾ This ensures that even the most demanding applications have the level of support they need.

8.2 Order data

Model number	Short description	Figure
	Windows Embedded Standard 7	
5SWWI7.1526-ENG	Microsoft OEM Windows Embedded Standard 7 32-bit, Service Pack 1, English; for APC810 with 945GME chipset; order CompactFlash separately (at least 16 GB)	
5SWWI7.1626-ENG	Microsoft OEM Windows Embedded Standard 7 64-bit, Service Pack 1, English; for APC810 with 945GME chipset; order CompactFlash separately (at least 16 GB)	
5SWWI7.1726-MUL	Microsoft OEM Windows Embedded Standard 7 Premium 32-bit, Service Pack 1, multilingual; for APC810 with 945GME chipset; order CompactFlash separately (at least 16 GB)	
5SWWI7.1826-MUL	Microsoft OEM Windows Embedded Standard 7 Premium 64-bit, Service Pack 1, multilingual; for APC810 with 945GME chipset; order CompactFlash separately (at least 16 GB)	
	Required accessories	
	CompactFlash	
5CFCRD.016G-06	CompactFlash 16 GB B&R (SLC)	
5CFCRD.032G-06	CompactFlash 32 GB B&R (SLC)	
	Optional accessories	
	Windows Embedded Standard 7	
5SWWI7.1900-MUL	Microsoft OEM Windows Embedded Standard 7 32-bit, Service Pack 1, Language Pack DVD	
5SWWI7.2000-MUL	Microsoft OEM Windows Embedded Standard 7 64-bit, Service Pack 1, Language Pack DVD	

Table 252: 5SWWI7.1526-ENG, 5SWWI7.1626-ENG, 5SWWI7.1726-MUL, 5SWWI7.1826-MUL - Order data

⁵⁾ 64-bit versions are not supported by all systems

8.3 Overview

Model number	Edition	Target system	Chipset	Service Pack	Architecture	Language	Preinstalled	Minimum size of the disk	Minimum amount of RAM
5SWWI7.1526-ENG	Embedded	APC810	945GME	SP1	32-bit	English	Optional	16 GB	1 GB
5SWWI7.1626-ENG	Embedded	APC810	945GME Intel® Core™2 Duo	SP1	64-bit	English	Optional	16 GB	2 GB
5SWWI7.1726-MUL	Premium	APC810	945GME	SP1	32-bit	Multilingual	Optional	16 GB ¹⁾	1 GB
5SWWI7.1826-MUL	Premium	APC810	945GME Intel® Core™2 Duo	SP1	64-bit	Multilingual	Optional	16 GB ¹⁾	2 GB

1) The memory used by additional language packs is not taken into account in the minimum size of the disk.

8.4 Features with WES7 (Windows Embedded Standard 7)

The following list of features shows the most important device functions included in Windows Embedded Standard 7.

Function	Windows Embedded Standard 7	Windows Embedded Standard 7 Premium
Enhanced Write Filter (EWF)	✓	✓
File-Based Write Filter (FBWF)	✓	✓
Administrator accounts	✓	✓
User accounts	Configurable	Configurable
Windows Explorer shell	✓	✓
Registry filter	✓	✓
Internet Explorer 8.0	✓	✓
Internet Information Service (IIS) 7.0	✓	✓
Anti-malware (Windows Defender)	-	✓
Add-ons (Snipping Tool, Sticky Notes)	-	✓
Windows Firewall	✓	✓
.NET Framework 3.5	✓	✓
32-bit and 64-bit	✓	✓
Remote Desktop Protocol 7.0	✓	✓
File Compression Utility	✓	✓
Windows Installer Service	✓	✓
Windows XP mode	-	-
Media Player 12	✓	✓
DirectX	✓	✓
Multilingual user interface packs in the same image	-	✓
International components and language services	✓	✓
Language pack setup	✓	✓
Windows Update	Configurable	Configurable
Windows PowerShell 2.0	✓	✓
BitLocker	-	✓
AppLocker	-	✓
Tablet PC support	-	✓
Windows Touch	-	✓
Boot from USB flash drive	✓	✓
Accessories	✓	✓
Page file	Configurable	Configurable
Number of fonts	134	134

Table 253: Device functions in Windows Embedded Standard 7

8.5 Installation

Upon request, B&R can preinstall Windows Embedded Standard 7 on a suitable CompactFlash card (32-bit: at least 8 GB necessary, 64-bit: at least 16 GB necessary). The system is then automatically configured when it is switched on for the first time. This procedure takes approximately 30 minutes, with the device being rebooted a number of times.

Information:

If the EWF should be used, all mass storage devices should be disconnected from the system during installation oder SYSPREP (except for the boot drive). It is also possible to disable additional mass storage devices in BIOS.

8.6 Drivers

All drivers required for operation are preinstalled along with the operating system. If an older version of the driver is still being used, the latest version can be downloaded and installed from the B&R website (www.br-automation.com). It is important that Enhanced Write Filter (EWF) is disabled for this.

8.6.1 Touch screen driver

A touch screen driver will be installed automatically if a touch controller is detected during the Windows Embedded Standard 7 installation. If a touch controller is not detected during Windows Embedded Standard 7 installation, or if an Automation Panel 800 / 900 is connected at a later time, then the touch screen driver needs to be installed manually or the additional touch screen interface must be selected in the touch screen settings in the Windows Control Panel. The driver is available in the Downloads section of the B&R website (www.br-automation.com). It is important that both the Enhanced Write Filter (EWF) and the File Based Write Filter (FBWF) are disabled for this.

Information:

Required drivers can only be downloaded from the B&R website, not from manufacturer websites.

9 Windows CE

9.1 General information

B&R Windows CE is an operating system that is optimally tailored to B&R's devices, i.e. it includes only the functions and modules that are required by each device. This makes this operating system extremely robust and stable. A further advantage of B&R Windows CE compared to other operating systems are the low licensing costs.

9.2 Order data

Model number	Short description	Figure
	Windows CE 6.0	
5SWWCE.0826-ENG	Microsoft OEM Windows CE 6.0 Professional, English; for APC810 with 945GME chipset; order CompactFlash separately (at least 128 MB).	
	Required accessories	
	CompactFlash	
5CFCRD.0128-03	CompactFlash 128 MB Western Digital (SLC)	
5CFCRD.016G-06	CompactFlash 16 GB B&R (SLC)	
5CFCRD.0256-03	CompactFlash 256 MB Western Digital (SLC)	
5CFCRD.0512-03	CompactFlash 512 MB Western Digital (SLC)	
5CFCRD.1024-03	CompactFlash 1 GB Western Digital (SLC)	
5CFCRD.1024-06	CompactFlash 1 GB B&R (SLC)	
5CFCRD.2048-03	CompactFlash 2 GB Western Digital (SLC)	
5CFCRD.2048-06	CompactFlash 2 GB B&R (SLC)	
5CFCRD.4096-03	CompactFlash 4 GB Western Digital (SLC)	
5CFCRD.4096-06	CompactFlash 4 GB B&R (SLC)	
5CFCRD.8192-03	CompactFlash 8 GB Western Digital (SLC)	
5CFCRD.8192-06	CompactFlash 8 GB B&R (SLC)	

Table 254: 5SWWCE.0826-ENG - Order data

9.3 Overview

Model number	Target system	Chipset	Language	Preinstalled	Minimum size of the disk	Minimum amount of RAM
5SWWCE.0826-ENG	APC810	945GME	English	Yes	128 MB	128 MB

9.4 Windows CE 6.0 features

Detailed information about Windows CE for B&R devices is available in the Downloads section of the B&R website (www.br-automation.com).

Features	Windows CE 6.0
Supported screen resolutions	VGA (TFT), SVGA (TFT), XGA (TFT)
Chipset	Intel 945GME
Color depth	16-bit or 65,536 colors ¹⁾
Graphics card driver	Intel(R) embedded graphics driver
Main memory	Automatic detection and use of up to 512 MB RAM
Boot time / Startup time	Approx. 25 seconds
Screen rotation	Not supported
Web browser	Internet Explorer
.NET	Compact Framework
Image size	Approx. 38 MB ²⁾ , uncompressed
Custom keys	Supported
PVI	Supported
Automation Device Interface	Supported
Remote Desktop Protocol for thin clients	Supported
B&R VNC Viewer	Supported
B&R Task Manager	Supported
B&R Picture Viewer	Supported
Compatible with zenOn	Yes
Compatible with Wonderware	No
Serial interfaces for any use	3
DirectX	No
Audio ports	"Line OUT" and "MIC" are supported. "Line IN" is not supported.

Table 255: Windows CE 6.0 features

- 1) The color depth depends on the display used.
- 2) The "Compress Windows CE image" function in the B&R Embedded OS Installer can be used to reduce the image size.

9.5 Requirements

The device must fulfill the following criteria to be able run the Windows CE operating system.

- At least 128 MB main memory
- At least one 128 MB CompactFlash card (size should be specified when ordered)

9.6 Installation

Windows CE is usually preinstalled at B&R.

9.7 B&R Embedded OS Installer

The B&R Embedded OS Installer makes it possible to install existing B&R Windows CE images. The 4 files NK.BIN, BLDR, LOGOXRES.BMP and LOGOQVGA.BMP must be available from an already functioning B&R Windows CE installation.

The B&R Embedded OS Installer is available in the Downloads section of the B&R website (www.br-automation.com). Additional information is available in the online help documentation for the B&R Embedded OS Installer.

10 Automation Runtime

10.1 General information

An integral component of Automation Studio is the real-time operating system, which makes up the software kernel that allows applications to run on a target system.

- Guaranteed highest possible performance for the hardware being used
- Runs on all B&R target systems
- Makes the application hardware-independent
- Easy portability of applications between B&R target systems
- Deterministic behavior guaranteed by cyclic runtime system
- Multitasking according to deterministic runtime rules
- Configuration of priorities, time classes and jitter tolerance
- Up to eight different time classes with any number of subroutines
- Guaranteed response to time and jitter tolerance violations
- Exception handling
- Configurable jitter tolerance in all task classes
- Support for all relevant programming languages, including IEC 61131-3 and ANSI C
- Extensive function library conforming to IEC 61131-3 as well as the expanded Automation library
- Access to all networks and bus systems via function calls or the Automation Studio configuration

B&R Automation Runtime is fully embedded in the corresponding target system (the hardware where Automation Runtime is installed). It allows application programs to access I/O systems (e.g. via fieldbus) and other devices (interfaces, networks, etc.).

10.2 Order data

Model number	Short description	Figure
	Automation Runtime	
1A4600.10	B&R Automation Runtime ARwin, incl. license sticker and copy protection	
1A4600.10-2	B&R Automation Runtime ARwin, ARNC0	
1A4600.10-3	B&R Automation Runtime ARwin+PVIControls incl. license sticker and copy protection	
1A4600.10-4	B&R Automation Runtime ARwin+ARNC0+PVIControls	
1A4601.06	B&R Automation Runtime AREmb, incl. license sticker and copy protection	
1A4601.06-2	B&R Automation Runtime AREmb, ARNC0	

Table 256: 1A4600.10, 1A4600.10-2, 1A4600.10-3, 1A4600.10-4, 1A4601.06, 1A4601.06-2 - Order data

10.3 Automation Runtime Windows (ARwin)

System support is provided by ARwin with an AS 2.7 / AR 2.xx upgrade.

10.4 Automation Runtime Embedded (AREmb)

System support is provided by AREmb with an AS 3.0.90 / AR 4.00 upgrade.

11 B&R Automation Device Interface (ADI) - Control Center

The ADI (Automation Device Interface) enables access to specific functions on B&R devices. Settings for devices can be read and configured using the B&R Control Center applet in the Control Panel.

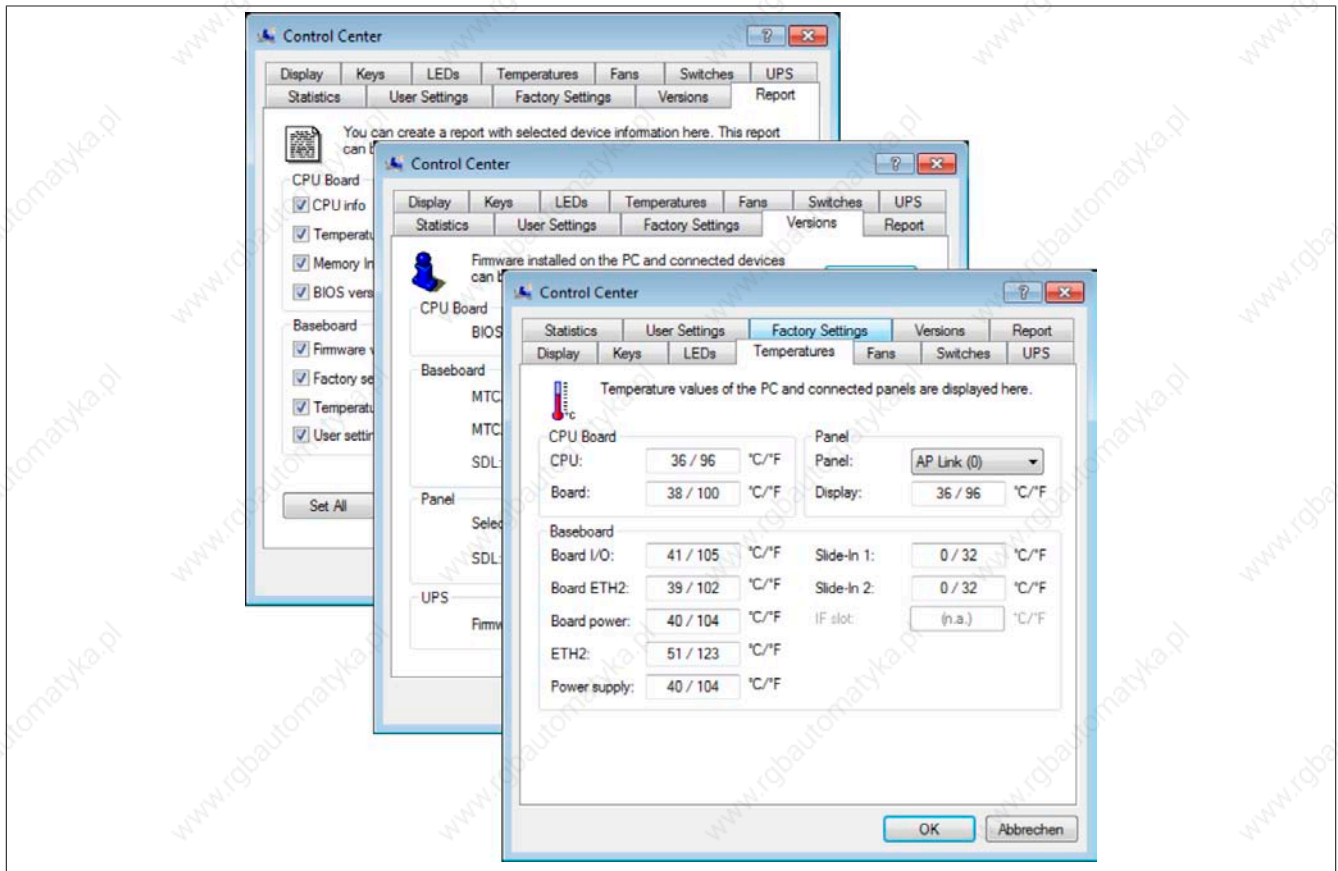

Figure 156: ADI Control Center screenshots - Examples

Information:

The temperature and voltage values (e.g. CPU temperature, core voltage, battery voltage) shown in the corresponding ADI window represent uncalibrated values for informational purposes. They cannot be used to draw any conclusions about hardware alarms or error conditions. The hardware components used have automatic diagnostic functions that can be applied in the event of error.

11.1 Functions

Information:

The functions provided by the Automation Device Interface (ADI) - Control Center vary according to the device series.

- Changing display-specific parameters
- Reading device-specific keys
- Updating the key configuration
- Enabling device-specific LEDs on a membrane keypad
- Reading and calibrating input devices (e.g. key switches, handwheels, joysticks, potentiometers)
- Reading temperatures, fan speeds, statistical data and switch settings
- Reading operating hours (power-on hours)
- Reading user and factory settings
- Reading software versions
- Updating and backing up BIOS and firmware
- Creating reports about the current system (support assistance)
- Setting the SDL equalizer value when adjusting SDL cables
- Changing the user serial ID

Supports the following systems:

- Automation PC 510
- Automation PC 511
- Automation PC 620
- Automation PC 810
- Automation PC 820
- Automation PC 910
- Panel PC 300
- Panel PC 700
- Panel PC 725
- Panel PC 800
- Power Panel 100/200
- Power Panel 300/400
- Power Panel 500
- Mobile Panel 40/50
- Mobile Panel 100/200
- Connected Automation Panel 800
- Connected Automation Panel 900

11.2 Installation

A detailed description of the Control Center can be found in the integrated online help documentation. The B&R Automation Device Interface (ADI) driver (also contains Control Center) is available in the Downloads section of the B&R website (www.br-automation.com).

1. Download and unzip the .zip archive.
2. Close all applications.
3. Run the Setup.exe file (e.g. double-click on it in Explorer).

Information:

The ADI driver is already included in B&R images of embedded operating systems.

If a more current ADI driver version exists (see the Downloads section of the B&R website), it can be installed later. It is important that Enhanced Write Filter (EWF) is disabled for this.

11.3 SDL Equalizer settings

1. Open the **Control Center** in the **Control Panel**.
2. Select the **Display** tab.
3. Click on **Settings**. This opens the following window:

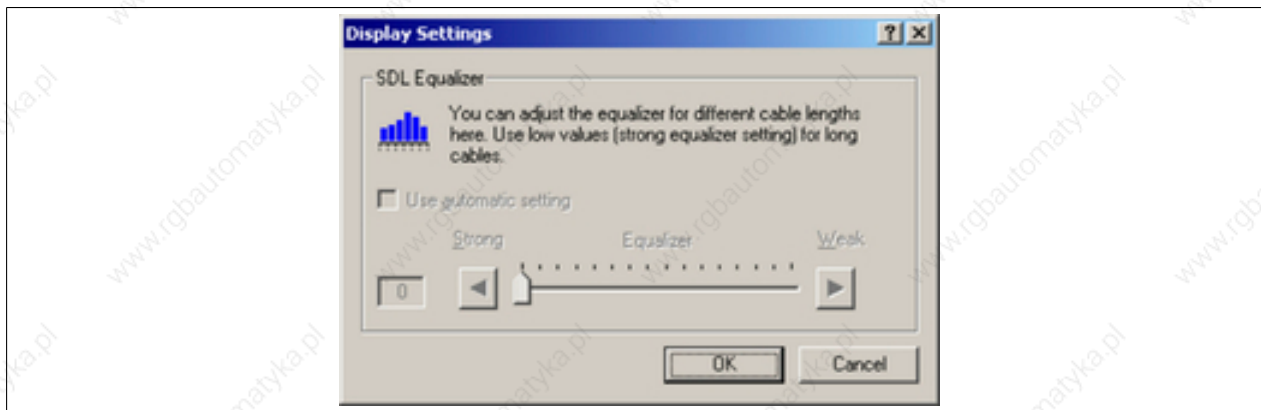

Figure 157: ADI Control Center - SDL Equalizer settings

The settings in this window can be used to configure the SDL Equalizer settings for the display. The equalizer is integrated into Automation Panel devices and adapts the DVI signal to different cable lengths. The equalizer value is automatically calculated based on the cable length. It is possible to set a different equalizer value in order to obtain the best possible display quality (e.g. in the event of low-quality cables or poor DVI signal quality).

The optimal value for the cable length is defined by selecting "Use automatic setting".

The equalizer value can only be changed if the function is supported by Automation Panel 900 (Panel firmware version 1.04 or higher).

11.4 UPS configuration

This window displays the status values for an optionally installed B&R add-on UPS and allows the battery settings for the UPS to be edited, updated and backed up. It is also possible to configure the system settings for the UPS.

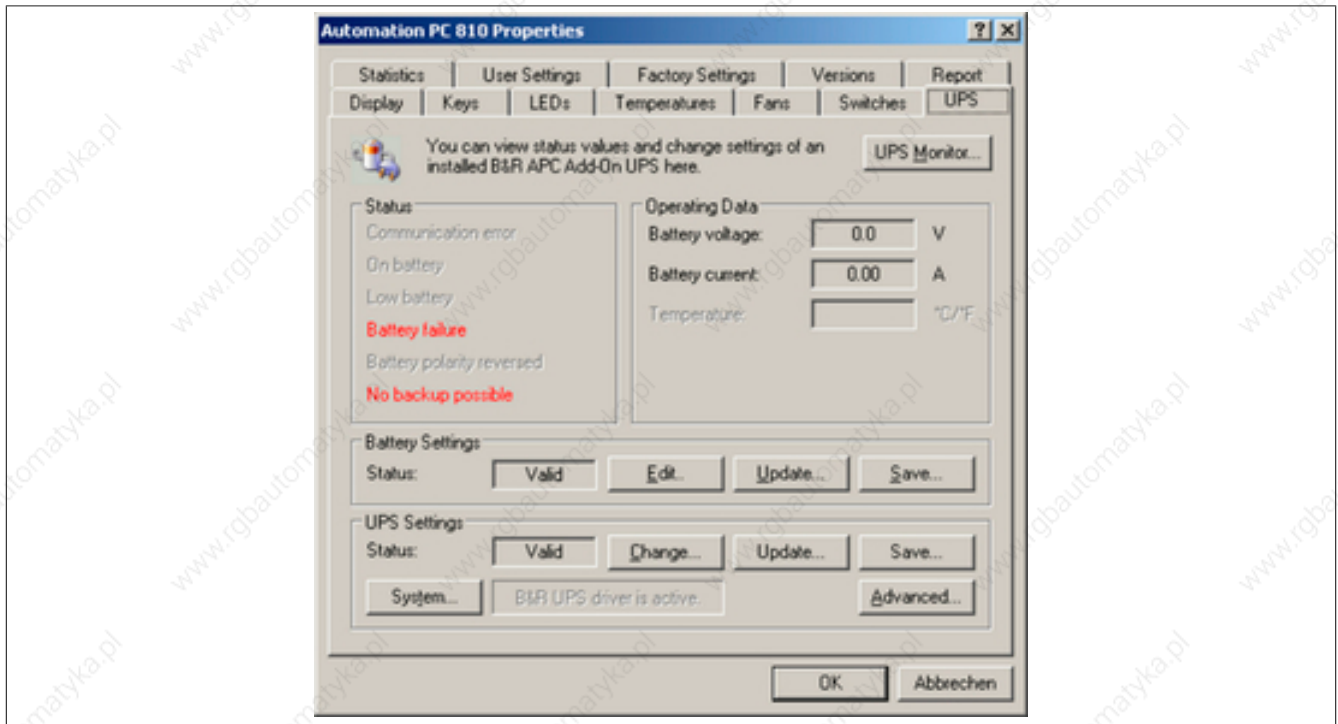

Figure 158: ADI Control Center - UPS settings

Caution!

The installed UPS must be selected and configured in the Power Options section of the Control Panel in order for battery operation to be supported.

Information:

The UPS service is supported in B&R Windows Embedded Version 2.10 and higher.

11.4.1 Installing the UPS service for the B&R add-on UPS

1. Open the **Control Center** in the **Control Panel**.
2. Select the **UPS** tab.
3. Under **UPS settings**, click on **System**. This opens the **Power options** in the Control Panel (**Power options** can also be opened directly from the **Control Panel**).
4. Go to the **UPS** tab and click **Select**.
5. Select "Bernecker + Rainer" as the manufacturer and "APC add-on UPS" as the model and then click **Finish**. The value for the COM connection is only required for a serially connected UPS and is ignored by the APC add-on UPS driver.
6. Click on **Apply** to start the UPS service. The UPS status and details will be displayed after a few seconds.
7. Click **OK**.

The text field next to **System** (on the **UPS** tab in the **Control Center**) also indicates whether the B&R UPS driver is active.

Information:

Administrator rights are required in order to change the energy options or display the UPS status.

11.4.2 Displaying UPS default values

1. Open the **Control Center** in the **Control Panel**.
2. Select the **UPS** tab.

The displayed values are updated automatically.

Information:

The status "Reversed battery polarity" is only displayed if using UPS firmware version 1.08 or higher. With UPS firmware versions 1.07 and older, switching between battery operation and normal operation can lead to a communication error.

3. Select "UPS monitor" to display UPS status changes since the last time the system or UPS driver was started.

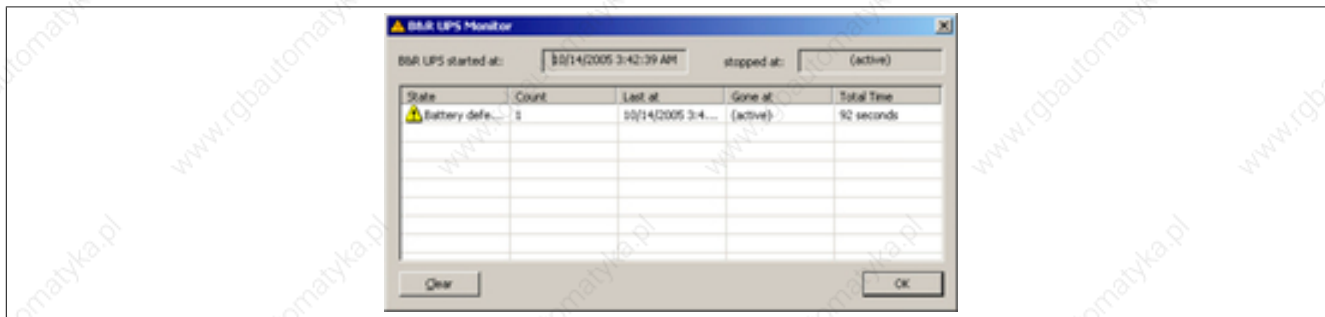

Figure 159: ADI Control Center - UPS monitor

The window is updated automatically when the status changes.

To remove a status from the list, click on **Clear**.

Information:

The current status of the UPS is also displayed on the UPS page in the power options when the UPS service is started in the Windows Control Panel.

Information:

In a German version of Windows XP Professional the battery status is shown as "Low" in the power options even if the battery is OK (Windows error). In an English version, three battery status levels are displayed: unknown, OK and replace. A low battery status is never displayed.

11.4.3 Changing UPS battery settings

1. Open the **Control Center** in the **Control Panel**.
2. Select the **UPS** tab.
3. Under **Battery settings**, click on **Edit**. This opens the "Open" dialog box.
4. Select and **open** the file containing the battery settings.



Figure 160: ADI Control Center - UPS battery settings

This window can be used to change the settings for the UPS battery.

Click **OK** to write the changed settings to the file. The battery settings for the UPS can then be updated with this file.

Information:

To make settings for non-B&R batteries, it is best to make a copy of a file that contains battery settings from B&R under a new name and then adjust the settings in this new file for the battery being used.

Current files with settings for batteries from B&R can be updated using B&R's "Upgrade PPC800 MTCX" software.

Information:

- The current UPS firmware version 1.10 does not use charge end voltage, deep discharge voltage, service life and deep discharge cycles.
- Service life is only included in version 2 (and higher) of the UPS battery settings and only valid for B&R UPS batteries at 25°C ambient temperature.
- Deep discharge cycles are only included in version 3 (and higher) of the UPS battery settings and only valid for UPS batteries from B&R.

Information:

To change the current battery settings on the UPS, they must first be saved to a file.

11.4.4 Updating UPS battery settings

1. Open the **Control Center** in the **Control Panel**.
2. Select the **UPS** tab.
3. Under **Battery settings**, click on **Update**. Clicking on "Open" opens a dialog box.
4. Select and **open** the file containing the battery settings. The "Download" dialog box is opened.

The transfer can be canceled by clicking on **Cancel**. "Cancel" is disabled when writing to flash memory.

Information:

- The UPS cannot be operated while the battery settings are being updated.
- If the transfer is interrupted, then the procedure must be repeated until the battery settings have been updated successfully. Otherwise, battery operation will no longer be possible.

Deleting the data in flash memory can take several seconds depending on the memory block being used. The progress indicator is not updated during this time.

Information:

The UPS is automatically restarted after a successful download. This can cause a brief failure in UPS communication.

11.4.5 Saving UPS battery settings

1. Open the **Control Center** in the **Control Panel**.
2. Select the **UPS** tab.
3. Under "Battery settings", click on **Save**. This opens the "Save as" window.
4. Enter a filename or select an existing file and click on **Save**.

Information:

UPS settings can only be saved with UPS firmware version 1.10 and higher.

The transfer can be aborted by clicking on **Cancel** in the Download dialog box.

11.4.6 Configuring UPS system settings

1. Open the **Control Center** in the **Control Panel**.
2. Select the **UPS** tab.
3. Under **UPS settings**, click on **Change**. This opens the following window:

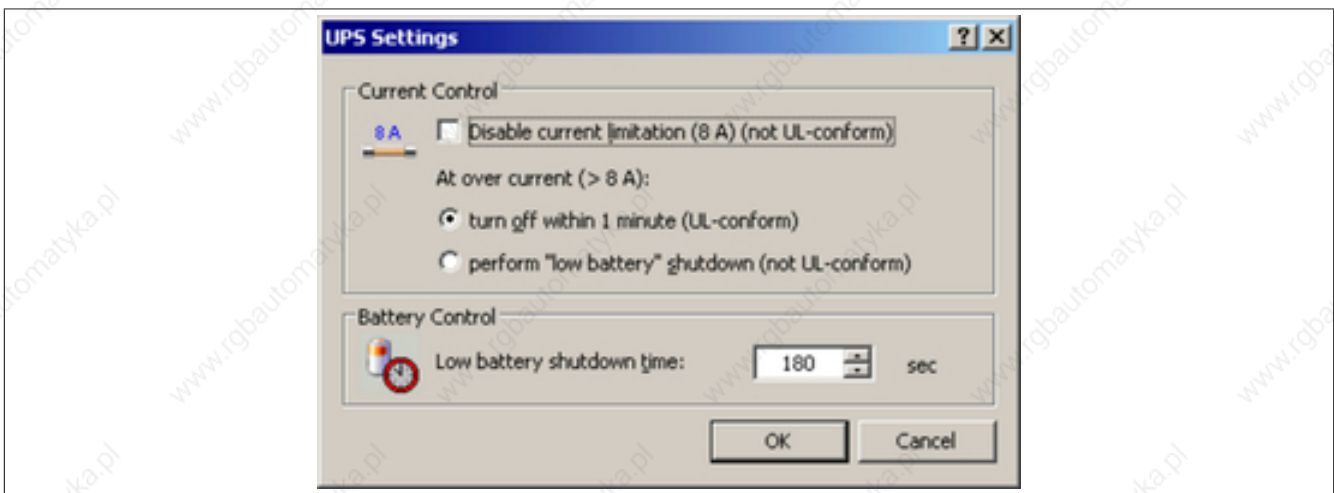

Figure 161: ADI Control Center - UPS settings

Additional information regarding UPS system settings can be found in the Windows help documentation.

Information:

- **UPS settings can only be changed with UPS firmware version 1.10 and higher. If there are no modified settings on the UPS, then the factory or default settings are used.**
- **The UPS is automatically restarted after the UPS settings have been changed. This can cause a brief disruption in communication with the UPS.**
- **Administrator rights are required in order to change the energy options or display the UPS status.**

11.4.6.1 Disabling 8 A current limitation

Information:

It is not UL compliant to switch off the 8 A current limitation on devices during battery operation!

"Low battery" shutdowns caused by overcurrent >8 A on devices running on the battery are not UL compliant!

Select the checkbox **Disable current limitation (8 A)**.

If current limitation is enabled (checkbox not selected), then the UPS uses battery operation to check whether the UPS battery is discharged with 8 A for longer than 16 seconds. If so, then an overcurrent alarm is sent to the PC.

Information:

Current limitation is only supported with UPS firmware version 1.10 and higher.

Enabling one of the two following options determines how the UPS should perform when an overcurrent alarm occurs:

If **Turn-off within 1 minute** is selected, then the UPS will be switched off within one minute when an overcurrent alarm occurs.

Warning!

The operating system will not be properly shut down if an overcurrent alarm occurs!

If **Perform "low battery" shutdown** is selected, then the UPS will also signal a "Low battery alarm" in addition to the overcurrent alarm and will be switched off after the defined **Low battery shutdown time**. This will allow the operating system to shut down properly when the UPS service is enabled.

11.4.6.2 Changing the shutdown time of the UPS when the battery is low

Enter the **Low battery shutdown time** in seconds. This is the amount of time that the UPS will wait before shutting off the power supply when the battery level is low.

This prevents the UPS battery from becoming too low if the Windows UPS service is not enabled to have the operating system turn off the UPS.

If the UPS service is enabled, then the UPS will be turned off by the operating system in accordance with the **Shutdown time** UPS service in Windows (see "Changing additional UPS settings" on page 309) when the battery level is low. The **Low battery shutdown time** will then be ignored.

Information:

- The low battery shutdown time must be set to at least 60 seconds so that the operating system has enough time to send the shutdown command to the UPS when the battery level is low (normally occurs after approximately 30 seconds).
- The low battery shutdown time can only be set with UPS firmware version 1.10 and higher. UPS firmware version 1.08 always uses a switch-off delay of 180 seconds. UPS firmware versions older than 1.08 do not shut down automatically when the battery level is low.

11.4.7 Changing additional UPS settings

1. Open the **Control Center** in the **Control Panel**.
2. Select the **UPS** tab.
3. Under **UPS settings**, click on **Advanced**. This opens the following window:

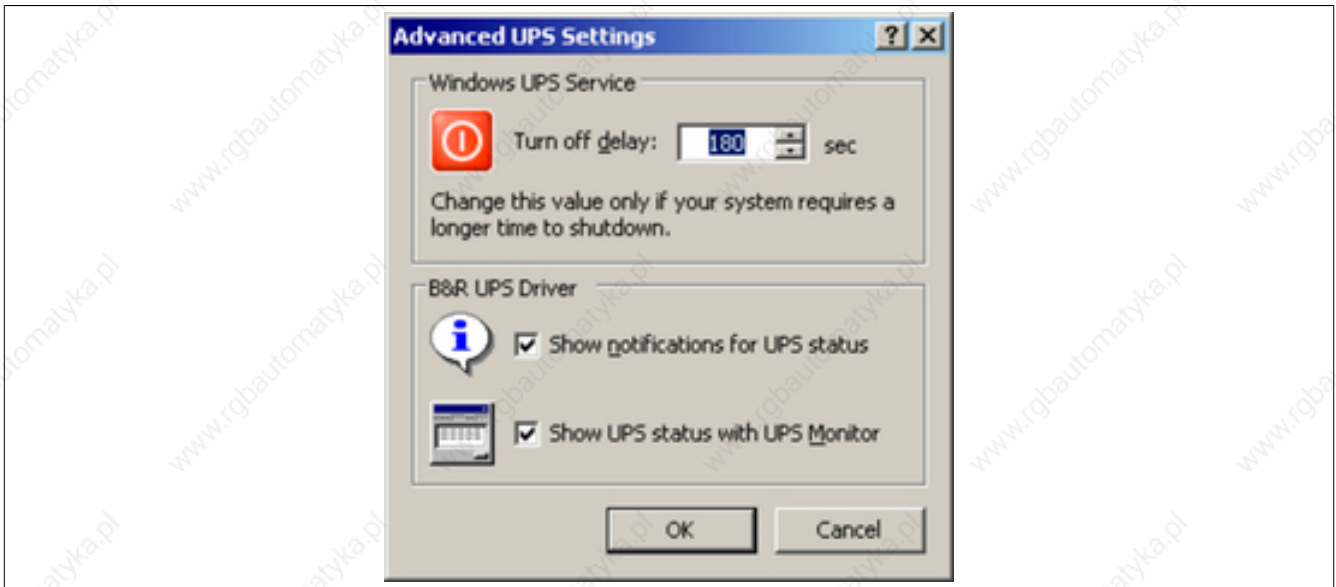

Figure 162: ADI Control Center - Advanced UPS settings

Information:

Administrator rights are required in order to display this window.

11.4.7.1 Changing the UPS shutdown time

The **Turn off delay** can be entered under **Windows UPS service** in seconds. This is the length of time that the UPS waits before switching off the power supply. When a critical alarm occurs (e.g. low battery level), the Windows UPS service will send a shutdown command with the turn off delay time to the UPS and shut down the system.

Information:

This time is evaluated by the **Windows UPS Service** but cannot be set in the **UPS system settings** of the power options. This value should only be changed if the system requires longer than the default setting of 180 seconds to shut down.

Caution!

The time entered must be longer than the time required to shut down the operating system.

11.4.7.2 Enabling UPS notifications

Under **B&R UPS driver**, enable the checkbox **Show notifications for UPS status**. Any changes to the UPS status will then trigger a message from the B&R UPS driver.

Information:

Shutting down the system is only reported by the **Windows UPS service**. The **UPS service** also sends other notifications if so enabled in the **UPS system settings** in the power options. These messages are only displayed when the **Windows Messenger service**⁶⁾ is active and the PC is connected to a network. In addition, some conditions of the B&R add-on UPS are not detected by the **Windows UPS Service** and therefore do not trigger messages (e.g. when there are no battery settings on the UPS). **Windows services** can be found by opening the **Control Panel** and selecting **"Services"** under **"Administrative tools"**.

If the checkbox **Show UPS status with UPS monitor** is also enabled, a new message is not displayed for every change. Instead, only a general message and request to start the B&R UPS monitor are shown. As long as the UPS monitor is active, no new messages will be displayed.

Information:

Regardless of these options, all changes to the **UPS status** are logged in the **Windows event log** (under **"Application"**).

⁶⁾ The **Windows Messenger service** is supported starting with **B&R Windows Embedded version 2.20** and higher.

11.4.8 Procedure following power failure

11.4.8.1 Overcurrent shutdown

If overcurrent >8 A is present during battery operation for a duration of 16 seconds, then an overcurrent shutdown takes place. A switch-off time of one minute is available to the system.

If power returns during this time, then the shutdown process is aborted.

Information:

Overcurrent shutdown has the highest priority.

11.4.8.2 Low battery shutdown

If the LowBatteryFlag is set during power failure, then a "low battery" shutdown is performed to prevent the battery from fully discharging. Once the switch-off time expires (3 minutes by default), the UPS shuts down.

If an "overcurrent" shutdown or "standard" shutdown is detected during the shutdown process, the "low battery" shutdown is replaced by the respective process.

11.4.8.3 Standard shutdown

The standard shutdown is in effect whenever the UPS service is active; the switch-off time is 3 minutes by default.

If power returns during the switch-off time, then the shutdown procedure is aborted.

If power returns during the shutdown process, then the shutdown timer will run until the B&R Industrial PC enters standby mode, at which point the system will be rebooted.

12 B&R Automation Device Interface (ADI) Development Kit

This software can be used to access B&R Automation Device Interface (ADI) functions directly from Windows applications created in one of the following development environments:

- Microsoft Visual C++ 6.0
- Microsoft Visual Basic 6.0
- Microsoft Embedded Visual C++ 4.0
- Microsoft Visual Studio 2005 (or newer)

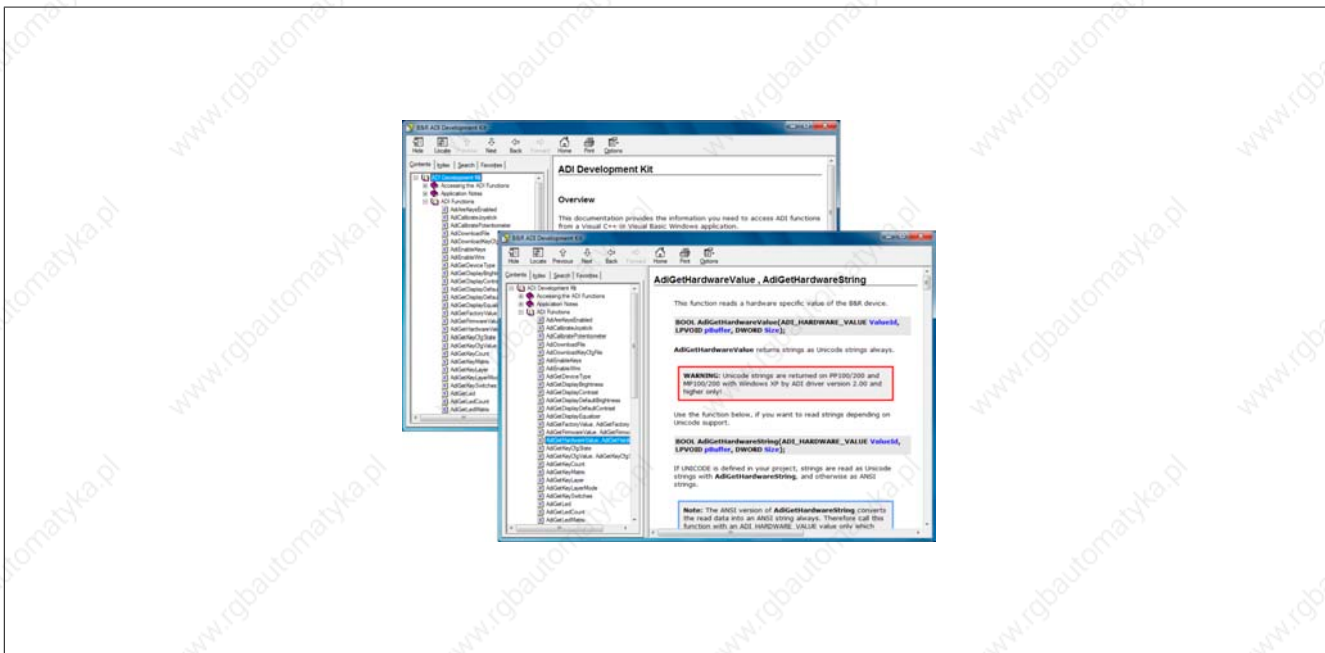

Figure 163: ADI Development Kit screenshots (version 3.60)

Features:

- One Microsoft Visual Basic module with ADI function declarations
- Header files and import libraries for Microsoft Visual C++
- Help files for Visual Basic and Visual C++
- Sample projects for Visual Basic and Visual C++
- ADI DLL (for application testing if no ADI driver is installed)

Supports the following systems (version 3.60 and higher):

- Automation PC 510
- Automation PC 511
- Automation PC 620
- Automation PC 810
- Automation PC 820
- Automation PC 910
- Panel PC 300
- Panel PC 700
- Panel PC 800
- Power Panel 100/200
- Power Panel 300/400
- Power Panel 500
- Mobile Panel 40/50
- Mobile Panel 100/200

The ADI driver installed on the stated product series must be suitable for that device. The ADI driver is already included in B&R images of embedded operating systems.

A detailed description of how to use ADI functions can be found in the online help documentation.

The B&R Automation Device Interface (ADI) development kit is available at no cost in the Downloads section of the B&R website (www.br-automation.com).

13 B&R Automation Device Interface (ADI) .NET SDK

This software can be used to access B&R Automation Device Interface (ADI) functions directly from .NET applications created using Microsoft Visual Studio 2005 or later.

Supported programming languages:

- Visual Basic
- Visual C++
- Visual C#

System requirements

- Development system: PC with Windows XP/7 and
 - Microsoft Visual Studio 2005 (or newer)
 - Microsoft .NET Framework 2.0 and/or Microsoft .NET Compact Framework 2.0 (or newer)

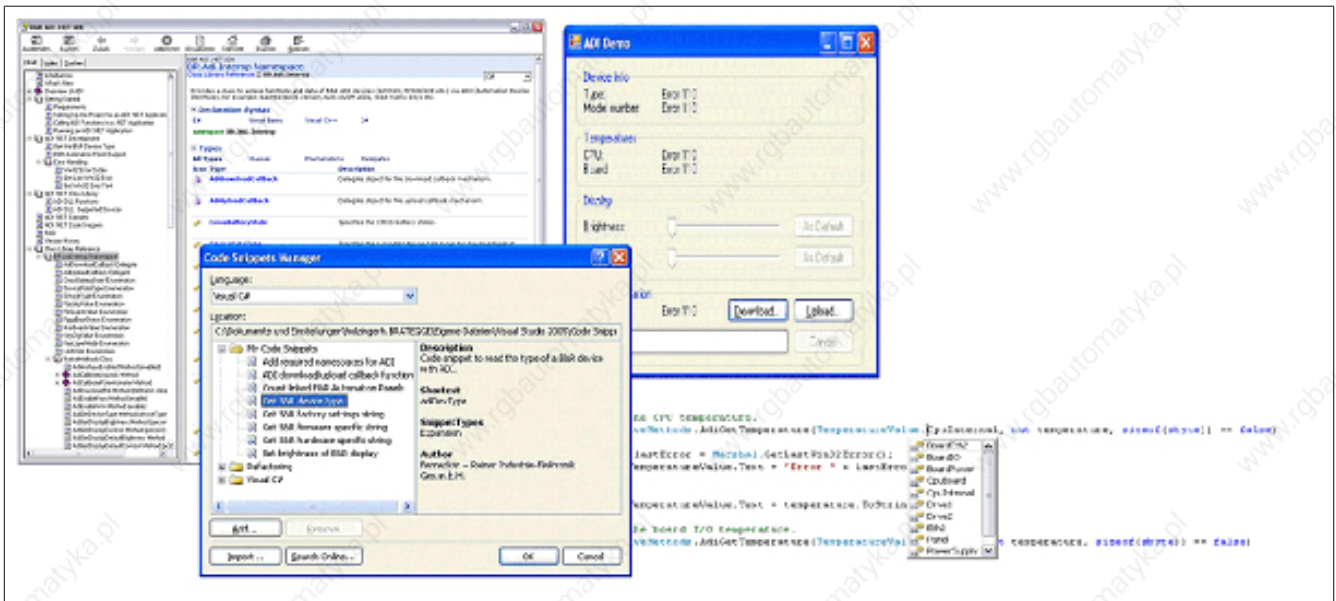

Figure 164: ADI .NET SDK screenshots (version 2.00)

Features (version 2.00 and higher):

- ADI .NET class library
- Help files in HTML Help 1.0 format (.chm) and MS Help 2.0 format (.HxS) (help documentation is in English)
- Sample projects and code snippets for Visual Basic, Visual C++ and Visual C#
- ADI DLL (for application testing if no ADI driver is installed)

Supports the following systems (version 2.00 and higher):

- Automation PC 510
- Automation PC 511
- Automation PC 620
- Automation PC 810
- Automation PC 820
- Automation PC 910
- Panel PC 300
- Panel PC 700
- Panel PC 800
- Power Panel 100/200
- Power Panel 300/400
- Power Panel 500
- Mobile Panel 40/50
- Mobile Panel 100/200

The ADI driver installed on the stated product series must be suitable for that device. The ADI driver is already included in B&R images of embedded operating systems.

A detailed description of how to use ADI functions can be found in the online help documentation.

The ADI .NET SDK is available in the Downloads section of the B&R website (www.br-automation.com).

14 B&R Key Editor

On display devices, it is often necessary to adapt the function keys and LEDs directly to the application software being used. The B&R Key Editor makes it quick and easy to implement a unique configuration for the application.

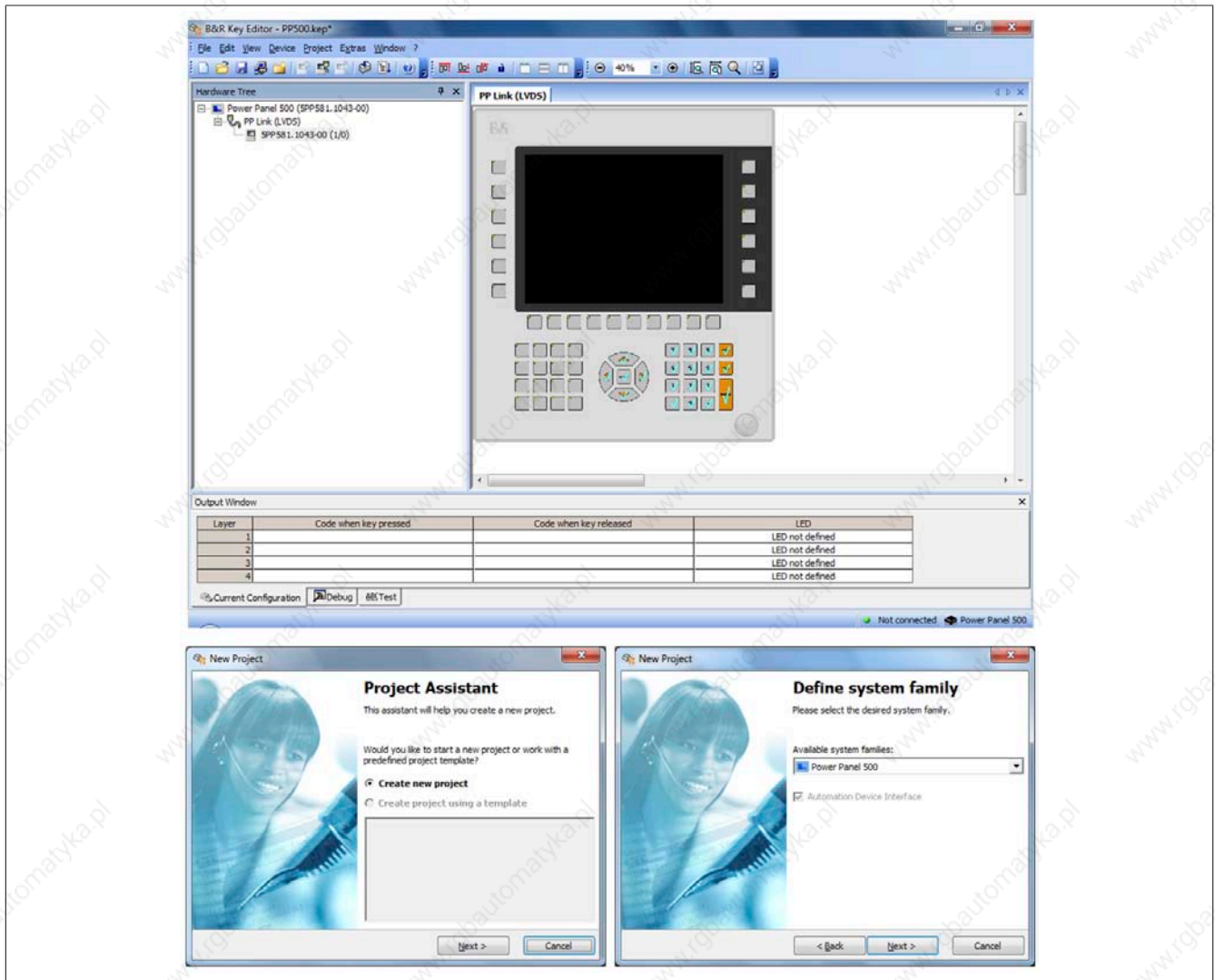

Figure 165: B&R Key Editor screenshots (version 3.30)

Features:

- Configuration of normal keyboard keys (A, B, C, etc.)
- Keyboard shortcuts (CTRL+C, SHIFT+DEL, etc.) using only one key
- Special key functions (change brightness, etc.)
- Assignment of functions to LEDs (HDD access, power, etc.)
- 4 assignments possible per key (using layers)
- Configuration of the panel locking time when multiple Automation Panel 900 devices are connected to Automation PC and Panel PC devices.

Supports the following systems (version 3.30):

- Automation PC 510
- Automation PC 511
- Automation PC 620
- Automation PC 810
- Automation PC 820
- Automation PC 910
- Automation Panel 800
- Automation Panel 830
- Automation Panel 900

- IPC2000, IPC2001, IPC2002
- IPC5000, IPC5600
- IPC5000C, IPC5600C
- Mobile Panel 40/50
- Mobile Panel 100/200
- Panel PC 300
- Panel PC 700
- Panel PC 800
- Power Panel 100/200
- Power Panel 300/400
- Power Panel 500

A detailed guide for configuring keys and LEDs can be found in the B&R Key Editor's online help documentation. The B&R Key Editor is available at no cost in the Downloads section of the B&R website (www.br-automation.com). It can also be found on the B&R HMI Drivers & Utilities DVD (model number 5SWHMI.0000-00).

Chapter 5 • Standards and certifications

1 Standards and guidelines

1.1 CE mark



This mark certifies that all harmonized EN standards for the applicable directives have been met for B&R products.

1.2 EMC directive

These devices meet the requirements of EC directive "2004/108/EC Electromagnetic compatibility" and are designed for the following areas:

EN 61131-2:2007	Programmable logic controllers - Part 2: Equipment requirements and tests
EN 61000-6-2:2005	Electromagnetic compatibility (EMC) - Part 6-2: Generic standards - Immunity for industrial environments
EN 61000-6-4:2007	Electromagnetic compatibility (EMC) - Part 6-4: Generic standards - Emission standard for industrial environments

1.3 Low voltage directive

These devices satisfy the requirements of EC directive "2006/95/EC Low voltage directive" and are designed for the following areas:

EN 61131-2:2007	Programmable logic controllers - Part 2: Equipment requirements and tests
EN 60204-1:2006 + A1:2009	Safety of machinery - Electrical equipment of machines - Part 1: General requirements

2 Certifications

Danger!

A complete system can only receive certification if ALL of the individual components it includes have the applicable certifications. If an individual component is being used that DOES NOT have an applicable certification, then the complete system will NOT RECEIVE certification.

B&R products and services comply with applicable standards. This includes international standards from organizations such as ISO, IEC and CENELEC, as well as national standards from organizations such as UL, CSA, FCC, VDE, ÖVE, etc. We are committed to ensuring the reliability of our products in an industrial environment.

Unless otherwise specified, the following certifications apply:

2.1 UL certification



Products with this label have been certified by Underwriters Laboratories and are listed as "Industrial Control Equipment". This mark is valid for the USA and Canada and simplifies the certification of your machines and systems in these areas.

Underwriters Laboratories (UL) in accordance with the UL508 standard - 17th Edition Canadian (CSA) standard in accordance with C22.2 No. 142-M1987

2.2 Certifications for use in potentially explosive environments

2.2.1 UL Haz. Loc. Certifications



Products with this label have been certified by Underwriters Laboratories and are listed as "Industrial Control Equipment for Use in Hazardous Locations". This mark is valid for the USA and Canada and simplifies the certification of your machines and systems in these areas.

Underwriters Laboratories (UL) in accordance with standard ANSI/ISA 12.12.01:2011 Canadian (CSA) standard in accordance with C22.2 No. 213-M1987

Ind. Cont. Eq.
for Haz.Locs.
Cl. I, Div. 2,
Groups ABCD
Listed 2P61

2.2.2 ATEX certification



Products with this mark have been certified by an accredited certification body and have been approved for use in potentially explosive environments.

II 3D Ex tc IIIA T85°C Dc
IP20 Tamb: 0°C to 55°C
FTZU 11 E 0001U

2.2.3 Requirements for use in potentially explosive environments

General safety guidelines

Automation PC 810 devices are suitable for use in the environments described above as well as in environments that are not at risk of explosion. Wiring must follow national regulations and meet all legal requirements. Devices must be installed in suitable protective housings and final assembly must be inspected and approved by the local authorities. Additional equipment must be suitable for the operating location.

Devices with explosion protection are to be used as intended and are only permitted to be operated by knowledgeable and qualified personnel according to these operating instructions and the corresponding user's manual. Operation in any other way endangers the safety and functionality of the devices and the connected systems. The operator is responsible for following all applicable safety and accident prevention regulations, as well as adhering to standards.

Mounting and installation

Automation PC 810 systems must be installed according to the guidelines in the user's manual. In order to guarantee sufficient air circulation, the specified amount of space around the device must be observed. The maximum ambient temperature is 50°C. A fan kit must be used in conjunction with a 5PC800.BM45-xxx processor board. The tightening torque for the power supply terminals is 0.5 Nm. Cables must be able to handle a surface temperature of 75°C. Devices must remain voltage-free until installation work is complete. Devices must be used within a potential equalization system and connected to the potential offset. ATEX: Devices must be installed in a protective housing that meets minimum IP54 (EN 60529) and "tc" (EN 60079-31) protection requirements.

Maintenance

Accumulated dust must be removed regularly.

Breakdowns and disassembly

Devices must be shut down and protected against accidental startup. Defective devices must be replaced by knowledgeable and qualified personnel.

The battery (Renata CR2477N) or fuses must not be removed while voltage is applied or only removed when in non-hazardous areas.

Danger!

Explosion hazard: Replacing components may impair eligibility for Class I, Division 2!

Explosion hazard: Connectors must not be disconnected while voltage is applied or only disconnected when in non-hazardous areas.

Warning!

Only non-transmitting USB devices used in accordance with the operating manual are permitted!

Conformity test and certification

Devices marked "Ex" satisfy the requirements set forth in directives 2004/108/EC and 94/9/EC as well as the harmonized standards EN 61131-2:2007, EN 61000-6-2:2005, EN 61000-6-4:2007, cl. 5.3 EN 60079-0:2009, cl. 6.1.2 EN 60079-31:2009.

Devices marked with "c-UL-us" satisfy the requirements set forth in CSA Std C22.2 No. 213-M1987, CSA Std C22.2 No. 142-M1987, UL Std 508 - 17th Edition and ANSI/ISA 12.12.01:2011.

Product documentation in detail

Additional product information is available on the B&R website at www.br-automation.com or from these user's manuals.

2.3 GL certification (Germanischer Lloyd)



Some B&R products have been certified by Germanischer Lloyd and are approved for use in maritime environments. GL certificates (type approval) are generally accepted by other classification societies during ship acceptance procedures.

Germanischer Lloyd (GL) in accordance with standard GL 2003 (Category C EMC 1)

Category C concerns devices that are protected from weather. EMC 1 defines the radiated and conducted emission limits for devices installed on a ship's bridge.

Information:

HDD, SSD and CD/DVD drives are only permitted to be used for service purposes.

Line filter 5AC804.MFLT-00 is absolutely mandatory in the supply line when used in a maritime environment. Additional information can be found on page Connecting to the end device.

The following table lists revisions from which GL certification applies to individual components.

Model number	Description	GL beginning with rev.
5PC810.SX01-00	APC810 system unit, 1 slot (PCI Express, PCI, depending on bus); 1 compact slide-in slot; Smart Display Link/DVI/Monitor, 2x RS232, 5x USB 2.0, 2x ETH 10/100/1000, 24 VDC (order 0TB103.9 screw clamp or 0TB103.91 cage clamp terminals separately)	G0
5PC810.SX02-00	APC810 system unit, 2 slots (PCI Express, PCI, depending on bus); 1 slot for Automation Panel Link transmitter; 1 slide-in compact and 1 slide-in slot; Smart Display Link/DVI/Monitor, 2x RS232, 5x USB 2.0, 2x ETH 10/100/1000, 24 VDC (order 0TB103.9 screw clamp or 0TB103.91 cage clamp terminals separately)	G0
5PC810.BX01-00	APC810 bus, 1 PCI	D0
5PC810.BX01-01	APC810 bus, 1 PCI Express (x4)	D0
5PC810.BX02-00	APC810 bus, 2 PCI	D0
5PC810.BX02-01	APC810 bus, 1 PCI, 1 PCI Express (x4)	D0
5PC800.B945-05	Intel Atom N270 CPU board, 1.6 GHz, single core, 533 MHz FSB, 512 kB L2 cache; 945GME chipset; 2 slots for SO-DIMM DDR2 modules (max. total of 3 GB), Realtek RTL8111C Ethernet controller	E0
5MMDDR.0512-01	SO-DIMM DDR2 RAM 512 MB PC2-5300	D0
5MMDDR.1024-01	SO-DIMM DDR2 RAM 1024 MB PC2-5300	D0
5MMDDR.2048-01	SO-DIMM DDR2 RAM 2048 MB PC2-5300	D0
5AC801.HS00-02	APC810 heat sink for CPU board with Atom processor N270	D0
5PC810.FA01-00	APC810 fan kit for 5PC810.SX01-00 system unit	D0
5PC810.FA02-01	APC810 fan kit for 5PC810.SX02-00 (revisions > D0)	D0
5AC600.485I-00	RS232/422/485 interface, for installation in an APC620, APC810 or PPC700	D0
5AC600.UPSB-00	Battery unit 5Ah; for APC620, APC810 or PPC800 UPS	D0
5AC600.UPSI-00	UPS module for APC620, APC810, PPC800; for system units 5PC600.SX01-00 (starting with Rev. H0), 5PC600.SX02-00 (starting with Rev. G0), 5PC600.SX02-01 (starting with Rev. H0), 5PC600.SX05-00 (starting with Rev. F0), 5PC600.SX05-01 (starting with Rev. F0), 5PC600.SF03-00 (starting with Rev. A0), 5PC810.SX*. 5PC820.1505-00, 5PC820.1906-00. Order cable (5CAUPS.0005-00 or 5CAUPS.0030-00) and battery unit (5AC600.UPSB-00) separately	E0
5CAUPS.0005-00	UPS cable 0.5 m; for UPS 5AC600.UPSI-00	D0
5CAUPS.0030-00	UPS cable 3 m; for UPS 5AC600.UPSI-00	D0
5AC801.ADAS-00	SATA hard disk adapter for operating a slide-in compact hard disk in a slide-in slot	D0
5AC801.DVDS-00	DVD-ROM SATA slide-in drive	D0
5AC801.DVRS-00	DVD-R/RW DVD+R/RW SATA drive, slide-in	D0
5AC801.HDDI-00	40 GB slide-in compact SATA hard disk, 24/7 operation with extended temperature range. Note: Please see the manual for information about using this hard disk.	D0
5AC801.HDDI-02	160 GB SATA slide-in compact hard disk; 24/7 operation with extended temperature range. Note: Please see the manual for information about using this hard disk.	C0
5AC801.HDDI-03	250 GB slide-in compact SATA hard disk, 24/7 operation. Note: Please see the manual for information about using this hard disk.	D0
5AC801.HDDI-99	APC810 slide-in compact HDD kit	D0
5AC801.HDDS-00	40 GB slide-in SATA hard disk; 24/7 operation with extended temperature range. Note: Please see the manual for information about using this hard disk.	D0
5AC801.SSDI-00	32 GB SATA SSD (SLC), slide-in compact	E0
5AC801.SSDI-01	60 GB SATA SSD (MLC), slide-in compact	C0
5AC801.SSDI-02	180 GB SATA SSD (MLC), slide-in compact	C0
5AC801.SSDI-03	60 GB SATA SSD (MLC), slide-in compact	A0
5AC801.SSDI-04	128 GB SATA SSD (MLC), slide-in compact	A0
5AC801.SDLO-00	Smart Display Link/DVI-D transmitter	D0
5ACPCI.ETH1-01	PCI Ethernet card 1x 10/100	D0
5ACPCI.ETH3-01	PCI Ethernet card 3x 10/100	D0
5AC804.MFLT-00	Line filter	D0
0TB103.9	Connector, 24 VDC, 3-pin female, 3.31 mm ² screw clamp, protected against vibration by the screw flange	D0
0TB103.91	Connector, 24 VDC, 3-pin female, 3.31 mm ² cage clamp, protected against vibration by the screw flange	D0
5CFCRD.0064-03	CompactFlash 64 MB Western Digital (SLC)	E0

Table 257: Revision of individual components with GL certification

Standards and certifications • Certifications

Model number	Description	GL beginning with rev.
5CFCRD.0128-03	CompactFlash 128 MB Western Digital (SLC)	E0
5CFCRD.0256-03	CompactFlash 256 MB Western Digital (SLC)	E0
5CFCRD.0512-03	CompactFlash 512 MB Western Digital (SLC)	E0
5CFCRD.1024-03	CompactFlash 1 GB Western Digital (SLC)	E0
5CFCRD.2048-03	CompactFlash 2 GB Western Digital (SLC)	F0
5CFCRD.4096-03	CompactFlash 4 GB Western Digital (SLC)	E0
5CFCRD.8192-03	CompactFlash 8 GB Western Digital (SLC)	E0
5CFCRD.0512-04	CompactFlash 512 MB B&R (SLC)	D0
5CFCRD.1024-04	CompactFlash 1 GB B&R (SLC)	D0
5CFCRD.2048-04	CompactFlash 2 GB B&R (SLC)	D0
5CFCRD.4096-04	CompactFlash 4 GB B&R (SLC)	D0
5CFCRD.8192-04	CompactFlash 8 GB B&R (SLC)	D0
5CFCRD.016G-04	CompactFlash 16 GB B&R (SLC)	E0
5CFCRD.0512-06	CompactFlash 512 MB B&R (SLC)	D0
5CFCRD.1024-06	CompactFlash 1 GB B&R (SLC)	D0
5CFCRD.2048-06	CompactFlash 2 GB B&R (SLC)	D0
5CFCRD.4096-06	CompactFlash 4 GB B&R (SLC)	D0
5CFCRD.8192-06	CompactFlash 8 GB B&R (SLC)	D0
5CFCRD.016G-06	CompactFlash 16 GB B&R (SLC)	D0
5CFCRD.032G-06	CompactFlash 32 GB B&R (SLC)	C0
5AC900.1000-00	DVI (male connector) to CRT (female connector) adapter. For connecting a standard monitor to a DVI-I interface.	C0

Table 257: Revision of individual components with GL certification

Certificate no. 11 858 - 10 HH

			
<h2>Type Approval Certificate</h2>			
This is to certify that the undemoted product(s) has/have been tested in accordance with the relevant requirements of the GL Type Approval System.			
Certificate No.	11 858 - 10 HH		
Company	Bernecker + Rainer Industrie-Elektronik GmbH B&R Straße 1 5142 Eggelsberg, Austria		
Product Description	Automation PC		
Type	Automation PC 810 ATOM, 4GB RAM, 1 or 2 PCI/PCIe Slots		
Environmental Category	C, EMC1		
Technical Data / Range of Application	System unit: 5PC810.SX01-00 (one slot), 5PC810.SX02-00 (two slots) CPU board: 5PC800.B945-05 Cooling element: 5AC801.HS00-02		
	options: Ventilationkit: 5PC810.FA01-00, 5PC810.FA02-01 Main memory: 5MMDR.XXXX-01 Slide-in compact disc: 5AC801.SSDI-XX, 5AC801.HDDI-XX Slide-in disc: 5AC801.DVDS-XX, 5AC801.DVRS-XX, 5AC801.HDDS-XX, 5AC801.ADAS-XX Serial adapter: 5AC600.485I-XX Compact flash: 5CFCRD.XXXX-XX UPS: module 5AC600. UPSI-XX, batterie unit 5AC600. UPSB-XX cable 5CAUPS.XXXX-XX, AP link transmitter: 5AC801.SDL0-00 Bus unit: 5PC810.BX01-XX (one slot), 5PC810.BX02-XX (two slots) PCI-card: 5ACPCI.XXX-XX		
Test Standard	Guidelines for the Performance of Type Approvals Chapter 2, Edition 2003 Guidelines for the Use of Computers and Computer Systems, Edition 1994		
Documents	Test report : Mikes E34678-00-00HO, Mikes S34730-00-00MJ, Mikes E34677-00-00HO, Mikes S34731-00-00MJ Prüfbeschreibung V1.50 (06.10.2010)		
Remarks	Filter 5AC804.MFLT-00 to be used in DC power line		
Valid until	2016-01-03		
Page	1 of 1	Type Approval Symbol	
File No.	I.B.05		
Hamburg,	2011-01-04		
Germanischer Lloyd	 Dr. Joannis Papanuskas	 Burkhard Lilienthal	
<small>This certificate is issued on the basis of "Guidelines for the Performance of Type Approvals Part 1, Procedure".</small>			

Figure 166: GL certificate no. 11 858 - 10 HH

Chapter 6 • Accessories

The following accessories have successfully completed functional testing at B&R and are approved for use with this device. Nevertheless, it is important to observe any limitations that may apply to the complete system when operated with other individual components. When operating the complete system, the specifications for the individual components must be adhered to.

All components listed in this manual have been subjected to extensive system and compatibility testing and are approved for use. B&R can make no guarantee regarding the functionality of non-approved accessories.

1 Replacement CMOS batteries

1.1 0AC201.91 / 4A0006.00-000

1.1.1 General information

This lithium battery is needed to back BIOS CMOS data and the real-time clock (RTC).

The battery is subject to wear and must be replaced when the battery power is insufficient ("Bad" status).

1.1.2 Order data

Model number	Short description	Figure
	Batteries	
0AC201.91	Lithium batteries 4 pcs., 3 V / 950 mAh button cell We hereby state that the lithium cells contained in this shipment qualify as "partly regulated". Handle with care. If the package is damaged, inspect the cells, repack intact cells and protect the cells against short circuit. For emergency information, call RENATA SA at +41 61 319 28 27.	
4A0006.00-000	Lithium battery, 3 V / 950 mAh, button cell	

Table 258: 0AC201.91, 4A0006.00-000 - Order data

1.1.3 Technical data

Warning!

The battery must be replaced by a Type CR2477N Renata battery only. The use of another battery may present a risk of fire or explosion.

The battery may explode if handled improperly. Do not recharge, disassemble or dispose of in fire.

Information:

The following characteristics, features and limit values only apply to this accessory and can deviate from those specified for the complete system. The data specifications for the complete system take precedence over those of individual components.

Product ID	0AC201.91	4A0006.00-000
General information		
Storage time	Max. 3 years at 30°C	
Certification		
CE		Yes
cULus	Yes	-
Electrical characteristics		
Capacity	950 mAh	
Self-discharging	<1% per year (at 23°C)	
Voltage range	3 V	
Environmental conditions		
Temperature		
Storage	-20 to 60°C	

Table 259: 0AC201.91, 4A0006.00-000 - Technical data

Product ID	0AC201.91	4A0006.00-000
Relative humidity		
Operation		0 to 95%
Storage		0 to 95%
Transport		0 to 95%

Table 259: 0AC201.91, 4A0006.00-000 - Technical data

2 Power connectors

2.1 0TB103.9x

2.1.1 General information

The single-row 3-pin terminal block 0TB103 is used to connect the supply voltage.

2.1.2 Order data

Model number	Short description	Figure
	Terminal blocks	
0TB103.9	Connector, 24 VDC, 3-pin female, 3.31 mm ² screw clamp, protected against vibration by the screw flange	
0TB103.91	Connector, 24 VDC, 3-pin female, 3.31 mm ² cage clamp, protected against vibration by the screw flange	

Table 260: 0TB103.9, 0TB103.91 - Order data

2.1.3 Technical data

Information:

The following characteristics, features and limit values only apply to this accessory and can deviate from those specified for the complete system. The data specifications for the complete system take precedence over those of individual components.

Product ID	0TB103.9	0TB103.91
General information		
Certification		
CE		Yes
cULus		Yes
cULus HazLoc Class 1 Division 2		Yes
GL		Yes
Terminal block		
Note	Protected against vibration by the screw flange Nominal values according to UL	
Number of pins	3 (female)	
Type of terminal clamp	Screw clamps	Cage clamps ²⁾
Cable type	Only copper wires (no aluminum wires!)	
Distance between contacts	5.08 mm	
Connection cross section		
AWG wire	26 to 14 AWG	26 to 12 AWG
Wire end sleeves with plastic covering		0.20 to 1.50 mm ²
Solid wires		0.20 to 2.50 mm ²
Fine strand wires	0.20 to 1.50 mm ²	0.20 to 2.50 mm ²
With wire end sleeves		0.20 to 1.50 mm ²
Fastening torque	0.4 Nm	-
Electrical characteristics		
Nominal voltage	300 V	
Nominal current ¹⁾	10 A / contact	
Contact resistance	≤ 5 mΩ	

Table 261: 0TB103.9, 0TB103.91 - Technical data

- 1) The limit data for each I/O module must be taken into consideration.
- 2) Cage clamp terminal blocks cannot be used side-by-side.

3 Replacement fan

3.1 General information

Information:

Fan filters are subject to wear and should be checked with appropriate frequency to determine whether the air flow provides sufficient cooling. Replacing or cleaning the fan filter is appropriate at that time.

3.2 Order data

Model number	Short description	Figure
	Accessories	
5AC801.FA01-00	APC810 replacement fan filter for 5PC810.SX01-00; 5 pcs.	
5AC801.FA02-00	APC810 replacement fan filter for 5PC810.SX02-00; 5 pcs.	
5AC801.FA03-00	APC810 replacement fan filter for 5PC810.SX03-00; 5 pcs.	
5AC801.FA05-00	APC810 replacement fan filter for 5PC810.SX05-00; 5 pcs.	

Table 262: 5AC801.FA01-00, 5AC801.FA02-00, 5AC801.FA03-00, 5AC801.FA05-00 - Order data

4 DVI/Monitor adapter

4.1 5AC900.1000-00

4.2 General information

This adapter enables a standard monitor to be connected to the DVI-I interface.

4.3 Order data

Model number	Short description	Figure
	Miscellaneous	
5AC900.1000-00	DVI (male connector) to CRT (female connector) adapter. For connecting a standard monitor to a DVI-I interface.	

Table 263: 5AC900.1000-00 - Order data

5 CompactFlash cards

5.1 General information

CompactFlash cards are storage media that are easy to replace. Due to their robustness against environmental influences (e.g. temperature, shock, vibration, etc.), CompactFlash cards are ideal for use as storage media in industrial environments.

5.2 General information

In order to be suited for use in industrial automation, CompactFlash cards must be highly reliable. The following items are very important to achieving the necessary level of reliability:

- The flash technology used
- An efficient algorithm for maximizing service life
- Good mechanisms for detecting and fixing errors in the flash memory

5.2.1 Flash technology

Currently, CompactFlash cards are available with MLC (multi-level cell) and SLC (single-level cell) flash blocks. SLC flash memory has a service life 10 times longer than MLC, which is why only CompactFlash cards with SLC flash blocks are suited for industrial applications.

5.2.2 Wear leveling

Wear leveling is an algorithm that can be used to maximize the service life of a CompactFlash card. There are three different algorithms:

- No wear leveling
- Dynamic wear leveling
- Static wear leveling

The basic idea behind wear leveling is to distribute data over a broad area of blocks or cells on the disk so that the same areas don't have to be cleared and reprogrammed over and over again.

5.2.2.1 No wear leveling

The earliest CompactFlash cards didn't have an algorithm for maximizing service life. The service life of a CompactFlash card was determined only by the guaranteed lifespan of the flash blocks.

5.2.2.2 Dynamic wear leveling

Dynamic wear leveling makes it possible to utilize unused flash blocks when writing to a file. If the disk is 80% full with files, then only 20% can be used for wear leveling.

The service life of the CompactFlash card is therefore dependent on the amount of unused flash blocks.

5.2.2.3 Static wear leveling

Static wear leveling monitors which data is rarely modified. From time to time, the controller then moves this data to blocks that have already been used frequently in order to prevent further wear on those cells.

5.2.3 ECC error correction

Bit errors can be caused by inactivity or when a certain cell is being operated. Error correction coding (ECC) implemented via hardware or software can detect and correct many errors of this type.

5.2.4 S.M.A.R.T. support

Self-Monitoring, Analysis and Reporting Technology (S.M.A.R.T.) is an industry standard for mass storage devices that has been introduced to monitor important parameters and quickly detect imminent failures. Critical performance and calibration data is monitored and stored in order to help predict the probability of errors.

5.2.5 Maximum reliability

CompactFlash cards supplied by B&R use SLC flash blocks and static wear leveling together with a powerful ECC algorithm to provide maximum reliability.

5.3 5CFCRD.xxxx-06

5.3.1 General information

Information:

B&R CompactFlash cards 5CFCRD.xxxx-06 and CompactFlash cards from a different manufacturer cannot be used in the same system at the same time. Due to differences in technology (older vs. newer technologies), problems can occur during system startup that are caused by different boot times.

see "Known problems/issues" on page 342

Information:

5CFCRD.xxxx-06 CompactFlash cards are supported on B&R devices with WinCE version ≥ 6.0 .

5.3.2 Order data

Model number	Short description	Figure
	CompactFlash	
5CFCRD.0512-06	CompactFlash 512 MB B&R (SLC)	
5CFCRD.1024-06	CompactFlash 1 GB B&R (SLC)	
5CFCRD.2048-06	CompactFlash 2 GB B&R (SLC)	
5CFCRD.4096-06	CompactFlash 4 GB B&R (SLC)	
5CFCRD.8192-06	CompactFlash 8 GB B&R (SLC)	
5CFCRD.016G-06	CompactFlash 16 GB B&R (SLC)	
5CFCRD.032G-06	CompactFlash 32 GB B&R (SLC)	

Table 264: 5CFCRD.0512-06, 5CFCRD.1024-06, 5CFCRD.2048-06, 5CFCRD.4096-06, 5CFCRD.8192-06, 5CFCRD.016G-06, 5CFCRD.032G-06 - Order data

5.3.3 Technical data

Caution!

A sudden loss of power may result in data loss! In very rare cases, the mass storage device may also become damaged.

To prevent damage and loss of data, the use of a UPS device is recommended.

Information:

The following characteristics, features and limit values only apply to this accessory and can deviate from those specified for the complete system. The data specifications for the complete system take precedence over those of individual components.

Product ID	5CFCRD. 0512-06	5CFCRD. 1024-06	5CFCRD. 2048-06	5CFCRD. 4096-06	5CFCRD. 8192-06	5CFCRD. 016G-06	5CFCRD. 032G-06
General information							
Capacity	512 MB	1 GB	2 GB	4 GB	8 GB	16 GB	32 GB
Data retention	10 years						
Data reliability	<1 unrecoverable error in 10^{14} bit read accesses						
Lifetime monitoring	Yes						
MTBF	>3,000,000 hours (at 25°C)						
Maintenance	None						
Supported operating modes	PIO Mode 0-6, Multiword DMA Mode 0-4, Ultra DMA Mode 0-4						
Continuous reading							
Typical	33 MB/s	33 MB/s	33 MB/s	33 MB/s	33 MB/s	36 MB/s	36 MB/s
Maximum	35 MB/s	35 MB/s	35 MB/s	34 MB/s	34 MB/s	37 MB/s	37 MB/s
Continuous writing							
Typical	15 MB/s	15 MB/s	15 MB/s	14 MB/s	14 MB/s	28 MB/s	28 MB/s
Maximum	18 MB/s	18 MB/s	18 MB/s	17 MB/s	17 MB/s	30 MB/s	30 MB/s

Table 265: 5CFCRD.0512-06, 5CFCRD.1024-06, 5CFCRD.2048-06, 5CFCRD.4096-06, 5CFCRD.8192-06, 5CFCRD.016G-06, 5CFCRD.032G-06 - Technical data

Accessories • CompactFlash cards

Product ID	5CFCRD.0512-06	5CFCRD.1024-06	5CFCRD.2048-06	5CFCRD.4096-06	5CFCRD.8192-06	5CFCRD.016G-06	5CFCRD.032G-06
Certification							
CE				Yes			
cULus				Yes			
cULus HazLoc Class 1 Division 2	-	-	-	-	-	Yes	-
ATEX Zone 22	-	-	-	-	-	Yes	-
GL				Yes			
Endurance							
Guaranteed data volume							
Guaranteed ¹⁾	50 TB	100 TB	200 TB	400 TB	800 TB	1600 TB	3200 TB
Results for 5 years ¹⁾	27.40 GB/day	54.79 GB/day	109.9 GB/day	219.8 GB/day	438.6 GB/day	876.72 GB/day	1753.44 GB/day
Clear/Write cycles							
Guaranteed	100,000						
SLC flash	Yes						
Wear leveling	Static						
Error correction coding (ECC)	Yes						
S.M.A.R.T. support	Yes						
Support							
Hardware	PP300/400, PP500, PPC300, PPC700, PPC725, PPC800, APC620, APC810, APC820						
Operating systems							
Windows 7 32-bit	No	No	No	No	No	Yes	Yes
Windows 7 64-bit	No	No	No	No	No	No	Yes
Windows Embedded Standard 7, 32-bit	No	No	No	No	Yes	Yes	Yes
Windows Embedded Standard 7, 64-bit	No	No	No	No	No	Yes	Yes
Windows XP Professional	No	No	No	Yes	Yes	Yes	Yes
Windows XP Embedded				Yes			
Windows Embedded Standard 2009	No	Yes	Yes	Yes	Yes	Yes	Yes
Windows CE 6.0	Yes	Yes	Yes	Yes	Yes	Yes ²⁾	Yes ²⁾
Windows CE 5.0	No						
Software							
PVI Transfer	≥ V3.2.3.8 (part of PVI Development Setup ≥ V2.06.00.3011)	≥ V3.2.3.8 (part of PVI Development Setup ≥ V2.06.00.3011)	≥ V3.2.3.8 (part of PVI Development Setup ≥ V2.06.00.3011)	≥ V3.2.3.8 (part of PVI Development Setup ≥ V2.06.00.3011)	≥ V3.2.3.8 (part of PVI Development Setup ≥ V2.06.00.3011)	≥ V3.6.8.40 (part of PVI Development Setup ≥ V3.0.0.3020)	≥ V4.0.0.8 (part of PVI Development Setup ≥ V3.0.2.3014)
B&R Embedded OS Installer	≥V3.10	≥V3.10	≥V3.10	≥V3.10	≥V3.10	≥V3.20	≥V3.21
Environmental conditions							
Temperature							
Operation	0 to 70°C						
Storage	-65 to 150°C						
Transport	-65 to 150°C						
Relative humidity							
Operation	Max. 85% at 85°C						
Storage	Max. 85% at 85°C						
Transport	Max. 85% at 85°C						
Vibration							
Operation	20 g peak, 20 to 2000 Hz, 4 in each direction (JEDEC JESD22, method B103) 5.35 g RMS, 15 min per level (IEC 68-2-6)						
Storage	20 g peak, 20 to 2000 Hz, 4 in each direction (JEDEC JESD22, method B103) 5.35 g RMS, 15 min per level (IEC 68-2-6)						
Transport	20 g peak, 20 to 2000 Hz, 4 in each direction (JEDEC JESD22, method B103) 5.35 g RMS, 15 min per level (IEC 68-2-6)						
Shock							
Operation	1.5 kg peak, 0.5 ms 5 times (JEDEC JESD22, method B110) 30 g, 11 ms 1 times (IEC 68-2-27)						
Storage	1.5 kg peak, 0.5 ms 5 times (JEDEC JESD22, method B110) 30 g, 11 ms 1 times (IEC 68-2-27)						
Transport	1.5 kg peak, 0.5 ms 5 times (JEDEC JESD22, method B110) 30 g, 11 ms 1 times (IEC 68-2-27)						
Altitude							
Operation	Max. 4572 m						
Mechanical characteristics							
Dimensions							
Width	42.8 ±0.10 mm						
Length	36.4 ±0.15 mm						
Height	3.3 ±0.10 mm						
Weight	10 g						

Table 265: 5CFCRD.0512-06, 5CFCRD.1024-06, 5CFCRD.2048-06, 5CFCRD.4096-06, 5CFCRD.8192-06, 5CFCRD.016G-06, 5CFCRD.032G-06 - Technical data

- Endurance of B&R CFs (with linear written block size ≥128 kB).
- Not supported by the B&R Embedded OS Installer.

5.3.4 Temperature humidity diagram

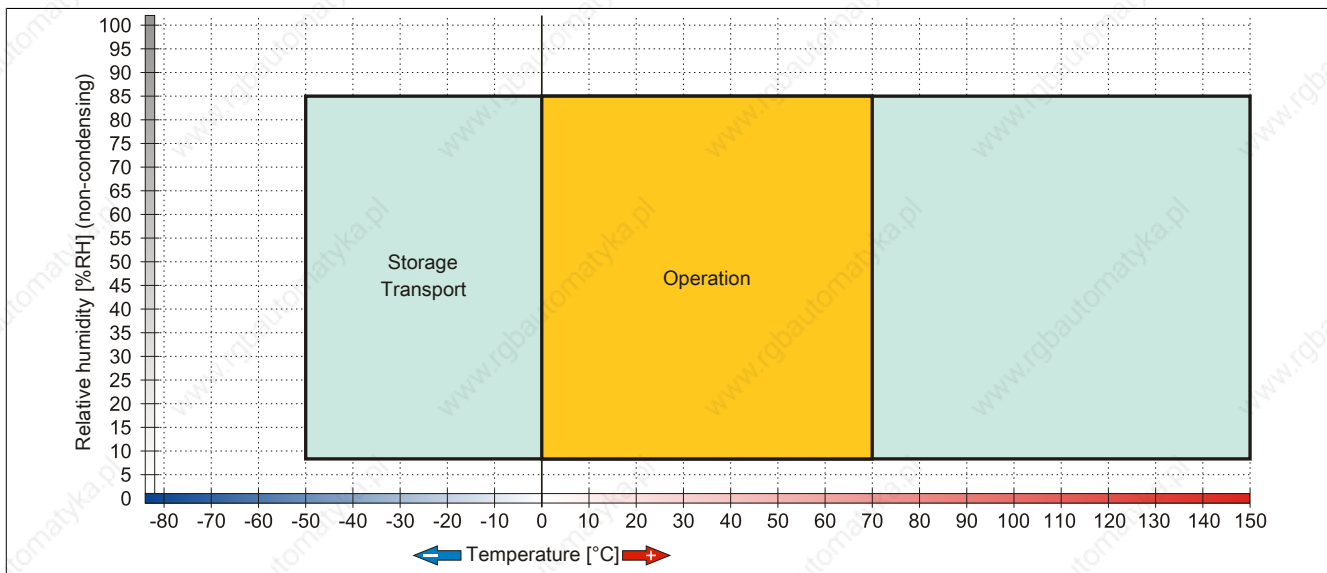

Figure 167: 5CFCRD.xxxx-06 CompactFlash cards - Temperature humidity diagram

5.3.5 Dimensions

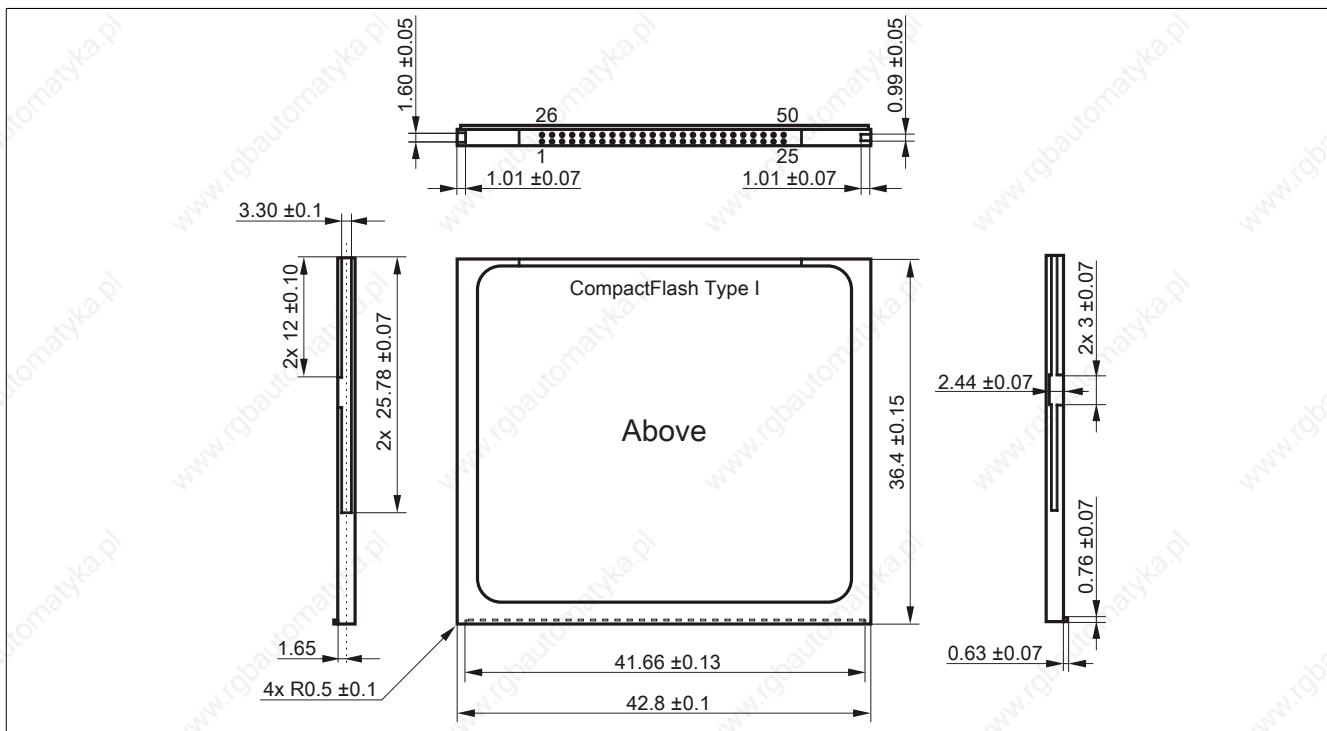

Figure 168: Type I CompactFlash card - Dimensions

5.3.6 Benchmark

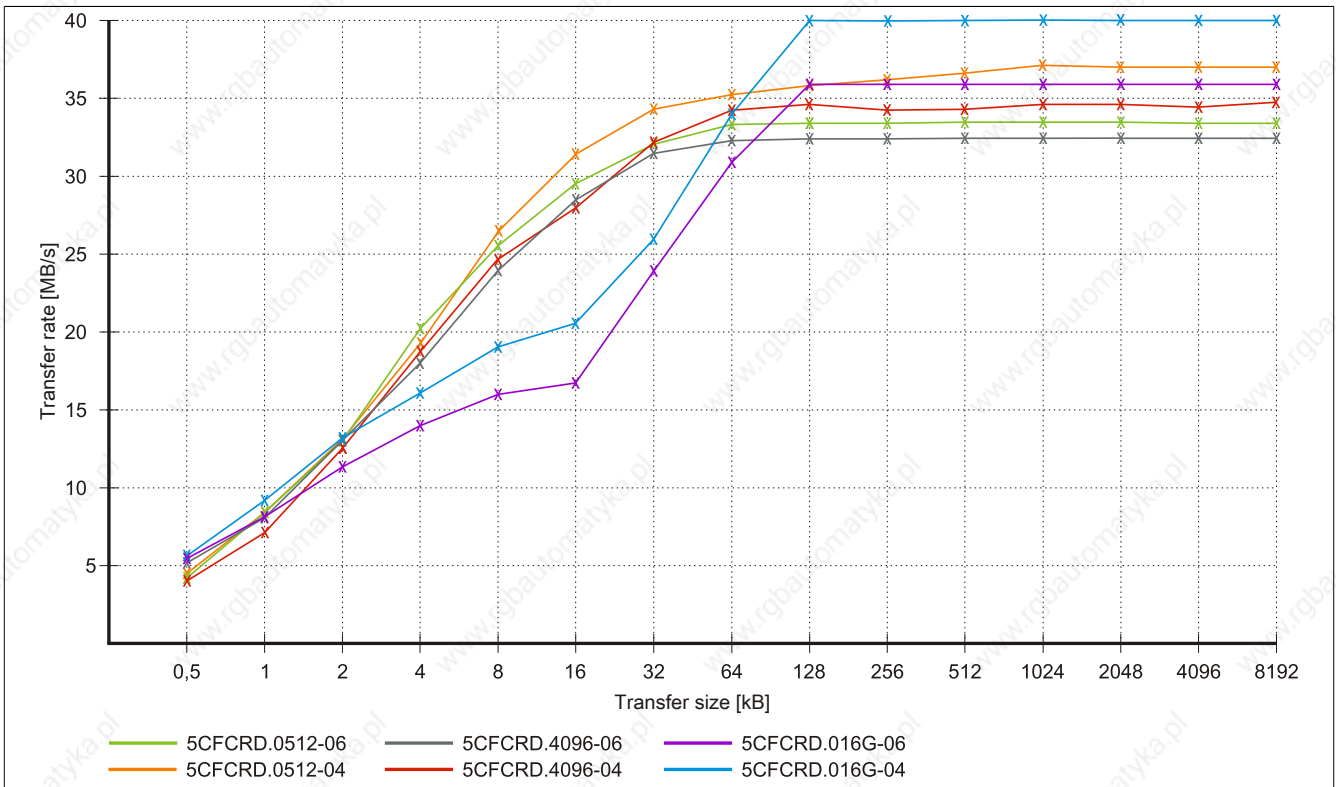

Figure 169: ATTO Disk Benchmark v2.34 read comparison - 5CFCRD.xxxx-04 and 5CFCRD.xxxx-06

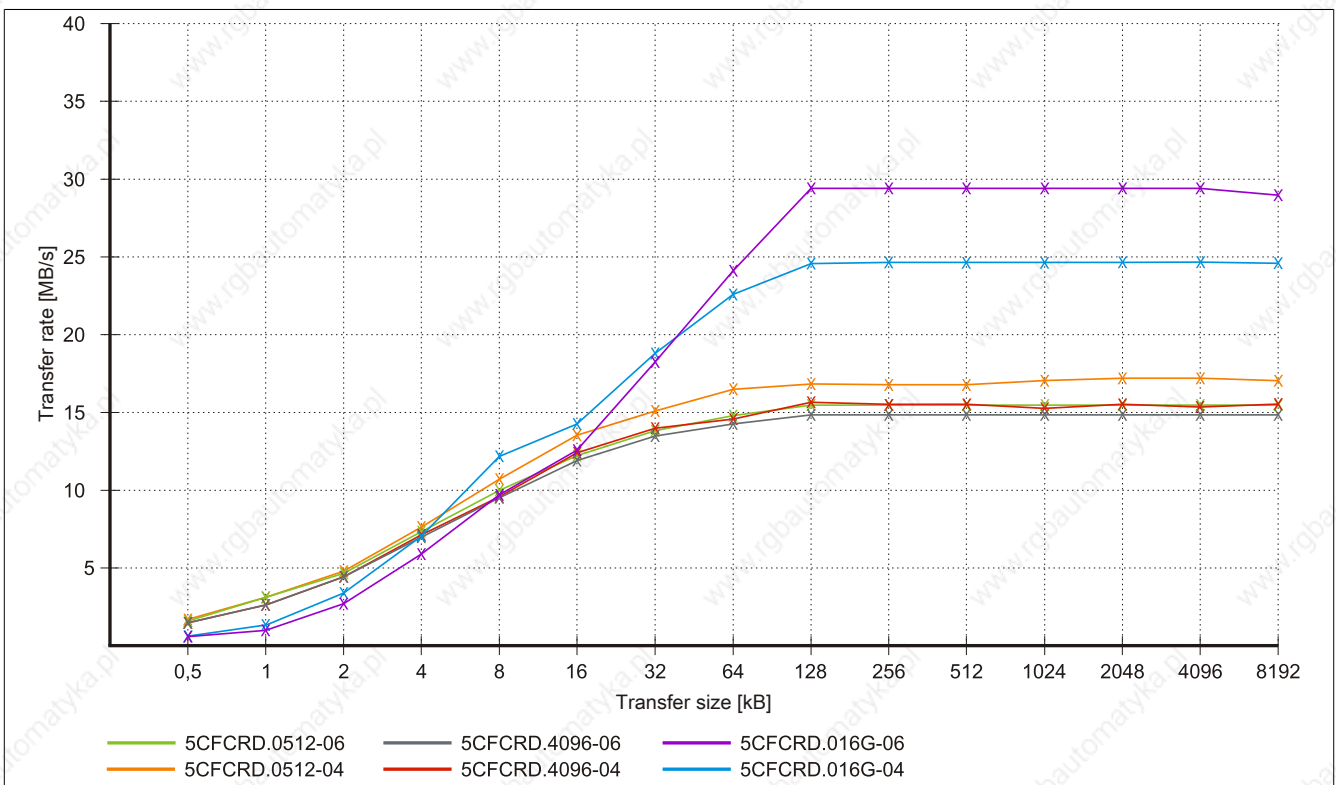

Figure 170: ATTO Disk Benchmark v2.34 write comparison - 5CFCRD.xxxx-04 and 5CFCRD.xxxx-06

5.4 5CFCRD.xxxx-04

5.4.1 General information

Information:

B&R CompactFlash cards 5CFCRD.xxxx-04 and CompactFlash cards from a different manufacturer cannot be used in the same system at the same time. Due to differences in technology (older vs. newer technologies), problems can occur during system startup that are caused by different boot times.

see "Known problems/issues" on page 342

Information:

5CFCRD.xxxx-04 CompactFlash cards are supported on B&R devices with WinCE version ≥ 6.0 .

5.4.2 Order data

Model number	Short description	Figure
	CompactFlash	
5CFCRD.0512-04	CompactFlash 512 MB B&R (SLC)	
5CFCRD.1024-04	CompactFlash 1 GB B&R (SLC)	
5CFCRD.2048-04	CompactFlash 2 GB B&R (SLC)	
5CFCRD.4096-04	CompactFlash 4 GB B&R (SLC)	
5CFCRD.8192-04	CompactFlash 8 GB B&R (SLC)	
5CFCRD.016G-04	CompactFlash 16 GB B&R (SLC)	

Table 266: 5CFCRD.0512-04, 5CFCRD.1024-04, 5CFCRD.2048-04, 5CFCRD.4096-04, 5CFCRD.8192-04, 5CFCRD.016G-04 - Order data

5.4.3 Technical data

Caution!

A sudden loss of power may result in data loss! In very rare cases, the mass storage device may also become damaged.

To prevent damage and loss of data, the use of a UPS device is recommended.

Information:

The following characteristics, features and limit values only apply to this accessory and can deviate from those specified for the complete system. The data specifications for the complete system take precedence over those of individual components.

Product ID	5CFCRD.0512-04	5CFCRD.1024-04	5CFCRD.2048-04	5CFCRD.4096-04	5CFCRD.8192-04	5CFCRD.016G-04
General information						
Capacity	512 MB	1 GB	2 GB	4 GB	8 GB	16 GB
Data retention	10 years					
Data reliability	<1 unrecoverable error in 10 ¹⁴ bit read accesses					
Lifetime monitoring	Yes					
MTBF	>3,000,000 hours (at 25°C)					
Maintenance	None					
Supported operating modes	PIO Mode 0-6, Multiword DMA Mode 0-4, Ultra DMA Mode 0-4					
Continuous reading						
Typical	35 MB/s (240X) ¹⁾	35 MB/s (240X) ¹⁾	35 MB/s (240X) ¹⁾	33 MB/s (220X) ¹⁾	27 MB/s (180X) ¹⁾	36 MB/s (240X) ¹⁾
Maximum	37 MB/s (260X) ¹⁾	37 MB/s (260X) ¹⁾	37 MB/s (260X) ¹⁾	34 MB/s (226X) ¹⁾	28 MB/s (186X) ¹⁾	37 MB/s (247X) ¹⁾

Table 267: 5CFCRD.0512-04, 5CFCRD.1024-04, 5CFCRD.2048-04, 5CFCRD.4096-04, 5CFCRD.8192-04, 5CFCRD.016G-04 - Technical data

Accessories • CompactFlash cards

Product ID	5CFCRD.0512-04	5CFCRD.1024-04	5CFCRD.2048-04	5CFCRD.4096-04	5CFCRD.8192-04	5CFCRD.016G-04
Continuous writing						
Typical	17 MB/s (110X)	17 MB/s (110X)	17 MB/s (110X)	16 MB/s (106X)	15 MB/s (100X)	18 MB/s (120X)
Maximum	20 MB/s (133X)	20 MB/s (133X)	20 MB/s (133X)	18 MB/s (120X)	17 MB/s (110X)	19 MB/s (126X)
Certification						
CE	Yes					
cULus	Yes					
GL	Yes					
Endurance						
Guaranteed data volume						
Guaranteed ²⁾	50 TB	100 TB	200 TB	400 TB	800 TB	1600 TB
Results for 5 years ²⁾	27.40 GB/day	54.79 GB/day	109.9 GB/day	219.8 GB/day	438.6 GB/day	876.72 GB/day
Clear/Write cycles						
Typical ³⁾	2,000,000					
Guaranteed	100,000					
SLC flash	Yes					
Wear leveling	Static					
Error correction coding (ECC)	Yes					
S.M.A.R.T. support	No					
Support						
Hardware	PP300/400, PP500, PPC300, PPC700, PPC725, PPC800, APC620, APC810, APC820					
Operating systems						
Windows 7 32-bit	No	No	No	No	No	Yes
Windows 7 64-bit				No		
Windows Embedded Standard 7, 32-bit	No	No	No	No	Yes	Yes
Windows Embedded Standard 7, 64-bit	No	No	No	No	No	Yes
Windows XP Professional	No	No	No	Yes	Yes	Yes
Windows XP Embedded				Yes		
Windows Embedded Standard 2009	No	Yes	Yes	Yes	Yes	Yes
Windows CE 6.0	Yes	Yes	Yes	Yes	Yes	Yes
Windows CE 5.0				No		Yes ⁴⁾
Software						
PVI Transfer	≥ V3.2.3.8 (part of PVI Development Setup ≥ V2.06.00.3011)	≥ V3.2.3.8 (part of PVI Development Setup ≥ V2.06.00.3011)	≥ V3.2.3.8 (part of PVI Development Setup ≥ V2.06.00.3011)	≥ V3.2.3.8 (part of PVI Development Setup ≥ V2.06.00.3011)	≥ V3.2.3.8 (part of PVI Development Setup ≥ V2.06.00.3011)	≥ V3.6.8.40 (part of PVI Development Setup ≥ V3.0.0.3020)
B&R Embedded OS Installer	≥V3.10	≥V3.10	≥V3.10	≥V3.10	≥V3.10	≥V3.20
Environmental conditions						
Temperature						
Operation	0 to 70°C					
Storage	-65 to 150°C					
Transport	-65 to 150°C					
Relative humidity						
Operation	Max. 85% at 85°C					
Storage	Max. 85% at 85°C					
Transport	Max. 85% at 85°C					
Vibration						
Operation	20 g peak, 20 to 2000 Hz, 4 in each direction (JEDEC JESD22, method B103) 5.35 g RMS, 15 min per level (IEC 68-2-6)					
Storage	20 g peak, 20 to 2000 Hz, 4 in each direction (JEDEC JESD22, method B103) 5.35 g RMS, 15 min per level (IEC 68-2-6)					
Transport	20 g peak, 20 to 2000 Hz, 4 in each direction (JEDEC JESD22, method B103) 5.35 g RMS, 15 min per level (IEC 68-2-6)					
Shock						
Operation	1.5 kg peak, 0.5 ms 5 times (JEDEC JESD22, method B110) 30 g, 11 ms 1 times (IEC 68-2-27)					
Storage	1.5 kg peak, 0.5 ms 5 times (JEDEC JESD22, method B110) 30 g, 11 ms 1 times (IEC 68-2-27)					
Transport	1.5 kg peak, 0.5 ms 5 times (JEDEC JESD22, method B110) 30 g, 11 ms 1 times (IEC 68-2-27)					
Altitude						
Operation	Max. 4572 m					

Table 267: 5CFCRD.0512-04, 5CFCRD.1024-04, 5CFCRD.2048-04, 5CFCRD.4096-04, 5CFCRD.8192-04, 5CFCRD.016G-04 - Technical data

Product ID	5CFCRD.0512-04	5CFCRD.1024-04	5CFCRD.2048-04	5CFCRD.4096-04	5CFCRD.8192-04	5CFCRD.016G-04
Mechanical characteristics						
Dimensions						
Width	42.8 ±0.10 mm					
Length	36.4 ±0.15 mm					
Height	3.3 ±0.10 mm					
Weight	10 g					

Table 267: 5CFCRD.0512-04, 5CFCRD.1024-04, 5CFCRD.2048-04, 5CFCRD.4096-04, 5CFCRD.8192-04, 5CFCRD.016G-04 - Technical data

- 1) Speed specification with 1X = 150 Kb/s. All specifications refer to Samsung flash chips, CompactFlash cards in UDMA mode 4, 30 ns cycle time in True IDE mode with sequential write/read test.
- 2) Endurance of B&R CFs (with linear written block size ≥128 kB).
- 3) Depends on the average file size.
- 4) Not supported by the B&R Embedded OS Installer.

5.4.4 Temperature humidity diagram

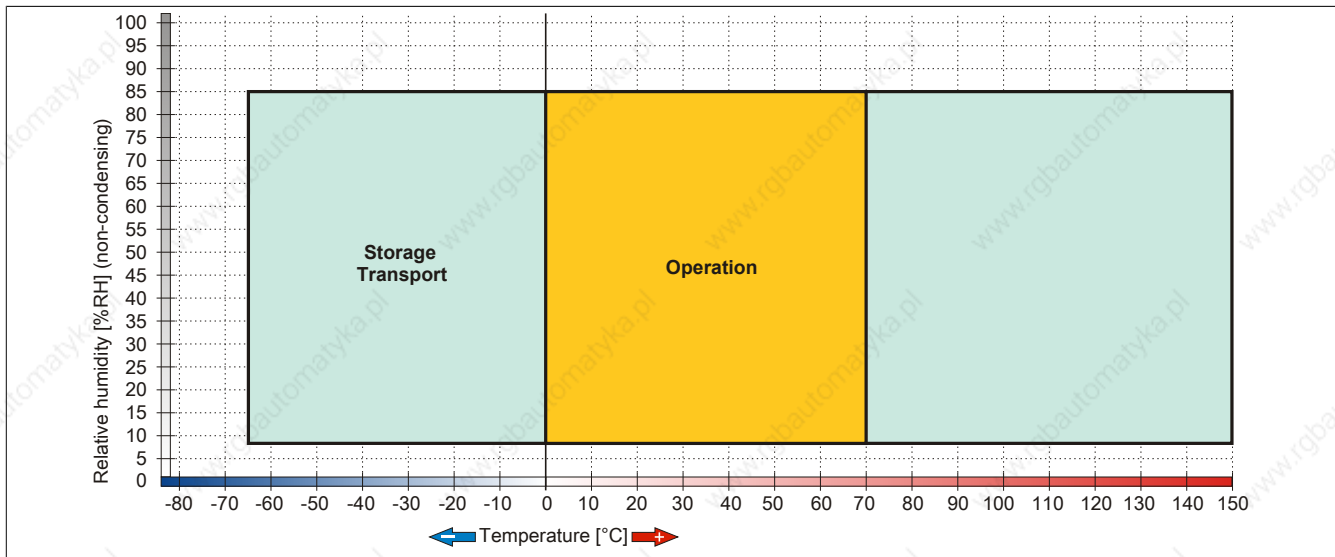

Figure 171: 5CFCRD.xxxx-04 CompactFlash cards - Temperature humidity diagram

5.4.5 Dimensions

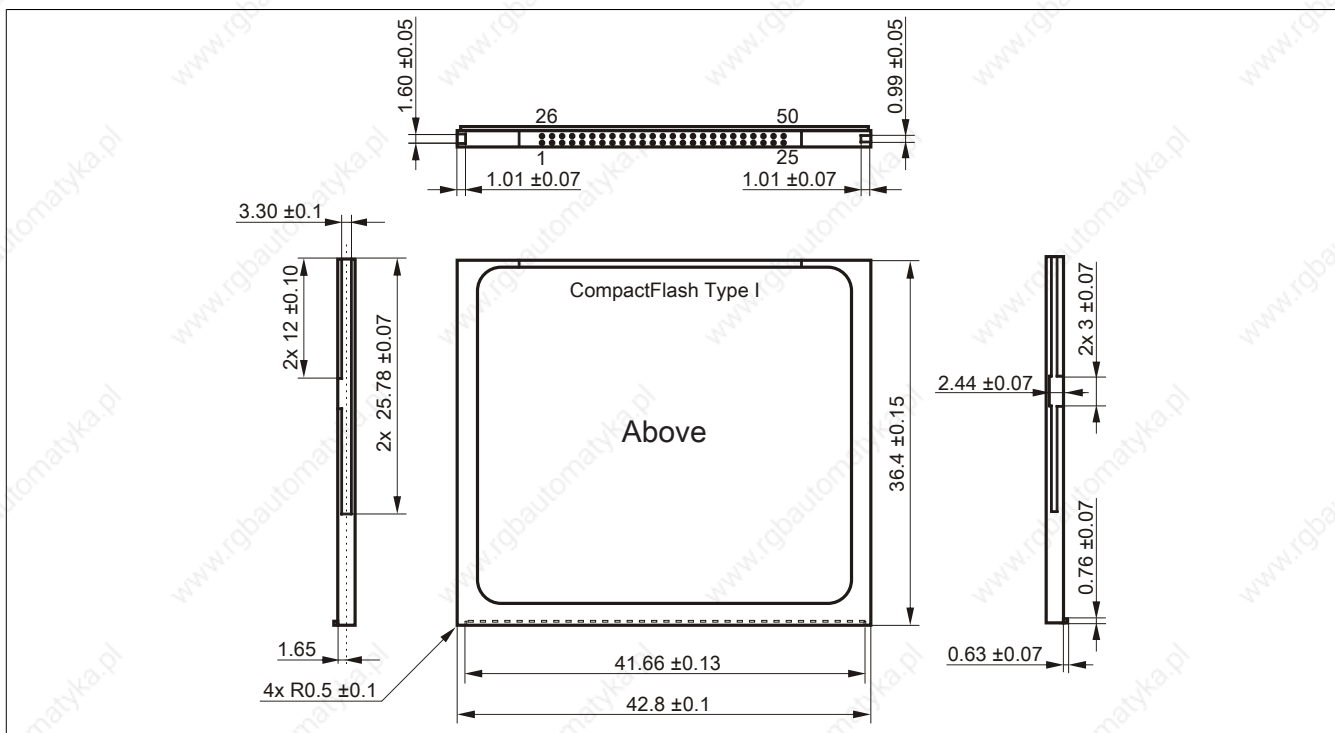

Figure 172: Type I CompactFlash card - Dimensions

5.4.6 Benchmark

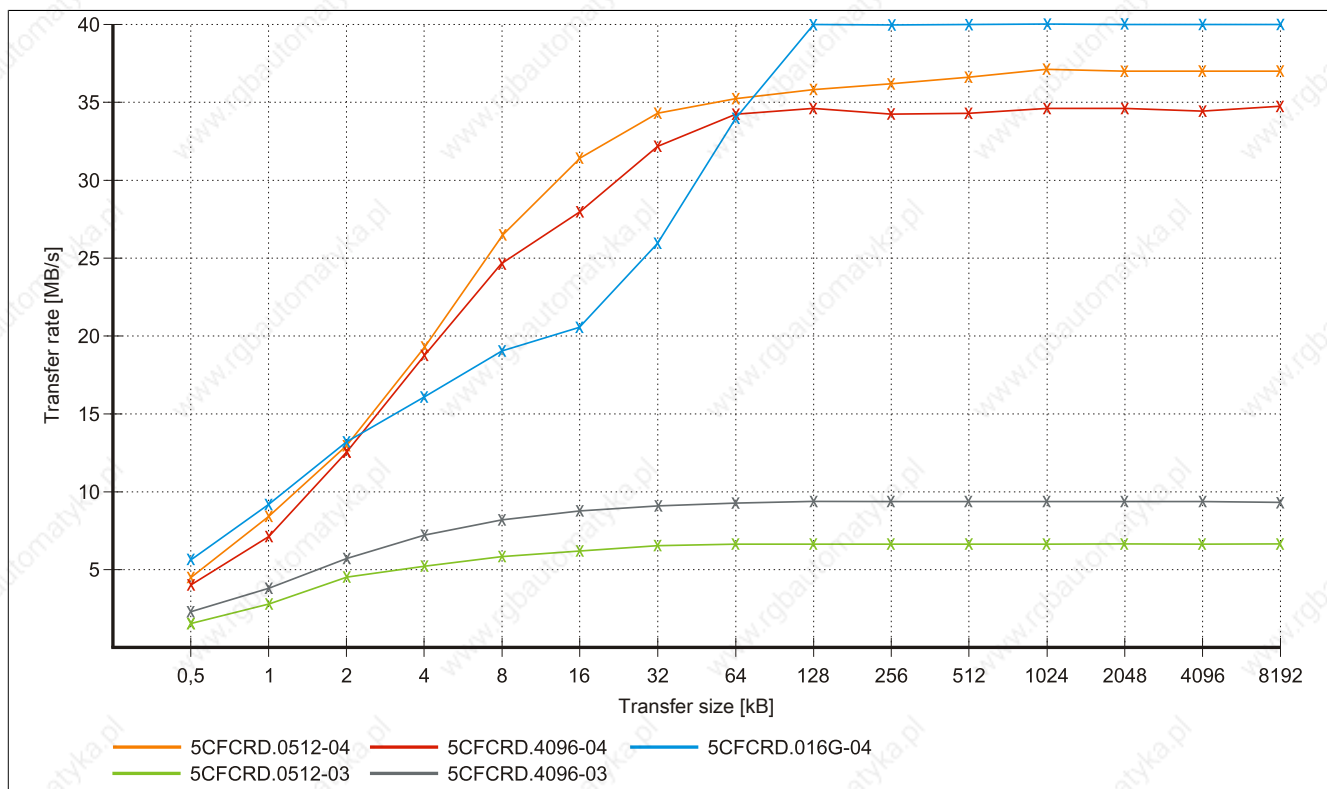

Figure 173: ATTO Disk Benchmark v2.34 read comparison - 5CFCRD.xxxx-03 and 5CFCRD.xxxx-04

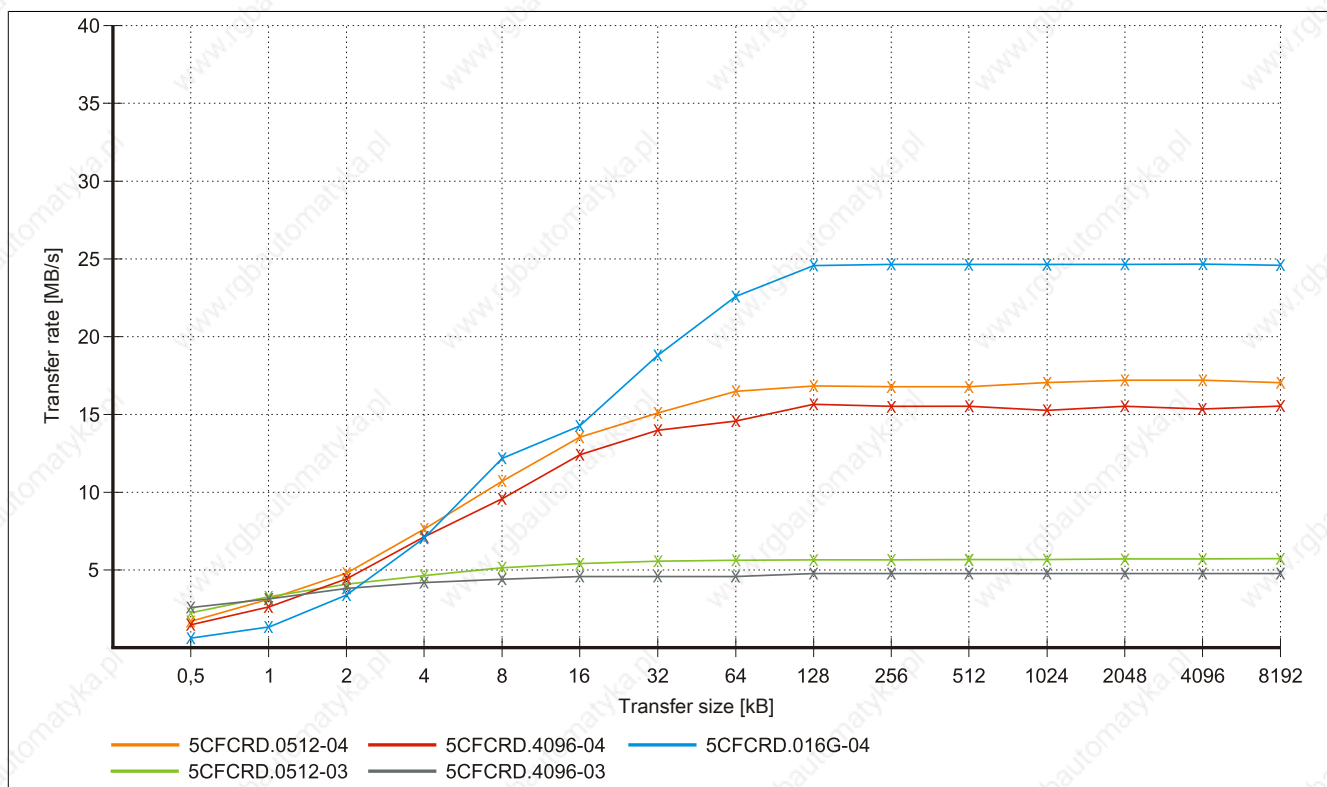

Figure 174: ATTO Disk Benchmark v2.34 write comparison - 5CFCRD.xxxx-03 and 5CFCRD.xxxx-04

5.5 5CFCRD.xxxx-03

5.5.1 General information

Information:

Western Digital CompactFlash cards 5CFCRD.xxxx-03 and CompactFlash cards from a different manufacturer cannot be used in the same system at the same time. Due to differences in technology (older vs. newer technologies), problems can occur during system startup that are caused by different boot times.

see "Known problems/issues" on page 342

Information:

On Windows CE 5.0 devices, 5CFCRD.xxxx-03 CompactFlash cards up to 1 GB are supported.

Information:

On CompactFlash cards 5CFCRD.xxxx-03, only the sticker and the description have changed. The technical data has not been changed.

5.5.2 Order data

Model number	Short description	Figure
	CompactFlash	
5CFCRD.0064-03	CompactFlash 64 MB Western Digital (SLC)	
5CFCRD.0128-03	CompactFlash 128 MB Western Digital (SLC)	
5CFCRD.0256-03	CompactFlash 256 MB Western Digital (SLC)	
5CFCRD.0512-03	CompactFlash 512 MB Western Digital (SLC)	
5CFCRD.1024-03	CompactFlash 1 GB Western Digital (SLC)	
5CFCRD.2048-03	CompactFlash 2 GB Western Digital (SLC)	
5CFCRD.4096-03	CompactFlash 4 GB Western Digital (SLC)	
5CFCRD.8192-03	CompactFlash 8 GB Western Digital (SLC)	

Table 268: 5CFCRD.0064-03, 5CFCRD.0128-03, 5CFCRD.0256-03, 5CFCRD.0512-03, 5CFCRD.1024-03, 5CFCRD.2048-03, 5CFCRD.4096-03, 5CFCRD.8192-03 - Order data

5.5.3 Technical data

Caution!

A sudden loss of power may result in data loss! In very rare cases, the mass storage device may also become damaged.

To prevent damage and loss of data, B&R recommends that you use a UPS device.

Information:

The following characteristics, features and limit values only apply to this accessory and can deviate from those specified for the complete system. The data specifications for the complete system take precedence over those of individual components.

Product ID	5CFCRD.0064-03	5CFCRD.0128-03	5CFCRD.0256-03	5CFCRD.0512-03	5CFCRD.1024-03	5CFCRD.2048-03	5CFCRD.4096-03	5CFCRD.8192-03
General information								
Capacity	64 MB	128 MB	256 MB	512 MB	1 GB	2 GB	4 GB	8 GB
Data retention	10 years							
Data reliability	<1 unrecoverable error in 10 ¹⁴ bit read accesses							
Lifetime monitoring	Yes							
MTBF	>4,000,000 hours (at 25°C)							

Table 269: 5CFCRD.0064-03, 5CFCRD.0128-03, 5CFCRD.0256-03, 5CFCRD.0512-03, 5CFCRD.1024-03, 5CFCRD.2048-03, 5CFCRD.4096-03, 5CFCRD.8192-03 - Technical data

Accessories • CompactFlash cards

Product ID	5CFCRD.0064-03	5CFCRD.0128-03	5CFCRD.0256-03	5CFCRD.0512-03	5CFCRD.1024-03	5CFCRD.2048-03	5CFCRD.4096-03	5CFCRD.8192-03
Maintenance	None							
Supported operating modes	PIO Mode 0-4, Multiword DMA Mode 0-2							
Continuous reading Typical	8 MB/s							
Continuous writing Typical	6 MB/s							
Certification CE cULus GL	Yes Yes Yes							
Endurance								
Clear/Write cycles Typical	>2,000,000							
SLC flash	Yes							
Wear leveling	Static							
Error correction coding (ECC)	Yes							
S.M.A.R.T. support	No							
Support								
Hardware	MP100/200, PP100/200, PP300/400, PP500, PPC300, PPC700, PPC725, PPC800, Provit 2000, Provit 5000, APC620, APC680, APC810, APC820							
Operating systems								
Windows 7 32-bit	No							
Windows 7 64-bit	No							
Windows Embedded Standard 7, 32-bit	No	No	No	No	No	No	No	Yes
Windows Embedded Standard 7, 64-bit	No							
Windows XP Professional	No	No	No	No	No	No	Yes	Yes
Windows XP Embedded	No	No	No	Yes	Yes	Yes	Yes	Yes
Windows Embedded Standard 2009	No	No	No	No	Yes	Yes	Yes	Yes
Windows CE 6.0	Yes	Yes	Yes	Yes	Yes	Yes	Yes	Yes ¹⁾
Windows CE 5.0	Yes	Yes	Yes	Yes	Yes	No	No	No
Software								
PVI Transfer	≥V2.57 (part of PVI Development Setup ≥ V2.5.3.3005)							
B&R Embedded OS Installer	≥ V2.21							
Environmental conditions								
Temperature								
Operation	0 to 70°C							
Storage	-50 to 100°C							
Transport	-50 to 100°C							
Relative humidity								
Operation	8 to 95%, non-condensing							
Storage	8 to 95%, non-condensing							
Transport	8 to 95%, non-condensing							
Vibration								
Operation	Max. 16.3 g (159 m/s ² 0-peak)							
Storage	Max. 30 g (294 m/s ² 0-peak)							
Transport	Max. 30 g (294 m/s ² 0-peak)							
Shock								
Operation	Max. 1000 g (9810 m/s ² 0-peak)							
Storage	Max. 3000 g (29430 m/s ² 0-peak)							
Transport	Max. 3000 g (29430 m/s ² 0-peak)							
Altitude								
Operation	Max. 24383 m							
Mechanical characteristics								
Dimensions								
Width	42.8 ±0.10 mm							
Length	36.4 ±0.15 mm							
Height	3.3 ±0.10 mm							
Weight	11.4 g							

Table 269: 5CFCRD.0064-03, 5CFCRD.0128-03, 5CFCRD.0256-03, 5CFCRD.0512-03, 5CFCRD.1024-03, 5CFCRD.2048-03, 5CFCRD.4096-03, 5CFCRD.8192-03 - Technical data

1) Not supported by the B&R Embedded OS Installer.

5.5.4 Temperature humidity diagram

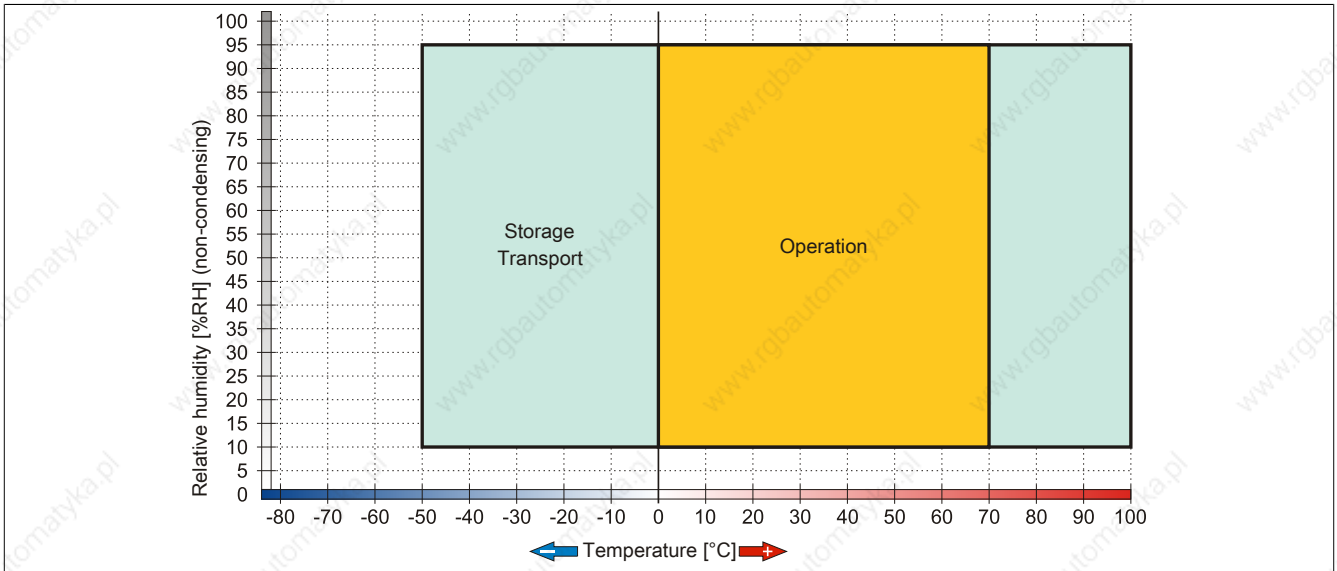

Figure 175: 5CFCRD.xxxx-03 CompactFlash cards - Temperature humidity diagram

5.5.5 Dimensions

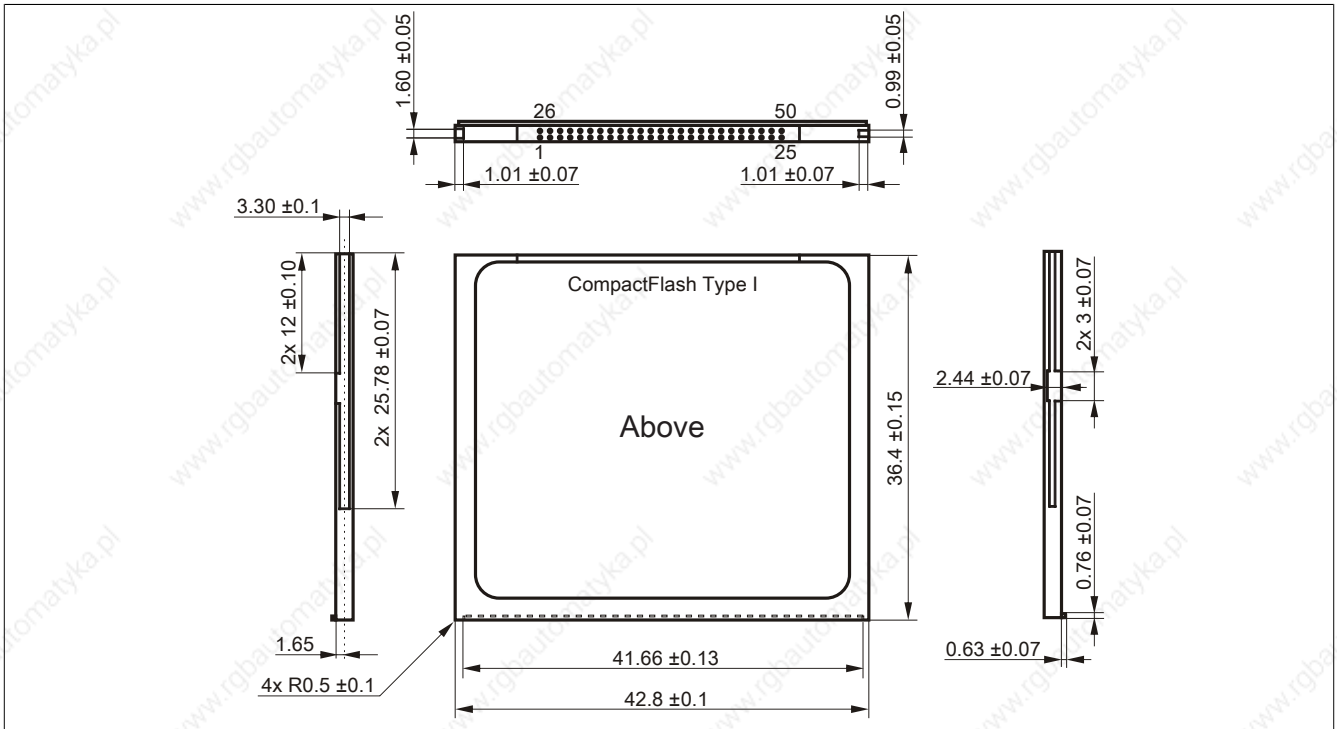

Figure 176: Type I CompactFlash card - Dimensions

5.6 Known problems/issues

The following is a known issue for devices with two CompactFlash slots:

- Using two different types of CompactFlash cards can cause problems with Automation PCs and Panel PCs. For example, it is possible that one of the two cards is not detected during system startup. This is caused by different startup speeds. CompactFlash cards with older technology require significantly more time during system startup than CompactFlash cards with newer technology. This behavior occurs near the end of the time frame provided for startup. The problem described can occur because the startup time for the CompactFlash cards fluctuates due to the different components being used. Depending on the CompactFlash cards being used, this error may occur never, sometimes or always.

6 USB media drive

6.1 5MD900.USB2-01

6.1.1 General information

The USB media drive is a drive combination with diskette, DVD-RW/CD-RW drive, CompactFlash slot and USB ports (front and back). It is connected to a USB port on the B&R Industrial PC.

- Desktop or rack-mounted operation (mounting rail brackets)
- Integrated USB diskette drive
- Integrated DVD-RW/CD-RW drive
- Integrated IDE/ATAPI CompactFlash slot (hot pluggable)
- Integrated USB 2.0 connection (up to 480 Mbit high speed)
- +24 VDC supply (back)
- USB/B 2.0 connection (back side)
- Optional front cover

6.1.2 Order data

Model number	Short description	Figure
	USB accessories	
5MD900.USB2-01	USB 2.0 drive combination, consists of DVD-R/RW DVD+R/RW, FDD, CompactFlash slot (Type II), USB connection (Type A on front, Type B on back); 24 VDC, (order screw clamp 0TB103.9 or cage clamp 0TB103.91 separately)	
	Required accessories	
	Other	
5SWUTI.0000-00	OEM Nero CD-RW Software, only available with a CD writer.	
	Terminal blocks	
0TB103.9	Connector, 24 VDC, 3-pin female, 3.31 mm ² screw clamp, protected against vibration by the screw flange	
0TB103.91	Connector, 24 VDC, 3-pin female, 3.31 mm ² cage clamp, protected against vibration by the screw flange	
	USB accessories	
5A5003.03	Front cover, for remote CD-ROM drive 5A5003.02 and USB 2.0 drive combination 5MD900.USB2-00, 5MD900.USB2-01 and 5MD900.USB2-02	
	USB cable	
5CAUSB.0018-00	USB 2.0 connection cable type A - type B, 1.8 m	
5CAUSB.0050-00	USB 2.0 connection cable type A - type B, 5 m	

Table 270: 5MD900.USB2-01 - Order data

6.1.3 Interfaces

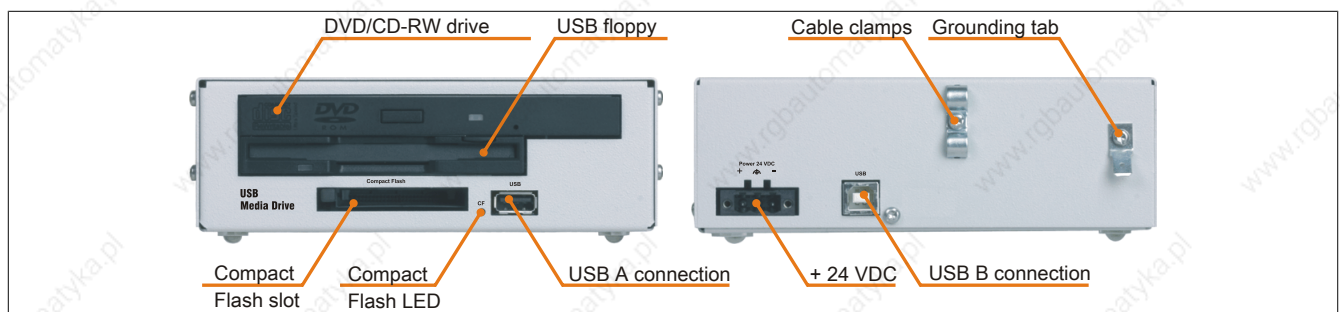

Figure 177: 5MD900.USB2-01 - Interfaces

6.1.4 Technical data

Information:

The following characteristics, features and limit values only apply to this individual component and can deviate from those specified for the complete system. For the complete system in which this individual component is used, refer to the data given specifically for that device.

Accessories • USB media drive

Product ID	5MD900.USB2-01
General information	
Max. cable length	5 m (not including hub)
Certification	
CE	Yes
cULus	Yes
Interfaces	
CompactFlash slot 1	
Type	Type I
Connection	IDE/ATAPI
Activity LED	Signals read or write access to an inserted CompactFlash card
USB	
Type	USB 2.0
Design	Type A front Type B back
Transfer rate	Low speed (1.5 Mbit/s), full speed (12 Mbit/s), high speed (480 Mbit/s)
Current load	Max. 500 mA
CD / DVD drive	
Data buffer capacity	8 MB
Data transfer rate	Max. 33.3 MB/s
Speed	Max. 5090 rpm ±1%
Noise level	Approx. 48 dBA in a distance of 50 cm (full read access)
Compatible formats	CD-DA, CD-ROM mode 1/mode 2 CD-ROM XA mode 2 (form 1, form 2) Photo CD (single-/multi-session), Enhanced CD, CD text DVD-ROM, DVD-R, DVD-RW, DVD-Video DVD-RAM (4.7GB, 2.6GB) DVD+R, DVD+R (dual layer), DVD+RW
Laser class	Class 1 laser
Service life	60000 POH (power-on hours)
Interface	IDE (ATAPI)
Startup time	
CD	Max. 14 seconds (0 rpm to read access)
DVD	Max. 15 seconds (0 rpm to read access)
Access time	
CD	130 ms (24x)
DVD	130 ms (8x)
Readable media	
CD	CD/CD-ROM (12 cm, 8 cm), CD-R, CD-RW
DVD	DVD-ROM, DVD-R, DVD-RW, DVD-RAM, DVD+R, DVD+R (dual layer), DVD+RW
Writable media	
CD	CD-R, CD-RW
DVD	DVD-R/RW, DVD-RAM (4.7 GB), DVD+R/RW, DVD+R (dual layer)
Read speed	
CD	24x
DVD	8x
Write speed	
CD-R	10 to 24x
CD-RW	10 to 24x
DVD+R	3.3 - 8x
DVD+R (dual layer)	2.4 - 4x
DVD+RW	3.3 - 8x
DVD-R	2 - 6x
DVD-R (dual layer)	2 - 4x
DVD-RAM	3 - 5x
DVD-RW	2 - 6x
Write methods	
CD	Disk at once, session at once, packet write, track at once
DVD	Disk at once, incremental, overwrite, sequential, multi-session
Disk drive	
Data transfer rate	250 kbit/s (720 kB) or 500 kbit/s (1.25 MB and 1.44 MB)
Diskette media	High density (2HD) or normal density (2DD) 3.5" diskettes
Capacity	720 kB / 1.25 MB / 1.44 MB (formatted)
MTBF	30000 POH (power-on hours)
Rotation speed	Up to 360 rpm
Electrical characteristics	
Nominal voltage	24 VDC ±25%
Operating conditions	
Protection in accordance with EN 60529	Front: IP65 (only with optional front cover), back: IP20
Environmental conditions	
Temperature ¹⁾	
Operation	5 to 45°C
Storage	-20 to 60°C
Transport	-40 to 60°C

Table 271: 5MD900.USB2-01 - Technical data

Product ID	5MD900.USB2-01
Relative humidity	
Operation	20 to 80%
Storage	5 to 90%
Transport	5 to 95%
Vibration	
Operation	5 to 500 Hz: 0.3 g (2.9 m/s ² 0-peak)
Storage	10 to 100 Hz: 2 g (19.6 m/s ² 0-peak)
Transport	10 to 100 Hz: 2 g (19.6 m/s ² 0-peak)
Shock	
Operation	5 g, 11 ms
Storage	60 g, 11 ms
Transport	60 g, 11 ms
Altitude	
Operation	Max. 3000 m
Mechanical characteristics	
Dimensions	
Width	156 mm
Height	52 mm
Depth	140 mm
Weight	Approx. 1100 g (without front cover)

Table 271: 5MD900.USB2-01 - Technical data

- 1) Temperature specifications refer to operation at 500 meters. The maximum ambient temperature is typically derated by 1°C per 1000 meters (starting at 500 meters above sea level).

6.1.5 Dimensions

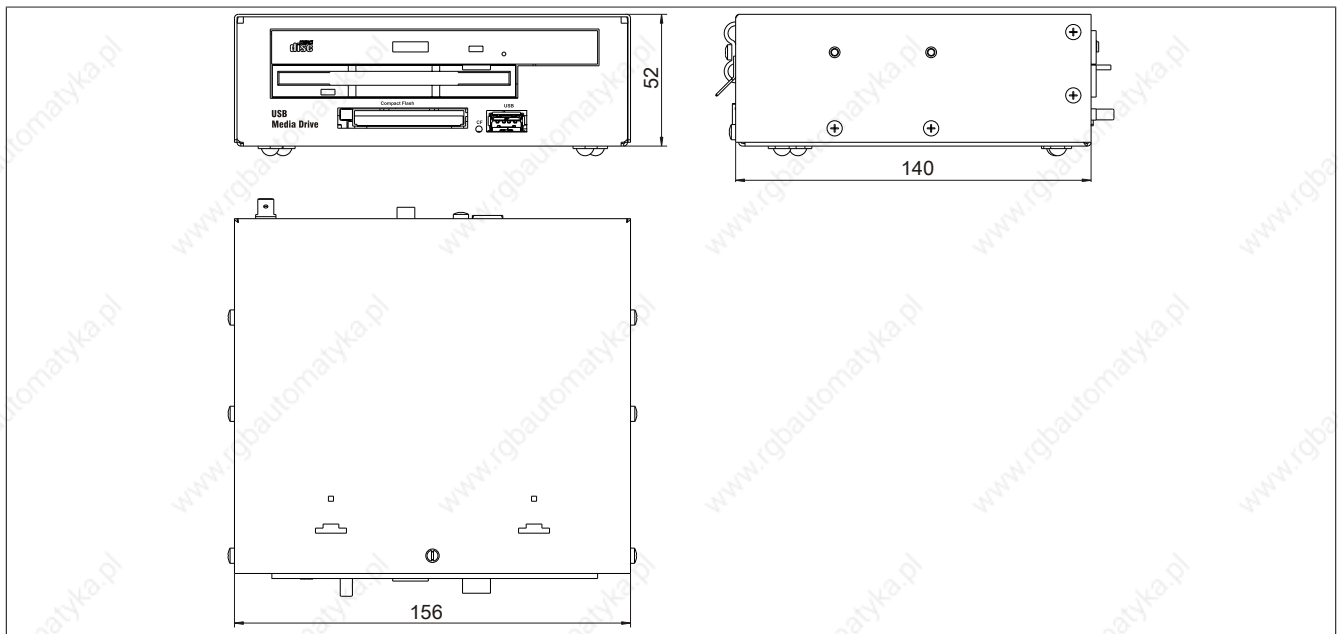

Figure 178: 5MD900.USB2-01 - Dimensions

6.1.6 Dimensions with front cover

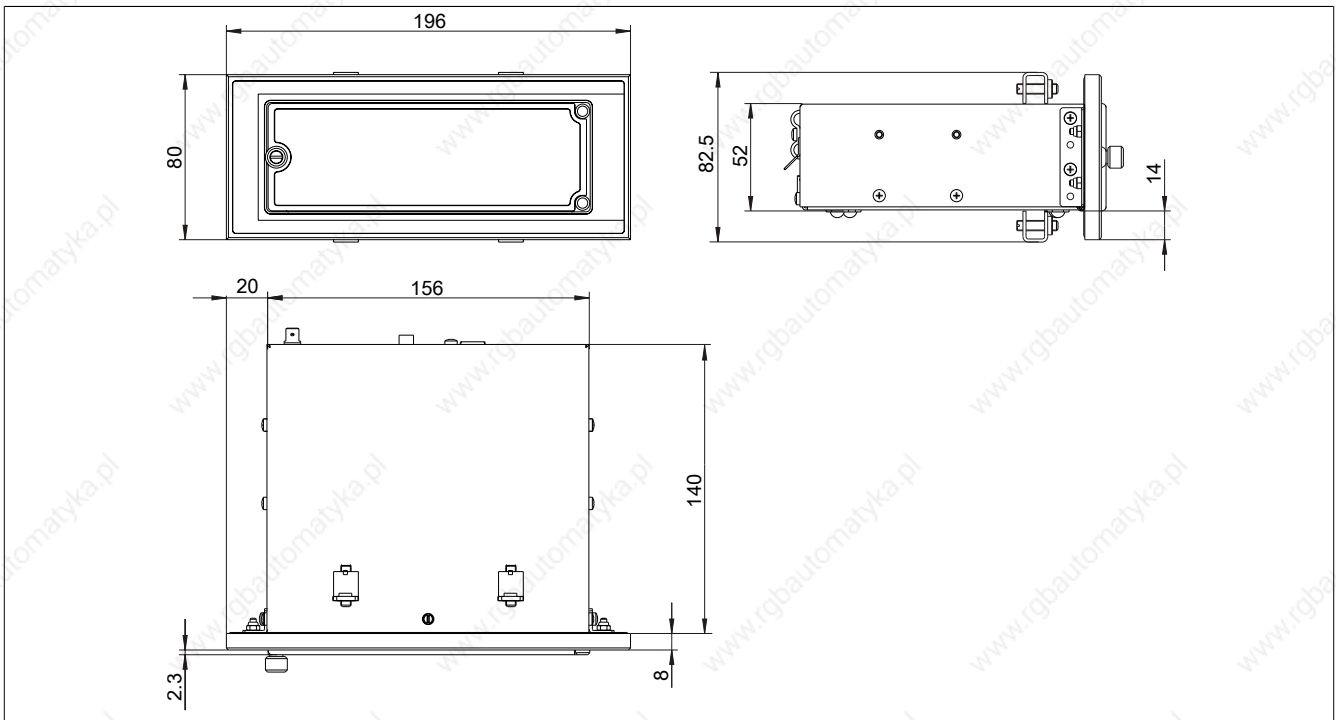

Figure 179: USB media drive with front cover - Dimensions

6.1.7 Cutout installation

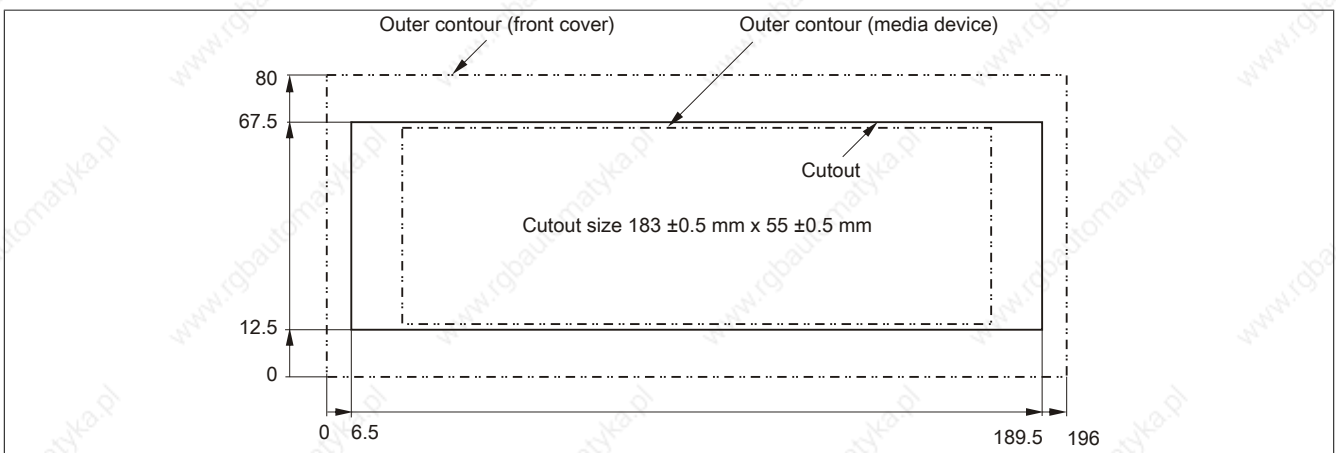

Figure 180: USB media drive with front cover - Installation cutout

6.1.8 Contents of delivery

Quantity	Component
1	USB media drive
2	Mounting rail brackets

Table 272: 5MD900.USB2-01 - Contents of delivery

6.1.9 Installation

The USB media drive can be operated as a desktop device (rubber feet) or as a rack-mounted device (2 mounting rail brackets included).

6.1.9.1 Mounting orientation

Because of limits to the mounting orientation with the components used (floppy, DVD-CDRW drive), the USB media drive is only permitted to be mounted and operated as shown in the following figure.

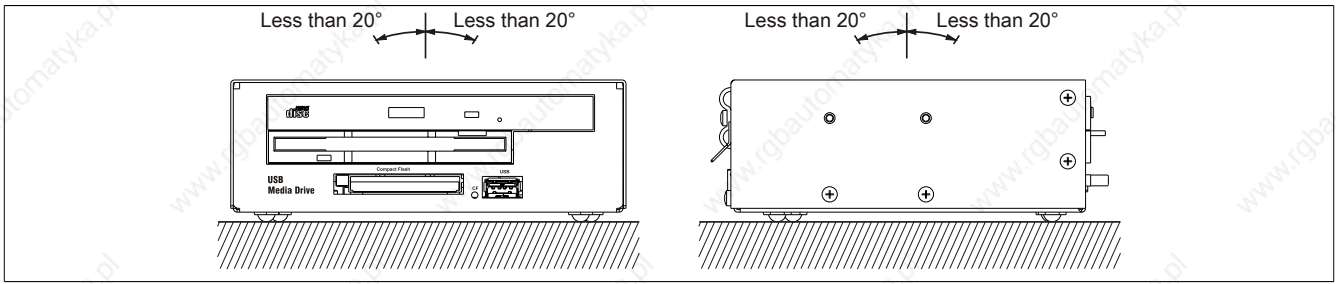

Figure 181: 5MD900.USB2-01 - Mounting orientation

6.2 5MD900.USB2-02

6.2.1 General information

The USB media drive features a DVD-R/RW DVD+R/RW drive, a CompactFlash slot and one USB port on both the front and back. It is connected to a USB port on the B&R Industrial PC.

- Desktop or rack-mounted operation (mounting rail brackets)
- Integrated DVD-R/RW DVD+R/RW drive
- Integrated IDE/ATAPI CompactFlash slot (hot pluggable)
- Integrated USB 2.0 connection
- +24 VDC supply (back)
- USB 2.0 connection (back)
- Optional front cover

6.2.2 Order data

Model number	Short description	Figure
5MD900.USB2-02	USB accessories USB 2.0 drive combination, consists of DVD-R/RW DVD+R/RW, CompactFlash slot (Type II), USB connection (Type A on the front, Type B on the back); 24V DC (order screw clamp terminal OTB103.9 or cage clamp terminal OTB103.91 separately)	
	Required accessories	
	Other	
5SWUT1.0000-00	OEM Nero CD-RW Software, only available with a CD writer.	
	Terminal blocks	
OTB103.9	Connector, 24 VDC, 3-pin female, 3.31 mm ² screw clamp, protected against vibration by the screw flange	
OTB103.91	Connector, 24 VDC, 3-pin female, 3.31 mm ² cage clamp, protected against vibration by the screw flange	
	USB cable	
5CAUSB.0018-00	USB 2.0 connection cable type A - type B, 1.8 m	
5CAUSB.0050-00	USB 2.0 connection cable type A - type B, 5 m	

Table 273: 5MD900.USB2-02 - Order data

6.2.3 Interfaces

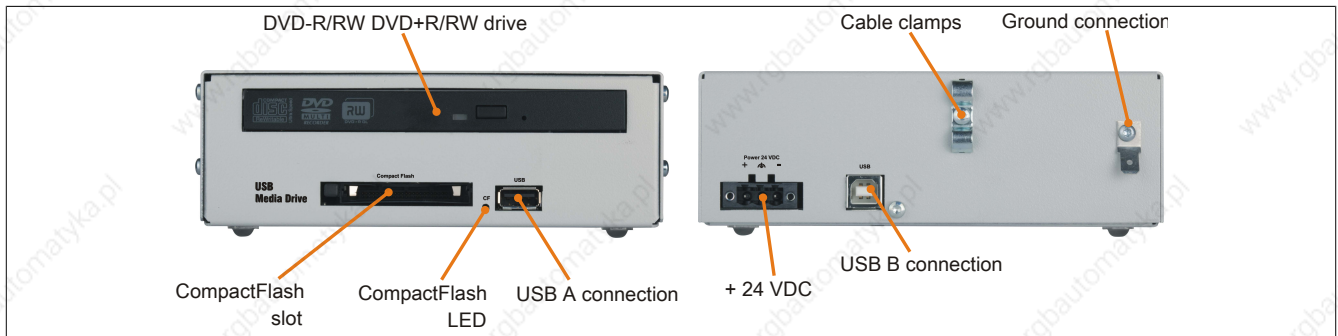

Figure 182: 5MD900.USB2-02 - Interfaces

6.2.4 Technical data

Product ID	5MD900.USB2-02
General information	
Max. cable length	5 m (not including hub)
Certification	
CE	Yes
cULus	Yes
Interfaces	
CompactFlash slot 1	
Type	Type I
Connection	IDE/ATAPI
Activity LED	Signals read or write access to an inserted CompactFlash card

Table 274: 5MD900.USB2-02 - Technical data

Product ID	5MD900.USB2-02
USB	
Type	USB 2.0
Design	Type A front Type B back
Transfer rate	Low speed (1.5 Mbit/s), full speed (12 Mbit/s), high speed (480 Mbit/s)
Current load	Max. 500 mA
CD / DVD drive	
Data buffer capacity	2 MB
Data transfer rate	Max. 33.3 MB/s
Speed	Max. 5090 rpm \pm 1%
Noise level	Approx. 45 dBA in a distance of 50 cm (full read access)
Compatible formats	CD-DA, CD-ROM mode 1/mode 2 CD-ROM XA mode 2 (form 1, form 2) Photo CD (single-/multi-session), Enhanced CD, CD text DVD-ROM, DVD-R, DVD-RW, DVD-Video DVD-RAM (4.7GB, 2.6GB) DVD+R, DVD+R (dual layer), DVD+RW
Laser class	Class 1 laser
Service life	60000 POH (power-on hours)
Interface	IDE (ATAPI)
Startup time	
CD	Max. 14 seconds (from 0 rpm to read access)
DVD	Max. 15 seconds (from 0 rpm to read access)
Access time	
CD	Typ. 140 ms (24x)
DVD	Typ. 150 ms (8x)
Readable media	
CD	CD/CD-ROM (12 cm, 8 cm), CD-R, CD-RW
DVD	DVD-ROM, DVD-R, DVD-RW, DVD-RAM, DVD+R, DVD+R (dual layer), DVD+RW
Writable media	
CD	CD-R, CD-RW
DVD	DVD-R/RW, DVD-RAM (4.7 GB), DVD+R/RW, DVD+R (dual layer)
Read speed	
CD	24x
DVD	8x
Write speed	
CD-R	10 to 24x
CD-RW	10 to 24x
DVD+R	3.3 to 8x
DVD+R (dual layer)	2.4 to 4x
DVD+RW	3.3 to 8x
DVD-R	2 to 6x
DVD-R (dual layer)	2 to 4x
DVD-RAM	3 to 5x
DVD-RW	2 to 6x
Write methods	
CD	Disk at once, session at once, packet write, track at once
DVD	Disk at once, incremental, overwrite, sequential
Electrical characteristics	
Nominal voltage	24 VDC \pm 25%
Operating conditions	
Protection in accordance with EN 60529	Front: IP65 (only with optional front cover), back: IP20
Environmental conditions	
Temperature ¹⁾	
Operation	5 to 45°C
Storage	-20 to 60°C
Transport	-40 to 60°C
Relative humidity	
Operation	20 to 80%
Storage	5 to 90%
Transport	5 to 95%
Vibration	
Operation	5 to 500 Hz: 0.3 g (2.9 m/s ² 0-peak)
Storage	10 to 100 Hz: 2 g (19.6 m/s ² 0-peak)
Transport	10 to 100 Hz: 2 g (19.6 m/s ² 0-peak)
Shock	
Operation	5 g, 11 ms
Storage	60 g, 11 ms
Transport	60 g, 11 ms
Altitude	
Operation	Max. 3000 m

Table 274: 5MD900.USB2-02 - Technical data

Product ID	5MD900.USB2-02
Mechanical characteristics	
Dimensions	
Width	156 mm
Height	52 mm
Depth	140 mm
Weight	Approx. 1100 g (without front cover)

Table 274: 5MD900.USB2-02 - Technical data

- 1) Temperature specifications refer to operation at 500 meters. The maximum ambient temperature is typically derated by 1°C per 1000 meters (starting at 500 meters above sea level).

6.2.5 Dimensions

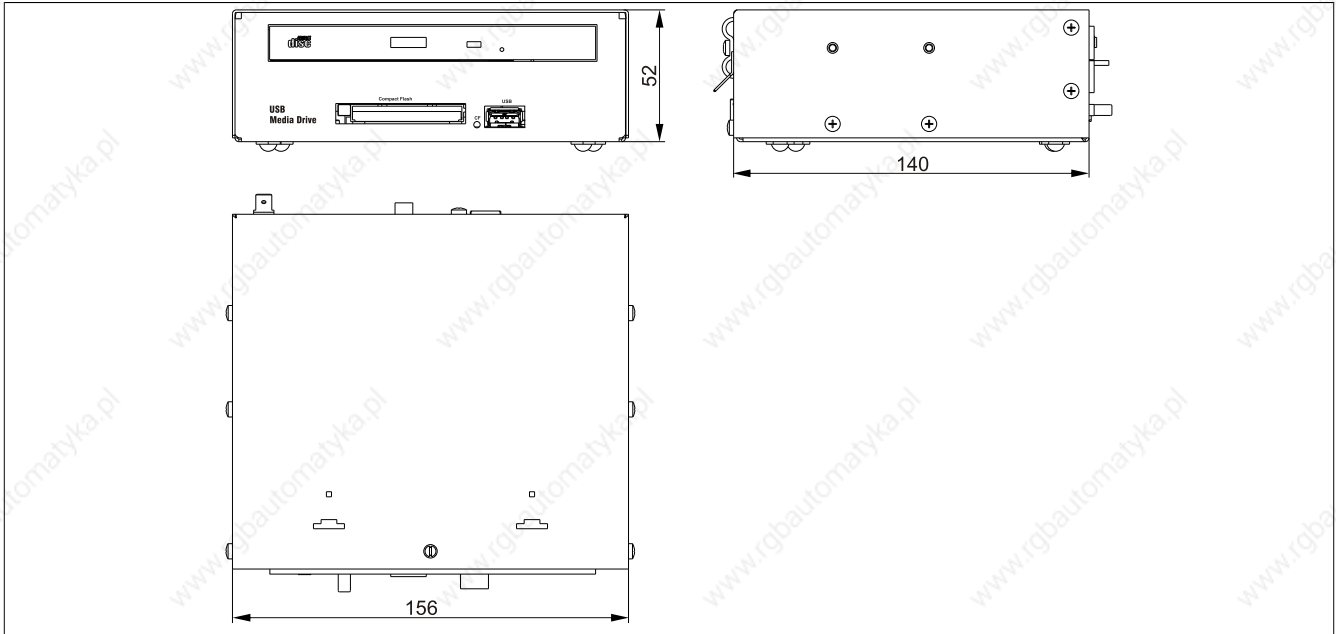

Figure 183: 5MD900.USB2-02 - Dimensions

6.2.6 Dimensions with front cover

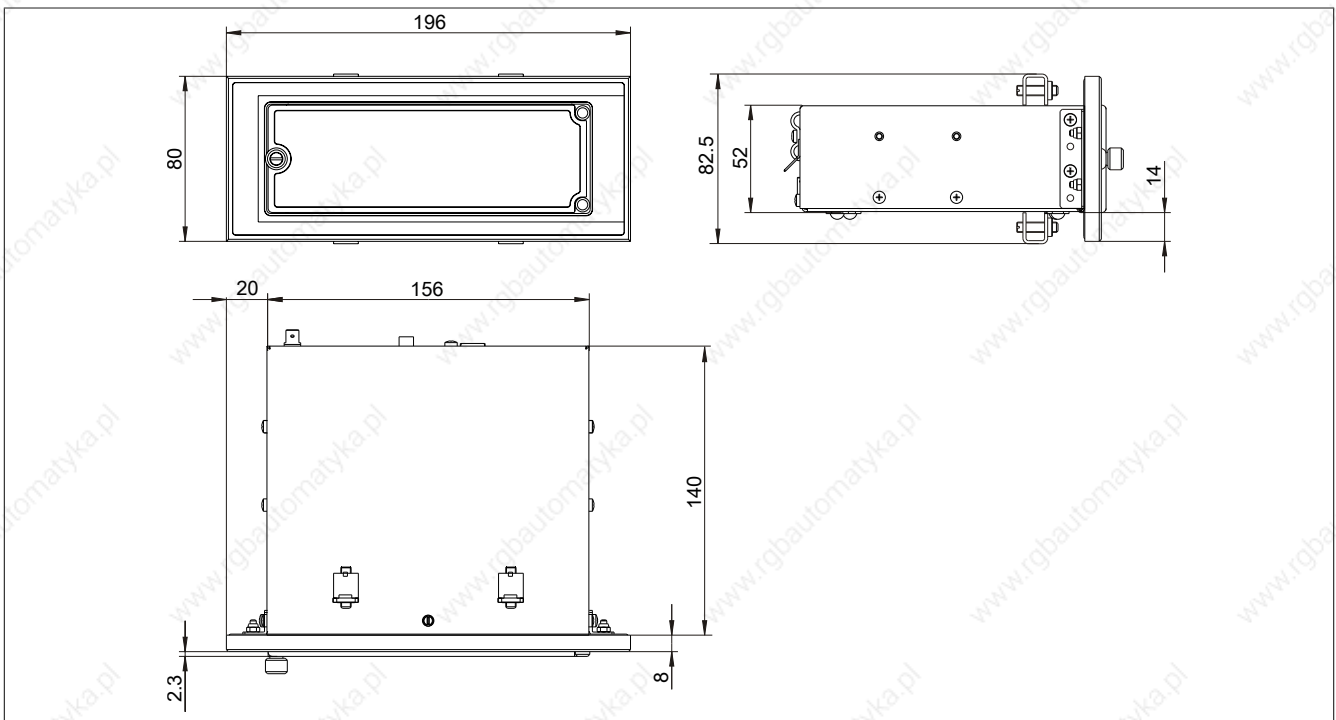

Figure 184: USB media drive with front cover - Dimensions

6.2.7 Cutout installation

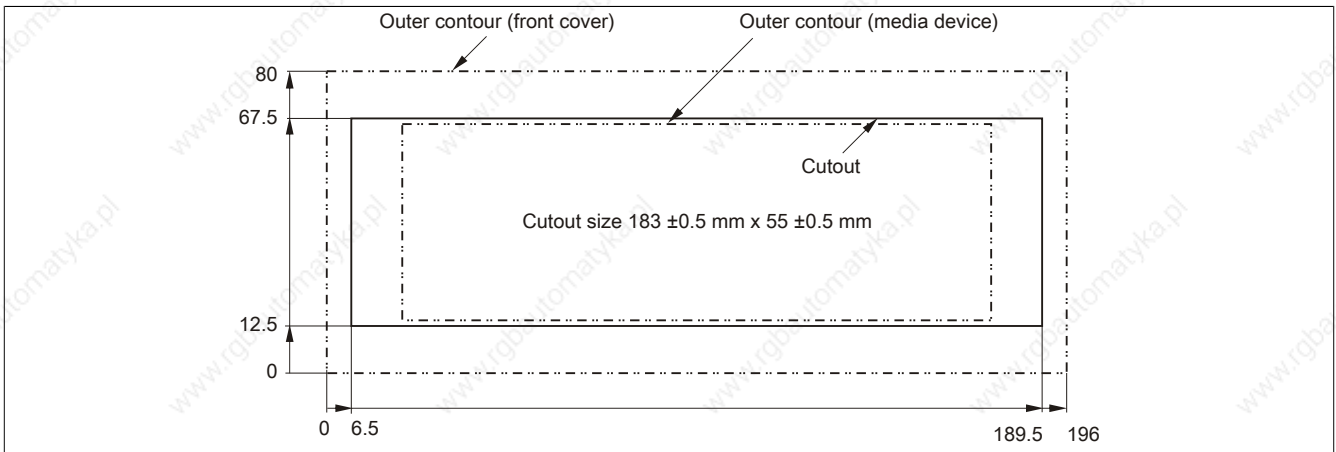

Figure 185: USB media drive with front cover - Installation cutout

6.2.8 Contents of delivery

Quantity	Component
1	USB media drive
2	Mounting rail brackets

Table 275: 5MD900.USB2-02 - Contents of delivery

6.2.9 Installation

The USB media drive can be operated as a desktop device (rubber feet) or as a rack-mounted device (2 mounting rail brackets included).

6.2.9.1 Mounting orientation

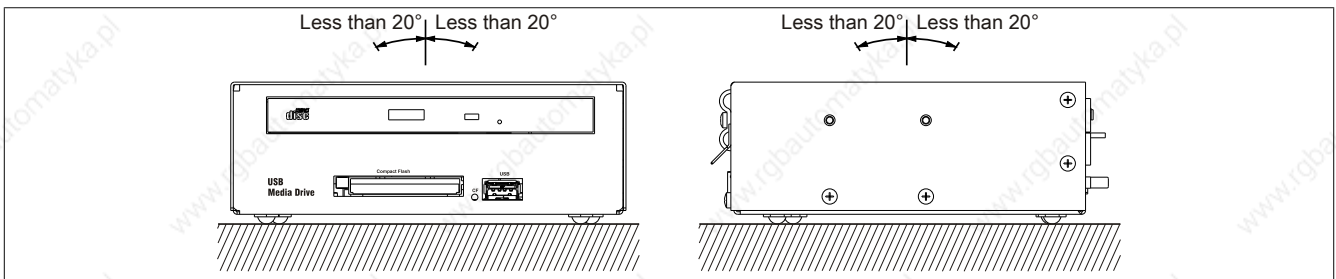

Figure 186: 5MD900.USB2-02 - Mounting orientation

6.3 5A5003.03

6.3.1 General information

This front cover can be mounted on the front of the USB media drive (model number 5MD900.USB2-00, 5MD900.USB2-01 or 5MD900.USB2-02) to protect the interface.

6.3.2 Order data

Model number	Short description	Figure
	USB accessories	
5A5003.03	Front cover, for remote CD-ROM drive 5A5003.02 and USB 2.0 drive combination 5MD900.USB2-00, 5MD900.USB2-01 and 5MD900.USB2-02	

Table 276: 5A5003.03 - Order data

6.3.3 Technical data

Product ID	5A5003.03
General information	
Certification	
CE	Yes
cULus	Yes
Mechanical characteristics	
Front	
Panel membrane	
Light background	Similar to Pantone 427CV
Dimensions	
Width	196 mm
Height	80 mm
Depth	8 mm

Table 277: 5A5003.03 - Technical data

6.3.4 Dimensions

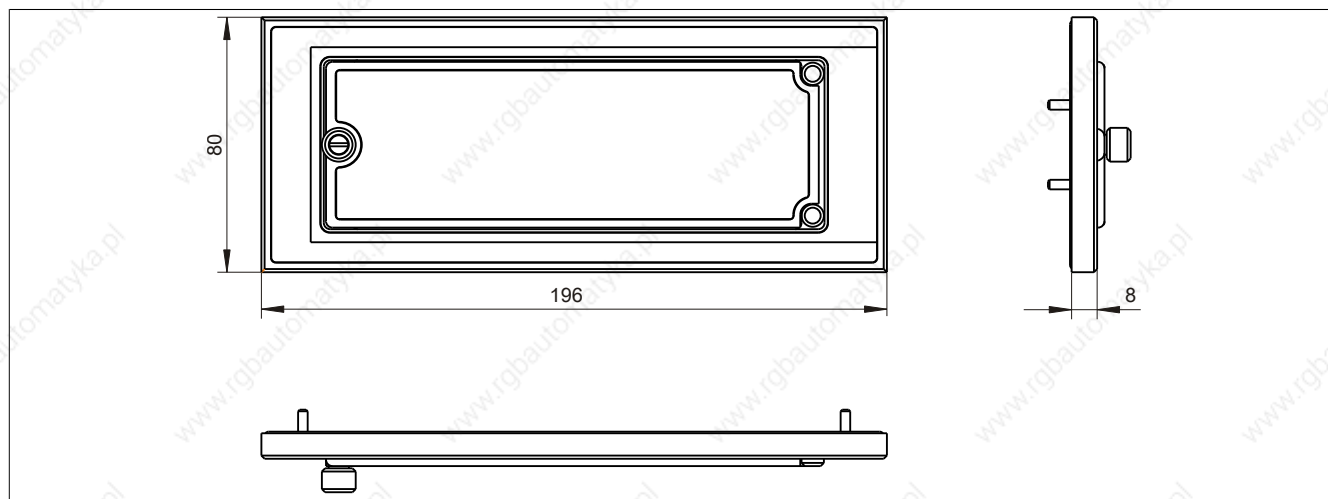

Figure 187: 5A5003.03 - Dimensions

6.3.5 Contents of delivery

Quantity	Component
1	Front cover 5A5003.03 for the USB media drive
4	M3 locknut
4	Cover retaining clip

Table 278: 5A5003.03 - Contents of delivery

6.3.6 Installation

The front cover is attached with 2 mounting rail brackets (included with the USB media drive) and 4 M3 locknuts. The 4 retaining clips provided can be used to mount the USB media drive and front cover as a whole, for example in a control cabinet door.

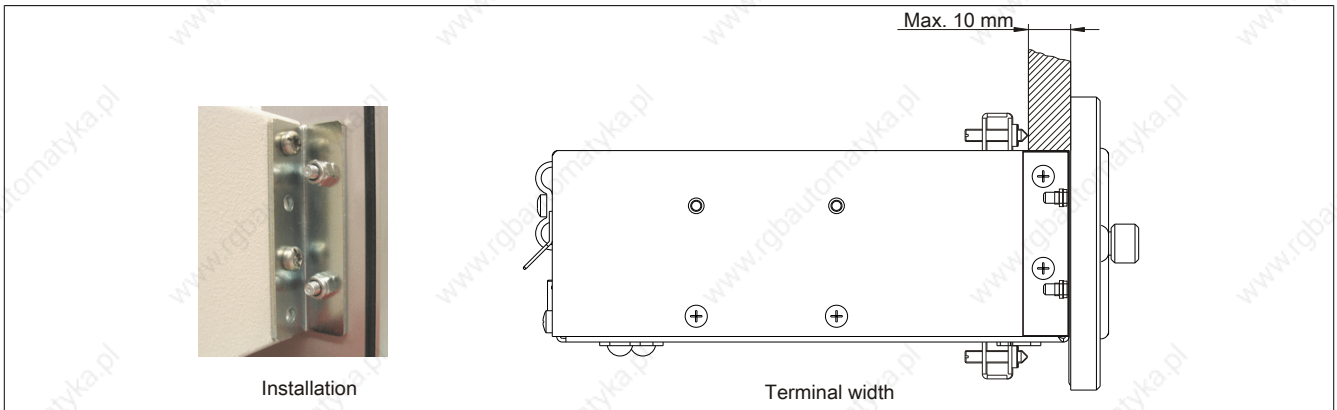

Figure 188: Front cover mounting and installation depth

6.3.6.1 Cutout installation

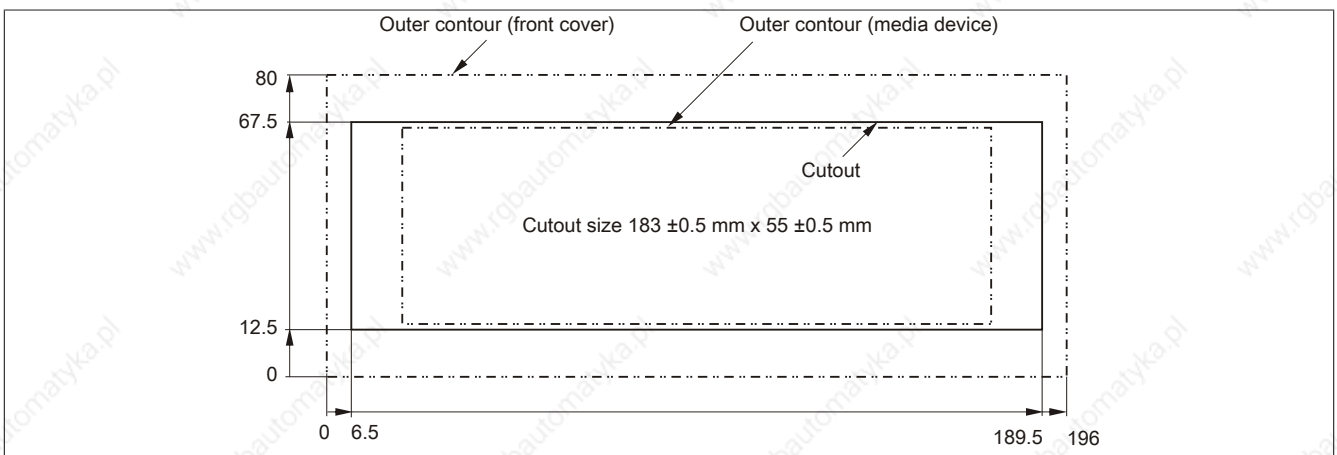

Figure 189: USB media drive with front cover - Installation cutout

7 USB flash drives

7.1 5MMUSB.2048-00

7.1.1 General information

USB flash drives are storage media that are easy to replace. Because of their fast data transfer (USB 2.0), USB flash drives are ideal for use as portable data storage. Without requiring additional drivers ("hot plugging", except in the case of Windows 98SE), the USB flash drive can immediately act as an additional drive where data can be read or written.

Information:

Due to the vast quantity of USB flash drives available on the market as well as their short product life cycle, we reserve the right to supply alternative products at any time. The following measures may therefore be necessary in order to boot from these flash drives as well:

- The flash drive must be reformatted or in some cases even repartitioned (set active partition).
- The flash drive must be the first bootable device in the BIOS boot order; alternatively, the IDE controllers can be disabled in BIOS. This can be avoided in most cases if the "fdisk /mbr" command is additionally executed on the USB flash drive.

7.1.2 Order data

Model number	Short description	Figure
	USB accessories	
5MMUSB.2048-00	USB 2.0 flash drive, 2048 MB	

Table 279: 5MMUSB.2048-00 - Order data

7.1.3 Technical data

Information:

The following characteristics, features and limit values only apply to this accessory and can deviate from those specified for the complete system. The data specifications for the complete system take precedence over those of individual components.

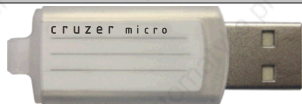
Product ID	5MMUSB.2048-00
General information	
Data retention	10 years
LEDs	1 LED (green) ¹⁾
MTBF	100,000 hours (at 25°C)
Type	USB 1.1, USB 2.0
Maintenance	None
Certification CE	Yes
Interfaces	
USB	
Type	USB 1.1, USB 2.0
Connection	To any USB Type A interface
Transfer rate	Low speed (1.5 Mbit/s), full speed (12 Mbit/s), high speed (480 Mbit/s)
Sequential reading	Max. 8.7 MB/s
Sequential writing	Max. 1.7 MB/s
Support	
Operating systems	
Windows XP Professional	Yes
Windows XP Embedded	Yes
Windows ME	Yes
Windows 2000	Yes
Windows CE 5.0	Yes
Windows CE 4.2	Yes
Electrical characteristics	
Power consumption	650 µA sleep mode, 150 mA read/write

Table 280: 5MMUSB.2048-00 - Technical data

Product ID	5MMUSB.2048-00
Environmental conditions	
Temperature	
Operation	0 to 45°C
Storage	-20 to 60°C
Transport	-20 to 60°C
Relative humidity	
Operation	10 to 90%, non-condensing
Storage	5 to 90%, non-condensing
Transport	5 to 90%, non-condensing
Vibration	
Operation	10 to 500 Hz: 2 g (19.6 m/s ² 0-peak), oscillation rate 1/minute
Storage	10 to 500 Hz: 2 g (19.6 m/s ² 0-peak), oscillation rate 1/minute
Transport	10 to 500 Hz: 2 g (19.6 m/s ² 0-peak), oscillation rate 1/minute
Shock	
Operation	Max. 40 g (392 m/s ² 0-peak) and 11 ms length
Storage	Max. 80 g (784 m/s ² 0-peak) and 11 ms length
Transport	Max. 80 g (784 m/s ² 0-peak) and 11 ms length
Altitude	
Operation	Max. 3048 m
Storage	Max. 12192 m
Transport	Max. 12192 m
Mechanical characteristics	
Dimensions	
Width	19 mm
Length	52.2 mm
Height	7.9 mm

Table 280: 5MMUSB.2048-00 - Technical data

1) Indicates data being transferred (sending and receiving).

7.1.4 Temperature humidity diagram

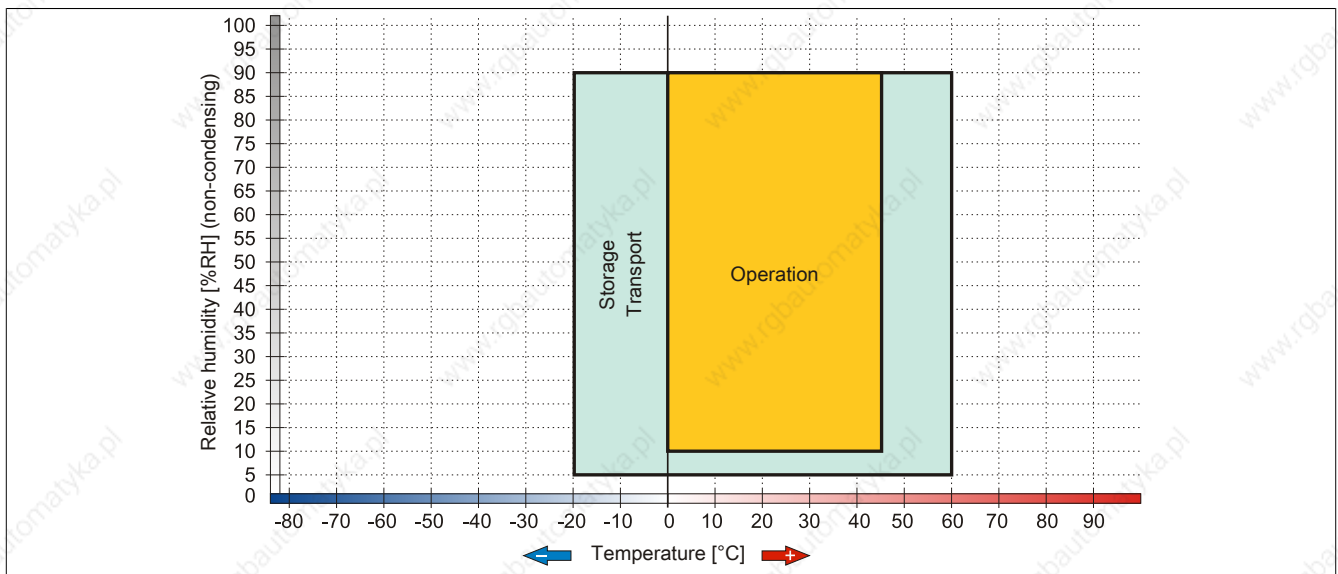

Figure 190: 5MMUSB.2048-00 - Temperature humidity diagram

7.2 5MMUSB.xxxx-01

7.2.1 General information

USB flash drives are storage media that are easy to replace. Because of their fast data transfer (USB 2.0), USB flash drives are ideal for use as portable data storage. Without requiring additional drivers ("hot plugging", except in the case of Windows 98SE), the USB flash drive can immediately act as an additional drive where data can be read or written.

Information:

Due to the vast quantity of USB flash drives available on the market as well as their short product life cycle, we reserve the right to supply alternative products at any time. The following measures may therefore be necessary in order to boot from these flash drives as well:

- The flash drive must be reformatted or in some cases even repartitioned (set active partition).
- The flash drive must be the first bootable device in the BIOS boot order; alternatively, the IDE controllers can be disabled in BIOS. This can be avoided in most cases if the "fdisk /mbr" command is additionally executed on the USB flash drive.

7.2.2 Order data

Model number	Short description	Figure
	USB accessories	
5MMUSB.2048-01	USB 2.0 flash drive, 2048 MB, B&R	
5MMUSB.4096-01	USB 2.0 flash drive, 4096 MB, B&R	

Table 281: 5MMUSB.2048-01, 5MMUSB.4096-01 - Order data

7.2.3 Technical data

Product ID	5MMUSB.2048-01	5MMUSB.4096-01
General information		
Capacity	2 GB	4 GB
Data retention	>10 years	
LEDs	1 LED (green) ¹⁾	
MTBF	>3,000,000 hours	
Type	USB 1.1, USB 2.0	
Maintenance	None	
Default file system	FAT16	FAT32
Certification CE	Yes	
Interfaces		
USB	USB 1.1, USB 2.0	
Type	To any USB Type A interface	
Connection	Low speed (1.5 Mbit/s), full speed (12 Mbit/s), high speed (480 Mbit/s)	
Transfer rate	Full speed max. 1 MB/s, High speed max. 32 MB/s	
Sequential reading	Full speed max. 0.9 MB/s, High speed max. 23 MB/s	
Sequential writing		
Support		
Operating systems		
Windows 7	Yes	
Windows XP Professional	Yes	
Windows XP Embedded	Yes	
Windows ME	Yes	
Windows 2000	Yes	
Windows CE 5.0	Yes	
Windows CE 4.2	Yes	
Electrical characteristics		
Power consumption	Max. 500 µA sleep mode, max. 120 mA read/write	
Environmental conditions		
Temperature		
Operation	0 to 70°C	
Storage	-50 to 100°C	
Transport	-50 to 100°C	

Table 282: 5MMUSB.2048-01, 5MMUSB.4096-01 - Technical data

Product ID	5MMUSB.2048-01	5MMUSB.4096-01
Relative humidity		
Operation	85%, non-condensing	
Storage	85%, non-condensing	
Transport	85%, non-condensing	
Vibration		
Operation	20 to 2000 Hz: 20 g (peak)	
Storage	20 to 2000 Hz: 20 g (peak)	
Transport	20 to 2000 Hz: 20 g (peak)	
Shock		
Operation	Max. 1500 g (peak)	
Storage	Max. 1500 g (peak)	
Transport	Max. 1500 g (peak)	
Altitude		
Operation	Max. 3048 m	
Storage	Max. 12192 m	
Transport	Max. 12192 m	
Mechanical characteristics		
Dimensions		
Width	17.97 mm	
Length	67.85 mm	
Height	8.35 mm	

Table 282: 5MMUSB.2048-01, 5MMUSB.4096-01 - Technical data

1) Indicates data being transferred (sending and receiving).

7.2.4 Temperature humidity diagram

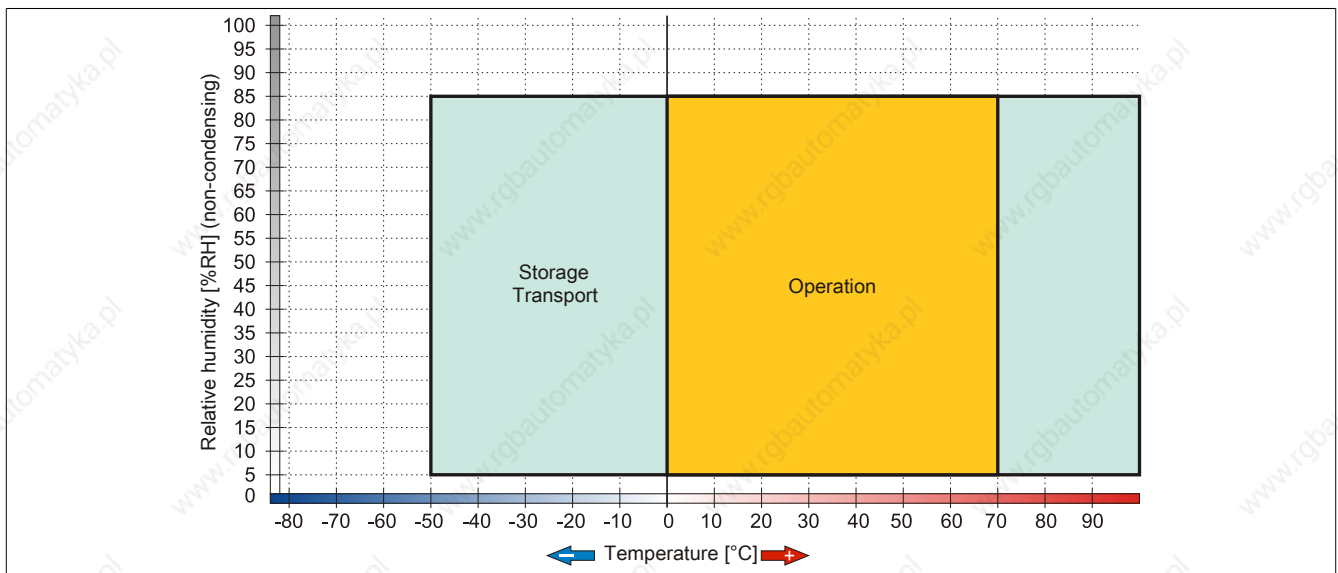

Figure 191: 5MMUSB.xxxx-01 - Temperature humidity diagram

8 HMI Drivers & Utilities DVD

8.1 5SWHMI.0000-00

8.1.1 General information

This DVD contains drivers, utilities, software upgrades and user's manuals for B&R panel system products (see the "Industrial PCs" or "Visualization and operation" section of the B&R website at www.br-automation.com).

When the DVD is created, its contents are identical to the files found in the Downloads section of the B&R website (under Service - "Material related downloads").

8.1.2 Order data

Model number	Short description	Figure
5SWHMI.0000-00	<p>Other</p> <p>HMI Drivers & Utilities DVD</p>	

Table 283: 5SWHMI.0000-00 - Order data

8.1.3 Contents (V2.10)

BIOS product upgrades

- Automation PC 620 / Panel PC 700 CPU board 815E and 855GME BIOS
- Automation PC 620 / Panel PC 700 CPU board X855GME BIOS
- Automation PC 620 / Panel PC 700 CPU board 945GME N270 BIOS
- Automation PC 680
- Automation PC 810 / Automation PC 820 / Panel PC 800 B945GME BIOS
- Automation PC 810 / Panel PC 800 945GME N270 CPU board BIOS
- Automation PC 810 / Panel PC 800 GM45 CPU board BIOS
- Provit 2000 product family - IPC2000/2001/2002
- Provit 5000 product family - IPC5000/5600/5000C/5600C
- Power Panel 100 BIOS devices
- Mobile Panel 100 BIOS devices
- Power Panel 100 / Mobile Panel 100 user boot logo
- Power Panel 100 / Mobile Panel 100 REMHOST utility
- Power Panel 300/400 BIOS devices
- Power Panel 300/400 BIOS user boot logo
- Panel PC 310

Device drivers

- Automation Device Interface (ADI)
- Audio
- Chipset
- CD-ROM
- LS120
- Graphics
- Network

- PCI / SATA RAID controller
- Touch screen
- Touchpad
- Interface board

Firmware upgrades

- Automation PC 620 / Panel PC 700 (MTCX, SDLR, SDLT)
- Automation PC 810 (MTCX, SDLR, SDLT)
- Automation PC 820 (MTCX, SDLR, SDLT)
- Mobile Panel 100 (SMCX)
- Panel PC 300 (MTCX)
- Power Panel 100 (aPCI)
- Power Panel 300/400 (aPCI)
- Power Panel 300/400 (MTCX)
- Panel PC 800 (MTCX, SDLR, SDLT)
- UPS firmware

Utilities/Tools

- B&R Embedded OS Installer
- Windows CE Tools
- User boot logo conversion program
- SATA RAID Installation Utility
- Automation Device Interface (ADI)
- CompactFlash service life calculator (Silicon Systems)
- Miscellaneous
- MTC utilities
- B&R Key Editor
- MTC & Mkey utilities
- Mkey utilities
- UPS configuration software
- ICU ISA configuration
- Intel PCI NIC boot ROM
- Diagnostic programs

Windows

- Windows CE 6.0
- Windows CE 5.0
- Windows CE 4.2
- Windows CE 4.1
- Windows CE Tools
- Windows Embedded Standard 2009
- Thin client
- Windows NT Embedded
- Windows XP Embedded
- VNC viewer

MCAD templates for

- Industrial PCs
- Visualization and operating devices
- Slide-in label templates
- Custom designs

ECAD templates for

- Industrial PCs
- Automation PCs
- Automation Panel 900
- Panels (Power Panel)

Documentation for

- Automation PC 620
- Automation PC 680
- Automation PC 810
- Automation PC 820
- Automation Panel 800
- Automation Panel 900
- Panel PC 310
- Panel PC 700
- Panel PC 725
- Panel PC 800
- Power Panel 15/21/35/41
- Power Panel 100/200
- Power Panel 300/400
- Mobile Panel 40/50
- Mobile Panel 100/200
- Mobile Panel connection box
- Provit 2000
- Provit 3030
- Provit 4000
- Provit 5000
- Provit Benchmark
- Provit Mkey
- Windows CE 5.0 Help
- Windows CE 6.0 Help
- Windows NT Embedded application guide
- Windows XP Embedded application guide
- Uninterruptible power supply
- Implementation guides
- B&R Hilscher fieldbus cards (CANopen, DeviceNet, PROFIBUS, PROFINET)

Service tools

- Acrobat Reader 5.0.5 (freeware in German, English and French)
- Power Archiver 6.0 (freeware in German, English and French)
- Internet Explorer 5.0 (German and English)
- Internet Explorer 6.0 (German and English)

9 Uninterruptible power supply

With an optionally integrated UPS, the B&R Industrial PC makes sure that the PC system completes write operations even when a power failure occurs. When the UPS detects a power failure, it switches to battery operation immediately without interruption. This means that all running programs are shut down properly by the UPS software to prevent the possibility of inconsistent data (only functions if the UPS is already configured and the driver is enabled).

Information:

- **The monitor/panel is not buffered by the UPS and will shut off when the power fails.**
- **More detailed information about uninterruptible power supplies can be found in the user's manual for the external UPS. This can be downloaded from the B&R website.**

Because the charging circuit is integrated in the housing of the B&R Industrial PC, installation has been simplified to merely attaching the connection cable to the battery unit mounted next to the PC.

Special emphasis was placed on ease of maintenance when the battery unit was designed. Batteries are easily accessible from the front and can be replaced in just a few moments when servicing.

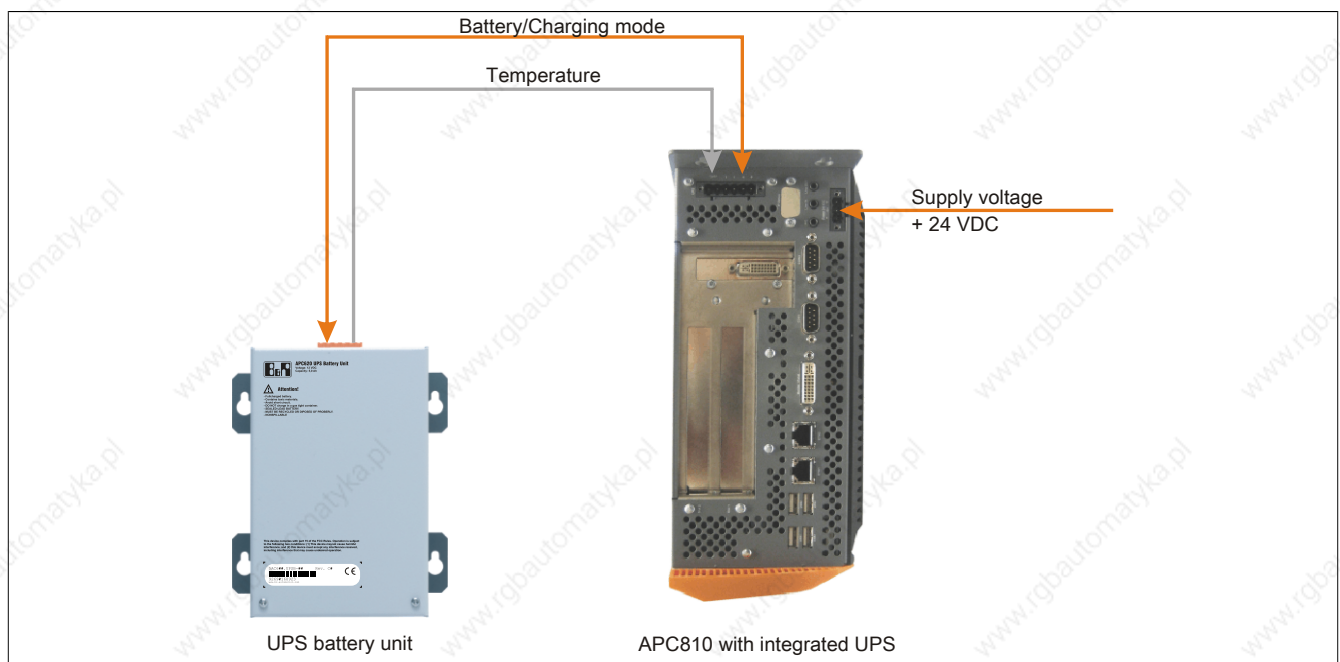

Figure 192: UPS principle

9.1 Features

- Long-lasting, maintenance-free rechargeable batteries
- Communication via integrated interfaces
- Temperature sensor
- Driver software
- Deep discharge protection

9.2 Requirements

- A suitable system unit
- Add-on UPS module 5AC600.UPSI-00
- Battery unit 5AC600.UPSB-00
- UPS connection cable 0.5 m (5CAUPS.0005-00) or 3 m (5CAUPS.0030-00)
- Configuration of the B&R UPS in the ADI Control Center

9.3 5AC600.UPSI-00

9.3.1 General information

This add-on UPS module can easily be installed in an appropriate system unit (for a list of required revisions, see section 9.2 "Requirements" on page 361).

9.3.2 Order data

Model number	Short description	Figure
	Uninterruptible power supplies	
5AC600.UPSI-00	UPS module for APC620, APC810, PPC800; for system units 5PC600.SX01-00 (beginning with rev. H0), 5PC600.SX02-00 (beginning with rev. G0), 5PC600.SX02-01 (beginning with rev. H0), 5PC600.SX05-00 (beginning with rev. F0), 5PC600.SX05-01 (beginning with rev. F0), 5PC600.SF03-00 (beginning with rev. A0), 5PC810.SX*, 5PC820.1505-00, 5PC820.1906-00. Order cable (5CAUPS.0005-00 or 5CAUPS.0030-00) and battery unit (5AC600.UPSB-00) separately.	
	Required accessories	
	Uninterruptible power supplies	
5AC600.UPSB-00	Battery unit 5 Ah; for APC620, APC810 or PPC800 UPS	
5CAUPS.0005-00	UPS cable 0.5 m; for UPS 5AC600.UPSI-00	
5CAUPS.0030-00	UPS cable 3 m; for UPS 5AC600.UPSI-00	

Table 284: 5AC600.UPSI-00 - Order data

9.3.3 Technical data

Information:

The following characteristics, features and limit values only apply to this accessory and can deviate from those specified for the complete system. The data specifications for the complete system take precedence over those of individual components.

Product ID	5AC600.UPSI-00
General information	
Certification	
CE	Yes
cULus	Yes
GL	Yes
Electrical characteristics	
Power consumption	Max. 7.5 watts
Power failure bypass	Max. 20 min at 150 W load
Deep discharge protection	Yes, at 10 V on the battery unit
Short circuit protection	No
Battery charging data	
Charging current	Max. 0.5 A
Switching threshold	
Battery operation	13 V
Mains operation	15 V

Table 285: 5AC600.UPSI-00 - Technical data

9.3.4 Installation

This module is installed using the materials included in delivery. For more information regarding installation, see chapter 7 "Maintenance and service".

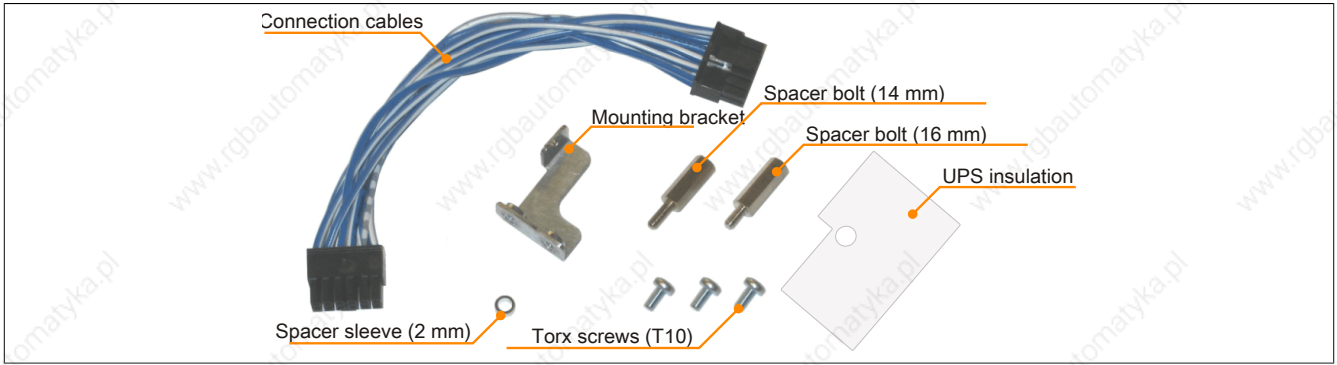

Figure 193: 5AC600.UPI-00 Add-on UPS module - Installation materials

9.4 5AC600.UPSB-00

9.4.1 General information

The battery unit has a limited service life and should be replaced regularly (after the specified service life at the latest).

9.4.2 Order data

Model number	Short description	Figure
	Uninterruptible power supplies	
5AC600.UPSB-00	Battery unit 5 Ah; for APC620, APC810 or PPC800 UPS	

Table 286: 5AC600.UPSB-00 - Order data

9.4.3 Technical data

Information:

The following characteristics, features and limit values only apply to this accessory and can deviate from those specified for the complete system. The data specifications for the complete system take precedence over those of individual components.

Product ID	5AC600.UPSB-00	
Revision	D0	E0
General information		
Battery	Energys Cyclon 12 V 5 Ah (6 connected in series)	
Type	10 years ¹⁾	
Service life	Single cell	
Design		
Temperature sensor	NTC resistance	
Maintenance interval during storage	6 month interval between charges	
Certification		
CE	Yes	
cULus	Yes	
GL	Yes	
Charge duration when battery low	Typ. 15 hours	
Electrical characteristics		
Nominal voltage	12 V	
Battery current	Max. 8 A	
Capacity	5 Ah	
Fuse ²⁾	No ³⁾	Yes
Deep discharge voltage	10 V	
Environmental conditions		
Temperature		
Charging mode	-30 to 60°C	
Operation	-40 to 80°C	
Storage	-65 to 80°C	
Transport	-65 to 80°C	
Relative humidity		
Operation	5 to 95%, non-condensing	
Storage	5 to 95%, non-condensing	
Transport	5 to 95%, non-condensing	
Altitude		
Operation	Max. 3000 m	

Table 287: 5AC600.UPSB-00, 5AC600.UPSB-00 - Technical data

Product ID	5AC600.UPSB-00
Mechanical characteristics	
Dimensions	
Width	104 mm ⁴⁾
Length	170.5 mm
Height	87.5 mm
Weight	Approx. 3200 g

Table 287: 5AC600.UPSB-00, 5AC600.UPSB-00 - Technical data

- 1) At 25°C (up to 80% battery capacity).
- 2) 25 A fuse. Replacement fuses can be ordered separately whenever needed.
- 3) The fuse can be installed later in revisions up to and including D0. More information can be found in the "Maintenance and service" chapter of the APC810 and PPC800 user's manuals.
- 4) Dimensions without mounting clips.

9.4.4 Temperature/Service life diagram up to 20% battery capacity

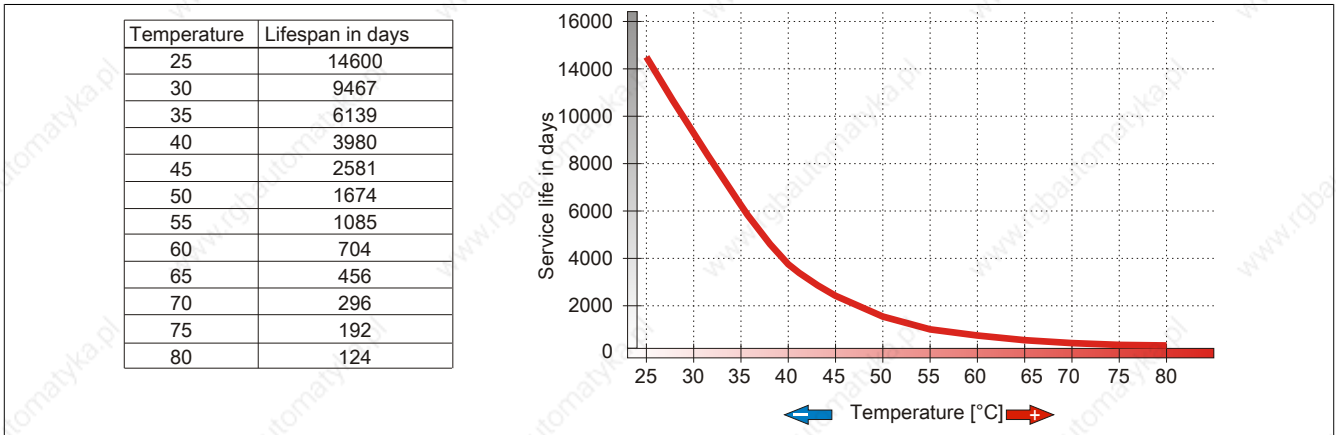

Figure 194: Temperature/Service life diagram

9.4.5 Deep discharge cycles

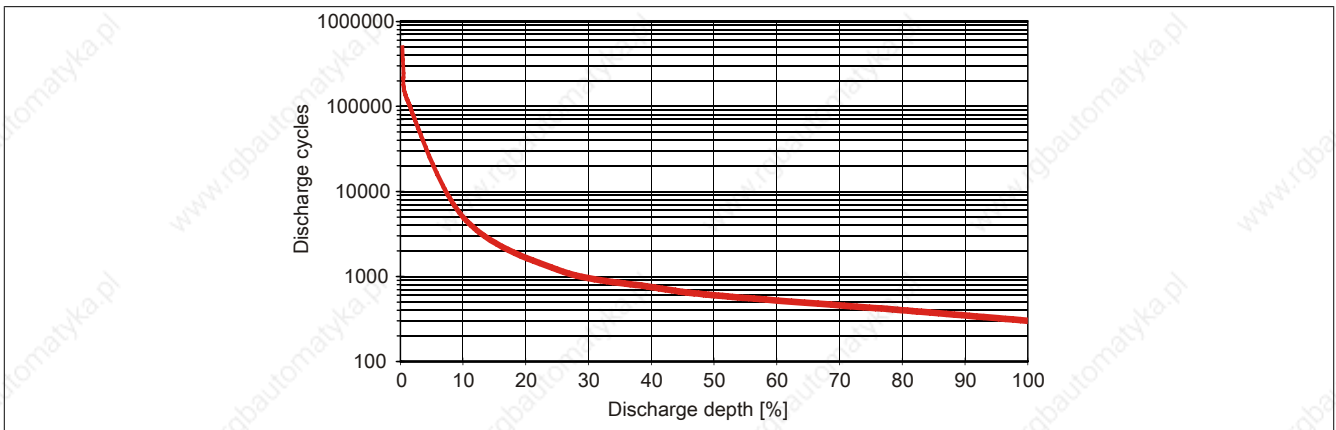

Figure 195: Deep discharge cycles

9.4.6 Dimensions

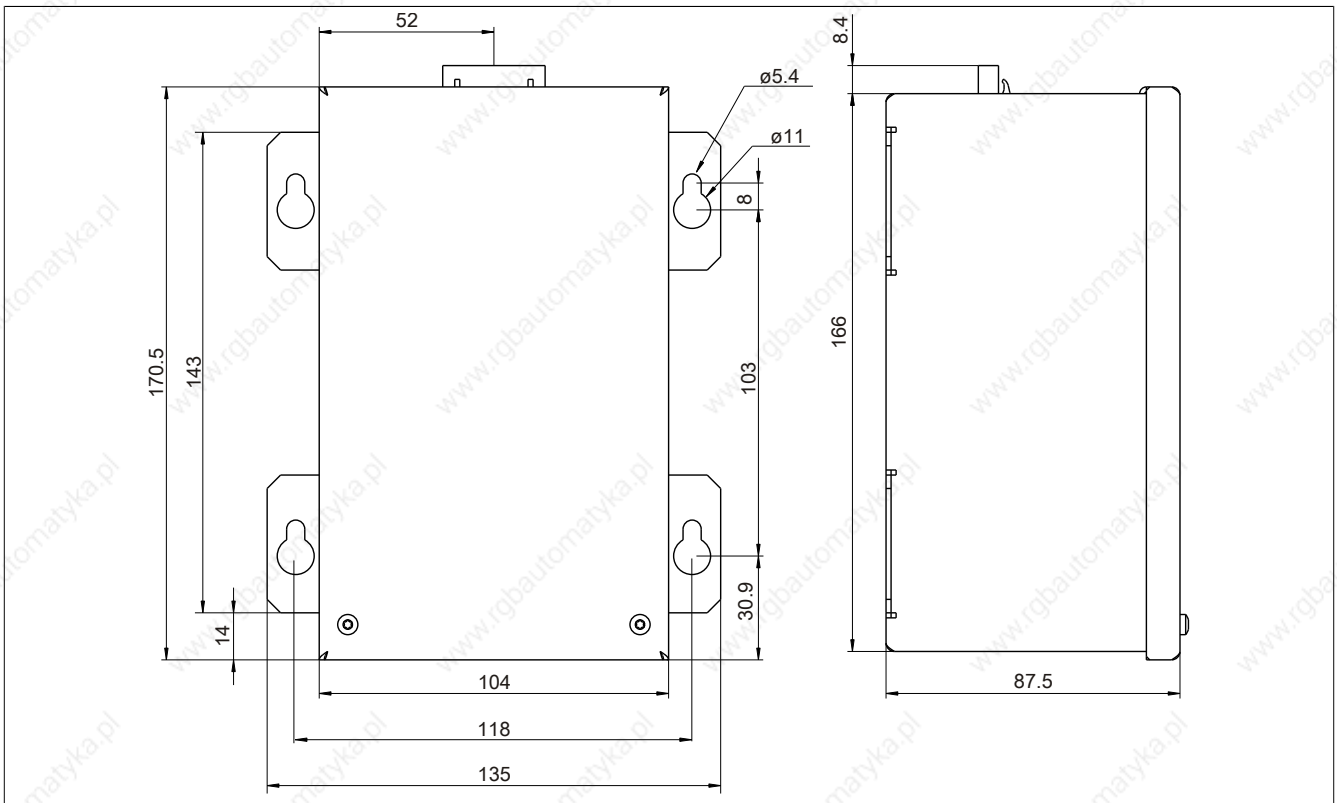

Figure 196: 5PC600.UPSB-00 - Dimensions

9.4.7 Drilling template

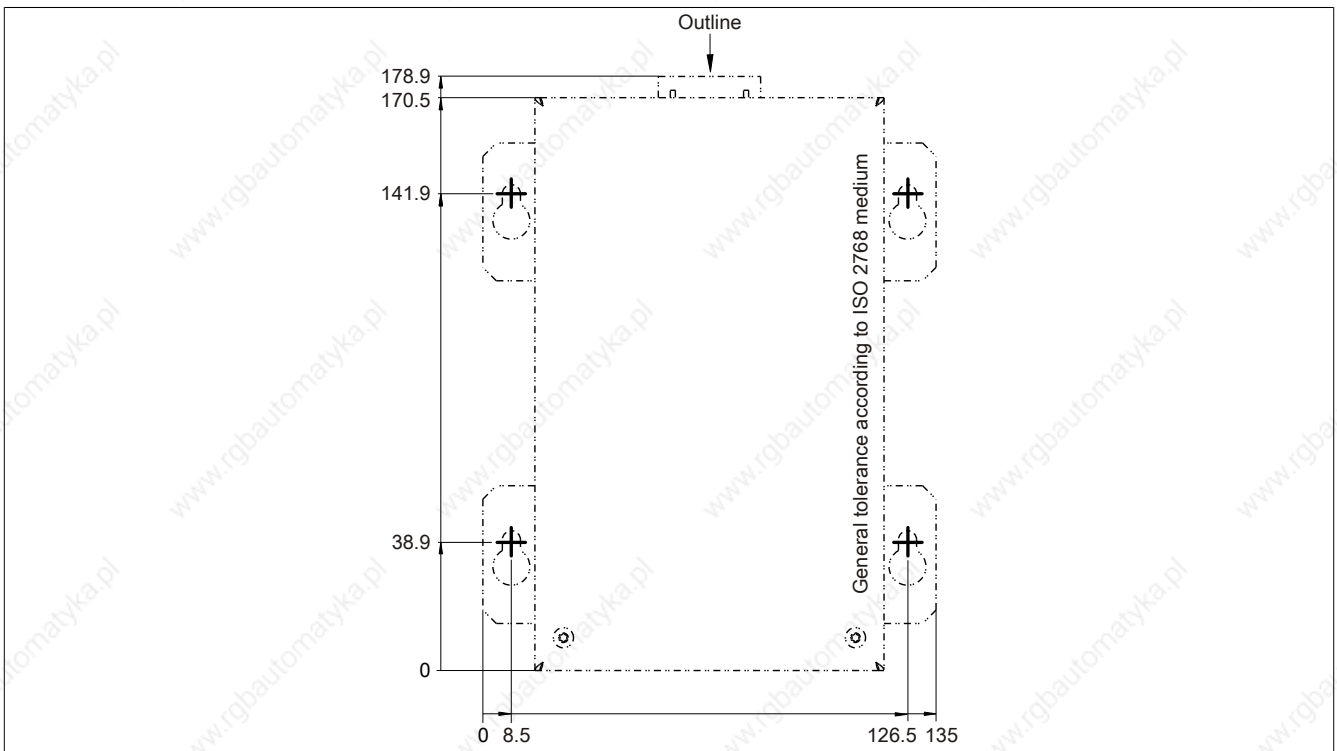

Figure 197: 5PC600.UPSB-00 - Drilling template

9.4.8 Installation instructions

Due to the unique construction of these batteries, they can be stored and operated in any position.

9.5 5CAUPS.00xx-00

9.5.1 General information

The UPS connection cable establishes the connection between the add-on UPS module (5AC600.UPSI-00) and the battery unit (5AC600.UPSB-00). It is available in lengths of 0.5 m and 3 m.

9.5.2 Order data

Model number	Short description	Figure
	Uninterruptible power supplies	
5CAUPS.0005-00	UPS cable 0.5 m; for UPS 5AC600.UPSI-00	
5CAUPS.0030-00	UPS cable 3 m; for UPS 5AC600.UPSI-00	

Table 288: 5CAUPS.0005-00, 5CAUPS.0030-00 - Order data

9.5.3 Technical data

Information:

The following characteristics, features and limit values only apply to this accessory and can deviate from those specified for the complete system. The data specifications for the complete system take precedence over those of individual components.

Product ID	5CAUPS.0005-00	5CAUPS.0030-00
General information		
Certification		
CE		Yes
cULus		Yes
GL		Yes
Cable structure		
Wire cross section		2x 0.5 mm ² (AWG 20) 4x 2.5 mm ² (AWG 13)
Conductor resistance		At 0.5 mm ² max. 39 Ω/km At 2.5 mm ² max. 7.98 Ω/km
Outer sheathing		
Material		Thermoplastic PVC-based material
Color		Window gray (similar to RAL 7040)
Connector		
Type	6-pin connector with clamping yoke / 6-pin multipoint connector with clamping yoke	
Electrical characteristics		
Operating voltage		Max. 300 V
Peak operating voltage		Typically 12 VDC / max. 15 VDC
Test voltage		
Wire/Wire		1500 V
Current load		10 A at 20°C
Environmental conditions		
Temperature		
Moving		-5 to 80°C
Static		-30 to 80°C
Mechanical characteristics		
Dimensions		
Length	0.5 m	3 m
Diameter	8.5 mm ±0.2 mm	
Flex radius		
Moving	10x wire cross section	
Fixed installation	5x wire cross section	
Weight	Approx. 100 g	Approx. 470 g

Table 289: 5CAUPS.0005-00, 5CAUPS.0030-00 - Technical data

9.6 5AC600.UPSF-00

9.6.1 General information

The UPS fuse kit can be used to add a fuse for the 5AC600.UPSB-00 battery unit.

Information about installing the 5AC600.UPSF-00 fuse kit can be found in the section "Installing the UPS fuse kit on the battery unit" on page 420.

Information:

The 5AC600.UPSF-00 UPS fuse kit is only needed for battery units up to and including revision D0. A 25 A fuse is integrated on the connector circuit board beginning with revision E0.

9.6.2 Order data

Model number	Short description	Figure
	Uninterruptible power supplies	
5AC600.UPSF-00	UPS fuse kit for battery unit 5AC600.UPSB-00 up to revision D0.	

Table 290: 5AC600.UPSF-00 - Order data

9.7 5AC600.UPSF-01

9.7.1 General information

These 25 A fuses are replacement parts for the 5AC600.UPSB-00 battery unit (beginning with revision E0) as well as the 5AC600.UPSF-00 fuse kit.

9.7.2 Order data

Model number	Short description	Figure
	Uninterruptible power supplies	
5AC600.UPSF-01	UPS fuse, 5 pcs.	

Table 291: 5AC600.UPSF-01 - Order data

10 Line filter

10.1 5AC804.MFLT-00

10.1.1 General information

The 5AC804.MFLT-00 line filter may be necessary to satisfy requirements regarding conducted disturbances in supply lines in accordance with the 2003 edition of GL EMC1 (Germanischer Lloyd).

The line filter should be installed as close to the end device as possible; the supply line from the end device to the line filter should be kept as short as possible.

10.1.2 Order data

Model number	Short description	Figure
5AC804.MFLT-00	Accessories Line filter	

Table 292: 5AC804.MFLT-00 - Order data

10.1.3 Technical data

Information:

The following characteristics, features and limit values only apply to this accessory and can deviate from those specified for the complete system. The data specifications for the complete system take precedence over those of individual components.

Product ID	5AC804.MFLT-00
General information	
Certification	
CE	Yes
cULus	Yes
GL	Yes
Terminal block	
Connection cross section	
With wire end sleeves	1.5 mm ²
Flexible	0.2 to 1.5 mm ²
Inflexible	0.2 to 2.5 mm ²
Electrical characteristics	
Nominal voltage	24 VDC -25% / +30%
Nominal current	8 A
Environmental conditions	
Temperature	
Operation	-25 to 65°C
Storage	-25 to 65°C
Transport	-25 to 65°C
Mechanical characteristics	
Housing	
Material	Galvanized steel plate
Dimensions	
Width	54 mm
Length	94 mm
Depth	32.15 mm
Weight	205 g

Table 293: 5AC804.MFLT-00 - Technical data

10.1.4 Dimensions

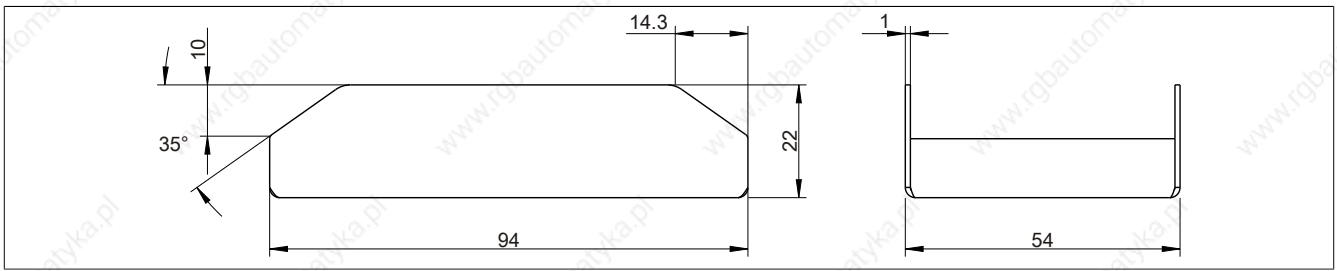

Figure 198: 5AC804.MFLT-00 - Dimensions

10.1.5 Drilling template

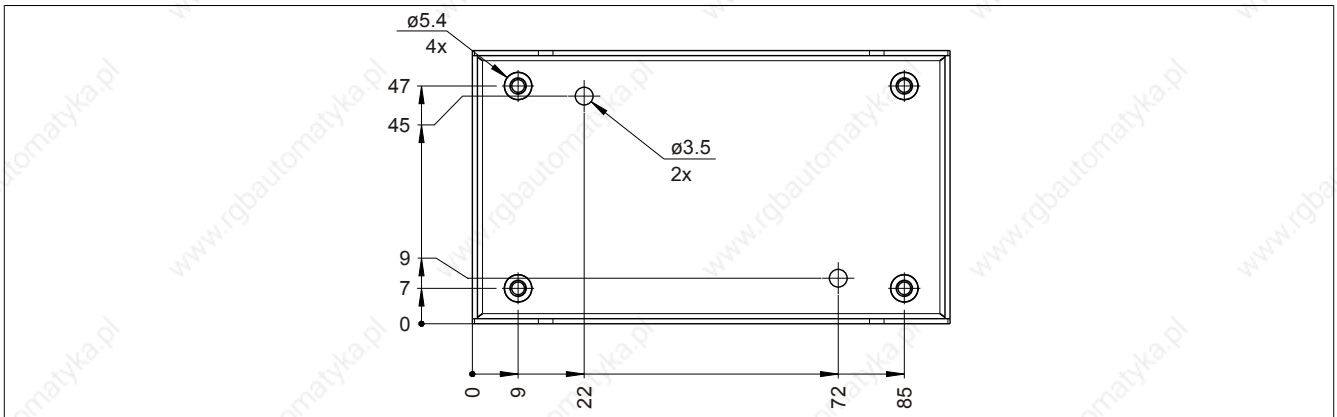

Figure 199: 5AC804.MFLT-00 - Drilling template

10.1.6 Connecting to the end device

The line filter must be connected between the supply voltage and the end device.

The following points must be observed:

- Use shielded, twisted wires.
- Keep the lines as short as possible (supply voltage - line filter - end device).
- The line filter must be installed on an unpainted, oil-free metallic surface.

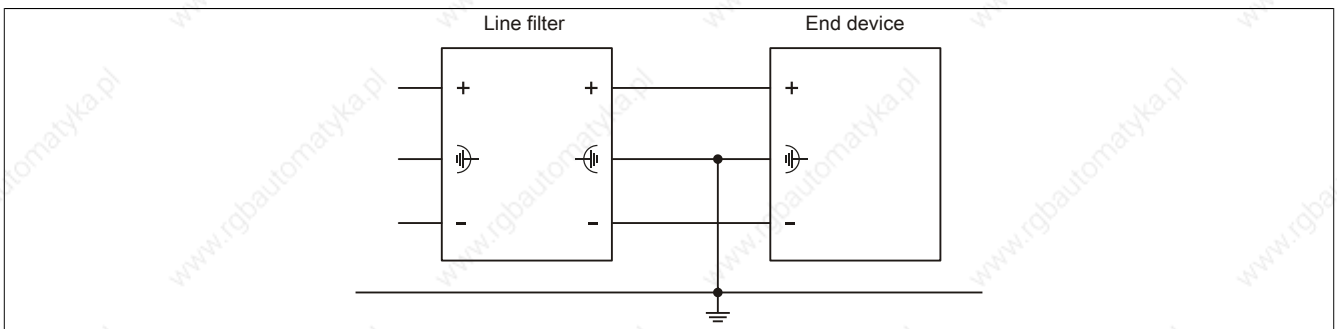

Figure 200: Connection example

11 PCI plug-in cards

11.1 5ACPCI.ETH1-01

11.1.1 General information

These universal (3.3 V and 5 V) half-size PCI Ethernet card have a 10/100 Mbit/s network connection and can be inserted and operated in a standard 16-bit PCI slot as an additional network interface.

- PCI Ethernet card
- 1 network connection (10/100 Mbit/s)



Figure 201: 5ACPCI.ETH1-01 - PCI 10/100 Ethernet card

11.1.2 Order data

Model number	Short description	Figure
	Accessories	
5ACPCI.ETH1-01	PCI Ethernet card 1x 10/100	

Table 294: 5ACPCI.ETH1-01 - Order data

11.1.3 Technical data

Product ID	5ACPCI.ETH1-01
General information	
B&R ID code	\$A58A
Diagnostics	
Data transfer	Yes, using status LED
Certification	
CE	Yes
cULus	Yes
GL	Yes

Table 295: 5ACPCI.ETH1-01 - Technical data

Product ID	5ACPCI.ETH1-01
Interfaces	
Ethernet	
Quantity	1
Controller	Intel 82551ER
Design	Shielded RJ45 port
Transfer rate	10/100 Mbit/s
Cable length	Max. 100 m between two stations (segment length)

Table 295: 5ACPCI.ETH1-01 - Technical data

11.1.3.1 Ethernet interface

Information:

The following characteristics, features and limit values only apply to this individual component and can deviate from those specified for the complete system. For the complete system in which this individual component is used, refer to the data given specifically for that device.

Ethernet interface		
Controller	Intel 82551ER	
Power supply	Universal card (2 notches) for 3.3 V or 5 V	
Cabling	S/STP (Cat 5e)	
Transfer rate	10/100 Mbit/s	
Cable length	Max. 100 m (min. Cat 5e)	
LED	On	Off
Green	100 Mbit/s	10 Mbit/s
Orange	Link (Ethernet network connection available)	Activity (blinking - data transfer in progress)

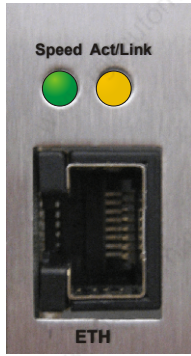

Table 296: 5ACPCI.ETH1-01 - Technical data

11.1.4 Driver support

A special driver is required in order to operate the Intel 82551ER Ethernet controller. Drivers for approved operating systems (Windows XP Professional, Windows XP Embedded and MS-DOS) are available in the Downloads section of the B&R website (www.br-automation.com).

Information:

Required drivers can only be downloaded from the B&R website, not from manufacturer websites.

11.1.5 Dimensions

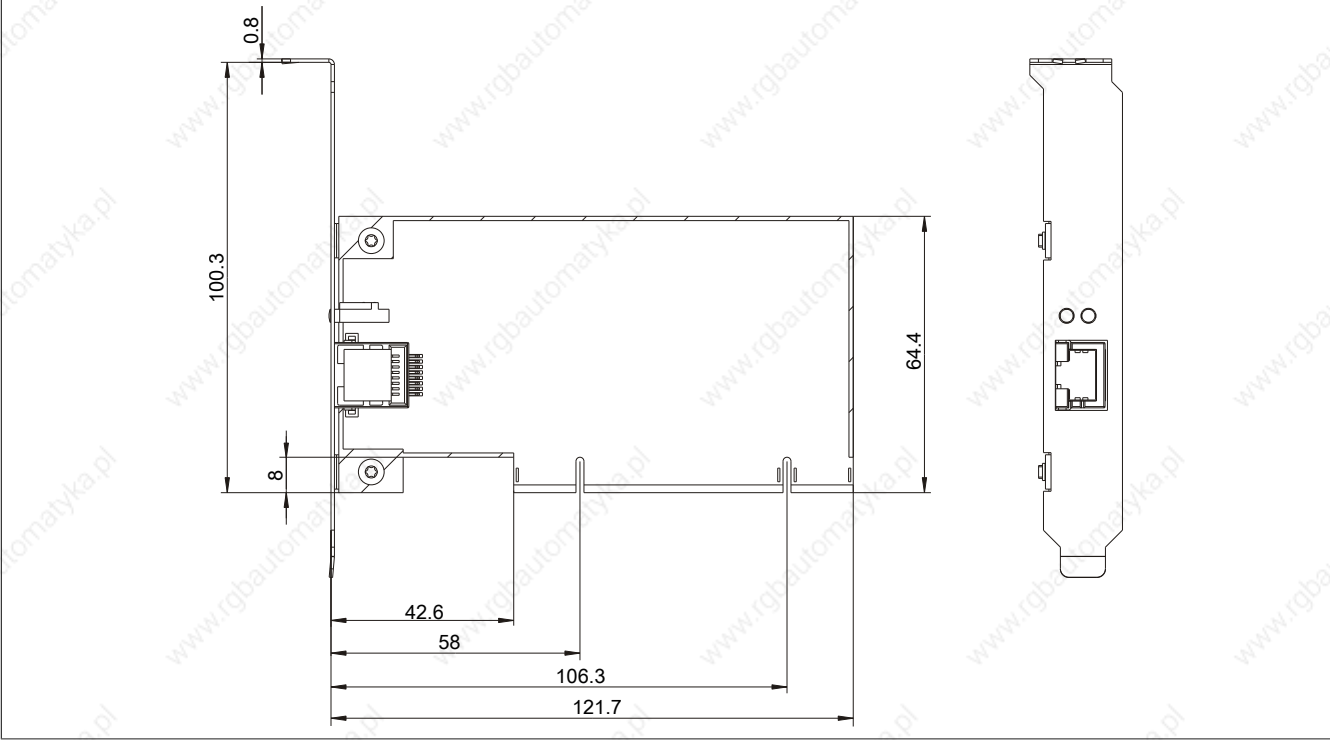

Figure 202: 5ACPCI.ETH1-01 - Dimensions

11.2 5ACPCI.ETH3-01

11.2.1 General information

These universal (3.3 V and 5 V) half-size PCI Ethernet card have three 10/100 Mbit/s network connections and can be inserted and operated in a standard 16-bit PCI slot as an additional network interface.

- PCI Ethernet card
- 3 network connections (10/100 Mbit/s)



Figure 203: 5ACPCI.ETH3-01 - PCI 10/100 Ethernet card

11.2.2 Order data

Model number	Short description	Figure
Accessories		
5ACPCI.ETH3-01	PCI Ethernet card 3x 10/100	

Table 297: 5ACPCI.ETH3-01 - Order data

11.2.3 Technical data

Product ID	5ACPCI.ETH3-01
General information	
B&R ID code	\$A58B
Diagnostics Data transfer	Yes, using status LED
Certification	
CE	Yes
cULus	Yes
GL	Yes

Table 298: 5ACPCI.ETH3-01 - Technical data

Product ID	5ACPCI.ETH3-01
Interfaces	
Ethernet	
Quantity	3
Controller	Intel 82551ER
Design	Shielded RJ45 port
Transfer rate	10/100 Mbit/s
Cable length	Max. 100 m between two stations (segment length)

Table 298: 5ACPCI.ETH3-01 - Technical data

11.2.3.1 Ethernet interface

Information:

The following characteristics, features and limit values only apply to this individual component and can deviate from those specified for the complete system. For the complete system in which this individual component is used, refer to the data given specifically for that device.

Ethernet connections		
Controller	each with Intel 82551ER	
Power supply	Universal card (2 notches) for 3.3 V or 5 V	
Cabling	S/STP (Cat 5e)	
Transfer rate	10/100 Mbit/s	
Cable length	Max. 100 m (min. Cat 5e)	
LED	On	Off
Green	100 Mbit/s	10 Mbit/s
Orange	Link (Ethernet network connection available)	Activity (blinking - data transfer in progress)

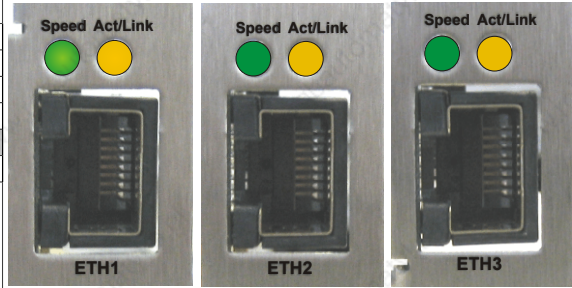

Table 299: 5ACPCI.ETH3-01 - Technical data

11.2.4 Driver support

A special driver is required in order to operate the Intel 82551ER Ethernet controller. Drivers for approved operating systems (Windows XP Professional, Windows XP Embedded and MS-DOS) are available in the Downloads section of the B&R website (www.br-automation.com).

Information:

Required drivers can only be downloaded from the B&R website, not from manufacturer websites.

11.2.5 Dimensions

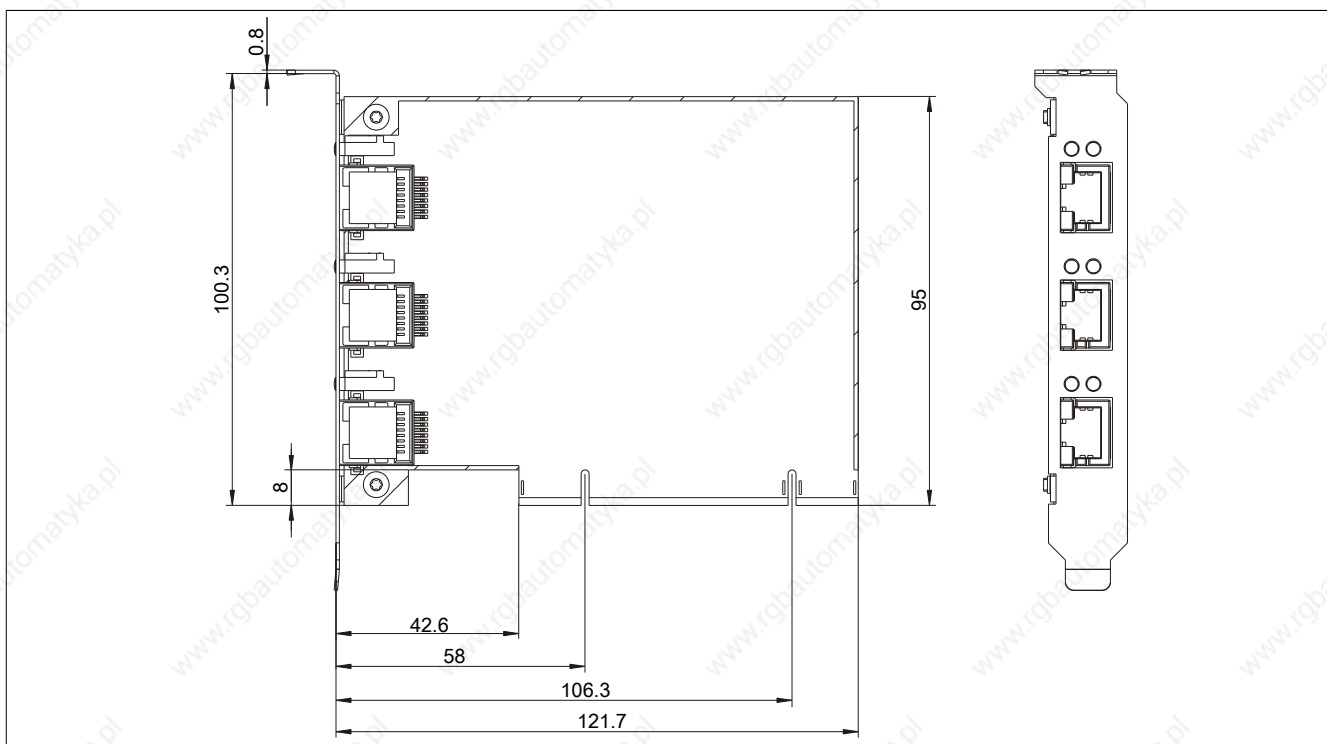

Figure 204: 5ACPCI.ETH3-01 - Dimensions

12 Cables

12.1 DVI cables

12.1.1 5CADVI.0xxx-00

12.1.1.1 General information

5CADVI.0xxx-00 DVI cables are designed for use in inflexible applications.

Caution!

Power must be turned off before plugging in and unplugging cables.

12.1.1.2 Order data

Model number	Short description	Figure
	DVI cable	
5CADVI.0018-00	DVI-D cable, 1.8 m	
5CADVI.0050-00	DVI-D cable, 5 m	
5CADVI.0100-00	DVI-D cable, 10 m	

Table 300: 5CADVI.0018-00, 5CADVI.0050-00, 5CADVI.0100-00 - Order data

12.1.1.3 Technical data

Product ID	5CADVI.0018-00	5CADVI.0050-00	5CADVI.0100-00
General information			
Certification		Yes	
CE		Yes	
cULus		Yes	
GL		Yes	
Cable structure			
Wire cross section		AWG 28	
Shield		Individual cable pairs and entire cable	
Cable shielding		Tinned copper mesh, optical coverage >86%	
Outer sheathing			
Material		PVC	
Color		Beige	
Labeling		AWM STYLE 20276 80°C 30V VW1 DVI DIGITAL SINGLE LINK DER AN	
Connector			
Type		2x DVI-D (18+1), male	
Connection cycles		100	
Locating screw tightening torque		Max. 0.5 Nm	
Electrical characteristics			
Conductor resistance		Max. 237 Ω/km	
Insulation resistance		Min. 100 MΩ/km	
Mechanical characteristics			
Dimensions			
Length	1.8 m ±50 mm	5 m ±80 mm	10 m ±100 mm
Diameter		Max. 8.5 mm	
Flex radius	≥5x cable diameter (connector - ferrite bead and ferrite bead - ferrite bead)		
Weight	Approx. 260 g	Approx. 460 g	Approx. 790 g

Table 301: 5CADVI.0018-00, 5CADVI.0050-00, 5CADVI.0100-00 - Technical data

12.1.1.4 Flex radius specifications

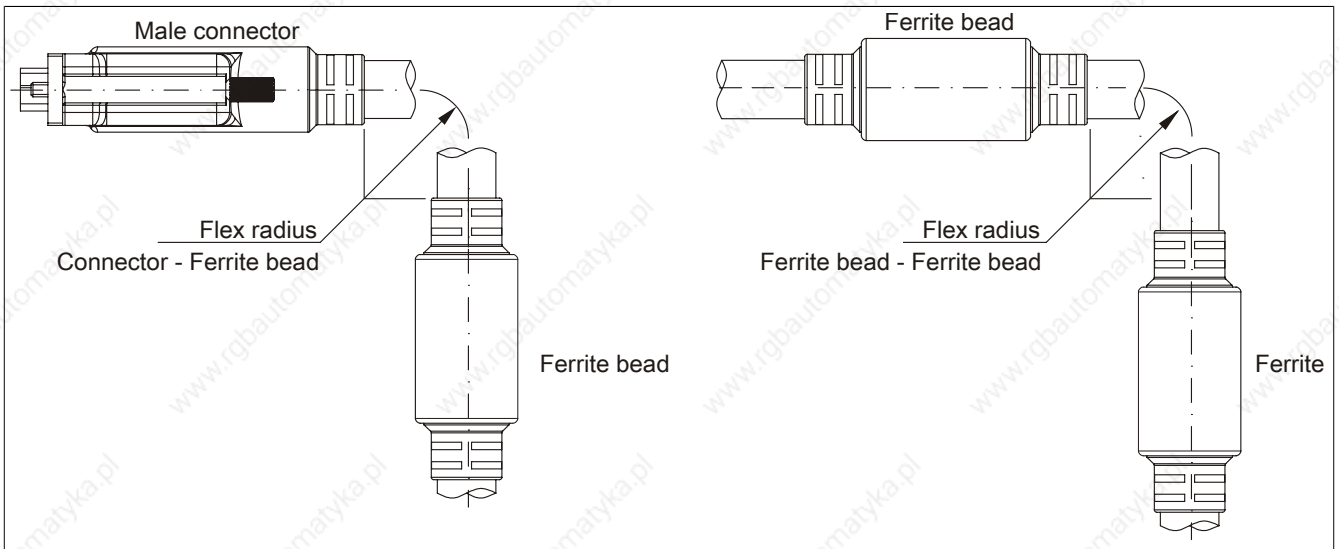

Figure 205: Flex radius specifications

12.1.1.5 Dimensions

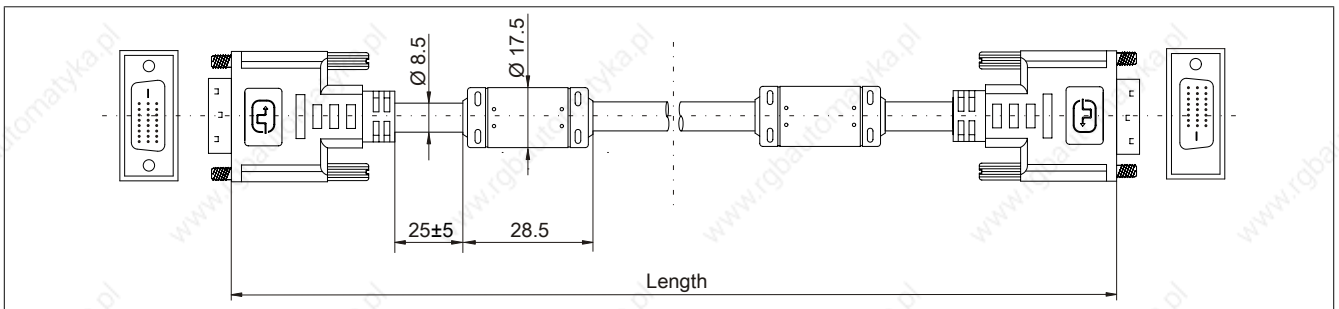

Figure 206: 5CADVI.0xxx-00 - Dimensions

12.1.1.6 Cable pinout

Warning!

If you choose to make a suitable cable yourself, it should be wired according to these specifications. If a self-made cable is used, B&R cannot guarantee that it will function properly. All cables provided by B&R are guaranteed to function properly.

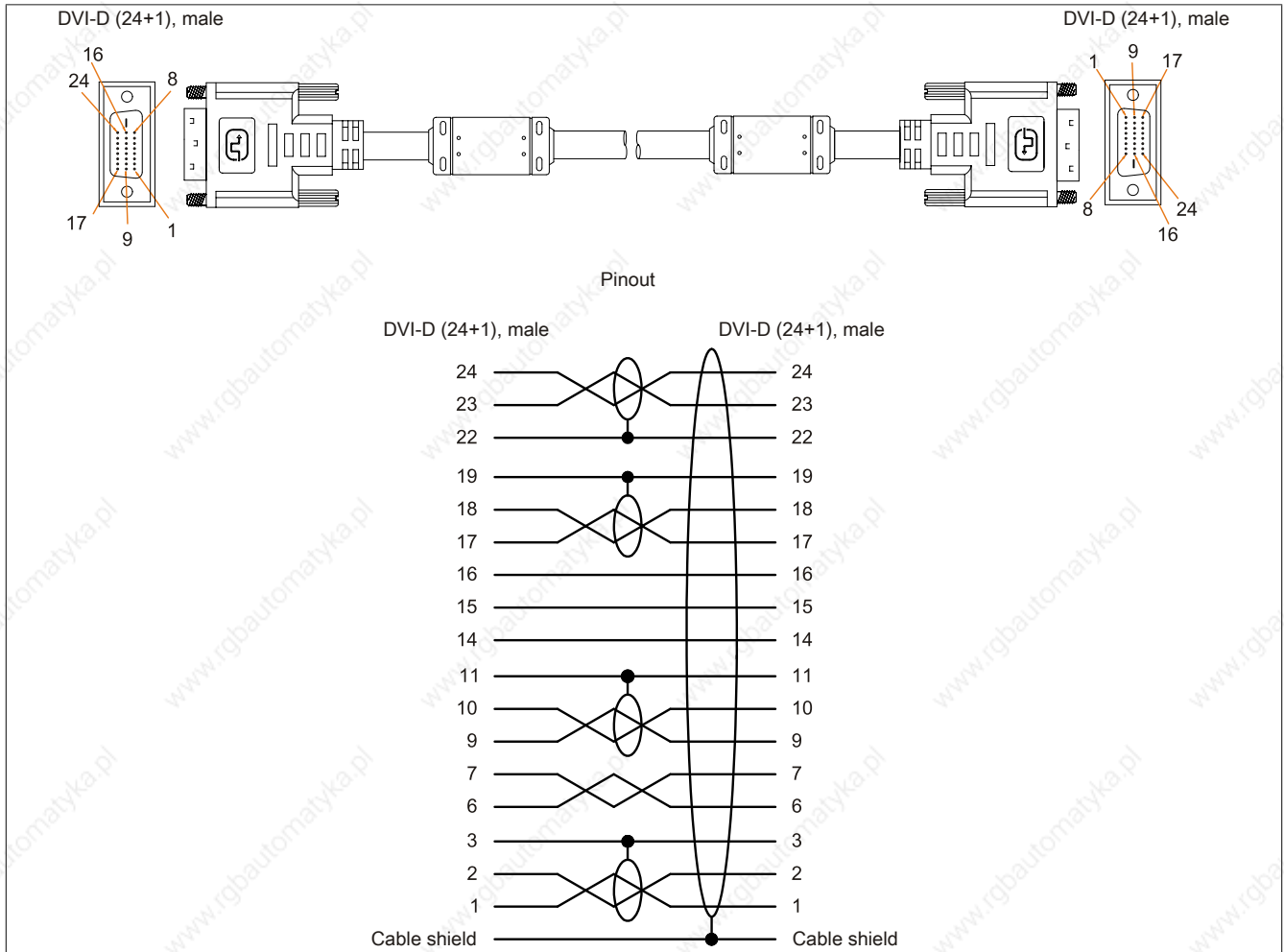

Figure 207: 5CADVI.0xxx-00 - Pinout

12.2 SDL cables

12.2.1 5CASDL.0xxx-00

12.2.1.1 General information

5CASDL.0xxx-00 SDL cables are designed for use in inflexible applications. SDL flex cables 5CASDL.0xxx-03 are required for flexible applications (e.g. swing arm systems).

Caution!

Power must be turned off before plugging in and unplugging cables.

12.2.1.2 Order data

Model number	Short description	Figure
	SDL cables	
5CASDL.0018-00	SDL cable, 1.8 m	
5CASDL.0050-00	SDL cable, 5 m	
5CASDL.0100-00	SDL cable, 10 m	
5CASDL.0150-00	SDL cable, 15 m	
5CASDL.0200-00	SDL cable, 20 m	
5CASDL.0250-00	SDL cable, 25 m	
5CASDL.0300-00	SDL cable, 30 m	

Table 302: 5CASDL.0018-00, 5CASDL.0050-00, 5CASDL.0100-00, 5CASDL.0150-00, 5CASDL.0200-00, 5CASDL.0250-00, 5CASDL.0300-00 - Order data

12.2.1.3 Technical data

Product ID	5CASDL.0018-00	5CASDL.0050-00	5CASDL.0100-00	5CASDL.0150-00	5CASDL.0200-00	5CASDL.0250-00	5CASDL.0300-00
General information							
Certification				Yes			
CE				Yes			
cULus				Yes			
GL				Yes			
Cable structure							
Wire cross section	AWG 28			AWG 24			
Shield	Individual cable pairs and entire cable						
Cable shielding	Tinned copper mesh, optical coverage >85%						
Outer sheathing							
Material	PVC						
Color	Black						
Labeling	E74020-C (UL) AWM STYLE 20176 80°C 30V VW-1 DVI DIGITAL LINK						
Connector							
Type	2x DVI-D (24+1), male						
Connection cycles	100						
Contacts	Gold-plated						
Mechanical protection	Metal cover with crimped stress relief						
Locating screw tightening torque	Max. 0.5 Nm						
Electrical characteristics							
Conductor resistance				≤93 Ω/km			
AWG 24				-			
AWG 28	≤237 Ω/km						
Insulation resistance	Min. 10 MΩ/km						
Mechanical characteristics							
Dimensions							
Length	1.8 m ±30 mm	5 m ±30 mm	10 m ±50 mm	15 m ±100 mm	20 m ±100 mm	25 m ±100 mm	30 m ±100 mm
Diameter	Typ. 8.6 ±0.2 mm Max. 9 mm			Typ. 11 ±0.2 mm Max. 11.5 mm			
Flex radius	≥5x cable diameter (connector - ferrite bead and ferrite bead - ferrite bead)						
Flexibility	Limited flexibility; valid for ferrite bead - ferrite bead (tested 100 cycles with 5x cable diameter, 20 cycles / minute)						
Weight	Approx. 300 g	Approx. 580 g	Approx. 1500 g	Approx. 2250 g	Approx. 2880 g	Approx. 4800 g	Approx. 5520 g

Table 303: 5CASDL.0018-00, 5CASDL.0050-00, 5CASDL.0100-00, 5CASDL.0150-00, 5CASDL.0200-00, 5CASDL.0250-00, 5CASDL.0300-00 - Technical data

12.2.1.4 Flex radius specifications

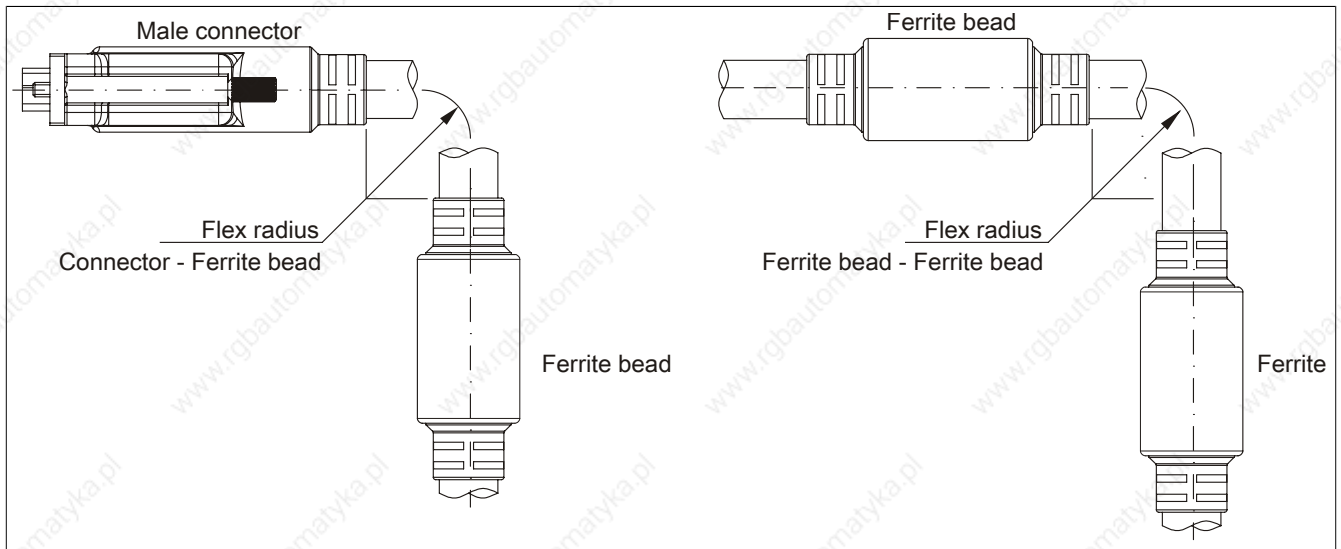

Figure 208: Flex radius specifications

12.2.1.5 Dimensions

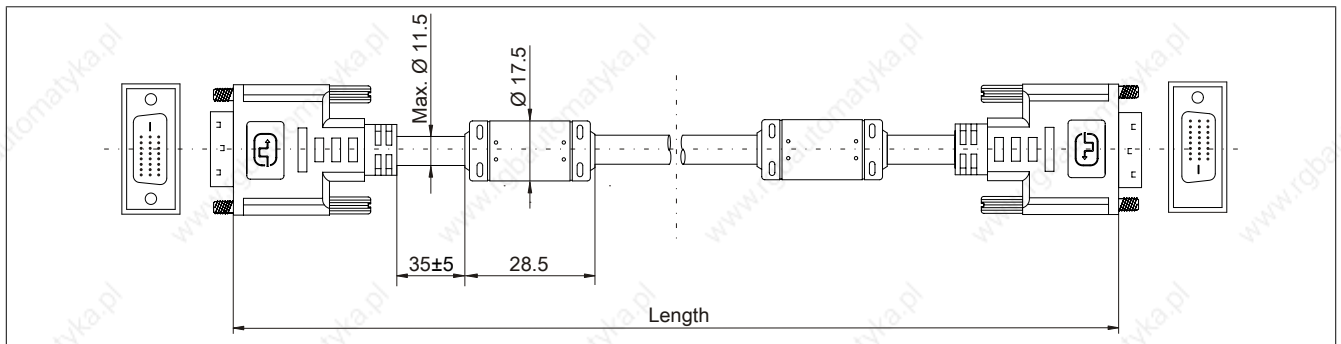

Figure 209: 5CASDL.0xxx-00- Dimensions

12.3 SDL cables with 45° male connector

12.3.1 5CASDL.0xxx-01

12.3.1.1 General information

5CASDL.0xxx-01 SDL cables with a 45° connector are designed for use in inflexible applications.

Caution!

Power must be turned off before plugging in and unplugging cables.

12.3.1.2 Order data

Model number	Short description	Figure
	SDL cable - 45° connector	
5CASDL.0018-01	SDL cable with 45° male connector, 1.8 m	
5CASDL.0050-01	SDL cable with 45° male connector, 5 m	
5CASDL.0100-01	SDL cable with 45° male connector, 10 m	
5CASDL.0150-01	SDL cable with 45° male connector, 15 m	

Table 304: 5CASDL.0018-01, 5CASDL.0050-01, 5CASDL.0100-01, 5CASDL.0150-01 - Order data

12.3.1.3 Technical data

Product ID	5CASDL.0018-01	5CASDL.0050-01	5CASDL.0100-01	5CASDL.0150-01
General information				
Certification				
CE	Yes			
cULus	Yes			
GL	Yes			
Cable structure				
Wire cross section	AWG 28		AWG 24	
Shield	Individual cable pairs and entire cable			
Cable shielding	Tinned copper mesh, optical coverage >85%			
Outer sheathing				
Material	PVC			
Color	Black			
Connector				
Type	2x DVI-D (24+1), male			
Connection cycles	100			
Contacts	Gold-plated			
Mechanical protection	Metal cover with crimped stress relief			
Locating screw tightening torque	Max. 0.5 Nm			
Electrical characteristics				
Conductor resistance				
AWG 24	-		≤93 Ω/km	
AWG 28	≤237 Ω/km		-	
Insulation resistance	Min. 10 MΩ/km			
Mechanical characteristics				
Dimensions				
Length	1.8 m ±30 mm	5 m ±50 mm	10 m ±100 mm	15 m ±100 mm
Diameter	Max. 9 mm		Max. 11.5 mm	
Flex radius				
Fixed installation	≥5x cable diameter (connector - ferrite bead and ferrite bead - ferrite bead)			
Flexibility	Limited flexibility; valid for ferrite bead - ferrite bead (tested 100 cycles with 5x cable diameter, 20 cycles / minute)			
Weight	Approx. 300 g	Approx. 590 g	Approx. 2800 g	Approx. 2860 g

Table 305: 5CASDL.0018-01, 5CASDL.0050-01, 5CASDL.0100-01, 5CASDL.0150-01 - Technical data

12.3.1.4 Flex radius specifications

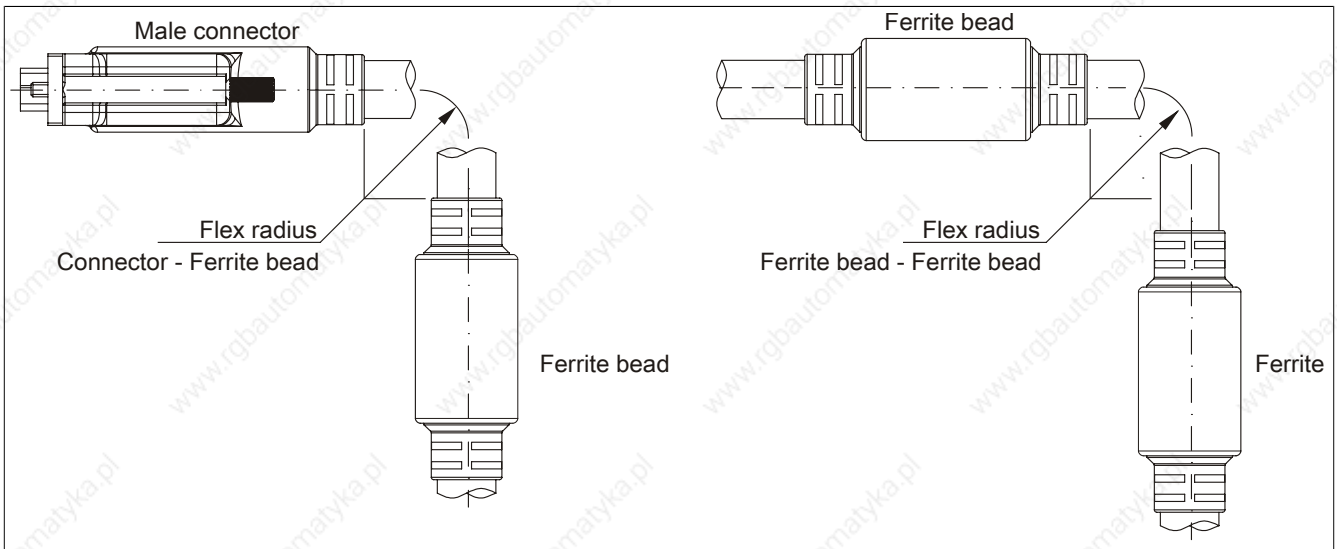

Figure 211: Flex radius specifications

12.3.1.5 Dimensions

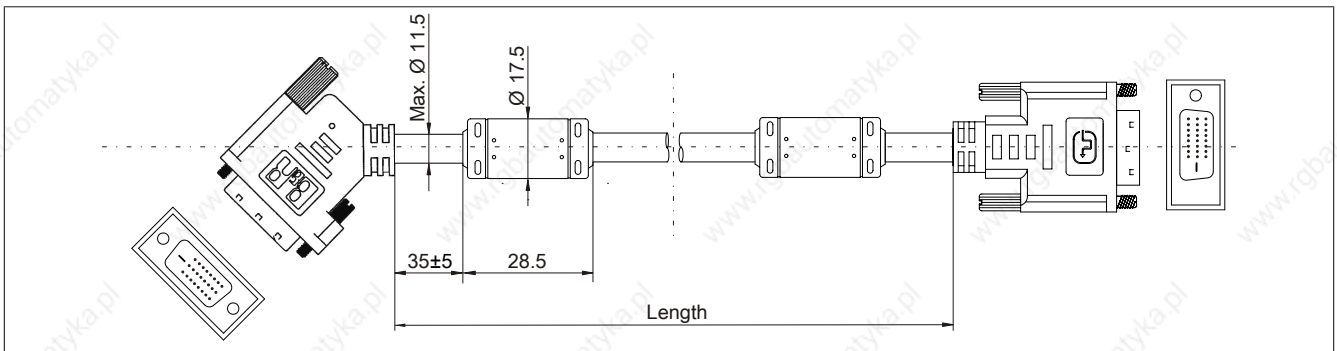

Figure 212: 5CASDL.0xxx-01 - Dimensions

12.3.1.6 Cable pinout

Warning!

If you choose to make a suitable cable yourself, it should be wired according to these specifications. If a self-made cable is used, B&R cannot guarantee that it will function properly. All cables provided by B&R are guaranteed to function properly.

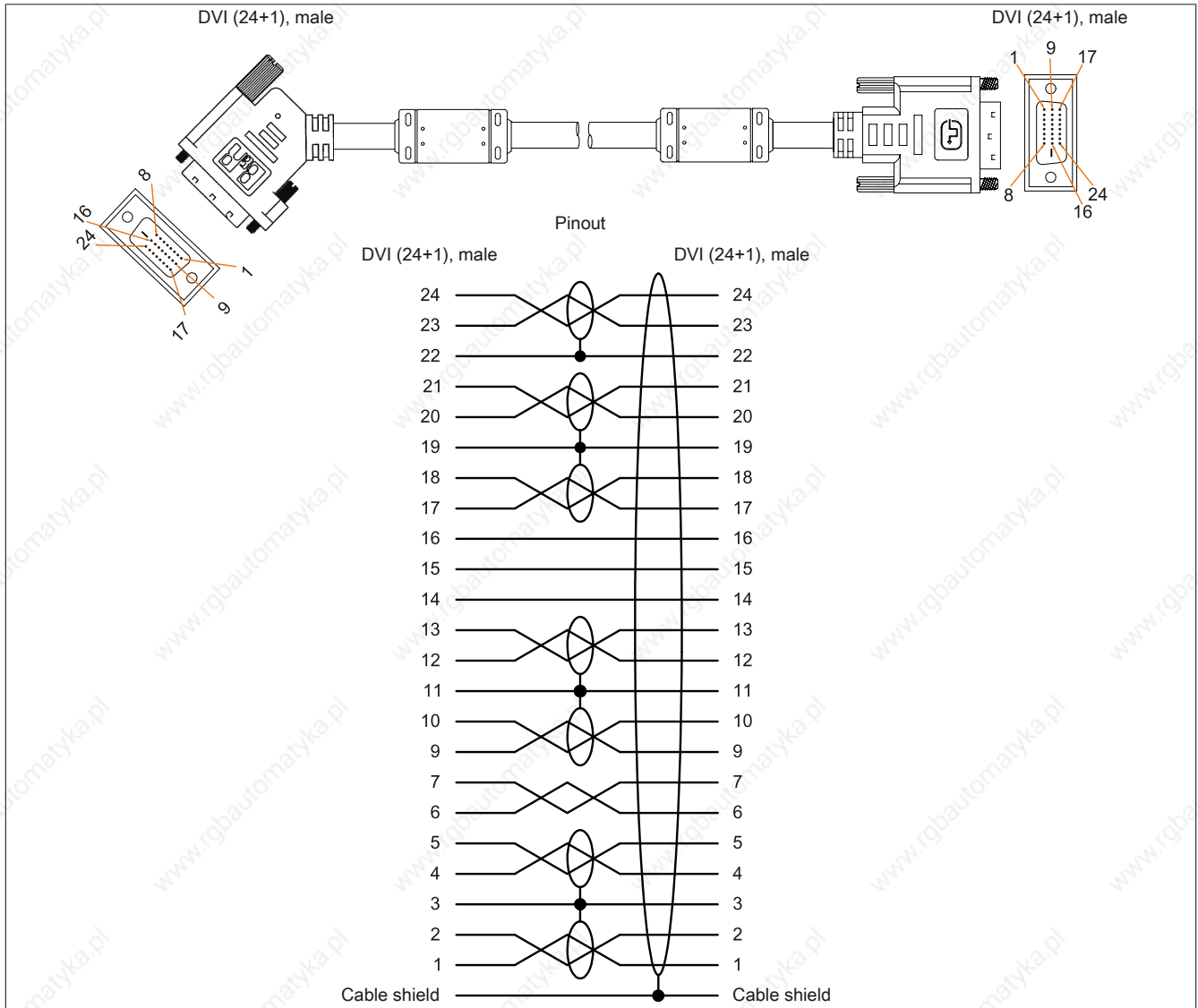

Figure 213: 5CASDL.0xxx-01 - Pinout

12.4 SDL flex cables

12.4.1 5CASDL.0xxx-03

12.4.1.1 General information

5CASDL.0xxx-03 SDL flex cables are designed for use in both inflexible and flexible applications (e.g. support arm systems).

Caution!

Power must be turned off before plugging in and unplugging cables.

12.4.1.2 Order data

Model number	Short description	Figure
	SDL flex cable	
5CASDL.0018-03	SDL flex cable, 1.8 m	
5CASDL.0050-03	SDL flex cable, 5 m	
5CASDL.0100-03	SDL flex cable, 10 m	
5CASDL.0150-03	SDL flex cable, 15 m	
5CASDL.0200-03	SDL flex cable, 20 m	
5CASDL.0250-03	SDL flex cable, 25 m	
5CASDL.0300-03	SDL flex cable, 30 m	

Table 306: 5CASDL.0018-03, 5CASDL.0050-03, 5CASDL.0100-03, 5CASDL.0150-03, 5CASDL.0200-03, 5CASDL.0250-03, 5CASDL.0300-03 - Order data

12.4.1.3 Technical data

Product ID	5CASDL. 0018-03	5CASDL. 0050-03	5CASDL. 0100-03	5CASDL. 0150-03	5CASDL. 0200-03	5CASDL. 0250-03	5CASDL. 0300-03
General information							
Certification				Yes			
CE				Yes			
cULus				Yes			
GL				Yes			
Cable structure							
Wire cross section				AWG 24 (control wires) AWG 26 (DVI, USB, data)			
Properties				Silicone- and halogen-free			
Shield				Individual cable pairs and entire cable			
Cable shielding				Aluminum-clad foil + tinned copper mesh			
Outer sheathing				Special semi-glossy TMPU			
Material				Black			
Color				(B&R) SDL Cable (UL) AWM 20236 80°C 30V E 63216			
Labeling							
Connector							
Type				2x DVI-D (24+1), male			
Connection cycles				Min. 200			
Contacts				Gold-plated			
Mechanical protection				Metal cover with crimped stress relief			
Locating screw tightening torque				Max. 0.5 Nm			
Electrical characteristics							
Operating voltage				≤30 V			
Test voltage				1 kV			
Wire/Wire				0.5 kV			
Wire/Shield				100 ±10 Ω			
Wave impedance							
Conductor resistance							
AWG 24				≤95 Ω/km			
AWG 26				≤145 Ω/km			
Insulation resistance				>200 MΩ/km			
Operating conditions							
Approbation				UL AWM 20236 80°C 30 V			
Flame resistant				In accordance with UL758 (cable vertical flame test)			
Oil and hydrolysis resistance				According to VDE 0282-10			

Table 307: 5CASDL.0018-03, 5CASDL.0050-03, 5CASDL.0100-03, 5CASDL.0150-03, 5CASDL.0200-03, 5CASDL.0250-03, 5CASDL.0300-03 - Technical data

Product ID	5CASDL.0018-03	5CASDL.0050-03	5CASDL.0100-03	5CASDL.0150-03	5CASDL.0200-03	5CASDL.0250-03	5CASDL.0300-03
Environmental conditions							
Temperature							
Storage	-20 to 80°C						
Moving	-5 to 60°C						
Fixed installation	-20 to 80°C						
Mechanical characteristics							
Dimensions							
Length	1.8 m ±20 mm 5 m ±45 mm 10 m ±90 mm 15 m ±135 mm 20 m ±180 mm 25 m ±225 mm 30 m ±270 mm						
Diameter	Max. 12 mm						
Flex radius							
Fixed installation	≥6x cable diameter (connector - ferrite bead)						
	≥10x cable diameter (from ferrite bead - ferrite bead)						
Flexible installation	≥15x cable diameter (from ferrite bead - ferrite bead)						
Flexibility	Flexible; valid for ferrite bead - ferrite bead (tested 300,000 cycles with 15x cable diameter, 4800 cycles/hour)						
Drag chain data							
Flex cycles	300,000						
Velocity	4800 cycles/hour						
Flex radius	180 mm; 15x cable diameter						
Hub	460 mm						
Weight	Approx. 460 g	Approx. 1020 g	Approx. 1940 g	Approx. 2840 g	Approx. 3740 g	Approx. 4560 g	Approx. 5590 g
Tension							
During operation	≤50 N						
During installation	≤400 N						

Table 307: 5CASDL.0018-03, 5CASDL.0050-03, 5CASDL.0100-03, 5CASDL.0150-03, 5CASDL.0200-03, 5CASDL.0250-03, 5CASDL.0300-03 - Technical data

12.4.1.4 Flex radius specifications

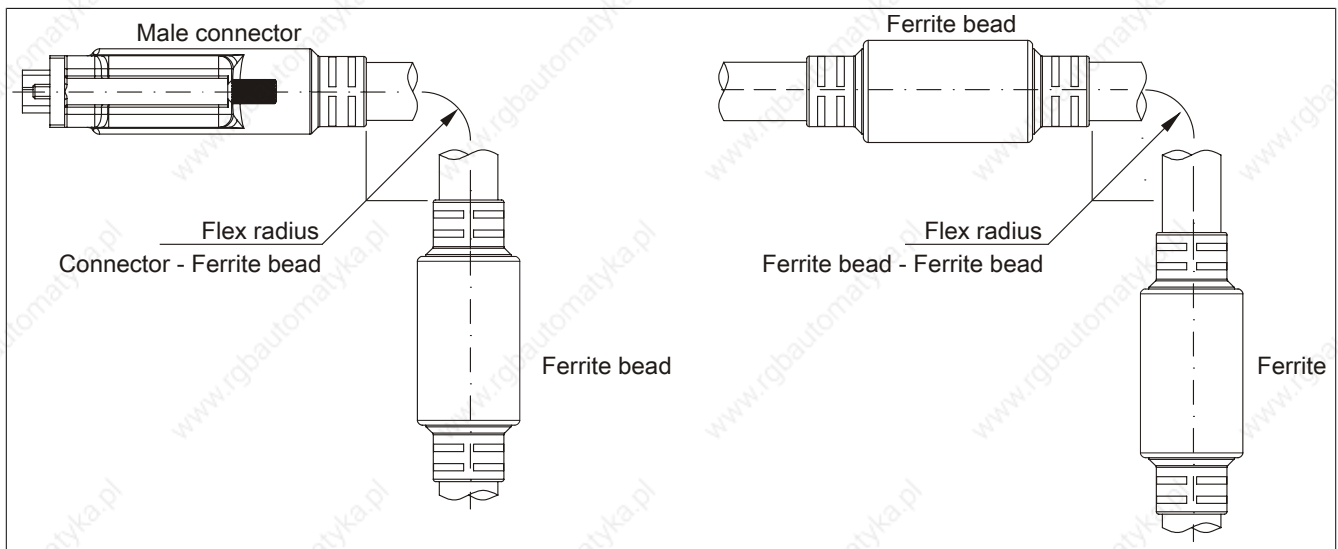

Figure 214: Flex radius specifications

12.4.1.5 Dimensions

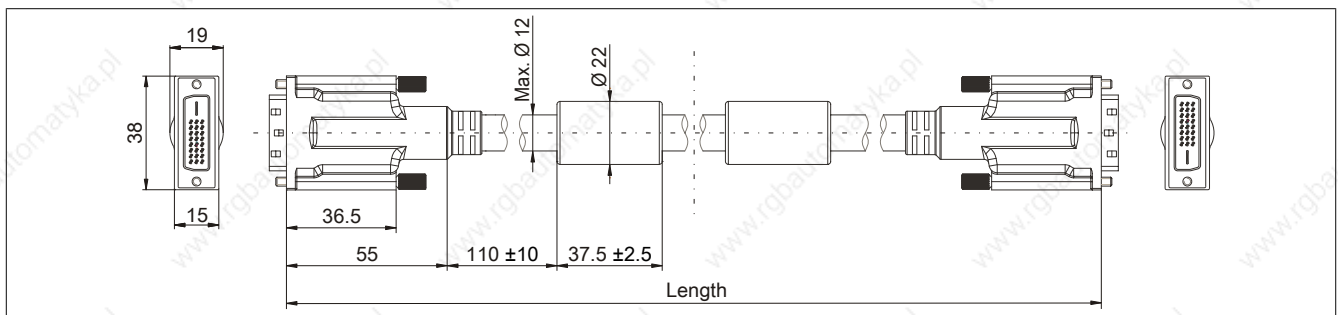

Figure 215: 5CASDL.0xxx-03 - Dimensions

12.4.1.6 Structure

Element	Assignment	Cross section
DVI	TMDS data 0	26 AWG
	TMDS data 1	26 AWG
	TMDS data 2	26 AWG
	TMDS cycle	26 AWG
USB	XUSB0	26 AWG
	XUSB1	26 AWG
Data	SDL	26 AWG
	DDC cycle	24 AWG
Control wires	DDC data	24 AWG
	+5 V	24 AWG
	Mass	24 AWG
	Hot plug detect	24 AWG

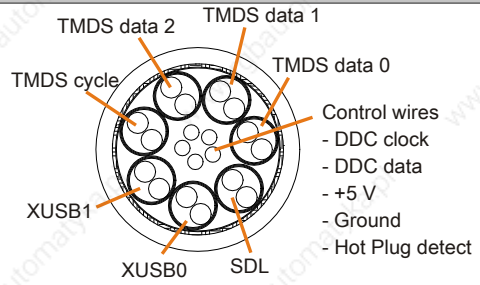

Table 308: 5CASDL.0xxx-03 SDL flex cables - Structure

12.4.1.7 Cable pinout

Warning!

If you choose to make a suitable cable yourself, it should be wired according to these specifications. If a self-made cable is used, B&R cannot guarantee that it will function properly. All cables provided by B&R are guaranteed to function properly.

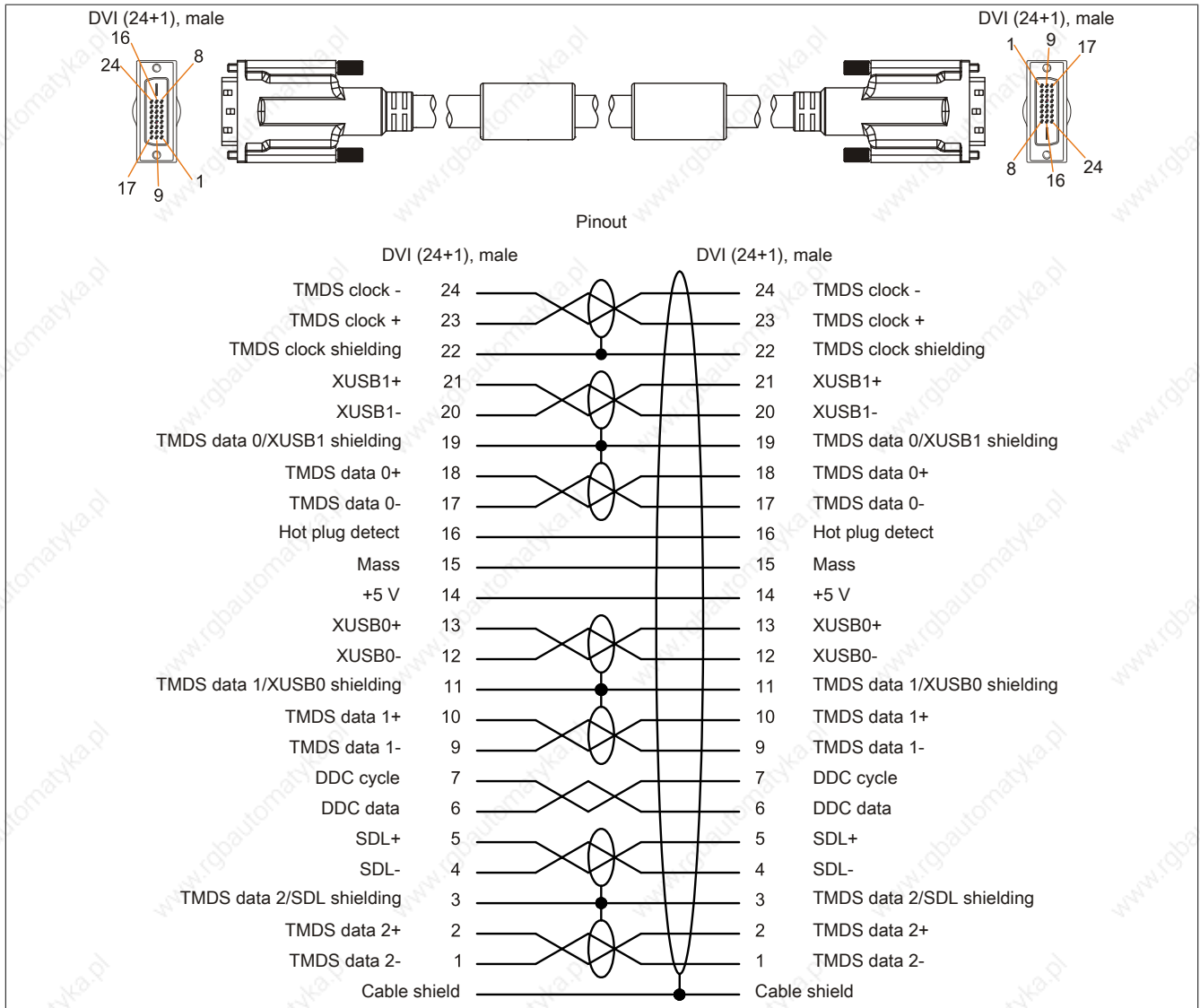

Figure 216: 5CASDL.0xxx-03 - Pinout

12.5 SDL flex cables with extender

12.5.1 5CASDL.0xx0-13

12.5.1.1 General information

5CASDL.0xx0-13 SDL flex cables with an extender are designed for use in both inflexible and flexible applications (e.g. support arm systems).

Caution!

Power must be turned off before plugging in and unplugging cables.

12.5.1.2 Order data

Model number	Short description	Figure
	SDL flex cable	
5CASDL.0300-13	SDL flex cable with extender, 30 m	
5CASDL.0400-13	SDL flex cable with extender, 40 m	
5CASDL.0430-13	SDL flex cable with extender, 43 m	

Table 309: 5CASDL.0300-13, 5CASDL.0400-13, 5CASDL.0430-13 - Order data

12.5.1.3 Technical data

Product ID	5CASDL.0300-13	5CASDL.0400-13	5CASDL.0430-13
General information			
Certification			
CE		Yes	
cULus		Yes	
GL		Yes	
Cable structure			
Wire cross section		AWG 24 (control wires) AWG 26 (DVI, USB, data)	
Properties		Silicone- and halogen-free	
Shield		Individual cable pairs and entire cable	
Cable shielding		Aluminum-clad foil + tinned copper mesh	
Outer sheathing			
Material		Special semi-glossy TMPU	
Color		Black	
Labeling		(B&R) SDL cable (UL) AWM 20236 80°C 30V E63216	
Connector			
Type		2x DVI-D (24+1), male	
Connection cycles		Min. 200	
Contacts		Gold-plated	
Mechanical protection		Metal cover with crimped stress relief	
Locating screw tightening torque		Max. 0.5 Nm	
Electrical characteristics			
Operating voltage		≤30 V	
Test voltage			
Wire/Wire		1 kV	
Wire/Shield		0.5 kV	
Wave impedance		100 ±10 Ω	
Conductor resistance			
AWG 24		≤95 Ω/km	
AWG 26		≤145 Ω/km	
Insulation resistance		>200 MΩ/km	
Operating conditions			
Approbation		UL AWM 20236 80°C 30 V	
Flame resistant		In accordance with UL758 (cable vertical flame test)	
Oil and hydrolysis resistance		According to VDE 0282-10	
Environmental conditions			
Temperature			
Storage		-20 to 60°C	
Moving		-5 to 60°C	
Fixed installation		-20 to 60°C	

Table 310: 5CASDL.0300-13, 5CASDL.0400-13, 5CASDL.0430-13 - Technical data

Product ID	5CASDL.0300-13	5CASDL.0400-13	5CASDL.0430-13
Mechanical characteristics			
Dimensions			
Length	30 m ±280 mm	40 m ±380 mm	43 m ±410 mm
Diameter		Max. 12 mm	
Extender box			
Width		35 mm	
Length		125 mm	
Height		18.5 mm	
Flex radius			
Fixed installation	≥6x cable diameter (connector - ferrite bead) ≥10x cable diameter (from ferrite bead - ferrite bead)		
Flexible installation	≥15x cable diameter (from ferrite bead - ferrite bead)		
Flexibility	Flexible; valid for ferrite bead - ferrite bead (tested 300,000 cycles with 15x cable diameter, 4800 cycles/hour)		
Drag chain data			
Flex cycles		300,000	
Velocity		4800 cycles/hour	
Flex radius		180 mm; 15x cable diameter	
Hub		460 mm	
Weight	Approx. 5430 g	Approx. 7200 g	Approx. 7790 g
Tension			
During operation		≤50 N	
During installation		≤400 N	

Table 310: 5CASDL.0300-13, 5CASDL.0400-13, 5CASDL.0430-13 - Technical data

12.5.1.4 Flex radius specifications

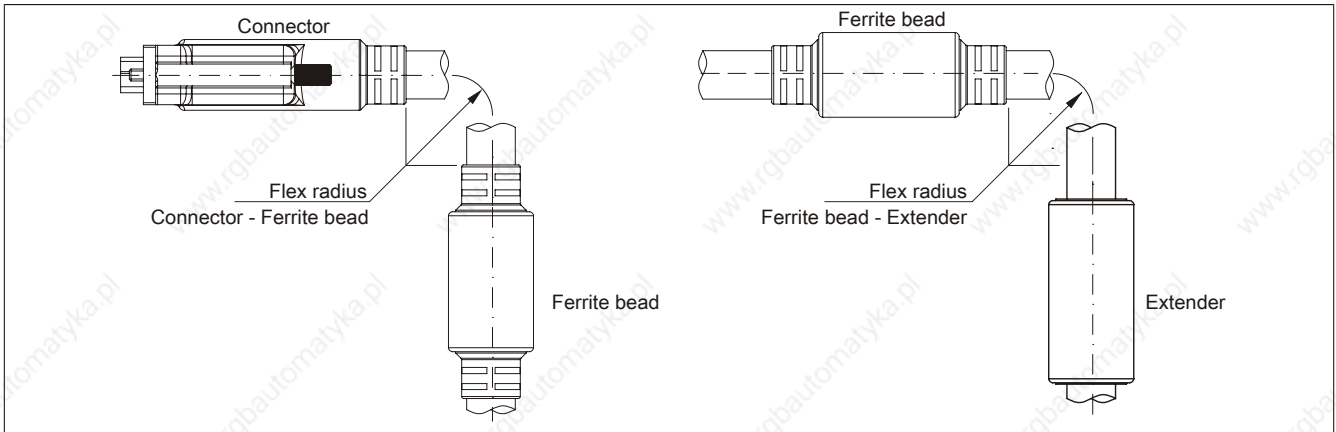

Figure 217: Flex radius specification with extender

12.5.1.5 Dimensions

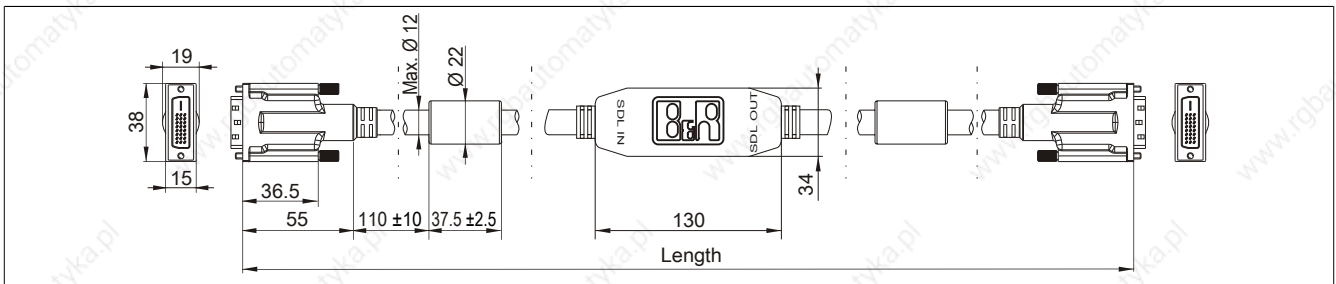

Figure 218: 5CASDL.0xx0-13 - Dimensions

12.5.1.6 Cable pinout

Warning!

If you choose to make a suitable cable yourself, it should be wired according to these specifications. If a self-made cable is used, B&R cannot guarantee that it will function properly. All cables provided by B&R are guaranteed to function properly.

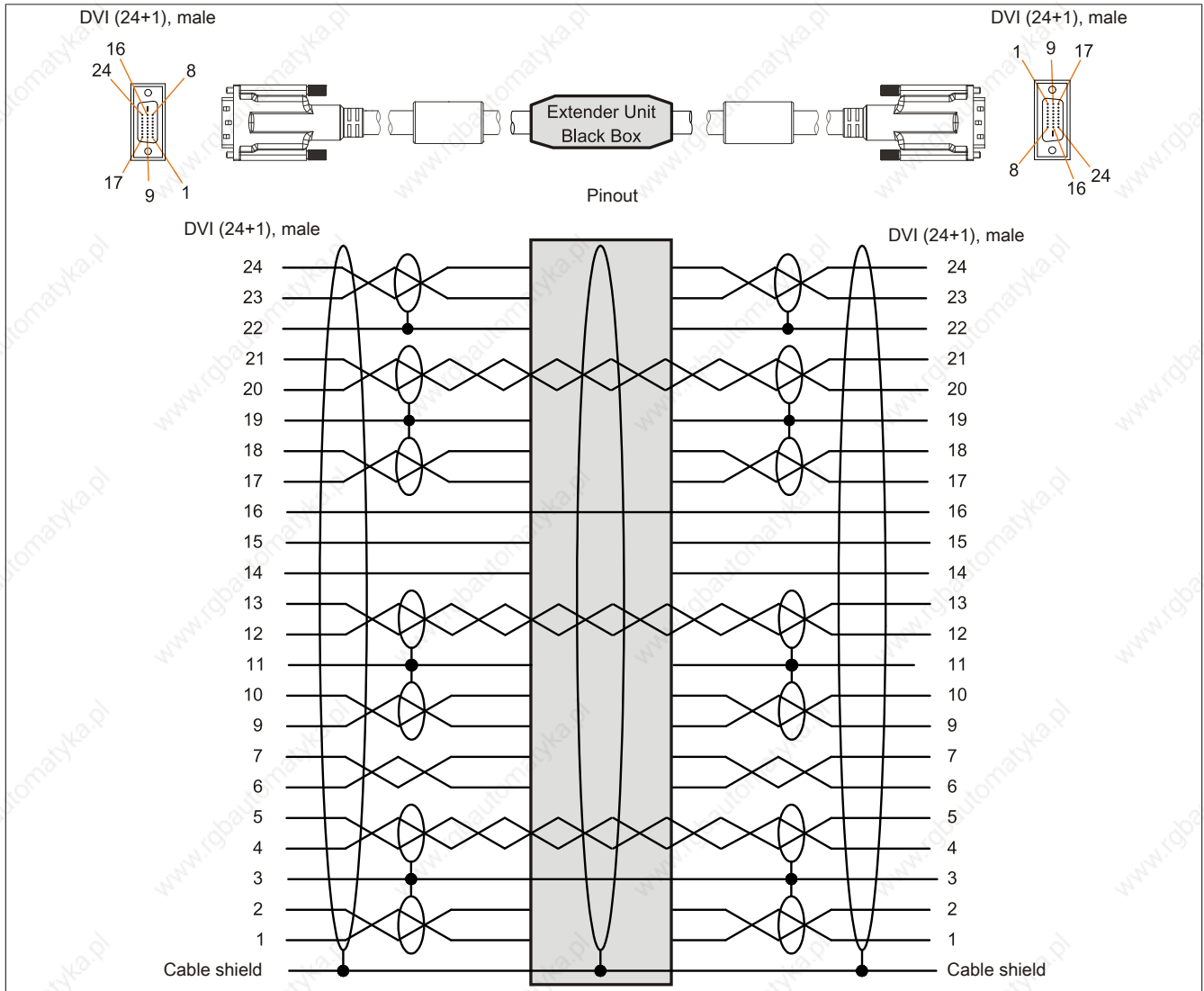

Figure 219: 5CASDL.0xx0-13 - Pinout

12.5.1.7 Cable connection

SDL flex cables with an extender must be connected between the B&R Industrial PC and the Automation Panel display unit in the correct direction. The proper signal direction is indicated on the extender.

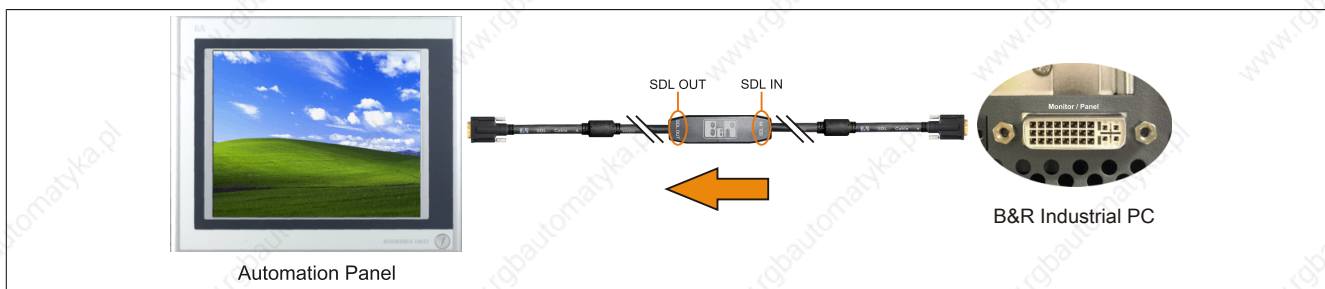

Figure 220: Example of the signal direction for an SDL flex cable with extender

12.6 USB cables

12.6.1 5CAUSB.00xx-00

12.6.1.1 General information

USB cables are designed to achieve USB 2.0 transfer speeds.

12.6.1.2 Order data

Model number	Short description	Figure
	USB cable	
5CAUSB.0018-00	USB 2.0 connection cable type A - type B, 1.8 m	
5CAUSB.0050-00	USB 2.0 connection cable type A - type B, 5 m	

Table 311: 5CAUSB.0018-00, 5CAUSB.0050-00 - Order data

12.6.1.3 Technical data

Product ID	5CAUSB.0018-00	5CAUSB.0050-00
General information		
Certification		
CE		Yes
cULus		Yes
Cable structure		
Wire cross section		AWG 24, 28
Shield		Entire cable
Outer sheathing		
Color		Beige
Connector		
Type	USB type A male and USB type B male	
Mechanical characteristics		
Dimensions		
Length	1.8 m ±30 mm	5 m ±50 mm
Diameter		Max. 5 mm
Flex radius		Min. 100 mm

Table 312: 5CAUSB.0018-00, 5CAUSB.0050-00 - Technical data

12.6.1.4 Cable pinout

Warning!

If you choose to make a suitable cable yourself, it should be wired according to these specifications. If a self-made cable is used, B&R cannot guarantee that it will function properly. All cables provided by B&R are guaranteed to function properly.

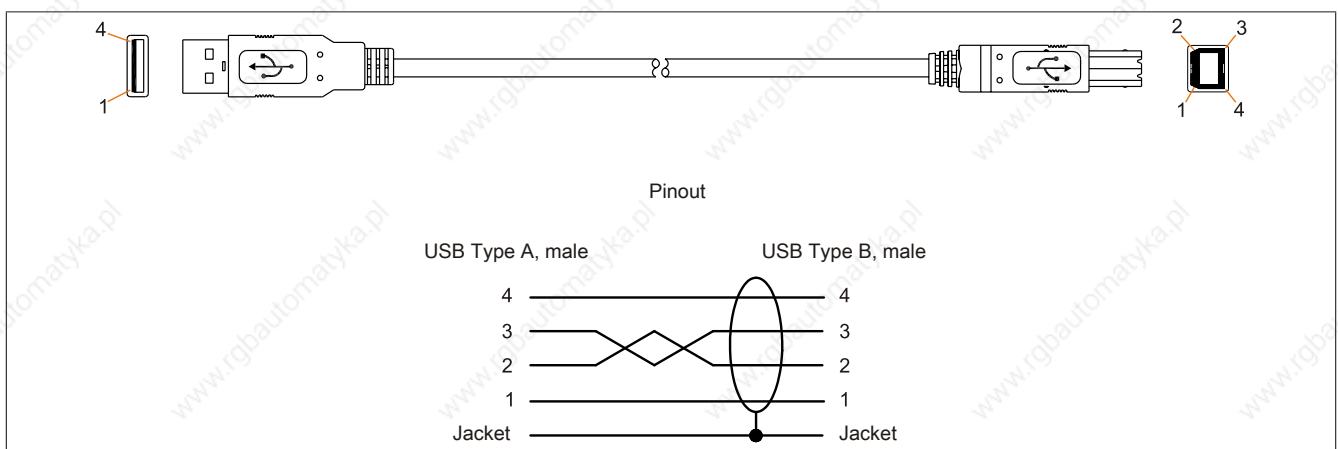

Figure 221: 5CAUSB.00xx-00 USB cables - Pinout

12.7 RS232 cables

12.7.1 9A0014.xx

12.7.1.1 General information

RS232 cables are used as extension cables between two RS232 interfaces.

12.7.1.2 Order data

Model number	Short description	Figure
	RS232 cable	
9A0014.02	RS232 extension cable for remote operation of a display unit with touch screen, 1.8 m	
9A0014.05	RS232 extension cable for remote operation of a display unit with touch screen, 5 m	
9A0014.10	RS232 extension cable for remote operation of a display unit with touch screen, 10 m	

Table 313: 9A0014.02, 9A0014.05, 9A0014.10 - Order data

12.7.1.3 Technical data

Product ID	9A0014.02	9A0014.05	9A0014.10
General information			
Certification CE		Yes	
Cable structure			
Wire cross section		AWG 26	
Shield		Entire cable	
Outer sheathing Color		Beige	
Connector			
Type	9-pin male/female DSUB connector		
Locating screw tightening torque	Max. 0.5 Nm		
Mechanical characteristics			
Dimensions			
Length	1.8 m ±50 mm	5 m ±80 mm	10 m ±100 mm
Diameter		Max. 5 mm	
Flex radius		Min. 70 mm	

Table 314: 9A0014.02, 9A0014.05, 9A0014.10 - Technical data

12.7.1.4 Cable pinout

Warning!

If you choose to make a suitable cable yourself, it should be wired according to these specifications. If a self-made cable is used, B&R cannot guarantee that it will function properly. All cables provided by B&R are guaranteed to function properly.

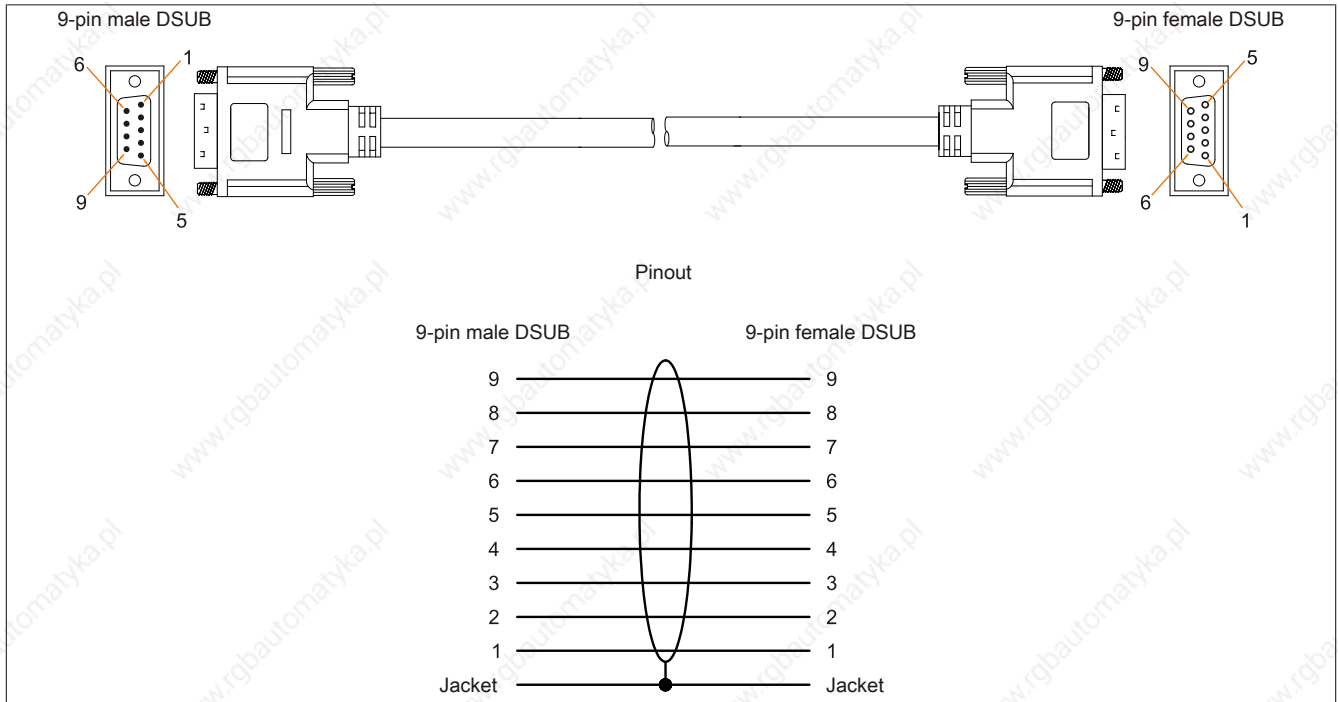

Figure 222: 9A0014.xx RS232 cables - Pinout

12.8 Internal supply cable

12.8.1 5CAMSC.0001-00

12.8.1.1 General information

This supply cable is used internally, for example to provide power to special PCI cards. It is connected to the mainboard.

For requirements and procedures, see "Connecting an external device to the mainboard" on page 432.

Caution!

Power must be turned off before plugging in and unplugging cables.

12.8.1.2 Order data

Model number	Short description	Figure
5CAMSC.0001-00	Internal supply cable	

Table 315: 5CAMSC.0001-00 - Order data

12.8.1.3 Technical data

Product ID	5CAMSC.0001-00
General information	
Certification CE	Yes
Cable structure	
Wire cross section	AWG 22
Connector	
Type	1x 4-pin male disk drive power connector, 1x 4-pin female connector housing
Mechanical characteristics	
Dimensions	
Length	100 mm ±5 mm
Flexibility	Flexible

Table 316: 5CAMSC.0001-00 - Technical data

13 HDD replacement disk tray

13.1 5AC801.FRAM-00

13.1.1 General information

To ensure that a hard disk can be replaced as quickly as possible, it is possible to install a compartment on the APC810 for storing a replacement HDD.

For more information about installing the HDD replacement disk tray, see chapter "Maintenance and service".



Figure 223: 5AC801.FRAM-00 - HDD replacement disk tray

13.1.2 Order data

Model number	Short description	Figure
	Accessories	
5AC801.FRAM-00	APC810 SATA hard disk replacement tray	

Table 317: 5AC801.FRAM-00 - Order data

13.1.3 Technical data

Product ID	5AC801.FRAM-00
General information	
Certification CE	Yes
Mechanical characteristics	
Dimensions	
Width	106 mm
Height	101 mm
Depth	18 mm

Table 318: 5AC801.FRAM-00 - Technical data

13.1.4 Dimensions

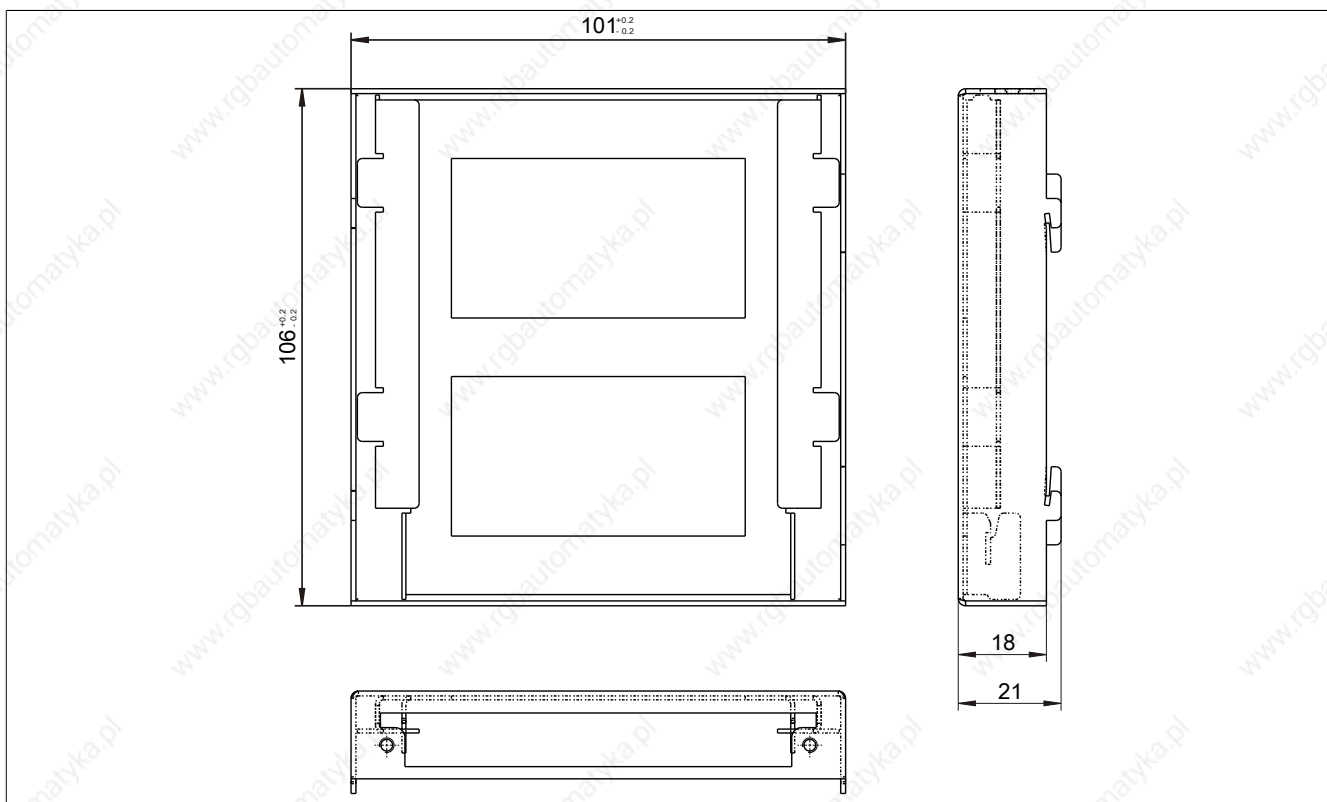

Figure 224: 5AC801.FRAM-00 - Dimensions

Chapter 7 • Maintenance and service

This chapter describes service/maintenance work that can be carried out by a qualified end user.

1 Changing the battery

The lithium battery buffers the internal real-time clock (RTC) and CMOS data.

Information:

- The product design allows the battery to be changed with the B&R device switched either on or off. In some countries, safety regulations do not allow batteries to be changed while the module is switched on.
- Any BIOS settings that have been made will remain when the battery is changed with the power turned off (stored in non-volatile EEPROM). The date and time must be reset later since this data is lost when the battery is changed.
- The battery should only be changed by qualified personnel.

Warning!

The battery must be replaced by a Type CR2477N Renata battery only. The use of another battery may present a risk of fire or explosion.

The battery may explode if handled improperly. Do not recharge, disassemble or dispose of in fire.

The following replacement lithium batteries are available: 4A0006.00-000 (1 pc.) and 0AC201.91 (4 pcs.).

1.1 Battery status evaluation

The status of the battery is determined immediately after the device is started and subsequently checked by the system every 24 hours. During this measurement, the battery is subjected to a brief load (approximately 1 second) and then evaluated. Once determined, the battery status is displayed in BIOS (under Advanced -> OEM features -> System board features -> Voltage values) and in the B&R Control Center (ADI driver); it can also be read in a customer application using the ADI library.

Battery status	Description
N/A	The hardware or firmware being used is too old and does not support reading the battery status.
GOOD	Data buffering is intact.
BAD	From the point when battery capacity is recognized as insufficient (BAD), data buffering is intact for approximately another 500 hours.

Table 319: Battery status

From the point when battery capacity is recognized as insufficient, data buffering is intact for approximately another 500 hours. When replacing the battery, data is buffered for approximately 10 minutes by a gold leaf capacitor.

1.2 Procedure

- Disconnect the power supply to the B&R Industrial PC.
- Touch the housing or ground connection in order to discharge any electrostatic charge from your body.
- Remove the cover from the battery compartment and carefully pull out the battery using the removal strip.

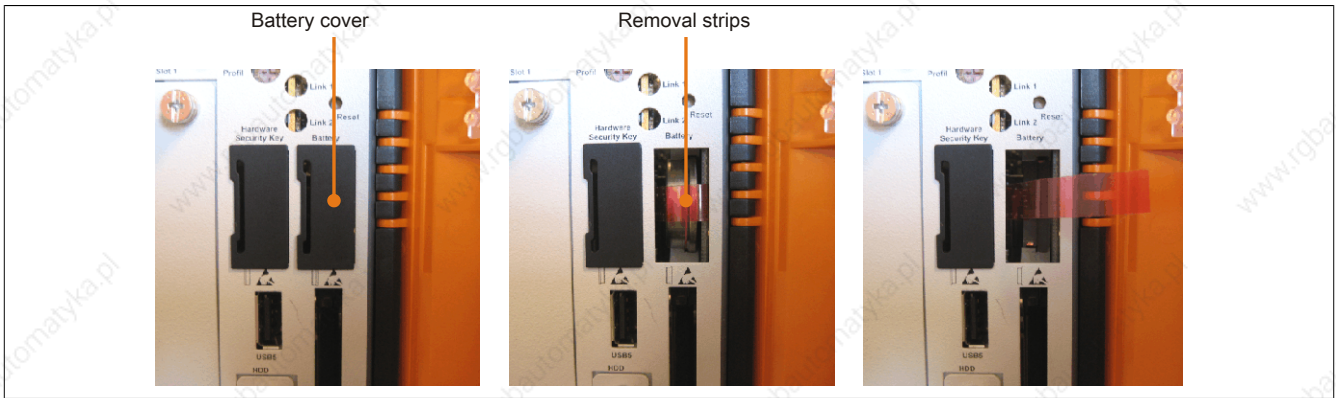

Figure 225: Removing the battery

- The battery should not be held by its edges. Insulated tweezers may also be used to insert the battery.

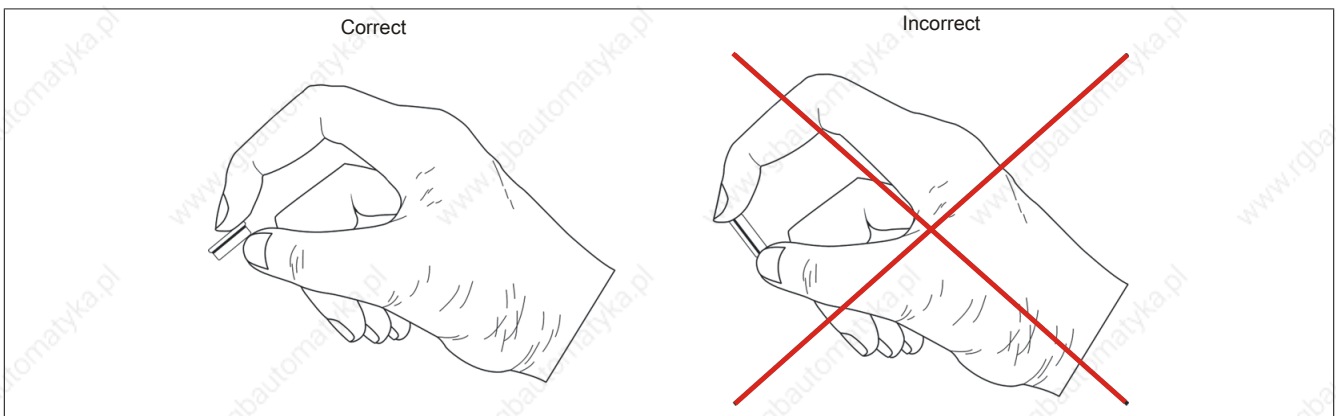

Figure 226: Battery handling

- Insert the new battery with the correct polarity.

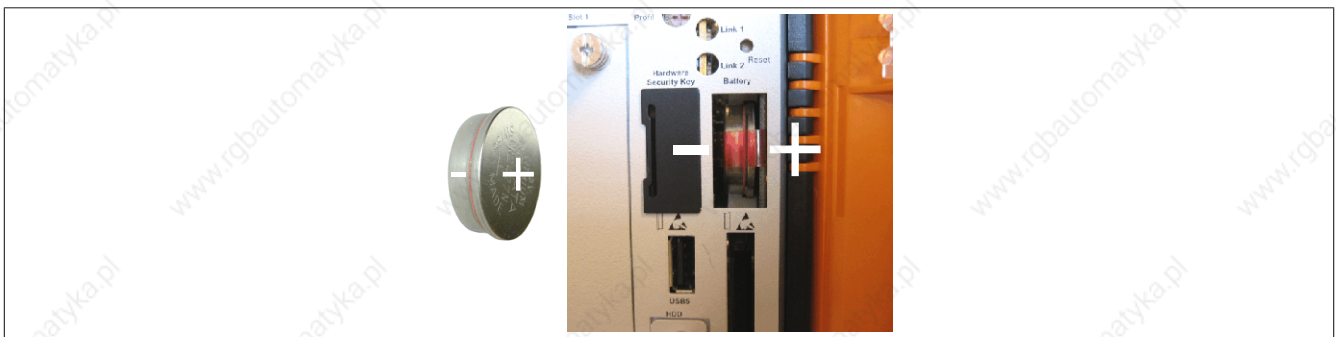

Figure 227: Battery polarity

- To make the next battery replacement easier, be sure the removal strip is in place when inserting the battery.
- Reconnect the power supply to the B&R Industrial PC (plug in the power cable).
- Reset the date and time in BIOS.

Warning!

Lithium batteries are considered hazardous waste. Used batteries should be disposed of in accordance with applicable local regulations.

2 Replacing a CompactFlash card

Caution!

Power must be turned off before replacing CompactFlash cards.

The CompactFlash card can be replaced quickly and easily by pressing the ejector (see image) with a pointed object such as a pen.

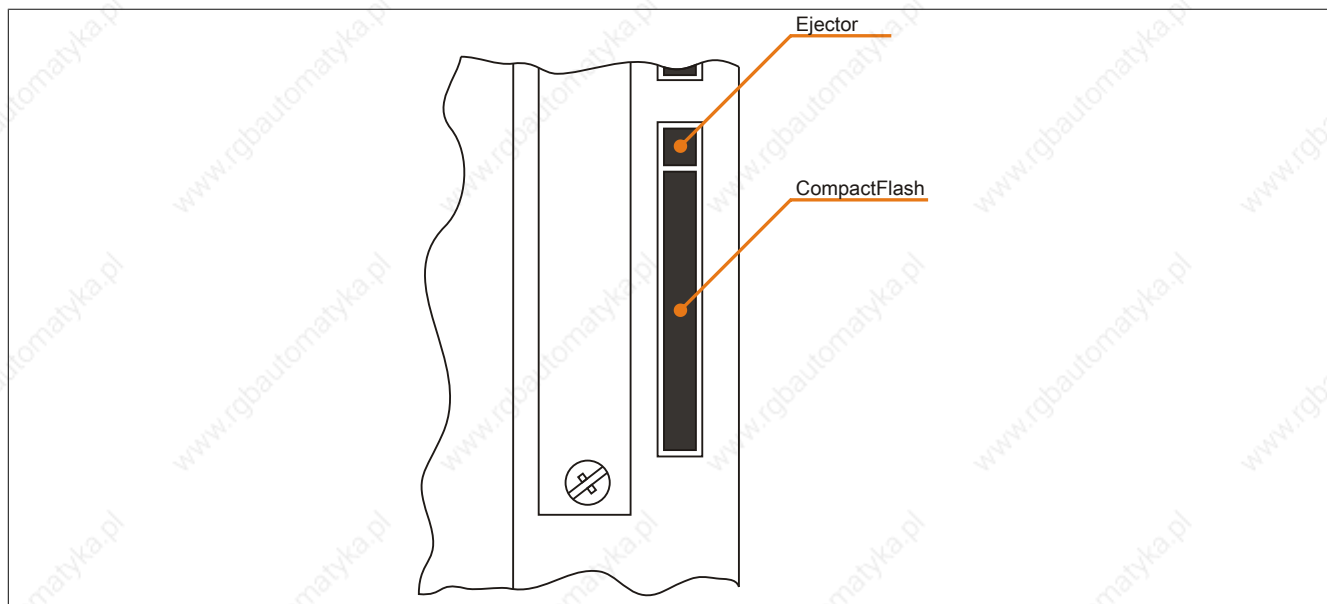

Figure 228: CompactFlash + ejector

3 Installing and replacing slide-in compact drives

Information:

The SATA I interface allows disks to be replaced during operation (hot plugging). In order to take advantage of this capability, this feature must be supported by the operating system.

3.1 Procedure

1. Loosen and remove the two quick release screws on the protective cover / slide-in compact drive.

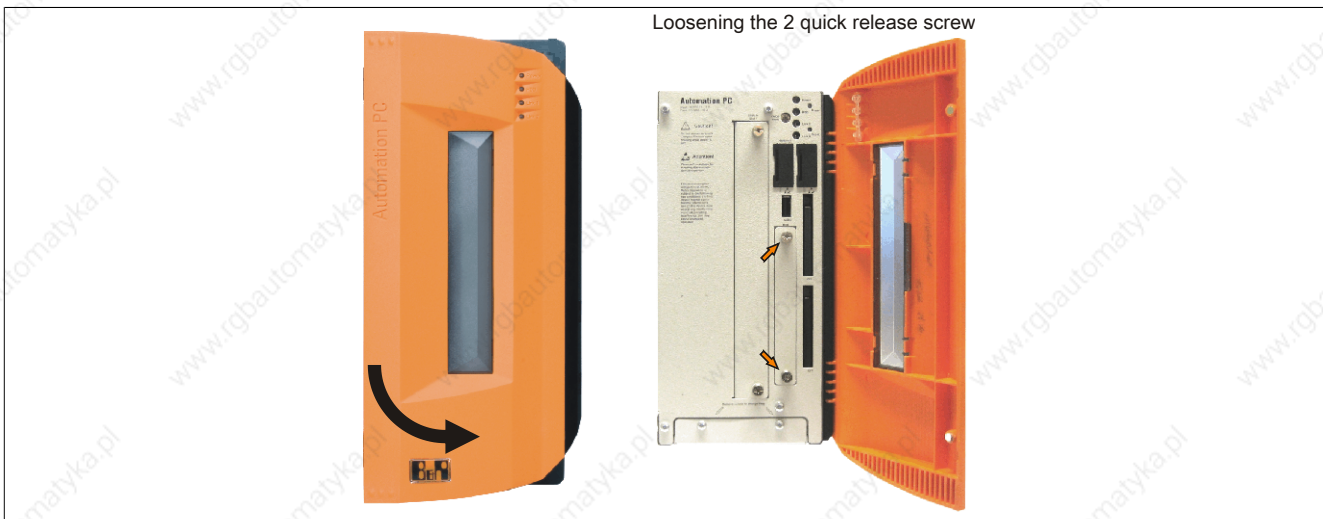

Figure 229: Loosening the quick release screws

2. Insert the compact SATA drive and tighten the quick release screws.



Figure 230: Inserting the compact SATA drive

4 Installing and replacing slide-in drives

Slide-in drives can be installed and replaced in system units with 2, 3 or 5 card slots.

4.1 Procedure

1. Disconnect the power supply to the B&R Industrial PC.
2. Touch the housing or ground connection in order to discharge any electrostatic charge from your body.
3. Remove the dummy slide-in module or slide-in drive by unscrewing the two quick release screws.

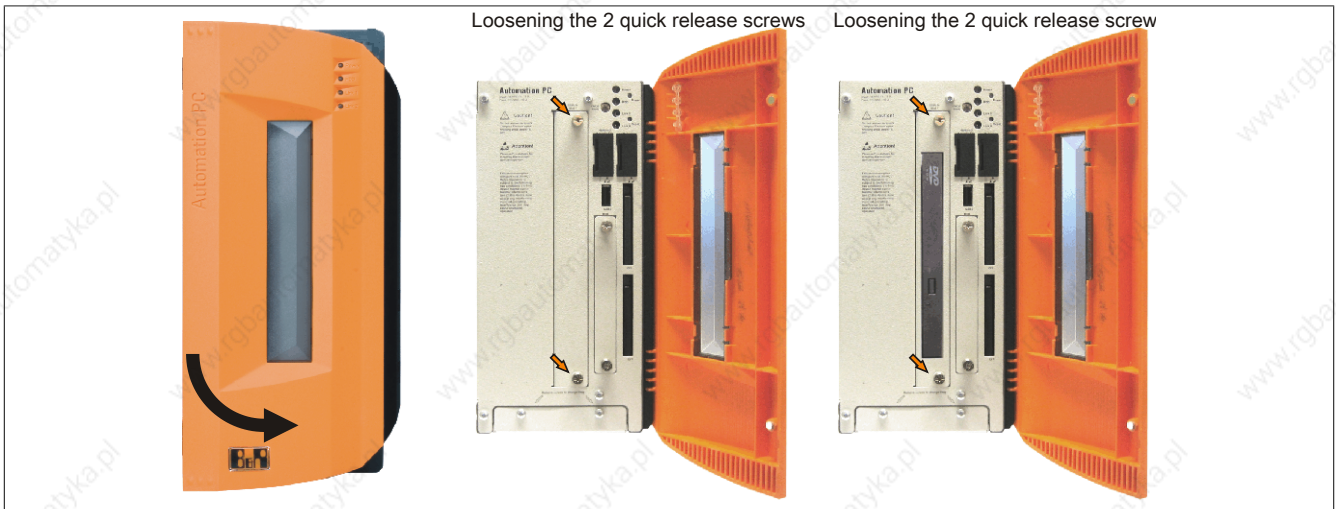

Figure 231: Loosening the quick release screws

4. Insert the slide-in drive and tighten with the two $\frac{1}{4}$ turn screws.



Figure 232: Installing the slide-in drive

5 Installing a slide-in compact adapter

Slide-in compact adapters can be installed and replaced in system units with 2, 3 or 5 card slots. A slide-in compact drive (e.g. slide-in compact HDD) can be installed in a slide-in slot using the slide-in compact adapter.

5.1 Procedure

1. Disconnect the power supply to the B&R Industrial PC.
2. Touch the housing or ground connection in order to discharge any electrostatic charge from your body.
3. Remove the dummy slide-in module or slide-in drive by unscrewing the two quick release screws.



Figure 233: Loosening the quick release screws

4. Insert the slide-in compact adapter and tighten the two quick release screws.



Figure 234: Installing the slide-in compact adapter

5. Once the adapter has been installed, the slide-in compact drive can be inserted.

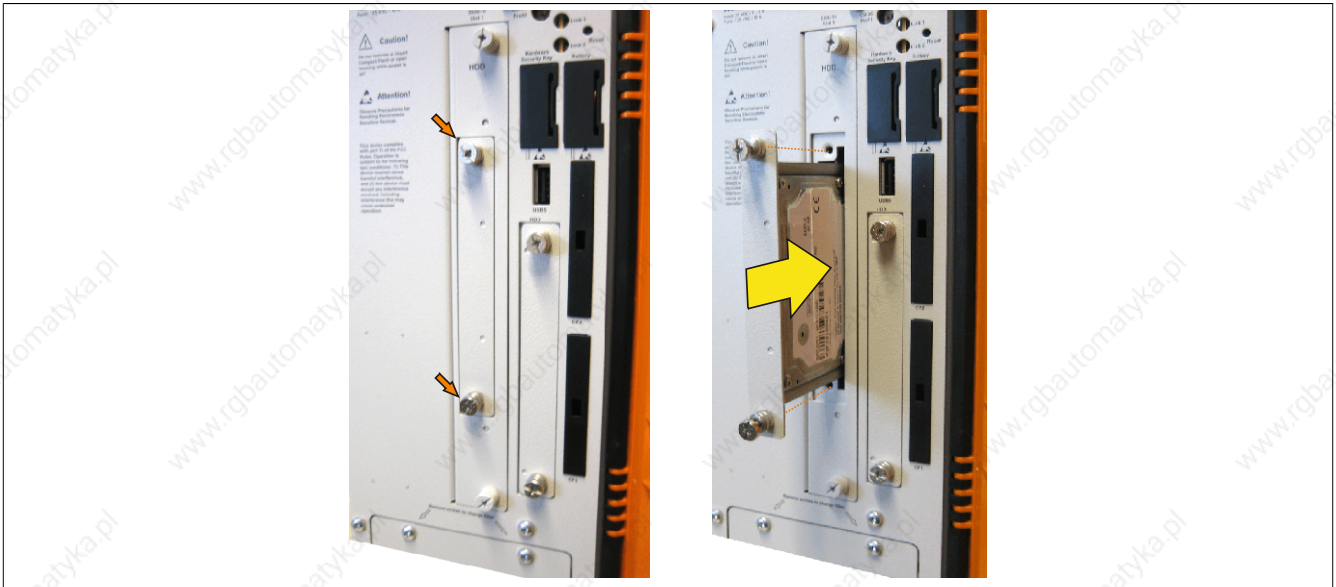

Figure 235: Inserting the slide-in compact drive

6 Installing and replacing fan kits

6.1 Procedure

1. Remove the fan kit cover. Loosen the Torx (T10) screws and slide the cover forward.



Figure 236: Removing the fan kit insert

2. Insert the frame by mounting the contact board side to the sliding contacts on the system unit and fasten using the quick release screws.

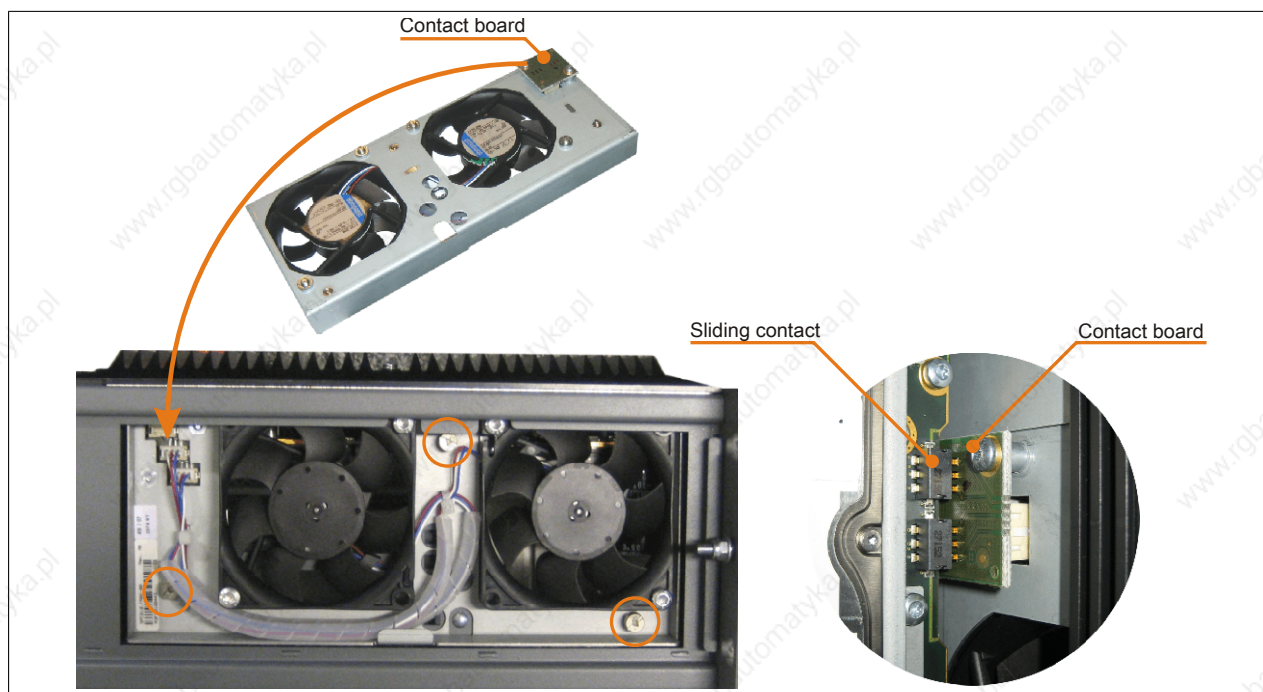

Figure 237: Inserting and fastening the fan kit

3. Place the dust filter in the fan kit cover and secure it with the filter clasp.

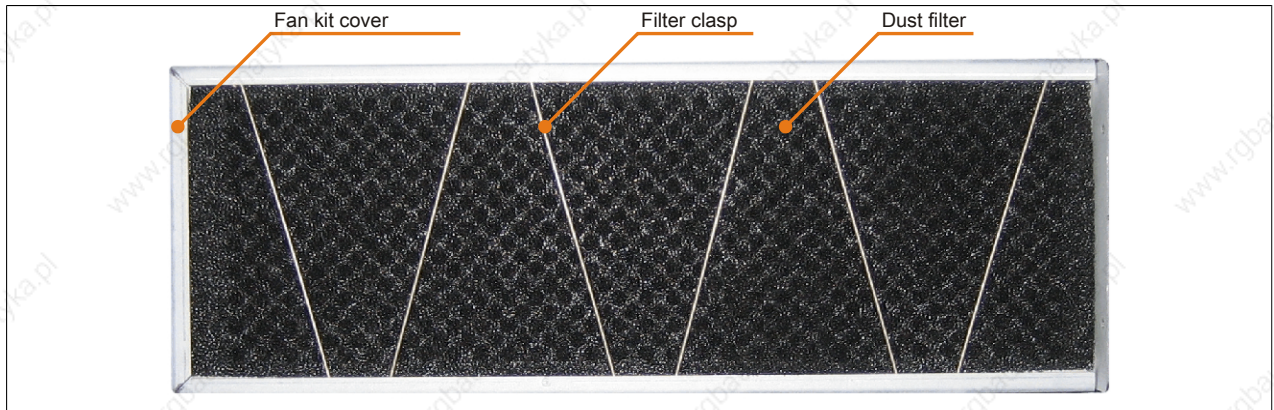

Figure 238: Securing the dust filter with the filter clasp

4. Place the fan kit cover in the housing and fasten using the Torx screws removed earlier.

Information:

The dust filter should be checked regularly depending on the area of use and degree of contamination.

Installation is the same as for all APC810 devices.

7 Installing the UPS module

This module is installed using the materials included in delivery.

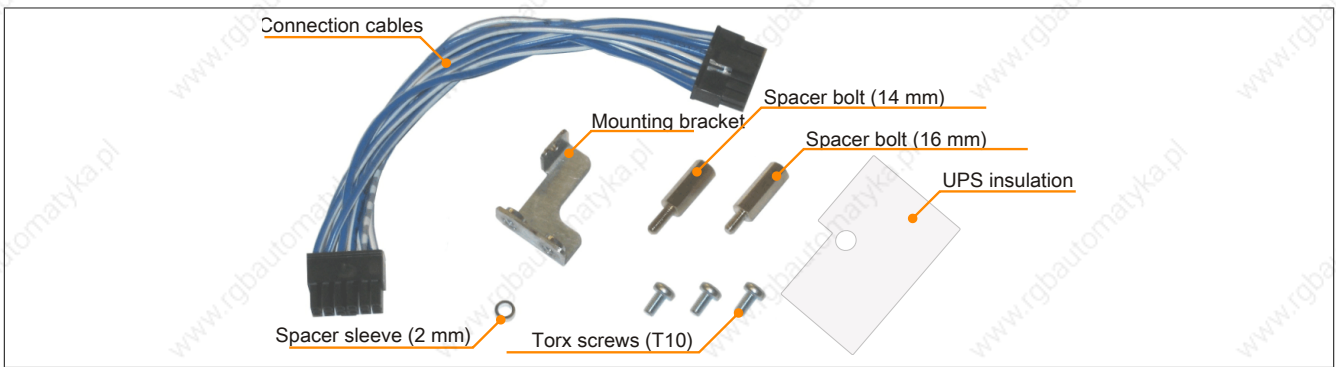

Figure 239: 5AC600. UPSI-00 Add-on UPS module - Installation materials

Installation may vary depending on the system unit variant (1, 2, 3 or 5 card slots) or whether an add-on interface module (IF option) is installed in the APC810.

7.1 Installation without installed add-on interface module

Different parts are used depending on the system unit and whether the add-on interface module is installed or not installed.

7.1.1 1-slot APC810

1. Remove the side cover (see "Installing the side cover" on page 422).
2. Remove the UPS module cover by removing the 2 marked Torx screws (T10).



Figure 240: Removing the UPS module cover

3. Screw in the spacing bolt and spacing ring on the mainboard (using the M5 hex socket screwdriver).

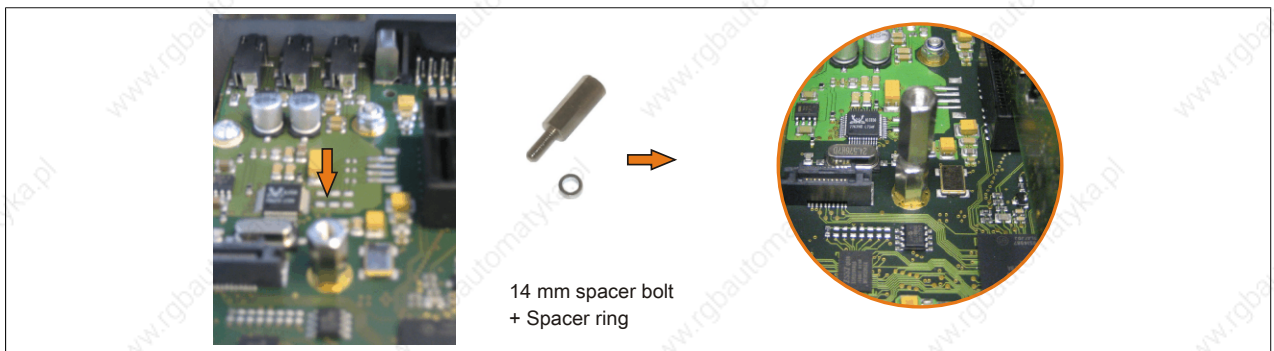

Figure 241: Screwing in the spacing bolt and spacing ring

4. Install the UPS module using 2 Torx screws (T10) on the housing and 1 Torx screw (T10) on the mainboard (spacing bolt). Use the previously removed Torx screws from the mounting materials.

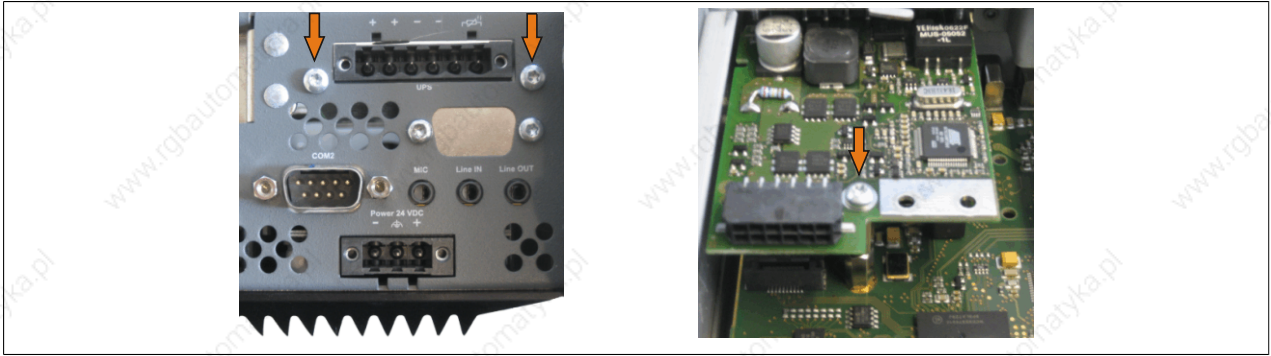

Figure 242: Installing the UPS module

5. Attach the connection cable (see marked female connector).

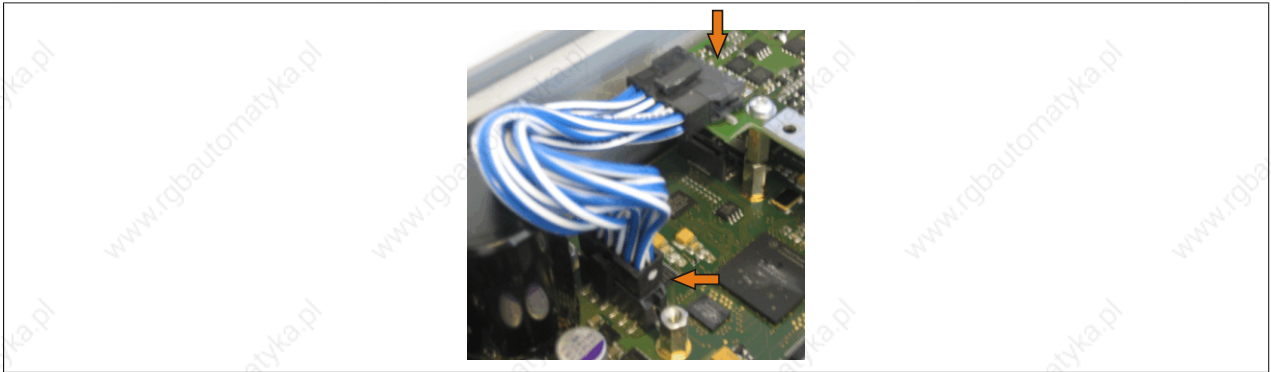

Figure 243: Attaching the connection cable

Information:

When connecting the cable, make sure that the connector locks into place.

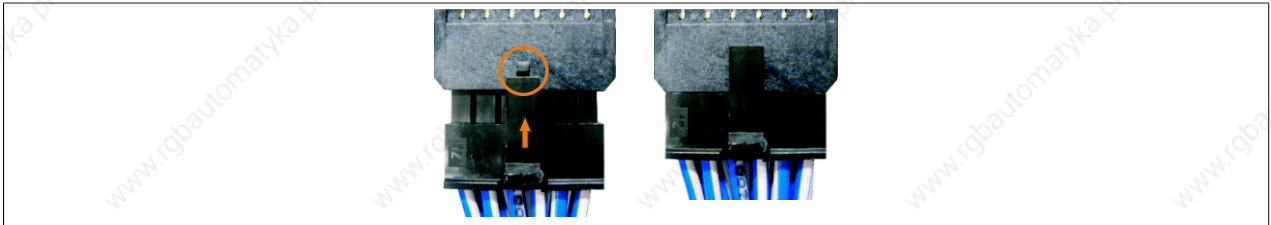

Figure 244: Connector locking mechanism

6. Attach the side cover.

7.1.2 2- and 3-slot APC810

1. Remove the side cover (see "Installing the side cover" on page 422).
2. Remove the UPS module cover by removing the 2 marked Torx screws (T10).

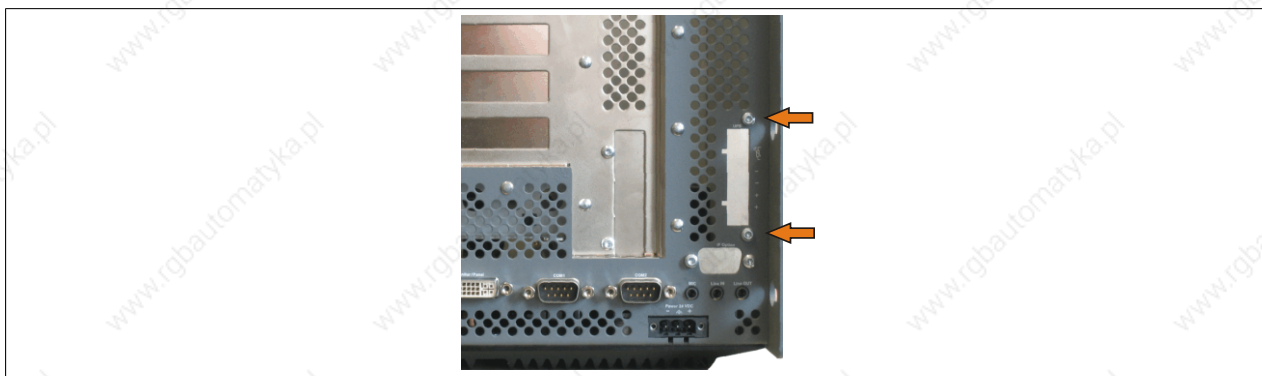

Figure 245: Removing the UPS module cover

3. Screw in the spacing bolt and spacing ring on the mainboard (using the M5 hex socket screwdriver).

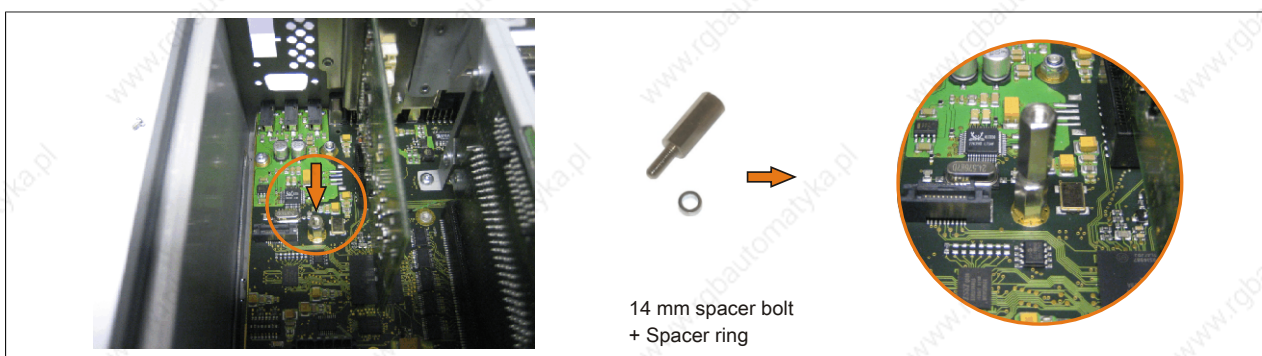

Figure 246: Screwing in the spacing bolt and spacing ring

4. Install the mounting bracket on the UPS module using 2 Torx screws (T10).

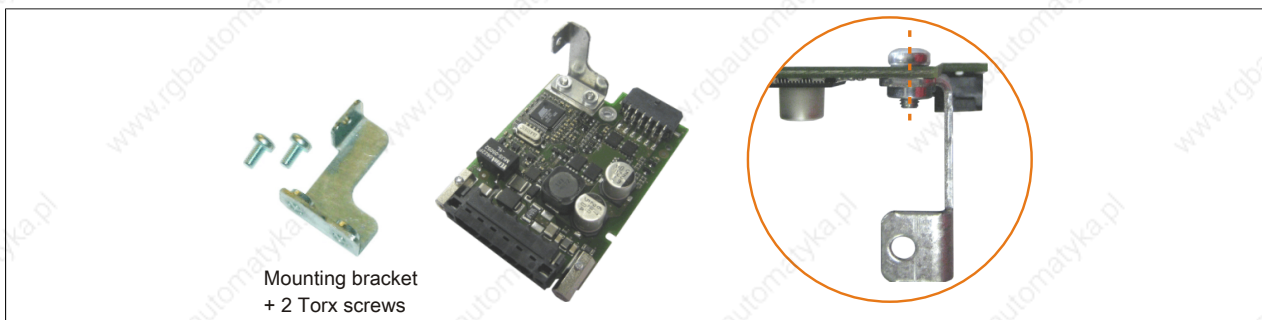

Figure 247: Installing the mounting bracket

5. Install the UPS module using 2 Torx screws (T10) on the housing and 1 Torx screw (T10) on the mainboard (spacing bolt). Use the previously removed Torx screws from the mounting materials.

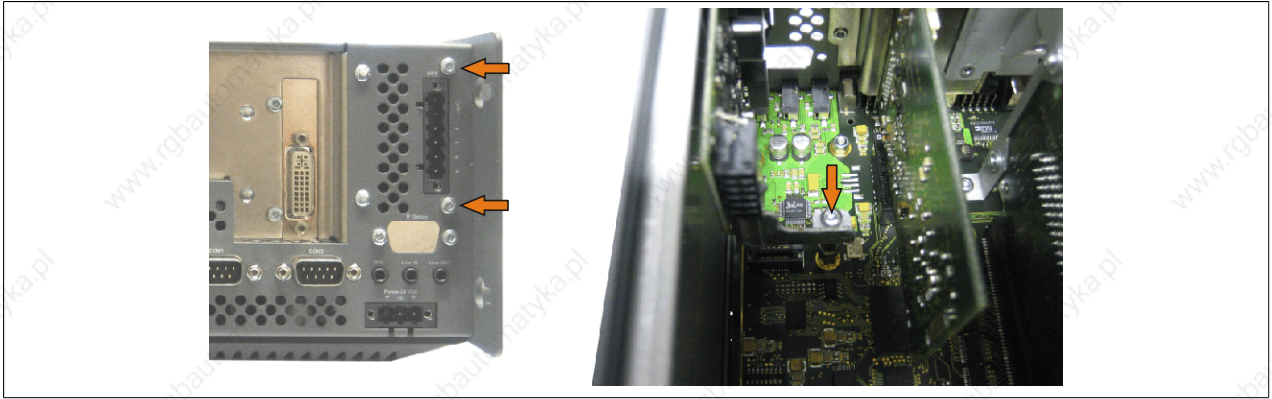

Figure 248: Installing the UPS module

6. Attach the connection cable (see marked female connector).

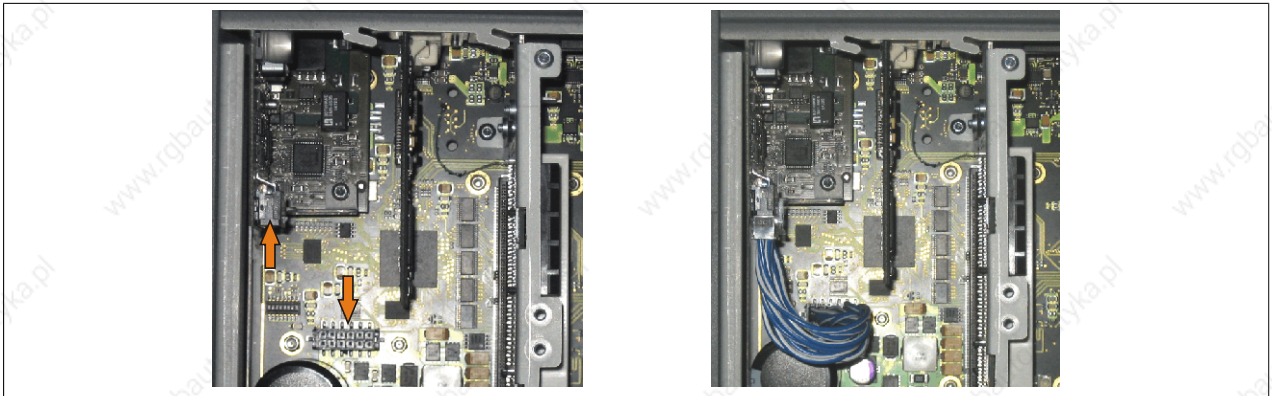

Figure 249: Attaching the connection cable

Information:

When connecting the cable, make sure that the connector locks into place.

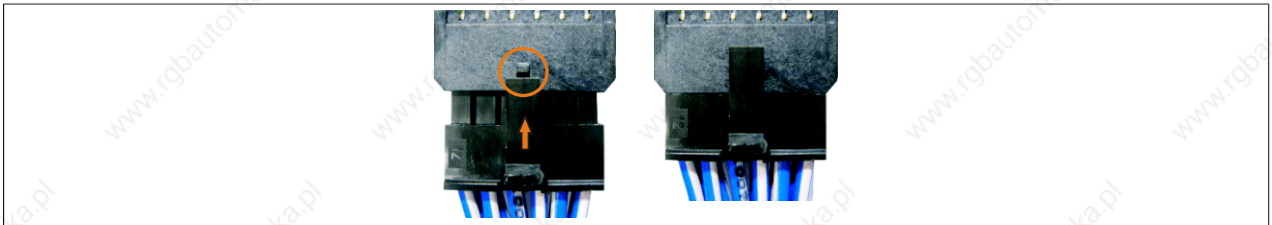

Figure 250: Connector locking mechanism

7. Attach the side cover.

7.1.3 5-slot APC810

1. Remove the side cover (see "Installing the side cover" on page 422).
2. Remove the UPS module cover by removing the 2 marked Torx screws (T10).

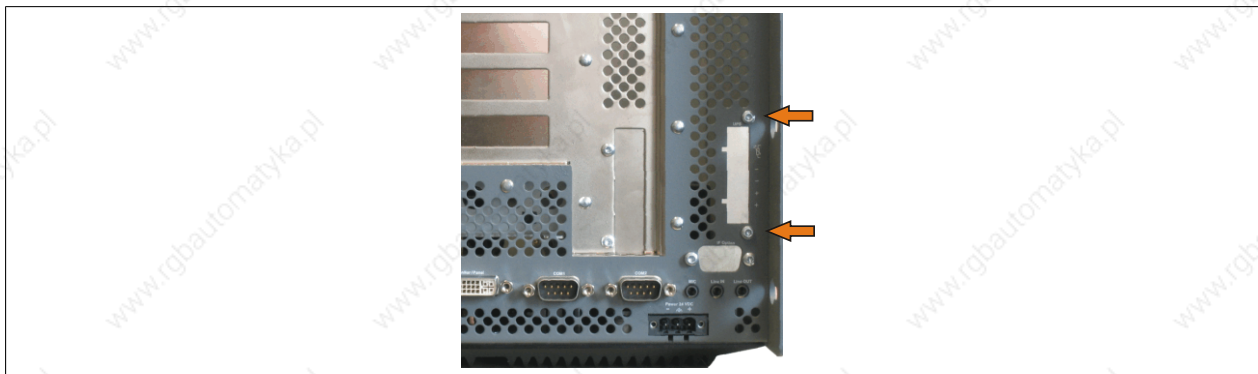

Figure 251: Removing the UPS module cover

3. Screw in spacing bolt and spacing ring (using M5 hex socket screwdriver).

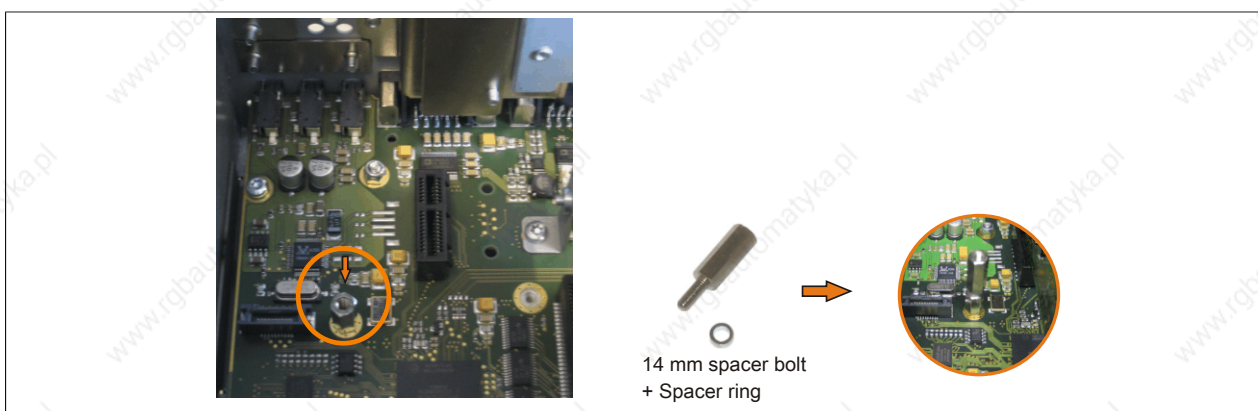

Figure 252: Screwing in the spacing bolt and spacing ring

4. Install the mounting bracket on the UPS module using 2 Torx screws (T10).

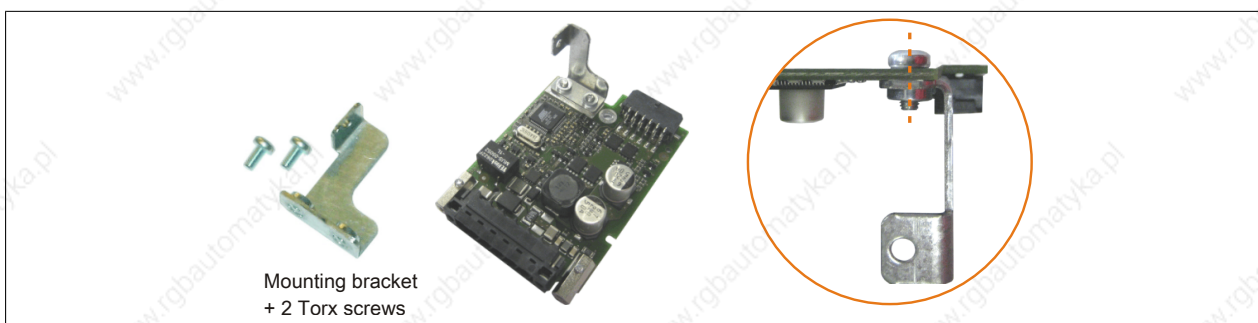

Figure 253: Installing the mounting bracket

5. Install the UPS module using 2 Torx screws (T10) on the housing and 1 Torx screw (T10) on the mainboard (spacing bolt). Use the previously removed Torx screws from the mounting materials.

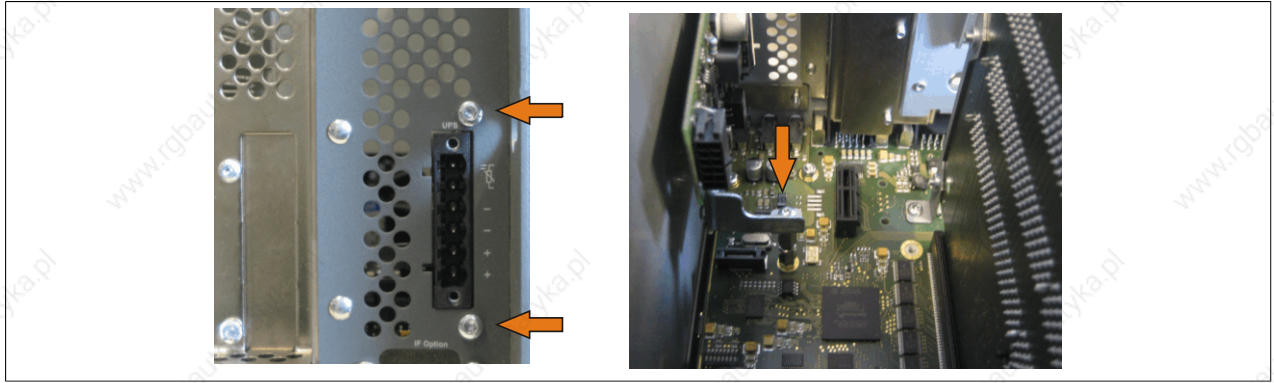

Figure 254: Installing the UPS module

6. Attach the connection cable (see the marked female connector).

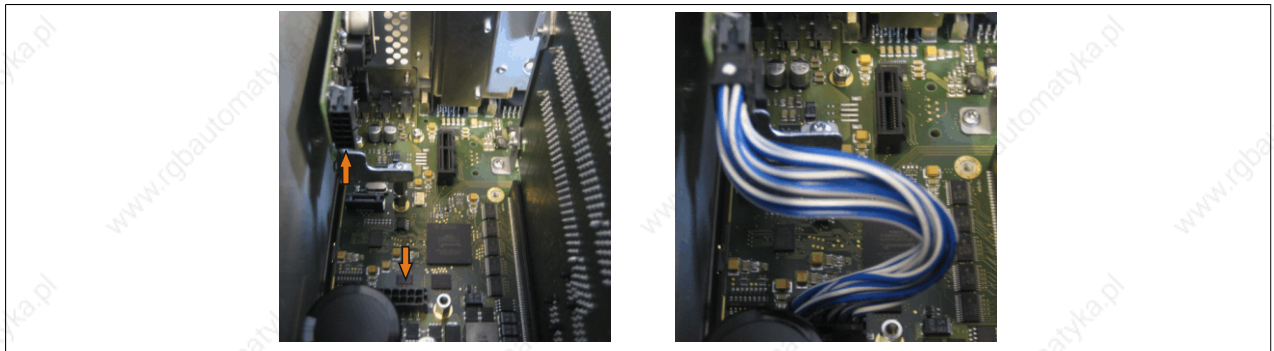

Figure 255: Attaching the connection cable

Information:

When connecting the cable, make sure that the connector locks into place.

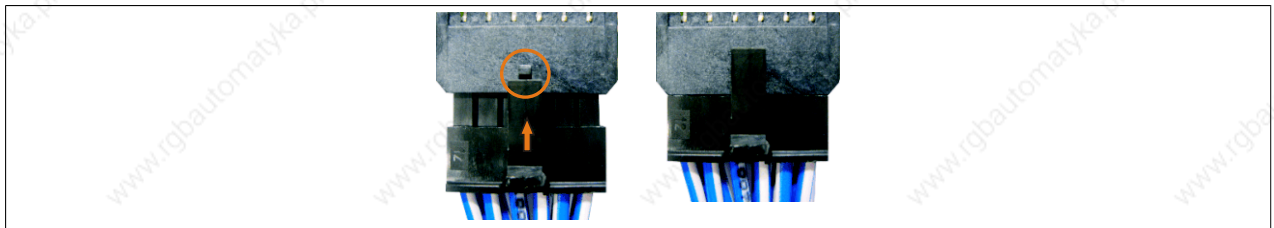

Figure 256: Connector locking mechanism

7. Attach the side cover.

7.2 Installation with installed add-on interface module

7.2.1 1-slot APC810

1. Remove the side cover (see "Installing the side cover" on page 422).
2. Remove the UPS module cover by removing the 2 marked Torx screws (T10).



Figure 257: Removing the UPS module cover

3. Screw in the spacing bolt (using the M5 hex socket screwdriver).

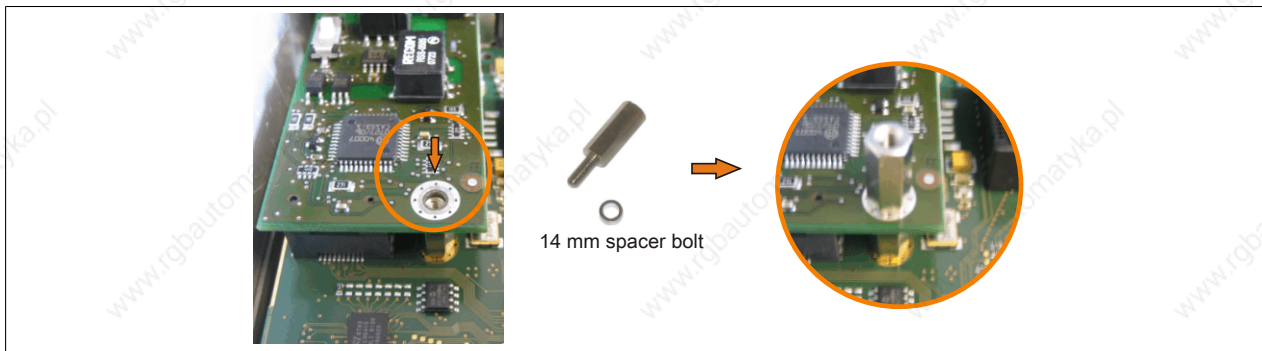

Figure 258: Screwing in the spacing bolt

4. Install the UPS module using 3 Torx screws (T10). Use the previously removed Torx screws and one Torx screw from the installation material.

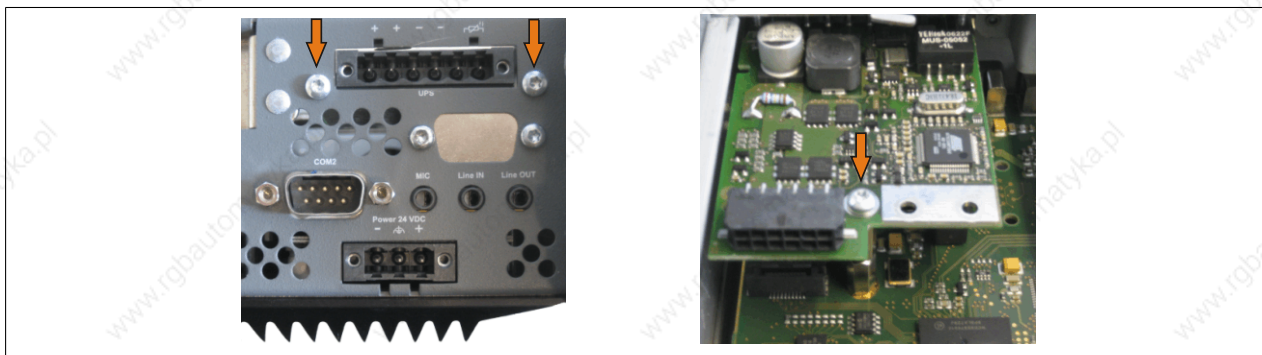

Figure 259: Installing the UPS module

5. Attach the connection cable (see marked female connector).

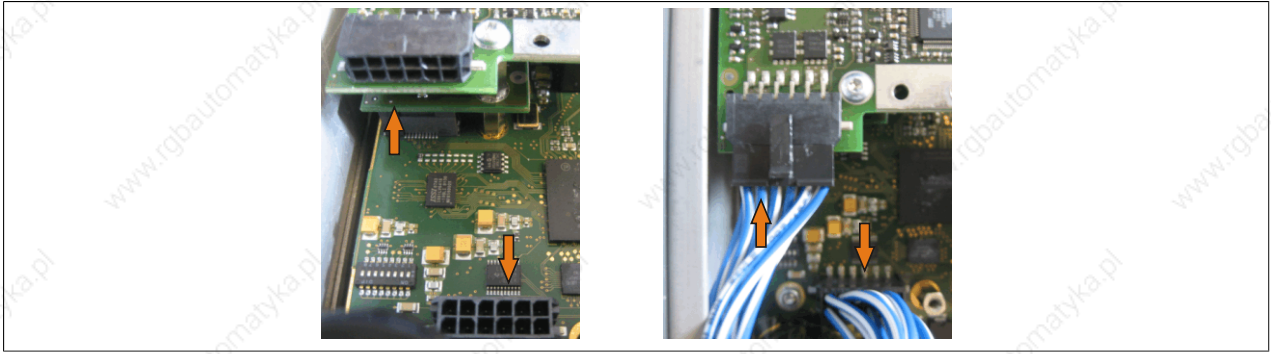

Figure 260: Attaching the connection cable

Information:

When connecting the cable, make sure that the connector locks into place.

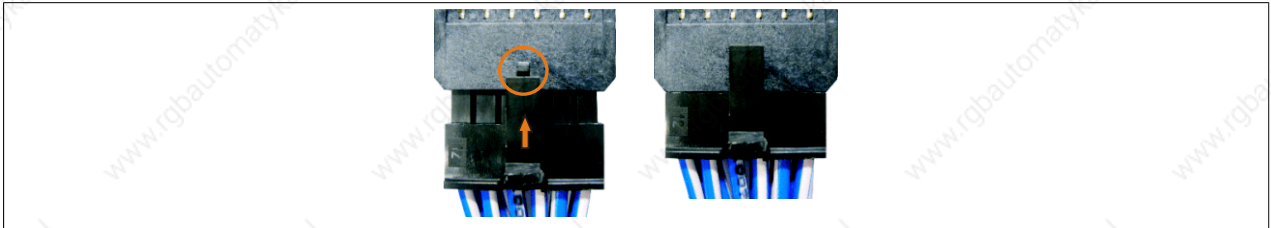

Figure 261: Connector locking mechanism

6. Attach the cover plate and side cover.

7.2.2 2- and 3-slot APC810

1. Remove the side cover (see "Installing the side cover" on page 422).
2. Remove the UPS module cover by removing the 2 marked Torx screws (T10).

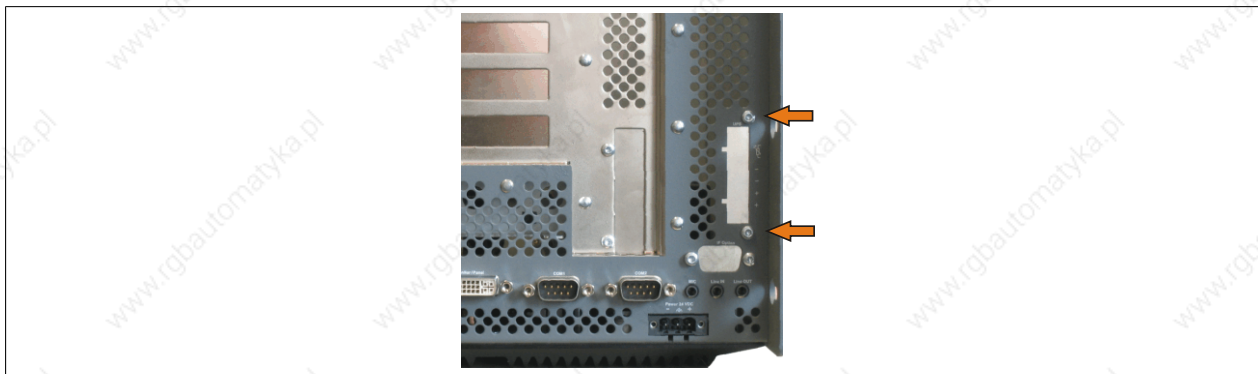

Figure 262: Removing the UPS module cover

3. Screw in the spacing bolt (using the M5 hex socket screwdriver).

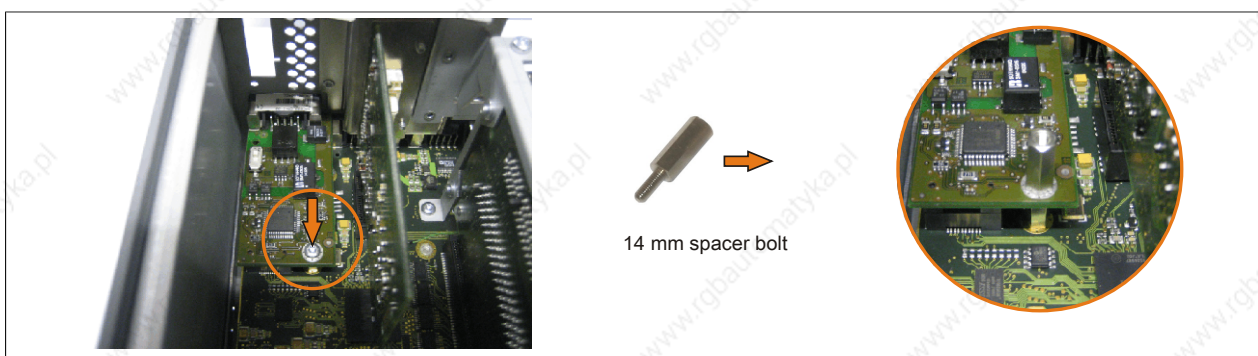

Figure 263: Screwing in the spacing bolt

4. Install the mounting bracket on the UPS module using 2 Torx screws (T10).

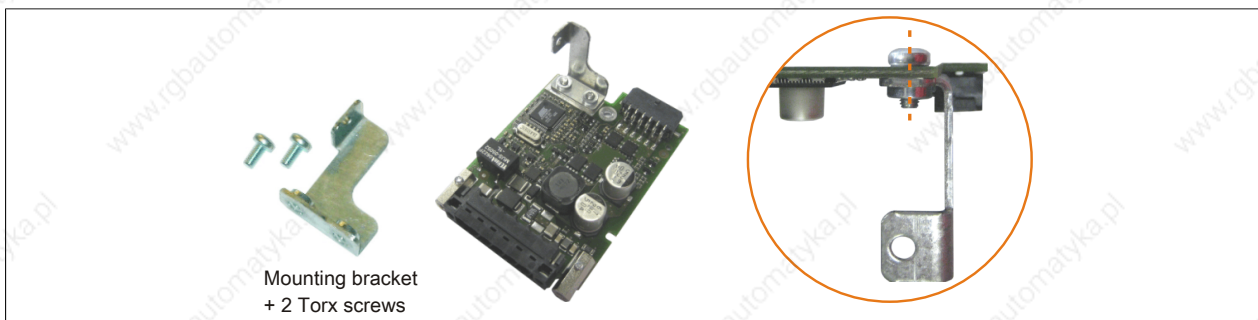

Figure 264: Installing the mounting bracket

5. Install the UPS module using 3 Torx screws (T10). Use the previously removed Torx screws and one Torx screw from the installation material.

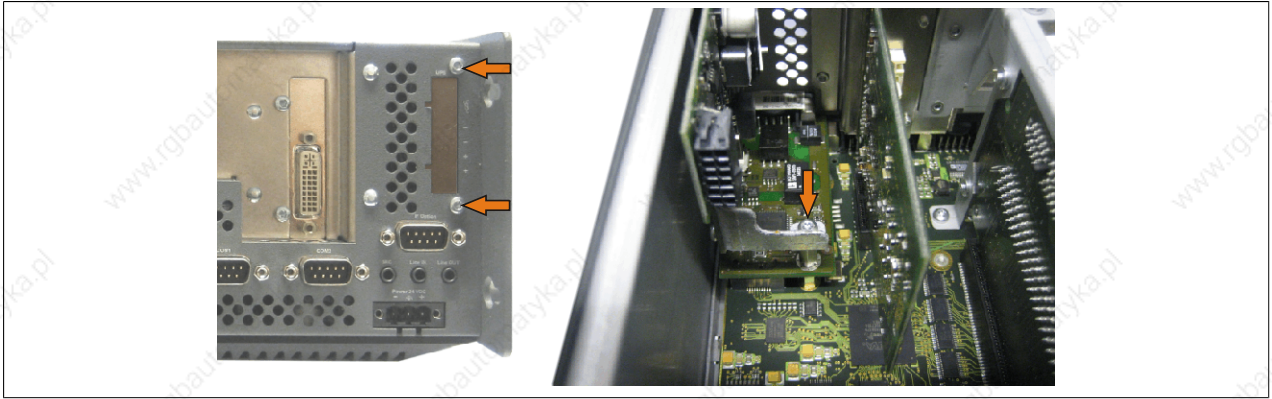

Figure 265: Installing the UPS module

6. Attach the connection cable (see marked female connector).

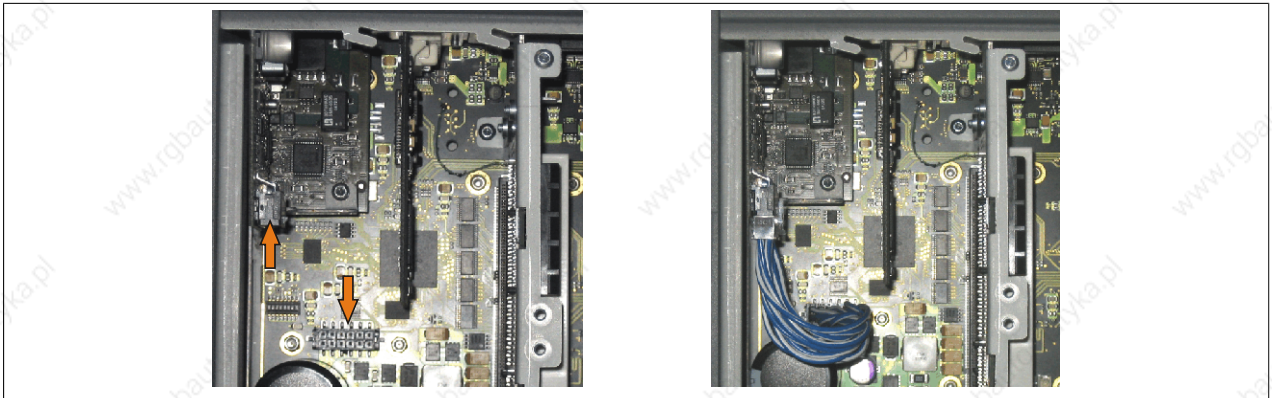

Figure 266: Attaching the connection cable

Information:

When connecting the cable, make sure that the connector locks into place.

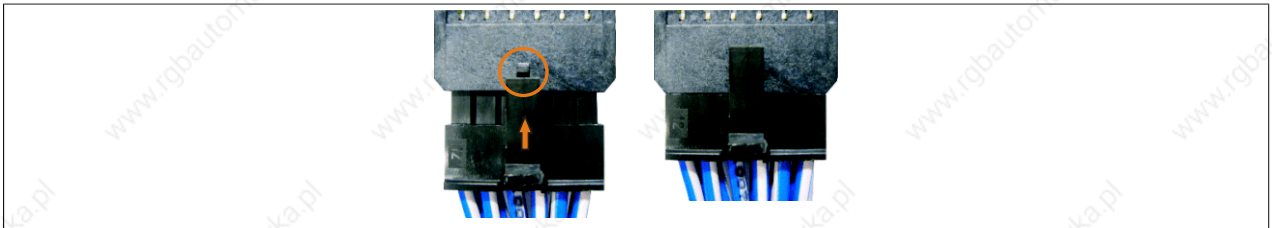

Figure 267: Connector locking mechanism

7. Attach the cover plate and side cover.

7.2.3 5-slot APC810

1. Remove the side cover (see "Installing the side cover" on page 422).
2. Remove the UPS module cover by removing the 2 marked Torx screws (T10).

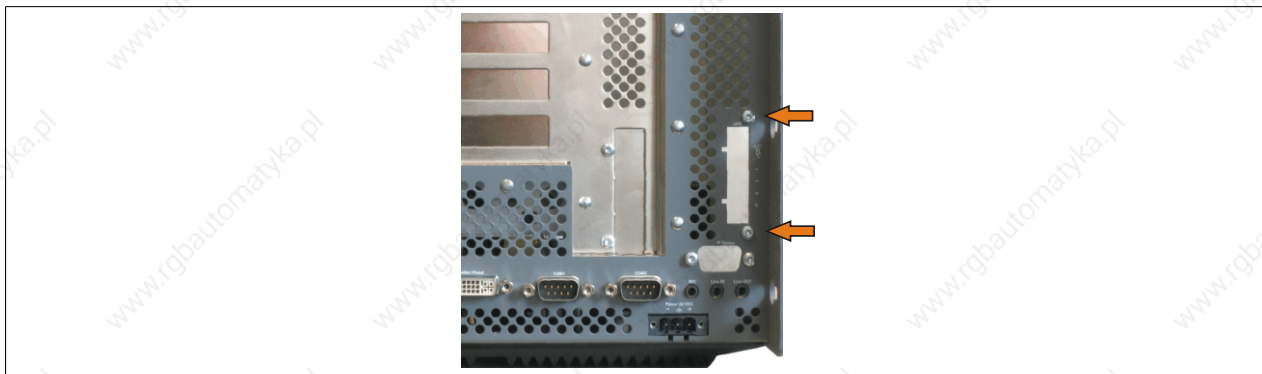

Figure 268: Removing the UPS module cover

3. Screw in the spacing bolt (using the M5 hex socket screwdriver).

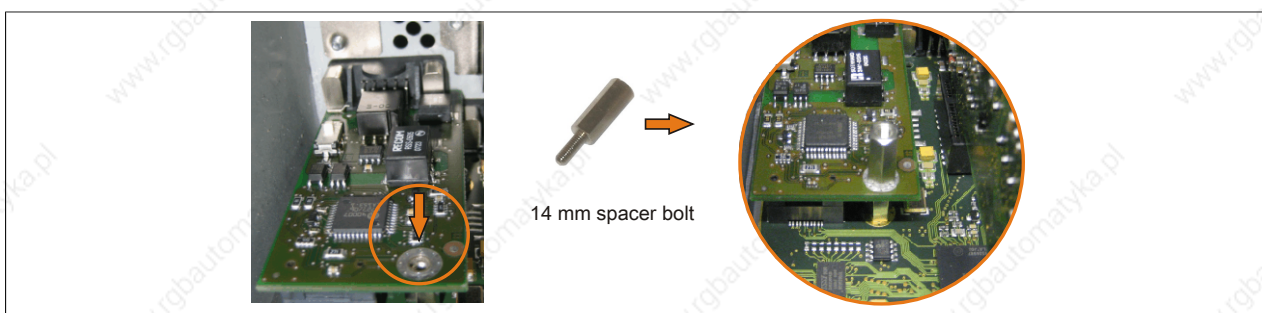

Figure 269: Screwing in the spacing bolt

4. Install the mounting bracket on the UPS module using 2 Torx screws (T10).

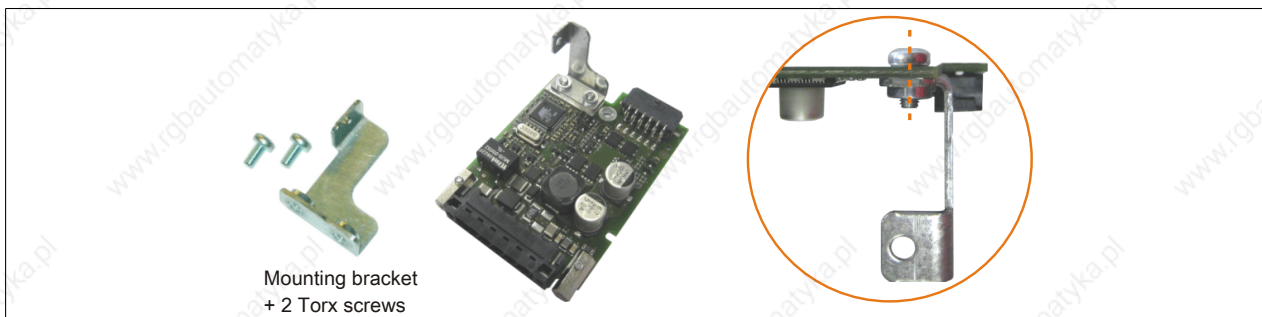

Figure 270: Installing the mounting bracket

5. Install the UPS module using 3 Torx screws (T10). Use the previously removed Torx screws and one Torx screw from the installation material.

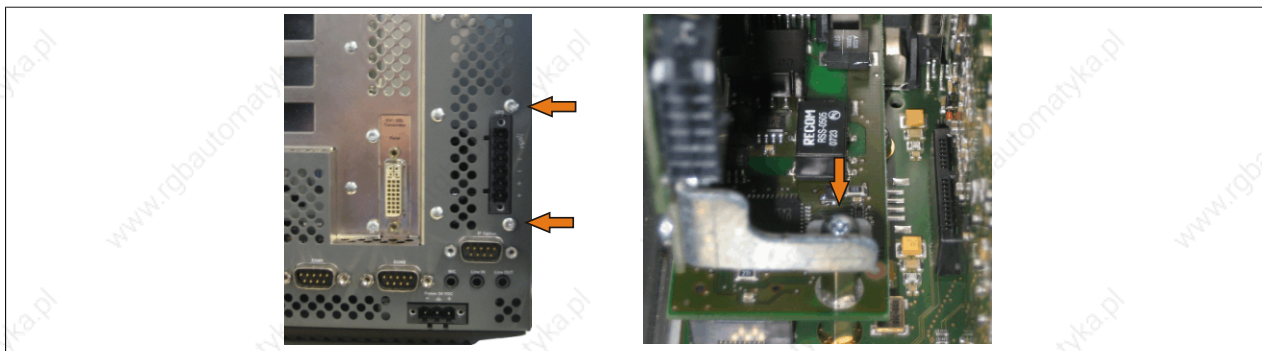

Figure 271: Installing the UPS module

6. Attach the connection cable (see marked female connector).

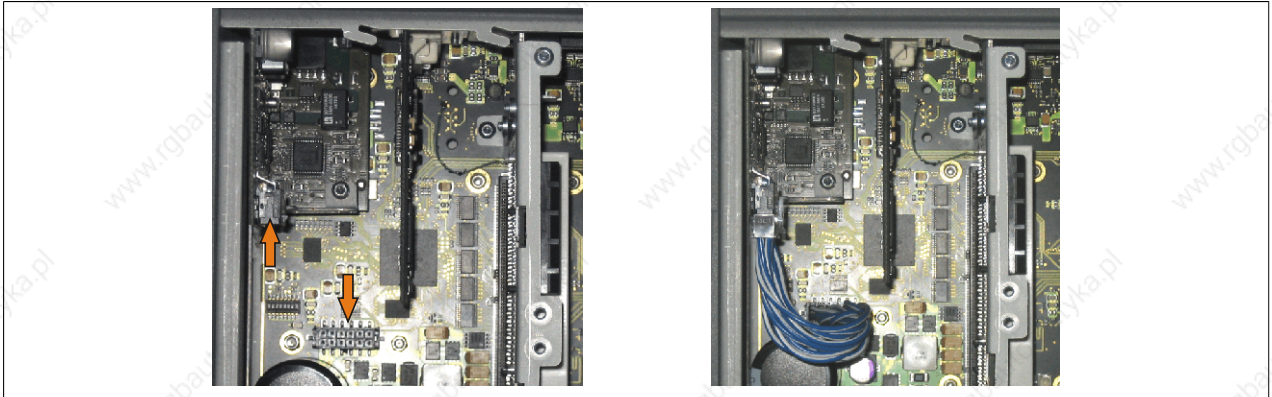

Figure 272: Attaching the connection cable

Information:

When connecting the cable, make sure that the connector locks into place.

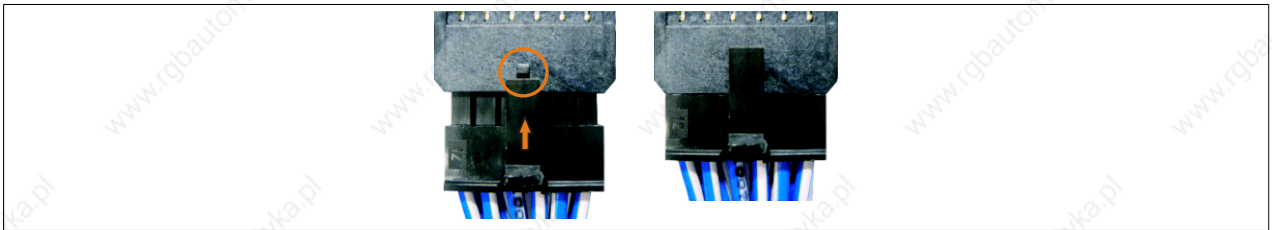

Figure 273: Connector locking mechanism

7. Attach the cover plate and side cover.

8 Installing the UPS fuse kit on the battery unit

Information:

The 5AC600.UPSF-00 UPS fuse kit is only needed for battery units up to and including revision D0. A 25 A fuse is integrated on the connector circuit board beginning with revision E0.

8.1 Procedure

1. Power to the 5AC600.UPSB-00 battery unit must be disconnected by unplugging the UPS connection cable from the B&R Industrial PC.
2. Remove the cover on the battery unit. This is done by unscrewing the two Torx screws (T10) so that the cover can be removed by sliding it towards the orange connector.



Figure 274: Removing the cover for the battery unit

3. To install the fuse, the red cable must be disconnected from the battery circuit board.



Figure 275: Disconnecting the cable

- The male fuse kit connector must be connected to the female connector on the red cable (1). The female fuse kit connector must be connected to the male connector on the battery circuit board (2).

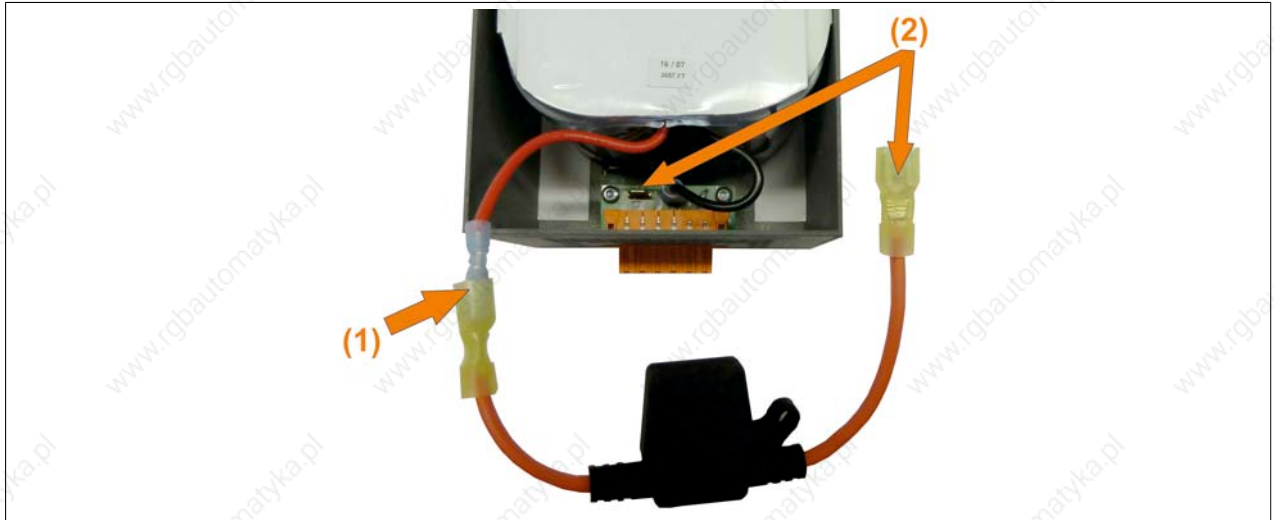

Figure 276: Connecting the fuse

- The fuse can then be secured in the battery unit.



Figure 277: Securing the fuse

- The cover for the battery unit can now be reattached. Insert the clips on the cover into the notch on the battery unit and tighten down the cover with the Torx screws removed previously.
- Reconnect the 5AC600.UPSB-00 battery unit to the B&R Industrial PC.

9 Installing the side cover

The side cover can be easily removed by loosening the Torx (T10) screws. The number of Torx screws can vary depending on the system.

9.1 1-slot APC810

1. Disconnect the power supply to the Automation PC 810.
2. Touch the housing or ground connection in order to discharge any electrostatic charge from your body.
3. Open the orange front cover. The Combi-Torx screws (T10) behind the cover that are marked in the image must then be removed.
4. After the screws have been removed, the side cover can be removed by sliding it toward the front.



Figure 278: 1-slot APC810 - Installing the side cover

9.2 2- and 3-slot APC810

1. Disconnect the power supply to the Automation PC 810.
2. Touch the housing or ground connection in order to discharge any electrostatic charge from your body.
3. Open the orange front cover. The Combi-Torx screws (T10) behind the cover that are marked in the image must then be removed.
4. After the screws have been removed, the side cover can be removed by sliding it toward the front.



Figure 279: 2-slot APC810 - Installing the side cover

9.3 5-slot APC810

1. Disconnect the power supply to the Automation PC 810.
2. Touch the housing or ground connection in order to discharge any electrostatic charge from your body.
3. Open the orange front cover. The Combi-Torx screws (T10) behind the cover that are marked in the image must then be removed.
4. After the screws have been removed, the side cover can be removed by sliding it toward the front.



Figure 280: 5-slot APC810 - Installing the side cover

10 AP Link installation

10.1 Procedure

1. Remove the side cover (see "Installing the side cover" on page 422).
2. Remove the AP Link module cover by removing the 2 marked Torx screws (T10).

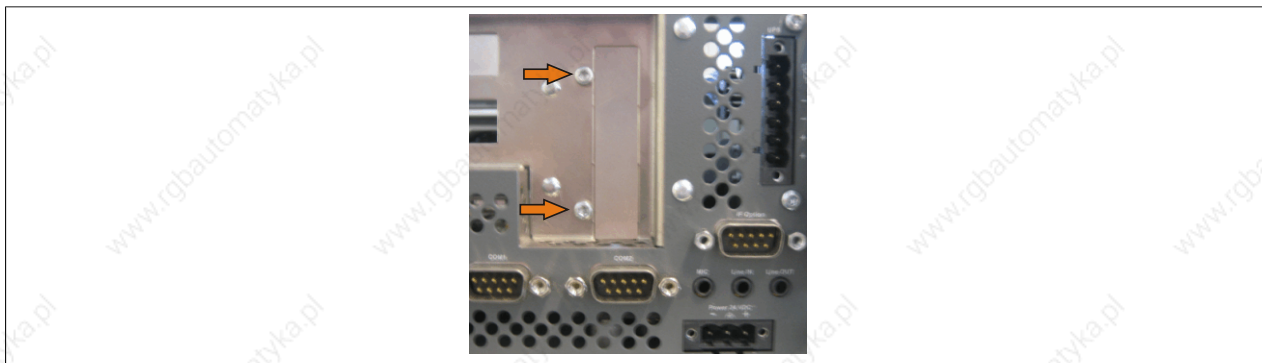

Figure 281: Removing the AP Link module cover

3. Insert the AP Link card in the appropriate slot.

Warning!

When inserting the AP Link card, be sure to push it all the way into the AP Link slot.

Do not force the card into the slot.

4. Install the AP Link module using 3 Torx screws (T10). Use the previously removed Torx screws and an additional Torx screw from the installation material.

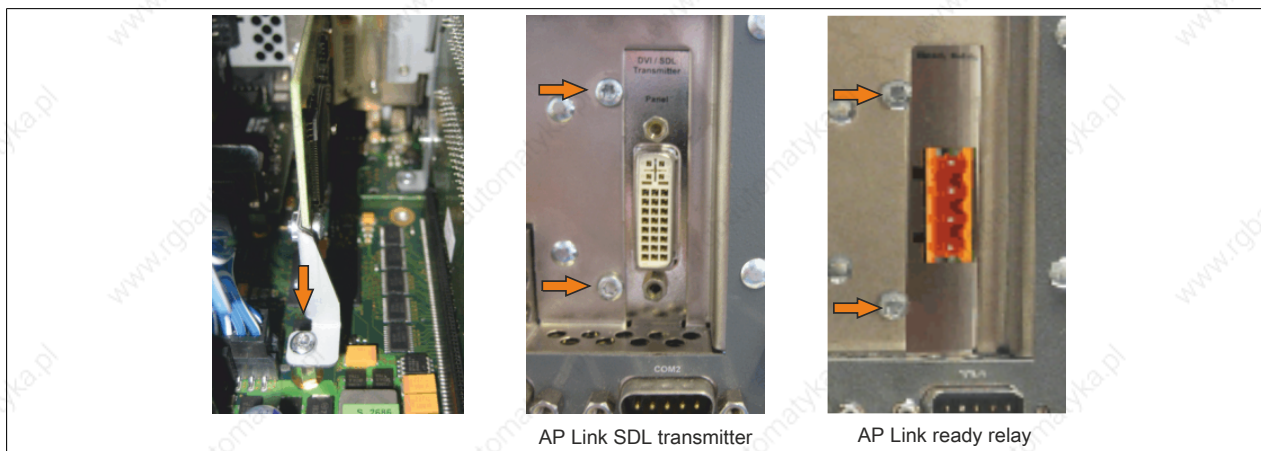

Figure 282: Installing the AP Link module

5. Attach the cover plate and side cover.

11 Replacing a PCI SATA RAID hard disk in a RAID 1 set

This example assumes that the secondary hard disk (HDD1) is defective in a RAID 1 configuration. In such a case, the defective hard disk can be replaced by the replacement drive SATA hard disk.

Model number of PCI SATA RAID controller	Model number of required replacement SATA HDD	Note
5ACPCI.RAIC-01	5ACPCI.RAIC-02	60 GB hard disk
5ACPCI.RAIC-03	5ACPCI.RAIC-04	160 GB hard disk
5ACPCI.RAIC-05	5MMHDD.0250-00	250 GB hard disk
5ACPCI.RAIC-06	5MMHDD.0500-00	500 GB hard disk

Table 320: Overview of required replacement SATA HDD for PCI SATA HDD RAID controller

A size 10 Torx screwdriver is needed to replace the hard disk.

11.1 Procedure

1. Disconnect the power supply.
2. Touch the housing or ground connection in order to discharge any electrostatic charge from your body.
3. Remove the side cover.
4. Remove the SATA RAID insert.
5. Loosen the 4 appropriate fastening screws (M3x5).

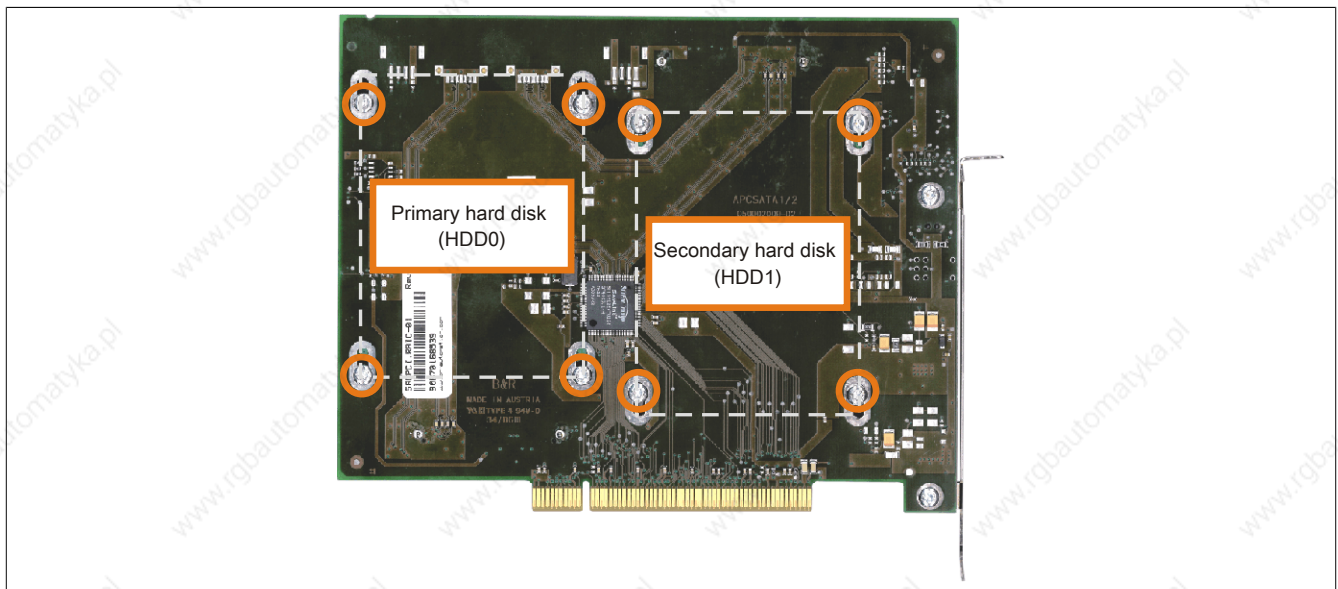

Figure 283: Screw layout on the back side of the 5ACPCI.RAIC-03 SATA RAID controller

6. On the front side, slide the hard disk down and away (Replacing the hard disk - left image).
7. Insert the new hard disk carefully into the connector (Replacing the hard disk - right image), being careful to only touch it on the front, not on the top.

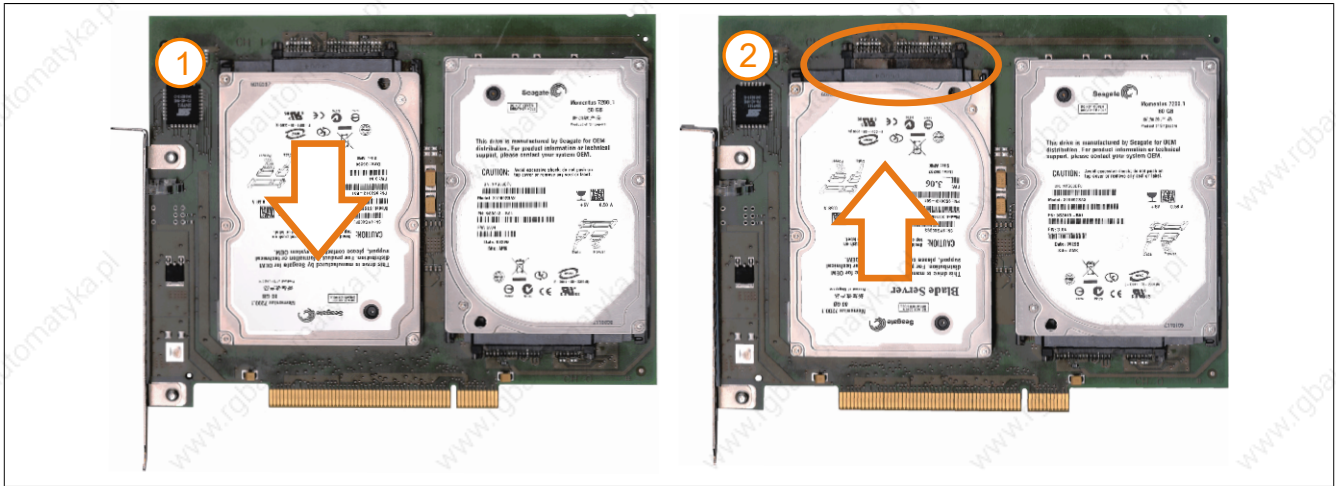

Figure 284: Replacing the hard disk

8. Re-secure the hard disk using the 4 fastening screws (M3x5) used earlier.
9. Reassemble the device in the reverse order.
10. An error message is output by the RAID BIOS after starting the system "RAID1 set is in Rebuild status. The rebuild will continue after boot sequence is complete".
11. A rebuild can be performed immediately in SATA RAID BIOS or once the PC has booted - see "Rebuild mirrored set" on page 225.

12 Installing the HDD replacement disk tray

12.1 Procedure

1. Remove the side cover (see "Installing the side cover" on page 422).
2. Insert the replacement HDD in the replacement disk tray and fasten using the quick release screws.



Figure 285: Inserting the replacement hard disk in the replacement disk tray

3. Attach the HDD replacement disk tray to the ventilation slots on the side of the APC810 housing using the hooks provided.
4. Affix to the inside of the side cover by lightly bending the hooks with a suitable tool (e.g. universal pliers).

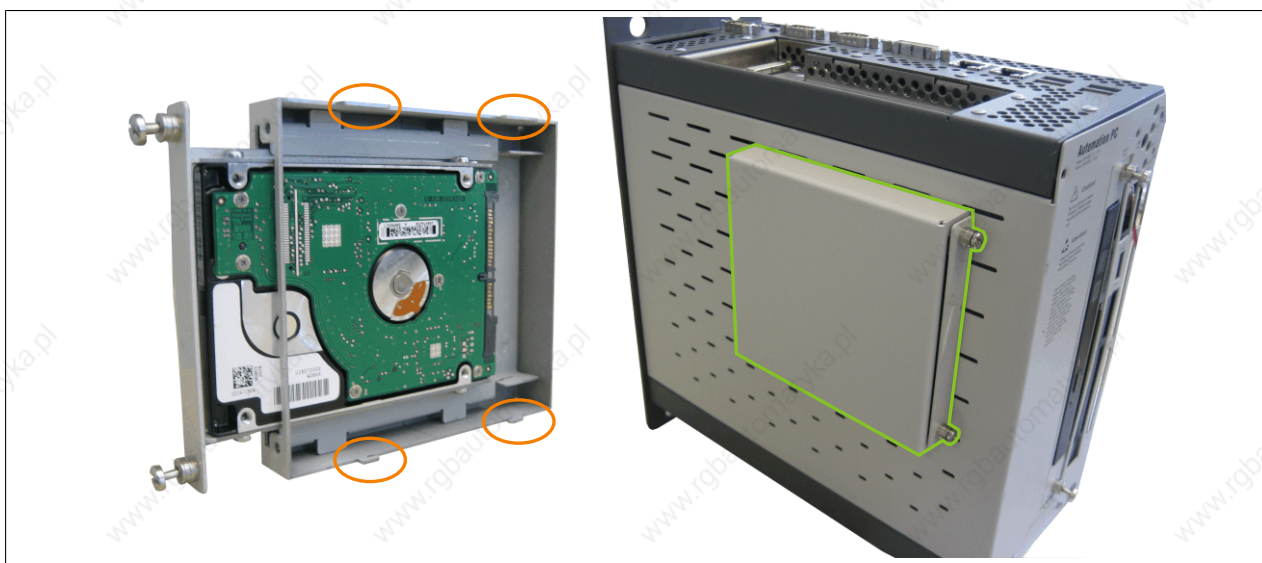

Figure 286: Installing the replacement disk tray in the APC810

5. Attach the side cover.

13 Installing the ready relay /2 in the add-on UPS slot

13.1 Procedure

1. Remove the side cover (see section 9 "Installing the side cover" on page 422).
2. Remove the UPS module cover or mounted UPS by loosening the 2 marked Torx screws (T10).

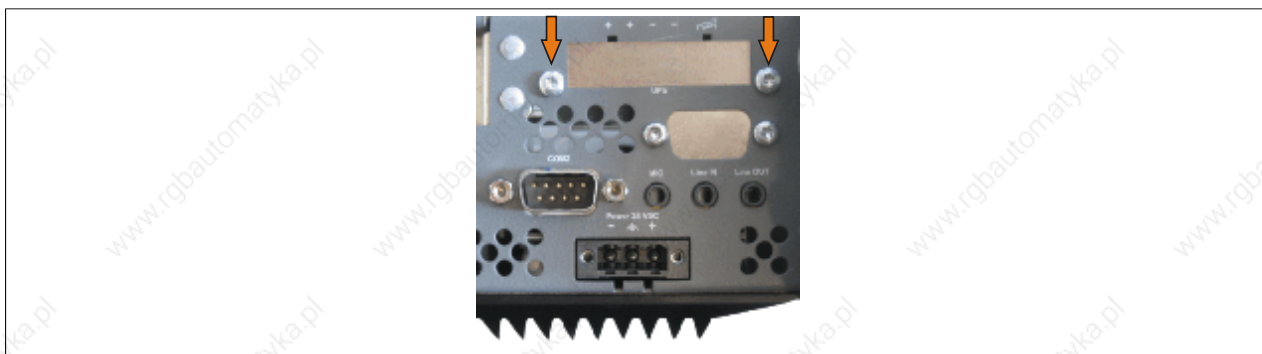

Figure 287: Removing the UPS module cover

3. Attach the spacing bolt and spacing ring (if not already mounted from the UPS) on the mainboard (using the size 5 hex screwdriver). The 14 mm spacing bolt must be used for APC810 system units 5PC810.SX01-00, 5PC810.SX02-00 and 5PC810.SX03-00. The 16 mm spacing bolt must be used for the 5PC810.SX05-00 system unit.

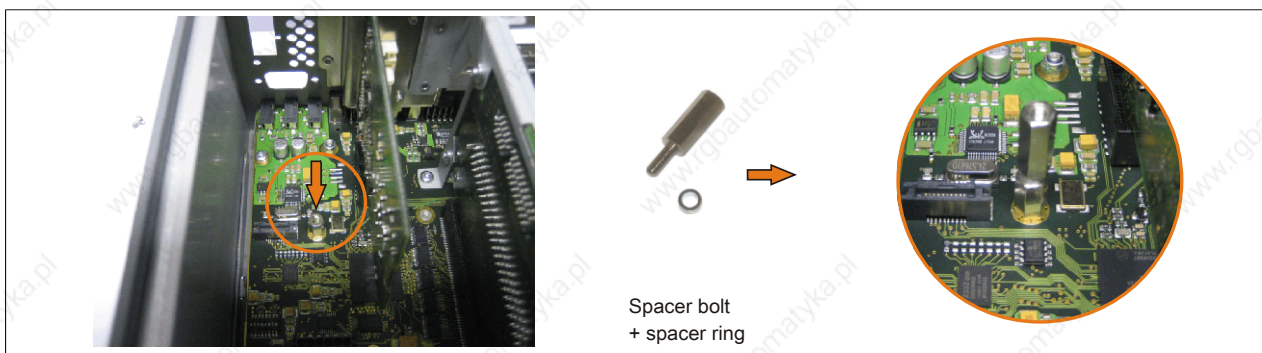

Figure 288: Screwing in the spacing bolt and spacing ring

4. Install the ready relay with 2 Torx screws (T6) and the mounting bracket on the housing with 1 Torx screw (T6) on the mainboard (spacing bolt).

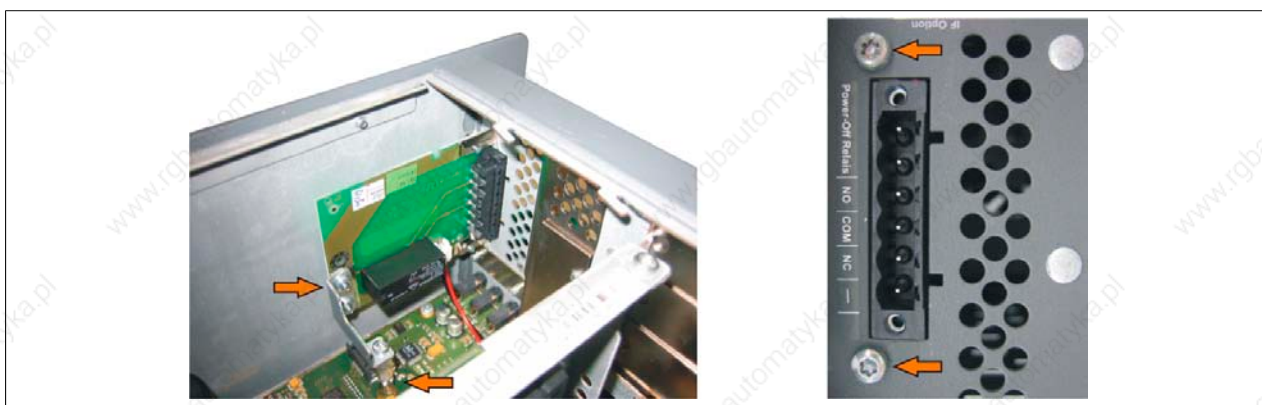

Figure 289: Installing the ready relay

5. Attach the connection cable.

Information:

When connecting the internal supply voltage cable, make sure that the connector locks into place.

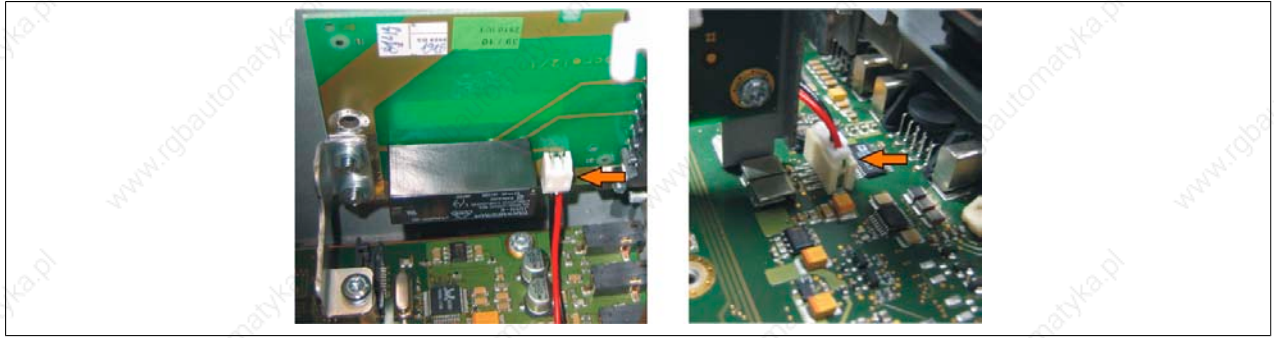

Figure 290: Attaching the connection cable

6. Attach the side cover.

Appendix A

1 Maintenance Controller Extended (MTCX)

The MTCX controller (FPGA processor) is located on the mainboard (part of every system unit) of the APC810 device.

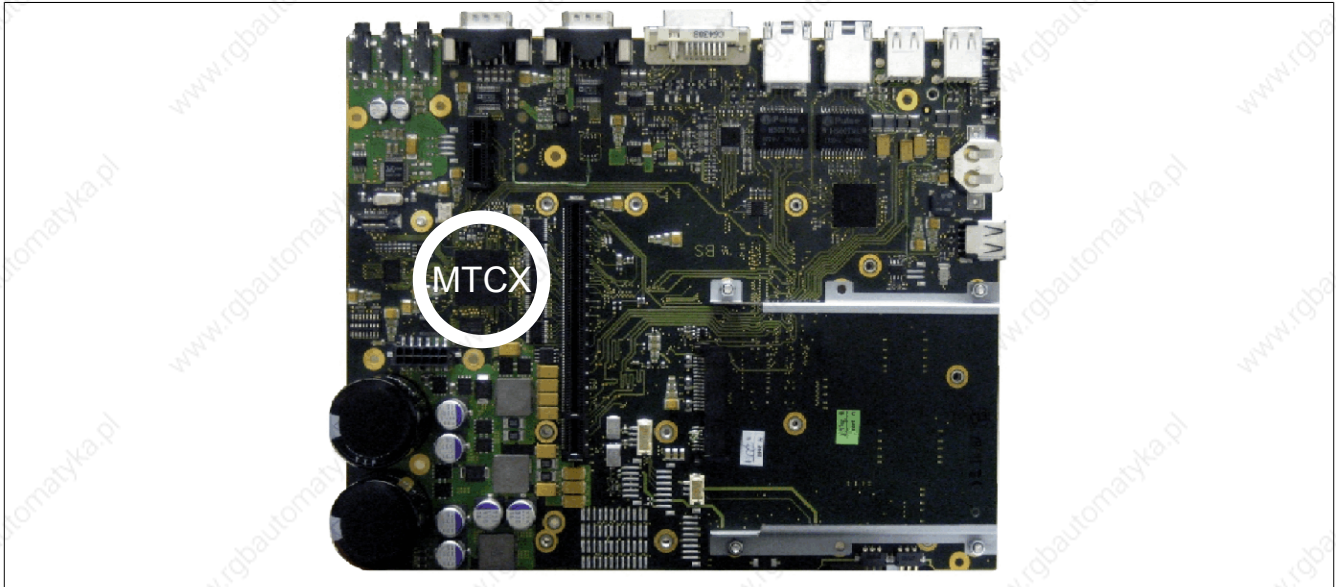

Figure 291: MTCX controller location

The MTCX is responsible for the following monitoring and control functions:

- Power on (power OK sequencing) and power failure logic
- Watchdog handling (NMI and reset handling)
- Temperature monitoring (I/O area, power supply, slide-in drive 1/2)
- Fan control
- Key and LED handling/coordination (matrix keyboard on B&R display units)
- Advanced desktop operation (keys, USB forwarding)
- Daisy chain display operation (touch screen, USB forwarding)
- Panel locking mechanism (can be configured using B&R Control Center - ADI driver)
- Backlight control for connected B&R displays
- Statistical data recording (power cycles - records every switch-on, power on and fan hour; each full hour is counted, i.e. not increased at 50 minutes)
- SDL data transfer (display, matrix keyboard, touch screen, service data, USB)
- LED status indicators (Power, HDD, Link 1, Link 2)

Extended MTCX functions are available by upgrading firmware ⁷⁾. The version can be read in BIOS ("Advanced" - Baseboard/Panel Features) or in approved Microsoft Windows operating systems with the B&R Control Center.

1.1 Temperature monitoring - Fan control

The MTCX constantly monitors the temperature using temperature sensors (see "Temperature sensor locations" on page 38), which directly determines how the fans are controlled. The speed depends on the measured temperature. Limit values may depend on the MTCX firmware version being used.

⁷⁾ Available in the Downloads section of the B&R website (www.br-automation.com).

Sensor range	Startup temperature	Max fan speed at:
CPU	65°C	81°C
Board CPU	65°C	81°C
Board I/O	60°C	76°C
Board ETH2	60°C	76°C
Board power	60°C	76°C
Power supply	60°C	76°C
ETH2 controller	70°C	86°C
Slide-in 1/2	44°C	60°C

Table 321: Temperature limits of the fan (MTCX PX32 ≥ V0.06)

Once the startup temperature is reached, the device is started at the minimum fan speed. The maximum fan speed is reached at a startup temperature of 16°C. The fan speed in this area is controlled depending on the temperature.

For example, slide-in 1/2: 44°C + 16°C = 60°C --> Maximum fan speed

The fans will only be shut off again if the evaluation temperature is more than 6°C below the switch-on temperature for a period of 4 hours (=overshoot time).

2 Connecting an external device to the mainboard

A male connector on the mainboard allows +5 VDC and +12 VDC to be branched off in order to provide power to special PCI cards, for example.

This voltage can be accessed using the "5CAMSC.0001-00" on page 396. The connector is located close to the bus unit(s) and can be attached with a cable tie (see arrow in image). In order to reach the connector, the side cover (see "Installing the side cover" on page 422) of the APC810 as well as any slide-in drives and PCI insert cards must be removed.



Figure 292: Connector location for external devices

Connector for external devices			
Pin	Assignment	Power	4-pin connector, male
1	+12 VDC	Max. 10 watts	
2	GND	Max. 5 watts	
3	GND		
4	+5 VDC		



Table 322: Connector on the mainboard - Pinout

Connections are protected with a 1 A multi-fuse.

Figure 1:	Base system configuration.....	29
Figure 2:	Configuration - Optional components.....	30
Figure 3:	Temperature sensor locations.....	38
Figure 4:	Supply voltage for system units.....	40
Figure 5:	Serial number sticker (front).....	47
Figure 6:	Serial number sticker (back).....	47
Figure 7:	A3C70168444 - Example of serial number search.....	48
Figure 8:	5PC810.SX01-00 + 5PC810.BX01-00 - Block diagram.....	49
Figure 9:	5PC810.SX01-00 + 5PC810.BX01-01 - Block diagram.....	50
Figure 10:	5PC810.SX02-00 + 5PC810.BX02-00 - Block diagram.....	51
Figure 11:	5PC810.SX02-00 + 5PC810.BX02-01 - Block diagram.....	52
Figure 12:	5PC810.SX03-00 + 5PC810.BX03-00 - Block diagram.....	53
Figure 13:	5PC810.SX05-00 + 5PC810.BX05-00 - Block diagram.....	54
Figure 14:	5PC810.SX05-00 + 5PC810.BX05-01 - Block diagram.....	55
Figure 15:	5PC810.SX05-00 + 5PC810.BX05-02 - Block diagram.....	56
Figure 16:	Standard half-size 32-bit PCI card - Dimensions.....	66
Figure 17:	Standard half-size PCIe card - Dimensions.....	66
Figure 18:	LED status indicators - Front.....	68
Figure 19:	5PC810.SX01-00 - Interfaces on top.....	76
Figure 20:	5PC810.SX01-00 - Interfaces on front.....	77
Figure 21:	5PC810.SX01-00 - Dimensions.....	80
Figure 22:	5PC810.SX01-00 - Drilling template.....	81
Figure 23:	5PC810.SX02-00 - Interfaces on top.....	83
Figure 24:	5PC810.SX02-00 - Interfaces on front.....	84
Figure 25:	5PC810.SX02-00 - Dimensions.....	87
Figure 26:	5PC810.SX02-00 - Drilling template.....	88
Figure 27:	5PC810.SX03-00 - Interfaces on top.....	90
Figure 28:	5PC810.SX03-00 - Interfaces on front.....	91
Figure 29:	5PC810.SX03-00 - Dimensions.....	94
Figure 30:	5PC810.SX03-00 - Drilling template.....	95
Figure 31:	5PC810.SX05-00 - Interfaces on top.....	98
Figure 32:	5PC810.SX05-00 - Interfaces on front.....	99
Figure 33:	5PC810.SX05-00 - Dimensions.....	101
Figure 34:	5PC810.SX05-00 - Drilling template.....	102
Figure 35:	1-slot bus units.....	103
Figure 36:	2-slot bus units.....	103
Figure 37:	3-slot bus units.....	103
Figure 38:	5-slot bus units.....	104
Figure 39:	5AC801.HDDI-00 - Temperature humidity diagram.....	113
Figure 40:	5AC801.HDDI-01 - Temperature humidity diagram.....	115
Figure 41:	5AC801.HDDI-02 - Temperature humidity diagram.....	117
Figure 42:	5AC801.HDDI-03 - Temperature humidity diagram.....	119
Figure 43:	5AC801.HDDI-04 - Temperature humidity diagram.....	121
Figure 44:	5AC801.SSDI-00 - Temperature humidity diagram.....	124
Figure 45:	5AC801.SSDI-00 - ATTO disk benchmark v2.34 - Cyclic read.....	125
Figure 46:	5AC801.SSDI-00 - ATTO disk benchmark v2.34 - Cyclic write.....	125
Figure 47:	5AC801.SSDI-01 - Temperature humidity diagram.....	127
Figure 48:	5AC801.SSDI-02 - Temperature humidity diagram.....	129
Figure 49:	5AC801.SSDI-03 - Temperature humidity diagram.....	131
Figure 50:	5AC801.SSDI-04 - Temperature humidity diagram.....	133
Figure 51:	5MMSSD.0060-00 - Temperature humidity diagram.....	135
Figure 52:	5MMSSD.0060-01 - Temperature humidity diagram.....	137
Figure 53:	5MMSSD.0128-01 - Temperature humidity diagram.....	139
Figure 54:	5MMSSD.0180-00 - Temperature humidity diagram.....	141
Figure 55:	5AC801.HDDS-00 - Temperature humidity diagram.....	144
Figure 56:	5AC801.DVDS-00 - Temperature humidity diagram.....	146
Figure 57:	5AC801.DVRS-00 - Temperature humidity diagram.....	149

Figure 58:	PCI SATA RAID controller.....	150
Figure 59:	5ACPCI.RAIC-01 - Temperature humidity diagram.....	152
Figure 60:	5ACPCI.RAIC-02 - Temperature humidity diagram.....	154
Figure 61:	PCI SATA RAID controller.....	155
Figure 62:	5ACPCI.RAIC-03 - Temperature humidity diagram.....	157
Figure 63:	5ACPCI.RAIC-04 - Temperature humidity diagram.....	159
Figure 64:	PCI SATA RAID controller.....	160
Figure 65:	5ACPCI.RAIC-05 - Temperature humidity diagram.....	162
Figure 66:	PCI SATA RAID controller.....	163
Figure 67:	5ACPCI.RAIC-06 - Temperature humidity diagram.....	165
Figure 68:	5MMHDD.0250-00 - Temperature humidity diagram.....	167
Figure 69:	5MMHDD.0500-00 - Temperature humidity diagram.....	169
Figure 70:	5PC810.FA01-00 - Fan kit.....	170
Figure 71:	5PC810.FA02-00 and 5PC810.FA02-01 - Fan kit	171
Figure 72:	5PC810.FA03-00 - Fan kit.....	172
Figure 73:	5PC810.FA05-00 - Fan kit.....	173
Figure 74:	5PC810.SX02-00 - Installation example in system unit.....	175
Figure 75:	Installation example with the 5PC810.SX02-00 system unit.....	177
Figure 76:	5AC801.RDYR-01 - Contents of delivery.....	179
Figure 77:	Add-on interfaces (IF option).....	180
Figure 78:	5AC600.CANI-00 - Terminating resistor for add-on CAN interface.....	182
Figure 79:	5AC600.CANI-00 - Contents of delivery / mounting material.....	182
Figure 80:	Add-on RS232/422/485 interface - Operated in RS485 mode.....	185
Figure 81:	5AC600.485I-00 - Contents of delivery / mounting material.....	185
Figure 82:	Mounting plates.....	186
Figure 83:	Vertical mounting orientation.....	187
Figure 84:	Horizontal mounting orientation.....	187
Figure 85:	Standard mounting - Spacing.....	188
Figure 86:	Flex radius - Cable connection.....	189
Figure 87:	Grounding concept.....	190
Figure 88:	Settings for Passmark BurnInTest Pro V4 and a 2-slot APC810 with DVD.....	192
Figure 89:	Test overview of a 2-slot APC810 with DVD.....	193
Figure 90:	One Automation Panel 900 system via onboard DVI.....	196
Figure 91:	One Automation Panel 900 system via onboard SDL.....	198
Figure 92:	One Automation Panel 800 system via onboard SDL.....	200
Figure 93:	One AP900 system and one AP800 system via onboard SDL.....	202
Figure 94:	Four Automation Panel 900 systems via onboard SDL.....	204
Figure 95:	One Automation Panel 900 system via SDL AP Link.....	207
Figure 96:	Four Automation Panel 900 systems via SDL AP Link.....	209
Figure 97:	Two Automation Panel 900 systems via onboard SDL and SDL AP Link.....	212
Figure 98:	Eight Automation Panel 900 systems via onboard SDL and SDL AP Link.....	214
Figure 99:	Six AP900 and two AP800 systems via onboard SDL and SDL AP Link.....	217
Figure 100:	Local connection of USB peripheral devices on the APC810.....	220
Figure 101:	Remote connection of USB peripheral devices on the APC900 via DVI.....	221
Figure 102:	Remote connection of USB peripheral devices on the APC800/900 via SDL.....	221
Figure 103:	Open the RAID Configuration Utility.....	222
Figure 104:	RAID Configuration Utility - Menu.....	222
Figure 105:	RAID Configuration Utility - Menu.....	223
Figure 106:	RAID Configuration Utility - Create RAID set - Striped.....	223
Figure 107:	RAID Configuration Utility - Create RAID set - Mirrored.....	224
Figure 108:	RAID Configuration Utility - Delete RAID set.....	224
Figure 109:	RAID Configuration Utility - Rebuild mirrored set.....	225
Figure 110:	RAID Configuration Utility - Resolve conflicts.....	225
Figure 111:	RAID Configuration Utility - Low level format.....	226
Figure 112:	Boot screen.....	229
Figure 113:	945GME BIOS Main menu.....	231
Figure 114:	945GME Advanced menu.....	232

Figure 115:	945GME Advanced - ACPI configuration.....	233
Figure 116:	945GME Advanced - PCI configuration.....	234
Figure 117:	945GME Advanced - PCI IRQ resource exclusion.....	235
Figure 118:	945GME Advanced - PCI interrupt routing.....	236
Figure 119:	945GME Advanced - PCI Express configuration.....	237
Figure 120:	945GME Advanced - Graphics configuration.....	239
Figure 121:	945GME Advanced - CPU configuration.....	241
Figure 122:	945GME Advanced - Chipset settings.....	242
Figure 123:	945GME Advanced - I/O interface configuration.....	243
Figure 124:	945GME Advanced - Clock configuration.....	243
Figure 125:	945GME Advanced - IDE configuration.....	244
Figure 126:	945GME Advanced - Primary IDE master.....	245
Figure 127:	945GME Advanced - Primary IDE slave.....	246
Figure 128:	945GME Advanced - Secondary IDE master.....	247
Figure 129:	945GME Advanced - Secondary IDE slave.....	248
Figure 130:	945GME Advanced - USB configuration.....	249
Figure 131:	945GME Advanced - Keyboard/Mouse configuration.....	250
Figure 132:	945GME Advanced - Remote access configuration.....	251
Figure 133:	945GME Advanced - CPU board monitor.....	253
Figure 134:	945GME Advanced - Baseboard/Panel features.....	254
Figure 135:	945GME Advanced - Panel control.....	255
Figure 136:	945GME Advanced - Baseboard monitor.....	256
Figure 137:	945GME Advanced - Legacy devices.....	257
Figure 138:	945GME Boot menu.....	258
Figure 139:	945GME Security menu.....	259
Figure 140:	945GME Security - Hard disk security user password.....	260
Figure 141:	945GME Security - Hard disk security master password.....	261
Figure 142:	945GME Power menu.....	261
Figure 143:	945GME Exit menu.....	263
Figure 144:	PCI and PCIe routing with enabled 945GME APIC CPU board (COM Express) for BIOS ≤ version 1.12.....	273
Figure 145:	PCI and PCIe routing with enabled 945GME APIC CPU board (COM Express) for BIOS ≥ version 1.14 (bus units 5PC810.BX0x-0x).....	274
Figure 146:	PCI and PCIe routing with enabled 945GME APIC CPU board (COM Express) for BIOS ≥ version 1.14 (bus unit 5PC810.BX05-02).....	275
Figure 147:	Software version.....	276
Figure 148:	Firmware version of the AP Link SDL transmitter.....	277
Figure 149:	Creating a bootable diskette in Windows XP - Step 1.....	282
Figure 150:	Creating a bootable diskette in Windows XP - Step 2.....	282
Figure 151:	Creating a bootable diskette in Windows XP - Step 3.....	282
Figure 152:	Creating a bootable diskette in Windows XP - Step 4.....	283
Figure 153:	Creating a bootable diskette in Windows XP - Step 5.....	283
Figure 154:	Creating a USB flash drive for B&R upgrade files.....	284
Figure 155:	Creating a CompactFlash card for B&R upgrade files.....	285
Figure 156:	ADI Control Center screenshots - Examples.....	302
Figure 157:	ADI Control Center - SDL Equalizer settings.....	304
Figure 158:	ADI Control Center - UPS settings.....	305
Figure 159:	ADI Control Center - UPS monitor.....	306
Figure 160:	ADI Control Center - UPS battery settings.....	307
Figure 161:	ADI Control Center - UPS settings.....	308
Figure 162:	ADI Control Center - Advanced UPS settings.....	310
Figure 163:	ADI Development Kit screenshots (version 3.60).....	312
Figure 164:	ADI .NET SDK screenshots (version 2.00).....	314
Figure 165:	B&R Key Editor screenshots (version 3.30).....	316
Figure 166:	GL certificate no. 11 858 - 10 HH.....	323
Figure 167:	5CFCRD.xxxx-06 CompactFlash cards - Temperature humidity diagram.....	333
Figure 168:	Type I CompactFlash card - Dimensions.....	333
Figure 169:	ATTO Disk Benchmark v2.34 read comparison - 5CFCRD.xxxx-04 and 5CFCRD.xxxx-06.....	334

Figure 170:	ATTO Disk Benchmark v2.34 write comparison - 5CFCRD.xxxx-04 and 5CFCRD.xxxx-06	334
Figure 171:	5CFCRD.xxxx-04 CompactFlash cards - Temperature humidity diagram	337
Figure 172:	Type I CompactFlash card - Dimensions	337
Figure 173:	ATTO Disk Benchmark v2.34 read comparison - 5CFCRD.xxxx-03 and 5CFCRD.xxxx-04	338
Figure 174:	ATTO Disk Benchmark v2.34 write comparison - 5CFCRD.xxxx-03 and 5CFCRD.xxxx-04	338
Figure 175:	5CFCRD.xxxx-03 CompactFlash cards - Temperature humidity diagram	341
Figure 176:	Type I CompactFlash card - Dimensions	341
Figure 177:	5MD900.USB2-01 - Interfaces	343
Figure 178:	5MD900.USB2-01 - Dimensions	345
Figure 179:	USB media drive with front cover - Dimensions	346
Figure 180:	USB media drive with front cover - Installation cutout	346
Figure 181:	5MD900.USB2-01 - Mounting orientation	347
Figure 182:	5MD900.USB2-02 - Interfaces	348
Figure 183:	5MD900.USB2-02 - Dimensions	350
Figure 184:	USB media drive with front cover - Dimensions	350
Figure 185:	USB media drive with front cover - Installation cutout	351
Figure 186:	5MD900.USB2-02 - Mounting orientation	351
Figure 187:	5A5003.03 - Dimensions	352
Figure 188:	Front cover mounting and installation depth	353
Figure 189:	USB media drive with front cover - Installation cutout	353
Figure 190:	5MMUSB.2048-00 - Temperature humidity diagram	355
Figure 191:	5MMUSB.xxxx-01 - Temperature humidity diagram	357
Figure 192:	UPS principle	361
Figure 193:	5AC600.UPSI-00 Add-on UPS module - Installation materials	363
Figure 194:	Temperature/Service life diagram	365
Figure 195:	Deep discharge cycles	365
Figure 196:	5PC600.UPSB-00 - Dimensions	366
Figure 197:	5PC600.UPSB-00 - Drilling template	366
Figure 198:	5AC804.MFLT-00 - Dimensions	370
Figure 199:	5AC804.MFLT-00 - Drilling template	370
Figure 200:	Connection example	370
Figure 201:	5ACPCI.ETH1-01 - PCI 10/100 Ethernet card	371
Figure 202:	5ACPCI.ETH1-01 - Dimensions	373
Figure 203:	5ACPCI.ETH3-01 - PCI 10/100 Ethernet card	374
Figure 204:	5ACPCI.ETH3-01 - Dimensions	376
Figure 205:	Flex radius specifications	378
Figure 206:	5CADVI.0xxx-00 - Dimensions	378
Figure 207:	5CADVI.0xxx-00 - Pinout	379
Figure 208:	Flex radius specifications	381
Figure 209:	5CASDL.0xxx-00 - Dimensions	381
Figure 210:	5CASDL.0xxx-00 - Pinout	382
Figure 211:	Flex radius specifications	384
Figure 212:	5CASDL.0xxx-01 - Dimensions	384
Figure 213:	5CASDL.0xxx-01 - Pinout	385
Figure 214:	Flex radius specifications	387
Figure 215:	5CASDL.0xxx-03 - Dimensions	387
Figure 216:	5CASDL.0xxx-03 - Pinout	388
Figure 217:	Flex radius specification with extender	390
Figure 218:	5CASDL.0xx0-13 - Dimensions	390
Figure 219:	5CASDL.0xx0-13 - Pinout	391
Figure 220:	Example of the signal direction for an SDL flex cable with extender	392
Figure 221:	5CAUSB.00xx-00 USB cables - Pinout	393
Figure 222:	9A0014.xx RS232 cables - Pinout	395
Figure 223:	5AC801.FRAM-00 - HDD replacement disk tray	397
Figure 224:	5AC801.FRAM-00 - Dimensions	398
Figure 225:	Removing the battery	400
Figure 226:	Battery handling	400

Figure 227:	Battery polarity.....	400
Figure 228:	CompactFlash + ejector.....	401
Figure 229:	Loosening the quick release screws.....	402
Figure 230:	Inserting the compact SATA drive.....	402
Figure 231:	Loosening the quick release screws.....	403
Figure 232:	Installing the slide-in drive.....	403
Figure 233:	Loosening the quick release screws.....	404
Figure 234:	Installing the slide-in compact adapter.....	404
Figure 235:	Inserting the slide-in compact drive.....	405
Figure 236:	Removing the fan kit insert.....	406
Figure 237:	Inserting and fastening the fan kit.....	406
Figure 238:	Securing the dust filter with the filter clasp.....	407
Figure 239:	5AC600.UPSI-00 Add-on UPS module - Installation materials.....	408
Figure 240:	Removing the UPS module cover.....	408
Figure 241:	Screwing in the spacing bolt and spacing ring.....	408
Figure 242:	Installing the UPS module.....	409
Figure 243:	Attaching the connection cable.....	409
Figure 244:	Connector locking mechanism.....	409
Figure 245:	Removing the UPS module cover.....	410
Figure 246:	Screwing in the spacing bolt and spacing ring.....	410
Figure 247:	Installing the mounting bracket.....	410
Figure 248:	Installing the UPS module.....	411
Figure 249:	Attaching the connection cable.....	411
Figure 250:	Connector locking mechanism.....	411
Figure 251:	Removing the UPS module cover.....	412
Figure 252:	Screwing in the spacing bolt and spacing ring.....	412
Figure 253:	Installing the mounting bracket.....	412
Figure 254:	Installing the UPS module.....	413
Figure 255:	Attaching the connection cable.....	413
Figure 256:	Connector locking mechanism.....	413
Figure 257:	Removing the UPS module cover.....	414
Figure 258:	Screwing in the spacing bolt.....	414
Figure 259:	Installing the UPS module.....	414
Figure 260:	Attaching the connection cable.....	415
Figure 261:	Connector locking mechanism.....	415
Figure 262:	Removing the UPS module cover.....	416
Figure 263:	Screwing in the spacing bolt.....	416
Figure 264:	Installing the mounting bracket.....	416
Figure 265:	Installing the UPS module.....	417
Figure 266:	Attaching the connection cable.....	417
Figure 267:	Connector locking mechanism.....	417
Figure 268:	Removing the UPS module cover.....	418
Figure 269:	Screwing in the spacing bolt.....	418
Figure 270:	Installing the mounting bracket.....	418
Figure 271:	Installing the UPS module.....	418
Figure 272:	Attaching the connection cable.....	419
Figure 273:	Connector locking mechanism.....	419
Figure 274:	Removing the cover for the battery unit.....	420
Figure 275:	Disconnecting the cable.....	420
Figure 276:	Connecting the fuse.....	421
Figure 277:	Securing the fuse.....	421
Figure 278:	1-slot APC810 - Installing the side cover.....	422
Figure 279:	2-slot APC810 - Installing the side cover.....	422
Figure 280:	5-slot APC810 - Installing the side cover.....	423
Figure 281:	Removing the AP Link module cover.....	424
Figure 282:	Installing the AP Link module.....	424
Figure 283:	Screw layout on the back side of the 5ACPCI.RAIC-03 SATA RAID controller.....	425

Figure index

Figure 284:	Replacing the hard disk.....	426
Figure 285:	Inserting the replacement hard disk in the replacement disk tray.....	427
Figure 286:	Installing the replacement disk tray in the APC810.....	427
Figure 287:	Removing the UPS module cover.....	428
Figure 288:	Screwing in the spacing bolt and spacing ring.....	428
Figure 289:	Installing the ready relay.....	428
Figure 290:	Attaching the connection cable.....	429
Figure 291:	MTCX controller location.....	430
Figure 292:	Connector location for external devices.....	432

Table 1:	Manual history.....	14
Table 2:	Environmentally friendly separation of materials.....	21
Table 3:	Description of the safety notices used in this documentation.....	22
Table 4:	Range of nominal sizes.....	22
Table 5:	Ambient temperature without a fan kit.....	32
Table 6:	Ambient temperature without a fan kit.....	33
Table 7:	Ambient temperature without a fan kit.....	34
Table 8:	Ambient temperature with a fan kit.....	35
Table 9:	Ambient temperature with a fan kit.....	36
Table 10:	Temperature sensor locations.....	38
Table 11:	Overview of humidity specifications for individual components.....	39
Table 12:	1-slot APC variant - Power calculation table.....	41
Table 13:	1-slot APC variant - Power calculation table.....	42
Table 14:	2-slot APC variant - Power calculation table.....	43
Table 15:	2-slot APC variant - Power calculation table.....	44
Table 16:	3-slot APC variant - Power calculation table.....	45
Table 17:	5-slot APC variant - Power calculation table.....	46
Table 18:	Supply voltage connection 24 VDC.....	57
Table 19:	COM1 - Pinout.....	58
Table 20:	COM2 - Pinout.....	58
Table 21:	Monitor/Panel interface - RGB, DVI, SDL.....	59
Table 22:	DVI interface - Pinout.....	59
Table 23:	Cable lengths and resolutions for SDL transmission.....	59
Table 24:	Cable lengths and resolutions for DVI transmission.....	60
Table 25:	Ethernet interface (ETH1).....	61
Table 26:	Ethernet interface (ETH2).....	62
Table 27:	USB1, USB2, USB3 and USB4 interfaces.....	63
Table 28:	USB5 interface.....	63
Table 29:	MIC, Line IN, Line OUT.....	64
Table 30:	Add-on interface slot.....	64
Table 31:	Add-on UPS slot (with and without installed UPS).....	65
Table 32:	Overview of 64-bit cards.....	66
Table 33:	LED status indicators - Data.....	68
Table 34:	CMOS profile switch.....	68
Table 35:	Power button.....	69
Table 36:	Reset button.....	69
Table 37:	Battery.....	70
Table 38:	Battery status.....	70
Table 39:	Hardware security key.....	71
Table 40:	CompactFlash slot (CF1).....	72
Table 41:	CompactFlash slot (CF2).....	72
Table 42:	Slide-in slot 1.....	73
Table 43:	Slide-in slot 2.....	73
Table 44:	Slide-in compact slot.....	74
Table 45:	5PC810.SX01-00 - Order data.....	75
Table 46:	5PC810.SX01-00 - Technical data.....	77
Table 47:	5PC810.SX02-00 - Order data.....	82
Table 48:	5PC810.SX02-00 - Technical data.....	84
Table 49:	5PC810.SX03-00 - Order data.....	89
Table 50:	5PC810.SX03-00 - Technical data.....	91
Table 51:	5PC810.SX05-00 - Order data.....	96
Table 52:	5PC810.SX05-00 - Technical data.....	99
Table 53:	5PC810.BX01-00, 5PC810.BX01-01, 5PC810.BX02-00, 5PC810.BX02-01, 5PC810.BX03-00, 5PC810.BX05-00, 5PC810.BX05-01, 5PC810.BX05-02 - Order data.....	104
Table 54:	5PC810.BX01-00, 5PC810.BX01-01, 5PC810.BX02-00, 5PC810.BX02-01, 5PC810.BX03-00, 5PC810.BX05-00, 5PC810.BX05-01, 5PC810.BX05-02 - Technical data.....	104
Table 55:	5PC800.B945-00, 5PC800.B945-01, 5PC800.B945-02, 5PC800.B945-03, 5PC800.B945-04, 5PC800.B945-05 - Order data.....	106

Table 56:	5PC800.B945-10, 5PC800.B945-11, 5PC800.B945-12, 5PC800.B945-13, 5PC800.B945-14 - Order data.....	106
Table 57:	5PC800.B945-00, 5PC800.B945-01, 5PC800.B945-02, 5PC800.B945-03, 5PC800.B945-04, 5PC800.B945-05 - Technical data.....	107
Table 58:	5PC800.B945-10, 5PC800.B945-11, 5PC800.B945-12, 5PC800.B945-13, 5PC800.B945-14 - Technical data.....	107
Table 59:	5AC801.HS00-00, 5AC801.HS00-01, 5AC801.HS00-02 - Order data.....	109
Table 60:	5AC801.HS00-00, 5AC801.HS00-01, 5AC801.HS00-02 - Technical data.....	109
Table 61:	5MMDDR.0512-01, 5MMDDR.1024-01, 5MMDDR.2048-01 - Order data.....	111
Table 62:	5MMDDR.0512-01, 5MMDDR.1024-01, 5MMDDR.2048-01 - Technical data.....	111
Table 63:	5AC801.HDDI-00 - Order data.....	112
Table 64:	5AC801.HDDI-00 - Technical data.....	112
Table 65:	5AC801.HDDI-01 - Order data.....	114
Table 66:	5AC801.HDDI-01 - Technical data.....	114
Table 67:	5AC801.HDDI-02 - Order data.....	116
Table 68:	5AC801.HDDI-02 - Technical data.....	116
Table 69:	5AC801.HDDI-03 - Order data.....	118
Table 70:	5AC801.HDDI-03 - Technical data.....	118
Table 71:	5AC801.HDDI-04 - Order data.....	120
Table 72:	5AC801.HDDI-04 - Technical data.....	120
Table 73:	5AC801.SSDI-00 - Order data.....	122
Table 74:	5AC801.SSDI-00 - Technical data.....	122
Table 75:	5AC801.SSDI-01 - Order data.....	126
Table 76:	5AC801.SSDI-01 - Technical data.....	126
Table 77:	5AC801.SSDI-02 - Order data.....	128
Table 78:	5AC801.SSDI-02 - Technical data.....	128
Table 79:	5AC801.SSDI-03 - Order data.....	130
Table 80:	5AC801.SSDI-03 - Technical data.....	130
Table 81:	5AC801.SSDI-04 - Order data.....	132
Table 82:	5AC801.SSDI-04 - Technical data.....	132
Table 83:	5MMSSD.0060-00 - Order data.....	134
Table 84:	5MMSSD.0060-00 - Technical data.....	134
Table 85:	5MMSSD.0060-01 - Order data.....	136
Table 86:	5MMSSD.0060-01 - Technical data.....	136
Table 87:	5MMSSD.0128-01 - Order data.....	138
Table 88:	5MMSSD.0128-01 - Technical data.....	138
Table 89:	5MMSSD.0180-00 - Order data.....	140
Table 90:	5MMSSD.0180-00 - Technical data.....	140
Table 91:	5AC801.ADAS-00 - Order data.....	142
Table 92:	5AC801.ADAS-00 - Technical data.....	142
Table 93:	5AC801.HDDS-00 - Order data.....	143
Table 94:	5AC801.HDDS-00 - Technical data.....	143
Table 95:	5AC801.DVDS-00 - Order data.....	145
Table 96:	5AC801.DVDS-00 - Technical data.....	145
Table 97:	5AC801.DVRS-00 - Order data.....	147
Table 98:	5AC801.DVRS-00 - Technical data.....	147
Table 99:	5ACPCI.RAIC-01 - Order data.....	150
Table 100:	5ACPCI.RAIC-01 - Technical data.....	151
Table 101:	5ACPCI.RAIC-02 - Order data.....	153
Table 102:	5ACPCI.RAIC-02 - Technical data.....	153
Table 103:	5ACPCI.RAIC-03 - Order data.....	155
Table 104:	5ACPCI.RAIC-03 - Technical data.....	156
Table 105:	5ACPCI.RAIC-04 - Order data.....	158
Table 106:	5ACPCI.RAIC-04 - Technical data.....	158
Table 107:	5ACPCI.RAIC-05 - Order data.....	160
Table 108:	5ACPCI.RAIC-05 - Technical data.....	161
Table 109:	5ACPCI.RAIC-06 - Order data.....	163
Table 110:	5ACPCI.RAIC-06 - Technical data.....	164

Table 111:	5MMHDD.0250-00 - Order data.....	166
Table 112:	5MMHDD.0250-00 - Technical data.....	166
Table 113:	5MMHDD.0500-00 - Order data.....	168
Table 114:	5MMHDD.0500-00 - Technical data.....	168
Table 115:	5PC810.FA01-00 - Order data.....	170
Table 116:	5PC810.FA01-00 - Technical data.....	170
Table 117:	5PC810.FA02-00, 5PC810.FA02-01 - Order data.....	171
Table 118:	5PC810.FA02-00, 5PC810.FA02-01 - Technical data.....	171
Table 119:	5PC810.FA03-00 - Order data.....	172
Table 120:	5PC810.FA03-00 - Technical data.....	172
Table 121:	5PC810.FA05-00 - Order data.....	173
Table 122:	5PC810.FA05-00 - Technical data.....	174
Table 123:	5AC801.SDL0-00 - Order data.....	175
Table 124:	5AC801.SDL0-00 - Technical data.....	175
Table 125:	DVI interface - Pinout.....	176
Table 126:	Cable lengths and resolutions for SDL transmission.....	176
Table 127:	5AC801.RDYR-00 - Order data.....	177
Table 128:	5AC801.RDYR-00 ready relay - Pinout.....	177
Table 129:	5AC801.RDYR-01 - Order data.....	178
Table 130:	5AC801.RDYR-01 - Pinout.....	178
Table 131:	5AC600.CANI-00 - Order data.....	180
Table 132:	5AC600.CANI-00 - Technical data.....	180
Table 133:	CAN - Pinout.....	181
Table 134:	Add-on CAN - I/O address and IRQ.....	181
Table 135:	CAN - Bus length and transfer rate.....	181
Table 136:	CAN - Cable requirements.....	181
Table 137:	5AC600.485I-00 - Order data.....	183
Table 138:	5AC600.485I-00 - Technical data.....	183
Table 139:	RS232/RS422 - Pinout.....	183
Table 140:	Add-on RS232/422/485 - I/O address and IRQ.....	183
Table 141:	RS232 - Bus length and transfer rate.....	184
Table 142:	RS232 - Cable requirements.....	184
Table 143:	RS422 - Bus length and transfer rate.....	184
Table 144:	RS422 - Cable requirements.....	184
Table 145:	RS485 - Bus length and transfer rate.....	185
Table 146:	RS422 - Cable requirements.....	185
Table 147:	Evaluation example using a 2-slot APC810.....	194
Table 148:	Selecting display units.....	195
Table 149:	Possible system unit and CPU board combinations.....	196
Table 150:	Link modules.....	196
Table 151:	Cables for DVI configurations.....	196
Table 152:	Possible Automation Panel devices, resolutions and segment lengths.....	197
Table 153:	Possible system unit and CPU board combinations.....	198
Table 154:	Link modules.....	198
Table 155:	Cables for SDL configurations.....	198
Table 156:	Cable lengths and resolutions for SDL transmission.....	199
Table 157:	Possible system unit and CPU board combinations.....	200
Table 158:	Cables for SDL configurations.....	200
Table 159:	Cable lengths and resolutions for SDL transmission.....	201
Table 160:	Possible system unit and CPU board combinations.....	202
Table 161:	Link modules.....	202
Table 162:	Possible system unit and CPU board combinations.....	204
Table 163:	Link modules.....	204
Table 164:	Cables for SDL configurations.....	205
Table 165:	Cable lengths and resolutions for SDL transmission.....	206
Table 166:	Possible system unit and CPU board combinations.....	207
Table 167:	Link modules.....	207

Table 168:	Cables for SDL configurations.....	208
Table 169:	Cable lengths and resolutions for SDL transmission.....	208
Table 170:	Possible system unit and CPU board combinations.....	209
Table 171:	Link modules.....	210
Table 172:	Cables for SDL configurations.....	210
Table 173:	Cable lengths and resolutions for SDL transmission.....	210
Table 174:	Possible system unit and CPU board combinations.....	212
Table 175:	Link modules.....	212
Table 176:	Cables for SDL configurations.....	213
Table 177:	Cable lengths and resolutions for SDL transmission.....	213
Table 178:	Possible system unit and CPU board combinations.....	214
Table 179:	Link modules.....	215
Table 180:	Cables for SDL configurations.....	215
Table 181:	Cable lengths and resolutions for SDL transmission.....	216
Table 182:	Possible system unit and CPU board combinations.....	218
Table 183:	Link modules.....	218
Table 184:	Segment lengths, resolutions and SDL cables.....	218
Table 185:	BIOS-relevant keys in the RAID Configuration Utility.....	222
Table 186:	BIOS-relevant keys for POST.....	230
Table 187:	BIOS-relevant keys.....	230
Table 188:	945GME Main menu - Configuration options.....	231
Table 189:	945GME Advanced menu - Configuration options.....	232
Table 190:	945GME Advanced - ACPI configuration - Configuration options.....	233
Table 191:	945GME Advanced - PCI configuration - Configuration options.....	234
Table 192:	945GME Advanced - PCI IRQ resource exclusion - Configuration options.....	235
Table 193:	945GME Advanced - PCI interrupt routing - Configuration options.....	236
Table 194:	945GME Advanced - PCI Express configuration - Configuration options.....	237
Table 195:	945GME Advanced - Graphics configuration - Configuration options.....	239
Table 196:	945GME Advanced - CPU configuration - Configuration options.....	241
Table 197:	945GME Advanced - Chipset settings - Configuration options.....	242
Table 198:	945GME Advanced - I/O interface configuration - Configuration options.....	243
Table 199:	945GME Advanced - Clock configuration - Configuration options.....	244
Table 200:	945GME Advanced - IDE configuration - Configuration options.....	244
Table 201:	945GME Advanced - Primary IDE master - Configuration options.....	245
Table 202:	945GME Advanced - Primary IDE slave - Configuration options.....	246
Table 203:	945GME Advanced - Secondary IDE master - Configuration options.....	247
Table 204:	945GME Advanced - Secondary IDE slave - Configuration options.....	248
Table 205:	945GME Advanced - USB configuration - Configuration options.....	249
Table 206:	945GME Advanced - Keyboard/Mouse configuration - Configuration options.....	251
Table 207:	945GME Advanced - Remote access configuration - Configuration options.....	251
Table 208:	945GME Advanced - CPU board monitor - Configuration options.....	253
Table 209:	945GME Advanced - Baseboard/Panel features - Configuration options.....	254
Table 210:	945GME Advanced - Panel control - Configuration options.....	255
Table 211:	945GME Advanced - Baseboard monitor - Configuration options.....	256
Table 212:	945GME Advanced - Legacy devices - Configuration options.....	257
Table 213:	945GME Boot menu - Configuration options.....	258
Table 214:	945GME Security menu - Configuration options.....	259
Table 215:	945GME Security - Hard disk security user password.....	260
Table 216:	945GME Security - Hard disk security master password.....	261
Table 217:	945GME Power menu - Configuration options.....	262
Table 218:	855GME (XTX) Exit menu - Configuration options.....	263
Table 219:	Profile overview.....	264
Table 220:	945GME Main (Profile setting overview).....	264
Table 221:	945GME Advanced - ACPI configuration - Profile setting overview.....	264
Table 222:	945GME Advanced - PCI configuration - Profile setting overview.....	264
Table 223:	945GME Advanced - PCI Express configuration - Profile setting overview.....	265
Table 224:	945GME Advanced - Graphics configuration - Profile setting overview.....	265

Table 225:	945GME Advanced - CPU configuration - Profile setting overview.....	266
Table 226:	945GME Advanced - Chipset configuration - Profile setting overview.....	266
Table 227:	945GME Advanced - I/O interface configuration - Profile setting overview.....	266
Table 228:	945GME Advanced - Clock configuration - Profile setting overview.....	266
Table 229:	945GME Advanced - IDE configuration - Profile setting overview.....	267
Table 230:	945GME Advanced - USB configuration - Profile setting overview.....	267
Table 231:	945GME Advanced - Keyboard/Mouse configuration - profile setting overview.....	267
Table 232:	945GME Advanced - Remote access configuration - Profile setting overview.....	268
Table 233:	945GME Advanced CPU board monitor profile setting overview.....	268
Table 234:	945GME Advanced - Baseboard/Panel Features profile setting overview.....	268
Table 235:	945GME Main (Profile setting overview).....	269
Table 236:	945GME Security profile setting overview.....	269
Table 237:	945GME Power profile setting overview.....	269
Table 238:	945GME BIOS - POST messages.....	270
Table 239:	RAM address assignment.....	271
Table 240:	I/O address assignment.....	271
Table 241:	IRQ interrupt assignments in PIC mode.....	271
Table 242:	IRQ interrupt assignments in APIC mode.....	272
Table 243:	9S0000.01-010, 9S0000.01-020 - Order data.....	286
Table 244:	Tested resolutions and color depths for DVI signals.....	286
Table 245:	Tested resolutions and color depths for RGB signals.....	286
Table 246:	5SWWXP.0600-ENG, 5SWWXP.0600-GER, 5SWWXP.0600-MUL, 5SWWXP.0500-ENG, 5SWWXP.0500-GER, 5SWWXP.0500-MUL - Order data.....	287
Table 247:	5SWWI7.0100-ENG, 5SWWI7.1100-ENG, 5SWWI7.0100-GER, 5SWWI7.1100-GER, 5SWWI7.0300-MUL, 5SWWI7.1300-MUL, 5SWWI7.0200-ENG, 5SWWI7.1200-ENG, 5SWWI7.0200-GER, 5SWWI7.1200-GER, 5SWWI7.0400-MUL, 5SWWI7.1400-MUL - Order da- ta.....	289
Table 248:	5SWWXP.0426-ENG - Order data.....	292
Table 249:	Device functions in Windows XP Embedded with FP2007.....	292
Table 250:	5SWWXP.0726-ENG - Order data.....	294
Table 251:	Device functions in Windows Embedded Standard 2009.....	294
Table 252:	5SWWI7.1526-ENG, 5SWWI7.1626-ENG, 5SWWI7.1726-MUL, 5SWWI7.1826-MUL - Order da- ta.....	296
Table 253:	Device functions in Windows Embedded Standard 7.....	297
Table 254:	5SWWCE.0826-ENG - Order data.....	299
Table 255:	Windows CE 6.0 features.....	299
Table 256:	1A4600.10, 1A4600.10-2, 1A4600.10-3, 1A4600.10-4, 1A4601.06, 1A4601.06-2 - Order data.....	301
Table 257:	Revision of individual components with GL certification.....	321
Table 258:	0AC201.91, 4A0006.00-000 - Order data.....	324
Table 259:	0AC201.91, 4A0006.00-000 - Technical data.....	324
Table 260:	0TB103.9, 0TB103.91 - Order data.....	326
Table 261:	0TB103.9, 0TB103.91 - Technical data.....	326
Table 262:	5AC801.FA01-00, 5AC801.FA02-00, 5AC801.FA03-00, 5AC801.FA05-00 - Order data.....	327
Table 263:	5AC900.1000-00 - Order data.....	328
Table 264:	5CFCRD.0512-06, 5CFCRD.1024-06, 5CFCRD.2048-06, 5CFCRD.4096-06, 5CFCRD.8192-06, 5CFCRD.016G-06, 5CFCRD.032G-06 - Order data.....	331
Table 265:	5CFCRD.0512-06, 5CFCRD.1024-06, 5CFCRD.2048-06, 5CFCRD.4096-06, 5CFCRD.8192-06, 5CFCRD.016G-06, 5CFCRD.032G-06 - Technical data.....	331
Table 266:	5CFCRD.0512-04, 5CFCRD.1024-04, 5CFCRD.2048-04, 5CFCRD.4096-04, 5CFCRD.8192-04, 5CFCRD.016G-04 - Order data.....	335
Table 267:	5CFCRD.0512-04, 5CFCRD.1024-04, 5CFCRD.2048-04, 5CFCRD.4096-04, 5CFCRD.8192-04, 5CFCRD.016G-04 - Technical data.....	335
Table 268:	5CFCRD.0064-03, 5CFCRD.0128-03, 5CFCRD.0256-03, 5CFCRD.0512-03, 5CFCRD.1024-03, 5CFCRD.2048-03, 5CFCRD.4096-03, 5CFCRD.8192-03 - Order data.....	339
Table 269:	5CFCRD.0064-03, 5CFCRD.0128-03, 5CFCRD.0256-03, 5CFCRD.0512-03, 5CFCRD.1024-03, 5CFCRD.2048-03, 5CFCRD.4096-03, 5CFCRD.8192-03 - Technical data.....	339
Table 270:	5MD900.USB2-01 - Order data.....	343
Table 271:	5MD900.USB2-01 - Technical data.....	344

Table 272:	5MD900.USB2-01 - Contents of delivery.....	346
Table 273:	5MD900.USB2-02 - Order data.....	348
Table 274:	5MD900.USB2-02 - Technical data.....	348
Table 275:	5MD900.USB2-02 - Contents of delivery.....	351
Table 276:	5A5003.03 - Order data.....	352
Table 277:	5A5003.03 - Technical data.....	352
Table 278:	5A5003.03 - Contents of delivery.....	352
Table 279:	5MMUSB.2048-00 - Order data.....	354
Table 280:	5MMUSB.2048-00 - Technical data.....	354
Table 281:	5MMUSB.2048-01, 5MMUSB.4096-01 - Order data.....	356
Table 282:	5MMUSB.2048-01, 5MMUSB.4096-01 - Technical data.....	356
Table 283:	5SWHMI.0000-00 - Order data.....	358
Table 284:	5AC600.UPSI-00 - Order data.....	362
Table 285:	5AC600.UPSI-00 - Technical data.....	362
Table 286:	5AC600.UPSB-00 - Order data.....	364
Table 287:	5AC600.UPSB-00, 5AC600.UPSB-00 - Technical data.....	364
Table 288:	5CAUPS.0005-00, 5CAUPS.0030-00 - Order data.....	367
Table 289:	5CAUPS.0005-00, 5CAUPS.0030-00 - Technical data.....	367
Table 290:	5AC600.UPSF-00 - Order data.....	368
Table 291:	5AC600.UPSF-01 - Order data.....	368
Table 292:	5AC804.MFLT-00 - Order data.....	369
Table 293:	5AC804.MFLT-00 - Technical data.....	369
Table 294:	5ACPCI.ETH1-01 - Order data.....	371
Table 295:	5ACPCI.ETH1-01 - Technical data.....	371
Table 296:	5ACPCI.ETH1-01 - Technical data.....	372
Table 297:	5ACPCI.ETH3-01 - Order data.....	374
Table 298:	5ACPCI.ETH3-01 - Technical data.....	374
Table 299:	5ACPCI.ETH3-01 - Technical data.....	375
Table 300:	5CADVI.0018-00, 5CADVI.0050-00, 5CADVI.0100-00 - Order data.....	377
Table 301:	5CADVI.0018-00, 5CADVI.0050-00, 5CADVI.0100-00 - Technical data.....	377
Table 302:	5CASDL.0018-00, 5CASDL.0050-00, 5CASDL.0100-00, 5CASDL.0150-00, 5CASDL.0200-00, 5CASDL.0250-00, 5CASDL.0300-00 - Order data.....	380
Table 303:	5CASDL.0018-00, 5CASDL.0050-00, 5CASDL.0100-00, 5CASDL.0150-00, 5CASDL.0200-00, 5CASDL.0250-00, 5CASDL.0300-00 - Technical data.....	380
Table 304:	5CASDL.0018-01, 5CASDL.0050-01, 5CASDL.0100-01, 5CASDL.0150-01 - Order data.....	383
Table 305:	5CASDL.0018-01, 5CASDL.0050-01, 5CASDL.0100-01, 5CASDL.0150-01 - Technical data.....	383
Table 306:	5CASDL.0018-03, 5CASDL.0050-03, 5CASDL.0100-03, 5CASDL.0150-03, 5CASDL.0200-03, 5CASDL.0250-03, 5CASDL.0300-03 - Order data.....	386
Table 307:	5CASDL.0018-03, 5CASDL.0050-03, 5CASDL.0100-03, 5CASDL.0150-03, 5CASDL.0200-03, 5CASDL.0250-03, 5CASDL.0300-03 - Technical data.....	386
Table 308:	5CASDL.0xxx-03 SDL flex cables - Structure.....	388
Table 309:	5CASDL.0300-13, 5CASDL.0400-13, 5CASDL.0430-13 - Order data.....	389
Table 310:	5CASDL.0300-13, 5CASDL.0400-13, 5CASDL.0430-13 - Technical data.....	389
Table 311:	5CAUSB.0018-00, 5CAUSB.0050-00 - Order data.....	393
Table 312:	5CAUSB.0018-00, 5CAUSB.0050-00 - Technical data.....	393
Table 313:	9A0014.02, 9A0014.05, 9A0014.10 - Order data.....	394
Table 314:	9A0014.02, 9A0014.05, 9A0014.10 - Technical data.....	394
Table 315:	5CAMSC.0001-00 - Order data.....	396
Table 316:	5CAMSC.0001-00 - Technical data.....	396
Table 317:	5AC801.FRAME-00 - Order data.....	397
Table 318:	5AC801.FRAME-00 - Technical data.....	397
Table 319:	Battery status.....	399
Table 320:	Overview of required replacement SATA HDD for PCI SATA HDD RAID controller.....	425
Table 321:	Temperature limits of the fan (MTCX PX32 ≥ V0.06).....	431
Table 322:	Connector on the mainboard - Pinout.....	432

0AC201.91.....	324
0TB103.9.....	326
0TB103.91.....	326
1A4600.10.....	301
1A4600.10-2.....	301
1A4600.10-3.....	301
1A4600.10-4.....	301
1A4601.06.....	301
1A4601.06-2.....	301
4A0006.00-000.....	324
5A5003.03.....	352
5AC600.485I-00.....	183
5AC600.CANI-00.....	180
5AC600.UPSB-00.....	364
5AC600.UPSF-00.....	368
5AC600.UPSF-01.....	368
5AC600.UPSI-00.....	362
5AC801.ADAS-00.....	142
5AC801.DVDS-00.....	145
5AC801.DVRS-00.....	147
5AC801.FA01-00.....	327
5AC801.FA02-00.....	327
5AC801.FA03-00.....	327
5AC801.FA05-00.....	327
5AC801.FRAM-00.....	397
5AC801.HDDI-00.....	112
5AC801.HDDI-01.....	114
5AC801.HDDI-02.....	116
5AC801.HDDI-03.....	118
5AC801.HDDI-04.....	120
5AC801.HDDS-00.....	143
5AC801.HS00-00.....	109
5AC801.HS00-01.....	109
5AC801.HS00-02.....	109
5AC801.RDYR-00.....	177
5AC801.RDYR-01.....	178
5AC801.SDL0-00.....	175
5AC801.SSDI-00.....	122
5AC801.SSDI-01.....	126
5AC801.SSDI-02.....	128
5AC801.SSDI-03.....	130
5AC801.SSDI-04.....	132
5AC804.MFLT-00.....	369
5AC900.1000-00.....	328
5ACPCI.ETH1-01.....	371
5ACPCI.ETH3-01.....	374
5ACPCI.RAIC-01.....	150
5ACPCI.RAIC-02.....	153
5ACPCI.RAIC-03.....	155
5ACPCI.RAIC-04.....	158
5ACPCI.RAIC-05.....	160
5ACPCI.RAIC-06.....	163
5CADVI.0018-00.....	377
5CADVI.0050-00.....	377
5CADVI.0100-00.....	377
5CAMSC.0001-00.....	396
5CASDL.0018-00.....	380
5CASDL.0018-01.....	383
5CASDL.0018-03.....	386
5CASDL.0050-00.....	380
5CASDL.0050-01.....	383
5CASDL.0050-03.....	386

Model number index

5CASDL.0100-00.....	380
5CASDL.0100-01.....	383
5CASDL.0100-03.....	386
5CASDL.0150-00.....	380
5CASDL.0150-01.....	383
5CASDL.0150-03.....	386
5CASDL.0200-00.....	380
5CASDL.0200-03.....	386
5CASDL.0250-00.....	380
5CASDL.0250-03.....	386
5CASDL.0300-00.....	380
5CASDL.0300-03.....	386
5CASDL.0300-13.....	389
5CASDL.0400-13.....	389
5CASDL.0430-13.....	389
5CAUPS.0005-00.....	367
5CAUPS.0030-00.....	367
5CAUSB.0018-00.....	393
5CAUSB.0050-00.....	393
5CFCRD.0064-03.....	339
5CFCRD.0128-03.....	339
5CFCRD.016G-04.....	335
5CFCRD.016G-06.....	331
5CFCRD.0256-03.....	339
5CFCRD.032G-06.....	331
5CFCRD.0512-03.....	339
5CFCRD.0512-04.....	335
5CFCRD.0512-06.....	331
5CFCRD.1024-03.....	339
5CFCRD.1024-04.....	335
5CFCRD.1024-06.....	331
5CFCRD.2048-03.....	339
5CFCRD.2048-04.....	335
5CFCRD.2048-06.....	331
5CFCRD.4096-03.....	339
5CFCRD.4096-04.....	335
5CFCRD.4096-06.....	331
5CFCRD.8192-03.....	339
5CFCRD.8192-04.....	335
5CFCRD.8192-06.....	331
5MD900.USB2-01.....	343
5MD900.USB2-02.....	348
5MMDDR.0512-01.....	111
5MMDDR.1024-01.....	111
5MMDDR.2048-01.....	111
5MMHDD.0250-00.....	166
5MMHDD.0500-00.....	168
5MMSSD.0060-00.....	134
5MMSSD.0060-01.....	136
5MMSSD.0128-01.....	138
5MMSSD.0180-00.....	140
5MMUSB.2048-00.....	354
5MMUSB.2048-01.....	356
5MMUSB.4096-01.....	356
5PC800.B945-00.....	106
5PC800.B945-01.....	106
5PC800.B945-02.....	106
5PC800.B945-03.....	106
5PC800.B945-04.....	106
5PC800.B945-05.....	106
5PC800.B945-10.....	106
5PC800.B945-11.....	106

5PC800.B945-12.....	106
5PC800.B945-13.....	106
5PC800.B945-14.....	106
5PC810.BX01-00.....	104
5PC810.BX01-01.....	104
5PC810.BX02-00.....	104
5PC810.BX02-01.....	104
5PC810.BX03-00.....	104
5PC810.BX05-00.....	104
5PC810.BX05-01.....	104
5PC810.BX05-02.....	104
5PC810.FA01-00.....	170
5PC810.FA02-00.....	171
5PC810.FA02-01.....	171
5PC810.FA03-00.....	172
5PC810.FA05-00.....	173
5PC810.SX01-00.....	75
5PC810.SX02-00.....	82
5PC810.SX03-00.....	89
5PC810.SX05-00.....	96
5SWHMI.0000-00.....	358
5SWWCE.0826-ENG.....	299
5SWWI7.0100-ENG.....	289
5SWWI7.0100-GER.....	289
5SWWI7.0200-ENG.....	289
5SWWI7.0200-GER.....	289
5SWWI7.0300-MUL.....	289
5SWWI7.0400-MUL.....	289
5SWWI7.1100-ENG.....	289
5SWWI7.1100-GER.....	289
5SWWI7.1200-ENG.....	289
5SWWI7.1200-GER.....	289
5SWWI7.1300-MUL.....	289
5SWWI7.1400-MUL.....	289
5SWWI7.1526-ENG.....	296
5SWWI7.1626-ENG.....	296
5SWWI7.1726-MUL.....	296
5SWWI7.1826-MUL.....	296
5SWWXP.0426-ENG.....	292
5SWWXP.0500-ENG.....	287
5SWWXP.0500-GER.....	287
5SWWXP.0500-MUL.....	287
5SWWXP.0600-ENG.....	287
5SWWXP.0600-GER.....	287
5SWWXP.0600-MUL.....	287
5SWWXP.0726-ENG.....	294
9A0014.02.....	394
9A0014.05.....	394
9A0014.10.....	394
9S0000.01-010.....	286
9S0000.01-020.....	286

1	
1-slot APC810	
Dimensions.....	80
Interfaces.....	76
Technical data.....	77
2	
2-slot APC810	
Dimensions.....	87
Interfaces.....	83
Technical data.....	84
3	
3-slot APC810	
Dimensions.....	94
Interfaces.....	90
Technical data.....	91
5	
5-slot APC810	
Dimensions.....	101
Interfaces.....	98
Technical data.....	99
9	
945GME.....	106
945GME CPU board.....	106
A	
Accessories.....	324
ACPI.....	271, 272
Add-on interface slot.....	64
add-on UPS module.....	362
Add-on UPS slot.....	65
ADI.....	302
.NET SDK.....	314
Development Kit.....	312
SDL Equalizer settings.....	304
air circulation.....	188, 188
Ambient temperature	
Maximum.....	32
Maximum with a fan kit.....	35
Maximum without a fan kit.....	32
Minimum.....	37
APC810 with 1 card slot	
Drilling template.....	81
APC810 with 2 card slot	
Drilling template.....	88
APC810 with 3 card slot	
Drilling template.....	95
APC810 with 5 card slot	
Drilling template.....	102
AP Link installation.....	424
AP Link slot.....	65
ARemb.....	301

ARwin.....	301
ATEX certification.....	319
Automation Runtime.....	301
Automation Runtime Embedded.....	301
Automation Runtime Windows.....	301

B

B&R Automation Device Interface.....	302
B&R CompactFlash.....	335
B&R Control Center.....	302
B&R Embedded OS Installer.....	285, 300
B&R Key Editor.....	316
Battery status evaluation.....	70, 399
beep codes.....	270
BIOS 945GME	
ACPI configuration.....	233
Advanced.....	232
Baseboard/Panel features.....	254
Baseboard monitor.....	256
Boot.....	258
Chipset settings.....	242
Clock configuration.....	243
CPU board monitor.....	253
CPU configuration.....	241
Exit.....	263
Graphics configuration.....	239
Hard disk security master password.....	261
Hard disk security user password.....	260
I/O interface configuration.....	243
IDE configuration.....	244
Keyboard/Mouse configuration.....	250
Legacy devices.....	257
Main.....	231
Panel control.....	255
PCI configuration.....	234
PCI Express configuration.....	237
Power.....	261
Remote access configuration.....	251
Security.....	259
USB configuration.....	249
BIOS default settings.....	264
BIOS error signals.....	270
BIOS Setup keys.....	230
BIOS upgrade.....	276

C

Cable connections.....	189
Cables.....	377
DVI cables.....	377
SDL cables.....	380
SDL cables with 45° male connector.....	383
SDL flex cables.....	386
SDL flex cables with extender.....	389
USB cables.....	393
Card slots.....	66
CE mark.....	318
Certifications.....	319
ATEX.....	319
Germanischer Lloyd.....	321
UL.....	319

UL Haz. Loc.....	319
Changing the battery.....	399
climate-controlled chamber.....	194
CMOS profile switch.....	68
COM1.....	58, 58
COM2.....	58, 58
CompactFlash	
Benchmark.....	338
CompactFlash cards.....	329
CompactFlash slot.....	72, 72
Complete system.....	31
Configuration	
Base system.....	29
Optional components.....	30
Connecting an external device.....	432
Control Center.....	191, 302
CPU boards.....	106
Creating reports.....	302

D

deflect disturbances.....	190
Device interfaces.....	57
Dimensions	
1-slot APC810.....	80
2-slot APC810.....	87
3-slot APC810.....	94
5A5003.03.....	352
5MD900.USB2-02.....	350
5-slot APC810.....	101
Standard half-size PCI cards.....	66
Standard half-size PCIe cards.....	66
Dimension standards.....	22
Disposal.....	21, 21
Distribution of resources	
I/O address assignments.....	271
dongle.....	71
Drives.....	112
dual-channel memory.....	111
DVI.....	59
DVI cables.....	377
DVI resolution.....	60
Dynamic wear leveling.....	329

E

Electromagnetic compatibility.....	318
Embedded OS Installer.....	285
EMC directive.....	318
ESD.....	19
Electrical components with a housing.....	19
Electrical components without a housing.....	19
Individual components.....	19
Packaging.....	19
ETH1.....	61
ETH2.....	62
Ethernet.....	61, 62
evaluate the temperature.....	192
Evaluating temperatures.....	191
example programs.....	194
External device.....	432

F	
Fan control.....	430
Fan kit.....	170
Firmware upgrade.....	279
Flex radius.....	189
Flex radius specifications.....	189
Functional ground.....	190
G	
General tolerance.....	22
Germanischer Lloyd.....	321
GL certification.....	321
Ground connection.....	190
Grounding.....	57, 190
Guidelines.....	22
H	
Hardware security key.....	71
Heat sinks.....	109
HMI Drivers & Utilities DVD.....	358
Humidity specifications.....	39
I	
I/O address assignment.....	271
immunity to disturbances.....	190
implementation guide.....	194
Installation.....	186
Installing and replacing fan kits.....	406
Installing and replacing slide-in compact drives.....	402
Installing and replacing slide-in drives in a slide-in slot.....	403
Installing a slide-in compact adapter.....	404
Installing the HDD replacement disk tray.....	427
Installing the ready relay /2.....	428
Installing the side cover.....	422
Installing the UPS fuse kit.....	420
Installing the UPS module.....	408
Interfaces.....	57
Interrupt assignment.....	271
K	
Key Editor.....	316
L	
LED.....	68
LED status indicators.....	68
Line filter.....	369
loopback plug.....	193
Low battery.....	309, 311
Low voltage directive.....	318
M	
Main memory.....	111
Maintenance Controller Extended.....	430
Manual history.....	14

MIC, Line IN, Line OUT.....	64
Monitor/Panel interface.....	59
Mounting orientation.....	187
mounting plates.....	186
MS-DOS.....	286
MTCX.....	430

O

Operating system	
Windows 7.....	289
Windows CE.....	299
Windows Embedded Standard 2009.....	294
Windows Embedded Standard 7.....	296
Windows XP Embedded.....	292
Windows XP Professional.....	287

P

Parity error.....	270
PCI.....	371
PCI / PCIe.....	66
Peripheral USB devices.....	220
plug-in card.....	371
Power button.....	69
Power connectors.....	326
Power failure.....	311
Proper ESD handling.....	19

R

RAM address assignment.....	271
Relative humidity.....	39
Replacing a CompactFlash card.....	401
Replacing a PCI SATA RAID hard disk.....	425
Reset button.....	69
Resolution.....	106
Reversed battery polarity.....	306
RS232 cables.....	394

S

Safety notices.....	19
Environmental conditions.....	20
Environmentally friendly disposal.....	21
Installation.....	20
Intended use.....	19
Operation.....	20
Policies and procedures.....	19
Protection against electrostatic discharge.....	19
Separation of materials.....	21
Transport and storage.....	20
SDL.....	59
SDL cables.....	380
SDL cables with 45° male connector.....	383
SDL flex cables.....	386
SDL flex cables with extender.....	389
SDL resolution.....	59, 176, 199, 206, 208, 210, 213, 216
Security key.....	71
Sensor.....	38
serial interface.....	58, 58

Serial number sticker.....	47, 47
Slide-in slot.....	73, 73
Smart Display Link.....	59
software versions.....	302
spacing.....	188
Standards and guidelines.....	318
Static wear leveling.....	329
supply voltage.....	57, 190
Supply voltage block diagram.....	40

T

Temperature monitoring.....	430
Temperature monitoring - Fan control.....	430
Temperature sensor locations.....	38
Temperature specifications.....	31
temperature testing.....	191
Temperature testing instructions.....	191
Temperature testing procedure.....	191

U

UL certification.....	319
UL Haz. Loc. Certifications.....	319
Uninterruptible power supply.....	361
Upgrade	
BIOS.....	276
Firmware.....	279
Upgrade information.....	276
Upgrade problems.....	285
UPS.....	361
Changing the battery settings.....	306
Changing the shutdown time.....	309
Changing the UPS shutdown time.....	310
Configuring UPS system settings.....	308
Displaying UPS default values.....	305
Installing the UPS service.....	305
Low battery shutdown.....	311
Overcurrent shutdown.....	311
power failure.....	311
Saving battery settings.....	308
Standard shutdown.....	311
Updating battery settings.....	307
UPS configuration.....	305
UPS configuration.....	305
UPS fuse kit.....	420, 420
USB cables.....	393
USB flash drive.....	354
USB interfaces.....	63
USB media drive.....	343
user serial ID.....	302

W

WES2009.....	294
WES7.....	297
Windows 7.....	289
Windows CE.....	299
Windows CE 6.0 features.....	299
Windows Embedded Standard 2009.....	294
Windows Embedded Standard 7.....	296
Windows XP Embedded.....	292

Windows XP Professional..... 287