

DMP 96 A - ...-2P

from program version: **01394 ... 01397,**
013B0 ... 013B3,
013A9, 013U0, 013U1

Input:
 ...: **P1...P5: Pt 100 -150...600°C**
L1...L2: Fe-CuNi Type L 0...850°C
J1...J2: Fe-CuNi Type J 0...850°C
K1...K2: NiCr-Ni Type K 0...1200°C

as **Single channel controller**
2P: Two-point controller

Option: two limit-value contacts

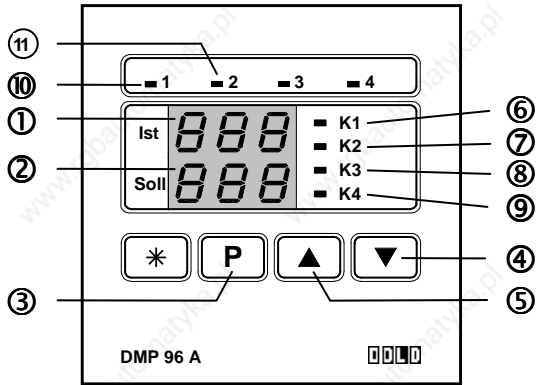

Installation and operation of the unit

Operating and display elements

- ① Actual value display in operating mode, parameter display in input mode
- ② Nominal value display in operating mode, parameter value in input mode
- ③ Jump to input level and operating level, confirmation key, keying through the parameters on one level
- ④ Reducing code value, parameter value
- ⑤ Increasing code value, parameter value
- ⑥ LED is lit if output K 1 is active
- ⑦ LED is lit if output K 2 is active
- ⑧ LED is lit if output K 3 is active (option)
- ⑨ LED is lit if output K 4 is active (option)
- ⑩ LED is lit if nominal value 1 is activated
- ⑪ LED is lit if nominal value 2 is activated

Safety notes

Please read these notes on safety attentively and note the listed points! They concern the safety of persons and of the equipment!

The unit is conceived mainly as a temperature controller. However, it can also be used for other, slow changing physical dimensions, where one measurement per second is sufficient for accurate function. The logical cohesion of the temperature controller must then be transferred to the appropriate dimensions. Substantial damage to persons and property can be caused through improper use, application, installation, configuration or operation within a plant! Important! The unit must not be used as a safety device, it serves as process controller, process control as well as process monitoring!

The unit must not be installed in the EX-area! If everything with process dimensions from the EX-area and the unit is installed outside the EX-area, all supply lines of the unit, which lead into the EX-area, must be directed over safety barriers!

The satisfactory and safe operation of the unit presupposes, that the unit is transported, stored and installed with due care and that it is properly fitted.

This unit must be installed, configured, commissioned and parameters have been setting by qualified persons only, who are familiar with the installation, commissioning and servicing or comparative units, as well as with the installation, for which the unit is used and must have knowledge of measuring control and regulating methods.

The operating personnel of the plant, in which the unit is to be used, must be instructed in its operation by qualified persons.

Please note

- the contents of these manual, especially the notes of installation, commissioning and adaptation of the unit to the controlling system,
- the safety regulations affixed to the unit,
- the respective safety regulations for the installation and the operation of electric plant,
- keep these manual for later applications.

The regulations mentioned in these manual are valid for all EC countries. For application in a country outside the EC, the appropriate national regulations must be observed.

This unit has been manufactured and tested according to DIN EN 61010 part 1 "protection measures for electronic measuring units", and has left our factory in a safety and operational technical satisfactory condition.

Order code (identification of the unit)

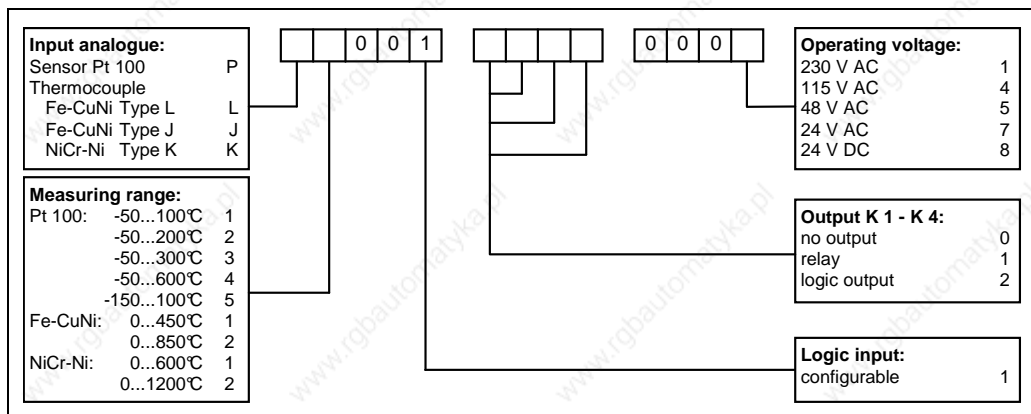

Rating plate

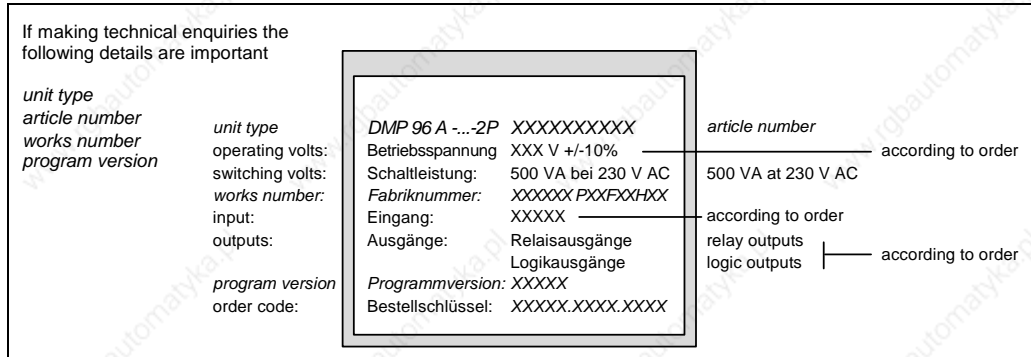

Mounting location of the unit

The mounting location must be free from vibrations. The unit must not be mounted in the proximity of motors, transformers, valves and other inductive loads. The ambient temperature at the mounting location can be 0...50°C with a relative humidity of ≤ 75% (without dewing). Aggressive gases and vapours can quickly destroy the unit. Any fitting position is suitable.

Fitting of the unit

- Insert the unit from the front side into the control panel cutout
- Suspending the fastener in the lateral nipple of the grip by the back of the control panel
- Thereby the flat sides of the fastener must border of the housing
- The fastener must be tighten against the back of the control panel symmetrical with a screwdriver
- Any fitting position is suitable.

Please note: Don't resort to force!

Installation notes

Please read the installation notes attentively and observe all listed points when installing the unit. If these notes are ignored, function interferences can occur, the required EMV guide lines are not complied with, and CE-conformity is no longer fulfilled. Ensure before connecting and commissioning of the unit, that the operating voltage and the required operating voltage ratio of the unit comply with those at the location (see rating plate and technical data). If necessary, carry out the appropriate measures.



Ensure that the control voltage and load voltage at the location is switched off and secured against switch on for the period of installing the unit. The electrical connections are to be carried out in accordance with the connection diagram and the appropriate national regulations. Use multi core cable end at wiring with flexible jumper wire. Arrange the supply lines to the unit in such a way, that they are free from tensile load under all conditions and that they are not in any possible danger of being cut-off or crushed.

Shielded cables must be used for sensor leads, for thermocouples shielded compensatory leads. The sensor leads must be arranged spatially separated from the load leads and control leads (power lines).

Compensatory leads for thermocouples must not be intermediately clamped with normal clamps, as otherwise additional thermocouples are created, which could falsify the measuring result! Connect the shield of the sensor lead with the unit as close as possible to the fitting board and lay the lead with a minimum of 1.5 mm² cross-section from this point to the earthed collecting bar.

Inductive loads, such as contactors, valves, motors, transformers etc., switched from the unit, as well as inductive loads installed in the same control cabinet or in the same plant, must be suppressed with unit-specific interference suppressers! The load circuits and control circuits of the unit relays must be fused against overload.

These manual do not contain all notes on the regulations, standards etc., which must be observed and followed when working with the unit in connection with plants. These regulations, standards etc. must be compiled and observed by the operator of the unit, application-specific.

Terminal connection diagram (in dependence on version)

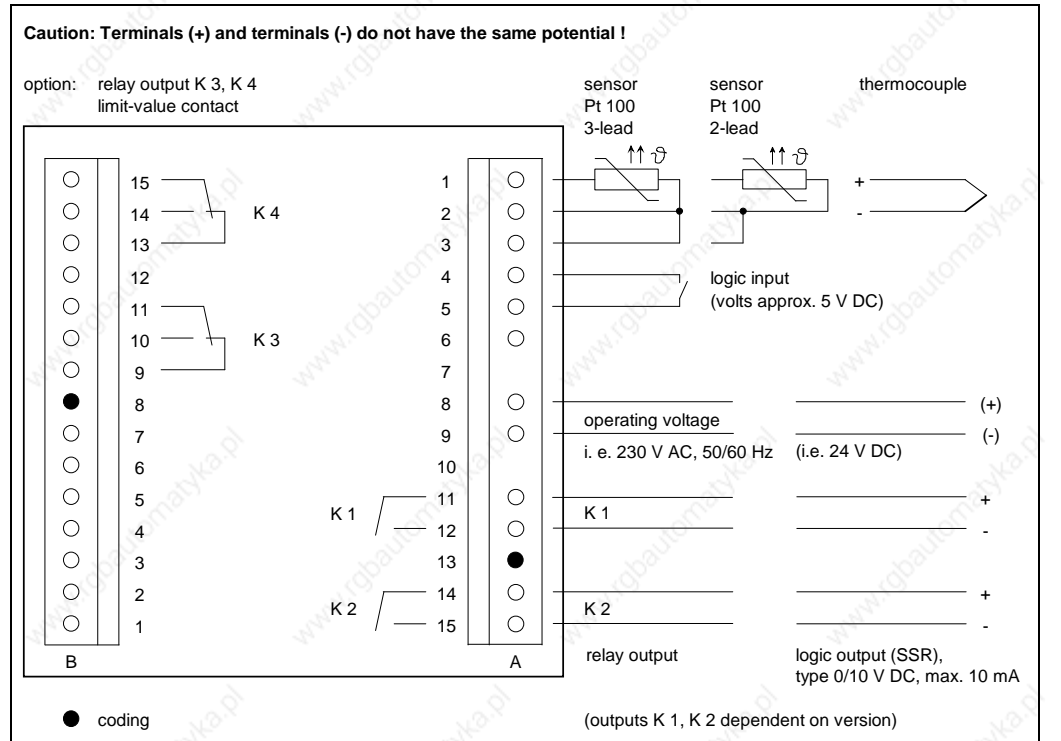

Wiring diagram (Wiring example)

To enable effective discharge of interferences the shielding of the sensor leads and signal leads must be connected to earth at the side of the unit.

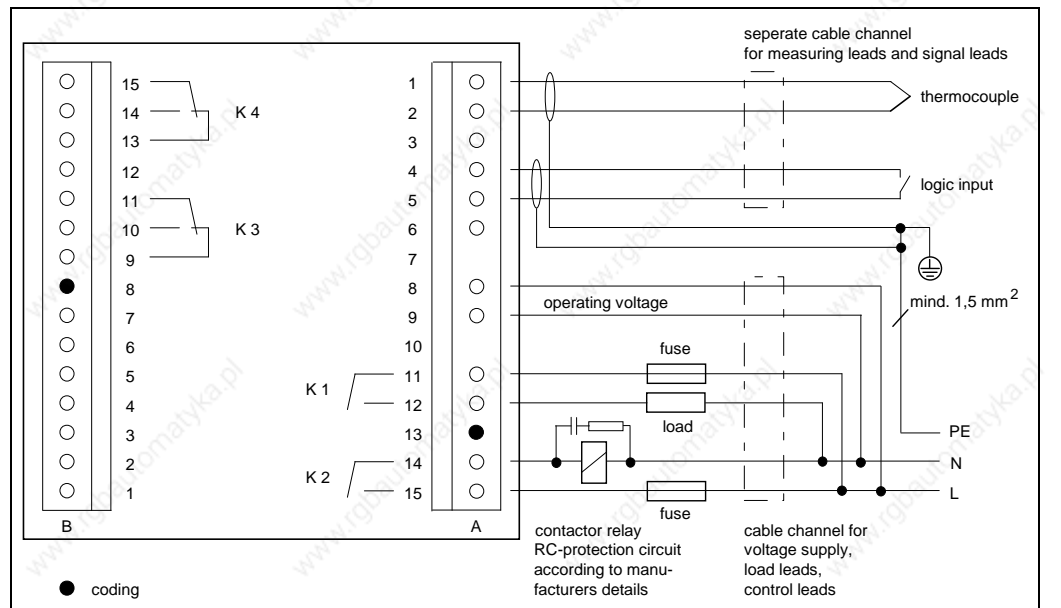

Commissioning and adaptation of the unit

The unit is supplied pre-configured to an application, so by switching on some function is present. This pre-configuration is suitable for the given requirements in only a few cases, it means, the unit must be adapted to the controller system of the plant, in which it is to be used.

Switch on



Check the wiring again carefully! Incorrect wiring of the unit can lead to serious damage to the unit and the plant! Ensure that the load voltage of the plant is switched off at the initial switch on of the unit, because the unit is not yet adapted to the plant and can therefore possibly cause error functions.

Now switch on the operating voltage of the unit.

Lead balancing or zero point correction

When operating the unit with a resistance thermometer with the two wire method, the lead resistance, as well as a safety barrier, is noticeable through a constant temperature measuring error. This temperature measuring error can be corrected on the configuration level (code 155) with the parameter "Cor". Furthermore, the temperature difference between the temperature of the measuring point, the temperature sensors, the unit and the temperature of the process can be equalised with this parameter.



Temperature differences between measuring point and process should be kept to a minimum by selecting the measuring point! This substantially improves the controller result! When the temperature sensor is fitted improperly, overheating or under cooling can occur, and therefore, damage to personnel or material!

Setting the operating nominal value

Depending on configuration of the parameter "Co.u" at the configuration level (code 155) you can set your operating nominal value at the operating level or at the nominal value input level (code 77).

Please note

If the nominal value is taken out of adjustment during the operation of the plant, then the plant must first build-up to the new value! It means, there will be some instability in the regulation, until the actual value has set itself to the new nominal value. During operation as PID controller with relay output, it can be some time after switch on before the controller relay responds and the unit is seen to carry out its task, due to the PID typical time character!

Configuration and programming of the unit

Parameter setting at the various levels

	current value: +1 after approx. 3 s +10 after approx. 6 s +100
	current value: -1 after approx. 3 s -10 after approx. 6 s -100
	enter

After accepting the last parameter, jump back into operating mode. If within approx. 20 seconds (timeout) no key is activated, automatic jump back to operating mode. The possibly altered value is not accepted. With the star key the timeout can be restarted (extended). If an incorrect code number is accepted for jumping to a level, you have to wait for timeout and for the jump back to operating mode before you can input a new code number (approx. 20 seconds). After this a new code input can be carried out.

The operating structure

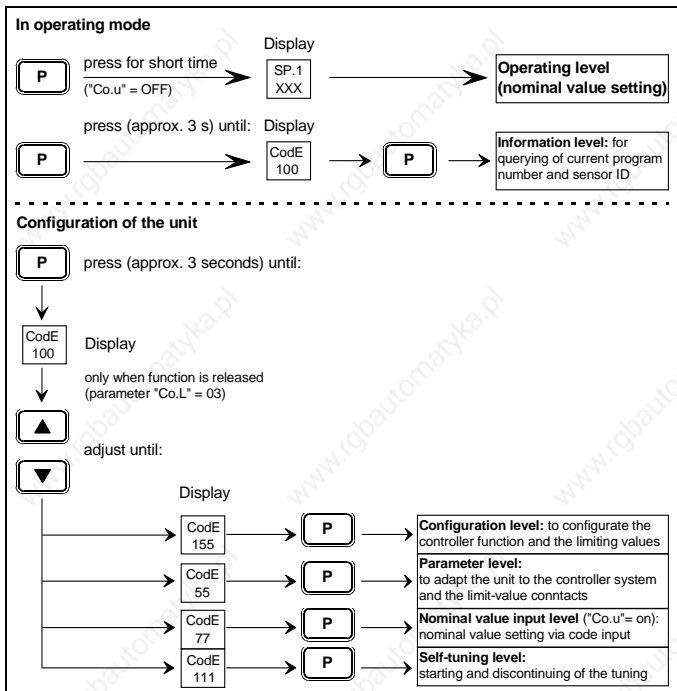

Parameters of the configuration level (code 155)	Display / Works setting
After changing configuration or re-configuration the controller character and the switching function of the limit contacts, the appropriate parameters must be set at the parameter level (code 55) or be adapted to the controlled system. After any change of configuration or reconfiguration of the setpoint range (parameters "rA.H" and "rA.L") the setpoint settings at the operating level or at the nominal value input level (code 77) must be checked and adapted to the setpoint range.	"Con"
Lead balancing or zero point correction	"Cor" / 0.0°C
Nominal value range end Adjustment range: Maximum setpoint range according to sensor ID	"rA.H" / maximum setpoint range
Nominal value range start Adjustment range: Maximum setpoint range according to sensor ID. With configuration "rA.L" = "rA.H" nominal value setting at the operating level or at the nominal value input level is not possible. With configuration "rA.H" < "rA.L" switching between the set values at the operating level or at the nominal value input level is possible with the buttons or .	"rA.L" / 0.0°C
Configuration control output or limit comparator K 1 01: cooling controller with hysteresis setting to higher temperature 02: cooling controller with PID-character 03: limit comparator closed in goodband 04: heating controller with hysteresis setting to lower temperature 05: heating controller with PID-character 06: limit comparator open in goodband	"Co.1" / 05
Configuration limit-value contact output K 2 output K 3 (option) output K 4 (option) 00: output no function 01: limit contact absolute, make contact referenced to increasing temperature 02: limit contact following to the nominal value, make contact referenced to increasing temperature 03: limiting comparator in the approval range closed 04: limit contact absolute, break contact referenced to increasing temperature 05: limit contact following to the nominal value, break contact referenced to increasing temperature 06: limiting comparator in the approval range open	"Co.2" / 00 "Co.3" / 00 "Co.4" / 00
Error allocation output K 1 - K 4 output K 1 output K 2 output K 3 output K 4 on: output active in event of an error OFF: output inactive in event of an error	"Fd.1" / OFF "Fd.2" / OFF "Fd.3" / OFF "Fd.4" / OFF
Incorrect error allocation at the outputs can, in the event of an error, cause substantial damage to persons and property!	
Nominal value setting on: nominal value setting via nominal value input level (code 77) OFF: nominal value setting via operating level	"Co.u" / OFF
Display resolution 00: resolution 0.1°C 01: resolution 1°C	"rES" / 00
Configuration logic input (the contact must be opened or closed for a minimum of 0.5 seconds, so that the required function occurs). 00: logic input no function 01: switching nominal value burden contact open nominal value 1 contact closed nominal value 2 02: stop function contact closed controller output K 1 deactivated and lower display dark 03: programming disabled contact closed programming enabled contact closed programming disabled	"Co.L" / 00

Parameters of the parameter level (code 55)	Display / Works setting
In dependence of configuration only those parameters become accessible, which are required for the appertaining function.	"PAr"
K 1 Output with hysteresis ("Co.1" = 01, 04) hysteresis	"HY.1" / 1.0°C
K 1 Output with PID-character ("Co.1" = 02, 05) proportional band (refer to max. setpoint range by sensor ID) integral time (setting 0 = portion 0) derivative time (setting 0 = portion 0) cycle time Set the PID return parameter according to your experiences or your measurements or start a self-tuning.	"Pb.1" / 5.0% "ti.1" / 250 s "td.1" / 50 s "CY.1" / 30 s
K 1 Limiting comparator ("Co.1" = 03, 06) symmetric spreading (hysteresis 0.5°C fix)	"bd.1" / 5.0°C
K 2 Limit contact absolute ("Co.2" = 01, 04) limit absolute hysteresis	"LA.2" / 0.0°C "HY.2" / 1.0°C
K 2 Limit contact following to the nominal value ("Co.2" = 02, 05) limit relative hysteresis	"Lr.2" / 0.0°C "HY.2" / 1.0°C
K 2 Limiting comparator ("Co.2" = 03, 06) symmetric spreading (hysteresis 0.5°C fix)	"bd.2" / 5.0°C
K 2 Limit contact ("Co.2" = 00) limit contact no function	"noP"
K 3 Limit contact absolute ("Co.3" = 01, 04) limit absolute hysteresis	"LA.3" / 0.0°C "HY.3" / 1.0°C
K 3 Limit contact following to the nominal value ("Co.3" = 02, 05) limit relative hysteresis	"Lr.3" / 0.0°C "HY.3" / 1.0°C
K 3 Limiting comparator ("Co.3" = 03, 06) symmetric spreading (hysteresis 0.5°C fix)	"bd.3" / 5.0°C
K 3 Limit contact ("Co.3" = 00) limit contact no function	"noP"
K 4 Limit contact absolute ("Co.4" = 01, 04) limit absolute hysteresis	"LA.4" / 0.0°C "HY.4" / 1.0°C
K 4 Limit contact following to the nominal value ("Co.4" = 02, 05) limit relative hysteresis	"Lr.4" / 0.0°C "HY.4" / 1.0°C
K 4 Limiting comparator ("Co.4" = 03, 06) symmetric spreading (hysteresis 0.5°C fix)	"bd.4" / 5.0°C
K 4 Limit contact ("Co.4" = 00) limit contact no function	"noP"

Nominal value input level (code 77)	Display / Works setting
Setting the nominal value is only possible with code input, if parameter "Co.u" is on at the configuration level.	"uSr"
Nominal value 1	"SP.1" / 0.0°C
Nominal value 2 (appears only with configuration "Co.L" = 01)	"SP.2" / 0.0°C

Nominal value setting via operating level	Display / Works setting
Nominal value 1 ("Co.u" = OFF)	"SP.1" / 0.0°C
Nominal value 2 ("Co.u" = OFF, "Co.L" = 01)	"SP.2" / 0.0°C

Information level	Display
Querying of current program number and sensor-ID in the information level.	"inF"
Current program number	"Pnr"
Sensor ID as in table	"SEn"

Sensor-ID:

Sensor ID:	ID by ordering key:	Sensor:	Max. display range:	Max. setpoint range:
P 1	P 1	Pt 100	-69...149°C	-50...100°C
P 2	P 2	Pt 100	-69...249°C	-50...200°C
P 3	P 3	Pt 100	-69...349°C	-50...300°C
P 4	P 4	Pt 100	-69...699°C	-50...600°C
P 5	P 5	Pt 100	-169...149°C	-150...100°C
tL1	L 1	Fe-CuNi Type L	-24...499°C	0...450°C
tL2	L 2	Fe-CuNi Type L	-24...899°C	0...850°C
tJ1	J 1	Fe-CuNi Type J	-24...499°C	0...450°C
tJ2	J 2	Fe-CuNi Type J	-24...899°C	0...850°C
tn1	K 1	Ni Cr-Ni Type K	-24...649°C	0...600°C
tn2	K 2	Ni Cr-Ni Type K	-24...1299°C	0...1200°C

Adapting the PID controller automatically to the controlled system - the self-tuning

- set nominal value and tune the controller
- let controller stabilise and operate the plant
- evaluate controller efficiency and correct controller parameters if necessary.

Please note

The self-tuning works according to the setting rules of Ziegler-Nichols. With controlled systems of a higher order and with controlled systems with greater dead times and delay times, it does not always lead to optimal results. The controller parameters must be corrected only with greater actual value fluctuations after self-tuning. The tuning on the heating is only possible, if heat is removed from the system, so that the temperature falls again below the nominal value. The tuning on the cooling side is only possible, if the system develops its own heat, so that the temperature after cooling rises above the nominal value by itself.

To correct the controller parameters yourself, you will need in-depth knowledge of regulating methods!

Lifetime of the relays!

For tuning the algorithm use a correcting setpoint which is spread by the value set for the setpoint (parameter "HLP"). This corrected setpoint prevents temperature peaks occurring above the setpoint during optimization from damaging the controlled commodity. The tuning difference must be adjusted to the specific application.

The self-tuning level (code 111)	Display / Works setting
Setting the parameters tuning "OPt" and correcting setpoint "HLP" before start up the self-tuning in this level.	"tun"
Correcting setpoint 70...100 % for heating 100...130 % for cooling	"HLP" / 90 %
Start up by key enter by key	OPt on
Discontinuation by key enter by key	OPt OFF



During self-tuning extreme conditions can occur in the plant. The self-tuning procedure must be monitored continuously. After self-tuning the parameter "CY.X" at the parameter level must be checked.

Lifetime of the relays!

Inspections of the tuning

The inspection of the tuning is important for the correct setting of the process. The inspection of the settings can be carried out by observation of the controller procedure or by recording the controller curve with a suitable recording apparatus.

Lifetime of the relay

Period per switching cycle	Period, after which the 10 ⁶ switching cycles are reached (8 hour/day operation with 500 VA load)
2 minutes	approx. 11.4 years
60 seconds	approx. 5.7 years
30 seconds	approx. 2.8 years

This table is not valid for SSR relays (solid state relays)

Error messages

Display	Error
Er.1	Pt 100: falling below range, exceeding range, sensor faulty (interruption or short circuit), thermocouple: falling below range, exceeding range, sensor faulty (interruption), sensor lead (balancing lead) cross-polarity, ambient temperature of the unit > 70°C or < -10°C
Er.9	System error (switch unit off/on)

The switching character of the limit contacts

Switching functions in reference to rising actual value. The shaded areas identify those areas, in which the output relay is active, it means, if it is closed.

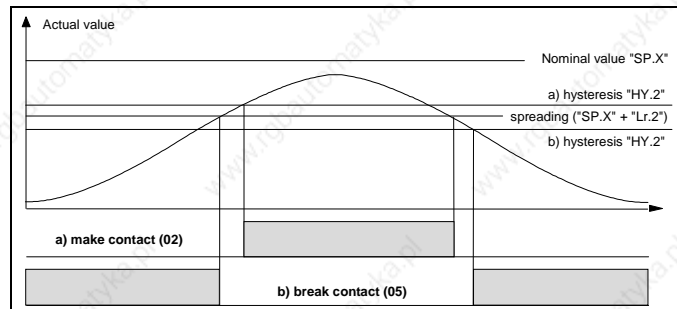

Example: Limit contact K 2 following to the nominal value

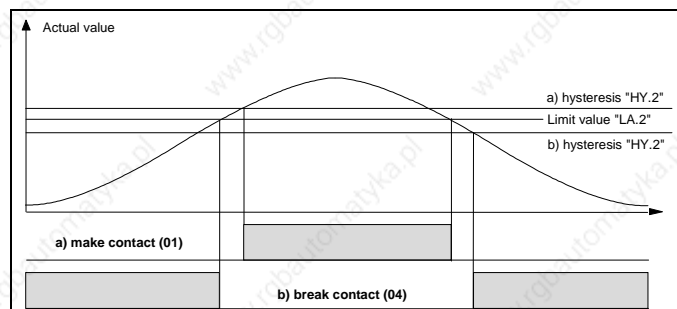

Example: Limit contact K 2 absolute

Technical data

Input analogue
Pt 100 two-wire lead, three-wire lead range according to sensor ID
two-wire lead switching: circuit balancing maximum 9 Ω
three-wire lead switching: wire resistance compensation maximum 50 Ω each lead
Thermocouple
Fe-CuNi Type L range according to sensor ID
Fe-CuNi Type J range according to sensor ID
Ni Cr-Ni Type K range according to sensor ID

Common data
measuring cycle resolution 1 s
≥ 12 Bit

Logic input external, potential free contact, contact voltage approx. 5 V DC

Outputs
2 Relay outputs K 1 and K 2, make contact
2 Relay outputs (option) K 3 and K 4, change over
contact load ≤ 250 V AC, ≤ 8 A resistive load, type 500 VA with 10⁶ switching cycles or **Logic outputs** for SSR instead of K 1 or K 2 (typ. 0/10 V DC, max. 10 mA)

Energy supply
Operating voltage 230 V AC ± 10%, 48...62 Hz
Rate of power input ≤ 4 VA
Special voltages: 115 V AC, 48 V AC, 24 V AC, 24 V DC, other special voltages ask the producer, protection: the unit has a built-in thermal protection

Climatic requirements
according to 75% relative humidity without dewing
working temperature range 0...+50°C
storage temperature range -30...+70°C

Electric safety
according to DIN EN 61 010
excess voltage category III
degree of contamination 2 according to DIN EN 60 335
protection class II
isolation group C according to DIN VDE 0110 b
type of protection DIN EN 60 529 IP 50
front panel (optionally: IP 54 with the proper mounting and a suitable sealing ring) IP 50
housing IP 30
connections IP 20
Terminal connections: screwed socket strips nominal cross section 2.5 mm²

Housing, mounting
Pull-out housing for mounting control panel as per DIN 43 700 with a B fastener as per DIN 43 835 (M 4 screw clamp)
Material: PPO, glass-fiber reinforced (Noryl GFN2SE1), self-extinguishing, non-dripping, fire protection class UL 94 V1
Front panel dimensions 96 x 96 mm
Control panel cutout 92^{+0.8} x 92^{+0.8} mm
Recess depth 91 mm

CE - conformity
Interference emission trade EN 50 081-1
industry EN 50 081-2
Interference immunity trade EN 50 082-1
industry EN 50 082-2
IEC 801-2
IEC 801-3
IEC 801-4

Subject to technical and functional change.