



Hardware and Engineering

PS 4-271-MM1

06/99 AWB 2700-1364 GB

1st published 1999, edition 06/99

© Moeller GmbH, Bonn

Author: Peter Roersch

Editor: Thomas Kracht

Translators: B & H, Terence Osborn

For Immediate Delivery call KMParts.com at (866) 595-9616



Caution!

Dangerous electrical voltage!

Before commencing the installation

- Disconnect the power supply of the device.
- Ensure that the device cannot be accidentally restarted.
- Verify isolation from the supply.
- Earth and short circuit.
- Cover or enclose neighbouring units that are live.
- Follow the engineering instructions (AWA) of the device concerned.
- Only suitably qualified personnel may work on this device/system.
- Before installation and before touching the device ensure that you are free of electrostatic charge.
- Connecting cables and signal lines should be installed so that inductive or capacitive interference do not impair the automation functions.
- Install automation devices and related operating elements in such a way that they are well protected against unintentional operation.
- Suitable safety hardware and software measures should be implemented for the I/O interface so that a line or wire breakage on the signal side does not result in undefined states in the automation devices.
- Ensure a reliable electrical isolation of the low voltage for the 24 volt supply. Only use power supply units complying with IEC 60 364-4-41 or HD 384.4.41 S2.
- Deviations of the mains voltage from the rated value must not exceed the tolerance limits given in the specifications, otherwise this may cause malfunction and dangerous operation.
- Emergency stop devices complying with IEC/EN 60 204-1 must be effective in all operating modes of the automation devices. Unlatching the emergency-stop devices must not cause uncontrolled operation or restart.
- Devices that are designed for mounting in housings or control cabinets must only be operated and controlled after they have been installed with the housing closed. Desktop or portable units must only be operated and controlled in enclosed housings.
- Measures should be taken to ensure the proper restart of programs interrupted after a voltage dip or failure. This should not cause dangerous operating states even for a short time. If necessary, emergency-stop devices should be implemented.

IBM is a registered trademark of International Business Machines Corporation.

All other brand and product names are trademarks or registered trademarks of the owner concerned.

All rights reserved, including those of the translation.

No part of this manual may be reproduced in any form (printed, photocopy, microfilm or any other process) or processed, duplicated or distributed by means of electronic systems without written permission of Moeller GmbH, Bonn.

Subject to alterations without notice.

For Immediate Delivery call KMParts.com at (866) 595-9616

Contents

Contents	1
About This Manual	3
Documentation for PS 4-271	3
Symbols used	4
1 About the PS 4-271 Compact PLC	5
Hardware and software requirements	5
Features	5
Setup	6
Elements of the PS 4-271	8
2 Engineering	15
Overview of terminals	15
Programming device interface	16
Suconet K interface	17
Setting of bus terminating resistors	18
Local expansion	18
Electromagnetic compatibility (EMC)	19
Layout of control cabinet	22
Power supply	26
Lightning protection measures	28
3 Mounting	29
Mounting on top-hat rail	29
Mounting with mounting feet	30
4 Software Configuration	31
General	31
Creating configurations	31
Setting the parameters of the PS 4-271	35
Configuration example	47
5 Slave Addressing	51
Slaves without CPU	51
Slaves with CPU	53

6 Operation	55
Power-up behaviour	55
Shutdown behaviour	55
Operating states of the PLC	56
Start-up behaviour	59
Transferring programs	61
Starting the PLC with a memory module plugged in	63
Programming via Suconet K	63
7 Test/Commissioning/Diagnostics	65
LEDs	65
Diagnostic status word	66
Diagnostic bytes	69
Message byte	75
8 Representation of Analog Values	77
Analog-digital conversion	77
Appendix	83
Slave addressing	84
Technical data	88
Index	95

About This Manual

Documentation for PS 4-271

The documentation for the PS 4-271-MM1 compact PLC (referred to below as the PS 4-271) is subdivided into four manuals with the following topics:

Hardware and engineering

User interface for the programming software

Programming

Training guide

Hardware and engineering manual

This “Hardware and engineering” manual explains how to install and configure the PLC and how to alter the settings on the PLC.

How to configure and set parameters for the PLC in the topology configurator of the SucoSoft S 40 programming software is described in the chapter entitled “Software configuration”.

The “Slave addressing” chapter defines the general syntax rules for addressing the stations in a Suconet K network.

The chapter “Test/Commissioning/Diagnostics” provides an overview of the possible error and diagnostic signals and their meanings.

User interface for the programming software

The PS 4-271 is programmed with version 3.0 or higher of the Sucosoft S 40 programming software (Windows, IEC 1131).

The user interface of this software is described in manual AWB 2700-1305 GB.

Programming

Information on how to program the PS 4-271 can be found in the “Language elements of the PS 4-150/-200/-300 and PS 416” manual (AWB 2700-1306 GB).

Training guide

The AWB 27-1307 GB training guide illustrates the most important functions of Sucosoft S 40 with the help of practical examples.

Symbols used

Symbols with the following meaning are used in this manual:



► Indicates instructions on what to do.



Draws your attention to useful tips and additional information.

Warning!

Warns of the possibility of damage. The product itself or anything in the immediate vicinity of the product or data could be damaged.



Caution!

Warns of the possibility of serious damage. The product itself, anything in the immediate vicinity of the product or data could be seriously damaged or destroyed; there is also a risk of serious or fatal injury.

1 About the PS 4-271 Compact PLC

Hardware and software requirements

To program the PS 4-271, you need a PC (IBM or IBM-compatible) equipped with

Pentium microprocessor

Operating system Windows 95, Windows 98 or Windows NT 4.0¹⁾

16 MByte RAM

(32 MByte recommended)

3.5"/1.44 MByte diskette drive and CD-ROM

Hard disk with at least 50 MByte free memory; during installation, the directory C:\{_PS 4_}.TMP will be created and then deleted again. To do this, there must be at least 250 kBytes available on drive "C".

Serial COM interface

Parallel printer interface (LPT)

VGA graphics card

ZB 4-303-KB1 programming cable (connecting cable between PC and PS 4-271)

- 1) (version 3.x of Sucasoft is the last version supported by Windows 3.1x).

Features

The PS 4-271 has the following distinguishing features:

120/240 V AC power supply

12 digital inputs 120/240 V AC

8 relay outputs

4 analog inputs

0 to 10 V, 0(4) to 20 mA

0 to 1500 Ω, e.g.: Pt1000, Ni1000

4 analog outputs (0 to 10 V, 0(4) to 20 mA)

Setup

Figure 1 provides an overview of the controls, indicators and connecting terminals of the PLC.



Warning!

Always ground yourself before touching the PLC to protect the components against electrostatic discharge.

Key to figure 1:

- ① 120/240 V AC power supply
- ② Digital inputs 120/240 V AC
- ③ Status LEDs for digital inputs 0.0 to 0.7
- ④ Plug-in screw terminal
- ⑤ Analog inputs AI₀, AI₁: 0 to 10 V/0(4) to 20 mA
- ⑥ Analog inputs AI₂, AI₃: Pt1000, Ni1000
- ⑦ Analog outputs AQ₀, AQ₁: 0 to 10 V
- ⑧ Analog outputs AQ₂, AQ₃: 0 to 20 mA
- ⑨ Status LEDs for digital inputs 1.0 to 1.3
- ⑩ Relay outputs (make contacts) 24 V DC or 250 V AC
- ⑪ Status LEDs for digital outputs C0 to C7
- ⑫ Suconet K interface
- ⑬ Setpoint potentiometers P1, P2
- ⑭ Switch S1 for bus terminating resistors
- ⑮ Programming device interface (PRG)
- ⑯ Memory module
- ⑰ Status LEDs for PLC

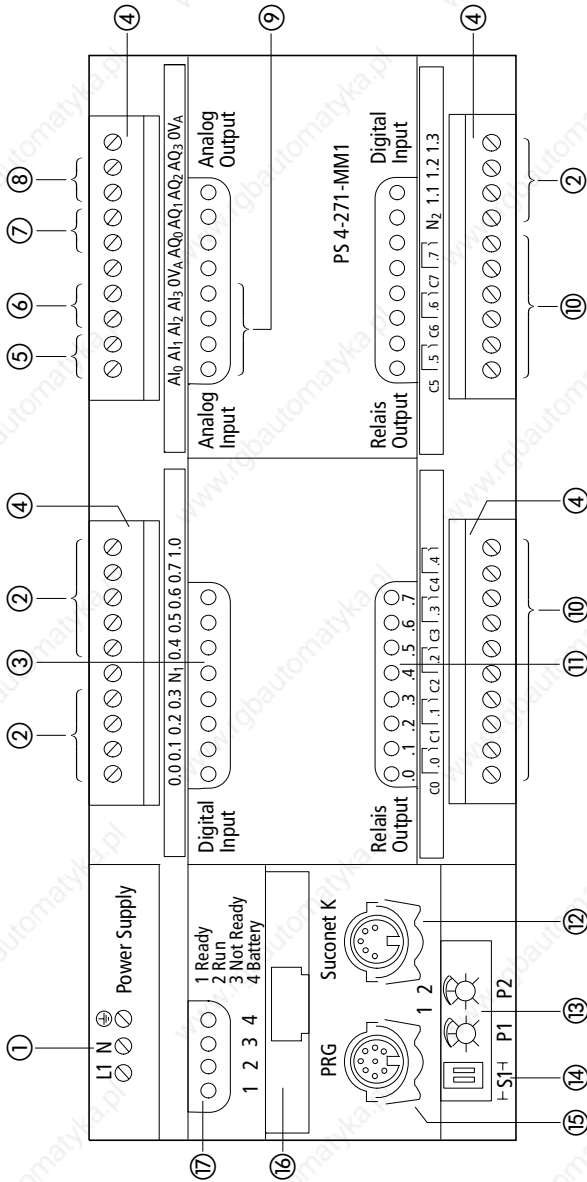

Figure 1: Setup of PS 4-271

Elements of the PS 4-271

① Power supply unit

The PS 4-271 requires a power supply rated at 120/240 V AC.

② Digital inputs

The PLC has 12 digital inputs. These are electrically isolated from the CPU and designed for a rated voltage of 120/240 V AC. The inputs I0.0 to I0.7 and I1.0 to I1.3 can be addressed in bits, bytes or words.

Three different external cables can be connected to the groups of input. Only one external cable should be used for each group..

Group	External cable
I0.0 to 0.3	1
I0.4 to I0.7 and I1.0	2
I1.1 to I1.3	3

The two neutral conductor terminals N1/N2 are isolated.

③, ⑨ Status LEDs for analog outputs

LEDs for inputs I0.0 to I0.7 indicate the physical, logical states of the signal inputs, as well as the diagnostic status word of the PLC (see the section entitled "Description of the diagnostic status word" on Page 67).

④ Plug-in screw terminal

Please refer to the chapter "Engineering" for a summary of terminals for the digital and analog inputs/outputs.

⑤, ⑥ Analog inputs

The PLC has 4 analog inputs. You can configure inputs AI₀ and AI₁ as voltage inputs (0 to 10 V) or current inputs (0(4) to 20 mA). The inputs AI₂ and AI₃ are provided for connecting temperature sensors such as Pt1000 or Ni1000. All inputs have a resolution of 10 bits (1024 increments).

The addresses of the analog inputs are as follows:

AI ₀	IAW0.0.0.4
AI ₁	IAW0.0.0.6
AI ₃	IAW0.0.0.8
AI ₄	IAW0.0.0.10

See also the chapter "Representation of Analog Values".

⑦, ⑧ Analog outputs

The PLC has 4 analog outputs. Outputs AQ₀ and AQ₁ generate signals of 0 to 10 V. Outputs AQ₂ and AQ₃ can be configured for 0(4) to 20 mA signals. You adjust the output range from 4 to 20 mA in the Sucosoft S 40 programming software.

All outputs have a resolution of 12 bits (4096 increments).

The addresses of the analog outputs are as follows:

AQ ₀	QAW0.0.0.0
AQ ₁	QAW0.0.0.2
AQ ₃	QAW0.0.0.4
AQ ₄	QAW0.0.0.6

See also the chapter "Representation of Analog Values".

⑩ Relay outputs

The PLC has 8 relay outputs, which are electrically isolated from the CPU. The terminals of all contacts are accessible. The contacts can take a load of up to 12 A and thus allow you to switch large loads.

The outputs can be addressed in bits or bytes.

⑪ **Status LEDs for the relay outputs**

LEDs (LEDs) indicate the logical states of the relay outputs.

⑫ **Suconet K interface**

The interface has the following functions:

Networking:

Network interface for Suconet K stations (e.g. for connecting Suconet K master or slave PLCs, EM 4-... expansion modules).

The programming of networks via Suconet K is described in the section entitled "Programming via Suconet K" on Page 63. The Suconet K interface (RS 485) is electrically isolated from the CPU.

Transparent communication:

Transparent communication for the exchange of data with partner devices which have a serial interface (e.g. printers, terminals, etc.). Data for process control must not be exchanged.

Transparent communication via the Suconet K interface is enabled by the "SCO" function block of Sucosoft S 40. A description of the function block can be found in the manual "Language elements of PS 4-150/-200/-300 and PS 416" (AWB 2700-1306 GB). The interface is electrically isolated from the CPU.

The parameters of the interface such as "baud rate", "parity", "stop bit" can be set in the topology configurator of Sucosoft S 40 via `·Edit → Set Parameters → Transparent mode·`.

A maximum of 127 bytes of data can be transferred.

⑬ Setpoint potentiometers

The two setpoint potentiometers P_1 and P_2 can be set externally with a screwdriver. This allows you to change setpoint values without a programming device. The resolution is 10 bits. In the programming software, you can address the setpoint potentiometers with the operands "IAW0.0.0.0" and "IAW0.0.0.2".

⑭ Switch S1 for setting the bus terminating resistors

The bus terminating resistors of the stations which are physically first and last on the bus must be turned on. The bus terminating resistors of stations between these two must be turned off (see section "Setting of bus terminating resistors" on Page 18).

⑮ Programming device interface (PRG)

The interface has the following functions:

Programming of the PLC with a PC

Data exchange with partner devices which have a serial interface (e.g. printers, terminals, etc.). Data for process control must not be exchanged.

Communication via the interface is controlled by the "SCO" function block of Sucosoft S 40. A description of the block can be found in the manual "Language elements of PS 4-150/-200/-300 and PS 416" (AWB 2700-1306 GB). The interface is electrically isolated from the CPU.

The parameters of the interface are fixed:

Baud rate: 9600 Baud
Data bits: 8
Stop bits: 1
Parity bits: 0
Max. transferrable data: 63 Byte

⑩ Memory modules

The PS 4-271 has an internal 32 kByte RAM memory with battery backup. The memory is subdivided into data and user program memory areas.

Up to 24 kByte are available for the user program. The storage space for data and user program is allocated dynamically: if the data memory requires more than 8 kByte, the size of the user program memory is reduced accordingly.

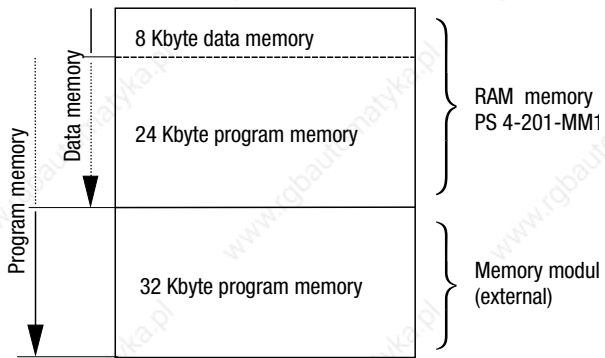

Figure 2: Dynamic memory allocation

The memory capacity of the internal RAM can be expanded with plug-in memory modules. The following modules are available:

The 32 kByte RAM module increases the size of the user program memory. There is then a maximum of 56 kByte of user program memory available.

The 128 kByte flash module is divided into a 64 kByte backup memory (the user program is stored instead of being reset in the event of voltage failure) and a 64 kByte memory - for recipe data, for example.

The 160 kByte combination module combines all the features of the above two memory modules.

17 Status LEDs for the PLC

The PLC states are indicated with the LEDs “Ready“, “Run“, “Not Ready” and “Battery“. The meaning of the indicators is described in the section "LEDs" on Page 65.

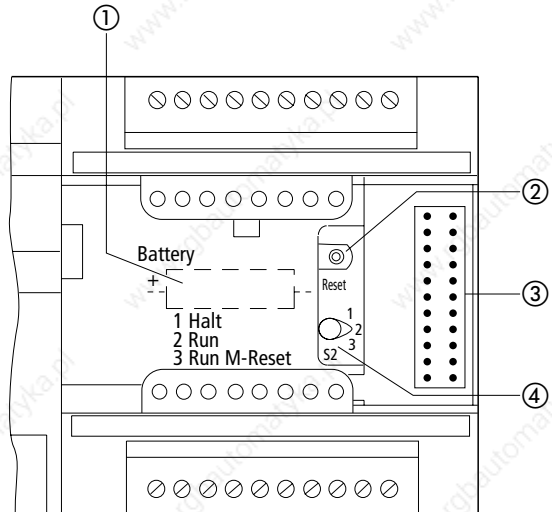

Figure 3: Controls and LEDs of the PS 4-271 (with cover open)

- ① Backup battery
- ② Reset button
- ③ Plug connector for local expansion module
- ④ Mode selector

① **Backup battery**

The battery backs up the internal RAM memory and the real-time clock.



Warning!

Only change the backup battery when the power supply is switched on or you will lose programs and data.

②, ④ **Mode selector/
Reset button**

With the mode selector, you can select between the modes “Halt“, “Run” and “Run M reset“. The modes are explained in the section entitled "Operating states of the PLC" starting on Page 56.

③ **Plug connector for local expansion modules**

The plug connector represents the interface to the terminals of LE 4-... local expansion modules.

Real-time clock

The PLC has a real-time clock with battery backup. It allows time-controlled switching of machines and plants. You can set or scan the real-time clock with a function block in the user program. The function block also enables switching between summer and winter time (DST).

2 Engineering

Overview of terminals

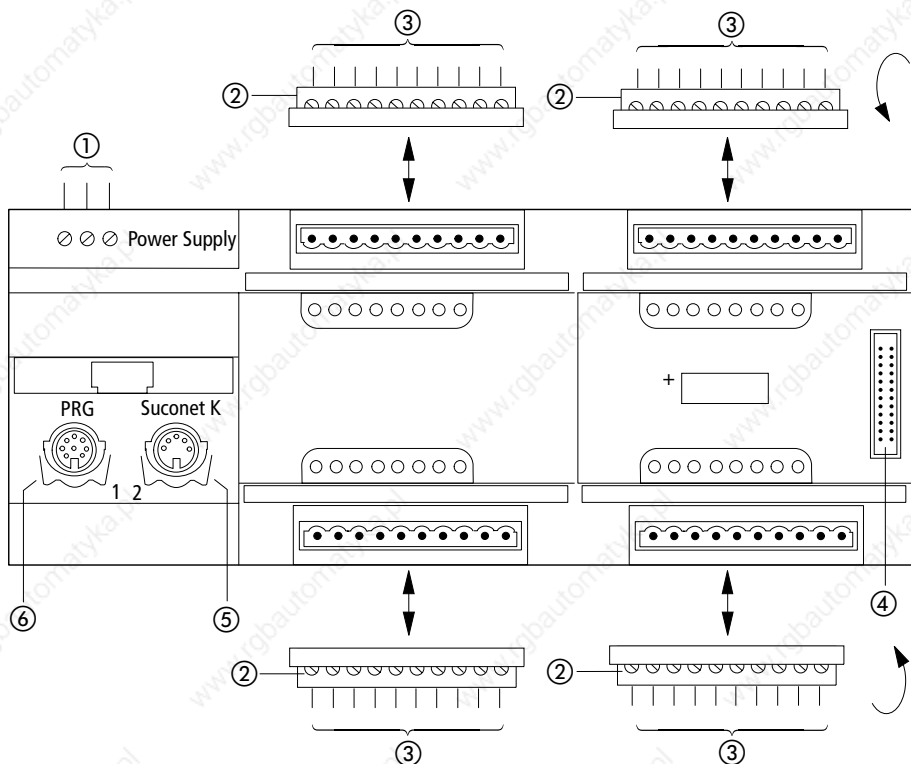

Figure 4: Overview of terminals

- ① Screw terminals, terminal capacities:
Flexible with ferrule - 0.22 to 2.5 mm² (AWG 24 to 13)
Solid - 0.22 to 2.5 mm² (AWG 24 to 13)
- ② Plug-in screw terminal
- ③ Terminal capacities:
Flexible with ferrule - 0.22 to 1.5 mm² (AWG 24 to 16)
Solid - 0.22 to 2.5 mm² (AWG 24 to 13)
- ④ Plug connector for local expansion module (LE 4)
- ⑤ Suconet K interface (RS 485)
- ⑥ Programming device interface (RS 232)

Programming device interface

Pin assignment of connector

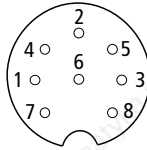

Figure 5: Pin assignment of programming device (PRG) interface (left-hand socket, top view)

PIN 1	Unused
PIN 2	RxD
PIN 3	0 V for interface
PIN 4	Unused
PIN 5	TxD
PIN 6 – 8	Unused

Connecting the programming device (PC)

► Connect the PC to the PRG interface by means of the ZB 4-303-KB1 programming cable (left-hand socket) of the PS 4-271:

PS 4-271-MM1:	PC:
PRG interface	COM interface
(8-pin DIN connector)	(9-pin socket)

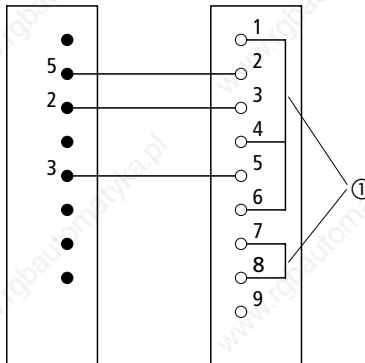

Figure 6: Pin assignment of ZB 4-303-KB1 programming cable

① Jumpers



Warning!

To prevent potential equalisation currents arising between the PLC and PC, devices attached to the PRG and Suconet K interfaces must have the same ground potential. If the ground potentials differ, the interfaces can be destroyed.

If it is not possible to achieve equal ground potentials, connect the PC to the mains supply via an isolating transformer or use a laptop powered by an internal battery.

Suconet K interface

Connector pin assignment

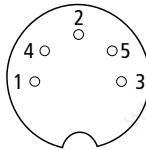

Figure 7: Pin assignment of Suconet K interface (right-hand socket, top view)

PIN 1	Data cable RS 485, Suconet K (TB/RB)
PIN 2, 3, 5	Assigned internally
PIN 4	Data cable RS 485, Suconet K (TA/RA)



The interface is also used for connecting the ZB 4-501-TC1 telecontrol module and the ZB 4-501-UM3 interface converter.

Connecting to the Suconet K field bus

- Use the KPG 1-PS3 bus cable to connect additional Suconet K stations (PS 4, EM 4) to the PS 4-271 compact PLC.



- ▶ Connect the screen of the Suconet K data cable to the potential equalisation strip ensuring a large contact area and low impedance joint (e.g. with a metal cable clip) (see also Page 19).

Setting of bus terminating resistors

- ▶ Set the bus terminating resistors on the PLC for the first and last physical stations on the line. To do this, set both S1 switches to the “ON” position. The S1 switches must be set to “OFF” for all other stations on the bus.

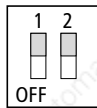

Figure 8: Bus terminating resistors active



Both S1 switches must be set to the same position for the PLC to work correctly.

Local expansion

The PS 4-271 is locally expandable. The local expansion modules (LE 4) are connected to the local bus connector of the PS 4-271 using a bus connecting cable. All of the available types of LE 4 can be used. However, note the following limitations:

A maximum of five LE 4 can be connected to the bus.

The local expansion modules with digital inputs/outputs can be used at positions 1 to 5 (1st to 5th module).

No more than two of the LE 4 modules below can be used per local bus; they can only be arranged immediately after the master (1st and 2nd module):

Electromagnetic
compatibility (EMC)

LE 4-206-AA1	LE 4-503-BS1
LE 4-206-AA2	LE 4-505-BS1
LE 4-501-BS1	LE 4-622-CX1

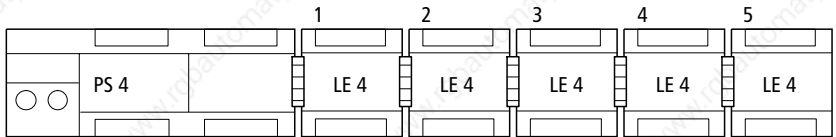

Electromagnetic compatibility (EMC)

Please refer to the engineering rules in the manual “EMC engineering guidelines for automation devices” (AWB 27-1287-GB).



Warning!

Electromagnetic interference.

Emission and line-conducted interference according to ENV 50 140 und ENV 50 141 may alter your measuring result by 20 %.

If incorrectly connected the PLC can emit interference that can adversely affect other devices.

Screening of data and signal cables

- ▶ Use only screened cable for connecting to the PRG programming device interface or to the Suconet K interface of the PS 4-271. In general, the smaller the mutual impedance the better the screening effect.
- ▶ Run the screened data and signal cables as close to the device as possible

Data plug

- ▶ Connect the screen braid to the metal cover of the connector (in the case of DIN connector).

Ends of signal cables

- ▶ Strip back the screen at the ends of signal input cables.
- ▶ Insulate it with heat shrinkable sleeving, for example.

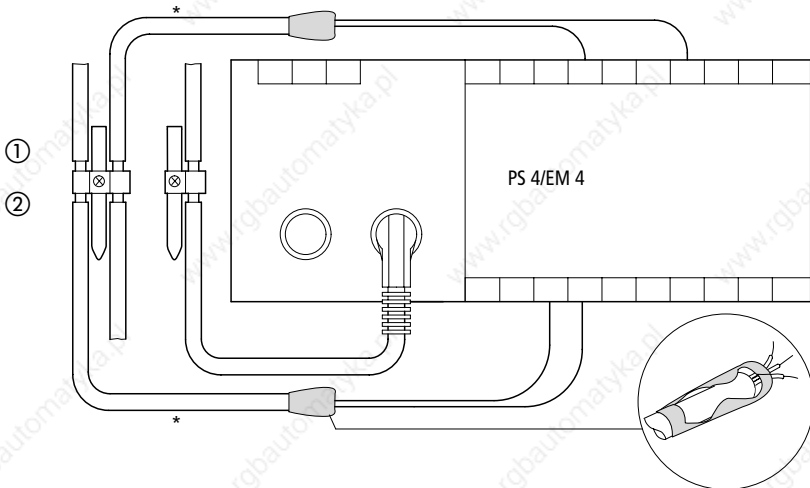

* Connecting diagram only, for pin assignment of the PS 4-271 see Page 27

- ① Mounting with top-hat rail on mounting plate
- ② Mounting on mounting plate

Grounding of data and signal cables

- ▶ Remove the cable casing in the area of the contact clip.
- ▶ Place a contact clip around the stripped section or press the stripped section into the snap fastener of the terminal clip depending on the type you are using.
- ▶ Connect the contact clip or terminal clip to the top-hat rail or mounting plate ensuring a low impedance connection.
- ▶ Fasten the top-hat rail to the mounting plate.



Warning!

Make sure that all connections are protected against corrosion and – if painted mounted plates are used – the joints are free of paint.

- ▶ Ground the top-hat rail using a large surface area joint.

①

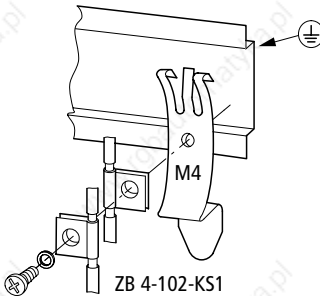

FM 4/TS 35
(Weidmüller)

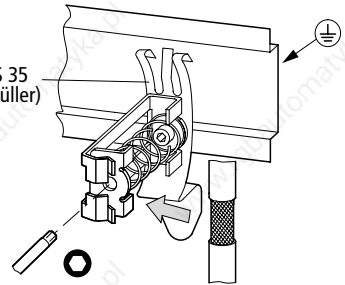

②

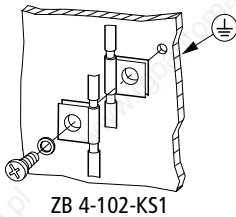

KLBü 3-8 SC
(Weidmüller)

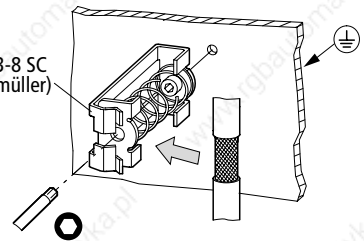

Layout of control cabinet

The arrangement of components in the control cabinet will have a significant effect on whether the plant or machine functions reliably. When planning, designing and installing the equipment, ensure that the power and control sections are separated from one another. The power section includes:

- Contactors
- Coupling modules
- Transformers
- Frequency converters
- Current converters
- DC power supply units

To effectively eliminate electromagnetic interference, we recommend subdividing the control cabinet into sections according to the different power and interference levels. For small control cabinets, simple partitions are often sufficient to reduce electrical interference.

Ventilation

To ensure that the PS 4-271 is adequately ventilated, a minimum clearance of 5 cm (2 ") must be allowed between the components and the ventilation slots in the casing. The values stated in the Technical Data (see Appendix) must be adhered to.

Device arrangement

The PS 4-271 must be mounted horizontally in the control cabinet.

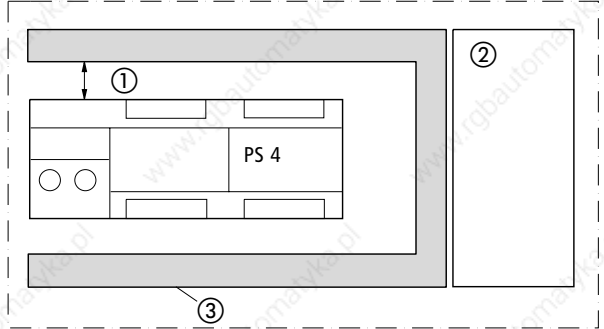

Figure 9: Horizontal installation

- ① At least 5 cm (2 ") clearance
- ② Power section
- ③ Cable duct

Interference suppression

- ▶ Fit all suppression circuits as close as possible to the source of interference (contactor, relay, valve).



Switched inductances should be suppressed as a matter of principle.

Cable routing and wiring

The following categories of cables are used:

Heavy current cable (e.g. power cable which carries large currents or cables for current converters, contactors, solenoid valves)

Control signal cables
(e.g. digital input cables)

Measuring signal cables
(e.g. field bus cables)



In order to prevent capacitive and inductive interference, always run power, control and signal cables as far apart as possible. If it is impossible to run cables apart, you should at least screen the interfering cable.

To keep interference to a minimum, always ensure that cables inside and outside the control cabinet are run correctly as follows:

- ▶ Avoid having long sections of cables with differing power ratings run parallel to each other.
- ▶ Always keep AC cables away from DC cables.
Adhere to the following minimum clearances:
at least 10 cm between heavy current cables and signal cables;
at least 30 cm between heavy current and data/analog cables.
- ▶ When routing cables, make sure feed and return conductors of the same circuit are run together. The sum of all currents is zero due to the opposing direction of flow of current and any fields generated are balanced out.

Layout of control cabinet

- ① Cover
- ② Communication cables
- ③ Cable duct
- ④ Measuring, analog cables
- ⑤ Control cables
- ⑥ Heavy current cables
- ⑦ Continuous partition

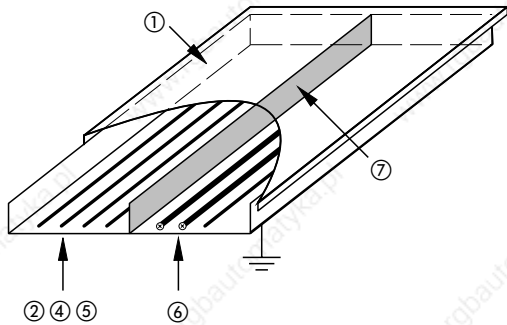
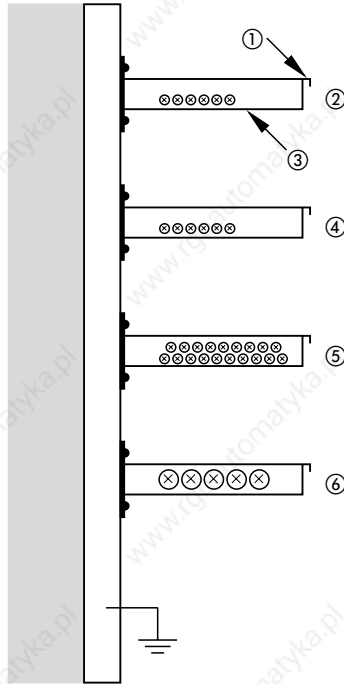

Figure 10: Separate routing of power and signal cables

Power supply

The following page shows the circuit diagram for a possible power supply.



Maintain a spacing of at least 30 cm (12 ") between analog cables and 120/240 V AC cables.

Make sure the supply to analog actuators and encoders is electrically isolated. If electrical isolation is insufficient, the manufacturers of analog encoders and actuators offer appropriate filters.

Key to Figure 11:

- ① Main switch
- ② Circuit-breaker for power supply units
- ③ Control transformer
(to EN 60 204 part 1 required)
- ④ Miniature circuit-breaker
- ⑤ Where power supplies or control circuits are ungrounded, an insulation monitoring device must be used (EN 60 204 part 1 and VDE 0100 part 725).
- ⑥ Screen grounding of signal cables (see also Page 19)
- ⑦ External protection of relay contacts, such as 6 A circuit- breaker, e.g. FAZN B16 (100% protection against short circuit and overload).
Warning: if a 10 A circuit-breaker is used, there is no overload protection in the event of failure. This is because the plug-in screw terminal will accept a maximum load of 12 A, but the circuit-breaker can bear a maximum of 1.45 times the rated current (14.5 A) before it disconnects.
- ⑧ 240 V AC relay outputs must be connected to the same phase (e.g. L1); potential difference max. 250 V AC.
- ⑨ Connect the top-hat rail to PE, connect the top-hat rail to the mounting plate ensuring a low impedance joint

Power supply

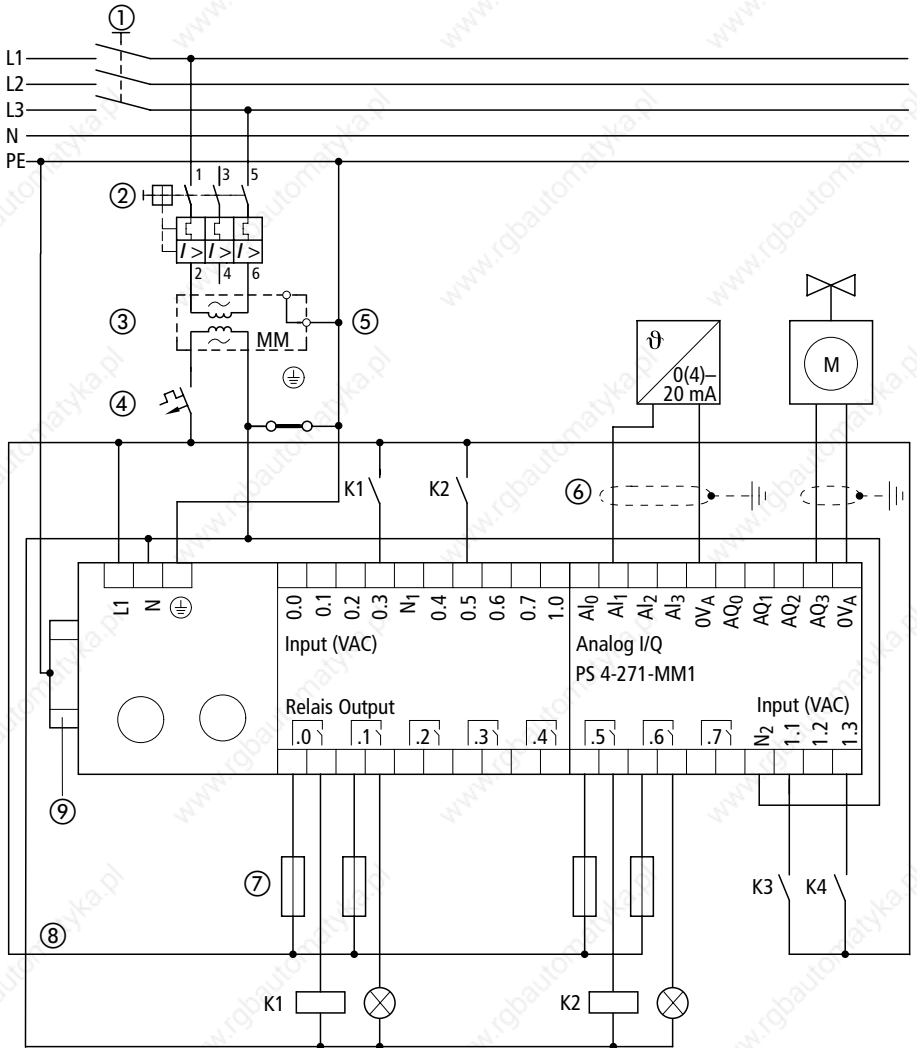

Figure 11: Power supply

Lightning protection measures

Exterior lightning protection

Cables crossing from one building to another should always be protected by screening. Metal conduits are the best solution for this. Elements which protect against overvoltage, such as varistors or other surge arresters, should be used for signal cables. Cables should be protected at the point of entry into the building, or at the latest at the control cabinet.

Interior lightning protection

Interior lightning protection includes all measures which reduce the effects of the lightning current and its electric and magnetic fields on metallic and electrical installations inside a building. Protection comprises:

- Lightning protection equipotential bonding
- Screening
- Overvoltage protecting devices.

For further information, please refer to the following Moeller GmbH manuals:

- Electromagnetic compatibility (EMC) of automation systems (TB 27-001-GB)
- Electromagnetic compatibility (EMC) of machines and plants (TB 02-022 GB).

3 Mounting

Mounting on top-hat rail

To mount the PLC on top-hat rail, proceed as follows:

- ▶ Place the device on the top-hat rail so that the top of the rail fits into the groove.
- ▶ Insert a screwdriver ① into the elongated hole of the spring clip and lever the spring clip downwards ②.
- ▶ Press the device fully onto the top-hat rail ③.
- ▶ Release the spring clip; it will then engage behind the top-hat rail thus fastening the device.
- ▶ Check that the device is secure.

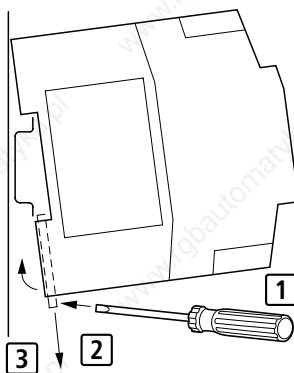

Figure 12: Mounting on top-hat rail

Mounting

Mounting with mounting feet

To mount the device on mounting feet, proceed as follows:

- ▶ Press in the mounting feet so they snap into position ①.
- ▶ Check that the device is seated properly. The lugs must engage in the holes ②.
- ▶ Fasten the mounting feet to the mounting plate with M4 screws ③.
- ▶ Make sure the device is in contact with the mounting plate over a large area thus ensuring low impedance. For this, the contacts attached to the underside of the device must touch the mounting plate.

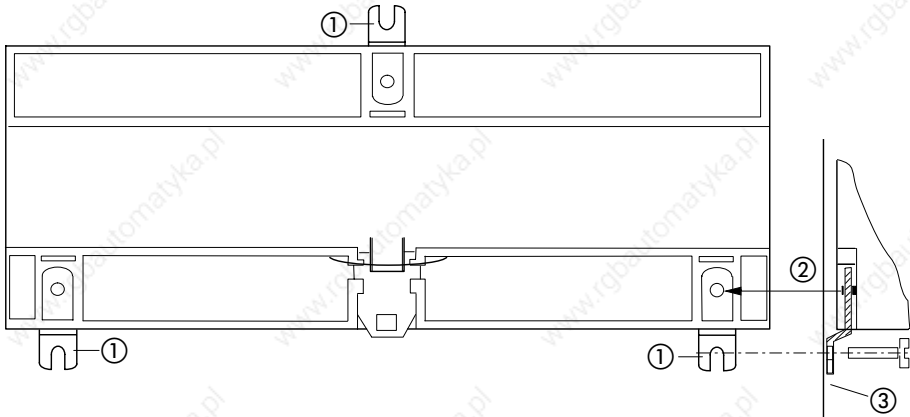

Figure 13: Mounting with mounting feet

4 Software Configuration

General

You must configure the PLCs and all other components you need for your application with the graphical topology configurator of Sucosoft S 40. In this, you select the components of the network, place them at the desired position in the network and define the communication conditions with parameter dialog boxes. Possible network components:

PS 4-... master PLC with LE 4-... local expansion modules

Slaves without their own CPU; they expand the remote inputs/outputs such as EM 4-... expansion modules, LE 4-... local expansion modules, RMQ... operator panels, MI 4-... operator panels and display units, etc.

Slaves with their own CPU such as PS 4 PLCs.



The principles of device configuration are described below and then illustrated with an example.

Creating configurations

What devices are to be included in the configuration?

PS 4-271 with master function

Used as a basic unit, a PS 4 PLC such as the PS 4-271-MM1 represents the smallest unit for which it is possible to create a configuration. To expand the number of inputs/outputs, LE 4 local expansion modules or EM 4 remote expansion modules can be connected to the PLC.

Example

Figure 14 shows a PS 4-271 with an LE 4 local expansion module. The PS 4-271 is the master on the Suconet K line and manages an EM 4 remote expansion module with LE 4 local expansion modules as slaves. All units are brought together in a configuration.

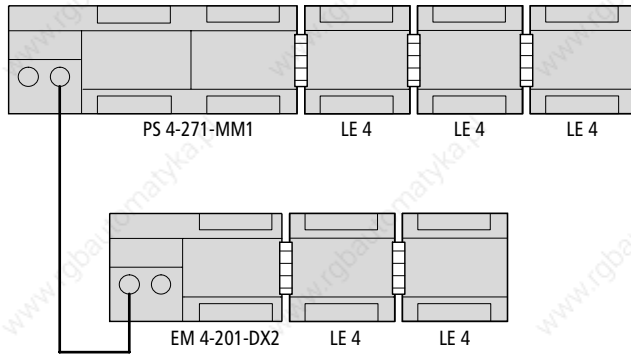

Figure 14: Configuration of a slave without CPU in the master configuration

PS 4-271 with master/slave function

The PS 4-271 can also be used as a slave PLC on the Suconet K line. If it is expanded locally with a network module, it can simultaneously act as a master for the stations on this line.

Example

In Figure 15, the PS 4-341 with LE 4 local expansion modules connected to it has the function of a master. It is expanded with a PS 4-271 as a slave via line 1 and forms configuration 1.

The PS 4-271 has an additional function: in conjunction with an LE 4-501-BS1 network module, it is also master on line 2. An EM 4 is connected on this line as a slave. The PS 4-271 forms configuration 2 with the two LE 4 and the EM 4.

As a result of its master/slave function, the PS 4-271 has the task of collecting the data from the locally connected LE 4 and EM 4 expansion modules and sending this data after conditioning to the PS 4-271 as the higher-ranking master.

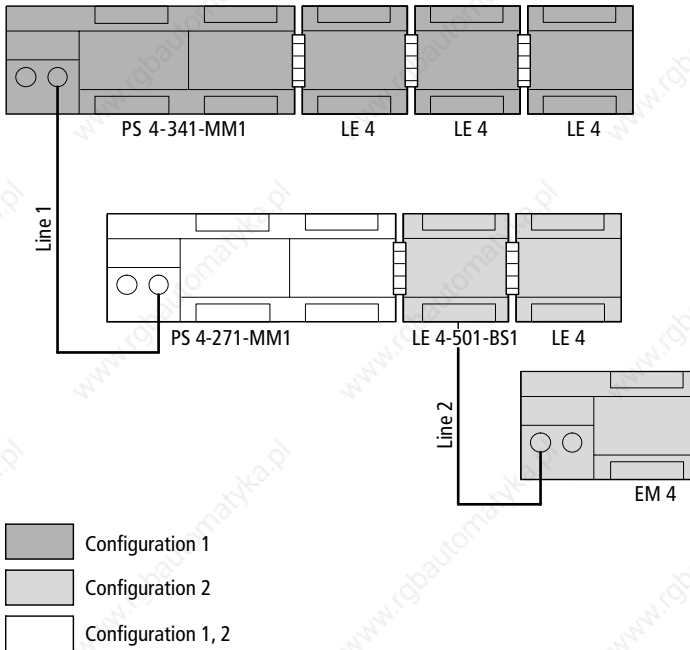

Figure 15: Dual configuration of a slave with CPU

How do I configure the stations?

In the device configuration, an address is defined for every station in accordance with its position in the network. The address consists of the line, station and module numbers and is assigned automatically by the topology configurator.

Line number

Line numbers are allocated consecutively from left to right in ascending order.

The LE 4s are connected to the basic unit via line 0.

Line 1 is connected to the Suconet K interface of the basic unit.

Additional lines can be built from LE 4-501-BS1 network modules which are connected to the basic unit. The first device immediately after the basic unit is given the line number 2, the second the number 3.

Station number

Station numbers are allocated consecutively from top to bottom with the master being given the number "0", the first slave the number "1", etc.

Module number

The module numbers are assigned from left to right in ascending order with the basic unit being given the number "0", the first local expansion module the number "1", etc.



In the topology configurator of Sucosoft S 40, the numbers of the components are displayed above each device. At the same time, the sequence of numbers matches the first three digits of the variable address.

Setting the parameters of the PS 4-271

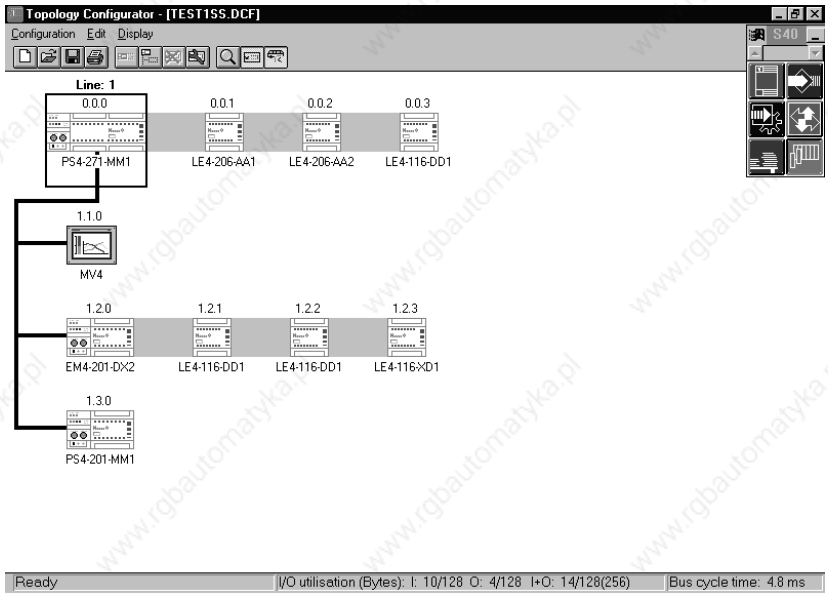

Figure 16: Addressing of stations in the topology configurator

Setting the parameters of the PS 4-271

You can change how the PS 4-271 functions to suit your particular application. To do this, you set parameters for the Suconet K interface and analog inputs/outputs. The parameters are set in the topology configurator of Sucosoft S 40.

You cannot set parameters for the setpoint potentiometers integrated in the PS 4-271. They are displayed for your information with the analog inputs:

Setpoint potentiometer	Channel	Address	Resolution	Value range
P1	0	IAW 0.0.0.0	10 Bit	0 to 1023
P2	1	IAW 0.0.0.2	10 Bit	0 to 1023

- ▶ Call «Edit → Set Parameters» menu in the topology configurator and set the parameters for the functions:

General settings

(Suconet K master/slave, transparent mode)

Analog general,

to,

Analog outputs.

General settings

- ▶ Change to the «Edit → Set Parameters → General Settings» dialog box.

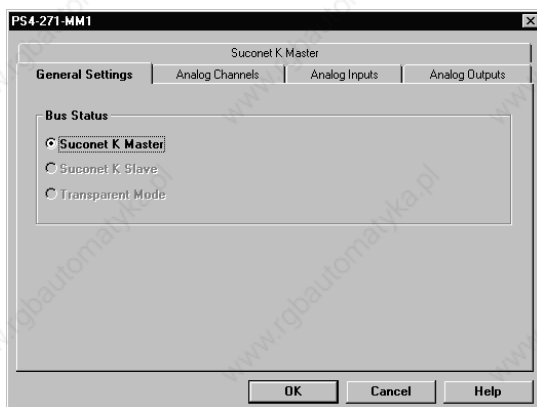

Bus status:

- ▶ Decide whether you want to operate the PLC with the bus status Suconet K master, Suconet K slave or Transparent mode and change to the corresponding dialog box (see sections below).

Suconet K master

Click on the tab “Suconet K Master“. The bus status “Master” must be selected in the “General settings” dialog box. The following dialog box will appear:

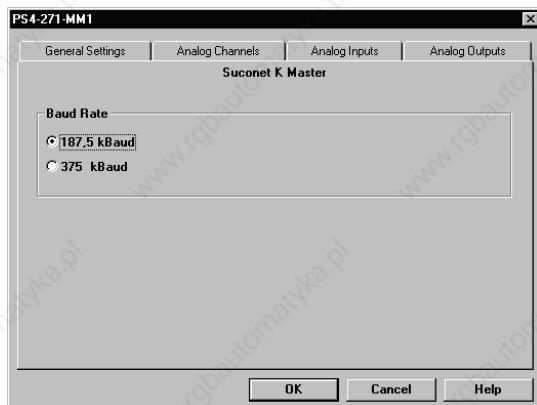

In this box, you set the transmission rate for the exchange of data via Suconet K:

187.5 kBaud:

- ▶ Set the baud rate to 187.5 kBaud if Suconet K1 stations are also connected to the Suconet K line.

375 kBaud:

- ▶ Set the baud rate to 375 kBaud if only Suconet K stations are connected to the Suconet K line.

Suconet K slave

Click on the tab “Suconet K slave“. The bus status “Slave” must be selected in the “General Settings” dialog box. The following dialog box will appear

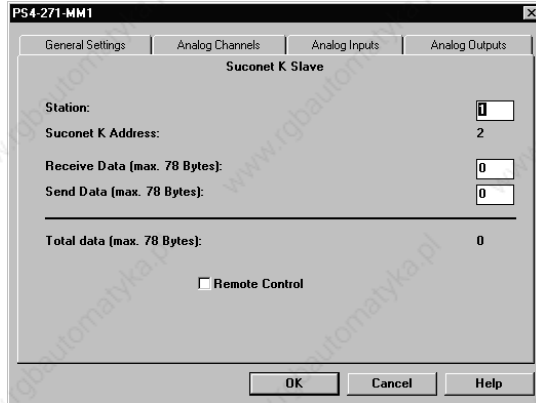

In this dialog box, enter the following:

Station number:

The station number is the number of the station on the Suconet K line. The station number of the master is always “0”. The station number of the slave starts with “1” in ascending order. Enter the number displayed for the slave in the configuration for the associated master.

Suconet K address:

This shows the internal Suconet K address. It is not possible to change this. The Suconet K address is always 1 higher than the station number.

Receive data:

The number of data bytes the slave is to receive from the master. The number of receive data bytes must always agree with the number of send bytes from the master.

Send data:

The number of data bytes the slave is to send to the master. The number of send bytes must always agree with the number of receive bytes from the master.

Limits for number of send and receive bytes

The Suconet K protocol allows data with a variable length to be transferred cyclically, whereby the number of bytes is dependent on the settings for the master and intelligent slave (see below). The data length for communication with slaves for expanding the remote inputs/outputs is dependent on the slave type. With intelligent slaves, you can specify the number of send and receive bytes yourself. However, the following maximum values must not be exceeded:

Table 1: Maximum values for send and receive bytes for the PS 4-150

Send/receive bytes	Master	Slave
Max. no. of send bytes (output)	128	78
Max. no. of receive bytes (input)	128	78
Max. no. of send and receive bytes (output/input)	128	78



The maximum length of receive data (input bytes) also includes the diagnostic bytes from the slave and from any local expansion modules which are connected to it.

Remote control:

- ▶ Mark this check box if the slave is to change to the status “Halt” or “Run” along with the master.

Transparent mode

In this mode, the Suconet K interface is assigned another function:

With the help of the SCO function block, optional data can be exchanged transparently with a partner device via this interface. For further information, please refer to “SCO function block” in the manual “Language elements for PS 4-150/-200/-300 and PS 416” (AWB 2700-1306 GB).

- ▶ To set the parameters of the interface, click on the tab “Transparent mode”.

The bus status “Transparent mode” must be selected in the “General Settings” dialog box. The dialog box below appears:

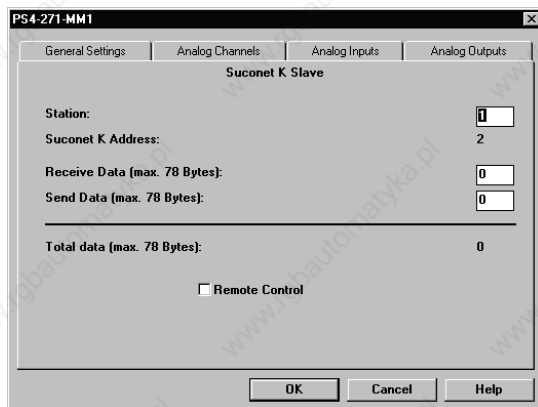

Baud rate:

The baud rate defines the data transmission rate of the stations. Set the highest baud rate the connected stations can handle.

Parity:

This parameter defines whether error detection will take place with even or odd parity or whether no parity will be used.

Stop bit:

The stop bit is not a bit in the true meaning. It defines the time interval between two characters. Please refer to the manual for the connected terminal device for the correct setting.

Analog general

- Change to ‹Edit → Set Parameters → Analog General› dialog box.

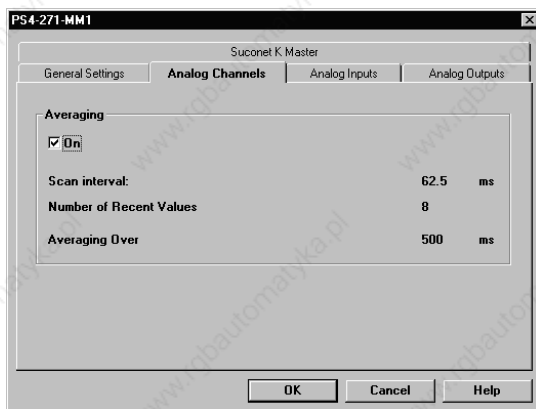

Averaging:

You can switch on averaging for the analog input channels "2" to "5". Input channels "0" and "1" for the integrated setpoint potentiometer of the PS 4-271 are not averaged.

With averaging switched on, the analog value is formed from the arithmetic mean of the last eight measured values. They are scanned at intervals of 62.5 ms. I.e., the time taken for averaging is 500 ms.

At the start, the first measured value is taken to be the mean and this is updated with each new measured value scanned. This avoids a long transient effect due to the number of averaged values.

With averaging switched off, the currently received analog values are read.

Scan interval: Constant time pattern with which the PS 4-271 reads in new measured values for analog channels 2 to 5.

Number of recent values: The number of most recent values used for averaging.

Averaging over: Time over which averaging takes place. It follows from the product
Scanning interval × No. recent values.

Setting the parameters for analog inputs

► Change to the ‹Edit → Set Parameters → Analog Inputs › dialog box.

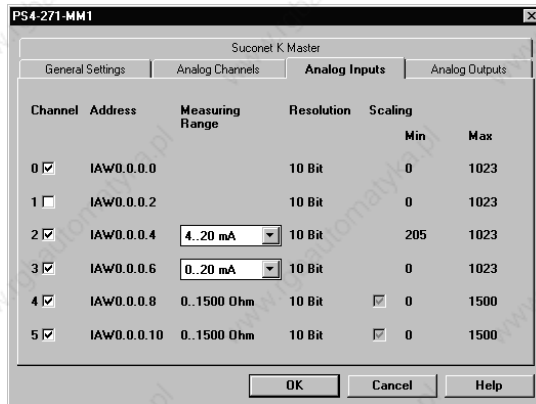

Channel:

Number of the analog channel.

Address:

Operand address of the input channel for addressing from the user program.

Measuring range:

Value range of the physical measured value that can be recorded by the input channel.

Resolution:

Bit width used internally to represent the physical measured value.

Value range:

The value range indicates the smallest/largest digital value the input signal can take on after conversion. The value range of the analog resistance inputs (channels 4 and 5) has been adapted to resistance measurement. The input signals of between 0 and 1500 Ω are resolved and scaled into a value between 0 and 1023 (with 10 bit resolution) thus providing a value range of 0 to 1500.

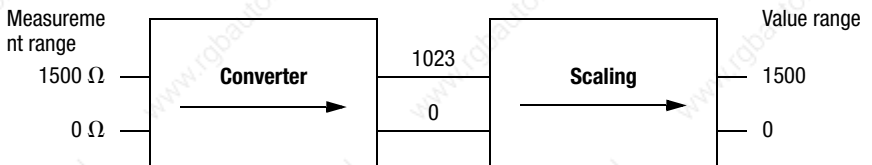

The value calculated can be converted into a temperature value with the help of the “Linearisation” function block.

Scaling:

The values of the analog inputs and any other value you wish can be scaled with the “DataScale” function block. For further details on this, please refer to “DataScale” function block in the manual “Language elements for PS 4-150/-200/-300 and PS 416” (AWB 2700-1306 GB).

Linearisation:

The values of the analog resistance inputs can be linearised with the help of the linearisation function block. The measured value in a range of 0 to 1500 Ω is converted into a °C or a °F value depending on the function block used.

Setting the parameters for analog outputs

- Change to the ‹Edit → Set Parameters → Analog Outputs› dialog box.

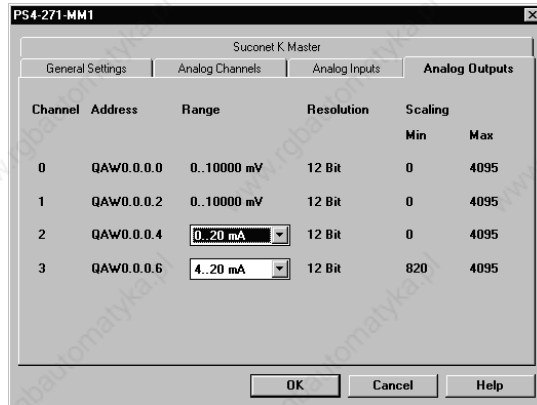

Channel:

Number of the output channel.

Address:

Operand address of the output channel for addressing from the user program.

Setting the parameters of the PS 4-271

Range:

Range of the physical measured value which the output channel can output. The range of channels 2 and 3 can be set to 0 to 20 mA or 4 to 20 mA.

Resolution:

Bit width used internally to represent the physical measured value.

Value range:

The value range depends on the range that is preset:

Range	Value range
0 to 20 mA	0 to 4095
4 to 20 mA	820 to 4095

Configuration example

The example shows the configuration and parameter settings for two controllers which exchange data via Suconet K.

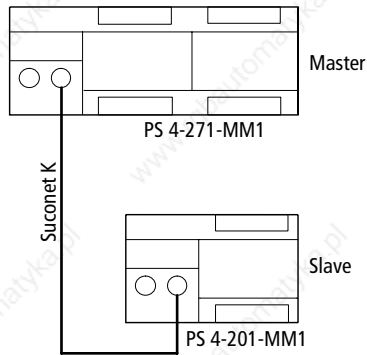

One configuration and one user program must be created for each PLC:

The following parameters must be set:

Software Configuration

Configuration 1:
for PS 4-271-MM1

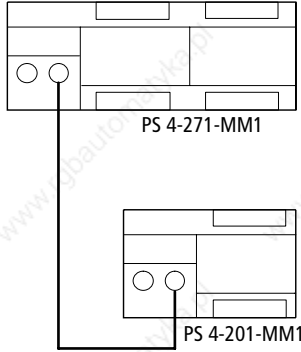

Configuration 2:
for PS 4-201-MM1

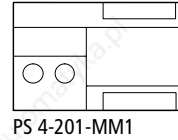

Configuration	Station	Parameters
Configuration 1	PS 4-271-MM1	Suconet K master, e.g. 375 kBaud
	PS 4-201-MM1	Receive data ¹⁾ : e.g. 40 Send data ²⁾ : e.g. 38 CRC ⁵⁾ : e.g. ✓ (yes)
Configuration 2	PS 4-201-MM1	Suconet K slave Receive data ³⁾ : e.g. 38 Send data ⁴⁾ : e.g. 40 Remote Control: e.g. ✓ (yes)

- | | |
|-----------------------------|---|
| 1) Receive data, for master | Number of bytes the master is to receive from the slave. Must agree with the number of send data bytes in the configuration for the slave. |
| 2) Send data, for master | Number of bytes the master is to send to the slave. Must agree with the number of receive data bytes in the configuration for the slave. |
| 3) Receive data for slave | Number of bytes the slave is to receive from the master. Must agree with the number of send data bytes in the configuration for the master. |
| 4) Send data for slave | Number of bytes the slave is to send to the master. Must agree with the number of receive data bytes in the configuration for the master. |

Configuration example

5) CRC

Method for increasing the security of data transfer. Activate CRC (ON) if increasing the data security is more important than optimising the reaction time.

Configuration example

In the example, the devices highlighted in the diagram are those to be configured.

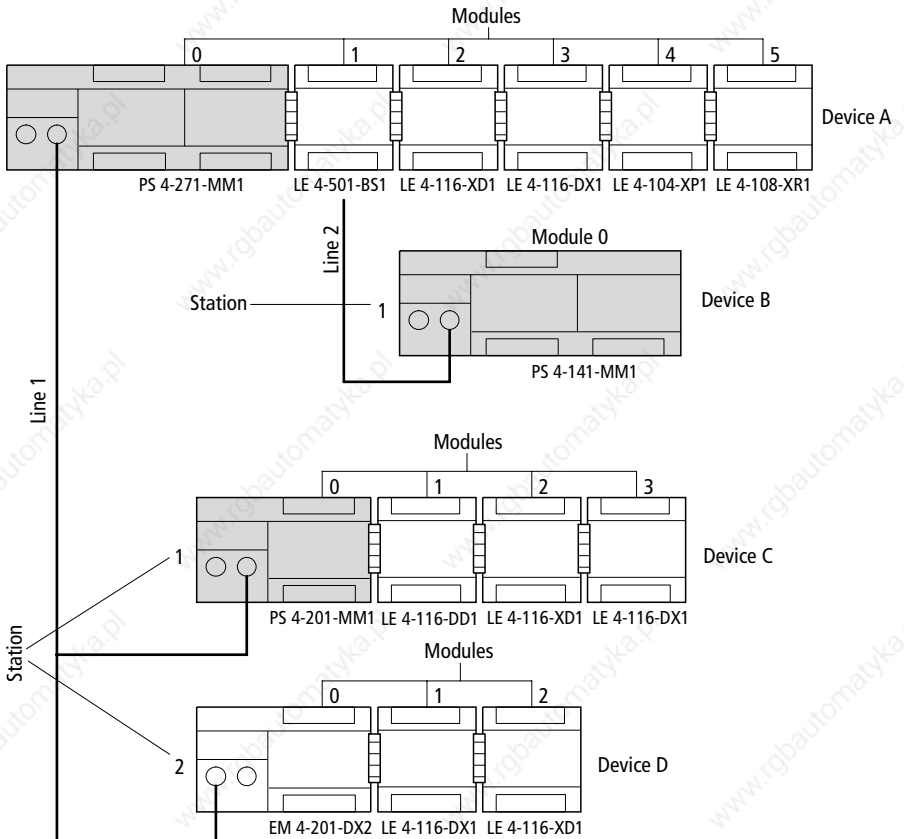

Figure 17: Configuration example

Master: Device A
Slaves: Devices B, C, D

Configuration of device A

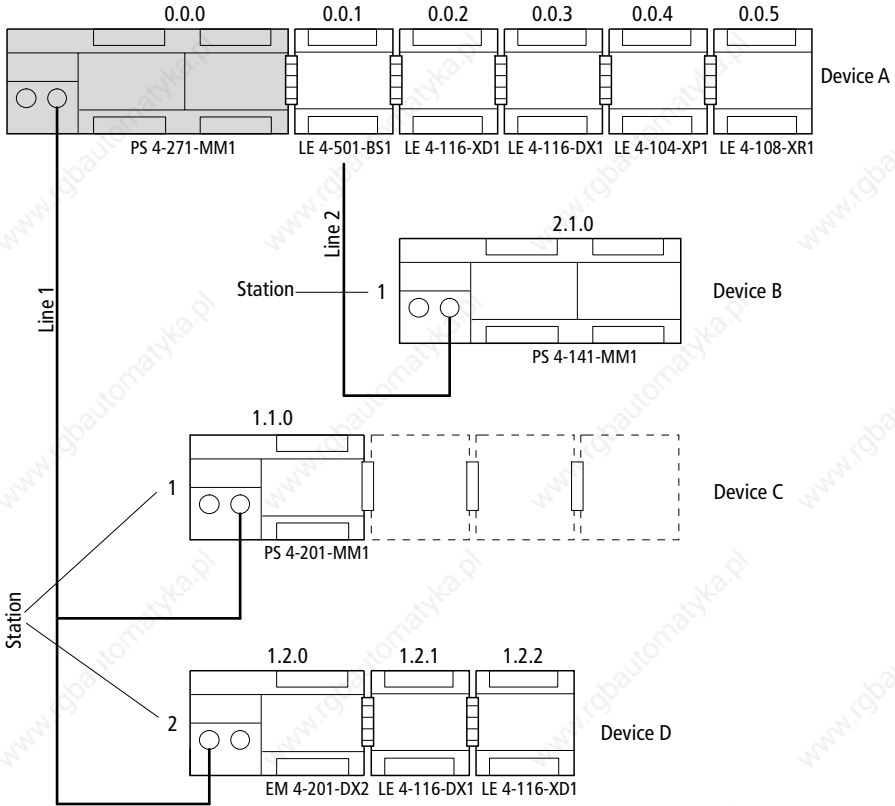

Figure 18: Configuration of device A

Configuration example

Table 2: Configuration of device A

Device	Type	Line	Stn.	Module	Parameters
A	PS 4-271-MM1	0	0	0	Bus status: master Baud rate: 375 kbit/s CRC status: OFF
	LE 4-501-BS1	0	0	1	Bus status: master Baud rate: 375 kbit/s CRC status: OFF
	LE 4-116-XD1	0	0	2	–
	LE 4-116-DX1	0	0	3	–
	LE 4-104-XP1	0	0	4	–
	LE 4-108-XR1	0	0	5	–
B	PS 4-141-MM1	2	1	0	Input data: 20 Output data: 10
C	PS 4-201-MM1	1	1	0	Input data: 25 Output data: 12
D	EM 4-201-DX2	1	2	0	–
	1st LE 4	1	2	1	–
	2nd LE 4	1	2	2	–

Configuration of device B

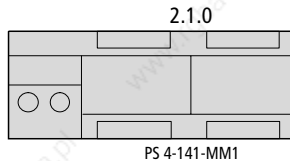

Figure 19: Configuration of device B

Table 3: Configuration of device B

Device	Type	Line	Stn.	Module	Parameters
B	PS 4-141-MM1	0	0	0	Bus status: Slave Input data: 10 Output data: 20 Remote control: OFF

Configuration of device C

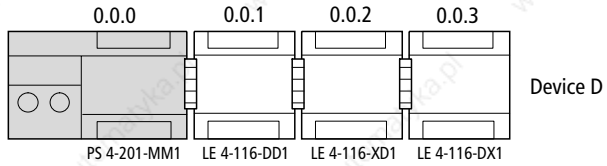

Figure 20: Configuration of device C

Table 4: Configuration of device C

Device	Type	Line	Stn.	Module	Parameters
C	PS 4-201-MM1	0	0	0	Bus status: slave Input data: 12 Output data: 25 Remote control: OFF
	1st LE 4	0	0	1	–
	2nd LE 4	0	0	2	–
	3rd LE 4	0	0	3	–

5 Slave Addressing

Slaves without CPU

The master and slaves without a CPU communicate using either the Suconet K or K1 protocol. The master selects the protocol automatically according to the capabilities of the slaves. It is not necessary to set the receive or send data length in the topology configurator. Suconet K/K1 selects the appropriate message length and automatically addresses the relevant data areas in your application.

As a result, remote I/O operands can be accessed in the same way as local I/O operands.

The general syntax rule for the addressing of I/O operands is:

Operand data type-Line-Station-Module-Byte-Bit

If the PS 4-271 is used as a master, the following slave operands can be addressed using the values specified in the table:

Table 5: Operand addressing of slaves without CPU

Operand	Line	Station	Module	Word/Byte	Bit
I/Q/IS	1 to 3 (0 = master)	1 to 8 (line 1, 2, 3) (0 = master)	1 to 5 (local expansions of the master) (0 = master basic unit)	0, 1, 2, ...	0 to 7
IB/QB/ IAB/QAB/ ISB					–
IW/QW/ IAW/QAW			1 to 6 (local expansions of slaves) (0 = slave basic unit)	0, 2, 4, ...	–
ID/QD					0, 4, 8, ...

I = input; Q = output,
IS = status/diagnostics,
IA = analog input, QA = analog output

Example

You wish to scan the inputs of slaves 1 and 2 in the diagram below.

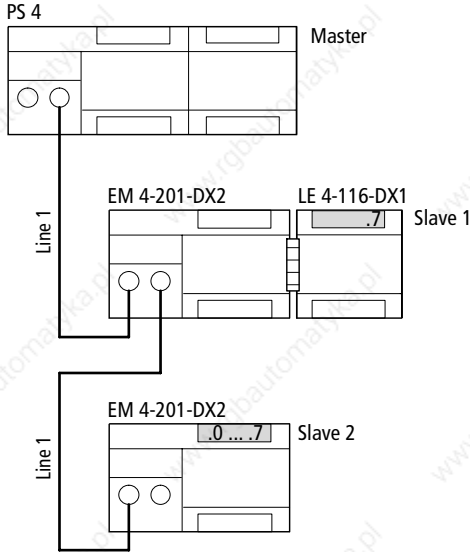

Figure 21: Configuration example for scanning the inputs of remote slaves

The syntax for scanning of the inputs can be seen from the configuration:

Table 6: Syntax for scanning slaves without CPU

IL program in ...	Data flow	Operand	Data type	Line	Stn.	Module	Byte/word	Bit	S 40 syntax
...Master	Master ↑ Slave 1	I	Bit	1	1	1	0	7	LD %I1.1.1.0.7
	Master ↑ Slave 2	IB	Byte	1	2	0	0	-	LD %IB1.2.0.0

Slaves with CPU

The input and output operands cannot be accessed directly during communication between the master and slaves with CPU. The communication data therefore has to be addressed using the RD/SD operands.

The general syntax rule for addressing the operands is:

Operand data type-Line-Station-Module-Byte-Bit

If the PS 4-271 is used as the master, the following slave operands can be addressed using the values specified in the table below:

Table 7: Operand addressing for slaves with CPU

Operand	Line	Station	Module	Word/byte	Bit
RD/SD IS	1 to 3 (0 = master)	1 to 8 (line 1, 2, 3) (0 = master)	1 to 5 (local expansions of the master) (0 = master basic unit)	0, 1, 2, ...	0 to 7
RDB/SDB ISB					–
RDW/SDW				0, 2, 4, ...	
RDD/SDD				0, 4, 8, ...	

RD = receive data; i.e. set number of receive bytes
SD = send data; i.e. set number of send bytes
IS = status/diagnostics

Example

The PS 4-271 (the master) exchanges data of type “word” with a slave with CPU. You define the number of send and receive bytes when configuring the stations in the Sucosoft S 40 topology configurator (see chapter "Software Configuration" on Page 31).

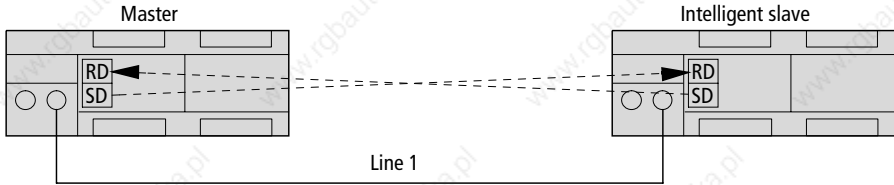

Figure 22: Configuration example for the sending or receiving of communication data

The syntax for sending or receiving of data can be seen from the configuration.

Table 8: Syntax for addressing slaves with CPU (data type: word)

IL program in ...	Data flow	Operand	Data-type	Line	Stn.	Module	Byte/word	Bit	Syntax
... Master	Master ← Slave Master → Slave	RDW/ SDW	Word	1	1	0	0	–	RDW1.1.0.0/ SDW1.1.0.0
... Slave	Slave ← Master Slave → Master	RDW/ SDW	Word	0	0	0	0	–	RDW0.0.0.0/ SDW0.0.0.0

6 Operation

Power-up behaviour

When the power is switched on, the PS 4-271 performs a system test. The PLC then switches to the “Ready” or “Run” state provided it has detected no hardware errors.

The system test includes the following routines:

- Memory test
- Hardware test
- Operating system test
- User program test

The results of the test are indicated by the “Ready“, “Run” and “Not Ready” LEDs. If the test is successful, the LEDs light briefly on powering up; if there is a fault, they flash.

If the “Ready” and “Not Ready” LEDs flash at the same time, the PLC does not have an operating system. The PLC is in boot state.

The status of the PLC depends on the position of the mode selector switch (see Table 9).

Shutdown behaviour

The power supply unit of the PLC detects when the power supply has been disconnected. The power supply unit is able to bridge voltage dips of ≤ 10 ms. If a longer voltage dip occurs, the internal 5 V power supply remains stable for a further 5 ms. The microcontroller uses this time to save all the information needed to restart into memory areas reserved for this purpose.

Operating states of the PLC



The PLC can have the following operating states: “Run“, “Ready“, “Not Ready“:

Communication with the PC is possible in all three operating states. This means that the current operating state of the PLC, the real-time clock and the diagnostic bits, for example, can always be read.

Ready

The “Ready” state features the following characteristics:

- If there is a user program in the PLC, it is not run;
- Outputs are reset and disabled.

The PLC can be changed to the “Ready” state

- By pressing the “Reset” button if the mode selector switch is in the “Halt” position;

- By powering up when the mode selector switch is in the “Halt” position;

- In the programming software of the PC;

- In slave mode, by the master switching to “Halt” when the “Remote control” function is set to “ON” in the Sucosoft topology configurator;

- By operating the flap of the memory module.

Run

The user program is executed in the “Run” state.

The PLC can be switched to the “Run” state

- By pressing the “Reset” button when the mode selector switch is in the “Run” or “Run M reset” position;

By powering up when the mode selector switch is in the “Run” or “Run M reset” position;

In the programming software of the PC;

In slave mode, by the master switching to the “Run” state when the “Remote control” function is set to “ON” in the Sucosoft topology configurator.

Not Ready

The user program is not executed in the “Not Ready” state.

The PLC can be switched to the “Not Ready” state

In response to a hardware error

In response to a serious error in the user program (e.g. cycle time overshoot).

Once the error has been rectified and acknowledged, the “Not Ready” state can be cancelled as follows:

By pressing the reset button; If the mode selector switch is in the “Run M reset” position, the PLC will switch to the “Run” state;

By switching the power supply off and then on; if the mode selector switch is in the “Run M reset” position, the PLC will switch to the “Run” state;

In the programming software of the PC.

Overview

Table 9: Overview of operating states

Position of mode selector switch	State of PLC before action	Action		State of PLC after action (DSW = diagnostic status word)
		Press reset button	Switch power off/on	
1 (Halt)	Run	×	–	Ready
	Ready	×	–	Ready; DSW acknowledged ¹⁾
	Not Ready	×	–	Ready; DSW acknowledged ¹⁾
	Run	–	×	Ready, after remainder of cycle processed ¹⁾
	Ready	–	×	Ready ¹⁾
	Not Ready	–	×	Not Ready
		–	–	DSW (diagnosis)
		–	–	DSW (error)
2 (Run)	Run	×	–	Acknowledgement of DSW
	Ready	×	–	Run (depends on system parameter setup) ^{1) 2)}
	Not Ready	×	–	Via "Ready" to "Run" (depends on setup) ¹⁾
	Run	–	×	Run (with start condition) ¹⁾ , after remainder of cycle processed
	Ready	–	×	Run (depends on system parameter setup) ^{1) 2)}
	Not Ready	–	×	Via "Ready" to "Run" (depends on system parameter setup) ¹⁾
3 (Run M reset)	Run	×	–	Acknowledgement of DSW
	Ready	×	–	Run (cold start) ¹⁾
	Not Ready	×	–	Run (cold start) ¹⁾
	Run	–	×	Run (cold start) ¹⁾
	Ready	–	×	Run (cold start) ¹⁾
	Not Ready	–	×	Run (cold start) ¹⁾

Key to Table 9:

- 1) If the programs in the memory module and the RAM of the PLC are not the same, the program is copied from the memory module to the RAM.
- 2) After the user program is transferred to the PLC or after booting the memory module, the PLC switches to “Not Ready” if the start condition was set to “Halt” in the system parameter setup; this means that a cold start is required.

Each time the PLC is started by means of “Power on”, “Reset” or with the PC, the backup program is first compared with the program in RAM. If they are not the same, the program from the memory module (backup) is copied into the RAM.

If there is an error in the user program in the memory module, it is updated if the user program in the RAM is valid. An update always takes place when the user program is transferred from the PC to the PLC.

Start-up behaviour

The PLC can be made to perform a cold start or warm start:

Cold start

A cold start causes all data fields (marker areas, inputs/outputs, function block parameters) to be reset. Recipe markers are retained, however. The user program is executed again from the beginning.

A cold start can be initiated as follows:

By pressing the “Reset” button when the mode selector switch is in the “Run M reset” position; requirement: the PLC must be in the “Ready” or “Not Ready” state;

By powering up the PLC when the mode selector switch is in the “Run M reset” position;

With the programming software of the PC; requirement: the PLC must be in the “Ready” or “Not Ready” state.

A cold start must be performed after transferring a new user program to the PLC.

Warm start

When performing a warm start, the user program continues from the point at which it was interrupted to the end of the cycle. The outputs and communication data are reset to “0” for the remainder of the cycle. The PLC is then initialised and the program executed. Retentive markers and variables are retained.

The procedure for setting retentive marker areas is described in the “Sucosoft S 40 user interface” manual (AWB 2700-1305 GB).

A warm start can be initiated as follows:

By pressing the “Reset” button when the mode selector switch is in the “Run” position;
requirement: the PLC must be in the “Ready” state;

By powering up when the mode selector switch is in the “Run” position;

With the programming software of the PC;
requirement: the PLC is in the “Ready” state.



The system parameters can also be used to initiate a warm start when the mode selector switch is on “Run” and the PLC is in the “Not Ready” state. To do this, enter a 2 in the “Start after Not Ready” line; i.e. the PLC will perform a warm start.



Warning!

When initiating a warm start by means of the system parameters, data consistency may not be maintained.

Transferring programs

If the user program contains no syntax errors, the compiler in the programming device (PC) translates it into code that can be understood and run by the CPU. You then load (transfer) the user program into the RAM of the CPU where the microprocessor will run it when in the “Run” state.

PC → PLC

To transfer programs from the PC to the PLC, the PS 4-271 must be in the “Ready” or “Not Ready” state although the mode selector switch on the control panel can be in any position.

- ▶ Transfer the program to the PLC (see Chapter 8 of the “Sucosoft S 40 user interface” manual, AWB 2700-1305-GB).

If the mode selector switch is in the “Halt” position, the “Ready” and “Not Ready” LEDs light during transfer of the program. This indicates that the data transfer between the PS 4-271 and the PC is being performed correctly.



The section "Programming via Suconet K" on Page 63 deals with the transfer of the program to the PLC via Suconet K.

PC → memory module

- ▶ Switch off the PLC and plug in the memory module.
- ▶ Switch on the PLC again. The PLC must be in the “Ready” or “Not Ready” state.
- ▶ Transfer the program from the PC to the memory module (see Chapter 8 of the “Sucosoft S 40 user interface”, (AWB 2700-1305-GB).

Starting the PLC with a memory module plugged in

Starting the PLC with a memory module plugged in

Follow the steps below if you wish to start the PS 4-271 with a memory module plugged in:

- ▶ Switch off the PLC and plug in the memory module. The mode selector switch can be in any position.
- ▶ Switch on the PLC. The program in the memory module will be transferred to the PS 4-271 and the PLC will run with the set start conditions (see Table 9).

Programming via Suconet K

Several networked stations can be programmed and test and commissioning functions run from a single PC attached to Suconet K. This method applies to all stations connected to line 1 which is served directly by the master. If one of these stations (e.g. LE 4-501-BS1) is at the head of another line, it will not be possible to access the remote stations attached to this line (dashed line in the diagram below). Further information on this topic can be found in the "Sucosoft S 40 user interface" manual (AWB 2700-1305-GB).

Operation

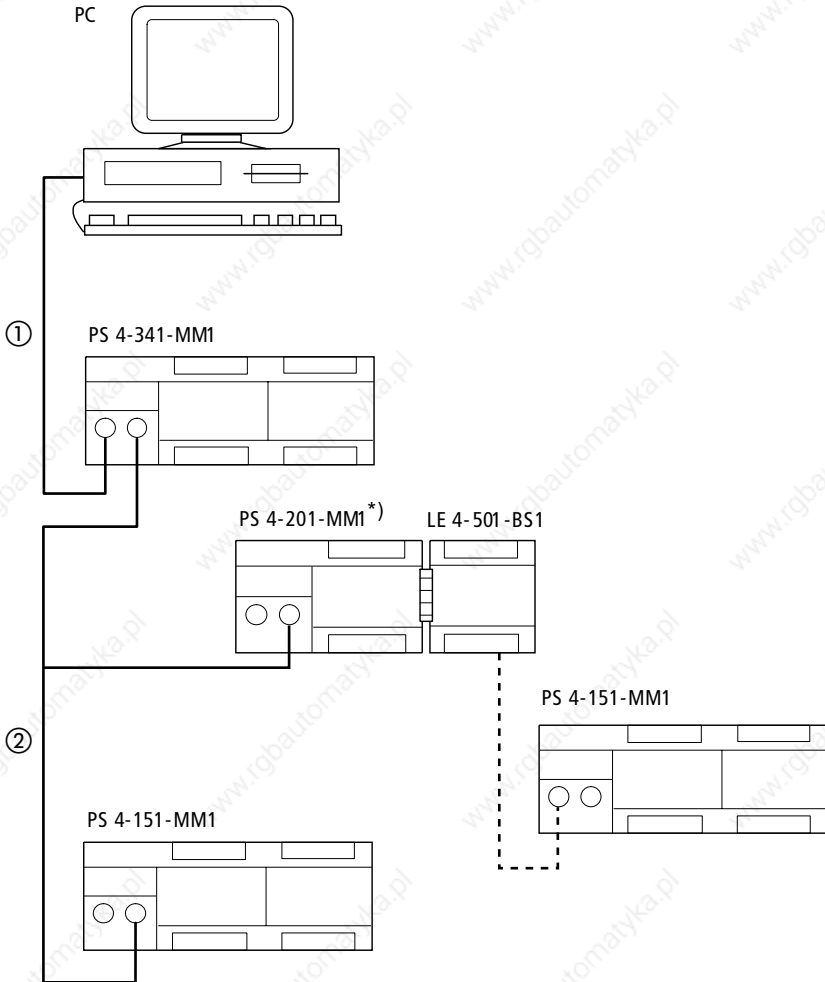

Figure 23: Network programming

*)Programming via Suconet K using the PS 4-201-MM1 requires version 05 or higher.

- ① Programming cable
- ② Suconet K line 1

7 Test/Commissioning/Diagnostics

The LEDs, the diagnostic status word or various diagnostic status bytes and the message byte provide information on the state of the devices.

LEDs

The coloured light-emitting diodes (LEDs) enable quick and easy diagnosis of the PLC's functions.

Table 10: Meaning of the LEDs

LED	Status	Meaning
Ready	Off	–
	On (yellow)	Self-test successfully completed and CPU ready to start
	Flashing (for 3 seconds)	Suconet K error, e.g. station disconnected
Run	Off	Program in "Halt" state
	On (yellow)	User program is running
Not Ready	Off	No CPU, user program errors
	On (red)	CPU error serious error in user program
Ready and Not Ready	Flashing simultaneously	No operating system present in PLC, PLC is in boot state
Battery	Off	Battery working correctly
	On (red)	Battery error ¹⁾
Status of inputs	Off	Input not activated
	On (green)	Input activated
Status of outputs	Off	Output not activated
	On (green)	Output activated



1) Caution!

Data can be lost if the battery no longer supplies sufficient power. Make sure the power supply is switched on when you replace the battery!

Diagnostic status word

The diagnostic status word provides an overview of the error messages. It consists of 16 diagnostic bits which are subdivided into two categories:

Category D (diagnostics): Bit 0 to 7

Category E (errors): Bit 8 to 15

The diagnostic bits of category D are for information. They can be displayed when the PLC is in the “Run” or “Ready” state.

Category E diagnostic bits switch the PLC to the “Not Ready” state when they appear.

Structure

Byte 1								Byte 0							
Bit 15	14	13	12	11	10	9	8	7	6	5	4	3	2	1	0
ECT	EDC	EWD	EPM	EDR	ERT	ENR	–	DAC	DBM	DMC	DLK	DLS	DDK	DDS	–

Table 11: Description of the diagnostic status word

Byte	Bit	Code	Meaning	Description of the error
0	0	–	–	Not used
	1	DDS	Diagnostics Remote status	Error in the status of a remote expansion module. The Suconet K interface of the basic unit has detected an error in one of the network stations. The error can be located by checking the diagnostic bytes of the individual stations.
	2	DDK	Diagnostics Remote configuration	Error in the configuration of the remote expansion module. Possible causes: Fewer Suconet stations than specified in the topology configurator Fault in connection to station Data transmission error
	3	DLS	Diagnostics Local status	Error in the status of the local expansion module, e.g. digital outputs short-circuited
	4	DLK	Diagnostics Local configuration	Error in the configuration of the local expansion module; e.g. wrong/faulty LE 4
	5	DMC	Diagnostics Memory card	Memory module faulty or not suitable for creating a backup or for storing files.
	6	DBM	Diagnostics Battery module	Battery voltage is too low. Replace the battery.
	7	DAC	Diagnostics Power failure	Power supply failure
1	8	–	–	Not used
	9	ENR	Restart only with retentive marker reset	This message appears if you selected the "Halt" option under "Start after Not Ready" in the PS 4-271 configuration and you attempted a warm start after an error of category E occurred. In this situation, you can only restart with a retentive marker reset.
	10	ERT	Error Run Time	The PLC identified a run-time error; e.g. array index violation.
	11	EDR	Error Data retention	Data retained in the operating system is corrupted.
	12	EPM	Error Program module	Error in the program memory; error identified in the user program's checksum.
	13	EWD	Error Watch dog	Not supported
	14	EDC	Error DC	DC supply failure in the basic unit
	15	ECT	Error Cycle Time	Cycle time violation; the maximum cycle time set in the program was exceeded.

Display in the “Test and commissioning” menu

In Sucosoft S 40, the diagnostic bits are displayed in the “System diagnostics” window (see Chapter 8 of the “Sucosoft S 40 user interface” manual, AWB 2700-1305-GB).

Display with LEDs

The diagnostic word (diagnostic bits 0 to 15) can also be displayed with LEDs 0.0 to 0.7 on the PLC using the following procedure:

- ▶ Set the mode selector switch to the “Halt” position and refer to the following tables to interpret the operating state (do not press the reset button so that the PLC remains in the “Run” state). To acknowledge error messages, set the mode selector switch to “Run” or “Run/M reset” and press the “Reset” button.

Table 12: Diagnostic bit display using the LEDs

LED	PLC state Run/Ready	PLC state Not Ready
.0.0	–	–
.0.1	DDS	ENR
.0.2	DDK	ERT
.0.3	DLS	EDR
.0.4	DLK	EPM
.0.5	DMC	EWD
.0.6	DBM	EDC
.0.7	DAC	ECT

Diagnostic bytes

You can scan the diagnostic bytes shown in the diagram to obtain more information on the status of the basic unit together with any local expansion modules connected to it:

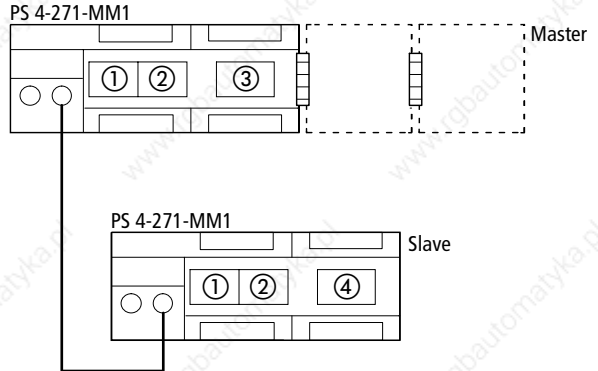

- ① Diagnostic byte for display of the states of the basic unit and any local expansion modules connected to it
- ② Diagnostic byte for display of the analog inputs in the basic unit (wire break signal)
- ③ Diagnostic byte for display of the states of the slave
- ④ Diagnostic byte for display of the states of the master

① States of basic unit and local expansion modules

This diagnostic byte provides information on the basic unit and any local expansion modules connected to it. The information is the same as byte 0 of the diagnostic status word and can therefore be found in Table 11.

Structure

Bit 7	6	5	4	3	2	1	0
DAC	DBM	DMC	DLK	DLS	DDK	DDS	–

Scan instruction

LD AT %ISB0.0.0.0:BYTE;

or

LD AT %IS0.0.0.0.1:B00L;

.

.

.

LD AT %IS0.0.0.0.7:B00L;

Display in Sucosoft S 40

see under ②

② Status of analog inputs in the basic unit

You can set analog inputs AI0 and AI1 (channels 2 and 3) to input signals of between 4 and 20 mA. If the input current drops below 4 mA, a wire break signal is generated. For each of the two inputs is available a message bit which is set if the current drops below 4 mA. The input value is then set to the value 205. If the current rises above 4 mA, the bit is set to the "0" signal again.

Diagnostic bytes

Structure

Bit 7	6	5	4	3	2	1	0
–	–	–	–	–	–	AI ₁	AI ₀

Scan instruction

LD AT %ISB0.0.0.1:BYTE; (Bit 0 = AI0, Bit 1 = AI1)

or

LD AT %ISO.0.0.1.0:BOOL; (input AI0)

LD AT %ISO.0.0.1.1:BOOL; (input AI1)

Display in Sucosoft S 40

You can examine and interpret the diagnostic bits in the “Test and commissioning” menu:

- ▶ Select ‹Test and commissioning → Connection List → Topology›.
- ▶ Mark the PS 4-271 and select the “Display/force inputs/outputs” function.

The messages are displayed in the ISW0. The ISW0 is subdivided:

The individual messages are displayed with 0 to 7 in accordance with the diagnostic status word (bits 0 to 7). Positions 8 and 9 display the wire break signals of analog inputs AI0 and AI1.

③ **PS 4-271 used as master: scan of slave states**

When used as a master, the PS 4-271 continuously receives one or more diagnostic bytes from each slave which indicate the state of the slave. The available information will depend on the type of the individual slave; i.e. the diagnostic information differs according to the type of station. The diagnostic information indicates, for example, whether

The device ID is incorrect

A device has been disconnected from the bus

A short-circuit has occurred at the digital output of a station, etc.

The diagnostic information and its meaning are described in the manuals for the individual Suconet stations and local expansion modules.

Example of diagnostic byte scan

In the example, the following configuration is used: a PS 4-271 with slave function is connected to a PS 4-271 with master function via Suconet K. The diagnostic byte of the slave is to be scanned in the user program of the master. The diagnostic byte has the content:

Diagnostic bytes

- Bit 0: Reserved
- Bit 1: 0 = Station in Run
1 = Station in Halt
- Bit 2: 0 = ok
1 = Length error of the receive data
- Bit 3: Reserved
- Bit 4: 0 = ok
1 = Hardware error
- Bit 5: 0 = ok
1 = Short circuit
- Bit 6: 0 = ok
1 = No connection
- Bit 7: 0 = ok
1 = Wrong device type

Scan in user program of master

```
LD AT %ISBx.y.0.0: BYTE;
```

or

```
LD AT %ISx.y.0.0.1:B00L;
```

```
.  
.  
.
```

```
LD AT %ISx.y.0.0.7:B00L;
```

x = line number

y = station number

Display in Sucosoft S 40

The diagnostics bt can be evaluated in the “Test and Commissioning” tool:

- ▶ Select ‘Test and Commissioning → Connection List → Topology’.
- ▶ Mark the slave and select the “Display/force inputs/outputs” function. The signals are displayed in the ISB0.

The messages are shown in ISB0.

④ **PS 4-271 as slave: scan of master states**

When used as a slave, the PS 4-271 is also a basic unit with its own program and configuration. Consequently, the diagnostic bytes described in ① and ② can also be scanned in this case. In addition, the states of the master can be scanned by means of the diagnostic byte ISB2.

Structure of diagnostic byte ISB2

Bit 7	6	5	4	3	2	1	0
-------	---	---	---	---	---	---	---

Bit 1: Halt communication

- 0 = master in Run
- 1 = master in Halt

Bit 2: Input length error

- 0 = ok
- 1 = length error in message

Bit 6: No connection

- 0 = ok
- 1 = no connection to master

Bits 0, 3, 4, 5 and 7 not used!

Scan in user program of slave

LD AT %ISB0.0.0.2: Byte;

or

LD AT %ISO.0.0.2.1: BOOL; (Halt communication)

LD AT %ISO.0.0.2.2: BOOL; (Input length error)

LD AT %ISO.0.0.2.6: BOOL; (No connection)

Display in Sucosoft S 40

You can examine and interpret the diagnostic bits in the “Test and Commissioning” menu:

- ▶ Select <Test and Commissioning → Connection list → Topology>.

Message byte

- ▶ Mark the PS 4-271 and the “Display/force inputs/ outputs” function.

The signals of the basic unit are displayed in the diagnostic bytes ISB0 and ISB1; the signals of the master in the diagnostic byte ISB2.

Message byte

The message byte provides information on the state of the PLC, image data relating to the network stations, the start-up behaviour of the PLC, etc. The message byte can be scanned with the help of the “PLC_Message” function block (refer to the manual “Language elements for PS 4-150/-200/-300 and PS 416” (AWB 2700-1306-GB).

Table 13: Message status byte

Bit no.	Code	Meaning
0	ISA	1st cycle after start
1	IRE	1st cycle after pressing the reset button; set for a duration of one cycle
2	IFO	Static forcing active
3	REC	Remainder of cycle after warm start. The PS 4-271 completes the remainder of the cycle after every warm start.
4	ICS	The bit indicates the type of restart for the first cycle: 1 = cold start, 0 = warm start
5	NKD_1	New data transfer to the on-board SBI
6	NKD_2	New data transfer to the SBI of the first local expansion module (LE 4-501-BS1)
7	NKD_3	New data transfer to the SBI of the second local expansion module (LE 4-501-BS1)

For further information on the message byte, please refer to the description of the “PLC_Message” function block in the manual “Language elements of the PS 4-150/-200/-300 and PS 416” (AWB 2700-1306-GB).

8 Representation of Analog Values

Analog-digital conversion

The PS 4-271 converts an analog input signal into a digital value with a length of 10 bits and an internal 12-bit digital value into an analog output signal. The digital base value range is represented by:

0 to 4095 dec or 0 to FFF hex (12 bit) or
0 to 1023 dec or 0 to 3FF hex (10 bit).

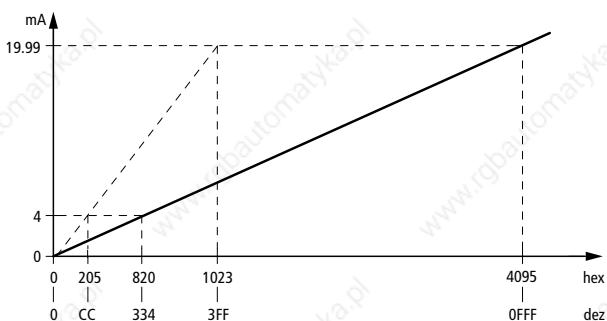

Figure 24: Analog/digital conversion

Analog inputs

Inputs AI₀ and AI₁ can process either the signals 0 to 10 V or 0 (4) to 20 mA. You set the parameters you require in the topology configurator (see the chapter "Software Configuration").

Representation of Analog Values

Inputs for 0 to 20 mA/0 to 10 V

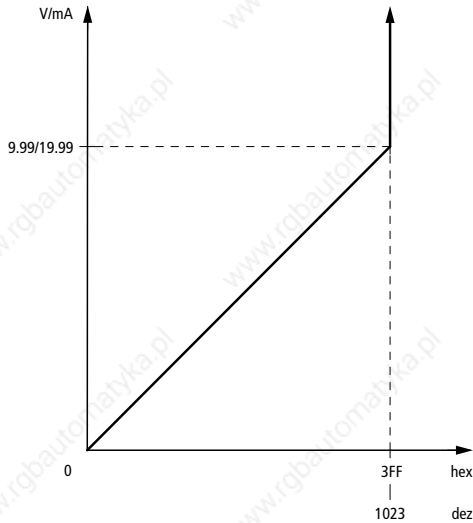

Figure 25: Value range for current/voltage inputs

If the input current exceeds 20 mA/10 V, the measured value is treated as the maximum value 1023.

If the input current becomes negative through polarity reversal of the conductors, then the measured value is treated as 0.

Inputs for 4 to 20 mA

Figure 26: Value range for current inputs 4 to 20 mA

If the input current exceeds 20 mA, the maximum value “1023” of the value range is generally stated.

If the input current drops below 4 mA or becomes negative through polarity reversal of the conductors, the value 205 (CC hex) is always displayed as the measured value. In this case, a diagnostic bit (wire break) is set (see also Page 70).

The value range 0 to 1023 can be scaled with the help of the “DataScale” function block.

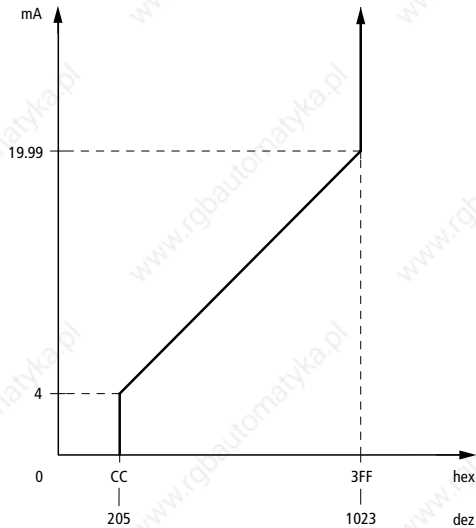
Pt1000/Ni1000 inputs

Inputs AI₂ and AI₃ process signals from resistance thermometers of type Pt1000 or Ni1000. The input range for the resistance value is 0 to 1500 Ω. The resistance values of the thermometers start at 185 Ω (Pt1000) and 695 (Ni1000), from which follows the operating range below:

Operating range of Pt1000 and Ni1000:

R [Ω]	ϑ [°C]	ϑ [F]
Pt1000		
185	-200	-328
1500	+130.5	+266.8
Ni1000		
695	-60	-76
1500	+82.5	+180.6

The value in the range 0 to 1500 can be linearised with the help of the linearisation function block and converted into a temperature value. There are four function blocks available for this:

Function block name	Resistance thermometer (input)	Temperature (output)
PttoCelsius	Pt1000	Celsius
PttoFahrenheit	Pt1000	Fahrenheit
NltoCelsius	Ni1000	Celsius
NltoFahrenheit	Ni1000	Fahrenheit

Analog outputs

Outputs AQ_0 and AQ_1 provide an output of 0 to 10 V, AQ_2 and AQ_3 provide an output of 0 (4) to 20 mA. Their parameters are set in the topology configurator.

If a current output of 4 to 20 mA was specified, 4 mA is generally output if the value drops below 334 dec.

If the value exceeds or drops below the permissible value range for the outputs as a result of a defective input, the corresponding maximum or minimum value is output

Outputs 0 to 20 mA/0 to 10V.

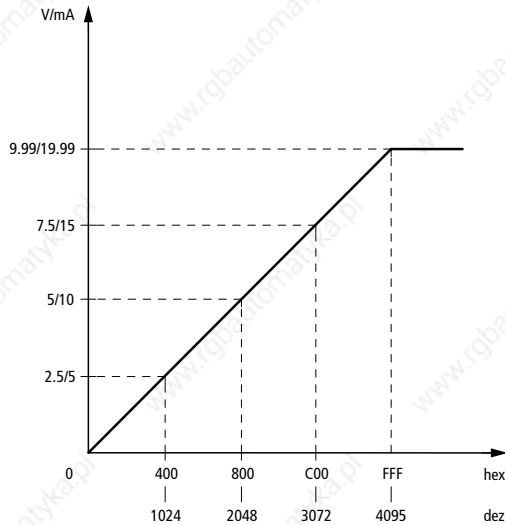

Figure 27: Value range for current inputs 4 to 20 mA/ 0 to 10 V

Representation of Analog Values

Output 4 to 20 mA/0 to 10 V

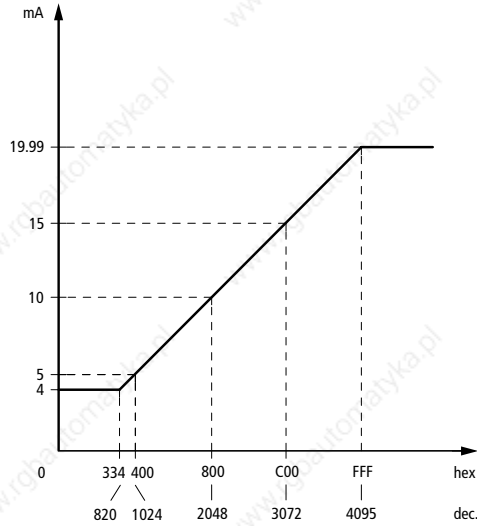

Figure 28: Value range for current outputs 4 to 20 mA

Appendix

Accessories

Designation	Type	Description/application
Programming cable	ZB 4-303-KB1	Adapter for programming the PS 4-271 from a PC
Memory module	ZB 4-901-SF1	1 MB flash memory module for use as user program backup and recipe memory
	ZB 4-128-SF1	128 kB flash memory (recipe memory)
Screw terminal	ZB 4-110-KL1	Screw terminal for the input/output level
Twin-level terminal block	ZB 4-122-KL1	Twin-level terminal block for distributing potential; e.g. for connecting 3-pole proximity switches to a PLC or local expansion module.
Hinged cover	ZB 4-101-GZ1	Cover for labelling the inputs/outputs (PS 4, EM 4, LE 4)
Fixing clip	ZB 4-101-GF1	Fixing bracket for screwing the PS 4 onto a mounting plate
Backup battery	ZB 4-600-BT1	Battery for backing up the RAM of the PS 4-271
Simulator	ZB 4-108-ES1	Simulator for digital inputs
Data cable	KPG 1-PS3	Cable between PS 4-271 and slave; length: 0.5 m
T connector	TBA 3.1	For connecting a station to the Suconet K/K1 line
Data plug connector	S 1-PS3	5-pin DIN connector for the RS 485 interface of the PS 4-201-MM1
Cable	LT 309.096	Cable, 2 × 0.5 mm ² , screened and twisted for making up Suconet K cables
Screen grounding kit	ZB 4-102-KS1	Screen grounding kit for Suconet
Snap-on mounting for top-hat rail	FM4/TS35	Manufactured by Weidmüller, order no. 068790
Clip for snap-on mounting	KLBü3-8SC	Manufactured by Weidmüller, order no. 169226

Slave addressing Receive bytes

Slave	Byte 1	Byte 2	Byte 3	...	Last byte	Data type
A 4-220.1	RDBx.y.0.0	RDBx.y.0.1				Byte, Word
A 5-220.1	RDBx.y.0.0	RDBx.y.0.1	RDBx.y.0.2	...	RDBx.y.0.6	Byte, Word
CM 4-501-FS1	IBx.y.0.0	RDBx.y.0.1	RDBx.y.0.1	...	RDBx.y.0.5	Bit, Byte
EM 4-101-AA1 V 01	IABx.y.0.0	IABx.y.0.1	IABx.y.0.2	...	IABx.y.0.5	Byte
EM 4-101-AA1 V 02						
AA1B64 (8 Bit/SBI)	IABx.y.0.0	IABx.y.0.1	IABx.y.0.2	...	IABx.y.0.5	Byte
AA1W33 (12 Bit/SBI)	IAWx.y.0.0		IAWx.y.0.2		IAWx.y.0.4	Word
EM 4-101-AA2						
AA2B84	IABx.y.0.0	IABx.y.0.1	IABx.y.0.2	...	IABx.y.0.7	Byte
AA2W84	IAWx.y.0.0		IAWx.y.0.2	...	IAWx.y.0.14	Word
EM 4-101-DD2/106	IBx.y.0.0	IBx.y.0.1				Bit, Byte
EM 4-101-DD2/88	IBx.y.0.0					Bit, Byte
EM 4-111-DR2	IBx.y.0.0					Bit, Byte
EM 4-201-DX2	IBx.y.0.0	IBx.y.0.1				Bit, Byte, Word
EM 4-201-DX2 with LE	IBx.y.0.0	IBx.y.0.1	IBx.y.1.0	...	IBx.y.6.1	Bit, Byte, Word
EPC 335	RDBx.y.0.0	RDBx.y.0.1	RDBx.y.0.2	...	RDBx.y.0.6	Bit, Byte, Word
LE 4-501-BS1	RDBx.y.0.0	RDBx.y.0.1	RDBx.y.0.2	...	RDBx.y.0.77	Bit, Byte, Word
MI 4	RDBx.y.0.0	RDBx.y.0.1	RDBx.y.0.2	...	RDBx.y.0.77	Bit, Byte, Word
MV 4	RDBx.y.0.0	RDBx.y.0.1	RDBx.y.0.2	...	RDBx.y.0.119	Bit, Byte, Word
PS 3-8	IBx.y.0.0	IBx.y.0.1				Bit, Byte
PS 3-AC	IBx.y.0.0	IBx.y.0.1	IABx.y.0.0	...	IABx.y.0.3	(Bit), Byte
PS 3-DC	IBx.y.0.0	IBx.y.0.1	IABx.y.0.0	...	IABx.y.0.3	(Bit), Byte
PS 316 (SBI)/306	RDBx.y.0.0	RDBx.y.0.1	RDBx.y.0.2	...	RDBx.y.0.6	Bit, Byte, Word
PS 4-141-MM1	RDBx.y.0.0	RDBx.y.0.1	RDBx.y.0.2	...	RDBx.y.0.77	Bit, Byte, Word
PS 4-151-MM1	RDBx.y.0.0	RDBx.y.0.1	RDBx.y.0.2	...	RDBx.y.0.77	Bit, Byte, Word
PS 4-1x1, active	RDBx.y.0.0	RDBx.y.0.1	RDBx.y.0.2	...	RDBx.y.0.6	Bit, Byte
PS 4-1x1, passive	IBx.y.0.0	–	IABx.y.0.0		IABx.y.0.1	(Bit), Byte

Slave addressing

Slave	Byte 1	Byte 2	Byte 3	...	Last byte	Data type
PS 4-201-MM1	RDBx.y.0.0	RDBx.y.0.1	RDBx.y.0.2	...	RDBx.y.0.77	Bit, Byte, Word
PS 4-271-MM1	RDBx.y.0.0	RDBx.y.0.1	RDBx.y.0.2	...	RDBx.y.0.77	Bit, Byte, Word
PS 4-401-MM1	RDBx.y.0.0	RDBx.y.0.1	RDBx.y.0.2	...	RDBx.y.0.6	Byte, Word
PS 4-401-MM2	RDBx.y.0.0	RDBx.y.0.1	RDBx.y.0.2	...	RDBx.y.0.83	Bit, Byte, Word
PS 4-341-MM1	RDBx.y.0.0	RDBx.y.0.1	RDBx.y.0.2	...	RDBx.y.0.119	Bit, Byte, Word
RBI 1.1	IBx.y.0.0	IBx.y.0.1	IABx.y.0.0	...	IABx.y.0.3	(Bit), Byte
RMQ 16I	IBx.y.0.0	IBx.y.0.1				Bit, Byte
SBI-AMD3	RDBx.y.0.0	RDBx.y.0.1	RDBx.y.0.2	...	RDBx.y.0.6	Byte, Word
SBI-AMX	RDBx.y.0.0	RDBx.y.0.1	RDBx.y.0.2	...	RDBx.y.0.6	Byte, Word
SIS-K-06/07	RDBx.y.0.0	RDBx.y.0.1	RDBx.y.0.2	...	RDBx.y.0.6	Bit, Byte, Word
10/10	RDBx.y.0.0	RDBx.y.0.1	RDBx.y.0.2	...	RDBx.y.0.9	Bit, Byte, Word
15/15	RDBx.y.0.0	RDBx.y.0.1	RDBx.y.0.2	...	RDBx.y.0.14	Bit, Byte, Word
24/24	RDBx.y.0.0	RDBx.y.0.1	RDBx.y.0.2	...	RDBx.y.0.23	Bit, Byte, Word
30/30	RDBx.y.0.0	RDBx.y.0.1	RDBx.y.0.2	...	RDBx.y.0.29	Bit, Byte, Word
40/40	RDBx.y.0.0	RDBx.y.0.1	RDBx.y.0.2	...	RDBx.y.0.39	Bit, Byte, Word
50/50	RDBx.y.0.0	RDBx.y.0.1	RDBx.y.0.2	...	RDBx.y.0.49	Bit, Byte, Word
60/60	RDBx.y.0.0	RDBx.y.0.1	RDBx.y.0.2	...	RDBx.y.0.59	Bit, Byte, Word
SIS-Typ-80D0 to	RDBx.y.0.0	RDBx.y.0.1	RDBx.y.0.2	...	RDBx.y.0.6	Bit, Byte, Word
SIS-Typ-80EF	RDBx.y.0.0	RDBx.y.0.1	RDBx.y.0.2	...	RDBx.y.0.6	Bit, Byte, Word

x = line, y = station

Send bytes

Slave	Byte 1	Byte 2	Byte 3	...	Last byte	Data type
A 4-220.1	SDBx.y.0.0	SDBx.y.0.1				Byte, Word
A 5-220.1	SDBx.y.0.0	SDBx.y.0.1	SDBx.y.0.2	...	SDBx.y.0.5	Byte, Word
CM 4-501-FS1	QBx.y.0.0	SDBx.y.0.1	SDBx.y.0.1	...	SDBx.y.0.5	Bit, Byte
EM 4-101-AA1 V 01	QABx.y.0.0	QABx.y.0.1	QABx.y.0.2	–	QABx.y.0.4	Byte
EM 4-101-AA1 V 02						
AA1B64 (8 Bit/SBI)	QABx.y.0.0	QABx.y.0.1	QABx.y.0.2	–	QABx.y.0.4	Byte
AA1W33 (12 Bit/SBI)	QAWx.y.0.0		QAWx.y.0.2		QAWx.y.0.4	Word
EM 4-101-AA2						
AA2B84	QABx.y.0.0	QABx.y.0.1	QABx.y.0.2	–	QABx.y.0.3	Byte
AA2W84	QAWx.y.0.0		QAWx.y.0.2	...	QAWx.y.0.6	Word
EM 4-101-DD2/106	QBx.y.0.0	QBx.y.0.1				Bit, Byte
EM 4-101-DD2/88	QBx.y.0.0					Bit, Byte
EM 4-111-DR2	QBx.y.0.0					Bit, Byte
EM 4-201-DX2 with LE	QBx.y.1.0	QBx.y.1.1	QBx.y.2.0	...	QBx.y.6.1	Bit, Byte, Word
EPC 335	SDBx.y.0.0	SDBx.y.0.1	SDBx.y.0.2	...	SDBx.y.0.5	Bit, Byte, Word
LE 4-501-BS1	SDBx.y.0.0	SDBx.y.0.1	SDBx.y.0.2	...	SDBx.y.0.77	Bit, Byte, Word
MI 4	SDBx.y.0.0	SDBx.y.0.1	SDBx.y.0.2	...	SDBx.y.0.77	Bit, Byte, Word
MV 4	SDBx.y.0.0	SDBx.y.0.1	SDBx.y.0.2	...	SDBx.y.0.119	Bit, Byte, Word
PS 3-8	QBx.y.0.0	QBx.y.0.1				Bit, Byte
PS 3-AC	QBx.y.0.0	QBx.y.0.1	QABx.y.0.0			(Bit), Byte
PS 3-DC	QBx.y.0.0	QBx.y.0.1	QABx.y.0.0			(Bit), Byte
PS 316 (SBI)/306	SDBx.y.0.0	SDBx.y.0.1	SDBx.y.0.2	...	SDBx.y.0.5	Bit, Byte, Word
PS 4-141-MM1	SDBx.y.0.0	SDBx.y.0.1	SDBx.y.0.2	...	SDBx.y.0.77	Bit, Byte, Word
PS 4-151-MM1	SDBx.y.0.0	SDBx.y.0.1	SDBx.y.0.2	...	SDBx.y.0.77	Bit, Byte, Word
PS 4-1x1, aktiv	SDBx.y.0.0	SDBx.y.0.1	SDBx.y.0.2	...	SDBx.y.0.5	Bit, Byte
PS 4-1x1, passiv	QBx.y.0.0	–	–		–	(Bit), Byte

Slave addressing

Slave	Byte 1	Byte 2	Byte 3	...	Last byte	Data type
PS 4-201-MM1	SDBx.y.0.0	SDBx.y.0.1	SDBx.y.0.2	...	SDBx.y.0.77	Bit, Byte, Word
PS 4-271-MM1	SDBx.y.0.0	SDBx.y.0.1	SDBx.y.0.2	...	SDBx.y.0.77	Bit, Byte, Word
PS 4-341-MM1	SDBx.y.0.0	SDBx.y.0.1	SDBx.y.0.2	...	SDBx.y.0.119	Bit, Byte, Word
PS 4-401-MM1	SDBx.y.0.0	SDBx.y.0.1	SDBx.y.0.2	...	SDBx.y.0.5	Byte, Word
PS 4-401-MM2	SDBx.y.0.0	SDBx.y.0.1	SDBx.y.0.2	...	SDBx.y.0.83	Bit, Byte, Word
RBI 1.1	QBx.y.0.0	QBx.y.0.1	QABx.y.0.0			(Bit), Byte
RMQ 16I	QBx.y.0.0	QBx.y.0.1				Bit, Byte
SBI-AMD3	SDBx.y.0.0	SDBx.y.0.1	SDBx.y.0.2	...	SDBx.y.0.5	Byte, Word
SBI-AMX	SDBx.y.0.0	SDBx.y.0.1	SDBx.y.0.2	...	SDBx.y.0.5	Byte, Word
SIS-K-06/07	SDBx.y.0.0	SDBx.y.0.1	SDBx.y.0.2	...	SDBx.y.0.5	Bit, Byte, Word
10/10	SDBx.y.0.0	SDBx.y.0.1	SDBx.y.0.2	...	SDBx.y.0.9	Bit, Byte, Word
15/15	SDBx.y.0.0	SDBx.y.0.1	SDBx.y.0.2	...	SDBx.y.0.14	Bit, Byte, Word
24/24	SDBx.y.0.0	SDBx.y.0.1	SDBx.y.0.2	...	SDBx.y.0.23	Bit, Byte, Word
30/30	SDBx.y.0.0	SDBx.y.0.1	SDBx.y.0.2	...	SDBx.y.0.29	Bit, Byte, Word
40/40	SDBx.y.0.0	SDBx.y.0.1	SDBx.y.0.2	...	SDBx.y.0.39	Bit, Byte, Word
50/50	SDBx.y.0.0	SDBx.y.0.1	SDBx.y.0.2	...	SDBx.y.0.49	Bit, Byte, Word
60/60	SDBx.y.0.0	SDBx.y.0.1	SDBx.y.0.2	...	SDBx.y.0.59	Bit, Byte, Word
SIS-Typ-80D0 bis	SDBx.y.0.0	SDBx.y.0.1	SDBx.y.0.2	...	SDBx.y.0.5	Bit, Byte, Word
SIS-Typ-80EF	SDBx.y.0.0	RDBx.y.0.1	SDBx.y.0.2	...	SDBx.y.0.5	Bit, Byte, Word
VTP 0-H-Tx	SDBx.y.0.0	SDBx.y.0.1	SDBx.y.0.2	...	SDBx.y.0.5	Byte, Word
VTP 1/2-H-T6	SDBx.y.0.0	SDBx.y.0.1	SDBx.y.0.2	...	SDBx.y.0.17	Byte, Word
ZB 4-501-UM2	SDBx.y.0.0	SDBx.y.0.1	SDBx.y.0.2	...	SDBx.y.0.23	Bit, Byte, Word

x = line, y = station

Technical data

General	
Standards	EN 61 131-2, EN 50 178
Ambient temperature	0 to 55 °C
Storage temperature	-20 to 70 °C
Vibration resistance	1 g/0 to 150 Hz
Vibration	Constant 1 g, f = 0 to 150 Hz
EMC	see Page 94
Programming interface	RS 232, length of programming cable < 3 m
Network interface	RS 485
Bus	Suconet K
Length of data cable	600 m/300 m
Transmission speed	187.5 kbps to 375 kbps
Operating mode	Master/slave
Degree of protection	IP 20
Rated insulation voltage U_i	1500 V AC to IEC 1131 Part 2
Real-time clock	Yes
Accuracy of real-time clock	6.1 minutes per year (battery backup)
Battery (life)	Typically 5 years
Expansion capacity (local)	Up to 5 LEs
Expansion capacity (remote)	Up to 8 stations
User and data memory (internal)	32 kB
Memory (external)	32 kByte RAM 128 kByte FLASH 32 kByte RAM+128 kByte FLASH
Typical cycle time for 1 K instructions (bits, bytes)	5 ms
No. of inputs (local)	12
No. of outputs (local)	8 (relay)
Weight	Approx. 950 g

Technical data

Power supply

Rated voltage U_e	120/240 V AC
Permissible range	98 to 264 V AC
Frequency	47 to 63 Hz
Rated current I_e	0.3 A (120 V AC)/ 0.15 A (240 V AC)
Inrush current and duration	4 A < 5 ms
Power dissipation (for device as a whole, without LE)	Approx. 12.5 W (240 V AC) Approx. 9.5 W (120 V AC)
Bridging of voltage dips	
Duration of dip	10 ms
Repetition rate	1 s
Error display	Yes (LED)
Protection class	1
Electrically isolated	Yes
Terminals	Screw terminals
Terminal capacity	
Flexible with ferrule	0.22 to 2.5 mm ² (AWG 24 to 13)
Solid	0.22 to 2.5 mm ² (AWG 24 to 13)
Rated insulation voltage	1500 V AC to IEC 1131Part 2
m max. current load for LE bus (5V)	1.2 A

Inputs

No. of inputs	12
Rated voltage U_e	120 V AC/47 to 63 Hz 240 V AC/47 to 55 Hz
Rated current I_e for "1" signal	
120 V AC/50 Hz	Typically 6 mA
240 V AC/50 Hz	Typically 12 mA
Electrical isolation	
Input to input	No
input to LE bus/Suconet K	Yes
Insulation voltage	1500 V AC
Overtoltage category	II, basic insulation

Representation of Analog Values

Different phases at adjacent inputs	Not permissible, between groups only switchable by phase (see page 8)
Switching level to EN 61 131-2	
Limit values type "1"	$U_n = 120 \text{ V AC} = 240 \text{ V AC}$
Min. high level	79 V 164 V
Max. low level	20 V 40 V
On-delay	
120/240 V AC	Typically 10 ms at 50 Hz
Off-delay	
120/240 V AC	Typically 30 ms at 50 Hz
Status indicators for inputs	Yes (LED)
Terminals	Plug-in screw terminals
Terminal capacity	
Flexible with ferrule	0.22 to 1.5 mm ² (AWG 24 to 16)
Solid	0.22 to 2.5 mm ² (AWG 24 to 16)
Setpoint potentiometers	
No.	2
Value range	10 bits (1024 units)
Setting	With screwdriver
Analog inputs	
No.	4; 2 × current/voltage, 2 × resistance
Signal range	0 to 10 V
Input resistance	220 kΩ
Total error	Typically 0.8% of full scale
Current	0 mA to 20 mA (4 mA to 20 mA by means of software)
Input resistance	250 Ω
Total error	Typically 0.8% of full scale
Resistance	0 to 1500 Ω
Sensors	Pt1000, Ni1000
Measuring current	Approx. 0.4 mA
Total error	Typically 0.8% of full scale

Technical data

Sensor element connection type	Two-wire connection to transmitter
Digital representation of input signal	10 bits (1024 units)
Terminals	Plug-in screw terminals
Terminal capacity	
Flexible with ferrule	0.22 to 1.5 mm ² (AWG 24 to 16)
Solid	0.22 to 2.5 mm ² (AWG 24 to 13)
Outputs	
No. of outputs	8
Contacts	Make contacts
Electrical isolation	Yes, in groups of 1
Rated voltage U_e	250 V AC
Uninterrupted current I_{th}	max. 8 A (UL/CSA: 10 A)
Short-circuit-proof $\cos\varphi = 1$	16 A characteristic B (FAZN B16) at 600 A
Short-circuit-proof $\cos\varphi = 0,5$ bis $0,7$	16 A characteristic B (FAZN B16) at 900 A
Contact material	AgNi90/10
Response time	Typically 6 ms
Opening time	Typically 10 ms
Bounce time	Typically 0.5 ms
Minimum contact voltage	> 12 V
Minimum contact current	> 0.5 A
Minimum load	6 W
Switching capacity	
AC	max. 2000 VA (250 V/8 A/10 A UL/CSA)
DC	max. 240 W (30 V DC/8 A/10 A UL/CSA)
Lifespan, mechanical	10 000 000 switch operations
mechanical switching frequency	10 Hz
resistive lamp load	2 Hz
inductive load	0.5 Hz

Representation of Analog Values

Lifespan, electrical at 8 A/230 V AC/70 °C	100000 switch operations
Operation at AC 15, 250 V, 3 A $\cos\varphi = 0.4$, 600 Ops/h	300000 switch operations
Operation at DC 13, 24 V DC, 1 A L/R = 150 ms, 500 Ops/h	200000 switch operations
Filament lamp load	
1000 W at 230/240 V AC	25000 switch operations
500 W at 115/120 V AC	25000 switch operations
Fluorescent tubes	
with electronic ballast	10 × 58 W at 230/240 V AC/ 25000 switch operations
conventional p.f. correction	1 × 58 W at 230/240 V AC/ 25000 switch operations
without p.f. correction	10 × 58 W at 230/240 V AC/ 25000 switch operations
Parallel connection of outputs to increase power	not permissible
Protection of relay contact	FAZN B16 mcb or 8 A fuse (slow)
Contact protection	None
Short-circuit/overload protection	No
Insulation	IEC 664/VDE 0110 (01/89)
Contamination level	3
Overvoltage category	III
Creepage distance coil/contact	8 mm
Air clearance coil/contact	8 mm
Test voltage	
at open contact	1 kV
coil/contact	4 kV
Status LEDs for outputs	Yes
Terminals	Plug-in screw terminals

Technical data

Terminal capacity	
Flexible with ferrule	0.22 to 1.5 mm ² (AWG 24 to 16)
Solid	0.22 to 2.5 mm ² (AWG 24 to 13)
Analog outputs	
No.	2
Signal range	0 to 20 mA, 4 to 20 mA
Resolution in bits	12 (4096 units)
Total error	Typically 0.4% of full scale
Load	Max. 500 Ω
Connection type	Two-wire connection
No.	2
Signal range	0 to 10 V
Resolution in bits	12 (4096 units)
Total error	Typically 0.4% of full scale
Output load	Min. 2 kΩ
Connection type	Two-wire connection
Terminals	Plug-in screw terminals
Terminal capacity	
Flexible with ferrule	0.22 to 1.5 mm ² (AWG 24 to 16)
Solid	0.22 to 2.5 mm ² (AWG 24 to 13)

Representation of Analog
Values

General EMC specifications for automation equipment

Emission	EN 55 011/22 Class A		
Interference immunity			
ESD	EN 61 000-4-2	Contact discharge Air discharge	4 kV 8 kV
RFI	EN 61 000-4-3	AM/PM	10 V/m
Burst	EN 61 000-4-4	Mains/digital I/O Analog I/O, field bus	2 kV 1 kV
Surge	EN 61 000-4-5	Digital I/O, asymmetrical Mains DC, asymmetrical Mains DC, symmetrical Mains AC, asymmetrical Mains AC, symmetrical	0.5 kV 1 kV 0.5 kV 2 kV 1 kV
Immunity to line-conducted interference	EN 61 000-4-6	AM	10 V

Index

A

Address of network stations	34
Analog inputs	8
Analog outputs	9
Analog/digital conversion	77
Avoiding interference	29

B

Backup battery	14, 83
Backup memory	12
Battery changing	66
Baud rate	10
Bus cable	17
Bus terminating resistors	11
Setting	18

C

Cable	83
Cable routing	29
Cold start	59
Combination module	13
Commissioning	65
Communication conditions	31
Configuration example	47
Connecting the PC	16
Connecting the programming device	16
Connection	
Data and signal cables	19
Overview	19
Programming device	16
Suconet K field bus	17
ZB 4-501-TC1 telecontrol module	17
ZB 4-501-UM3 interface converter	17
Connector pin assignment	
Suconet K interface	17
Controls and indicators	6, 13
CRC	47
Current inputs	8

D

Data cable 83
 Data plug connector 83
 Data security 47
 Device arrangement 23
 Diagnosis 66
 Digital inputs 8
 Documentation 3
 DST 14
 Dynamic memory allocation 12

E

Electrical interference 22
 Electromagnetic compatibility 19
 Electromagnetic effect 22
 Elements of the PLC 8

F

Fastening the PLC 23
 Features 5
 Figure 6
 Fixing clip 83
 Flash module 12

H

Hardware requirements 5
 Hinged cover 83

I

Indicators 6, 13
 Inductances 23
 Input data 46

L

Layout 6, 7
 Layout of control cabinet 22
 LEDs 6, 8, 13, 65
 Lightning protection measures 28
 Limits, send and receive data 39
 Line number 34
 Local expansion 18
 Local expansion modules 14

M

Master PLC	31
Memory	
Allocation, dynamic	12
Capacity	12
Memory module	12, 83
Memory test	55
Message byte	75
Mode selector	14
Module number	34
Mounting	
Fixing clips	30
Position	23
Top-hat rail	29

N

Network interface	10
Not Ready	57

O

Operand addressing	
Slaves with CPU	53
Slaves without CPU	51
Operating states, overview	58
Output data	46
Output signals	9

P

Parameter dialog fields	31
Parity	10
PC communication	56
Pin assignment	17
Programming device interface	16
PLC_Message	75
Plug connector	14
Plug connector for local expansion module	15
Potential equalisation currents	17
Power supply	26
Power supply unit	8
Power-up behaviour	55
Programming cable	5, 16, 83
Programming device interface (PRG)	11
Pin assignment	16

Programming of networks 10
 Programming via Suconet K 63

R

RAM memory 12
 RAM module 12
 Ready 56
 Real-time clock 14
 Receive data 46
 Recipe data 12
 Relay outputs 9
 Reset button 14
 Retention 60
 Run 56

S

Screen grounding kit 83
 Screw terminal 8, 83
 Selecting your network components 31
 Send data 46
 Serial interface 10
 Setpoint potentiometers 11
 Shutdown behaviour 55
 Simulator 83
 Slave addressing 51, 84
 Slave PLC with CPU 31
 Slave PLC without CPU 31
 Software configuration 31
 Software requirements 5
 Start-up behaviour 59
 Station number 34
 Status LEDs 13, 65
 Stop bit 10
 Suconet K
 Connection 17
 Interface 10, 17
 Summer/winter time
 Switching between 14
 Suppression of sources of interference 23
 Symbols 4
 Syntax 51, 53
 System test 55

T	
T connector	83
Temperature sensor	8
Terminal capacities, screw terminals	15
Terminals	
Overview	15
Transferring user programs	61
Transparent communication	10
Twin-level terminal block	83
U	
User program test	55
V	
Ventilation	22
Voltage inputs	8
W	
Warm start	60
Wire break signals	70
Wiring	29