

# COMPAX User Guide

## Compact Servo Controller



From software version V6.26

April 2001

**HAUSER**  
We automate motion



Reg. Nr. 36 38

Parker Hannifin GmbH  
EMD Hauser  
P. O. Box: 77607-1720  
Robert-Bosch-Str. 22  
D-77656 Offenburg, Germany  
Phone: +49 (0)781 509-0  
Fax: +49 (0)781 509-176  
<http://www.parker-emd.com>

Parker Hannifin plc  
Electromechanical Division  
21 Balena Close  
Poole, Dorset  
BH17 7DX UK  
Phone: +44 (0)1202 69 9000  
Fax: +44 (0)1202 69 5750  
<http://www.parker-emd.com>



# 1. Contents

<b>1. Contents .....</b>	<b>2</b>
<b>2. Unit assignment:.....</b>	<b>7</b>
<b>3. Safety instructions .....</b>	<b>8</b>
3.1 General dangers .....	8
3.2 Safe working practices.....	8
3.3 Special safety instructions .....	8
3.4 Conditions of warranty.....	9
<b>4. COMPAX – CD .....</b>	<b>9</b>
<b>5. Switch-on status .....</b>	<b>10</b>
5.1 Configuration when supplied .....	10
5.2 Commissioning.....	10
5.3 Equipment replacement.....	12
<b>6. Conditions for usage .....</b>	<b>13</b>
<b>7. Start-up manual.....</b>	<b>14</b>
7.1 Overview:.....	14
7.1.1 Components required .....	14
7.1.2 Overview of unit technology.....	15
7.2 COMPAX-M unit features .....	17
7.2.1 Connector and terminal assignment .....	17
7.2.2 COMPAX-M system network, NMD10 / NMD20 mains module .....	18
7.2.3 COMPAX-M dimensions/installation.....	20
7.2.4 Connector assignment COMPAX-M.....	21
7.3 Mains module NMD10/NMD20 .....	22
7.3.1 Overview NMD .....	22
7.3.2 Dimensions / installation .....	22
7.3.3 NMD connector assignment .....	23
7.3.4 Technical data / power features NMD.....	23
7.4 COMPAX 35XXS unit features .....	26
7.4.1 Plug and connection assignment COMPAX 35XXM.....	26
7.4.2 Installation and dimensions of COMPAX 35XXM .....	27
7.4.3 Wiring COMPAX 35XXM.....	28

7.4.4	COMPAX 35XXM connector assignment.....	29
<b>7.5</b>	<b>COMPAX 25XXS unit characteristics.....</b>	<b>30</b>
7.5.1	COMPAX 25XXS connector and connection assignment.....	30
7.5.2	COMPAX 25XXS-specific technical data.....	32
7.5.3	COMPAX 25XXS dimensions / installation.....	33
7.5.4	Connector assignment COMPAX 25XXS.....	34
<b>7.6</b>	<b>COMPAX 45XXS/85XXS unit characteristics .....</b>	<b>35</b>
7.6.1	Plug and connection assignment COMPAX 45XXS/85XXS .....	35
7.6.2	COMPAX 45XXS/85XXS installation / dimensions.....	36
7.6.3	COMPAX 45XXS/85XXS-specific wiring .....	37
7.6.4	COMPAX 45XXS/85XXS connector and pin assignment.....	39
<b>7.7</b>	<b>COMPAX 1000SL Unit characteristics .....</b>	<b>40</b>
7.7.1	Connector and terminal assignment for COMPAX 1000SL .....	40
7.7.2	Connector assignment COMPAX 1000SL (overview).....	42
7.7.3	Mounting and dimensions COMPAX 1000SL.....	43
7.7.4	Safety chain / emergency stop functions.....	44
<b>7.8</b>	<b>Connections to the motor .....</b>	<b>46</b>
7.8.1	Resolver / SinCos .....	46
7.8.2	Additional brake control .....	51
<b>7.9</b>	<b>Interfaces.....</b>	<b>52</b>
7.9.1	Digital inputs and outputs (excluding COMPAX 1000SL).....	52
7.9.2	Digital inputs and outputs for COMPAX 1000SL .....	53
7.9.3	Technical data / Connections of inputs and outputs .....	54
7.9.4	Initiators and D/A monitor.....	55
7.9.5	Service D/A monitor / override .....	56
7.9.6	Service D/A monitor .....	56
7.9.7	D/A monitor option D1 .....	58
7.9.8	RS232 interface.....	59
7.9.9	Absolute value sensor (option A1) .....	59
7.9.10	X13: Encoder interfaces, .....	60
7.9.10.1	Encoder interfaces / analogue rpm specification for COMPAX.....	60
7.9.10.2	Area of application of process interfaces.....	60
7.9.10.3	Encoder interfaces / Analogue rpm specification / Step direction input for COMPAX 1000SL .....	61
7.9.11	HEDA interface (option A1/A4).....	63
7.9.12	Bus connection.....	63
<b>7.10</b>	<b>Technical data.....</b>	<b>64</b>
<b>8.</b>	<b>Operating Instructions .....</b>	<b>67</b>
<b>8.1</b>	<b>Overview:.....</b>	<b>67</b>
8.1.1	Block structure of the basic unit (not applicable for COMPAX 1000SL) .....	68
8.1.2	Password protection .....	70
<b>8.2</b>	<b>Configuration .....</b>	<b>71</b>
8.2.1	Front plate operation (not available with COMPAX 1000SL) .....	71
8.2.2	Configuration when supplied .....	72

8.2.3	Configuration process .....	72
8.2.4	Safety instructions for initial start-up.....	73
8.2.5	Configuration parameters.....	74
8.2.6	Absolute value function with standard resolver.....	79
8.2.7	Machine zero mode .....	80
8.2.8	Limit switch operation .....	89
<b>8.3</b>	<b>Configuration via PC using "ServoManager" .....</b>	<b>91</b>
8.3.1	Installing ServoManager.....	91
8.3.2	Configuring COMPAX .....	91
8.3.3	Individual configuration of synchronous motors.....	91
<b>8.4</b>	<b>Positioning and control functions .....</b>	<b>95</b>
8.4.1	Absolute positioning [POSA] .....	96
8.4.2	Relative positioning [POSR].....	96
8.4.3	Process velocity [SPEED].....	97
8.4.4	Acceleration and braking time [ACCEL].....	97
8.4.5	Setting/resetting an output [OUTPUT].....	98
8.4.6	Setting multiple digital outputs [OUTPUT O12=1010].....	98
8.4.7	Switch off drive unit. [OUTPUT O0] .....	98
8.4.8	OUTPUT O0=... in program .....	98
8.4.9	Password [GOTO].....	99
8.4.10	External velocity specification. [SPEED SYNC].....	99
8.4.11	Mark-related positioning [POSR] .....	100
8.4.12	Preparatory instructions .....	101
8.4.13	Changes in speed within a positioning process [POSR SPEED].....	101
8.4.14	Comparators during positioning [POSR OUTPUT] .....	103
8.4.15	Cam controller with compensation for switching delays .....	104
8.4.16	Programmable waiting time [WAIT] .....	107
8.4.17	Program jump [GOTO] .....	107
8.4.18	Sub-program jump [GOSUB].....	107
8.4.19	Instruction to end a sub-program. [RETURN].....	107
8.4.20	END instruction [END] .....	107
8.4.21	Start a program loop [REPEAT] .....	108
8.4.22	Branching [IF I7=1] .....	108
8.4.23	Binary IF query of inputs [IF I12=101-1] .....	108
8.4.24	Comparative operations .....	109
8.4.25	Specific processing of data record groups. WAIT START.....	109
8.4.26	Jump with data record selection [GOTO EXT].....	109
8.4.27	Sub-program jump with data record selection [GOSUB EXT].....	110
8.4.28	Error handling [IF ERROR GOSUB] .....	110
8.4.29	STOP / BREAK handling [IF STOP GOSUB xxx].....	111
8.4.30	Arithmetic.....	113
	8.4.30.1 Parameter assignments .....	113
	8.4.30.2 Arithmetic and variables .....	114
8.4.31	Position monitoring (P93=1, 2, 3).....	117
8.4.32	Idle display .....	119
8.4.33	Speed monitoring in speed control mode (P93="4").....	120
8.4.34	PLC sequential step tracking .....	122
8.4.35	Engaging and disengaging the motor brake.....	123
8.4.36	Output of variable voltage .....	124

<b>8.5</b>	<b>Optimization functions</b> .....	<b>125</b>
8.5.1	Optimization parameters .....	127
8.5.2	Speed monitor .....	132
8.5.3	Optimization display .....	133
8.5.4	External position localization with position adjustment.....	136
<b>8.6</b>	<b>Interfaces</b> .....	<b>138</b>
8.6.1	Digital inputs and outputs .....	138
8.6.1.1	Digital inputs and outputs for COMPAX 1000SL .....	140
8.6.1.2	Free assignment of inputs and outputs .....	143
8.6.1.3	COMPAX virtual inputs.....	145
8.6.1.4	I/O assignment of variants.....	147
8.6.1.5	Function of inputs.....	148
8.6.1.6	Synchronous STOP using I13 .....	151
8.6.1.7	Function of outputs.....	153
8.6.1.8	Diagrams:.....	154
8.6.2	PLC data interface (function not available with COMPAX 1000SL) .....	156
8.6.3	RS232 interface.....	160
8.6.3.1	Interface description .....	160
8.6.3.2	Interface functions .....	162
8.6.3.3	Read and write program sets and parameters .....	163
8.6.3.4	Binary data transfer using RS232 .....	166
8.6.4	Process coupling using HEDA (Option A1 / A4).....	168
<b>9.</b>	<b>Accessories and options</b> .....	<b>173</b>
9.1	System concept .....	173
9.2	Overview.....	174
9.3	Motors.....	176
9.4	HAUSER linear actuators.....	177
9.5	Data interfaces .....	178
9.5.1	RS232.....	178
9.5.2	Bus systems .....	178
9.5.2.1	Interbus-S / Option F2 .....	178
9.5.2.2	RS485 / Option F1/F5 .....	178
9.5.2.3	Profibus / option F3 .....	178
9.5.2.4	CAN - Bus / Option F4.....	178
9.5.2.5	CANopen / Option F8.....	178
9.5.2.6	CS31system bus / Option F7 .....	178
9.6	Process interfaces.....	179
9.6.1	Encoder interface .....	179
9.6.2	Absolute value sensor (A1) .....	183
9.6.3	High resolution SinCos sensor system (S1/S2) <sup>®</sup> .....	183
9.6.4	Option S3 for linear motors. ....	184
9.6.5	HEDA interface .....	185
9.6.6	D/A monitor (D1) (option not available with COMPAX 1000SL).....	185
9.6.7	Analogue speed specification (E7) (option not available with COMPAX 1000SL).....	186
9.7	Accessories.....	187

9.7.1	External control panel (not available for COMPAX 1000SL).....	187
9.7.2	Terminal module for COMPAX 1000SL (EAM) .....	188
9.7.3	EAM5/01: DC feed for COMPAX-M .....	189
9.7.4	EMC measures.....	191
9.7.4.1	Power filter .....	191
9.7.4.2	Motor output throttle .....	192
9.7.5	External ballast resistors.....	193
9.7.6	ServoManager.....	200
9.7.7	Hand-held terminal.....	200
9.8	Appendix: COMPAX components.....	206
<b>10. Appendix .....</b>		<b>207</b>
10.1	Status values of the standard unit (COMPAX XX00).....	207
10.2	Additional COMPAX measuring quantities .....	210
10.3	COMPAX parameter.....	212
10.3.1	VP parameter can be modified "On Line" .....	212
10.3.2	COMPAX standard parameters .....	212
10.3.3	Monitoring and limitation characteristics .....	222
10.4	Error handling and error messages.....	223
<b>11. Application examples .....</b>		<b>226</b>
11.1.1	Overview.....	226
11.1.2	External data record selection .....	227
11.1.3	Mark-referenced positioning .....	229
11.1.4	Speed step profiling / comparator switching points .....	231
11.1.5	SPEED SYNC .....	233
11.1.6	Speed control mode .....	234
11.1.7	Fast start .....	236
11.1.8	Implementing a torque controller.....	237
<b>12. Index.....</b>		<b>238</b>

**Data security**

The parameter and program memory are created using ZP-RAM. This memory is unaffected by mains power failure.  
 This module has a guaranteed service life of 10 years (calculated from the first start-up).  
 ZP-RAM failure causes data loss; COMPAX contains wild data.  
 If you encounter problems of this kind, contact HAUSER.

© SinCos is a registered trademark of Firma Stegmann.

## 2. Unit assignment:

This documentation applies to the following units:

- ◆ COMPAX 10XXSL
- ◆ COMPAX 25XXS
- ◆ COMPAX 45XXS
- ◆ COMPAX 85XXS
- ◆ COMPAX P1XXM
- ◆ COMPAX 02XXM
- ◆ COMPAX 05XXM
- ◆ COMPAX 15XXM
- ◆ COMPAX 35XXM

XX: Unit variants

### Key to unit designation

e.g.: COMPAX 0260M:

COMPAX: name

02: performance class

60: Variant e.g. "00": Standard model

"60": electronic transmission

M: unit type "M": multi-axis model

"S": single-axis unit

...

### HAUSER type plate

The type plate is located on the upper side of the unit and contains the following:



option name

serial number

equipment name

part number

### Notes for repeat customers regarding modified software versions:

#### Please check the software version of your unit.

Despite all efforts on our part, software modifications may change procedures as well as cause functional changes.

Please notify us immediately if you detect unexplainable problems when using a new software version.

## 3. Safety instructions

### 3.1 General dangers

General dangers when safety instructions are not complied with

The unit described contains leading edge technology and is operationally reliable. However, hazards may occur if the unit is employed incorrectly or for improper use. Energized, moving or rotating parts can

- ◆ cause fatal injury to the user
- ◆ cause material damage

Proper use

This unit is designed for use in high voltage units (VDE0160). This unit automates motion processes. The ability to switch several units at once makes it possible to combine several motion processes. Reciprocal interlocks must be installed in such cases.

### 3.2 Safe working practices

The unit must be operated by skilled staff only.

- ◆ When used in this manual, the term "trained staff" refers to people who,
  - due to their training, experience and knowledge of current standards, guidelines, accident prevention regulations and operating conditions, have received authorization from the head of health and safety at the site to perform the necessary activities, while recognizing and avoiding any associated dangers (definition of personnel as per VDE105 or IEC364)
  - are familiar with first aid and the on-site safety equipment,
  - have read and observed the safety instructions
  - have read and observed the User Guide (or the section which applies to the tasks to be executed).

This applies to all tasks relating to set-up, start-up, configuration, programming and modification of the operating conditions, operating modes and maintenance.

Please note in particular the functions contained in the start-up manual relating to operational readiness and emergency stop.

The User Guide must be present at the unit at all times.

### 3.3 Special safety instructions

- ◆ Check the arrangement of unit and documentation.
- ◆ Never disconnect the electrical connections when energized.
- ◆ Use safety equipment to ensure that moving or rotating parts cannot be touched.
- ◆ Ensure that the unit is in perfect working order before operation.
- ◆ Include the operational readiness and emergency stop functions of the unit (see start-up manual) in the safety and emergency stop functions of your machine.
- ◆ Only operate unit with the front cover attached.
- ◆ Ensure mains module has sufficient nominal and peak power ratings.
- ◆ Ensure that the unit arrangement enables the units with higher power ratings to be fitted more closely to the power unit than the units with lower ratings (COMPAX-M).
- ◆ Ensure that motors and linear drive units (if available) are sufficiently secured.
- ◆ Ensure that all energized connectors cannot be touched. The unit carries voltages ratings of up to 750V, which could fatally injure the operator.



### 3.4 Conditions of warranty

- ◆ The unit must not be opened.
- ◆ Do not make any alterations to the unit, except for those described in the User Guide.
- ◆ Only activate inputs, outputs and interfaces as described in the User Guide.
- ◆ When installing units, ensure that the heat sinks receive sufficient ventilation.
- ◆ Secure units as per the assembly instructions contained in the start-up manual using the securing bores provided for this purpose. We cannot assume any responsibility for any other methods used for securing the units.

#### Note on option exchange

In order to check hardware and software compatibility, it is necessary for COMPAX options to be changed at the factory.

## 4. COMPAX – CD

On the accompanying CD, you will find all instructions for COMPAX and the operating software "ServoManager".

Once the CD is inserted in a Windows – computer, the HTML desktop (default.htm) is normally automatically started – if an Internet browser is present. If you do not have an Internet browser on your computer, please install a version: the software is usually available to download free of charge.

If the desktop does not start automatically, please execute the file "default.htm" (e.g. by double clicking on the file or via "Start": "Run"). The "default.htm" file is located directly on the CD (not in the sub-directory).

Use Language selection (top right in window) to select the language required. Follow the CD instructions shown on the window in the center of the screen. Use the list on the left-hand side to select the required instructions or software.

## 5. Switch-on status

### 5.1 Configuration when supplied

When supplied, COMPAX is not configured. Parameter P149 is set to "0":

**P149="0"**: COMPAX is not configured and switches to OFF mode when switched on (24V DC and operating voltage) (motor switched off). In addition to this, when switched on, all parameters (apart from bus settings P194, P195, P196 and P250) are set to their default values.

**P149="1"**: COMPAX is configured and once switched on (24V DC and operating voltage) tries to engage the motor.

### 5.2 Commissioning

Meaning of LEDs on the front panel

#### COMPAX-M / -S

LED	Color	Meaning, when switched on
Ready	green	24V DC present and initialization complete
Error	red	COMPAX - Error (E1...E56) present or COMPAX is initialized.

Mains module

LED red Error	LED green Ready	Possible errors
off	on	no errors
on	off	Heat sink temperature too high or error in logic voltage (24V DC too low or unit is defective)  Emergency stop is activated and ready contact is released.
on	on	Ballast switching unit overload or undervoltage (<100V DC or <80V AC).

#### COMPAX 1000SL

Status	Red LED (H2)	Green LED (H1)
24V not available	off	off
24V are switched on, boot up	on	off
Unit OFF	off	blinking
Unit error; drive switched off	on	blinking
Unit error; drive powered	on	on
Unit RUNNING	off	on



#### Caution!

If there is no control voltage, no displays will appear to indicate that operating voltage is present.

**Note:** With Error E40, external enabling is missing with COMPAX 45XXS, COMPAX 85XXS and COMPAX 1000SL (Hardware input).

After 24V DC of control voltage is switched on, COMPAX has two statuses available once the initialization phase has been completed:

1. COMPAX is OFF  
 COMPAX is not configured (P149="0") or with COMPAX XX70:  
 I12="0" (final stage blocked).  
 Now configure COMPAX (e.g. using the ServoManager / ParameterEditor).  
 Set P149="1"  
 Configuration is accepted with VC and VP of COMPAX.
2. COMPAX displays error E57  
 COMPAX is configured (P149="1"). However, operating voltage is not present.  
 Check COMPAX configuration \* .  
 Alterations are accepted with VC and VP of COMPAX.

**\*) Configuring**

- a) Using ServoManager:  
 P149="1", VP and VC are transferred when being downloaded to COMPAX from the ServoManager.
- b) Using hand-held terminal:  
 P149="1", VP and VC are generated by the hand-held terminal.
- c) Without an auxiliary device, e.g. a terminal:  
 P149="1", VP and VC must be transmitted after COMPAX configuration.

Switch on operating voltage

With E57: acknowledge error by pressing Enter.

When OFF: command: "OUTPUT O0=0" or  
 switch 24V DC on / off

**Motor is powered; COMPAX display shows "RUN".**

**Flow chart:**

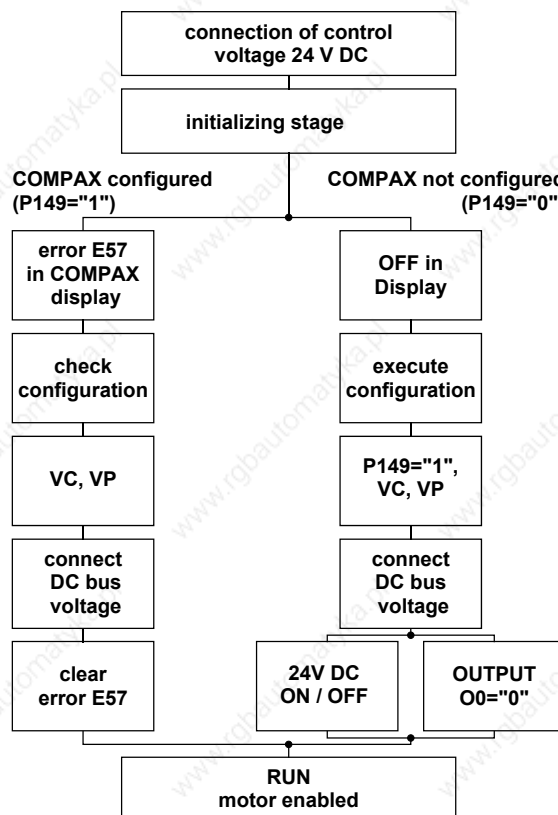

## 5.3 Equipment replacement

### Previous software $\geq$ V2.0

- ◆ Procedure for copying the complete COMPAX setting onto a new unit
- ◆ Start ServoManager.
- ◆ Connect old COMPAX via RS232.
- ◆ Use menu "Insert: Axis: From controller" to set up an axis which contains all COMPAX settings (all parameters: including system parameters, data records and (with COMPAX XX70) existing curves).
- ◆ Connect new COMPAX.
- ◆ Use menu "Online: Download" to transfer data (without system parameters<sup>1</sup>) into the new COMPAX.

### Transferring system parameters

- ◆ Call up ParameterEditor (Menu: PC Tools: ParameterEditor)
- ◆ Use menu "Online: Copy" menu to transfer all parameters (including system parameters) to COMPAX.

### Previous software $\leq$ V2.0

Procedure for copying the complete COMPAX setting onto a new unit

- ◆ Start ServoManager.
- ◆ Connect old COMPAX via RS232.
- ◆ Use menu "Insert: Axis: New" to set up a new axis.
- ◆ Use menu "Online: Upload" to load all COMPAX settings (all parameters: including system parameters, data records, and (in COMPAX XX70) existing curves) into the new axis.
- ◆ Connect new COMPAX.
- ◆ Use menu "Online: Download" to transfer data (without system parameters) into the new COMPAX.

### Transferring system parameters

- ◆ Call up ParameterEditor (Menu: PC Tools: ParameterEditor)
- ◆ Use menu "Online: Copy" menu to transfer all parameters (including system parameters) to COMPAX.

---

<sup>1</sup> System parameters are internal parameters; you will only obtain an identical COMPAX – setting if these are also transferred.

## 6. Conditions for usage

### - for CE-compliant operation in industrial and business sectors -

The EU guidelines on electromagnetic compatibility 89/336/EEC and electrical means of production for use within particular voltage limits 73/23/EEC are satisfied, if the following peripheral conditions are complied with.

**Only operate the units in the condition in which they are supplied, i.e. with all housing plates and the front cover.**

**COMPAX P1XXM, COMPAX 02XXM, COMPAX 05XXM and COMPAX 15XXM may only be operated with HAUSER mains modules (NMD10 or NMD20) or on COMPAX 35XXM.**

**Power filter:**

**A power filter is required in the power line. The filtering can be executed once for the entire system or as separate process for each unit.**

**The following power filters are required for standalone operation:**

**NMD10 / COMPAX 45XXS / COMPAX 85XXS: Order No.: NFI01/02**

**NMD20: Order No.: NFI01/03**

**COMPAX 35XXM: Order No.: NFI01/04 or /05**

**COMPAX 25XXS: Order No.: NFI01/01 or /06**

**COMPAX 10XXSL: Order No.: NFI01/01 or /02**

**Length of connection:** connection between power filter and unit: unscreened: < 0.5m  
screened: < 5m

**Motor and resolver cable:**

**Only operate the unit with a HAUSER motor and resolver cable (with connectors containing special surface screening).**

In such cases, the following cable lengths are permitted.

<b>Motor cable</b>	< 100m (the cable must not be rolled up) For motor lines of >20m, a motor output throttle must be used Up to 16A nominal motor current: Type: MDR01/01 16A / 2mH. Between 16A and 30A: Type: MDR01/02 30A / 1.1mH. Over 30A nominal motor current: Type: MDR01/03 >30A / 0.64mH.
<b>Resolver cable</b>	< 100m

**Motors:**

**Operation with HAUSER motors.**

**Control:**

**Only operate with calibrated controller (avoid feedback oscillation).**

**Earthing:**

- ◆ The filter housing, the mains module and the COMPAX must be surface connected with good metal conductivity and low inductivity to the cabinet ground.
- ◆ Never secure the filter housing or the unit to coated surfaces.

**Cable laying:**

- ◆ Ensure that you have largest spacing possible between the signal and load lines.
- ◆ Signal lines must never pass sources of strong interference (motors, transformers, relays,...).

**Accessories**

- ◆ Only use accessories recommended by HAUSER (absolute value sensor, encoder,...).



**Provide large surface contact areas down both sides of all cable screening.**

**Warning:**

This is a product of the restricted sales class as per IEC 61800-3. In a domestic environment, this product may cause high frequency disturbances, in which case the user can be requested to implement suitable measures.

## 7. Start-up manual

# Compact Servo Controller

### 7.1 Overview:

#### 7.1.1 Components required

In addition to a COMPAX, you will require the following components for a COMPAX application:

- ◆ a motor with or without a transmission.
- ◆ mains supply.
- ◆ emergency stop circuit.
- ◆ various cables for connecting components.
  - ◆ motor cable and resolver cable.
  - ◆ supply line for voltage supply.
  - ◆ supply line for 24V DC control voltage.
- ◆ hand-held terminal or PC (with RS232 cable) containing the ServoManager program for configuring COMPAX.

## 7.1.2 Overview of unit technology

### COMPAX-M and COMPAX-S

- ◆ work with the same firmware, yet have differences with regard to
- ◆ housing and assembly technology and
- ◆ power areas.

The following table shows the main features of the range of available units

#### Common function characteristics:

**Interfaces:** 16 (8 with COMPAX 1000SL) digital inputs/outputs, RS232; machine zero, limit switch, override input

**Fieldbus options:** RS485, Interbus-S, Profibus, CS31, CAN – Bus, CANopen, HEDA (synchronous serial realtime interfaces)

**Other options (excluding COMPAX 1000SL):** absolute encoder sensor; encoder input; encoder simulation; D/A monitor

#### COMPAX P1XXM COMPAX 02XXM COMPAX 05XXM COMPAX 15XXM

**Supply via central mains module: NMD10 / NMD20:** Up to max. 3\*500V AC

**Dimensions (DxHxW):** COMPAX P1XXM: 340\*400\*60 [mm]      COMPAX-M: 340\*400\*85 [mm]

**Design:** COMPAX-M with NMD mains module

**Installation:** in series

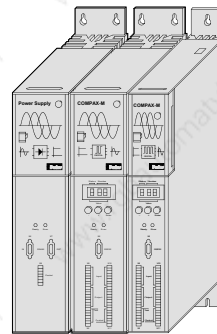

**Power:**  
**COMPAX ...**  
**P1XXM: 3.8 kVA**  
**02XXM: 4.5 kVA**  
**05XXM: 8.0 kVA**  
**15XXM: 17 kVA**

#### COMPAX 35XXM

**Supply** Up to max. 3 \* 500V AC (integrated power unit)

**Dimensions (DxHxW):** 40 \* 400 \* 220 [mm]

**Design:**

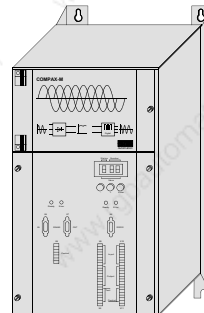

**Power**  
**35.0 kVA**

**COMPAX 1000SL**      **Supply** Up to max. 1\*250V AC (integrated power unit)

**Dimensions** (DxHxW):      146\*180\*85 [mm]

**Design:**

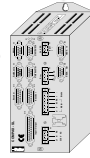

**Power**  
**1 kVA**

**COMPAX 25XXS**      **Supply** Up to max. 1 (3)\*250V AC (integrated power unit)

**Dimensions** (DxHxW):      220\*240\*130 [mm]

**Design:**

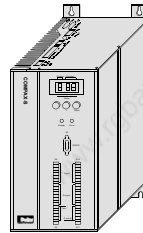

**Power**  
**2.5 kVA**

**COMPAX 45XXS**      **Supply** Up to max. 3\*500V AC (integrated power unit)

**COMPAX 85XXS**

**Dimensions** (DxHxW):      275\*350\*125 [mm]

**Design:**

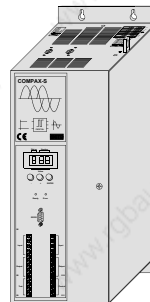

**Power**  
**4.5 kVA**  
**8.6 kVA**



## 7.2 COMPAX-M unit features

### 7.2.1 Connector and terminal assignment

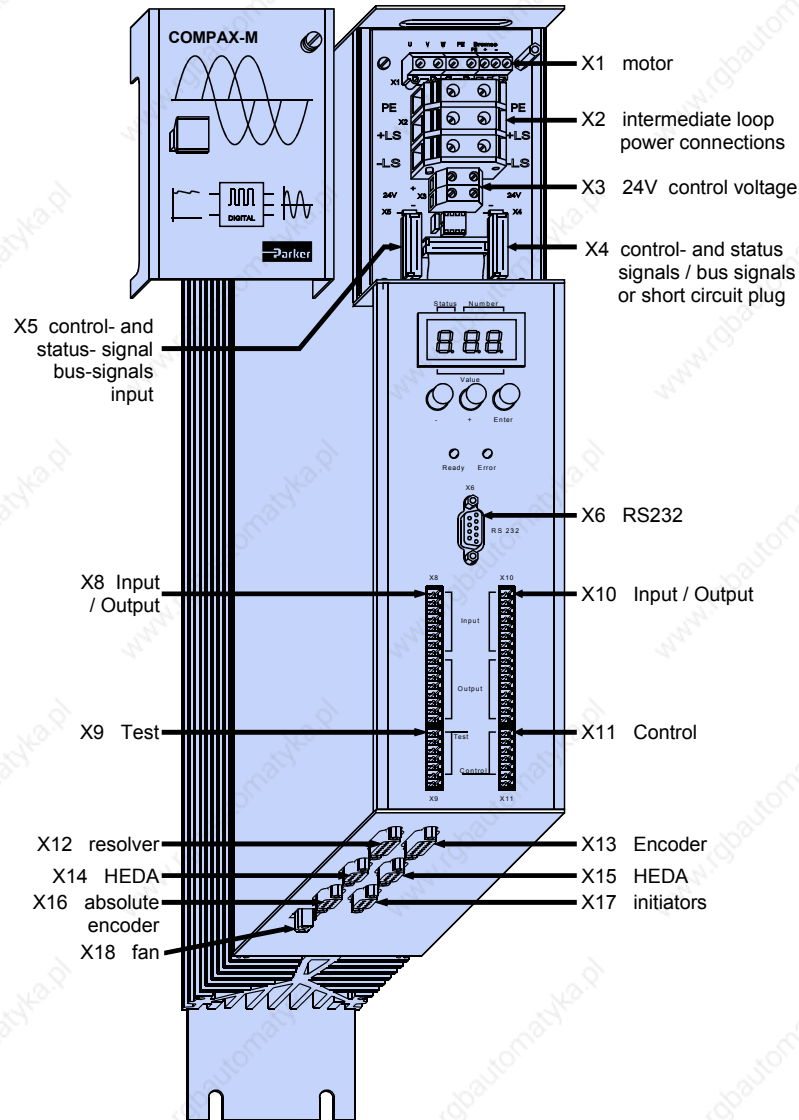

**Before wiring up, always de-energize the unit.**

**Even once the mains supply has been switched off, dangerous levels of voltage can remain in the system for up to 5 min.**

Meaning of LEDs on front plate

LED	Color	Meaning, when switched on
Ready	green	24V DC present and initialization complete
Error	red	COMPAX - fault (I1...E56) present.

**7.2.2 COMPAX-M system network, NMD10 / NMD20 mains module**

A COMPAX-M drive system consists of one mains module and one or more drive controllers. The units are coupled with one another with flatband cables (see below). These are arranged behind the front plate cover of the power unit and the drive controller.

The power unit converts mains power (up to 3 \* 500V AC) into DC current for the intermediate circuit.

The two connectors for connection to the bus systems are located on the front plate of the power unit. The connection assignment complies with the specifications for 2-cable remote bus.

The 24V DC control voltage required by the system network is supplied from the power unit.

A connector terminal on the front of the power unit is used for connecting the control and status signals (EMERGENCY STOP, readiness) which you can incorporate in the control of the entire system.

These signals and the bus lines are connected internally via a preformed doublesided flatband cable. These cables are included with the drive controller. The connectors which receive these connection cables are housed under the front plate cover of the mains module and the drive controller.

**Short circuit connectors**

Attach a short circuit connector to the outgoing connector on the drive controller that is furthest away from the mains module. The short circuit connector (order No. 102-908000) is included with the mains module.

**Installation arrangement**

	<p><b>Before wiring up, always de-energize the unit.</b>  <b>Even once the mains supply has been switched off, dangerous levels of voltage can remain in the system for up to 5 min.</b></p>
---	--

**Wiring up the system network**

The wires required for creating the system network are included in the delivery. Open the front cover (upper section of front side) by loosening the top right knurled screw and wire up the following:

- ◆ 24V DC voltage supply.
- ◆ PE and DC current.
- ◆ Emergency stop, ready and bus signals with a terminating connector on the last unit.

From the mains module to the individual COMPAX-M.

➡ When delivered, the terminating connector is located on the mains module.

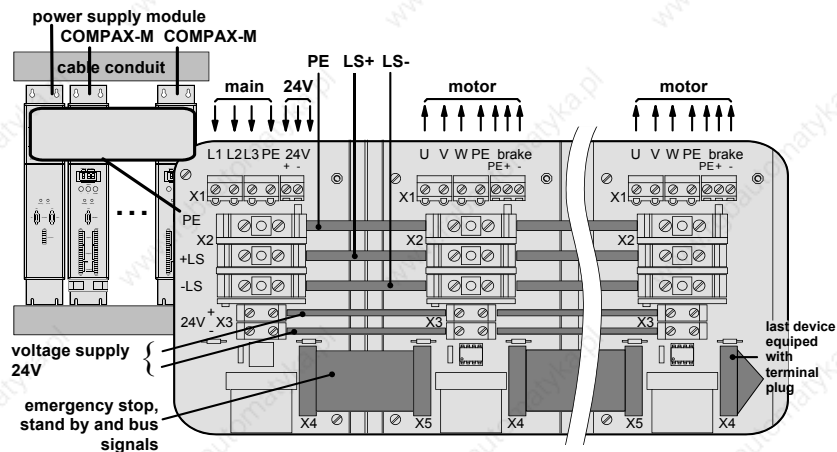

### Wiring up the motor

Unit side

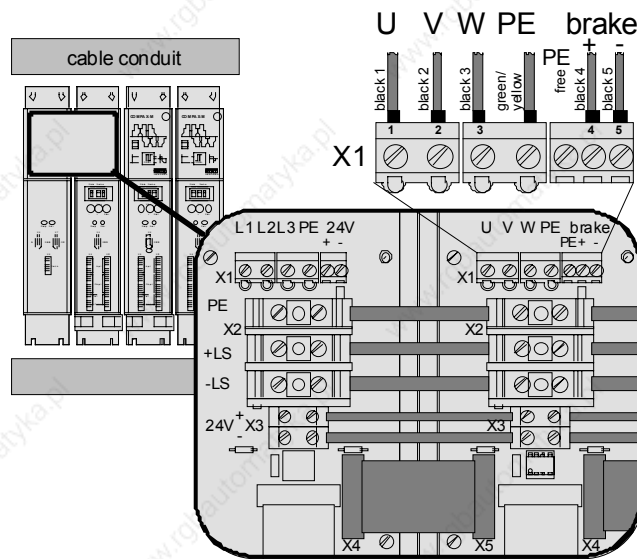

Screened connection

Note the screened connection of the motor cable on the upper unit side.  
Clamp the motor cable with the open place of the screen braid under the ground terminal (see figure on the right).

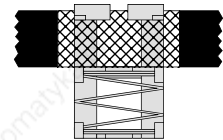

 **Only wire up brake in motors which have a holding brake! If not, do not wire.**

### Wiring up mains power / control voltage

The mains supply and the control voltage supply are provided by the mains module.

#### Power supply:

- ◆ 3\*80V AC – max. 3\*500V AC; 45 - 65Hz
- ◆ Fuse protection:  
NMD10: 16A (K circuit breaker in 20A)  
NMD20: 35A  
K circuit breaker or similar Neozed fusible cut-out.

#### Control voltage

- ◆ 24V DC ±10%
- Ripple <1V<sub>ss</sub>
- Fuse protection: max. 16A

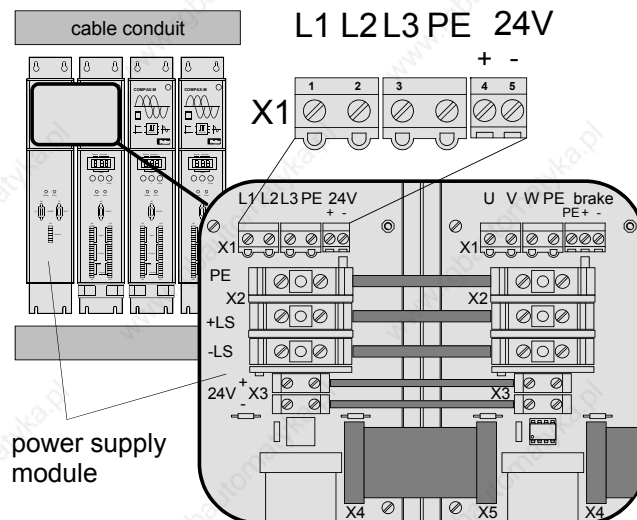

**7.2.3 COMPAX-M dimensions/installation**

The specific design of the COMPAX-M controller allows for wall installation (distance: 61mm in COMPAX P1XXM and 86mm in larger units) in two different ways.

**Direct wall installation:**

**Direct wall installation and dimensions of COMPAX-M and the mains modules.**

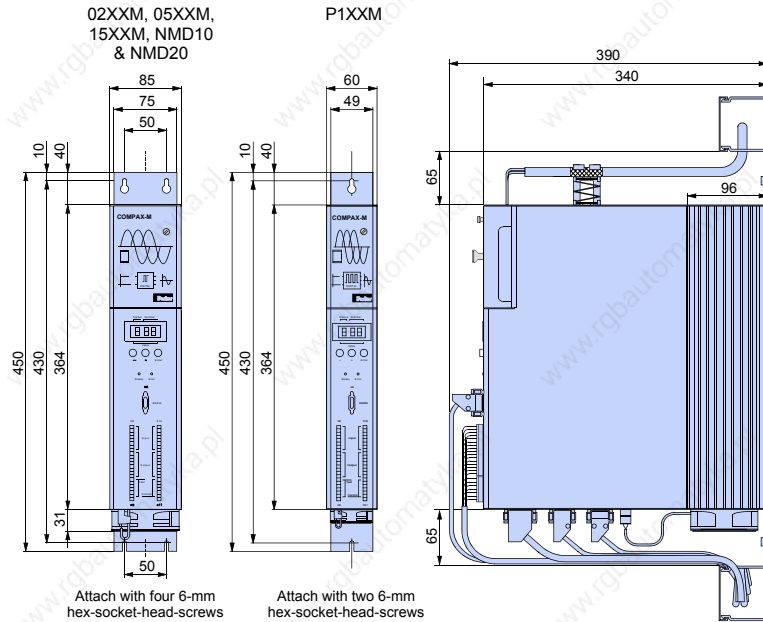

The controllers are attached to the mounting plate with the back of the heat sink.

**Indirect wall installation:**

**Indirect wall installation of COMPAX 02XXM, COMPAX 05XXM and COMPAX 15XXM and the mains modules NMD10 and NMD20.**

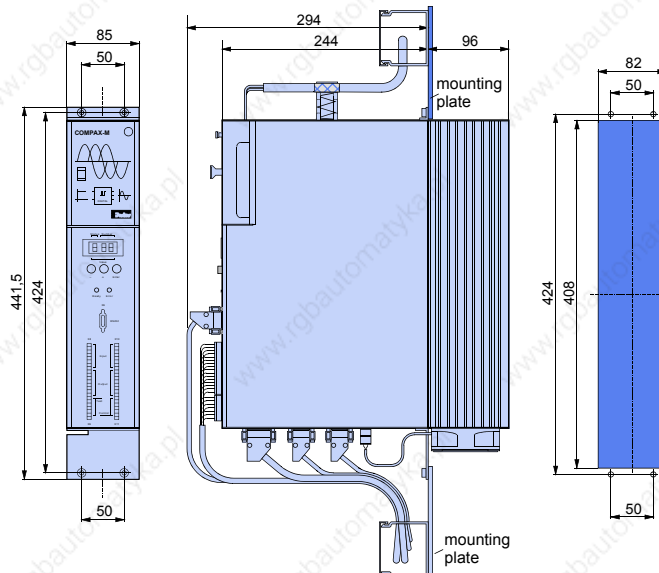

The heat sink is pushed back through a hole in the panel (on right of diagram). A separate heat chamber is created between the installation plate and the rear wall of the control cabinet. The angles required under designation MTS2 must be complied with.

➡ Indirect wall installation is not possible with COMPAX P1XXM.

**Fan configuration**

<b>Units with fan:</b>	COMPAX P1XXM, COMPAX 05XXM, COMPAX 15XXM
<b>Units without fan:</b>	COMPAX 02XXM, NMD10, NMD20

## 7.2.4 Connector assignment COMPAX-M

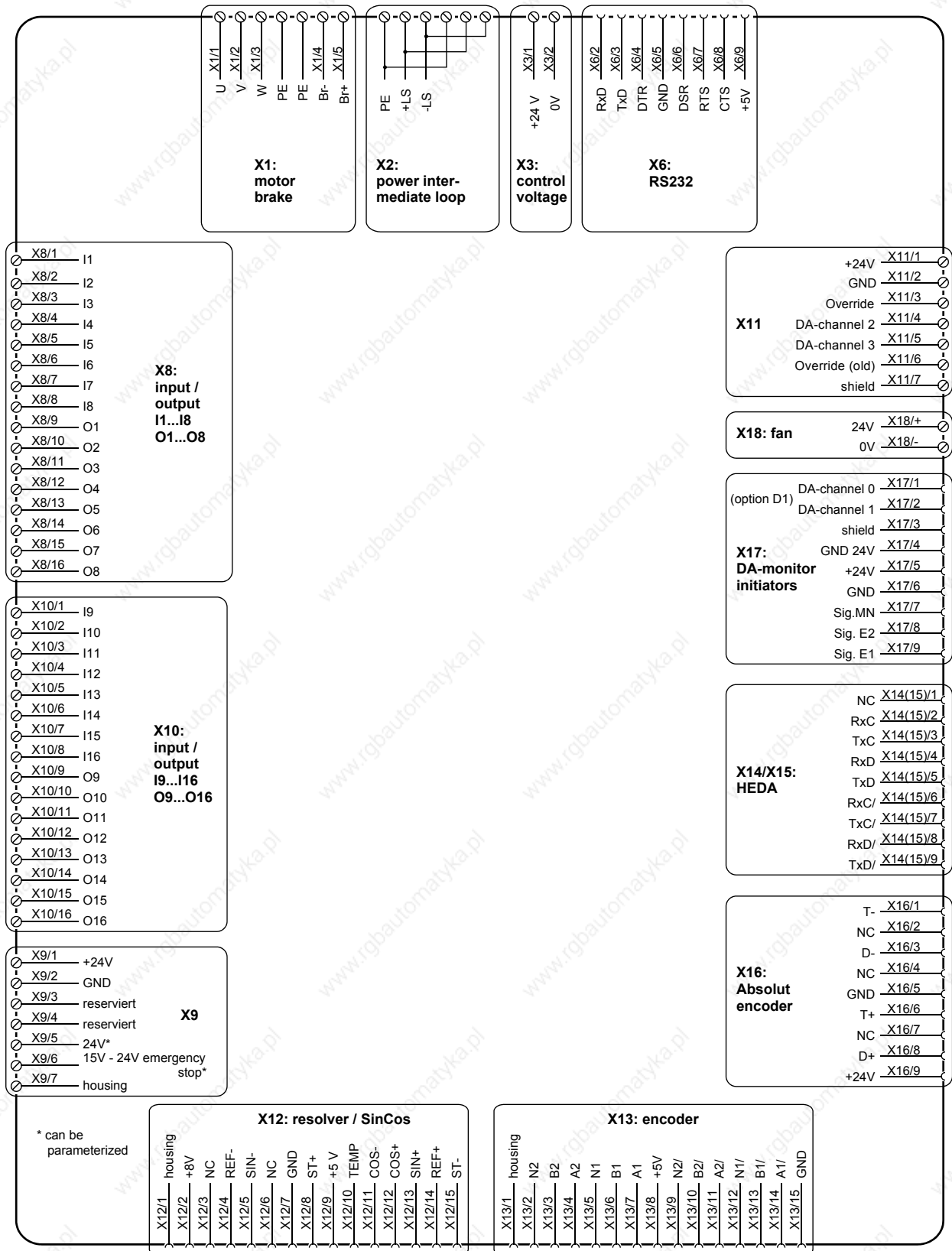

The assignment of X12 does not apply for the S3 option.  
The bus connections are made via the mains module.

### 7.3 Mains module NMD10/NMD20

The mains module ensures the supply of current to the COMPAX-M (not COMPAX 35XXM) axis controller and the SV drive connected into the network. It is connected to the 3-phase power supply with 3 \* 400V AC and PE. 24V DC voltage must be provided for the control electronics.

#### 7.3.1 Overview NMD

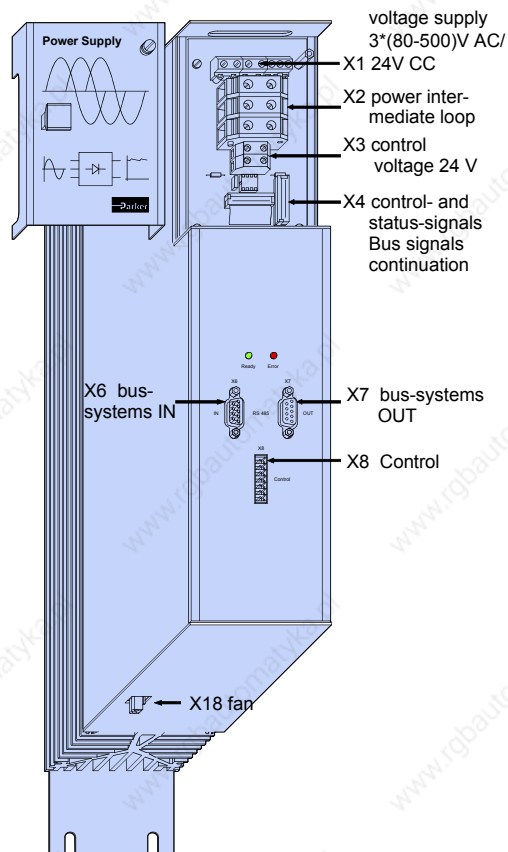

**Before wiring up, always de-energize the unit.**

**Even once the mains supply has been switched off, dangerous levels of voltage can remain in the system for up to 5 min.**



**The PE connection must be a 10mm<sup>2</sup> version**

#### 7.3.2 Dimensions / installation

Dimensions and installation of the NMD10 and NMD20 power units correspond to the data for COMPAX-M (see Page 20).

### 7.3.3 NMD connector assignment

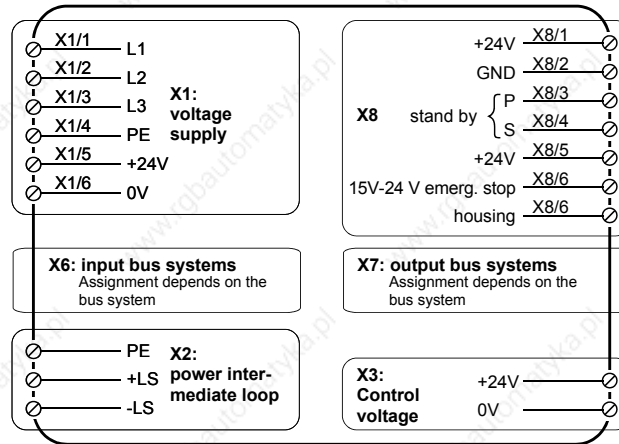

### 7.3.4 Technical data / power features NMD

#### Function

Generates DC current when run directly off a mains source.

#### CE conformity

- ◆ EMC immunity/emissions as per EN61800-3.
- ◆ Safety: VDE 0160/EN 50178.

#### Output power

	Nominal power	Peak power
<b>NMD10:</b>	10 kW	20 kW (<3s)
<b>NMD20:</b>	20 kW	40 kW (<3s)

#### Mains fuse protection

NMD10: 16A (K circuit breaker in 20A)

NMD20: 35A

K circuit breaker or similar Neozed fusible cut-out.

#### Supply voltage up to max. 3\*500V AC

Operating range: 3\*80V AC - 3\*500V AC; 45 - 65 Hz.

Typical AC mains: 400V ±10%; 460V ±10%; 480V ±5%

#### Control voltage

- ◆ 21.6V up to 26.4V DC (0.8A)
- ◆ Ripple: < 1V<sub>ss</sub>
- ◆ Fuse protection: max. 16A

#### Dissipation power

- ◆ without fan: max. 120W (standard)
- ◆ with fan: max. 250W.

**Overvoltage limitation**

Energy recuperated during braking is stored in the supply capacitors. The capacity and storable energy is:

**NMD10/NMD20: 1100µF / 173 Ws**

If the energy recuperated from braking causes overvoltage, then ballast resistances are engaged.

**Activation of the internal ballast resistance for NMD20**

The internal ballast resistance is activated by a bridge between +LS and X5/1. In the NMD20 delivery status this bridge is fitted.

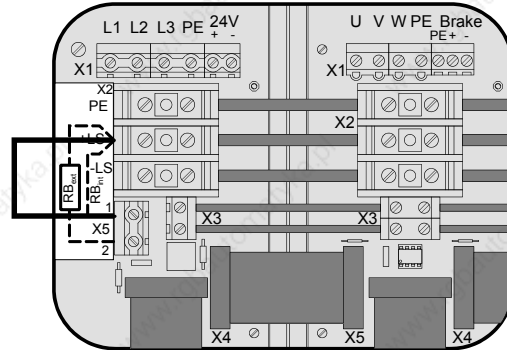

**Maximum braking power:**

Braking power	Duration	Cooling down time
<b>NMD10</b>		
17 kW	<50 ms	≥ 10s
4.0 kW	<1s	≥ 50s
Without fan: 120W	unlimited	
With fan: 250W	unlimited	
<b>NMD20</b>		
9.5 kW	<50 ms	≥ 10s
2.5 kW	<1s	≥ 50s
Without fan: 120W	unlimited	
With fan: 200W	unlimited	

➡ External ballast resistances can be used with NMD20 (see Page 193).

If the braking power of the internal ballast resistance is insufficient, an external ballast resistance can be connected.

**Connecting the external ballast resistance**

**The external ballast resistance is connected between +LS and X5/2. To do this, the bridge between +LS and X5/1 must be removed.** The full braking power cannot be used with this bridge present.

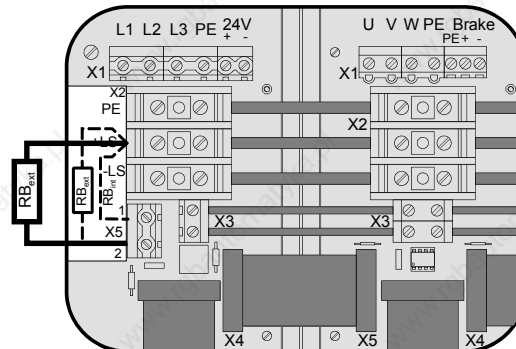

Output X5 is protected from short circuits.

**Thermal protection**

An emergency stop is triggered at 85°C heat sink temperature, the ready contact is released and the red LED lights up.



#### If a phase malfunctions, no displays appear

#### Error diagnosis in the mains module

LED red Error	LED green Ready	Possible errors
off	on	no errors
on	off	<ul style="list-style-type: none"> <li>◆ Heat sink temperature too high</li> <li>or</li> <li>◆ error in logic voltage (24V DC too low or unit is defective)</li> <li>⇒ Emergency stop is activated and ready contact is released.</li> </ul>
on	on	<ul style="list-style-type: none"> <li>◆ Ballast switch overloaded</li> <li>or</li> <li>◆ undervoltage (&lt;100V DC or &lt;80V AC).</li> </ul>

⇒ Ready contact and green LED are coupled.



**Caution!** If the unit has no control voltage, no displays will indicate that operating voltage is present.

**7.4 COMPAX 35XXS unit features**

The 35 kW servo control COMPAX 35XXM - a performance upgrade to the COMPAX family.

- ◆ Compact unit with output currents of 50 A<sub>eff</sub> / 100 A<sub>eff</sub> (<5s) with integrated power unit.
- ◆ Additional COMPAX-M controllers of up to 15 KW can be arranged in rows.

**7.4.1 Plug and connection assignment COMPAX 35XXM**

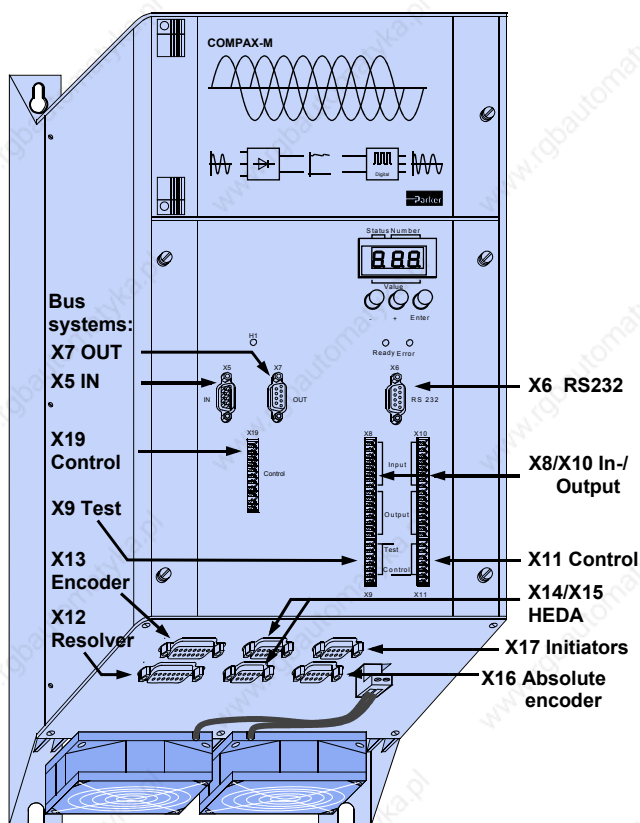

 **Before wiring up, always de-energize the unit.**  
 Even once the mains supply has been switched off, dangerous levels of voltage can remain in the system for up to 5 min.

 **When working with motors without a holding brake, the brake lines must not be connected to COMPAX**

 **Caution!**  
 If the unit has no control voltage, no displays will indicate that operating voltage is present.

Plan view

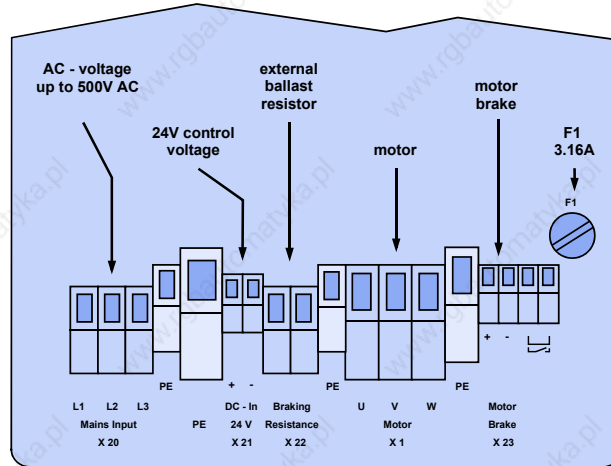

### Specific technical data

**Supply voltage up to max. 3 \* 500V AC**  
 Operating range: 3\*80V AC - 3\*500V AC; 45 - 65 Hz.  
 Typical AC mains: 400V ±10%; 460V ±10%; 480V ±5%

### Note!

**Switching on the operating voltage for a second time:**  
 Before switching on the operating voltage for a second time, you must wait for at least 2.5 minutes otherwise you may overload the condenser load resistance.

### Control voltage

◆ 21.6V to 26.4V DC • Ripple: < 1V<sub>SS</sub> • fuse protection: max. 16A

### Mains supply fuse protection

62A K circuit breaker or suitable Neozed conventional fuse.

### Regeneration mode

- ◆ Storable energy: 3450µF/542 Ws
- ◆ External ballast resistance: 10Ω/2 kW  
 For the external ballast resistors available, please see Page 193.

## 7.4.2 Installation and dimensions of COMPAX 35XXM

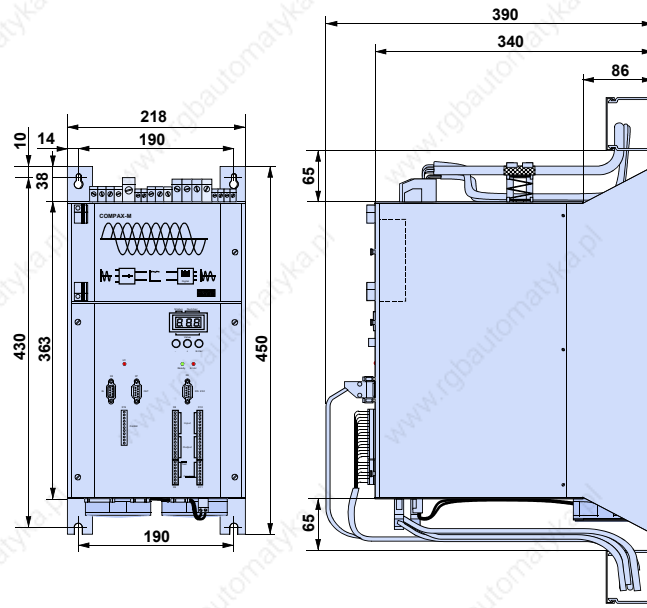

Fastening with 4 M6 hex-socket head screws.

7.4.3 Wiring COMPAX 35XXM

Wiring up motor, mains power / control voltage and external ballast resistance

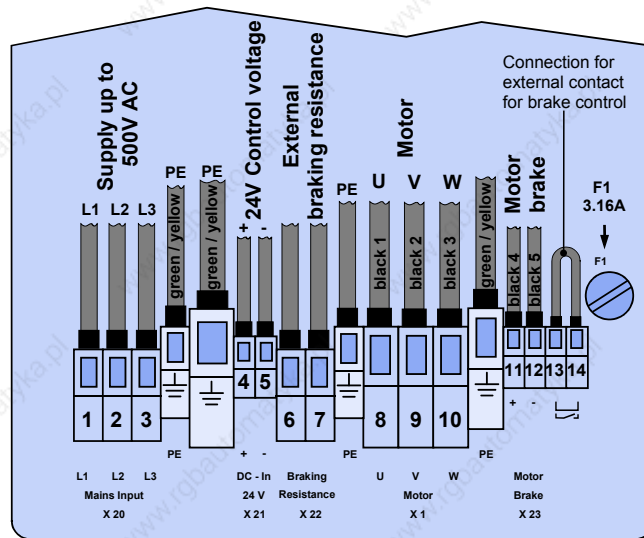

\* max. 1.6A

The PE connection must be a version of at least 10mm<sup>2</sup>

Wiring up system network

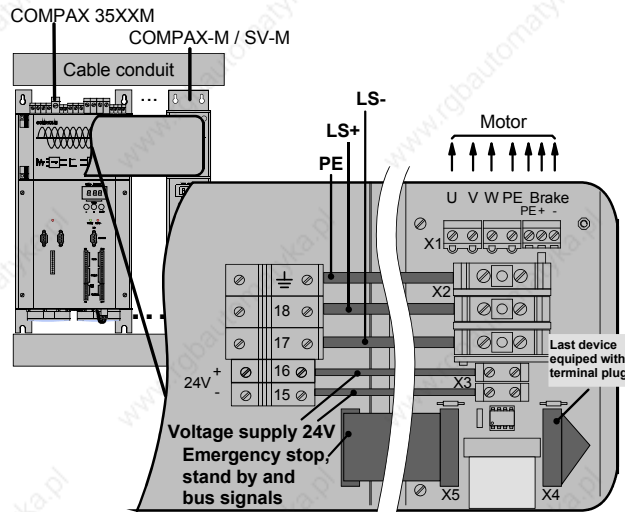

### 7.4.4 COMPAX 35XXM connector assignment

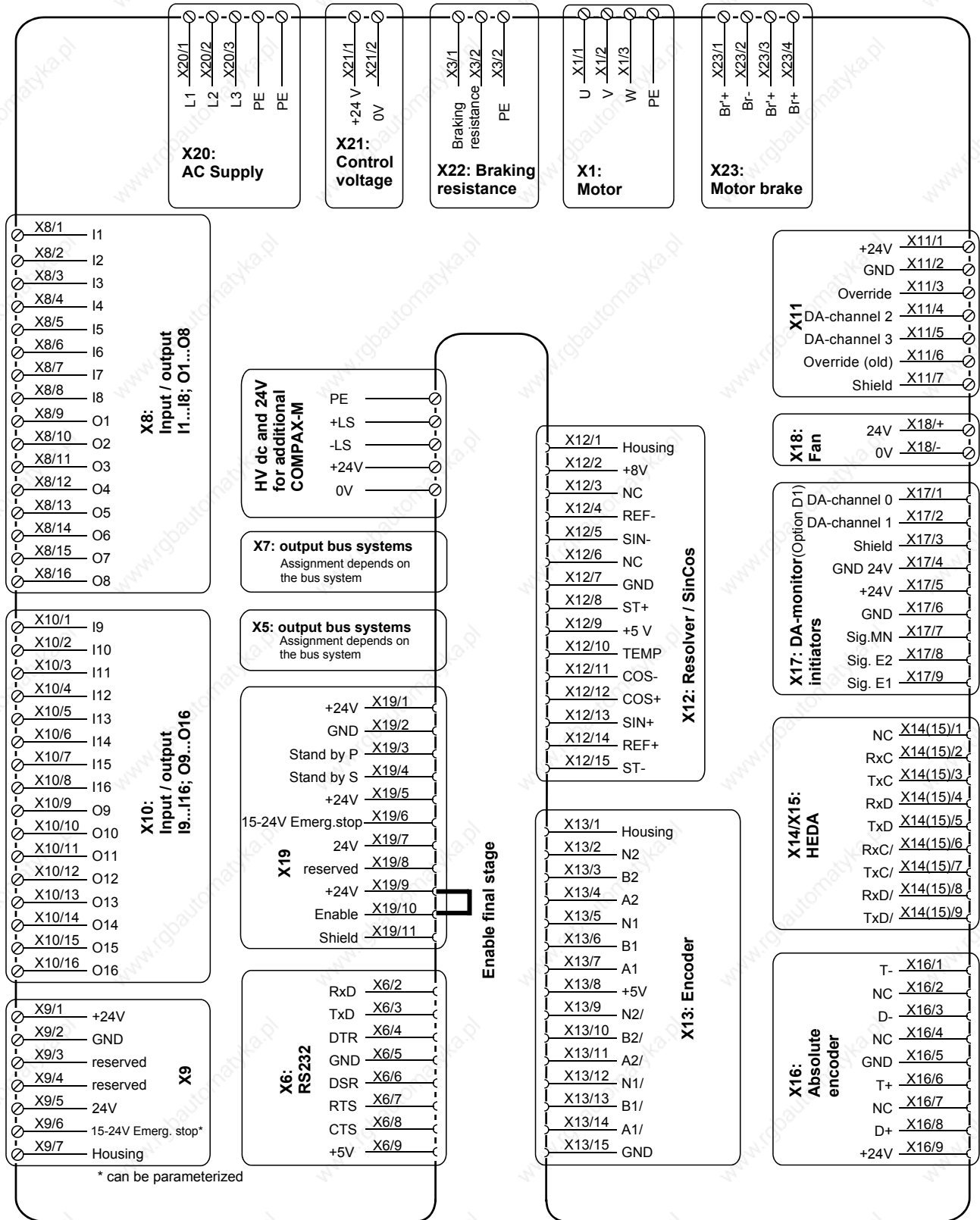

The assignment of X12 does not apply for the S3 option.

Unit hardware	Connector / cable	Technical data	Configuration	Positioning and control functions	Optimization functions	Interfaces	Accessories / options	Status	Parameter	Error list
---------------	-------------------	----------------	---------------	-----------------------------------	------------------------	------------	-----------------------	--------	-----------	------------

**7.5 COMPAX 25XXS unit characteristics**

**7.5.1 COMPAX 25XXS connector and connection assignment**

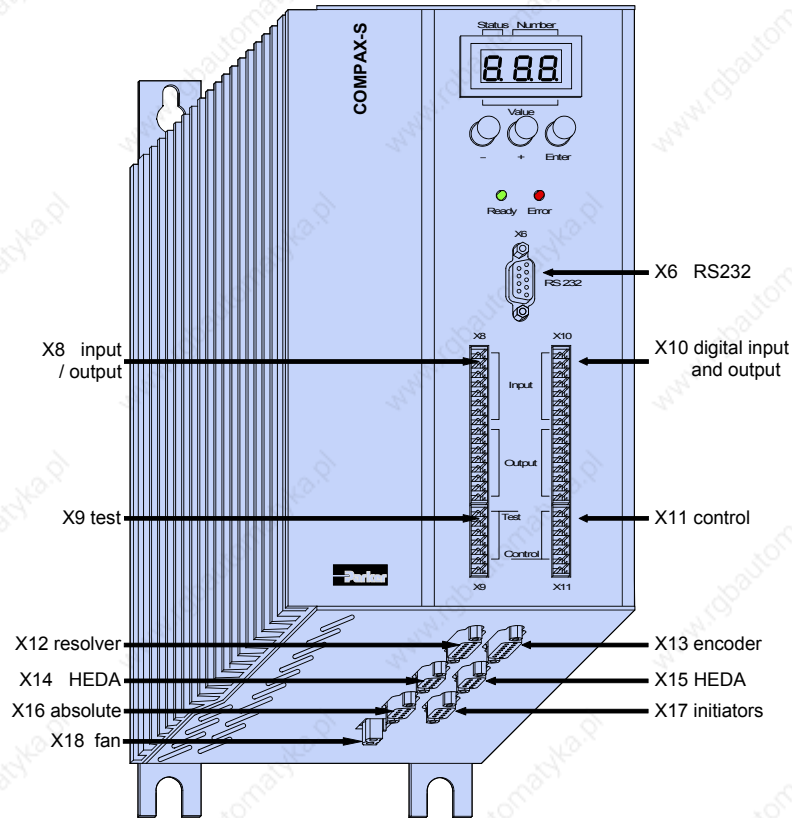

**Meaning of the LEDs on the front plate**

LED / color	Meaning, when switched on
Ready / green	24V DC present and initialization complete
Error / red	COMPAX - fault (E1...E56) present.

**Plan view of COMPAX 25XXS**

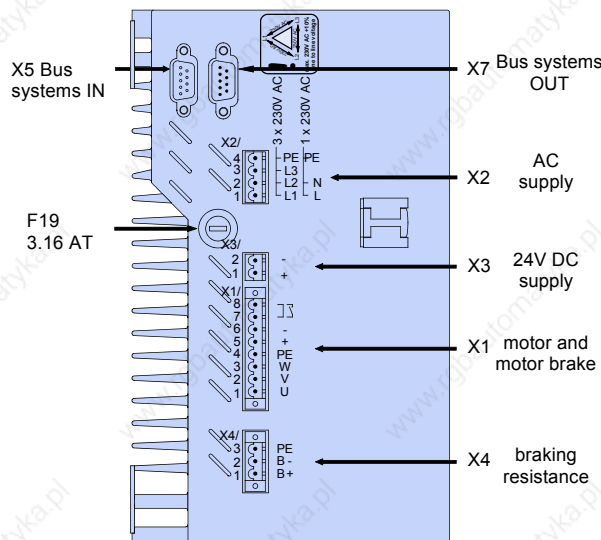

 **Before wiring up, always de-energize the unit.**  
**Even once the mains supply has been switched off, dangerous levels of voltage can remain in the system for up to 5 min.**

 **When working with motors without a holding brake, the brake lines must not be connected to COMPAX**

 **The PE connection occurs with 10mm<sup>2</sup> under a fixing bolt**

 **Caution!**  
**If the unit has no control voltage, no displays will indicate that operating voltage is present.**

### Wiring up motor

#### On unit side

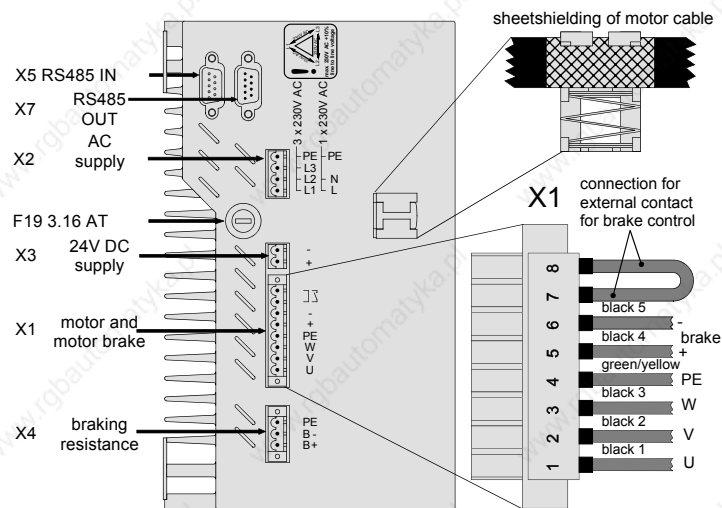

- ◆ Note the screened connection of the motor cable on the upper side of the unit.
- ◆ Clamp the motor cable with the open section of the screen braid under the ground terminal.

**Wiring up mains power / control voltage**

**Motor side**

◆ Via connectors.

The mains supply and control voltage supply are located on the upper side of the unit.

Power supply: there are 2 options (with the same output power):

3 \* 80V AC - 3 \* 250V AC • 45-65Hz • fuse protection: 10A

1 \* 100V AC - 1 \* 250V AC • 45-65Hz • Fuse protection: 16A

◆ Control voltage 24V DC ±10% ripple <1V<sub>ss</sub>

Fuse protection: 16A

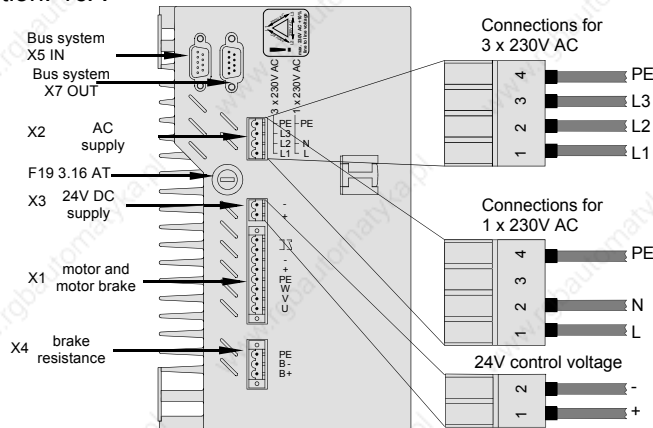

**Note! Do not apply 3 \* 400V AC.**

**Only wire up brake in motors with a holding brake! Otherwise, do not wire up.**

**7.5.2 COMPAX 25XXS-specific technical data**

**Overvoltage limitation**

◆ Energy recuperated during braking is stored in the supply capacitors. The capacity and storable energy is:

**COMPAX 25XXS: 1000 μF / 27 Ws**

If the recuperated energy causes overvoltage, then external ballast resistances can be engaged.

**Maximum braking power with external ballast resistance**

Braking power	Duration	Cooling down time
COMPAX 25XXS: ≤1.0 kW	unlimited	
with R <sub>ext</sub> ≥ 56Ω: ≤2.5 kW	<2s	≥ 10s

⇒ We can supply external ballast resistances for COMPAX 25XXS (see Page 193).

**Connecting ballast resistance to COMPAX-S**

The ballast resistance is connected to B+, B- and, if necessary, PE. Output X4 is protected from short circuits.

**Mating connectors X1, X2, X3 and X4**

Mating connectors for X1,...X4 from Phoenix are included with the following type designations:

X1: MSTB2.5/8/STF-5.08 (with screw connection)

X2: MSTB2.5/4/ST-5.08 (without screw connection)

X3: MSTB2.5/2/ST-5.08 (without screw connection)

X4: MSTB2.5/3/STF-5.08 (with screw connection)

You can acquire Phoenix housings for these connectors and these can be used once adapted to our cables. Designation: KGG-MSTB2.5/(pin number).



### 7.5.3 COMPAX 25XXS dimensions / installation

The two retaining plates supplied can be attached to the back/left side or the heat sink side. Retaining screws: 4 M6 hex-socket head screws.

#### Design in series

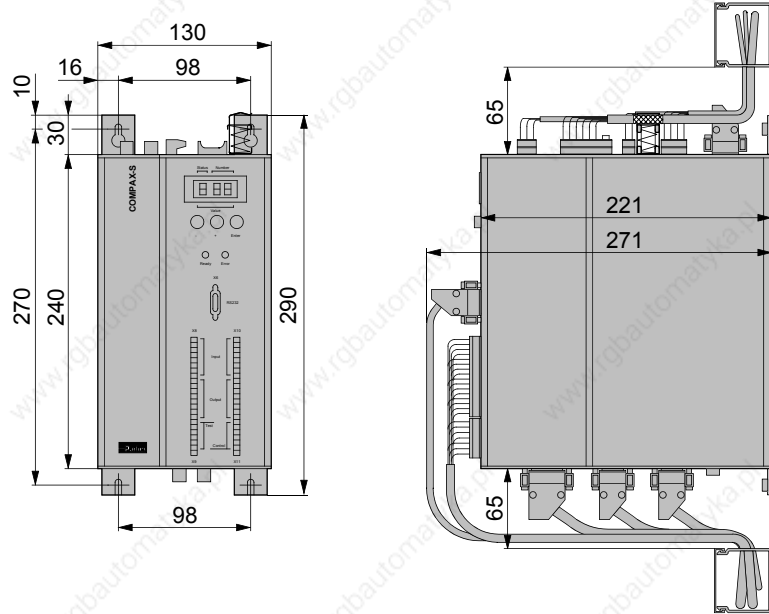

The left-hand side of the unit heat sink is fastened to a metal wall using 2 retaining plates.  
Installation distance: 135mm (device distance:5mm)

#### Delivery status

The design is delivered ready for connection in series!

#### Flat design

The left-hand side of the unit heat sink is fastened to a metal wall using 2 retaining plates.

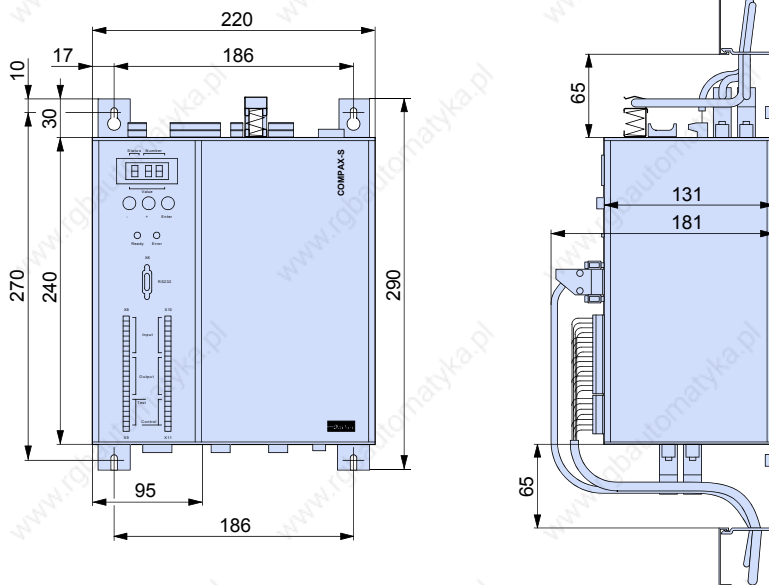

#### Converting the front plates

- ◆ Install the retaining plate on the required side.
  - ◆ Unfasten front plate and blind plate. There are 2 screws on both the upper and lower sides of the unit.
- Install the front plate and then the blind plate at the required point.

7.5.4 Connector assignment COMPAX 25XXS

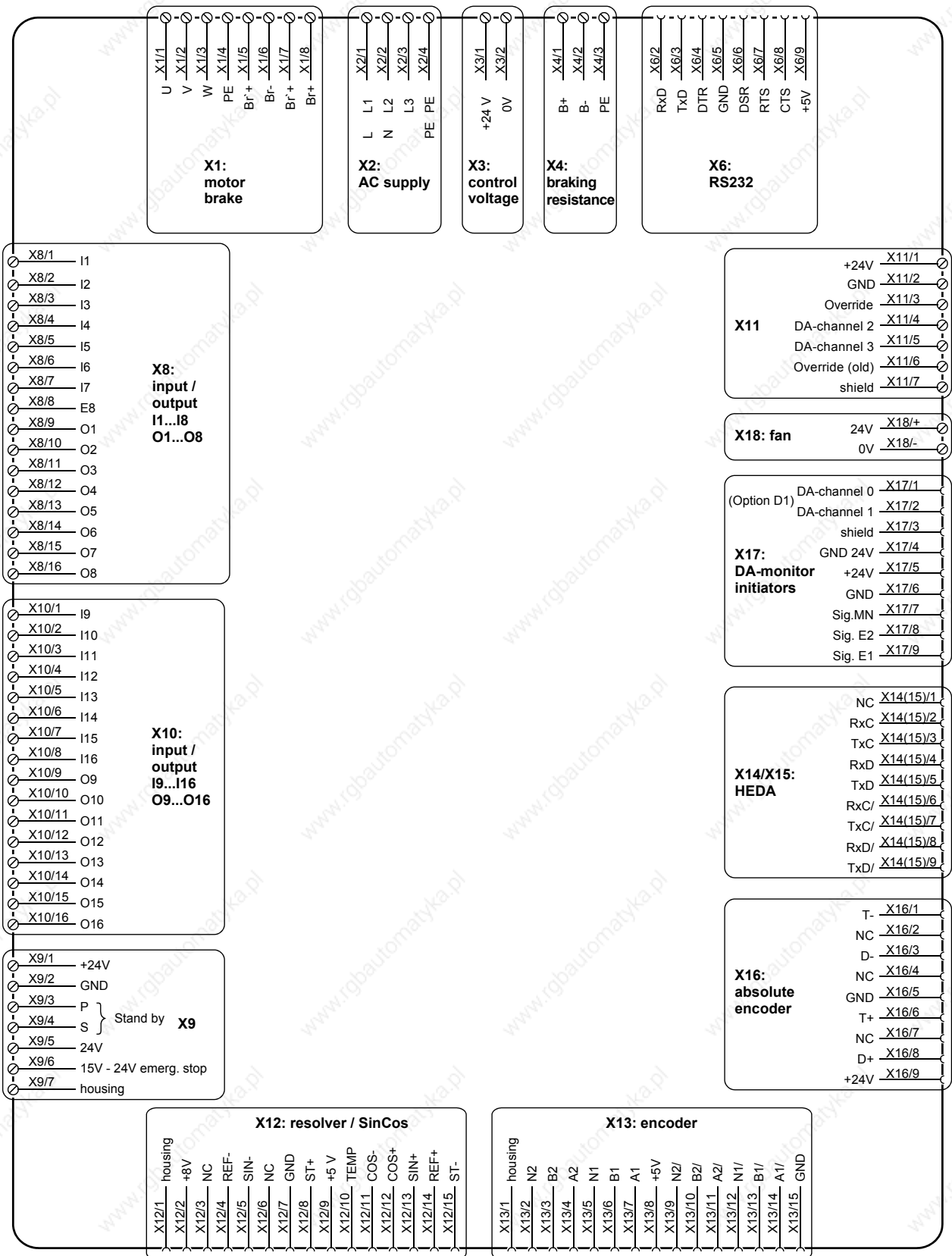

The assignment of X12 does not apply for the S3 option.

You will find the assignment of the connectors X5 and X7 (bus systems) on Page 63!

## 7.6 COMPAX 45XXS/85XXS unit characteristics

### 7.6.1 Plug and connection assignment COMPAX 45XXS/85XXS

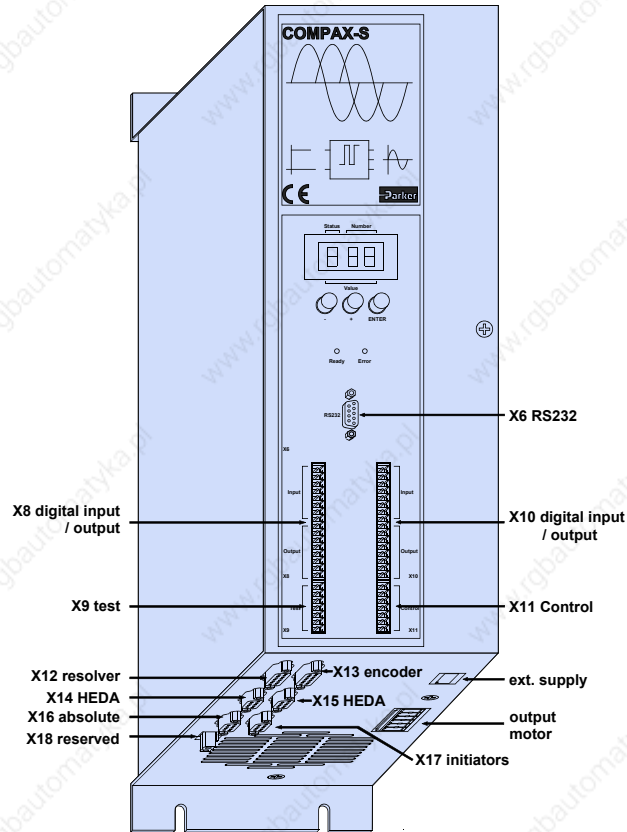

Plan view

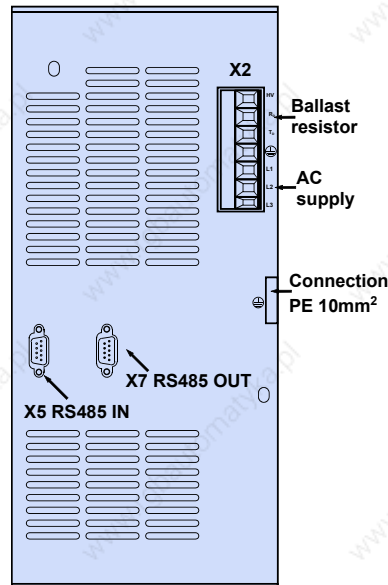

**7.6.2 COMPAX 45XXS/85XXS installation / dimensions**

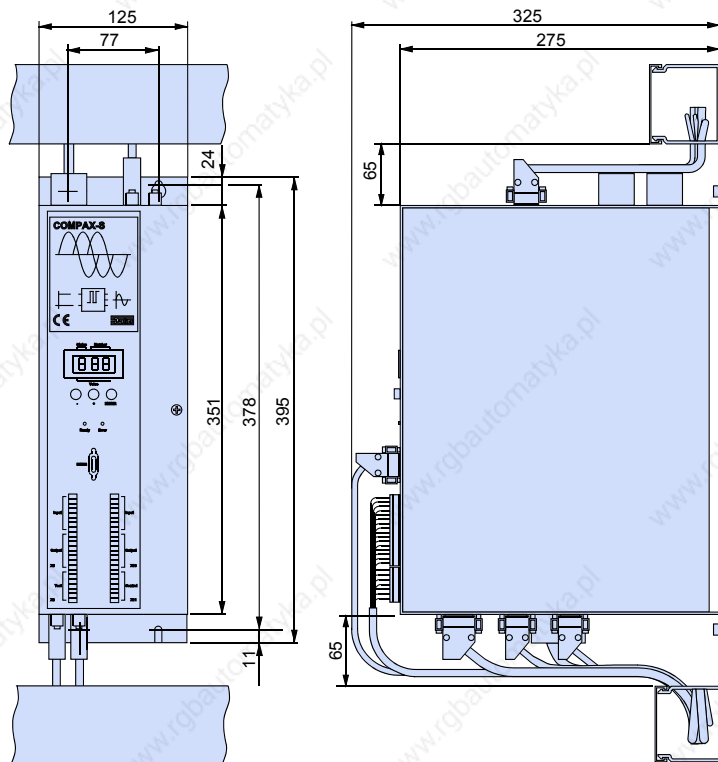

Fastening: 4 M5 hex-socket head screws  
 Installation distance: 130mm (device distance:5mm)

**Meaning of the LEDs on the front plate**

LED	Color	Meaning, when switched on
Ready	Green	24V DC present and initialization complete
Error	red	CPX error present. or mains supply or control voltage absent.

 **Before wiring up, always de-energize the unit. Even once the mains supply has been switched off, dangerous levels of voltage can remain in the system for up to 5 min.**

 **When working with motors without a holding brake, the brake lines must not be connected to COMPAX**

### 7.6.3 COMPAX 45XXS/85XXS-specific wiring

**Wiring up mains power / enabling internal ballast resistance**

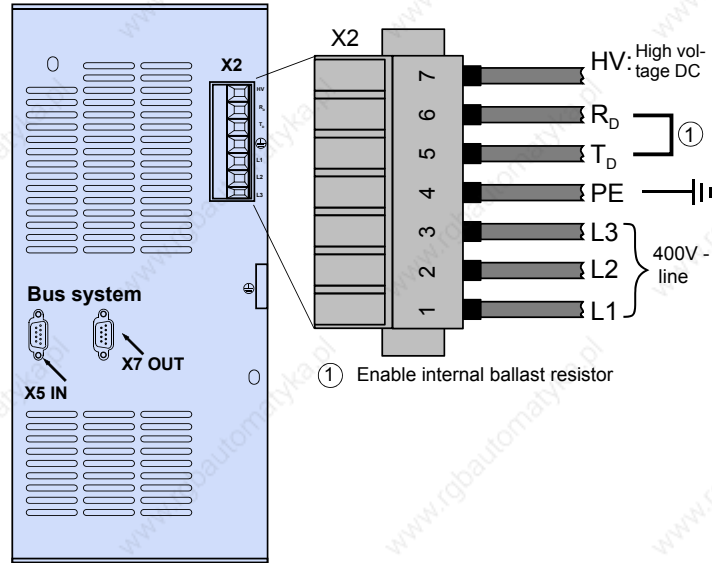

X2HV: DC current output

◆ Power supply:

3 \* 80V AC – max. 3 \* 500V AC; fuse protection: max. 16A

◆ Control voltage 24V DC ±10% ripple <1V<sub>ss</sub> -

**Wiring up motor / control voltage / enable**

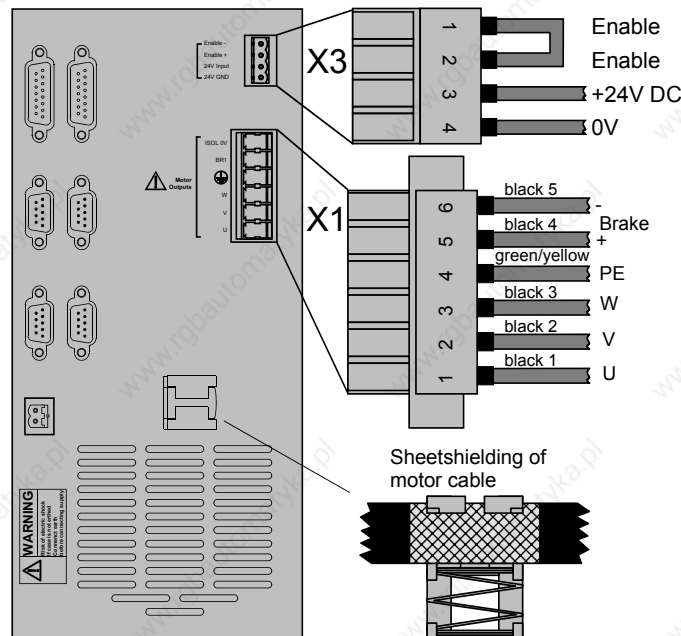

Note the screened connection of the motor cable on the lower side of the unit.

➔ Clamp the motor cable with the open section of the braided screen under the ground terminal.

**⚠ Only wire up brake lines in motors which have a holding brake. Otherwise, do not wire up.**

**Enable bridges:  
X3/1 - X3/2**

The final stage is enabled using a bridge between X3/1 - X3/1.  
If this connection is missing, the final stage is voltage-free and error message E40 appears (see from Page 223).

**Overvoltage  
limitation**

- ◆ Energy recuperated during braking is stored in the supply capacitors. The capacity and storable energy is:
  - COMPAX 45XXS: 330µF/52 Ws
  - COMPAX 85XXS: 500µF/80 Ws

If the recuperated energy causes overvoltage, then the internal ballast resistance is engaged.

**Enable internal ballast resistance: X2/5 - X2/6**

The internal ballast resistance is enabled by a bridge between X2/5 and X2/6.  
If this connection is missing, the controller operates without ballast resistance; in braking mode, error message E38 may appear (see from Page 223).

**Maximum braking  
power of the  
internal ballast  
resistance**

Braking power	Duration	Cooling down time
COMPAX 45/85S: 300W	unlimited	
≤1.5 kW	<10s	≥ 10s

➡ We provide external ballast resistances for COMPAX 45XXS / 85XXS (see Page 193).

**Connecting a ballast resistance to COMPAX 4500S/ COMPAX 8500S**

The ballast resistance is connected to HV, T<sub>D</sub> and PE.  
The output is protected from short circuits.

**Note!**

When an external ballast resistance is connected, the bridge between R<sub>D</sub> and T<sub>D</sub> must be removed.

### 7.6.4 COMPAX 45XXS/85XXS connector and pin assignment

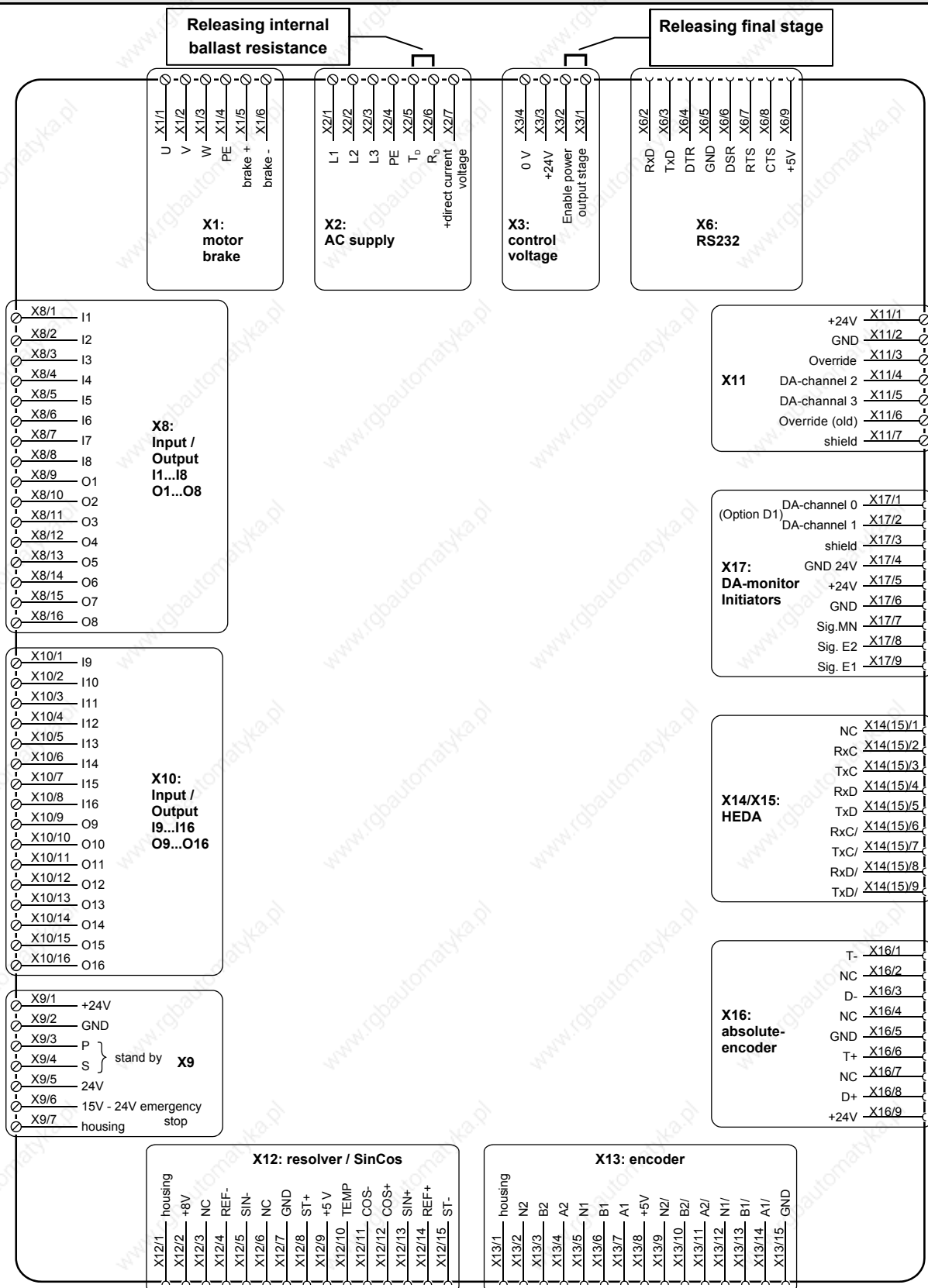



The assignment of X12 does not apply for the S3 option.

You will find the assignment of the connectors X5 and X7 (bus systems) on Page 63!

**7.7 COMPAX 1000SL Unit characteristics**

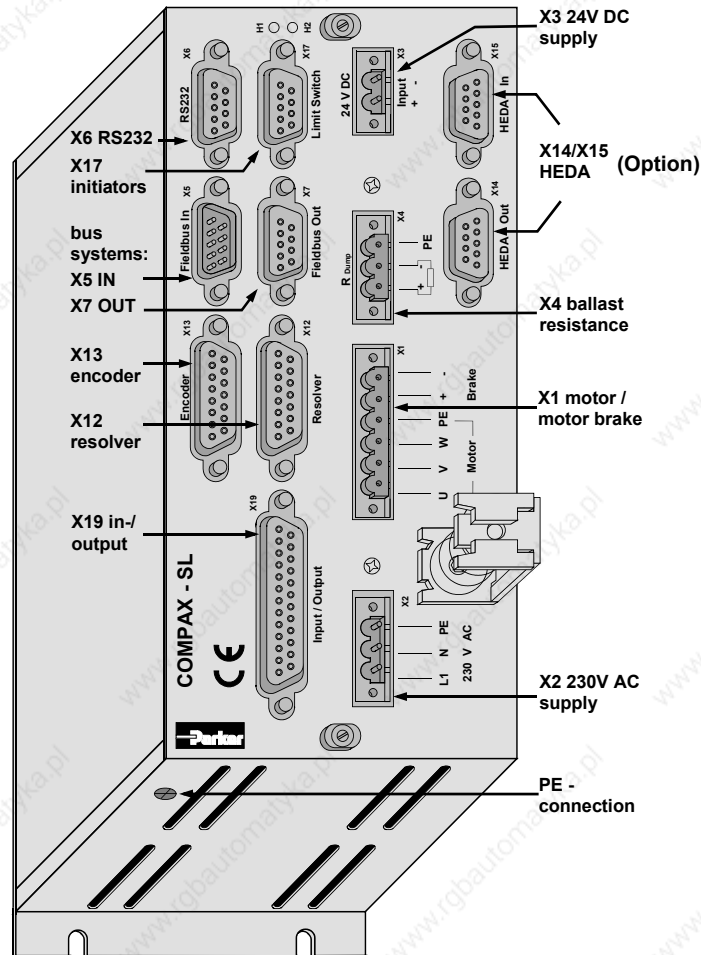
**7.7.1 Connector and terminal assignment for COMPAX 1000SL**



 **Before wiring up, always de-energize the unit.**  
 Even once the mains supply has been switched off, dangerous levels of voltage can remain in the system for up to 5 min.

 **When working with motors without a holding brake, the brake lines must not be connected to COMPAX**

 **Caution!**  
 If the unit has no control voltage, displays will not indicate if operating voltage is present.

**PE – terminal:** at least 2.5mm<sup>2</sup>

**LED display** The following statuses are shown by the LEDs.

Status	Red LED (H2)	Green LED (H1)
24V not available	off	off
24V are switched on, boot up	on	off
Unit OFF	off	blinking
Unit error; drive switched off	on	blinking
Unit error; drive powered	on	on
Unit RUNNING	off	on



**Unit wiring  
COMPAX  
1000SL**

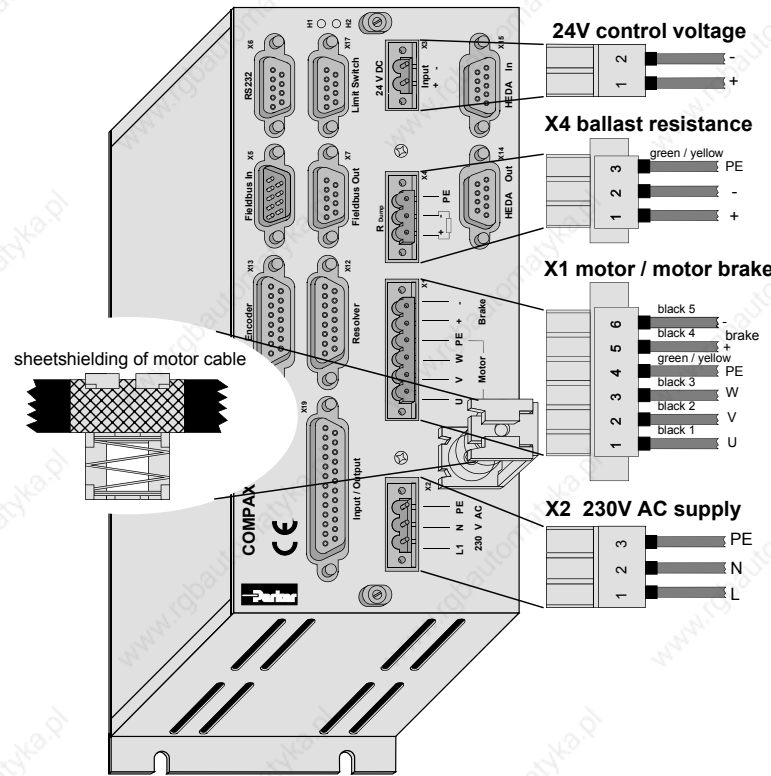

- ◆ Clamp the motor cable with the open section of the screen braid under the ground terminal.
  - ◆ Power supply:  
1\*100V AC - 1\*250V AC • 45-65Hz • Fuse protection: 10A
  - ◆ Control voltage 24V DC  $\pm 10\%$  ripple  $< 1V_{SS}$  • Fuse protection: max. 16A
- The screen clamp for the screen connection of the motor cable is included and must be screwed on in the illustrated position.

**⚠ Only wire up brake in motors with a holding brake! Otherwise, do not wire up.**

**Overvoltage limitation**

- ◆ Energy recuperated during braking is stored in the supply capacitors. The capacity and storable energy is:  
**COMPAX 10XXSL: 660  $\mu$ F / 17 Ws**
- If the recuperated energy causes overvoltage, then external ballast resistances can be engaged.

**Maximum braking power with external ballast resistance**

Braking power	Duration	Cooling down time
COMPAX 10XXSL: $\leq 1.6kW$		unlimited

➡ We provide external ballast resistances for COMPAX 1000SL (see Page 193).

**Connecting the ballast resistance**

The ballast resistance is connected to B+, B- and, if necessary, PE. Output X4 is protected against short circuiting.

**Mating connectors X1, X2, X3 and X4**

Mating connectors for X1,...X4 from Phoenix are included with the following type designations:

- X1: MSTB2.5/6/STF-5.08 (with screw connection)
- X2: MSTB2.5/3/ST-5.08 (without screw connection)
- X3: MSTB2.5/2/ST-5.08 (without screw connection)
- X4: MSTB2.5/3/STF-5.08 (with screw connection)

You can acquire Phoenix housings for these connectors and these can be used once adapted to our cables. Designation: KGG-MSTB2.5/(pin number).

7.7.2 Connector assignment COMPAX 1000SL (overview)

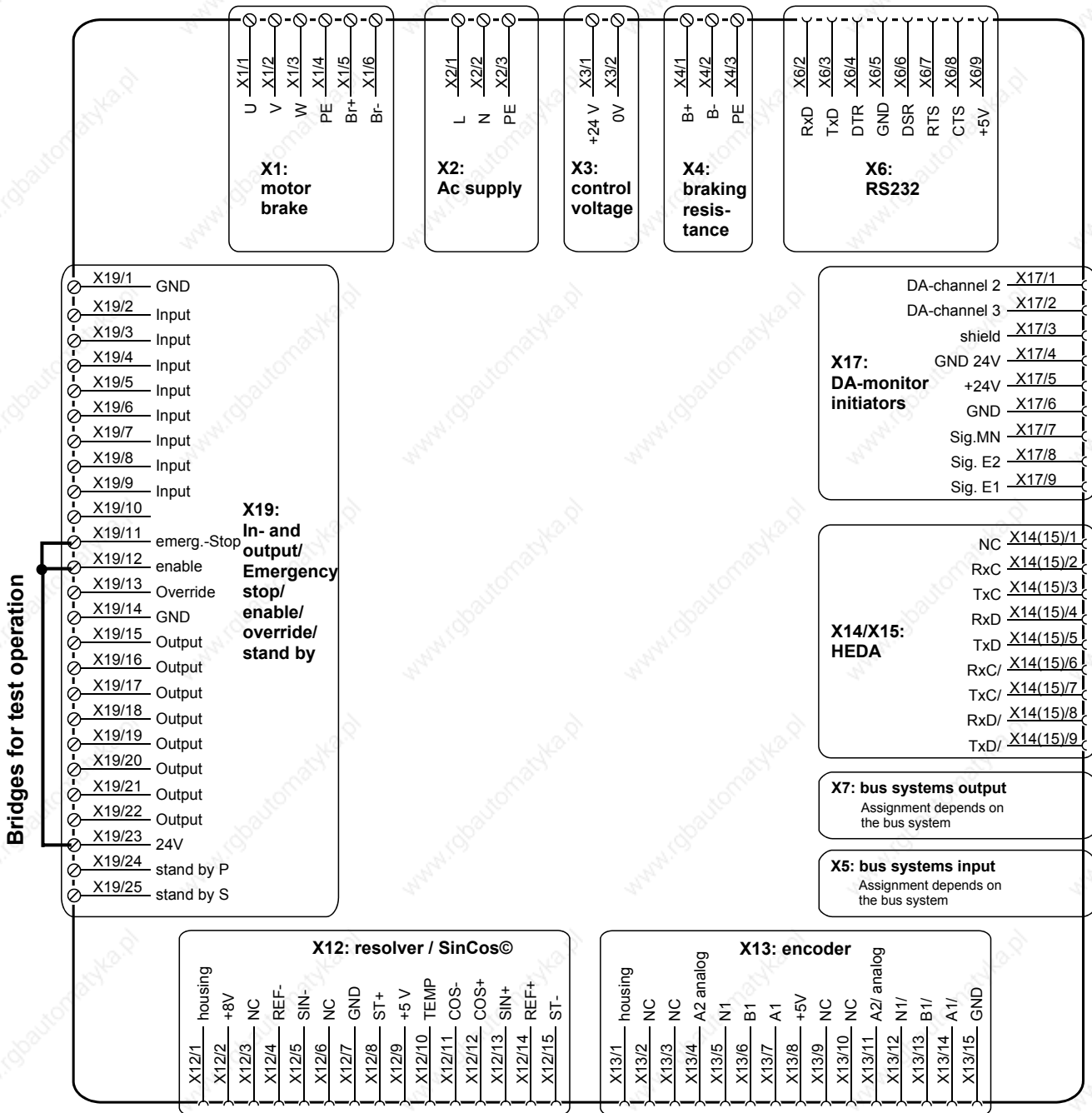

The assignment of X12 does not apply for the S3 option.

#### 7.7.3 Mounting and dimensions COMPAX 1000SL

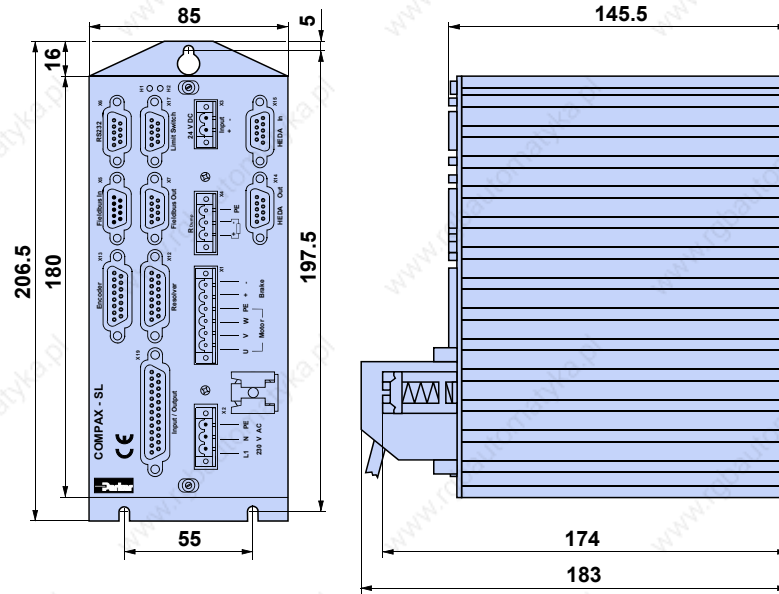

Fastening: 3 M4 hex-socket head screws  
 Installation distance: 100mm (device distance:15mm)

**7.7.4 Safety chain / emergency stop functions**

**Readiness, safety chain**

Establishing a safety chain for monitoring the drives and other control components or a superordinate control unit usually requires a connection protected from wire breaks. The contact outputs (closer) P (X8(9)/3) and S (X8(9)/4) are used for this purpose. This closer establishes sequential switching for the mains module and the axis controller. When the unit is operating correctly, the contacts are closed (P and S are connected) and thereby indicate the readiness of the unit. If an error occurs or if the drive system is switched off, the readiness is not displayed and the chain is interrupted (see below).

**Emergency stop**

The emergency stop input is used to activate or deactivate all drive controllers or an individual controller supplied by the mains module. In accordance with the safety chain described above, this input must be activated to power the motors. This occurs either via an external contact between X8(9)/5 and X8(9)/6 (as is shown in the figure below) or by applying voltage of between 15V and 24V to the input X8(9)/6 against GND (X8(9)/2). If the contact is opened or the voltage is removed from X8(9)/6 or routed to GND24V, the emergency stop sequence is processed, e.g. all motors of the connected drive controller are decelerated and switched off (no torque on the motor shaft); the ready contact drops.

Emergency stop characteristics :

- ◆ After an emergency stop: error E55 (even in OFF status) and O1="0". The current command is interrupted.
- ◆ The controller brakes the motor (braking time: P10 relative to the time set with ACCEL).
- ◆ When at a standstill, the controller is switched off and any idle holding brake is closed.
- ◆ Once the problem has been rectified, E55 must be acknowledged.
- ◆ The current command is continued after START.

**Emergency stop and ready on connector:**

**NMD: X8**  
**COMPAX-S: X9:**

Connectors: Phoenix MC1.5/7-ST-3.81	Pin	Assignment
	1	+24V DC (<50mA)
	2	0V
	3	P: Ready contact
	4	S: Ready contact
	5	+24V DC – Output for emergency stop
	6	Emergency stop input (activated by 15V – 24V)
	7	Screen

**COMPAX 35XXM: X19**

Connectors: Phoenix MC1.5/7-ST-3.81	Pin	Assignment
	1	+24V DC (<50mA)
	2	0V
	3	P: Ready contact
	4	S: Ready contact
	5	+24V DC – Output for emergency stop
	6	Emergency stop input (activated by 15V – 24V)
	7	+24V DC (<50mA)
	8	reserved
	9	+24V DC (<50mA)
	10	Enable
	11	Screen

### COMPAX 1000SL X19

25 pin Sub-D socket strip screw connection UNC4-40		Pin	Assignment
		23	+24V DC (<50mA)
		1	0V
		24	P: Ready contact
		25	S: Ready contact
		11	Emergency stop input (activated by 15V – 24V)

### Emergency stop input direct to COMPAX-M X9

Connector: Phoenix MC1.5/7-ST-3.81 	Pin	Assignment
	1	+24V DC (<50mA)
	2	0V
	3	reserved
	4	reserved
	5	+24V DC – Output for emergency stop
	6	Emergency stop input (activated by 15V – 24V)
	7	Screen

### \* Emergency stop input on COMPAX-M

The emergency stop input on COMPAX-M X9 is enabled via parameter P219.  
 Meaning:

- ◆ P219="0": No emergency stop input on COMPAX-M X9
- ◆ P219="7": Emergency stop input on COMPAX-M X9 with the following data
- ◆ Stop with P10 as relative ramp time (P10 = braking time from 100% speed to 0%).
- ◆ The motor is switched off.
- ◆ Error message E56 is generated.
- ◆ The ready contact drops.

### Principle of safety chain and emergency stop function

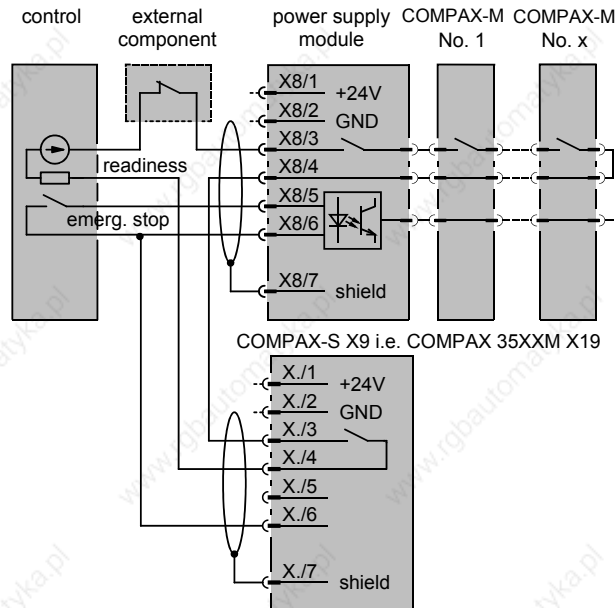

**Ready contact:** max. 0.5A, 60V, 30W

➡ Applies to potential - 24V power supply.

**7.8 Connections to the motor**

**Cable assignment in the terminal boxes**

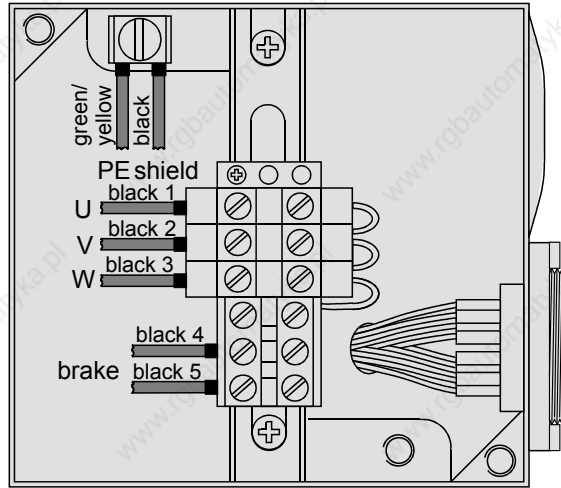

**7.8.1 Resolver / SinCos**

Pin from X12	Assignment with resolver or option S1/ S2 <sup>2</sup>	Assignment with option S3 <sup>3</sup>
1	Housing	Housing
2	+8V	+8V
3	NC	HALL3
4	REF-	+5V
5	SIN-	SIN- / A/
6	NC	HALL2
7	GND	GND
8	ST+	+5V
9	+5V	+5V
10	TEMP	TEMP
11	COS-	COS- / B/
12	COS+	COS+ / B
13	SIN+	SIN+ / A
14	REF+	HALL1
15	ST-	GND HALL

<sup>2</sup> The S1/2 options are required for operation with the sensor system SinCos.

<sup>3</sup> The S3 option is required for operation of linear motors.

## Connecting cable to motor

		Resolver cable	Sensor cable (SinCos®)	Motor cable				
				With connectors: HJ96, HJ116, HDY55, HDY70, HDY92, HDY115		With terminal boxes: HJ155, HJ190, HDY142		
				1.5mm <sup>2</sup> up to 13.8A	2.5mm <sup>2</sup> up to 18.9A	2.5mm <sup>2</sup> up to 18.9A	6mm <sup>2</sup> up to 32.3A	10mm <sup>2</sup> up to 47.3A
Standard cable	Cable sheathed	REK32/..	GBK16/..	MOK42/..	MOK43/..	MOK21/..	MOK11/..	MOK46/..
	Connector set	085-301312 800-030031	085-301317 800-030031	085-301306	085-301306	125-518162 125-216800	125-518211 125-217000	125-518200
	Cable	102-150200	102-150210	102-508896	102-508902	102-508902	102-150030	102-150040
	Cable data in mm <sup>1</sup>	8,0/80/120	7,5/38/113	10,7/107/107	13,7/137/137	13,7/137/137	16,5/124/124	22,5/168/168
High-flex cable	Cable sheathed	REK33/..	GBK17/..	MOK44/..	MOK45/..	MOK14/..	MOK11/..	MOK46/..
	Connector set	085-301312 800-030031	085-301317 800-030031	085-301306	085-301306	125-518162 125-216800	125-518211 125-217000	125-518200
	Cable	102-000030	-	102-000020	102-000010	102-000010	102-150030	102-150040
	Cable data in mm <sup>1</sup>	8,2/61,5/61,5	8,0/40/64	9,2/69/69	11/82,5/82,5	11/82,5/82,5	16,5/124/124	22,5/168/168

### Resolver cable for HJ and HDY motors

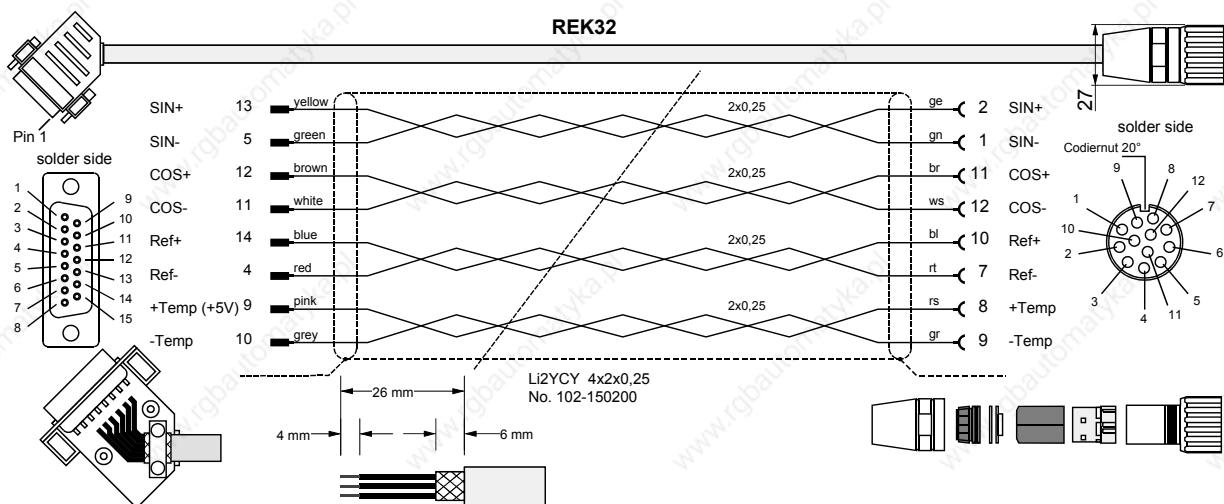

➡ In HJ – motors, ensure that the thermal sensor has the correct terminal arrangement.

### Version in high-flex: REK33 (same layout)

### Packaging

Packaging of motor in accordance with connector manufacturer's specification

#### Packaging of device

- Strip 26mm sheathing off.
- Cut sheath down to 6 mm.
- Strip 4mm of insulation of ends and coat in tin.

<sup>\*1</sup> Cable diameter / minimum bending radius (static) / minimum bending radius (dynamic)

### Length codes for preformed cables

Length [m]	1.0	2.5	5.0	7.5	10.0	12.5	15.0	20.0	25.0	30.0	35.0	40.0	45.0	50.0
Code	01	02	03	04	05	06	07	08	09	10	11	12	13	14

Example REK32/09: length 25m

### Motor cable for HJ and HDY – motors

#### MOK42 (max. 13,8A)

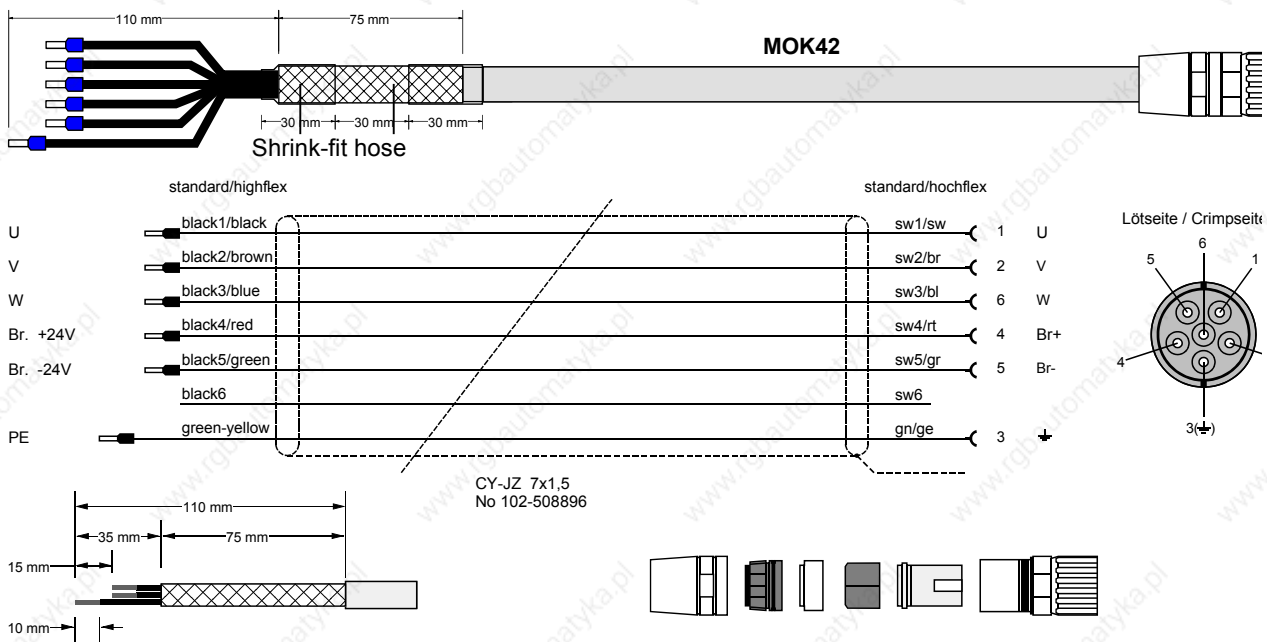

#### Version in high-flex: MOK44 (same layout)

#### MOK43/.. (max. 18.9A): HJ (version in high-flex: MOK45)

Layout corresponds to MOK42, however motor lines in 2.5 mm<sup>2</sup>

### Packaging

#### Packaging of motor in accordance with connector manufacturer's specification

Contacts for 1.5 mm<sup>2</sup> and 2.5 mm<sup>2</sup> are supplied with the connector set.

#### Packaging of device

##### Material:

- 6 x crimping sleeves.
- 6 cm shrink-fit hose.

##### Procedure:

- Strip 110 mm sheathing off cable.
- Cut down sheath to approx. 35 mm, loosen,
- fold back over outer cover (approx. 75 mm) and stick with insulating tape.
- Shorten sw1,sw2,sw3,sw4,sw5 approx. 15 mm ; (gn/ge approx. 15 mm longer); cut down sw6.
- Attach 2 x approx. 30 mm shrink-fit hose (sticky).
- Strip 10 mm of insulation of ends of wires and secure with crimping sleeve 1.5.



### MOK21 (max. 18,9A)

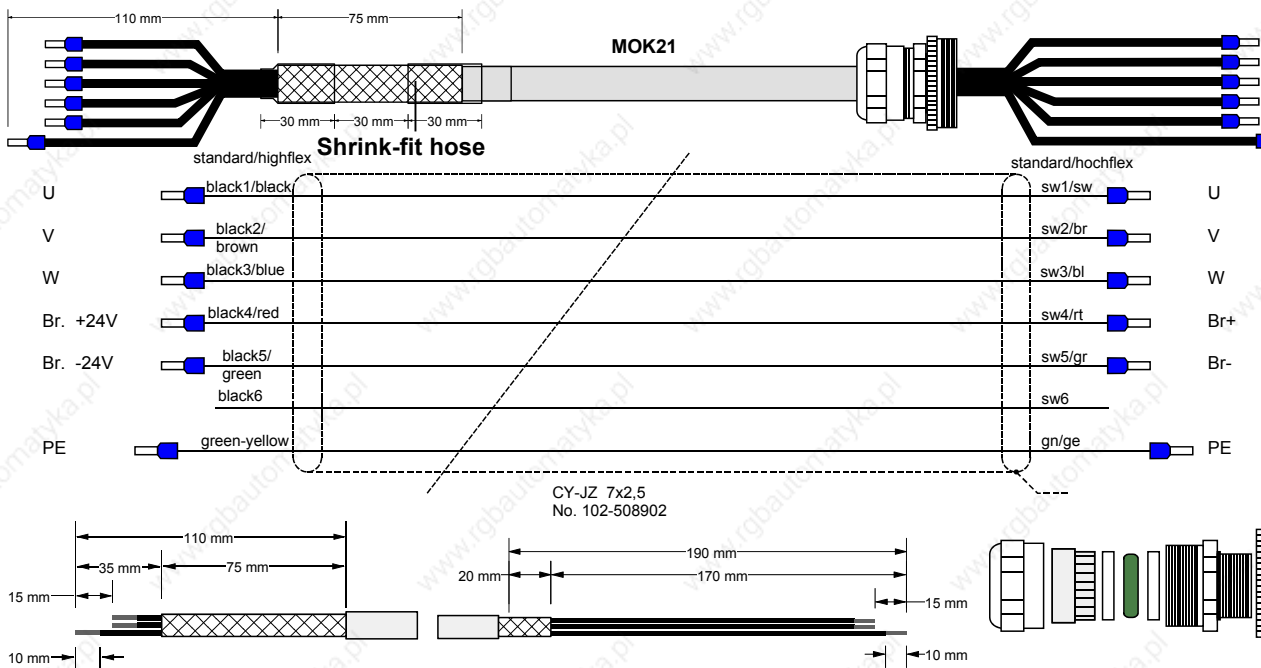

### Version in high-flex: MOK14 (same layout)

**MOK11 (max. 32.3A) in high-flex (same layout to MOK21, however in 6 mm<sup>2</sup>)**

**MOK46 (max. 47.3A) in high-flex (same layout to MOK21, however in 10mm<sup>2</sup>)**

## Packaging

### Packaging of device

#### Material:

- 6 x crimping sleeves.
- 6 cm shrink-fit hose.

#### Procedure:

- Strip 110 mm sheathing off cable.
- Cut sheath down to approx. 35 mm, loosen,
- fold back over outer cover (approx. 75 mm) and stick with insulating tape.
- Shorten sw1,sw2,sw3,sw4,sw5 ca. 15 mm (gn/ge approx. 15 mm longer) cut down sw6.
- Attach 2 x approx. 30 mm shrink-fit hose (sticky).
- Strip 10 mm of insulation off ends of wires and secure with crimping sleeves 2.5.

### Packaging of motor in accordance with manufacturer's specification

- Strip 190 mm sheathing of cable.
- Cut sheath down to approx. 170 mm, stick remaining 20 mm with insulating tape.
- Shorten sw1,sw2,sw3,sw4,sw5 by approx. 15 mm (gn/ge approx. 15 mm longer) cut down sw6.
- Strip 10 mm of insulation of ends of wires and secure with crimping sleeves 2.5.

### SinCos© cable for HJ and HDY motors

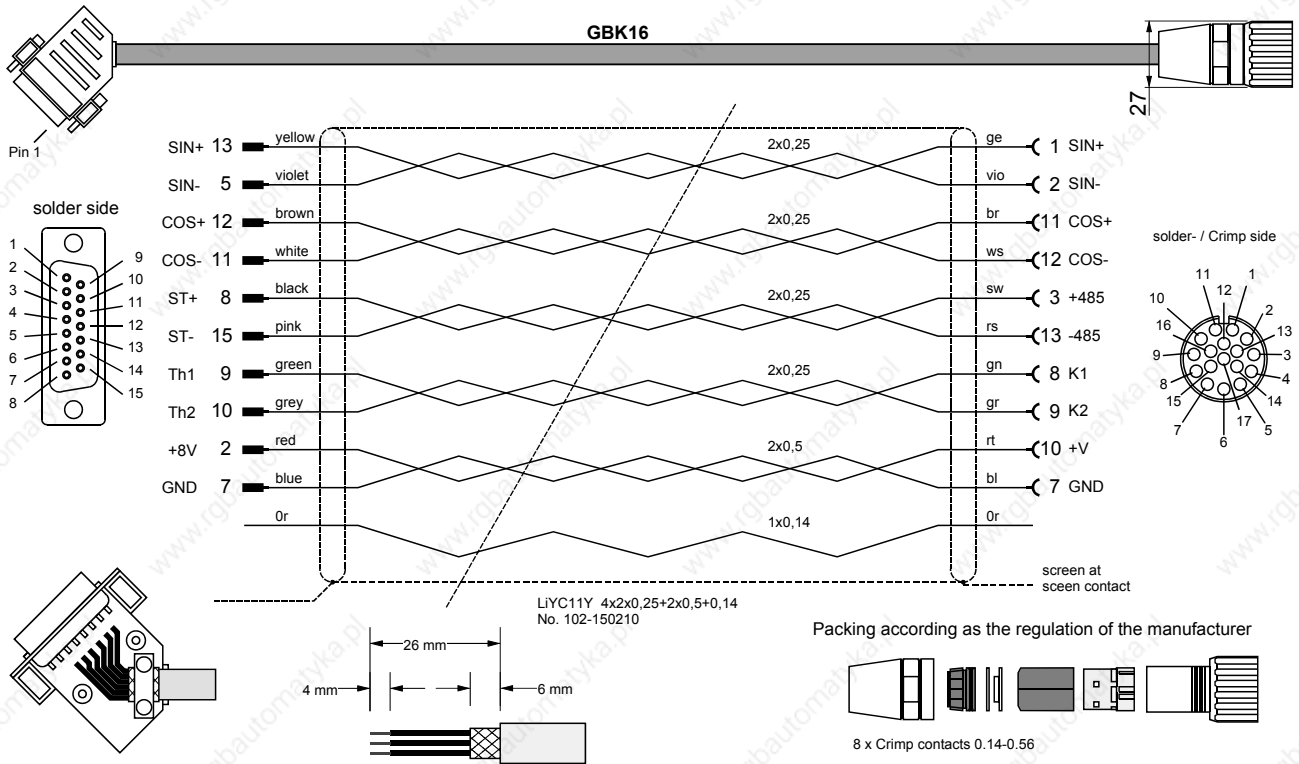

### Version in high-flex: GBK17 (same layout)

### Packaging

#### Packaging of motor in accordance with connector manufacturer's specification

#### Packaging of device

- Strip 26mm sheathing off.
- Cut sheath down to 6 mm.
- Strip 4mm of insulation of ends and coat in tin.
- Place sheath over large area of housing (e.g. fold sheath over outer cover and fasten down by relieving tension).

### 7.8.2 Additional brake control

COMPAX controls the motor retaining brake independently (also see Page 123). When running applications which require additional brake control note the following, based on the unit type used.

#### COMPAX-M / COMPAX 45XXS / COMPAX 85XXS, COMPAX 1000SL

With these units, you must implement measures for suppression. Note the following application example:

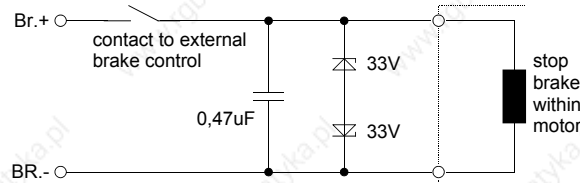

These protective measures are available in COMPAX-M / COMPAX 45XXS / COMPAX 85XXS for applications without external brake control.

#### COMPAX 25XXS / COMPAX 35XXM

In COMPAX 25XXS (X1/7 and X1/8) and in COMPAX 35XXM (X23: bridge), 2 connections are available for connecting the external contact. These connections are already bridged in the connector when supplied. External protective measures are not required for COMPAX 25XXS and COMPAX 35XXM.

##### External contact connection:

The bridge is removed and is replaced by connecting an external contact.

## 7.9 Interfaces

### 7.9.1 Digital inputs and outputs (excluding COMPAX 1000SL)

The inputs and outputs have PLC voltage levels (High signal = 24V DC)

#### Assignment of X8 (Input/Output)

	X8 Pin	Assignment	Meaning		
Connectors: Phoenix MC1.5/16-ST- 3.81	1.	Input I1	SHIFT	= "0"	= "1"
	2.	Input I2		Manual+	Find machine zero
	3.	Input I3		Manual-	Approach real zero
	4.	Input I4		Quit	Teach real zero
	5.	Input I5		Start	-
	6.	Input I6		Stop (interrupt data record)	Break (breaks off data record)
	7.	Input I7	Freely assignable in the standard unit.		
	8.	Input I8			
	9.	Output O1	= "1": No fault = "0": errors E1 ... E58; the drive does not accept any positioning commands. After "Power on" O1 remains at "0" until after the self test.		
	10.	Output O2	= "1": No warning = "0": error ≥ E58		
	11.	Output O3	Machine zero has been approached		
	12.	Output O4	Ready for start		
	13.	Output O5	Programmed set point reached		
	14.	Output O6	Idle after stop		
	15.	Output O7	Freely assignable in the standard unit.		
	16.	Output O8			

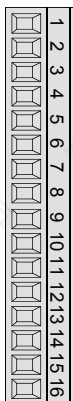

➡ The "SHIFT signal" (I1) must be assigned before or at the same time as the relevant input.

#### Assignment of X10 (Input/Output)

	X10 Pin	Assignment	Meaning
Connector: Phoenix MC1.5/16-ST- 3.81	1.	Input I9	Freely assignable in the standard unit.
	2.	Input I10	
	3.	Input I11	
	4.	Input I12	
	5.	Input I13	
	6.	Input I14	
	7.	Input I15	
	8.	Input I16	
	9.	Output O9	
	10.	Output O10	
	11.	Output O11	
	12.	Output O12	
	13.	Output O13	
	14.	Output O14	
	15.	Output O15	
	16.	Output O16	

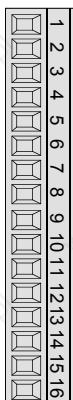

➡ Note the assignment for unit variants and for special functions.

### 7.9.2 Digital inputs and outputs for COMPAX 1000SL

COMPAX 1000SL physically has 8 digital inputs and 8 digital outputs which are assigned to connector X19.

COMPAX internally has 16 logic inputs and 16 logic outputs, some of which have functions assigned to them. This means that not all logic inputs and outputs can be interrogated or output via physical inputs and outputs. In order to enable flexible assignment, a matrix was created for input and output assignment respectively which makes it possible to assign the logic inputs and outputs to any of the physical inputs and outputs. The matrices for allocation are realized via parameters P156 to P160 (see Page 140). The assignment described below applies to COMPAX 1000SL (standard unit) with default settings for parameters P156 to P160.

#### Assignment X19 for COMPAX 1000SL

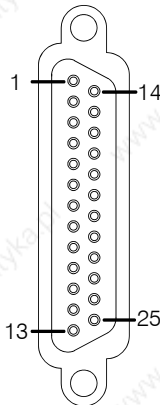
	X19 Pin	Assignment	Meaning for COMPAX 1000SL standard unit and default settings for parameters P156 to P160		
25 pin Sub-D socket strip screw connection UNC4-40  	1.	GND			
	2.	Input	SHIFT	= "0"	= "1"
	3.	Input		Manual+	Find machine zero
	4.	Input		Hand-	Approach real zero
	5.	Input		Quit	Teach real zero
	6.	Input		START	-
	7.	Input		Stop (interrupts data record)	Break (breaks off data record)
	8.	Input		Freely assignable in the standard unit. (I12)	
	9.	Input		Freely assignable in the standard unit. (I16)	
	10.	reserved			
	11.	Emergency stop		Emergency stop input (emergency stop is triggered by voltage < 15V DC)	
	12.	Enable		COMPAX 1000SL is enabled by 24V DC at X19/12	
	13.	Override		Input voltage 0 - +5V.	
	14.	GND			
	15.	Output		= "1": No fault = "0": errors E1 ... E58; the drive does not accept any positioning commands. After "Power on" O1 remains at "0" until after the self test.	
	16.	Output		= "1": No warning = "0": Error ≥ E58	
	17.	Output		Machine zero has been approached	
	18.	Output		Ready for start	
	19.	Output		Programmed set point reached	
	20.	Output		Idle after stop	
	21.	Output		Freely assignable in the standard unit. (O7)	
	22.	Output		Freely assignable in the standard unit. (O8)	
	23.	24VDC		Load < 50mA	
	24.	Ready P		Ready contact for building a safety chain	
	25.	Ready S		Ready contact for building a safety chain	

➡ Note the assignment for unit variants and for special functions.

7.9.3 Technical data / Connections of inputs and outputs

**Detection of input signals:**  
 0 → 1 over 9.15V means that "1" is recognised  
 1 → 0 over 8.05V means that "0" is recognised

<b>Load on outputs (not applicable for COMPAX 1000SL):</b>	1. O1...O16	Total of max. 1.6A
	2. O1...O4, O5...O8, O9...O12, O13...O16	Per group of 4, max. 0.8A; taking due account of 1.
	3. O	per output, max. 0.3A and 40nF capacitive <sup>4</sup> ; taking into account 1. and 2.

**Load on outputs for COMPAX 1000SL:** Per output, max. 0.3A • In total a sum load for all 8 outputs of max. 0.48A and 40nF capacitive<sup>5</sup>;

If overload occurs, an error message appears (E43: can be acknowledged with Power off/on); the corresponding group of four is switched off.

**Input connection using I7 as an example**

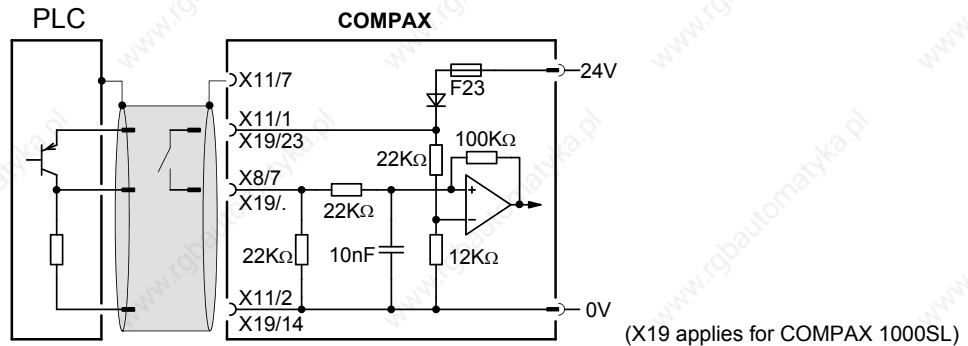

**Output connection using O7 as an example**

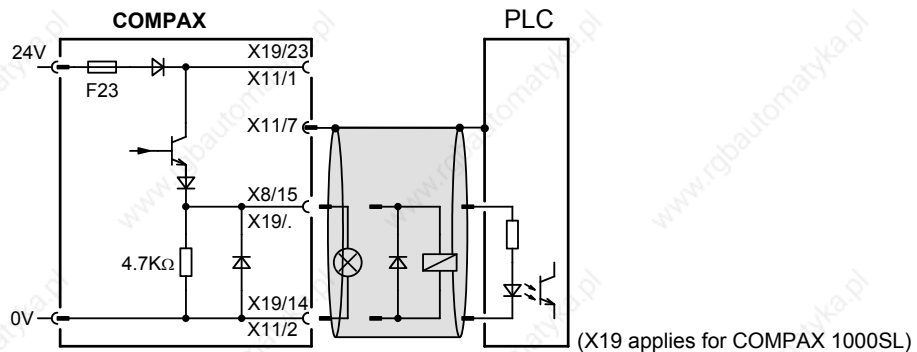

➡ For reasons of interference protection, we would recommend that you use a screened cable for the digital inputs and outputs. With COMPAX 1000SL, the screen is connected with the Sub-D housing.

➡ A protective connection is required when there is inductive load present.

**Input/output connection for 2 COMPAXs**

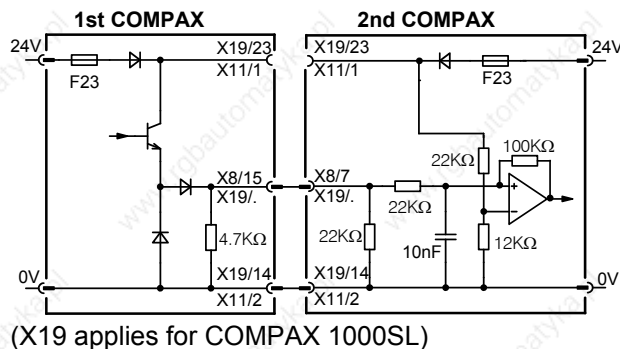

<sup>4</sup> A maximum of 4 COMPAX – inputs can be connected to one output.  
<sup>5</sup> A maximum of 4 COMPAX – inputs can be connected to one output.

### 7.9.4 Initiators and D/A monitor

#### Connection assignment on X17

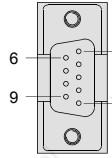
9 pin Sub-D pin strip plug housing with screw connection UNC4-40	Pin	Assignment
	1	DA channel 0 (option D1) Ri=2.8kΩ; <b>COMPAX 1000SL: DA channel 2; Ri=0.33kΩ;</b>
	2	DA channel 1 (option D1) Ri=2.8kΩ; <b>COMPAX 1000SL: DA channel 3; Ri=0.33kΩ;</b>
	3	reserved
	4	Ground 24V (Initiators supply)
	5	+24V (Initiators supply) <50 mA
	6	Ground for DA channels
	7	Input MZ initiator
	8	Input I2 initiator
	9	Input I1 initiator

#### Connection plan for the initiators with initiator connector

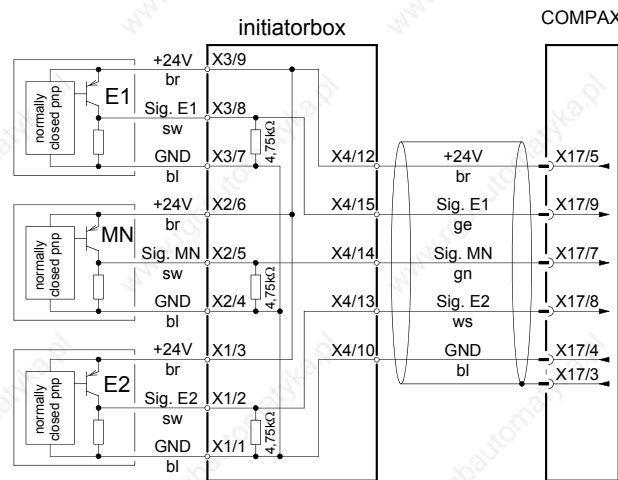

➡ Ensure that the initiator is rebound-free!

#### Requirements concerning the position of the initiators

##### Standard

When **operating with one initiator** (machine zero), this must be attached to one side of the stroke. When attaching the initiator, ensure that an initiator attached to the left-hand side can no longer be cleared to the left. The flank to be analyzed can therefore also be positioned before the end of the travel distance. The same applies correspondingly for the right-hand side.

##### Extended operation

When **operating with three initiators** (not standard), initiators I1 and I2 must be attached to the outer limits of the stroke range. The machine zero initiator is fitted between I1 and I2. The following limitation applies in such cases: the flank of the machine zero initiator must not be activated at the same time as a limit switch.

➡ If COMPAX is only operating as a speed controller or in the "continuous mode" or normal operating mode with a special machine zero mode (P212="10" see Page 80 onwards), then no initiators are required.

**7.9.5 Service D/A monitor / override**

**Assignment of X11 (not applicable for COMPAX 1000SL)**

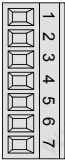
Connector: Phoenix MC1.5/7-ST-3.81 	Pin	Assignment
	1	+24V
	2	Ground 24V
	3	Override for speed reduction
	4	Standard DA channel 2: 8 Bit, Ri=2.21kΩ;
	5	Standard DA channel 3: 8 Bit, Ri=2.21kΩ;
	6	Override; previous input for existing applications
7	Screen	

With COMPAX 1000SL, the override input is on X19/13 (see Page 53), the Service D/A monitors on X17/1 und X17/2 (see Page 55).

**Override connection**

(not applicable for COMPAX 1000SL)

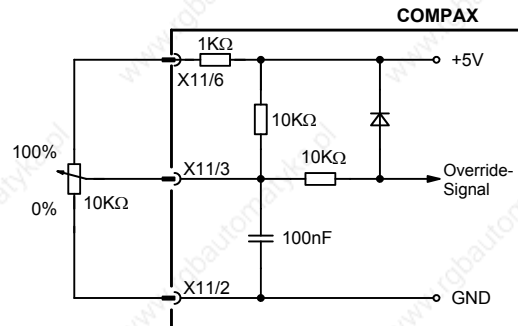

➡ The override input is read in a cycle of 100 ms. You can continue to use the previous override connection for current applications.

**Override - Connection for COMPAX 1000SL**

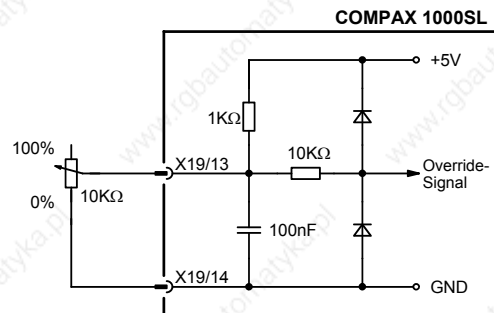

➡ The override input is read in a cycle of 100 ms.

**Note:** Wiring of override with screened cables only

**7.9.6 Service D/A monitor**

The service D/A monitor gives you the option of outputting internal measurement and intermediate parameters from COMPAX in the form of analogue voltage in the range of ±10V via X11 (X17 with COMPAX 1000SL) and visualizing these by means of an oscilloscope. This provides you with a capable aid for making the unit functions clear and qualifiable, especially during the start-up. This function (which is available in all units) provides you with two analogue output channels with a resolution of 8 bit and these are updated every 100 μs.



Using the parameters P76 and P77, you can select 2 parameters and adapt them to the required measuring range.

### Assignment of the channels

Channel 2: X11/4; X17/1 for COMPAX 1000SL<sup>6</sup>  
 Channel 3: X11/5; X17/2 for COMPAX 1000SL

### Meaning and range of values of P76 / P77

No.	Parameter	Range
P76 Value before decimal p.	Measuring parameter of channel 2. (see below for meaning).	0...18
P76 Value after decimal point <sup>7</sup>	Gain factor from channel 2. (factor = value * 10 000 000)	0.1... 10 000 000
P77 Value before decimal p.	Measuring parameter of channel 3. (see below for meaning).	0...18
P77 Value after decimal point	Gain factor from channel 3. (factor = value * 10 000 000)	0.1... 10 000 000

➡ The parameters can only be actuated once you have entered the password. They are validated using VP.

### D/A monitor standard measuring parameters

Service D/A monitor: Selection of measuring parameter using P76 / P77  
 D/A monitor (option D1): Selection of measuring parameter using P73 / P74

Measuring parameter No.	Measuring parameter	Reference value <sup>8</sup>
0	Nominal speed value sensor	20 000 min <sup>-1</sup>
1	Tracking error	128xMotor revolutions
2	Advance speed control	20 000 min <sup>-1</sup>
3	Nominal speed value of position controller	20 000 min <sup>-1</sup>
4	Actual speed value	20 000 min <sup>-1</sup>
5	Speed deviation	20 000 min <sup>-1</sup>
6	Not assigned	
7	Not assigned	
8	Nom. value of transverse current (torque) <sup>9</sup>	200A
9	Intermediate circuit voltage	1000V
10	Sine for co-ordinate transformation	
11	Voltage positioning signal for phase U	2 * U <sub>LS</sub>
12	Voltage positioning signal for phase V	2 * U <sub>LS</sub>
13	Phase current for phase U	200A
14	Phase current for phase V	200A
15	Actual value of transverse current (torque) <sup>10</sup>	200A
16	Longitudinal current	200A
17	Scaled transverse voltage (For amplification of 1 use: 10V = 2 * U <sub>LS</sub> )	2 * U <sub>LS</sub>
18	Scaled longitudinal voltage (For amplification of 1 use: 10V = 2 * U <sub>LS</sub> )	2 * U <sub>LS</sub>

You will find additional measuring parameters on Page 210!

<sup>6</sup> The initiator signals are looped through the monitor box ASS1/01.

<sup>7</sup> .0000001=factor 1  
 .000001=factor 10  
 .999999=factor 10 000 000

<sup>8</sup> Physical value with 10V output voltage and an amplification of 1

<sup>9</sup> To determine torque:  
 torque = transverse current \* 0.71 \* total torque constant

<sup>10</sup> To determine torque:  
 torque = transverse current \* 0.71 \* total torque constant

## D/A monitor option D1

Calculation of physical parameter using the measured value:

$$PG = \frac{MW * BG}{VS * 10V}$$

PG: physical parameter  
 MW: voltage on output channel in [V]  
 BG: reference value from the above table  
 VS: gain factor

**Example:** P76 = 4.000 0010 P77 = 13.000 0005

Therefore the following applies:

channel 2: measuring parameter 4 (actual speed value).  
 gain factor = 10

channel 3: measuring parameter 13 (phase current for phase U).  
 gain factor = 5

measured values:

$$\text{channel 0: } MW=2.5V \Rightarrow PG = \frac{2,5 * 20000 \text{min}^{-1}}{10 * 10V} = 500 \text{ rpm}$$

$$\text{channel 1: } MW = 3V \Rightarrow PG = \frac{3 * 200A}{5 * 10V} = 12A$$

The parameters of the D/A monitor can also be set to status S15 or be viewed via the optimization display (see Page 133).

### 7.9.7 D/A monitor option D1

 The option D1 cannot be used for COMPAX 1000SL.

This option provides you with two additional analogue output channels with a resolution of 12 bit. These channels are updated every 100 µs. Use the parameters P73 and P74 (as you do with the service D/A monitor) to select 2 quantities and to adapt them to the required measuring range using 2 parameters (P71 and P72). D/A monitor option D1 must be ordered as a separate item.

To obtain output from the measured signals, you will need an externally connected monitor box (ASS1/01) with 2 BNC bushes for connecting the measurement instruments. This is connected as follows:

- ◆ monitor box is connected to COMPAX connector X17.
- ◆ the initiator line is connected from X17 to the monitor box. The signals are fed through the monitor box.

#### Meaning and range of values of P71 - P74

No.	Parameter	Range
P71	Gain factor from channel 0.	1...10 000
P72	Gain factor from channel 1.	1...10 000
P73	Measuring parameter of channel 0. (For the meaning, see table on Page 56).	0...18
P74	Measuring parameter of channel 1. (For the meaning, see table on Page 56).	0...18

 The parameter can only be actuated once you have entered the password.

The measuring parameters are selected using P73 or P74

Example: P71=10 P72=5 P73=4 P74=13

Therefore, the following applies:

channel 0: measuring parameter 4 (actual speed value).  
 gain factor = 10

channel 1: measuring parameter 13 (phase current for phase U).  
 gain factor = 5

### 7.9.8 RS232 interface

#### Wiring diagram SSK1/...:COMPAX - PC/terminal

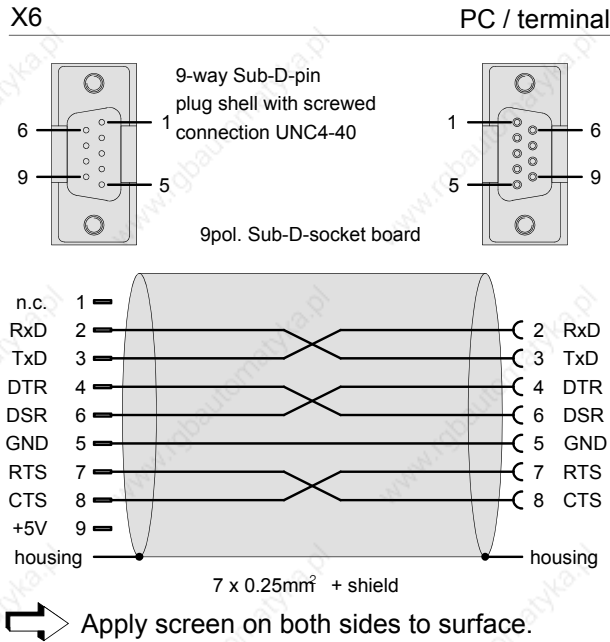

### 7.9.9 Absolute value sensor (option A1)

#### Cable plan GBK1/...: COMPAX absolute value sensor

➡ The option A1 cannot be used for COMPAX 1000SL.

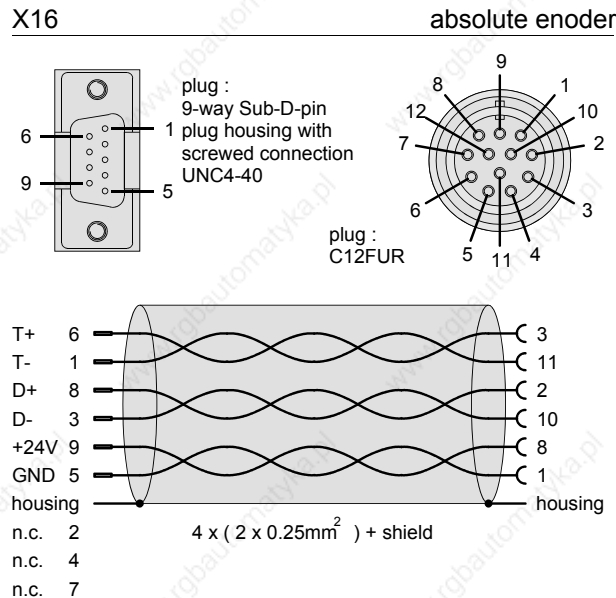

**7.9.10 X13: Encoder interfaces, ...**

**Encoder interfaces for COMPAX**

The encoder interfaces are available as options for COMPAX (excluding COMPAX 1000SL). 2 channels are present; channel 1 can be equipped as the encoder input and channel 2 as the encoder simulation. The necessary options are described on Page 179.

**Encoder interfaces for COMPAX 1000SL**

With COMPAX 1000SL, an encoder interface is integrated in the standard unit. This can be configured either as the encoder input or encoder simulation.

**7.9.10.1 Encoder interfaces / analogue rpm specification for COMPAX**

**Assignment on X13:**

(not COMPAX 1000SL)

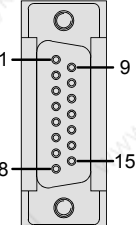
Connector X13	X13 Pin	Designation:	Function with encoder input or simulation	Function of channel 1 with option I7 for COMPAX XX6X or COMPAX XX70
15 pin Sub-D socket terminal strip Screws UNC4-40 	1	Housing	Screen terminal:	
	2	N2	Channel 2 zero impulse	
	3	B2	Channel 2 track B	
	4	2A	Channel 2 track A	
	5	N1	Channel 1 zero impulse	Enable
	6	B1	Channel 1 track B	+15V (<10mA)
	7	1A	Channel 1 track A	Input (±10V)
	8	+5V	Output +5V	
	9	N2/	Channel 2 zero impulse inverted	
	10	B2/	Channel 2 track B inverted	
	11	A2/	Channel 2 track A inverted	
	12	N1/	Channel 1 zero impulse inverted	Direction of rotation
	13	B1/	Channel 1 track B inverted	-15V (<10mA)
	14	A1/	Channel 1 track A inverted	Input (±10V)
	15	GND	Reference point	

➡ The "Incremental encoder" function is an option for which additional boards are required. If the relevant options are available, the following applies:  
 Channel 1: encoder input. Channel 2: encoder emulation

We can provide the relevant cables and a bus distributor for wiring up the encoder signals. Use these to implement various applications (see Page 179).

➡ When working with COMPAX XX6X (electronic transmission) and COMPAX XX70 (electronical curve control) variants, you can use option I7 via channel 1 to implement an analogue speed specification (see Page 186).

**7.9.10.2 Area of application of process interfaces**

	Unit variants			
	COMPAX XX00	COMPAX XX30	COMPAX XX60	COMPAX XX70
<b>Encoder emulation</b>	✓	✓	✓	✓
<b>Encoder input</b>	◆ External pos. localization ◆ SPEED SYNC	◆ External position localization (actual value)	◆ Master position (set value)	◆ Master position (set value)
<b>Analogue input</b>	◆ SPEED SYNC	-	◆ Master speed	◆ Master speed
<b>Cycle / direction input</b>	◆ SPEED SYNC	-	◆ Master position (set value)	◆ Master position

### 7.9.10.3 Encoder interfaces / Analogue rpm specification / Step direction input for COMPAX 1000SL

#### Encoder interface / Step direction input for COMPAX 1000SL

COMPAX 1000SL has an interface which can be configured either as encoder input, encoder simulation, analogue input or step direction input. Encoder simulation and analogue input can be used simultaneously. This interface is a fixed part of COMPAX 1000SL. No other encoder interfaces are possible. The connections are on connector X13:

#### Connector assignment X13 for COMPAX 1000SL

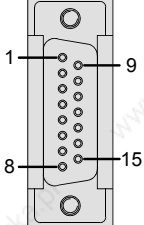
Connector X13	X13 Pin	Designation:	Function
15 pin Sub-D socket terminal strip Screws UNC4-40 	1	Housing	Screen terminal:
	2	nc	
	3	nc	
	4	2A	A2 (Analogue input)
	5	N1	Channel 1 zero impulse
	6	B1	Channel 1 track B or direction
	7	1A	Channel 1 track A or step
	8	+5V	Output +5V
	9	nc	
	10	nc	
	11	A2/	A2/ (Analogue input)
	12	N1/	Channel 1 zero impulse inverted
	13	B1/	Channel 1 track B inverted
	14	A1/	Channel 1 track A inverted
	15	GND	Reference point

#### Process interfaces Configuration options

Setting	Outputs	Inputs
P144 = 4 or 6 P146 = 0	<del>Not possible!</del>	Encoder input
P144 = 5 P146 = 0	<del>Not possible!</del>	Cycle / direction input
P144=7	<b>Encoder emulation</b>	Analogue input $\pm 10V$
	P146=8 512 Pulse/rev. P146 = 0 1024 Pulse/rev.	
P144 = 0	<b>Encoder emulation</b>	<del>switched off!</del>
	P146 = 8 512 Pulse/rev. P146 = 0 1024 Pulse/rev.	

X13: Encoder interfaces, ...

Configuring the process interfaces

P144	P146	Setting	
= 4/6	= 0	Encoder input (without terminator) for individual connections, use bus termination BUS06/01)	
= 5	= 0	Cycle / direction input <sup>11</sup>	Cycle input O1 – O1/
		Counter cycle signal (RS485/422)	Direction input B1 – B1/
= 0	= 0	Encoder simulation 1024 pulse / revolution	without analogue input
= 7	= 0	Encoder simulation 1024 pulse / revolution	with analogue input
= 0	= 8	Encoder simulation 512 pulse / revolution	without analogue input
= 7	= 8	Encoder simulation 512 pulse / revolution	with analogue input
= 7	= 0	Analogue input ±10V	Rpm specification as with option I7, however without direction of rotation input*
= 7	= 8	Input on A2 and A2/ Resolution: 20mV	

\* function analogue input

The I7 function **"direction of rotation"** can be implemented in COMPAX 1000SL by exchanging the differential inputs or by changing the rotation direction with parameter P214 Bit 0.

The I7 function **"enable"** can be implemented via Input I11. Use P232=4 to assign this function to Input I11 (COMPAX 1060/70SL only).

I11 = "1": Release analogue input

I11 = "0": Digital input value = 0 (input is set drift-free to 0)

Applications with COMPAX 1000SL and encoder (see page 179)

1. Direct encoder – COMPAX 1000SL connection  
Cable: GBK11 Bus terminal: BUS06/01 (the bus terminal is allocated to X13 as adapter)
2. Direct COMPAX (simulation) – COMPAX 1000SL (input) connection  
Cable: SSK7
3. Direct COMPAX 1000SL (simulation) – COMPAX (including COMPAX 1060SL or COMPAX 1070L) connection (input); Cable: SSK17
4. An encoder distributor (EAM4/01) is used for the integration of COMPAX 1000SL into an encoder bus consisting of several COMPAX, as described in the COMPAX User Guide.  
It should be noted that COMPAX 1000SL always uses channel 1 (encoder input and simulation).

<sup>11</sup> The operation mode is also configured via the parameters P143 and P98. These have the following significance:

$$P98 = \text{Reference dimension} \quad P143 = \frac{\text{Impulses per Reference dimension}}{4}$$

**Example:** Reference dimension = 100mm  
10 000 input pulses should give a movement of 100mm  
 $P143 = 10\,000 / 4 = 2500$

### 7.9.11 HEDA interface (option A1/A4)

➡ The HEDA interface is available for COMPAX XX00, COMPAX XX60 and COMPAX XX70.

HEDA option A4: for COMPAX 1000SL  
HEDA option A1: for all other COMPAX

#### Cable plan SSK14/..:

**IPM - COMPAX and COMPAX - COMPAX**  
X14/PC X15

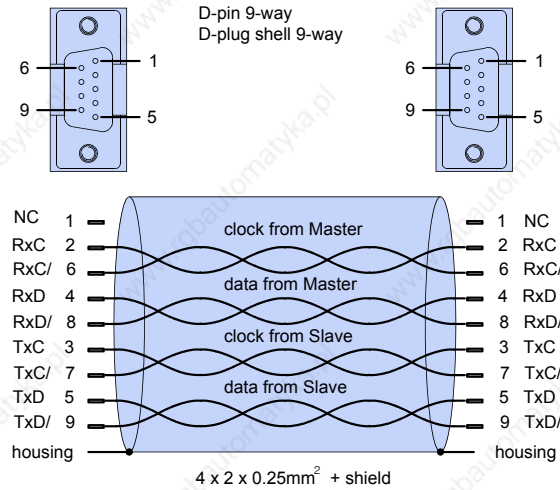

SSK14 must not be used on a COMPAX which is configured as a master (P243=1).

#### Cable plan SSK15/..:

**Cables for COMPAX master and COMPAX slave coupling:**

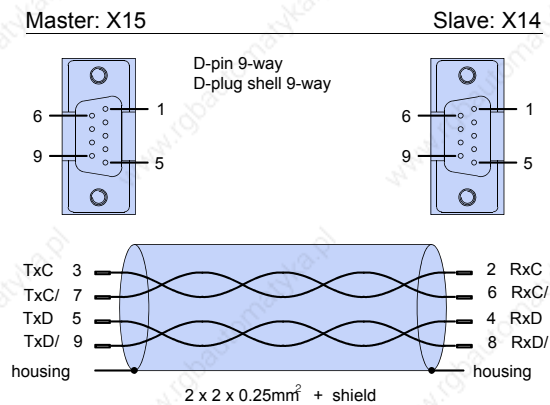

#### Terminating connector (BUS2/01).

**The last unit on the HEDA has a terminating connector (BUS2/01).**  
X15 BUS 2/01

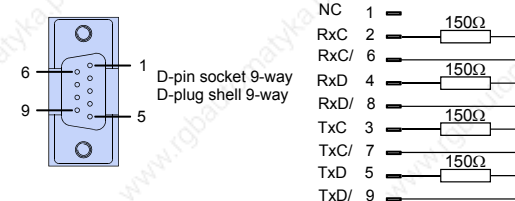

### 7.9.12 Bus connection

Special operating instructions are available for the bus systems.

## 7.10 Technical data

### Power characteristics

#### Functional capability

- Position, speed and current controller.
- IGBT final stage protected from short circuits and ground/earth faults.
- Digital positioning controller.
- Motion controller.

#### Supported motors/resolvers

- Sine-commuted synchronous motors up to a max. speed of 9000 rpm.
- Asynchronous motors.
- Supported resolvers:
  - Litton: JSSBH-15-E-5  
JSSBH-21-P4  
RE-21-1-A05  
RE-15-1-B04
  - Tamagawa: 2018N321 E64
  - Siemens: 23401-T2509-C202
- SinCos support (Stegmann).
- 3-phase synchronous linear motors<sup>12</sup>
  - Sine-cosine linear encoder (1V<sub>ss</sub>) or TTL (RS422)
  - Digital Hall sensor commutation (5V).

#### Output data for individual units

Unit COMPAX .	Nom.cur-rent [Aeff]	Peak current [Aeff] <5s	Power [kVA]
<b>with mains supply: 230V AC</b>			
10XXSL	2.5	5.0	1.0
25XXS	6.3	12.6	2.5
<b>at mains supply: 400V AC</b>			
45XXS	6.5	13.0	4.5
85XXS	12.5	25.0	8.6
P1XXM	5.5	8.5	3.8
02XXM	6.5	8.5	4.5
05XXM	11.5	17.0	8.0
15XXM	25.0	50.0	17.0
35XXM	50.0	100.0	35.0
<b>with mains supply: 460V AC</b>			
45XXS	5.4	13.0	4.5
85XXS	10.5	25.0	8.6
P1XXM	4.5	8.5	3.8
02XXM	5.4	8.5	4.5
05XXM	9.6	17.0	8.0
15XXM	21.0	50.0	17.0
35XXM	42.0	100.0	35.0

#### CE conformity

- EMC immunity/emissions as per EN61800-3.
- Safety: VDE 0160/EN 50178.

#### Supply voltage (limit values)

##### COMPAX-M (NMD)

- 3 \* 80V AC - 3 \* 500V AC; 45-65Hz.

##### COMPAX 35XXM

- 3 \* 250V - 3 \* 500V AC; 45 - 65 Hz.

##### COMPAX 25XXS

- 3 \* 80V AC - 3 \* 250V AC; 45 - 65 Hz
- 1 \* 100V AC-1 \* 250V AC; 45-65Hz

##### COMPAX 10XXSL

- 1 \* 100V AC-1 \* 250V AC; 45-65Hz

##### COMPAX 45XXS/85XXS

- 3 \* 80V AC - 3 \* 500V AC; 45-65Hz.

#### Mains supply fuse protection

K circuit breaker or similar Neozed fusible cut-out.

- NMD (COMPAX-M)
  - NMD10: 16A (K circuit breaker: 20A) NMD20: 35A
- COMPAX 35XXM: 62A
- COMPAX 25XXS: 1x230V AC: 16A  
3 \* 230V AC: 10A
- COMPAX 10XXSL: 16A
- COMPAX 45XXS/85XXS: 16A

#### DC bus voltage

- 300V DC with 3(1) \* 230V AC.
- 560V DC of 3 \* 400V AC supply.
- 650V DC with 3 \* 460V AC.

#### Output voltage to motor

Ignoring power losses, motor output rating is the maximum motor output voltage of the AC supply voltage available

#### Braking operation

- Storable energy
  - NMD10/20: 1100µF / 173Ws
  - COMPAX 25XXS: 1000µF/27 Ws
  - COMPAX 45XXS: 330µF/52 Ws
  - COMPAX 85XXS: 500µF/80 Ws
  - COMPAX 1000SL: 660µF/17 Ws
- Ballast resistances (see Page 193)

#### Control voltage

- 24V DC ±10%, Ripple <1V<sub>ss</sub>
- Current required:
  - 1.3A for COMPAX 35XXM.
  - 1A for COMPAX 45XXS/85XXS.
  - 0.8A for the other units (incl. NMD).

<sup>12</sup> Reduced nominal data apply for linear motors; see Page 177.



- Digital outputs, each 100 mA.
- If needed, for fan approx. 100 mA.
- For motor holding brake (0.35A-1.6A).
- If needed, absolute encoder: 0.3A.

### Accuracy

- Positioning on the motor shaft:  
Resolution: 16 bits (= 0.3 minutes of angle)  
Absolute accuracy: +/-15 minutes of angle

### Maximum power dissipation

- COMPAX 10XXSL: .....50W
- COMPAX P1XXM: .....140W
- COMPAX 02XXM / NMD10/20:..120W
- COMPAX 05/10/15XXM:.....250W
- COMPAX 25XXS: .....80W
- COMPAX 45XXS/85XXS: .....170W
- COMPAX 35XXM:.....610W

### Data record memory

250 data records, protected from power failure.  
Data record functions

- Positioning commands, I/O instructions, program commands:  
ACCEL, SPEED, POSA, POSR, WAIT, GOTO, GOSUB, IF, OUTPUT, REPEAT, RETURN, END, WAIT START, GOTO EXT, GOSUB EXT, SPEED SYNC, OUTPUT A0, GOTO, POSR SPEED, POSR OUTPUT , +, -, \*, /.

### Target value generator

- Ramps: linear, quadr., smooth; 10ms...60s.
- Travel specified in increments, mm, inch or variable using a scaling factor.

### Monitoring functions

- Mains power/auxiliary control voltage.
- Motor and final stage temperature/blocking protection.
- Tracking error monitoring.
- Ready contact: 0.5A; 60V; 30W.

### Ambient conditions

- Temperature range: 0...45°C.
- Max. relative air humidity as per DIN 40040 class F ( $\leq 75\%$ ); no condensation.

## Interfaces

### Control inputs: 16 (8 for COMPAX 1000SL)

- 24V DC, 10 kOhm (see ex page 52).

### Control outputs: 16 (8 for COMPAX 1000SL)

- active HIGH, short circuit protected; 24V (see ex page 52).

### RS 232

- 9600 baud or 4800 baud (for COMPAX 1000SL, fixed at 9600 baud).
- Length of words 8 bits, 1 start bit, 1 stop bit.
- Software handshake XON, XOFF.

### Programmable controller data interface (excluding COMPAX 1000SL)

- via 5 binary inputs and outputs.

### Encoder interface (option; standard for COMPAX 1000SL)

- Encoder emulation: 512 or 1024 counts/rev
- Encoder input: RS422 interface; supply: 5V 120-10000 lines/rev

### COMPAX 1000SL signal interfaces (optional)

- Encoder emulation or
- encoder input or
- step/direction input or
- analogue input  $\pm 10V$

### Absolute value sensor interface (option A1) (excluding COMPAX 1000SL)

- Supply voltage: 24V $\pm$ 10%.
- Sensing code: grey code, single step.
- Direction of counting: in clockwise direction when looking at the shaft: rising.
- Data interface: RS422 /24 bit data format (start: MSB). • Cycle frequency: 100 kHz.

### SinCos<sup>®</sup> (option S1/S2/S3)

- High-resolution encoder instead of resolver.
- Single-turn or multi-turn (absolute value over 4096 motor revolutions).
- Option S2 with multi-turn: absolute value sensor with programmable transmission factor.
- Option S3 for linear motors.

### HEDA: synchronous, serial real time interface

Included in option A4 or option A1.

## Bus connection: optional

dc-insulated bus connection.

### RS485

- Max. 115k baud • 2 or 4 wire/RS485

### Interbus S

- 2-conductor remote bus • 500 kBaud.
- max. 64 participants per ring.

### Profibus

- 1.5 MBaud • Sinec L2-DP and FMS.

## CS31

- COMPAX - ABB interface.

## CANbus

- Up to 1.0 MBaud • Basic CAN.
- CAN protocol as per specification 1.2.
- Hardware as per ISO/DIS 11898

## CANopen

- Protocol as per CiA DS 301.
- Profile CiA DS 402 for drives.

## Operation

### Parameter input/status request

- Via COMPAX hand-held terminal.
- Via RS232 and bus interface.
- Via the programmable controller data interface (excluding COMPAX 1000SL).
- Status query also via the 3-digit LED display on the front plate (excluding COMPAX 1000SL).

## Housing

### Housing

- Fully-enclosed metal housing.
- Insulation: VDE 0160/protection class IP20.
- IP54 on request.

### Connections

- Motor, power bus, control inputs/outputs via terminals.
- Sensor cables, interfaces via connectors.

### Installation

- Wall mounting, suitable for installation in industrial control cabinets.

### Dimensions

- NMD/COMPAX-M: see Page 20.
- COMPAX 25XXS: see Page 33.
- COMPAX 10XXSL: see Page 43.
- COMPAX 45XXS/85XXS: see Page 36.
- Weights: COMPAX P1XXM:..... 5.6 kg  
 COMPAX 10XXSL: ..... 1.6 kg  
 COMPAX 25XXS: ..... 4.6 kg  
 COMPAX 45XXS/85XXS: . 6.5 kg  
 COMPAX 02XX: ..... 7.1 kg  
 COMPAX 05/15: ..... 7.8 kg  
 COMPAX 35XXM: ..... 22.5 kg  
 NMD10: ..... 7.6 kg  
 NMD20: ..... 8.1 kg

## Standard delivery

- COMPAX with User Guide.

- ServoManager.

## Mains module

For technical data, see Page 23.

## Permissible 3-phase mains

The units (COMPAX or NMD) can be operated on all mains types<sup>1</sup>. Examples:

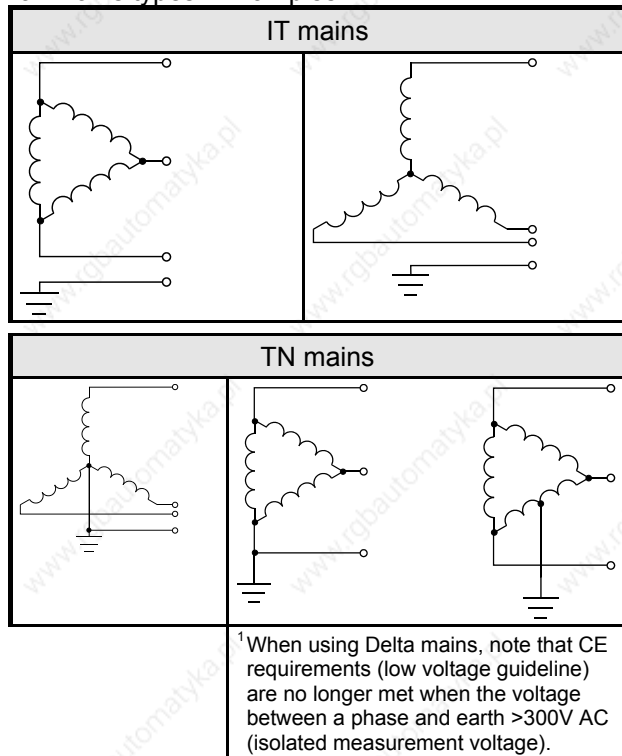

## Leakage current

The leakage current (current on the mains PE) is mainly caused by the capacitive resistance between the conductor and screening of the motor cable. Additional leakage current occurs when using a radio interference suppresser as the filter circuit is connected to earth via the capacitors.

The size of the leakage current depends on the following factors:

- ◆ length of motor cable.
- ◆ cycle frequency.
- ◆ with or without radio interference suppresser.
- ◆ motor cable screened or not.
- ◆ motor earthed at site or not.

The leakage current is very important regarding safety when handling and operating the unit.

### Please note

The unit must be operated with an effective earth connection which satisfies the appropriate specifications for high levels of leakage current (>3.5 mA).

The Servo booster must not be operated with a fault current circuit breaker due to the risk of higher levels of leakage current. If an FI circuit breaker is installed, it must not interrupt the current circuit despite the following conditions (e.g. from ABB series F804):

- ◆ DC component in leakage current (3-phase rectifier bridge).
- ◆ Brief occurrence of pulse-shaped leakage currents when switching on.
- ◆ High levels of leakage current.

## 8. Operating Instructions

# Compact Servo Controller

### 8.1 Overview:

The COMPAX digital positioning system has been designed for multi-axis applications in handling and automation technology. COMPAX contains all the functions required for a compact positioning system. These functions are:

- ◆ digital inputs and outputs (PLC interface)
- ◆ a serial interface (RS232)
- ◆ a data record memory
- ◆ an integrated IGBT final stage.

You will need auxiliary equipment (PC, hand-held terminal) to configure and program COMPAX.

COMPAX is very flexible and offers all the advantages of digital control technology thanks to its completely digital design which encompasses positioning, speed and current control. The main features are:

- ◆ controller parameters which can be reproduced and are drift-free
- ◆ simple copying of set values
- ◆ no offset problems
- ◆ the implementation of efficient, flexible and adaptable setpoint generation.

8.1.1 Block structure of the basic unit (not applicable for COMPAX 1000SL)

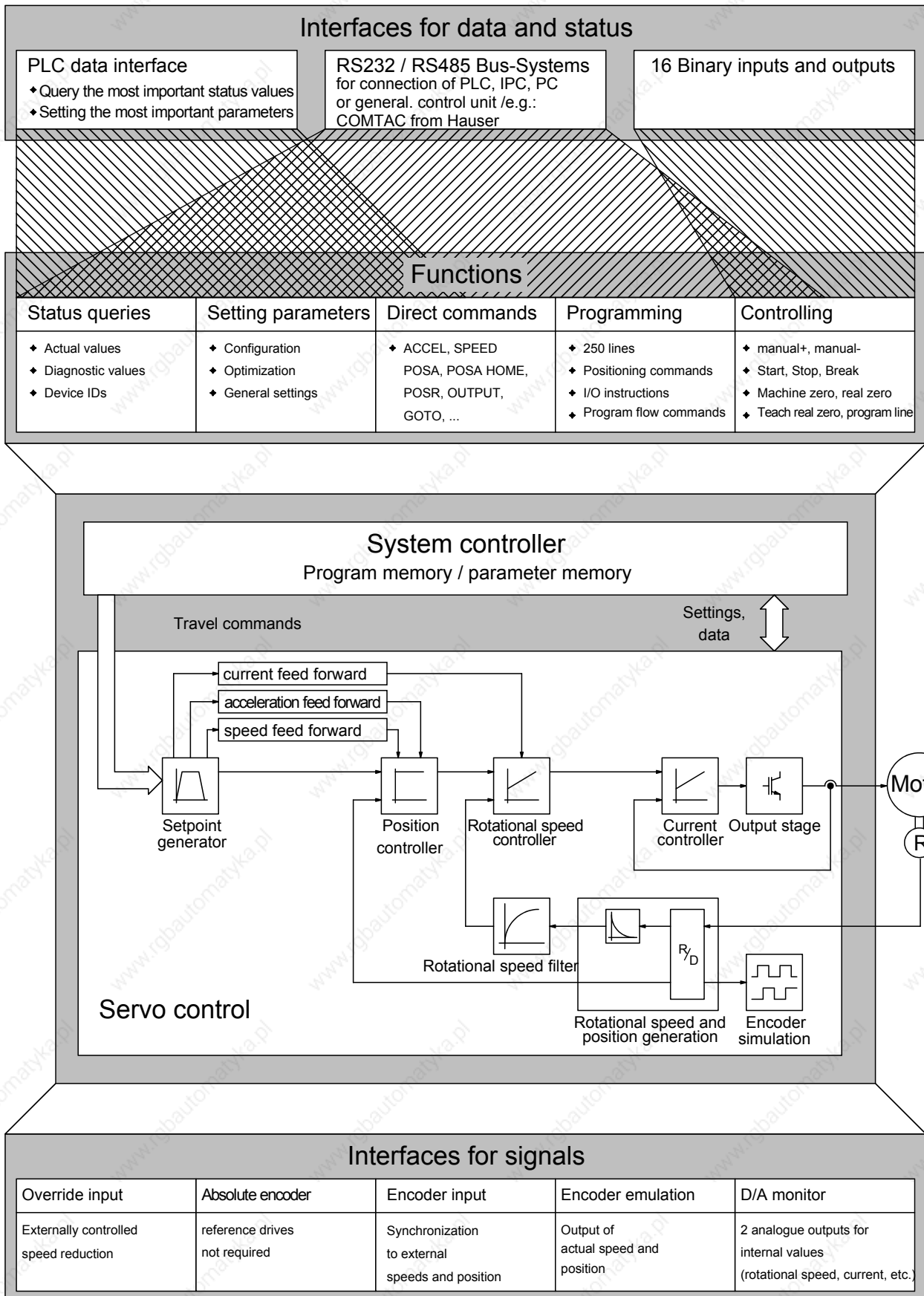

#### Explanations for the block structure

##### Interfaces for data and status

**PLC data interface** The following commands are available via 5 binary inputs (I7...I11) and 5 binary outputs (O7...O11):  
 POSA, POSR, SPEED, ACCEL, GOTO, VP, modifying parameters P1..P49, querying status S1...S12. (Function not available with the COMPAX 1000SL)

**RS 232** All functions are available via RS232.

**Bus systems** All functions are available via the bus interface (Interbus S, Profibus, CAN bus, CANOpen, CS31 or RS485 (ASCII/binary with 2 or 4 wires). A description is available as a separate item.

**Binary inputs and outputs**  
 Inputs:  
 I1...I6: control functions or freely assignable.  
 I7...I16: freely assignable or programmable.  
 Outputs:  
 O1...O6: control outputs or freely assignable.  
 O7...O16: freely assignable or programmable.

#### Functions

**Query status** The status can be queried via the PLC data interface, the bus interface and partially via the front plate display.

#### Setting parameters

**Configuring** Operating mode, units for travel data, motor types, ramp shapes, directions, drive types, reference systems, ....

**Optimizing** Via the uncoupled stiffness, damping and advance control parameters.

**General settings** Replacement and specification values, limitations, control parameters.

**Programming data records** Programming a sequential program with up to 250 data records.

**Controlling**  
 Functions: manual mode, start, stop, break, teach functions ....  
 Messages no fault, no warning, machine zero has been approached, ready for start, position reached, idle after stop or break.  
 Program control: external data record selection, analyzing binary inputs, setting binary outputs, triggering positioning processes,...

**System controller** Function monitoring and co-ordination

**Control** Digital control with robust control loops. Automatic calculation from existing design quantities.

## Password protection

### Interfaces for signals

<b>Override input</b>	Analogue input (see <b>Start-up manual</b> ) for continual reduction of the set speed.
<b>Absolute value sensor (option)</b>	This option supports an absolute value sensor attached to the motor; reference travel is therefore no longer required after initialization has been executed once (see <b>Start-up manual</b> and <b>Accessories and options</b> ). (Function not available with the COMPAX 1000SL)
<b>HEDA (option)</b>	Real time data channel For implementing track and contour tasks using the HAUSER "IPM" interpolation module for PC and IPC or direct COMPAX - COMPAX coupling with one COMPAX as the master.
<b>Encoder input</b>	COMPAX can be synchronized to an external speed (and/or position, e.g. with the "Electronic transmission" unit variant) via this input (see <b>Start-up manual</b> and <b>Accessories and options</b> ).
<b>Encoder simulation</b>	The actual position value can be made available to other units via this channel (see <b>Start-up manual</b> and <b>Accessories and options</b> ) .  An encoder bus can also be created. (see description in " <b>Accessories and options</b> ")
<b>D/A monitor</b>	18 internal measuring and intermediate parameters are output as analogue voltage (+/-10V) via two 8 bit channels (or optionally 12 bit channels).

## 8.1.2 Password protection

COMPAX contains password protection to prevent unwanted data manipulation. Before you configure COMPAX or set your parameters, you must enable these functions with a password. When the axis is at standstill, proceed as follows to enable and block:

### Deactivate password protection: activate password protection:

- transmit GOTO 302 to COMPAX
- 
- switch the unit off  
or
  - transmit GOTO 270 to COMPAX.

### Protected parameters

All parameters, except P40-P49, are protected by password.  
 The COMPAX program is not protected by a password.

### Note!

- Conditions for password input :
- There must not be any programs running.

## 8.2 Configuration

### 8.2.1 Front plate operation (not available with COMPAX 1000SL)

Using the COMPAX front plate, you can query particular status values and perform the most important bus settings. Also whenever an error occurs, COMPAX shows the error number on the display.

**Querying status values and modifying the bus parameters.**

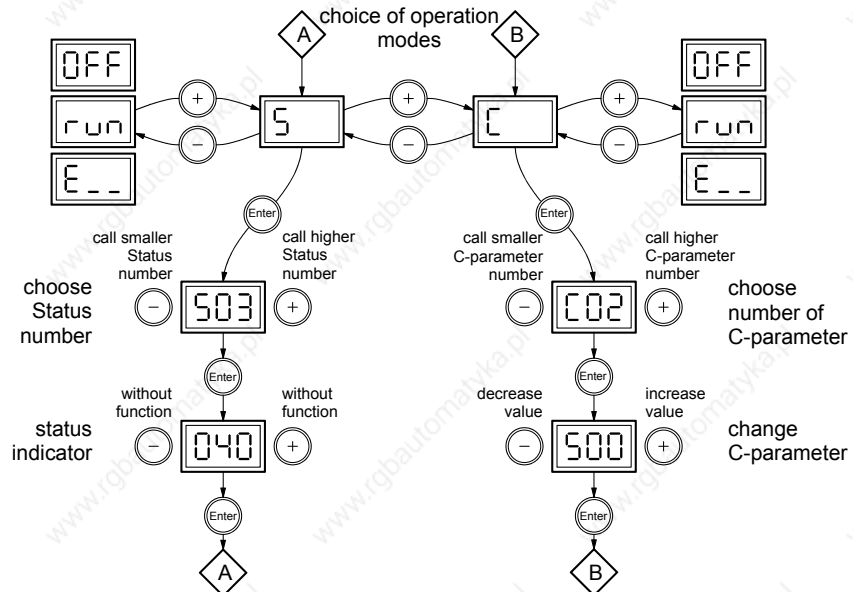

The following status values can be displayed via the front plate:  
 S03-S08, S11, S19-S26 (hexadecimal display), S27, S30, S31, S37-S39  
 (description of the status values: see Page 207).  
 The remaining status values can be queried via the interfaces.

**Meaning of the bus parameters:**

C parameters	COMPAX parameters	Meaning	Valid from
C01	P194	Address of unit	Power on
C02	P195	Baud rate:	Power on
C03	P196	Bus protocol	Power on
C11	P250	HEDA address	immediately
C04 - C10		reserved	

Display value	Baud rate [Baud]	Display value	Baud rate [Baud]	Display value	Baud rate [Baud]
0	600	31	31 250	172	172 800
1	1200	38	38 400	187	187 500
2	2400	50	50 000	250	250 000
4	4800	57	57 600	345	345 600
9	9600	62	62 500	375	375 000
10	10 000	76	76 800	500	500 000
19	19 200	100	100 000	800	800 000
20	20 000	115	115 200	999	1 000 000
28	28 800	125	125 000		

➡ Please see operating instructions for the bus option used for the relevant range of values and the precise setting options.

**Acknowledging error messages**

Once you have rectified the cause of the error, you can acknowledge the error by pressing the "Enter" key.

## 8.2.2 Configuration when supplied

When supplied, COMPAX is not configured. Parameter P149 is set to "0":

**P149="0"**: COMPAX is not configured and switches to OFF mode when switched on (24V DC and operating voltage) (motor switched off). In addition to this, when switched on, all parameters (apart from bus settings P194, P195, P196 and P250) are set to their default values.

**P149="1"**: COMPAX is configured and once switched on (24V DC and operating voltage) tries to engage the motor.



If you are configuring using ServoManager, P149 is automatically set to "1" once ServoManager has executed successful configuration.

### Controller design concept

To operate the COMPAX controller design concept, you must have a basic level of technical control knowledge. COMPAX calculates the internal system and controller parameters required using simple, application-specific values, which are generally accessible.

A strong controller design obviates the need for tedious controller optimization. This configuration provides you with a stable controller.

### Power on with motor switched off

If the control process is unstable because COMPAX has been incorrectly configured, you can switch on COMPAX so that the drive remains switched off even with power on. To do this, when switching on COMPAX simultaneously press the "-" key. The following will then happen:

- the drive is switched off.
- the digital outputs O1...O6 are set to "0".
- when the PLC data interface is switched on: O7=1, O8, O11=0
- the password protected functions are enabled.

Once you have correctly configured COMPAX or you have corrected the relevant parameters, you can engage the drive and outputs again using the command "OUTPUT O0 = 0".

(Function not available with the COMPAX 1000SL)

## 8.2.3 Configuration process

### Switching off the drive



Before you configure COMPAX or modify the configuration, the drive must be switched off e.g. using the command OUTPUT O0=1 or 2 (see Page 98).

### Modifying parameters

The COMPAX configuration is carried out using parameters as follows:

- select operating mode.
- specify units for the travel data.
- select motor from the motor list or configure an external motor.
- select ramp shape.
- define direction.
- use the design data to specify the drive type.
- define the reference system.



➡ **The ParameterEditor (part of the ServoManager) automatically guides you into the "Guided configuration" menu through the input masks with the configuration settings.**

From the next page, there is a clear description of the configuration process for implementing new configurations. If this process is followed, you can specify all the parameters required for your application.

In Chapter "Machine zero mode", you will find a description of options for machine zero and limit switch configurations which deviate from the standard.

➡ The configuration parameter are not accepted directly once they have been modified. COMPAX will only accept the new parameters once the VC commands (valid configuration) have been issued. The ServoManager automatically sets the parameters as valid after configuration!

**Power on for drive**

Using the command OUTPUT O0=0.



**Note that once a configuration has been set or modified, there is a risk if some parameters have been incorrectly programmed. You must secure the displacement area of your system when switching on the drive.**

## 8.2.4 Safety instructions for initial start-up

### Risks from incorrect wiring!

In order to avoid the risks from incorrectly wired systems during initial start-up, use the following settings for personal safety and protection of the mechanical system:

**P15 = 10% (motor speed limited to 10% nominal value)**

**P16 = 100% (torque limited to 100% nominal value)**

- The drive must remain at standstill after the system switch on.
- Execute a travel operation e.g. with POSR \* or manually +/-.

If this travel operation is executed correctly, then P15 and P16 can be reset to their original values.

The following faults may occur:

- The drive does not remain at standstill when switched on, or
- the drive runs out of control after the start command.

In both cases, either error E10 or error E54 is triggered.

If error E54 occurs, the drive is switched off.

A possible cause of the error is incorrect wiring in the motor or resolver systems.

### 8.2.5 Configuration parameters

#### Operating mode

**Parameter P93: valid from next move command.**

##### Normal mode:

**P93 = "1"**

Positioning processes refer to real zero.

To set the reference, use the "Find machine zero" function (Input I1="1" and I2="1", see Page 148) once the system is switched on.

Various machine zero modes are described from Page 80.

##### Continuous mode:

**P93 = "2"**

Positioning processes always refer to the relevant start position.

The "Find machine zero" function is not necessary but possible.

Set P1 (real zero) = 0.

To avoid inaccuracies during conversions, use the "Increments" measurement units in continuous mode (see below).

➡ Operation with absolute value sensors is not permitted when working in continuous mode.

##### Speed controller

**P93 = "4":**

In this operating mode, the drive controller operates as a speed controller, the position controller is switched off. The following applies:

- Commands not permitted: POSA, POSR, POSR SPEED, POSR OUTPUT, POSA HOME, ACCEL-.
- The SPEED command contains a prefix for the direction of rotation.
- Output O3 is not assigned; O5 has the "Programmed nominal speed reached" function (see Page 120).
- The data record indicator is set to N001 using "Approach real zero".
- The "Find machine zero" function (I1&I2) is not assigned.

#### Unit for travel data

**Parameter P90**

mm

**P90 = "1"**

Inch

**P90 = "2"**

Increments

**P90 = "0": Accurate increment operation without conversion inaccuracies.**

➡ This measuring unit is only useful when using the "General drive" drive type and especially in continuous mode. The levels of accuracy are not increased when working with other drive types.

The "Travel per motor revolution" (P83) is specified in increments.

Meaning: P83 = 2" when n = 4, 5, 6, ... 16

This corresponds to a resolution of 16 .... 65 536 increments per motor revolution.

P83 influences the resolution and also the max. travel distance:

the max. travel distance is limited to  $\pm 4$  million units. This corresponds to 61 revolutions at a maximum resolution of 65 536 increments per motor revolution. The maximum travel distance can be increased by reducing P83. Meaning:

P83	Maximum travel in motor revolutions
16	$\pm 250\ 000$
32	$\pm 125\ 000$
64	$\pm 62\ 500$
128	$\pm 31\ 250$
256	$\pm 15\ 625$
512	$\pm 7812$
1024	$\pm 3906$
2048	$\pm 1953$
4096	$\pm 976$
8192	$\pm 488$
16 384	$\pm 244$
32 768	$\pm 122$
65 536	$\pm 61$

In **continuous mode**, this limitation applies to a single command.  
In **normal mode**, this limit applies to the entire displacement area.

### Motor type

#### Parameter P100

The motor parameters are required for COMPAX motor-specific settings. The motor parameters of the HAUSER motors recommended for COMPAX are available in a list in ServoManager / ParameterEditor and can be selected from there.

You can configure additional motors using the "External motor" function.

### Basic conditions for external motors:

- Sine-commuted motors (sinusoidal EMC)
- Resolver / SinCos (see start-up manual under "Technical data" on Page 64).



The nominal currents of the motors and units must be adapted. If you are using nominal currents which are smaller in relation to the unit nominal current, current recording will be less accurate.

### Ramps

#### linear

#### Parameter P94

##### P94 = "1"

Simplest, time-oriented function; not smooth

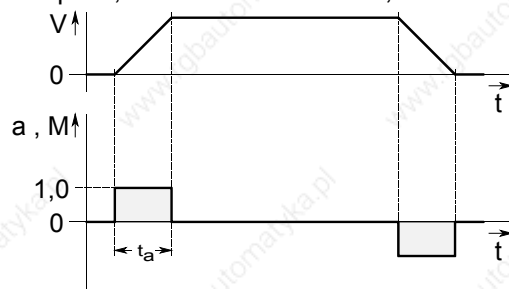

Current requirement: 1 times

## Configuration parameters

### smooth

#### P94="2"

The mechanics are subject to minimum load when using the smooth function.

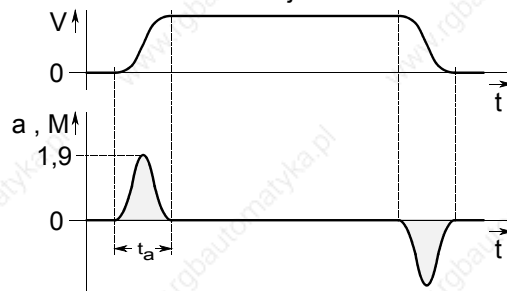

Current required: 1.9 times

### quadratic

#### P94="3"

Gentle running in to the nominal value; overshings are prevented.

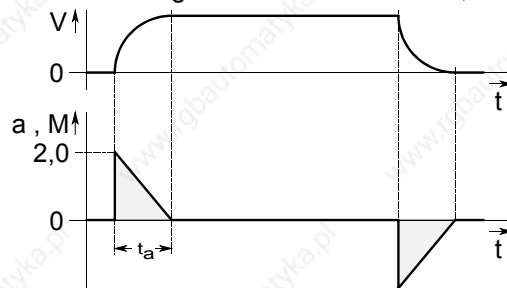

Current required: 2 times

**t<sub>a</sub>**: Ramp time (can be set using the command "ACCEL", see Page 97)

**v**: Speed:

**a**: Acceleration.

**M**: acceleration torque

### Transfer of P94

Modifications to P94 become effective from the next move command.

**Exception:** For the functions:

- stop after passing a limit switch and
  - synchronous stop via I13 (see Page 151).
- the ramp type only becomes valid with VC

## Drive type:

### Parameter P80: select drive type

Various data are required for additional configuration depending on the drive type selected. This modifies the assignment of the parameters P81 - P85. Continue configuration with the drive type selected.

## Spindle drive:

### P80=2:

<b>P81: length</b>	Length of spindle Range: 0 ... 5000mm
<b>P82: diameter</b>	Diameter of spindle Range: 8 ... 80mm
<b>P83: Pitch</b>	Pitch per spindle revolution. Range: 1 ... 400mm

**P85: ratio** Motor / spindle ratio.  
Range: 1 (1:1)...100 (100:1) ≡ motor: transmission

**P84: moment of inertia** Moment of inertia of transmission and clutch referenced to the drive side.  
Range: 0...200kgcm<sup>2</sup>

**P92: Minimum mass** Minimum translational mass moved [kg].  
Range: 0...P88

**P88: Maximum mass** Maximum translational mass moved in [kg].  
Range: 0...500kg

#### Rack+pinion/ toothed belts

**P80= "4" or "8"**

**P82: Number of teeth on pinion** Range: see tooth pitch

**P83: tooth pitch** Distance between two teeth  
The range of values for the number of teeth and tooth pitch is determined by the pitch. Meaning: pitch = number of teeth \* tooth pitch.  
Range of pitch values: 1 ... 410 mm

**P85: ratio** Ratio from motor to rack-and-pinion/toothed belt.  
Range: motor: transmission ≡ 1 (1:1)...100 (100:1)

**P84: moment of inertia** Moment of inertia of transmission and clutch referenced to motor shaft.  
Range: 0...200kgcm<sup>2</sup>

**P92: minimum mass** Minimum translational mass moved [kg]. Range: 0...P88

**P88: maximum mass** Maximum translational mass moved in [kg].  
Range: 0...500kg

**HLE / HPLA data for the drive type: "Toothed belt"**

	HLE80C	HLE100C	HLE150C	HPLA80	HPLA120	HPLAB180	HPLAR180 rack+pinion
Teeth on pinion (P82)	19	17	24	18	27	21	28
Tooth pitch (P83)	10mm	10mm	10mm	10mm	10mm	20mm	10mm

#### General drive

**P80=16:**

**P81: Minimum moment of inertia** Total minimum moment of inertia: motor, transmission and load referenced to the motor shaft.  
Range: 0...P82 [kgmm<sup>2</sup>]

**P82: maximum moment of inertia** Total maximum moment of inertia: motor, transmission and load referenced to the motor shaft.  
Range: P81...200 000kgmm<sup>2</sup>

**P83: travel per motor revolution** Range: 10 ... 4 000 000µm  
or 16 ... 65 536 increments.

### Reference system

#### Parameter P213: direction of machine zero

(this describes the default setting, for more information see Page 80)

#### Standard reference system: no end or reversing initiators; one machine zero initiator at the end of the displacement area

The machine zero initiator must be attached so that it can only be cleared in one direction; i.e. attached to one side.

Use parameter P213 to inform COMPAX of the side on which the MZ<sup>13</sup> (machine zero) initiator is attached.

**P213="0"**: The machine zero initiator is approached with the motor turning clockwise (when facing the motor shaft).

**P213="1"**: The machine zero initiator is approached with the motor turning anti-clockwise.

**Setting aid** Set P215="0":

Actuate Hand+; the drive moves in the direction of the MZ initiator, then the following applies: P213="0", if this is not the case, set P213="1".

➡ The following basic setting applies for this standard reference system (≡ no end or reversing initiators; one machine zero initiator at the end of the displacement area): P212="1", P217="0", P216="0". You will find other options for defining a reference system in the next chapter.

### Specifying software end limits

Specify the software end limits of the displacement area by using parameters P11 and P12. Each time a positioning command is issued, COMPAX checks whether the target is within the travel distance. If this is not the case, error E25 is reported.

➡ When working in continuous mode, these limits always apply for the current positioning process.

**P11: maximum position** Range: ±4 000 000 [units corresp. P90]

**P12: minimum position** Range: ±4 000 000 [units corresp. P90]

### Specifying point of real zero (RZ)

Absolute positioning commands refer to RZ. RZ is specified relative to machine zero.

➡ P1 must be set to 0 in continuous mode.

**P1: point of real zero** Range: ±4 000 000 [units corresp. P90]

### P215: direction of rotation

P215 establishes the positive direction of travel (positive end of displacement area) referenced to the motor direction of rotation.

**P215="0"** the motor is turning clockwise when traveling in the positive direction

**P215="1"** the motor is turning anti-clockwise when traveling in the positive direction

- Clockwise means when looking at the motor shaft.

**Setting aid:** Proceed with Hand+; the motor must move in the direction which is defined as being the positive direction. If this is not the case, then P215 must be modified.

➡ P215 has no influence on the setting of the machine zero direction (P213); if it has the same mechanical design.

<sup>13</sup> MZ: machine zero

## 8.2.6 Absolute value function with standard resolver

### Absolute value function without special sensor for up to 4096 rpm

#### Activated with P206=2

- Parameter P206=2 is used to activate the absolute value resolver.
- COMPAX reads the current actual position cyclically every 2ms and stores this data alternatively onto 2 memory stores (Pos 2, Pos 3) protected against power failure.
- The current imported position is shown in Status S12.
- After Power On, the last stored actual positions (Pos 2 and Pos 3) are read and compared with each other and the current read resolver angle (Pos 1).

A3 is set, when

- the last saved actual position (Pos 2) lies within a definable window (P161) around Pos 1,
- and when
- Pos 2 and Pos 3 are less than P161 from one another (to ensure that the drive stops when switched off).

Renewed referencing (find machine zero) is not required.

S12 is copied after Power On, enabling of the controller or after an error in S1.

If the last saved actual position (Pos 4) lies outside a definable window (P161), then A3 is not set, so a renewed referencing (find machine zero) is necessary.

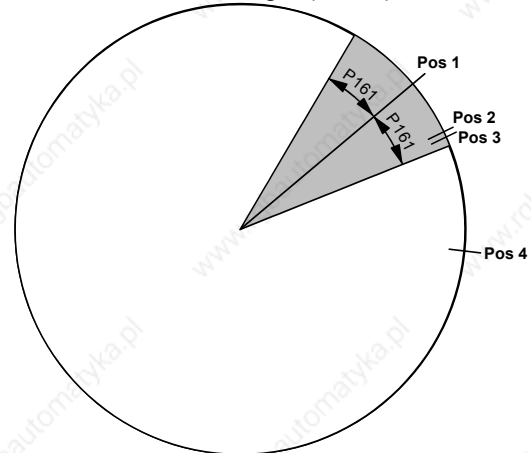

**Condition:** in the switched off status, the motor or mechanics must not be moved. Ensure this by using e.g. a motor brake or self-braking gearbox.

#### Maximum angle difference P161:

P161 gives the maximum permissible angle difference between the saved and the current actual position when switching on.

**Range:** 1 ... 2047; default value 100; where 4096 = 1 motor revolution.

If P161 is exceeded, then a new reference is necessary (find machine zero).

#### Note

- After error E42 (resolver/sensor error), referencing must always be implemented.
- The absolute value sensor function described above only functions with resolvers.
- The absolute value function with resolvers is not supported by COMPAX XX30.

#### Value range S12

The value range of the absolute value S12 lies between  $-2048$  and  $2047.9999$  (0 corresponds to the machine zero when  $P1=0$ ). In addition, a value sign conversion occurs (value jumps from the positive maximum value to the negative maximum value; or vice versa), whereby at the next comparison  $S12 \rightarrow S1$  an error of precisely 4096 occurs.

Use a real zero P1 to shift the value range (around  $-P1$ ).

Ex. 1:  $P1=-2000$  value range S12:  $-48 \dots 4047$  rpm.

With knowledge of this relationship, it is possible to create a positive travel area of maximum  $0 \dots 4096$  by the following actions:

- ◆ Travel to center of total travel area
- ◆ PH with  $P1=-2048$  and  $P212=10$
- ◆  $S1 = S12 = 2048$  at this point



Travel from POSA 0 ... POSA 4095.9999 possible without value sign conversion.

### 8.2.7 Machine zero mode

#### Overview:

#### P212: setting the machine zero mode

- = "0": MZ equals external initiator rounded with resolver zero & machine zero travel using 2 reversing initiators.
- = "1": MZ equals external initiator rounded with resolver zero.
- = "3": MZ equals external zero pulse\*
- = "4": MZ equals external initiator rounded with the external zero pulse.\*
- = "5": MZ equals resolver zero
- = "6": reserved
- = "7": MZ equals external initiator (without resolver zero).
- = "8": MZ equals a limit switch
- = "10": MZ teach
- = "11": Machine zero - initiator (without resolver zero) with 2 reversing initiators

P212 becomes valid immediately after a modification.

\* ⇨ P212=3 & P212=4 is only permitted for COMPAX XX00 and COMPAX XX30.

#### Function of the machine zero mode

**Machine zero equals external initiator & resolver zero / 2 reversing initiators.**

#### P212 = "0"

Start search direction / initiator side	Application
P213: defines the initiator flank of the machine zero initiator that is being evaluated; i.e. the side from which the initiator is approached.	Linear movements
P3: the prefix defines the start search direction.	
P215: influences the start search direction during find machine zero.	
P29: shifts the actual machine zero in the direction of the clockwise rotating motor.	
P216: sets the limit switch position (must also then be set if there are no configured limit switches (P217=0))	

#### Example of a reference system definition

- P215="0": the motor rotates clockwise when traveling in the positive direction; i.e. the positive end in the diagram is on the right-hand side.
- P212="0": operating mode with reversing initiators; i.e. with 3 initiators.
- P217="0": operating mode without end initiators. I1 and I2 act as reversing initiators during "Find machine zero".
- P216="0": the I1 initiator is started by the clockwise rotating motor.
- P3 = positive (when P3 = negative, reverses start search direction)

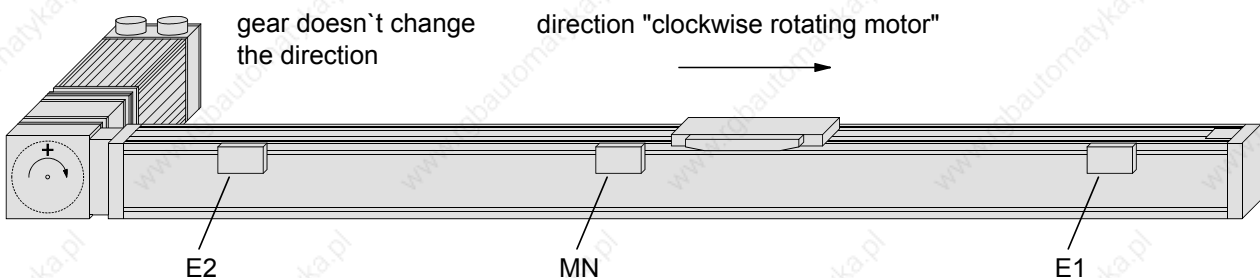



### Real zero

The position reference for positioning process is real zero; this can be freely defined over the entire displacement area. Real zero is defined with reference to machine zero.

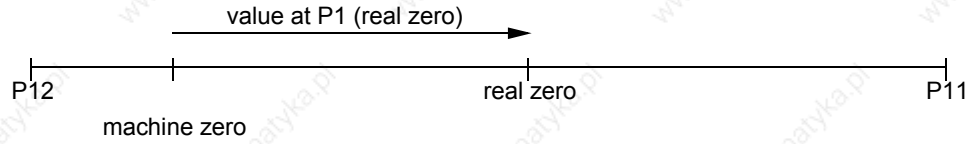

### Movement process during find machine zero, depends on start point:

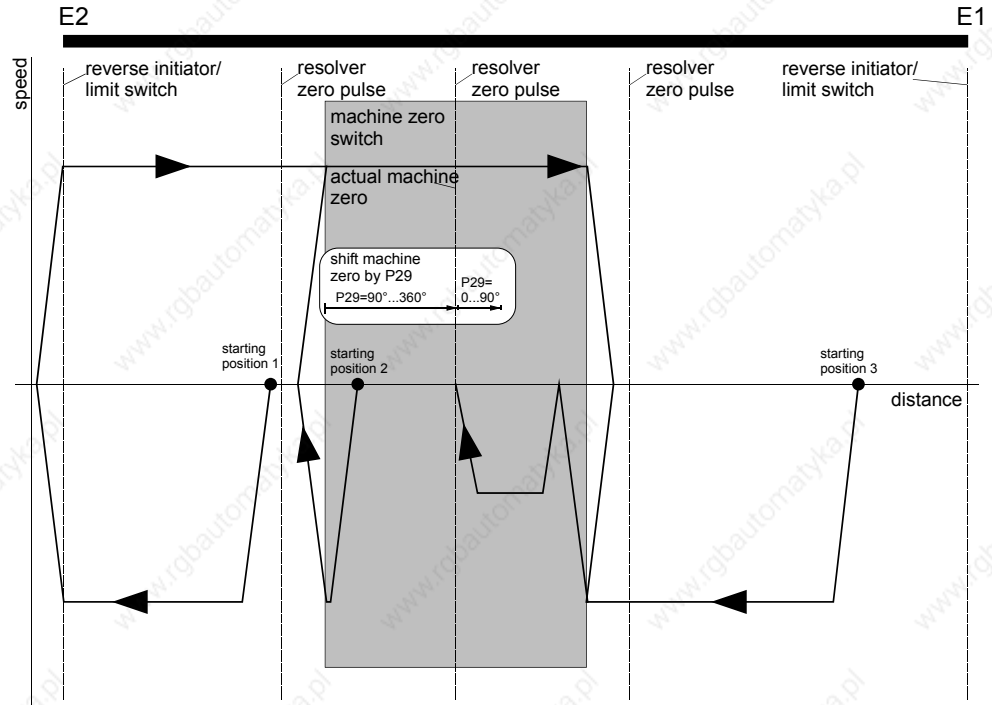

The speed used for find machine zero is specified by P3; the accelerating and braking time by P7.

### Additional machine zero modes

The machine zero modes described below are all used without reversing initiators. The search direction and the evaluated initiator side are influenced as follows with these machine zero modes:

P213: defines the start search direction and (if there is an initiator fitted) the initiator flank of the machine zero initiator which is being evaluated; i.e. the side from which the initiator is approached

P3: no influence in the start search direction during find machine zero.

P215: no influence on find machine zero.

P29: shifts the actual machine zero in the direction of the clockwise rotating motor (see below).

**Machine zero equals external initiator & resolver zero**

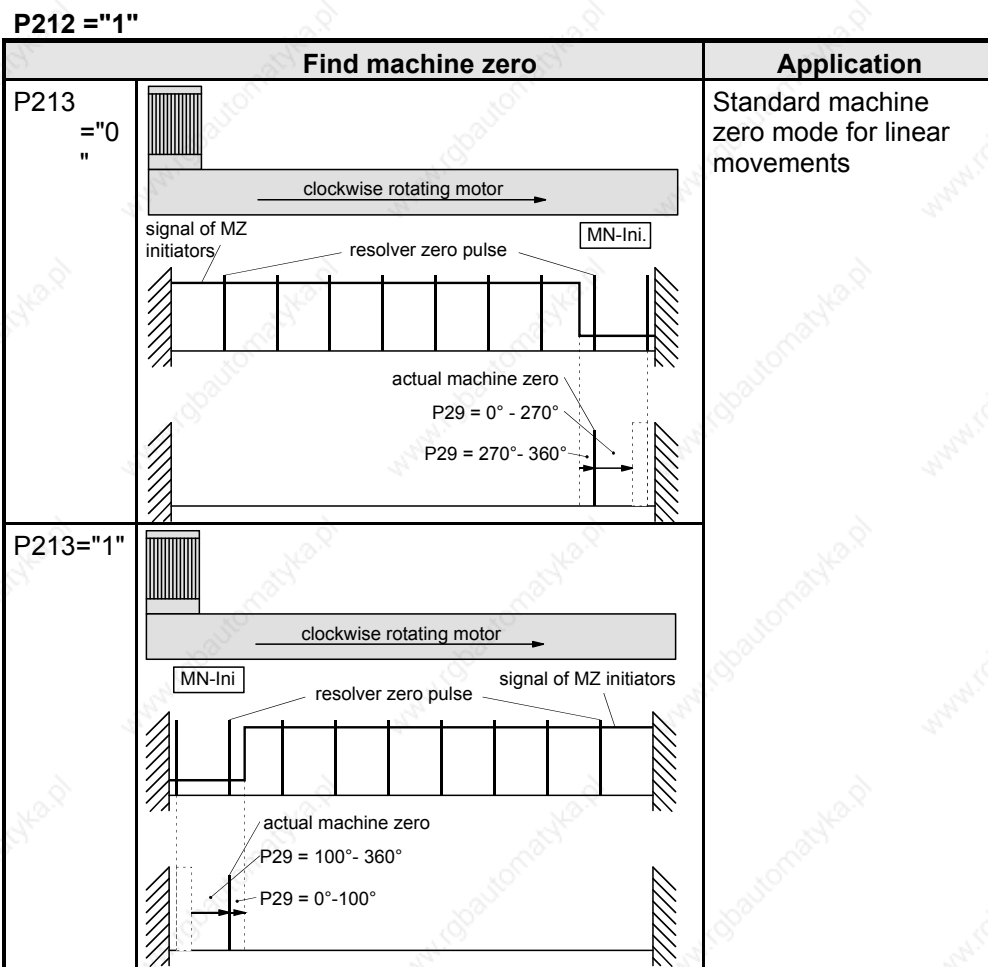

### Shifting machine zero

### Explanation for shifting machine zero using P29, taking the example of P212="1"

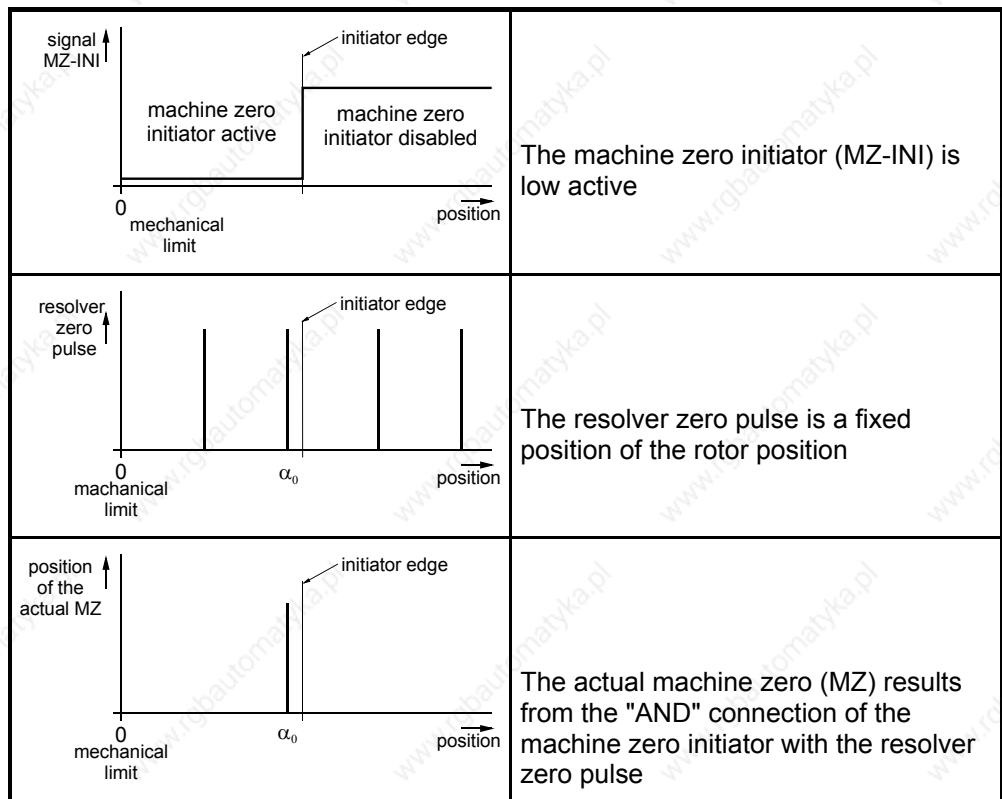

#### Example 1: $\alpha_0 = 90^\circ$ ; clockwise rotating motor in direction of mechanical limitation

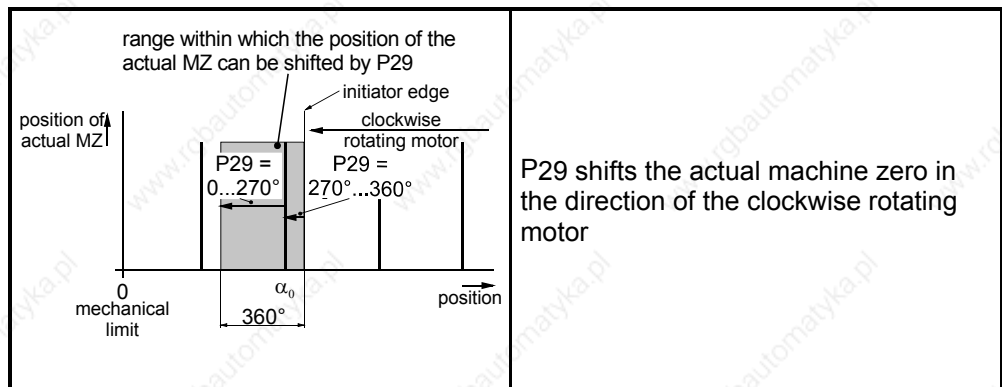

#### Example 2: $\alpha_0 = 90^\circ$ ; clockwise rotating motor away from the direction of the mechanical limitation travel

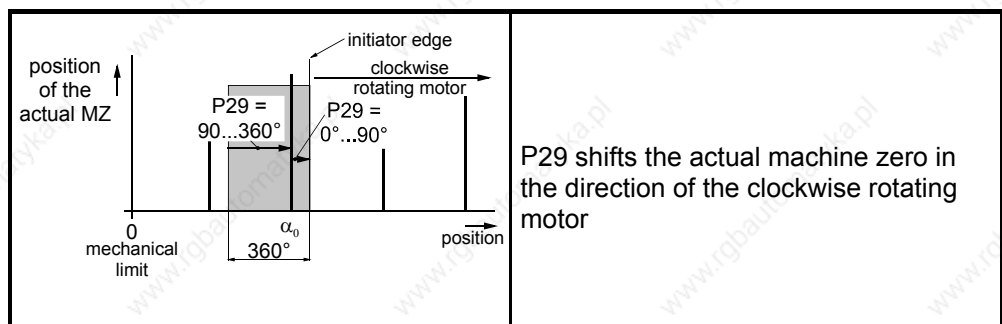

## Machine zero mode

**Machine zero equals external zero pulse**

**P212="3" (only permitted for COMPAX XX00 and COMPAX XX30!)**

Find machine zero			Application
P213="0"	<p>P29=0°</p>	<p>P29=90°</p>	General rotatory movements
P213="1"			

### Conditions for this operating mode:

- External encoder; read via an encoder input module (I2, I4)
- Encoder input parametrized by: P144="6"  
Specify P98 (travel per encoder revolution), P214 (encoder direction) and P143 (encoder pulse number).

**Machine zero equals external initiator & external zero pulse**

**P212="4" (only permitted for COMPAX XX00 and COMPAX XX30!)**

	Find machine zero.	Application
P213="0"	<p>clockwise rotating motor</p> <p>signal MZ-ini. encoder zero pulse MN-Ini</p> <p>position of the actual MZ</p> <p><math>P29 = 0^\circ - 360^\circ</math></p>	<p>Linear and rotatory movements.</p> <p>If you have an encoder on the load, with this setting you obtain a reproducible machine zero response to any transmission factor which does not round to whole digits (i.e. not precisely displayable).</p>
P213="1"	<p>clockwise rotating motor</p> <p>MN-Ini encoder zero pulse signal MZ-ini.</p> <p>position of the actual MZ</p> <p><math>P29 = 0^\circ - 360^\circ</math></p>	<p>Example of an transmission factor that cannot be displayed exactly:</p> <p><math>\frac{17 \text{ teeth}}{11 \text{ teeth}}</math></p>
<p><b>Note!</b> If <math>P75 \neq 0</math> for this setting, external position localization is switched on.</p>		

**Conditions for this operating mode:**

- External encoder; read via an encoder input module (E2, E4)
- Encoder input parametrized by: P144="6"  
Specify P98 (travel per encoder revolution), P214 (encoder direction) and P143 (encoder pulse number).

## Machine zero mode

**Machine zero equals resolver zero**

**P212 = "5"**

Find machine zero		Application
P213="0"	<p>P29=0°</p> <p>resolver zero pulse command "search MZ"</p>	<p>General rotatory movements.</p> <p>This is a simple method of implementing machine zero, especially if the transmission runs at high speeds.</p>
	<p>P29=90°</p> <p>resolver zero pulse command "search MZ"</p> <p>90°</p>	
P213="1"	<p>resolver zero pulse command "search MZ"</p> <p>resolver MZ pulse command "search MZ"</p>	
	<p>resolver MZ pulse command "search MZ"</p> <p>resolver MZ pulse command "search MZ"</p> <p>90°</p>	

**Machine zero equals external initiator (without resolver zero)**

**P212 = "7"**

Find machine zero		Application
P213="0"	<p>clockwise rotating motor</p> <p>signal of MZ-init.</p> <p>MN-Ini</p> <p>P29 = 0° - 360°</p> <p>0° 360°</p> <p>position of actual MZ</p>	<p>Linear and rotatory movements.</p> <p>If you have an encoder on the motor side, with this setting you obtain a reproducible machine zero response to any transmission factor which does not round to whole digits (i.e. not precisely displayable).</p> <p>Example of an transmission factor that cannot be displayed exactly:</p> <p>17 teeth 11 teeth</p> <p>Accuracy: depends on P3.</p> <p>Accuracy in motor revolutions:</p> $= \frac{1\text{ms} \cdot \frac{P3}{100} \cdot P104}{60 \cdot 1000}$
P213="1"	<p>clockwise rotating motor</p> <p>signal MZ-init.</p> <p>MN-Ini</p> <p>P29 = 0° - 360°</p> <p>0° 360°</p> <p>position of actual MZ</p>	

**Machine zero equals a limit switch**

**P212 = "8"**

	Find machine zero	Application
P213="0"		Linear movements. No need for a machine zero initiator.  <b>Function</b> Travels during "Find machine zero": <ul style="list-style-type: none"> <li>to the relevant limit switch.</li> <li>back to the 3rd resolver zero pulse.</li> </ul> The 3rd resolver zero pulse is evaluated as machine zero.
P213="1"		<b>Supplement</b> With P202, the distance between initiator and machine zero can be increased (e. g. for large gear ratios). Meaning: P202=0 or 3; function as described. With P202>3, the distance of the machine zero can be moved by further resolver zero pulses. P202 unit: Resolver zero pulses = motor revolutions

**Condition:**

P217 = "1"

P216 = set correctly.

In the above diagram: P216="1": (limit switch E1 is approached with anti-clockwise rotating motor)

**Wiring up:**

The input of the machine zero initiator (X17/7) must be wired up with the relevant limit switch:

P213="0": X17/8 must be connected to X17/7.

P213="1": X17/9 must be connected to X17/7.

**Teach machine zero**

P212="10": Teach machine zero

When activated via the command "Find machine zero" (Input I1&I2 or command "POSA Home"), the current position of the motor is defined as the machine zero.



A machine zero initiator is not required with this method.

Via parameter P29, machine zero can be moved from the taught point by up to one motor revolution. The drive then executes machine zero travel from the current position by the angle P29 in a clockwise direction.

Range of values for P29: 0...360 degrees (other values are considered as 0).



If P29=0, machine zero travel is not implemented.

## Machine zero mode

**Machine zero -  
initiator  
(without  
resolver zero)  
with 2 reversing  
initiators**

**P212="11": Machine zero - initiator (without resolver zero) with 2 reversing initiators**

Application: Applications with belt drives where the belts may skip during operation.



## 8.2.8 Limit switch operation

### P217 ="0" Operating mode without end initiators

### P217 ="1" Operating mode with two end initiators

2 initiators are required.

The displacement area is limited by the initiators attached at both ends of it. When one of the end initiators is activated, an error message appears, the drive is decelerated using P10; this does not apply to the "Find machine zero" function. Subsequently, the limit switches can be deactivated with Hand+ or Hand-.

When P212 = 0 (or = "2"), the initiators are used as reversing initiators during "Find machine zero".

In other machine zero modes, the initiators can be switched to end initiators by P217 via bit 0="1".

#### Limit switch monitoring during the reference travel

Bit 1<sup>14</sup> (P217) = 0: limit switches are not monitored during reference travel.  
 = 1: (P217= 3) limit switches are monitored during "Find machine zero" (when P212<>0 and P212<>2).

The operating mode bit 1 (P217)=1 assumes that 3 initiators are connected. Here it is not possible to use one of the two end initiators as a machine zero initiator. Regardless of the search direction P213, both limit switches are monitored.

#### Response when the limit switch is reached:

When one of the two limit switches is reached, COMPAX responds with an emergency stop. Then the following applies: move out of the danger zone using Hand+/-, then acknowledge. In such cases, the "MZ approached" output is not set.

#### Limit switch monitoring without locking the movement

Bit 2 (P217) = 0: function corresponding to Bit 0 and Bit 1.  
 = 1: (P217= 5) after activation of a limit switch, the drive is braked with P10 (standard), however travel movements are still possible afterwards using POSA and POSR.

The operating mode bit 1 (P217)=5 assumes that 3 initiators are connected. Here it is not possible to use one of the two end initiators as a machine zero initiator.

#### P216: specifying the limit switch position

Initiator I1 is assigned the direction of motor rotation using P216.

**P216: ="0": initiator I1 is approached with the clockwise rotating motor.**

**P216: ="1": initiator I1 is approached with the anti-clockwise rotating motor.**

➡ Clockwise rotation defined when looking at the motor shaft.

#### Setting aid:

Move to a limit switch using Hand+ (when P215="0"); an error message appears in the COMPAX display:

- error 50: I1 has been activated; i.e. P216="0"
- error 51: I2 has been activated; i.e. P216="1"

➡ This allocation only applies if P215="0"; if P215="1" the allocation is reversed.

When operating with the reversing initiators, but no limit switches, an error message will not appear. You then have two options:

<sup>14</sup> Bit-counting begins with Bit 0.

## Limit switch operation

---

- to set P216, switch on operation with limit switches (P216="1") or
- in status value S24, see bits 3 and 4 (from the left) to determine which initiator is activated. Meaning:  
Bit 3: I2 is activated, i.e. P216="1"  
Bit 4: I1 is activated, i.e. P216="0"

## 8.3 Configuration via PC using "ServoManager"

➡ There is a separate manual describing how to work with ServoManager.

### 8.3.1 Installing ServoManager

- Preparation** Before installation, deactivate the following programs:
- any virus detection software.
  - the Miro Pinboard in Miro graphic cards.
- Information concerning these programs.  
Following installation, the virus software can be reactivated.  
Problems may also occur during program execution with Miro Pinboard.
- Installation** Start the "Setup.exe" program on disk 1. The installation is a menu-guided process.  
Following the installation, a Windows program group will appear containing the ServoManager and the terminal.

### 8.3.2 Configuring COMPAX

- Create connection to COMPAX: cable SSK1 (see Page 59).
- Call up ServoManager.
- Create a new project (Menu: Project: New).
- Using the menu "Axis: Insert: From controller" to set up an axis which contains all COMPAX settings (all parameters: including system parameters and data records, curves are also available for COMPAX XX70).
- Use the menu "Servo-Tools: to switch to ParameterEditor.
- Call up menu "Configuration: Guided configuration".  
All configuration parameters are queried one after another.

### 8.3.3 Individual configuration of synchronous motors

In addition to the motors contained in ServoManager / ParameterEditor, you can configure almost all synchronous motors. The conditions required for the motors and resolvers are listed in the start-up manual under "Technical data".

To modify motor parameters, the motor must be switched off (use OUTPUT O0=1 or press the "-" button on the front plate while switching on COMPAX).

You will find the data required for this on the HAUSER motor type plate.

## Individual configuration of synchronous motors

### Motor type plate

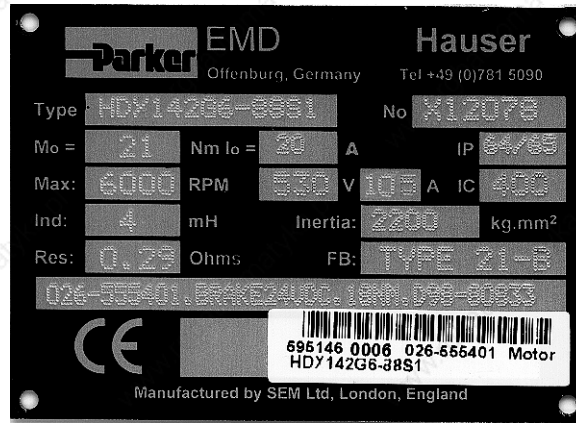

### Proceed as follows:

The following parameters can be read directly from the motor type plate :

- P101 number of motor terminals
- P102: EMC [V/1000 rpm]  
These two values are included in the motor type description (type).  
HDY xxx Ax-xxxS

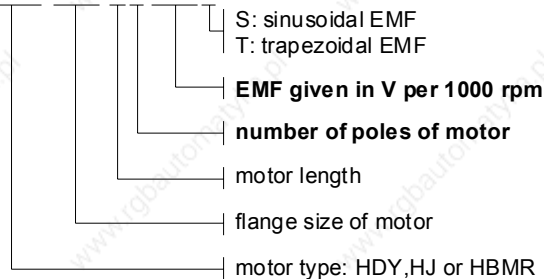

- P103: motor moment of inertia (inertia) [kgmm<sup>2</sup>]
- P109: stator inductivity (ind) [μH]
- P113: maximum mechanical speed (max)[rpm]
- P116: stator resistance (res) [Ω]
- P105: effective value of nominal current  $I_N$  [mA]  
HBMR motors:  $I_N = 0.95 * I_0$   
HDY motors:  $I_N = 0.85 * I_0$   
HBMR 55 and 70:  $I_N = 0.85 * I_0$
- P106: nominal torque MZ  
HBMR motors:  $M_N = 0.92 * M_0$   
HDY motors:  $M_N = 0.82 * M_0$   
HBMR 55 and 70:  $M_N = 0.82 * M_0$   
when  $I_0$  = idle current  
 $M_0$  = idle torque

The other parameters are derived from the type plate data

### Nominal motor speed for the HBMR motors

- P104: nominal motor speed [rpm]

EMC	$n_N$ [rmin <sup>-1</sup> ]	
	$U_{ZW}=300V$	$U_{ZW}=560V$
32	5000	
44	4000	5000
64	2600	5000
88		3500
130		2400
180		1700
260		1250
360		800

with  
EMC: counter EMC  
 $n_N$ : nominal speed  
 $U_{ZW}$ : intermediate circuit voltage  
300V: with 230V AC  
560V: with 3 \* 400V AC

#### Nominal motor speed for HDY motors:

- P104: nominal motor speed [rpm]

EMC	$n_N$ [min <sup>-1</sup> ]	
	$U_{ZW}=300V$	$U_{ZW}=560V$
32	5000	
44	4400	5000
64	2800	5000
88	2000	3800
130	1400	2500
180		1800

with  
 EMC: counter EMC  
 $n_N$ : nominal speed  
 $U_{ZW}$ : intermediate circuit voltage  
 300V: with 230V AC  
 560V: with 3 \* 400V AC

#### Parameter for saturation characteristic curve:

- P119 start of saturation [%]
- P120: end of saturation [%]
- P121: minimum stator inductivity [%]

	Flange size	P119	P120	P121
HBMR	<= 115 mm	100	280	40
	>= 142 mm	70	240	40
HDY/ HJ		100	400	100

Saturation is switched off when P119 = P121 = 100% and P120 = 400%.



If the saturation is unknown, use the HDY values.

#### The additional parameters in the motor table should only be modified under exceptional circumstances.

Default values of the HBMR and HDY motors:

Parameter	Standard	Meaning	Unit
P107	300	Pulse current	%
P108	3000	Pulse current time	ms
P129	0	Resolver offset	Degree
P130	"2"	Resolver frequency	
P131	"2"	Resolver amplification	
P132	"2"	Position sensor	
P133	65 536	Sensor dash count	Increments

#### Holding brake

#### For motors with holding brake.

Calculate the braking delay in P17 (for more information, see Page 123).

The parameters for Parker motors can be found in the motor catalogue (Art. No.190-060011)

#### Drive type

If you initially want to operate the motor without mechanics, select:

- P80=16: general drive.
- P81=P82=moment of inertia of the motor.
- P93=2: continuous mode.
- Call up the "Parameter: Guided parameter setting" menu.  
The remaining parameters are queried one after the other.
- Use menu "Online: Download" to transfer the data into COMPAX and validate the settings.



#### Caution!

Secure the displacement area of your system or the motor. When switching on, a risk may be posed by incorrect configuration data.

### Safety instructions for the first start-up

### Risks from incorrect wiring!

In order to avoid risks caused by incorrect system wiring during first start-up, use the following settings for personal safety and to protect the mechanics:

**P15 = 10% (motor speed limited to 10% nominal value)**

**P16 = 100% (torque limited to 100% of nominal torque)**

- The drive must remain at standstill after the system has been switched on.
- Execute a travel operation, e.g. with POSR x or manually +/-.

If this travel operation is executed correctly, reset P15 and P16 to their original values.

The following faults may occur:

- The drive does not remain at standstill once switched on, or
- the drive runs out of control after the start command.

In both cases, either error E10 or error E54 is triggered.

If error E54 occurs, the drive is switched off.

A possible cause of the error is incorrect wiring in the motor or resolver systems.

The servo controller will operate once error E55 is acknowledged on the front plate using "Enter".

If the controller is set to "OFF", it will be brought into operation by switching the 24V control voltage off and then on.

- Use menu "Online: Command" to transmit commands to COMPAX (e.g. POSR 100: the motor travels 100 units in the positive direction).

 **COMPAX is now configured.**

**For more information, please use the table of contents or the glossary at the end of the User Guide.**

### 8.4 Positioning and control functions

The COMPAX basic unit is designed to meet the technical control requirements of a servo axis. Special control commands are implemented in the different unit variants for synchronisation or gearing functions. The support of a superordinate control unit is required for more complex systems, especially for the co-ordination of several axes. Parker supplies solutions based on PCs and PLCs, as well as the compact industrial computer COMTAC as a multi-axis simultaneous control unit. Up to 250 sequentially numbered sets of commands can be stored in the COMPAX program memory. Program execution can be controlled via data interfaces or binary inputs/outputs. It is possible to select addresses (data record selection) using the interpretation of the adjoining binary input signals (external data record selection).

The command set structure has been deliberately kept simple and resembles the well-known programming language Basic. Program control instructions, comparator functions, setting/resetting of outputs and the motion-related commands for specifying velocity, position, acceleration time, etc. are also possible.

**Program example:**

```

N001: ACCEL 250      acceleration time 250 ms
N002: SPEED 80      velocity 80%
N003: REPEAT 10     specified wait loop 1s
N004:               IF I7=1 GOTO 9   query I7 to log. 1
N005:               WAIT 100        waiting time 100 ms
N006: END           end REPEAT loop
N007: OUTPUT O7=1   sets output; no positioning
N008: GOTO 13
N009: POSA 1250     positioning
N010: OUTPUT O8=1   sets O8 for 500 ms
N011: WAIT 500
N012: OUTPUT O8=0
N013: END
    
```

The range of commands used with the compact COMPAX servo control unit is deliberately different in terms of type and range to the standardized NC programming standards as described in DIN 66024 and DIN 66025. COMPAX is not designed with the control and calculation capability of a complete CNC controller, even though it can perform many CNC functions.

All commands are processed in sequence (sequential step programming). The program can be interrupted or suspended using a break or stop signal. The axis is then decelerated using the preset time delay. The program can then be continued from another point.

**Start program**

Once "Power on" is in place, the data record indicator is at 1. If the program is to started at another point, the data record indicator can be adjusted using the command "GOTO xxx" (The direct command is only recognized by COMPAX if A4 "Ready for start" = "1").

Using the "START" command (via the digital Input I5 or using the direct "START" command via an interface), you can start the program from the selected data record number.

➡ The data record indicator is set to 001 using the "Find machine zero" or "Approach real zero".  
 This function can be set to binary inputs using parameter P211.

### 8.4.1 Absolute positioning [POSA]

#### POSA

#### Reference point is real zero (RZ).

Positioning is executed with the acceleration speed set using ACCEL and the velocity set using SPEED. If these values have not previously been set, substitute values will apply:

SPEED: parameter P2; ACCEL: parameter P6 (see Page 212)

#### Syntax: POSA value

Value: figure with two digits after the decimal point (three for inches) in the unit defined in P90; a control parameter (P40..P49) or a variable (V1..V39)  
e.g. POSA .P40

The range is defined by the software end limits P11 and P12.

**Example:** N005: POSA 150.50 Absolute positioning to +150.5 units  
N006: POSA -500 Absolute positioning to -500 units

#### Additional function:

- A position approached manually can be transferred as a POSA command into a previously selected data record using "TEACH data record" (via an interface).
- POSA HOME command via interface triggers "find machine zero".  
POSA HOME is not permitted in the COMPAX – program.

➡ When in continuous mode, relative positioning is also adopted with POSA.

### 8.4.2 Relative positioning [POSR]

#### POSR

#### The reference point is the current position.

#### Syntax: POSR value

Value: two digits after the decimal point (three for inches) in the unit defined in P90; a control parameter (P40..P49) or a variable (V1..V39)  
e.g. POSR .P40

The range is defined by the software end limits P11 and P12.

**Example:** N005: POSR 2000 Relative positioning by +2000  
N006: POSR-100.25 Relative positioning by -100.25

➡ The positioning commands POSR and POSA can be controlled using binary input I15 "Fast start". This function is switched on using P18. COMPAX then waits until I15="1" before it executes POSR or POSA (see Page 151).



### 8.4.3 Process velocity [SPEED]

#### SPEED

#### Process velocity as % of nominal velocity

(Nominal velocity = nominal speed \* travel per motor rotation).

- valid until a new value is programmed.

When in **speed control mode**, direction of rotation is specified by the prefix.

**Syntax:** **SPEED value**

Value: 0.0000001...100%<sup>15</sup>, a control parameter (P40..P49) or a variable (V1..V39) e.g. SPEED .P40

Smallest steps = 0.002384min<sup>-1</sup>

**Example:** N005: SPEED 70 sets velocity to 70% of nominal speed.

➡ The set velocity can be reduced using the analogue override input (X11.6) (see start-up manual).

### 8.4.4 Acceleration and braking time [ACCEL]

#### ACCEL ACCEL-

#### Specification for acceleration and braking time .

- without prefix: time specification for acceleration and deceleration process.
- negative prefix: separate time specification for deceleration process.
- valid until a new value is programmed.
- Acceleration process can be specified using parameter P94 (see Page 75).
- 

**Note:** If a travel command is interrupted by STOP or BREAK, the STOP / BREAK – ramp is not executed by ACCEL- but by the value defined as the acceleration time.

**Syntax:** **ACCEL value**

Value: 10...65 000 ms, a control parameter (P40..P49) or a variable (V1..V39) e.g. ACCEL .P40 (timescale = 10 ms)

The negative prefix for the deceleration time specification must be set before the control parameters e.g.: ACCEL- .P40 (P40 > 0)

➡ The time specified in ms applies for nominal velocity (100%). The actual time is proportional to the velocity selected.

$$\text{Meaning: } t_a = \frac{\text{SPEED}}{100\%} \text{ ACCEL}$$

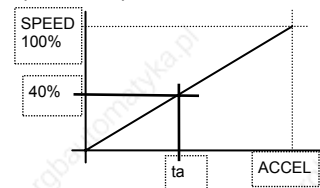

**Example:** N005: ACCEL 300 sets the acceleration and deceleration ramp to 300 ms  
 N006: ACCEL -200 sets the deceleration ramp to 200 (≙200 ms when SPEED=100%)

<sup>15</sup> For asynchronous motors, up to a max. of 300%.

### 8.4.5 Setting/resetting output [OUTPUT]

#### OUTPUT

**Syntax:** OUTPUT output = 1/0  
Output O1<sup>16</sup>...O16

**Example:** N005: OUTPUT O8=1 Sets output 8  
N005: OUTPUT O8=0 Resets output 8

### 8.4.6 Setting multiple digital outputs [OUTPUT O12=1010]

#### OUTPUT O12=1010

Multiple outputs can be set simultaneously.

**Syntax:** OUTPUT O12=1010  
OUTPUT O10=O1--O11 ("-"<sup>17</sup> = is not modified)  
O10="0"; O11="1"; O12, O13 are not changed; O14="0"; O15=O16="1".  
(this is valid for max. 8 outputs)

- Note**
- A maximum of 8 outputs can be processed per OUTPUT command.
  - The comparator command "POSR .... OUTPUT ...." is still limited to setting one output.

### 8.4.7 Switch off drive unit. [OUTPUT O0]

#### OUTPUT O0

**Syntax:** OUTPUT O0 = number  
Number: 0/3: drive subject to torque when brake is open.  
1: Drive 9 switched off when brake is closed.  
2: Drive switched off when brake is open.

The time behaviour of the final stage and brake can be configured; see Page 123.

Note: The command can only be set within a program **with COMPAX XX00 and COMPAX XX60!** (see below!)

**Example:** OUTPUT O0=1 Drive switched off when brake closed.

### 8.4.8 OUTPUT O0=... in program

**Limitation:** The command OUTPUT O0=0,1,2 can only be programmed **on the COMPAX XX00 and COMPAX XX60** in the program.  
No error monitoring is executed during switched off status except for emergency stop (E55/E56).

<sup>16</sup> O1...O6 only if masked via P225.

<sup>17</sup> Instead of "-", "." is also an option

This means that all errors which can be acknowledged (e.g. lag errors or resolver errors), which occur during the switched off status (e.g. by separating the resolver line) are ignored.  
Only errors still present after Power On are displayed.

### 8.4.9 Password [GOTO]

#### GOTO

**Syntax:** **GOTO number**  
 Number = "302": Deactivates password protection  
 = "270": Activates password protection  
**Note:** You can also use this command in the data record memory.

**Example:** GOTO 302 Enables programming levels and parameters.

### 8.4.10 External velocity specification. [SPEED SYNC]

#### SPEED SYNC

Entry at BDF2: **SPEED Ent**

**COMPAX synchronizes itself to an external velocity specification.**

**Note:** function only applies to COMPAX XX00 with options E2, E4 or E7!  
**SPEED SYNC cannot be used at the same as the external position adjustment (switched on via P75 ≠ 0)!**

Instead of specifying velocity using the SPEED command, the process command velocity is read externally from the encoder interface when you use SPEED SYNC.

**Setting condition:** P144="4" and P188="0"

**Setting aid:** the speed of the motor and sensor is the same when using P98=P83 and the correctly set parameter P143 (pulse speed sensor).

- No travel synchronization; use our "Electronic transmission" or "Electronical curve control" unit variant for this purpose.

#### External speed set via option E7

Meaning: 10V = 100% of  $n_{Nominal}$  (P104)  
 P93=1 or 2  
 P80=16 (general drive)  
 P83= distance per motor revolution [ $\mu\text{m}$ ]  
 P90=1 [mm]  
 P144=7 (analogue rpm specification)

Calculation of P98:

$$P98 = \frac{P83 \cdot P104 \cdot P143}{1000 \cdot 60 \cdot 1000000}$$

with: P143=1 000 000  
 P104 in [1/min]

Accuracy data can be found on Page 186

### 8.4.11 Mark-related positioning [POSR]

#### POSR

Use this command to position e.g. a mark relative to an external signal.

**Syntax: POSR value**

**Value:** two digits after the decimal point (three for inches) in unit corresp. to P90; a control parameter (P40..P49) or a variable (V1..V39)  
e.g. POSR .P40.

The prefix determines the direction in which the mark is approached.

**Note!**

POSR 0 is not permitted!

**Note:**  **When the mark reference is activated, do not use the POSA command!**

<b>I14:</b>	<b>Activating mark reference .</b> I14 must be present before the command.
<b>I16:</b>	<b>Mark input</b> The rising flank is evaluated (pulse > 0.6ms).
<b>O16:</b>	With "0", the mark is missing after travel to the mark is completed (P38).
<b>P35:</b>	= "1": Mark reference switched on; = "0": Mark reference switched off.
<b>P37,P38:</b>	A mark window is specified relative to the start position using P37 and P38.
<b>P37:</b>	Minimum travel to mark. (relative to start position).
	Range of values for P37: <b>0.00 ... P38</b>
<b>P38:</b>	Maximum travel to mark. (relative to start position).
	Range of values for P38: <b>P37 ... 4 000 000</b>
<b>P39:</b>	Maximum feed length, if there is no mark in the mark window (relative to start position).
	Range of values for P39: <b>P38 ... P11 or P12</b>

**Example:** POSR 100 P35="1"; P37=+300; P38=+600; P39=+800; I14="1".

If the mark is between +300 and +600, mark +100 is positioned, if the mark is outside the window it is positioned to 800.

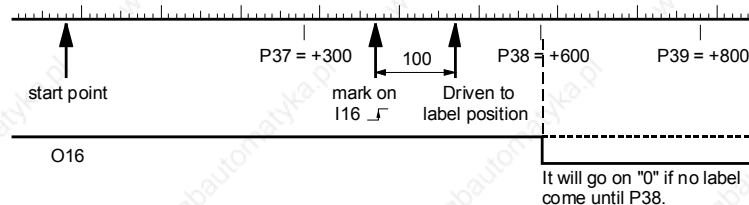

**Note!**

The drive positioning is not limited by P39.

If the mark is within the mark window, COMPAX executes positioning using the POSR value for a value of the corresponding size, even after P39.

The process range can be limited using P11 and P12.

 When the mark reference is switched on, the inputs I14, I15, and I16 are no longer available for external data record selection (GOTOEXT, GOSUBEXT).

### 8.4.12 Preparatory instructions

The following command combinations are preparatory instructions for creating speed step profiles or setting comparator switch points. The prepared positioning process is started using POSA or POSR. Note the following:

- Combined commands can be mixed (POSR SPEED, POSR OUTPUT).
- A total of 8 combined commands can be programmed per positioning process.
- The positioning values of the command combinations are always positive and refer to the start point of the positioning process. They represent differences in travel. The direction is specified by the next positioning command. This can be relative (POSR) or absolute (POSA). Meaning:
- The positioning values for speed steps, ramp times or comparators always apply from the point at which positioning starts (for POSA and POSR)
- The positioning values for speed steps, ramp times or comparators are numerical values:
  - If the following positioning is positive, COMPAX calculates them as positive values.
  - If the following positioning is negative, COMPAX calculates them as negative values.
- If a process cycle has been interrupted by "Stop", continue the cycle using "Start".
- The preparatory instructions are canceled by the "Hand+/-", "Find machine zero" and "Approach real zero" commands.

### 8.4.13 Changes in speed within a positioning process [POSR SPEED]

#### POSR SPEED

Each speed step profile can have a maximum of 8 speed steps. The comparator value is specified as a relative dimension. It is referenced to the positioning start point.

**Syntax:** POSR value 1 SPEED value 2

Value 1: only positive values permitted (unit corresponds to P90); two digits after the decimal point (three for inches), a control parameter (P40..P49) or a variable V1 ... V39.

Value 2: no digits after the decimal point; numerical value, a control parameter (P40..P49) or a variable V1 ... V39.  
e.g.: POSR .P40 SPEED .P41

<b>Example:</b>	N001: ACCEL 250	Acceleration and braking time = 250 ms
	N002: SPEED 20	Starting velocity = 20%
	N003: POSR 150 SPEED 30	1st speed step when starting position $\pm 150$ , sets velocity to 30%.
	N004: POSR 300 SPEED 50	2st speed step when starting position $\pm 300$ , sets velocity to 50%.
	N005: POSR 500 SPEED 80	3st speed step when starting position $\pm 500$ , sets velocity to 80%.
	N006: POSR 900 SPEED 60	4st speed step when starting position $\pm 900$ , sets velocity to 60%.
	N007: POSA -1000	Positioning command to position -1000 (position -1000 is approached with all of or one part of the speed step profile depending on the start point).
	N008: POSR 200 SPEED 50	Prepares a new speed step profile.
	N009: ...	

## Changes in speed within a positioning process [POSR SPEED]

### Speed step profile extended by ramp time

#### Compatibility:

Speed step profiling is still possible in the previous version with no restrictions.

#### Function:

- In addition to the new velocity, the acceleration time can be defined for the speed step profile. This becomes effective at the transition to the defined velocity and remains valid until a new acceleration time is defined.
- The braking time is assigned within the speed step profile, not by using ACCEL-, but defined by the velocity change.
- The deceleration ramp for the target position is defined by the previously set ramp (braking time applicable before the speed step profile).

#### POSR x SPEED y ACCEL z

Abbreviation: PR x SD y AL z

x, y, z: number, parameter .P40 (P40-P49) or variable .V1 (V1-V39)

#### Example:

PR .P40 SD .V31 AL 200

#### Note:

- The last ramp time selected using a prepared command from ACCEL remains valid for future positioning processes.
- The situation with SPEED is same.
- A braking time previously defined with ACCEL- remains unaffected.

#### Example:

ACCEL 1000  
ACCEL -2000  
SPEED 25  
POSR x SPEED 100 ACCEL 300  
POSR y SPEED 10 ACCEL 100  
POSA z  
POSA 0

Generally valid acceleration time  
Generally valid braking time  
Generally valid velocity  
1st speed step at position x  
2nd speed step at position y  
Start positioning to z  
Return with SD 10, AL100 and AL-2000

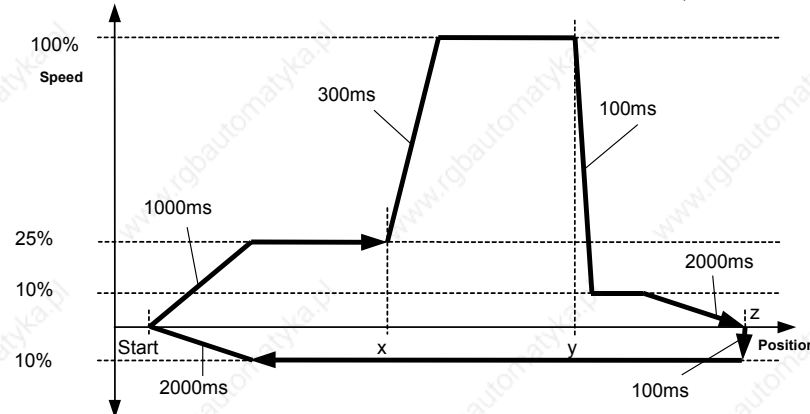

- 1 Position x is reached at 25% velocity and 1000ms acceleration time.
- 2 Position y is reached at 100% velocity and 300ms acceleration time.
- 3 Position z is reached at 10% velocity and 100ms acceleration time.
- 4 To stop at position z, a braking ramp of 2000ms is used for early deceleration.
5. After the command POSA 0, the drive returns to the starting point (= position 0). The drive accelerates for the last set 100 ms to the last set velocity of 10% and returns to position 0. The braking time of 2000 ms set before the speed step profile is used as the braking ramp.

## 8.4.14 Comparators during positioning [POSR OUTPUT]

### POSR OUTPUT

#### Setting and resetting freely assignable outputs within a positioning process.

A maximum of 8 comparators can be set in one positioning process. The comparator value is specified as a relative dimension. It is referenced to the positioning start point.

**Syntax:** POSR value OUTPUT output = 1/0

**Value:** only positives value are permitted (unit corresponds to P90); two digits after the decimal points (three for inches) a control parameter (P40..P49) or a variable (V1..V39)  
e.g. POSR .P40 OUTPUT A7=1.

<b>Examples:</b>	N001: ACCEL 250	Acceleration and braking time = 250 ms
	N002: SPEED 50	Starting velocity = 50%
	N003: POSR 150 OUTPUT A8=1	1st comparator at start position 150, sets output O8 to 1.
	N004: POSR 300 OUTPUT A7=1	2nd comparator at start position 300, sets output O7 to 1.
	N005: POSR 500 OUTPUT O7=0	3rd comparator at start position 500, sets output O7 to 0.
	N006: POSR 900 OUTPUT O8=0	4th comparator at start position ±900, sets output O8 to 0.
	N007: POSA 1000	Positioning command to 1000 (Position +1000 is approached; the travel-dependent comparators are set once the relative positions have been reached).
	N008: POSR 200 OUTPUT O7=1	Prepares new comparators.

➡ Outputs O1 to O6 can also be used as comparators once enabled via P225 (see Page 139).

#### Diagram of specified example for POSR OUTPUT

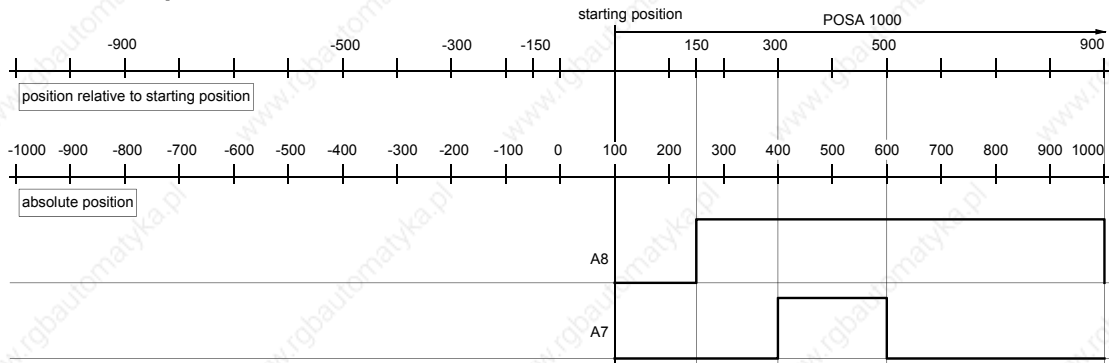

#### Diagram of example using POSA -1000 as positioning

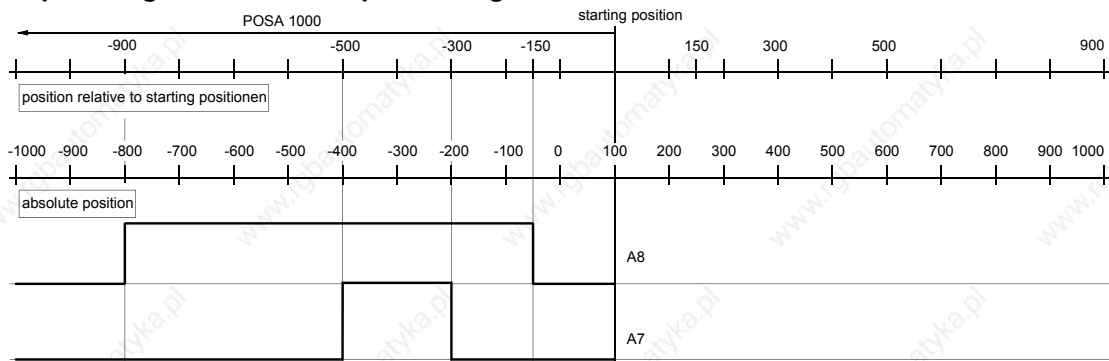

### 8.4.15 Cam controller with compensation for switching delays

With the function "Cam controller", you can switch 4 actuators (switch elements) dependent on position.

#### Function of the cam controller:

- The switching positions are fixed positions within the positioning range.
- The reference value for the switching positions can be selected from:
  - the position actual value (S1) or
  - the position set point or
  - the absolute value (S12)
- The switching delay of the actuators is compensated for dependent on the speed.

#### Outputs of the cam controller

Outputs O9 ... O12

#### Parametrization of the cam controller

Parametrization occurs via variables in the range V50 ... V70.

No.:	Contents	Unit	min	stand ard	max	valid from
V50	Operation mode cam controller 0: <b>inactive</b> 1: <b>position actual value</b> (without consideration of P1 and P215) 2: <b>position set point</b> (without consideration of P1 and P215) 3: <b>reserved</b> 4: <b>S1 (position actual value)</b> Number range: +/- 4 mill. units (P90) 5: <b>position set point</b> Number range: +/- 4 mill. units (P90) 6: <b>absolute value (S12)</b> Number range: +/- 2048 units (P90)		0	0		VP
V51	Polarity O9...O12 Valence Bit 9: Polarity O9 256 Bit 10: Polarity O10 512 Bit 11: Polarity O11 1024 Bit 12: Polarity O12 2048 If the corresponding bit is set, then the relevant output is inverted.		0	0	3840	VP
V52	reserved					VP
V53	reserved					VP
V54	reserved					VP
V55	Position control cam 1 (O9) on*	P90	-4 000 000	0.00	+4 000 000	VP
V56	Switch-on lag control cam 1	ms	0	0	1000	VP
V57	Position control cam 1 (O9) off*	P90	-4 000 000	0.00	+4 000 000	VP
V58	Switch-off lag control cam 1	ms	0	0	1000	VP
V59	Position control cam 2 (O10) on*	P90	-4 000 000	0.00	+4 000 000	VP
V60	Switch-on lag control cam 2	ms	0	0	1000	VP
V61	Position control cam 2 (O10) off*	P90	-4 000 000	0.00	+4 000 000	VP
V62	Switch-off lag control cam 2	ms	0	0	1000	VP
V63	Position control cam 3 (O11) on*	P90	-4 000 000	0.00	+4 000 000	VP
V64	Switch-on lag control cam 3	ms	0	0	1000	VP
V65	Position control cam 3 (O11) off*	P90	-4 000 000	0.00	+4 000 000	VP
V66	Switch-off lag control cam 3	ms	0	0	1000	VP
V67	Position control cam 4 (O12) on*	P90	-4 000 000	0.00	+4 000 000	VP
V68	Switch-on lag control cam 4	ms	0	0	1000	VP
V69	Position control cam 4 (O12) off*	P90	-4 000 000	0.00	+4 000 000	VP
V70	Switch-off lag control cam 4	ms	0	0	1000	VP

\* The switching processes described apply for increasing setpoint and P215=0; with decreasing setpoint switch off occurs at the same position where switch on previously occurred.



The variables for parametrization of the cam controller are not password protected!



**Note!** With the instruction V0=x (global instruction to all variables), variables V50 ... V70 will also be changed!

#### Example 1: Normal positioning

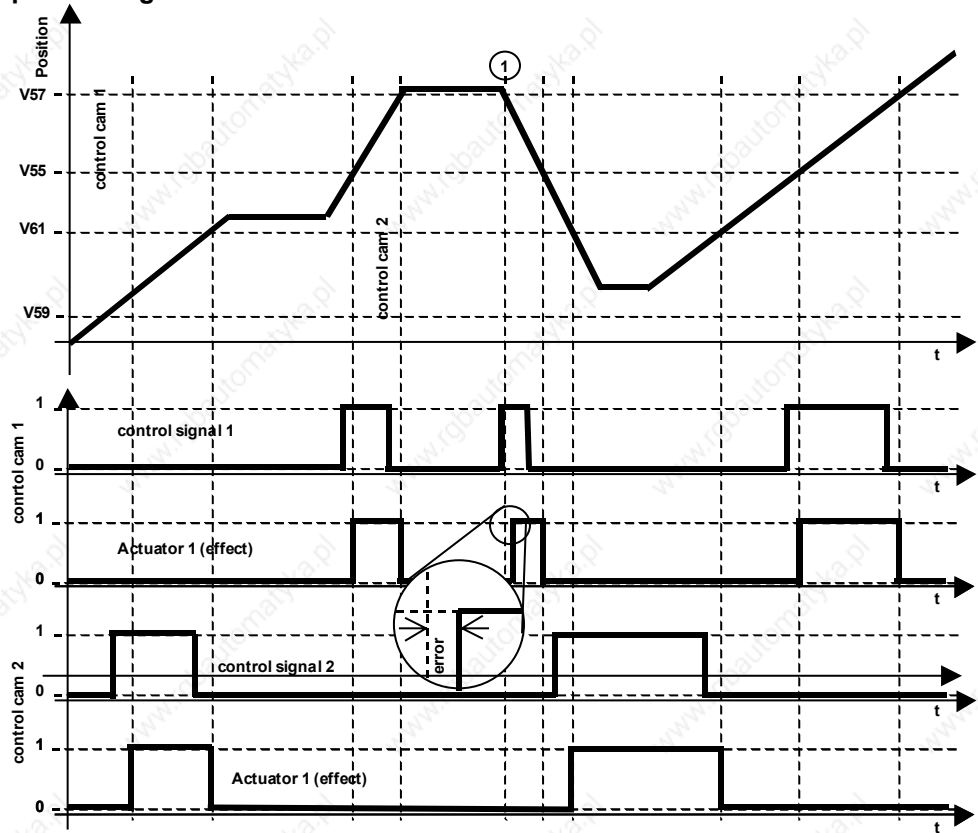

#### Explanation regarding cam controller

COMPAX calculates a travel difference from the lag times of the switch elements ( $\Delta p_{on}$  and  $\Delta p_{off}$ ). A constant speed is assumed.

The switching signal is (with increasing setpoint) activated by  $\Delta p_{on}$  before the control cam position for On and deactivated again by  $\Delta p_{off}$  before the control cam position for Off.

#### Requirements for safe and time correct switching of the cam controller:

The cam positions, as well as the range  $\Delta p$  before the cam position must be moved through at constant speed.

#### Problem point:

In Example 1, point ①, the idle position is located just above V57, so that the control cam 1 cannot be activated too early. This means that the switch-on lag of the actuator cannot be compensated. This causes a switching error.

In this case, COMPAX activates the control cam output immediately after the relevant positioning command is received.

### Behaviour during negative position values, falling position and P215=0

- POSA
- POSR
- SPEED
- ACCEL
- OUTPUT
- Password
- SPEED SYNC
- Mark reference
- POSR
- SPEED
- POSR
- OUTPUT
- Cam controller**
- WAIT**
- GOTO**
- GOSUB**
- RETURN**
- END
- REPEAT
- IF I..
- Comparison
- WAIT Start
- GOTO / GOSUB EXT
- IF Error/ Stop
- Arithmetic
- Position monitoring
- Idle display
- Speed monitoring
- Engage / disengage brake / final stage
- Variable voltage

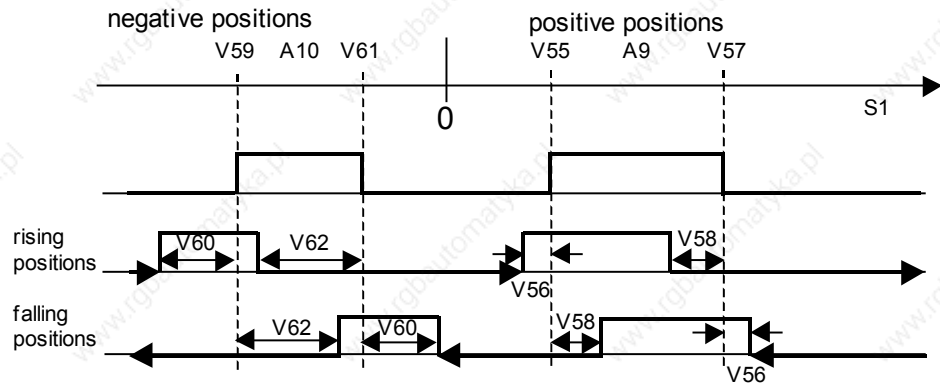

The relevant distances  $\Delta p$  resulting from the times are shown.

### Example 2: Positioning with subsequent cam operation (COMPAX XX70)

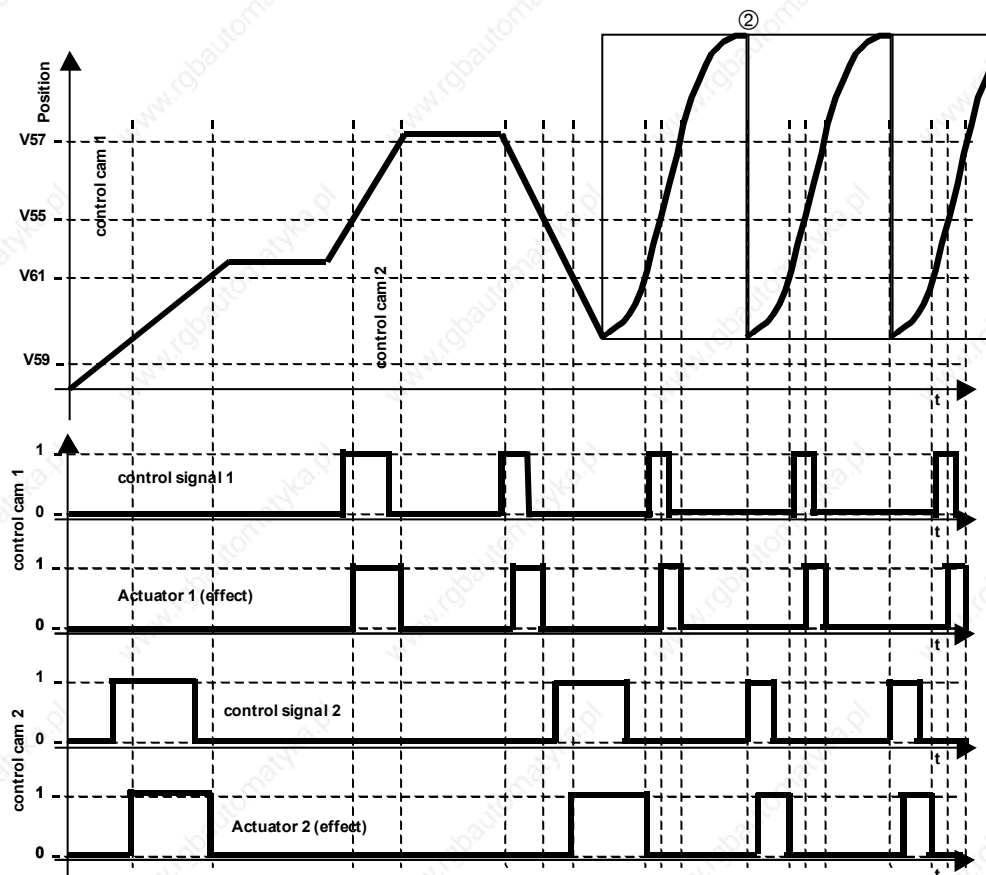

**Explanation:** At position ② (reset function to next curve) no compensation is implemented for the switching delay.

**Note:** The cam controller is calculated using a cycle of 1ms.

### 8.4.16 Programmable waiting time [WAIT]

#### WAIT

Programmable waiting time in ms before the next data record is processed.

**Syntax:** WAIT value Value: 10...65 000 [ms] a control parameter (P40..P49) or a variable (V1..V39)  
e.g. WAIT .P40 (time pattern 10 ms)

**Example:** N005: WAIT 500 Sets the waiting time to 500 ms before the next data record is processed.

### 8.4.17 Program jump [GOTO]

#### GOTO

Program jump to specified data record number.

**Syntax:** GOTO data record number  
Data record number: 1...250

**Example:** N045: GOTO 60 Jumps to data record N060

### 8.4.18 Sub-program jump [GOSUB]

#### GOSUB

Jump to a sub-program .

**Syntax:** GOSUB data record number  
Data record number: 1...250

**Example:** N005: GOSUB 100 Calls up sub-program  
N100: ... Starts sub-program  
N101: ...  
...  
Nxxx: RETURN Ends sub-program, jumps back to N006

**Note:**  Never use GOTO to jump out of a sub-program or to a sub-program.

### 8.4.19 Instruction to end a sub-program. [RETURN]

#### RETURN

This executes a return jump to the main program.

**Syntax:** RETURN

### 8.4.20 END instruction [END]

#### END

END instruction for a REPEAT loop or for the program.  
To end a program, you implement a program stop. The data record indicator is not modified.

**Syntax:** END

Start a program loop [REPEAT]

## 8.4.21 Start a program loop [REPEAT]

### REPEAT

The following program sequence is run through the number of times specified until an END instruction appears.

**Syntax:** REPEAT value  
Value: 1...65 000 a control parameter (P40..P49) or a variable (V1..V39)  
e.g. REPEAT .P40

**Example:** N005: REPEAT 10 Starts a program loop, which is run through 10 times  
N006: ...  
N007: END End of loop

 A loop can be prematurely exited using GOTO.

## 8.4.22 Branching [IF I7=1]

### IF I7=1

Branching related to a control input

**Syntax:** IF control input=1/0 GOTO/GOSUB data record number  
Control input: I1<sup>18</sup> ...I16

**Examples:** IF I7=1 GOTO 010 If I7 = "1", a jump is made to data record N010  
IF I7=0 GOSUB 010 If I7 = "0", a jump is made to the sub-program in data record N010

## 8.4.23 Binary IF query of inputs [IF I12=101-1]

### IF I12=101-1

Multiple inputs can be queried simultaneously.

The inputs are compared with a mask. The mask contains individual bits 1 or 0, and a space marker (-)<sup>19</sup> for "not taken into consideration".

**Syntax:** IF I12=101-1 GOTO 123  
-> I12 = 1, I13=0, I14=1, I15= "not considered", I16 = 1.  
Binary IF querying of status values or outputs is not possible.

A maximum of 8 inputs can be queried per IF instruction.

<sup>18</sup> I1...I6 only if masked via P221.

<sup>19</sup> Instead of "-", "." is also an option

### 8.4.24 Comparative operations

**Syntax:** IF <single Operand> <compare> <Operand> GOTO xxx  
or  
IF <single Operand> <compare> <Operand> GOSUB xxx

**Simple Operand:**

- a parameter Pxxx or
- a variable <sup>20</sup> Vxxx or
- a status value Sxxx (S1-S15, S30, S40ff)

**Operand:**

- A simple Operand or
- A constant with max. 8 significant digits

**Comparison:**

- < smaller
- > larger
- = equals
- <> not equal
- <= equal to/less than
- >= equal to/greater than

Depending on the result of the comparison, a GOTO or GOSUB is carried out.

**Examples:** IF P40>100 GOTO 234  
IF V030<>P49 GOTO 123

**Limitation:** Within the IF query, operations with logic operators (AND, OR) are not possible.

#### Writing convention of variables (V0-V39) and control parameters (P40-P49)

For reasons of compatibility, a preceding point (full stop) is expected in the syntax for motion commands:  
e.g.: POSA .P40, ACCEL .V10

The new comparison and arithmetic commands will operate without a preceding point (full stop): e.g.:  
P41=V10+S1, IF V20 > S2 GOTO 10

### 8.4.25 Specific processing of data record groups. WAIT START.

#### WAIT START

**Entry at BDF<sup>21</sup>: WAIT Ent**

When this instruction is issued, COMPAX interrupts the programming procedure until a external START (E5 or via interface) is issued (reaction time <30 ms). For shorter reaction times, refer to I15 on Page 151.

**Syntax:** WAIT Start

### 8.4.26 Jump with data record selection [GOTO EXT]

#### GOTO EXT

**Jump with data record selection via the inputs I9 to I16.**

**Entry at BDF2: GOTO Ent**

Data record selection as for GOSUB EXT (see below).

<sup>20</sup> for variables, see Page 114.

<sup>21</sup> Applies to the manual terminal BDF2/01

### 8.4.27 Sub-program jump with data record selection [GOSUB EXT]

#### GOSUB EXT

Entry at BDF2: GOSUB Ent

**Jump into a sub-program with data record selection via the inputs I9 to I16.**

The bit pattern of inputs I9 to I16 is interpreted as a data record number (binary).

$I_{16} \dots I_9 \Rightarrow 2^7 \dots 2^0$   
 e.g. 00 010 100 = 20  $\Rightarrow$  jumps to sub-program at data record 20.



**Note!**

**If inputs have been assigned functions (e.g. fast start I15 or external position adjustment I11), they are not taken into consideration when using GOSUB EXT (read logically as "0"):**

$\Rightarrow$  The assignments of each of the binary inputs I16...I9 must be taken into consideration for the individual unit variants (COMPAX XX50M,...).

When the PLC data interface is activated, the commands GOTO EXT and GOSUB EXT are blocked!

### 8.4.28 Error handling [IF ERROR GOSUB]

#### IF ERROR GOSUB

To influence the error reactions.

**Syntax:**

**IF ERROR GOSUB xxx**

This instruction can only be programmed as normal IF instructions in the program. Use this instruction to define the program procedure when an error status occurs.

**Note!**

The error sub-program is called up with a delay by P17 (brake delay). When performing a WAIT START, COMPAX does not branch into the error sub-program if an error occurs!

**Function:**

Normally, an error in the COMPAX will cause an actively running move to be interrupted. Depending on the type of error, the drive is switched off. The program is however stopped no matter what the error type.

The instruction 'IF ERROR GOSUB xxx' allows you to, e.g. set the outputs to defined statuses when an error occurs.

If such an instruction has been run once in the program and then an error later occurs,

- the current move is interrupted,
- if necessary, the axis is (depending on the error) switched off and
- the 'Error program', which has been programmed from program number xxx, is executed.

**Priority:**

The error program has priority over the stop program.

A running stop program is interrupted by the error program and continued after the error program is executed.

**Error program:**

The error program must not contain

- any motion commands (POSA, POSR, POSR ..., WAIT POSA, WAIT POSR, SPEED in the speed control mode, ),
- any sub-program jumps (GOSUB, IF ... GOSUB, ...),
- any COMPAX XX70 commands,
- any approach real zero and find machine zero commands,
- any speed step commands (POSR ... SPEED ...) or
- comparator commands (POSR ... OUTPUT ...)

and is used to bring the individual outputs (e.g. the control output for a pump or a valve) into a safe status.

#### Error program with WAIT START

Each error program must contain a 'WAIT START' instruction. The 'WAIT START' instruction causes the programming procedure to stop until an external QUIT and START occurs. Then OUTPUT instructions can again be present for resetting the outputs. There must be a RETURN or END instruction at the end of the error program.

- The END instruction stops the program.
- The RETURN instruction executes a jump back into the program line which was previously interrupted. If necessary, an interrupted movement is continued (provided that the error has been acknowledged).

#### Example:

Main Program	Error Program
N001: IF ERROR GOSUB 200	N200: OUTPUT O9=0
N002: OUTPUT O9=1	N201: WAIT START
N003: POSA 0	N202: OUTPUT O9=1
N004: POSA 4000	N203: RETURN
N005: OUTPUT O9=0	
N006: GOTO 002	

If the axis is now stopped and switched off due to an error, e.g. during POSA 4000 positioning, a sub-program jump is then executed to program line 200 and output O9 is set to zero at this point. The program then stops in program line 201 and waits until the error has been acknowledged and, if necessary, a new start is made. At program line 202, output O9 is switched on again, at program line 203, a jump is made back to the previously interrupted program line N004. The axis executes the rest of the travel to position 4000, and the main program is then continued at program line N005. If the error program is concluded with END rather than RETURN, the program indicator remains in the same position. The program stops running at this point. Machine zero then has to be approached or the program indicator must be reset explicitly.

### 8.4.29 STOP / BREAK handling [IF STOP GOSUB xxx]

#### IF STOP GOSUB xxx

For influencing behavior after STOP or BREAK.

#### Syntax:

#### IF STOP GOSUB xxx

This instruction can only be programmed, like normal IF instructions, in the program. It controls the procedure executed in the program when a stop status occurs.

Normally, a STOP / BREAK command in the COMPAX will cause a actively running move to be interrupted; the program is stopped.

The 'IF STOP GOSUB xxx' instruction makes it possible to set the outputs to defined states in a stopped condition.

If such an instruction has already run in the program and a stop command occurs later:

- the current travel motion is interrupted and then
- a 'Stop program' is run, this is stored from program line number xxx.

## STOP / BREAK handling [IF STOP GOSUB xxx]

### Stop program:

The stop program must not contain

- any motion commands (POSA, POSR, POSR ..., WAIT POSA, WAIT POSR, SPEED in the speed control mode, ),
- any sub-program jumps (GOSUB, IF ... GOSUB, ...),
- any COMPAX XX70 commands,
- any approach real zero and find machine zero commands,
- any speed step commands (POSR ... SPEED ...) or
- comparator commands (POSR ... OUTPUT ...) and is used to bring the individual outputs (e.g. the control output for a pump or a valve) into a safe status.

### Error program with WAIT START

The 'WAIT START' instruction must be included; it stops the programming procedure before an external START is executed again.

Then OUTPUT instructions can again be present for resetting the outputs.

There must be a RETURN or END instruction at the end of the stop program.

- The END instruction stops the program.
- The RETURN instruction executes a jump back into the previously interrupted program line, a travel motion which was interrupted by STOP is continued; the next command is executed after the BREAK.

### Priority:

The error program has priority over the stop program.

A running stop program is interrupted by the error program and continued after the error program has run.

### Example:

Main Program

Stop Program

```
N001: IF STOP GOSUB 240
N002: OUTPUT O9=1
N003: POSA 0
N004: POSA 4000
N005: OUTPUT O9=0
N006: GOTO 002
```

```
N240: OUTPUT O9=0
N241: WAIT START
N242: OUTPUT O9=1
N243: RETURN
```

If the axis has been stopped due to a STOP, e.g. during POSA 4000 positioning, sub-program jump is then made to program line 240 and output O9 is set to zero at this point.

The program then stops in program line 241 and waits until a new start occurs.

At program line 242, output O9 is switched on again, at program line 243, a jump is made back to the previously interrupted program line N004.

The axis therefore executes the rest of the travel to position 4000 and the main program is then continued at program line N005.

If the stop program is concluded using END rather than RETURN, the program indicator remains in the same position. The program stops running at this point.

Machine zero has to be approached or the program indicator must be reset explicitly.

POSA  
POSR  
SPEED  
ACCEL  
OUTPUT  
Password  
SPEED  
SYNC  
Mark  
reference  
POSR  
SPEED  
POSR  
OUTPUT  
Cam  
controller  
WAIT  
GOTO  
GOSUB  
RETURN  
END  
REPEAT  
IF I..  
Comparison  
WAIT Start  
GOTO /  
GOSUB EXT  
IF Error/ Stop  
Arithmetic  
Position  
monitoring  
Idle display  
Speed  
monitoring  
Engage /  
disengage  
brake / final  
stage  
Variable  
voltage



### 8.4.30 Arithmetic

#### 8.4.30.1 Parameter assignments

**Syntax:** N001: P40 = 123.456

N002: V19 = P1

The assignments for parameters and variables are defined with an equal sign. The variables are represented by V0 to V39.

**Note** The assignment of variables is also possible as a direct command, e.g. from a terminal.

**Items permitted to the left of the equal sign:**

- a parameter Pxxx or
- a variable Vxxx (V0 - V39) or
- a curve point lxxxx (digital or analogue auxiliary functions when using COMPAX XX70) or
- a curve point Fxxxx (set points when using COMPAX XX70)

**Items permitted to the right of the equal sign:**

- an operand  
or
- a simple arithmetic term<sup>22</sup>

**An operand is:**

- a parameter Pxxx or
- a variable Vxxx (V1 - V39) or
- a status value Sxxx or
- a constant with max. 8 significant digits + sign + decimal point.

All parameters may be assigned.

The commands "VP" and "VC" (with which the parameters are validated) can be programmed in the program.

**Example:**

N123: P081=30 (modifies moment of inertia)

N124: VC

N234: P013=10 (modifies lag tolerance)

N235: VP

#### Curve memory

COMPAX XX70: the curve memory is also accessible:

**Example:**

N200: F5450=0.5 (modifies idle position of 1st curve)

N201: I5460=128 (modifies master cycle route of 1st curve)

N202: VF (validates curve)



For more information, see operating instructions for electronical curve control.

<sup>22</sup> Curve points can only be modified using an assignment; an arithmetic term is not allowed.

### 8.4.30.2 Arithmetic and variables

Values can be linked with one another using the four basic types of calculation and the result can be assigned to a parameter or a variable.

**Syntax:** A simple arithmetic term is:

• <b>&lt;Operand&gt; &lt;Operator&gt; &lt;Operand&gt;</b>	• P10+10; V1-S1; 2*P13; P13/P14; V7\V3; S12%P40
• <b>&lt;Befehl&gt; &lt;Operand&gt;</b>	• POSA .V10; SPEED .V30; ...

Operations are not allowed after commands; use variables instead for such cases, e.g..

N001: V001= S1 + 100.5

**not allowed:** POSA S1 + 100.5

N002: POSA .V001

**Operators:**

	Function	Example:
<b>+</b>	for addition	P10+10
<b>-</b>	for subtraction	V1-S1
<b>*</b>	for multiplication	2 * P13
<b>/</b>	for division	P13/P14
<b>\</b>	for whole number division (formation of the whole number component)	<b>V7\V3:</b> where <b>V7=30</b> and <b>V3=7</b> , the result is: <b>V7\V3=4</b> V7/V3=4.2857...; whole number component= 4
<b>%</b>	for the formation of the division remainder (Modulo)	<b>S12%P40</b> with <b>S12=30</b> and <b>P40=7</b> , the result is: <b>S12%P40=2</b> S12/P40=4 remainder 2; division remainder = 2

**Operands**

The following operands may be used:

- constants,
- parameters,
- status values, (S1-S15, S30, S40ff)
- variables (V1-V39); after commands with preceding point (full stop): POSA .V1

**Status values:**

Not all status values can be used as operands.

Status values S01 to S15, S30, and S40ff are permitted.

**Variables:**

In addition to the 10 user parameters P40 to P49, **39 variables V1-V39** are available. V0 is used for global assigning of a value to all variables.

The variables are automatically buffer-stored in the ZPRAM, i.e. after Power On they contain the old value.

**Note:** When the cam controller is switched off (V50=0), it is possible to use the variables V51 ... V70 as free variables

**Note:**  After commands the variables (like user parameters P40 to P49) are preceded by a "point" (full stop): POSA .V1, ACCEL .V22

**Global assignment:**

V0 is used for globally assigning a value to all variables.

Example:

V0=0: V1...V70=0

V0=17: V1...V70=17

**Note!** With the instruction V0=x, variables V50 ... V70 and therefore the settings of the cam controller are also changed!

#### Arithmetic and variable examples:

N001: P013 = 2 * P013	(Multiplication)
N002: P010 = P040 + 1000.1234	(Addition)
N003: P005 = P005 / 2	(Division)
N004: P250 = P250 - 1	(Subtraction)
N005: V002 = V001 \ 1	(Whole number division)
N006: V3 = S15 % P12	(Modulo)
N007: POSR .V30	

Only one operation or command is permitted per program line.

#### Number format:

All calculations are executed in 48 bit format (real number); 24 bits before the decimal point and 24 bits after the decimal point.  
Such a real number can be represented with a maximum of 10 places, incl. prefix and decimal point.  
Up to 7 places can be recorded after the decimal point.  
Ex. 1234567.89; -1.2345678

#### Dealing with calculation errors:

If a number overrun occurs while an arithmetic term is being calculated (because the range of values is not sufficient or if divided by 0), COMPAX reacts as follows:

- collective error message E07 is activated.
- the program is stopped for safety reasons.
- the drive remains powered.
- any travel movements are interrupted using the stop ramp.

After Quit and Start, the same command would be processed again and probably cause another error message.

For this reason, appropriate care should be taken when programming.  
The causes of the error are stored in the optimization display (P233/P234=39) and the last calculation error stored is always the first to be displayed.

#### Accuracy of calculations:

Errors occur in the arithmetic due to the systematic errors which arise during the display of figures in the control processor (the smallest number which can be displayed is  $2^{-24}$ ).

The calculation error can usually be ignored for addition, subtraction and multiplication.

**Note!** When dividing, significant discrepancies can result.

#### Division $y = x1 / x2$

The "maximum relative input error" for the division  $y = x1 / x2$  is calculated using the following formula:

$$\delta \leq \left| \frac{\Delta x_1}{x_1} \right| + \left| \frac{\Delta x_2}{x_2} \right| \quad x_1, x_2 \neq 0 \quad \text{when } \Delta x_1 = \Delta x_2 = 2^{-24}$$

or absolute:

$$\Delta y = \frac{|x_2| * \Delta x_1 + |x_1| * \Delta x_2}{x_2^2} \quad x_2 \neq 0 \quad \text{when } \Delta x_1 = \Delta x_2 = 2^{-24}$$

**Example:**  $x_1=12345.6$ ;  $x_2 = 0.0001$   
Result:  $y = 123456000$

$$\text{max. relative error: } \delta \leq \left| \frac{2^{-24}}{12345.6} \right| + \left| \frac{2^{-24}}{0.0001} \right| = 0.000596$$

$$\text{max. absolute error: } \Delta y = \frac{|0.0001| * 2^{-24} + |12345.6| * 2^{-24}}{0.0001^2} = 73585.51$$

## Arithmetic

### Read status and assign variables

To include the actual position in a calculation, for example, you may assign as follows:

N100: V030=S1

or

N100: V030= S1 + 10

The variable V030 derived in this way can be used later, for example, in a positioning instruction as a preset target.

### Initializing variables:

After Power On, the variables retain the old value as before Power Off as they are stored in the ZPRAM. With the special instruction V000=x, all variables (on the cam controller settings) are set to the value x.

## Writing convention of variables (V0-V39) and control parameters (P40-P49)

For reasons of compatibility, a preceding point (full stop) is expected in the syntax for motion commands: e.g.: POSA .P40, ACCEL .V10

The new comparison and arithmetic commands will operate without a preceding point (full stop): e.g.: P41=V10+S1, IF V20 > S2 GOTO 10

POSA  
 POSR  
 SPEED  
 ACCEL  
 OUTPUT  
 Password  
 SPEED  
 SYNC  
 Mark  
 reference  
 POSR  
 SPEED  
 POSR  
 OUTPUT  
 Cam  
 controller  
 WAIT  
 GOTO  
 GOSUB  
 RETURN  
 END  
 REPEAT  
 IF I..  
 Comparison  
 WAIT Start  
 GOTO /  
 GOSUB EXT  
 IF Error/ Stop  
 Arithmetic  
**Position  
 monitoring**  
 Idle display  
 Speed  
 monitoring  
 Engage /  
 disengage  
 brake / final  
 stage  
 Variable  
 voltage

### 8.4.31 Position monitoring (P93=1, 2, 3)

There are 2 settings for O5 "Position reached" which are set with P227:

P227 bit 4 <sup>23</sup> = "1"	Meaning / function
<b>OM1</b> <sup>24</sup>	<b>O5 toggles when the position is reached</b> O5 toggles after every new positioning when position is reached.
<b>P227 bit 4 = "0"</b>	
<b>P14 &gt; 0, small values</b> (small in comparison with the process travel) <b>OM2</b>	O5 = "1": nominal value reached and lag error < P14 O5 = "1" if set point generator has finished the ramp and the lag error is smaller than P14. If the lag error after O5 = "1" is greater than P14, then O5 = "0" until the lag is again less than P14.
<b>P14 &gt;&gt; 0, large value</b> (large in comparison with process travel) <b>OM3</b>	O5 = "1": nominal value reached (independent of P14) O5 = "1" as soon as the set point generator has finished the ramp and stays at "1" until the start of the next positioning move.

#### Functional description:

**OM1: O5 toggles when the position is reached**

Example:

O5 is toggled (=changed, i.e. from O5="1" to O5="0", from O5="0" to O5="1") after every positioning move (set point generator has reached target position) .  
When an error occurs (Exx is indicated), O5 stays at the current value.  
Can be adjusted using: **P227 bit 4 = "1"**

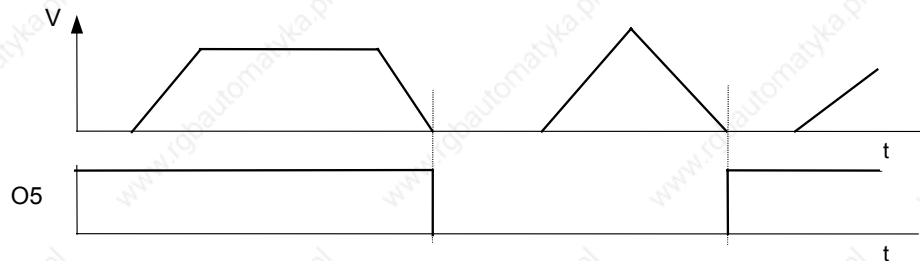

**PLC - sequential step tracking**

With this function you can use a host PLC for precise tracking of the COMPAX positioning. You will find a description of this from Page 122.

**OM2: O5 = "1": nominal value reached and lag error < P14**

O5="1": nominal value on nominal value sensor reached and lag error < P14.  
If the lag error is again > P14, then O5="0" is set.  
Can be adjusted using: **P227 bit 4 = "0"** (default setting)

<sup>23</sup> Bit counting begins with 0.

<sup>24</sup> OM: Operating mode

## Position monitoring (P93=1, 2, 3)

Example:

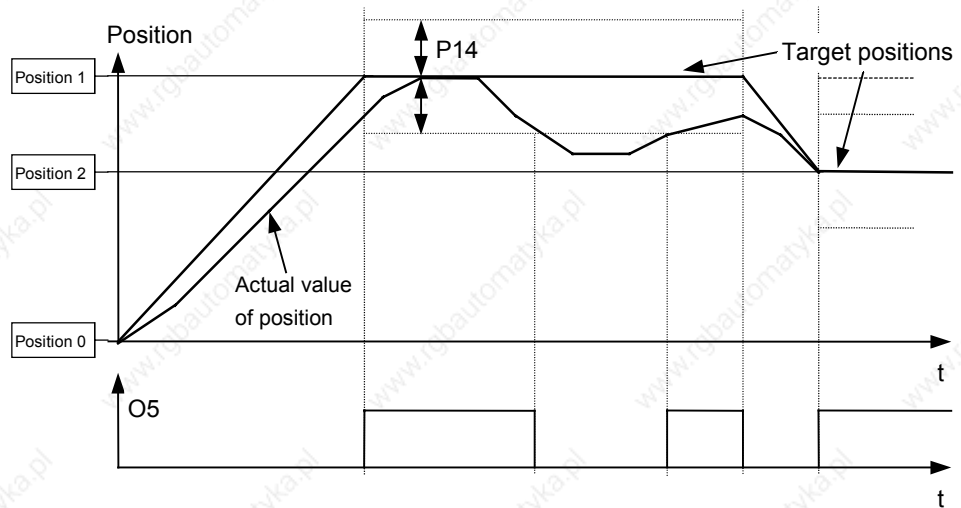

For purposes of clarity a poor loop setting is shown here.

**OM3: O5 = "1":  
nominal value  
reached  
(independent of P14)**

O5="1": nominal value on nominal value generator reached (independent of P14, since P14 is set as very large value)  
Can be adjusted using: **P227 bit 4<sup>25</sup> = "0"** (default setting)

Example:

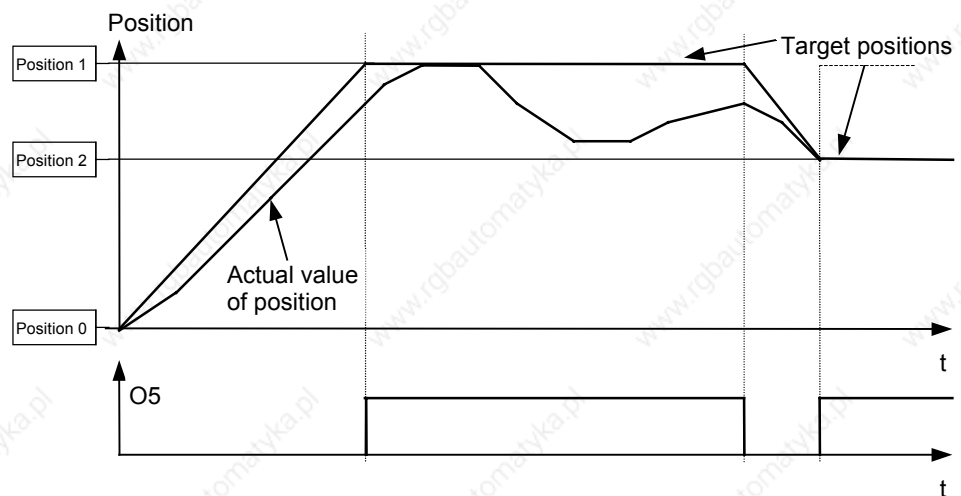

A poor controller setting has been selected by way of illustration.

25 Bit counting begins with 0.

### 8.4.32 Idle display

Display showing whether the axis is at standstill or moving.

The display is set to output O2 using the setting **P227 bit 1<sup>26</sup> = "1"** ; the standard function of O2 "No warning" no longer applies in this case.

P229 then serves as a switching threshold, above which an idle condition is reported with O2="1" and indicated in per-thousands (€ of P104) of nominal speed.

Nominal speed < P229: O2="1"; drive at standstill

Nominal speed ≥ P229: O2="0"; drive moving

P229 = 0: O2="0"; no idle display

Range of numbers P229: 0 - 255‰

**P227 bit 1 = "0"** O2 assigned the "No warning" display (default value).

**Example:**

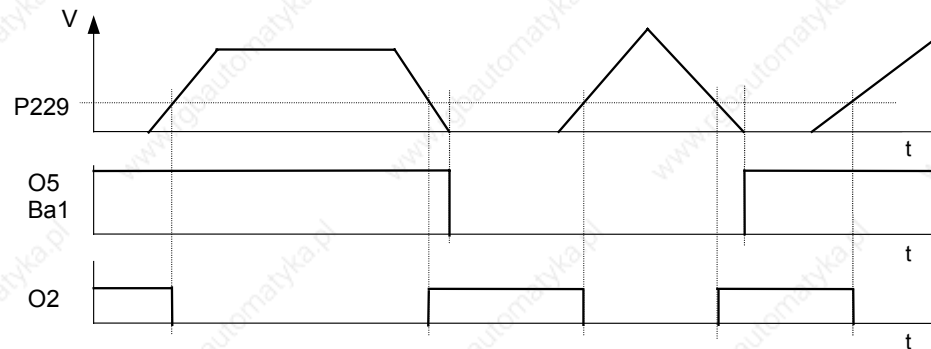

To avoid O2 continuously switching over during nominal speed value disturbance (during synchronization applications), a minimum pulse time (= minimum positioning time) is defined.

Once nominal speed < P229 has been detected and P229 has then been exceeded again, the next nominal speed check is executed after 50 ms.

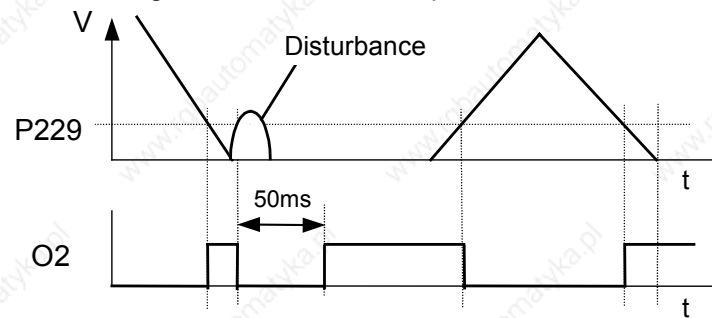

<sup>26</sup> Bit counting begins with 0.

### 8.4.33 Speed monitoring in speed control mode (P93="4")

There are 2 settings for O5 "Position reached" which are set with P227:

P227 Bit 4=1 <sup>27</sup>	Meaning / function
OM1 <sup>28</sup> :	<b>O5 toggles when speed is reached</b> O5 toggles after every new speed definition when speed is reached.
<b>P227 bit 4 = "0"</b>	
<b>P14&gt;0, small values</b> (small in comparison with the changes in speed) OM2:	<b>O5 = "1": nominal value reached and &lt; P14</b> O5="1" if set point generator has finished the ramp and the speed difference is smaller than P14. If, after O5="1", the speed difference is again greater than P14, then O5 = 0 until the difference is again less than P14.
<b>P14&gt;P15</b> (large in comparison with changes in speed) OM3:	<b>O5 = "1": nominal value reached (independent of P14)</b> O5=1 as soon as the set point generator has reached the set speed, and stays at "1" until the next speed change.

#### Functional description:

In speed control mode, P14 is given as a percentage of the set speed. In addition, the speed is checked against the speed tolerance defined in P13. P13 is defined in speed control mode as a percentage of the set speed and is an absolute limit.  
Speed difference > P13: error E10 is triggered  
When P13=0, error E10 (and E49) can be switched off.

#### Special features in speed control mode:

**OM1: O5 toggles when speed is reached**

#### Example:

O5 is toggled (=changed, i.e. from O5="1" to O5="0", from O5="0" to O5="1") following every speed change (set point generator has reached demanded speed) In case of error (Exx is indicated), O5 remains at the current value. Can be adjusted using: **P227 bit 4 = "1"**

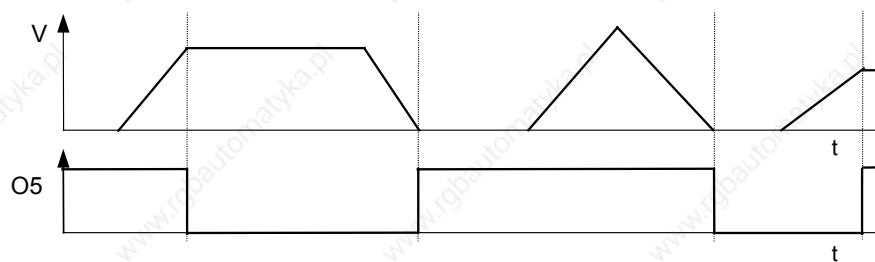

<sup>27</sup> Bit counting begins with 0.

<sup>28</sup> OM1: operating mode 1



**OM2: O5 = "1":  
nominal value  
reached and lag  
error < P14**

O5="1": nominal value reached on nominal value generator and speed deviation < P14.  
If the speed deviation returns to > P14, O5="0" is set.  
Can be adjusted using: **P227 bit 4 = "0"** (default setting)

Example:

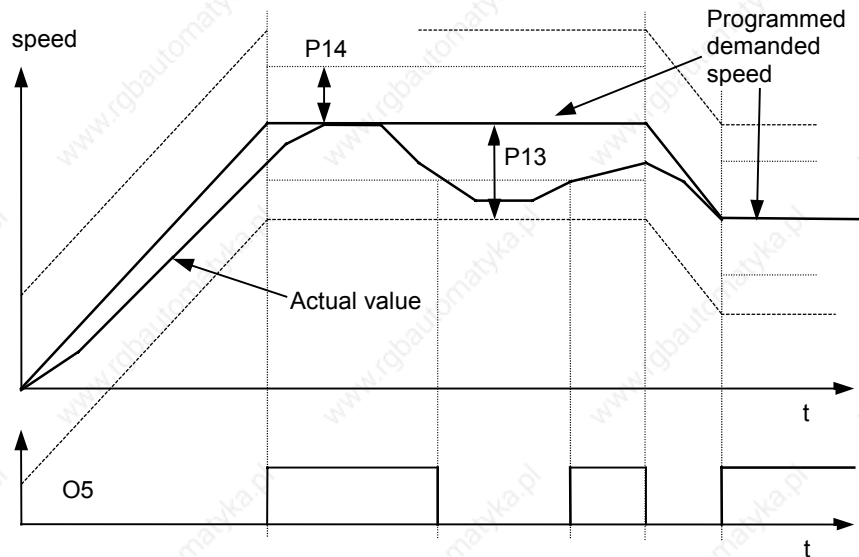

If the actual value moves outside P13, error E10 is triggered.

**OM3: O5 = "1":  
nominal value  
reached  
(independent of P14)**

O5="1": nominal value on nominal value generator reached (independent of P14 as P14 is set as a very large value)  
Can be adjusted using: **P227 bit 4<sup>29</sup> = "0"** (default setting)

Example:

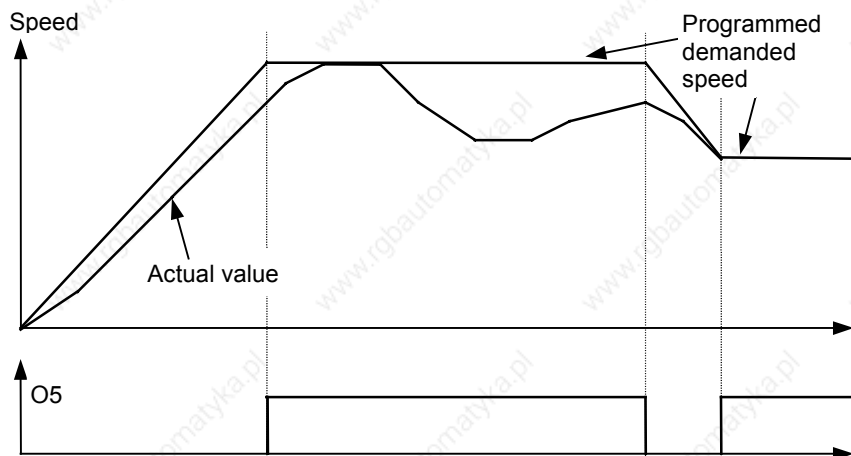

<sup>29</sup> Bit counting begins with 0.

Unit hardware
Connector / cable assignment
Technical data
Configuration
Positioning and control functions
Optimization functions
Interfaces
Accessories / options
Status
Parameter
Error list

### 8.4.34 PLC sequential step tracking

Use the function "O5 toggles when position/speed reached" and a marker in the PLC to implement precise tracking of the COMPAX. This also recognizes positioning processes which are completed again during the next PS cycle.

#### Implementation:

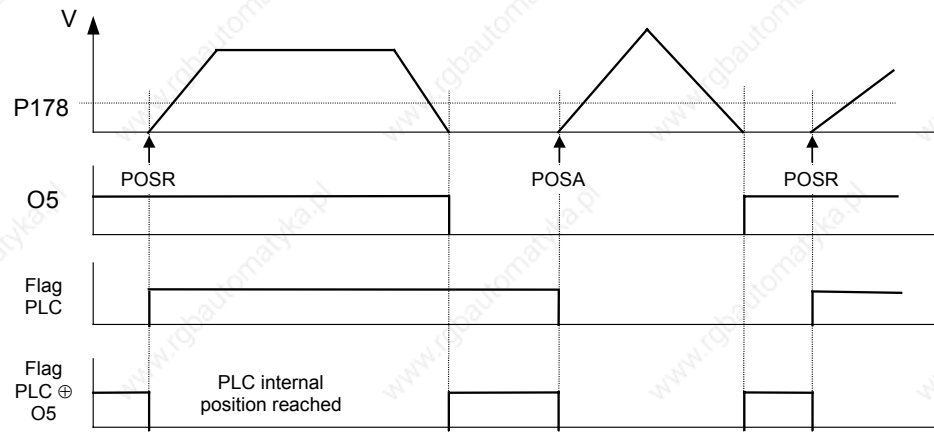

The PLC marker is toggled when a positioning command is transmitted. The "EXCLUSIVE-OR" operation of the PLC marker and output O5 can be processed as a PLC-internal "Position reached" message.

- POSA
- POSR
- SPEED
- ACCEL
- OUTPUT
- Password
- SPEED
- SYNC
- Mark reference
- POSR
- SPEED
- POSR
- OUTPUT
- Cam controller
- WAIT
- GOTO
- GOSUB
- RETURN
- END
- REPEAT
- IF I..
- Comparison
- WAIT Start
- GOTO / GOSUB EXT
- IF Error/ Stop
- Arithmetic
- Position monitoring
- Idle display
- Speed monitoring
- Engage / disengage** brake / final stage
- Variable voltage

### 8.4.35 Engaging and disengaging the motor brake

COMPAX controls the idle holding brake of the motor and final stage. The time behaviour can be set using P17 and P211 Bit 2.

**Application:** If you are using an axis which is under torque when idle (e.g. when using a z axis), the drive can be engaged and disengaged in a manner which ensures that the load does not move. To do this, the drive remains powered during the reaction time of the idle holding brake. This can be set using P17 (see following diagrams).

<b>Final stage blocked by:</b> <ul style="list-style-type: none"> <li>error or</li> <li>OUTPUT O0="1" or</li> <li>emergency STOP.</li> </ul>	<b>The final stage is enabled via:</b> <ul style="list-style-type: none"> <li>quit or</li> <li>OUTPUT O0="0" or</li> <li>once Power is on with P211 Bit 2="0".</li> </ul>	<b>The final stage is enabled via:</b> <ul style="list-style-type: none"> <li>OUTPUT O0="0" (the lag of 0.5s is switched off)</li> </ul>
--	---	--

#### P17=0

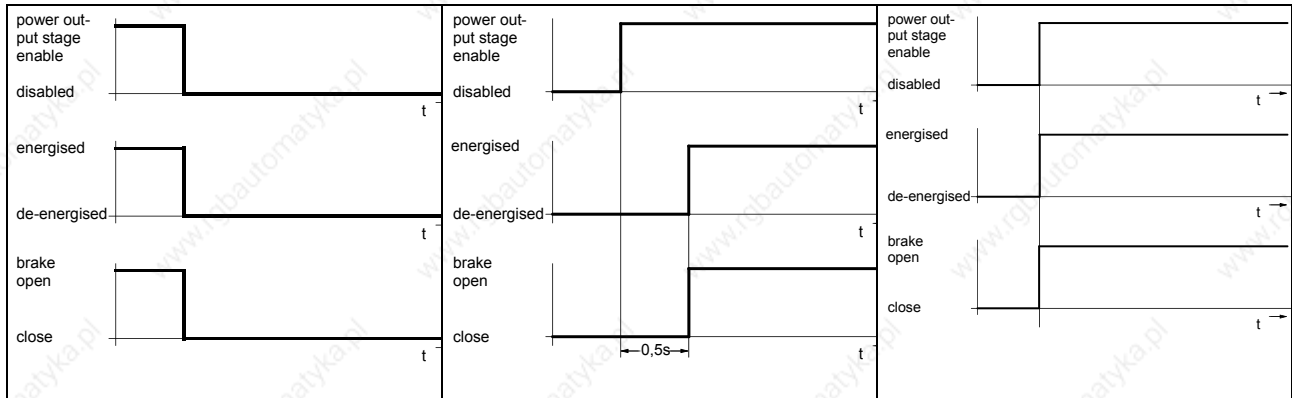

#### P17>0

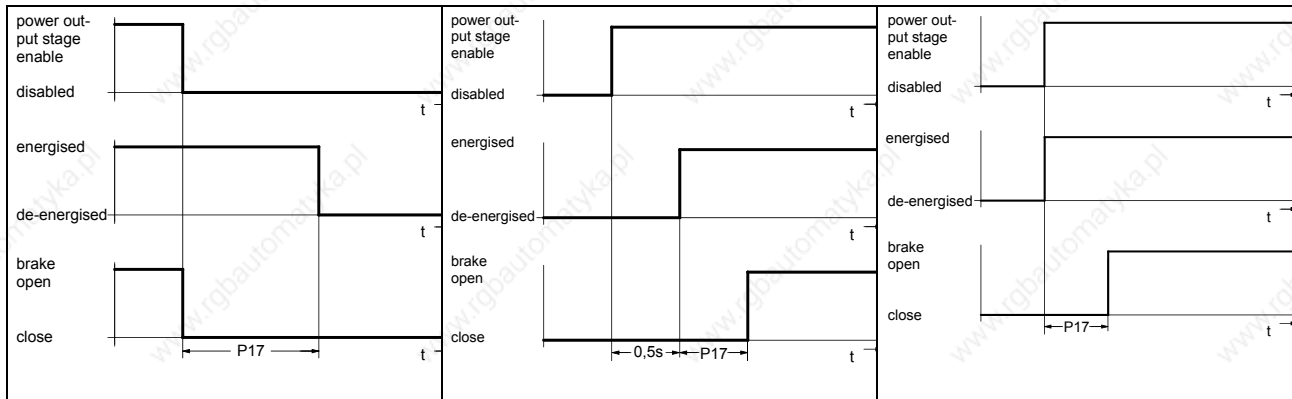

#### Range of values for P17:

Meaning	Unit	Min. Value	Standard	Maximum value	Applies to ...
Braking delay	ms	0	0	500	VP

### 8.4.36 Output of variable voltage

POSA  
 POSR  
 SPEED  
 ACCEL  
 OUTPUT  
 Password  
 SPEED  
 SYNC  
 Mark  
 reference  
 POSR  
 SPEED  
 POSR  
 OUTPUT  
 Cam  
 controller  
 WAIT  
 GOTO  
 GOSUB  
 RETURN  
 END  
 REPEAT  
 IF I.  
 Comparison  
 WAIT Start  
 GOTO /  
 GOSUB EXT  
 IF Error/ Stop  
 Arithmetic  
 Position  
 monitoring  
 Idle display  
 Speed  
 monitoring  
 Engage /  
 disengage  
 brake / final  
 stage  
Variable  
voltage

The direct output of variable voltage is supported via the D/A monitor channels 0 to 3.

#### Service D/A monitor (channels 2 & 3):

Addressable using parameters P76 (channel 2) and P77 (channel 3)  
 P76 Channel 2 X11/4  
 P77 Channel 3 X11/5  
 Resolution: 8 bit (incl. sign); corresponds to a resolution of 80 mV  
 Range: -10V...+10V  
 The calculation for output on the 8 bit channels 2 & 3 is as follows:  
 Parameter setting for required voltage U (-10V ... +10V)  
 P76 (P77) = 39 + Y (39,Y)  
 39: selection of voltage output

Value before decimal point:  
 Value after decimal point:

**For positive voltage:**  $Y = U * 0.0101067 / 10V$   
**For negative voltage:**  $Y = U * 0.0101067 / 10V + 0.0202134$

(Note: set U negative in the 2nd formula)

Characteristic curve:

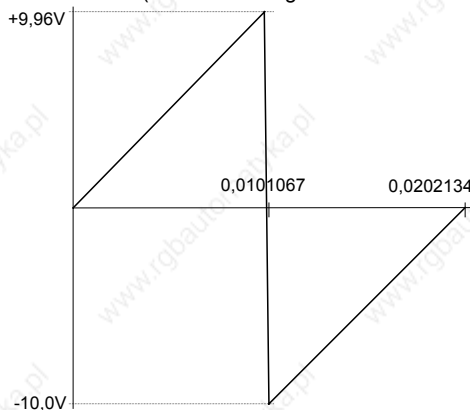

#### Option D/A monitor (channels 0 & 1):

Addressable using P71 (channel 0) and P72 (channel 1)  
 P71 Channel 0 X17/1  
 P72 Channel 1 X17/2  
 Resolution: 12 bit (incl. sign); corresponds to a resolution of 5 mV  
 Range: -10V...+10V  
 The calculation for the output on the 12-bit channels 0 and 1 is as follows:  
 Parameter setting for required voltage U (-10V ... +10V)  
 P71 (P72) = Y  
 P73 (P74) = 39: selection of voltage output

Calculating the output value:

$$Y = U * 101067 / 10V$$

Characteristic curve:

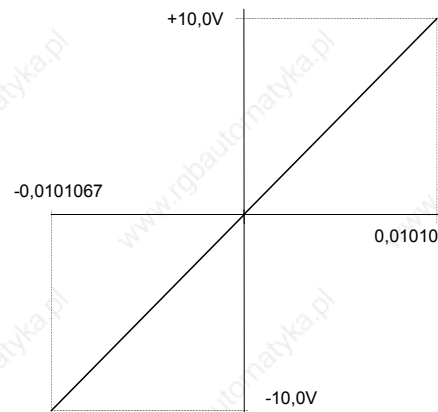

## 8.5 Optimization functions

Important requirements for a rapid, stable adjustment are the correct information about the physical characteristic values of the application. COMPAX requires the following data:

- The parameters of the motor.  
For Parker – standard motors, select the connected motor type from a list; the relevant parameters are stored in the ServoManager.  
For other motors, the relevant parameters P100-P133 must be set according to the connected motor (see from Page 91).
- The parameters of the application.  
These are mainly the moments of inertia (with and without load) that the drive has to move, which are set, depending on the drive type, via the parameters P80 ... P92.
- Dependent on the sensor system, you can select from 2 structure variants; these also contain (set via the ServoManager) fixed settings of optimizing parameters. The standard structure corresponds to the previous COMPAX control structure. With the standard structure, you can directly transfer previous, already optimized parameter sets.
- After this, the optimal control dynamic is set by increasing the stiffness (P23). This is usually sufficient to obtain good control results.

### User-defined settings

- For further optimization, you can adapt the parameters of the set structure variants optimally to your application (user-defined settings).
- As another alternative, you can select structure variant 3 and optimize it with the relevant parameters.

### Optimizing the movement cycle

- At the end of every optimization of the control accuracy, the movement cycle must be optimized. For this, use the pre-control parameters P25, P26, P69 and P70.



### Optimizing with the ServoManager:

Use the menu "**Online: Parameters**" to change the optimizing parameters directly in COMPAX (these settings are accepted after modification with "Return").

## Output of variable voltage

### Optimization process:

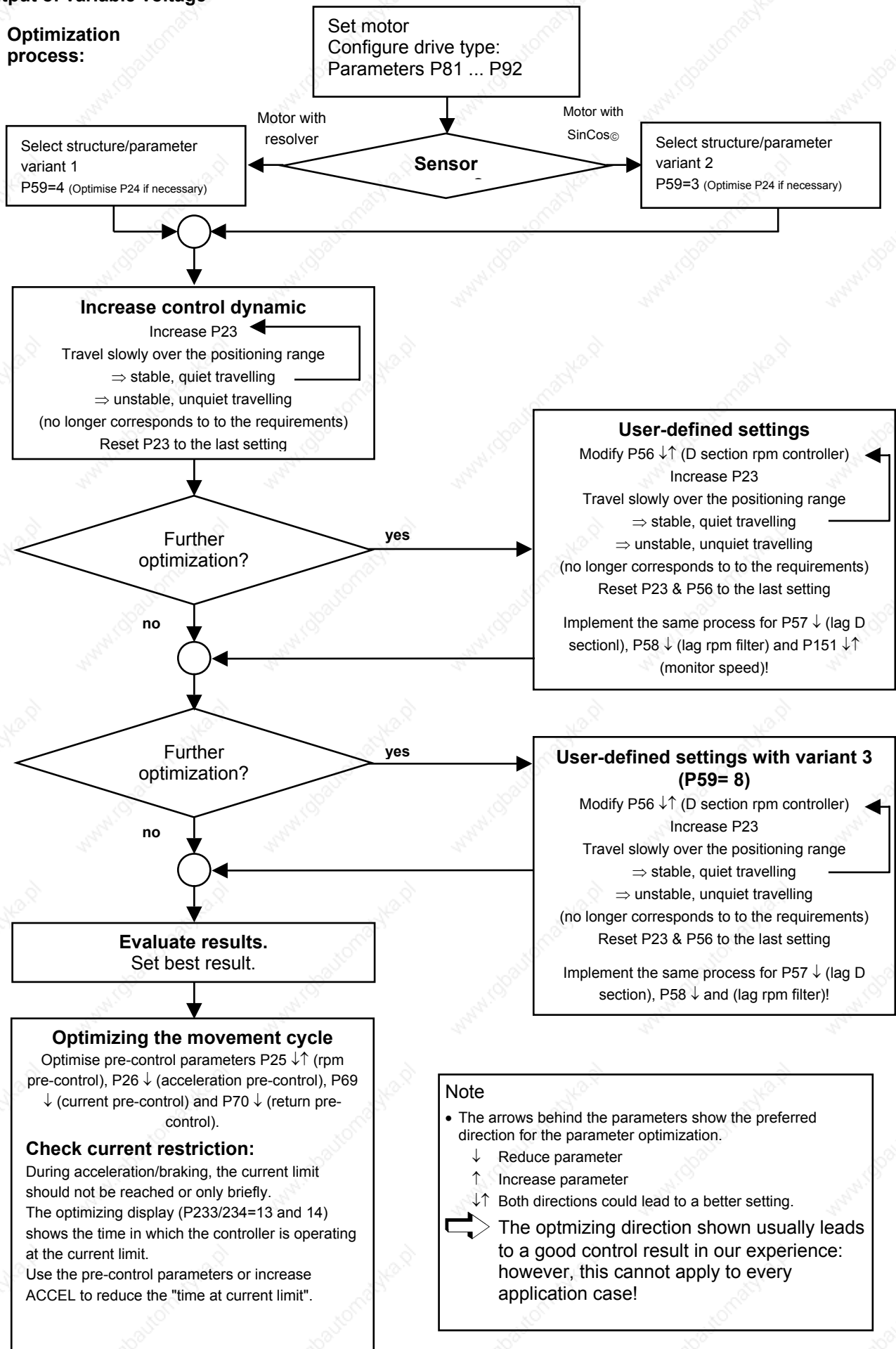

## 8.5.1 Optimization parameters

### Structure variants:

#### Structure and parameter settings using the ServoManager:

In addition to the standard structure (which corresponds to the previous COMPAX control structure), you can select from 3 structure variants.

These include, in addition to a specific control structure, pre-defined settings for specific optimizing parameters. By selecting the individual structures in the ParameterEditor, the following parameters can be set:

No.	Meaning	Standard	Variant 1	Variant 2	Variant 3
P59	Structure switch measuring	0	4	3	8
P56	D section rpm controller (%)	0	40	40	40
P57	Filter acceleration (%)	100	175	350	100
P58	Lag rapid rpm signal (%)	100	0	0	100
P50	Monitor	100 (switched off)	101 (switched on)	101 (switched on)	100 (switched off)
P151	Monitor speed (%)	30	30	30	30
P27	Moment of inertia (%)	100	100	85	100
P69	Return pre-control (%)	0	100	100	100
P70	Current pre-control value (%)	0	100	100	100

**Standard:** Previous COMPAX control structure; use this structure if you already have optimized parameter sets.

**Variant 1:** Structure switch: Variant 1 for resolver

**Variant 2:** Structure switch: Variant 2 for SinCos®

**Variant 3:** Structure switch: Variant 3 "Rapid rpm controller"

### P59: Structure switch measuring

The structure switch measuring (P59) permits the following settings:

No.	Meaning	Settings
P59	Structure switch measuring	0: Standard 4: Variant 1 (for resolver) 3: Variant 2 (for SinCos®) 8: Variant 3 (rapid rpm controller)
	Sensitive stiffness (P23) Larger setting range for P23	+16
	Sensitive D section (P56) Larger setting range for P56	+65536 The D section is reduced by 1/256.



By selecting a structure variant with the structure switch P59, no further parameters are influenced.

Only by selecting a variant through ServoManager (menu parameters: controller structure / monitor) can complete parameter sets (as described above) be set.

### P23: stiffness of drive

**The stiffness is proportional to the controller speed.**

Nominal value: 100% Range: 10%...5000%

#### Increase stiffness

Control is faster. The control circuit starts from a critical value. Set the stiffness so that sufficient safety distance from the critical value is ensured.

#### Reduce stiffness

Control is slower. This increases lag error. Current limitation is reached later.

## Optimization parameters

**Main effect:**

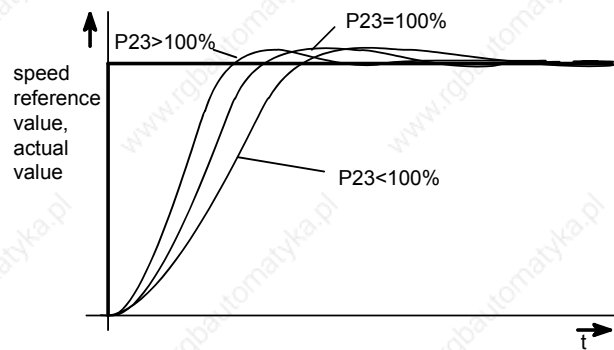

### P24: damping of drive

**Damping influences the height of the harmonics and reduces the vibrations.**  
Nominal value: 100% Range: 0%...500%

**Increase damping**

Harmonies become smaller. The drive vibrates at high frequency from a specific value.

**Reduce damping**

The harmonies of the actual value increase and it vibrates longer around the nominal value. The drive vibrates permanently from a specific value.

**Main effect:**

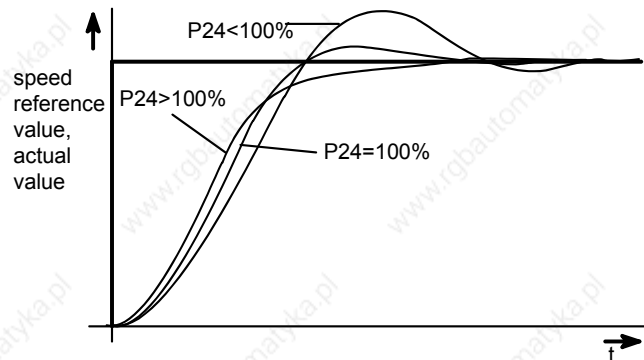

### P56: D section rpm controller

Nominal value: 0 Range: 0%...500%  
The D section should generally be set for elastically coupled double mass systems. These are systems in which the connection between the motor and the load is not rigid. It must be noted here, that with sufficiently high torques being transmitted, even supposedly rigid connections can become elastic.

### P57: Lag D section rpm controller

**P57: Lag D section rpm controller**  
Nominal value: 100% Range: 0%...550%

### P58: Lag rpm filter

**P58: Lag rpm filter**  
Nominal value: 100% Range: 0%...550%

### P27: moment of inertia

**Use this parameter to adapt the controller to very large changes in load.**  
Nominal value: 100% Range: 10%...500%  
COMPAX is informed of the relative change in moment of inertia which occurs before a change in load when the motor is idle (e.g. via the RS232 interface). The nominal value (100%) corresponds to the value calculated by parameters P81 to P92.

**Note:** After changing P27, P23 usually needs modification P23 in order to achieve optimal control results.



### Advance control measures

### Advance control of speed, acceleration and power

**Advantages:**

- Minimum lag error
- Better attenuation characteristics
- Higher dynamic levels with lower maximum current

**Principle:**

The positioning process is calculated in the nominal value setter and is specified to the position controller as the nominal value. This ensures that the nominal value setter contains the advance information required for positioning: speed, acceleration and power processes. This information is switched to the controller so the lag error is reduced to a minimum, the controller has better attenuation characteristics and drive dynamics are increased.

**Main structure:**

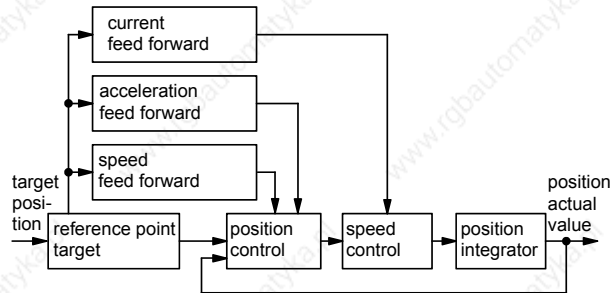

➡ The stability of the control process is not influenced by the advance control measures.

**Without advance control measures:**

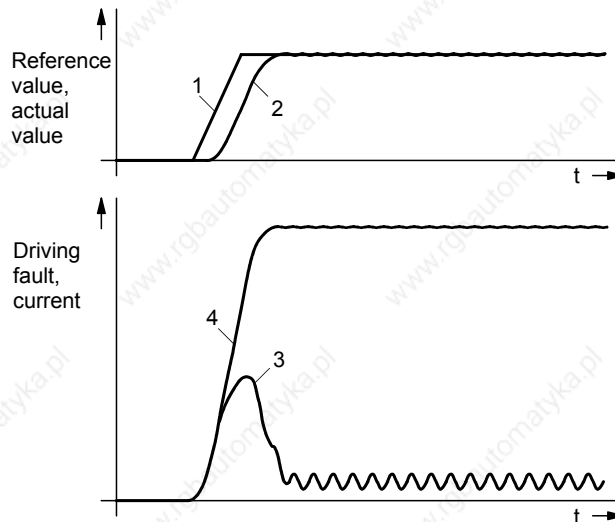

- 1: Nominal speed value
- 2: Actual speed value
- 3: Motor power
- 4: Lag error

## Optimization parameters

### P25: Advance speed control:

Advance speed control  
Nominal value: 100% Range: 0%...500%

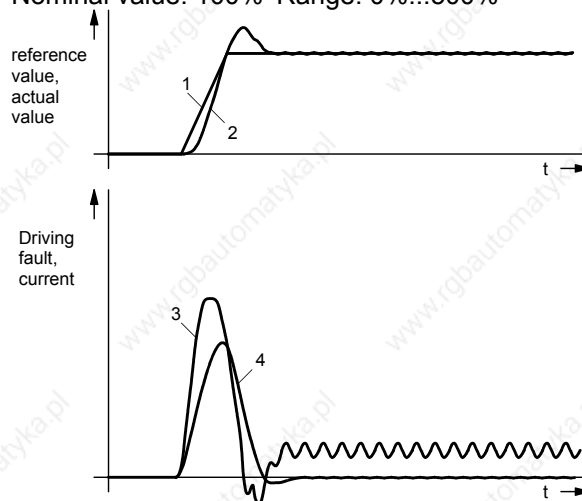

- 1: Nominal speed value
- 2: Actual speed value
- 3: Motor power
- 4: Lag error

### P26: Advance acceleration control

Advance speed and acceleration control  
Nominal value: 100% Range: 0%...500%

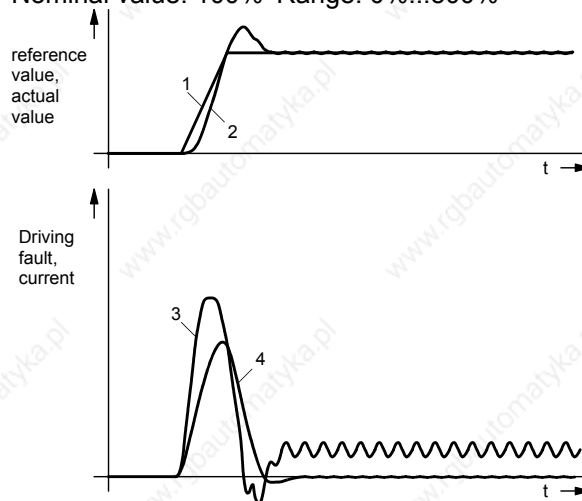

- 1: Nominal speed value
- 2: Actual speed value
- 3: Motor power
- 4: Lag error

### P70: Advance power control

Advance speed, acceleration and power control  
Nominal value: 100% Range: 0%...500%

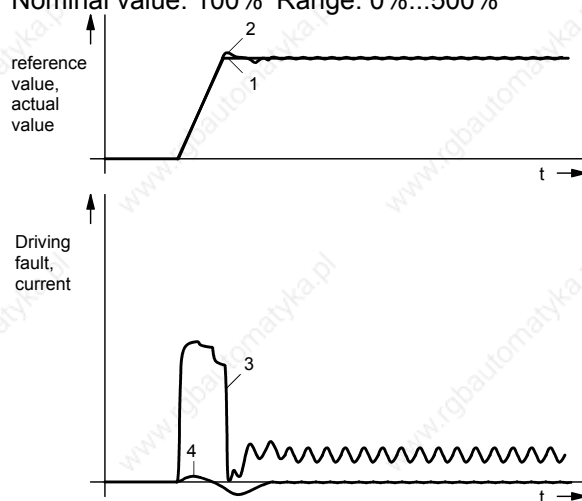

- 1: Nominal speed value
- 2: Actual speed value
- 3: Motor power
- 4: Lag error

### Advance reverse control

The advance reverse control can be engaged to increase optimization of guide characteristics and reduce dynamic lag error by using P69. Nominal value: 100% Range: 0 ... 500% default value: 0; applies to VP

#### Control processes for optimization

Targets / problems	Stiffness (P23)	Damping (P24)	Advance contr. factors (P25, P26, P70)	Acceleration time (ACCEL)	Ramp shape (P94)	Other measures
Minimizing lag error	increase	-	=100% optimize if necessary	increase	-	-
No harmonics	-	increase	decrease	increase	quadratic (P94="3")	increase max. torque (P16)
Unusually high harmonics caused by power limitation	decrease	decrease	decrease	increase	linear (P94="1")	increase max. torque (P16)
Vibrating at higher frequencies (perceptible as noise)	decrease	decrease	-	-	-	check min. mass (P92) and min. moment of inertia (P81).
Vibrating at lower frequencies (perceptible as motion)	-	increase	-	-	-	check max. mass (P88) and max. moment of inertia (P82).
High motor or final stage temperatures	decrease	-	-	increase	linear (P94="1")	decrease max. torque (P16)

Unit hardware

Connector / cable assignment

Technical data

Configuration

Positioning and control functions

Optimization functions

Interfaces

Accessories / options

Status

Parameter

Error list

### 8.5.2 Speed monitor

#### Speed determination standard:

In COMPAX the drive speed is required as an actual value for speed control (loop underlying the position control).

The actual speed value is derived by differentiating the position signal.

In certain applications, such as with large ratios  $J_{load}/J_{motor}$ , the loop response time is limited by quantization noise.

#### Speed monitor:

COMPAX includes a speed monitor for determining speed, which can be turned on using parameter P50.

Use the speed monitor to set a higher level of stiffness corresponding to a faster control process.

#### Function:

The monitor reproduces the dynamic behavior of the drive. It receives the same input signal as the physical drive. An additional loop is used to compare the output magnitude with the actual output magnitude of the drive (actual position value from resolver) and hold it at the same value. This additional loop makes corrections to the internal monitor values.

The advantage is that the speed is available directly as an intermediate value of the monitor and can be used for speed control.

Use this speed signal to attain a stable control process or to operate the drive control process with higher levels of stiffness (P23) and the same levels of damping.

#### Settings:

P50=100: without monitor (default setting and function as before)

P50=101: with monitor

P151: responsiveness of the monitor control (standard 30%)

P151>30%: monitor loop becomes faster

P151<30%: monitor loop becomes slower

#### Using the speed monitor

- For large ratios  $J_{load}/J_{motor}$ .



**Note! Do not use the speed monitor when operating asynchronous motors.**

### 8.5.3 Optimization display

The optimization display (status S13 and S14) is an aid for optimizing COMPAX without the need for an additional visual aid. It provides access to the characteristic parameters of the positioning process (optimization parameters).

From a selection of 14 different parameters for the positioning process, you can assign 2 parameters to the status values S13 and S14 by using the parameters P233 (S13) and P234 (S14).

The optimization parameters are reset before each new positioning process and they are continually updated during the positioning process.

#### Optimization parameters:

P233/P234 <sup>30</sup>	Meaning
1	Positioning time (from start of positioning to "Position reached")
2	max. intermediate circuit voltage in [V]
3	reserved
4	max. undershoot referenced to max. position (amount) (only for highly shifted loops)
5	max. position overshoot [units corresp. P90] (amount)
6	max. position undershoot [units corresp. P90] (amount)
7	max. acceleration lag error [units corresp. P90]
8	max. braking lag error [units corresp. P90]
9	max. acceleration speed in [%] of motor nominal speed
10	max. braking speed in [%] of motor nominal speed
11	max. acceleration current in [%] of motor nominal current
12	max. braking current in [%] of motor nominal current
13	max. time in current limit for acceleration, in [ms]
14	max. time in current limit for braking, in [ms]
56	square of peak motor current (reference value: 80 000A <sup>2</sup> )

Enter the corresponding number in the first column in the parameter. This means

- P233 determines status S13   ♦   P234 determines status S14

#### Description of optimization parameters

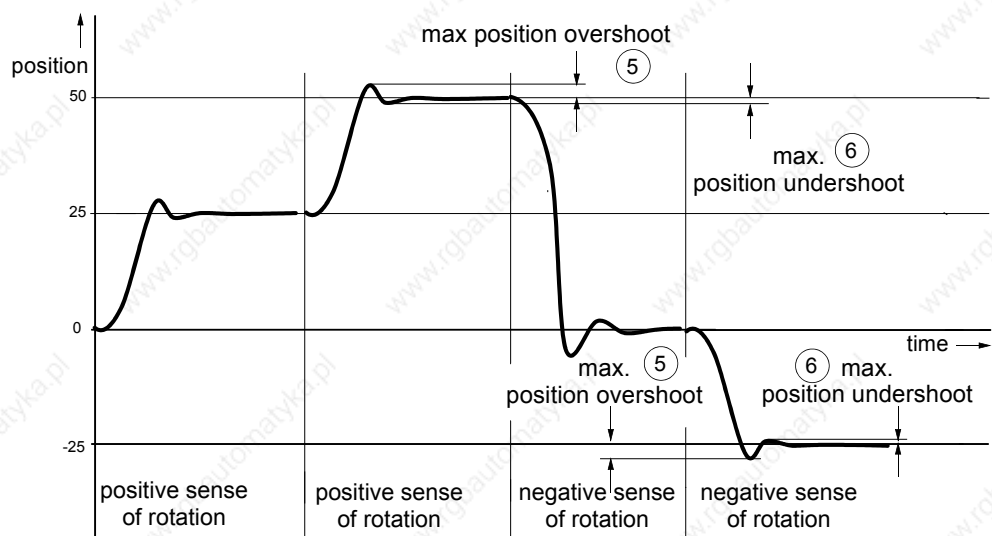

<sup>30</sup> P233/P234 are set as valid with VP

## Optimization display

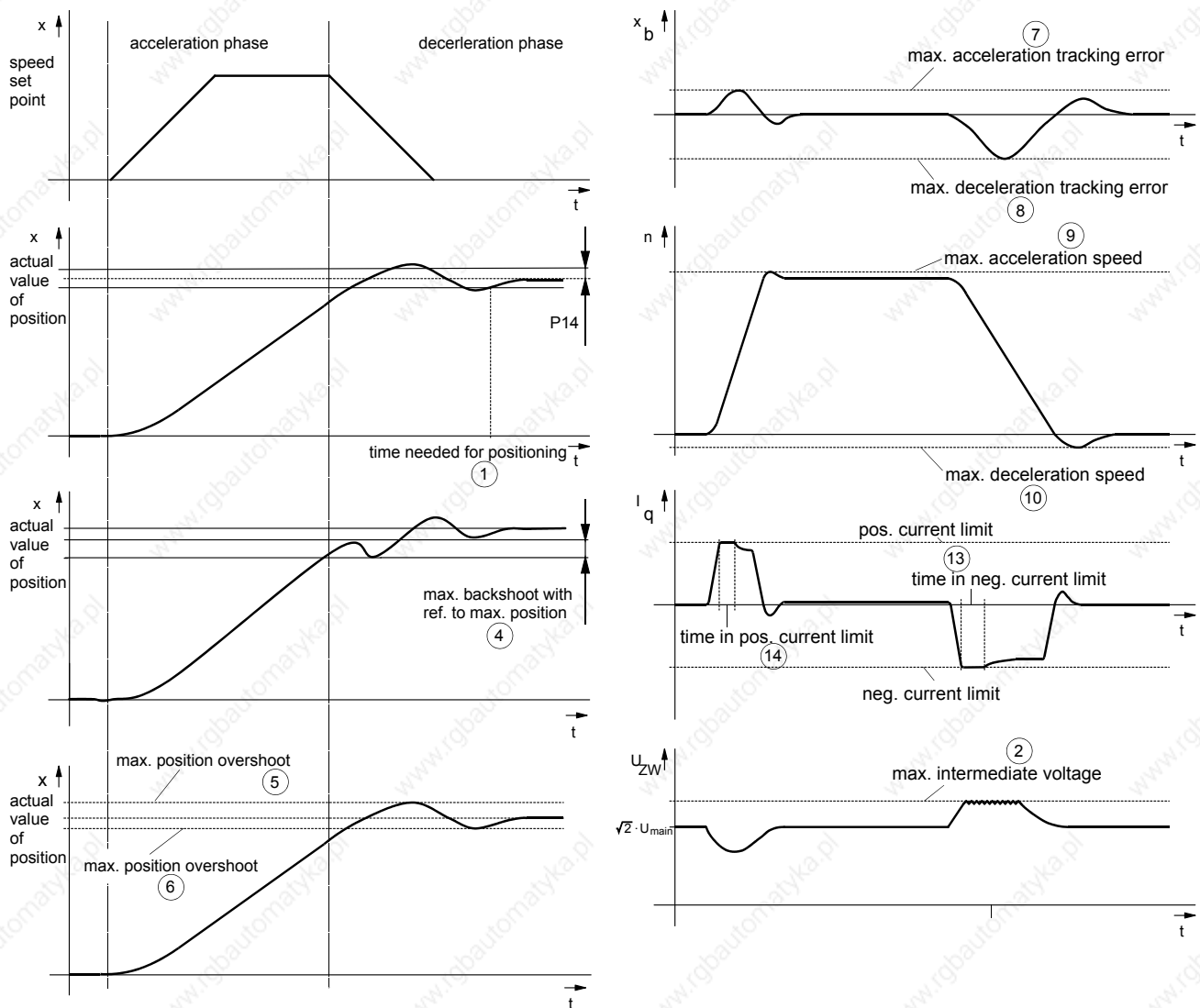

➡ You will find a complete status list on Page207.

### Square of peak motor current

**Reference value: 80 000A<sup>2</sup>**

The maximum peak current of a motor phase is continually determined once COMPAX is switched on and this is stored as status S13 or S14 using P233/234=56.

This display is generated as long as the motor is powered. The value is reset when COMPAX is switched off (after "OFF").

Obtaining the peak motor current using S13 (P233=56) as an example:

$$I_{max} = \sqrt{S13 * 80000A^2}$$

Use the effective value

$$I_{eff} = \frac{I_{max}}{\sqrt{2}}$$

to calculate the peak load within the motor cycle.

If this value rises to 1.5 times the peak current of the system, error E41 is triggered. You will find more detailed explanations on the limiting characteristics of COMPAX on Page 222.

#### Access to additional parameters via S13 and S14:

P233/P234	Meaning
15	Current number of HEDA transmission errors
16	Average no. of HEDA transmission errors per second
17	Total number of HEDA transmission errors since beginning of synchronization
18	Process nominal value received via HEDA
19	HEDA control word Bit 3 <sup>31</sup> : Transmission error COMPAX -> IPM Bit 8: fast start via HEDA
20	HEDA status word Bit 0="1": no errors (corresponds to COMPAX output O1) Bit 1="1": no warnings (corresponds to COMPAX output O2) Bit 3="1": transmission error IPM -> COMPAX Bit 8="1": COMPAX lag warning ("1" - in position, i.e. within lag warning window) Bit 9="1": HEDA interface active (COMPAX synchronized) Default setting: Bit 0="1", Bit 1="1", Bit 3="0", Bit 8="1", Bit 9="1": S13/S14=771
21	CPX X50 max. pos. synchronous lag error [units corresp. P90]
22	CPX X50 max. neg. synchronous lag error [units corresp. P90]
23	Output value of D/A monitor channel 0 (10V corresponds to 1)
24	Output value of D/A monitor channel 1 (10V corresponds to 1)
25	Output value of service D/A monitor channel 2 (10V corresp. to 1)
26	Output value of service – D/A monitor channel 3 (10V corresp. to 1)
27	External encoder position (units corresp. P90)
28	Measuring error (Difference between resolver position and external encoder position in the unit corresponding to P90)
29	Effective motor load in % of the permitted continuous motor load (E53 is indicated from 100%)
30	Effective unit load in % of the permitted continuous unit load (E53 is indicated from 100%)
31	Mark synchronization function indicator (COMPAX XX70)
32	"Scaled correction factor" (COMPAX XX70)
33	"Cycle counter" (COMPAX XX70)
35	Digital inputs I1-I16
36	Status S16 (bits 16...23) and digital outputs O1-O16 (bits 0...15)
37	Encoder frequency channel 4 in incr./ms" (COMPAX XX60, COMPAX XX7X)
39	Cause of calculation error E07 0 Invalid Operator 1 Division by 0 2 Overflow 3 Underflow

You will find the meanings of the DA monitor values on Page 52.

The corresponding number in the first column should be entered in the parameter. This means

- P233 determines status S13 ♦ P234 determines status S14



You will find additional special diagnosis values on Page 210.

<sup>31</sup> Bit counting begins with 0.

### 8.5.4 External position localization with position adjustment

#### Only available in COMPAX XX00!

The external position localization with position adjustment described below is only available in the standard unit (COMPAX XX00). Solutions adapted to specific applications are available in the unit variants.

A slip between motor position and the position of the drive (e.g. a material feed) is not detected. If the slip is too large, the external position can be entered (e.g. recorded by a measuring wheel) using encoder channel 1. In this way, COMPAX corrects the internal actual position value.

To limit access to the position adjustment, use P36 to limit the speed correction value resulting from the difference in positions.

This can be especially useful in the acceleration phase, if the material is slipping through because of the higher correction speed.

#### Recommendation:

To avoid all inaccuracies during internal calculations, it is important to use the measuring unit "Increments".

#### Configuring the external position adjustment:

Parameter	Meaning	valid from..
P75	<p>Maximum permitted measuring error (difference between resolver position and encoder position)</p> <p><b>The external position adjustment is enabled using measuring error P75 &gt; 0.</b></p> <p>When P75 is reached, error E15 is generated and the drive is switched off.</p> <p><b>Control position adjustment via digital input I11</b></p> <p>If the external position measurement and position adjustment (P75&gt;0) is switched off, position adjustment operation can be switched on and off using input I11. For this, assign I11 with this function via P232=4.</p> <p>I11="0": External position adjustment switched off (reaction time approx. 5 ms).</p> <p>I11="1": External position adjustment switched on.</p> <p>P232 becomes effective immediately and has a default value of 0. If P232=0, I11 will not have an effect on the position adjustment; this is then switched on and off using P75.</p> <p><b>Note!</b> If P232=4 (activated I11), I11 can no longer be used for GOTO / GOSUB EXT.</p>	VP
P36	<p>Limitation of speed correction value for external position adjustment (only available in COMPAX XX00 and COMPAX XX30)</p> <p>"0": switched off (default value)</p> <p>When P36=0, the speed correction value is not limited.</p> <p>P36 is specified in % of the nominal speed (P104).</p> <p><b>Note! When position localization is switched off, P36 must = 0!</b></p>	VP
P144	<p>Sets encoder channel 1</p> <p>= "4": without external position localization</p> <p>= "6": external position localization switched on via channel 1.</p>	VC
P143	<p>Number of encoder pulses per encoder rotation from channel 1; range: 120...2 000 000.</p>	VC
P98	<p>Travel of load per encoder rotation units (corresp. to P90).</p>	VC



Parameter	Meaning	valid from..
P214	Encoder direction. ="0": positive direction for encoder rotating clockwise. ="1": positive direction for encoder rotating anti-clockwise. <b>Setting aid:</b> <ul style="list-style-type: none"> <li>Switch off external position adjustment (P144=4) and data record P214=0.</li> <li>Note S42 (position of external sensor).</li> <li>Proceed with POSR x axis.</li> <li>S1 and S42 must change by the same value (x).                             <ul style="list-style-type: none"> <li>If the prefix of the modification is different, set data record P214="1".</li> <li>If the modification has a different amount, check P143 and P98.</li> </ul> </li> </ul>	VP



The command "SPEED SYNC" cannot be used in external position localization!

### Limit values of parameters

A number overrun is possible in special applications. To prevent this occurring, the following condition must be met:  $V \geq 1$

Determine V depending on drive type and measuring unit:

Drive type	Measuring unit	Determining V
Spindle drive	mm (inch)	$V = K \cdot P85 (\cdot 25,4)$
Rack-and-pinion/ toothed belt	mm (inch)	$V = K \cdot \frac{P85}{P82} (\cdot 25,4)$
General drive	mm (inch)	$V = K \cdot 1000 (\cdot 25,4)$
General drive	Incr.	$V = K$

Using

$$K = \frac{P98 \cdot 16384}{P83 \cdot P143}$$

### Slip filter for external position localization

A slip filter with a differentiating element (D-element) is provided to optimize external position adjustment.

No.	Meaning	Unit	Minimum value	Default value	Maximum value	Valid from...
P67	D-element slip filter	%	0	100	500	VP
P68	Slip filter lag	%	0	100	5000	VP

Both parameters are set to 100% as standard. The time constants are then identical and the filter ineffective. Meaning:

Parameter	Effect	Application
P67 = P68	Filter ineffective (standard)	
P67 < P68 or P67 = 0	Filter has delaying effect	<ul style="list-style-type: none"> <li>Low resolution of measuring system</li> <li>Interference on the measuring signal</li> </ul>
P67 > P68	Filter has differentiating effect	at high dynamic requirements. <b>Conditions:</b> high-resolution measuring system and low interference on the measuring signal.

## 8.6 Interfaces

The COMPAX interfaces for data and status are digital inputs with an PLC data interface, an RS232 interface and an optional bus interface (interbus S, CAN bus, CANopen, profibus, CS31 or RS485).

The RS232 interface can be operated simultaneously with other interfaces.

### 8.6.1 Digital inputs and outputs

To control the program process, 16 inputs and 16 outputs are available (8 inputs and 8 outputs with COMPAX 1000SL).

**I/O - assignment of standard unit**

➡ O7-O11 and I7-I11 are assigned when the PLC data interface is switched on.

Input	Assignment
I1 (X8/1; X19/x)	SHIFT
I2 (X8/2; X19/x)	Manual+
I3 (X8/3; X19/x)	Hand-
I4 (X8/4; X19/x)	Quit
I5 (X8/5; X19/x)	START
I6 (X8/6; X19/x)	Stop (interrupts data record)
I7 (X8/7; X19/x)	Freely assignable in the standard unit.
I8 (X8/8; X19/x)	Freely assignable in the standard unit.
SHIFT I2	Find machine zero (MZ)
SHIFT I3	Approach real zero (RZ)
SHIFT I4	Teach real zero
SHIFT I5	reserved
SHIFT I6	Break (breaks off data record)
I9 (X10/1; X19/x)	Freely assignable in the standard unit.
I10 (X10/2; X19/x)	Freely assignable in the standard unit.
I11 (X10/3; X19/x)	Assigned when P232=4 (activates position adjustment); otherwise free.
I12 (X10/4; X19/x)	Freely assignable in the standard unit.
I13 (X10/5; X19/x)	Freely assignable in the standard unit.
I14 (X10/6; X19/x)	Assigned when mark reference is activated (P35=1) (activates mark reference); otherwise free.
I15 (X10/7; X19/x)	Fast start (can be activated using P18)
I16 (X10/8; X19/x)	Is assigned if mark reference is activated (P35=1) (mark input); otherwise free.

➡ The assignment of inputs on X19 applies only to COMPAX 1000SL.

Output	Assignment
O1 (X8/9; X19/x)	= "1": No fault = "0": errors E1 ... E58; the drive does not accept any positioning commands. After "Power on" O1 remains at "0" until after the self test.
O2 (X8/10; X19/x)	= "1": No warning = "0": error $\geq$ E58
O3 (X8/11; X19/x)	Machine zero has been approached
O4 (X8/12; X19/x)	Ready for start
O5 (X8/13; X19/x)	Programmed nominal position reached
O6 (X8/14; X19/x)	Idle after stop
O7 (X8/15; X19/x)	Freely assignable in the standard unit.
O8 (X8/16; X19/x)	Freely assignable in the standard unit.
O9 (X10/9; X19/x)	Freely assignable in the standard unit.
O10 (X10/10; X19/x)	Freely assignable in the standard unit.
O11 (X10/11; X19/x)	Freely assignable in the standard unit.
O12 (X10/12; X19/x)	Freely assignable in the standard unit.
O13 (X10/13; X19/x)	Freely assignable in the standard unit.
O14 (X10/14; X19/x)	Freely assignable in the standard unit.
O15 (X10/15; X19/x)	Freely assignable in the standard unit.
O16 (X10/16; X19/x)	For "0": mark disappears after max. feed length <sup>32</sup>

➡ The assignment of outputs on X19 applies only to COMPAX 1000SL.

<sup>32</sup> Only assigned if the mark reference is activated (P35=1).

### 8.6.1.1 Digital inputs and outputs for COMPAX 1000SL

#### Allocation of logic inputs for input pins of X19

The source (input pin on X19) from which the respective logic input is to be read is specified via parameters P156, P157 and P158. Inputs which are not read by an input pin on X19 can be allocated a fixed "0" or "1" (this is not, of course, applicable for all inputs). The parameters are 24 bits large with 4 bits defined per logic input. This allocation can be easily done with the assistance of the ServoManager. With direct access via RS232, a terminal or a fieldbus, the following table can be used for setting the parameters.

Value:	Source fixed logical value (0 or 1) or pin of X19										factor	computed values	Allocation: Input reads from which source	Logical inputs
	=0	=1	/2	/3	/4	/5	/6	/7	/8	/9				
	0	1	2	3	4	5	6	7	8	9				
											1	Value * factor	P156 bit 0...3	Input 1
											16	+ Value * factor	P156 bit 4...7	Input 2
											256	+ Value * factor	P156 bit 8... 11	Input 3
											4096	+ Value * factor	P156 bit 12...15	Input 4
											65536	+ Value * factor	P156 bit 16...19	Input 5
											1048576	+ Value * factor	P156 Bit 20...23	Input 6
												Σ Total		
														<ul style="list-style-type: none"> <li>• Total ≤ 8 388 607: P156 = Total</li> <li>• Total &gt; 8 388 607: P156 = Total – 16 777 216</li> </ul>

											1	Value * factor	P157 bit 0...3	Input 7
											16	+ Value * factor	P157 bit 4...7	Input 8
											256	+ Value * factor	P157 bit 8... 11	Input 9
											4096	+ Value * factor	P157 bit 12...15	Input10
											65536	+ Value * factor	P157 bit 16...19	Input 11
											1048576	+ Value * factor	P157 Bit 20...23	Input 12
												Σ Total		
														<ul style="list-style-type: none"> <li>• Total ≤ 8 388 607: P156 = Total</li> <li>• Total &gt; 8 388 607: P156 = Total – 16 777 216</li> </ul>

											1	Value * factor	P158 bit 0...3	Input 13
											16	+ Value * factor	P158 bit 4...7	Input 14
											256	+ Value * factor	P158 bit 8...11	Input 15
											4096	+ Value * factor	P158 bit 12...15	Input 16
												Σ		

**Note** Note that only one selection can be made per line, i.e. only one cross is permitted!

### Example:

The following assignment must be configured:

- "0" → input 1
- X19 pin 3 → input 2
- X19 pin 4 → input 3
- X19 pin 5 → input 4
- X19 pin 6 → input 5
- X19 pin 7 → input 6
- "0" → input 7
- "0" → input 8
- "0" → input 9
- "0" → input 10
- "0" → input 11
- X19 pin 8 → input 12
- X19 pin 2 → input 13
- "1" → input 14
- "0" → input 15
- X19 pin 9 → input 16

Wert:	Source fixed logical value (0 or 1) or pin of X19									factor	computed values	Allocation: Input reads from which source	Logical inputs	
	=0	=1	/2	/3	/4	/5	/6	/7	/8					/9
X	1									1	0*1=0	P156 bit 0...3	Input 1	
			x							16	+ 3*16=48	P156 bit 4...7	Input 2	
				x						256	+ 4*256=1024	P156 bit 8...11	Input 3	
					x					4096	+ 5*4096=20480	P156 bit 12...15	Input 4	
						x				65536	+ 6*65536= 393216	P156 bit 16...19	Input 5	
							x			1048576	+ 7*1048576=7340032	P156 bit 20...23	Input 6	
Value of P156:											Σ	7 754 800	♦ Total ≤ 8 388 607 P156 = Total	
Value of P156:												7 754 800	♦ Total > 8 388 607 P156 = Total - 16 777 216	
x										1	0*1=0	P157 bit 0...3	Input 7	
x										16	+ 0*16=0	P157 bit 4...7	Input 8	
x										256	+ 0*256=0	P157 bit 8...11	Input 9	
x										4096	+ 0*4096=0	P157 bit 12...15	Input 10	
x										65536	+ 0*65536=0	P157 bit 16...19	Input 11	
							x			1048576	+ 8*1048576=8388608	P157 bit 20...23	Input 12	
Value of P157:											Σ	8 388 608	♦ Total ≤ 8 388 607 P156 = Total	
Value of P157:												-8 388 608	♦ Total > 8 388 607 P156 = Total - 16 777 216	
		x								1	2*1=2	P158 bit 0...3	Input 13	
	x									16	+ 1*16=16	P158 bit 4...7	Input 14	
x										256	+ 0*256=0	P158 bit 8...11	Input 15	
							x			4096	+ 9*4096=36 864	P158 bit 12...15	Input 16	
Value of P158:											Σ	36 882		

The remaining inputs stay open and are therefore not imported.  
You can see the calculation of the setting values on the right.

### Note

- It is in principle possible to read 2 inputs from the same input pin. Of course note should be taken of the resulting function.
- If you do not need the enable input I12, fixed logic "1" can be allocated.
- With P233=49 (or P234=49), physical inputs pin 9 – pin 2 are written to the optimization display status S13 (S14). Meaning: pin 2 = bit 0 ... pin 9 = bit 7.

## Digital inputs and outputs

### Allocation of output pins of X19 to the logic outputs

The target (output pin on X19) on which the respective logic output is to be written is specified via parameters P159 and P160. The parameters are 24 bits large with 4 bits defined for allocating each output to an output pin

This allocation can be easily done with the assistance of the ServoManager.

With direct access via RS232, a terminal or a fieldbus, the following table can be used for setting the parameters.

Outputs																factor	computed values	Allocation: output is assigned to pin X	X19 Output Pin		
value:	0	1	2	3	4	5	6	7	8	9	10	11	12	13	14					15	
																		1	Value * factor	P159 bit 0...3	/15
																		16	+ Value * factor	P159 bit 4...7	/16
																		256	+ Value * factor	P159 bit 8...11	/17
																		4096	+ Value * factor	P159 bit 15...11	/18
<b>Value of P159:</b>																Σ					

Outputs																factor	computed values	Allocation: output is assigned to pin X	X19 Output Pin		
value:	0	1	2	3	4	5	6	7	8	9	10	11	12	13	14					15	
																		1	Value * factor	P160 bit 0...3	/19
																		16	+ Value * factor	P160 bit 4...7	/20
																		256	+ Value * factor	P160 bit 8...11	/21
																		4096	+ Value * factor	P160 bit 11...15	/22
<b>Value of P160:</b>																Σ					

### Example:

The following assignment must be configured:

Output 1 → X19 Pin 15

Output 3 → X19 Pin 16

Output 4 → X19 Pin 17

Output 5 → X19 Pin 18

Output 8 → X19 Pin 19

Output 10 → X19 Pin 20

Output 14 → X19 Pin 21

Output 16 → X19 Pin 22

You can see the calculation of the setting values on the right.

Outputs																factor	computed values	Allocation: output is assigned to pin X	X19 Output Pin		
value:	0	1	2	3	4	5	6	7	8	9	10	11	12	13	14					15	
X																		1	0*1=0	P159 bit 0...3	/15
	X																	16	+ 2*16=32	P159 bit 4...7	/16
		X																256	+ 3*256=768	P159 bit 8...11	/17
			X															4096	+ 4*4096=16384	P159 bit 11...15	/18
<b>Value of P159:</b>																Σ	17184				
							X											1	7*1=7	P160 bit 0...3	/19
								X										16	+ 9*16=144	P160 bit 4...7	/20
									X									256	+ 13*256=3328	P160 bit 8...11	/21
										X								4096	+ 15*4096=61440	P160 bit 11...15	/22
<b>Value of P160:</b>																Σ	64919				

### Note

- With P233=49 (or P234=49 respectively) physical outputs pin 22 – pin 15 are written to the optimization display status S13 (S14). Meaning: pin 15 = bit 8 ... pin 22 = bit 15.

### 8.6.1.2 Free assignment of inputs and outputs

#### Free assignment of inputs

You can make the permanently assigned standard inputs I1 to I6 available for assignment using parameter P221. Meaning:

Input	Function without SHIFT	Function with SHIFT	Valency
I1 (X8/1)	SHIFT	-	1 (Bit 1) <sup>33</sup>
I2 (X8/2)	Manual+	Find machine zero (MZ)	2 (Bit 2)
I3 (X8/3)	Hand-	Approach real zero (RZ)	4 (Bit 3)
I4 (X8/4)	Quit	Teach real zero	8 (Bit 4)
I5 (X8/5)	START	reserved	16 (Bit 5)
I6 (X8/6)	STOP	Break (breaks off data record)	32 (Bit 6)

#### Setting P221

Each input is assigned a valency. Calculate the sum of the valencies of the required free inputs and enter this in parameter P221.

#### Example:

Hand+ and Hand- should be possible via the inputs; I1, I4, I5 and I6 should be freely available.

$$1 (I1) + 8 (I4) + 16 (I5) + 32 (I6) = 57$$

You will obtain this setting using P221 = 57.



Note that when I1 is freely assigned (SHIFT), you can no longer perform any "Functions with shift" via the inputs!



You can directly cancel all input functions (apart from Hand+ and Hand-) as commands using interfaces (RS232, bus system).

#### Free assignment of outputs

- The status outputs O1 to O6 can be freely assigned using parameter P225.
- Use P223 and P224 to assign the outputs of the OUTPUT WORD command of the bus systems (Interbus-S, Profibus, CAN – Bus, ...).
- Use P245 and P246 to assign the outputs of the HEDA bus (COMPAX with IPM via the option A1).
- Permanently assigned outputs of unit variants (COMPAX XX30, ...) cannot be masked.

#### Structural diagram

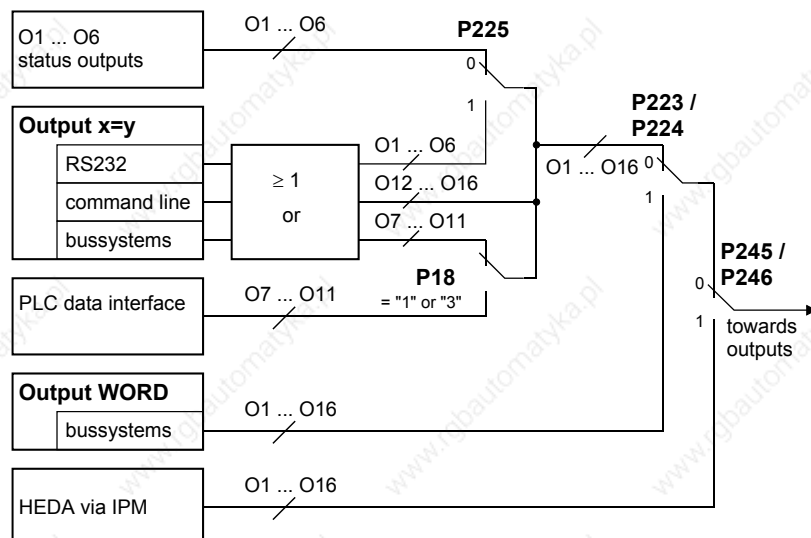

<sup>33</sup> Counting starts at 1.

## Digital inputs and outputs

### Explanation:

**P225: makes outputs freely available.**

The permanently assigned standard outputs O1 to O6 can be made freely available using parameter P225. Meaning:

Output	Function	Valency
O1 (X8/1)	= "1": No fault = "0": errors E1 ... E58	1 (Bit 1) <sup>34</sup>
O2 (X8/2)	= "1": No warning = "0": Error ≥ E58	2 (Bit 2)
O3 (X8/3)	Machine zero has been approached	4 (Bit 3)
O4 (X8/4)	Ready for start	8 (Bit 4)
O5 (X8/5)	Programmed nominal position reached	16 (Bit 5)
O6 (X8/6)	Idle after stop	32 (Bit 6)

### Setting P225

Each output is assigned a valency. Calculate the total of the valencies for the required free outputs and enter this in parameter P225.

### Example:

"Ready for start" and "Idle after stop" should be possible via the outputs; O1, O2, O3 and O5 should be freely available.

$$1 (O1) + 2 (O2) + 4 (O3) + 16 (O5) = 23$$

You will obtain this setting using P225 = 23.



Using the interfaces (RS232, bus systems) and using the data record program, the outputs can optionally (in parallel) be described using OUTPUT Ox=y.

### PLC data interface

When the PLC data interface is activated, the outputs must not be addressed using the interfaces (RS232, bus systems) or using the data record program.

### Note!

Simultaneous operation with the OUTPUT WORD command or with HEDA is not permitted!

### Switching to OUTPUT WORD command or to HEDA bus

**P223 / P224: switching to OUTPUT WORD command**

**P245 / P246: switching to HEDA bus**

Access to the outputs can be assigned as bits to the OUTPUT WORD command or to HEDA. Only the enabled outputs are then described by the OUTPUT WORD command or by HEDA.

<sup>34</sup> Counting starts at 1.



Outputs	OUTPUT parallel	HEDA
	P223	P245
O1	1 (Bit 1) <sup>35</sup>	1 (Bit 1)
O2	2 (Bit 2)	2 (Bit 2)
O3	4 (Bit 3)	4 (Bit 3)
O4	8 (Bit 4)	8 (Bit 4)
O5	16 (Bit 5)	16 (Bit 5)
O6	32 (Bit 6)	32 (Bit 6)
O7	64 (Bit 7)	64 (Bit 7)
O8	128 (Bit 8)	128 (Bit 8)
	P224	P246
O9	1 (Bit 1)	1 (Bit 1)
O10	2 (Bit 2)	2 (Bit 2)
O11	4 (Bit 3)	4 (Bit 3)
O12	8 (Bit 4)	8 (Bit 4)
O13	16 (Bit 5)	16 (Bit 5)
O14	32 (Bit 6)	32 (Bit 6)
O15	64 (Bit 7)	64 (Bit 7)
O16	128 (Bit 8)	128 (Bit 8)

#### Setting P223, P224, P245, P246

Each output is assigned a valency. Calculate the total of the valencies of the required outputs and enter this in the relevant parameter.

#### Example:

O4 to O16 should be influenced by the OUTPUT WORD command; O1, O2 and O3 should be available via OUTPUT Ox=y.

$$8 (O4) + 16 (O5) + 32 (O6) + 64 (O7) + 128 (O8) = 248$$

When P223 = 248 and P224 = 255 (total of all valencies), you will obtain this setting.

### 8.6.1.3 COMPAX virtual inputs

COMPAX provides 48 logic inputs. These are divided into:

- inputs I1 ... I16 which are actuated via the physical inputs.
- virtual inputs I17 ... I32 which are activated via a fieldbus (object CPX\_STW).
- virtual inputs I33 ... I48 which are activated via a COMPAX command (OUTPUT O33 ... OUTPUT O48, or abbreviated: OT O33 ... OT O48).

#### Access to COMPAX control functions

Access to COMPAX control functions (functions which are allocated to inputs I1...I16 by default) can be configured via parameters P221 and P222 (see structural diagram on the right).

The allocation of the bits in P221 and P222 respectively to the relevant inputs can be found in the parameter description)

<sup>35</sup> Counting starts at 1.

## Digital inputs and outputs

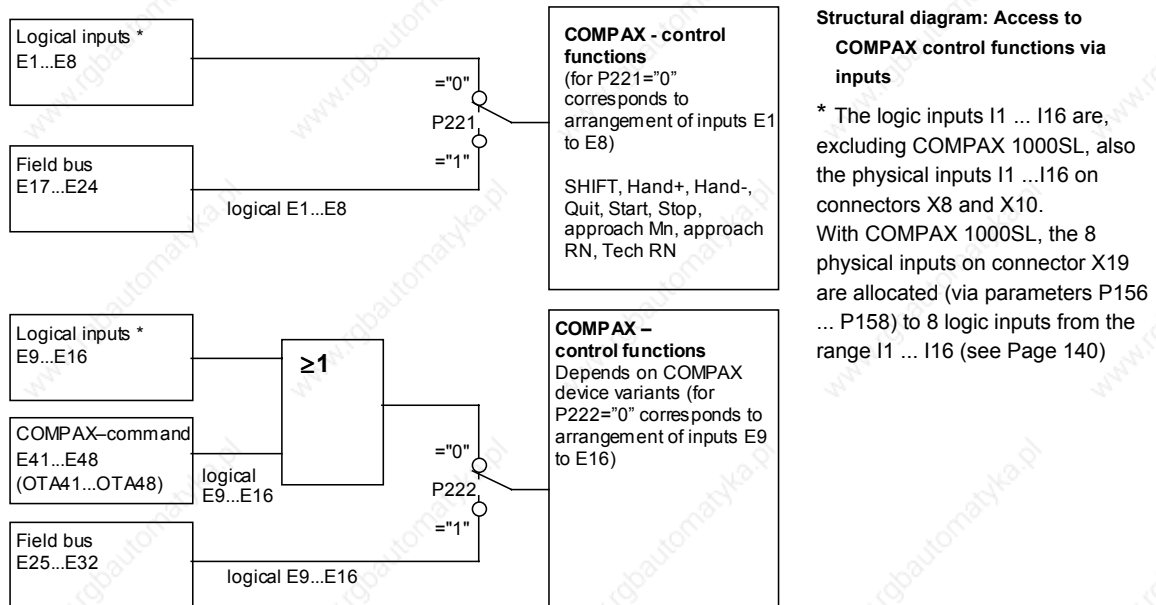

### Remarks regarding the structural diagram

- The control functions corresponding to I1.. I8 **cannot** be activated via OT O33...OT O40.
- The control functions corresponding to I9...I16 can be activated simultaneously via the physical inputs and via OT O41...OT O48.
- The enable input I12 (in COMPAX 1000SL, COMPAX XX70 and COMPAX XX30) must also be activated when allocated to the fieldbus (via P222).

### Interrogation of inputs in the COMPAX program (IF I ..)

All inputs can be interrogated independently of parameters P221 and P222 in the COMPAX program with IF I... .

The virtual inputs I33...I48 in the COMPAX program can also be set via the commands OT O33...OT O48.

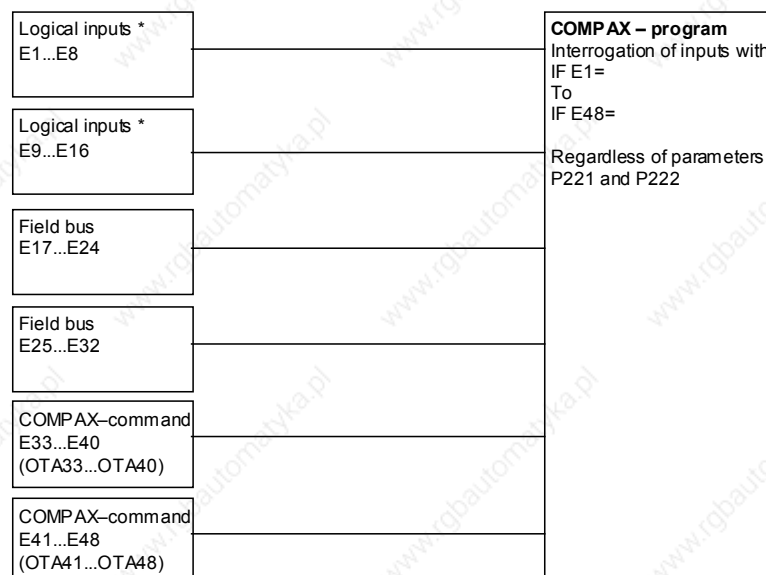

With P233=48 (or P234=48), virtual inputs I48 – I25 are written to the optimization display status S13 (S14). Meaning: I25 = bit 0 ... I48 = bit 23.

#### 8.6.1.4 I/O assignment of variants

##### COMPAX XX30: Round table control

- I12: final stage enable
- I13: measuring error compensation by external position measurement
- I14: release brake
- O14: no measuring error
- O16: no power to final stage

##### COMPAX XX50: Synchronous cycle control

- I6: STOP ineffective during synchronization process.
- I1 & I6: BREAK interrupts the synchronization process.
- I12: Material simulation
- I13: Manual step
- I14: Switches on mark reference
- I15: Ends synchronous travel  
(The "Fast start" function is not possible)
- I16: Mark input
- O5: Position reached at synchronization command (WAIT POSA, WAIT POSR)  
="0": when the axis starts  
="1": after return run.
- O14: Synchronous comparator
- O15: Chaff length
- O16: Reject length

##### COMPAX XX60: Electronic transmission

- I14: Switches over the dimension reference
- I15: Transmission factor selection
- I16: Enable master nominal value

##### COMPAX XX70: Cam control

- I12: Enable final stage
- I13: ="0": Decoupling = "1": Coupling
- I14: Mark input
- I15: ="0": Disables auxiliary functions ; = "1": Enables auxiliary functions
- I16: Enables master position
- O7...O14: Digital auxiliary functions.
- O13/O14: Cannot be used via OUTPUT.
- O14: Mark not in mark window.
- O15: Lag warning
- O16: Synchronous run



**Please refer to the instructions for the variant you are using for up-to-date information!**

### 8.6.1.5 Function of inputs

When working with pre-assigned inputs, always note the following:

- The SHIFT signal (I1) may only change if I2...I5 = "0".

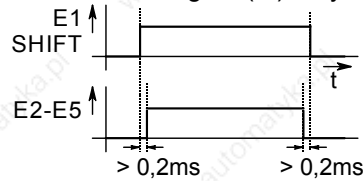

- The "STOP" and "BREAK" functions (input I6) have top priority.
- For the inputs I1 to I5, only the first input present will be detected and the relevant function activated. The other functions are then blocked; this means, e.g.: If Quit (I4) is set during a process involving Hand+ (I2="1"), Quit is not detected even after I2="0". A new rising flank will be required for Quit (I4).

#### Exception: START

If a program is interrupted by STOP when START is present (I5), the program is then continued using I6="0" (STOP is deactivated).

Length of signal  $\geq$   
1ms

For sure detection, the signals must be present for  $\geq$  1ms.

#### SHIFT

##### Input I1



- Switches to the functions for inputs I2 to I6.
- Signal I1 may only change if I2...I6 = "0".

#### Hand+/Hand-

##### Input I2/I3



- Processes the axis in manual mode (velocity: P5; ramp time: P9).
- Conditions for manual procedure:
  - The axis must be stationary and powered.
  - There must not be any programs running (exception: program is at WAIT START).
  - When the end limits are reached (P11, P12), the drive is stopped.
- The outputs O5 "Nominal position reached" and O4 "Ready for START" are at "0" during manual mode; O5 remains at "0" even once manual mode has been completed.

#### QUIT

##### Input I4



- Acknowledges an error message or warning.
- If the error is rectified, O1 "No fault" or O2 "No warning" is set.
- The following functions are possible when there is an error present:
  - VP, VC, VF
  - Quit
  - OUTPUT O0
  - GOTO data record indicator / password

### START

#### Input I5



- Starts the program data record at WAIT START, after Power On and after STOP.
- Performs the next data records (commands) before the next WAIT START command, an END instruction or a STOP or BREAK signal.
- O4 "Ready for start" is reset.

#### Note!

- Once a positioning process has been interrupted by STOP (I6="1"), the process can be continued, when START (I5="1") is present, using a descending flank at STOP (I6="0").

Temporal course of a start sequence:

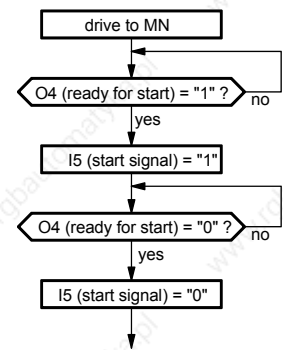

### STOP

#### Input I6



- The positioning process is interrupted using "1" and the axis is stopped in a controlled manner.
- O4 "Ready for start" and O6 "Idle after stop" = "1".
- A new start command is required to complete the positioning process. When START is present, resetting the STOP signal is sufficient (I6="0").

### Find MZ

#### Input SHIFT I2



- Finds the machine zero point (when using reversing initiators: process velocity: P3 - the direction of the search can be determined using the P3 sign ; ramp time: P7).
- Once the MZ is reached, output O3 "Machine zero approached" is set. This remains set until another "Find MZ" order is issued.
- Output O5 "Programmed position reached" = "0".
- The data record indicator is reset to N001.
- Reference travel, prompted by the digital inputs, interrupts a positioning command specified by the interfaces (POSA, POSR, LOOP).

### Approach RZ

#### Input SHIFT I3



- The axis travels to the real zero point (process velocity: P4; ramp time: P8).
- O4 "Ready for start" = "0" until RZ is reached.
- Output O5 "Programmed position reached" = "0", and once real zero is approached = "1".
- Data record indicator is reset to N001.
- In continuous mode the axis does not move; the data record indicator is set to N001.

### Teach in real zero (Teach Z)

#### Input SHIFT I4



- The current position of the axis is used as the reference point (real zero) for all positioning instructions; i.e. P1 is modified.
- The data record indicator is set to 1.
- The real zero is stored protected against power failure.
- O4 "Ready for start" is not modified.
- The teach in function can be switched off using P211.
- The function does not operate in continuous mode.

## Digital inputs and outputs

### Input SHIFT I5

- When P211="3", the data record indicator is set to 1 using "Shift I5".

### P211: blocking and modifying teach in functions

P211	Function
= 0	The functions I1 + I4, Teach N, I1 + I5 and Teach Z are enabled.
= 1	Teach Z is blocked; the data record indicator is set to 1 using I1 + I4 or "Teach Z".
= 2	Teach N is blocked; the data record indicator is set to 1 using I1 + I5 or "Teach N". (Teach Z is enabled)
= 3	The functions Teach N and Teach Z are blocked. With I1 + I4, Teach N, I1 + I5 or Teach Z, the data record indicator is set to 1.

### Break

### Input SHIFT I6











- The positioning process is interrupted, the axis is stopped.
- O4 "Ready for start" is reset.
- The program data record is not ended after a start. The next data record applies.

### EMERGENCY STOP

- During an EMERGENCY STOP, the data record is interrupted, the drive brakes with braking time P10; after P10, the motor is switched off.
- The interrupted data record is continued to its completion after acknowledgment and START.

Transfers that trigger functions are described. All other transfers and statuses do not trigger any functions.

### Triggering functions:

Function	I1	I2	I3	I4	I5	I6
Start Hand+	0		0	0	0	0
End Hand+	X		X	X	X	0
Start Hand-	0	0		0	0	0
End Hand-	X	X		X	X	0
QUIT	0	0	0		0	0
START	0	0	0	0		0
START	0	0	0	0	1	
STOP	0	X	X	X	X	1
Find MZ	1		0	0	0	0
Approach RZ	1	0		0	0	0
Teach - RZ	1	0	0		0	0
SHIFT I5	1	0	0	0		0
BREAK	1	X	X	X	X	1

### Activate position adjustment

### Input I11

- Function is switched on by P232="4" (see Page 136).
- I11="0": External position adjustment switched off (reaction time approx. 5 ms).
- I11="1": External position adjustment switched on.

### Fast start

### Input I15



### Special START input

- Input for fast and defined starting of positioning process.
- The "Fast start" function is switched on using P18=2 or 3 (when using P18=3, the PLC data interface is also switched on).
- When I15="0", all positioning processes (POSA, POSR) are blocked.
- When I15="1", positioning processes are started. I15 has no influence during a positioning process.
- A positioning process interrupted with STOP is continued using START (I5="1") and "Fast START" (I15="1").
- The reaction time of I15 before the start of the positioning process is 1.5 ms.
- I15 has no effect in speed control mode.

➡ **Note!** The START signal (I5) is not replaced by I15; after STOP, a START signal (I5) is required to start the program and for WAIT START.

### 8.6.1.6 Synchronous STOP using I13

I13 in the standard model (COMPAX XX00) provides a STOP function with which you can stop and idle multiple COMPAX units simultaneously, regardless of the current speed.

### Synchronous STOP:

P219=128 or 135 enables the synchronous stop via I13 (P219 bit 7<sup>36</sup>=1).

I13="1": Normal mode

I13="0": Synchronous STOP is activated.

After I13="0"

- the drive is stopped using P10 as the **absolute ramp time** and
- the ramp type selected via P94<sup>37</sup>.
- Error message E08 is output,
- O1 is set to 0 and
- the ready contact is opened.

While I13=0, any further positioning attempts are negatively acknowledged with E08. No negative acknowledgment comes from HEDA.

➡ Synchronous STOP function using I13 is only available on the standard unit (COMPAX XX00).

### Diagram:

Stop using I6

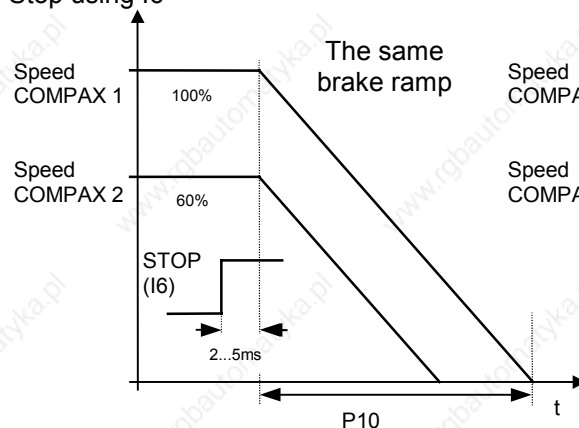

Stop using I13

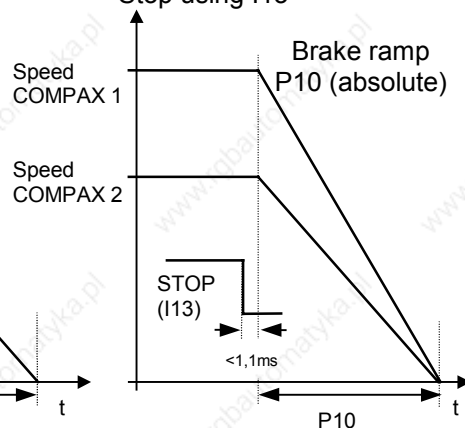

➡ Using I13 for stop bring both axes to a stop simultaneously.

<sup>36</sup> Bit counting begins with bit 0.

<sup>37</sup> A modified ramp time is used after "VC" for the "Synchronous stop via I13" function.

## Digital inputs and outputs

**Note for MZ travel:** If MZ travel is interrupted by the synchronous stop, then O3 "Machine zero approached" is not output.

### Additional assignment of P219:

P219 = xx000000=0: COMPAX-M does not evaluate the additional emergency stop input.

(Additional emergency stop input: X9/5-X9/6 (front plate); COMPAX-M only)

P219 = xx000111=7: Emergency stop with P10 as relative ramp time, then switch off, message E56, display E56, output O1 = 0, ready contact removed.

Also effective in programming mode!



#### 8.6.1.7 Function of outputs

##### No fault

##### O1

- O1="1" if there is no error for group E1 ... E57.
- O1="0" if there is an error for group E1 ... E57; the drive does not accept positioning commands.

##### No warning

##### O2

- O2="1" if there are no errors  $\geq E58$ .
  - O2="0" if there is an error  $\geq E58$ .
- O2 is assigned the "Idle display" function via P227 bit 1="1" (see Page ).119

##### Machine zero has been approached

##### O3

- When "1" is displayed, this indicates that a reference system has been defined, i.e. there is information about the position of machine zero.
- When in "Normal mode", positioning is only possible when O3="1".
- By using an absolute value sensor and the relevant option (O1), O3="1" remains as such even if the unit has been switched off in the meantime.
- Once the "Find machine zero" function has been activated (I1&I2="1"), O3="0" until machine zero is found.

##### Ready for start

##### O4

- "Ready for START" is used for program control.
- O4 is set,
- if the program is at a WAIT START instruction and waiting for the START signal,
- after an interruption with STOP or BREAK and these signals are no longer present,
- after a corrected error condition and
- after Power On.
- at program end with the END command.
- O4 has no significance for direct command specifications.

##### Position reached

##### O5

- O5 is set to "0" when starting a positioning process; this applies for POSA, POSR, WAIT POSA, WAIT POSR, approach real zero, approach machine zero, Hand+, Hand-.
- O5 is set once the positioning has been completed in the correct manner. This applies for POSA, POSR, WAIT POSA, WAIT POSR, approach real zero. POSR 0 causes the brief resetting of O5.
- Conditions for O5="1":
- The actual position value is in the positioning window (+/-P14) and
- the nominal value sensor has reached the target point of the nominal value specification.
- O5 is set in speed control mode, if the nominal value generator has processed the speed ramp.

### Idle after stop or break

#### O6

- O6="1" indicates that the axis is at a standstill due to a STOP (I6) or BREAK (I1&I6).
- O6 is reset when the axis moves again.

### Mark missing after maximum feed length

#### O16

- Only assigned if mark reference is activated (P35=1).
- With "0", the mark disappears once the maximum feed length is reached (see Page 100)

### 8.6.1.8 Diagrams:

#### In data record memory mode

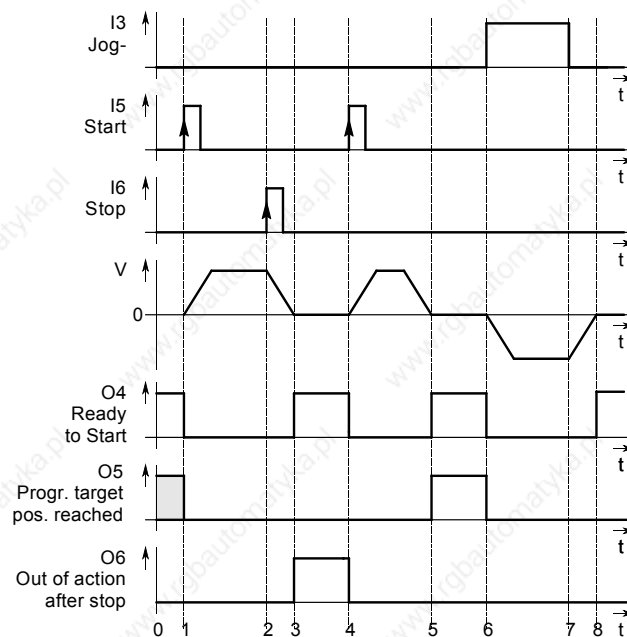

- Caption:**
- 0 COMPAX ready for new start.
  - 1 When using START at input I5, the outputs O4 and O5 are reset. The axis moves.
  - 2 Interruption using STOP at input I6. After idle, message at output O6 (3).
  - 4 START using I5. Positioning process is continued.
  - 5 Positioning process ended. Message via O4 and O5="1".
  - 6 Manual processing of axis. O5 and O4 ="0".
  - 7 Specification for manual processing ended. Drive decelerates.
  - 8 Manual process ended. Drive at standstill. Ready message for output O4 is set.

### Direct command specification

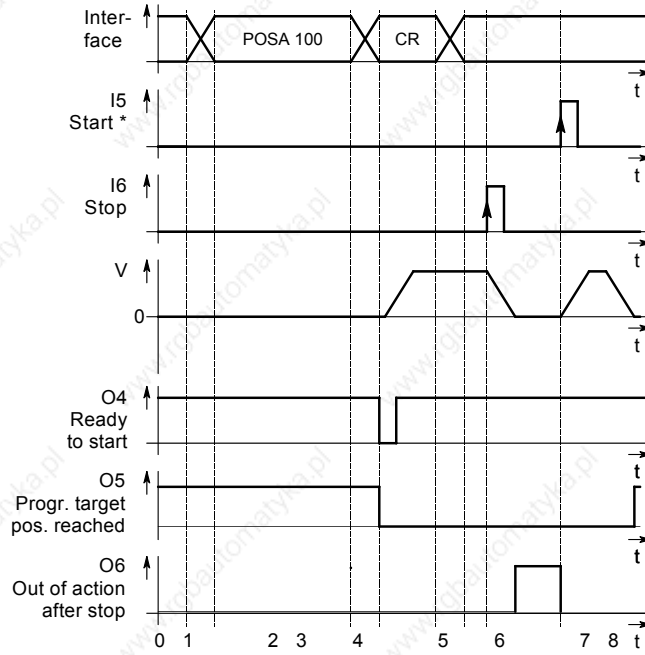

\* When using this START, a processing command interrupted by STOP and specified by a interface is restarted.

### Finding machine zero in normal mode

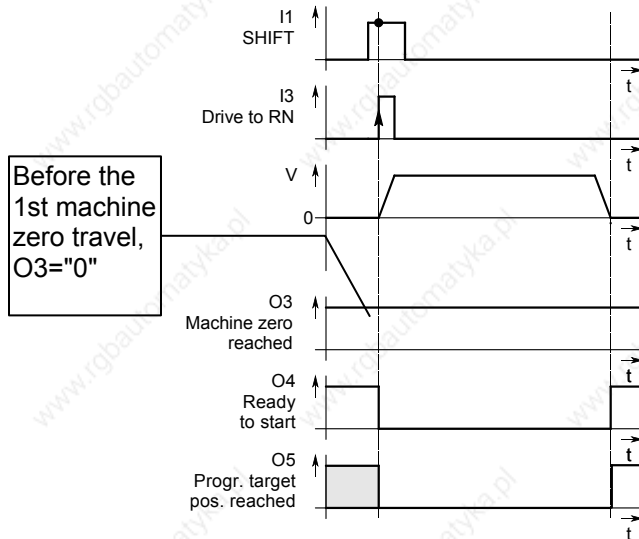

### Approaching real zero

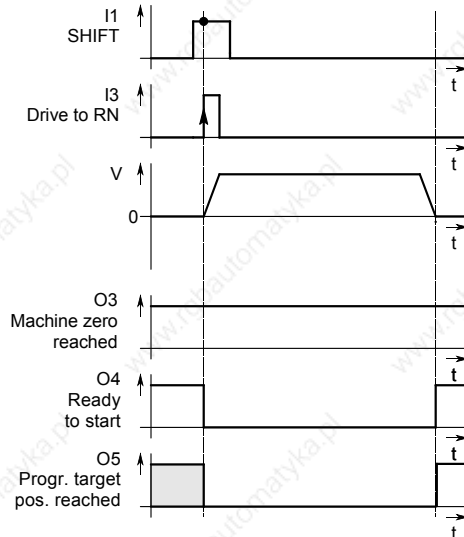

## 8.6.2 PLC data interface (function not available with COMPAX 1000SL)

This universal data interface allows data to be exchanged with all PLC types, regardless of manufacturer and origin. You will need five binary inputs and outputs for this process. These can be divided into four data lines (BCD format) and one control line.

### Functions available:

- Direct commands
- Absolute and relative positioning commands (POSA, POSR)
- Specification of acceleration time and velocity (ACCEL, SPEED)
- Password enabling or modifying data record indicator (GOTO)
- Queries of status S1...S12 (actual values).
- Modifying parameters P1...P49 with defined parameter acceptance (VP).

### Activation:

The PLC data interface is activated by setting P18 (P18="1" or "3". When it is "3", the "Fast start" function I15 is also switched on) and by switching off and on. The following binary inputs and outputs are assigned:

Input/output	Meaning
I7 (X8/7)	Control line "UBN"
I8 (X8/8)	Data bit 2 <sup>0</sup>
I9 (X10/1)	Data bit 2 <sup>1</sup>
I10 (X10/2)	Data bit 2 <sup>2</sup>
I11 (X10/3)	Data bit 2 <sup>3</sup>
O7 (X8/15)	Control line "RDY"
O8 (X8/16)	Data bit 2 <sup>0</sup>
O9 (X10/9)	Data bit 2 <sup>1</sup>
O10 (X10/10)	Data bit 2 <sup>2</sup>
O11 (X10/11)	Data bit 2 <sup>3</sup>

⇒ O7...O11 are no longer available for the OUTPUT command. The GOSUB EXT and GOTO EXT commands are no longer permitted when P18="1". Instead use the GOTO command.

Each transfer begins with the start letter "E" and ends with the end letter "F". In between them is the command. This consists of two BCD numbers (called function code) for the command type and of numerical values for position, velocity, acceleration time, etc. The numerical values can contain special figures:

Figure BCD coded	Meaning
"D" ≡ "1101"	Negative prefix
"0" ≡ "0000"	Positive prefix
"C" ≡ "1100"	Decimal point
"A" ≡ "1010"	Assignment "="

⇒ Use status S29 to e.g. track the interface data via the front plate display.

### Syntax of individual commands:

#### Positioning commands POSA, POSR

Start sign	"E" ≡ "1110"
Function code 1:	"0" ≡ "0000"
Function code 2:	"1" ≡ "0001": POSA "2" ≡ "0010": POSR
Sign	"0" ≡ "0000": positive "D" ≡ "1101": negative
Numerical value	10 <sup>6</sup>
Numerical value	10 <sup>5</sup>
Numerical value	10 <sup>4</sup>
Numerical value	10 <sup>3</sup>
Numerical value	10 <sup>2</sup>
Numerical value	10 <sup>1</sup>
Numerical value	10 <sup>0</sup>
Decimal point	"C" ≡ "1100"
Numerical value	10 <sup>-1</sup>
Numerical value	10 <sup>-2</sup>
Numerical value	10 <sup>-3</sup>
End sign	"F" ≡ "1111"

#### Velocity specification SPEED

Start sign	"E" ≡ "1110"
Function code 1:	"0" ≡ "0000"
Function code 2:	"4" ≡ "0100"
Sign	"0" ≡ "0000": positive "D" ≡ "1101": negative
Numerical value	10 <sup>1</sup>
Numerical value	10 <sup>0</sup>
Decimal point	"C" ≡ "1100"
Numerical value	10 <sup>-1</sup>
Numerical value	10 <sup>-2</sup>
Numerical value	10 <sup>-3</sup>
End sign	"F" ≡ "1111"

#### Acceleration time ACCEL

Start sign	"E" ≡ "1110"
Function code 1:	"0" ≡ "0000"
Function code 2:	"5" ≡ "0101"
Sign	"0" ≡ "0000": positive "D" ≡ "1101": negative
Numerical value	10 <sup>4</sup>
Numerical value	10 <sup>3</sup>
Numerical value	10 <sup>2</sup>
Numerical value	10 <sup>1</sup>
Numerical value	10 <sup>0</sup>
End sign	"F" ≡ "1111"

#### Adjust data record indicator / enable password: GOTO

Start sign	"E" ≡ "1110"
Function code 1:	"0" ≡ "0000"
Function code 2:	"6" ≡ "0110"
Numerical value	10 <sup>2</sup>
Numerical value	10 <sup>1</sup>
Numerical value	10 <sup>0</sup>
End sign	"F" ≡ "1111"

PLC data interface (function not available with COMPAX 1000SL)

## Modify parameters P1...P49

Start sign	"E" ≡ "1110"
Function code 1:	"1" ≡ "0001"
Function code 2:	"3" ≡ "0011"
Parameter No. tens column	
Parameter No. digits column	
Assignment code: "A"	≡ "1010"
Sign	"0" ≡ "0000": positive "D" ≡ "1101": negative
Numerical value 10 <sup>6</sup>	
Numerical value 10 <sup>5</sup>	
Numerical value 10 <sup>4</sup>	
Numerical value 10 <sup>3</sup>	
Numerical value 10 <sup>2</sup>	
Numerical value 10 <sup>1</sup>	
Numerical value 10 <sup>0</sup>	
Decimal point	"C" ≡ "1100"
Numerical value 10 <sup>-1</sup>	
Numerical value 10 <sup>-2</sup>	
End sign	"F" ≡ "1111"

## Acceptance of VP parameter

Start sign	"E" ≡ "1110"
Function code 1:	"1" ≡ "0001"
Function code 2:	"4" ≡ "0100"
End sign	"F" ≡ "1111"

## Status query S1...S12 (actual values)

Start sign	"E" ≡ "1110"
Function code 1:	"1" ≡ "0001"
Function code 2:	"6" ≡ "0110"
Numerical value 10 <sup>1</sup>	
Numerical value 10 <sup>0</sup>	
End sign	"F" ≡ "1111"

## Status response S1...S12 (actual values)

Start sign	"E" ≡ "1110"
Sign	"0" ≡ "0000": positive "D" ≡ "1101": negative
Numerical value 10 <sup>6</sup>	
Numerical value 10 <sup>5</sup>	
Numerical value 10 <sup>4</sup>	
Numerical value 10 <sup>3</sup>	
Numerical value 10 <sup>2</sup>	
Numerical value 10 <sup>1</sup>	
Numerical value 10 <sup>0</sup>	
Decimal point	"C" ≡ "1100"
Numerical value 10 <sup>-1</sup>	
Numerical value 10 <sup>-2</sup>	
Numerical value 10 <sup>-3</sup>	
End sign	"F" ≡ "1111"

The following signs are not necessary when transferring:

- Positive prefixes and initial zeros.
- For whole number values: the decimal point and the figures after the decimal point.

#### Function codes of commands

Function code BCD coded		Command
F-code1	F-code2	
0	1	POSA
0	2	POSR
0	4	SPEED
0	5	ACCEL
0	6	GOTO
1	3	Modify parameters (P1-P49)
1	4	VP (valid parameter)
1	6	Query status (S1-S12)

#### Procedure for transmitting a sign

- PLC assigns the sign (4 bit) to I8...I11.
- Once the data is stable, the PLC sets the UBN to "1".
- COMPAX reads the sign and sets RDY to "0".
- PLC sets UBN to "0".
- COMPAX sets RDY to high.

**Exception:** If the data direction is then reversed, COMPAX can set the RDY line to "0". This is the case for the last sign of a status query.

#### Process for receiving a sign

- PLC sets UBN to "1".
- COMPAX assigns the sign (4 bit) to O8...O11.
- COMPAX sets RDY to "1"
- PLC reads the sign and sets UBN to "0".
- COMPAX sets RDY to "0".

**Exception:** If the data direction is then reversed, COMPAX can set the RDY line to "1". This is the case for the last sign of a status response.

#### Signal procedure using the example of a status query

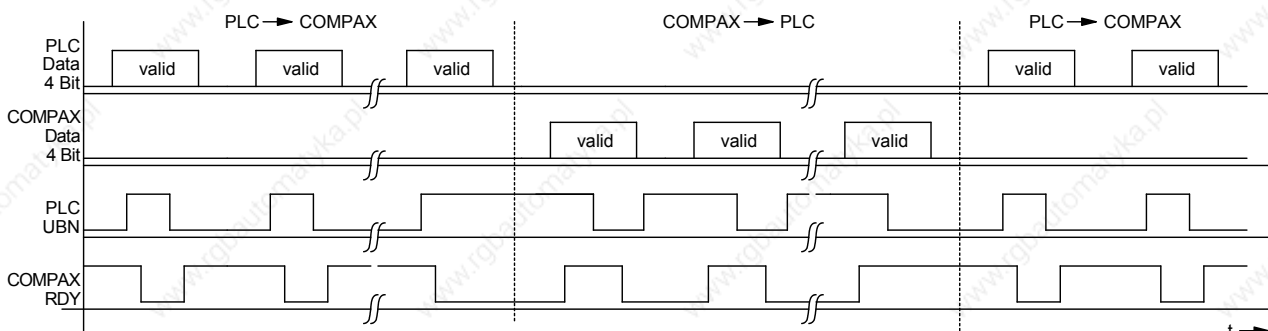

➡ It is important that the data ready message is only assigned after the data (when using PLC, one cycle later); i.e. once the data has been safely assigned.

#### Reset interface

If a fault means that the signal "RDY" is missing, the interface can be reset to its initial status using signal "E" (start sign). The next "UBN" is then detected even though "RDY" is missing.

### 8.6.3 RS232 interface

You can communicate with COMPAX via an RS232 interface on a PC. The following functions are available.

- Direct command input and execution in on-line mode.
- Read status values.
- Read and write program data records (the complete stock of commands is available here).
- Read and write (password protected) parameters.
- Transmit control instructions.

#### 8.6.3.1 Interface description

Interface parameters

<b>Interface</b>	RS 232
<b>Baud rate:</b>	9600* or 4800 (selected with P19) COMPAX 1000SL: fixed setting 9600
<b>Word length:</b>	8 bit
<b>Stop bit:</b>	1
<b>Parity:</b>	none
<b>Hardware handshake:</b>	yes (RTS,CTS)
<b>Software handshake:</b>	XON, XOFF (can be selected using P20)
<b>Entry buffer:</b>	error string, max. 30 characters
<b>Output buffer:</b>	status string, max. 30 characters
<b>Data format:</b>	ASCII
<b>End sign:</b>	C <sub>R</sub> (carriage return) or C <sub>R</sub> L <sub>F</sub> (carriage return, line feed)

\* Default setting; simultaneously press the three front plate buttons while switching on to set COMPAX to 9600 Baud.

COMPAX receives

- all displayable ASCII characters
  - any inserted spaces
  - a function sign, if nec. (\$, ?, !)
  - C<sub>R</sub> (carriage return) for storing the command in the intermediate memory. If no function signs have been transmitted, the command is accepted and executed if necessary (see next page).
  - L<sub>F</sub> (line feed) has no meaning to COMPAX
- ⇒ COMPAX only receives a command if a previously transmitted command was answered with C<sub>R</sub> L<sub>F</sub> >.

COMPAX responds:

Meaning of function signs

- if the syntax is error-free with C<sub>R</sub> L<sub>F</sub> > or the required response and C<sub>R</sub> L<sub>F</sub> >
- if there are errors, depending on the contents of P20

\$	<b>Automatic "Position reached" message</b> 1. only applies to POSA and POSR 2. COMPAX transmits: \$C <sub>R</sub> L <sub>F</sub> > when the position is reached.
'	<b>Interpreting and storing commands</b> COMPAX stores the instruction in the intermediate memory (capacity: one instruction) without executing it.
?	<b>Echo</b> COMPAX sends the data received with C <sub>R</sub> L <sub>F</sub> >.
!	<b>Executing commands</b> Whenever a "!" occurs, the instruction is executed from the intermediate memory.

These function signs can be attached to any instruction.

Example:

POSA 100 \$ C<sub>R</sub> L<sub>F</sub>

COMPAX moves and responds once position 100 is reached with: \$ C<sub>R</sub> L<sub>F</sub> >



### P20: Software handshake (SH) / error transmission

Function	Activation using P20	Valid from
Software handshake	"0": without "1": with XON, XOFF	Power on
Error transmission	"0": Error only when there is activity at the interface and if the transmitted command triggers an error. No negative command acknowledgement (E90 ...E94). "2": No transmission of error or negative command acknowledgments (E90 ...E94). "4": Messages are indicated for all errors and negative command acknowledgments (E90 ...E94) when they occur using $C_R L_F >$ . "6": Error and negative command acknowledgement (E90 ...E94) only when there is activity at the interface.	Immediately
End sign selection	"0": $C_R L_F >$ "8": $C_R$	Power on
Binary transfer	"0": without      "16": with	Immediately
BCC: Block check	"0": without      "128": with (EXOR via all signs apart from the end sign)	Power on

⇒ Implement the required setting by entering the sum of the set values in P20.

### Example in Quick-Basic of how to transmit and receive COMPAX data via the RS232 interface.

<pre> DIM text\$(30) a\$="com1:9600,N,8,1"  OPEN a\$ FOR RANDOM AS #1 text\$="S1" PRINT #1,text\$ text\$="" INPUT #1, text\$ PRINT text\$ END                 </pre>	<ul style="list-style-type: none"> <li>• The text string "text\$" is defined with a length of 30.</li> <li>• The interface parameters are assigned to the "a\$" string. Meaning:                         <ul style="list-style-type: none"> <li>• com1: the com1 serial interface is used.</li> <li>• 9600: sets baud rate to 9600</li> <li>• N: no parity</li> <li>• 8: 8 bit word length</li> <li>• 1: one stop bit</li> </ul> </li> <li>• The interface is initialized and marked with #1 (channel 0).</li> <li>• Status S1 must be queried.</li> <li>• text\$ is output on channel 1.</li> <li>• text\$ is deleted so that the response can be accepted.</li> <li>• S1 is read by channel 1 in text\$</li> <li>• S1 is output on screen</li> </ul>
--	--

### 8.6.3.2 Interface functions

#### Direct command entry

When making direct command entries via RS232, use the abbreviated form for most instructions (two letters).

#### Commands permitted for the various modes of operation

Refer to table on Page 165!



When using "Direct command entry", write an "END" instruction in data memory No. 1 because the start command refers to the program memory if the unit contains no direct commands.

#### Preparatory positioning commands

3. These commands can be transmitted to COMPAX when idle and during a positioning process.

4. The commands are accepted with the next positioning command

Instruction	Abbreviated form	Meaning
ACCEL	AL	Accelerating and braking time in ms
ACCEL-	AL-	Separate specification of braking time.
SPEED	SD	Velocity in %
POSR value1 SPEED value2	PR SD	Preparation for speed step profiling.
POSR value1 OUTPUT Oxx=y	PR OT	Sets comparator function. The comparators are also indicated using "C <sub>R</sub> L <sub>F</sub> > comparator No." via RS232 (see example 2).

**Example 1:** POSR 100 SPEED 50 C<sub>R</sub>L<sub>F</sub> or

PR 100 SD 50 C<sub>R</sub>L<sub>F</sub>  
Prepares a speed step.

**Example 2:** PR 200 OT O9=1 1st comparator  
PR 100 OT O10=1 2nd comparator  
POSA1000\$

The following signs are returned:

- 2 C<sub>R</sub>L<sub>F</sub> > after 100 units
- 1 C<sub>R</sub>L<sub>F</sub> > after 200 units
- \$ C<sub>R</sub>L<sub>F</sub> > after 1000 units

#### Positioning commands

- Positioning commands can be transmitted to COMPAX when idle and during a positioning process.
- If the axis is moving, the command is acknowledged negatively.
- The current settings (ACCEL, SPEED, ...) apply to the positioning command; i.e. these settings can still be modified before the positioning command is transmitted.
- A positioning command specified by the interfaces is interrupted by a reference journey prompted by the digital inputs. (POSA, POSR, LOOP).

Instruction	Abbr. form	Meaning
POSA	PA	Absolute position
POSA HOME	PH	Find machine zero
POSR	PR	Relative position
OUTPUT O0	OT O0	Switch off drive

**Example 1:** POSA 2500C<sub>R</sub>L<sub>F</sub> or PA 2500C<sub>R</sub>L<sub>F</sub>  
Proceed to position 2500

#### Influencing the active positioning process



This command is only permitted if COMPAX has not received any more commands since the positioning command currently being processed (excluding commands which are not position dependent, such as OUTPUT, GOTO and ACCEL, ACCEL-).

- Direct modification of velocity of an active positioning process.
- The type of speed transfer and the ensuing braking ramp can be influenced by previously modified acceleration times (ACCEL, ACCEL-).

Instruction	Abbreviated form	Meaning
POSR 0 SPEED value	PR 0 SD	Direct speed modification.

### Commands which are not position-dependent

- These commands are processed regardless of a positioning process specified by the interface (not during an internal data record procedure).

Instruction	Abbreviated form	Meaning
OUTPUT	OT	Set output
GOTO	GO	Adjusts data record indicator and enables / blocks password.

### Commands which are only permitted when drive is idle

- The axis must be at a standstill if modified VP parameters are to be transferred.
- The axis must be switched off if modified VC parameters are to be transferred (e.g. via OUTPUT O0=1).

Instruction	Abbreviated form	Meaning
VALID PARAMETER	VP	Modified parameter accepted (not configuration parameters).
VALID CONFIGURATION	VC	All parameters are accepted with VC.

### Read the status values

Use the serial interface to query all status values, even during a positioning process.

- **Sxx** transmitted, xx = number of the status value.
- COMPAX returns the current value.

**Example:** S1 C<sub>R</sub> L<sub>F</sub>

Response: S001:xxxxxxxx,xxxmm C<sub>R</sub> L<sub>F</sub> >

➡ The decimal point for S1 - S12 is always the ninth digit after the ":".

### 8.6.3.3 Read and write program sets and parameters

➡ Also possible during a positioning process.

### Download: writing the sets and parameters

Instruction	Meaning
Nxxx: Instruction	Write set xxx with <b>instruction</b> .
Pxxx=value	Write parameter xxx with <b>value</b> .
Pxxx="name" (Only for P40-P49)	Assigns parameter xxx with <b>name</b> .

**Example:** N005: POSA 100 C<sub>R</sub> L<sub>F</sub> or N005: PA 100 C<sub>R</sub> L<sub>F</sub>  
The POSA 100 instruction is written in data record 5.

### Upload: read the sets and parameter

Instruction	Meaning
Nxxx	Read data record xxx.
Pxxx	Read parameter xxx.

## RS232 interface

**Example:** P40 C<sub>R</sub> L<sub>F</sub>  
 COMPAX transmits the contents of P40: P40=value name C<sub>R</sub> L<sub>F</sub>>

### Transmitting control instructions

Instruction	Abbreviated form	Meaning
START Nxxx	SNxxx	Execute program set xxx (this set only).
START	ST	Start program.
STOP	SP	Stop program/positioning. SP corresponds to a STOP pulse
QUIT	QT	Acknowledge error
TEACH Z	TZ	Accepts current position as real zero point. (P1 is modified). The data record indicator is set to 1.
TEACH Nxxx	TNxxx	Current position is written into set xxx using the POSA command. Not possible in "Reset mode".
BREAK	BK	Interrupts positioning or program step.

**Example:** START N010 C<sub>R</sub> L<sub>F</sub> or SN 010 C<sub>R</sub> L<sub>F</sub>  
 Set 10 is executed

### P211: blocking and modifying the teach in functions

P211	Function
= 0	The functions I1 + I4, Teach N, I1 + I5 and Teach Z are enabled.
= 1	Teach Z is blocked; the data record indicator is set to 1 using I1 + I4 or "Teach Z".
= 2	Teach N is blocked; the data record indicator is set to 1 using I1 + I5 or "Teach N". (Teach Z is enabled)
= 3	The functions Teach N and Teach Z are blocked. With I1 + I4, Teach N, I1 + I5 or Teach Z, the data record indicator is set to 1.

### Negative command acknowledgement

If commands are issued using RS232 and they cannot be executed (invalid commands, missing password or COMPAX is busy), a warning is sent back.  
 Meaning:

<b>E90</b>	Syntax error; command not valid
<b>E91</b>	Command cannot be executed in this COMPAX operating mode.
<b>E92</b>	Function running, command cannot be executed
<b>E93</b>	Data record memory active, command cannot be executed
<b>E94</b>	Password missing

These warnings are not entered in status S18 (error history).

### Authorization of commands in different modes of operation

Operating status	Commands available
<b>Commands available in all operating modes / statuses</b>	<ul style="list-style-type: none"> <li>• Status query (Sxx)</li> <li>• Parameter query and assignment (Pxxx, Pxxx=value)</li> <li>• Data record query and assignment (Nxxx, Nxxx=value)</li> <li>• Set / reset outputs (OUTPUT Ox=y); <b>Not OUTPUT O0!</b></li> </ul>
<ul style="list-style-type: none"> <li>• Stop</li> <li>• Emergency stop</li> <li>• OFF (motor switched off)</li> <li>• Error present</li> </ul>	<ul style="list-style-type: none"> <li>• VP, VC, VF</li> <li>• Quit</li> <li>• OUTPUT O0</li> <li>• GOTO data record indicator / password</li> </ul>
<ul style="list-style-type: none"> <li>• In data record operation</li> </ul>	<ul style="list-style-type: none"> <li>• VP</li> </ul>
<ul style="list-style-type: none"> <li>• During positioning process (as preparation for the next command)</li> </ul> <p>➡ No program processing!</p>	<ul style="list-style-type: none"> <li>• VP</li> <li>• SPEED<sup>38</sup> / ACCEL</li> <li>• POSR value SPEED value / POSR value</li> <li>• OUTPUT Ox=y</li> <li>• GOTO data record indicator / password</li> </ul>
<ul style="list-style-type: none"> <li>• Find machine zero</li> <li>• Approach real zero</li> <li>• Manual +/-</li> </ul>	No other commands possible!
<ul style="list-style-type: none"> <li>• During RUN and motor under torque</li> </ul> <p>➡ No positioning!</p> <p>➡ No stop present!</p> <p>➡ No error present!</p>	All commands and functions are possible!

<sup>38</sup> SPEED is not available in speed control mode.



### Valency: \*1

$2^{15} 2^{14} \dots 2^2 2^1 2^0$ .

Transmission sequence, e.g.: "84 4C MSB LSB".

### \*1 Negative numbers

Negative numbers are represented in complement to two format. Creating the complement to two:

- Determine bit combination of the positive numerical value.
- Negate the binary value.
- Add 1.

### \*2 Format conversion

You can generate this format from any number (as long as it has digits after the decimal place) as follows.

#### Example:

Number = 450.5

1. Multiply number by  $2^{24}$ .

$$450.5 * 2^{24} = 7\ 558\ 135\ 808.$$

2. 7 558 135 808: convert into a hexadecimal number (if necessary into an integer first) => 0x00 01 C2 80 00 00 ≡ before decimal place, after decimal place ≡ MSB,.... LSB, MSB,.... LSB.

3. These bytes must now be entered into the commands in the sequence specified. The sequence of the bytes is reversed. Do not alter the sequence of the bits.

This conversion also applies to negative numbers.

#### Examples of the number format of "xx xx xx xx xx xx"

Number	MSB			LSB		
10	00	00	0A	00	00	00
360	00	01	68	00	00	00
450,5	00	01	C2	80	00	00
-1	FF	FF	FF	00	00	00
	Digits before the decimal place			Digits after the decimal place		

The following string will be produced, e.g. for POSA 360.0:

"88 41 00 00 00 68 01 00"

**Note:** transfer all digits!

### Start-up during binary transfer

**Note:** when binary transfer is switched on, note the following.

- ◆ Only create RS232 connection when participants are switched on or
- ◆ when participants are enabled, the RS232 can be re-initialized by COMPAX using Power on.

### 8.6.4 Process coupling using HEDA (Option A1 / A4)

➡ See also Page 185.

#### Synchronization and fast start via HEDA:

HEDA (SSI interface) can be used for synchronization of several axes with simultaneous ( $\pm 2.5 \mu s$ ) processing of individual controller time slices. The master (operating mode 1) transmits 2 synchronization words to the slave axes, enabling them to synchronize. The slave axes (operating mode 2) synchronize automatically. No response is transmitted from the slave axes to the master. The master only transmits to axis address 1. Therefore, all slaves must also be set to address 1 (P250=1).

➡ Acyclic communication between master and slave is not possible.

#### Variant support:

**COMPAX XX00 as slave to transmit "Fast start" or as master**  
**COMPAX XX60 as master or slave not when P212=3 and P212=4**  
**COMPAX XX70 as master or slave only when P31=9 or 0**

#### Physical limits:

Max. 16 participants in the master/passive slave operating mode and max. 50m cable length.

#### Hardware requirements:

The units must be fitted with the O1 / A4 (COMPAX 1000SL) option. There must be a terminating connector bus 2/01 on the last slave.

#### HEDA parameters:

Parameter No.	Meaning	Valid from	Default value
P243	HEDA operating mode	VP	0
P245*	Assign outputs O1 ... O8 to the HEDA bus	immediately	0
P246*	Assign outputs O9 ... O16 to the HEDA bus	immediately	0
P247	Max. average transmission errors	VP	5
P248	Max. transmission errors	VP	15
P249	Synchronization monitoring	VP	10
P250	Unit addresses (in master – slave mode =1)	VP	0

\*In the HEDA master - HEDA slave operating mode (passive slave to COMPAX master), P245=P246=0 is set.

#### Operating modes:

No.	P243	P250	Operating mode	Description
0	Not relevant	= 0	Independent single axis	No coupling, no synchronization
0	0	= 1 ... 9	Slave on IPM <sup>39</sup> via HEDA	Coupled operation and acyclic communication possible via HEDA
1	Bit 0="1" (P243=1)	= 1	<b>COMPAX as master</b>	<b>Master axis transmits synchronous word and 7 words to address 1</b>
2	Bit 1="1" (P243=2)	= 1	<b>Passive slave to COMPAX master</b>	<b>Slave receives at address 1 (P250=1), but does not send anything back</b>

➡ **Note!**

If HEDA coupling is activated and the master executes "Find machine zero", this will result in a positional offset between master and slave. You should therefore execute machine zero travel when the HEDA coupling is deactivated.

<sup>39</sup> The interpolation module IPM can also be used as a master, but only with COMPAX XX00; COMPAX XX60, COMPAX XX70



#### Fast start

P18 is expanded with the following bits:

P18	Meaning
Bit 0	=0 without PLC data interface =1 with PLC data interface
Bit 1	=0 fast start on I15 not active =1 fast start on I15 active
Bit 2	reserved
Bit 3	=0 fast start on HEDA bit 8 not active =1 fast start on HEDA bit 8 active only permitted with P18: bit 1=1 (see below).

The fast start is synchronized using P18 bit 3 for HEDA with master and slave, i.e. input 15 must be on the slave and the master fast start (triggered by I15 in master) must also be on HEDA so that it can be executed.

This operating mode is also set with **P18=10**.

If I15 is not required on the slave, then set I15="1".

**Note:** The fast start is additionally delayed by 1 ms for all axes; i. e. in total 2.5ms (+1.5ms reaction time I15)

#### Transmittable parameters:

- The master transmits one data block per ms to address 1, consisting of
- HEDA control word, inc. fast start on bit 8 (bit 8 is automatically generated in the master from I15 "Fast start").
  - Process value, selected with parameter P184 depending on family (COMPAX XX00, COMPAX XX60, COMPAX XX70) between:

#### Master output quantity:

Output quantity	Master
• Encoder position (COMPAX XX70) + master channel duration period	P184=40
• Internal time base / encoder velocity before P35* (COMPAX XX70)	P184=42
• Scaled master position before P35* (COMPAX XX70)	P184=43
• Nominal position value in resolver increments [65536 increments/revolution]	P184=44
• Actual position value in resolver increments [65536 increments/revolution]	P184=45
• Differentiated resolver position [increments/ms]	P184=46

\* The quantity is unaffected by P35.

#### Slave input quantities:

Coupling the slave to the transmitted quantity is implemented with P188.

Input quantities	Slave
• Encoder coupling (P184 in master =40) The input signal is used as an encoder signal.	P188=40
• Internal time base / encoder velocity before P35* (COMPAX XX70) The input signal is used as a master velocity. Application: coupling several axes to one master signal (e.g. an internal time base)	P188=42
• Scaled master position before P35* (COMPAX XX70) The input signal is used as a master position. Application: coupling several axes to one master signal (e.g. an internal time base)	P188=43
• Input quantity is interpreted as an encoder signal even though it is not an encoder signal (P184 in master ≠ 40) see below for more information.	P188=140

\* The quantity can be influenced by P35.

### Permissible combinations and required parameter settings:

Master output quantities: P184=	Slave input quantities: P188=	Can be used in slave unit versions:	Settings in master and slave for adapting the process quantities: P98 is identical in all units
40 <small>(CPX 00 CPX 60, CPX 70)</small>	40	CPX 60, CPX 70	$P143_s = P143_M^{40}$
	43	CPX 70	
42 <small>(CPX 70)</small>	42	CPX 70	$P143_s = P143_M$
43 <small>(CPX 70)</small>	140* 43	CPX 60, CPX 70 CPX 70	$P143_s = P143_M$
44 <small>(CPX 00 CPX 60, CPX 70)</small>	140* 43	CPX 60, CPX 70 CPX 70	$P143_s = 2^{14} = 16384$
45 <small>(CPX 00 CPX 60, CPX 70)</small>	140* 43	CPX 60, CPX 70 CPX 70	$P143_s = 2^{14} = 16384$
46 <small>(CPX 00 CPX 60, CPX 70)</small>	42	CPX 70	$P143_s = P143_M$

\* When the encoder position P184=40 is transferred, the encoder position is transferred into high word and the duration period of the pulses is transferred into low word to support a duration period measurement in the slave.

If a mixture of application purposes is undertaken, e.g. master P184=44 (nominal value) and slave with encoder coupling, then the slave must be informed using P188=140 (in such cases only the high word is processed).

### Application examples:

	1st unit: Master	Slave
<p>Coupling of several axes to one encoder; HEDA distributes the signals</p>	<p>COMPAX XX60 COMPAX XX70 (P31=1) Encoder input P184=40 (encoder position+duration period) P188=40</p>	<p>COMPAX XX60 COMPAX XX70 (P31=9) P188=40 (encoder input; duration period available)</p>
<p>Replacing the encoder emulation using HEDA bus</p> <p><b>Note:</b> There is a time misalignment between master and slave of 2ms; <b>Remedy:</b> activate identical program sets together using "Fast start".</p>	<p>COMPAX XX00 COMPAX XX60 COMPAX XX70</p> <p>P184=44 (nominal position value) or P184=45 (actual position value) P188=0</p>	<p>COMPAX XX60 COMPAX XX70 P188=140 Setting P143 = 16384 (¼ of the increments are always in P143 as quadrupling occurs during encoder inputs)</p>

<sup>40</sup> P143<sub>s</sub>: parameter P143 of the slave  
P143<sub>M</sub>: parameter P143 of the master

	1st unit: Master	Slave
Coupling of several cams with the same time base and separate master or slave oriented label synchronization (see above)	COMPAX XX70 P184=42 (time base) P188=42	COMPAX XX70 P188=42 P143 <sub>s</sub> =P143 <sub>M</sub>
Linking of several cams with the same time base and absolute zero drift between the axes due to the transfer of a position value (see above)	COMPAX XX70 P184=43 (scaled master position) P188=43	COMPAX XX70 P188=43 P143 <sub>s</sub> =P143 <sub>M</sub>

#### Error handling

Only position signals can be completely restored following HEDA transmission errors. When transmitting velocities, transmission errors can lead to drift tendencies between the axis positions. **For this reason use of the position values is preferred.**

#### Error messages:

HEDA transmission or synchronization errors are errors E76, E77 and E78 (see the Error list in the User Guide).

**E76:** Synchronization is interrupted with E76, therefore an alignment is implemented whereby the process position value is aligned in such a manner that a position leap does not occur.

**E77/E78:** With E77/E78, the slave attempts to reach the new undisturbed process position value in order to maintain the reference system.



#### Note!

Transmitting "VC" interrupts the synchronization.

Only activate "VC" when the unit is switched off.

When working with the user terminal BDF2, "VC" is transmitted when the "Parameter edit" menu is exited.

#### Transmission error procedure:

Position values / position (P184=40/43/44/45): linear interpolation using old values  
Velocity values / frequencies (P184=42/46): retains old value

#### Synchronizing process values:

In cases when P188>0 on the master side, a fixed delay in the associated process value is implemented, amounting to a total of 2 ms. This ensures that the master waits until all axes have received the process value. This ensures that all axes, including the master, continue to process the new nominal values simultaneously.

- Note:**
- Except for fast start, no additional I/O's are sent.
  - There can be only one master on the bus!

- Note:**
- The position values for P184=44 and P184=45 are derived independently of the current positioning operating mode (normal, continuous, reset). They are obtained from the nominal position value and the actual position value and made available in 24-bit format, as if with counter channels. This avoids jerky changes in the start torque (in continuous mode) or when reading the end of the curve (in reset mode). Only the lower 24 bits of these values are transmitted, consisting of the resolver value and maximum 256 motor revolutions.

The required cable types are listed on Page 63.



Unit hardware
Connector assignment / cable
Technical data
Configuration
Positioning and control functions
Optimization functions
Interfaces
Accessories / options
Status
Parameter
Error list

## 9. Accessories and options

### Compact Servo Controller

#### 9.1 System concept











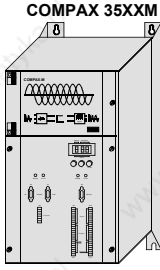
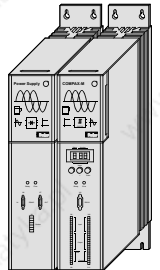
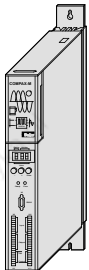
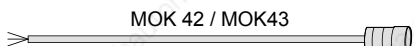
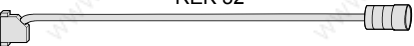

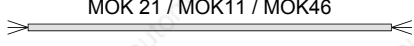
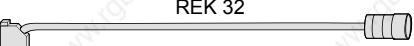
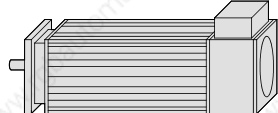
The COMPAX system concept is based on a basic unit which contains the function-important components and additional system components. These can be used to extend a system for your specific requirements.

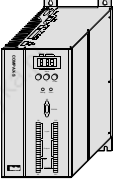

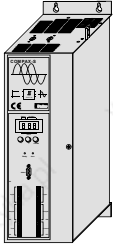

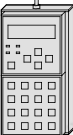





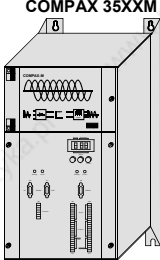
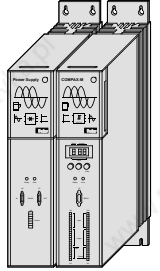
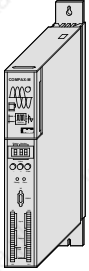



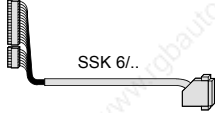
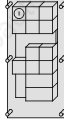
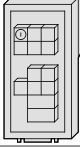

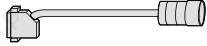



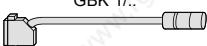





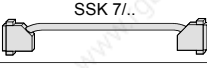
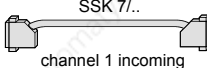
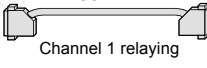

The system consists of the following components:

- ◆ COMPAX
  - This contains:
    - digital inputs and outputs (PLC interface)
    - serial interface (RS232)
    - front plate with status and error display
    - data record memory
    - integrated IGBT final stage
- ◆ mains module to produce power voltage (without transformer); with emergency stop function.
- ◆ drive unit (motor, transmission and cable).
- ◆ aids for controlling COMPAX using the digital inputs and outputs.
- ◆ interface cable for operating COMPAX via the serial interface RS232.
- ◆ options which support other application areas.
- ◆ hand-held terminal for menu-guided configuration and programming of COMPAX.
- ◆ PC software for supported parameter specification and for creating programs.

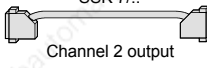
9.2 Overview

The following table shows the COMPAX system components and the relevant associated cables.

 <p>COMPAX 35XXM</p>  <p>COMPAX-M with Power module NMD</p>  <p>COMPAX P1XXM</p>	Drives	Synchronous motor	 <p>MOK 42 / MOK43</p>  <p>REK 32</p>	<p>HDY055.. HDY070.. HDY092.. HDY115.. HJ96.. HJ116..</p>  	
			 <p>MOK 21 / MOK11 / MOK46</p>  <p>REK 32</p>	<p>HDY142.. HJ155 HJ190..</p> 	
		Other motor types		<p>initiator set IVD 1/.. for 3 initiators</p> 	<p>initiators: IN HE 521506</p>
 <p>COMPAX 25XXS</p>  <p>COMPAX 10XXSL</p>  <p>COMPAX 45XXS COMPAX 85XXS</p>	Interfaces	RS232	<p>The RS232 - interface is available in the standard device</p>  <p>SSK 1/..</p>	To PC or Terminal	
			<p>handheld terminal BDF 2/01</p> 		
		bus systems	<p>RS 485 ASCII / binary Option F1: 4-Wire Option F5: 2-Wire</p>	 <p>SSK13/...</p>	to further bus subscribers
			<p>Interbus-S Option F2</p>		
			<p>Profibus Option F3</p>		
<p>CAN Bus Option F4</p>					
<p>CANopen Option F8</p>					
<p>CS31-System bus Option F7</p>					
HEDA	<p>as plug-in option</p> 	<p>HEDA Option A1 COMPAX 1000SL: Option A4</p>	<p>SSK14/.. : IPM - COMPAX COMPAX - COMPAX SSK15/.. : COMPAX-Master - COMPAX-Slave</p>  <p>BUS 2/01: Bus termination</p>	to an IPC with Hauser plug-in board "IPM" for contouring	

     	Interfaces	 SSK 6/..		Operating panel BDF 1/02 	Operating panel BDF 1/03 		
		SinCos Option S1/S2		 GBK 16/..	SinCos installed in the motor		
	SinCos Option S3 für Linearmotoren		 GBK 18/..	SinCos installed in the motor			
	Absolute encoder Interface A1		 GBK 1/..	Absolute encoder  STEGMANN AA100			
	Encoder	Channel 1	Encoder-Input I 2		 GBK 11/..	Encoder  Litton G71SSLDBI-4096-151-050BX	
			(with cable connection)	 SSK 7/..	Direct to encoder simulation of COMPAX oder SV Drive		
		Channel 2	Encoder-Input I 4 (without cable connection)		 SSK 4/..	Encoder-distributor  EAM 4/01	to the Encoder distributors
			EncoEer-simulation Option I 3		 SSK 7/..	 SSK 7/.. channel 1 incoming	
						 SSK 7/.. Channel 1 relaying	
						Bus termination BUS 1/01 	
 SSK 7/.. Channel 2 output							
D/A - Monitor D1 (12 Bit)		 ASS 1/01	Direct to an encoder input e.g. to COMPAX-M				
Analogue output of intermediate values		 ASS 1/01	to oscilloscope				
Ballast resistors	NMD20	Ballast resistor BRM 4/..with 1.5m cable obtainable in 3 ratings for connection to the power module NMD20					
	COMPAX 35XXM	Ballast resistor BRM 7/01 with 1.5m cable for connection to COMPAX 35XXM					
	COMPAX 45XXS / 85XXS	Ballast resistor BRM 6/01 with 1.5m cable for connection to COMPAX 45XXS / COMPAX 85XXS					
	COMPAX 2500S	Ballast resistor BRM 5/01 with 0.3m cable for connection to COMPAX 25XXS					
	COMPAX 1000SL	Ballast resistor BRM 8/01 with 0.25m cable for connection to COMPAX 10XXSL					
PC-Software	COMPAX ServoManager with: ParameterEditor and ProgrammEditor CamEditor for COMPAX XX70 						

These Options are not available for COMPAX 1000SL

**9.3 Motors**

**EMD motors**

Suitable motors are described in the motor catalogue (Article No.: 192-060011)!

**Linear motor:**

COMPAX also supports the operation of linear motors. For this, COMPAX requires option S3 (interface to linear encoder and Hall sensor; assignment X12 see Page 46).

Conditions regarding the linear motor:

- 3 phase synchronous linear motors with:
  - sine-cosine linear encoder (1V<sub>ss</sub>).or TTL (RS422)
  - digital Hall sensor commutation (5V) with following signal sequence:

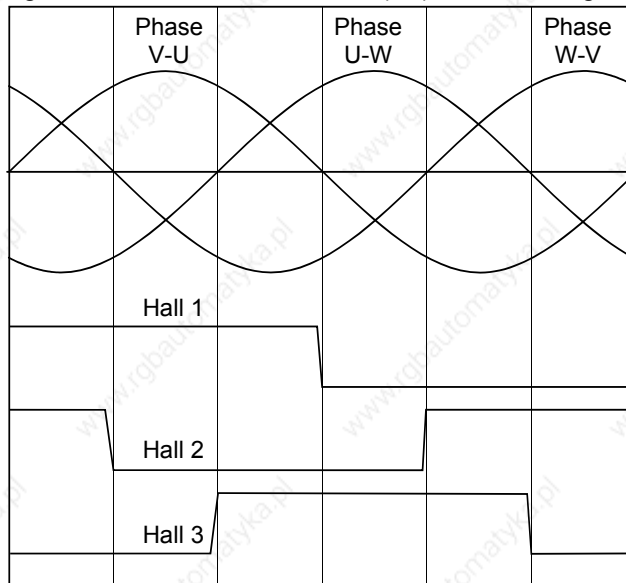

The depicted signal sequence applies for positive direction.

**Note concerning the reference mode:**

Only the modes P212=7 and P212=11 are presently available as reference modes for linear motors!

**Linear motor LXR**

For highly dynamic and precise applications, we provide the linear motor LXR, which can be operated with COMPAX 25XXS or COMPAX 10XXSL (with the S3 option and GBK18 and GBK20 cable). Ask for our leaflet.

**Note:**

When operating the linear motor LXR, reduced nominal and peak currents apply to COMPAX:

Unit COMPAX ..	Nominal current [A <sub>eff</sub> ]	Peak current [A <sub>eff</sub> ] <5s	Power [kVA]
<b>with mains supply: 230V AC</b>			
<b>10XXSL</b>	2.1	4.2	0.8
<b>25XXS</b>	4.1	8.2	1.4



### 9.4 HAUSER linear actuators

The HAUSER "HLEc" linear unit is available with various cross sections:

- **HLE80C** cross section: 80 mm x 80 mm up to 6m long
- **HLE100C** cross-section: 100 mm x 100 mm up to 7m long
- **HLE150C** cross-section: 150 mm x 150 mm up to 10m long

Highly dynamic, modular linear axis "HPLA" with toothed belt drive or rack-and-pinion drive:

- **HPLA80:** cross section: 80 mm x 80 mm up to 50m for rack-and-pinion, up to 20m for toothed belt
- **HPLA120:** cross section: 120 mm x 120 mm up to 50m for rack-and-pinion, up to 20m for toothed belt
- **HPLA180:** cross section: 180 mm x 180 mm up to 50m for rack-and-pinion, up to 20m for toothed belt

**Electric cylinder ET: with 50 - 1500 mm stroke. Tensile and shear forces up to 21000 N**

**Vertical actuators with toothed belt: up to 2500mm stroke; up to 100kg payload**

The attached transmissions are available with ratios of 3:1, 5:1, 7:1, 10:1 and 25:1.

 Please contact us if you require more information.

#### Initiator set

If you are using, e.g. a rack-and-pinion drive, toothed belt drive or spindle drive, you can obtain the necessary initiators and initiator connectors and cable from us. We can also supply you with retaining material on request.

## 9.5 Data interfaces

### 9.5.1 RS232

Use the RS232 interface, fitted as standard in COMPAX, to connect COMPAX with a PC or terminal. This can then be used to operate COMPAX. The SSK1/.. interface cable is available as a connecting cable (for available lengths, see Page 206).

### 9.5.2 Bus systems

The bus systems are options which you can select to use or not. They require an additional board to be fitted in COMPAX. The connection is located on the mains module or, in COMPAX-S and COMPAX 35XXM, directly on the unit. The controllers, connected to the mains module or COMPAX 35XXM, are already connected via the flatband cable available in the system network.

#### 9.5.2.1 Interbus-S / Option F2

You will find an object directory in the special documentation. The connection arrangement is based on the specifications of 2-conductor remote bus.

#### 9.5.2.2 RS485 / Option F1/F5

The RS485 interface is described in the special documentation. 2 different options are available:

- F1: 4 wire RS485
- F5: 2 wire RS485

#### 9.5.2.3 Profibus / option F3

The Profibus is described in the special documentation. Functions:

- Sinec L2-DP and FMS
- 1.5M Baud
- Communication with Simatic S7<sup>©</sup> is supported by special function modules.

#### 9.5.2.4 CAN - Bus / Option F4

The Profibus is described in the special documentation. Functions:

- BasicCAN
- up to 1M Baud
- CAN protocol as per specification 1.2
- Hardware as per ISO/DIS 11898

#### 9.5.2.5 CANopen / Option F8

- Protocol as per CiA DS 301.
- Profile CiA DS 402 for drives.

#### 9.5.2.6 CS31system bus / Option F7

- COMPAX – ABB – interface.

## 9.6 Process interfaces

### 9.6.1 Encoder interface

The encoder interface option E2 (E4)<sup>41</sup> enables the connection of an external incremental encoder (such as: Litton encoder G71SSLDBI-4096-151-05BX). Use this to synchronize COMPAX with an external speed using the "SPEED SYNC" command. The encoder pulses per revolution and the translational travel per encoder revolution are set via the COMPAX parameters P143 and P98.

No.	Meaning	Unit	Minimum value	Default value	Maximum value	Valid from...
P98	Travel of axis per encoder revolution	corresp. P90	0	0.000000	4 000 000	VC
P143	Encoder pulses per revolution (channel 1)		120	4096	2 000 000	VC
P146	Resolution of encoder emulation (channel 2) (for permanent SinCos setting, see Page 183)	=0: 1024 =8: 512				VC

- Technical data:**
- RS422 interface ♦ 5V supply;
  - 120-10 000 increments/revolution ( $f_{\min}$ : 4 kHz;  $f_{\max}$ : 500 kHz).

**Dimension diagram:** Dimensional diagram for Litton encoder G71SSLDBI-4096-151-05BX:

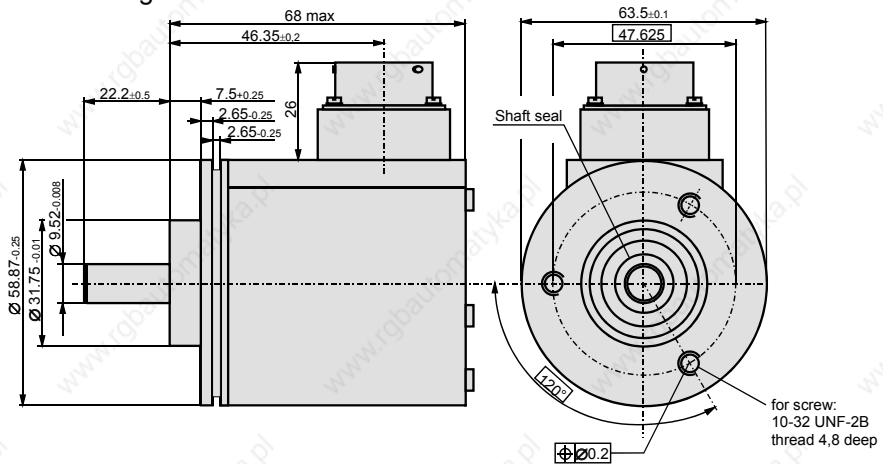

<sup>41</sup> Does not apply for COMPAX 1000SL. COMPAX 1000SL allows to configure the generally available signal interface either as encoder input or as encoder emulation (See page 61).

### Encoder module and accessories:

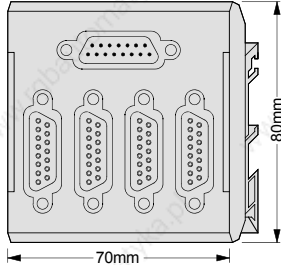
<b>E2</b>	Encoder input module with line terminator for individual connections; not for creating an encoder bus.	<b>Not for COMPAX 1000SL:</b> With COMPAX 1000SL, the signal interface usually present can be configured either as an encoder input or encoder simulation (see Page 61).
<b>E3</b>	E3: Encoder emulation	
<b>E4</b>	Encoder input module without line terminator for creating an encoder bus.	
<b>EAM4/01</b> Design:	Encoder distributor for creating an encoder bus. 	Depth: 40 mm without mating connector The module is engaged on the terminal bus bar.
<b>BUS1/01</b>	Bus termination for encoder distributor EAM4/01.	
<b>BUS6/01</b>	Bus termination for encoder - COMPAX 1000SL connection	
<b>GBK11/..</b>	Encoder cable for connecting COMPAX with an encoder.	
<b>SSK7/..</b>	Connector cable between encoder distributors or from an encoder emulation.	
<b>SSK4/..</b>	Connector cable between COMPAX and encoder distributor.	
<b>SSK17/..</b>	Connector cable between COMPAX 1000SL (encoder emulation) – COMPAX	

### Assignment of EAM4/01 (corresp. X13)

Pin	Channel 1		Channel 2	
	X1: IN	X2: OUT	X3: IN	X4: OUT
1	Screen	Screen	Screen	Screen
2	NC	N1	NC	N2
3	NC	B1	NC	B2
4	NC	1A	NC	2A
5	N1	NC	N2	NC
6	B1	NC	B2	NC
7	1A	NC	2A	NC
8	+5V	NC	+5V	NC
9	NC	N1/	NC	N2/
10	NC	B1/	NC	B2/
11	NC	O1/	NC	A2/
12	N1/	NC	N2/	NC
13	B1/	NC	B2/	NC
14	O1/	NC	A2/	NC
15	GND	NC	GND	NC

### Applications with encoder:

#### Individual connections

#### Encoder COMPAX

- Cable: GBK 11/..
- Encoder input module E2 with line terminator, or for
- COMPAX 1000SL: Configured as encoder input (P144=4; P146=0) and with bus termination BUS 6/01 (sits as an intermediate connector on X13)

#### SV drive COMPAX

- Cable: SSK 7/..  
Note! Note direction.  
cable in: SV drive  
cable out: COMPAX
- Encoder input module E2 with line terminator, or for
- COMPAX 1000SL: Configured as encoder input (P144=4; P146=0) and with bus termination BUS 6/01 (sits as an intermediate connector on X13).

#### COMPAX COMPAX

- Cable: SSK 7/.. or SSK17 (see principal diagrams below)  
Note! Note direction.  
cable in: COMPAX with encoder emulation  
cable out: COMPAX with encoder input
- Encoder simulation E3 for COMPAX (master) (in COMPAX 1000SL encoder simulation configured)
- Encoder input module E2 for COMPAX (slave) (in COMPAX 1000SL encoder input configured and with bus termination BUS 6/01)

#### COMPAX – COMPAX (both not COMPAX 1000SL)

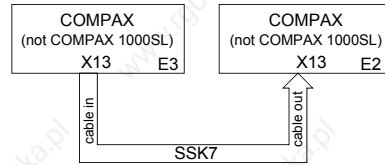

#### COMPAX (not COMPAX 1000SL) – COMPAX 1000SL

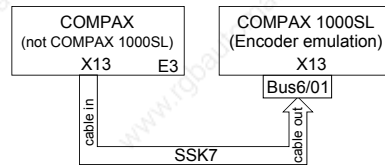

#### COMPAX 1000SL – COMPAX 1000SL

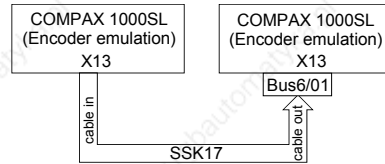

#### Encoder bus with COMPAX

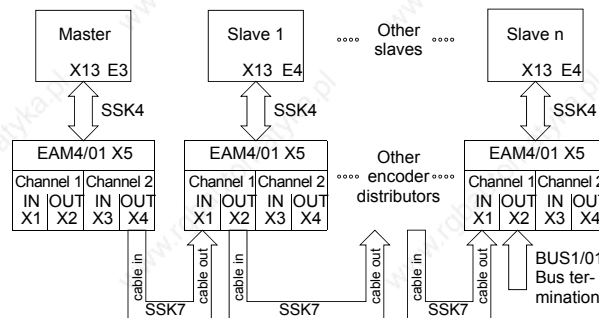

#### Requirements per COMPAX:

- one encoder distributor ..... **EAM 4/01**
- one cable for the COMPAX and encoder distributor connection ... **SSK 4/..**
- one bus cable for connecting the encoder distributors ..... **SSK 7/..**
- Encoder simulation in the master ..... **E3** (configured in COMPAX 1000SL)
- Encoder input module in each slave..... **E4** (configured in COMPAX 1000SL)
- Bus terminator ..... **BUS 1/01**

#### Encoder bus with encoder or encoder emulation in SV drive

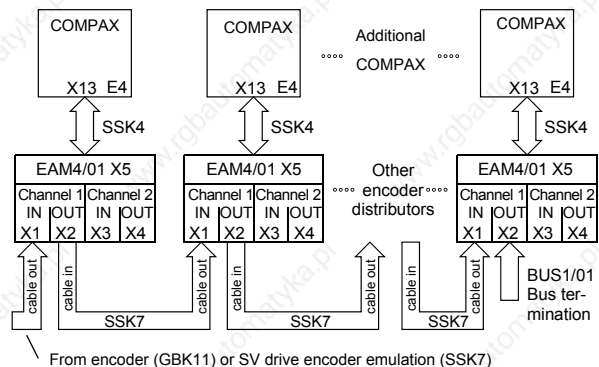

The following are required:

- per COMPAX
- one encoder distributor ..... **EAM 4/01**
- one cable for the COMPAX and encoder distributor connection ... **SSK 4/..**
- one bus cable for the connection between the encoder distributors ... **SSK7/..**
- Encoder input module ..... **E4** (configured in COMPAX 1000SL)
- Bus terminator ..... **BUS 1/01**
- **For the encoder:** encoder cable ..... **GBK11/..**
- For the SV drive: Cable: ..... **SSK7/..**

**Encoder bus mixed**

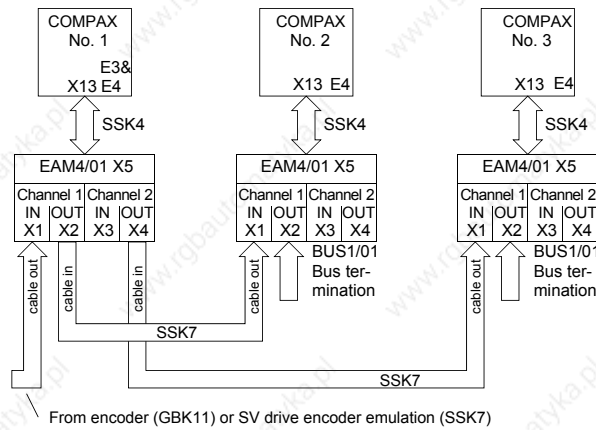

- COMPAX 1 and COMPAX 2 receive the signals from one encoder.
- COMPAX 3 receives the actual COMPAX 1 value concerning its emulation.

The following are required:

- per COMPAX
  - one encoder distributor ..... **EAM 4/01**
  - one cable for the COMPAX and encoder distributor connection . **SSK 4/..**
  - 3 bus cables ..... **SSK 7/..**
  - 2 bus terminators ..... **BUS1/01**

**Encoder module:**

- COMPAX 1 (not possible with COMPAX 1000SL as there is only 1 encoder channel present!):
  - Encoder input module ..... **E4**
  - Encoder emulation ..... **E3**
- COMPAX 2, 3:
  - Encoder input module ..... **E4** (configured in COMPAX 1000SL)
  - Encoder cable: ..... **GBK11/..**

## 9.6.2 Absolute value sensor (A1)



The option A1 cannot be used for COMPAX 1000SL.

When using option A1 (the absolute value sensor interface), the reference travel (find machine zero) normally required in normal mode after switching on is not required. The reference travel is then only required during start-up. The current read sensor position can be found in Status S12.

### Supported absolute value sensors

The following Stegmann - absolute value sensors types are supported:

- AG100MS/GRAY 4096/4096
- or
- AG626XSR 4096/4096.

### Technical data

- Supply voltage: 24V ±10%.
- Sensing code: grey code, single step.
- Direction of counting: in clockwise direction when looking at the shaft: rising.
- Data interface: RS422 /24 bit data format (starting with: MSB).
- Cycle frequency: 100 kHz.

### Enable absolute value sensor input

When using equipped A1 option (if this is not already being executed by HAUSER), the absolute value sensor input is enabled using parameter P206. Meaning: P206 ="1" absolute value sensor input enabled.

### Note!

- Only activate the absolute value sensor input if an absolute value sensor has been connected correctly and physically.
- Continuous mode is not permitted when the absolute value sensor is active.

### Note

Option A1 also contains the HEDA interface.



Further information on the value range of S12 can be found on Page 79

## 9.6.3 High resolution SinCos sensor system (S1/S2)<sup>®</sup>

COMPAX uses option S1 to support the high-resolution, optical motor position recording process via the Stegmann SinCos sensor system (as a substitute for the motor position recording via resolver).

SinCos single-turn: Type SRS50

SinCos multi-turn: Type SRM50

A SinCos sensor provides the following improvements.

- Better concentricity.
- Position recorded with greater absolute accuracy:  
Resolver: ± 0.25°  
SinCos: ± 0.005°
- Resolution of motor speed:  
Resolver: 16/12 bit (speed-dependent ; 12 bit at higher speeds)  
SinCos: 19 bit over the whole range of motor speeds.
- Less noise at a higher dynamic level via the motor speed resolution.
- With the SinCos multi-turn you also get economical absolute value sensor function.  
4096 motor revolutions detected absolute.



Further information on the value range of S12 can be found on Page 79

**S2 – option:**

**SinCos multi-turn with programmable transmission factor**

When using a SinCos multi-turn, you can use the S2 option to adapt the range of the absolute position S12 to your application via a transmission factor. S12 then always contains the position value referenced to the reset path P96. Positioning is still implemented with reference to the actual value in Status S1.

**Standard:**

SinCos multi-turn records an absolute position of 4096 rotations. In applications such as controlling a round table via a transmission, the position of the table cannot be determined very accurately because 4096 rotations usually signifies several rotations of the table. By specifying the transmission factor P96 (ratio of motor : table), the absolute position S12 is reset to 0 after a table rotation. After "Power on" and after an error has occurred, S12 is transferred as the actual value (S1=S12). The function is switched on via P206="1".

No.	Meaning	Unit	Minimum value	Default value	Maximum value	Valid from...
P96	Transmission factor for the reset path of S2 – option ("0": no reset function)	-	0	0	4095	VC
P206	Enabled absolute value sensor input or the reset functions of the S2 option	="1": absolute value sensor input enabled or reset function switched on.				VP

**Please note**

- Set P1=0. Using P212=10 (see Page 80) you can still select the machine zero point as required.

**Note!**

This function does not affect the actual positioning process.  
 Example: P96=10 (sensor revolutions); P83=40 000µm (40mm)  
 After POSA 450 and then POSA 0, the drive reverses by 450 mm (and not just 50 mm).  
 To execute a positioning process within the reset path after traveling in one direction for a long time, evaluate S12.  
 E.g.: required position within the reset path = 10 mm  
 V1=10-S12  
 POSR .V1

**9.6.4 Option S3 for linear motors.**

See Page 176



### 9.6.5 HEDA interface

➡ **HEDA using option A1 (e.g. A4 for COMPAX 1000SL) for COMPAX XX00 and the interpolation module IPM as master, or for a COMPAX – COMPAX –coupling with the unit variants COMPAX XX00, COMPAX XX60 and COMPAX XX70, see from Page 168).**

Implementing tracking and contouring tasks with the HAUSER interpolation module (IPM) for PCs and industrial PCs.

Communication occurs via the **HEDA** interface, a rapid synchronous serial interface.

Functional scope of the IPM and COMPAX network:

- ◆ contours can be stored for up to 9 axes with up to 100000 points.
- ◆ 16 zero-related digital outputs.
- ◆ Exchange of data between 9 axes within 1ms (setpoint values, auxiliary functions, position, lag error, speed, torque)
- ◆ Freely programmable inputs and outputs  
(Once enabled via P221, P222 and P225, and allocation of outputs to HEDA via P245 and P245; see Page 139).
- ◆ internal data record memory can still be used to its full extent
- ◆ can be independently operated as a single axis positioning system
- Physical transfers:
  - RS485 level (counter-cycle driver);
  - DC decoupled using an optical coupler;
  - Cycle frequency: 5 Mbit/s.

➡ **Working with the HEDA interface is described from Page 168, where used with the interpolation module IPM, a special manual is available!**

### 9.6.6 D/A monitor (D1) (option not available with COMPAX 1000SL)

- The D/A monitor offers you the option of outputting COMPAX internal measurement and intermediate parameters in the form of analogue voltage in the range of  $\pm 10V$ . For description, see Page 58.

**9.6.7 Analogue speed specification (E7) (option not available with COMPAX 1000SL)**

Only in COMPAX XX6X and COMPAX XX70



Option E7 "Analogue speed specification" is available with COMPAX XX6X "Electronic transmissions" and COMPAX XX70 "Cam controller".

**Exception:**

In addition, E7 can be used with COMPAX XX00 to implement an external speed specification with the command "SPEED SYNC"; see Page 99 The "Encoder input" option (E2 or E4) cannot be used at the same time as E7.

Using option E7, you can specify a nominal speed value via connector X13 as analogue voltage in the range -10V to +10V. Use 2 digital inputs (PLC level), to define a nominal speed value of 0 and to initiate a change in the rotational direction.

**Configuration:**

The following configuration data must therefore be assigned permanent values:

P80 = "16" (general drive).

P90 = "1" (mm unit).

P83 = 100000  $\mu\text{m}$  (travel per motor revolution).

P93 = "4" (speed control mode).

P143 = 600 000

P144 = "7" (analogue speed specification).

P35 = "1" (transmission factor 1) (I15="0")

**I16 = "1" (external nominal value is valid)**

These parameters influence the interrelation between voltage and speed; they must therefore be specified and fixed. Specify the required speed directly in P98 in  $\text{min}^{-1}$  when input voltage is +10V.

**Accuracy**

Linearity error: <1%

Amplification error: <5% (you can compensate for these with P98).

Offset: <15 mV

Temperature drift: 100 ppm/K

**Connection assignment**

**Connector X13:**

Pin X13 or EAM4/01 X1: (encoder assignment)	COMPAX-Input I Output O	Signal	Circuit proposal
6 (B1)	A	+15V <10 mA	
7 (O1)	E	UE	
13 (B1\)	A	-15V <10 mA	
15 (GND)	A	GND	
14 (O1\)	E	UE\	Bridge to 15 (GND)
5 (N1)	E	Enable	"1" for enable "0" $\equiv$ nominal digital value 0
12 (N1\)	E	Direction of rotation	"1" for positive direction of rotation
1		Screen	

Level on the "Enable" and "Direction of rotation" inputs: 5.5V...30V = "1".



$U_E$  and  $U_{E\setminus}$  is a differential input. Actively assign  $U_{E\setminus}$  to a potential (e.g. to GND).

### 9.7 Accessories

#### 9.7.1 External control panel (not available for COMPAX 1000SL)

Use the control panels to control COMPAX via the digital inputs. They contain the following functions:

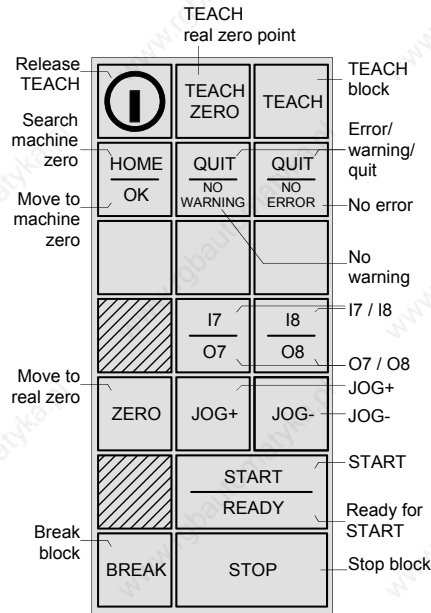

The control panel is available for front plate installation or with housing.

**BDF1/02: for front plate installation**

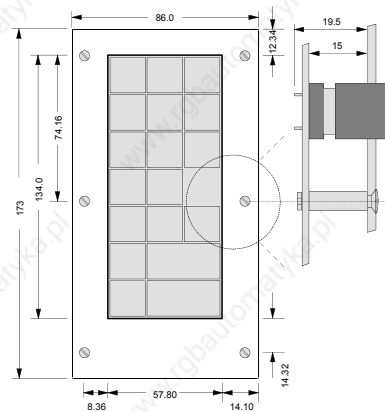

**BDF1/03: with housing**

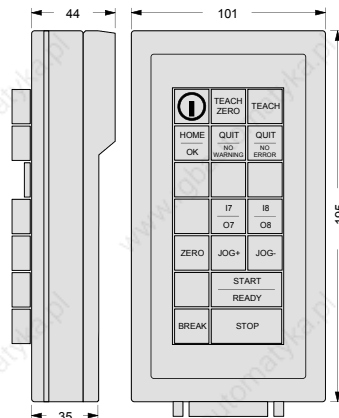

➡ The control panels are connected with COMPAX via the cable SSK6/..

**Wiring plan and assignment of SSK6/..**

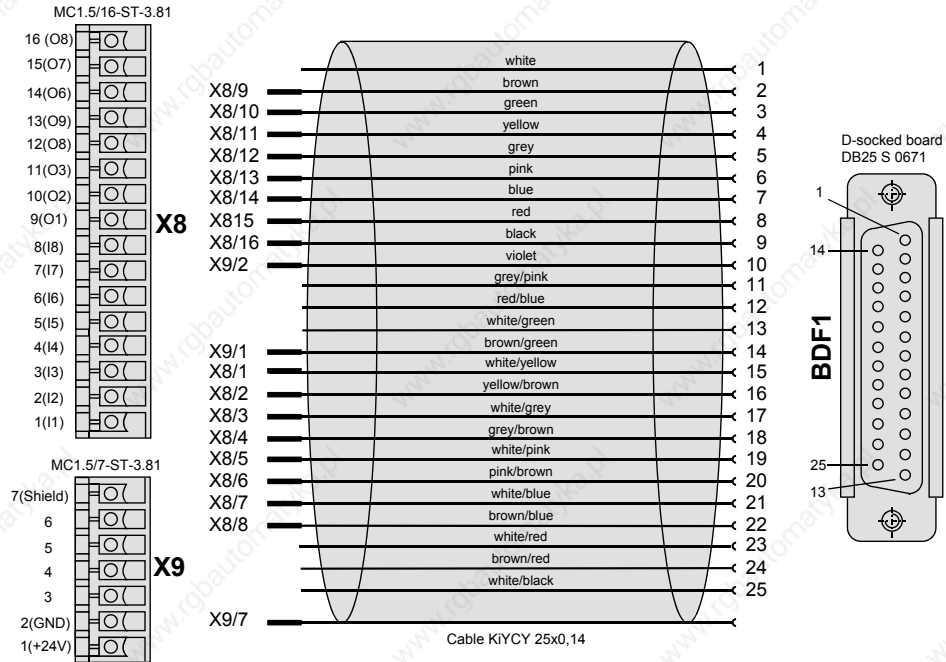

**9.7.2 Terminal module for COMPAX 1000SL (EAM)**

The terminal module EAM3/.. is used for the onward wiring of the COMPAX 1000SL connector X19 (physical inputs / outputs, ...) to a terminal series and a Sub-D connector.

The module can be fixed in the control cabinet to an installation rail with a mounting rail.

The terminal module EAM3/.. contains the cable for connecting with COMPAX 1000SL.

Available lengths of connection lead: 1m; 2.5m; 5m

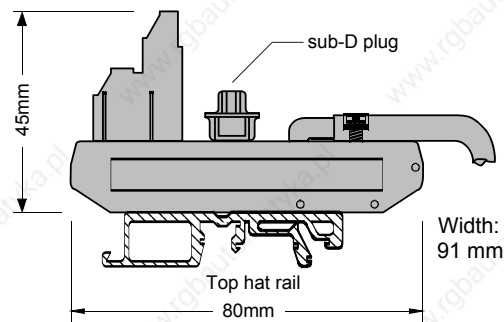

**Terminal assignment**

The terminal assignment corresponds to the pin assignment on X19.

### 9.7.3 EAM5/01: DC feed for COMPAX-M

The power supply is normally over a central mains module; NMD10 or NMD20. With the component EAM5/01, available as an accessory, DC voltage can be supplied: the component contains the connections of the mains module.

**Input voltage range** 100V DC – 650V DC.

The DC intermediate circuit must be limited to 750V in braking mode.

Power voltage is connected directly to COMPAX-M X2

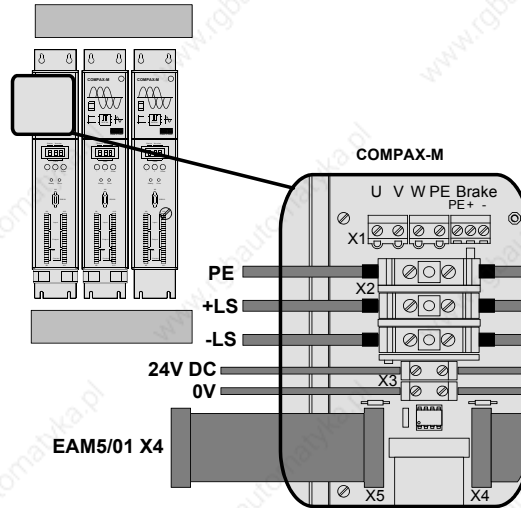

#### Design of EAM5/01:

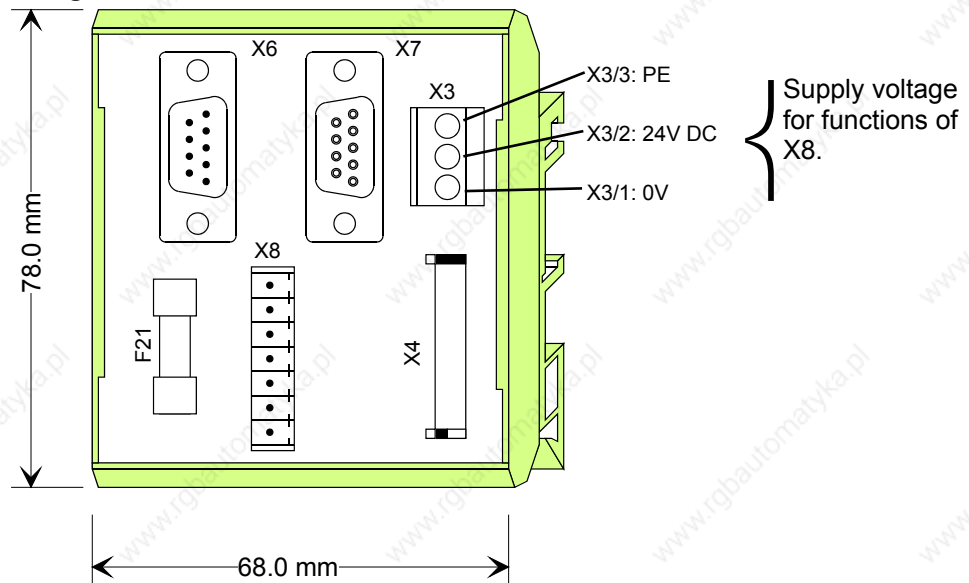

#### Note

- UMK housing from Phoenix
- to be attached to top hat rail of various sizes
- without mating connector approx. 4.5 cm deep

#### Terminal assignment

The component contains the connections of the mains module.

EAM5/01 X6 = mains module X6: input bus systems

EAM5/01 X7 = mains module X7: output bus systems

EAM5/01 X3 = mains module X3: 24V DC supply

### EAM5/01: DC feed for COMPAX-M

EAM5/01 X8 = mains module X8: control

EAM5/01 X4 = mains module X4: signal connection to COMPAX-M X5; connection cable included

EAM5/01 F21: 24V DC fuse 0.5A/M

#### **Delivery scope:**

EAM5/01.

Mating connector X8.

Signal connection EAM5/01 - COMPAX-M (0.5m).

Short circuit connector for the last COMPAX-M on X4.

## 9.7.4 EMC measures

### 9.7.4.1 Power filter

The following power filters can be used for RF suppression and compliance with the emission limit values specified in EN61800-3.

Type: NFI01/02

**NMD10 / COMPAX 45XXS / 85XXS**  
**COMPAX 1000SL** (in COMPAX 1000SL for motor lines >50m):

**NMD20:** Type: NFI01/03

Dimension diagram:

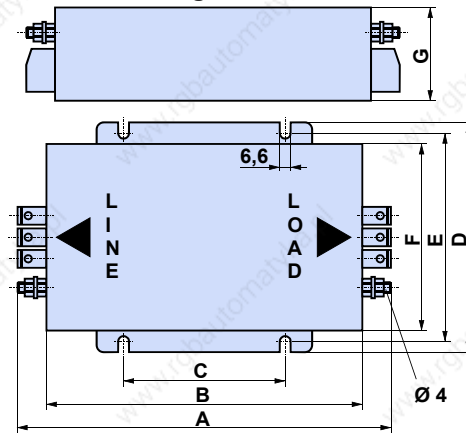

	NFI01/02	NFI01/03
A	177	240
B	151	217
C	70±0.3	115±0.3
D	140	159
E	125	145±0.5
F	111	129
G	65	64

**COMPAX 35XXM:** Type: NFI01/04

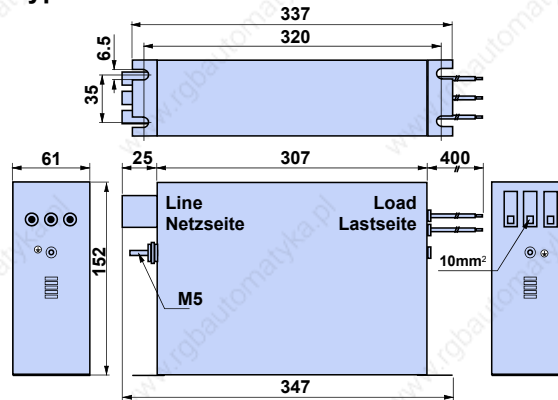

**COMPAX 35XXM with serially mounted COMPAX-M contr.:** Type: NFI01/05

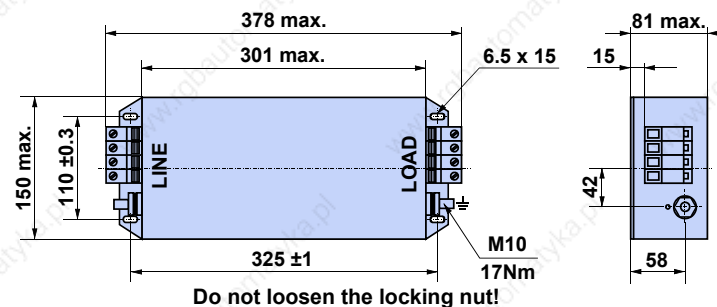

## EMC measures

**COMPAX 25XXS:  
COMPAX 10XXSL**

**COMPAX 25XXS: motor cable >10m  
COMPAX 10XXSL: motor cable >50m**

**Type: NF101/01 dimension diag.:**

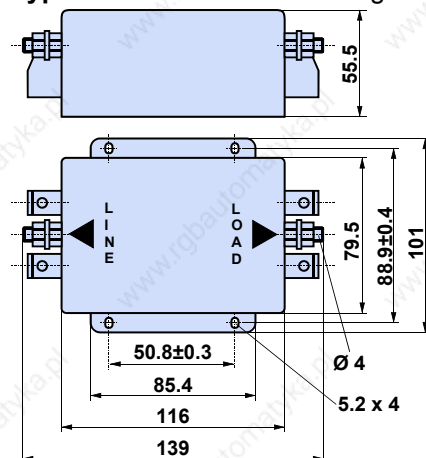

**COMPAX 25XXS: motor cable ≤10m**

**Type: NF101/06 dimension diagram:**

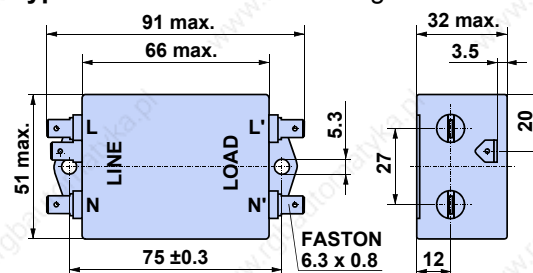

**Length of connection between power filter and unit:**

- Unscreened: <0.5m
- Screened: <5m

### 9.7.4.2 Motor output throttle

We supply motor output throttles for use with long motor lines (greater than 20m)

**Up to 16A nominal motor current:**

- Type: **MDR01/01** 16A / 2mH

**Up to 30A nominal motor current:**

- Type: **MDR01/02** 30A / 1.1mH

**Over 30A nominal motor current:**

- Type: **MDR01/03** >30A / 0.64mH

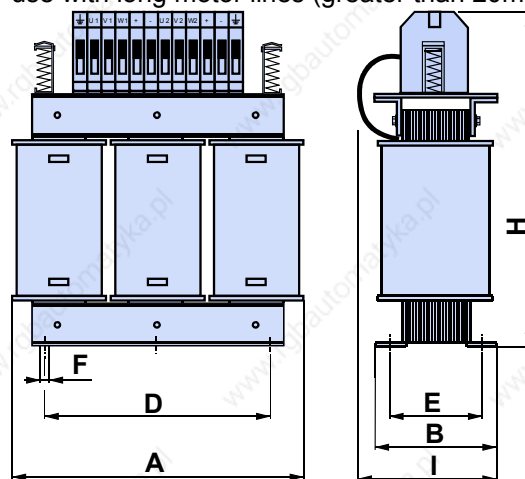

	MDR01/01	MDR01/02	MDR01/03
A [mm]	150	180	205
B [mm]	67	76	107
D [mm]	113	136	157
E [mm]	50	57	83
F [mm]	6	6	7
H [mm]	195	195	260
I [mm]	95	110	150
Weight [kg]	4	6	17

**Wiring of motor output throttle**

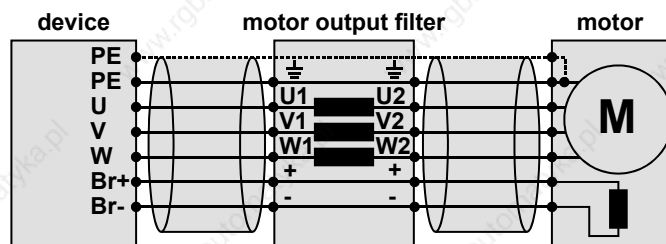



## 9.7.5 External ballast resistors

External ballast resistors:

### NMD20 with external ballast resistance of 15Ω

Braking power	Duration	Cooling down time
BRM4/01: 0.57 kW	unlimited	
6.8 kW	<1s	>20s
37 kW	<0.4s	>120s
BRM4/02: 0.74 kW	unlimited	
8.9 kW	1s	>20s
37 kW	<0.4s	>120s
BRM4/03: 1.50 kW	unlimited	
18 kW	<1s	>20s
37 kW	<0.4s	>20s

### COMPAX 25XXS with external ballast resistance of 56Ω

Braking power	Duration	Cooling down time
BRM5/01: 180W	unlimited	
1 kW	<1s	>10s
2.3 kW	<0.4s	≥8s

### COMPAX 45XXS/85XXS with external ballast resistance of 22Ω

Braking power	Duration	Cooling down time
BRM6/01: 450W	unlimited	
6.9 kW	<1s	>20s
28 kW	<0.4s	≥120s

### COMPAX 35XXM with external ballast resistance of 10Ω

Braking power	Duration	Cooling down time
BRM7/01: 2.00 kW	unlimited	
56 kW	<1s	>100s
17 kW	<1s	>10s

### COMPAX 10XXSL with external ballast resistance of 100Ω

Braking power	Duration	Cooling down time
BRM8/01: 60W	unlimited	
Dynamic 253W	<1s	≥10s

Dimension diagram:  
BRM4, BRM6 and  
BRM7

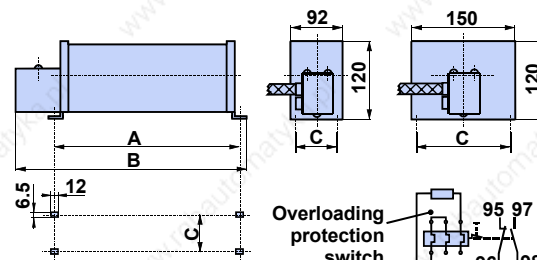

	BRM4/01	BRM4/02	BRM4/03	BRM6	BRM7
A	250	300	540	250	560
B	330	380	620	330	640
C	64	64	64	64	150



The ballast resistors are fitted with a 1.5m connecting cable. The maximum permitted length is 2m.

Dimension diagram:  
BRM5/01

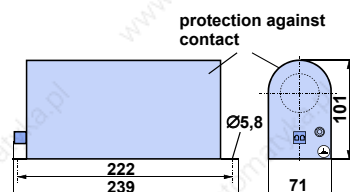

BRM5/01 is fitted with a 0.3m connecting cable. The maximum permitted length is 2m.

## External ballast resistors

Dimension diagram:  
BRM8/01

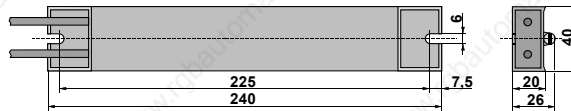

BRM8/01 is fitted with a 0.25m connecting cable.  
The maximum permitted length is 2m.

**Danger!**



**Housing temperature may reach 200°C.**

The external ballast resistances should be fitted so that contact protection is provided.

The housing temperature of the ballast resistance may rise to 200°C depending on the application.

Fit the connection lines underneath.

Observe the information on the resistances (warning signs).

## Diagrams: Brake pulse power - cooling period

Authorised braking impulse power with NMD20

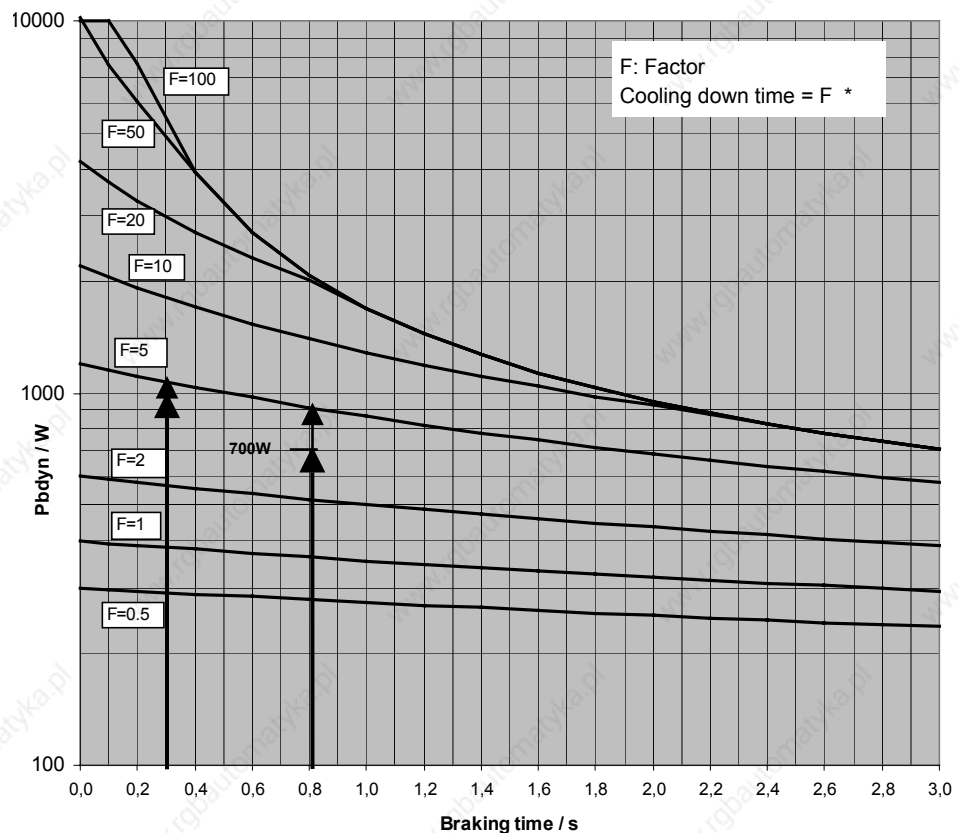

**Example 1:** For a braking time of 0.8s, a braking power of 700W is required.  
The following can be determined from the diagram:  
At the required magnitudes, this is between factor F=2 and factor F=5.  
To maintain operating safety, select factor F=5; therefore the required cooling down time equals:  
Cooling down time = F \* braking time = 5 \* 0.8s = 4s

**Example 2:** For a braking time of 0.3s, a braking power of 1000W is required.  
The following can be determined from the diagram:  
At the required magnitudes, this is between factor F=2 and factor F=5.  
To maintain operating safety, select factor F=5; therefore the required cooling down time equals:  
Cooling down time = F \* braking time = 5 \* 0.3s = 1.5s

**Authorised braking impulse power for NMD20 with BRM4/03**

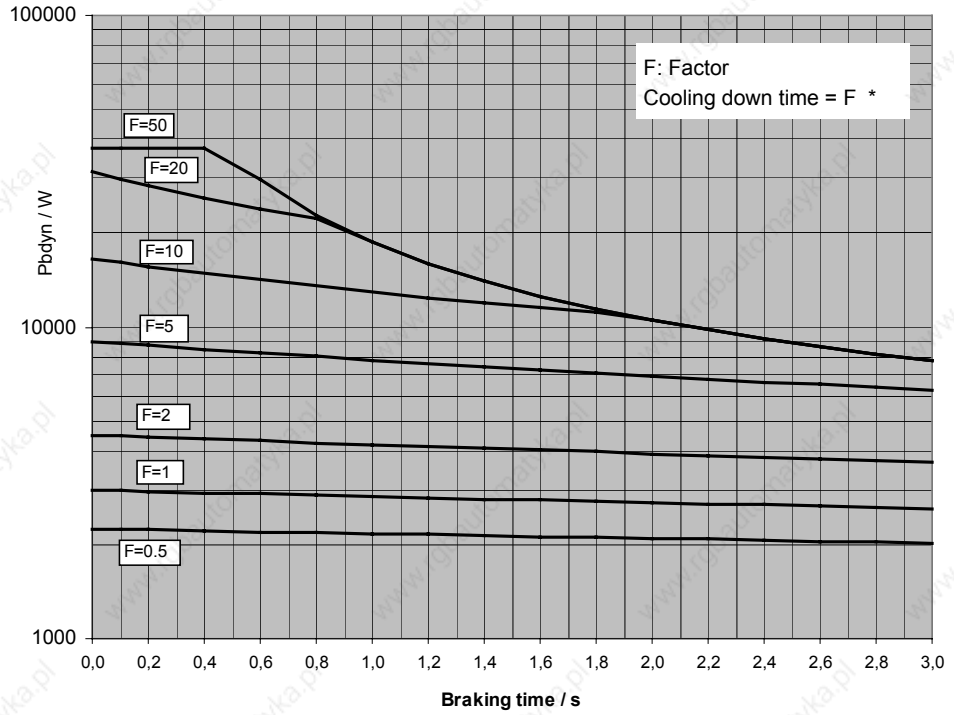

**Authorised braking impulse power for NMD20 with BRM4/02**

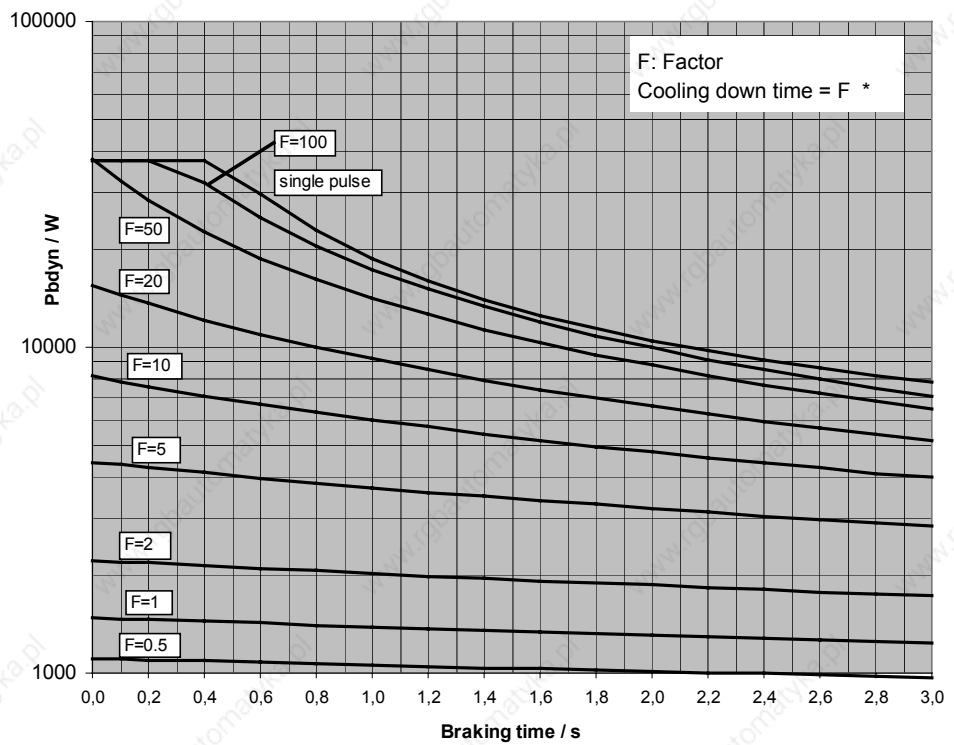

Unit  
hardware

Connector / cable  
assignment

Technical data

Configuration

Positioning and  
control functions

Optimization  
functions

Interfaces

Accessories /  
options

Status

Parameter

Error list

External ballast resistors

Authorised braking impulse power for NMD20 with BRM4/01

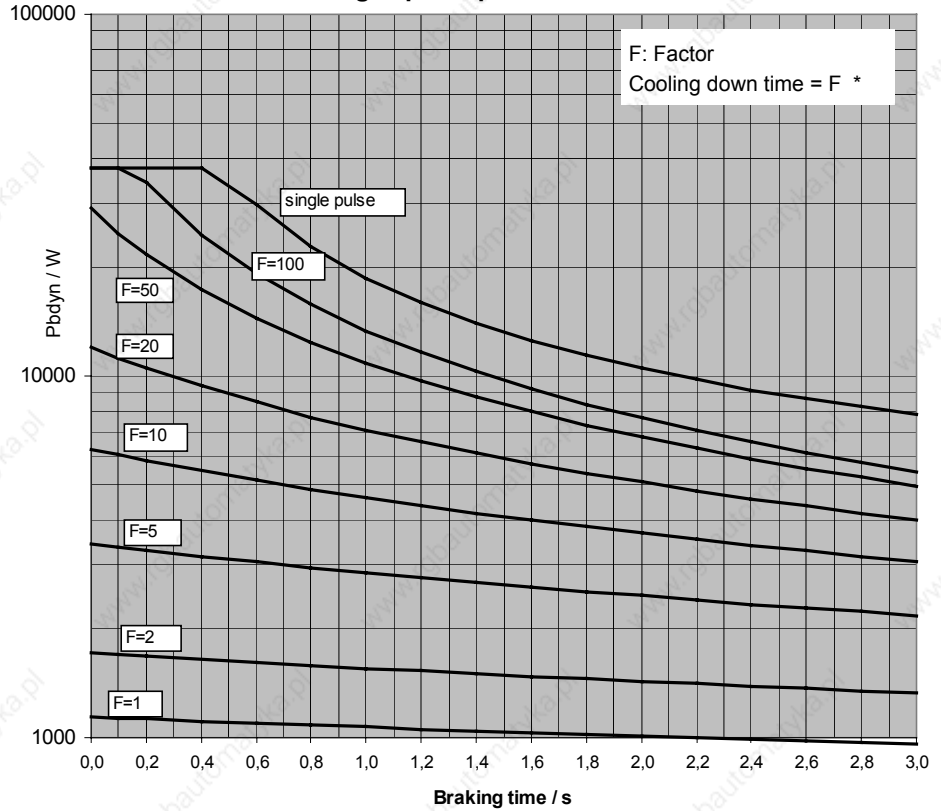

Authorised braking impulse power for NMD10

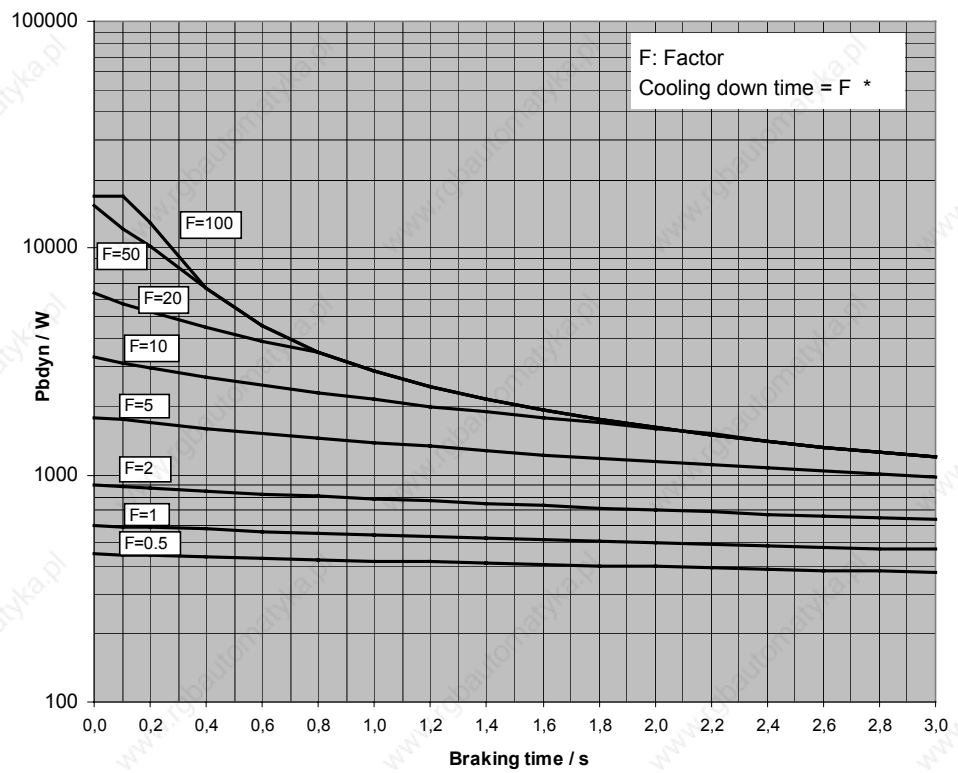

**Authorised braking impulse power for COMPAX 2500S with BRM5/01**

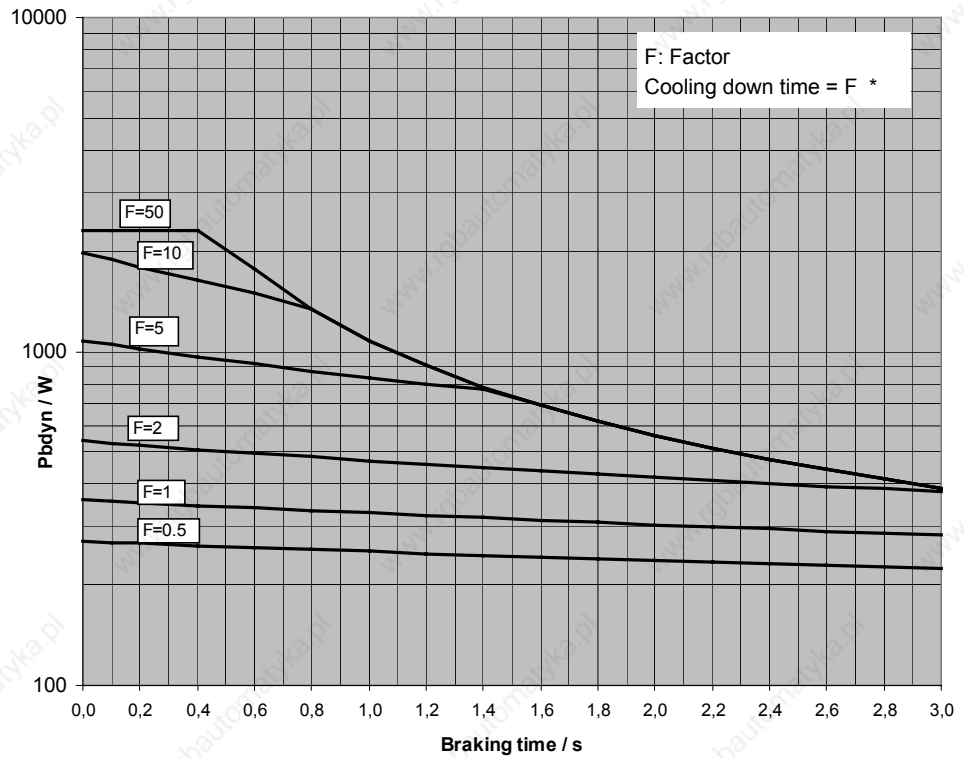

**Authorised braking impulse power for COMPAX 4500S and COMPAX 8500S**

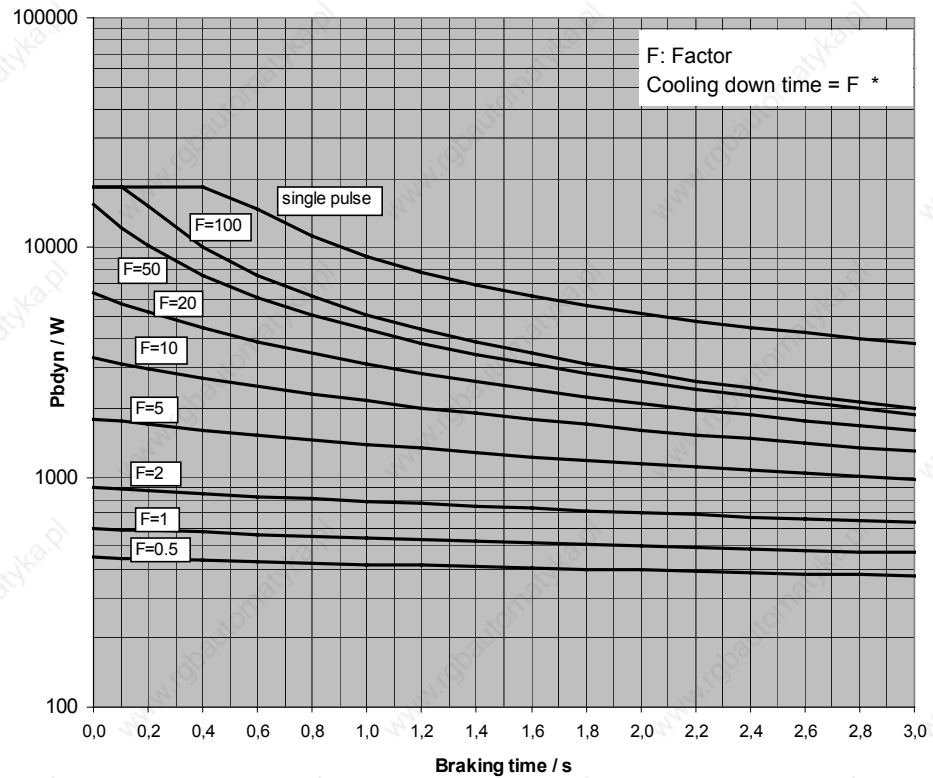

## External ballast resistors

**Authorised braking impulse power for COMPAX 4500S and COMPAX 8500S with BRM 6/01**

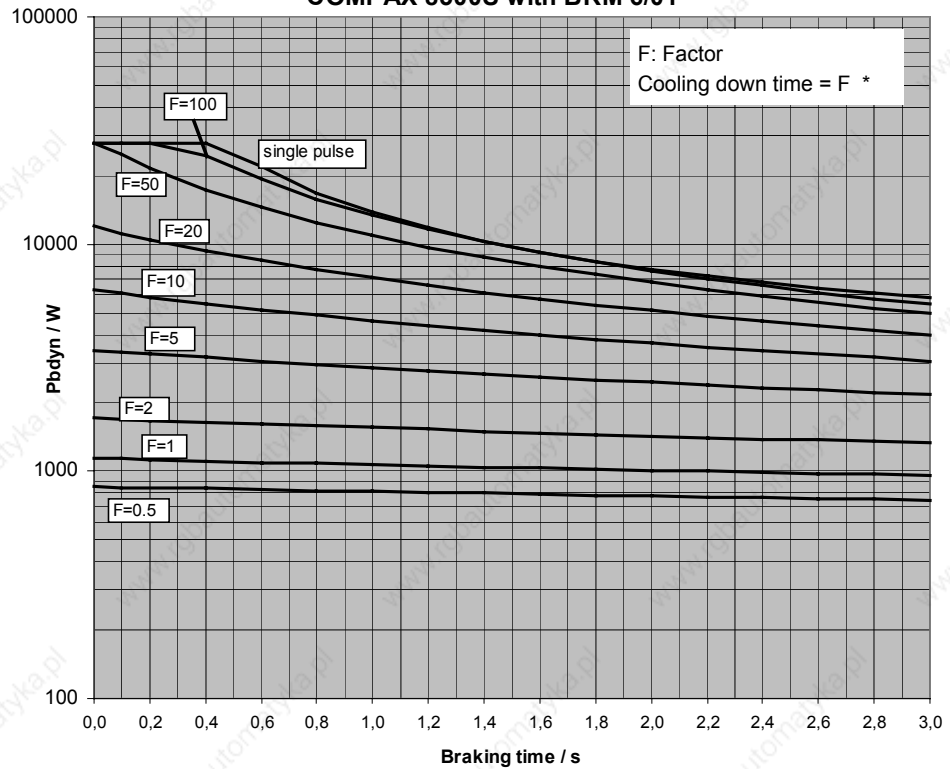

**Authorised braking impulse power for COMPAX3500M with BRM7/01**

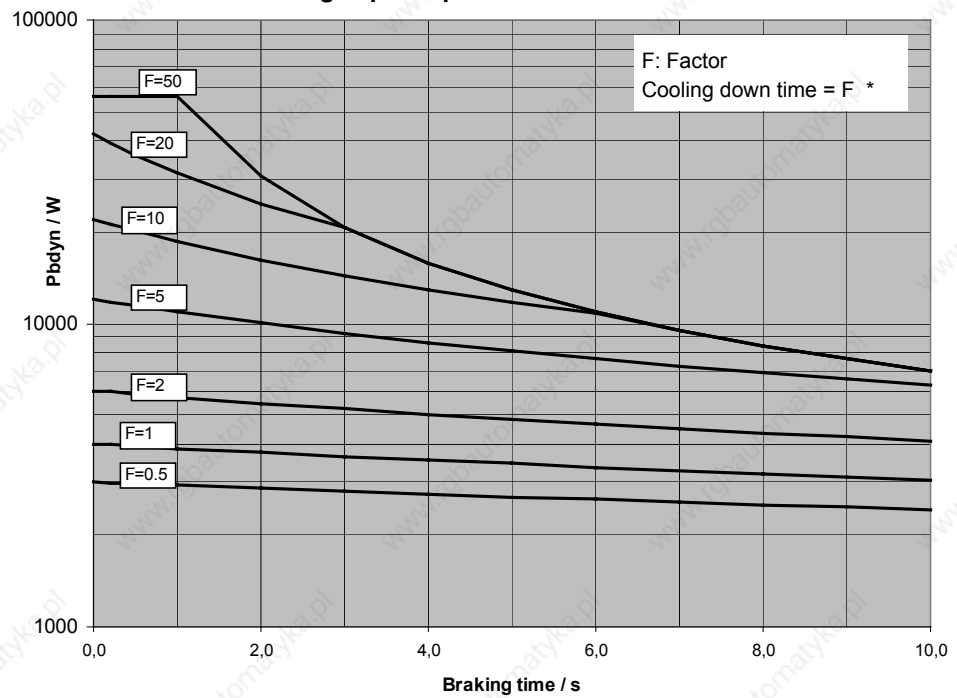

**Permissible brake pulse power for COMPAX 1000SL with BRM8/01**

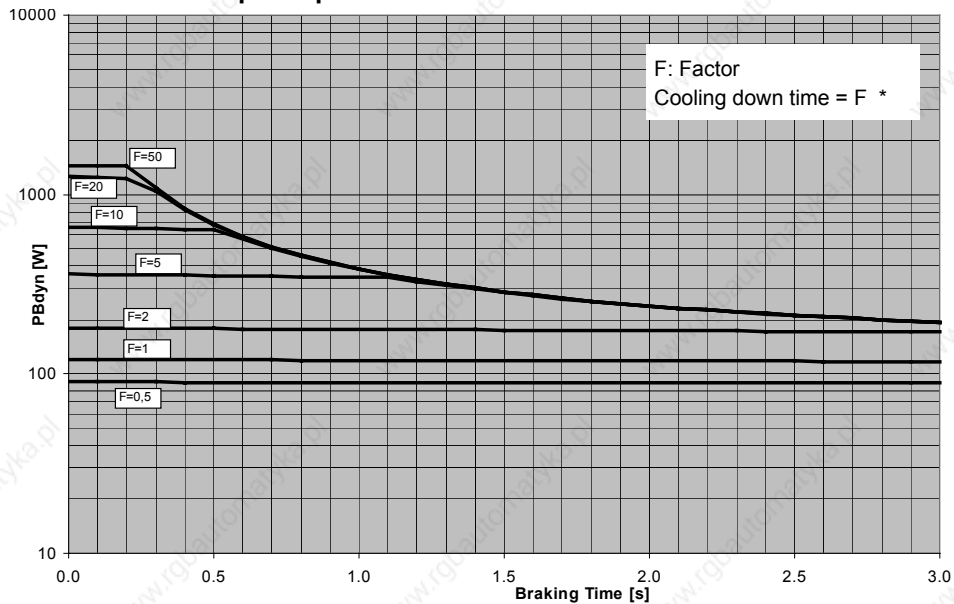

Unit hardware
Connector / cable assignment
Technical data
Configuration
Positioning and control functions
Optimization functions
Interfaces
Accessories / options
Status
Parameter
Error list

## ServoManager

### 9.7.6 ServoManager

Use the ServoManager to process complete COMPAX projects; it is included with COMPAX. It contains the following program modules:

- ParameterEditor: for configuring and parametrizing COMPAX.
- ProgramEditor: for creating COMPAX programs
- Terminal: for working directly on the connected COMPAX.

The ServoManager and the program modules are described in a separate manual.

### 9.7.7 Hand-held terminal

The BDF2/01 hand-held terminal is a simple aid with which you can operate and easily configure COMPAX with the guided menus. The hand-held unit is connected to COMPAX X6 and powered via the RS232 interface. It is therefore suitable for rapid diagnosis and supporting start-up.

#### Design:

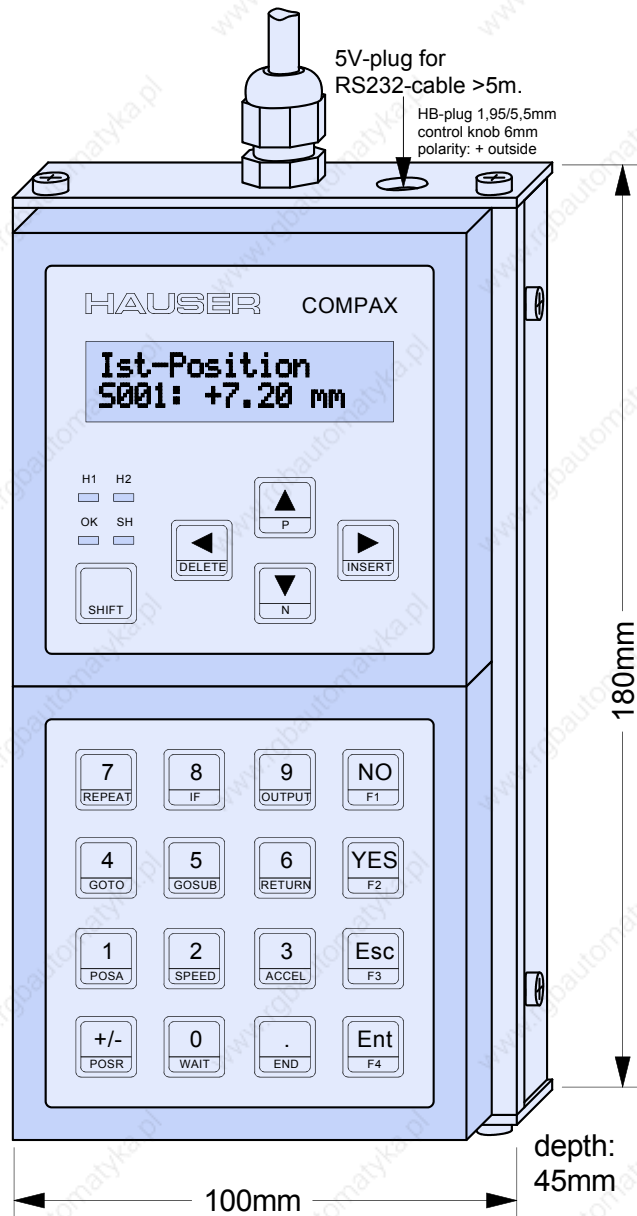



**Functions** The hand-held terminal contains the following functions:

- display any status value.
- menu-guided configuration
- view and edit programs.
- view and edit parameters
- direct entry of commands

**Key functions** The keys are all assigned two functions. Press the SHIFT key to activate the second function of a key. The second function is displayed in turquoise in the lower section of the key.

Keys	Function
NO	Answers a question negatively
YES	Answers a question positively
ESC	Escape
ENT	Confirms and accepts
SHIFT	Selects second function of the key: press once: on; press again: off
DELETE	Deletes program data record, all jumps to addresses are automatically corrected
INSERT	Inserts program data record, all jumps to addresses are automatically corrected
P	Directly select parameter input
N	Directly select program memory
F3	Quit
<b>Special functions</b>	
WAIT Ent	WAIT START
GOTO Ent	GOTO EXT
GOSUB Ent	GOSUB EXT
SPEED Ent	SPEED SYNC
<b>Special COMPAX XX70 commands</b>	
F1	SETC x
F2	SETM x
F3	SETS
F4	LOOP x
POSR Ent	POSR CAM

Lit display	Function	
	dark	bright
H1 (red)	No error	Error
H2 (amber)	No warning	Warning: heat sink temperature >70°C
OK (green)	Unit not ready	Unit ready for operation
SH (amber)	First key function	Second key function (SHIFT key pressed)
All	No voltage	Unit not ready for operation

**Supply** The cable is 1.5 m long. The hand-held terminal is also powered through this cable. If the distances involved are longer (>5m), the hand-held terminal will require a direct power supply for fault-free operation.

**Error handling** When an error message is present, you can modify the parameter and configuration. To do this, press ESC; the error display goes out and the menu appears. The H1 LED indicates that the error is still present. Once you have modified the parameter, acknowledge the error using F3.

## Hand-held terminal

### Menu:

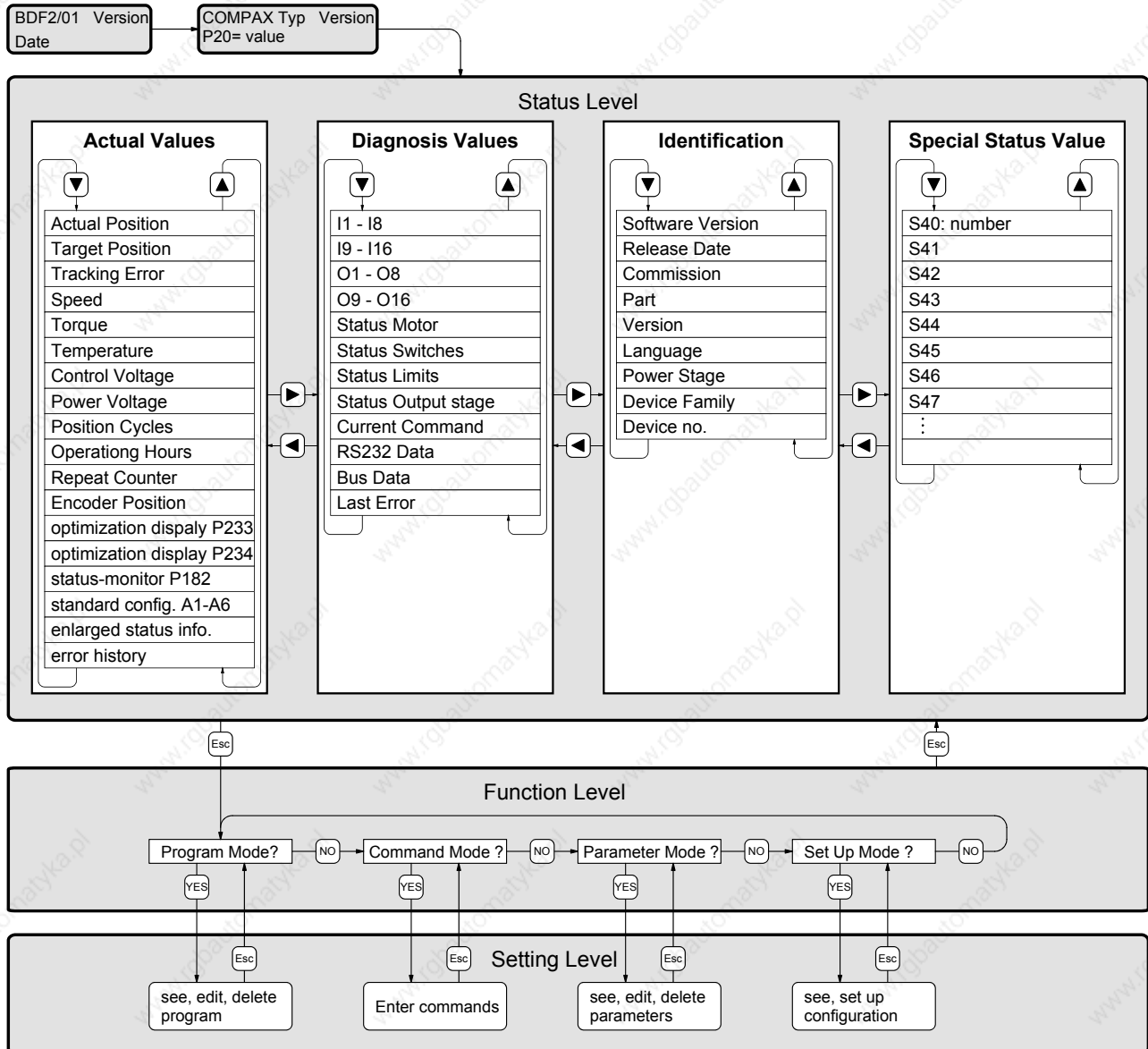

➡ When the hand-held terminal is connected to COMPAX, the password remains the same.

➡ The menu items of the setting levels are described below.

### View, edit, delete program

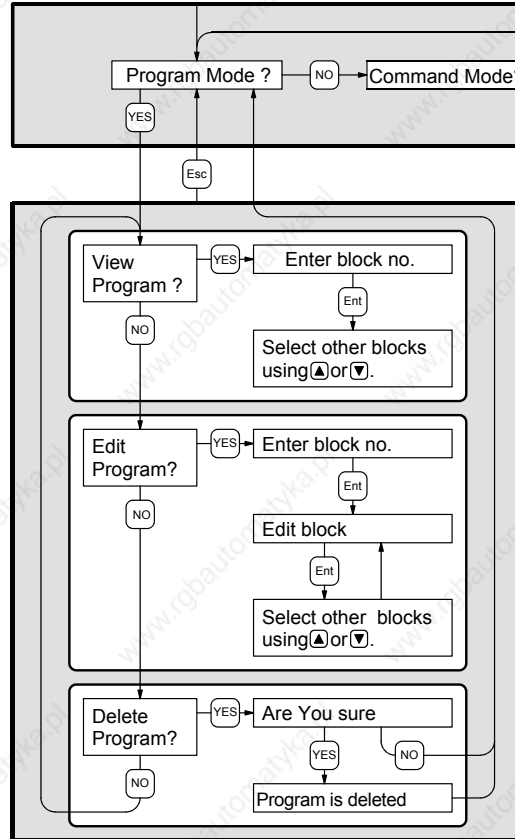

Commands or numerical values are modified by overwriting them.

### Direct command entry

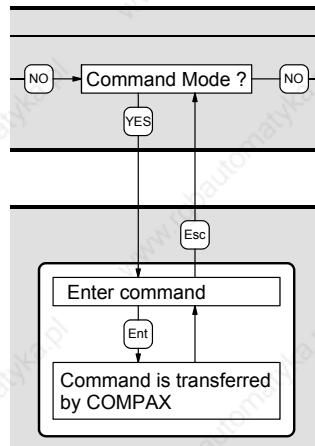

Once you have transmitted the command using "Ent", this command reappears in the display and it can be modified and transmitted again.

### Special control function

When OUTPUT O.="X", the cursor is positioned under "X" after the command is transmitted. The value can be modified and transmitted.

## Hand-held terminal

### View, edit and reset parameter

"VC" is generated when you exit the menu.

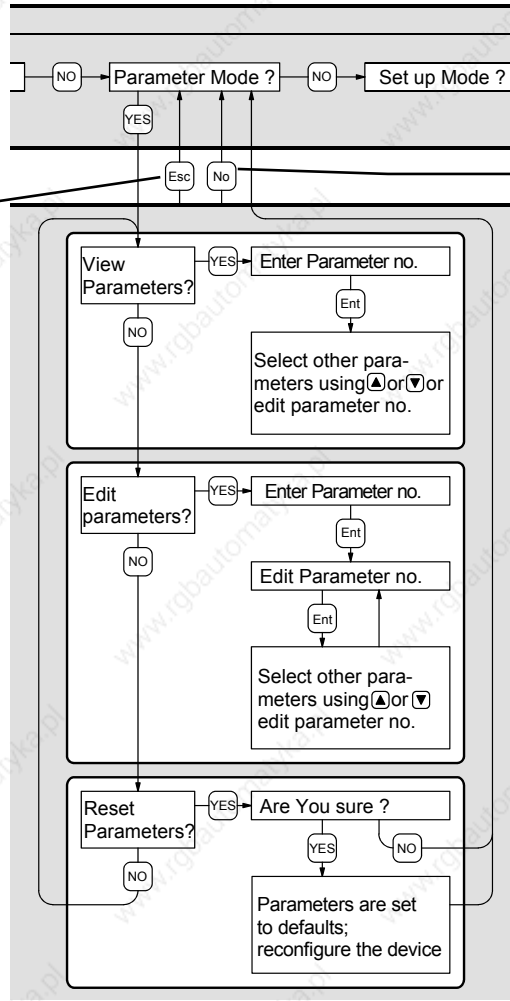

Exits the menu without "VC".

- When you exit the "Parameter edit" menu using "Esc", the "VC" command (transfer configuration) is transmitted to COMPAX. The configuration parameters are therefore only valid from this moment.
- When exiting the "Parameter edit" menu using "NO", the "VC" command is not transmitted.

### View, set configuration

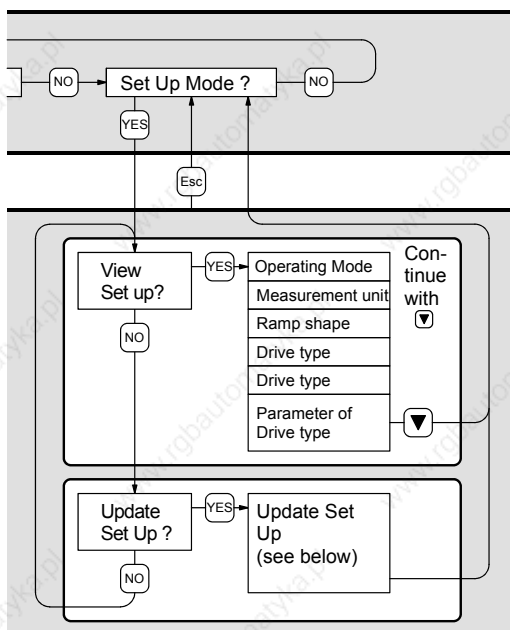

### Set configuration

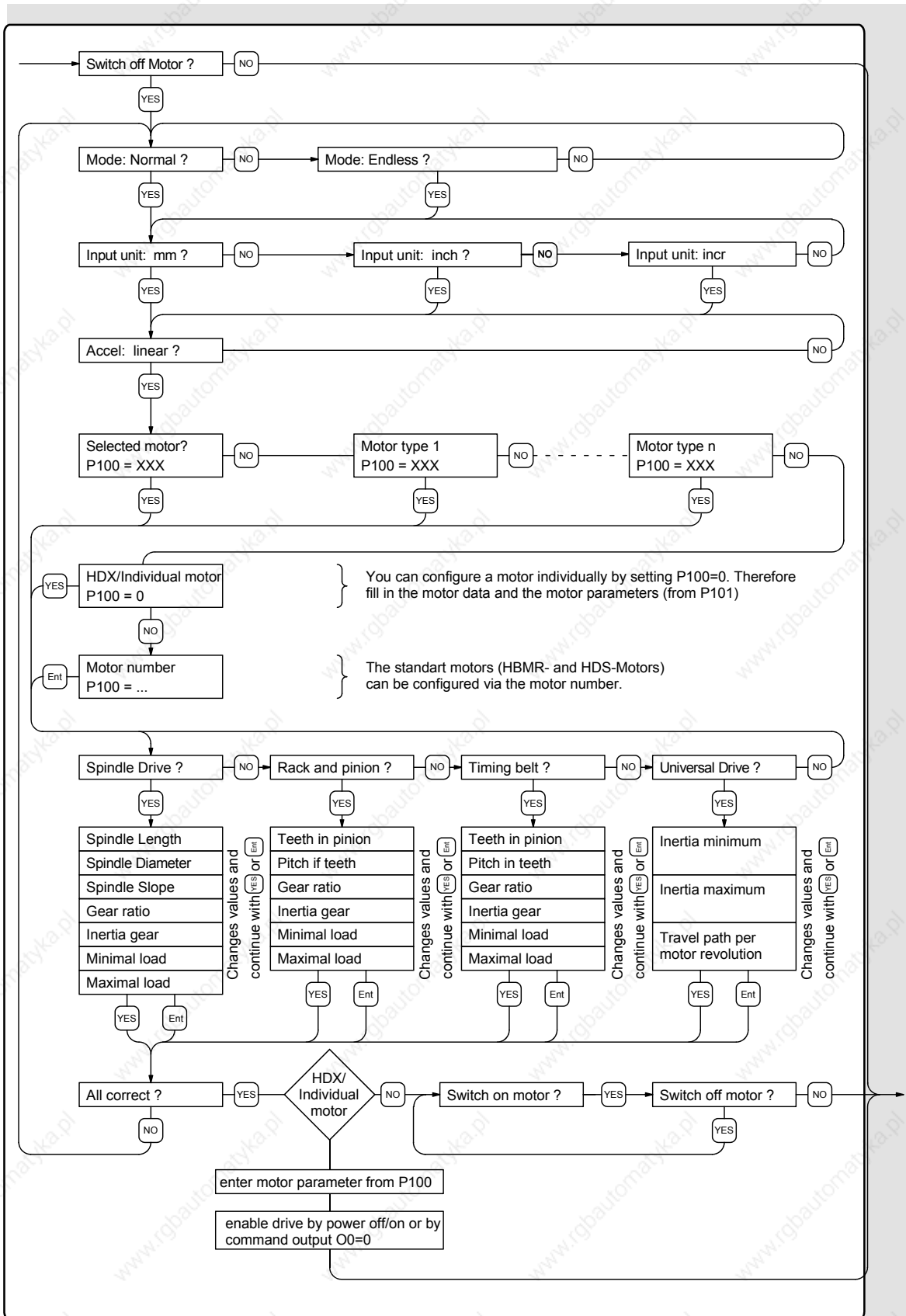

Unit hardware
Connector assignment / cable
Technical data
Configuration
Positioning and control functions
Optimization functions
Interfaces
Accessories / options
Status
Parameter
Error list

### 9.8 Appendix: COMPAX components

Mains module for COMPAX-M (excluding COMPAX 35XXM)			
<b>NMD10</b>	Up to 3 x 500 V AC mains supply connection; direct mains supply operation 10 kW cont. output		
<b>NMD20</b>	As NMD10, but with 20 kW continuous output; external ballast resistances available in 3 sizes.		
HDY and HJ motors			
You will find information about our range of motors in the motor documentation.			
Motor and resolver cable for HDY and HJ motors			
You will find motor and resolver cables on Page 46.			
HAUSER linear unit and initiator equipment			
<b>HLE</b>	80mm / 100mm / 150mm edge length (ask for information material!)		
<b>HPLA</b>	80mm / 120mm / 180mm edge length (ask for information material!)		
<b>Initiator equipment</b>	<b>IVD1/..</b>	Initiator distr.connect. w. cables of the f. lengths [m]:2.5; 5; 7.5; 10; 12.5; 15; 20; 25; 30; 35; 40; 45; 50	
	<b>Initiator</b>	PNP induction proximity switch: IN HE 521 506 with 6m cable.	
Accessories			
<b>BDF2/01</b>	Hand-held terminal for configuring and operating COMPAX		
<b>BDF1/03</b>	External control panel with housing and without cable		
<b>BDF1/02</b>	External control panel for front plate installation without cable		
<b>SSK6/..</b>	Interface cable between contr. panel and COMPAX av.- in the following lengths: 2.5; 5; 7.5; 10; 12.5; in [m]		
<b>SSU1/01</b>	RS232 - RS485 converters used in conjunction with option F1		
<b>GBK16</b>	COMPAX – motor cable for disposing of SinCos.		
<b>Encoder: GBK11/..</b>	Encoder cable for connecting COMPAX with an encoder.		
<b>EAM4/01</b>	Encoder distributor for creating an encoder bus.	<b>BUS1/01</b>	Bus termination for encoder bus
<b>SSK4/..</b>	Connector cable between COMPAX and encoder distributor.		
<b>SSK7/..</b>	Connector cable between encoder distributors or from an encoder emulation.		
<b>ASS1/01</b>	Monitor box for outputting internal measurement signals with D1 option.		
<b>SSK1/..</b>	RS 232	Interface cable for PC COMPAX, available in the following lengths: 2.5; 5; 7.5; 10; in [m]	
<b>Ballast resistors</b>	<b>NMD20:</b>	BRM4: 0.57 kW-1.5 kW (15Ω)	<b>COMPAX 25XXS:</b> BRM5/01: 250W (56Ω)
	<b>COMPAX 45XXS/85XXS:</b>	BRM6/01: 450W (22Ω)	<b>COMPAX 35XXM:</b> BRM7/01: 2 kW (10Ω)
	<b>COMPAX 1000SL</b>	BRM8/01: 60W (100Ω)	
<b>AC power filter</b>	<b>NMD10 / COMPAX 45XXS/85XXS:</b> NFI01/02 <b>COMPAX 25XXS:</b> NFI01/01 or NFI01/06 (≤ 10m motor cable) <b>COMPAX 35XXM:</b> NFI01/04 or NFI01/05 (with additional COMPAX-M) <b>NMD20:</b> NFI01/03 <b>COMPAX 1000SL:</b> NFI01/01 (<50m motor cable) Or NFI01/02 (>50m motor cable)		
<b>Motor outp. throttle</b>	For motor lines >20m: MDR01/01 (16A/2mH) • MDR01/02 (30A/1.1mH) • MDR01/03 (>30A/0.64mH)		
<b>Ass. angle bracket:</b>	MTS2: for indirect wall installation (heat sink in separate heat chamber) of COMPAX 02/05/15XXM		
<b>Fan set for NMD</b>	Fan set for NMD10 and NMD20 to increase max. brake performance		
<b>ServoManager</b>	To read and write COMPAX parameters and programs		
<b>Bus terminal</b>	<b>BUS1/01:</b> Encoder bus	<b>BUS2/01:</b> HEDA	<b>BUS3/01:</b> Profibus
	<b>BUS4/01:</b> RS485	<b>BUS6/01:</b> Encoder terminal for COMPAX 1000SL	
Options			
<b>F1</b>	4-wire RS485 interface		<b>F5</b> 2-wire RS485 interface
<b>F2</b>	Interbus S interface	<b>F3</b> Profibus	<b>F7</b> CS31 <b>F8</b> CANopen <b>F4</b> CANbus
<b>E2</b>	Encoder interface with line terminator for individual connections.		
<b>E3</b>	Encoder simulation for resolver		
<b>E4</b>	Encoder interface without line terminator for creating an encoder bus.		
<b>E7</b>	Analogue speed specification only for COMPAX XX6X and COMPAX XX70 or for SPEED SYNC with COMPAX XX00!		
<b>A1</b>	Absolute value sensor/HEDA	Cable to COMPAX: GBK1/.. lengths: 2.5; 5; 7.5; 10; 12.5; 15; 20; 25; 30; 35; 40; 45; 50 [m]	
<b>A4</b>	HEDA f. COMPAX 1000SL	Cable COMPAX/COMPAX: SSK14/.. lengths :2.5; 5; 7.5; 10; 12.5; 15; 20; 25; 30; 35; 40; 45; 50 [m]	
<b>D1</b>	D/A monitor	To output the measurement signals, you will need monitor box ASS1/01.	
<b>S1</b>	Sensor interface for SinCos, single-turn or multi-turn	<b>S2</b>	Programmable sensor interface for SinCos multi-turn
<b>S3</b>	Sensor-interface for linear motors (cable: GBK18)		

# 10. Appendix

## 10.1 Status values of the standard unit (COMPAX XX00)

### Actual values

Designation:	Status No.	Unit	Meaning
Actual position	S01	corresp. P90	Current position referenced to real zero.
Target position	S02	corresp. P90	End position of current or last positioning cycle implemented.
Lag error	S03	0.1 [corresp. P90]	Difference between nominal and actual position during a positioning cycle.
Velocity	S04	[%]	Current axis traversing speed.
Torque	S05	[%]	Current torque as a percentage of the nominal motor torque.
Temperature	S06	[°C] C is transmitted	Temperature of power final stage (≤ 85°C)
Control voltage	S07	[V]	Value of control voltage
Mains power	S08	[V]	Value of power or intermediate circuit voltage
Travel cycle	S09	-	Number of axis motion cycles.
Operating hours	S10	[h]	COMPAX controller operating hours
Repeat counter	S11	-	Loop counter of an active REPEAT loop.
Sensor position	S12	corresp. P90	Position of absolute value sensor (option A1) not available in COMPAX XX10 and COMPAX XX30.
Optimization display	S13		With optimization parameter selected using P233.
Optimization display	S14		With optimization parameter selected using P234.
Status monitor	S15		D/A monitor value selected using P182.
Status bits 1	S16		Information from the status outputs O1...O6 and the last OUTPUT O0 command
Status bits 2	S17		Information about COMPAX status.
Error history	S18		The last 4 errors and type of acknowledgement. See below. (only errors E1 ... E57)

### Diagnosis values

Designation:	Status No.	Meaning
I1-I8	S19	Logic signal level of inputs 1...8
I9-I16	S20	Logic signal level of inputs 9...16
O1-O8	S21	Logic signal level of outputs 1...8
O9-O16	S22	Logic signal level of outputs 9...16
Status drive	S23	Diagnosis values for the status of the drive. (see below for meaning)
Status switch	S24	Diagnosis values for the status of the switch. (see below for meaning)
Status limits	S25	Diagnosis values for the limit value monitoring . (see below for meaning)
Status final stage	S26	Diagnosis value for the status of the final stage.
Current data record	S27	Display of the data record currently being executed.
RS232 data	S28	reserved
Bus data	S29	Interbus-S data / PLC data interface / RS485
Last error	S30	Error number of the last error to occur (only errors E1 ... E57).

Unit hardware  
Connector assignment / cable  
Technical data  
Configuration  
Positioning and control functions  
Optimization functions  
Interfaces  
Accessories / options  
Status  
Parameter  
Error list

Hand-held terminal

## Unit designations

Designation:	Status No.	Meaning	
Software version	S31	Designation of software version.	
Software date	S32	Date when program was created.	
Order	S33	Order number (6 digits)	Order&part (10 digits) is a unique unit no.
Part	S34	Serial four-digit number	
Version	S35	Not assigned.	
IFM identification	S36	Date, version and designation of the bus option (hardware module)	
Unit designation	S37	COMPAX P1XXM: 80 COMPAX 05XXM: 170 COMPAX 25XXS: 4 COMPAX 10XXSL: 20	COMPAX P1XXM N1: 90 COMPAX 15XXM: 500 COMPAX 45XXS: 6 COMPAX 02XXM: 85 COMPAX 35XXM: 1000 COMPAX 85XXS: 5
Unit family	S38	E.g. "00": COMPAX XX00 "30": COMPAX XX30 ...	
Unit	S39	"0": COMPAX E "1": COMPAX-M "2": COMPAX-S "4": COMPAX-SL "9": SV drive	
Status values	S40	Number of status values present	

## Special COMPAX XX00 status values

Designation:	Status No.	Unit	Meaning
Speed	S41	%	External velocity when using the SPEED SYNC command.
Encoder position	S42	P90	External position when using external position localization.
Measuring error	S47	P90	During external position localization: difference between resolver position and encoder position.
Current nominal value	S49	P90	Current internal nominal value (output of nominal value setter and track nominal value directly specified by HEDA).

## Meaning of status bits

The status bits are not relevant for normal operation; they must not be used for control purposes. They do provide accurate error analysis if you contact HAUSER in case of problems. - The bits are counted from the left to the right.

## S23, S24, S25

Bit	Drive status (S23)	Switch status (S24)	Limits status (S25)
	-1111-----1111-	-111-111-110 <sup>42</sup> --	-11-11-11-11-
1 (left)	Not assigned	Not assigned	Not assigned
2	Drive not at standstill	Override function	reserved
3	Deceleration phase	Limit switch 2 (-) activated	reserved
4	Acceleration phase	Limit switch 1 (+) activated	Not assigned
5	Speed reached (speed regulation)	Not assigned	Not assigned
6	Not assigned	Not assigned	No motor current
7	Not assigned	Zero initiator activated	
8	Not assigned	reserved	Not assigned
9	Not assigned	reserved	Not assigned
10	Not assigned	Not assigned	Position not OK.
11	Not assigned	Not assigned	Tracking error
12	Speed reached (positioning)	reserved	Not assigned
13	Positioning process complete	Do not change data record (emergency stop)	Not assigned
14	Drive blocked	reserved	Speed limit reached
15	Machine zero reference present	Not assigned	Current limit reached
16 (right)	Not assigned	Not assigned	Not assigned

<sup>42</sup> The "0" is not shown on the front plate.



### Output of status bits via the front plate

The status bits are output via the front plate using 2 hex values.

#### S16, S17

S16:		
Bit	Meaning	
1	="1":No fault ="0":errors E1 ... E57; the drive does not accept any positioning commands. After "Power on", bit 1 remains at "0" until the self-test has been executed.	
2	="1":No warning ="0" Error $\geq$ E57	
3	Machine zero has been approached	
4	Ready for start	
5	Programmed nominal position reached	
6	Idle after stop	
7, 8	Bit 7	Bit 8
	0	0
	1	0
	0	1
S17:		
Bit	Meaning when "1"	
1	Password 302 active	
2	Service password active	
3	Command active; move commands (POSA, POSR; speed in speed control mode) are rejected using E92.	
4	Program memory running	
5	Stop via input I6	
6	reserved	
7	RUN ("0" = OFF or switched off when error occurs)	
8	---	

Bit sequence during transmission of S16 / S17:

Bit 1 is on the left (the transmission starts with bit 1)

E.g.: S17= "1000 0000" during ASCII transfer.

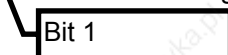

COMPAX front plate: display "01"

E.g.: password 302 active S17 = 0x80 (if all other bits ="0").

### Explanation of error history S18

The errors which occur are recorded by COMPAX in an 8-stage shift register. The entire contents of this memory can be read using a status query. Once the error has been acknowledged, "99" is inserted. Once a new error occurs, this is inserted in the shift memory.

When querying using S18, the contents of the shift register are output separated by spaces.

Once the unit is switched off, S18 is retained. If the unit is switched off while an error is present, a Power On acknowledgement is created when the unit is switched on, i.e. a "98" is inserted in the shift memory.

**Example:** S18C<sub>RL</sub>F

Response: S018: 99 55 10 99 53 98 10 99C<sub>RL</sub>R>

- The last error, an emergency stop (E55), has been acknowledged.
- E10 occurred before this (E10 has not been acknowledged).
- E53 has been acknowledged.
- E10 has been acknowledged by Power on.

The error memory is completely reset to "00" by the reset parameter, i.e. "00" means no errors.

Hand-held terminal

Status monitor S15

You can assign the values of the service D/A monitor to status S15 using parameter P182.

Selection of status value using P182

P182	Measuring parameter	Reference parameter
0	Nominal speed value sensor	20 000 min <sup>-1</sup>
1	Tracking error	128 motor revolutions
2	Advance speed control	20 000 min <sup>-1</sup>
3	Nominal speed value of position controller	20 000 min <sup>-1</sup>
4	Actual speed value	20 000 min <sup>-1</sup>
5	Loop difference for speed	20 000 min <sup>-1</sup>
6	Not assigned	
7	Not assigned	
8	Nominal value of transverse current (torque) <sup>43</sup>	200A
9	Intermediate circuit voltage	1000V
10	Sine for co-ordinate transformation	
11	Voltage positioning signal for phase U	
12	Voltage positioning signal for phase V	
13	Phase current for phase U	200A
14	Phase current for phase V	200A
15	Actual value of transverse current (torque) <sup>44</sup>	200A
16	Longitudinal current	200A
17	Scaled transverse voltage (For amplification 1 use: 10V = 2 * U <sub>LS</sub> )	2 * U <sub>LS</sub>
18	Scaled longitudinal voltage (For amplification 1 use: 10V = 2 * U <sub>LS</sub> )	2 * U <sub>LS</sub>

The reference parameter corresponds to value 1.

Note concerning status monitor S15

Scaling status monitor S15:

S15 does not have the same scaling as S13/S14.

For S15 use: S15=1 for the reference value which is given for the D/A monitor.

10.2 Additional COMPAX measuring quantities

D/A monitor channels 0 ... 3 Status monitor S15 (P182); HEDA		
Selection	Measuring quantity	Reference value
0	Nominal speed value sensor	20 000 min <sup>-1</sup>
1	Tracking error	128 motor revolutions
2	Advance speed control	20 000 min <sup>-1</sup>
3	Nominal speed value of position controller	20 000 min <sup>-1</sup>
4	Actual speed value	20 000 min <sup>-1</sup>
5	Loop difference for speed	20 000 min <sup>-1</sup>
6	Not assigned	
7	Speed controller output (nominal current value)	200A
8	Nominal value of transverse current (torque)	200A
9	Intermediate circuit voltage	1000V
10	Sine for co-ordinate transformation	
11	Voltage positioning signal for phase U	2 * U <sub>LS</sub>
12	Voltage positioning signal for phase V	2 * U <sub>LS</sub>
13	Phase current for phase U	200A
14	Phase current for phase V	200A
15	Actual value of transverse current (torque)	200A
16	Longitudinal current	200A

Signal indicators (optimization display) S13 / S14 (P233/P234)	
Selec	Meaning
1	Positioning time (from start of positioning to "Position reached")
2	max. intermediate circuit voltage in [V]
3	reserved
4	max. undershoot referenced to max. position (amount) (only for highly misadjusted loops)
5	max. position overshoot [units corresp. P90] (amount)
6	max. position undershoot [units corresp. P90] (amount)
7	max. acceleration lag error [units corresp. P90]
8	max. braking lag error [units corresp. P90]
9	Max. acceleration speed in [%] of the nominal motor speed
10	max. braking speed in [%] of motor nominal speed
11	max. acceleration current in [%] of motor nominal current
12	max. braking current in [%] of motor nominal current
13	max. time in current limit during acceleration, in [ms]
14	max. time in current limit during braking, in [ms]
15	Current number of HEDA transmission errors
16	Average no. of HEDA transmission errors per second

<sup>43</sup> To determine torque: torque = 3 \* transverse current \* 0.71 \* torque constant

<sup>44</sup> To determine torque: torque = 3 \* transverse current \* 0.71 \* torque constant

D/A monitor channels 0 ... 3 Status monitor S15 (P182); HEDA		
Selection	Measuring quantity	Reference value
17	Scaled transverse voltage (For amplification of 1 use: 10V = 2 * ULS )	2 * ULS
18	Scaled longitudinal voltage (For amplification of 1 use: 10V = 2 * ULS )	2 * ULS
19	Host frequency 12/18 Mhz	2 <sup>23</sup>
20	Analogue HF1 CPX 70 / IPM	100%=0.1V
21	Analogue HF2 CPX 70 / IPM	100%=0.1V
22	Master position (CPX 70)	M <sub>T</sub> =0.1 V
23	Slave nominal position (CPX 70)	S <sub>T</sub> =0.1 V
24	Master speed (CPX 60, CPX 70)	2000min <sup>-1</sup> =1V
25		
26		
27		
28		
29		
30		
Meaning		
31	Function pointer mark synchronization (range 0-7)	
32	Scaled correction factor 0 ... 1000 per thousands	
33	Cycle counter X70	
34	DSP wait time [ms]	
35	Digital inputs I1-I16 (range 0-2 <sup>16</sup> )	
36	Status S16 (Bit 16...23) & digital outputs O1-O16 (Bit 0...15)	
37	Frequency encoder channel 4 [inc/ms]	
38	Frequency encoder channel 5 [inc/ms] (reserved)	
39	Constant value 0.00001	
Meaning		
40	Encoder position master channel	
41	Encoder velocity (reserved)	
42	Internal time base of P35	
43	Scaled master position	
44	Nominal position value in resolver increments	
45	Actual position value in resolver increments	
46	Differentiated resolver position	
47		
48	Bit 23...8: virtual inputs I33...I48 Bit 7...0: virtual inputs I32...I25	
49		
50	smoothed load torque (reference 200A)	
51	Actual position S1 in physical units P90 (integral digit)	
52	Actual position S1 in physical units P90 (fractional digits)	
53		
54		
55		
56		
57		
58		

Signal indicators (optimization display) S13 / S14 (P233/P234)		
Selec tion	Meaning	
17	Total number of HEDA transmission errors since beginning of synchronization	
18	Process nominal value HEDA	
19	HEDA control word	
20	HEDA status word	
21	CPX X50 max. pos. synchronous lag error [units corresp. P90]	
22	CPX X50 max. neg. synchronous lag error [units corresp. P90]	
23	Output value of D/A monitor channel 1 (10V corresponds to 1)	
24	Output value of D/A monitor channel 2 (10V corresponds to 1)	
25	Output value of service D/A monitor channel 3 (10V corresponds to 1)	
26	Output value of service D/A monitor channel 4 (10V corresponds to 1)	
27	External encoder position (units corresp. P90)	
28	Measuring error (Difference between resolver position and external encoder position in the unit corresponding to P90)	
29	Effective motor load in % of the permissible motor continuous load (from 100% = 1.1 <sub>Nominal</sub> E53 is indicated)	
30	Effective unit load in % of the permitted continuous unit load (E53 is displayed from 100%)	
Variant:	Reference values	
7x	10V = 2 <sup>23</sup>	
7x	10V = 2 <sup>23</sup> per thousands	
7x	10V = 2 <sup>23</sup> cycles	
00,60,7x	10V = 2 <sup>23</sup> ms	
00,60,7x	10V = 2 <sup>23</sup>	
00,60,7x	10V = 2 <sup>23</sup>	
60,7x	10V = 2 <sup>23</sup> encoder increments/ms	
	10V = 2 <sup>23</sup> encoder increments/ms	
39	Cause of calculation error E07	
Variant:	Reference values	
60,7x	10V = 2 <sup>23</sup> encoder increments	
60,7x	10V = 2 <sup>23</sup> encoder increments/ms	
7x	10V = 2 <sup>23</sup> encoder increments/ms	
7x	10V = 2 <sup>23</sup> encoder increments	
00,60,7x	10V = 128 motor revolutions	
00,60,7x	10V = 128 motor revolutions	
00,60,7x	10V = 2 <sup>22</sup> increments/ms	
47	Mark position (units corresp. P90) (COMPAX XX70)	
49	COMPAX 1000SL only Bit 15...8: physical output status on X19/22...X19/15 Bit 7...0: physical input status on X19/9...X19/2	
50	P-component position controller (reserved)	
51	P-component speed controller (reserved)	
52	I-component speed controller (reserved)	
53	D-component speed controller (reserved)	
54	P-component current controller (reserved)	
55	I-component current controller (reserved)	
56	Square of motor – peak current (reference value: 80 000A <sup>2</sup> ) <sup>45</sup>	
57	from V5.61: square of the scaled resolver level (sin <sup>2</sup> + cos <sup>2</sup> ); reference value 1.0 <0.25 -> E42 (level error, 161) >1.0 -> E42 (limit error, 160)	
58		
59	Depiction of status monitor	
60	Sensor designation SinCos	
61	Value read acyclically by S1 option	
62	1st cyclic channel of S1 = position (100µs) (reference: 2 <sup>-24</sup> revol.)	
63	2nd cyclic channel of S1 (1 ms)	
64	3rd cyclic channel of S1 (1 ms)	
65	Absolute value from S2 option in format 12:12, limited to 0 ... P96 (reference: 1 revolution = 4096)	
66	Absolute value from S1 option, not limited (reference: 2 <sup>-12</sup> revolutions)	
67	Additional error numbers with E42	
68	Option designation / SW version number (S1 / S2 option)	
69		
70		
71		
72	from V5.14: sensor temperature SinCos (SR types only)	

<sup>45</sup> The peak value is deleted after 24V off/on or after shut down of the final stage (OTA=1/2).

## 10.3 COMPAX parameter

### 10.3.1 VP parameter<sup>46</sup> can be modified "On Line"

VP parameters can be modified and transferred and the password specified in any COMPAX operating mode.



#### Note!

Note the following points.

#### 1. Processor load

When parameters are being validated using the "VP" command, the response time and command execution time is temporarily extended due to the increased computing time. e.g. when the parameters are transferred, a "Stop signal" is recognized after a short delay. Typical delay times would be:

range of parameters: P1 ... P79: approx. 0.5 ms per parameter.  
>P79: approx. 20 ms.

#### 2. Modifying the controller setting

When modifying the controller setting via parameters P23, P24, P25, P26, P27 or P70, comparison processes may occur. These may be detected as short axis readjustments. Therefore: only modify parameters in small steps when the axis is active.

#### 3. Area of application

This extension to the function is used for the start-up and for optimizing the axis. It is not intended for the implementation of control tasks.



**Please note: The axis must be switched off if modified VP parameters are to be transferred (e.g. via OUTPUT O0=1).**



### 10.3.2 COMPAX standard parameters

#### Parameter groups:

Control parameters	P40 ... P49
Limitations	P11 ... P16
Bus parameters	P135 ... P142; P190 ... P196
D/A monitor, status monitor S15	P71 ... P74, P76, P77, P182
Inputs/outputs: assignment / meaning	P18, P211, P221 ... P225, P227, P245, P246
Define encoder interfaces(option)	P75, P98, P143, P144, P146, P232
Substitution and specification values:	P1 ... P10
HEDA	P181, P184 ... P188, P243, P247 ... P250
Configuration parameters	P80 ... P85, P88, P90, P92, P93, P98
Mark reference	P35, P37, P38, P39
Define mechanical reference system	P29, P206, P212 ... P217,
Motor parameters	P100 ... P133
Optimization parameters, optimization display	P21 ... P27, P50, P67 ... P70, P94, P151, P233, P234
Parameters of software variants	P30 ... P39
RS232	P19, P20
Other parameters	P17, P218, P219, P229
PLC data interface	P18

- Parameters not described here are reserved.

<sup>46</sup> VP means "Valid Parameter" and is a COMPAX command with which COMPAX accepts a modified parameter from a specific parameter group. The VP parameters are marked in the following parameter lists in the column "Valid from...".

### Remark

The specified limit values refer to all parameters. Theoretical combinations are possible within these limits, however they could cause an internal number overrun. The following limitation applies.

The travel per motor revolution must be greater than 0.01 mm or with increment unit: > 10 increments.

Travel per motor revolution:

- Spindle drive: P83;
- rack-and-pinion/toothed belt P82 \* P83;
- general drive: P83 (/1000 in mm)

### List of parameters, sorted by number

No.	Meaning	Unit	Minimum value	Default value	Maximum value	Valid from...
P1	Real – zero point (distance real zero-machine zero).	corresp. P90	- 1 000 000	0.00	+1 000 000	immediat.
P2	Substitute for non-programmed velocity.	%	1.00	10.00	100.00	immediat.
P3	Velocity for find machine zero.	%	-100.00	10.00	100.00	immediat.
P4	Velocity for approach real zero.	%	1.00	10.00	100.00	immediat.
P5	Velocity for processing by hand.	%	1.00	10.00	100.00	immediat.
P6	Substitute value for non-programmed ramp time.	ms	1	1000	60 000	immediat.
P7	Ramp time for approach machine zero.	ms	1	1000	60 000	immediat.
P8	Ramp time for approach point of real zero.	ms	1	1000	60 000	immediat.
P9	Ramp time for processing by hand.	ms	1	1000	60 000	immediat.
P10	Ramp time after limit switch or emergency stop is activated.	ms	1	250	60 000	immediat.
P11	Max. positive position referenced to machine zero.	corresp. P90	P12	+4 000 000.0 0	+4 000 000.00	VP
P12	Max. negative position referenced to machine zero.	corresp. P90	- 4 000 000.00	- 4 000 000.00	P11	VP
P13	Max. permitted lag tolerance (error E10 is triggered when exceeded); E10 & E49 are switched off with specification "0".	corresp. P90 or % of <sup>47</sup> P104	0	10.00	4 000 000.0 0	VP "0" immediat.
P14	Max. permitted positioning zone (applies for message O5 : "Position reached")	corresp. P90 or % of <sup>48</sup> P104	0.00	1.00	4 000.00	VP
P15	Max. permitted velocity	%	0.00	100.00	100.00 <sup>49</sup>	VP
P16	Max. permissible torque	% of P105	0	200	300	VP
P17	Engine brake lag	ms	0	0	4000	VP
P18	PLC data interface Fast start via I15 Fast start via HEDA <b>Note!</b> Settings with bit 1 and bit 3 are only permitted in COMPAX XX00.	Bit 0 <sup>50</sup> =0 without PLC data interface =1 with PLC data interface Bit 1 =0 fast start via I15 not active =1 fast start via I15 active Bit 3 =0 no fast start via HEDA =1 fast start via HEDA active only permitted with P18 when bit 1=1.				VP
P19	RS232 Baud rate	Bit/s	4800	9600 <sup>51</sup>	9600	Power on

<sup>47</sup> In speed control mode in % of nominal speed (P104), otherwise corresponds to P90

<sup>48</sup> In speed control mode in % of nominal speed (P104), otherwise corresponds to P90

<sup>49</sup> For asynchronous motors, the maximum permitted velocity may be up to 300% of the nominal velocity.

<sup>50</sup> Bit counting begins at bit 0.

<sup>51</sup> By simultaneously pressing the three front plate keys when switching on, the baud rate is set to 9600. With COMPAX 1000SL, the baud rate is always set to 9600.

## COMPAX standard parameters

No.	Meaning	Unit	Minimum value	Default value	Maximum value	Valid from...
P20	RS232 handshake	Software handshake	"0": without "1": with XON, XOFF			Power on
	<b>P20 setting.</b> The sum of the specified values is entered in P20.	Error transmission / negative command acknowledgement (E90 - E94)	"0": Error only with interface activity and if the transmitted command triggers an error. No neg. command acknowledgement (E90 - E94). "2": no transmission of error and no neg. command acknowl. (E90 - E94). "4": Messages are indated for errors and neg. command acknowl. (E90 - E94) as soon as th. occur w. Exx C <sub>R</sub> L <sub>F</sub> >. "6": errors & neg. command acknowl. (E90 - E94) only with interface activity.			immediat.
		End sign selection	"0": C <sub>R</sub> L <sub>F</sub> >	"8": C <sub>R</sub>		Power on
		Binary transfer	"0": without	"16": with		immediat.
		BCC: block check EXOR via all signs apart from the end sign	"0": without	"128": with		Power on
P21	Factor for influencing the travel per motor revolution		0.1000	1.0000	10.0000	VP&VC
P22	Factor for modifying the speed which is allocated to speed SPEED 100%. <sup>52</sup>		0.5000	1.0000	2.0000	VP&VC
P23	Stiffness of drive	%	10	100	5000	VP
P24	Speed controller damping	%	0	100	500	VP
P25	Speed – advance control value	%	0 <sup>53</sup>	100	500	VP
P26	Acceleration – advance control value	%	0	100	500	VP
P27	Moment of inertia	%	10	100	500	VP
P29	Machine zero comparison	Degree	0	0	360	VP
P35	Switch on mark reference		"0": switched off "1": switched on			VP
P36	Limitation of speed correction value for external position adjustment (only COMPAX XX00 and COMPAX XX30) ="0": switched off	% of nominal speed (P104)	0	0	100	VP
P37	Minimum travel to mark	corr.. P90	0.00	0.00	<P38	VP
P38	Maximum travel to mark	corr.. P90	>P37	0.00	4 000 000.00	VP
P39	Maximum feed length	corr..P90	≥P38	0.00	<P11 or P12	VP
P40	Control parameters		-4 000 000	0	+4 000 000	immediat.
P41	Control parameters		-4 000 000	0	+4 000 000	immediat.
P42	Control parameters		-4 000 000	0	+4 000 000	immediat.
P43	Control parameters		-4 000 000	0	+4 000 000	immediat.
P44	Control parameters		-4 000 000	0	+4 000 000	immediat.
P45	Control parameters		-4 000 000	0	+4 000 000	immediat.
P46	Control parameters		-4 000 000	0	+4 000 000	immediat.
P47	Control parameters		-4 000 000	0	+4 000 000	immediat.
P48	Control parameters		-4 000 000	0	+4 000 000	immediat.
P49	Control parameters		-4 000 000	0	+4 000 000	immediat.

<sup>52</sup> When motor nominal speeds have been modified, use this factor to perform a simple adaptation to the current program.

<sup>53</sup> When P93 = 4, P25 must be >0.

No.	Meaning	Unit	Minimum value	Default value	Maximum value	Valid from...
P50	Enable speed monitor (=101)	=100: without monitor (default setting) =101: with monitor				VP
P56	D section rpm controller	%	0	0	10 000	VP
P57	Filter acceleration	%	0	100	550	VP
P58	Lag rapid rpm signal	%	0	100	550	VP
P59	Structure switch measuring	0: Standard: 4: Variant 1 (for resolver) 3: Variant 2 (for SinCos®) 8: Variant 3 (Rapid rpm controller) +16: Sensitive stiffness (P23) Larger setting range for P23 +65536: Sensitive D section (P56) Larger setting range for P56				VP
P67	D-element slip filter	%	0	100	500	VP
P68	Slip filter lag	%	0	100	5000	VP
P69	Reverse advance control ("0" : without reverse advance control)	%	0	0	500	VP
P70	Current – advance control value	%	0	0	500	VP
P71	D/A monitor 1 amplification		1	5	4 000 000	VP
P72	D/A monitor 2 amplification		1	10	4 000 000	VP
P73	Address of D/A monitor 1		0	4	18	VP
P74	Address of D/A monitor 2		0	15	18	VP
P75	Max. permitted measuring error (difference betw. resolver pos. and external encoder pos.) The external position localization is switched on with a measuring error ≠ 0 and the internal position is corrected.	P90	0	0	4 000 000	VP
P76	Address of D/A monitor 3 (decimal place =0 = amplification 1)		0	4.000 000 1	20 000	VP
P77	Address of D/A monitor 4 (decimal place =0 = amplification 1)		0	15.000 000 1	20 000	VP
P80	Drive type	"2": Spindle drive "4/8": rack-and-pinion/toothed belt "16": general drive / linear motor				VC
<b>Drive type "Spindle drive" (P80="2")</b>						
P81	Length	mm	0.00	0.00	5000.00	VC
P82	Diameter	mm	8.00	0.00	80.00	VC
P83	Pitch	mm	1.00	0.00	400.00	VC
P84	Moment of inertia for transmission and coupling	kgcm <sup>2</sup>	0.00	0.00	200.00	VC
P85	Ratio		1.0000000	1.0000000	100.0000000	VC
P88	Max. translational mass moved	kg	0		500	VC
P92	Min. translational mass moved	kg	0		P88	VC
<b>"Rack-and-pinion/toothed belt" drive type (P80="4/8")</b>						
P82	Tooth number		Tooth number * tooth pitch			VC
P83	Tooth pitch	mm	= 1.00 ..... 410.00			VC
P84	Moment of inertia for transmission and coupling	kgcm <sup>2</sup>	0.00	0.00	200.00	VC
P85	Ratio		1.0000000	1.0000000	100.0000000	VC
P88	Max. translational mass moved	kg	0		500	VC
P92	Min. translational mass moved	kg	0		P88	VC
<b>"General drive" drive type (P80="16")</b>						
P81	Min. total moment of inertia	kgmm <sup>2</sup>	0.00	0.00	Jmax.(82)	VC
	With linear motors: $P81 = \frac{m_{min} \cdot P126}{(1000 \cdot 2 \cdot \Pi)^2}$					

Unit hardware  
Connector assignment / cable  
Technical data  
Configuration  
Positioning and control functions  
Optimization functions  
Interfaces  
Accessories / options  
Status  
Parameter  
Error List:

## COMPAX standard parameters

No.	Meaning	Unit	Minimum value	Default value	Maximum value	Valid from...
P82	Max. total moment of inertia	kgmm <sup>2</sup>	0	0.00	200 000	VC
	With linear motors: $P82 = \frac{m_{max} \cdot P126}{(1000 \cdot 2 \cdot \Pi)^2}$					
P83	Travel per motor revolution	µm or inchr.	10	0.00	4 000 000 µm 65 536 Inchr.	VC
	With linear motors: P83 = P126					
P90	Unit for travel	"0": increments "1": mm "2": inch				VC
P93	Operating mode	"1": normal mode "2": Continuous mode "4": speed control mode <sup>54</sup>				55
P94	Ramp shape	"1": linear "2": smooth "3": quadratic.				56
P96	Transmission factor for the reset route of S2 option. ="0": no reset function.	-	0	0	4095	VC
P98	Travel of axis per encoder revolution	corresp. P90	0	0.0000000	4 000 000	VC
<b>No.</b>		<b>Valid for<sup>57</sup></b>				
P100	Motor number	Motor selection				VC
P101	Number of terminals	A,S	2	2	12	VC
	Linear motor: P101=2	L				
P102	EMC	S	V * min/ 1000	10	400	VC
	P102=EMC[V/(m/s)] * P126/60 000	L				
P103	Moment of inertia	A,S	kgmm <sup>2</sup>	0	200 000	VC
	Linear motor: $P103 = \frac{m_{Forcer} \cdot P126}{(1000 \cdot 2 \cdot \Pi)^2}$	L				
P104	Nominal speed	A,S	min <sup>-1</sup>	500	9000	VC
	Linear motor: $P104 = \frac{V_{nominal} \cdot 1000 \cdot 60000}{P126}$	L				
P105	Nominal current	A,S,L	mA	200	100 000	VC
P106	Nominal torque	A,S	mNm	0	100 000	VC
	Linear motor: $P106 = \frac{F_{nominal} \cdot P126}{(1000 \cdot 2 \cdot \Pi)}$	L				
P107	Pulse current	A,S,L	%	100	400	VC
P108	Max. time in current limit (P16)	A,S,L	ms	1000	5000	VC
P109	Stator inductivity	A,S,L	µH	0	200 000	VC
P110	Magnetization current	A	mA	100	0.7 * P105	VC
P111	Rotor time constants	A	ms	5	2000	VC

<sup>54</sup> When in speed control mode, P25 must > 0.

<sup>55</sup> From next process command

<sup>56</sup> From next process command

<sup>57</sup> A: parameter for asynchronous motors

S: parameter for synchronous motors

L: parameter for linear motors



No.	Meaning	Unit	Minimum value	Default value	Maximum value	Valid from...	
P112	Slip frequency	A	mHz	100		20 000	VC
P113	Maximum speed	A,S	min <sup>-1</sup>	0		9000	VC
	Linear motor: $P113 = \frac{V_{max} \cdot 1000 \cdot 60000}{P126}$	L					
P115	Angular speed	A	% of P104	50	100	200	VC
P116	Stator resistance	A,S,L	mOhm	0		150 000	VC
P119	Start of saturation	S,L	%	70	100	<P120	VC
P120	End of saturation	S,L	%	> P119	400	400	VC
P121	Minimum stator inductivity	S,L	% of P109	10	100	100	VC
P122	Main inductivity	A	μH	0		2 000 000	VC
P123	Rotor – scatter inductivity	A	μH	0		200 000	VC
P124	Rotor resistance	A	mOhm	0		10 000	VC
P125	Nominal voltage	A	V	10		400	VC
P126	Pitch length of motor magnets in μm (2 * Pole distance)	L		20 000		100 000	VC
P127	Denominator: Dash count linear encoder per pitch length (see P133)	L	-	0	1	<P133	VC
P128	Cut-off value of temperature sensor for E48	A,S,L	Ω	0	0	20 000	VC
				"0": HDX / HDY – motors "1270": HJ – motors			
P129	Resolver offset	A,S,L	Degree	0	0	360	VC
P130	Resolver frequency	A,S,L	"2":5kHz(P4)				VC
P131	Resolver – transformation ratio <sup>58</sup>	A,S,L	"2": ü = 0.5 (e.g. P4 resolver)				VC
	Level adaptation (1/ü) for resolver or SinCos <sup>®</sup> - sensor (from V5.61) <b>setting aids:</b> <sup>59</sup>		%	70	100	200	
				100% ≡ 0.5; 200% ≡ 0.25; 70% ≡ 0.71;			
P132	Position sensor	A,S	"2": 2-pol. resolver (P4)				VC
	With linear motors:	L	"10": TTL linear encoder "11": SinCos linear encoder				
P133	Sensor dash count	A,S	-	65 536			VC
	With linear motors: Dash count linear encoder per pitch length (counter: see P127) Dash count per pitch length = P133/P127 <sup>60</sup>	L	1/μm	> P127		< 8388607	
P134	Nominal load capacity of the external ballast resistance (100Ω) in [W]		Watts	2	60	8000	VC
P135 – P142	Bus – parameter						
P143	Encoder pulses per revolution (channel 1)			128	4096	2 000 000	VC

<sup>58</sup> Resolver transformation ratio = ü = resolver output voltage / resolver input voltage

<sup>59</sup> The read-in level is displayed in the square of the channel 57 optimizing display.

With P233=57 this value is in S13. Meaning:

$$P131 = \sqrt{\frac{0.405}{S13}} \cdot 100\% \text{ (rounded to the nearest percent)}$$

The current default setting "2" is still possible.

**Note:** Resolver with Ü=1 cannot be operated!

<sup>60</sup> Select P133 as large as possible to achieve maximum accuracy. P133 does not have fractional digits.

**COMPAX standard parameters**

No.	Meaning	Unit	Minimum value	Default value	Maximum value	Valid from...
P144	Setting encoder channel 1	="4": without external position localization ="6": external position localization switched on via channel 1.				VC
P146	Resolution of encoder emulation (channel 2)	=0: 1024 =8: 512				VC
P148	End stage designation	"Read only" – parameter ≡ S37				
P149	Configuration	"0": not valid "1": valid <sup>61</sup>				VC
P151	Responsiveness of the monitor control	%	0	30	500	VP
P156	Allocation of inputs I1...I6 to the input pins on X19 Source for Bit 0 – 3 input 1 Bit 4 – 7 input 2 Bit 8 – 11input 3 Bit 12 – 15 input 4 Bit 16 – 19 input 5 Bit 20 – 23 input 6	Bits	-8388608	X19/2→I1 X19/3→I2 X19/4→I3 X19/5→I4 X19/6→I5 X19/7→I6  = <b>7 754 802</b>	8388607	VP
P157	Allocation of inputs I7...I12 to the input pins on X19 Source for Bit 0 – 3 input 7 Bit 4 – 7 input 8 Bit 8 – 11input 9 Bit 12 – 15 input 10 Bit 16 – 19 input 11 Bit 20 – 23 input 12	Bits	-8388608	X19/8→I12  I7 ... I11 = "0"  = <b>-8 388 608</b>	8388607	VP
P158	Allocation of inputs I13...I16 to the input pins on X19 Source for Bit 0 – 3 input 13 Bit 4 – 7 input 14 Bit 8 – 11input 15 Bit 12 – 15 input 16 Bit 16 – 19 free Bit 20 – 23 free	Bits	-8388608	X19/9→I16 I13...I15 = "0"  = <b>36 864</b>	8388607	VP
P159	Allocation of output pins X19/15 ... X19/18 to the logic outputs Source for Bit 0 – 3 Pin X19/15 Bit 4 – 7 Pin X19/16 Bit 8 – 11Pin X19/17 Bit 12 – 15 Pin X19/18	Bits	0	O1→X19/15 O2→X19/16 O3→X19/17 O4→X19/18  = <b>12 816</b>	65535	VP
P160	Allocation of output pins X19/19 ... X19/22 to the logic outputs Source for Bit 0 – 3 Pin X19/19 Bit 4 – 7 Pin X19/20 Bit 8 – 11Pin X19/21 Bit 12 – 15 Pin X19/22	Bits	0	O5→X19/19 O6→X19/20 O7→X19/21 O8→X19/22  = <b>30 292</b>	65535	VP
P161	Maximum angle difference with absolute resolver function (4096 = 1 motor revolution)		1	100	2047	VP
P181	HEDA – parameter: coupling window (µm or increments)		0	10	4 000 000	VP
P182	Setting status monitor S15		0	0	532 767	VP

<sup>61</sup> When P149="0", all parameters apart from the bus settings P194, P195, P196, P250 are set to default values when switched on.

No.	Meaning	Unit	Minimum value	Default value	Maximum value	Valid from...
P184	Selection parameters for HEDA – process value (master) Default value: P184=0	40: encoder position 42: internal time base 43: scaled master position 44: nominal pos. value in resolver increm. 45: actual pos. value in resolver increments 46: differentiated resolver position				VP
P185 – P187	HEDA – parameter					
P188	Selection parameters for HEDA – process value (slave) Default value: P188=0	40: encoder coupling for encoder input signals (P184=40) 140: encoder coupling for other input signals (P184≠40) 42: internal time base 43: scaled master position				VP
P191 – P196	Bus – parameter					
P197	Order (status S33)	"Read only" – parameter				
P198	Part (status S34)	"Read only" – parameter				
P202	With machine zero mode P212="8": Distance machine zero – limit switch (setting "0" corresponds to "3")	motor revol.	3	0	255	VP
P206	Enables the absolute value	="1": absolute value sensor input enabled or reset function switched on (S2 opt.) = "2": absolute value sensor enabled				VP
P211	Disable and modify the Teach In – function  Also: enable final stage with OUTPUT O0="0" without lag (Bit 2="1")	"0" The teach data record and teach real zero functions are enabled. "1" Teach in real zero is blocked, data record indicator is set to 1 using I1 + I4 . "2" Teach in set is blocked, data record indicator is set to 1 using I1 + I5 . (Teach real zero is enabled) "3" The teach data record and teach in real zero functions are blocked. With I1 + I4, Teach N or I1 + I5, the data record indicator is set to 1. "4...7": The final stage is enabled with OUTPUT O0="0" without lag (P. 123)				immediately
P212	Machine – zero – mode  Settings "3" and "4" with COMPAX XX00 and COMPAX XX30 only	"0": MZ equals external initiator & resolver zero / 2 reversing initiators. "1": MZ equals external initiator & resolver zero. "3": MZ equals external zero pulse "4": MZ equals external initiator & external zero pulse. "5": MZ equals resolver zero "6": reserved "7": MZ equals external initiator (without resolver zero). "8": MZ equals limit switch "10": teaches machine zero "11": MZ equals initiator (without resolver zero) / 2 reversing initiators.				immediately
P213	Machine zero direction	"0": to the right "1": to the left				VP
P214	Encoder direction	"0": positive direction when encoder is turning clockwise. "1": positive direction when encoder is turning anti-clockwise.				VP
P215	Direction of rotation	"0": motor to the right "1": motor to the left				VP

Unit hardware
Connector / cable assignment
Technical data
Configuration
Positioning and control functions
Optimization functions
Interfaces
Accessories / options
Status
Parameter
Error List:

## COMPAX standard parameters

No.	Meaning	Unit	Minimum value	Default value	Maximum value	Valid from...
P216	Limit switch position E1 is approached when ...	"0": motor turns clockwise "1": motor turns anti-clockwise				immediat.
P217	Limit switch mode	"0": without limit switch "1": with limit switch (do not find during MZ) "3": with limit switch (find during MZ) "5": with limit switch (without pos. locking)				immediat.
P218	Error cutout Default value: P218=0 (E57 active)	Bit 0 = "0" E57 active = "1" E57 switched off				immediat.
P219	Emergency stop input on COMPAX-M / Synchronous STOP on COMPAX XX00	=0 no evaluation of emergency stop input on COMPAX-M =7 emergency stop input on COMPAX-M active =128 synchronous STOP on COMPAX XX0X without evaluation of emergency stop input on COMPAX-M =135 synchronous STOP on COMPAX XX0X with evaluation of emergency stop input on COMPAX-M				VP
P221	Freely assign standard inputs I1 ...I8 with "1"	Input (valency) [Bit No.]: E1 (1) [1] • E2 (2) [2] • E3 (4) [3] • E4 (8) [4] E5 (16) [5] • E6 (32) [6] • E6 (64) [7] • E6 (128) [8] P221 = sum of valencies of all required free inputs. The control functions are assigned to the fieldbus with the bit set (I17 ... I24)				immediat-ely
P222	Freely assign standard inputs I9 ...I16 with "1"	Input (valency) [Bit No.]: I9 (1) [1] • I10 (2) [2] • I11 (4) [3] • I12 (8) [4] I13 (16)[5] • I14 (32)[6] • I15 (64)[7] • I16 (128)[8] P222 = sum of valencies of all required free inputs. The control functions are assigned to the fieldbus with the bit set (I25 ... I32)				immediat-ely
P223	Assign outputs O1 - O8 to the OUTPUT WORD command with a "1"	Output (valency) [Bit No.]: O1 (1) [1] • O2 (2) [2] • O3 (4) [3] • O4 (8) [4] O5 (16) [5] • O6 (32) [6] • O7 (64) [7] • O8 (128) [8] P223 = sum of valencies of the OUTPUT WORD outputs				immediat-ely
P224	Assign outputs O9 - O16 to the OUTPUT WORD <sup>62</sup> command with "1"	Output (valency) [Bit No.]: O9 (1) [1] • O10 (2) [2] • O11 (4) [3] • O12 (8) [4] O13 (16)[5] • O14 (32)[6] • O15 (64)[7] • O16 (128) [8] P224 = sum of valencies of the OUTPUT WORD outputs				immediat-ely
P225	Freely assign standard outputs with "1"	Output (valency) [Bit No.]: O1 (1) [1] • O2 (2) [2] • O3 (4) [3] O4 (8) [4] • O5 (16) [5] • O6 (32) [6] P225 = sum of valencies of all required free outputs.				immediat-ely
P227	Assign special functions to outputs	Bit 1 <sup>63</sup> = "0": O2 is assigned the default function (=no warning). Bit 1="1": O2 is assigned the "Idle monitor" function. Bit 4="0": O5 is assigned the default function (position reached with evaluation of P14) Bit 4="1": O5 is assigned with the "O5 toggles when position reached" function.				immediat-ely
P229	Speed threshold for "Idle display" function (only switched on if P227 bit 1="1")	%	0	0	255	VP
P232	Function I11	=0: I11 can be freely assigned With external position adjustment switched on (P75>0): =4: I11 switches the external position adjustment (I11="0": off and I11="1": switched on) COMPAX 1060/70SL: With analogue ±10V – interface =4: I11 has the function "Enable analogue input (I11="0": Setpoint=0 I11="1": analogue input active)				VP
P233	Setting the optimization display S13	1...255				immediat-ely
P234	Setting the optimization display S14	1...255				immediat-ely

<sup>62</sup> OUTPUT WORD – command is available with bus systems.

<sup>63</sup> Bit-counting starts with Bit 0.

No.	Meaning	Unit	Minimum value	Default value	Maximum value	Valid from...
P243	HEDA operation mode		="0": single axis (when P250=0) or slave on IPM (P250=1 ... 9) ="1": COMPAX as master = "2": COMPAX as slave on a COMPAX master			VP
P245	Assign outputs O1 - O8 to the HEDA bus		Output (valency) [Bit No]: O1 (1) [1] • O2 (2) [2] • O3 (4) [3] • O4 (8) [4] O5 (16) [5] • O6 (32) [6] • O7 (64) [7] • O8 (128) [8] P245 = sum of valencies of the outputs allocated to the HEDA bus			immediately
P246	Assign outputs O9 - O16 to the HEDA bus		Output (valency) [Bit No]: O9 (1) [1] • O10 (2) [2] • O11 (4) [3] • O12 (8) [4] O13 (16)[5] • O14 (32)[6] • O15 (64)[7] • O16 (128) [8] P246 = sum of valencies of the outputs allocated to the HEDA bus			immediately
P247 - P250	HEDA parameter					VP

Unit hardware  
 Connector / cable  
 Technical data  
 Configuration  
 Positioning and control functions  
 Optimization functions  
 Interfaces  
 Accessories / options  
 Status  
 Parameter  
 Error List:

**10.3.3 Monitoring and limitation characteristics**

This section examines the relationships of COMPAX monitoring and limitation characteristics in more detail:

**Structural diagram:**

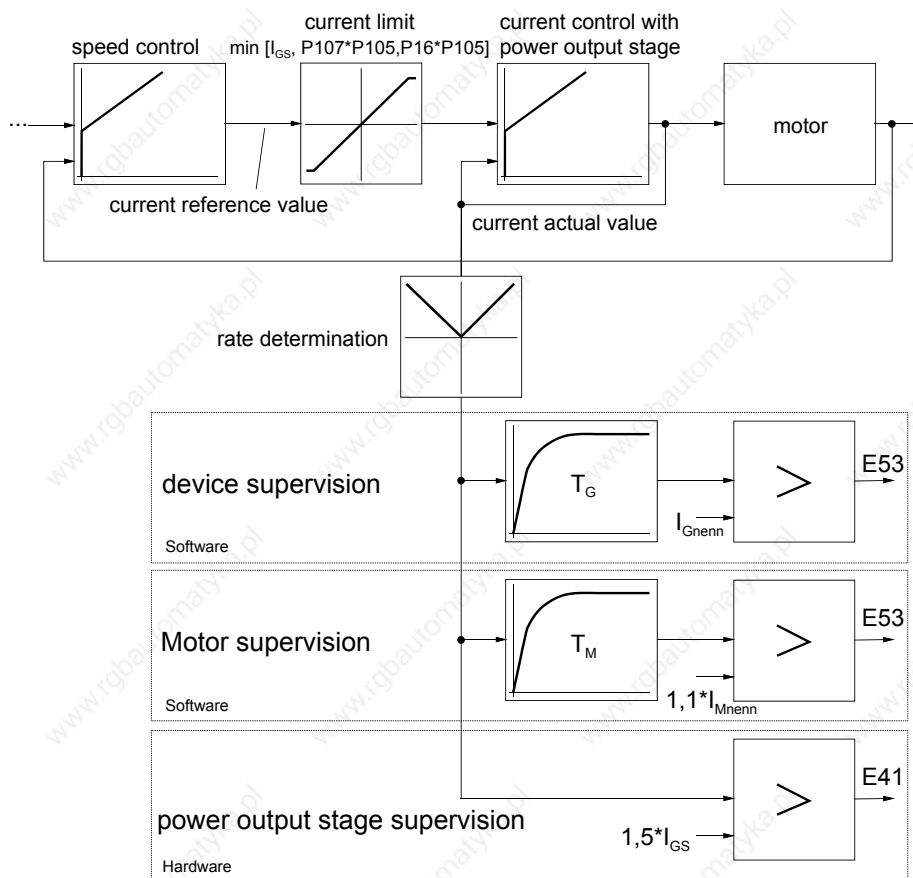

$I_{Unom.}$ : unit nominal current     $I_{Up.}$ : unit peak current     $I_{Mnom.}$ : motor nominal current

**Dynamic monitoring:**

In COMPAX, the nominal current value is limited to the smallest value of the following 3 quantities.

- $I_{Up.}$ :                      • unit peak current
- $P105 * P107$ :            • nominal motor current (P105) \* maximum pulse current permitted for the motor (P107)
- $P105 * P16$ :             • nominal motor current (P105) \* maximum permitted (user-set) torque (P16)

**Static monitoring**

This executes triple monitoring:

**Unit monitoring**

Using the unit-specific time constant  $T_G$ , a current greater than  $I_{Unom.}$  is permitted for a specific period; E53 then switches the unit off.

**Motor monitoring**

Using the time constant  $T_M$ , a current greater than  $1.1 * I_{Mnom.}$  is permitted for a specified period; E53 then switches the unit off.  $T_M$  is set so that the pulse current P107 can flow for the period set in P108.

**Final stage / short circuit monitoring**

Absolute monitoring to  $1.5 * I_{Up.}$ .

### 10.4 Error handling and error messages

- All errors are indicated by messages on the front plate error LED.
- An error number EXX appears in the display. You can modify parameters when an error message is present.
- When you have rectified the cause of the error, acknowledge the error using Enter, Quit or by switching the unit on again (Power on).
- When the LED (error) turns off, COMPAX is ready for operation.
- Switch off COMPAX if you are experiencing hardware errors (e.g. short circuit to outputs).
- The errors I1...I57 are also reported with the binary output O1="0"; the drive does not accept any positioning commands and the ready contact is opened.
- If COMPAX executes a travel motion, the drive is then decelerated using the programmed ramp time (for E50, E51 and E55 using ramp time P10) and, if specified in the error table, the unit is switched off after this time.
- The errors  $\geq$  E58 are also indicated with the binary output O2="0" (if O2 is configured in this manner, see parameter P227).

➡ If the specified measures cannot rectify the problem, there may be an electrical defect. Please send the unit and an **error description** to HAUSER.

No.	Cause	Action	Acknowledge with	Drive volt.-free
E00	Interruption of a positioning command using STOP / BREAK; is only reported via RS232.		Not necessary	no
E01	Not configured.	Configure.	Quit	yes
E05	Machine zero initiator not found. Error is only generated when using reversing initiators.	Check initiator.	Quit	no
E07	Calculation error	Check programmed arithmetic. (more accurate cause shown in the optimizing display P233/243=39; see Page 133)	Quit	no
E08	Synchronous STOP present	Check P219	Quit	no
E09	Drive not running.	Remove mechanical blockage (tools, foreign bodies).	Quit	no
E10	Lag error too large. or speed difference too great	Check mechanics for smooth operation, reduce load or feed force or increase P13. This error message can be turned off by setting P13="0".	Quit	see below
E11	Programmed position not reached.	Remove mechanical obstacles or increase P14.	Quit	no
E15	Error in 2nd position measuring system.	Check configuration and wiring.	Quit	yes
E16	The data record number selected does not exist.	Select data record number between 1...250.	Quit	no
E17	The data record number selected is too large. <sup>64</sup>	Select data record number between 1...250.	Quit	no
E18	The maximum data record 250 is already assigned.	Free data record 250.	Quit	no
E19	No space available in data record memory.	Delete data records or entire data record memory.	Quit	no
E20	Target position beyond positive end limit.	Correct target position.	Quit	no
E21	Target position beyond negative end limit.	Correct target position.	Quit	no
E22	Machine zero is not approached.	Find machine zero. This must be found after power on.	Quit	no

<sup>64</sup> with COMPAX 70: Curve number not present.

## Monitoring and limitation characteristics

No.	Cause	Action	Acknowledge with	Drive volt.-free
E23	The current command is not allowed.	<ul style="list-style-type: none"> <li>Positioning command in the speed control mode.</li> <li>Approach MZ in speed control mode.</li> <li>Travel command when drive is switched off.</li> <li>Hand +/- when an error is present.</li> <li>More than 8 consecutive comparator commands (preparatory commands, see Page 103) in the data record memory.</li> </ul>	Quit	no
E24	The speed selected is not valid.	Enter speed between 0...100%.	Quit	no
E25	The position selected is not valid.	Note end limits and "Software end limit monitoring" chapter in variant documentation.	Quit	no
E26	REPEAT without END or GOSUB without RETURN .	Insert END / RETURN command.	Quit	no
E27	Parameter must not be written.	Check parameter.	Quit	no
E29	Motor values missing.	Send unit to HAUSER.	Quit	yes
E30	Hardware fault.	Remove extreme external sources of fault.	Quit	yes
E31	Error in parameters.	Check parameter.	Quit	no
E32	Error in parameters.	Check parameter.	Quit	no
E33	Error in program memory.	Check data record memory.	Quit	no
E34	Error in program memory.	Check data record memory.	Quit	no
E35	Hardware fault.	Remove extreme external sources of fault.	Quit	no
E36	Hardware fault.	Faulty or incorrect unit hardware.	Power on	yes
E37	Auxiliary voltage +15 V missing.	Switch on again.	Power on	yes
E38	Voltage in intermediate circuit too high; e.g. if braking output is too high. Limits: COMPAX 25XXS: >400V COMPAX 10XXSL: >400V otherwise: >800V	Increase braking and idle times / check mains power. COMPAX 25XXS: external ballast resistance missing. COMPAX 45XXS/85XXS: bridges X2/5 - X2/6 missing. COMPAX 1000SL: Check value P134.	Quit	yes
E39	Temperature too high (>85°), cycle too hard.	Increase acceleration times.	Quit	yes
E40	Input "Enable final stage" (45/85S: X3/1-/2; 1000SL X19/24-X19/12, 35XXM: X19/9-/10) not assigned  Only with COMPAX 35XXM, COMPAX 45XXS, COMPAX 85XXS and COMPAX 1000SL! <b>Note!</b> With E40 there is no braking delay; the final stage is immediately switched off. The input has a direct effect on the hardware.		Quit	yes
E41	Final stage reports error. COMPAX 35XXM: Short circuit of the ballast resistance or undervoltage 24V COMPAX 1000SL: Overvoltage or ballast switching	Check motor and cable for ground fault, short circuit fault and function; remove extreme external sources of fault.	Quit	yes
E42	Resolver / sensor error.	Check resolver cable and connector for correct connections and faults. A special error code can be found in channel 67 of the optimization display. This means Error No. 1 ... 30: Sensor indicates error Error No. > 30: COMPAX indicates error Error No. =160: Sensor level too high Error No. =161: Sensor level too low (implement level adaptation using parameter P131)	Quit	yes
E43	Output overloaded.	Check I/O cables, connectors and external circuits. Note load limits (refer to start-up manual).	Quit	yes
E44	Positive auxiliary voltage outside tolerances.	Switch unit on again.	Power on	yes
E45	Negative auxiliary voltage outside tolerances.	Switch unit on again.	Power on	yes



No.	Cause	Action	Acknowledge with	Drive volt.-free
E46	Supply voltage +24V is too high.	Check +24V DC power unit.	Power on	yes
E47	Supply voltage +24V is too low.	Check +24V DC power unit.	Power on	yes
E48	Motor thermostatic switch reports error.	Check resolver cable, motor type and motor / remove external sources of heat.	Power on	yes
E49	Motor or drive reports blockage. Drive remains in the current limit (P16) for longer than P108	Free mechanics. This error message can be switched off by setting P13="0". Check motor cable.	Quit	yes
	COMPAX-S: speed controller oscillating	Optimize controller (reduce P23 stiffness).		
E50	Limit switch 1 activated.	Move by hand or POSA from limit switch.	see P217	no
E51	Limit switch 2 activated.	Move by hand or POSA from limit switch.		no
E52	Error in emergency stop circuit.	Check emergency stop switch contacts.	Quit	yes
E53	Motor overloaded.	Check dimensions.	Quit	yes
E54	Speed higher than the maximum motor speed or higher than P15 * 1.21	Reduce nominal speed or, if speed is too high due to harmonics, optimize controller.	Quit	yes
E55	External emergency stop. Intermediate circuit not enabled. Temperature overload.	Check system, then switch unit on again. Voltage must be at least 2s >320V. External load too great.	Quit	yes
E56	Emergency stop directly in COMPAX-M via X9/6 (switched on via P219=7)	Check system, then switch unit on again.	Quit	yes
E57	Voltage in intermediate circuit too low (<70V).	Check mains connection. Switch off E57 using P218 ="1".	Quit	yes
E58	Temperature is too high (>75°) or SinCos® - temperature error	Increase acceleration times.	Quit	no
E65	Encoder error	Check encoder cable. Axis is brought to a stop through speed control. (switch off using P218)	Quit	no
<b>Negative command acknowledgement (only for warnings)</b>				
E72	Block Check Character - error or general fault.	Re-send the characters	*	no
E90	Syntax error; command not valid	Check command structure.	*	no
E91	Command cannot be executed in this COMPAX operating mode.	Check COMPAX status	*	no
E92	Function running, command cannot be executed		*	no
E93	Data record memory active, command cannot be executed		*	no
E94	Password missing		*	no

\* Quit is not required.

### Response to lag error (error E10)

#### Position controller

COMPAX is switched from position control mode to speed control mode and speed 0 specified. The drive remains powered.

The next move command after the error acknowledgement brings the system back to position control.

#### Response to E15

COMPAX is switched from position control mode to speed control mode and speed 0 specified. The drive remains powered.

#### Speed controller

In speed control mode, control is referenced to speed 0.

Unit hardware  
Connector / cable assignment  
Technical data  
Configuration  
Positioning and control functions  
Optimization functions  
Interfaces  
Accessories / options  
Status  
Parameter

Error List:

# 11. Application examples

## 11.1.1 Overview

### External data record selection ..... 227

#### Application:

One of eight various workpieces should be made available at a data collection station. The number of the desired workpiece is set using a BCD selector switch. The transportation process is then triggered by a starting pulse.

### Mark-referenced positioning ..... 229

#### Application:

Pieces with lengths of between 100 mm and 500 mm should be cut from a plate roller. The cut-off positions are specified by marks on the plate. If two marks are separated by more than 500 mm, the plate should be pulled back to the last cut-off position.

### Speed step profiling / comparator switching points ..... 231

#### Application:

A bore spindle should be guided to the surface of the workpiece using a rapid feed movement. The bore is then bored to a defined depth using a considerably longer feed. When reversing the bore spindle, the unit should travel at a slow velocity while the drill is still in the bore. The remaining travel to the idle position is performed at a rapid speed.

The bore spindle should be switched on just before the boring process commences and should be switched off immediately after it has been removed from the bore. Movement of the conveyor belt should be blocked for as long as there is a risk of collision between the workpiece and drill.

### SPEED SYNC ..... 233

#### Application:

Cartons should be transferred from one conveyor belt (conveyor belt A), a belt operating at a very variable belt speed, to another conveyor belt (conveyor belt C), a belt which has a constant belt speed. This task should be performed using a transfer belt (conveyor belt B) installed between the two other belts. This belt receives cartons from conveyor belt A and, when triggered by a pulse, passes them on to conveyor belt B. In addition to this, when conveyor belt B is assigned, conveyor belt A should be blocked. Conveyor belt B is controlled by COMPAX.

### Speed control mode ..... 234

#### Application:

A centrifuge for manual operation should be operated by an operating mode switch. The centrifugal process should either be run at a permanently set speed or the test tubes should be removed, one after another, through the removal aperture. The shutter on the removal aperture must only be able to open when the centrifuge is at a standstill.

### Fast start ..... 236

#### Application:

Material should be fed to an extender stamping machine which operates at a maximum speed of 150 rpm. The material may only be supplied if the stamping tool is open and if the workpiece (already stamped) has been thrown up. The material supply should be released or blocked via a switch.

### Implementing a torque converters ..... 237

2 options are available for implementing a torque converters.

## 11.1.2 External data record selection

### Application:

One of eight various workpieces should be made available at a data collection station. The number of the desired workpiece is set using a BCD selector switch. The transportation process is then triggered by a starting pulse.

### Assignments:

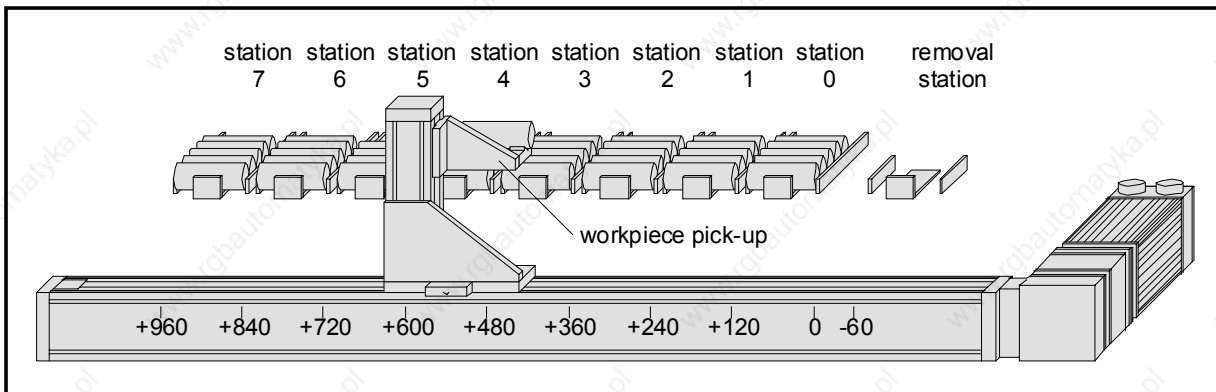

The horizontal movement is implemented using an NC axis controlled by COMPAX. A pneumatic cylinder, which is controlled by COMPAX using a double solenoid valve, raises and lowers the workpiece pick-up. COMPAX performs all the functions required without superordinate control.

### Wiring up the digital inputs and outputs:

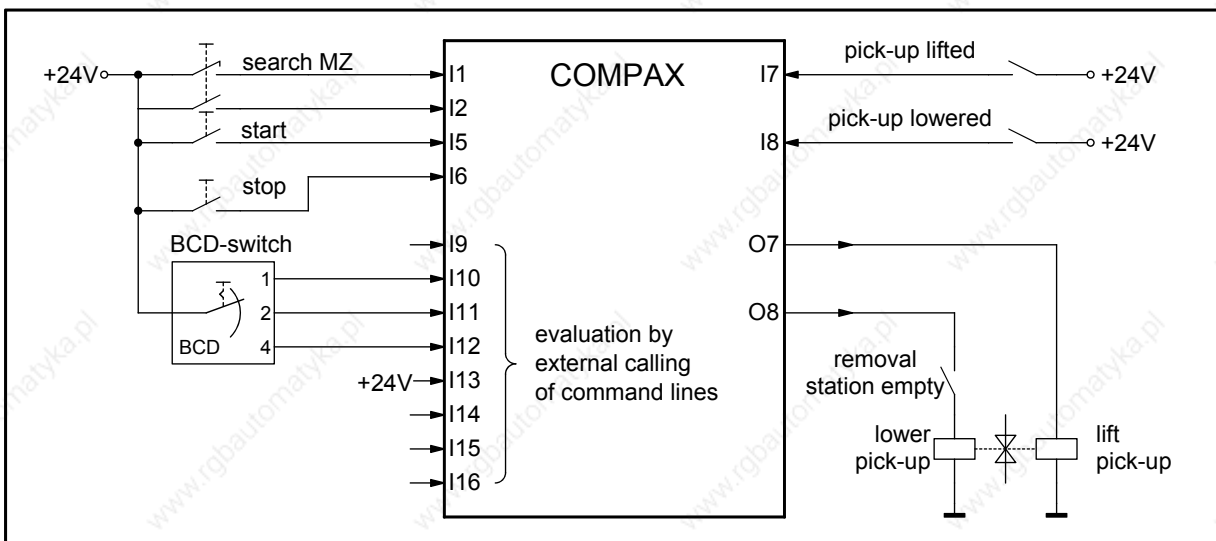

### Comments:

- The inputs I9, I14, I15 and I16 have to be placed on GND or left open.
- The BCD switch has eight settings. The outputs are encoded with binary.
- The "Data collection station empty" switch is closed when the data collection station is closed. The switch operation prevents the workpiece pick-up being lowered for as long as there is a workpiece in the data collection station.

### Function:

The first event after COMPAX has been started is the approaching of the data collection station. If the workpiece pick-up is not lowered, the assumption is made that there is still a workpiece in the workpiece pick-up. This is deposited in the data collection station by lowering the workpiece pick-up. The system is now ready for the first transportation process.

## External data record selection

To move one particular workpiece to the data collection station, the number of the station in question is first set on the BCD switch. The process is then triggered by a start pulse. To do this, the BCD switch setting must remain the same until the start of the first axis movement. The lowered workpiece pick-up is positioned under the station which is specified by the BCD switch. When the workpiece pick-up is raised, the front workpiece is taken out of the station. The axis returns to the data collection station. The workpiece pick-up is lowered there. The workpiece is thereby deposited in the data collection station. COMPAX now waits for the next transportation process.

### Programming:

#### Configuration:

P93 =+1 i.e. normal operating mode (absolute and relative positioning)

#### Names of inputs and outputs:

I7	pick-up raised	0 ⇒ no	1 ⇒ yes
I8	pick-up lowered	0 ⇒ no	1 ⇒ yes
O7	raise pick-up	0 ⇒ off	1 ⇒ on
O8	lower pick-up	0 ⇒ off	1 ⇒ on

#### List of programs:

N001: SPEED 50 .....;sets the speed  
N002: ACCEL 500 .....;sets the acceleration and braking ramps  
N003: OUTPUT O7=0 .....;pick-up raise function = off  
N004: OUTPUT O8=0 .....;pick-up lowering function = off  
N005: POSA -60 .....;moves to data collection station  
N006: IF I8=0 GOSUB deposits workpiece (36) .....;if pick-up is not lowered: deposits workpiece  
    Wait for START: .....;mark  
N007: WAIT START .....;waits for the start pulse  
N008: GOSUB EXT .....;calls up the corresponding inputs I9-I16 for the sub-program  
N009: GOSUB raises workpiece (32) .....;calls "Raise workpiece" sub-program  
N010: POSA -60 .....;proceeds to data collection station  
N011: GOSUB deposits workpiece (36) .....;calls up "Deposit workpiece" sub-program  
N012: GOTO waits for START (7) .....;goes to data record N007  
.....;Link table for external data record selection  
N016: POSA 120 .....;proceeds to station 0  
N017: RETURN .....;returns to main program  
N018: POSA 240 .....;proceeds to station 1  
N019: RETURN .....;returns to main program  
N020: POSA 360 .....;proceeds to station 2  
N021: RETURN .....;returns to main program  
N022: POSA 480 .....;proceeds to station 3  
N023: RETURN .....;returns to main program  
N024: POSA 600 .....;proceeds to station 4  
N025: RETURN .....;returns to main program  
N026: POSA 720 .....;proceeds to station 5  
N027: RETURN .....;returns to main program  
N028: POSA 840 .....;proceeds to station 6  
N029: RETURN .....;returns to main program  
N030: POSA 960 .....;proceeds to station 7  
N031: RETURN .....;returns to main program  
    Raise workpiece : .....;mark  
N032: OUTPUT O7=1 .....;activates "Raise" solenoid valve  
N033: IF I7=0 GOTO 33 .....;waits until workpiece pick-up is raised  
N034: OUTPUT O7=0 .....;deactivates "Raise" solenoid valve  
N035: RETURN .....;returns to main program  
    Deposit workpiece : .....;mark  
N036: OUTPUT O8=1 .....;activates "Lower" solenoid valve  
N037: IF I8=0 GOTO 37 .....;waits until the workpiece pick-up is lowered  
N038: OUTPUT O8=0 .....;deactivates "Lower" solenoid valve  
N039: RETURN .....;returns to main program

## 11.1.3 Mark-referenced positioning

### Application:

Pieces with lengths of between 100 mm and 500 mm should be cut from a plate roller. The cut-off positions are specified by marks on the plate. If two marks are separated by more than 500 mm, the plate should be pulled back to the last cut-off position.

### Assignments:

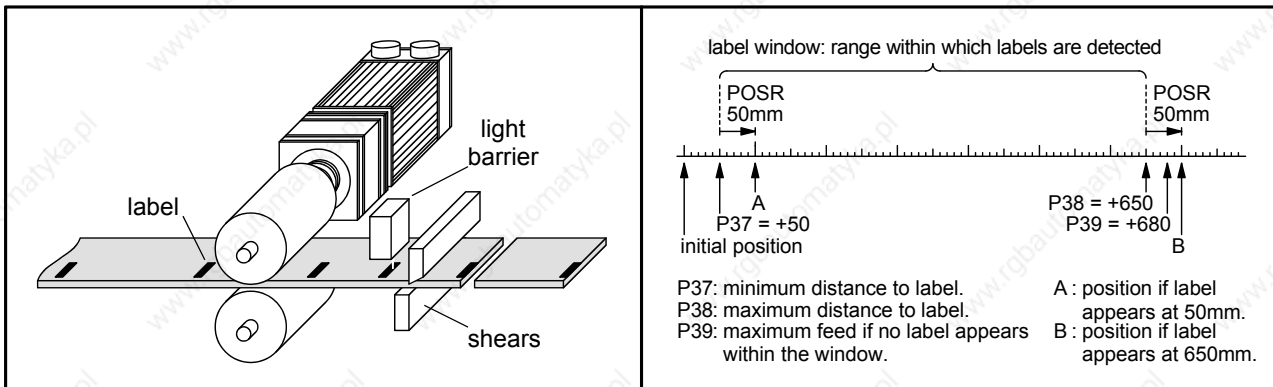

The plate is fed by a roller feed controlled by COMPAX. A reflex light barrier detects the marks on the plate and reports this to COMPAX. The distance between the light barrier and the shears is 50 mm. The shears are controlled and monitored by COMPAX.

### Wiring up the digital inputs and outputs:

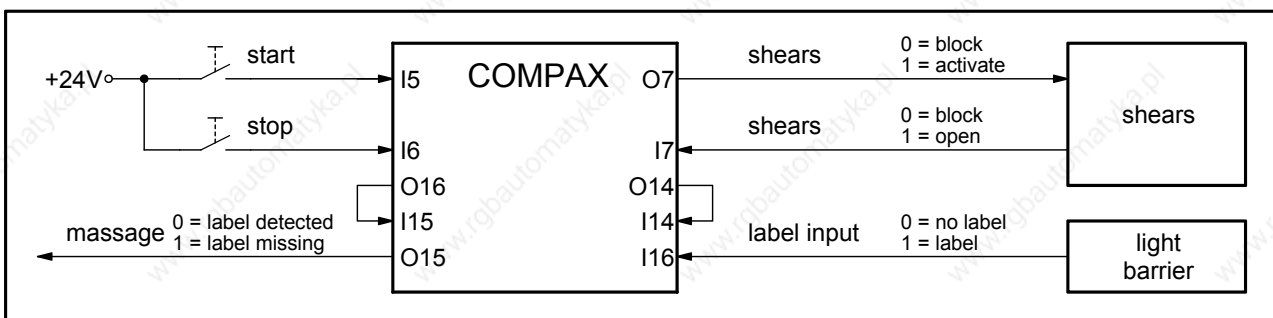

### Function:

The first event after COMPAX has been started is a rest of the control outputs. Once assurance has been received that the blades of the shears are open, COMPAX is ready for the initial cutting to length. The cutting to length process is triggered by a start pulse. COMPAX firstly activates the mark reference (I14) using O14. After a waiting time of 10 ms (which is used to compensate for any possible COMPAX timing offset), the mark-referenced positioning process is started using the "POSR 50 mm" command. The mark input (I16) is approved after a travel distance of 50 mm (P37). If the light barrier now detects a mark, COMPAX pushes the plate another 50 mm. This distance corresponds to the distance between the light barrier and the shears and is programmed using "POSR 50 mm". If no mark has been detected after a travel distance of 650 mm (P38), COMPAX stops the feed movement after a total of 680 mm (P39). At the end of the positioning process, output O16 indicates whether a mark has been detected within the mark window or not. This output is queried using I15. If I15 is at 1 (i.e. mark found), COMPAX sets the message output O15 to 0 and activates the shears. Once the blades have opened, COMPAX waits for the next start pulse. If I15 is 0 (i.e. no mark found), COMPAX sets the message output O15 to 1, blocks the mark reference (I14) via O14, pulls the plate back by 680 mm to the last cut-off position and waits for the next start pulse.

## Mark-referenced positioning

### Programming:

#### Configuration:

P93 = +2 i.e. continuous operating mode  
P35 = +1 i.e. mark reference switched on  
P37 = +50 i.e. minimum travel to mark = 50 mm  
P38 = +650 i.e. maximum travel to mark = 650 mm  
P39 = +680 i.e. maximum feed length, if no marks appear in the mark window = 680 mm

#### Names of inputs and outputs:

I7 shears	0 ⇒ closed	1 ⇒ open
I15 mark	0 ⇒ missing	1 ⇒ found
O7 shears	0 ⇒ block	1 ⇒ activate
O14 mark reference	0 ⇒ block	1 ⇒ activate
O15 message	0 ⇒ mark found	1 ⇒ mark missing

#### List of programs:

N001: SPEED 50 .....;sets the speed  
N002: ACCEL 250 .....;sets the acceleration and braking ramp  
N003: OUTPUT O7=0 .....;shears = block  
N004: OUTPUT O14=0 .....;mark reference = block  
N005: OUTPUT O15=0 .....;message = mark found

Wait for start: .....;mark

N006: IF I7=0 GOTO 6 .....;waits until shears are open  
N007: WAIT START .....;waits for start pulse  
N008: OUTPUT O14=1 .....;activates mark reference  
N009: WAIT 10 .....;waits until mark reference is activated  
N010: POSR 50 .....;mark-referenced positioning  
N011: WAIT 10 .....;waits until mark is missing or set  
N012: IF I15=0 GOTO reverses (18) .....;if mark is missing, reverses plate  
N013: OUTPUT O15=0 .....;sets "Mark found" message  
N014: OUTPUT O7=1 .....;activates shears  
N015: IF I7=1 GOTO 15 .....;waits until shears are closed  
N016: OUTPUT O7=0 .....;blocks shears  
N017: GOTO waits for start (6).....;goes to data record N006

Reverse: .....;mark

N018: OUTPUT O15=1 .....;sets "Mark missing" message  
N019: OUTPUT O14=0 .....;blocks mark reference  
N020: WAIT 10 .....;waits until mark reference is blocked  
N021: POSR -680.....;returns to start point  
N022: GOTO waits for start (6).....;goes to data record N006

### 11.1.4 Speed step profiling / comparator switching points

#### Application:

A bore spindle should be guided to the surface of the workpiece using a rapid feed movement. The bore is then bored to a defined depth using a considerably longer feed. When reversing the bore spindle, the unit should travel at a slow velocity while the drill is still in the bore. The remaining travel to the idle position is performed at a rapid speed.

The bore spindle should be switched on just before the boring process commences and should be switched off immediately after it has been removed from the bore. Movement of the conveyor belt should be blocked for as long as there is a risk of collision between the workpiece and drill.

#### Assignments:

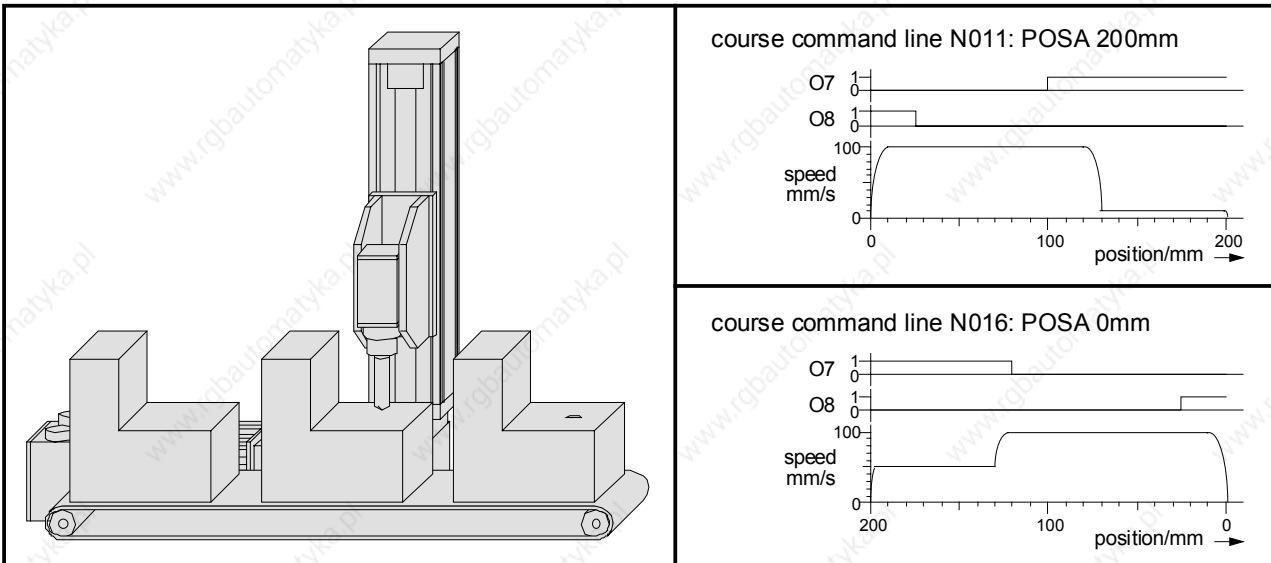

#### Function:

The feed movement is implemented using speed step profiling. The initial speed is first set to 100 mm/s using the "SPEED 100%" command (N007). This speed can be used until the start of the boring process. After a travel distance of 120 mm, the boring begins and the speed should then be 10 mm/s. The "POSR 120 mm SPEED 10%" command (N011) ensures that the speed is reduced from 100 mm/s to 10 mm/s for the following positioning after a distance of 120 mm. The position as of which the speed is then 10 mm/s depends on the set braking ramp (N001) and the output speed (N007). This means that braking is initiated from an appropriate stopping distance from the position where the bore starts.

When returning, the initial speed is set to 50 mm/s (N012) and, as of a travel distance of 70 mm, is accelerated to 100 mm/s (N013).

The bore spindle is switched on and off with the aid of the comparator switching points. During the feed movement, the spindle is switched on after a travel distance of 100 mm (N009). By the time the boring process begins after 130 mm, the spindle must have reached its operating speed. The spindle is switched off again when returning once the drill has left the bore (N014).

The conveyor belt is blocked for as long as the axis is located at a position of between 25 mm and 200 mm (N008 and N015).

## Speed step profiling / comparator switching points

### Programming:

#### Configuration:

P93 = +1 i.e. normal operating mode (absolute and relative positioning)

P94 = +1 i.e. linear ramp shape

SPEED 100% corresponds to 100 mm/s

#### Names of the inputs and outputs:

O7 bore spindle 0 ⇒ off 1 ⇒ on  
O8 conveyor belt 0 ⇒ block 1 ⇒ release

#### List of programs:

N001: ACCEL 200 .....;sets the acceleration and braking ramps

N002: SPEED 100 .....;sets the speed

N003: POSA 0 .....;approaches idle position

N004: OUTPUT O7=0 .....;bore spindle = off

N005: OUTPUT O8=1 .....;conveyor belt = release

Wait for start: .....;mark

N006: WAIT START .....;waits for start pulse

N007: SPEED 100 .....;sets starts speed to 100%

N008: POSR 25 OUTPUT O8=0 .....;sets the comparator point of the "Block conveyor belt"

N009: POSR 100 OUTPUT O7=1 .....;sets the comparator point of the "Switch on bore spindle"

N010: POSR 120 SPEED 10 .....;sets the speed steps

N011: POSA 200 .....;performs the positioning command with the set procedure

N012: SPEED 50 .....;sets starts speed to 50%

N013: POSR 70 SPEED 100 .....;sets speed step

N014: POSR 80 OUTPUT O7=0 .....;sets the comparator point of the "Switch off bore spindle"

N015: POSR 175 OUTPUT O8=1 .....;sets the comparator point of the "Release conveyor belt"

N016: POSA 0 .....;performs the positioning command with the set procedure

N017: GOTO waits for start (6) .....;goes to data record N006



## 11.1.5 SPEED SYNC

### Application:

Cartons should be transferred from one conveyor belt (conveyor belt A), a belt operating at a very variable belt speed, to another conveyor belt (conveyor belt C), a belt which has a constant belt speed. This task should be performed using a transfer belt (conveyor belt B) installed between the two other belts. This belt receives cartons from conveyor belt A and, when triggered by a pulse, passes them on to conveyor belt B. In addition to this, when conveyor belt B is assigned, conveyor belt A should be blocked. Conveyor belt B is activated using COMPAX.

### Assignments:

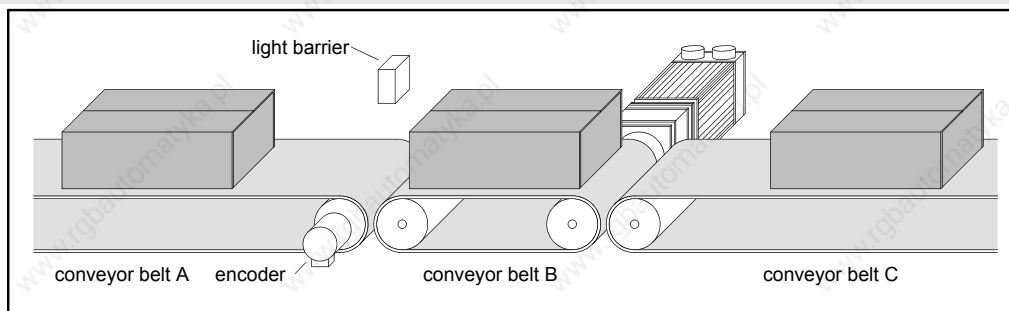

### Function:

The first event after COMPAX has been started is the release of conveyor belt A. The system then waits until the reflex light barrier (on I7) detects a carton (N003). Should a carton be received, the speed of conveyor belt B is set to that of conveyor belt A (N004). This speed is recorded using an encoder on conveyor belt A transmitting via the COMPAX encoder interface (channel 1). The positioning command (N005) now starts a feed movement using the distance which is required to transfer the whole carton onto conveyor belt B. Since the feed time is always the same as the speed of conveyor belt A, no errors occur due to slip between the carton and one of the conveyor belts. Once the whole carton has been received, the system waits until I8 reports that the carton has been passed to conveyor belt C (N008). If, during this waiting time, another carton arrives via conveyor belt A, this is blocked via O7. When the carton is passed on and conveyor belt A is blocked, the speed of conveyor belt B is set to that of conveyor belt C (N010). The carton is transferred to conveyor belt C at this constant speed using N011. Conveyor belt A is then released again (N002).

### Programming:

#### Configuration:

Encoder input E2 option

P93 = +2 i.e. continuous operating mode

P98 = 314 i.e. travel per axis per encoder revolution = 314 mm

P143 = 4096 i.e. encoder pulse number = 4096

#### Names of the inputs and outputs:

I7	receive carton	0 ⇒ no	1 ⇒ yes
I8	deposit carton	0 ⇒ no	1 ⇒ yes
O7	conveyor belt A	0 ⇒ block	1 ⇒ release

#### List of programs:

N001: ACCEL 200 .....;sets the acceleration and braking ramps  
 Transfer carton: .....;mark  
 N002: OUTPUT O7=1 .....;releases conveyor belt A  
 N003: IF I7=0 GOTO 3 .....;waits until carton is to be received  
 N004: SPEED SYNC .....;sets the speed to that on conveyor belt A  
 N005: POSR 360 .....;transfers the carton  
 N006: IF I7=0 GOTO 8 .....;queries whether carton is to be received  
 N007: OUTPUT O7=0 .....;blocks conveyor belt A  
 N008: IF I8=0 GOTO 6 .....;waits until carton is to be deposited  
 N009: OUTPUT O7=0 .....;blocks conveyor belt A  
 N010: SPEED 85 .....;sets the speed to that on conveyor belt C  
 N011: POSR 350 .....;deposits the carton  
 N012: GOTO transfers carton (2) .....;goes to data record N002

### 11.1.6 Speed control mode

#### Application:

A centrifuge for manual operation should be operated by an operating mode switch. The centrifugal process should either be run at a permanently set speed or the test tubes should be removed, one after another, through the removal aperture. The shutter on the removal aperture must only be able to open when the centrifuge is at a standstill.

#### Design and wiring up of the digital inputs and outputs:

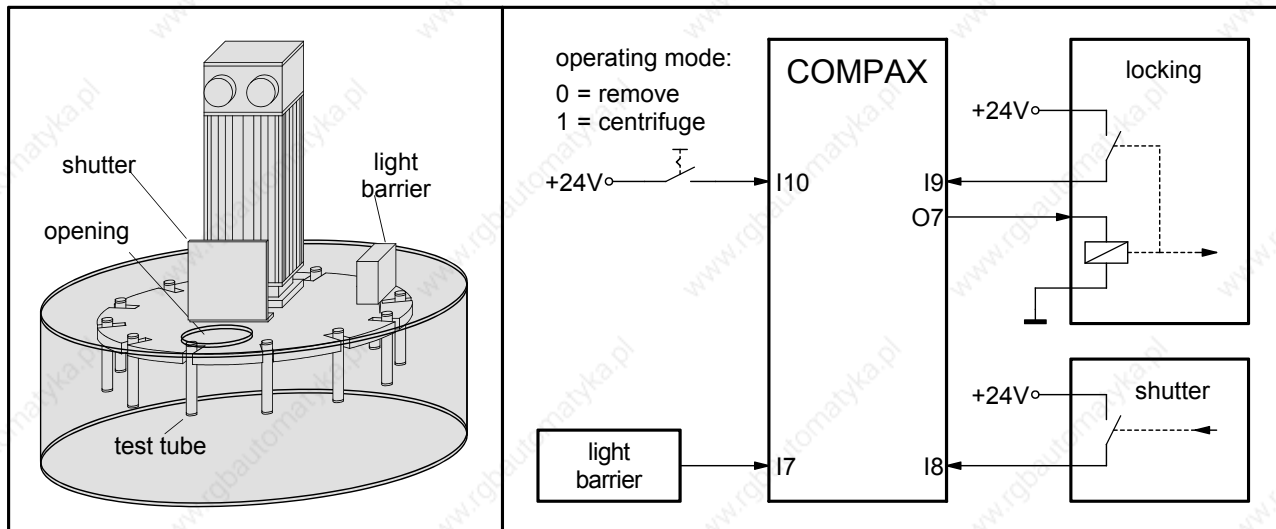

#### Function:

The first event after COMPAX has been started is the setting of the accelerating and braking time 10s (N001). A check is then run to find out whether the shutter is closed (N002). If it is not closed, the interlock is opened (N003) and the system waits until the shutter is closed (N004). If the shutter is closed, the interlock is also closed (N005). The interlock is checked for safety reasons (N006). The operating mode switch is then queried (N007).

If this is set to "Removal", the speed is set to 0.1 % using N008. The system waits until the light barrier is activated by a test tube (N010). When this occurs, the speed is set to 0 (N011) and the interlock is opened (N012). The shutter can now be opened to insert or remove a test tube. COMPAX monitors the opening and closing of the shutter (N013 / N014) to lock this again after the closing (N015 / N016) and to return to the operating mode query. If "Removal" is still set, the centrifuge is turned further to the next test tube. (N009 ensures that once the speed has accelerated to 0.1% (N008), the system waits until the previous test tube no longer activates the photoelectric barrier.)

If the operating mode switch is set in the "Centrifuge" position, the centrifuge is accelerated to 100% within 10s (N018). This speed is retained until the operating mode switch is set to "Removal" (N019 / N020). Then, the centrifuge is decelerated to 0.1% (N008) and stops at the next test tube. The test tubes can then be removed one after another.

## Programming:

### Configuration:

P93 = +4 i.e. speed control operating mode

P94 = +2 i.e. smooth ramp shape

### Names of the inputs and outputs:

I7	light barrier	0 ⇒ not activated	1 ⇒ activated
I8	shutter	0 ⇒ open	1 ⇒ closed
I9	interlock	0 ⇒ open	1 ⇒ closed
I10	operating mode	0 ⇒ remove	1 ⇒ centrifuge
O7	interlock	0 ⇒ closed	1 ⇒ open

### List of programs:

N001: ACCEL 10 000 .....;sets the accelerating and braking ramps to 10s

N002: IF I8=1 GOTO locks (5).....;checks whether the shutter is closed

N003: OUTPUT O7=1 .....;opens interlock

N004: IF I8=0 GOTO 4 .....;waits until the shutter is closed

Lock: .....;mark

N005: OUTPUT O7=0 .....;closes interlock

N006: IF I9=0 GOTO 6 .....;checks whether interlock is closed

Operating mode query:

N007: IF I10=1 GOTO centrifuges (18) .....;queries operating mode switch

Remove: .....;mark

N008: SPEED 0.1 .....;sets the speed to 0.1%

N009: WAIT 500 .....;waits 500 ms

N010: IF I7=0 GOTO 10 .....;waits until the light barrier is activated

N011: SPEED 0 .....;sets the speed to 0

N012: OUTPUT O7=1 .....;opens interlock

N013: IF I8=1 GOTO 13 .....;waits until shutter is opened

N014: IF I8=0 GOTO 14 .....;waits until shutter is closed again

N015: OUTPUT O7=0 .....;closes interlock

N016: IF I9=0 GOTO 16 .....;checks whether interlock is closed

N017: GOTO operating mode query (7) .....;goes to data record N007

Centrifuge: .....;mark

N018: SPEED 100 .....;sets speed to 100%

N019: IF I10=0 GOTO removing (8) .....;operating mode query

N020: GOTO 19 .....;goes to data record N019

### 11.1.7 Fast start

#### Application:

Material should be fed to an extender stamping machine which operates at a maximum speed of 150 rpm. The material may only be supplied if the stamping tool is open and if the workpiece (already stamped) has been thrown up. The material supply should be released or blocked via a switch.

#### Assignments:

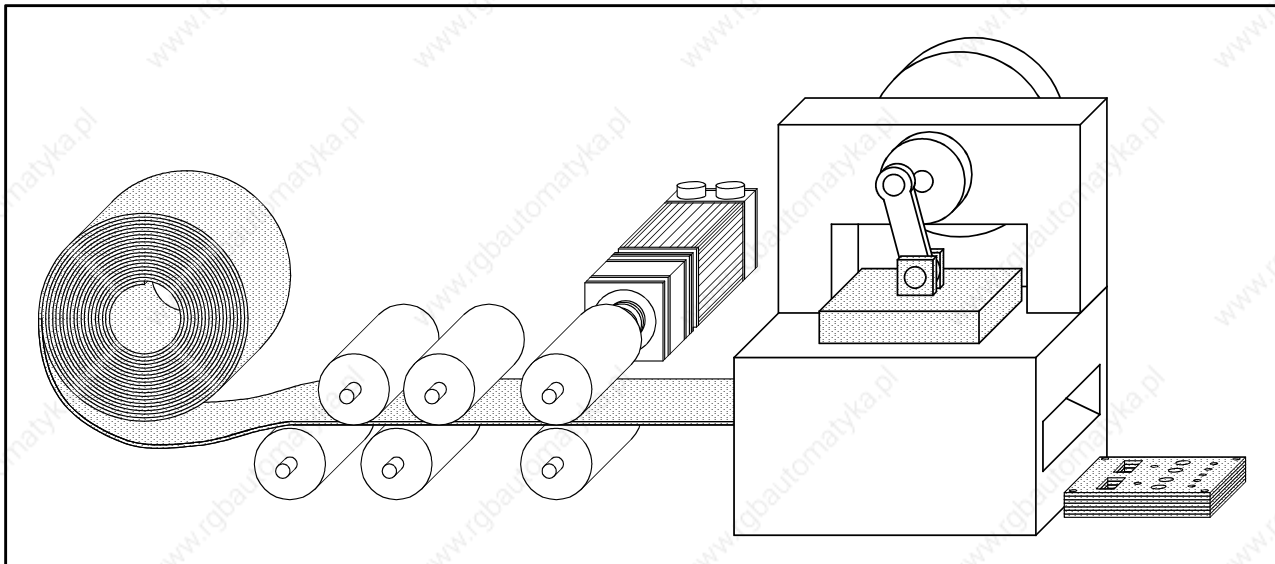

#### Function:

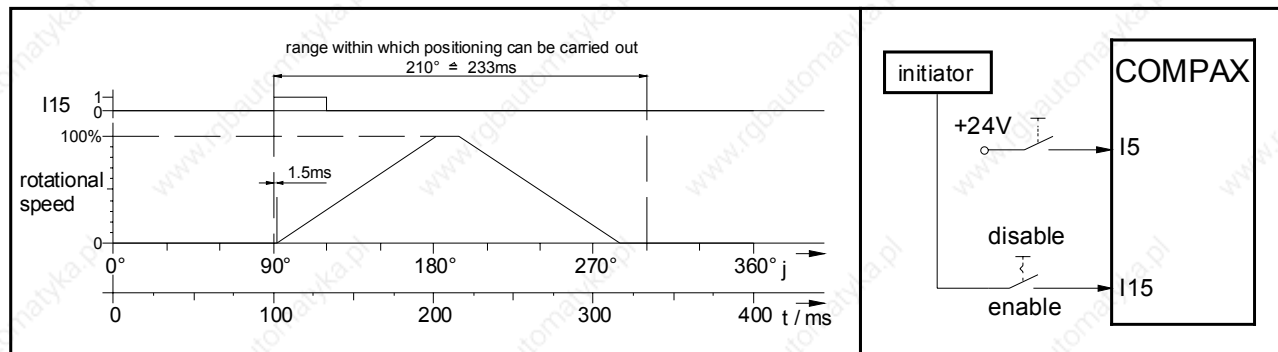

When the stamping machine runs at an operating speed of 150 strokes a minute, an operating cycle lasts 400 ms. The operating angle (at which the material can be fed) is  $210^\circ$ . 233 ms therefore remain for the feed movement. To ensure that the necessary drive dynamics are kept within these limits, as much of this time as possible must be used for the actual feed movement. This is why, the fast START is used here as it has a response time of only 1.5 ms. The feed movement is triggered by the signal that the initiator (on the eccentric axis) transfers via the release switch to COMPAX (I15) at an angle of  $\varphi = 90^\circ$ .

Once the system has been switched on, COMPAX is started via a start pulse on I5. The values for the accelerating and braking time are set in N001 and N002, as are those for the feed speed. The positioning command in N003 is only performed, if a rising flank (from 0 to 1) is detected on I15 (fast START). The time between the rising flank and the start of the feed movement is 1.5 ms. Data record N004 is used to return to N003 which ensures that the next positioning command is prepared. This is then performed after a rising flank on I15.

### Programming:

#### Configuration:

P93 = +2 i.e. continuous operating mode

P94 = +1 i.e. linear ramp shape

P18 = +2 i.e. fast START activated

#### Names of the inputs and outputs:

I15 fast START a flank from 0 to 1 triggers the fast START

#### List of programs:

N001: ACCEL 100 .....;sets the accelerating and braking ramps

N002: SPEED 100.....;sets the speed

Feed: .....;mark

N003: POSR 225.....;feed movement (triggered by fast START)

N004: GOTO feed (3).....;goes to data record N003

## 11.1.8 Implementing a torque controller

2 options are available:

#### Using speed control mode

You can attain a defined constant torque in speed control mode using the following setting.

- Set a high speed which cannot be reached.
- Define the desired torque using P16 in % of the nominal torque (max. 100%).
- Switch off errors E10 and E49 using P13=0.

COMPAX tries to reach the specified speed and increases the torque to the maximum permitted torque P16. This value is maintained regardless of the load.

#### In position controller mode

- Specify a position which cannot be approached (which is beyond the load position).
- Define the desired torque using P16 in % of the nominal torque (max. 100%).
- Switch off errors E10 and E49 using P13=0.
- You can now use SPEED to also define the speed at which you can run up to the load (block position).

COMPAX tries to reach the specified position and increases the torque in the load position to the maximum permitted torque P16. This value is maintained regardless of the load.

#### Changing error response:

E49 can also be switched off individually:

E49 occurs when the current (and/or the torque) remains in the limitation for longer than P108.

## 12. Index

- ABB – interface ..... 178
- Absolute positioning ..... 96
- Absolute value function
  - with standard resolver ..... 79
- Absolute value resolver ..... 79
- ACCEL ..... 97
- Acceleration and braking
  - time ..... 97
- Accessories and
  - options ..... 173
  - overview ..... 174
- Accuracy ..... 65
- Accuracy of calculations ... 115
- Acknowledging error
  - messages ..... 71
- Activate position
  - adjustment ..... 150
- Activating mark
  - reference ..... 100
- Actual position ..... 207
- Actual values Status
  - values ..... 207
- Addition ..... 114
- Advance acceleration
  - control P26 ..... 130
- Advance control
  - measures ..... 129
- Advance power control
  - P70 ..... 130
- Advance reverse control ... 130
- Advance speed control
  - P25 ..... 130
- Ambient conditions ..... 65
- Analogue rpm
  - specification for
    - COMPAX 1000SL ..... 61
- Analogue speed
  - specification (E7) ..... 186
- Angle difference P161 ..... 79
- Application example
  - external data record
    - selection ..... 227
    - fast start ..... 236
    - mark-referenced
      - positioning ..... 229
      - speed control mode ..... 234
      - speed step profiling /
        - comparator switching
          - points ..... 231
        - SPEED SYNC ..... 233
- Applications examples .. 226
- Applications with
  - encoder ..... 180
- Arithmetic ..... 114
- Assignment
  - absolute value sensor ..... 59
  - EAM4/01 ..... 180
  - HEDA ..... 63
  - Incremental encoder ..... 60
  - Inputs/Outputs ..... 52
  - RS232 interface ..... 59
  - X10 ..... 52
  - X11 ..... 56
  - X13 ..... 186
  - X13 ..... 60
  - X14 ..... 63
  - X16 ..... 59
  - X17 ..... 55
  - X6 ..... 59
  - X8 ..... 52
- Authorization of
  - commands in RS232 ..... 165
- Automatic "Position
  - reached" message ..... 160
- Avoiding harmonics ..... 131
- Ballast resistance ... 32, 38, 41
- Ballast resistors ..... 193
- Baud rate ..... 160
- BDF1/02 ..... 187
- BDF2/01 ..... 200
- Binary data transfer
  - using RS232 ..... 166
- Block check ..... 161
- Block structure of the
  - basic unit ..... 68
- Blocking and modifying
  - teach in functions P211 .. 150
- Blocking and modifying
  - the teach in functions
    - P211 ..... 164
- Brake control ..... 51
- Braking delay ..... 93
- Braking operation ..... 64
- Braking power
  - NMD ..... 24
- Braking power COMPAX
  - 1000SL ..... 41
- Branching ..... 108
- BREAK handling ..... 111
- BRM4 ..... 193
- BRM6 ..... 193
- BRM7 ..... 193
- Bus connection ..... 63
- Bus data ..... 207
- Bus parameters
  - setting ..... 71
- Bus systems ..... 178
- Bus termination ..... 180
- Cable ..... 206
- Cable laying ..... 13
- Cable lengths ..... 206
- Calculation errors ..... 115
- Cam controller ..... 104
- CAN-Bus ..... 178
- CANopen ..... 178
- CE-compliant ..... 13
- Changes in speed within
  - a positioning process ..... 101
- Command combinations ... 101
- Command variants ..... 109
- Comparative operations ... 109
- comparator switch points .. 101
- COMPAX – CD ..... 9
- COMPAX components ..... 206
- COMPAX 1000SL ..... 40
- COMPAX 25XXS
  - converting the front
    - plates ..... 33
- COMPAX 25XXS
  - specific technical data ..... 32
- COMPAX 25XXS
  - delivery status ..... 33
- COMPAX 25XXS design
  - in series ..... 33
- COMPAX 25XXS flat
  - design ..... 33
- COMPAX 25XXS unit
  - features ..... 30
- COMPAX 35XXS unit
  - features ..... 26
- COMPAX 45XXS/85XXS
  - connector assignment ..... 39
- COMPAX 45XXS/85XXS
  - unit characteristics ..... 35
- COMPAX XX30 ..... 147
- COMPAX XX50 ..... 147
- COMPAX XX60 ..... 147
- COMPAX XX70 ..... 147
- COMPAX-25XXS
  - plan view ..... 30
- COMPAX-M / NMD
  - direct wall installation ..... 20
- COMPAX-M / NMD
  - indirect wall installation ..... 20
- COMPAX-M system
  - network, mains module ..... 18
- COMPAX-M unit
  - features ..... 17
- Compensation of
  - switching delays ..... 104
- Components required ..... 14
- Conditions for usage ..... 13
- Conditions of warranty ..... 9
- Configuration ..... 72
- Configuration data ..... 74
- Configuration process ..... 72

Configuration via PC.....	91	E49 .....	237	Function of digital inputs ...	148
Configuration when supplied.....	72	E54 .....	225	Function of outputs .....	153
Connections to the drive .....	46	E76 .....	171	Function overview .....	69
Connector and connection assignment COMPAX 25XXS .....	30	E77 .....	171	Function signs .....	160
Connector assignment COMPAX 25XXS .....	34	E78 .....	171	Fuse protection .....	64
Connector assignment COMPAX-M .....	21	EAM .....	188	Fuse protection COMPAX 1000SL .....	41
Connector assignment NMD .....	23	EAM4/01 .....	180	Fuse protection COMPAX 2500S .....	32
Connector assignment COMPAX 1000SL .....	42	Earthing .....	13	Fuse protection COMPAX 3500M .....	27
Connector assignment X13 for COMPAX 1000SL.....	61	Echo.....	160	Fuse protection COMPAX 45/8500S .....	37
Continuous mode .....	74	Effective motor load ..	135, 211	Fuse protection NMD .....	23
point of real zero .....	78	Effective unit load .....	135, 211		
Control .....	147	Electronic transmission .....	147	GBK1 .....	59
Control voltage .....	64, 207	EMC measures .....	191	General drive .....	77
CS31.....	178	Emergency stop .....	44	Global assignment .....	114
Current data record .....	207	Emergency stop characteristics .....	44	GOSUB .....	107
Current nominal value .....	208	Emergency stop input on COMPAX-M .....	45	GOSUB EXT .....	110
Current requirement .....	75	Encoder .....	179	GOTO .....	99, 107
Currents .....	64	Encoder bus.....	182	GOTO EXT .....	109
Currents with linear motor LXR.....	176	Encoder cable.....	180		
Curve memory .....	113	Encoder distributor.....	180	Hall sensor commutation ..	176
		Encoder input module.....	180	Hand-held terminal.....	200
D/A - Monitor (D1) .....	58	Encoder interface.....	179	Hardware handshake.....	160
D/A monitor.....	56	Encoder interfaces for COMPAX 1000SL .....	61	HAUSER synchronous motors .....	176
D/A monitor (D1).....	185	Encoder module.....	180	HEDA .....	168, 183
Damping P24 .....	128	Encoder position .....	208	HEDA address .....	71
Data format.....	160	END .....	107	HEDA interface .....	185
Data security.....	6	End sign.....	160	HEDA parameters .....	168
Define encoder interfaces .....	212	Entry buffer .....	160	HEDA terminating connector.....	63
Delta mains.....	66	Equipment replacement.....	12	HEDA transmission errors .....	171
Diagnosis values .....	207	Error diagnosis in the mains module .....	25	Higher level of stiffness.....	132
Digital inputs Triggering functions.....	150	Error handling .....	110	HJ motor .....	93
Digital inputs and outputs Assignment .....	138	Error history .....	209	HLE data .....	77
Dimensions COMPAX 1000SL.....	43	Error program .....	110	Housing .....	66
Dimensions/installation COMPAX 25XXS .....	33	Error transmission.....	161	HPLA data.....	77
COMPAX-M .....	20	EU guidelines.....	13		
NMD .....	22	Executing commands .....	160	I/O assignment of variants.....	147
Direct command entry conditions .....	162	External contact for brake control .....	51	I11 .....	136
Direction of rotation .....	78	External control panel .....	187	Idle display .....	119
Division .....	114	External motors conditions .....	75	IF ERROR.....	110
Division remainder.....	114	External position localization .....	136	IF ERROR GOSUB.....	110
Drive status.....	208			IF I12=101-1.....	108
Drive type .....	76	Fan configuration COMPAX-M .....	20	IF I7=1 .....	108
E10 .....	225	Fast start.....	168, 169	IF query .....	108
E15 .....	225	Final stage, engaging and disengaging .....	123	IF STOP .....	111
		Find machine zero .....	149	IFM identification.....	208
		movement process .....	81	Increments .....	74
		Free assignment of inputs and outputs.....	143	Individual configuration of synchronous motors using Servo-Manager .....	91
		Front plate operation.....	71	Initial start-up .....	73
		Function codes of commands.....	159	Initializing variables.....	116
				Initiator set .....	177

Initiators		Output O16 .....	100
connection plan .....	55	output O5 .....	117
position .....	55	OUTPUT WORD .....	143
Initiators .....	55	Outputs	
Input connection .....	54	Load .....	54
Input I14 .....	100	Override input .....	97
Input I16 .....	100, 186		
Input level .....	54	P1 .....	78
Installation / dimensions		P100 .....	75
COMPAX		P11 .....	78
45XXS/85XXS .....	36	P12 .....	78
Installation and		P14 .....	117
dimensions of		P143 .....	136
COMPAX 3500M .....	27	P144 .....	136
Installation arrangement		P151 .....	132
of the COMPAX-M		P17 .....	123
mains module .....	18	P18 .....	169
Interbus-S .....	178	P182 .....	210
Interfaces .....	138	P184 .....	169
Interpreting and storing		P188 .....	169
commands .....	160	P206 .....	184
IPM .....	168	P213 .....	78
IT mains .....	66	P214 .....	137
		P215 .....	78
Lag error .....	207, 225	P217 .....	89
Last error .....	207	P219 .....	152
Leakage current .....	66	P223 .....	145
LED display COMPAX		P224 .....	145
1000SL .....	40	P227 .....	117, 119
LEDs .....	10	P229 .....	119
Length code for cable .....	47	P23 .....	127
Limit switch monitoring .....	89	P233 .....	133
Limit switch monitoring		P234 .....	133
without locking the		P24 .....	128
movement .....	89	P243 .....	168
Limit switch operation .....	89	P245 .....	145
Limit torque P16 .....	213	P246 .....	145
Limit values .....	213	P25 .....	130
Limitation functions .....	222	P250 .....	168
Limits status .....	208	P26 .....	130
Linear motor .....	176	P27 .....	128
Linear motor LXR .....	176	P35 .....	100
LXR .....	176	P36 .....	136
		P37 .....	100
Machine zero - initiator		P38 .....	100
(without resolver zero) .....	88	P39 .....	100
Machine zero		P40-P49 .....	109
comparison .....	83	P50 .....	132
Machine zero mode .....	80	P69 .....	130
Mains .....	66	P70 .....	130
Mains module NMD10 /		P71 .....	58
NMD20 .....	22	P72 .....	58
Mains power .....	207	P73 .....	58
Mains supply fuse		P74 .....	58
protection .....	27, 64	P75 .....	136
Mark input .....	100	P80 .....	76
Mark-related positioning ...	100	P81 .....	77
Master output quantity .....	169	P81 - P85 .....	76
Maximum feed length .....	100	P82 .....	77
Maximum mass .....	77	P83 .....	77
Maximum position P11 .....	78		
Maximum travel to mark ...	100		
Measuring error 135, 208, 211			
Minimizing lag error .....	131		
Minimum mass .....	77		
Minimum position P12 .....	78		
Minimum travel to mark ...	100		
Modulo .....	114		
Moment of inertia .....	77		
Monitoring .....	222		
Monitoring functions .....	65		
Motor monitoring .....	222		
Motor or final stage			
temperature too high .....	131		
Motor output throttle .....	192		
Motor throttle .....	206		
Motor type .....	75		
Motor type plate .....	92		
Motors .....	176		
Mounting COMPAX			
1000SL .....	43		
Multiplication .....	114		
Multi-turn .....	184		
Negative command			
acknowledgement ..	164, 225		
NMD output power .....	23		
NMD20 internal ballast			
resistance .....	24		
Nominal current .....	92		
Nominal currents .....	64		
Nominal currents with			
linear motor LXR .....	176		
Nominal motor speed .....	93		
Nominal torque .....	92		
Normal mode .....	74		
Number format .....	115		
Number of teeth on			
pinion .....	77		
O5 toggles when speed ...	120		
Operating hours .....	207		
Operating mode .....	74		
Operating mode with two			
end initiators .....	89		
Operators .....	114		
Optimization			
control .....	131		
Optimization display ..	133, 207		
Optimizing the controller ...	127		
Option E7 .....	186		
Order .....	208		
OUTPUT .....	98		
Output buffer .....	160		
Output connection .....	54		
Output data .....	64		
OUTPUT O0 .....	98		
OUTPUT O0=... in			
program .....	98		
OUTPUT O12=1010 .....	98		



P88 .....	77		
P90 .....	74	Querying status values	
P92 .....	77	via the front plate.....	71
P93 .....	74	Ramp shape .....	75
P94 .....	75	linear .....	76
P96 .....	184	quadratic .....	76
P98 .....	136	smooth .....	76
Parameter assignments.....	113	Ramp time .....	102
Parameter groups .....	212	Read and write program	
Parametrization of the		sets and parameters	
cam controller .....	104	via RS232.....	163
Parity .....	160	Read the status values	
Part .....	208	via RS232.....	163
Password .....	99	Readiness.....	44
Password input .....	70	Ready contact.....	45
Password protection .....	70	Real zero .....	81
Peak current .....	134	Reduction of dynamic	
PLC data interface.....	156	lag error.....	130
PLC sequential step		Reference systems	
tracking .....	122	example.....	80
Plug and connection		Relative positioning.....	96
assignment		REPEAT .....	108
COMPAX 35XXM.....	26	Repeat counter .....	207
COMPAX		Resolver / SinCos	
45XXS/85XXS.....	35	assignment.....	46
POSA.....	96	Resolver type.....	93
POSA HOME .....	96, 162	RETURN .....	107
Position monitoring .....	117	Return jump to main	
Position of machine zero ....	83	program.....	107
POSR .....	96, 100	Round table control.....	147
POSR OUTPUT .....	103	RS232.....	160
POSR SPEED .....	101	Example in Quick-Basic	161
Potentiometer		RS232 data.....	207
connection.....	56	RS232 interface	
Power .....	64	parameters .....	160
Power dissipation .....	65	RS485.....	178
Power filter.....	191		
Power on .....	73	S1 .....	183
Power on with motor		S1/2/3 assignment X12.....	46
switched off.....	72	S13 .....	133
Power with linear motor		S14 .....	133
LXR.....	176	S15 .....	210
Priority .....	110	S16 .....	209
Process coupling .....	168	S17 .....	209
Process interfaces		S18 .....	209
Configuration options		S2 .....	184
for COMPAX 1000SL.....	61	S3 .....	176
Process interfaces for		Safe working practices.....	8
unit variants.....	60	Safety chain .....	44
Process velocity.....	97	Safety chain and	
Profibus .....	178	emergency stop	
Program control		functions.....	44
data record selection.....	110	Safety instructions .....	8
Data record selection.....	109, 110	Saturation characteristic	
WAIT START .....	109	curve .....	93
Program jump .....	107	Screened connection of	
Program loop .....	108	motor cable	
Proper use .....	8	COMPAX 25XXS.....	31
Pulse current .....	93	COMPAX-M .....	19
Pulse current time.....	93		
		Sensor position .....	207
		Sequential step tracking....	122
		Service D/A monitor .....	124
		Service D/A monitor (D1)....	56
		Servo-Manager .....	200
		Setting multiple digital	
		outputs.....	98
		Setting/resetting outputs .....	98
		Setting/resetting outputs	
		within positioning .....	103
		SHIFT.....	148
		SHIFT.....	148
		Short circuit monitoring .....	222
		Signal procedure during	
		status query via PLC	
		interface.....	159
		SinCos .....	183
		Slave input quantities.....	169
		Software date.....	208
		Software handshake .....	160
		Software handshake .....	161
		Software version .....	1, 7, 208
		Specifying point of real	
		zero P1 (RZ).....	78
		Specifying software end	
		limits .....	78
		Specifying the limit	
		switch position P216.....	89
		Speed.....	208
		SPEED.....	97
		Speed control mode .....	74
		direction of rotation .....	97
		Speed control mode,	
		special features .....	120
		Speed monitor.....	132
		Speed monitoring in	
		speed control mode .....	120
		Speed step profile .....	102
		Speed step profiles .....	101
		SPEED SYNC.....	99
		SSK1 .....	59
		SSK14.....	63
		SSK15.....	63
		SSK6.....	188
		SSK7.....	180
		Standard commands.....	96
		Standard delivery .....	66
		Standard parameters .....	212
		Start-up	
		flow chart .....	11
		Status bits .....	208
		Status bits 1 .....	207
		Status monitor.....	207, 210
		Status values .....	207
		Step direction input for	
		COMPAX 1000SL .....	61
		Stiffness P23.....	127
		STOP .....	149
		Stop bit.....	160
		STOP handling.....	111

Stop program.....	112	Variables.....	114
Sub-program.....	107	Variables V51 ... V70 .....	114
Subtraction .....	114	Velocity .....	207
Supply status .....	10	Velocity specification, external .....	99
Supported resolvers .....	64	Version.....	208
Switch off.....	98	Vibrating at higher frequencies.....	131
Switch off drive unit .....	98	Voltage.....	124
Switch status .....	208	VP parameter, modifying OnLine.....	212
Switching delays.....	104	WAIT .....	107
Switching off .....	72	WAIT START .....	109
Switch-on status .....	10	Waiting time .....	107
Synchronization errors.....	171	Weights.....	66
Synchronizing to external velocity .....	99	Whole number division .....	114
Synchronous cycle control .....	147	Wiring up mains power / control voltage COMPAX 25XXS.....	32
Synchronous STOP using I13 .....	151	COMPAX 45/85S .....	37
System concept .....	173	COMPAX-M .....	19
Table of contents .....	2	Wiring up motor COMPAX 25XXS.....	31
Target position.....	207	COMPAX 45/85S .....	37
Teach in real zero.....	149	Wiring up the motor COMPAX-M .....	19
TEACH position .....	164	Wiring up the system network.....	18
Technical data .....	64	Word length .....	160
Technical data / power features NMD.....	23	X12 .....	46
Temperature .....	207	Zero point shifting .....	83
Terminal boxes .....	46		
Terminal module.....	188		
Test / control.....	56		
TN mains .....	66		
Toggling when position is reached .....	117		
Tooth pitch.....	77		
Torque .....	207		
Torque converter .....	226, 237		
Transmission errors.....	171		
Transmitting control instructions via RS232 ...	164		
Travel cycle .....	207		
Travel per motor revolution .....	77		
Type plate.....	7		
Unit .....	208		
increments .....	74		
Unit .....	74		
Unit assignment.....	7		
Unit designation.....	208		
Unit designations .....	208		
Unit family.....	208		
Unit monitoring .....	222		
Unit technology.....	15		
Unit wiring COMPAX 1000SL.....	41		
V0-V49.....	109		
Variable voltage.....	124		