

IGBT Modules

Sixpack, H Bridge

Short Circuit SOA Capability
 Square RBSOA

$I_{C25} = 165 \text{ A}$
 $V_{CES} = 1200 \text{ V}$
 $V_{CE(sat) \text{ typ.}} = 2.0 \text{ V}$

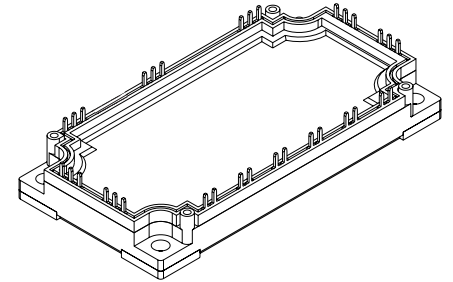
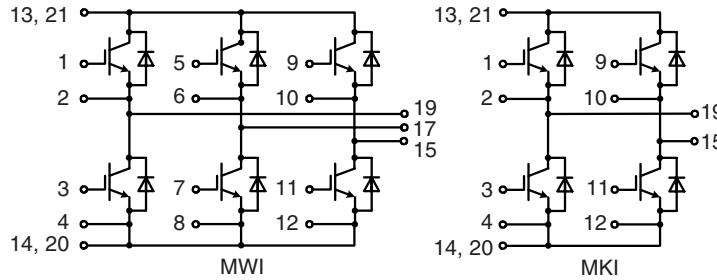

IGBTs

Symbol	Conditions	Maximum Ratings	
V_{CES}	$T_{VJ} = 25^{\circ}\text{C to } 150^{\circ}\text{C}$	1200	V
V_{GES}		± 20	V
I_{C25}	$T_C = 25^{\circ}\text{C}$	165	A
I_{C80}	$T_C = 80^{\circ}\text{C}$	115	A
I_{CM}	$V_{GE} = \pm 15 \text{ V}; R_G = 12 \Omega; T_{VJ} = 125^{\circ}\text{C}$	200	A
V_{CEK}	RBSOA; clamped inductive load; $L = 100 \mu\text{H}$	V_{CES}	
t_{SC}	$V_{CE} = 900 \text{ V}; V_{GE} = \pm 15 \text{ V}; R_G = 12 \Omega; T_{VJ} = 125^{\circ}\text{C}$ SCSOA; non-repetitive	10	μs
P_{tot}	$T_C = 25^{\circ}\text{C}$	640	W

Features

- NPT³ IGBTs
 - low saturation voltage
 - positive temperature coefficient for easy paralleling
 - fast switching
 - short tail current for optimized performance also in resonant circuits
- HiPerFRED™ diode:
 - fast reverse recovery
 - low operating forward voltage
 - low leakage current
- Industry Standard Package
 - solderable pins for PCB mounting
 - isolated copper base plate

Symbol	Conditions	Characteristic Values ($T_{VJ} = 25^{\circ}\text{C}$, unless otherwise specified)		
		min.	typ.	max.
$V_{CE(sat)}$	$I_C = 100 \text{ A}; V_{GE} = 15 \text{ V}; T_{VJ} = 25^{\circ}\text{C}$ $T_{VJ} = 125^{\circ}\text{C}$		2.0 2.3	V V
$V_{GE(th)}$	$I_C = 4 \text{ mA}; V_{GE} = V_{CE}$	4.5		6.5 V
I_{CES}	$V_{CE} = V_{CES}; V_{GE} = 0 \text{ V}; T_{VJ} = 25^{\circ}\text{C}$ $T_{VJ} = 125^{\circ}\text{C}$		1.4	1.4 mA mA
I_{GES}	$V_{CE} = 0 \text{ V}; V_{GE} = \pm 20 \text{ V}$			400 nA
$t_{d(on)}$ t_r $t_{d(off)}$ t_f	Inductive load, $T_{VJ} = 125^{\circ}\text{C}$ $V_{CE} = 600 \text{ V}; I_C = 100 \text{ A}$ $V_{GE} = \pm 15 \text{ V}; R_G = 12 \Omega$		330	ns
E_{on}			15	ns
E_{off}			750	ns
			45	ns
			12	mJ
C_{ies}	$V_{CE} = 25 \text{ V}; V_{GE} = 0 \text{ V}; f = 1 \text{ MHz}$		7.4	nF
Q_{Gon}	$V_{CE} = 600 \text{ V}; V_{GE} = 15 \text{ V}; I_C = 150 \text{ A}$		0.76	μC
R_{thJC}	(per IGBT)			0.19 K/W

Typical Applications

- MWI
 - AC drives
 - power supplies with power factor correction
- MKI
 - motor control
 - . DC motor amature winding
 - . DC motor excitation winding
 - . synchronous motor excitation winding
 - supply of transformer primary winding
 - . power supplies
 - . welding
 - . X-ray
 - . battery charger

Diodes

Symbol	Conditions	Maximum Ratings	
I_{F25}	$T_C = 25^\circ\text{C}$	200	A
I_{F80}	$T_C = 80^\circ\text{C}$	130	A

Symbol	Conditions	Characteristic Values		
		min.	typ.	max.
V_F	$I_F = 100\text{ A}; V_{GE} = 0\text{ V}; T_{VJ} = 25^\circ\text{C}$ $T_{VJ} = 125^\circ\text{C}$	2.3	2.6	V
I_{RM} t_{rr}	$I_F = 120\text{ A}; di_F/dt = -750\text{ A}/\mu\text{s}; T_{VJ} = 125^\circ\text{C}$ $V_R = 600\text{ V}; V_{GE} = 0\text{ V}$	58		A
		190		ns
R_{thJC}	(per diode)			0.3 K/W

Module

Symbol	Conditions	Maximum Ratings	
T_{VJ}	operating	-40...+125	$^\circ\text{C}$
T_{JM}		+150	$^\circ\text{C}$
T_{stg}		-40...+125	$^\circ\text{C}$
V_{ISOL}	$I_{ISOL} \leq 1\text{ mA}; 50/60\text{ Hz}$	2500	V~
M_d	Mounting torque (M5)	2.7 - 3.3	Nm

Symbol	Conditions	Characteristic Values		
		min.	typ.	max.
$R_{pin-chip}$			1.8	m Ω
d_S	Creepage distance on surface	10		mm
d_A	Strike distance in air	10		mm
R_{thCH}	with heatsink compound		0.01	K/W
Weight			300	g

Equivalent Circuits for Simulation

Conduction

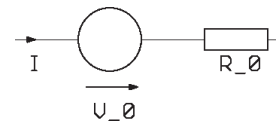

IGBT (typ. at $V_{GE} = 15\text{ V}; T_J = 125^\circ\text{C}$)
 $V_0 = 0.95\text{ V}; R_0 = 14\text{ m}\Omega$

Free Wheeling Diode (typ. at $T_J = 125^\circ\text{C}$)
 $V_0 = 1.3\text{ V}; R_0 = 7\text{ m}\Omega$

Thermal Response

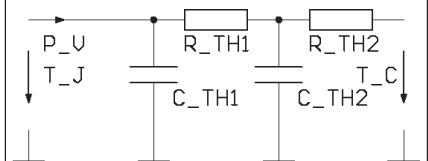

IGBT (typ.)

$C_{th1} = 0.389\text{ J/K}; R_{th1} = 0.139\text{ K/W}$
 $C_{th2} = 2.154\text{ J/K}; R_{th2} = 0.051\text{ K/W}$

Free Wheeling Diode (typ.)

$C_{th1} = 0.301\text{ J/K}; R_{th1} = 0.24\text{ K/W}$
 $C_{th2} = 2.005\text{ J/K}; R_{th2} = 0.062\text{ K/W}$

Dimensions in mm (1 mm = 0.0394")

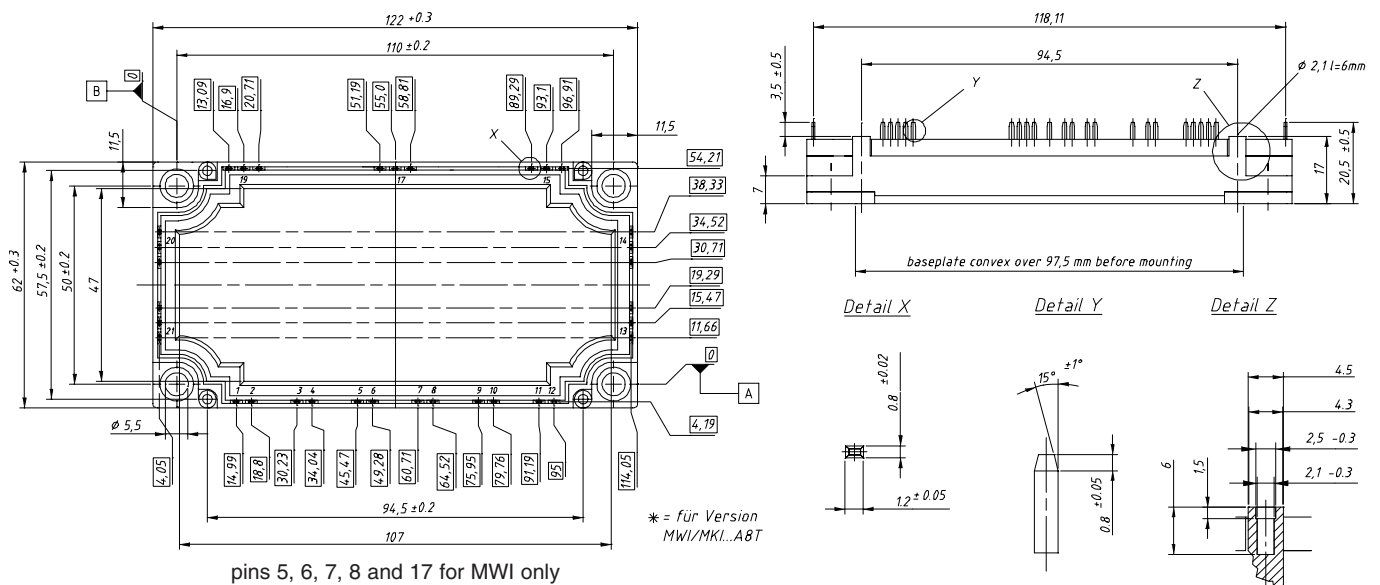

IXYS reserves the right to change limits, test conditions and dimensions.

© 2004 IXYS All rights reserved

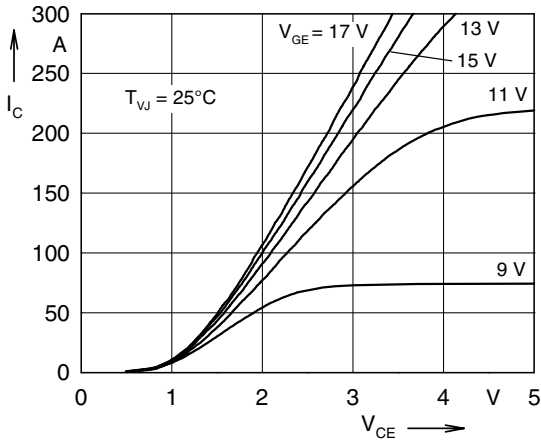

Fig. 1 Typ. output characteristics

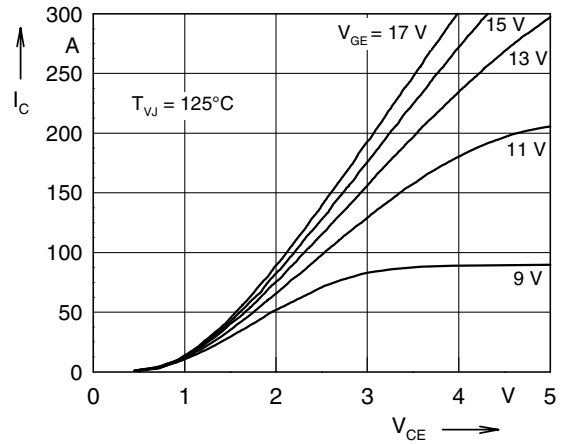

Fig. 2 Typ. output characteristics

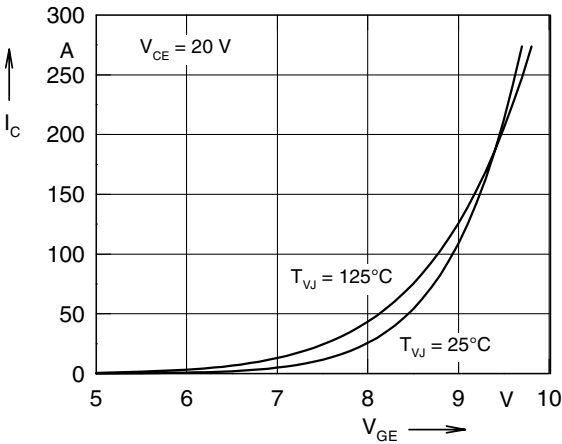

Fig. 3 Typ. transfer characteristics

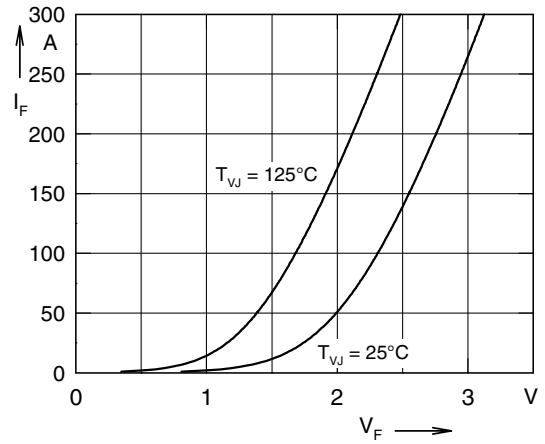

Fig. 4 Typ. forward characteristics of free wheeling diode

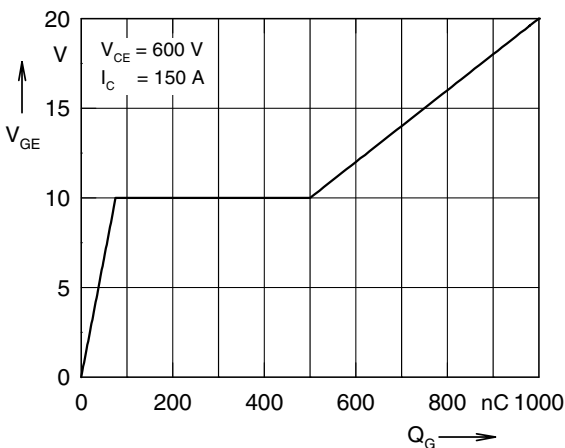

Fig. 5 Typ. turn on gate charge

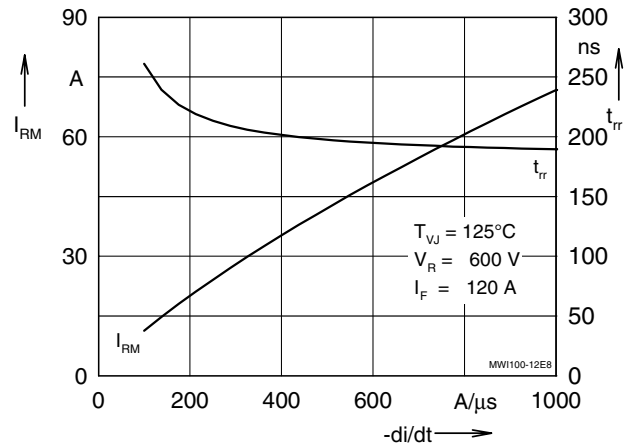

Fig. 6 Typ. turn off characteristics of free wheeling diode

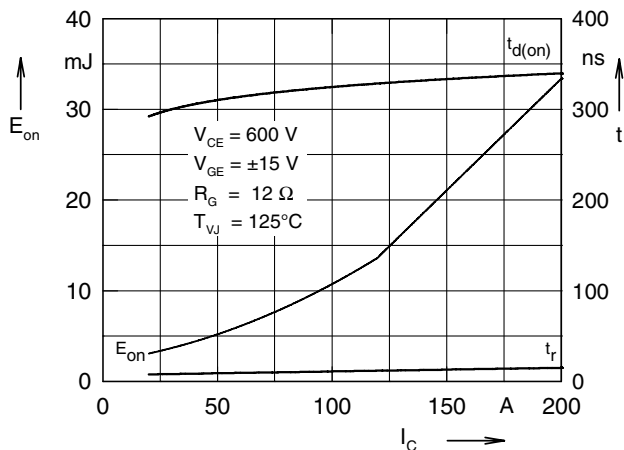

Fig. 7 Typ. turn on energy and switching times versus collector current

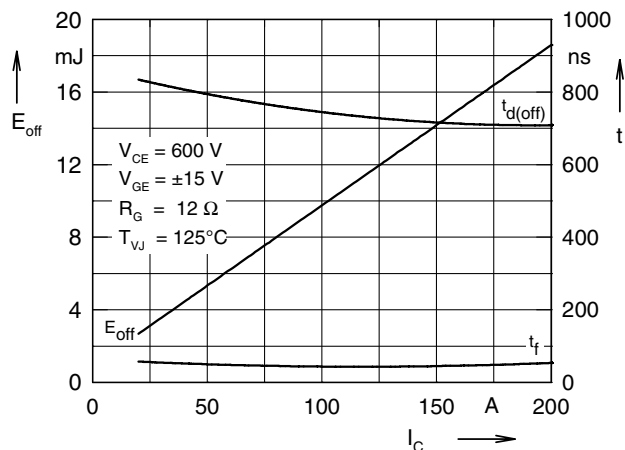

Fig. 8 Typ. turn off energy and switching times versus collector current

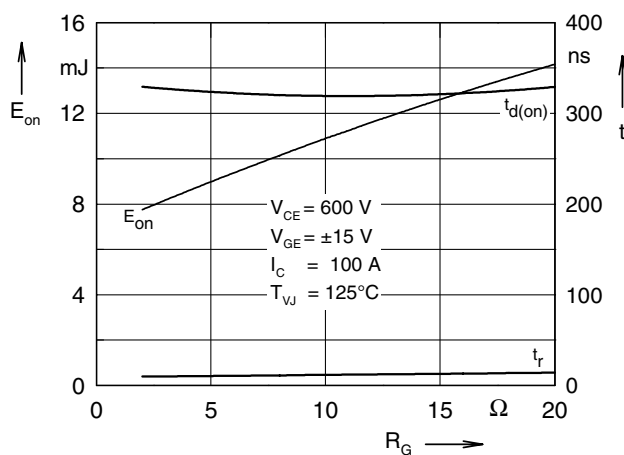

Fig. 9 Typ. turn on energy and switching times versus gate resistor

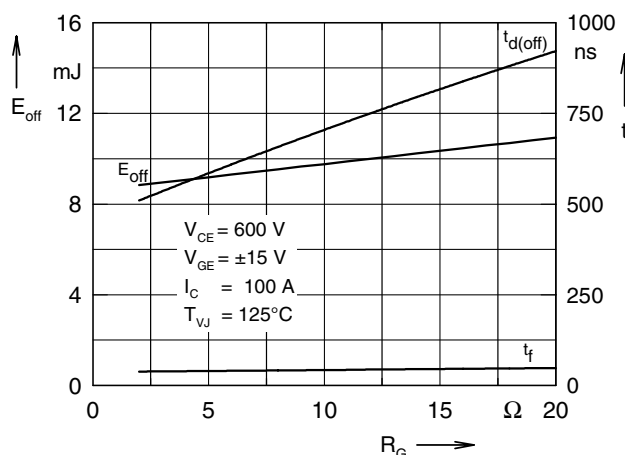

Fig. 10 Typ. turn off energy and switching times versus gate resistor

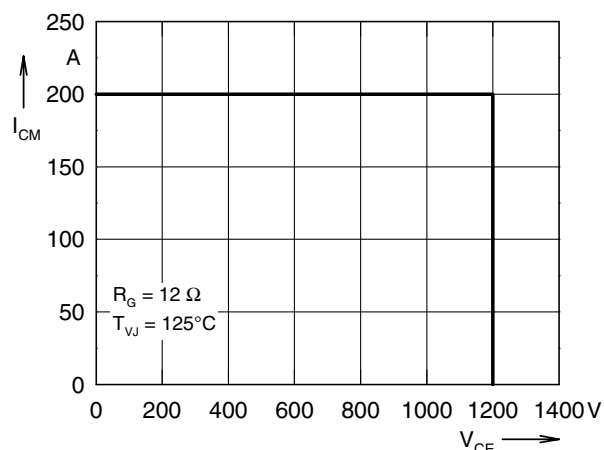

Fig. 11 Reverse biased safe operating area RBSOA

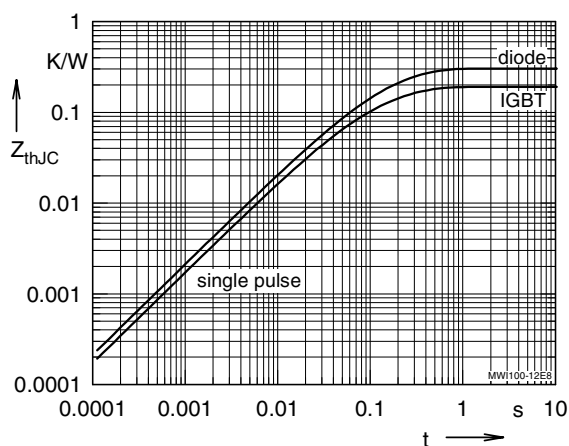

Fig. 12 Typ. transient thermal impedance

This datasheet has been downloaded from:

www.EEworld.com.cn

Free Download

Daily Updated Database

100% Free Datasheet Search Site

100% Free IC Replacement Search Site

Convenient Electronic Dictionary

Fast Search System

www.EEworld.com.cn