



# **SIMODRIVE 210**

## **Transistor DC Chopper for DC Feed Drives**

**Instruction Manual**

**Manufacturer Documentation**

**Edition 10.91**

# SIMODRIVE® Documentation

## Printing history

Brief details of this edition and previous editions are listed below.

The status of each edition is shown by the code in the "Remarks" column.

*Status code in "Remarks" column:*

**A** . . . New documentation.

**B** . . . Unrevised reprint with new Order-No.

**C** . . . Revised edition with new status.

If factual changes have been made on the page since the last edition, this is indicated by a new edition coding in the header on that page.

| <b>Edition</b> | <b>Order-No.</b>                           | <b>Remarks</b> |
|----------------|--|----------------|
| 10.90          | 6RB2101-0AA76 (GWE 462 112.9600.76 Jg-101) | <b>A</b>       |

Other functions not described in this documentation might be executable in the control. This does not however represent an obligation to supply such functions with a new control or when servicing.

This publication was produced on the Siemens 5800 Office System.  
Subject to change without prior notice.

The reproduction, transmission or use of this document or its contents is not permitted without express written authority. Offenders will be liable for damages. All rights, including rights created by patent grant or registration of a utility model or design, are reserved.

© Siemens AG 1987 All Rights Reserved

Editions

The following editions have been published so far. The sections changed since the previous edition are indicated in the "Changes" column.


| <u>Edition</u> | <u>Order No.</u>           | <u>Changes</u>    |
|----------------|----------------------------|-------------------|
| 01870.5        | GWE 462 112.9600.00 Ja-101 | First edition     |
| 05870.5        | GWE 462 112.9600.00 Jb-101 | Revised edition   |
| 01880.5        | GWE 462 112.9600.00 Jd-101 | Revised edition   |
| 03881.0        | GWE 462 112.9600.00 Jd-101 | Unchanged reprint |
| 02890.5        | GWE 462 112.9600.00 Je-101 | Revised edition   |
| 07900.5        | GWE 462 112.9600.00 Jg-101 | Revised edition   |

|  |   |
|--|---|
| <b>NOTE</b>  |   |
| These instructions apply only to units with controller modules   | 6RB2100-0NA01<br>6RB2100-0NA11<br>6RB2100-0NA21 |
| The SIMODRIVE unit may not be connected to a supply with ELCBs (permitted under DIN VDE 0160, Section 6.5).  |   |
| In the operational state, protection against direct contact is afforded in a form to render the units suitable for installation in electrical operating areas (DIN VDE 0558, Part 1a, Section 5.4.3.2.4).  |   |
| In compliance with DIN VDE 0160/05.88, all SIMODRIVE units are subjected to a high-voltage test at the time of routine testing. If the electrical equipment of machine tools undergoes high-voltage testing, all connectors must be separated or terminals opened (permissible under DIN VDE 0113, Part 1, Section 13.2). Damage to sensitive electronic components can thus be prevented. |   |

Pertinent wiring manual 6RB2101-0BA00

This Instruction Manual is also available in the following other languages:

|         |                          |
|---------|--------------------------|
| German  | Order No.: 6RB2101-0AA00 |
| French  | 6RB2101-0AA77            |
| Spanish | 6RB2101-0AA78            |
| Italian | 6RB2101-0AA72            |

|   |   |
|---|---|
|  | <p><b>CAUTION</b></p> <p>The modules of the unit include electrostatically sensitive devices. Before touching a PCB the person carrying out the work must himself be electrostatically discharged. The simplest way of accomplishing this is to touch an electrically conducting earthed object (e.g. a bare metal part of a switchboard or the protective-earth contact of a socket outlet).</p> |
|---|---|

| <b>Contents</b> |  | <b>Page</b> |
|-----------------|--|-------------|
|                 | <b>Safety instructions</b> .....   | 5           |
| <b>1</b>        | <b>Description of the unit</b> .....                                       | 6           |
| 1.1             | Application .....  | 6           |
| 1.2             | Mode of operation .....  | 6           |
| 1.3             | Technical data .....   | 7           |
| 1.3.1           | Ordering data overview .....   | 7           |
| 1.3.1.1         | Casing .....   | 7           |
| 1.3.1.2         | Power modules .....  | 7           |
| 1.3.1.3         | Options .....  | 8           |
| 1.3.2           | Rated data .....   | 8           |
| <b>2</b>        | <b>Installation</b> .....  | 10          |
| 2.1             | Installation of units .....  | 10          |
| 2.2             | Connecting instructions .....  | 10          |
| 2.3             | Inrush current limitation .....  | 11          |
| 2.4             | Screen connection and strain relief of cables .....                        | 12          |
| 2.5             | Terminals .....  | 13          |
| <b>3</b>        | <b>Commissioning</b> .....   | 14          |
| 3.1             | Matching the control system .....  | 14          |
| 3.1.1           | Matching to feed motors .....  | 14          |
| 3.1.1.1         | Setting the current limit .....  | 14          |
| 3.1.1.2         | Setting the speed-dependent current limit .....                            | 15          |
| 3.1.1.3         | Matching tables for 1HU motors .....                                       | 16          |
| 3.1.2           | Current setpoint limitation, "Hold against mechanical stop" function ..... | 23          |
| 3.1.3           | Tacho-generator .....  | 24          |
| 3.1.3.1         | Tacho-generator input .....  | 24          |
| 3.1.3.2         | Tacho-generator monitoring .....   | 24          |
| 3.1.3.3         | Tacho-generator simulation .....   | 25          |
| 3.1.4           | Speed controller adaptation .....  | 25          |
| 3.1.5           | Electrical weight compensation .....                                       | 26          |
| 3.1.6           | Current-controlled operation .....   | 27          |
| 3.1.7           | Current setpoint for parallel operation .....                              | 28          |
| 3.1.8           | External power supply for controller enabling .....                        | 29          |
| 3.1.9           | External voltage input for storage of fault memory signals .....           | 29          |
| 3.1.10          | Changing of variable components in the speed setpoint channel .....        | 30          |

|        | Page   |    |
|--------|--|----|
| 3.1.11 | Monitoring circuit "Speed controller at stop" .....          | 30 |
| 3.1.12 | Operation of control axes without power circuit module ..... | 31 |
| 3.1.13 | Matching the current controller gain .....                   | 31 |
| 3.1.14 | Testing the load cycle .....                                 | 32 |
| 3.2    | Signals .....  | 33 |
| 3.2.1  | Ready/fault signals .....                                    | 33 |
| 3.2.2  | Reset fault memories .....                                   | 33 |
| 3.2.3  | I <sup>2</sup> t signal .....                                | 33 |
| 3.3    | Test sockets, display elements .....                         | 34 |
| 3.4    | Start-up .....   | 35 |
| 4      | Maintenance .....  | 37 |
| 4.1    | Maintenance instructions .....                               | 37 |
| 4.2    | Faults .....   | 37 |
| 4.3    | Spare parts .....  | 39 |
| 4.4    | Connectors .....   | 40 |
| 5      | Block diagram .....  | 41 |
| 6      | Terminal connection diagram .....                            | 42 |
| 7      | Circuit diagram .....  | 44 |
| 8      | Wiring of different power module variants .....              | 49 |
| 9      | Dimension drawing .....                                      | 50 |
| 10     | Setting elements .....                                       | 52 |
|        | Setting data .....   | 53 |
|        | Notes on electrostatic charges .....                         | 54 |
|        | Addresses .....  | 56 |
|        | Standards and specifications .....                           | 56 |

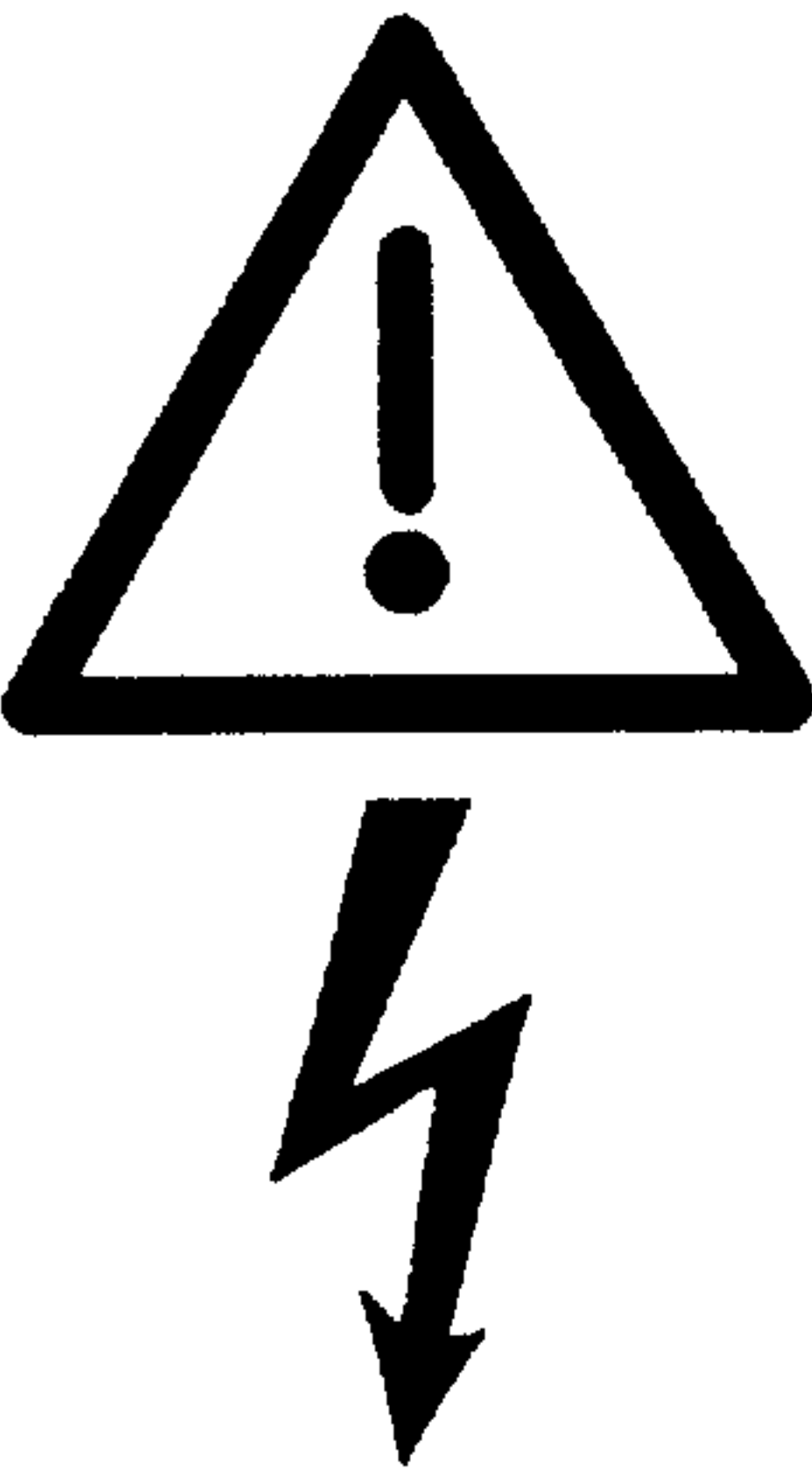
### NOTE

These instructions do not purport to cover all details or variations in equipment, nor to provide for every possible contingency to be met in connection with installation, operation or maintenance.

Should further information be desired or should particular problems arise which are not covered sufficiently for the Purchaser's purposes, the matter should be referred to the local Siemens Sales Office.

The contents of this instruction manual shall not become part or modify any prior or existing agreement, commitment or relationship. The Sales Contract contains the entire obligations of Siemens. The warranty contained in the contract between the parties is the sole warranty of Siemens. Any statements contained herein do not create new warranties or modify the existing warranty.

## Safety instructions

|   |  |
|---|--|
|  | <b>WARNING</b>   |
|   | <p>Hazardous voltages are present in this electrical equipment during operation.</p> <p>Non-observance of the safety instructions can result in severe personal injury or property damage.</p> <p>Only qualified personnel should work on or around this equipment after becoming thoroughly familiar with all warnings, safety notices, and maintenance procedures contained herein.</p> <p>The successful and safe operation of this equipment is dependent on proper handling, installation, operation and maintenance.</p> |

## Definitions

### • QUALIFIED PERSON

For the purpose of this instruction manual and product labels, a "qualified person" is one who is familiar with the installation, construction and operation of the equipment and the hazards involved.

In addition, he has the following qualifications:

1. Is trained and authorized to energize, de-energize, clear, ground and tag circuits and equipment in accordance with established safety practices.
2. Is trained in the proper care and use of protective equipment in accordance with established safety practices.
3. Is trained in rendering first aid.

### • DANGER

For the purpose of this instruction manual and product labels, "Danger" indicates death, severe personal injury or substantial property damage will result if proper precautions are not taken.

### • WARNING

For the purpose of this instruction manual and product labels, "Warning" indicates death, severe personal injury or substantial property damage can result if proper precautions are not taken.

### • CAUTION

For the purpose of this instruction manual and product labels, "Caution" indicates minor personal injury or property damage can result if proper precautions are not taken.

### • NOTE

For the purpose of this instruction manual, "Note" indicates information about the product or the respective part of the instruction manual which is essential to highlight.

# 1 Description of the unit

## 1.1 Application

Transistor DC choppers of type 6RB21.. are used in conjunction with DC servomotors such as the 1HU series in the range up to approx. 90 Nm for driving the feed axes of machine tools. They operate in four-quadrant operation and satisfy highest demands on the dynamic control response.

Complete units for driving 1 to 6 feed axes with a maximum DC output voltage of 210 V are available.

## 1.2 Mode of operation

Transistor DC choppers control the speed of the drive by means of a pulse-width-modulated DC output voltage.

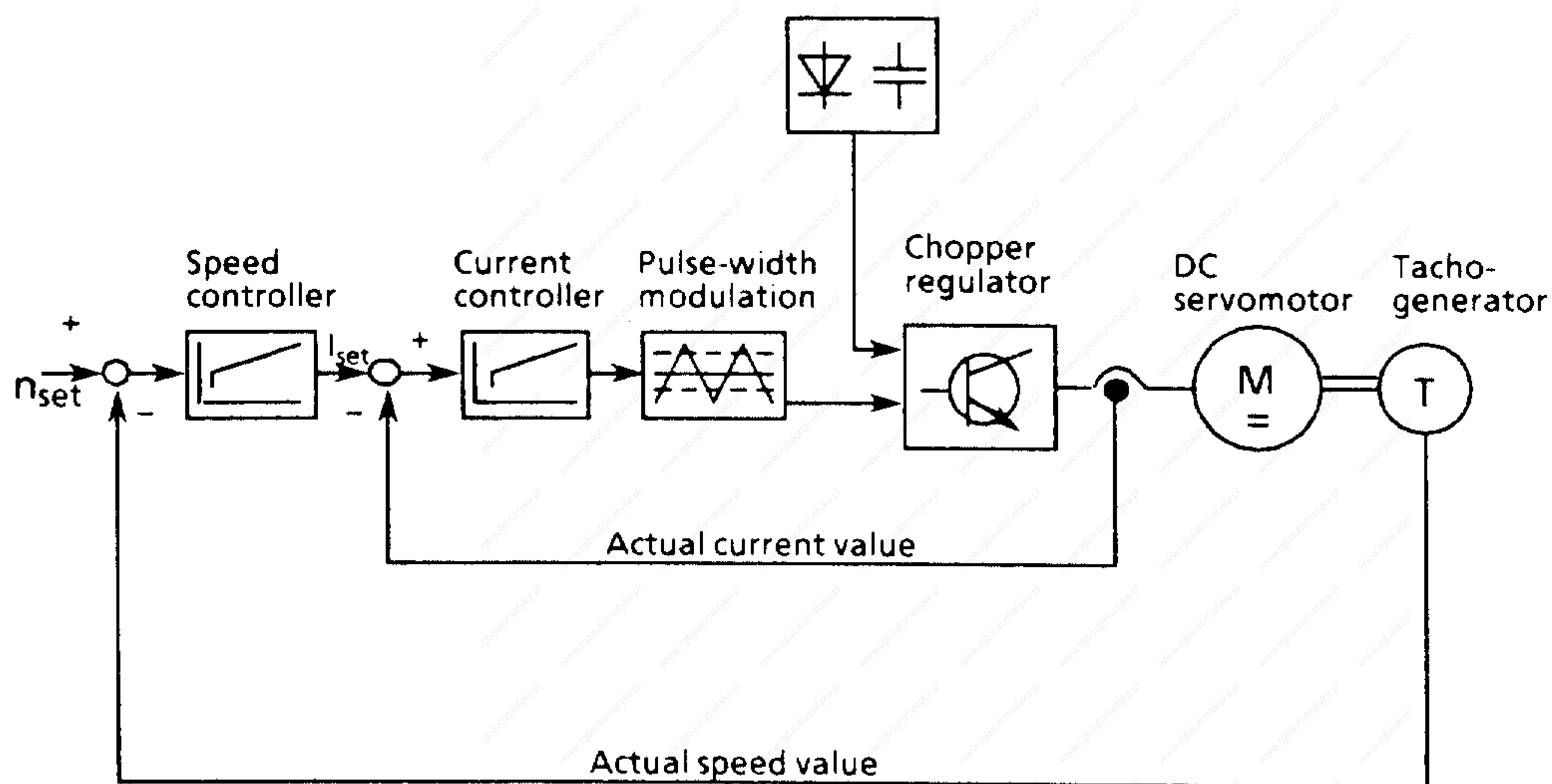


Fig. 1.1 Block diagram of the variable-speed DC feed drive



## 1.3 Technical data

### 1.3.1 Ordering data overview

#### 1.3.1.1 Casing

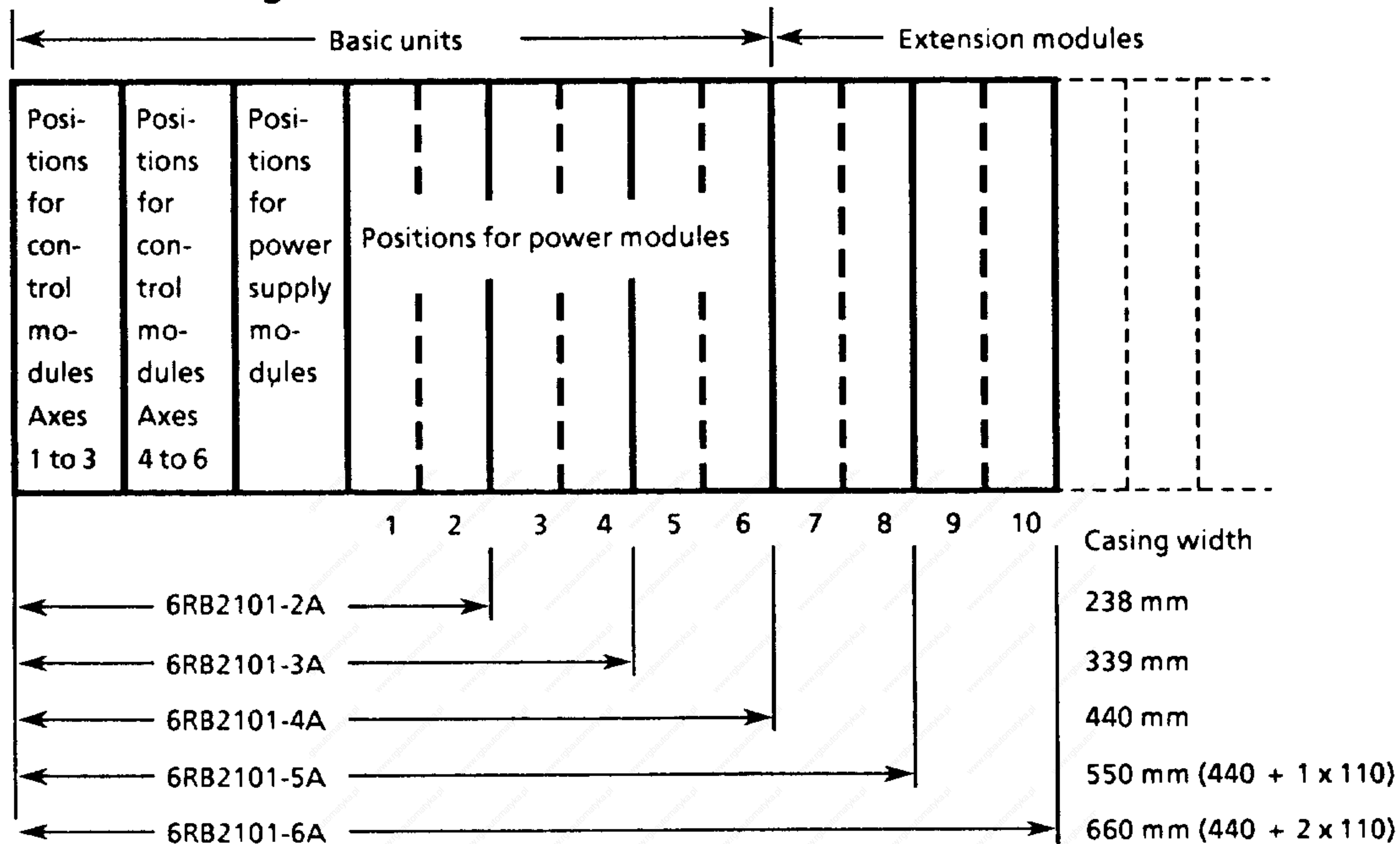


Fig. 1.2 Casing

#### 1.3.1.2 Power modules

| Designation*)      | Number of axes | Current $I_N/I_{max}$ | Notes                | Order No. Expansion set |
|--------------------|----------------|-----------------------|----------------------|-------------------------|
| A15, E15, H15, F15 | 1              | 5/15 A                | 1 axis on one module | 6RB2105-0SD80           |
| A25, E25, H25, F25 | 2              |                       | 2 axes on one module | 6RB2105-0SF80           |
| A35, E35, H35, F35 | 3              |                       | 3 axes on one module | 6RB2105-0SG80           |
| A19, E19, H19, F19 | 1              | 10/30 A               | 1 axis on one module | 6RB2110-0FD80           |
| A29, E29, H29, F29 | 2              |                       | 2 axes on one module | 6RB2110-0FF80           |
| A39, E39, H39, F39 | 3              |                       | 3 axes on one module | 6RB2110-0FG80           |
| A20, E20, H20, F20 | 1              | 20/60 A               | 1 module per axis    | 6RB2120-0FD80           |
| A30, E30, H30, F30 | 1              | 30/90 A               | 1 module per axis    | 6RB2130-0FD80           |
| A40, E40, H40, F40 | 1              | 40/120 A              | 1 module per axis    | 6RB2140-0FD80           |
| A60, E60, H60, F60 | 1              | 60/180 A              | 2 modules per axis   | 6RB2160-0FB80           |
| A90, E90, H90, F90 | 1              | 90/270 A              | 2 modules per axis   | 6RB2190-0FB80           |
| A98, E98, H98, F98 | 1              | 150/300 A             | 4 modules per axis   | Cannot be retrofitted   |

Table 1.1 Power modules

\*) A = Installed

H = Design for main spindle operation (installed)

E = Installation prepared

F = Prepared for main spindle operation

### 1.3.1.3 Options

| Designation                            | Notes  | Expansion set |
|--|--|---------------|
| G10*)                                  | Link-circuit voltage limitation 0.3/30 kW (continuous/short-time rating)   | 6SC6100-0AA81 |
| G20*)                                  | Link-circuit voltage limitation 0.9/90 kW (continuous/short-time rating)   | 6SC6100-0AB80 |
| B11<br>B12<br>B13<br>B14<br>B15<br>B16 | Terminal strip for connecting power cables with cross-sections exceeding those laid down by DIN VDE 0100 (depending on casing width) | 6SC6101-0SA20 |

\*) G10 and G20 must not be connected in parallel

Table 1.2 Options

### 1.3.2 Rated data

|                                  |   |
|----------------------------------|---|
| Rated supply voltage             | 3 AC 50/60 Hz 165 V or 220 V DC *) + 10 %, - 15 % |
| Rated output voltage             | DC 0 V to ± 210 V                                 |
| Short-time limit current         | 3 x I <sub>N</sub> (200 ms)                       |
| Efficiency                       | Approx. 95 %                                      |
| Number of feed axes              | 1 to 6  |
| Power loss P <sub>V</sub>        | P <sub>V</sub> ≈ 0.05 x P                         |
| Permissible ambient temperatures |   |
| - Inlet air temperature          | 0 °C to + 60 °C (also refer to Fig. 1.4)          |
| - Storage temperature            | - 25 °C to + 85 °C                                |

P = Power supplied to a load under typical feed drive conditions

I<sub>N</sub> = Rated current

\*) With direct supply via P200 and M200

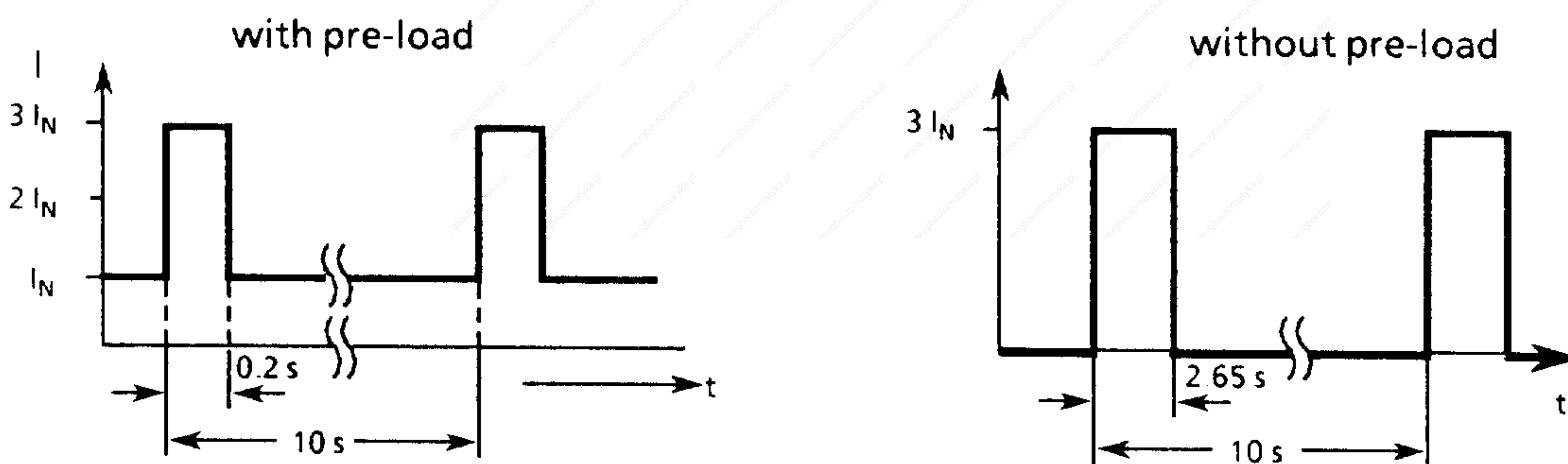


Fig 1.3 Rated load cycles for power modules in operation with short-time limit current

In operation without short-time limit current, a continuous current of 1.1 times the rated current is permissible (also see Section 3.1.14).

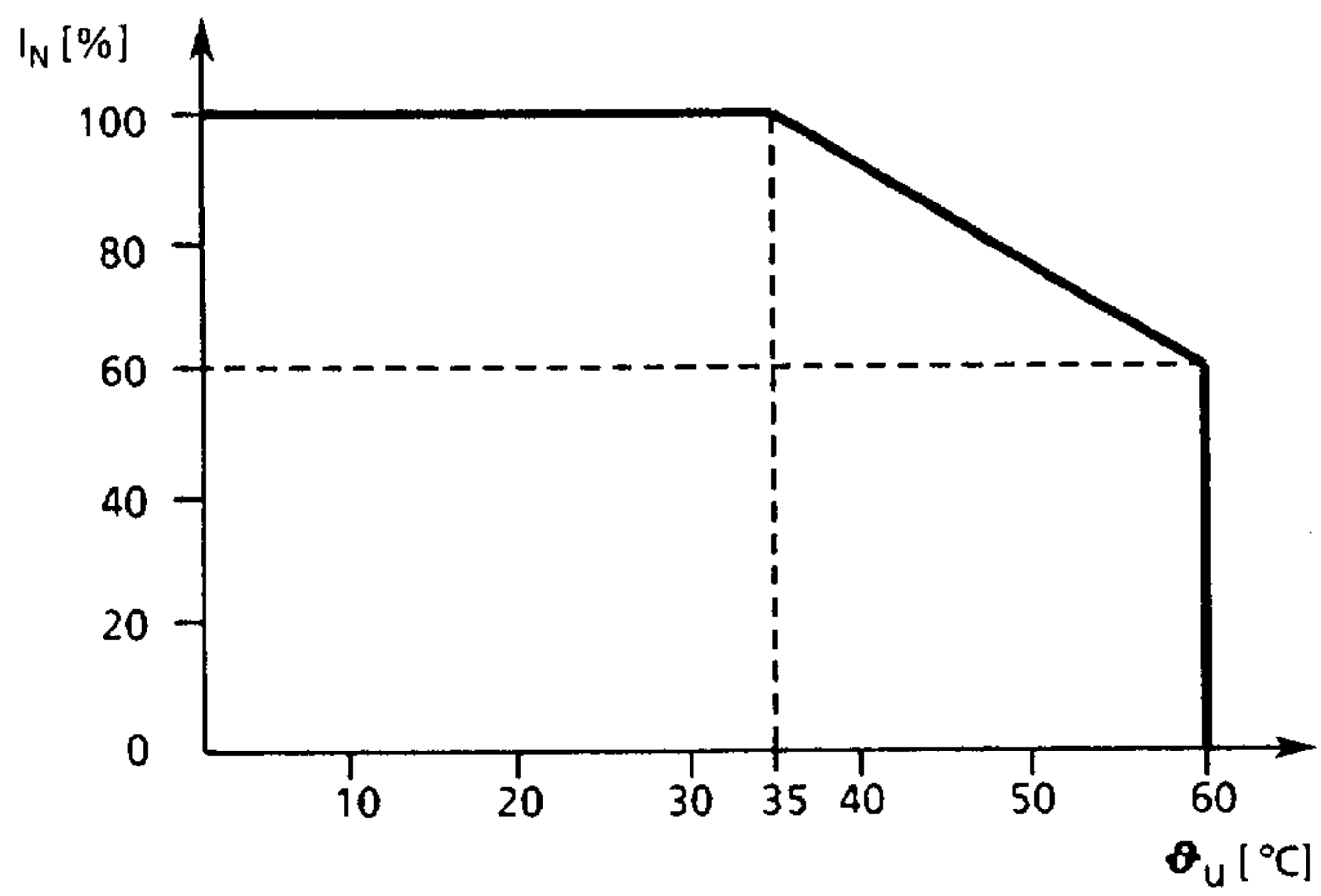


Fig. 1.4 Power reduction with raised inlet air temperature

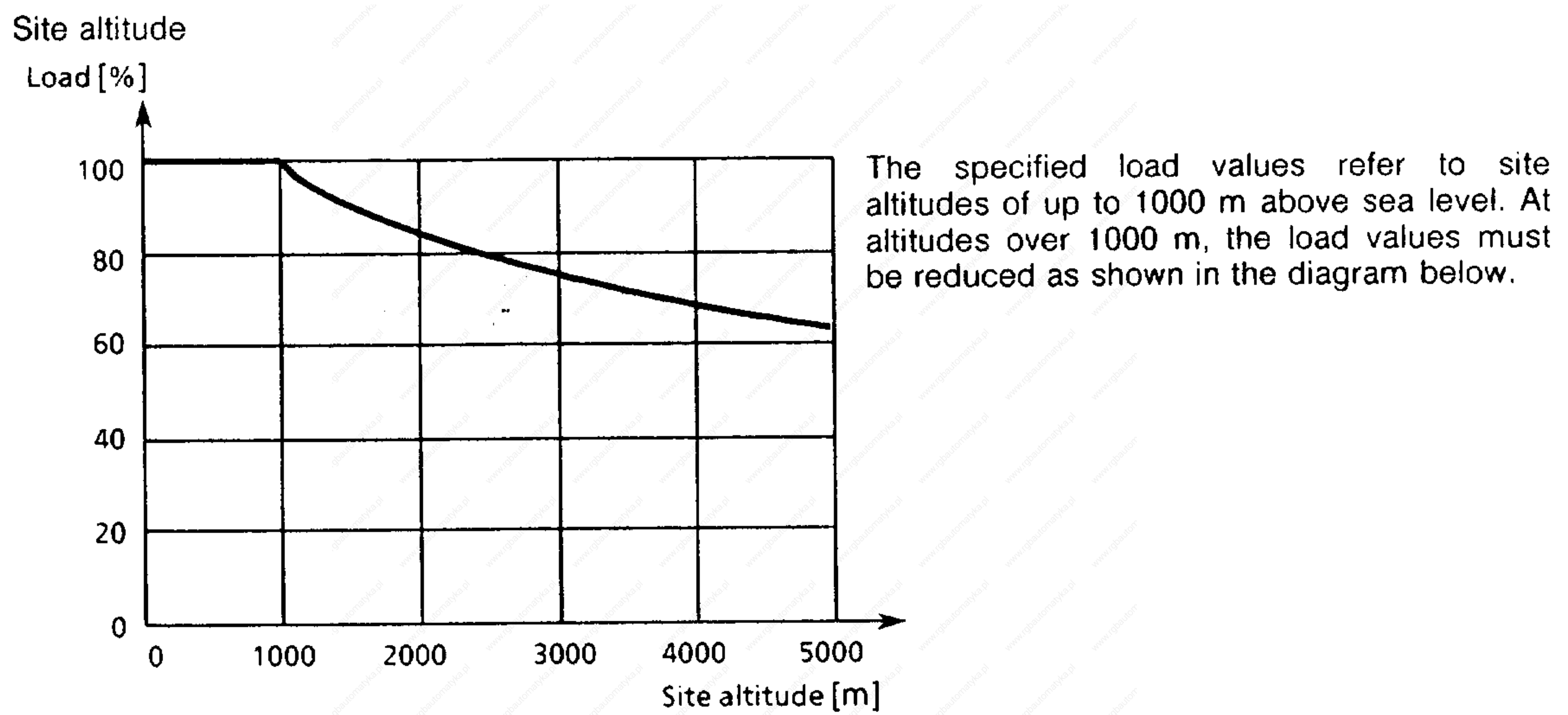


Fig. 1.5 Derating at site altitudes > 1000 m above sea level

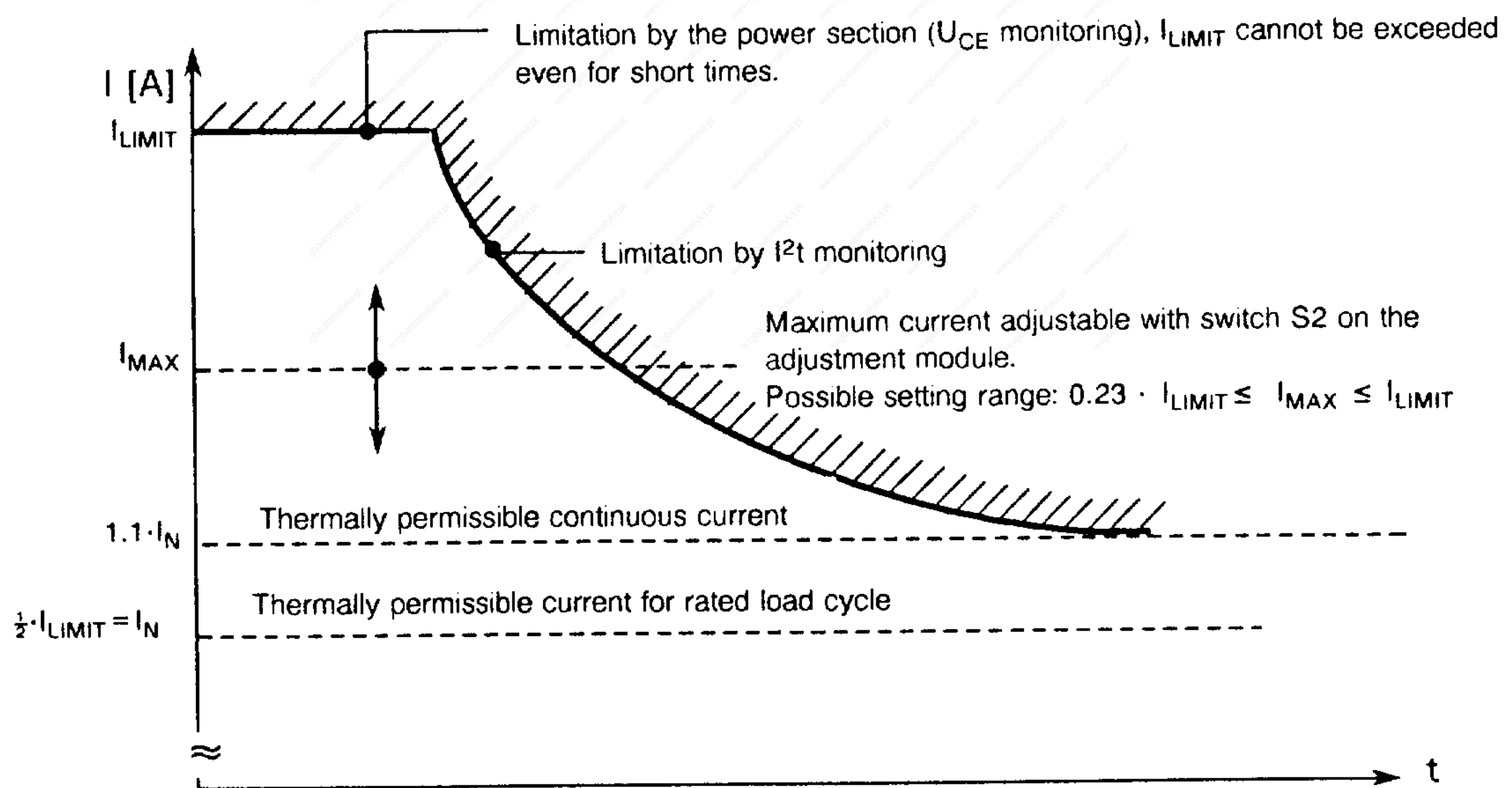


Fig. 1.6 Effective current limits

## 2 Installation

### 2.1 Installation of units

A minimum clearance of 100 mm must be available above and below the units to ensure unobstructed air supply.

The unit must be installed so as to be protected against conductive dust accumulations and vapours (degree of protection DIN 40050-IP00).

For mounting dimensions and location of the fixing points refer to the dimension drawings.

| NOTE |  |
|------|--|
| •    | The front cover provides protection against contact with live parts according to DIN VDE 0106, Part 7. |
| •    | The unit's internal power supply for the fans is not potentially isolated from the mains supply.       |

### 2.2 Connecting instructions

The units are connected to the mains via an autotransformer or an isolating transformer. When an isolating transformer is used, M200 on the power module must be earthed. Depending on the transformer and unit size, an inrush current limiting circuit must be provided if necessary (see Section 2.3 "Inrush current limitation").

|  | Rating of mains fuse           | Line protection | Fuse characteristic |
|--|--------------------------------|-----------------|---------------------|
| Operation without inrush current limit.  | 6x transformer rated current   | Not obtained    | Time-lag            |
| Operation with inrush current limitation | 1.3x transformer rated current | Obtained        | Time-lag            |

Table 2.1

Connect the units as recommended by the manufacturer and in accordance with the circuit diagram supplied by the customer. The current limiting circuit, the tacho input and the current controller gain of the unit must be matched to the type of motor used. For details refer to 3.1 "Matching the control system".

| NOTE |   |
|------|---|
| •    | The reference and actual value cables must be shielded and installed separately from the power cables.                |
| •    | Twisted leads are recommended for the motor conductors.   |
| •    | The control cables for the controller enabling circuits must be installed separate from the contactor control cables. |

The chassis earth connection between the NC and the PWM drive should be kept as short as possible using minimum conductor cross-sections of 4 mm<sup>2</sup>. Connect terminal + G0-X131 to the earthing point of the NC or, in systems without an NC, to earth.

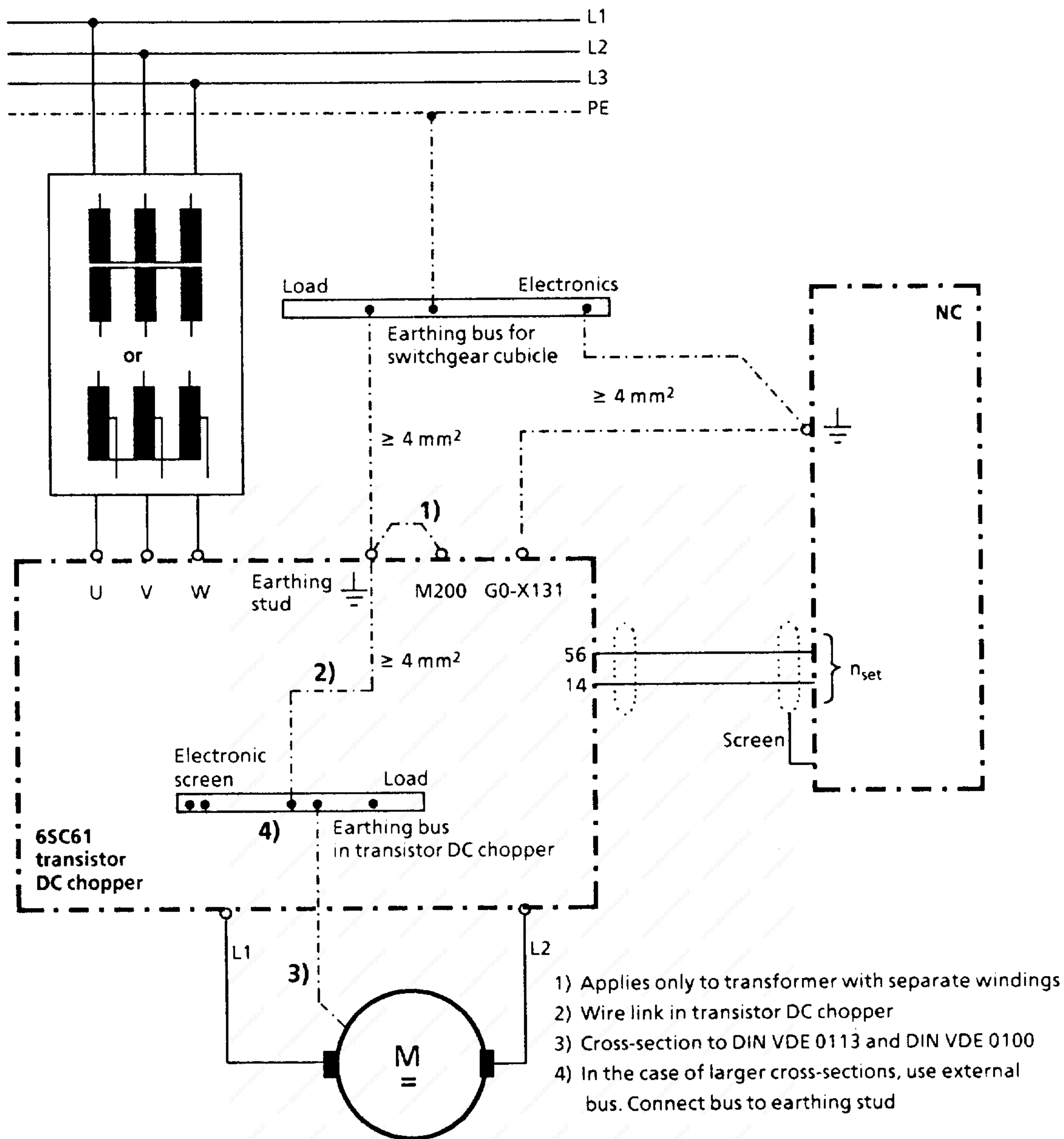


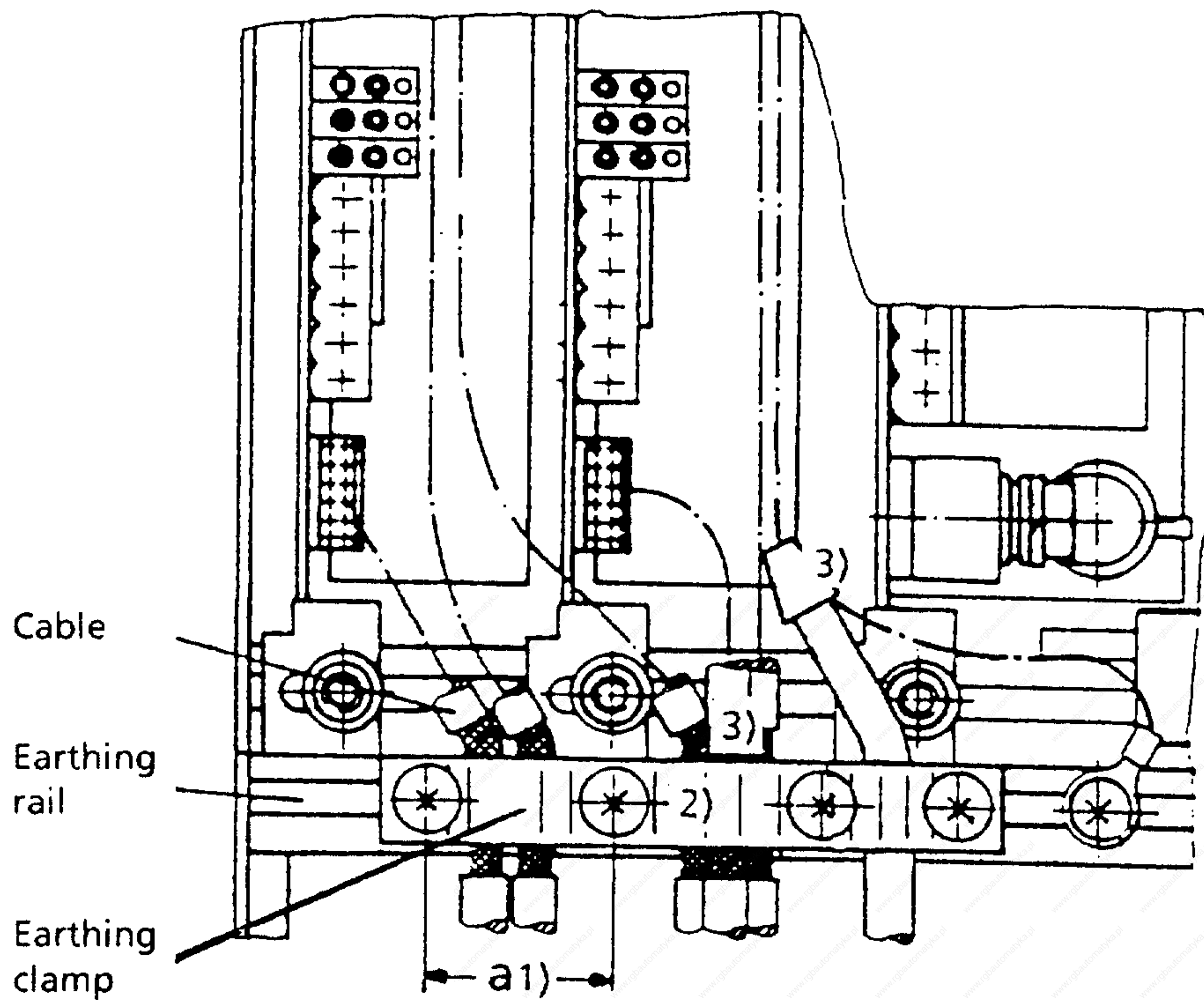
Fig. 2.1 Earthing concept

### 2.3 Inrush current limitation

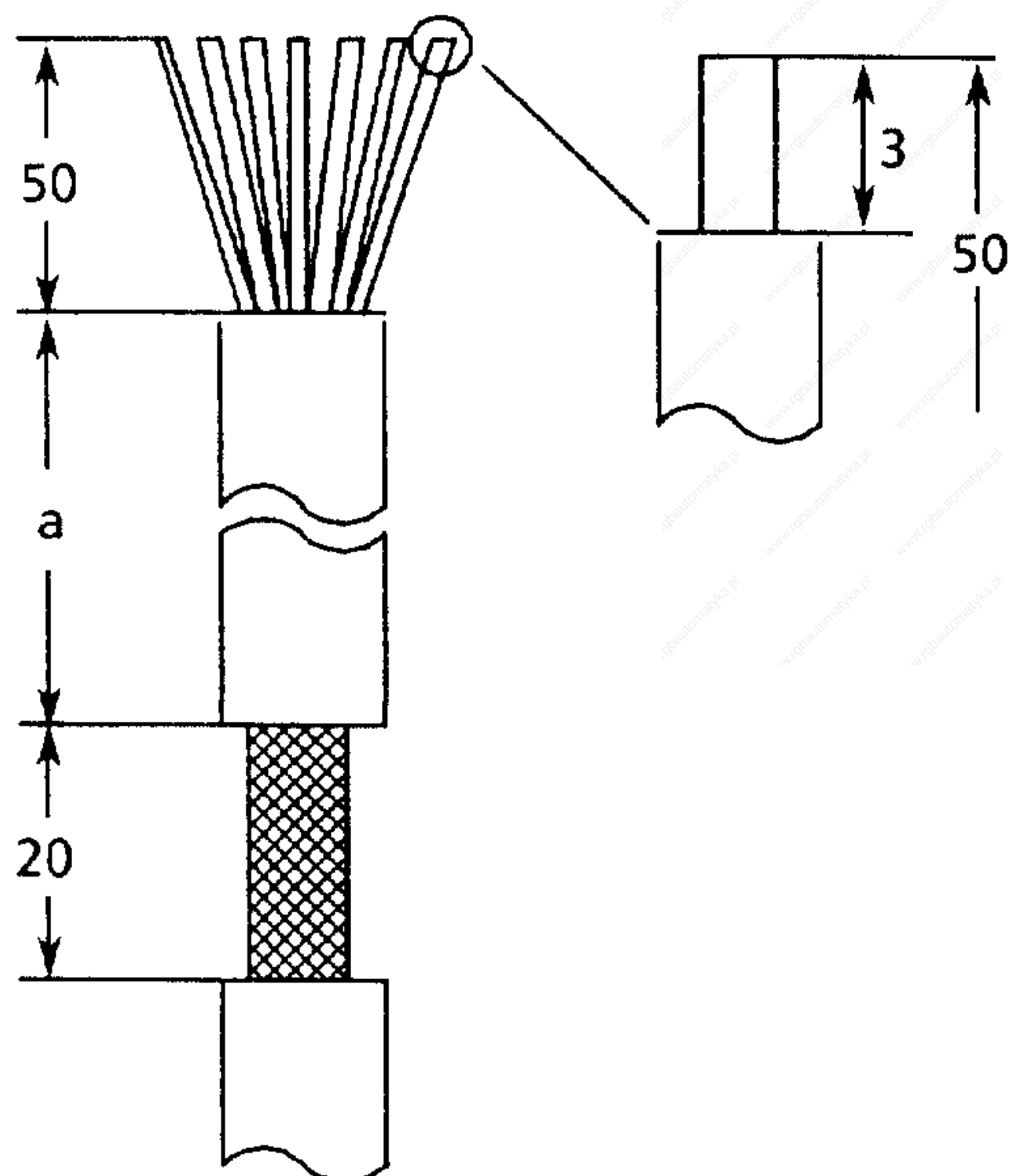
If a matching transformer rated higher than 5 kVA (in the case of autotransformers) or 8 kVA (in the case of isolating transformers) is required, resistors should be fitted for inrush current limitation.

If inrush current limitation is required, this should be installed as shown in connection diagram 462 112.9600.00 KL Sheet 2 (Section 6).

## 2.4 Screen connection and strain relief of cables



- 1) One to three cable screens can be connected depending on distance a between screws
- 2) **Important!** Screen of setpoint cables from NC must not be connected to chassis earth
- 3) Alternative method of connecting the cable screens



| Axes    | length a [mm] |
|---------|---------------|
| 1 and 4 | 150           |
| 2 and 5 | 80            |
| 3 and 6 | 20            |

Insulation stripped for earthing of cable screen and strain relief


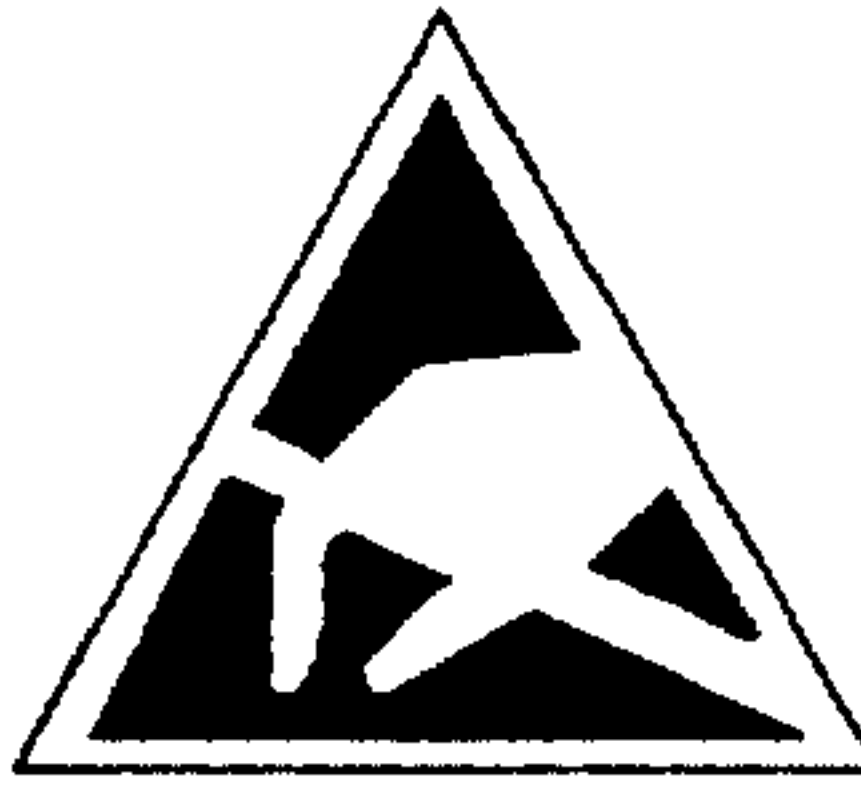
## 2.5 Terminals

| Terminal                       | Location                           | Function  | Type<br>****) | Typical voltage                  | Maximum permissible<br>conductor cross-section   |
|--------------------------------|------------------------------------|---|---------------|----------------------------------|--|
| <b>Power section</b>           |                                    |   |               |                                  |  |
| U, V, W                        | -                                  | Mains connection  | E             | 3 AC 165 V                       | Terminal for M8 **)  |
| $\frac{1}{=}$                  | -                                  | PE conductor  | E             | 0 V                              | Terminal for M8 **)  |
| M200 busbar                    | -                                  | <b>Isolating transformer only</b><br>Mass connection  | E             | 0 V                              | Terminal for M6 **)  |
|                                |                                    | Motor connections<br>5/15 A, 10/30 A<br>20/60 A, 30/90 A, 40/120 A<br>60/180 A, 90/270 A<br>150/300 A | A             | DC 210 V                         | 1.5 mm <sup>2</sup><br>16 mm <sup>2</sup><br>25 mm <sup>2</sup><br>Terminal for M6 **) |
| <b>Supply voltages</b>         |                                    |   |               |                                  |  |
| 7                              | +G0-X111                           | Auxiliary voltage (+18 - 30 V)  | A             | +24 V, 50 mA max.                | 1.5 mm <sup>2</sup>  |
| 10                             | +G0-X111                           | Auxiliary voltage (-18 --30 V)  | A             | -24 V, 50 mA max.                | 1.5 mm <sup>2</sup>  |
| 45                             | +G0-X111                           | Electronics voltage   | A             | +15 V, 10 mA max.                | 1.5 mm <sup>2</sup>  |
| 44                             | +G0-X111                           | Electronics voltage   | A             | -15 V, 10 mA max.                | 1.5 mm <sup>2</sup>  |
| 9, 19                          | +G0-X121                           | Enabling voltage  | E/A           | +24 V, 0 V                       | 1.5 mm <sup>2</sup>  |
| 11                             | +G0-X111                           | External auxiliary voltage  | E             | ±24 V, 1 A ***)                  | 1.5 mm <sup>2</sup>  |
| 15                             | +G0-X111<br>+G0-X131               | Elec. ground<br>Ref. earth } internally<br>connected  | A<br>E/A      | 0 V<br>0 V                       | 1.5 mm <sup>2</sup><br>Terminal for M6 **)   |
| <b>Electronic signals</b>      |                                    |   |               |                                  |  |
| R                              | +G0-X111                           | Fault latch reset   | E             | 0 V                              | 1.5 mm <sup>2</sup>  |
| 56, 14                         | +N <sub>0</sub> -X1 <sub>0</sub> 1 | Speed setpoint I  | E             | ±10 V                            | 1.5 mm <sup>2</sup>  |
| 24, 8                          | +N <sub>0</sub> -X4 <sub>0</sub> 1 | Speed setpoint II   | E             | ±10 V                            | 1.5 mm <sup>2</sup>  |
| 6                              | +N <sub>0</sub> -X1 <sub>0</sub> 1 | Integrator inhibition   | E             | +15 V                            | 1.5 mm <sup>2</sup>  |
| 96                             | +N <sub>0</sub> -X1 <sub>0</sub> 1 | Ext. current limit reduction  | E             | -15 V                            | 1.5 mm <sup>2</sup>  |
| 63                             | +G0-X121                           | Pulse enabling  | E             | +12 V to +30 V                   | 1.5 mm <sup>2</sup>  |
| 64                             | +G0-X121                           | Drive enabling  | E             | +12 V to +30 V                   | 1.5 mm <sup>2</sup>  |
| 65                             | +N <sub>0</sub> -X1 <sub>0</sub> 1 | Speed controller enabling   | E             | +12 V to +30 V                   | 1.5 mm <sup>2</sup>  |
| 16                             | +N <sub>0</sub> -X4 <sub>0</sub> 1 | Current actual value  | A             | ±10 V (R <sub>i</sub> = 2 kΩ)    | 1.5 mm <sup>2</sup>  |
| 58                             | +N <sub>0</sub> -X4 <sub>0</sub> 1 | Current setpoint  | E             | ±10 V                            | 1.5 mm <sup>2</sup>  |
| <b>Tacho generator</b>         |                                    |   |               |                                  |  |
| 55.1                           | +N <sub>0</sub> -X1 <sub>0</sub> 1 | Speed actual value n <sub>act</sub>   | E             | ±20 V                            | 1.5 mm <sup>2</sup>  |
| 55.2                           |                                    |   | E             | ±40 V                            | 1.5 mm <sup>2</sup>  |
| 55.3                           |                                    |   | E             | ±60 V                            | 1.5 mm <sup>2</sup>  |
| 13                             |                                    | Reference potential n <sub>act</sub>  | E             | 0 V (no frame)                   | 1.5 mm <sup>2</sup>  |
| <b>Messages</b>                |                                    |   |               |                                  |  |
| 5                              | +G0-X111                           | I <sup>2</sup> t >  | A             | 0 V, 50 mA                       | 1.5 mm <sup>2</sup>  |
| 74,73.1 (NC)*<br>72,73.2 (NO)* | +G0-X121                           | Relais contact, drive<br>fault/ready signals  | A             | AC 250 V, 5 A or<br>DC 30 V, 5 A | 1.5 mm <sup>2</sup>  |

Table 2.2

- \*) Terminals 73.1 and 73.2. are interconnected via a 0 Ω resistor  
 \*\*) For cable lugs to DIN 46234 X4<sub>0</sub>1 = X411,X421,X431  
 \*\*\*) Tolerance: +19 V to 30 V (see Chapter 3.1.9)  
 \*\*\*\*) E = Input A = Output N<sub>0</sub> = N1, N2 X1<sub>0</sub>1 = X111,X121,X131

### 3 Commissioning

|  |  |
|--|--|
| <br> | <b>WARNING</b>   |
|  | <p>Safe operation is dependent upon proper handling and installation by qualified personnel under observance of all warnings contained in this instruction manual.</p> <p>Non-observance can result in death, severe personal injury or substantial property damage.</p> <p>The modules of the unit contain electrostatically sensitive devices. Before touching a PCB the person carrying out the work must himself be electrostatically discharged. The simplest way of accomplishing this is to touch an electrically conducting earthed object (e.g. a bare metal part of a switchboard or the protective-earth contact of a socket outlet).</p> |

#### 3.1 Matching the control system

##### 3.1.1 Matching to feed motors

The data required for matching the transistor chopper to feed motors of the 1HU series are given in the matching tables for 1HU motors in Section 3.1.1.3.

##### 3.1.1.1 Setting the current limit

The settings are made by the switches S1, S2, S3 on the adjustment module.

| Switches S1, S2, S3<br>Contacts |   |   |   | Current limit $I_{max}$ in A<br>Power sections |         |         |         |         |         |         |
|---------------------------------|---|---|---|--|---------|---------|---------|---------|---------|---------|
| 2                               | 3 | 4 | 5 | 6RB2105  | 6RB2110 | 6RB2120 | 6RB2130 | 6RB2140 | 6RB2160 | 6RB2190 |
| o                               | o | o | o | 15.0   | 30.0    | 60.0    | 90.0    | 120     | 180     | 270     |
| x                               | o | o | o | 12.8   | 25.5    | 51.0    | 76.5    | 102     | 153     | 230     |
| o                               | x | o | o | 10.2   | 20.4    | 41.0    | 61.2    | 82      | 122     | 184     |
| x                               | x | o | o | 9.2  | 18.3    | 36.6    | 54.9    | 73      | 110     | 165     |
| o                               | o | x | o | 7.5  | 15.0    | 30.0    | 45.0    | 60      | 90      | 135     |
| x                               | o | x | o | 6.9  | 13.8    | 27.6    | 41.4    | 55      | 83      | 124     |
| o                               | x | x | o | 6.2  | 12.3    | 24.6    | 36.9    | 49      | 74      | 111     |
| x                               | x | x | o | 5.9  | 11.7    | 23.4    | 35.1    | 47      | 70      | 105     |
| o                               | o | o | x | 5.4  | 10.8    | 21.6    | 32.4    | 43      | 65      | 97      |
| x                               | o | o | x | 5.1  | 10.2    | 20.4    | 30.6    | 41      | 61      | 92      |
| o                               | x | o | x | 4.5  | 9.0     | 18.0    | 27.0    | 36      | 54      | 81      |
| x                               | x | o | x | 4.4  | 8.7     | 17.4    | 26.1    | 35      | 52      | 78      |
| o                               | o | x | x | 3.9  | 7.8     | 15.6    | 23.4    | 31      | 47      | 70      |
| x                               | o | x | x | 3.8  | 7.5     | 15.0    | 22.5    | 30      | 45      | 68      |
| o                               | x | x | x | 3.6  | 7.2     | 14.4    | 21.6    | 29      | 43      | 65      |
| x                               | x | x | x | 3.5  | 6.9     | 13.8    | 20.7    | 28      | 41      | 62      |

Table 3.1

o = Contact in normal position (OFF)  
 x = Contact in ON position



### 3.1.1.2 Setting the speed-dependent current limit

For 1HU motors see 3.1.1.3.

Characteristics 0 to 15 (Figs. 3.1 and 3.2) are set by switches S1, S2 and S3 on the adjustment module.

As shown in Table 3.1, the 100 % value of current  $I$  corresponds to the  $I_{max}$  current limit set and the 100 % value of the speed corresponds to the rated speed of the motor.

A minimum inductance ( $L_{motor} + L_{reactor} \approx 1 \text{ mH}$ ) is required for motors with disc-type rotors because of the temperature rise. Speed-dependent current limitation is not required in this case but the following diodes must be removed: V48 (axes 1 and 4), V82 (axes 2 and 5) and V100 (axes 3 and 6); or adjust characteristic 8 if necessary.

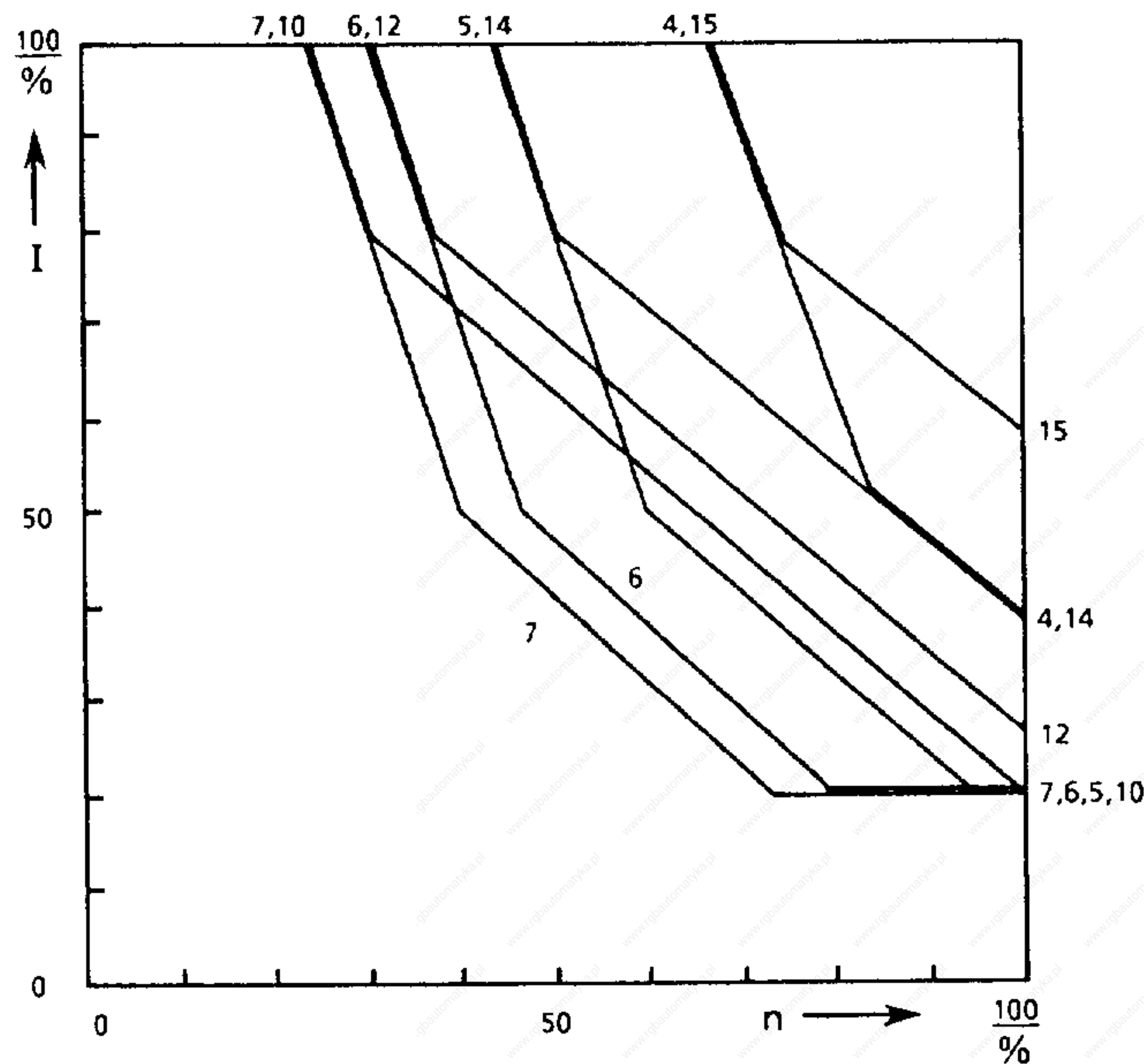


Fig. 3.1 Adjustable characteristics of speed-dependent current limitation

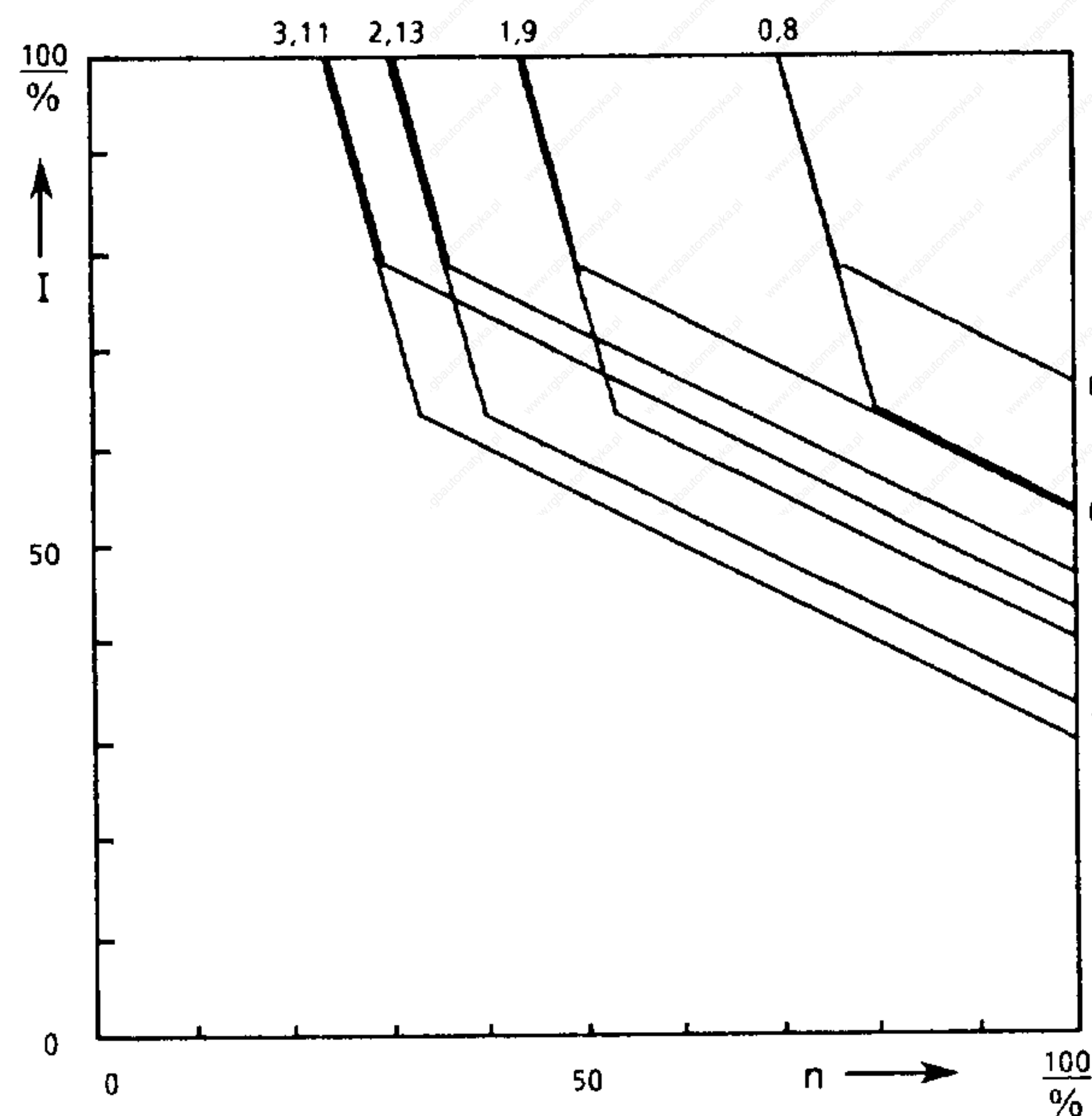


Fig. 3.2 Adjustable characteristics of speed-dependent current limitation

| Characteristic number | Switch S1, S2, S3 Contacts |   |   |   |
|-----------------------|----------------------------|---|---|---|
|                       | 6                          | 7 | 8 | 9 |
| 0                     | o                          | o | o | o |
| 1                     | o                          | o | o | x |
| 2                     | o                          | o | x | o |
| 3                     | o                          | o | x | x |
| 4                     | o                          | x | o | o |
| 5                     | o                          | x | o | x |
| 6                     | o                          | x | x | o |
| 7                     | o                          | x | x | x |
| 8                     | x                          | o | o | o |
| 9                     | x                          | o | o | x |
| 10                    | x                          | x | x | x |
| 11                    | x                          | o | x | x |
| 12                    | x                          | x | x | o |
| 13                    | x                          | o | x | o |
| 14                    | x                          | x | o | x |
| 15                    | x                          | x | o | o |

Table 3.2

o = Contacts in normal position (OFF)

x = Contacts in ON position

### 3.1.1.3 Matching tables for 1HU motors

Matching table for SIMODRIVE power modules **6RB2105-...** (5/15 A)

Short designation A15, A25, A35, H15, H25, H35

Settings by means of switches S1, S2 and S3 on the adjustment module.

| Servomotor   |                     |                    |                            | Current limit |   |   |   |                      | Speed-dependent current limit |   |   |   |               |
|--------------|---------------------|--------------------|----------------------------|---------------|---|---|---|----------------------|-------------------------------|---|---|---|---------------|
| 1HU          | M <sub>0</sub> [Nm] | I <sub>0</sub> [A] | n <sub>rated</sub> rev/min | Contacts      |   |   |   | I <sub>max</sub> [A] | Contacts                      |   |   |   | Terminal X1.1 |
|              |                     |                    |                            | 2             | 3 | 4 | 5 |                      | 6                             | 7 | 8 | 9 |               |
| 3054-0AC01** | 2.2                 | 3.3                | 2000                       | o             | o | o | o | 15.0                 | o                             | x | x | o | 55.2          |
| 3054-0AF01** | 2.2                 | 4.7                | 3000                       | o             | o | o | o | 15.0                 | x                             | x | o | x | 55.3          |
| 3056-0AC01** | 4.5                 | 6.7                | 2000                       | o             | o | o | o | 15.0                 | x                             | o | o | o | 55.2          |
| 3056-0AF01   | 4.5                 | 10.0               | 3000                       | o             | o | o | o | 15.0                 | x                             | o | o | o | 55.3          |
| 3058-0AC01** | 6.0                 | 8.8                | 2000                       | o             | o | o | o | 15.0                 | x                             | o | o | o | 55.2          |
| 3058-0AF01   | 6.0                 | 12.7               | 3000                       | o             | o | o | o | 15.0                 | x                             | o | o | o | 55.3          |
| 3070-0AC01   | 3.2                 | 4.5                | 2000                       | o             | o | o | o | 15.0                 | x                             | o | o | x | 55.2          |
| 3070-0AF01   | 3.2                 | 6.4                | 3000                       | o             | o | o | o | 15.0                 | x                             | o | o | o | 55.3 *        |
| 3071-0AC01   | 5.0                 | 7.1                | 2000                       | o             | o | o | o | 15.0                 | x                             | o | o | o | 55.2          |
| 3071-0AF01   | 5.0                 | 10.7               | 3000                       | o             | o | o | o | 15.0                 | x                             | o | o | o | 55.3 *        |
| 3073-0AC01   | 7.0                 | 10.0               | 2000                       | o             | o | o | o | 15.0                 | x                             | o | o | o | 55.2 *        |
| 3073-0AF01   | 7.0                 | 13.8               | 3000                       | o             | o | o | o | 15.0                 | x                             | o | o | o | 55.3 *        |
| 3074-0AC01   | 7.0                 | 9.7                | 2000                       | o             | o | o | o | 15.0                 | x                             | o | o | o | 55.2 *        |
| 3074-0AF01   | 7.0                 | 13.5               | 3000                       | o             | o | o | o | 15.0                 | x                             | o | o | o | 55.3 *        |
| 3076-0AC01   | 10.0                | 12.5               | 2000                       | o             | o | o | o | 15.0                 | x                             | o | o | o | 55.2 *        |
| 3100-0AC01   | 7.0                 | 9.5                | 2000                       | o             | o | o | o | 15.0                 | x                             | o | o | o | 55.2 *        |
| 3100-0AF01   | 7.0                 | 14.2               | 3000                       | o             | o | o | o | 15.0                 | x                             | o | o | o | 55.3 *        |
| 3101-0AC01   | 10.0                | 13.4               | 2000                       | o             | o | o | o | 15.0                 | x                             | o | o | o | 55.2 *        |
| 3102-0AD01   | 18.0                | 15.0               | 1200                       | o             | o | o | o | 15.0                 | x                             | o | o | o | 55.1 *        |
| 5040-0AC01   | 1.2                 | 1.9                | 2000                       | o             | o | x | o | 7.5                  | x                             | x | o | x | 55.2          |
| 5040-0AF01   | 1.2                 | 2.8                | 3000                       | o             | x | o | o | 10.2                 | x                             | x | o | x | 55.3          |
| 5042-0AC01   | 1.75                | 2.7                | 2000                       | o             | x | o | o | 10.2                 | x                             | x | o | x | 55.2          |
| 5042-0AF01   | 1.75                | 4.0                | 3000                       | o             | o | o | o | 15.0                 | x                             | x | o | x | 55.3          |
| 5044-0AC01   | 2.5                 | 3.6                | 2000                       | o             | o | o | o | 15.0                 | o                             | o | o | x | 55.2          |
| 5044-0AF01   | 2.5                 | 5.3                | 3000                       | o             | o | o | o | 15.0                 | o                             | o | o | o | 55.3          |

Table 3.3

o = Contact in normal position (OFF)

x = Contact in ON position

Contact S1.1, S2.1, S3.1: no function

Contact S1.10 or resistor R200: Contact S1.10 in ON position or R200 provided in the form of a jumper:  
All three axes are operated in current loop.

\* The dynamic response can be increased still further by removing diodes V48 (Axes 1 and 4), V82 (Axes 2 and 5) and V100 (Axes 3 and 6); the speed-dependent current limitation then becomes inoperative.

\*\* Also refer to Chap. 3.1.13 Matching the current controller gain.

Separately-ventilated motors can be used instead of the non-ventilated motors.

-0A.01 = non-ventilated motor

-0S.01 = separately-ventilated motor

Matching table for SIMODRIVE power modules **6RB2110-...** (10/30 A)

Short designation A19, A29, A39, H19, H29, H39

Settings by means of switches S1, S2 and S3 on the adjustment module.

| Servomotor   |                     |                    |                            | Current limit |   |   |   |                      | Speed-dependent current limit |   |   |   |               |
|--------------|---------------------|--------------------|----------------------------|---------------|---|---|---|----------------------|-------------------------------|---|---|---|---------------|
| 1HU          | M <sub>0</sub> [Nm] | I <sub>0</sub> [A] | n <sub>rated</sub> rev/min | Contacts      |   |   |   | I <sub>max</sub> [A] | Contacts                      |   |   |   | Terminal X1.1 |
|              |                     |                    |                            | 2             | 3 | 4 | 5 |                      | 6                             | 7 | 8 | 9 |               |
| 3054-0AF01** | 2.2                 | 4.7                | 3000                       | o             | o | o | o | 30.0                 | o                             | x | x | o | 55.3          |
| 3056-0AC01** | 4.5                 | 6.7                | 2000                       | o             | o | o | o | 30.0                 | o                             | o | x | o | 55.2          |
| 3056-0AF01** | 4.5                 | 10.0               | 3000                       | o             | o | o | o | 30.0                 | o                             | o | o | x | 55.3          |
| 3058-0AC01** | 6.0                 | 8.8                | 2000                       | o             | o | o | o | 30.0                 | o                             | o | o | x | 55.2          |
| 3058-0AF01** | 6.0                 | 12.7               | 3000                       | o             | o | o | o | 30.0                 | o                             | o | o | x | 55.3          |
| 3070-0AC01   | 3.2                 | 4.5                | 2000                       | o             | x | o | o | 20.4                 | x                             | o | x | x | 55.2          |
| 3070-0AF01   | 3.2                 | 6.4                | 3000                       | o             | o | o | o | 30.0                 | x                             | o | x | o | 55.3          |
| 3071-0AC01   | 5.0                 | 7.1                | 2000                       | o             | o | o | o | 30.0                 | o                             | o | x | x | 55.2          |
| 3071-0AF01   | 5.0                 | 10.7               | 3000                       | o             | o | o | o | 30.0                 | x                             | x | o | o | 55.3          |
| 3073-0AC01   | 7.0                 | 10.0               | 2000                       | o             | o | o | o | 30.0                 | x                             | x | o | o | 55.2          |
| 3073-0AF01   | 7.0                 | 13.8               | 3000                       | o             | o | o | o | 30.0                 | x                             | o | o | o | 55.3          |
| 3074-0AC01   | 7.0                 | 9.7                | 2000                       | o             | o | o | o | 30.0                 | x                             | o | o | o | 55.2          |
| 3074-0AF01   | 7.0                 | 13.5               | 3000                       | o             | o | o | o | 30.0                 | x                             | o | o | o | 55.3 *        |
| 3076-0AC01   | 10.0                | 12.5               | 2000                       | o             | o | o | o | 30.0                 | x                             | o | o | o | 55.2 *        |
| 3076-0AF01** | 10.0                | 20.0               | 3000                       | o             | o | o | o | 30.0                 | x                             | o | o | o | 55.3 *        |
| 3078-0AC01   | 14.0                | 17.0               | 2000                       | o             | o | o | o | 30.0                 | x                             | o | o | o | 55.2 *        |
| 3078-0AF01** | 14.0                | 25.0               | 3000                       | o             | o | o | o | 30.0                 | x                             | o | o | o | 55.3 *        |
| 3100-0AC01   | 7.0                 | 9.5                | 2000                       | o             | o | o | o | 30.0                 | x                             | x | o | x | 55.2          |
| 3100-0AF01   | 7.0                 | 14.2               | 3000                       | o             | o | o | o | 30.0                 | x                             | o | o | o | 55.3          |
| 3101-0AC01   | 10.0                | 13.4               | 2000                       | o             | o | o | o | 30.0                 | x                             | x | o | o | 55.2          |
| 3101-0AF01   | 10.0                | 20.5               | 3000                       | o             | o | o | o | 30.0                 | x                             | o | o | o | 55.3          |
| 3102-0AD01   | 18.0                | 15.0               | 1200                       | o             | o | o | o | 30.0                 | x                             | o | o | o | 55.1          |
| 3102-0AH01   | 18.0                | 24.0               | 2000                       | o             | o | o | o | 30.0                 | x                             | o | o | o | 55.2 *        |
| 3102-0SD01   | 29.0                | 23.0               | 1200                       | o             | o | o | o | 30.0                 | x                             | o | o | o | 55.1          |
| 3103-0AC01   | 12.5                | 15.7               | 2000                       | o             | o | o | o | 30.0                 | x                             | o | o | o | 55.2          |
| 3103-0AF01   | 12.5                | 23.5               | 3000                       | o             | o | o | o | 30.0                 | x                             | o | o | o | 55.3 *        |
| 3104-0AD01   | 25.0                | 19.5               | 1200                       | o             | o | o | o | 30.0                 | x                             | o | o | o | 55.1 *        |
| 3104-0AH01   | 25.0                | 31.0               | 2000                       | o             | o | o | o | 30.0                 | x                             | o | o | o | 55.2 *        |
| 3106-0AD01   | 32.0                | 24.0               | 1200                       | o             | o | o | o | 30.0                 | x                             | o | o | o | 55.1 *        |
| 3108-0AD01   | 38.0                | 31.0               | 1200                       | o             | o | o | o | 30.0                 | x                             | o | o | o | 55.1 *        |
| 3132-0AC01   | 47.0                | 31.0               | 1000                       | o             | o | o | o | 30.0                 | x                             | o | o | x | 55.1          |
| 5042-0AF01   | 1.75                | 4.0                | 3000                       | o             | o | x | o | 15.0                 | x                             | x | o | x | 55.3          |
| 5044-0AC01   | 2.5                 | 3.6                | 2000                       | o             | o | x | o | 15.0                 | o                             | o | o | x | 55.2          |
| 5044-0AF01   | 2.5                 | 5.3                | 3000                       | o             | x | o | o | 20.4                 | x                             | x | o | x | 55.3          |

Table 3.4

Explanations see Table 3.3

Matching table for SIMODRIVE power modules **6RB2120-...** (20/60 A)

Short designation A20, H20

Settings by means of switches S1, S2 and S3 on the adjustment module.

| Servomotor   |                     |                    |                            | Current limit |   |   |   |                      | Speed-dependent current limit |   |   |   |               |
|--------------|---------------------|--------------------|----------------------------|---------------|---|---|---|----------------------|-------------------------------|---|---|---|---------------|
| 1HU          | M <sub>0</sub> [Nm] | I <sub>0</sub> [A] | n <sub>rated</sub> rev/min | Contacts      |   |   |   | I <sub>max</sub> [A] | Contacts                      |   |   |   | Terminal X1.1 |
|              |                     |                    |                            | 2             | 3 | 4 | 5 |                      | 6                             | 7 | 8 | 9 |               |
| 3056-0AC01** | 4.5                 | 6.7                | 2000                       | x             | o | o | o | 51.0                 | o                             | x | x | x | 55.2          |
| 3056-0AF01** | 4.5                 | 10.0               | 3000                       | x             | o | o | o | 51.0                 | o                             | x | x | x | 55.3          |
| 3058-0AC01** | 6.0                 | 8.8                | 2000                       | o             | o | o | o | 60.0                 | o                             | x | x | o | 55.2          |
| 3058-0AF01** | 6.0                 | 12.7               | 3000                       | o             | o | o | o | 60.0                 | o                             | o | x | x | 55.3          |
| 3071-0AC01   | 5.0                 | 7.1                | 2000                       | o             | o | x | o | 30.0                 | o                             | o | x | x | 55.2          |
| 3071-0AF01   | 5.0                 | 10.7               | 3000                       | x             | o | o | o | 51.0                 | o                             | o | x | x | 55.3          |
| 3073-0AC01   | 7.0                 | 10.0               | 2000                       | x             | o | o | o | 51.0                 | o                             | o | x | o | 55.2          |
| 3073-0AF01   | 7.0                 | 13.8               | 3000                       | o             | o | o | o | 60.0                 | o                             | o | x | o | 55.3          |
| 3074-0AC01   | 7.0                 | 9.7                | 2000                       | o             | o | o | o | 60.0                 | o                             | o | o | x | 55.2          |
| 3074-0AF01   | 7.0                 | 13.5               | 3000                       | o             | o | o | o | 60.0                 | o                             | o | o | x | 55.3          |
| 3076-0AC01   | 10.0                | 12.5               | 2000                       | o             | o | o | o | 60.0                 | o                             | o | o | x | 55.2          |
| 3076-0AF01   | 10.0                | 20.0               | 3000                       | o             | o | o | o | 60.0                 | o                             | o | o | x | 55.3          |
| 3078-0AC01   | 14.0                | 17.0               | 2000                       | o             | o | o | o | 60.0                 | x                             | o | o | o | 55.2          |
| 3078-0AF01   | 14.0                | 25.0               | 3000                       | o             | o | o | o | 60.0                 | x                             | o | o | x | 55.3          |
| 3100-0AC01   | 7.0                 | 9.5                | 2000                       | o             | x | o | o | 41.0                 | o                             | o | x | o | 55.2          |
| 3100-0AF01   | 7.0                 | 14.2               | 3000                       | o             | o | o | o | 60.0                 | o                             | o | x | o | 55.3          |
| 3101-0AC01   | 10.0                | 13.4               | 2000                       | o             | o | o | o | 60.0                 | o                             | o | x | x | 55.2          |
| 3101-0AF01   | 10.0                | 20.5               | 3000                       | o             | o | o | o | 60.0                 | x                             | o | o | x | 55.3          |
| 3102-0AD01   | 18.0                | 15.0               | 1200                       | o             | o | o | o | 60.0                 | o                             | o | x | o | 55.1          |
| 3102-0AH01   | 18.0                | 24.0               | 2000                       | o             | o | o | o | 60.0                 | x                             | x | o | o | 55.2          |
| 3102-0SD01   | 29.0                | 23.0               | 1200                       | o             | o | o | o | 60.0                 | o                             | o | x | o | 55.1          |
| 3102-0SH01   | 29.0                | 39.0               | 2000                       | o             | o | o | o | 60.0                 | x                             | o | o | x | 55.2          |
| 3103-0AC01   | 12.5                | 15.7               | 2000                       | o             | o | o | o | 60.0                 | o                             | o | x | o | 55.2          |
| 3103-0AF01   | 12.5                | 23.5               | 3000                       | o             | o | o | o | 60.0                 | x                             | x | o | o | 55.3          |
| 3104-0AD01   | 25.0                | 19.5               | 1200                       | o             | o | o | o | 60.0                 | x                             | x | o | o | 55.1          |
| 3104-0AH01   | 25.0                | 31.0               | 2000                       | o             | o | o | o | 60.0                 | x                             | o | o | o | 55.2          |
| 3104-0SD01   | 40.0                | 31.0               | 1200                       | o             | o | o | o | 60.0                 | x                             | o | o | x | 55.1          |
| 3104-0SH01   | 40.0                | 50.0               | 2000                       | o             | o | o | o | 60.0                 | x                             | o | o | o | 55.2          |
| 3106-0AD01   | 32.0                | 24.0               | 1200                       | o             | o | o | o | 60.0                 | x                             | o | o | o | 55.1          |
| 3106-0AH01   | 32.0                | 42.0               | 2000                       | o             | o | o | o | 60.0                 | x                             | o | o | o | 55.2*         |
| 3106-0SD01   | 50.0                | 38.0               | 1200                       | o             | o | o | o | 60.0                 | x                             | o | o | o | 55.1          |
| 3108-0AD01   | 38.0                | 31.0               | 1200                       | o             | o | o | o | 60.0                 | x                             | o | o | o | 55.1*         |
| 3108-0AH01   | 38.0                | 46.0               | 2000                       | o             | o | o | o | 60.0                 | x                             | o | o | o | 55.2*         |
| 3108-0SD01   | 60.0                | 48.0               | 1200                       | o             | o | o | o | 60.0                 | x                             | o | o | o | 55.1          |
| 3132-0AC01   | 47.0                | 31.0               | 1000                       | o             | o | o | o | 60.0                 | o                             | o | x | o | 55.1          |
| 3132-0AF01   | 47.0                | 45.0               | 1500                       | o             | o | o | o | 60.0                 | x                             | o | o | x | 55.1          |
| 3132-0SC01   | 72.0                | 48.0               | 1000                       | o             | o | o | o | 60.0                 | o                             | o | x | x | 55.1          |
| 3134-0AC01   | 65.0                | 43.0               | 1000                       | o             | o | o | o | 60.0                 | x                             | o | o | o | 55.1          |
| 3134-0AF01   | 65.0                | 62.0               | 1500                       | o             | o | o | o | 60.0                 | x                             | o | o | o | 55.1          |
| 3136-0AC01   | 90.0                | 59.0               | 1000                       | o             | o | o | o | 60.0                 | x                             | o | o | o | 55.1          |
| 3136-0AF01   | 90.0                | 83.0               | 1500                       | o             | o | o | o | 60.0                 | x                             | x | o | o | 55.1          |

Table 3.5

Explanations see Table 3.3

Matching table for SIMODRIVE power modules **6RB2130...** (30/90 A)

Short designation A30, H30

Settings by means of switches S1, S2 and S3 on the adjustment module.

| Servomotor |                     |                    |                            | Current limit |   |   |   |                      | Speed-dependent current limit |   |   |   |               |
|------------|---------------------|--------------------|----------------------------|---------------|---|---|---|----------------------|-------------------------------|---|---|---|---------------|
| 1HU        | M <sub>o</sub> [Nm] | I <sub>o</sub> [A] | n <sub>rated</sub> rev/min | Contacts      |   |   |   | I <sub>max</sub> [A] | Contacts                      |   |   |   | Terminal X1.1 |
|            |                     |                    |                            | 2             | 3 | 4 | 5 |                      | 6                             | 7 | 8 | 9 |               |
| 3073-0AF01 | 7.0                 | 13.8               | 3000                       | x             | o | o | o | 76.5                 | o                             | o | x | o | 55.3          |
| 3074-0AC01 | 7.0                 | 9.7                | 2000                       | x             | o | o | o | 76.5                 | o                             | o | x | o | 55.2          |
| 3074-0AF01 | 7.0                 | 13.5               | 3000                       | x             | o | o | o | 76.5                 | o                             | o | x | o | 55.3          |
| 3076-0AC01 | 10.0                | 12.5               | 2000                       | o             | x | o | o | 61.2                 | o                             | o | o | x | 55.2          |
| 3076-0AF01 | 10.0                | 20.0               | 3000                       | o             | o | o | o | 90.0                 | o                             | o | x | x | 55.3          |
| 3078-0AC01 | 14.0                | 17.0               | 2000                       | x             | o | o | o | 76.5                 | o                             | o | o | o | 55.2          |
| 3078-0AF01 | 14.0                | 25.0               | 3000                       | o             | o | o | o | 90.0                 | o                             | o | x | o | 55.3          |
| 3100-0AF01 | 7.0                 | 14.2               | 3000                       | o             | x | o | o | 61.2                 | o                             | o | x | o | 55.3          |
| 3101-0AC01 | 10.0                | 13.4               | 2000                       | o             | x | o | o | 61.2                 | o                             | o | x | x | 55.2          |
| 3101-0AF01 | 10.0                | 20.5               | 3000                       | x             | o | o | o | 76.5                 | o                             | o | x | o | 55.3          |
| 3102-0AD01 | 18.0                | 15.0               | 1200                       | x             | o | o | o | 76.5                 | o                             | o | x | x | 55.1          |
| 3102-0AH01 | 18.0                | 24.0               | 2000                       | o             | o | o | o | 90.0                 | o                             | o | x | o | 55.2          |
| 3102-0SD01 | 29.0                | 23.0               | 1200                       | o             | o | o | o | 90.0                 | o                             | x | x | x | 55.1          |
| 3102-0SH01 | 29.0                | 39.0               | 2000                       | o             | o | o | o | 90.0                 | o                             | o | x | o | 55.2          |
| 3103-0AC01 | 12.5                | 15.7               | 2000                       | x             | o | o | o | 76.5                 | o                             | o | x | x | 55.2          |
| 3103-0AF01 | 12.5                | 23.5               | 3000                       | o             | o | o | o | 90.0                 | o                             | o | x | o | 55.3          |
| 3104-0AD01 | 25.0                | 19.5               | 1200                       | o             | o | o | o | 90.0                 | o                             | o | o | x | 55.1          |
| 3104-0AH01 | 25.0                | 31.0               | 2000                       | o             | o | o | o | 90.0                 | x                             | o | o | o | 55.2          |
| 3104-0SD01 | 40.0                | 31.0               | 1200                       | o             | o | o | o | 90.0                 | o                             | o | x | o | 55.1          |
| 3104-0SH01 | 40.0                | 50.0               | 2000                       | o             | o | o | o | 90.0                 | o                             | o | o | o | 55.2          |
| 3106-0AD01 | 32.0                | 24.0               | 1200                       | o             | o | o | o | 90.0                 | o                             | o | o | x | 55.1          |
| 3106-0AH01 | 32.0                | 42.0               | 2000                       | o             | o | o | o | 90.0                 | x                             | o | o | o | 55.2          |
| 3106-0SD01 | 50.0                | 38.0               | 1200                       | o             | o | o | o | 90.0                 | o                             | o | o | x | 55.1          |
| 3106-0SH01 | 50.0                | 65.0               | 2000                       | o             | o | o | o | 90.0                 | x                             | o | o | o | 55.2          |
| 3108-0AD01 | 38.0                | 31.0               | 1200                       | o             | o | o | o | 90.0                 | x                             | o | o | o | 55.1          |
| 3108-0AH01 | 38.0                | 46.0               | 2000                       | o             | o | o | o | 90.0                 | x                             | o | o | o | 55.2          |
| 3108-0SD01 | 60.0                | 48.0               | 1200                       | o             | o | o | o | 90.0                 | x                             | x | o | o | 55.1          |
| 3108-0SH01 | 60.0                | 72.0               | 2000                       | o             | o | o | o | 90.0                 | x                             | o | o | o | 55.2          |
| 3132-0AC01 | 47.0                | 31.0               | 1000                       | o             | o | o | o | 90.0                 | o                             | x | x | x | 55.1          |
| 3132-0AF01 | 47.0                | 45.0               | 1500                       | o             | o | o | o | 90.0                 | o                             | o | x | o | 55.1          |
| 3132-0SC01 | 72.0                | 48.0               | 1000                       | o             | o | o | o | 90.0                 | o                             | x | x | x | 55.1          |
| 3132-0SF01 | 72.0                | 70.0               | 1500                       | o             | o | o | o | 90.0                 | o                             | o | o | x | 55.1          |
| 3134-0AC01 | 65.0                | 43.0               | 1000                       | o             | o | o | o | 90.0                 | x                             | x | x | o | 55.1          |
| 3134-0AF01 | 65.0                | 62.0               | 1500                       | o             | o | o | o | 90.0                 | x                             | x | o | o | 55.1          |
| 3134-0SC01 | 100.0               | 66.0               | 1000                       | o             | o | o | o | 90.0                 | x                             | x | o | x | 55.1          |
| 3136-0AC01 | 90.0                | 59.0               | 1000                       | o             | o | o | o | 90.0                 | o                             | o | x | o | 55.1          |
| 3136-0AF01 | 90.0                | 83.0               | 1500                       | o             | o | o | o | 90.0                 | o                             | x | o | o | 55.1          |
| 3136-0SC01 | 135.0               | 89.0               | 1000                       | o             | o | o | o | 90.0                 | o                             | o | x | o | 55.1          |
| 3138-0AC01 | 115.0               | 80.0               | 1000                       | o             | o | o | o | 90.0                 | x                             | x | o | x | 55.1          |

Table 3.6

Explanations see Table 3.8

Matching table for SIMODRIVE power modules **6RB2140-...** (40/120 A)

Short designation A40, H40

Settings by means of switches S1, S2 and S3 on the adjustment module.

| Servomotor |                     |                    |                               | Current limit |   |   |   |                      | Speed-dependent current limit |   |   |   |                  |
|------------|---------------------|--------------------|-------------------------------|---------------|---|---|---|----------------------|-------------------------------|---|---|---|------------------|
| 1HU        | M <sub>0</sub> [Nm] | I <sub>0</sub> [A] | n <sub>rated</sub><br>rev/min | Contacts      |   |   |   | I <sub>max</sub> [A] | Contacts                      |   |   |   | Terminal<br>X1.1 |
|            |                     |                    |                               | 2             | 3 | 4 | 5 |                      | 6                             | 7 | 8 | 9 |                  |
| 3076-0AF01 | 10                  | 20                 | 3000                          | o             | x | o | o | 82                   | o                             | o | o | x | 55.3             |
| 3078-0AF01 | 14                  | 25                 | 3000                          | x             | o | o | o | 102                  | o                             | o | x | x | 55.3             |
| 3101-0AF01 | 10                  | 20.5               | 3000                          | x             | o | o | o | 102                  | x                             | x | x | x | 55.3             |
| 3102-0AH01 | 18                  | 24                 | 2000                          | x             | o | o | o | 102                  | o                             | o | x | x | 55.2             |
| 3102-0SD01 | 29                  | 23                 | 1200                          | x             | x | o | o | 73                   | o                             | o | x | o | 55.1             |
| 3102-0SH01 | 29                  | 39                 | 2000                          | x             | o | o | o | 102                  | o                             | o | x | x | 55.2             |
| 3103-0AF01 | 12.5                | 23.5               | 3000                          | o             | o | o | o | 120                  | o                             | x | x | o | 55.3             |
| 3104-0AD01 | 25                  | 19.5               | 1200                          | o             | x | o | o | 82                   | o                             | o | o | x | 55.1             |
| 3104-0AH01 | 25                  | 31                 | 2000                          | o             | o | o | o | 120                  | o                             | o | o | x | 55.2             |
| 3104-0SD01 | 40                  | 31                 | 1200                          | o             | x | o | o | 82                   | o                             | o | o | x | 55.1             |
| 3104-0SH01 | 40                  | 50                 | 2000                          | o             | o | o | o | 120                  | o                             | o | o | x | 55.2             |
| 3106-0AD01 | 32                  | 24                 | 1200                          | x             | o | o | o | 102                  | o                             | o | x | o | 55.1             |
| 3106-0AH01 | 32                  | 42                 | 2000                          | o             | o | o | o | 120                  | o                             | o | o | x | 55.2             |
| 3106-0SD01 | 50                  | 38                 | 1200                          | x             | o | o | o | 102                  | o                             | o | x | o | 55.1             |
| 3106-0SH01 | 50                  | 65                 | 2000                          | o             | o | o | o | 120                  | o                             | o | o | x | 55.2             |
| 3108-0AD01 | 38                  | 31                 | 1200                          | o             | o | o | o | 120                  | x                             | x | o | x | 55.1             |
| 3108-0AH01 | 38                  | 46                 | 2000                          | o             | o | o | o | 120                  | x                             | x | o | o | 55.2             |
| 3108-0SD01 | 60                  | 48                 | 1200                          | o             | o | o | o | 120                  | x                             | x | o | x | 55.1             |
| 3108-0SH01 | 60                  | 72                 | 2000                          | o             | o | o | o | 120                  | x                             | x | o | o | 55.2             |
| 3132-0AC01 | 47                  | 31                 | 1000                          | o             | o | o | o | 120                  | o                             | x | x | x | 55.1             |
| 3132-0AF01 | 47                  | 45                 | 1500                          | o             | o | o | o | 120                  | o                             | x | x | o | 55.1             |
| 3132-0SC01 | 72                  | 48                 | 1000                          | o             | o | o | o | 120                  | o                             | x | x | x | 55.1             |
| 3132-0SF01 | 72                  | 70                 | 1500                          | o             | o | o | o | 120                  | o                             | x | x | o | 55.1             |
| 3134-0AC01 | 65                  | 43                 | 1000                          | o             | o | o | o | 120                  | o                             | o | x | x | 55.1             |
| 3134-0AF01 | 65                  | 62                 | 1500                          | o             | o | o | o | 120                  | o                             | o | x | o | 55.1             |
| 3134-0SC01 | 100                 | 66                 | 1000                          | o             | o | o | o | 120                  | o                             | o | x | x | 55.1             |
| 3136-0AC01 | 90                  | 59                 | 1000                          | o             | o | o | o | 120                  | o                             | o | x | o | 55.1             |
| 3136-0AF01 | 90                  | 83                 | 1500                          | o             | o | o | o | 120                  | o                             | o | o | x | 55.1             |
| 3136-0SC01 | 135                 | 89                 | 1000                          | o             | o | o | o | 120                  | o                             | o | x | o | 55.1             |
| 3136-0SF01 | 135                 | 125                | 1500                          | o             | o | o | o | 120                  | o                             | o | o | x | 55.1             |
| 3138-0AC01 | 115                 | 80                 | 1000                          | o             | o | o | o | 120                  | x                             | x | x | o | 55.1             |
| 3138-0SC01 | 165                 | 116                | 1000                          | o             | o | o | o | 120                  | x                             | x | x | o | 55.1             |

Table 3.7

Explanations see Table 3.8

## Matching table for SIMODRIVE power modules 6RB2160-... (60/180 A)

Short designation A60, H60

Settings by means of switches S1, S2 and S3 on the adjustment module.

| Servomotor |                     |                    |                            | Current limit |   |   |   |                      | Speed-dependent current limit |   |   |   |               |
|------------|---------------------|--------------------|----------------------------|---------------|---|---|---|----------------------|-------------------------------|---|---|---|---------------|
| 1HU        | M <sub>0</sub> [Nm] | I <sub>0</sub> [A] | n <sub>rated</sub> rev/min | Contacts      |   |   |   | I <sub>max</sub> [A] | Contacts                      |   |   |   | Terminal X1.1 |
|            |                     |                    |                            | 2             | 3 | 4 | 5 |                      | 6                             | 7 | 8 | 9 |               |
| 3102-0SD01 | 29                  | 23                 | 1200                       | o             | x | x | o | 74                   | o                             | o | x | x | 55.1          |
| 3102-0SH01 | 29                  | 39                 | 2000                       | o             | o | x | o | 90                   | o                             | o | x | o | 55.2          |
| 3104-0AH01 | 25                  | 31                 | 2000                       | o             | x | o | o | 122                  | o                             | o | o | x | 55.2          |
| 3104-0SD01 | 40                  | 31                 | 1200                       | x             | o | x | o | 83                   | o                             | o | o | x | 55.1          |
| 3104-0SH01 | 40                  | 50                 | 2000                       | o             | x | o | o | 122                  | x                             | x | o | x | 55.2          |
| 3106-0AH01 | 32                  | 42                 | 2000                       | o             | o | o | o | 180                  | o                             | o | x | o | 55.2          |
| 3106-0SD01 | 50                  | 38                 | 1200                       | x             | x | o | o | 110                  | o                             | o | x | o | 55.1          |
| 3106-0SH01 | 50                  | 65                 | 2000                       | x             | o | o | o | 153                  | x                             | x | o | x | 55.2          |
| 3108-0AD01 | 38                  | 31                 | 1200                       | o             | x | o | o | 122                  | x                             | x | o | x | 55.1          |
| 3108-0AH01 | 38                  | 46                 | 2000                       | o             | o | o | o | 180                  | o                             | o | x | o | 55.2          |
| 3108-0SD01 | 60                  | 48                 | 1200                       | x             | o | o | o | 153                  | o                             | o | x | o | 55.1          |
| 3108-0SH01 | 60                  | 72                 | 2000                       | o             | o | o | o | 180                  | o                             | o | x | o | 55.2          |
| 3132-0AC01 | 47                  | 31                 | 1000                       | x             | x | o | o | 110                  | o                             | x | x | x | 55.1          |
| 3132-0AF01 | 47                  | 45                 | 1500                       | x             | o | o | o | 153                  | o                             | x | x | x | 55.1          |
| 3132-0SC01 | 72                  | 48                 | 1000                       | x             | x | o | o | 110                  | o                             | x | x | x | 55.1          |
| 3132-0SF01 | 72                  | 70                 | 1500                       | x             | o | o | o | 153                  | o                             | x | x | x | 55.1          |
| 3134-0AC01 | 65                  | 43                 | 1000                       | x             | o | o | o | 153                  | o                             | x | x | x | 55.1          |
| 3134-0AF01 | 65                  | 62                 | 1500                       | x             | o | o | o | 153                  | o                             | x | x | x | 55.1          |
| 3134-0SC01 | 100                 | 66                 | 1000                       | o             | x | o | o | 122                  | o                             | o | x | x | 55.1          |
| 3136-0AC01 | 90                  | 59                 | 1000                       | o             | o | o | o | 180                  | o                             | x | x | x | 55.1          |
| 3136-0AF01 | 90                  | 83                 | 1500                       | o             | o | o | o | 180                  | o                             | o | x | x | 55.1          |
| 3136-0SC01 | 135                 | 89                 | 1000                       | o             | o | o | o | 180                  | o                             | x | x | x | 55.1          |
| 3136-0SF01 | 135                 | 125                | 1500                       | o             | o | o | o | 180                  | o                             | o | x | x | 55.1          |
| 3138-0AC01 | 115                 | 80                 | 1000                       | o             | o | o | o | 180                  | o                             | o | x | o | 55.1          |
| 3138-0AF01 | 115                 | 134                | 1800                       | o             | o | o | o | 180                  | x                             | x | o | x | 55.2          |
| 3138-0SC01 | 165                 | 116                | 1000                       | o             | o | o | o | 180                  | o                             | o | x | o | 55.1          |

Table 3.8

o = Contact in normal position (OFF)

x = Contact to ON

Contact S1.1, S2.1, S3.1: no function

Contact S1.10 or resistor R200: Contact S1.10 in ON position or R200 provided in the form of a jumper:  
All three axes are operated in current loop.

Separately-ventilated motors can be used instead of the non-ventilated motors.

-0A.01 = non-ventilated motor

-0S.01 = separately-ventilated motor

Matching table for SIMODRIVE power modules **6RB2190-...** (90/270 A)

Short designation A90, H90

Settings by means of switches S1, S2 and S3 on the adjustment module.

| Servomotor |                     |                    |                            | Current limit |   |   |   |                      | Speed-dependent current limit |   |   |   |               |
|------------|---------------------|--------------------|----------------------------|---------------|---|---|---|----------------------|-------------------------------|---|---|---|---------------|
| 1HU        | M <sub>0</sub> [Nm] | I <sub>0</sub> [A] | n <sub>rated</sub> rev/min | Contacts      |   |   |   | I <sub>max</sub> [A] | Contacts                      |   |   |   | Terminal X1.1 |
|            |                     |                    |                            | 2             | 3 | 4 | 5 |                      | 6                             | 7 | 8 | 9 |               |
| 3104-0SH01 | 40.0                | 50.0               | 2000                       | o             | o | x | o | 135                  | x                             | x | x | o | 55.2          |
| 3106-0SH01 | 50.0                | 65.0               | 2000                       | o             | x | o | o | 184                  | o                             | o | x | o | 55.2          |
| 3108-0AH01 | 38.0                | 46.0               | 2000                       | x             | x | o | o | 165                  | o                             | o | o | x | 55.2          |
| 3108-0SD01 | 60.0                | 48.0               | 1200                       | o             | o | x | o | 135                  | o                             | o | x | o | 55.1          |
| 3108-0SH01 | 60.0                | 72.0               | 2000                       | o             | x | o | o | 184                  | x                             | x | x | o | 55.2          |
| 3132-0AF01 | 47.0                | 45.0               | 1500                       | x             | x | o | o | 165                  | o                             | x | x | x | 55.1          |
| 3132-0SC01 | 72.0                | 48.0               | 1000                       | x             | o | x | o | 124                  | o                             | x | x | x | 55.1          |
| 3132-0SF01 | 72.0                | 70.0               | 1500                       | x             | x | o | o | 165                  | o                             | x | x | x | 55.1          |
| 3134-0AF01 | 65.0                | 62.0               | 1500                       | x             | x | o | o | 165                  | o                             | x | x | x | 55.1          |
| 3134-0SC01 | 100.0               | 66.0               | 1000                       | o             | o | x | o | 135                  | o                             | x | x | x | 55.1          |
| 3136-0AC01 | 90.0                | 59.0               | 1000                       | o             | x | o | o | 184                  | o                             | x | x | x | 55.1          |
| 3136-0AF01 | 90.0                | 83.0               | 1500                       | o             | o | o | o | 270                  | o                             | x | x | x | 55.1          |
| 3136-0SC01 | 135.0               | 89.0               | 1000                       | o             | x | o | o | 184                  | o                             | x | x | x | 55.1          |
| 3136-0SF01 | 135.0               | 125.0              | 1500                       | o             | o | o | o | 270                  | o                             | x | x | x | 55.1          |
| 3138-0AC01 | 115.0               | 80.0               | 1000                       | o             | o | o | o | 270                  | o                             | x | x | x | 55.1          |
| 3138-0AF01 | 115.0               | 134.0              | 1800                       | o             | o | o | o | 270                  | x                             | x | x | o | 55.2          |
| 3138-0SC01 | 165.0               | 116.0              | 1000                       | o             | o | o | o | 270                  | o                             | x | x | x | 55.1          |

Table 3.9

o = Contact in normal position (OFF)

x = Contact to ON

Contact S1.1, S2.1, S3.1: no function

Contact S1.10 or resistor R200: Contact S1.10 in ON position or R200 provided in the form of a jumper:  
All three axes are operated in current loop.

Separately-ventilated motors can be used instead of the non-ventilated motors.

-0A.01 = non-ventilated motor

-0S.01 = separately-ventilated motor



### 3.1.2 Current setpoint limitation, "Hold against mechanical stop" function

When voltage is applied to terminal 96 (Figs. 3.3 and 3.4), the "Speed controller at maximum" monitoring system is deactivated.

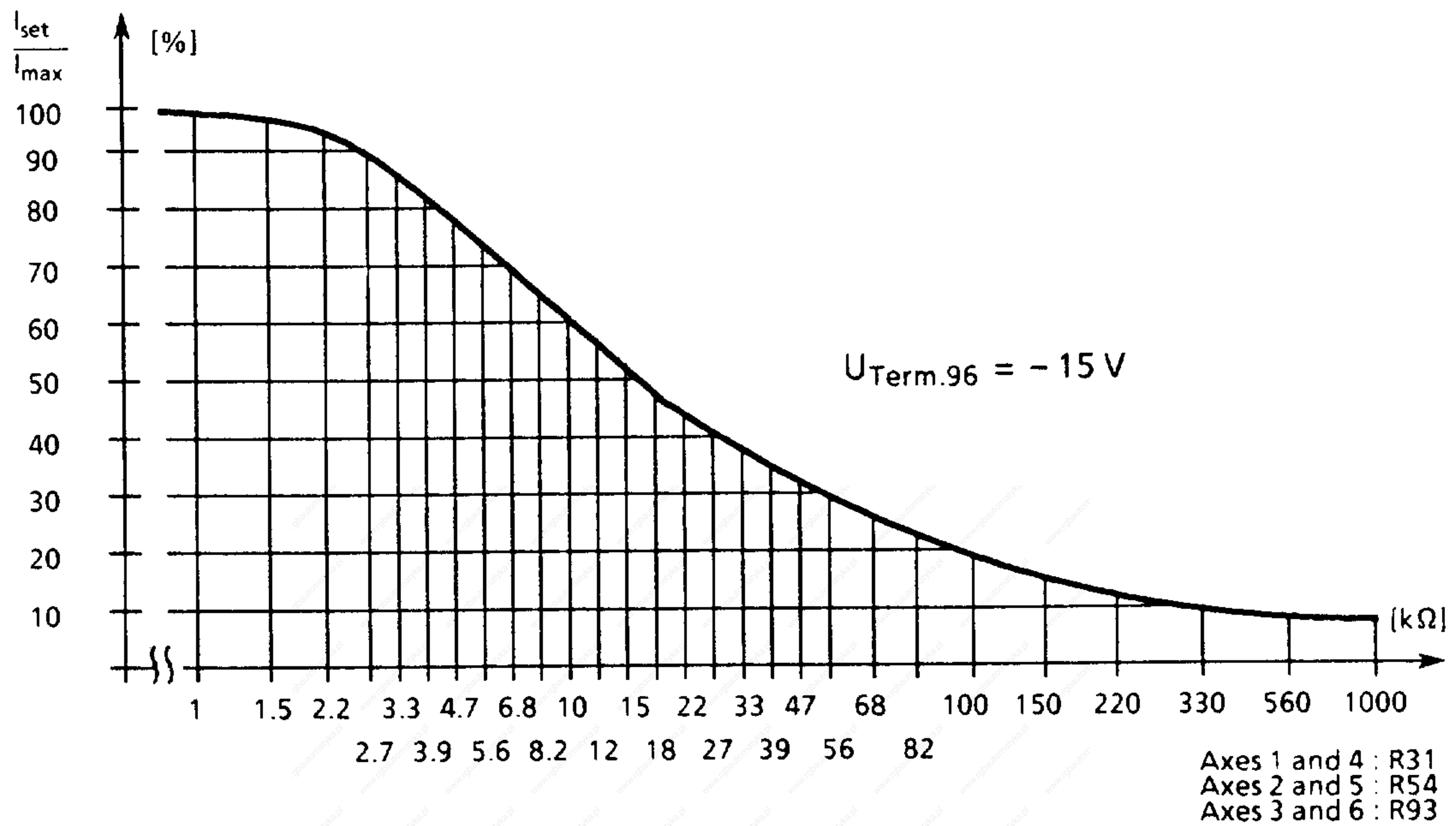


Fig. 3.3 Current setpoint limitation as a function of R31, R54, R93 on the adjustment module

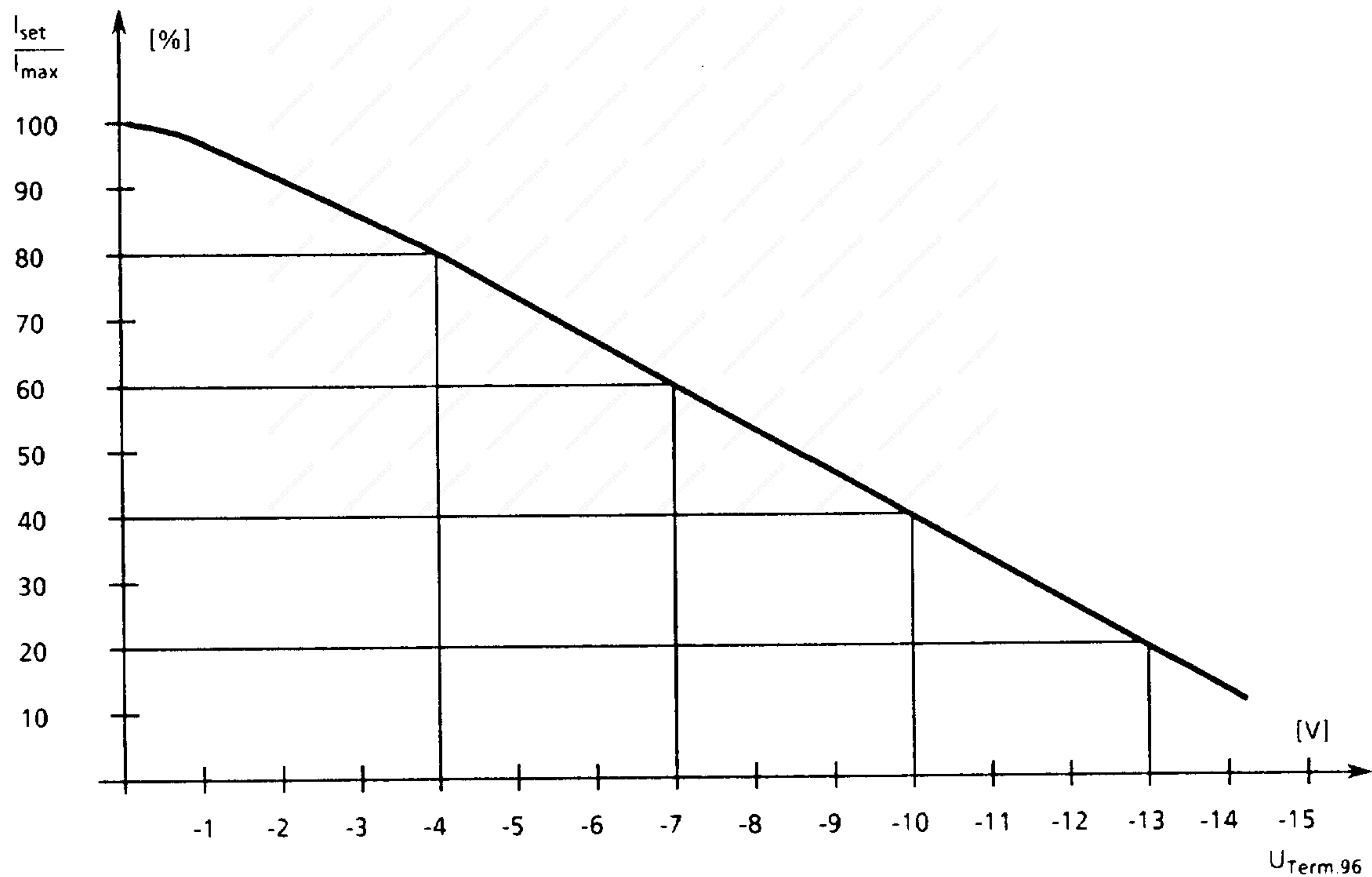


Fig. 3.4 Current setpoint limitation as a function of the voltage applied at terminal 96 (The input resistance of terminal 96 amounts to 12  $k\Omega$ )

### 3.1.3 Tacho-generator

#### 3.1.3.1 Tacho-generator input

The transistor chopper is set at the factory to a tacho-voltage of 20 V/1000 rev/min (e.g. by tacho-generator 1HU1052).

Connect the tacho-generator to the terminals as shown in Table 3.10. Higher tacho voltages must be reduced via an external divider. The internal resistance of the tacho-generator input is about 13 kΩ.

|                         |      |      |      |      |      |      |
|-------------------------|------|------|------|------|------|------|
| Rated speed in rev /min | 1000 | 1200 | 1500 | 1800 | 2000 | 3000 |
| Terminal                | 55.1 |      | 55.2 |      | 55.3 |      |

Table 3.10

With an actual speed value of 3 V/1000 rev/min, the resistors on the controller module must be changed according to Table 3.11.

| Axes 1 and 4 | Axes 2 and 5 | Axes 3 and 6 | New resistance value in kΩ |
|--------------|--------------|--------------|----------------------------|
| R181<br>R433 | R241<br>R436 | R248<br>R441 | 5.6<br>470                 |

Table 3.11

#### 3.1.3.2 Tacho-generator monitoring

The tacho-generator monitoring is set at the factory for tacho-generators with an internal resistance of  $R_i > 1 \text{ k}\Omega$ .

If tacho-generators with a lower internal resistance are used, remove the following resistors:

- R704 (Axes 1 and 4)
- R705 (Axes 2 and 5)
- R706 (Axes 3 and 6)

When these resistors are removed, the tacho-generator cable is no longer monitored for short circuit, but only for cable breakage.

To deactivate the tacho-generator monitoring:

- Remove R428
- Remove V79, V80 and R270 (Axes 1 and 4)
- Remove V92, V93 and R276 (Axes 2 and 5)
- Remove V112, V113 and R410 (Axes 3 and 6)

### 3.1.3.3 Tacho-generator simulation

A tacho-generator simulation can be used for a voltage range of  $7\text{ V} < U_T < 11\text{ V}$ . Terminal 55.2 is used for this purpose.

Adaptation is carried out with short-circuit links:

- Link X21 and X29 (axes 1 and 4)
- Link X24 and X30 (axes 2 and 5)
- Link X27 and X31 (axes 3 and 6)

When the tacho-generator simulation is used, disable the tachogenerator monitoring (see 3.1.3.2 "Tacho-generator monitoring").

### 3.1.4 Speed controller adaptation

The reset time  $T_{Nrated}$  of the speed controller can be set with potentiometers R135 (axes 1 and 4), R235 (axes 2 and 5) and R335 (axes 3 and 6). In order to adaptively reduce the reset time  $T_N$  of the speed controller at lowest speeds, the adjustment module must be fitted with resistor R15 (axes 1 and 4), R46 (axes 2 and 5) and R77 (axes 3 and 6). The reset time can be reduced to  $T_{Nadapt}$  with the following resistance values:

With  $0.1\text{ k}\Omega$  to 5 % of  $T_{Nrated}$   
 With  $1.2\text{ k}\Omega$  to 25 % of  $T_{Nrated}$   
 With  $1.8\text{ k}\Omega$  to 33 % of  $T_{Nrated}$   
 With  $3.9\text{ k}\Omega$  to 50 % of  $T_{Nrated}$

With  $10\text{ k}\Omega$  to 72 % of  $T_{Nrated}$   
 With  $20\text{ k}\Omega$  to 84 % of  $T_{Nrated}$   
 With  $39\text{ k}\Omega$  to 91 % of  $T_{Nrated}$

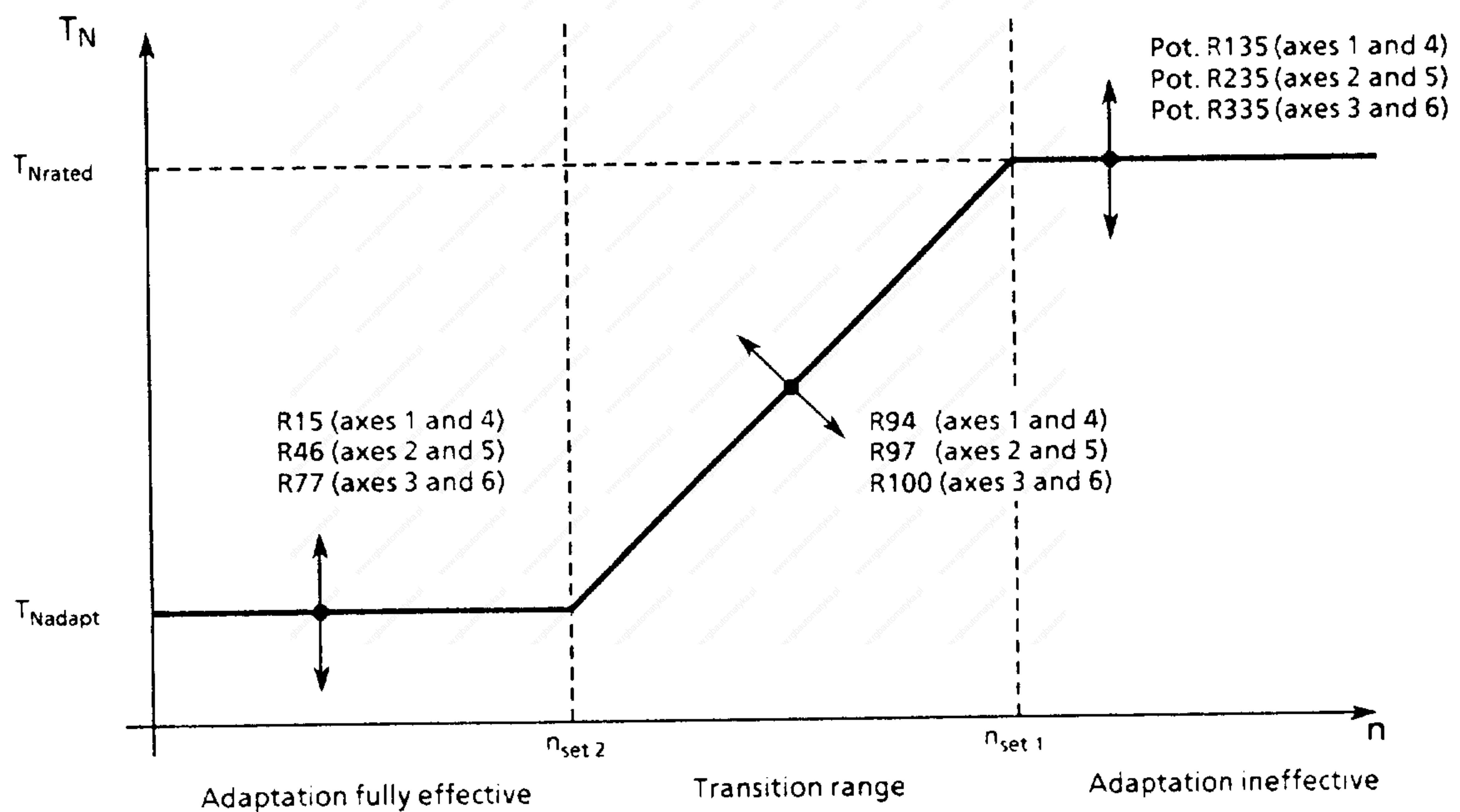


Fig. 3.5 Relationship between reset time and speed

With the version supplied from the factory (R94 (axes 1 and 4), R97 (axes 2 and 5), R100 (axes 3 and 6) =  $1.5\text{ k}\Omega$ ), reset time reduction starts at  $n_{set\ 1} \approx$  approx. 60 mV and reaches the set minimum value at  $n_{set\ 2} \approx$  approx. 12 mV.

The point at which adaptation becomes effective is set via the following resistors: R94 (Axes 1 and 4), R97 (axes 2 and 5) and R100 (axes 3 and 6) according to the following table (values apply to versions from B onwards).

| R in kΩ | $n_{set 1}$ in mV | $n_{set 2}$ in mV |
|---------|-------------------|-------------------|
| 0.1     | 20                | 4                 |
| 1.0     | 50                | 10                |
| 1.5     | 60                | 12                |
| 2.2     | 80                | 15                |
| 4.7     | 110               | 20                |
| 10.0    | 140               | 30                |
| open    | 200               | 33                |

Table 3.12

### 3.1.5 Electrical weight compensation

Resistors R3, R5 (axes 1 and 4), R32, R36 (axes 2 and 5) and R63, R67 (axes 3 and 6) are soldered into the adjustment module in order to achieve weight compensation with mechanically preloaded axes. When setting the resistance values, note that  $I_{weight}$  compensation must not be allowed to exceed  $I_{rated}$ .

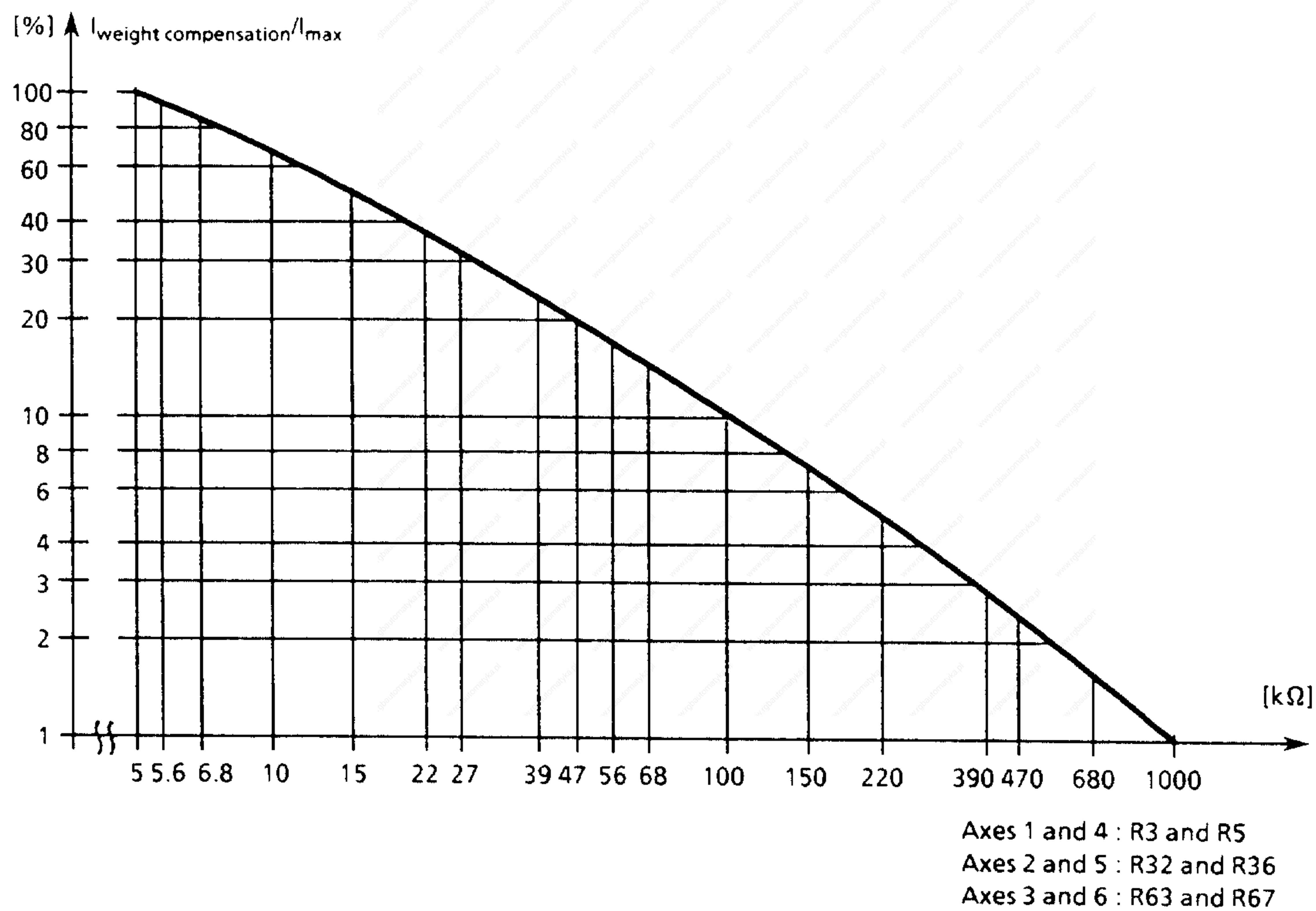


Fig. 3.6 Supplementary current setpoint for electrical weight compensation

A positive current setpoint on test socket T1 (axes 1 and 4), T2 (axes 2 and 5), T3 (axes 3 and 6) indicates that resistors R5, R36 and R67 have been fitted in the adjustment module. A negative current setpoint is obtained by fitting resistors R3, R32 and R63 in the adjustment module.

### 3.1.6 Current-controlled operation

Apply the current setpoint ( $I_{set}$ ) to the following terminals:

- X411:58 and X411:8 (axes 1 and 4)
- X421:58 and X421:8 (axes 2 and 5)
- X431:58 and X431:8 (axes 3 and 6)

Then implement the central pulse and controller enabling (connect terminal X121:63 and X121:64 to terminal X121:9 on the power supply).

The procedure subsequently adopted depends on the adjustment module version concerned and whether the current of the 3 (6) axes is to be controlled in common or individually.

#### Operate all 3 (6) axes under current control (with P component only)

##### a) 9-pole switch S1

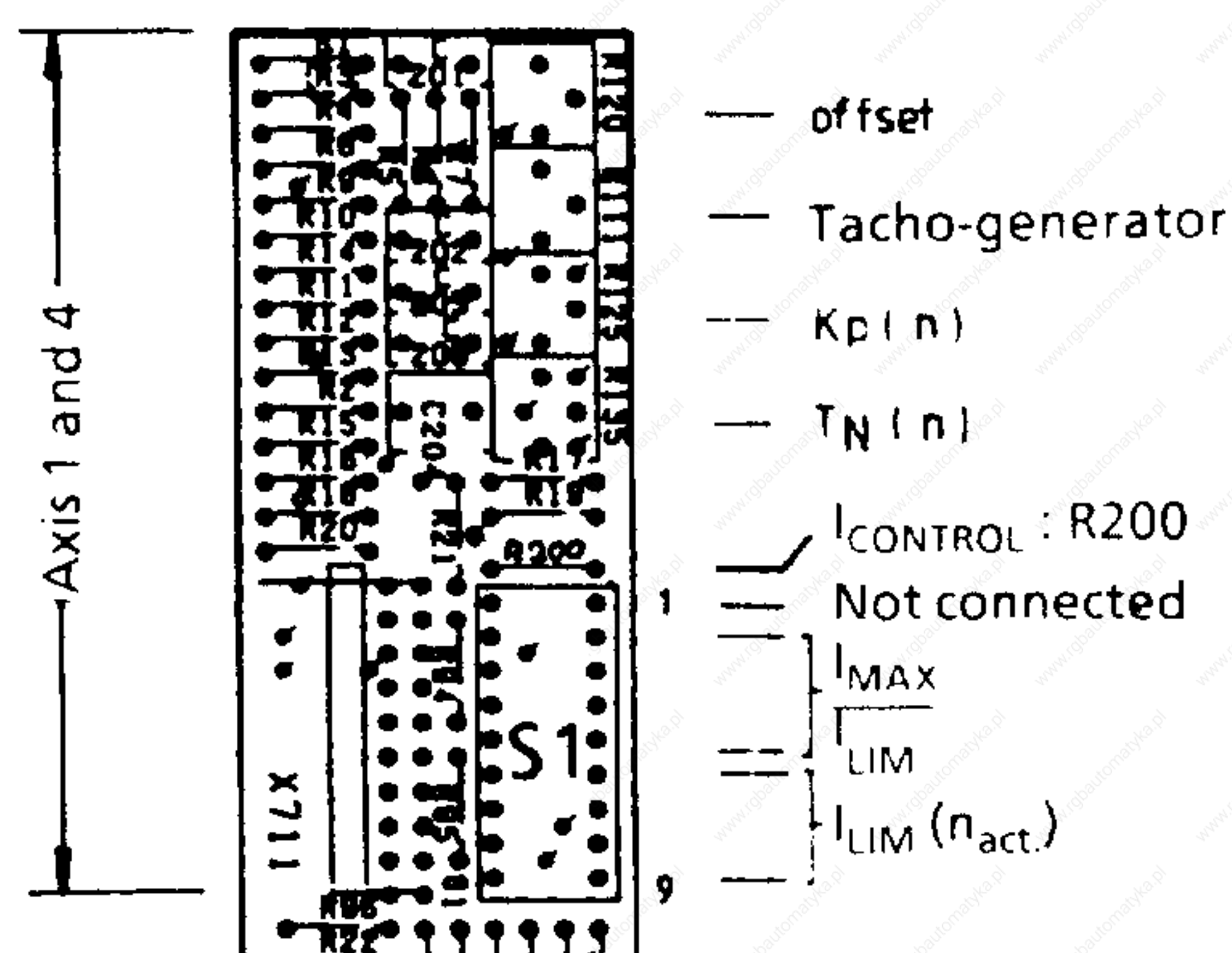


Fig. 3.7a

- Insert link R200 in the adjustment module
- Implement axis-specific controller enabling:

- Link X111:65 and X111:9 (axes 1 and 4)
- Link X121:65 and X121:9 (axes 2 and 5)
- Link X131:65 and X131:9 (axes 3 and 6)

##### b) 10-pole switch S1

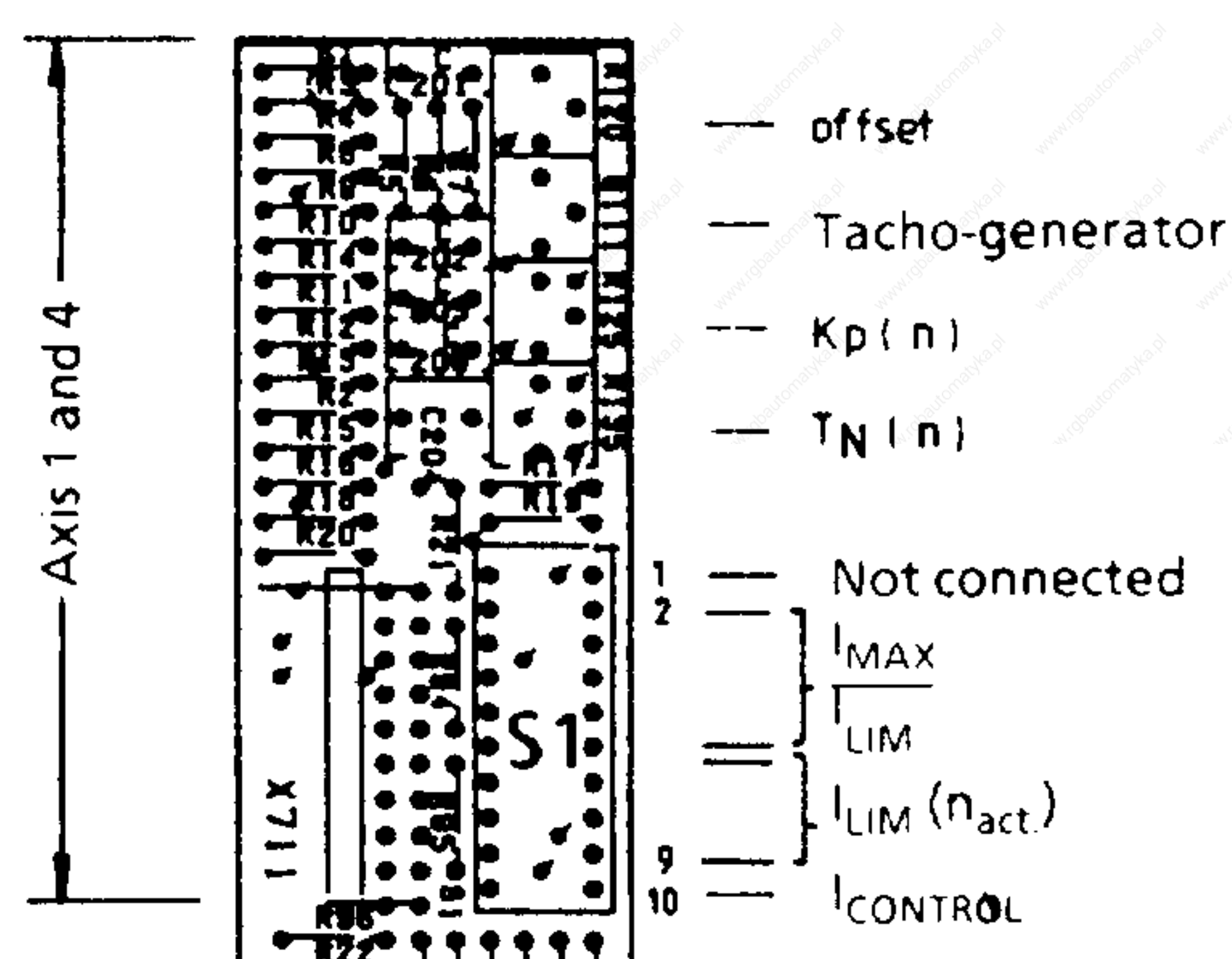


Fig. 3.7b

- Set switch S1.10 on adjustment module to ON
- Implement axis-specific controller enabling:

- Link X111:65 and X111:9 (axes 1 and 4)
- Link X121:65 and X121:9 (axes 2 and 5)
- Link X131:65 and X131:9 (axes 3 and 6)

### In order to operate individual axes under current control (with P component only)

- a) 9-pole switch S1
  - b) 10-pole switch S1
- Link R200 removed
  - Set switch S1.10 on the adjustment module to OFF
  - Remove the following resistors from the control module:
    - R263 (axes 1 and 4)
    - R369 (axes 2 and 5)
    - R327 (axes 3 and 6)
  - Implement axis-specific control lock-out:
    - Open X111:65 and X111:9 (axes 1 and 4)
    - Open X121:65 and X121:9 (axes 2 and 5)
    - Open X131:65 and X131:9 (axes 3 and 6)

### Current-controlled operation with PI current controller

The P controller alone is not a sufficiently accurate current-control mechanism for special applications which employ pure torque control and do not permit a steady-state deviation. Furthermore, the feedback of the actual speed value to the current setpoint across the short-circuited speed controller (0.5 k $\Omega$  in feedback circuit) with max. 600 mV causes an additional control error.

Torque-controlled operation with PI-current controller in which the actual speed value is not influenced can be implemented as follows:

- Activate terminal 6 on the controller module with + 15 V, thus disabling the integral-action component of the speed controller.
- Remove (using pliers) resistor R9 (1st axis) on the adjustment module. The actual speed value is now decoupled.
- To eliminate the effect of the speed controller offset, the potentiometers for  $K_p$  and  $T_N$  should be turned as far as possible to the left (minimum gain). The drift should also be compensated ( $I^* = 0$  V, test socket T = 0 V).
- The current setpoint is input via terminal 58-8.
- Terminal 56 must be connected to terminal 14.

All other terminals and switches must be set as for speed-controlled operation, i.e. terminals 63, 64, 65 enabled and switch S1.10 to OFF.

The current limits remain effective in current-controlled operation.

### **3.1.7 Current setpoint for parallel operation**

Variable-speed axis 1 or 4 of the control module can act as master and feed its current setpoint to slave axes 2 and/or 3 (or slave axes 5 and/or 6). The following modifications are made to the control module for this purpose:

- Axis 2 or 5 operates as slave:
  - Open link R431
  - Insert link R430
  - Feed -15 V to X121:96 ("Speed controller at maximum" deactivated)
- Axis 3 or 6 operates as slave:
  - Open link R449
  - Insert link R448
  - Feed -15 V to X131:96 ("Speed controller at maximum" deactivated)

### 3.1.8 External power supply for controller enabling

The internal power supply for control enabling can be deactivated by removing resistors R20 and R21 from module G0. An external isolated power supply (+ 24 V) can be connected via terminal X121:19 (reference potential) and terminal X121:9 of the power supply.

### 3.1.9 External voltage input for storage of fault memory signals

In order to be able to store the fault indications even when the unit is switched off, a non-stabilized voltage of + 24 V DC can be applied to terminals X111:11 and X111:15 of the power supply module. The tolerance range for this external voltage is 19 V to 30 V including ripple (see Fig. 3.8).

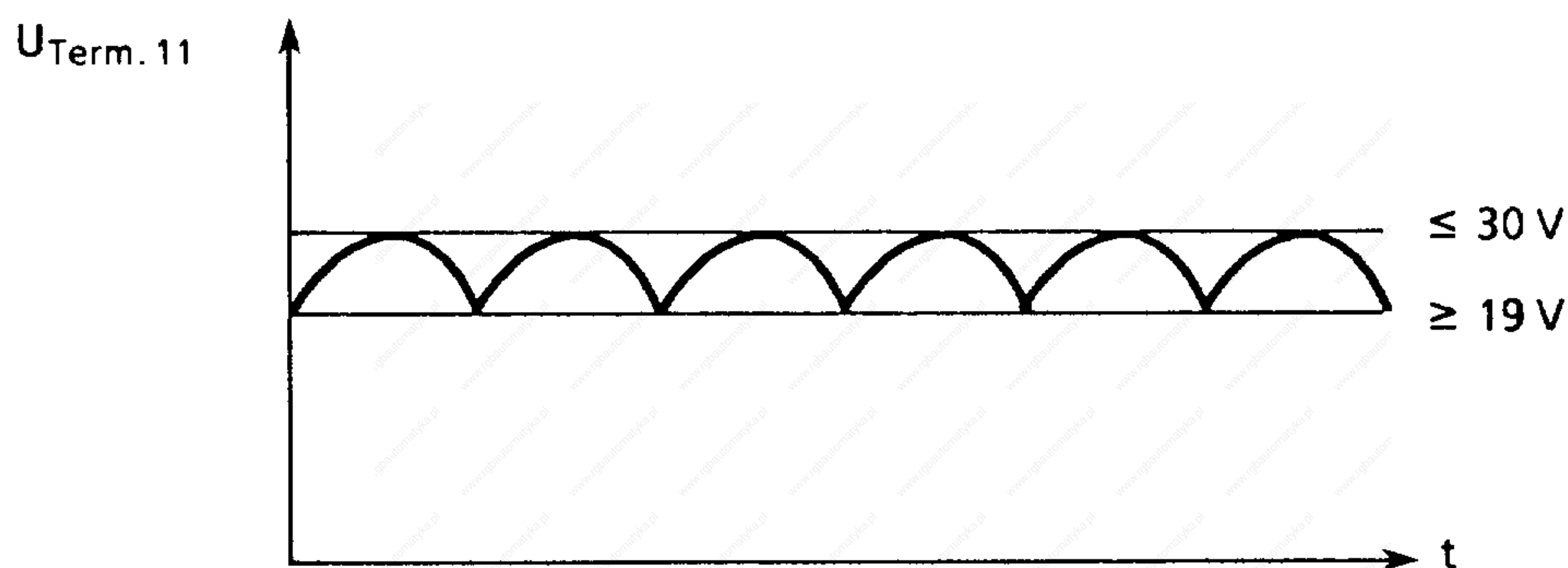


Fig. 3.8

If this function is utilized, it should be noted that each time the unit is switched off, the  $\pm 15 \text{ V}$  monitoring and the group fault memory will operate and produce a fault indication via the relay contact at terminals 72, 73.1, 73.2 and 74, owing to non-availability of the negative electronics voltage.

A distinction must therefore be made between the following cases:

**1) The unit is switched off in the absence of a fault signal.**

Consequence: The  $\pm 15 \text{ V}$  monitoring and the group fault memory operate and cause LEDs + G0-V2 and + G0-V1 to light up. The ready signal at terminals 72, 73.1, 73.2 and 74 disappears and a fault signal is output (see Chapter 3.2.1).

**2) The unit is switched off in consequence of a fault signal.**

Consequence a: When the unit has been switched off, the  $\pm 15 \text{ V}$  fault indication lights up in addition to the original fault lamp. In this case, the  $\pm 15 \text{ V}$  fault indication should be ignored.

Consequence b: Only the  $\pm 15 \text{ V}$  fault lamp and the group fault memory lamp light up when the unit has been tripped. In this case, the cause of the fault lies in the  $\pm 15 \text{ V}$  electronics voltage.

### 3.1.10 Changing of variable components in the speed setpoint channel

The smoothing time constant in the speed setpoint channel can be increased by the addition of capacitors C301 (axes 1 and 4), C302 (axes 2 and 5) and C303 (axes 3 and 6) on the controller module (see Fig. 3.9).

The input resistance of the speed setpoint channel can be adjusted by the addition of R450 (axes 1 and 4), R461 (axes 2 and 5) and R471 (axes 3 and 6).

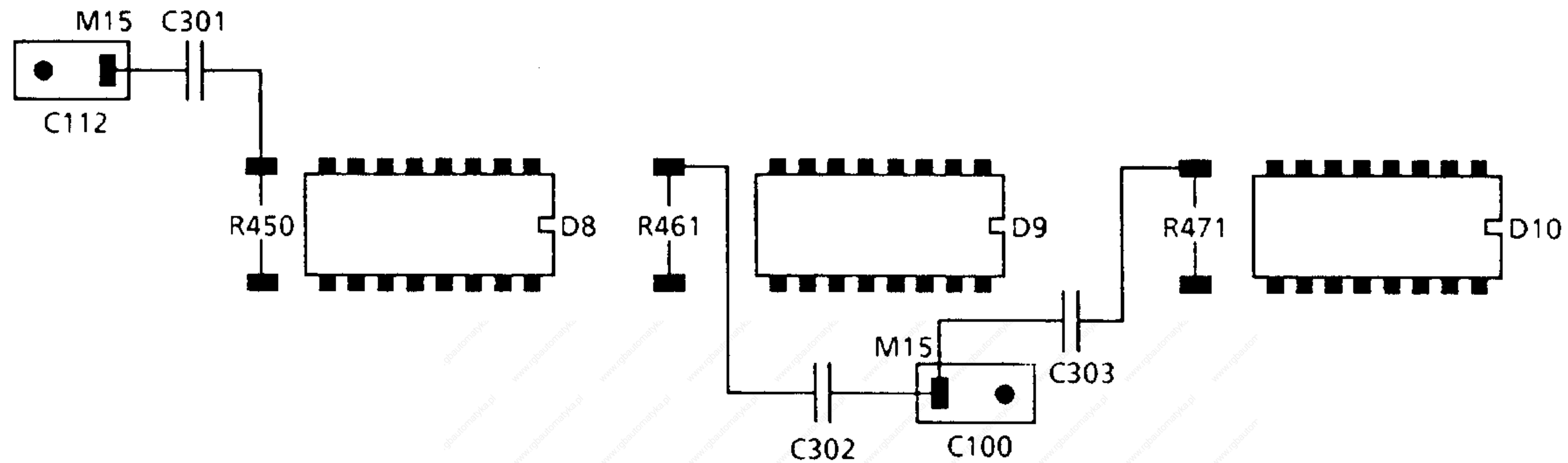


Fig. 3.9 ■ = Soldering pins (provided on controller modules in versions from J onwards)

### 3.1.11 Monitoring circuit "Speed controller at stop"

If the speed controller is at the stop for more than approx. 200 ms, pulse and controller inhibition will be initiated.

If necessary, this monitoring time can be extended by increasing the resistance value of R605 (axes 1 and 4), R646 (axes 2 and 5) and R656 (axes 3 and 6) on the controller module (as of version N on soldering pins).

Monitoring time for axis 1 (example):

$$\frac{t}{s} \approx \frac{R605}{M\Omega} \cdot 0.55$$



### 3.1.12 Operation of control axes without power circuit module

If no motor is connected to one of the axes, interconnect terminals 13 and 55.1 on connectors X111 (axes 1 and 4), X121 (axes 2 and 5), X131 (axes 3 and 6) on the control module using a 4.7 kohms resistor (see Fig. 3.10).

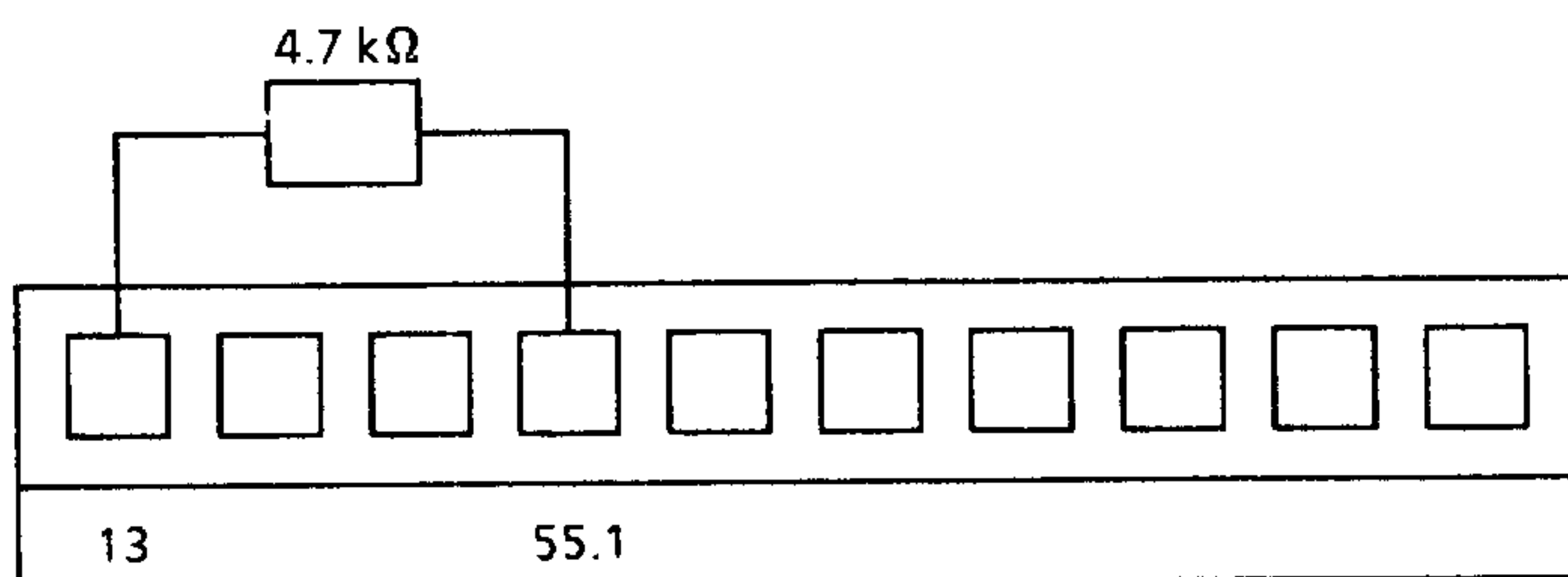


Fig. 3.10 Connector X1.1

The pulse cables must be provided with a terminating connector in order to prevent disturbances during operation without power circuit module.

Order No.: 6SC6101-0XB00 (16-way)  
6SC6101-0XB12 (34-way)

Adapter 1 x 34-way to 2 x 16-way  
Order No.: 6SC6101-0LA17

### 3.1.13 Matching the current controller gain

Stability problems may arise in the control circuit when DC servomotors are used which have a relatively high armature circuit inductance ( $L_a > 20$  mH, e.g. 1HU3056-0AC01) or with low inductance ( $L_a < 2$  mH, e.g. 1HU3078-0AF01). In this case the gain of the current controller must be increased for motors with high inductance or reduced for motors with low inductance.

The current gain can be varied by resistors R95 (axes 1 and 4), R98 (axes 2 and 5) and R101 (axes 3 and 6) on the adjustment module (Table 3.13).

The current gain has been adjusted in the works to  $K_p(I) = \text{approx. } 2.6$  with R95, R98 and R101 set to 680 ohms.

| R95, R98, R101 | Current gain $K_p(I)$ |
|----------------|-----------------------|
| 100 ohms       | ~14                   |
| 150 ohms       | ~10                   |
| 390 ohms       | ~ 4                   |
| 680 ohms       | ~ 2.6                 |
| 1 kohm         | ~ 2                   |
| 2.7 kohms      | ~ 1                   |

Table 3.13

### 3.1.14 Testing the load cycle

The  $I^2t$  curve (Fig. 3.11) describes the following monitoring function:

The actual current value is approximately squared and the result subsequently integrated. If the actual current value is larger than 1.1 times the rated current, the voltage excursion of the integrator is negative, otherwise it is positive.

If the integrator, starting from rest (start-up of the unit or reset command), has a negative total voltage excursion of about  $-15\text{ V}$ , the current setpoint limitation takes effect.

To calculate the given load cycle of the total voltage excursion, proceed as follows:

- 1) Divide the load cycle into time sections  $\Delta t_i$  ( $i = 1, \dots, n$ ) with constant current  $I$ .
- 2) Use the following formula to calculate the part voltage excursion  $\Delta U_i$  ( $i = 1, \dots, n$ ) for each time section depending on the sign:

$$\frac{\Delta U_i}{\text{V}} \equiv \frac{\Delta t_i}{\text{s}} \cdot \left[ 2.2 - 2 \cdot \left( \frac{I}{I_{\text{rated}}} \right)^2 \right]$$

- 3) Add the part voltage excursions according to sign.
- 4) Total voltage excursion  $\leq -15\text{ V} \rightarrow$  Load cycle impermissible  
 $> -15\text{ V} \rightarrow$  Load cycle permissible

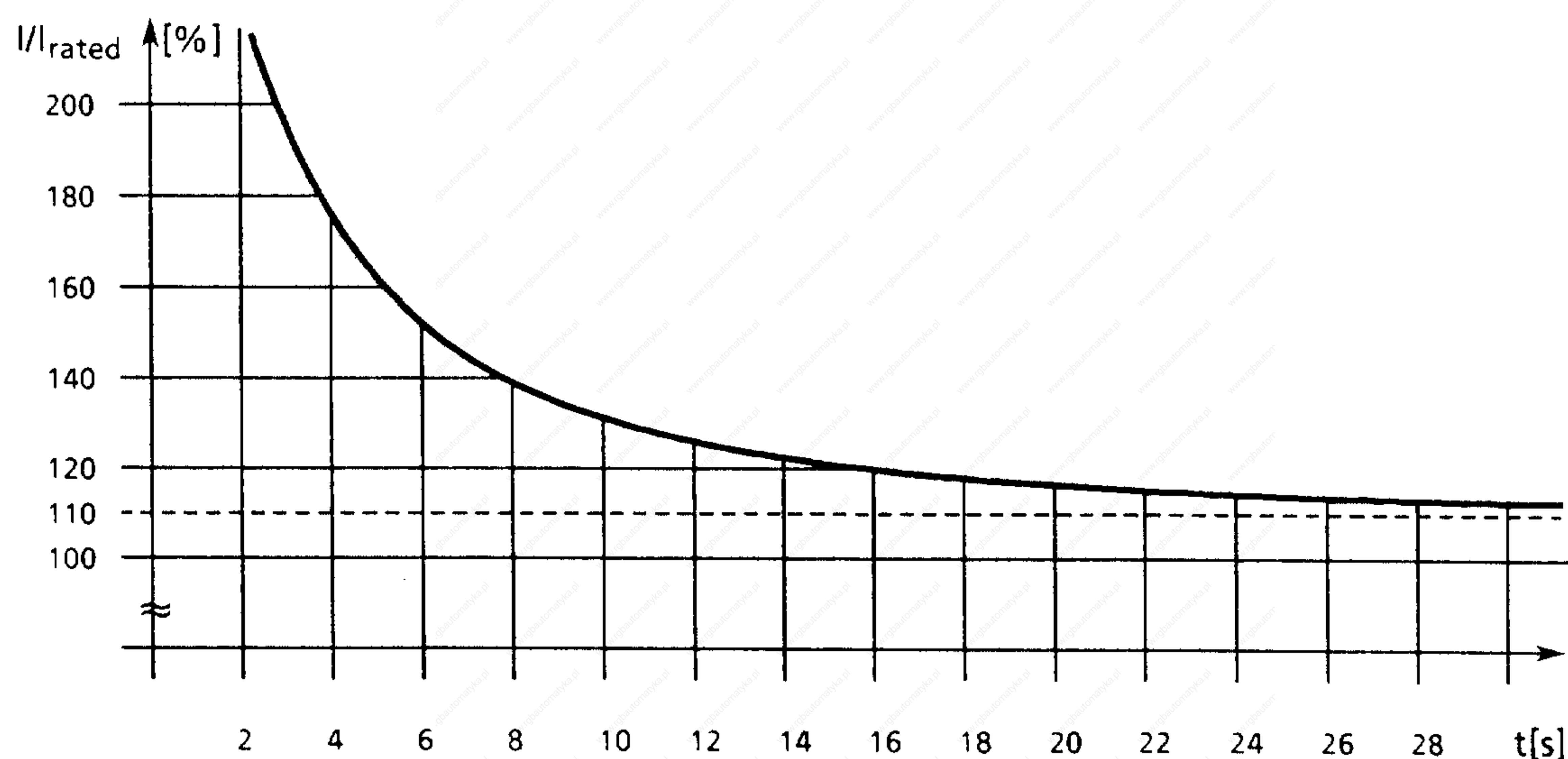


Fig. 3.11  $I^2t$  curve = thermally permissible time duration of overcurrent

## 3.2 Signals

No fault indication will appear any earlier than about 1 s after power-up.

### 3.2.1 Ready/fault signal

The ready indication can be changed into a fault indication by removing diode V13 on the power supply module (G0).

A fault indication occurs if the  $\pm 15$  V monitoring, the DC link voltage monitoring ( $U_{ZK} \gg$ ) or if the "Speed controller at maximum" monitoring operate.

The ready indication occurs if none of the aforementioned fault conditions applies and if the enable signal is present at terminals 63 and 64.

### 3.2.2 Reset fault memories

The fault memories in the chopper can be reset by applying an M signal to terminal R of connector X111 on the power supply module or by switching the unit off and then on again.

#### NOTE

The DC-link voltage must have dropped to at least 25 V before the unit is switched on again to ensure that an internal reset signal is generated. The link voltage takes approximately 10 s (depending on chopper version) to drop to the correct value.

### 3.2.3 I<sup>2</sup>t signal

Terminal 5 at location + G0-X111 provides a common output (open collector) for this signal for all axes. A relay can be connected across this output and terminal 7 or some other power supply (connect freewheel diode in parallel!) (Fig. 3.12). The relay is activated when the signal is active.

Relay data:  $U_N = 12$  V or 15 V,  $I_N \leq 50$  mA when using the internal voltage at terminal 7. When using an external voltage of 24 V, a 24 V relay can be used ( $U_N = 24$  V,  $I_N \leq 50$  mA).

If terminal 5 is direct-connected to the programmable logic controller (PLC), a pull-up resistor of 1.0 k $\Omega$  (1.0 W) must be connected to terminals 5 and 7 or some other power supply (indication active = L signal) (Fig. 3.13).

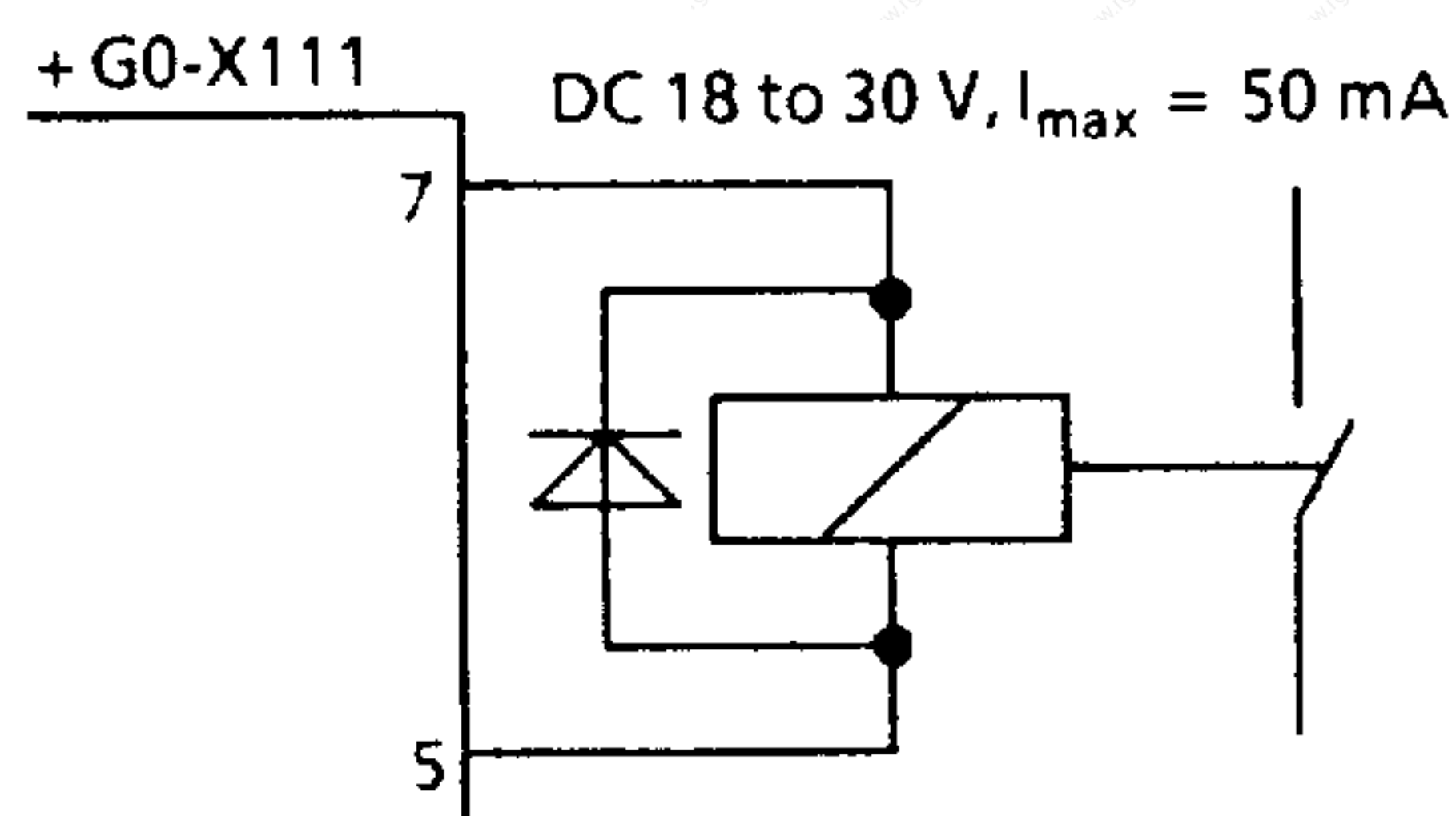


Fig. 3.12 Connection of a relay

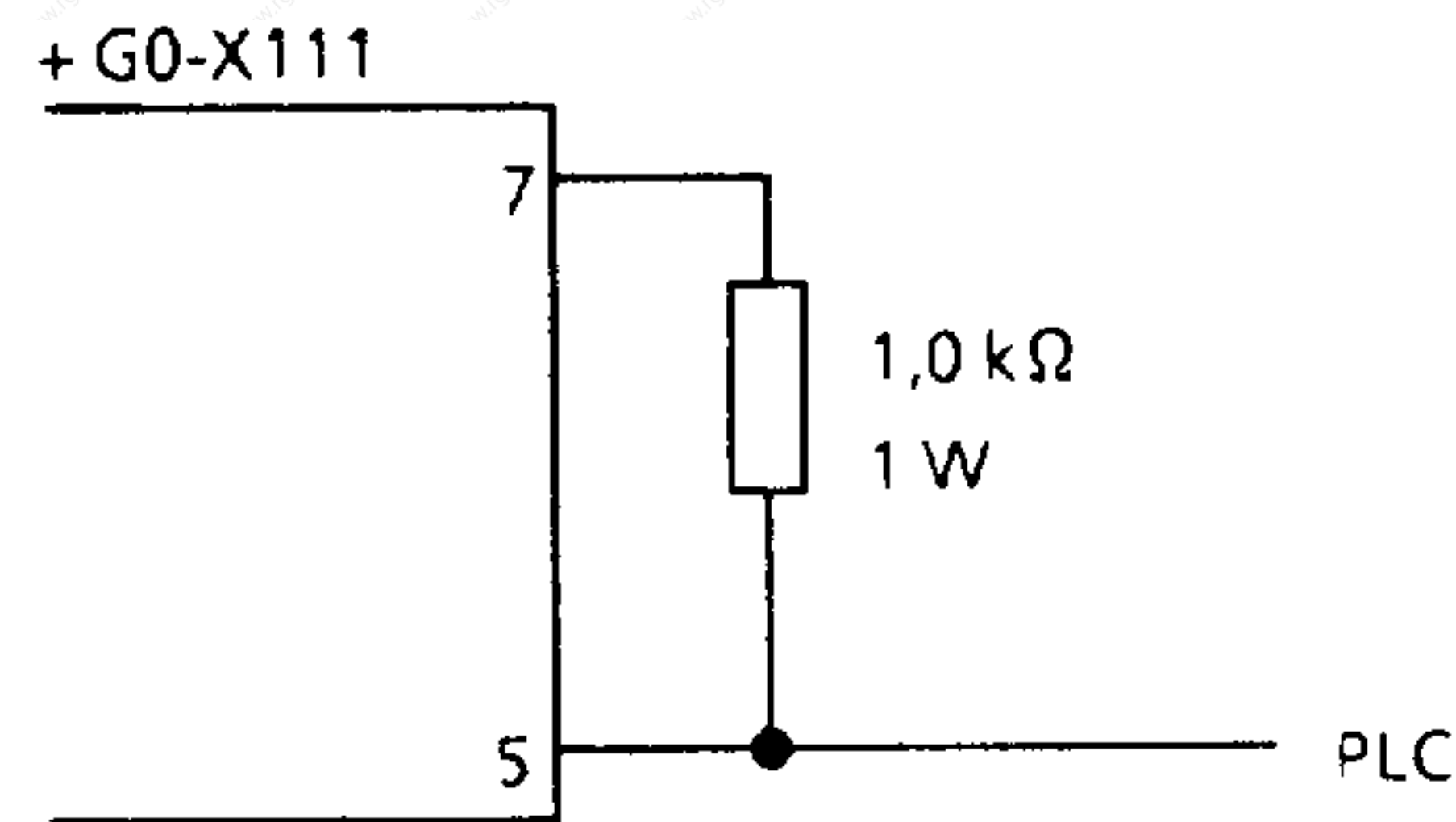


Fig. 3.13 Connection to the PLC  
resistor only necessary with power supplies  
6SC6100-0GA00 and -0GB00

## NOTE

The motor overtemperature indication has no effects in the unit.

The I<sup>2</sup>t indication is followed with a delay by a current reduction to the thermally permissible continuous current of the power section.

The unit does not cut out. To clear the fault indication, the unit must either be switched off or reset.

### 3.3 Test sockets, display elements

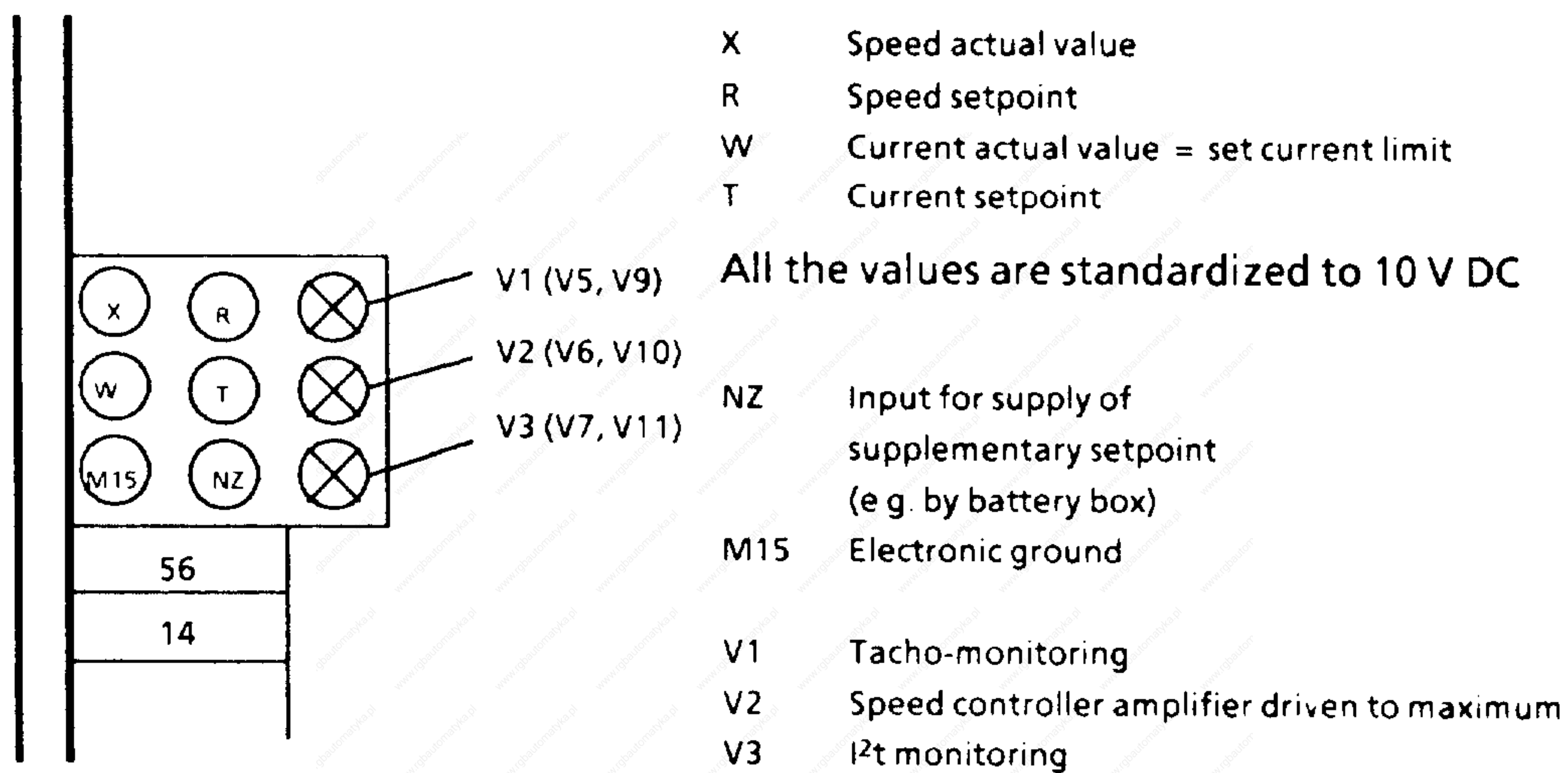
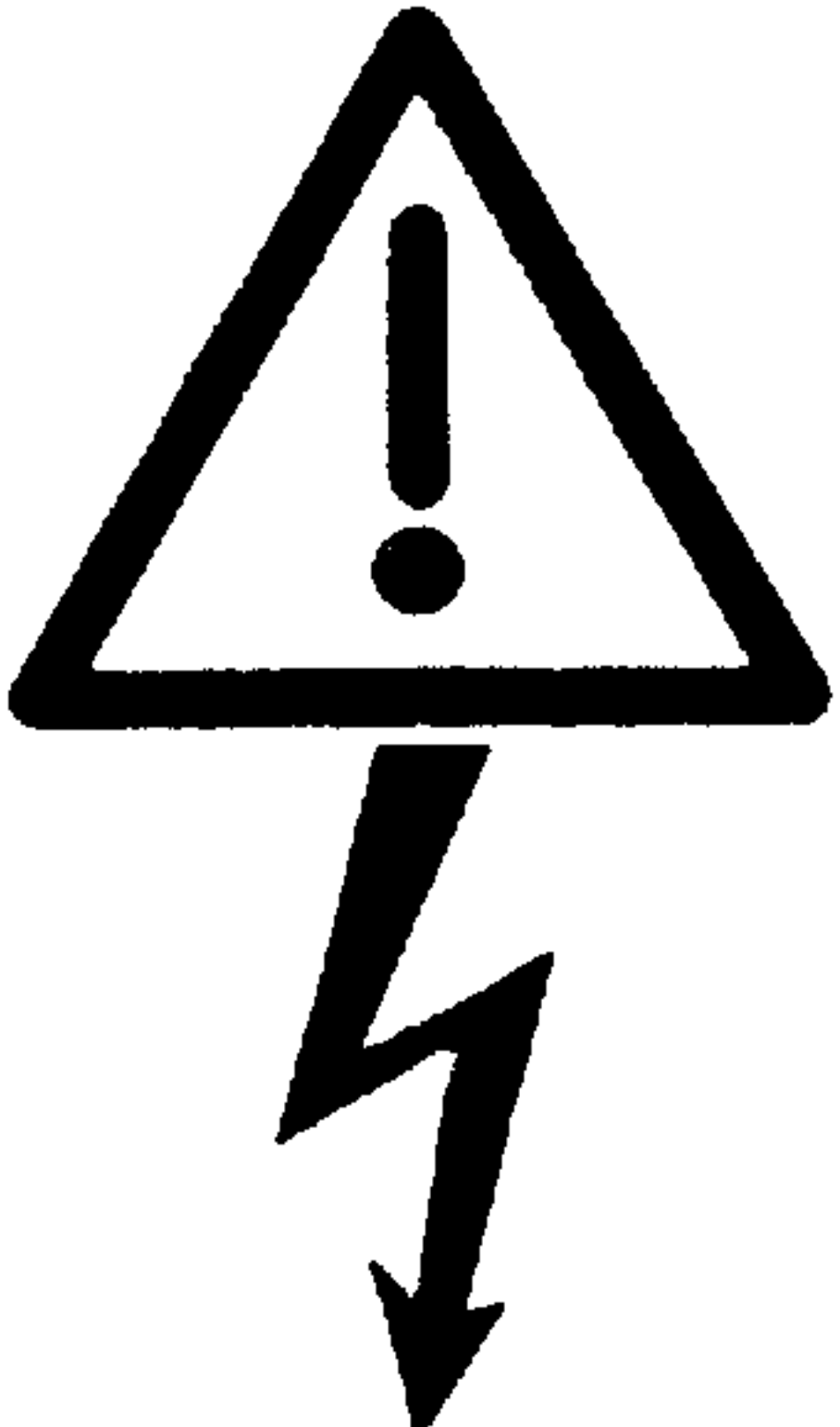


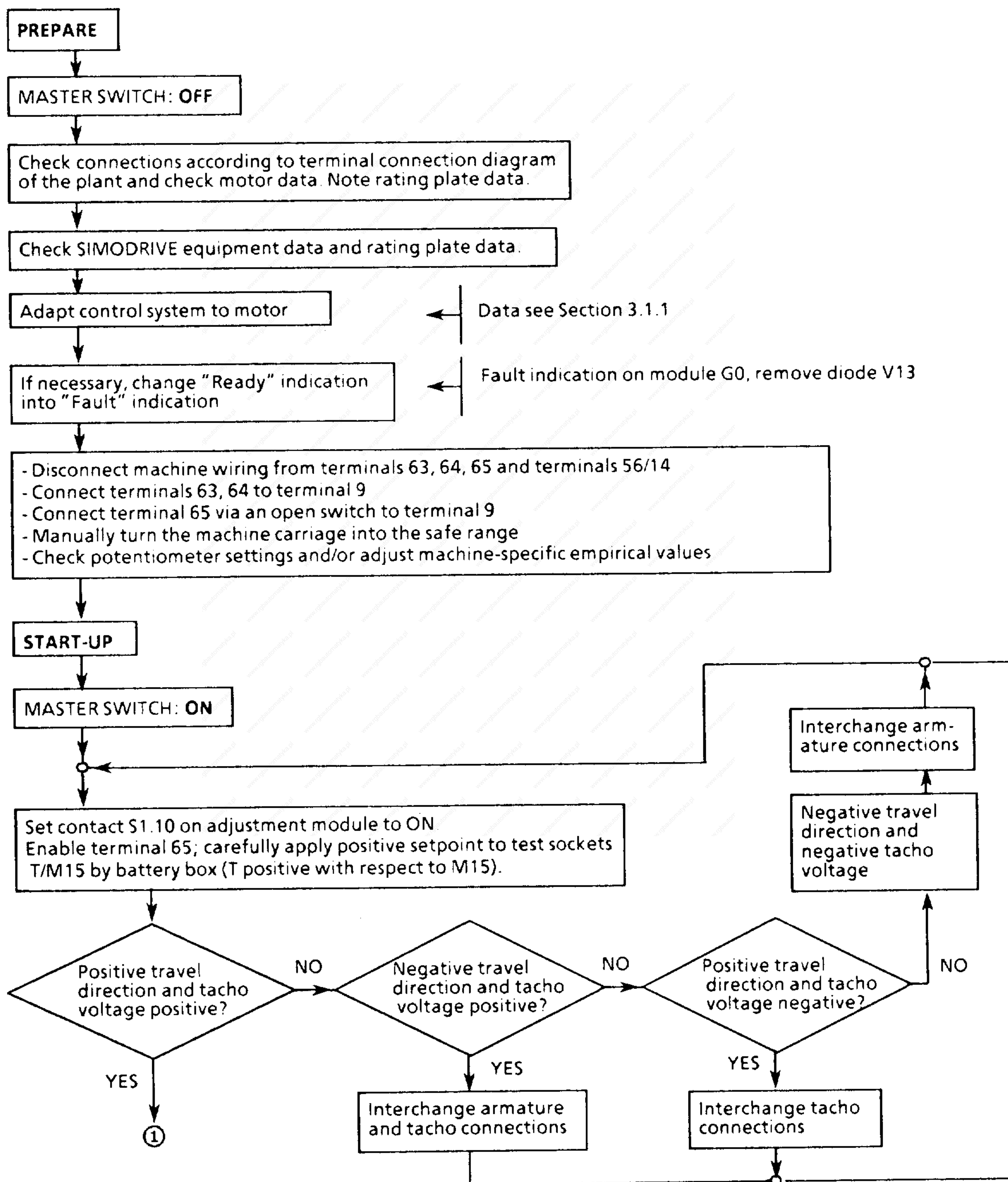
Fig. 3.14 Test sockets and display elements on controller modules N1 and N2

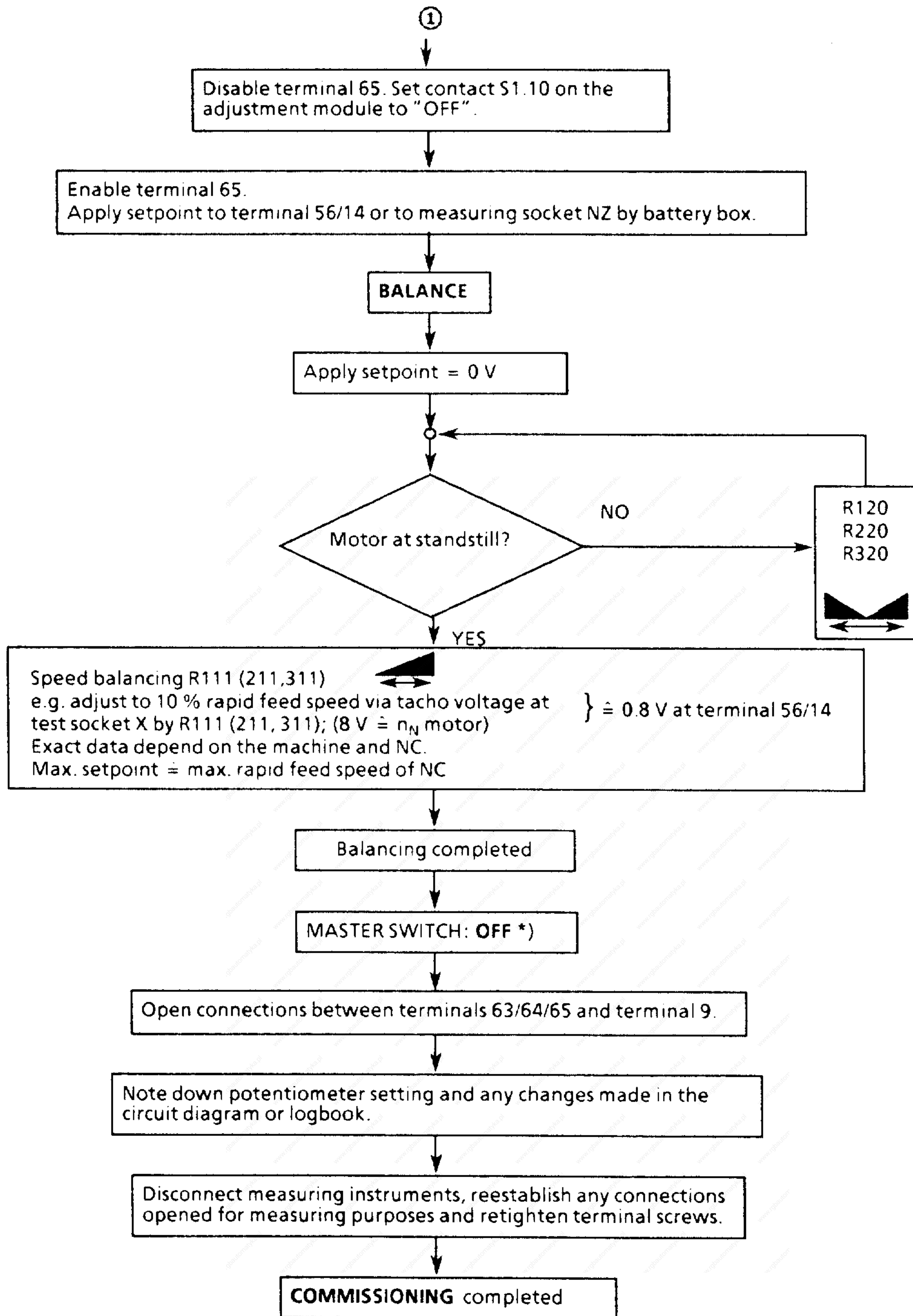



Fig. 3.15 Display elements on power supply module G0

### 3.4 Start-up

|   |  |
|---|--|
|  | <b>WARNING</b>   |
|   | <p>Safe operation is dependent upon proper handling and installation by qualified personnel under observance of all warnings contained in this instruction manual.</p> <p>The DC link capacitors cause high voltage to persist for a short time (about 4 minutes) after disconnection from the supply.</p> <p>Parts of the equipment may be live even when the motor is stationary.</p> <p>Non-observance can result in death, severe personal injury or substantial property damage</p> |





|   |  |
|---|--|
|  | <b>CAUTION</b>   |
|   | <p>In the event of faults, the DC-link circuit is still live for approx. 4 minutes after disconnection of the unit. For this reason the master switch must be opened and the DC-link circuit discharged before any work is carried out on the unit with the cover removed.</p> |

## 4 Maintenance

### WARNING

Hazardous voltages are present in this electrical equipment during operation. Failure to properly maintain the equipment can result in death, severe personal injury or substantial property damage.

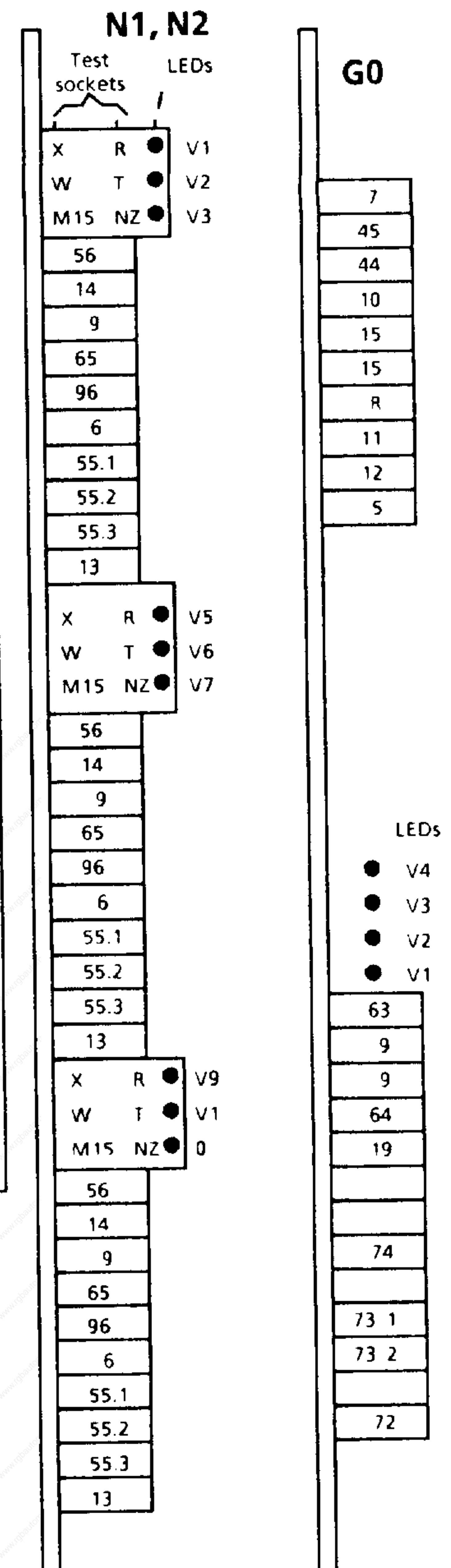
The instructions contained in this chapter and on product labels have to be followed.

- Maintenance shall be performed only by qualified personnel.
- Always de-energize and ground the equipment before maintenance.

The DC-link capacitors cause high voltage to persist for a short time (about 4 minutes) after disconnection from the supply.

Some parts remain live even when the motor is stationary.

Use only authorized spare parts in the repair of the equipment.



Modules for slots N1, N2 and G0

### 4.1 Maintenance instructions

The transistor DC chopper does not require any maintenance.

The bearings of the unit fans are permanently lubricated.

### 4.2 Faults

| Type of fault                                    | Displays               | Meaning | Possible causes  |
|--|------------------------|---------|--|
| Surface finish is poor or inaccurate positioning |                        |         | Motor defective (e.g. does not run smooth at low setpoints), P amplifier of speed controller set too low (potentiometers R125, R225, R325); mutual interference of axes (due to wrong shielding or wrong installation of earth wire) |
| Fuses blow                                       | F10, F110 or F310 blow |         | Fault in power section, check motor<br>Remedial action: Replace module   |
|  | F247                   |         | Fault in power supply and monitoring system or in the DC link voltage monitoring circuit 0.3/30 kW (G10)<br>Remedial action: Replace both modules  |

Table 4.1a

| Type of fault  | Displays  | Meaning  | Possible causes   |
|--|---|--|---|
| Axis does not move even though the reference value is applied to terminal 56 | Green LED + G0-V4 lights up, red LEDs do not light up   | No enabling signal at terminals 63 and/or 64   | Customer's interlocking circuit activated; R20, R21 disconnected  |
|  | No LED lights up  |  | External main fuse blown or not inserted or power supply defective  |
|  | Red LED + G0-V1 lights up, red LEDs (N <sub>0</sub> ) do not light up + G0-V2 lights up + G0-V3 lights up | ± 15 V out of tolerance or not available<br>Voltage of DC-link circuit too high        | Supply voltage too high, load inertia too high, current limit mismatched  |
|  | Red LED + G0-V1 lights up<br>Red LED + N <sub>0</sub> -V1* lights up                                      | Tacho monitoring circuit responded   | Tacho or tacho cable defective  |
|  | Red LED + G0-V1 lights up<br>Red LED + N <sub>0</sub> -V2* lights up                                      | Controller monitoring circuit responded (speed controller amplifier driven to maximum) | Motor line interrupted, mechanical system blocked, power section (A1 to A6) defective, ribbon cable between control and power section defective, motor or tacho connected with wrong polarity                           |
| Axis moves, but unit is de-energized again.                                  | Red LED + G0-V1 lights up<br>Red LED + G0-V3 lights up  | Overvoltage in DC-link circuit during braking  | Load moment of inertia too high, current limit not matched to motor, motor speed exceeds rated speed, resistor for voltage limitation overloaded, no loading by frictional forces, vertical axis without weight balance |
|  | Red LED + G0-V1 lights up<br>Red LED + N <sub>0</sub> -V2* lights up                                      | Acceleration or reversing time exceeds limit value (more than 200 ms)                  | Current limitation set too low or load inertia too high   |
|  | Red LED + N <sub>0</sub> -V3* lights up   | i <sup>2</sup> t monitoring circuit responded  | Effective torque too high, ACC/DEC too often, machining forces too high, motor defective  |

Table 4.1 b

N<sub>0</sub> = N1, N2

+ N<sub>0</sub>-V1\* ⇨ + N<sub>0</sub>-V1/-V5/-V9 ⇨ Tacho monitoring  
+ N<sub>0</sub>-V2\* ⇨ + N<sub>0</sub>-V2/-V6/-V10 ⇨ Speed controller amplifier at maximum  
+ N<sub>0</sub>-V3\* ⇨ + N<sub>0</sub>-V3/-V7/-V11 ⇨ i<sup>2</sup>t monitoring circuit

+ G0 - V1 ⇨ Σ-fault  
+ G0 - V2 ⇨ ± 15 V  
+ G0 - V3 ⇨ U<sub>DC-link</sub> >  
+ G0 - V4 ⇨ Enabling

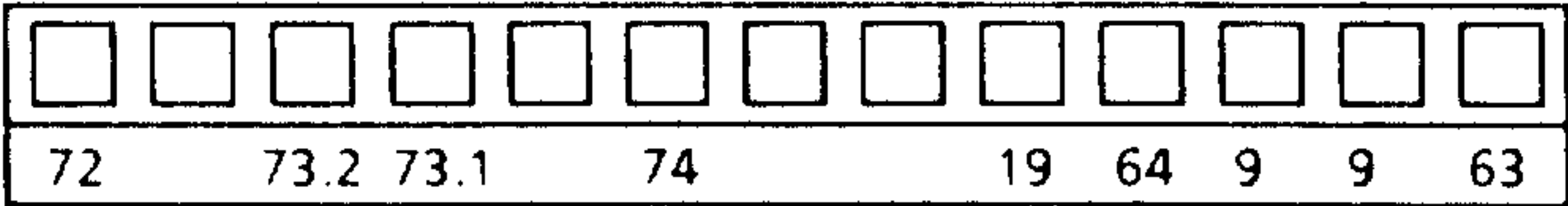
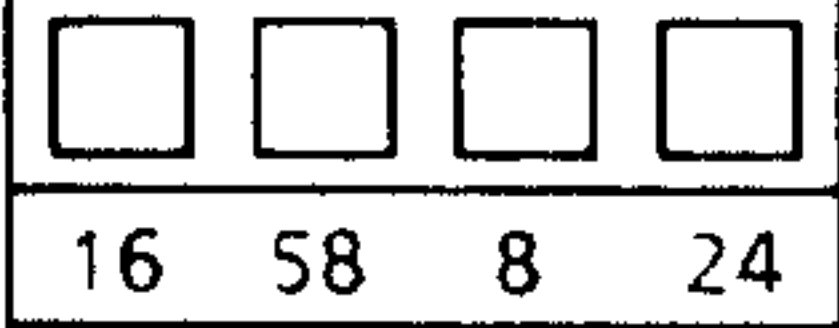
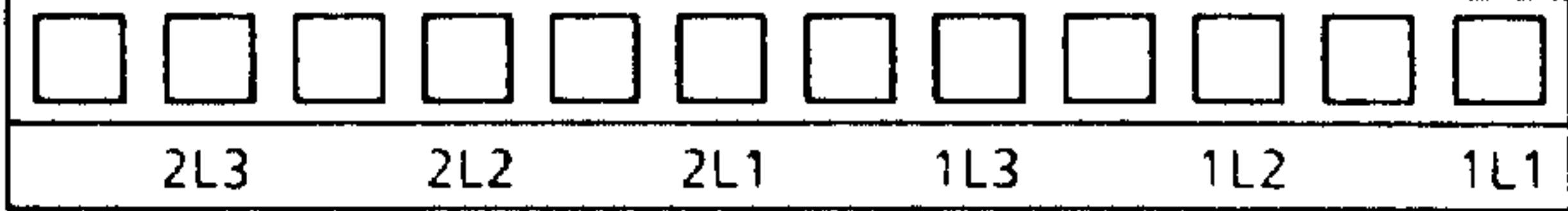
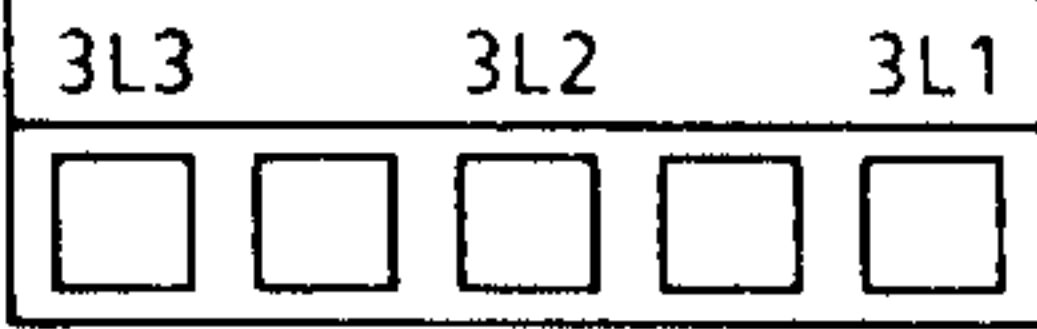
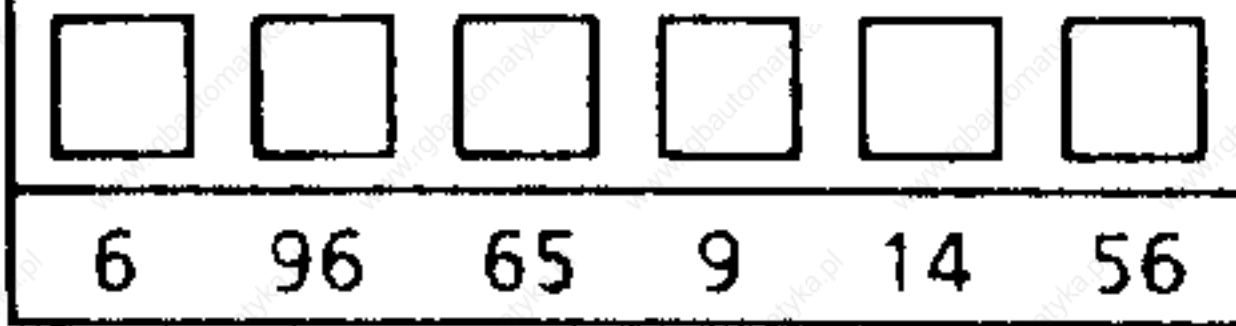
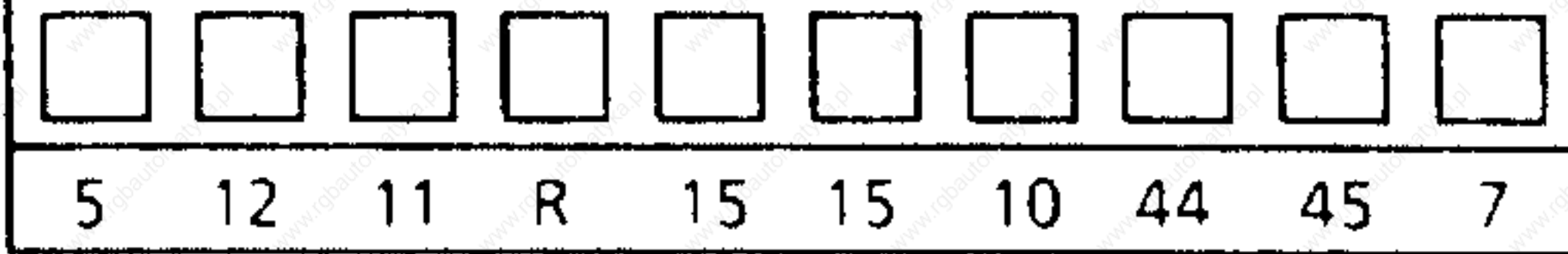
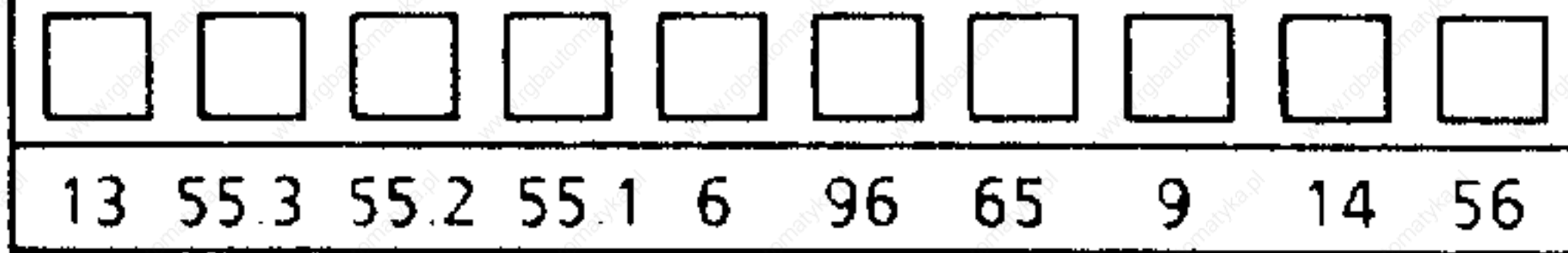
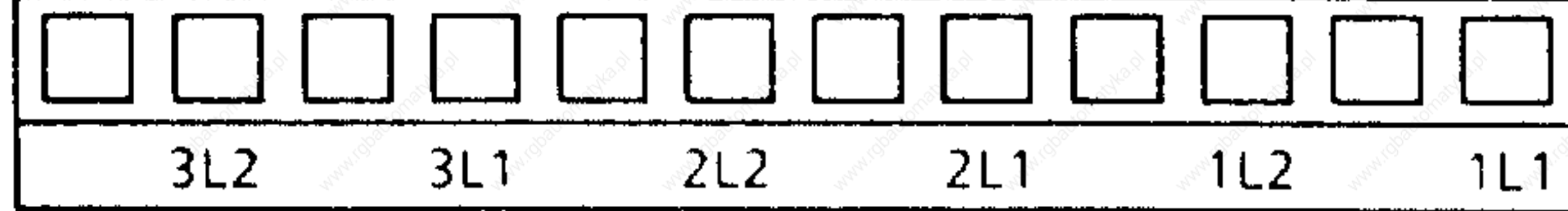
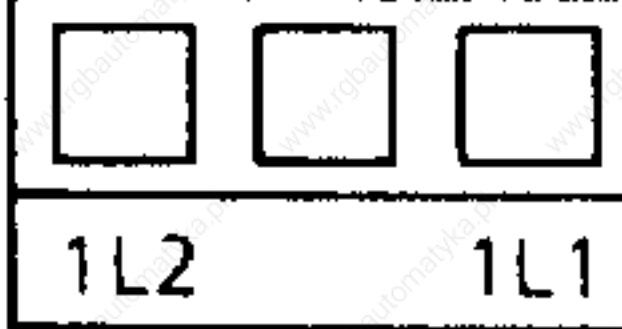
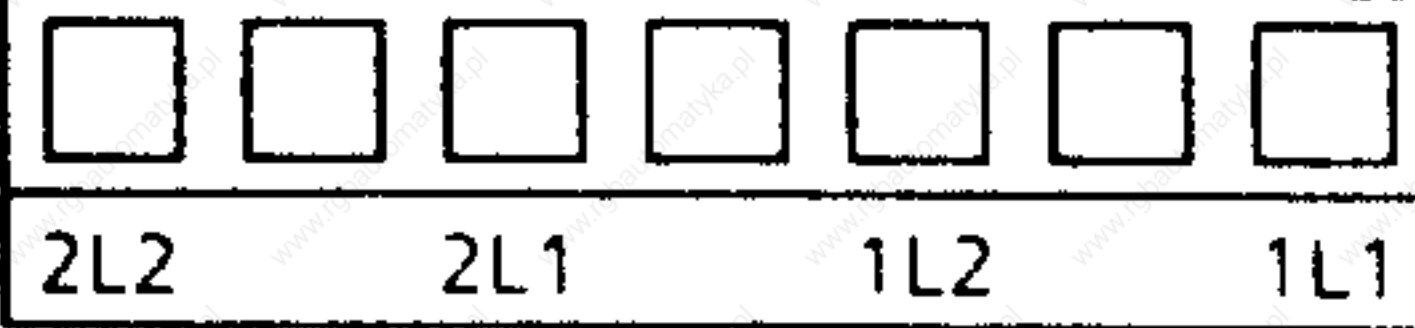
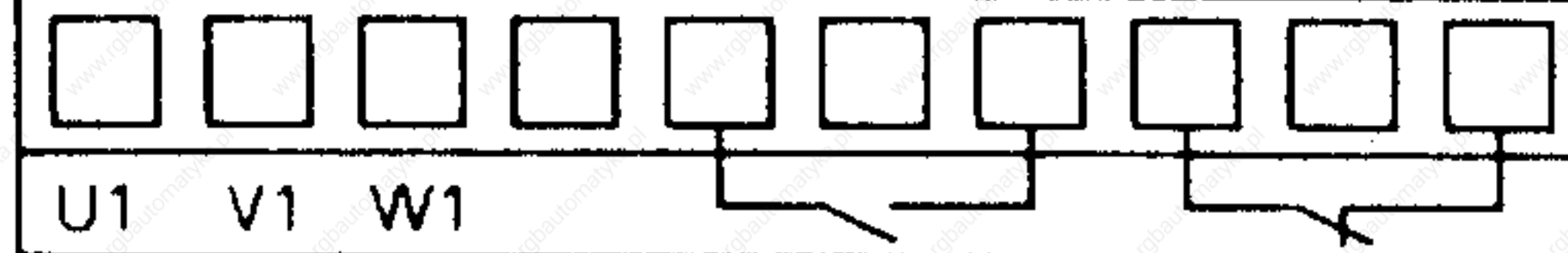
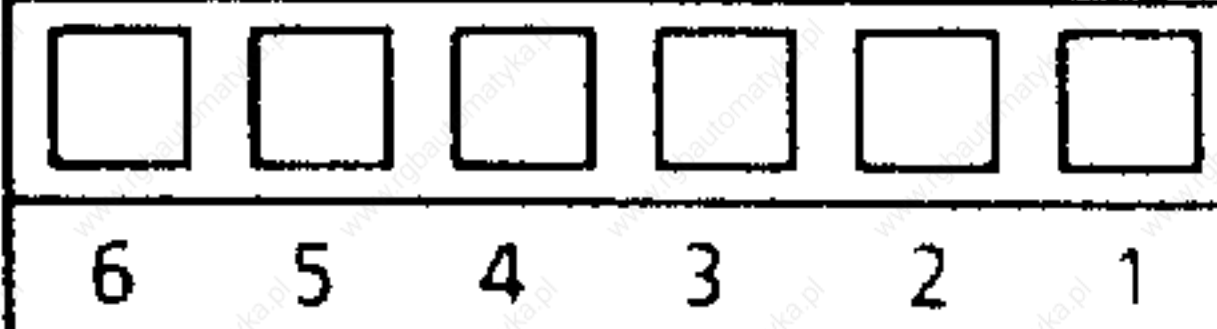


### 4.3 Spare parts

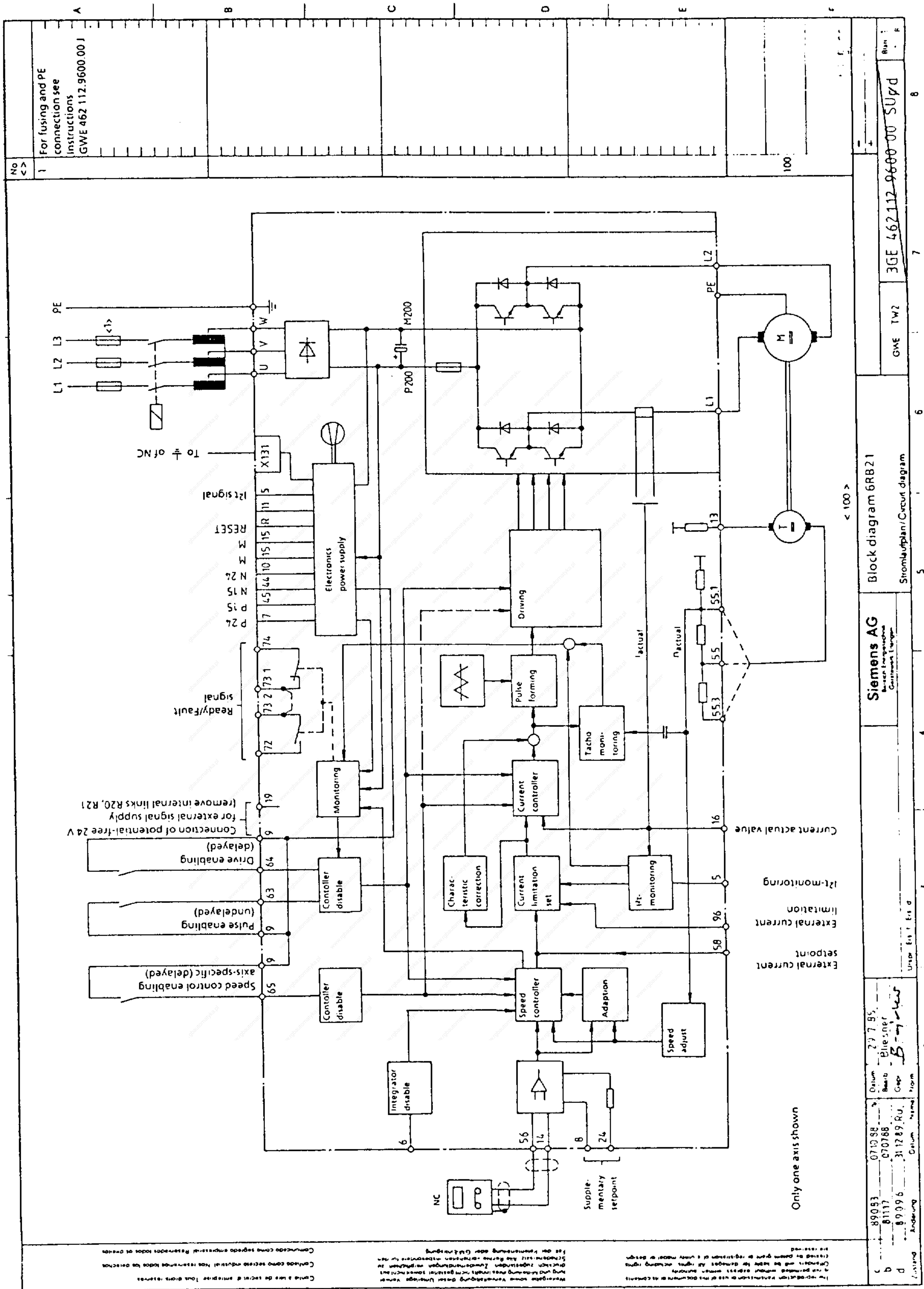
| Function   | Designation  | Order No.   |
|--|--|---|
| Power supply and monitoring  | G0   | 6SC6100-0GA11   |
| Power supply and monitoring including voltage limitation G10 (0.3/30 kW) | G0   | 6SC6100-0GB00   |
| DC-link voltage limitation G20 (0.9/90 kW)                               | A0.2   | 6SC6100-0AB00   |
| Resistor for G10, G20  | -  | 6SY9058   |
| Controller, analog<br>with<br>adjustment module                          | 1 axis<br>2 axes<br>3 axes   | N1, N2<br>6RB2100-0NA01<br>6RB2100-0NA11<br>6RB2100-0NA21   |
| Adjustment module<br>separately  | 1 axis<br>2 axes<br>3 axes   | -<br>6RB2100-0SA01<br>6RB2100-0SA11<br>6RB2100-0SA21  |
| Power modules  | 5/15 A 1 axis<br>5/15 A 2 axes<br>5/15 A 3 axes<br><br>10/30 A 1 axis<br>10/30 A 2 axes<br>10/30 A 3 axes<br><br>20/60 A 1 axis<br>30/90 A 1 axis<br>40/120 A 1 axis<br><br>60/180 A 1/2 axis<br>90/270 A 1/2 axis<br>150/300 A 1/4 axis L+<br>150/300 A 1/4 axis L- | A1 to A 10<br>6RB2105-0SD01<br>6RB2105-0SF01<br>6RB2105-0SG01<br><br>6RB2110-0FD01<br>6RB2110-0FF01<br>6RB2110-0FG01<br><br>6RB2120-0FD01<br>6RB2130-0FD01<br>6RB2140-0FD01<br><br>6RB2160-0FB00<br>6RB2190-0FB00<br>6RB2190-0FA01<br>6RB2190-0FA51 |
| Pulse distributor for 150/300 A power section                            | -  | 6SC6190-0FU00   |
| Rectifier  | 90 A, 180 A  | V0<br>6SY9056   |
| Capacitor  | 6000 µF/350 V  | C0 1 to C0 5<br>6ZY1073-0AA00   |
| Fan  | Type 3314 / 24 V DC  | E0.1 to E0.5<br>6SY9057   |
| Wiring material  | (assembly)   | -<br>6SC6101-0SA00  |
| Wiring accessories   | Control for 1 axis   | -<br>6SC6101-0SA12  |
| Ribbon cable (only for 6RB2101-2A to 6RB2101-4A)                         | 50pole to 3 x 16pole<br>50pole to 1 x 34pole and 1 x 16pole<br>50pole to 1 x 16pole and 1 x 34pole<br>50pole to 50pole   | -<br>6SC6101-0LA00<br>6SC6101-0LA01<br>6SC6101-0LA04<br>6SC6101-0LA05   |

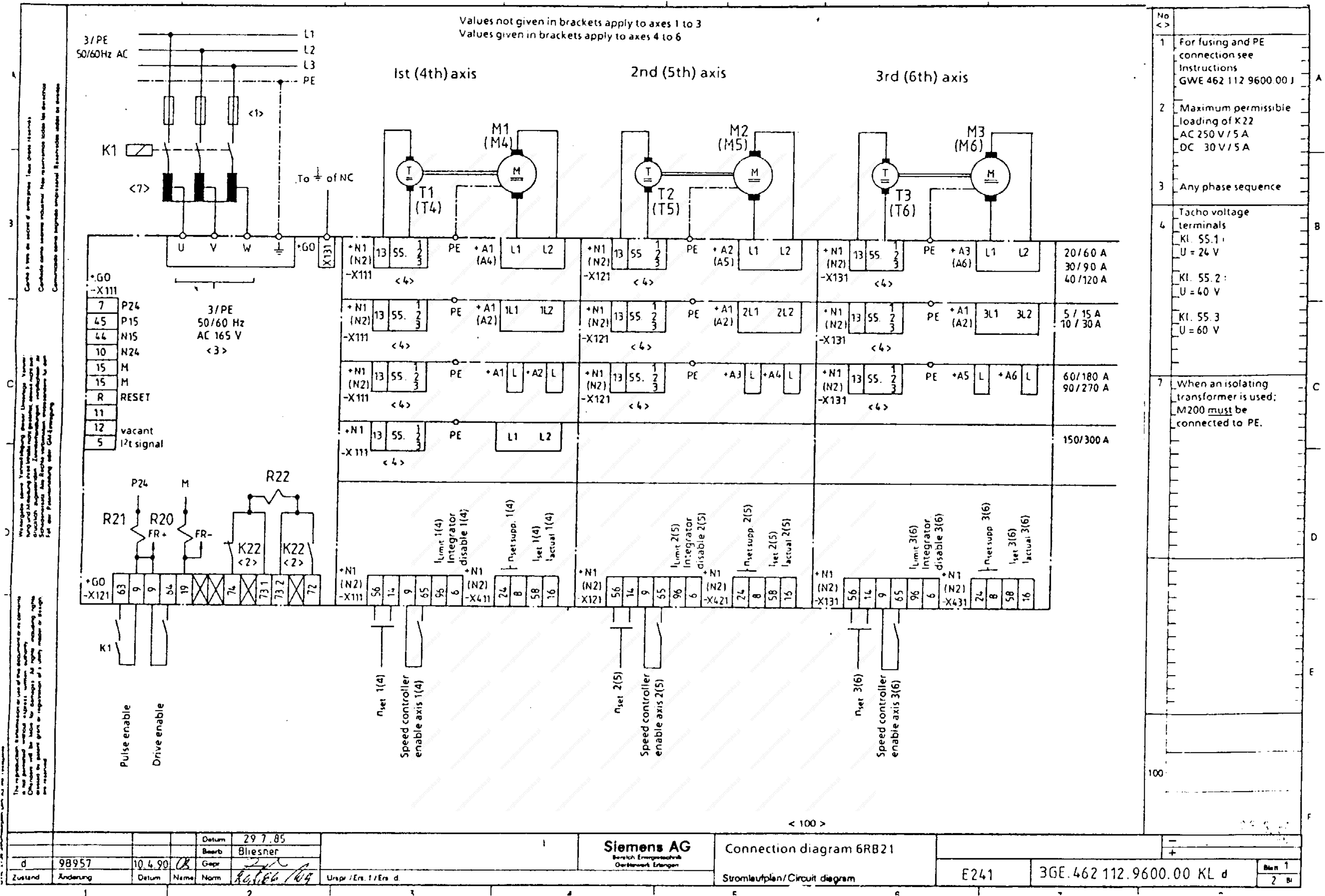
Table 4.2 Spare parts

## 4.4 Connectors

| Version Order No.                | Connectors  | Location                         | Cont. in:      |
|----------------------------------|---|----------------------------------|----------------|
| 462 000.0109.01<br>6SC6101-0XC01 |     | G0<br>X 121                      | 6SC61<br>6RB21 |
| 462 000.0109.02<br>6SC6101-0XC02 |    | N1/N2<br>X 411<br>X 421<br>X 431 | 6SC61<br>6RB21 |
| 462 000.0109.03<br>6SC6101-0XC03 |     | A.<br>X 231                      | 6SC61          |
| 462 000.0109.04<br>6SC6101-0XC04 |    | A.<br>X 232                      | 6SC61          |
| 462 000.0109.05<br>6SC6101-0XC05 |    | N1/N2<br>X 111<br>X 121<br>X 131 | 6SC61          |
| 462 000.0109.06<br>6SC6101-0XC06 |   | G0<br>X 111                      | 6SC61<br>6RB21 |
| 462 000.0109.07<br>6SC6101-0XC07 |   | N1/N2<br>X 111<br>X 121<br>X 131 | 6RB21          |
| 462 000.0109.08<br>6SC6101-0XC08 |   | A.<br>X 231                      | 6RB21          |
| 462 000.0109.09<br>6SC6101-0XC78 |  | A.<br>X 231                      | 6RB21          |
| 462 000.0109.10<br>6SC6101-0XC10 |   | A.<br>X 231                      | 6RB21          |
| 462 000.0109.11<br>6SC6101-0XC11 |   | A 0.3<br>X 126                   | 6SC61<br>6RB21 |
| 462 000.0109.12<br>6SC6101-0XC12 |   | A 0.2<br>X 501                   | 6SC61<br>6RB21 |

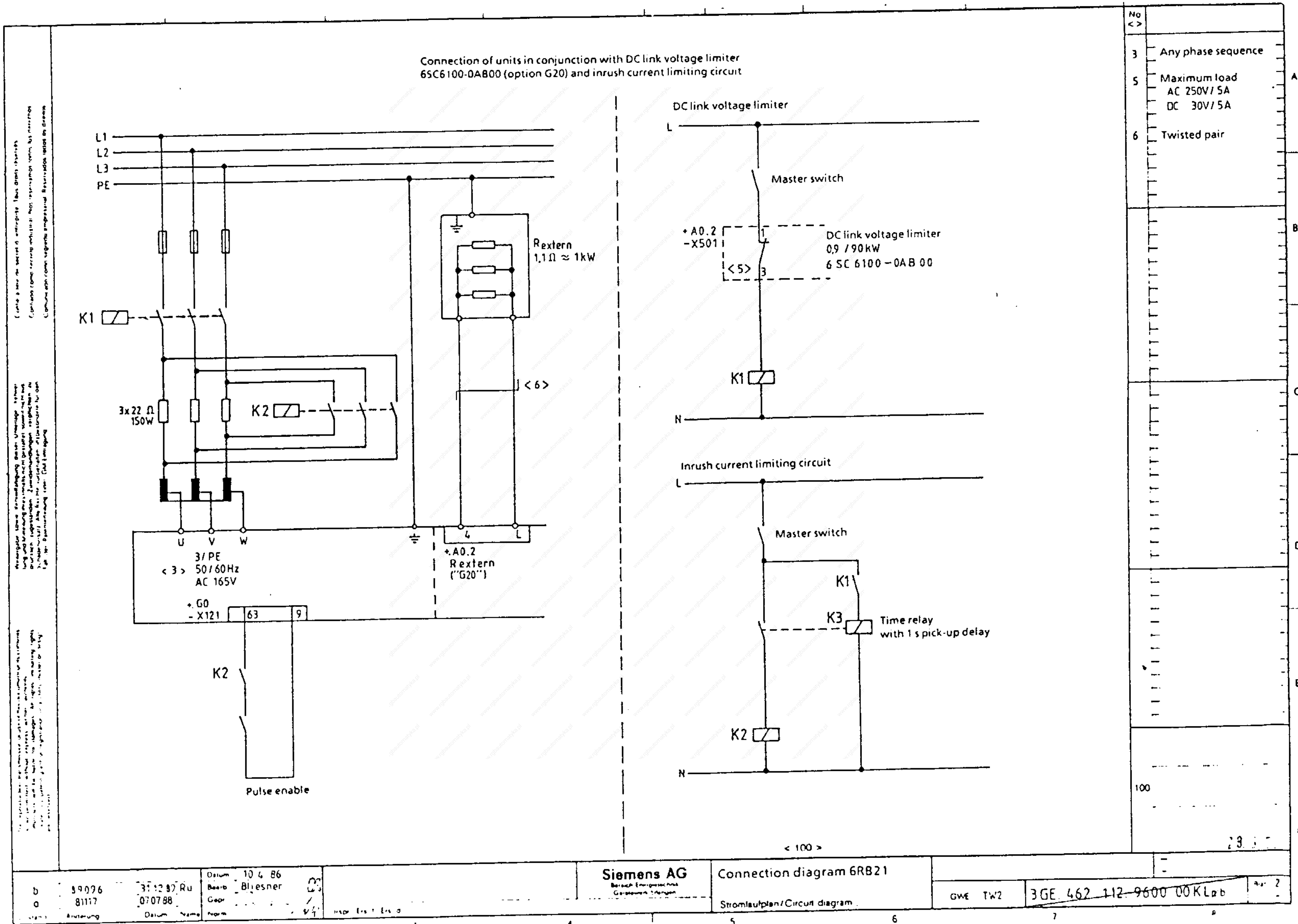
# 5 Block diagram





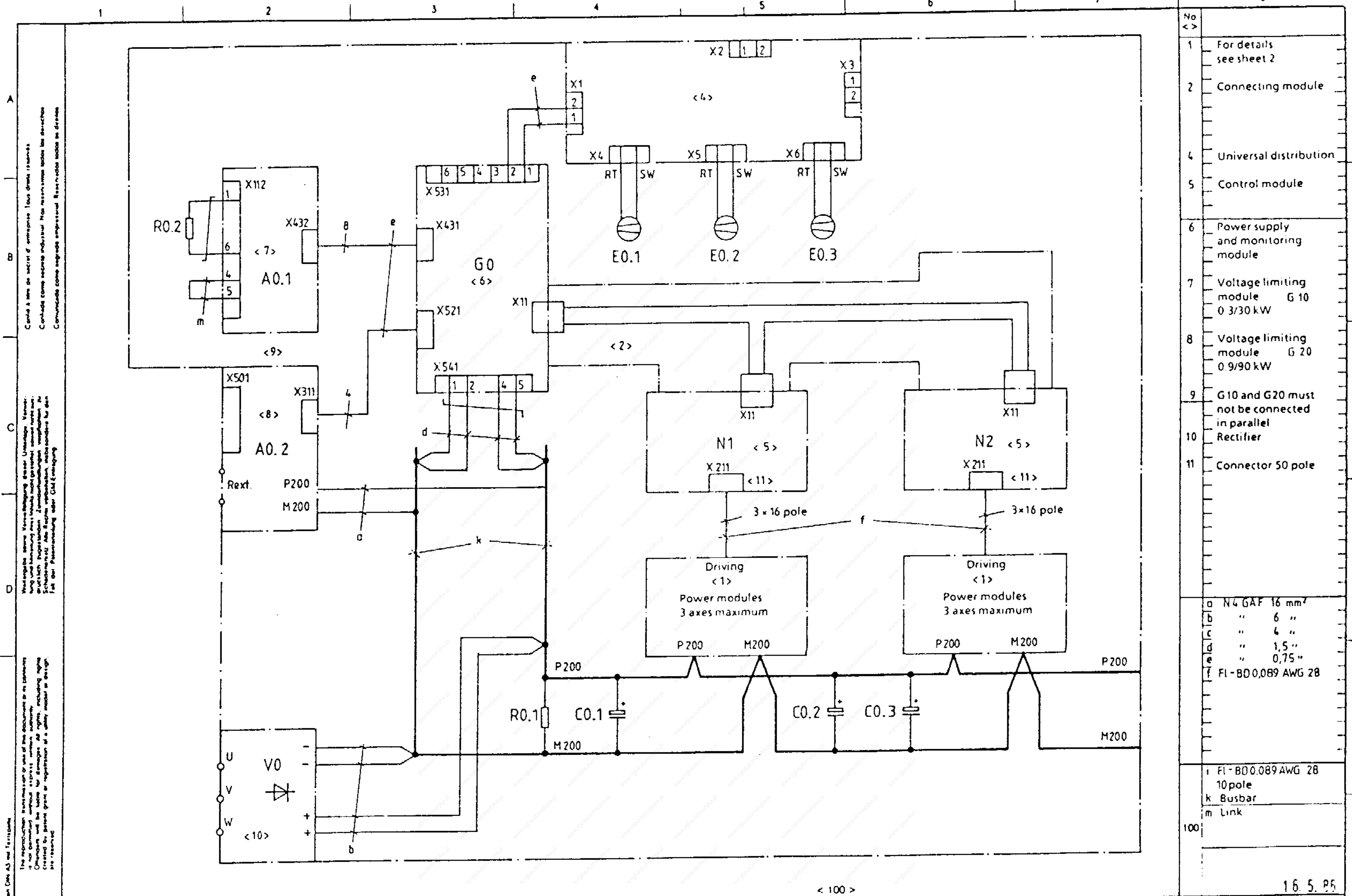
6 Terminal connection diagram

|                      |  |            |  |                               |  |      |  |                          |  |         |  |
|----------------------|--|------------|--|-------------------------------|--|------|--|--------------------------|--|---------|--|
| Date: 29.7.85        |  | Siemens AG |  | Connection diagram 6RB21      |  | E241 |  | 3GE.462.112.9600.00 KL d |  | Blatt 1 |  |
| Drawn: Bliesner      |  | Siemens AG |  | Stromlaufplan/Circuit diagram |  | E241 |  | 3GE.462.112.9600.00 KL d |  | Blatt 2 |  |
| Checked: [Signature] |  | Siemens AG |  | Stromlaufplan/Circuit diagram |  | E241 |  | 3GE.462.112.9600.00 KL d |  | Blatt 2 |  |
| Version: 10.4.90     |  | Siemens AG |  | Stromlaufplan/Circuit diagram |  | E241 |  | 3GE.462.112.9600.00 KL d |  | Blatt 2 |  |
| Author: [Signature]  |  | Siemens AG |  | Stromlaufplan/Circuit diagram |  | E241 |  | 3GE.462.112.9600.00 KL d |  | Blatt 2 |  |
| Norm: [Signature]    |  | Siemens AG |  | Stromlaufplan/Circuit diagram |  | E241 |  | 3GE.462.112.9600.00 KL d |  | Blatt 2 |  |
| Urspr./Ent./Erst d.  |  | Siemens AG |  | Stromlaufplan/Circuit diagram |  | E241 |  | 3GE.462.112.9600.00 KL d |  | Blatt 2 |  |



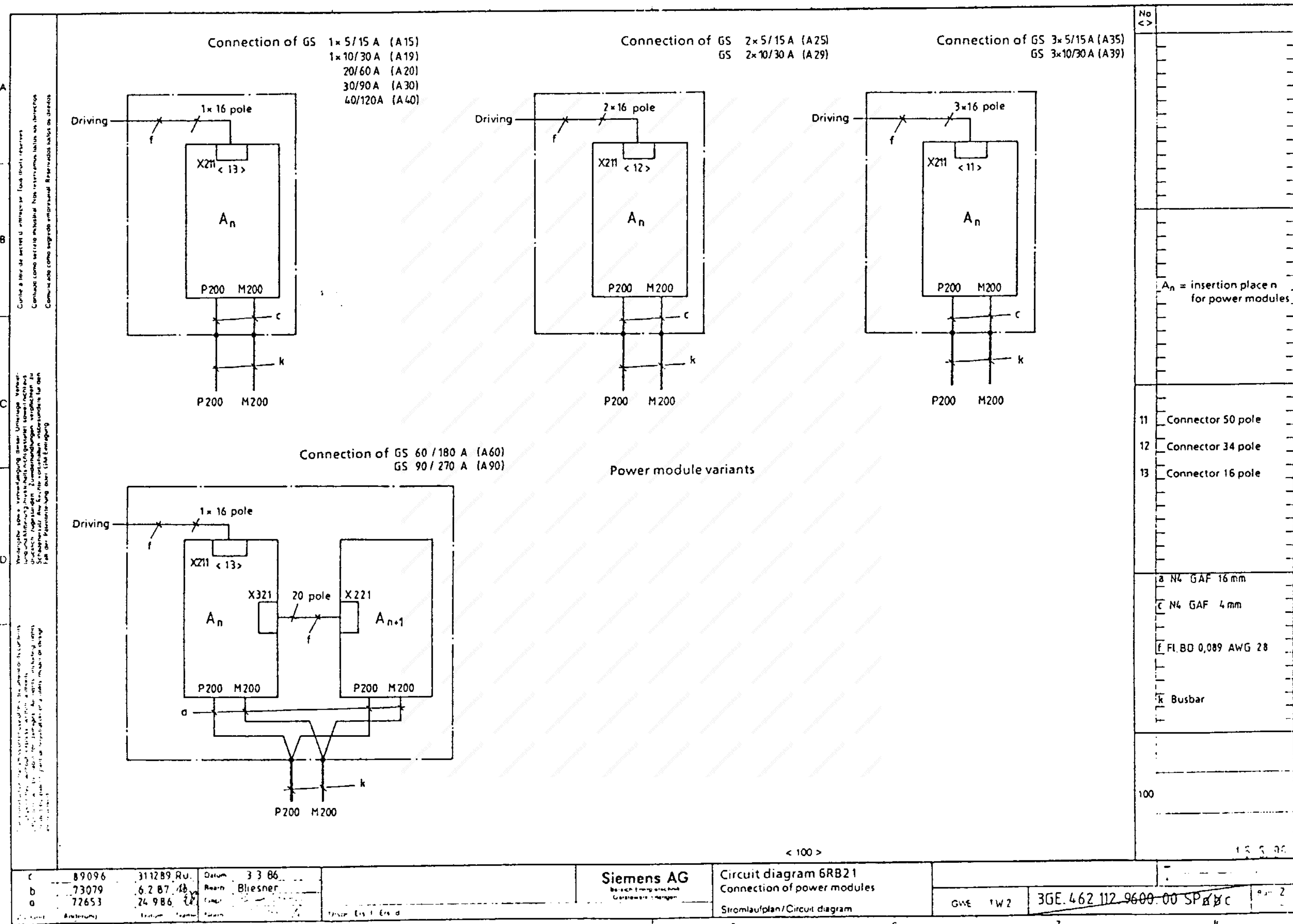
|                    |                         |  |   |   |                                 |       |
|--------------------|-------------------------|--|---|---|---------------------------------|-------|
| b 39026<br>o 81117 | 31.12.87 Ru<br>07.07.88 | Datum 10.6.86<br>Bearb. Blesner<br>Gepr. | <b>Siemens AG</b><br>Siemens AG<br>Siemens AG | Connection diagram 6RB21<br>Stromlaufplan/Circuit diagram | GWE TW2 3GE 462 112-9600 00KLab | No. 2 |
|--------------------|-------------------------|--|---|---|---------------------------------|-------|

# 7 Circuit diagram

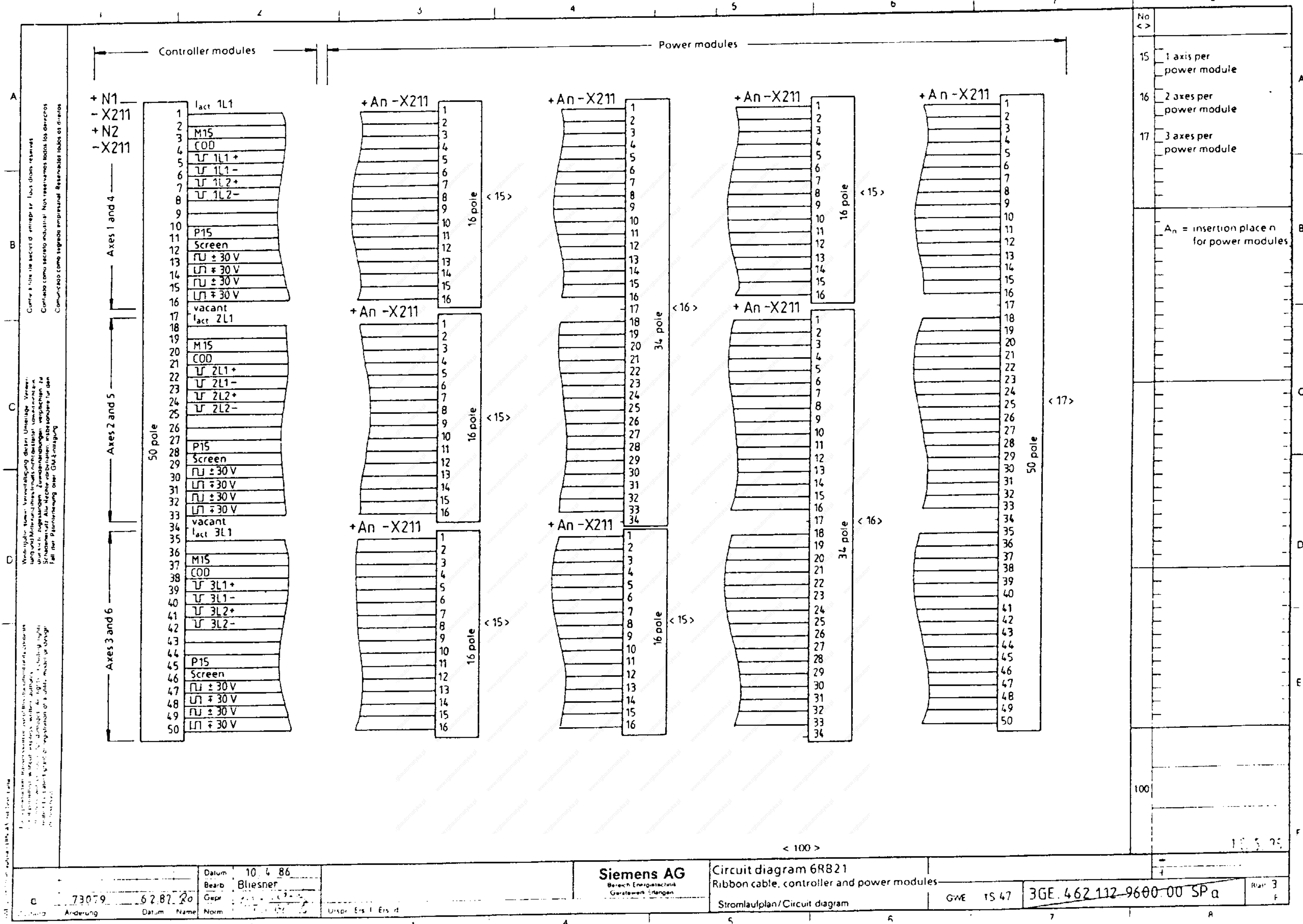


|     |    |   |
|-----|----|---|
| No  | <> |   |
| 1   |    | For details see sheet 2                       |
| 2   |    | Connecting module                             |
| 4   |    | Universal distribution                        |
| 5   |    | Control module                                |
| 6   |    | Power supply and monitoring module            |
| 7   |    | Voltage limiting module G 10<br>0.3/30 kW     |
| 8   |    | Voltage limiting module G 20<br>0.9/90 kW     |
| 9   |    | G10 and G20 must not be connected in parallel |
| 10  |    | Rectifier                                     |
| 11  |    | Connector 50 pole                             |
| a   |    | N4 GAF 16 mm <sup>2</sup>                     |
| b   |    | " 6 "   |
| c   |    | " 4 "   |
| d   |    | " 1.5 "                                       |
| e   |    | " 0.75 "                                      |
| f   |    | FI-BD0.089 AWG 28                             |
| i   |    | FI-BD0.089 AWG 28<br>10 pole                  |
| k   |    | Busbar  |
| m   |    | Link  |
| 100 |    |   |
|     |    | 16.5.85                                       |

|   |       |          |                          |        |          |       |        |   |       |        |    |      |          |   |       |          |    |      |  |   |  |  |  |                                    |  |
|---|-------|----------|--------------------------|--------|----------|-------|--------|---|-------|--------|----|------|----------|---|-------|----------|----|------|--|---|--|--|--|------------------------------------|--|
| <table border="1"> <tr> <td>c</td> <td>82331</td> <td>050988</td> <td>Gd</td> <td>Datum</td> <td>3.3.86</td> </tr> <tr> <td>d</td> <td>73079</td> <td>6.2.87</td> <td>Ro</td> <td>Beib</td> <td>Bliesner</td> </tr> <tr> <td>b</td> <td>85095</td> <td>31.12.83</td> <td>Ru</td> <td>Gepr</td> <td></td> </tr> </table> |       | c        | 82331                    | 050988 | Gd       | Datum | 3.3.86 | d | 73079 | 6.2.87 | Ro | Beib | Bliesner | b | 85095 | 31.12.83 | Ru | Gepr |  | <b>Siemens AG</b><br>Bereich Energietechnik<br>Geseamw. Anlagen |  | Circuit diagram 6RB21<br>Stromlaufplan/Circuit diagram |  | GWE TW2 3GE 462 112 9600 00 SP dxd |  |
| c   | 82331 | 050988   | Gd                       | Datum  | 3.3.86   |       |        |   |       |        |    |      |          |   |       |          |    |      |  |   |  |  |  |                                    |  |
| d   | 73079 | 6.2.87   | Ro                       | Beib   | Bliesner |       |        |   |       |        |    |      |          |   |       |          |    |      |  |   |  |  |  |                                    |  |
| b   | 85095 | 31.12.83 | Ru                       | Gepr   |          |       |        |   |       |        |    |      |          |   |       |          |    |      |  |   |  |  |  |                                    |  |
| Zustand   |       |          | Ers 1 462 019 7066 00 SP |        |          |       |        |   |       |        |    |      |          |   |       |          |    |      |  |   |  |  |  |                                    |  |

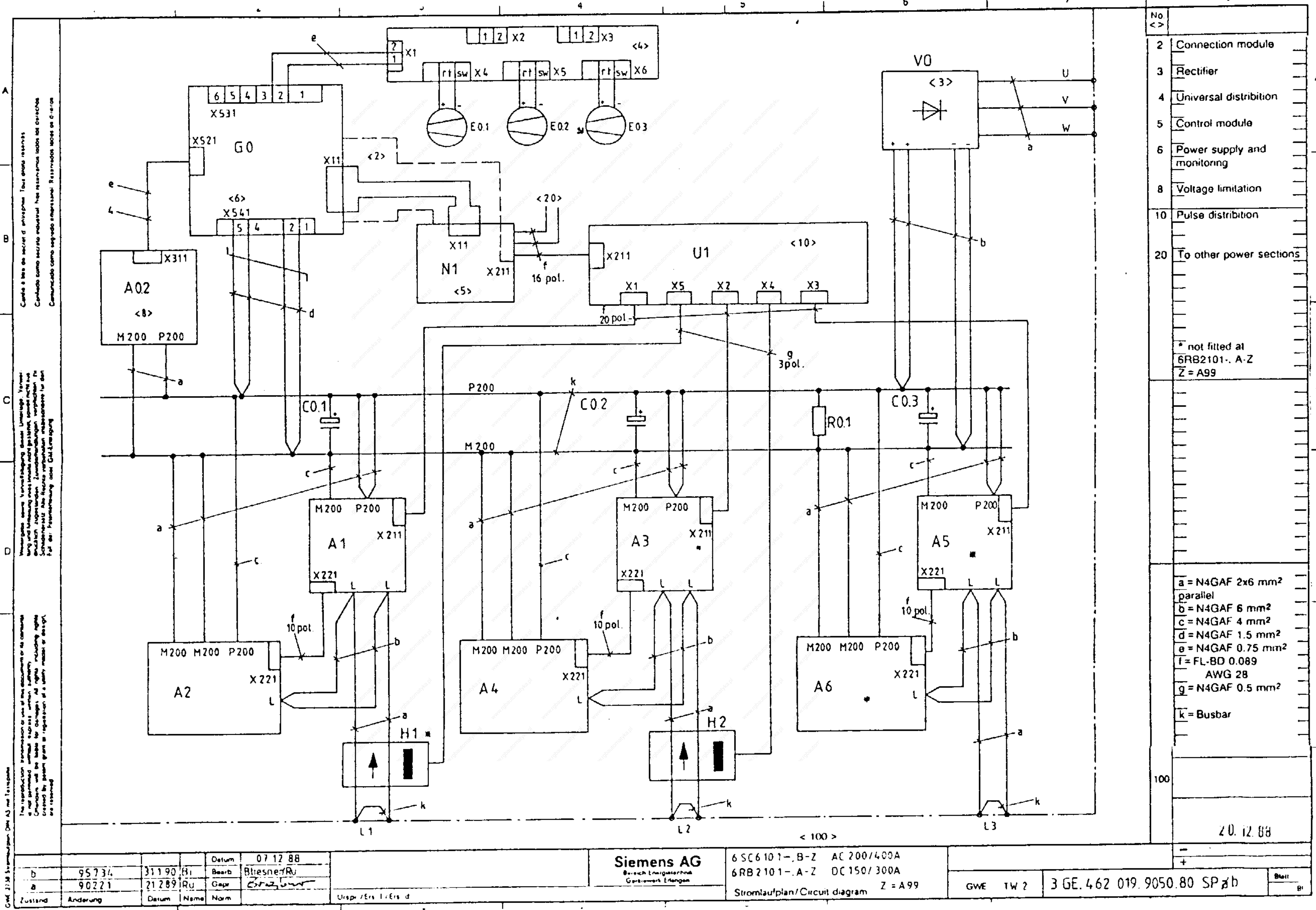


|   |       |           |       |          |  |   |         |                              |   |
|---|-------|-----------|-------|----------|--|---|---------|------------------------------|---|
| c | 89096 | 311289.RU | Datum | 3.3.86   | Siemens AG<br>Bosch Engineering<br>Customer Center | Circuit diagram 6RB21<br>Connection of power modules<br>Stromlaufplan/Circuit diagram | GWE 1W2 | 3GE.462.112.9600.00 SP d B C | 2 |
| b | 73079 | 6.2.87.18 | Revis | Bliesner |  |   |         |                              |   |
| a | 72653 | 24.9.86   | Erst  |          |  |   |         |                              |   |



|          |  |          |  |         |  |          |  |                         |  |                               |  |                     |  |                       |  |  |  |           |  |                          |  |         |  |
|----------|--|----------|--|---------|--|----------|--|-------------------------|--|-------------------------------|--|---------------------|--|-----------------------|--|--|--|-----------|--|--------------------------|--|---------|--|
| 73079    |  | 62.87.20 |  | 10.4.86 |  | Bliesner |  | Siemens AG              |  | Bereich Energietechnik        |  | Gerätebau, Erlangen |  | Circuit diagram 6RB21 |  | Ribbon cable, controller and power modules |  | GWE 1S 47 |  | 3GE.462.112-9600-00 SP a |  | Blatt 3 |  |
| Änderung |  | Datum    |  | Name    |  | Norm     |  | Urspr. Ers. I. Ers. II. |  | Stromlaufplan/Circuit diagram |  |                     |  |                       |  |  |  |           |  |                          |  |         |  |

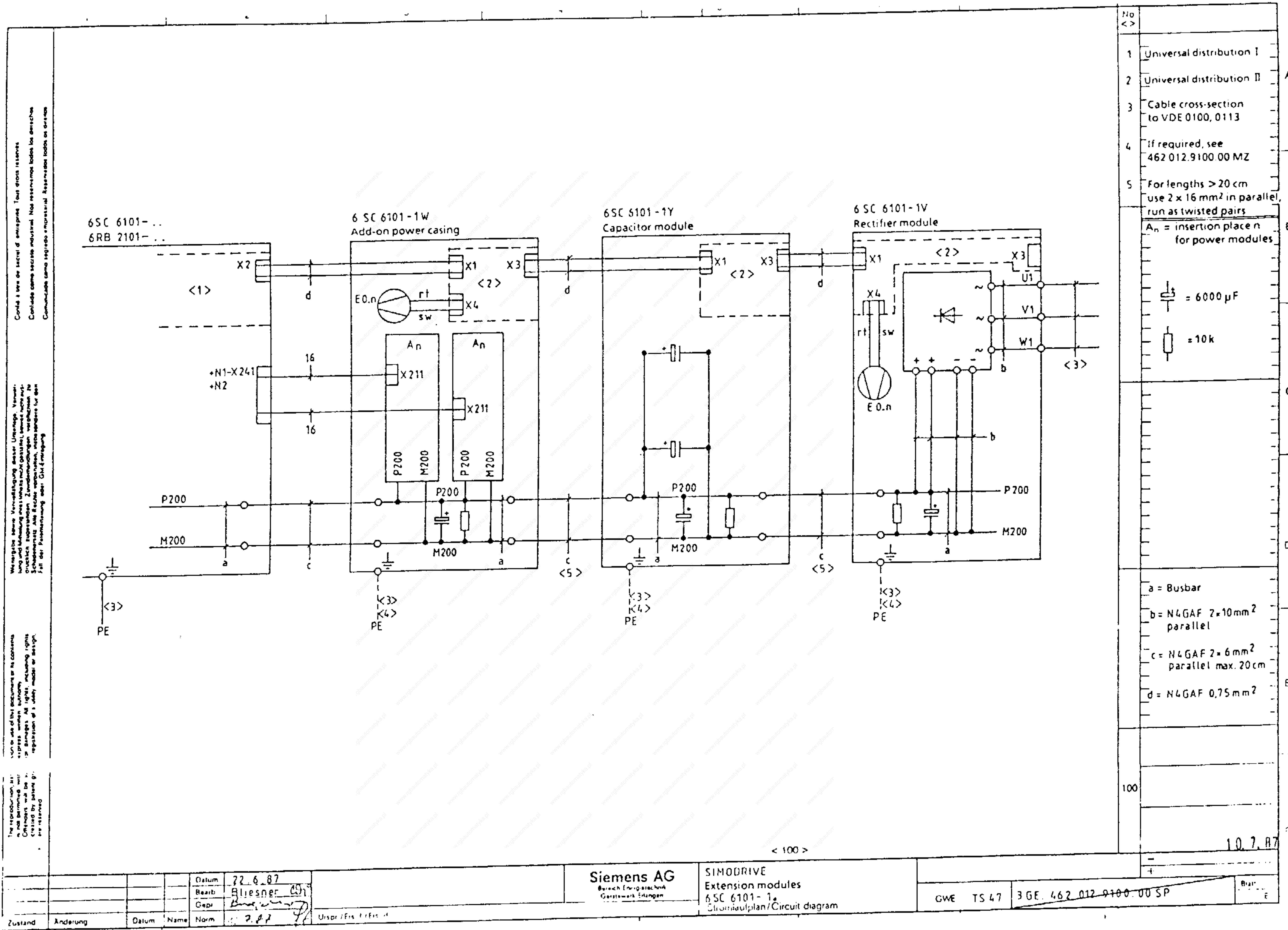




Cambio a lista de accesorios individual. Para obtener más detalles consulte el manual de instrucciones.   
 Cambio como accesorio individual. Para obtener más detalles consulte el manual de instrucciones.   
 Communicado como accesorio individual. Para obtener más detalles consulte el manual de instrucciones.   
 Einzelteile werden Vervielfältigung dieser Leistungsversorgungs- und Messungseinheiten nicht zulässig, sondern nur als Ersatzteile für die Reparatur der entsprechenden Einheiten.   
 The reproduction, transmission or use of this document or its contents is not permitted without explicit written authority.   
 Reproduktion, Verbreitung oder Gebrauch dieses Dokuments ist ohne schriftliche Genehmigung der Siemens AG nicht zulässig.

|  |    |                             |
|--|----|-----------------------------|
| No.  | <> |                             |
| 2  |    | Connection module           |
| 3  |    | Rectifier                   |
| 4  |    | Universal distribution      |
| 5  |    | Control module              |
| 6  |    | Power supply and monitoring |
| 8  |    | Voltage limitation          |
| 10   |    | Pulse distribution          |
| 20   |    | To other power sections     |
| * not fitted at 6RB2101-. A-Z<br>Z = A99   |    |                             |
| a = N4GAF 2x6 mm <sup>2</sup> parallel<br>b = N4GAF 6 mm <sup>2</sup><br>c = N4GAF 4 mm <sup>2</sup><br>d = N4GAF 1.5 mm <sup>2</sup><br>e = N4GAF 0.75 mm <sup>2</sup><br>f = FL-BD 0.089 AWG 28<br>g = N4GAF 0.5 mm <sup>2</sup><br>k = Busbar |    |                             |
| 100  |    |                             |
|  |    | 20.12.88                    |

|                    |          |                             |      |                                       |  |          |  |                             |  |
|--------------------|----------|-----------------------------|------|---------------------------------------|--|----------|--|-----------------------------|--|
| Datum: 07.12.88    |          | Siemens AG                  |      | 6SC6101-.B-Z AC 200/400A              |  | GWE TW ? |  | 3 GE.462.019.9050.80 SP ÷ b |  |
| Bearb: Bliesner/Ru |          | Bereich Leistungselektronik |      | 6RB2101-.A-Z DC 150/300A              |  |          |  |                             |  |
| Gepr: [Signature]  |          | Göteborg Erlangen           |      | Stromlaufplan/Circuit diagram Z = A99 |  |          |  |                             |  |
| Zustand            | Änderung | Datum                       | Name | Urspr./Ers. 1./Ers. d.                |  |          |  |                             |  |
| b                  | 95734    | 31.1.90                     | Ru   |                                       |  |          |  |                             |  |
| a                  | 90221    | 21.2.89                     | Ru   |                                       |  |          |  |                             |  |



Conecte a una línea de salida de energía. Tenga en cuenta las leyes locales y nacionales. No se reservan todos los derechos. Comunicarse como se indica en el manual. Reservados todos los derechos.

Wichtigste Hinweise: Vor der Montage des Moduls muss die Stromversorgung des Moduls sichergestellt sein. Die Montage muss durch einen qualifizierten Fachmann durchgeführt werden. Die Montageanleitung muss gelesen werden. Die Montageanleitung ist Teil der Produktdokumentation. Bei Fragen wenden Sie sich an den Kundendienst.

Important notes: The power supply of the extension module must be ensured before installation. The installation must be carried out by a qualified person. The installation instructions must be read. The installation instructions are part of the product documentation. In case of questions, contact the service department.

Observe the following: The power supply of the extension module must be ensured before installation. The installation must be carried out by a qualified person. The installation instructions must be read. The installation instructions are part of the product documentation. In case of questions, contact the service department.

|   |  |
|---|--|
| No  | <>   |
| 1   | Universal distribution I   |
| 2   | Universal distribution II  |
| 3   | Cable cross-section to VDE 0100, 0113  |
| 4   | If required, see 462 012 9100 00 MZ  |
| 5   | For lengths > 20 cm use 2 x 16 mm <sup>2</sup> in parallel, run as twisted pairs |
| A <sub>n</sub> = insertion place n for power modules  |  |
| = 6000 µF<br>= 10 k   |  |
| a = Busbar<br>b = N4 GAF 2 x 10 mm <sup>2</sup> parallel<br>c = N4 GAF 2 x 6 mm <sup>2</sup> parallel max. 20 cm<br>d = N4 GAF 0,75 mm <sup>2</sup> |  |
| 100   |  |
| 1.0.7.R7  |  |

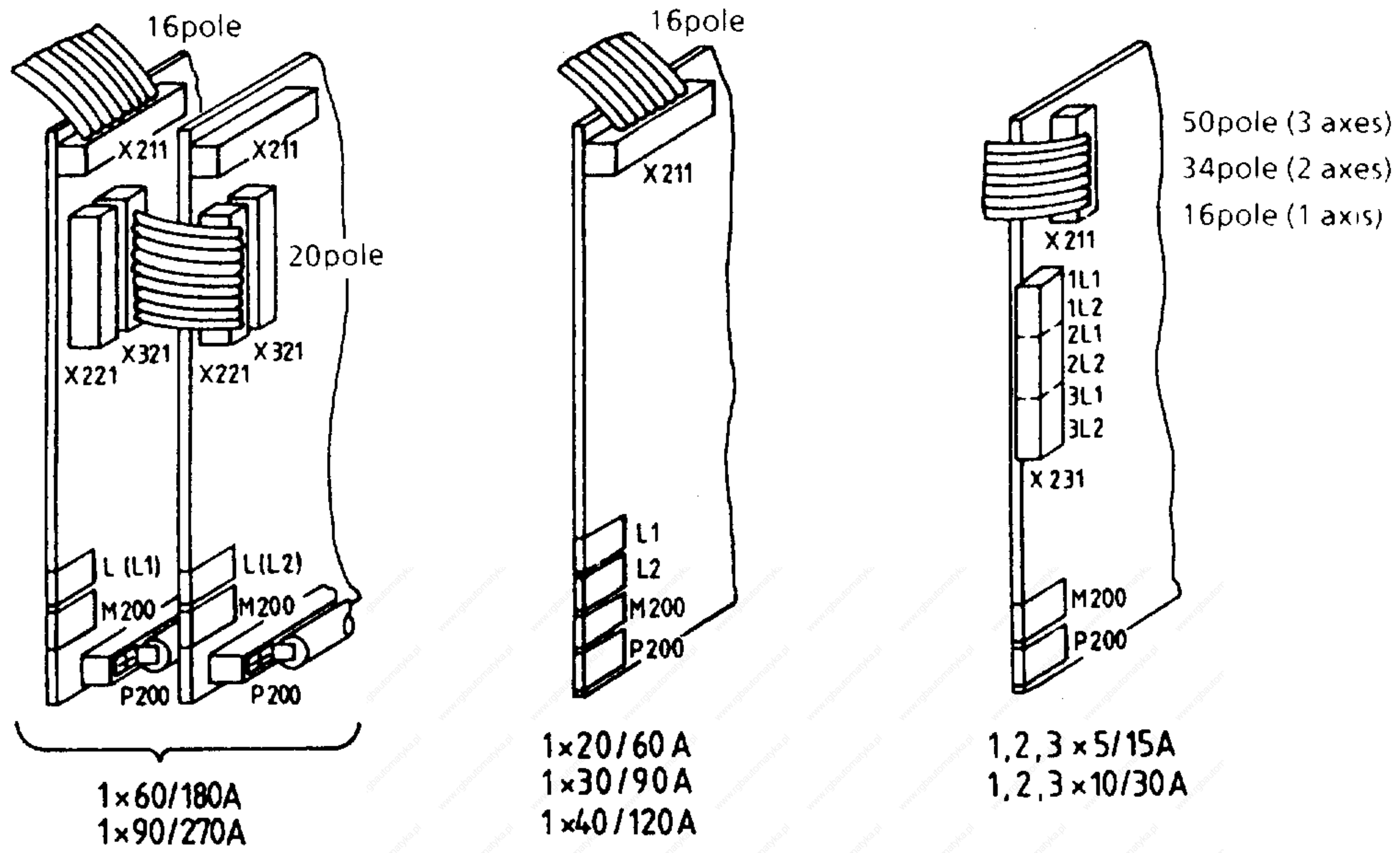
|         |          |         |          |      |       |
|---------|----------|---------|----------|------|-------|
| Zustand | Anderung | Datum   | Name     | Norm | 2.8.7 |
|         |          | 22.6.87 | Bliesner |      |       |
|         |          |         |          |      |       |

Siemens AG  
Bereich Energietechnik  
Gerätebau Erlangen

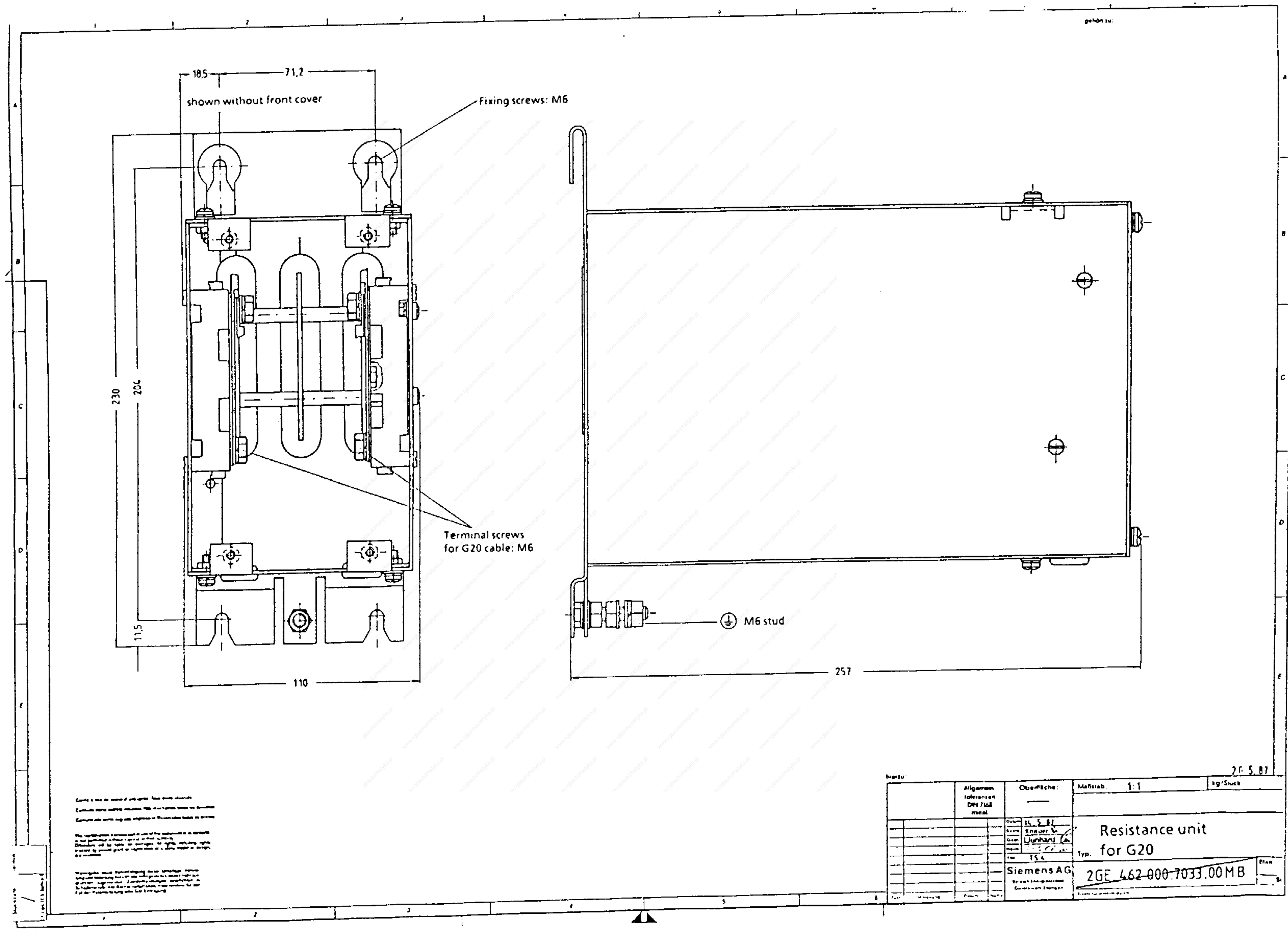
SIMODRIVE  
Extension modules  
6 SC 6101-1  
Stromaulplan/Circuit diagram

GWE TS 47 3 GE 462 012 9100 00 SP

## 8 Wiring of different power module variants









## Setting data

Serial No.:

| Power module | Servo motor |     |                      |                     |   | Current limit                       |   |   |   |   | Speed-dependent current limit |                                     |   |   |   |               |
|--------------|-------------|-----|----------------------|---------------------|---|-------------------------------------|---|---|---|---|-------------------------------|-------------------------------------|---|---|---|---------------|
|              | Axis        | 1HU | M <sub>0</sub> in Nm | I <sub>0</sub> in A | n <sub>rated</sub> in min <sup>-1</sup> | Contacts of DIL-switches S1, S2, S3 |   |   |   |   | I <sub>max</sub> in A         | Contacts of DIL-switches S1, S2, S3 |   |   |   | Terminal X1.1 |
|              |             |     |                      |                     |   | 1                                   | 2 | 3 | 4 | 5 |                               | 6                                   | 7 | 8 | 9 |               |
|              |             |     |                      |                     |   |                                     |   |   |   |   |                               |                                     |   |   |   |               |
|              |             |     |                      |                     |   |                                     |   |   |   |   |                               |                                     |   |   |   |               |
|              |             |     |                      |                     |   |                                     |   |   |   |   |                               |                                     |   |   |   |               |
|              |             |     |                      |                     |   |                                     |   |   |   |   |                               |                                     |   |   |   |               |
|              |             |     |                      |                     |   |                                     |   |   |   |   |                               |                                     |   |   |   |               |
|              |             |     |                      |                     |   |                                     |   |   |   |   |                               |                                     |   |   |   |               |

Setting of potentiometers:

|        | Tacho | Kp(n) | T <sub>N</sub> (n) |  |        | Tacho | Kp(n) | T <sub>N</sub> (n) |  |        | Tacho | Kp(n) | T <sub>N</sub> (n) |
|--------|-------|-------|--------------------|--|--------|-------|-------|--------------------|--|--------|-------|-------|--------------------|
| Axis 1 |       |       |                    |  | Axis 2 |       |       |                    |  | Axis 3 |       |       |                    |
| Axis 4 |       |       |                    |  | Axis 5 |       |       |                    |  | Axis 6 |       |       |                    |

Tacho-generator

|        | R181 | R433 | R704 | V79 | V80 | R270 | X21 | X29 |
|--------|------|------|------|-----|-----|------|-----|-----|
| Axis 1 |      |      |      |     |     |      |     |     |
| Axis 4 |      |      |      |     |     |      |     |     |

|        | R241 | R436 | R705 | V92 | V93 | R276 | X24 | X30 |
|--------|------|------|------|-----|-----|------|-----|-----|
| Axis 2 |      |      |      |     |     |      |     |     |
| Axis 5 |      |      |      |     |     |      |     |     |

|        | R248 | R441 | R706 | V112 | V113 | R410 | X27 | X31 |
|--------|------|------|------|------|------|------|-----|-----|
| Axis 3 |      |      |      |      |      |      |     |     |
| Axis 6 |      |      |      |      |      |      |     |     |

|            | R428 |
|------------|------|
| Axes 1 - 3 |      |
| Axes 4 - 6 |      |

**Speed controller adaption**

|        |     |     |  |        |     |     |  |        |     |      |
|--------|-----|-----|--|--------|-----|-----|--|--------|-----|------|
|        | R15 | R94 |  |        | R46 | R97 |  |        | R77 | R100 |
| Axis 1 |     |     |  | Axis 2 |     |     |  | Axis 3 |     |      |
| Axis 4 |     |     |  | Axis 5 |     |     |  | Axis 6 |     |      |

**Electrical weight compensation**

|        |    |    |  |        |     |     |  |        |     |     |
|--------|----|----|--|--------|-----|-----|--|--------|-----|-----|
|        | R3 | R5 |  |        | R32 | R36 |  |        | R63 | R67 |
| Axis 1 |    |    |  | Axis 2 |     |     |  | Axis 3 |     |     |
| Axis 4 |    |    |  | Axis 5 |     |     |  | Axis 6 |     |     |

**Speed setpoint channel**

|        |      |      |  |        |      |      |  |        |      |      |
|--------|------|------|--|--------|------|------|--|--------|------|------|
|        | C301 | R450 |  |        | C302 | R461 |  |        | C303 | R471 |
| Axis 1 |      |      |  | Axis 2 |      |      |  | Axis 3 |      |      |
| Axis 4 |      |      |  | Axis 5 |      |      |  | Axis 6 |      |      |

**Monitoring circuit "Speed controller at stop", current controller gain**

|        |      |     |  |        |      |     |  |        |      |      |
|--------|------|-----|--|--------|------|-----|--|--------|------|------|
|        | R605 | R95 |  |        | R646 | R98 |  |        | R656 | R101 |
| Axis 1 |      |     |  | Axis 2 |      |     |  | Axis 3 |      |      |
| Axis 4 |      |     |  | Axis 5 |      |     |  | Axis 6 |      |      |

**Machine-dependent values**

|                              | Axis 1<br>(X) | Axis 2<br>(Y) | Axis 3<br>(Z) | Axis 4<br>(U) | Axis 5<br>(V) | Axis 6<br>(W) |
|------------------------------|---------------|---------------|---------------|---------------|---------------|---------------|
| Setpoint at $V_{max}$ .      |               |               |               |               |               |               |
| Tacho voltage at $V_{max}$ . |               |               |               |               |               |               |
| Motor speed at $V_{max}$ .   |               |               |               |               |               |               |

Miscellaneous:

Date:

Commissioning engineer:



## Notes on electrostatic charges

### Electrostatically sensitive devices (ESD)

Generally, PCBs should not be touched unless work has to be carried out on them.

Before touching a PCB, the person carrying out the work must himself be electrostatically discharged. The simplest way of doing this is to touch an electrically conducting earthed object (e.g. a bare metal part of a switchboard or the protective earth contact of a socket outlet).

PCBs must not be allowed to come in contact with electrically insulating materials such as plastic foil, insulating table tops or clothing made of synthetic fibres.

PCBs may only be set down or stored on electrically conducting surfaces.

When carrying out soldering jobs on PCBs, make sure that the soldering tip has been earthed.

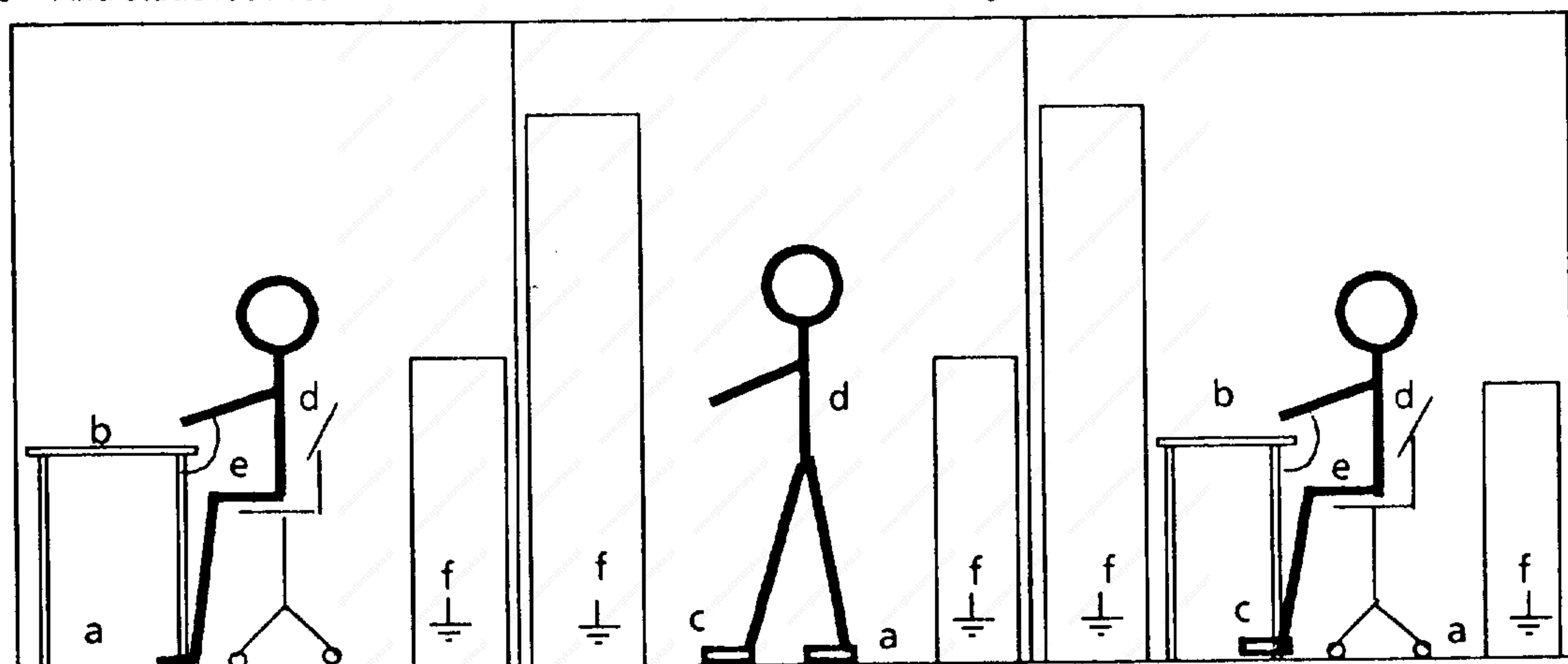
PCBs and electronic components should generally be packed in electrically conducting containers (such as metallized-plastic boxes or metal cans) before being stored or shipped.

If the use of non-conducting packing containers cannot be avoided, PCBs must be wrapped in a conducting material before being put in them. Examples of such materials include electrically conducting foam rubber or household aluminium foil.

For easy reference, the protective measures necessary when dealing with sensitive electronic components are illustrated in the sketches below.

a = Conductive flooring  
b = Anti-static table  
c = Anti-static footwear

d = Anti-static overall  
e = Anti-static chain  
f = Earthing connections of cabinets



Seated work station

Standing work station

Standing / seated work station

## Addresses

Messrs. Euchner  
Kohlhammerstr. 16  
D-7022 Leinfelden-Echterdingen 1

Du Pont de Nemours GmbH  
Max-Planck-Str. 11  
D-6057 Dietzenbach

Messrs. Kabelmetall Electro  
Postfach 25 51  
D-8500 Nürnberg 1

## Standards and specifications

|              |  |
|--------------|--|
| DIN 40050    | IP Degrees of protection   |
| DIN 46234    | Cable lugs   |
| DIN VDE 0100 | Specifications for the installation of power-current systems with operating voltages of up to 1000 V |
| DIN VDE 0106 | Protection against electric shock  |
| DIN VDE 0113 | Electrical equipment for industrial machines   |
| DIN VDE 0558 | VDE specifications for semiconductor converters  |

|                 |  |  |
|-----------------|--|--|
| Available from: | DIN standards  | DIN VDE specifications   |
|                 | Beuth-Verlag GmbH<br>Postfach 1145<br>D-1000 Berlin 30 | VDE-Auslieferungsstelle<br>Merianstraße 29<br>D-6050 Offenbach |

To  
Siemens AG

AUT E234  
Postfach 4848  
W-8500 Nürnberg 1

**Suggestions**

**Corrections**

concerning booklet:

SIMODRIVE 210  
Transistor PWM Inverter for Three-Phase  
Feed Drives with Analog Control

Manufacturer-Documentation

Instruction Manual

Order-No.: 6RB2101-0AA76  
(GWE 462 112.9600.76 Jg-101)

Edition: 10.90

**Sender**

Name \_\_\_\_\_

Firm/Department \_\_\_\_\_

Address: \_\_\_\_\_  
\_\_\_\_\_

Telephone: \_\_\_\_\_ / \_\_\_\_\_

If you have discovered any printing errors when reading this document, please send us details using this printed form. We would also be very grateful for any ideas and suggestions for improvement.

**Suggestions and/or corrections**

Published by Siemens AG  
Automation Group  
Automation Systems for  
Machine Tools, Robots, and  
Special-Purpose Machines  
Postfach 48 48, W-8500 Nürnberg 1  
Federal Republic of Germany

© Siemens AG 1987 All Rights Reserved  
Subject to change without prior notice

Siemens Aktiengesellschaft

Order No.: 6RB2101-0AA76  
Printed in the Fed. Rep. of Germany  
11910.3 GWE 462 112.9600.76 Jg-101

