



---

 In this user manual we have tried to describe the matters concerning the operation of this CNC system to the greatest extent. However, it is impossible to give particular descriptions for all unnecessary or unallowable operations due to length limitation and products application conditions; Therefore, the items not presented herein should be regarded as “impossible” or “unallowable”.

 Copyright is reserved to GSK CNC Equipment Co., Ltd. It is illegal for any organization or individual to publish or reprint this manual. GSK CNC Equipment Co., Ltd. reserves the right to ascertain their legal liability.

## Preface

Dear Users,

We are honored by your purchase of this GSK 988 Turning CNC System made by GSK CNC Equipment Co., Ltd.

This book is User Manual Volume II –“Installation and Debugging”.

To ensure safe and effective running, please read this manual carefully before installation and operation.

## Warning



Accident may occur by improper connection and operation! This system can only be operated by authorized and qualified personnel.

### Special caution:

The power supply fixed on/in the cabinet is exclusively used for the CNC system made by GSK.

It can't be applied to other purposes, or else it may cause serious danger!

# Cautions

## ■ Delivery and storage

- Packing box over 6 layers in pile is unallowed.
- Never climb the packing box, stand on it or place heavy objects on it.
- Do not move or drag the products by the cables connected to it.
- Forbid collision or scratch to the panel and display screen.
- Avoid dampness, insolation and drenching.

## ■ Open-package inspection

- Confirm that the products are the required ones.
- Check whether the products are damaged in transit.
- Confirm that the parts in packing box are in accordance with the packing list.
- Contact us in time if any inconsistency, shortage or damage is found.

## ■ Connection

- Only qualified personnel can connect the system or check the connection.
- The system must be earthed, and the earth resistance must be less than  $0.1\Omega$ . The earth wire cannot be replaced by zero wire.
- The connection must be correct and firm so as to avoid any fault or unexpected consequence.
- Connect with surge diode in the specified direction to avoid damage to the system.
- Switch off power supply before plugging out or opening electric cabinet.

## ■ Troubleshooting

- Switch off power supply before troubleshooting or changing components.
- Check the fault when short circuit or overload occurs. Restart can only be done after troubleshooting.
- Frequent switching on/off of the power is forbidden, and the interval time should be at least 1 min.

### **ANNOUNCEMENT!**

- This manual describes various possibilities as much as possible. However, operations allowable or unallowable cannot be explained one by one due to so many possibilities that may involve with, so the contents that are not specially stated in this manual shall be regarded as unallowable.

### **WARNING!**

- Please read this manual and a manual from machine tool builder carefully before installation, programming and operation, and strictly observe the requirements. Otherwise, products and machine may be damaged, workpiece be scrapped or the user be injured.

### **CAUTION!**

- Functions, technical indexes (such as precision and speed) described in this user manual are only for this system. Actual function configuration and technical performance of a machine tool with this CNC system are determined by machine tool builder's design, so functions and technical indexes are subject to the user manual from machine tool builder.
- Though this system adopts standard operation panel, the functions of the keys on the panel are defined by PLC program (ladder diagram). It should be noted that the keys functions described herein are for the standard PLC program (ladder diagram).
- For functions and effects of keys on control panel, please refer to the user manual from machine tool builder.

This manual is subject to change without further notice.

## **Safety Responsibility**

### **Manufacturer's Responsibility**

- Be responsible for the danger which should be eliminated and/or controlled on design and configuration of the provided CNC systems and accessories.
- Be responsible for the safety of the provided CNC systems and accessories.
- Be responsible for the provided information and advice for the users.

### **User's Responsibility**

- Be trained with the safety operation of CNC system and familiar with the safety operation procedures.
- Be responsible for the dangers caused by adding, changing or altering on original CNC systems and the accessories.
- Be responsible for the failure to observe the provisions for operation, adjustment, maintenance, installation and storage in the manual.

**This manual is reserved by end user.**

**We are full of heartfelt gratitude for your support by using GSK's products.**



---

---

# Contents

CHAPTER I	INSTALLATION LAYOUT .....	1
1.1	Overall Dimension of GSK988T and Accessories .....	1
1.1.1	Overall Dimension of the GSK988T Mainframe .....	1
1.1.2	Overall Dimension of GSK988T Operation Panel MPU02A .....	2
1.1.3	Overall Dimension of GSK988T Operation Panel MPU02B .....	3
1.1.4	Overall Dimension of GSK988T-H Mainframe .....	4
1.1.5	Overall Dimension of GSK988T- H Operation Panel .....	5
1.1.6	Overall Dimension of I/O Deconcentrator MCT02.....	5
1.2	Structure of GSK988T Control System .....	6
1.2.1	Front /Rear Panel Illustrations .....	6
1.2.2	General Connection Diagram .....	8
1.3	GSK988T Installation .....	9
1.3.1	Conditions of Electric Cabinet Installation .....	9
1.3.2	System Grounding Requirements .....	9
1.3.3	Interference Prevention Methods .....	9
CHAPTER II	INTERFACE SIGNAL DEFINITION AND CONNECTION .....	11
2.1	Connection with Drive Unit.....	11
2.1.1	Definition of the Drive Interface .....	11
2.1.2	Signal Instruction .....	11
2.1.3	Connection with the Drive Unit Interface .....	14
2.2	Connection with the Spindle .....	15
2.2.1	The 5 <sup>th</sup> Axis · Spindle Interface Definition.....	16
2.2.2	Signal Instruction .....	16
2.2.3	Connection with the Servo Spindle Drive Unit.....	17
2.2.4	Connection with the Spindle Inverter Interface.....	18
2.3	Connection with the Spindle Encoder .....	18
2.3.1	Interface Definition of the Spindle Encoder .....	19
2.3.2	Signal Instruction .....	19
2.3.3	Connection with the Spindle Encoder Interface .....	19
2.4	Connection with the 2 <sup>nd</sup> Spindle.....	20
2.4.1	Definition of the 2 <sup>nd</sup> Spindle (Analog Spindle) Interface .....	20
2.4.2	Connection with the 2 <sup>nd</sup> Spindle Inverter Interface.....	20
2.5	Connection with MPG .....	20
2.5.1	Definition of MPG Interface .....	20
2.5.2	Signal Instruction .....	21
2.5.3	Connection with MPG Interface.....	21
2.6	Connection with the Machine Panel .....	21
2.6.1	Communication Interface Definition .....	22
2.7	GSK988T General I/O Interface Definition .....	22
2.7.1	Definition of Input & Output Addresses .....	22
2.7.2	Input Signal .....	23
2.7.3	Output Signal .....	24
2.8	Connection with the Power Supply .....	25

2.8.1 Definition of Power Supply Interface .....	25
2.8.2 Connection between GSK988T and GSK-PB2 Power Supply Box .....	26
2.9 Connection with the External Equipment.....	26
2.9.1 RS-232 Interface Definition .....	27
2.9.2 Definition of GSK-CAN Bus Interface.....	27
2.9.3 Network Interface Definition .....	28
2.9.4 USB Interface Definition .....	28
<b>CHAPTER III MACHINE TOOL DEBUGGING-OPERATION.....</b>	<b>29</b>
3.1 Parameter Setting .....	29
3.1.1 System Parameters .....	29
3.1.2 Servo Parameters.....	32
3.2 Instruction of PC Communication Software GSKComm-M.....	35
3.2.1 Preparation for GSKComm-M .....	36
3.2.2 File Download (PC→CNC).....	37
3.2.3 Upload File (CNC→PC).....	38
3.3 Usage of U Disk .....	38
3.3.1 File Management Screen .....	38
3.3.2 Program Screen.....	39
3.3.3 PLC Screen .....	40
3.4 PLC Operation .....	42
3.4.1 PLC Execution and Stop.....	42
3.4.2 PLC Monitoring and Diagnosis.....	43
3.4.3 PLC Data Viewing and Setting .....	46
3.4.4 PLC On-line Modification.....	48
3.4.5 PLC Program Transmission.....	56
3.5 CNC Diagnosis.....	56
3.6 Servo Diagnosis.....	58
<b>CHAPTER IV MACHINE DEBUGGING-FUNCTIONS.....</b>	<b>60</b>
4.1 Emergency Stop and Hardware Limit.....	60
4.2 Basic Axis Parameters Setting.....	61
4.2.1 Axis Property.....	61
4.2.2 GSK-CAN Communication Setting of Axis and Servo .....	62
4.3 Gear Ratio Calculation and Setting .....	63
4.3.1 Gear Ratio Calculation .....	64
4.3.2 Gear Ratio Setting .....	65
4.4 Servo Related Setting .....	65
4.4.1 CNC Servo Parameter Setting .....	65
4.5 Acceleration/Deceleration Characteristic Adjustment.....	66
4.6 Reference Point and Software Limit .....	67
4.6.1 Reference Point of Absolute Encoder Setting .....	68
4.6.2 Reference Point Setting with Dog .....	69
4.6.3 Reference Point Setting without Dog .....	70
4.6.4 Setting of Stored Stroke Check .....	71
4.7 Pitch Error Compensation.....	73
4.8 Backlash Compensation .....	76



4.9 Spindle Function Adjustment .....	78
4.9.1 Spindle Encoder.....	78
4.9.2 Spindle Speed Analog Voltage Control.....	79
<b>CHAPTER V PARAMETER INSTRUCTION .....</b>	<b>82</b>
5.1 Parameters of System Setting .....	82
5.2 Parameters of the Interfaces of Input and Output .....	83
5.3 Parameters of Axis Control/Setting Unit .....	83
5.4 Parameters of the Coordinate System.....	87
5.5 Parameters of the Stroke Detection.....	90
5.6 Parameters of the Feedrate.....	92
5.7 Parameters of Control of Acceleration/Deceleration .....	95
5.8 Parameter of Servo and Backlash Compensation .....	98
5.9 Parameter of Input/Output .....	101
5.10 Parameter of Display and Editing .....	103
5.11 Parameter of Programming.....	106
5.12 Parameters of the Screw Pitch Error Compensation.....	109
5.13 Parameters of the Spindle Control.....	110
5.14 Parameters of the Tool Compensation .....	115
5.15 Parameters of Tool Life Management.....	119
5.16 Parameters of the Canned Cycle.....	121
5.16.1 Parameters of the Drilling Canned Cycle .....	121
5.16.2 Parameters of the Thread Cutting Cycle .....	122
5.16.3 Parameters of the Combined Canned Cycle.....	122
5.17 Parameters of the Rigid Tapping .....	124
5.18 Parameters of the Polar Coordinates Interpolation .....	127
5.19 Parameters of the User Macro Program.....	128
5.20 Parameters of the Skip Function .....	129
5.21 Parameters of the Graphic Display.....	131
5.22 Parameter of Run Hour and Parts Count Display.....	131
5.23 Parameter of MPG Feed.....	132
5.24 Parameter of PLC Axis Control.....	133
5.25 Parameters of the Basic Function.....	136
5.26 Parameters of GSK-CAN Communication Function.....	137
<b>CHAPTER VI STANDARD PLC FUNCTION CONFIGURATION .....</b>	<b>139</b>
6.1 Standard Panel on the Machine Tool .....	139
6.2 Addresses X, Y Definition.....	140
6.2.1 General I/O Interface on Machine Tool.....	140
6.2.2 MPG Interface.....	143
6.2.3 Spindle Interface .....	144
6.2.4 Standard Operation Panel .....	145
6.3 Standard PLC Functions .....	150
6.3.1 M Commands .....	150
6.3.2 Cycle Start and Feed Hold.....	150
6.3.3 Feed/Spindle Hold .....	151
6.3.4 Program Lock .....	151

6.3.5 Feedrate Override.....	152
6.3.6 Spindle Override .....	152
6.3.7 Spindle CCW/CW Control.....	153
6.3.8 Spindle Jog .....	154
6.3.9 Spindle 8-Point Pre-Orientation .....	154
6.3.10 Spindle Gear Control .....	156
6.3.11 Cooling Control .....	157
6.3.12 Lubricating Control.....	157
6.3.13 Chuck Control .....	158
6.3.14 Tailstock Control .....	160
6.3.15 Low Pressure Detection .....	161
6.3.16 Overtravel Signal of Axes .....	161
6.3.17 Tool Change Control.....	162
6.3.18 Emergency Stop .....	168
6.3.19 Tri-Colored Lamp.....	168
6.4 Standard PLC Parameter Instruction .....	169
6.4.1 Parameter K.....	169
6.4.2 Parameter DT .....	170
6.4.3 Parameter DC.....	171
6.4.4 Parameter D .....	172
6.5 Signals G, F Used in Standard PLC.....	172
6.5.1 Signal G .....	172
6.5.2 Signal F.....	174
<b>APPENDIX A ALARM LIST .....</b>	<b>177</b>
A.1 Program Alarms (P/S Alarms) .....	177
A.2 Parameter Alarms .....	186
A.3 Pulse Encoder Alarms .....	187
A.4 Servo Alarms .....	187
A.5 Overtravel Alarms .....	188
A.6 Spindle Alarms.....	188
A.7 System Alarms.....	188
A.8 Operation Panel Communication Prompts.....	189
A.9 GSK-CAN Communication Prompts.....	189
A.10 Servo Internal Alarms .....	191
<b>APPENDIX B MOTOR TYPE CODE LIST .....</b>	<b>195</b>
B.1 DAT2000C Series Motor Model Code List .....	195
B.2 DAP03C, DAY3025C Model Code List.....	196
<b>APPENDIX C COMMON ALARM REMEDY .....</b>	<b>197</b>
C.1 CNC Common Alarm Remedy .....	197
C.2 GSK-CAN Communication Prompts .....	197
C.3 DAT Feed Servo Alarm Remedy .....	198
C.4 Spindle Servo Alarm Remedy .....	204

## CHAPTER I INSTALLATION LAYOUT

### 1.1 Overall Dimension of GSK988T and Accessories

#### 1.1.1 Overall Dimension of the GSK988T Mainframe

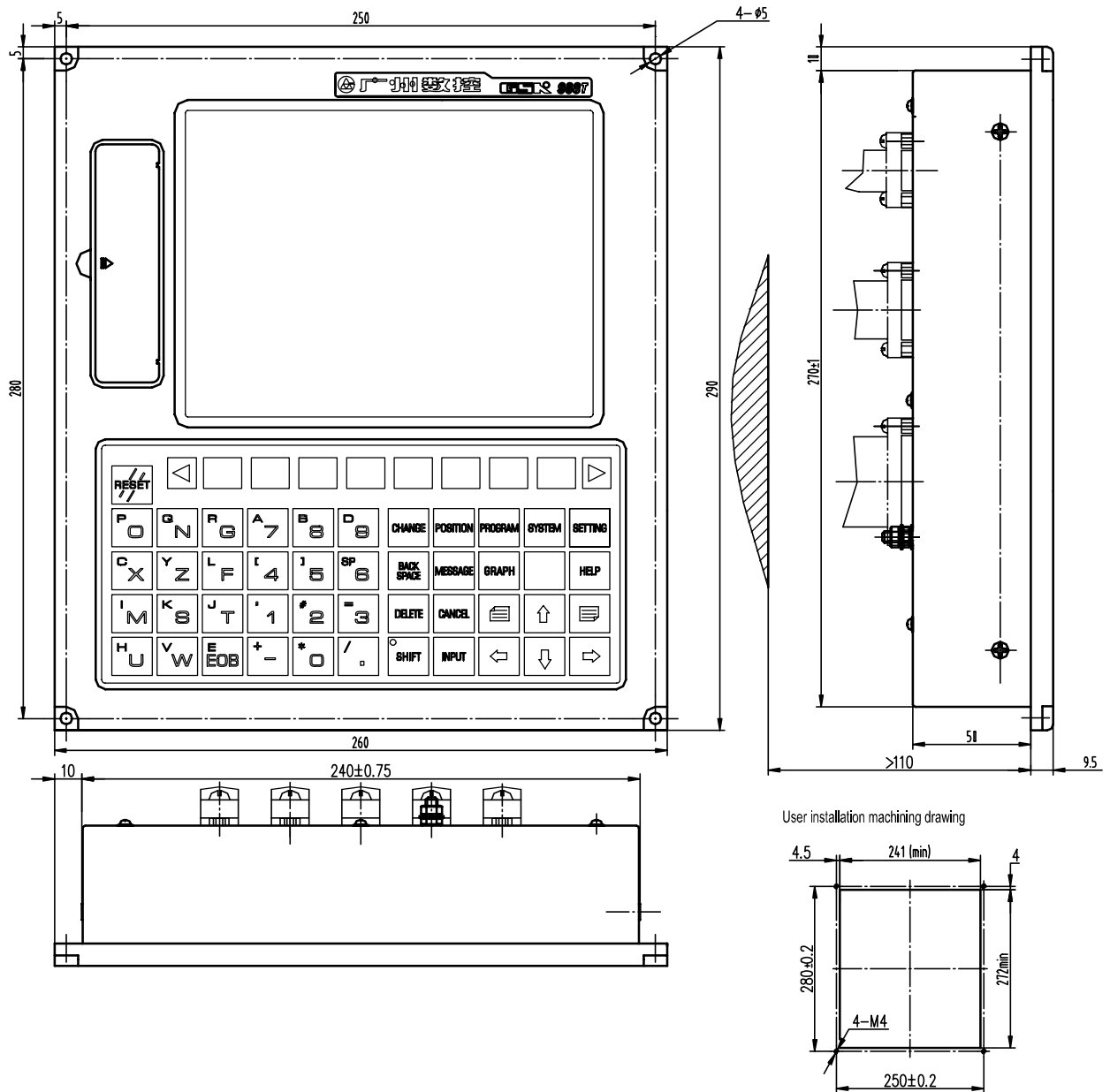

### 1.1.2 Overall Dimension of GSK988T Operation Panel MPU02A

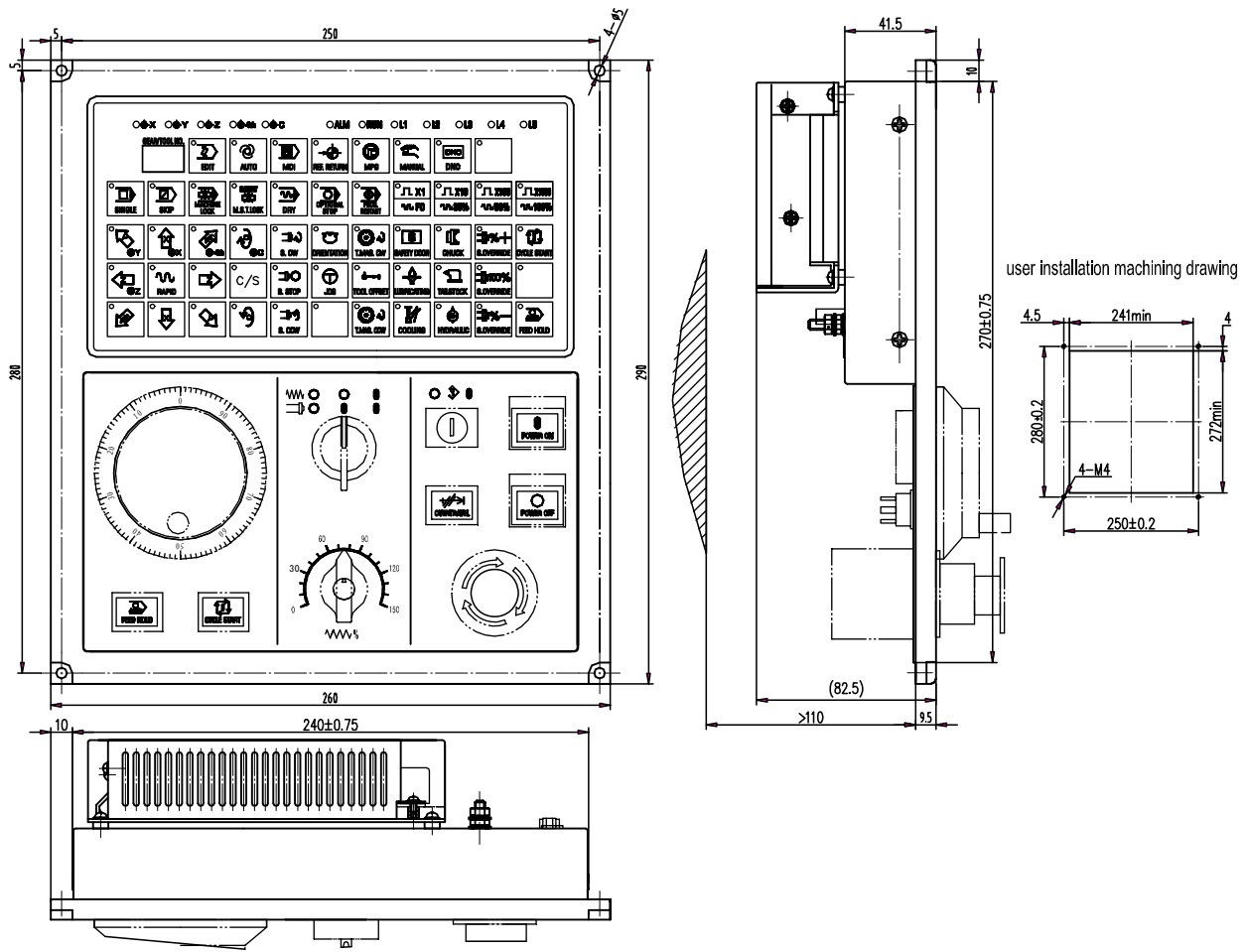

### 1.1.3 Overall Dimension of GSK988T Operation Panel MPU02B

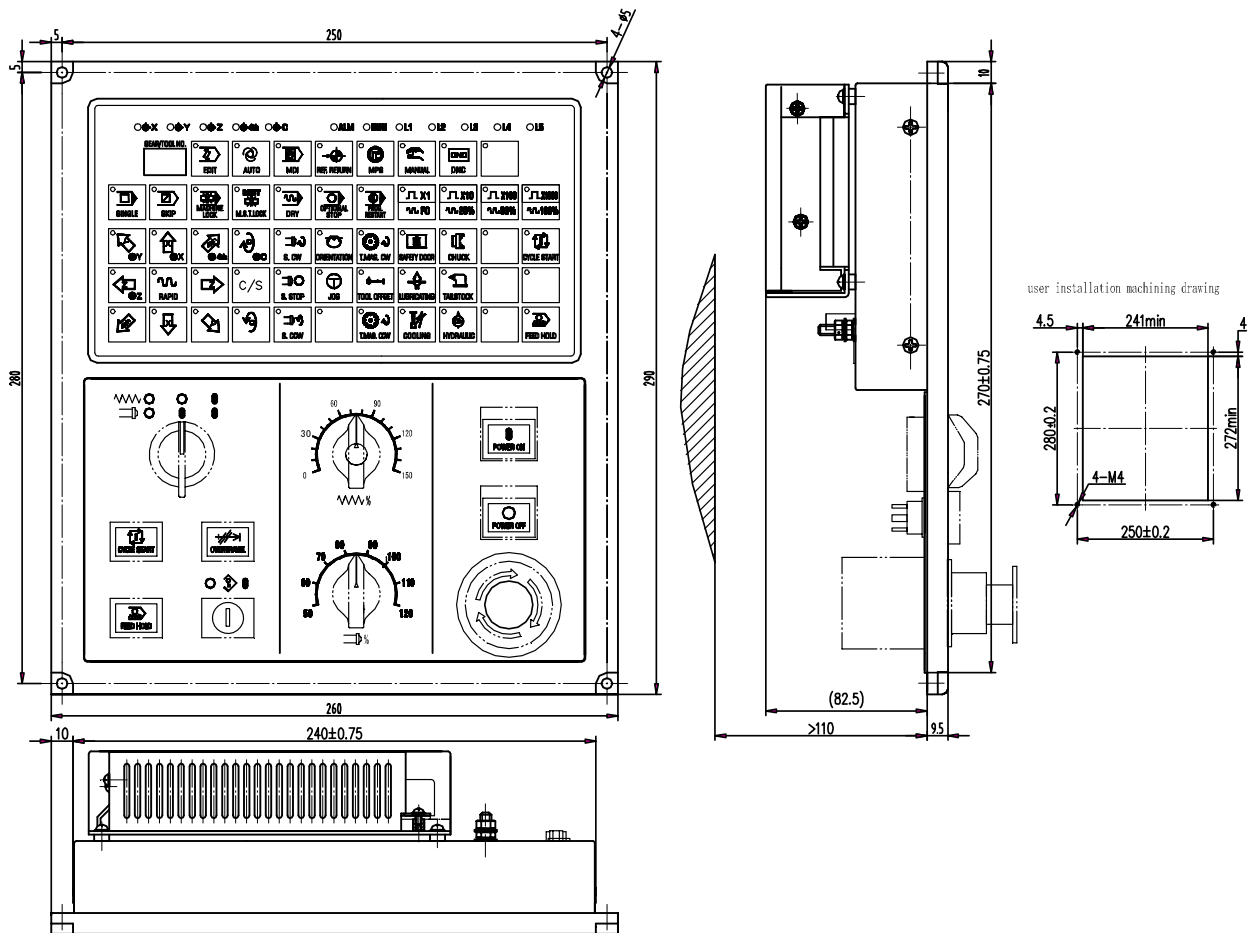

### 1.1.4 Overall Dimension of GSK988T-H Mainframe

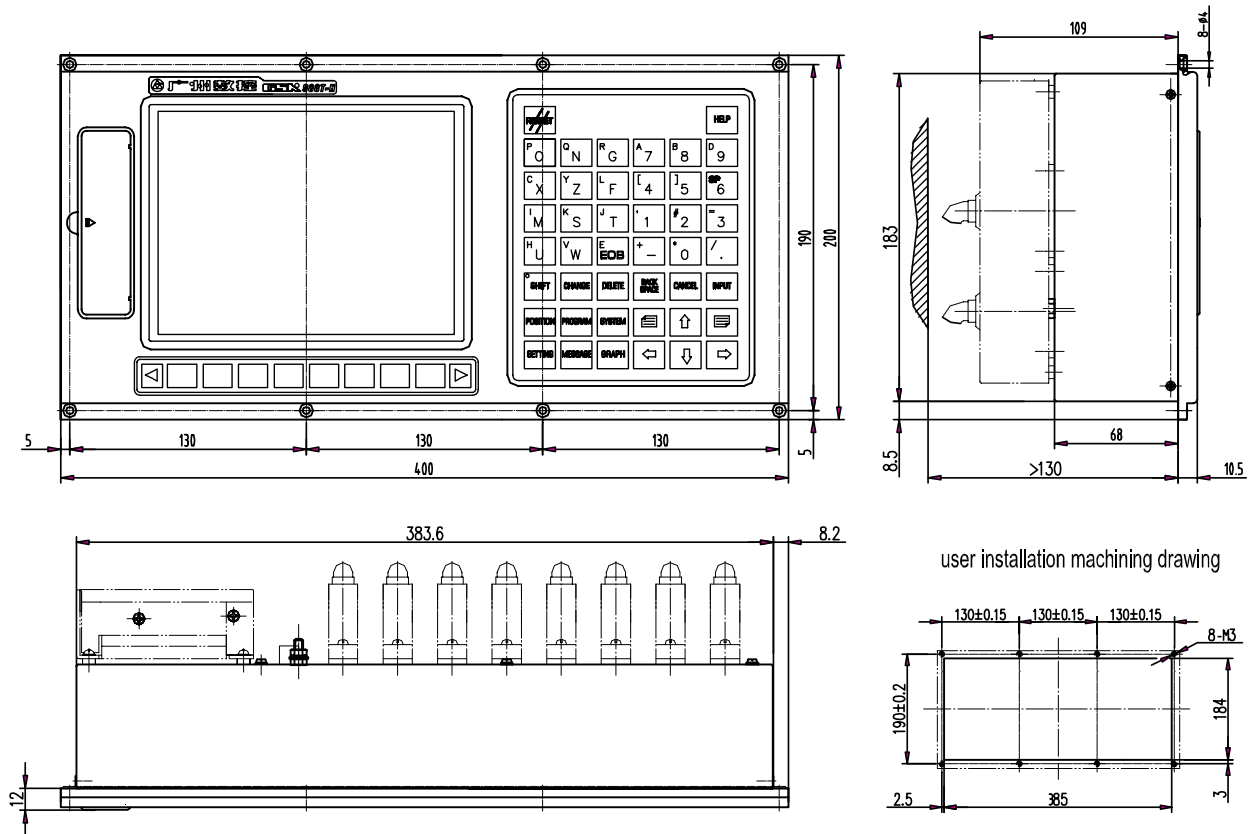

**Note: The panel of GSK988T-H is horizontal.**

### 1.1.5 Overall Dimension of GSK988T- H Operation Panel

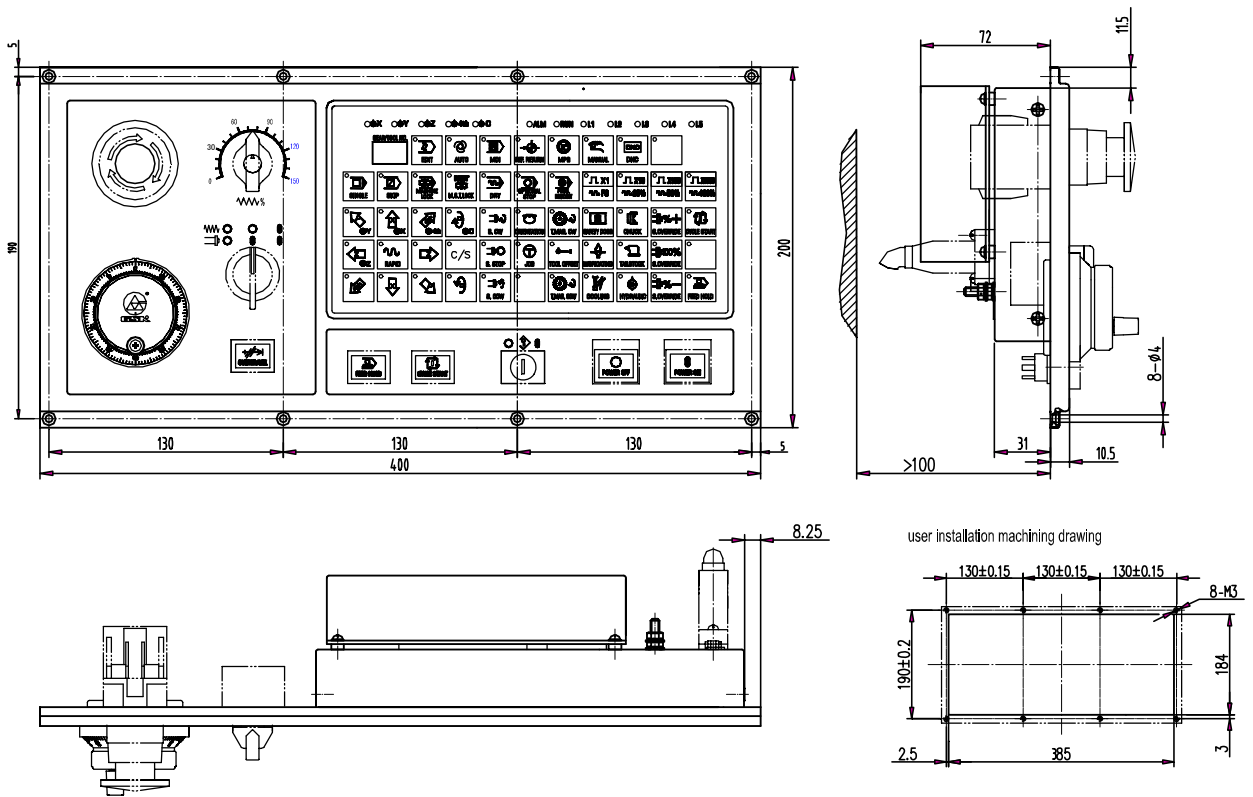

### 1.1.6 Overall Dimension of I/O Deconcentrator MCT02

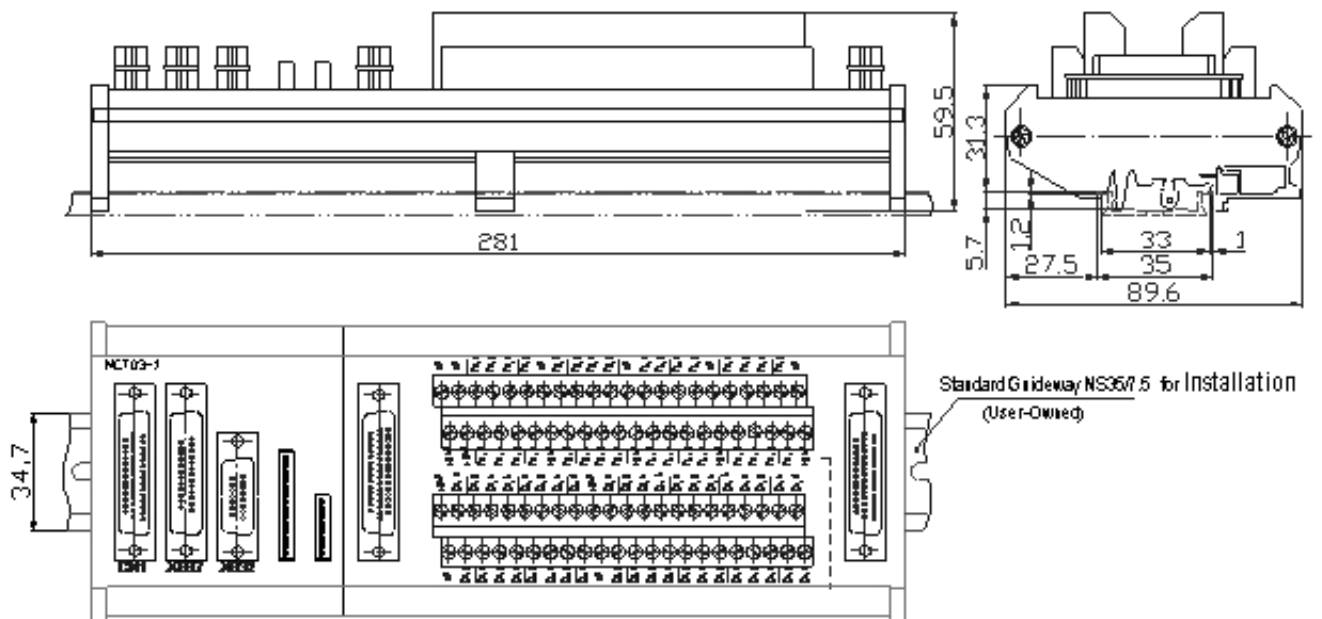

## 1.2 Structure of GSK988T Control System

### 1.2.1 Front /Rear Panel Illustrations

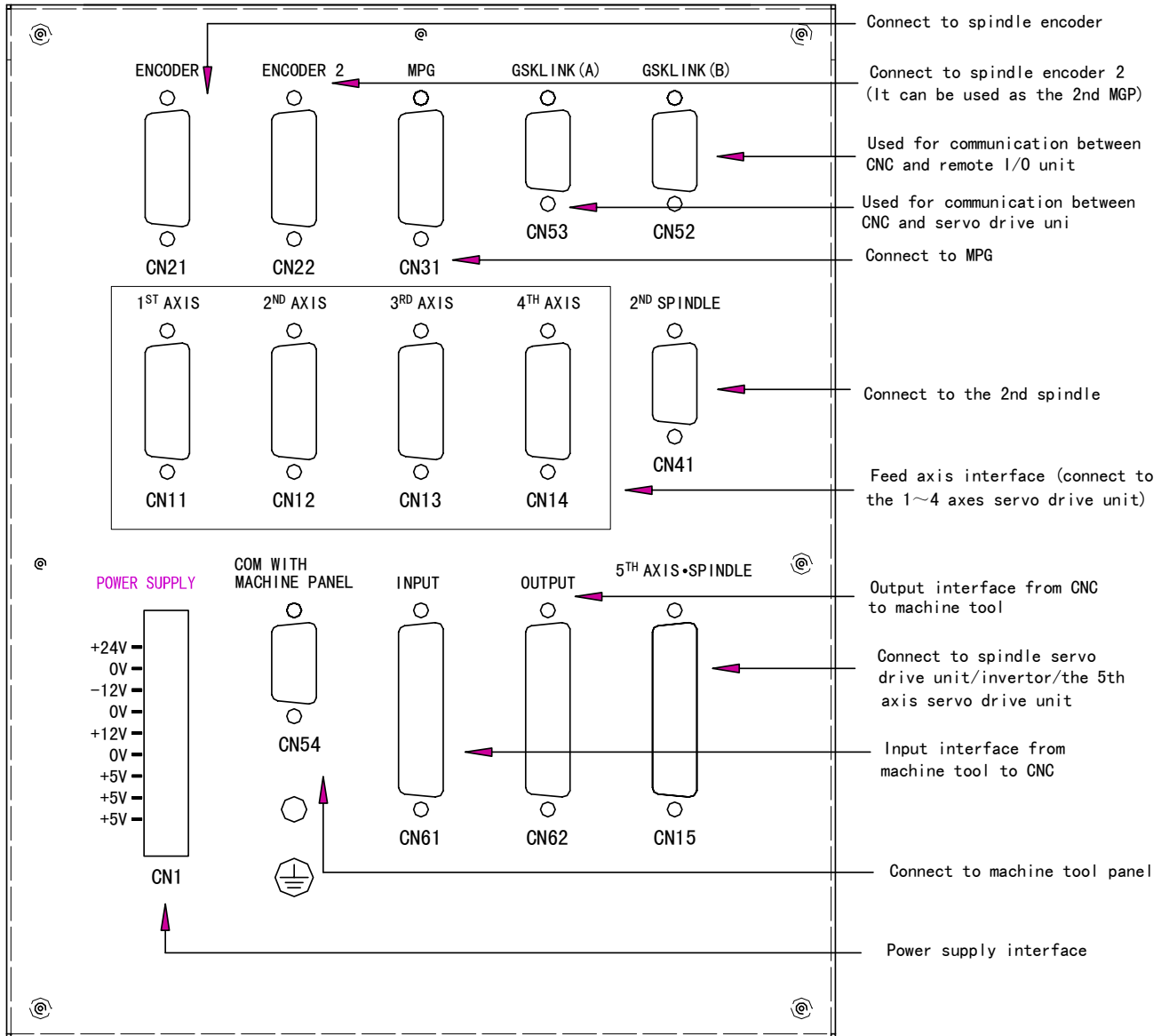

Fig. 1-2-1 The layout of GSK988T mainframe rear cover interfaces

**Note: These interfaces are compatible with GSK988T-H system. See Fig.1-2-1**



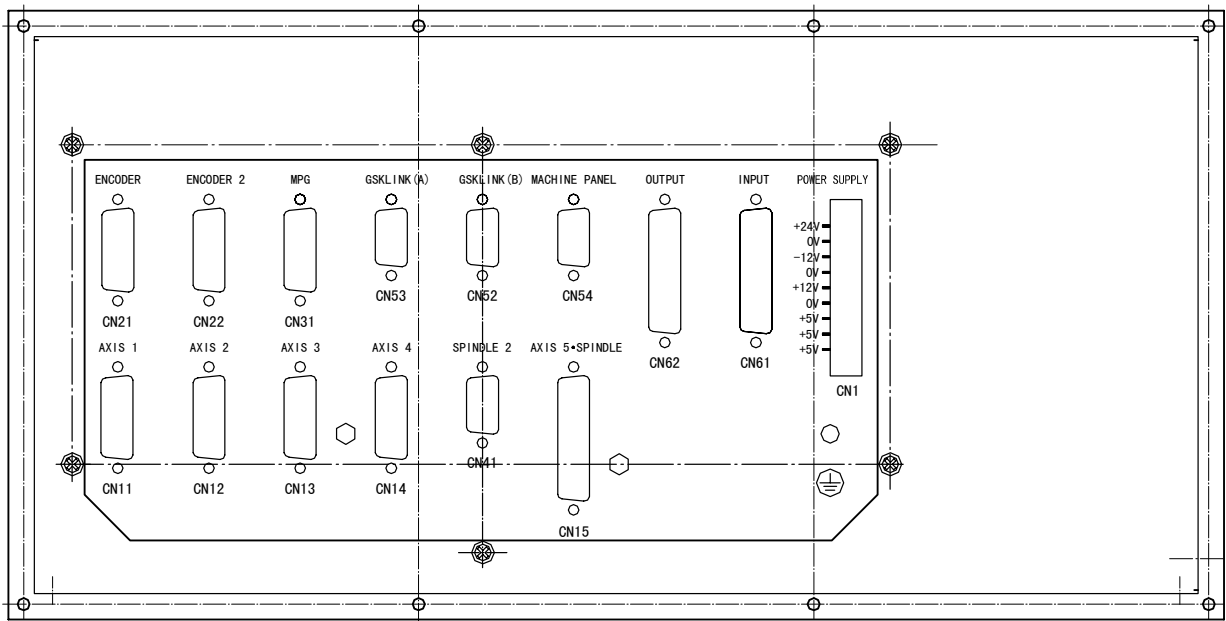

Fig. 1-2-2 The layout of GSK988T-H mainframe rear cover interfaces

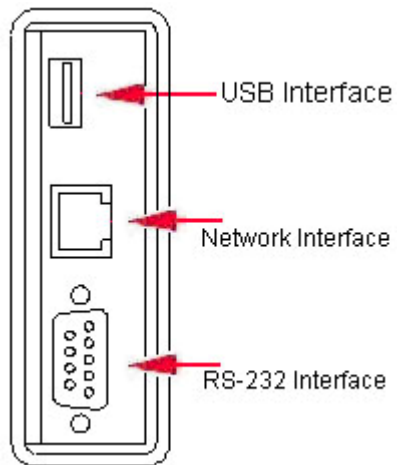

Fig. 1-2-3 The layout of GSK988T front panel interfaces

### 1.2.2 General Connection Diagram

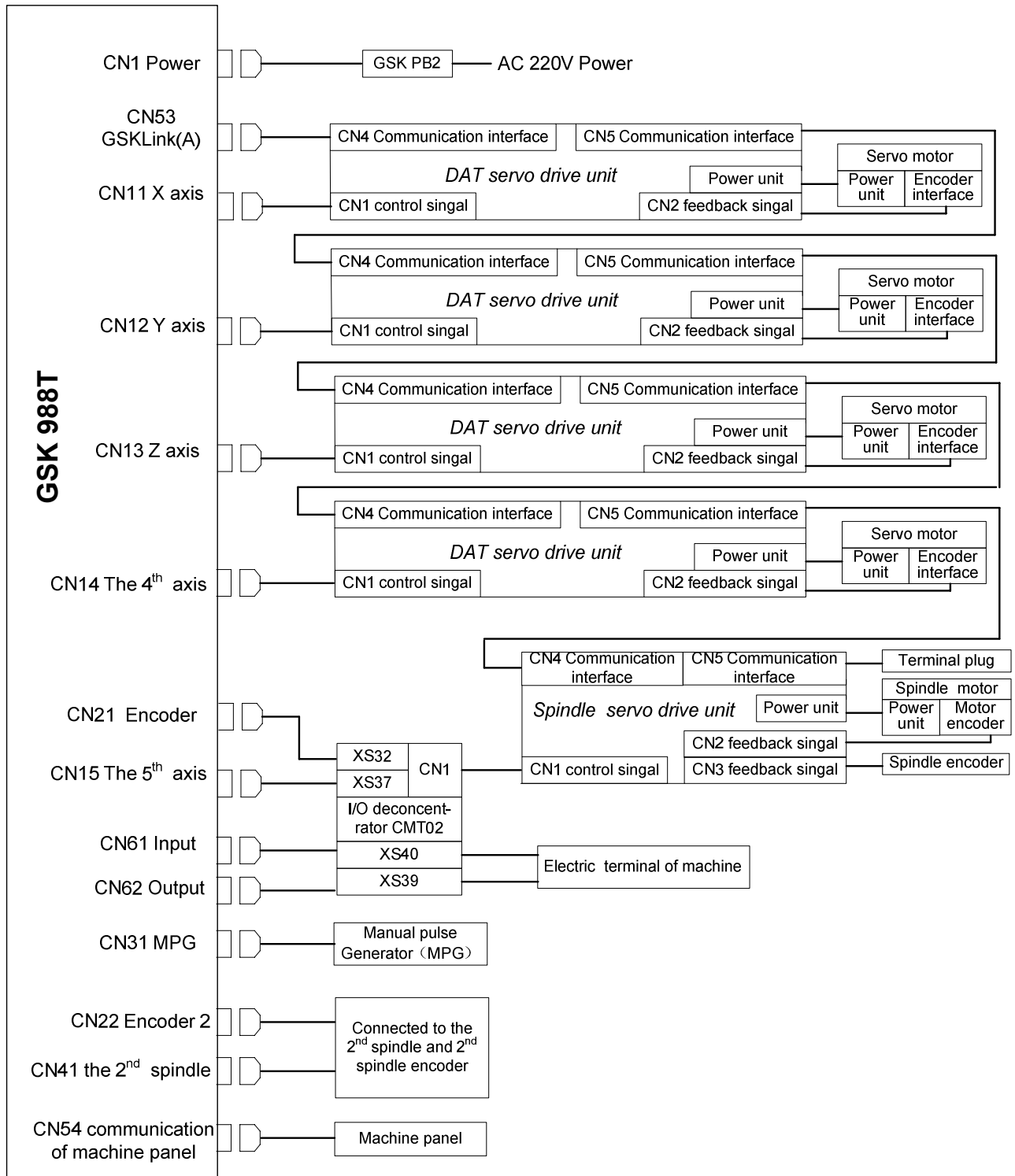

Fig. 1-2-4 GSK988T connection diagram

## 1.3 GSK988T Installation

### 1.3.1 Conditions of Electric Cabinet Installation

- Prevent the entry of dust, coolant and organic solution.
- The distance between CNC rear cover and the cabinet should not be less than 20cm. Ensure that the temperature difference (outside and inside the cabinet) will be less than 10°C in case of temperature rising in the cabinet.
- A radiator fan can be installed inside the cabinet to ensure ventilation.
- The display panel should be installed in proper place to avoid the coolant ejection.
- The interference of external electrical equipments to the CNC should be taken into consideration and be reduced to the greatest extent.

### 1.3.2 System Grounding Requirements

The following grounding systems are for CNC machine tool:

- Signal ground  
It provides the reference voltage of telecommunication system (0V).
- Frame ground  
It is used for the sake of safety. The shell of frame unit, panel and the interface cables shield should be connected together. It can also suppress the internal and external noise.
- System ground  
It is used to connect the devices and the frame ground with the ground.

**Note 1: The connection between signal and frame ground in the CNC control unit is only made at one place.**

**Note 2: Use the AC power line with grounding wire to ensure grounding during power supply.**

### 1.3.3 Interference Prevention Methods

Measures such as shielding electromagnetic radiation, absorbing impulse current and filtering power noise are taken into CNC design, which, to some extent, protects the CNC to external interference. To ensure a steady working of CNC, it is necessary to take following measures during CNC installation:

- ① Keep CNC far away from the interference source (such as inverter, AC contactor, static generator, high pressure generator and sectioning for power line, etc.)
- ② The power to CNC should be supplied via insulation transformer; the machine installed with CNC should be grounding; the CNC and drive unit should be connected with independent grounding wire via grounding point.
- ③ Interference suppression: connect the RC circuits parallelly at two ends of the AC coil; the RC circuit should be installed to the inductive load as near as possible; fly-wheel diode should be inversely connected in serial at two ends of the DC coil ; surge absorber should be connected in parallel at the winding head of AC motor (see Fig. 1-3-1).

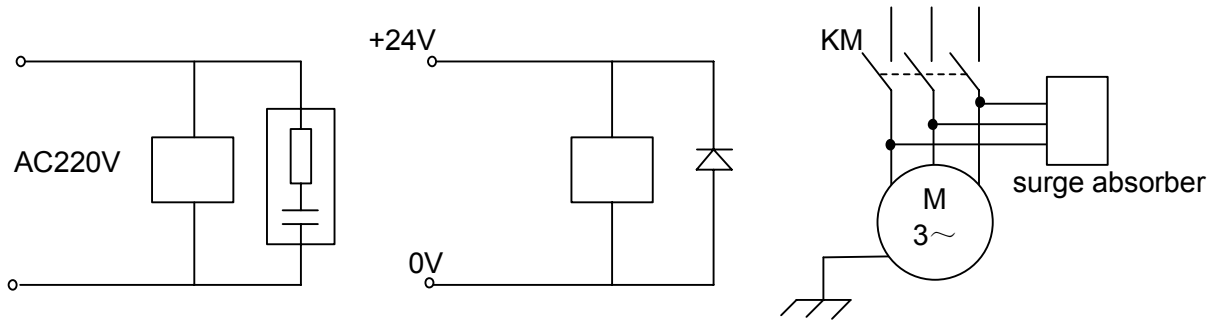

Fig. 1-3-1

- ④ The outgoing cable of CNC is twisted shielded cable or shielded cable; the shielding layer of the cable is single-end earthed at CNC side; the signal line should be as short as possible.
- ⑤ To reduce the interference between CNC signal cables and high-voltage cable, the following principles should be followed when wiring:

Group	Cable type	Group	Cable type
A	AC power line	B	DC coil (24VDC)
	AC coil		DC relay (24VDC)
	AC contactor		Cables between CNC and high-voltage electric cabinet
C	Cables between CNC and servo drive unit		Cables between CNC and machine tool

**Wiring Requirements:**

- The cable should be twisted pair.
- Bundle the cables of group A separately from the cables in groups B, C, and the distance should be no less than 10cm; or, make electromagnetic shielding for the cables in group A.
- Bundle the cables of group C separately from the cables in group A, and the distance should be no less than 10cm; or, make electromagnetic shielding for the cables in group C; the distance between group C cables and group B cables should be no less than 10cm.
- Bundle the cables of group B separately from the cables in group A; or, make electromagnetic shielding for the cables in group B; cables in group B should be bundled separately from the group C cables as far as possible.

## CHAPTER II INTERFACE SIGNAL DEFINITION AND CONNECTION

### 2.1 Connection with Drive Unit

#### 2.1.1 Definition of the Drive Interface

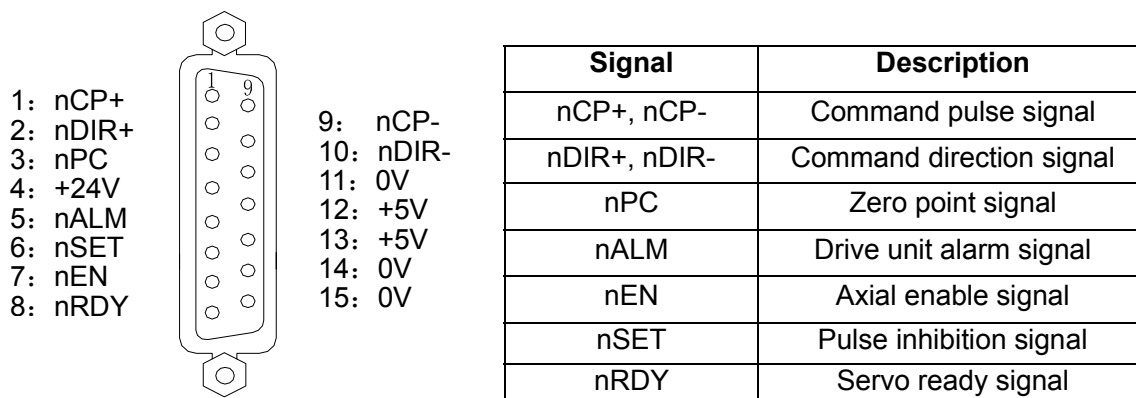

Fig. 2-1-1 CN11, CN12, CN13 and CN14 interfaces (15 pins, D-type female)

**Note:** CN1 is the 1<sup>st</sup> servo axis interface, CN2 is the 2<sup>nd</sup> one, CN3 the 3<sup>rd</sup> one, and CN4 the 4<sup>th</sup> one. Each controlled axis outputs the corresponding servo axis interface, which is set by parameter NO.1023.

#### 2.1.2 Signal Instruction

(1) Command pulse signal and nCP and command direction signal nDIR

nCP+ and nCP- are command pulse signals, nDIR+ and nDIR- are command direction signals, the two groups of signals all are difference (AM26LS31) output, the external is suggested to use AM26LS32 for receiving, refer to the following Fig.2-1-2 about the internal circuit:

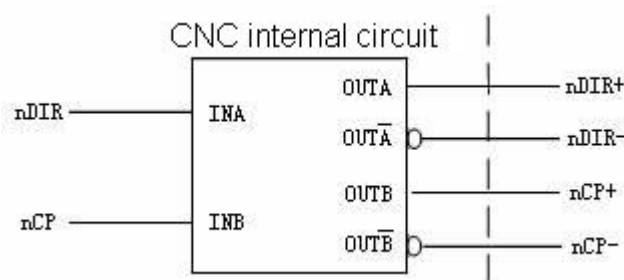

Fig. 2-1-2 Internal circuit of nCP and nDIR

(2) Drive unit alarm signal nALM

Whether the drive alarm level is low or high is set by 0 bit of parameter 1816; refer to Fig.2-1-3 for the internal circuit.

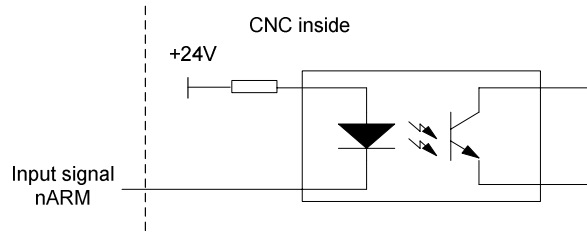

Fig. 2-1-3. Internal circuit of nARM

Input circuit of this type requires that the drive should provide the signal through the methods in the following Fig. 2-1-4:



Fig. 2-1-4. Methods of the drive unit providing signals

(3) Servo ready signal nRDY

nRDY signal is connected to the servo drive unit ready signal. See Fig. 2-1-5.

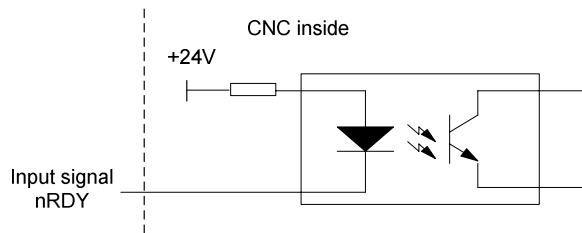

Fig. 2-1-5 Internal circuit of nRDY

(4) Axial enable signal nEN

When CNC is running normally, nEN signal output is valid (nEN signal connects with 0V), and the drive or the emergency stop alarms, CNC switched off, nEN signal outputs (nEn signal cuts off 0V). About the internal interface circuit, refer to the following Fig. 2-1-6:

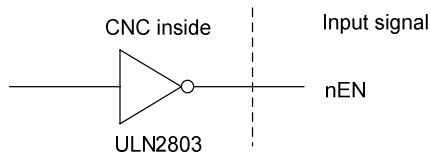

Fig. 2-1-6. Internal circuit of nEN

(5) Pulse inhibition signal nSET

nSET signal indicates the servo input inhibition. To improve the anti-interference ability between CNC and the drive, the signal is low-level when CNC outputs the pulse signal, if there isn't any pulse signals, it is high level; refer to the following Fig. 2-1-7 about the internal interface circuit:

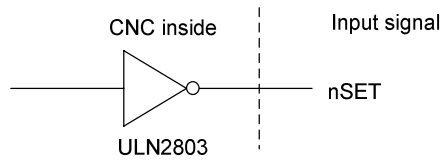

Fig. 2-1-7 Pulse forbidden signal circuit

(6) Zero point signal nPC

Take one-rotation signal of motor encoder or proximity switch signal as zero signals. About the internal connection circuit, refer to Fig. 2-1-8:

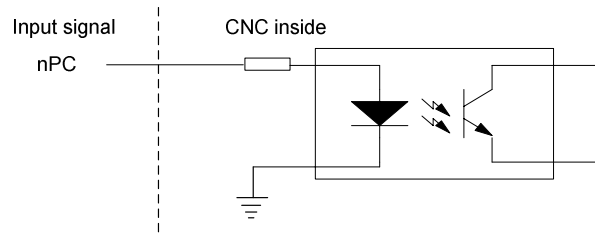

Fig. 2-1-8 Zero point signal circuit

① The illogram of PC signals provided by user is shown in Fig. 2-1-9:

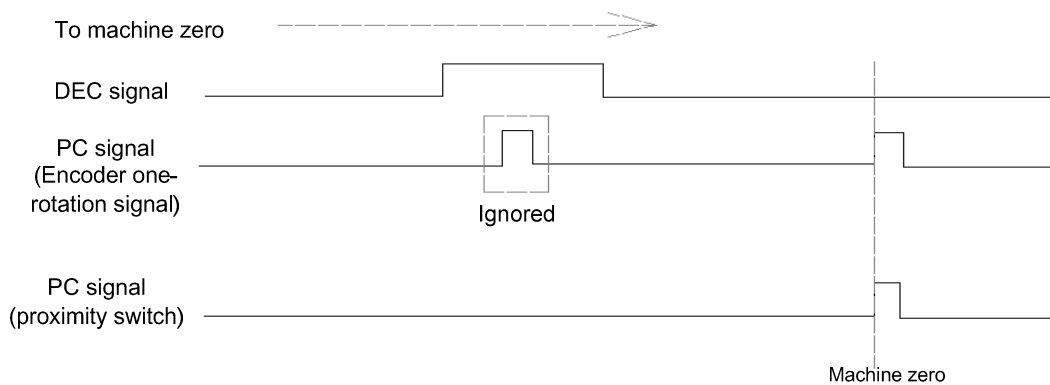

Fig. 2-1-9 Signal illogram

**Note:** During machine zero return, after releasing the deceleration switch, CNC determines the position of the reference point through detecting PC signal jumping, and the rising edge check and the falling edge check are both valid.

② Refer to Fig. 2-1-10 for the connection method of taking one NPN-type Hall unit as the deceleration signal:

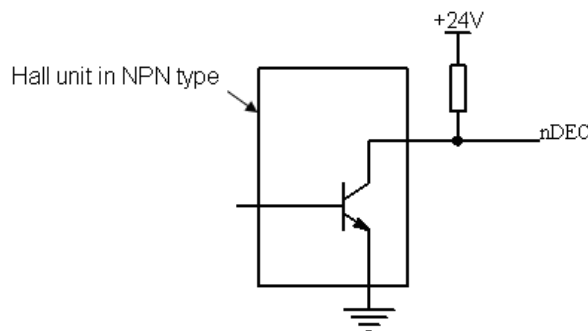

Fig. 2-1-10 Connection with NPN-type Hall unit

- ③ Refer to the following Fig. 2-1-11 about the connection method of taking one Hall unit in PNP type as one deceleration signal:

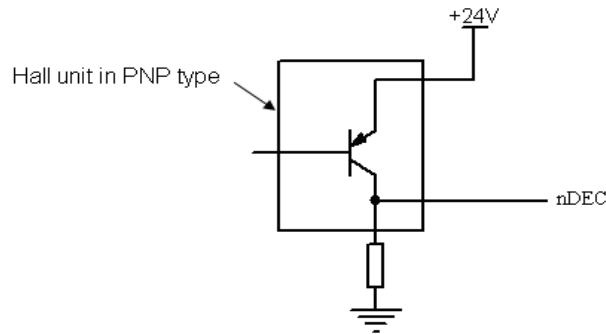
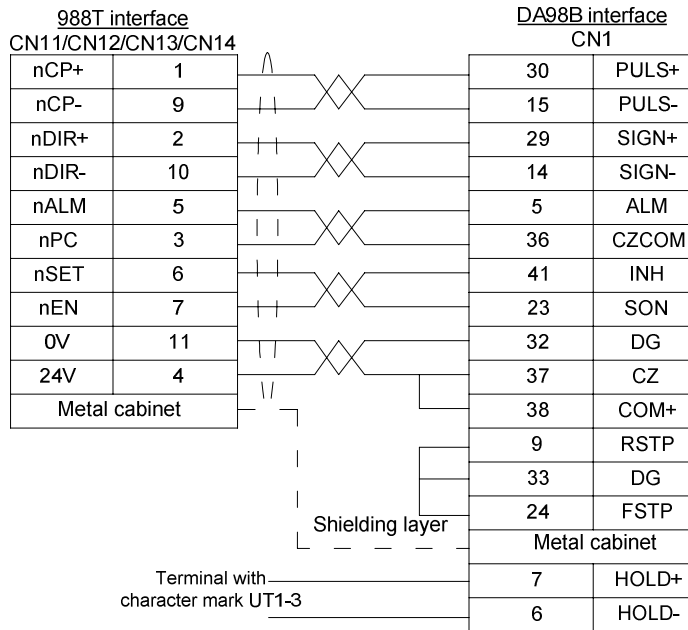

Fig. 2-1-11 Connection with Hall unit in PNP type

### 2.1.3 Connection with the Drive Unit Interface

The connection between GSK988T system and GSK DA98B drive unit is shown in the following figure.



Axis is with contracting brake which leads to pins "6" and "7"; it doesn't required to weld without contracting brake.

Fig. 2-1-12 Connection between GSK988T and DA98B



The connection between GSK988T and GSK DAT2000C drive unit is shown as follows:

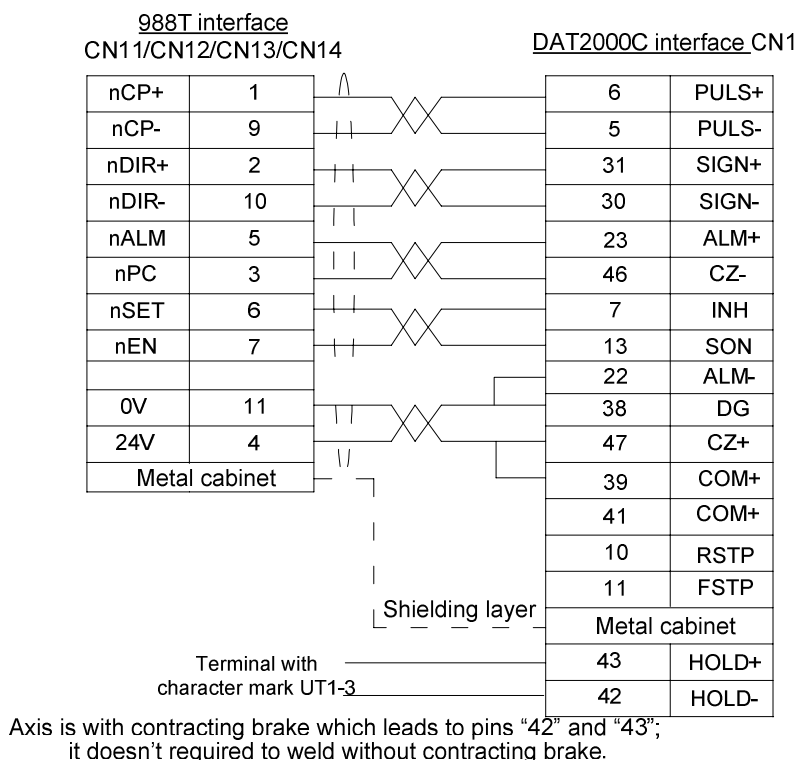

Fig. 2-1-13 Connection between GSK988T and DAT2000C drive unit

## 2.2 Connection with the Spindle

The spindle interface of GSK988T is CN15 (the fifth axis · spindle interface). It is equipped with the function of pulse output and analog voltage output, and can be adopted with the servo spindle drive unit or the common spindle Inverter, or taken as an independent 5<sup>th</sup> servo axial interface. Moreover, GSK988T system is also equipped with the 2<sup>nd</sup> spindle interface CN41 (refer to following chapters for details), and it can output 0~+10V analog voltage for extending the 2<sup>nd</sup> spindle or the power unit.

### 2.2.1 The 5<sup>th</sup> Axis · Spindle Interface Definition

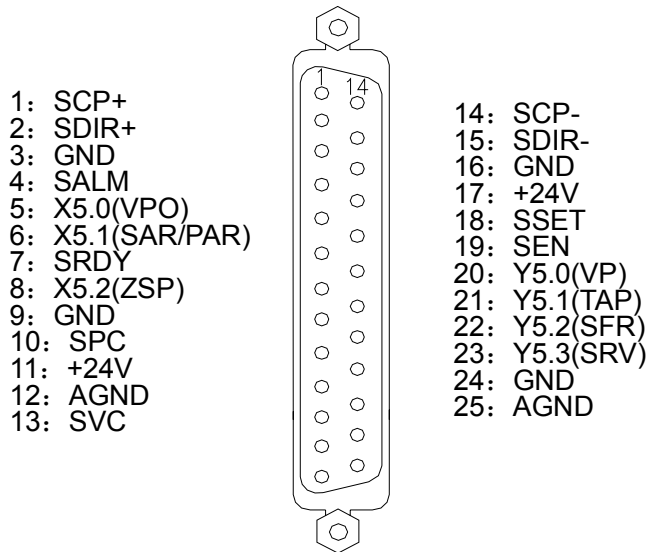

Fig. 2-2-1 CN15 servo spindle interface (25 cords, D type female)

Signal Definition	Explanation	Function Defined by Standard PLC Address
SCP+, SCP-	Command pulse signal	/
SDIR+,SDIR-	Command direction signal	/
SALM	Drive unit alarm signal	/
SRDY	Servo ready signal	/
SSET	Pulse forbidden signal	/
SEN	Axial enable signal	/
SPC	Zero point signal	/
SVC	0~+10V analog voltage output	/
AGND	Analog voltage output ground	/
X5.0 (VPO)	Address of PLC signal, binary input	Spindle speed/position status signal
X5.1 (SAR/PAR)	Address of PLC signal, binary input	Spindle position/speed reaching signal
X5.2 (ZSP)	Address of PLC signal, binary input	Spindle output at zero speed signal
Y5.0 (VP)	Address of PLC signal, binary output	Spindle speed/position switch signal
Y5.1 (TAP)	Address of PLC signal, binary output	Spindle speed loop gain selection signal 2 (used for tapping)
Y5.2 (SFR)	Address of PLC signal, binary output	Spindle CW signal
Y5.3 (SRV)	Address of PLC signal, binary output	Spindle CCW signal
+24V	+24V	/
GND	0V (binary input & output signal ground )	/

### 2.2.2 Signal Instruction

In the 5<sup>th</sup> axis · spindle interface, the internal circuits of SCP+, SCP-, SDIR+, SDIR-, SALM, SRDY, SSET, SEN are consistent with that of the similar signal in the drive interfaces CN11,

CN12, CN13, CN14. Refer to section 2.1.2.

(1) Zero point signal SPC

SPC signal is valid at low level. It is different with the nPC signal in CN11, CN12, CN13, CN14 interfaces (high-level nPC signal is valid). The internal circuit of SPC is shown in Fig. 2-2-2:

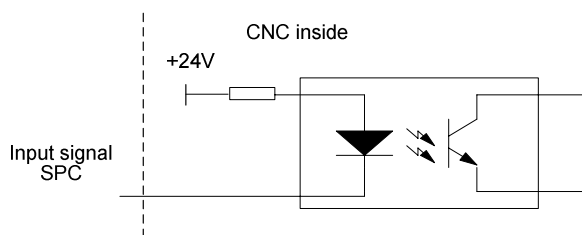

Fig. 2-2-2 Internal circuit of SPC

(2) Signals X5.0, X 5.1, X 5.2, X 5.3, X5.4

Signals X5.0, X 5.1, X 5.2, X 5.3, X 5.4 are the PLC signal addresses; binary input; the internal circuit is shown in Fig.2-2-3.

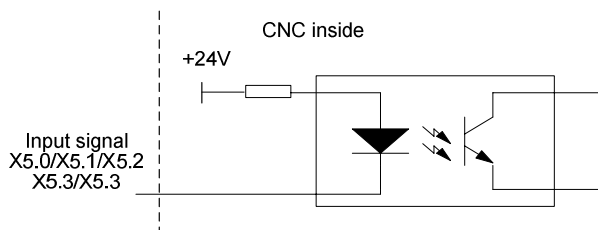

Fig.2-2-3

**Note:** In the 5th axis • spindle interface, low-level signals X5.0, X5.1, X5.2, X5.3, X5.4 are valid. The X address in general input CN61 (X0.0~X0.7, X1.0~X1.7, X2.0~X2.7, X3.0~X3.7) are valid during high-level input.

(3) Signals Y5.0, Y 5.1, Y 5.2, Y 5.3, Y 5.4

Signals Y5.0, Y 5.1, Y 5.2, Y 5.3, Y 5.4 are the PLC signal addresses; binary output. The internal circuit is shown in Fig. 2-2-4:

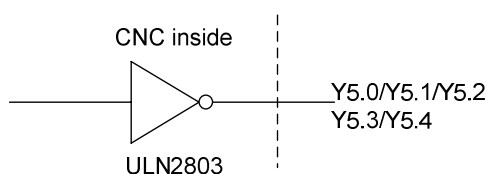

Fig. 2-2-4

### 2.2.3 Connection with the Servo Spindle Drive Unit

Connection between GSK988T and GSKDAP03C servo spindle drive unit is shown in the following figure. This connection can also be applied in spindle servo drive unit such as GSK DAP03/DAY3025C/DAY3025/DAY3100.

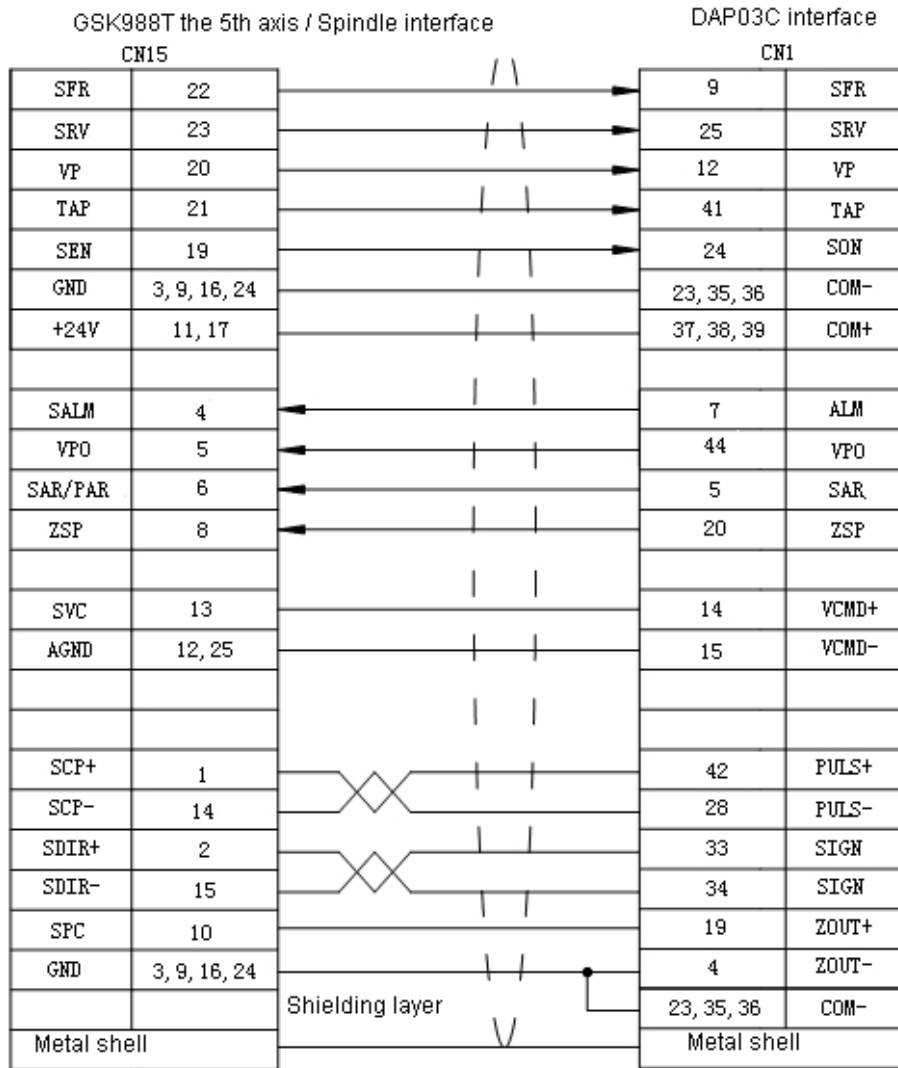

Fig. 2-2-5 Connection between GSK988T and DAP03C drive unit

### 2.2.4 Connection with the Spindle Inverter Interface

The 5<sup>th</sup> axis spindle interface (CN15) SVC port outputs 0~+10V voltage, the connection between GSK988T and the spindle inverter is shown in the following figure:

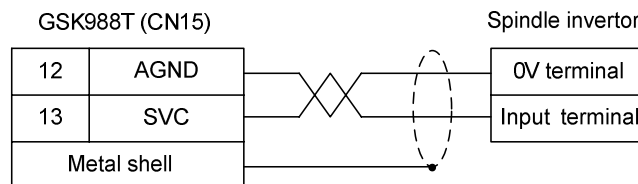

Fig. 2-2-6 Connection between GSK988T and inverter

### 2.3 Connection with the Spindle Encoder

GSK988T is equipped with two-channel encoder input interfaces (CN21 and CN22), CN21 interface is used as feedback input of spindle speed by default. When multi-spindle control function is started, select the encoder interface which receives the feedback pulse for the system control, through the selection signal PC2SLC (G28.7) of spindle encoder in PLC. When the interface (CN22) of encoder 2 does not connect to the encoder and the selection signal PC2SLC

of the position encoder is not set to 1, CN21 interface is taken as the feedback input of the spindle speed.

### 2.3.1 Interface Definition of the Spindle Encoder

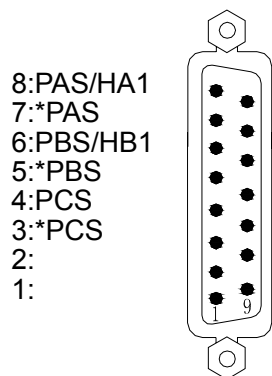

Fig. 2-3-1 Encoder interface of CN21 and CN22 (15 pins, D-type, male)

Signal	Description
*PAS/PAS	Encoder phase A pulse
*PBS/PBS	Encoder phase B pulse
*PCS/PCS	Encoder phase C pulse
HA1 (Only CN22 is with the signal)	The 2 <sup>nd</sup> MPG phase A signal (When it's not used in the 2 <sup>nd</sup> spindle encoder, it can be used to extend the 2 <sup>nd</sup> MPG)
HB1 (Only CN22 is with the signal)	The 2 <sup>nd</sup> MPG phase B signal (When it's not used in the 2 <sup>nd</sup> spindle encoder, it can be used to extend the 2 <sup>nd</sup> MPG.)

### 2.3.2 Signal Instruction

\*PCS/PCS, \*PBS/PBS and \*PAS/PAS are difference input signals of phase C, B and A respectively; \*PAS/PAS and \*PBS/PBS is the orthogonal square wave with difference of 90°, the maximum signal frequency <1MHz: The quantity of GSK988T encoder pulses is set by parameter No.3773 (the quantity of the spindle encoder pulses) and No.3803 (the quantity of the 2<sup>nd</sup> spindle encoder).

### 2.3.3 Connection with the Spindle Encoder Interface

The connection between GSK988T and the spindle encoder with the twisted pair line is shown in Fig. 2-3-2, and Changchun Yiguang ZLF-12-102.4BM-C05D encoder is taken as one example:

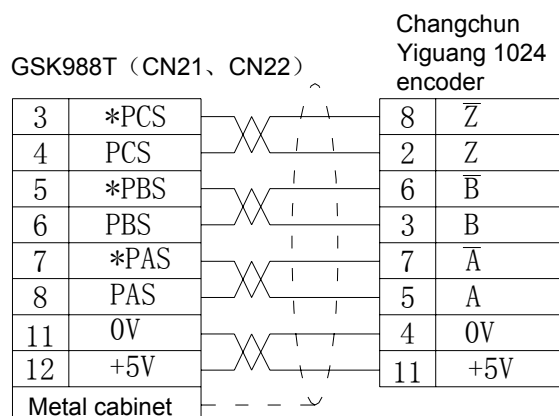
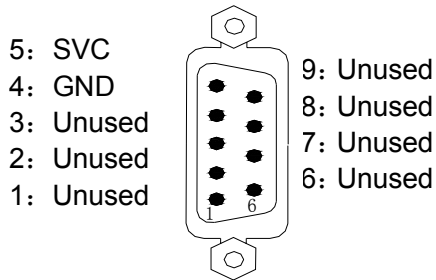

Fig. 2-3-2 Connection between GSK988T and the encoder

## 2.4 Connection with the 2<sup>nd</sup> Spindle

988T supports multi-spindle function. Two spindle analog voltage output interfaces include 5<sup>th</sup> axis spindle (CN15) interface and the 2<sup>nd</sup> spindle (CN41) interface. They are controlled by PLC signals. The 2<sup>nd</sup> spindle interface can be used to the 2<sup>nd</sup> inverter spindle or the unit head.

### 2.4.1 Definition of the 2<sup>nd</sup> Spindle (Analog Spindle) Interface



Signal	Description
SVC	0~+10V analog voltage output
GND	analog voltage output ground

Fig.2-4-1  
CN41 analog spindle interface  
(9pins, D-type, male)

### 2.4.2 Connection with the 2<sup>nd</sup> Spindle Inverter Interface

The 2<sup>nd</sup> spindle interface SVC port outputs 0~10V voltage. The connection is shown in Fig. 2-4-2:

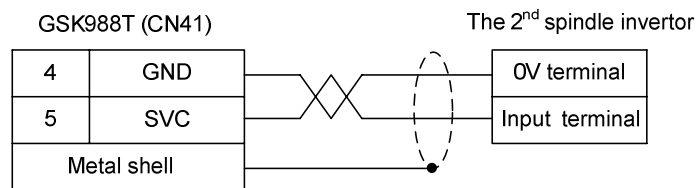
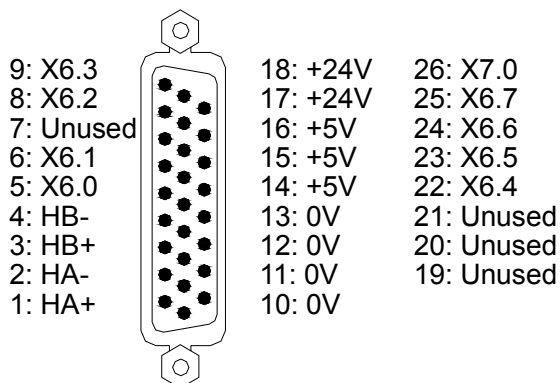

Fig. 2-4-2 Connection between GSK988T and the 2<sup>nd</sup> spindle inverter

## 2.5 Connection with MPG

### 2.5.1 Definition of MPG Interface



Signal	Description
HA+, HA-	MPG phase A signal input
HB+, HB-	MPG phase B signal input
X6.0~X7.0	PLC signal address; binary input

Fig. 2-5-1 CN31 MPG interface  
(26 pins, D-type male)

### 2.5.2 Signal Instruction

HA+, HA- and HB+, HB- are difference input signals of MPG phase A and B respectively. X6.0~X7.0 interfaces are input addresses defined by PLC interface, and it can also be used for axial selection of external MPG box and gear signal input.

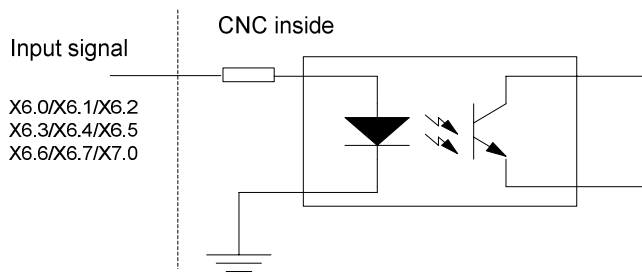

Fig. 2-5-2 Inside circuit of X6.0~X7.0 signal

### 2.5.3 Connection with MPG Interface

The typical connection between GSK988T and MPG is shown as the following figure:

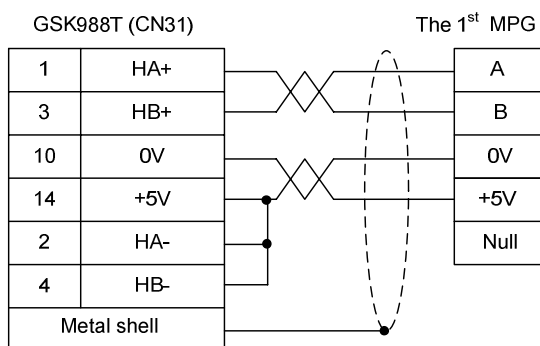

Fig. 2-5-3 Connection between GSK988T and the 1<sup>st</sup> MPG

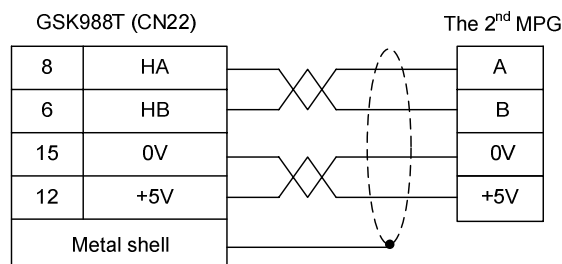

Fig. 2-5-4 Connection between GSK988T and 2<sup>nd</sup> MPG

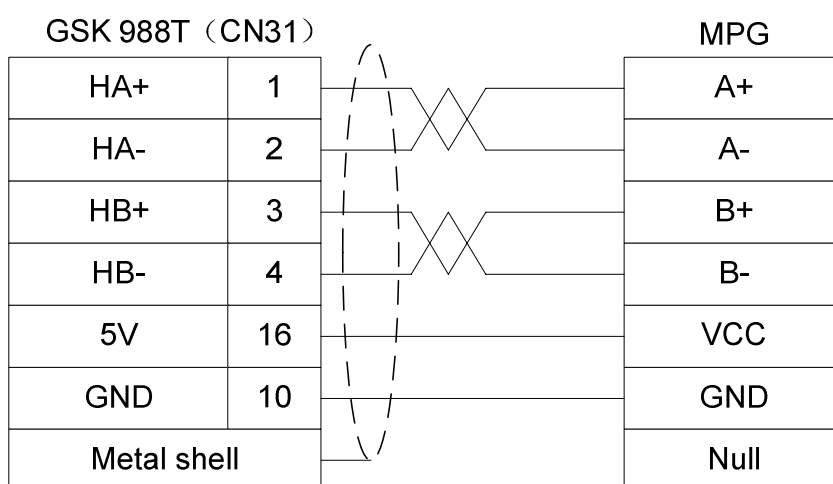
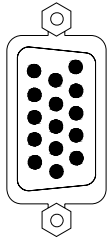

Fig.2-5-5 Connection between GSK988T and differential MPG

### 2.6 Connection with the Machine Panel

Connect between GSK988T system and the machine panel through communication.

### 2.6.1 Communication Interface Definition



Pin No.	Signal	IN/OUT	Description
1	RXDA	IN	Receive data difference signal
2	RXDB	IN	Receive data difference signal
4	TXDA	OUT	Send data difference signal
5	TXDB	OUT	Send data difference signal
7	RESET	OUT	Panel resetting signal

Fig. 2-6-1 Standard machine panel interface CN54  
(15 pins, D-type male)

## 2.7 GSK988T General I/O Interface Definition

### 2.7.1 Definition of Input & Output Addresses

Table 2-11 Definition of input & output addresses

Interface	CN61 Pin No.	PLC Address	Interface	CN62 Pin No.	PLC Address
<p>CN61 (male) input</p>	1	X0.0	<p>CN62 (female) output</p>	1	Y0.0
	2	X0.1		2	Y0.1
	3	X0.2		3	Y0.2
	4	X0.3		4	Y0.3
	5	X0.4		5	Y0.4
	6	X0.5		6	Y0.5
	7	X0.6		7	Y0.6
	8	X0.7		8	Y0.7
	9	X1.0		9	Y1.0
	10	X1.1		10	Y1.1
	11	X1.2		11	Y1.2
	12	X1.3		12	Y1.3
	13	X1.4		13	Y1.4
	14	X1.5		14	Y1.5
	15	X1.6		15	Y1.6
	16	X1.7		16	Y1.7
	29	X2.0		29	Y2.0
	30	X2.1		30	Y2.1
	31	X2.2		31	Y2.2
	32	X2.3		32	Y2.3
	33	X2.4		33	Y2.4
	34	X2.5		34	Y2.5
	35	X2.6		35	Y2.6
	36	X2.7		36	Y2.7



37	X3.0	37	Y3.0
38	X3.1	38	Y3.1
39	X3.2	39	Y3.2
40	X3.3	40	Y3.3
41	X3.4	41	Y3.4
42	X3.5	42	Y3.5
43	X3.6	43	Y3.6
44	X3.7	44	Y3.7
17	X4.0	17~19, 26~28	0V
18	X4.1	20~25	+24V
19	X4.2		
20	X4.3		
25	X4.4		
26	X4.5		
27	X4.6		
28	X4.7		
21~24	0V		

### 2.7.2 Input Signal

Input signal is the one which the machine electric wire or the machine panel transmits to CNC, and after connecting the input signal and +24V, the input is valid; if they are cut off, the input is invalid. The input signal of contacts on the machine side should satisfy the following conditions:

Contact capacity: DC30V, 16mA above;

Leakage current between contacts during opening: Below 1mA;

Voltage drop between contacts during closing: Below 2V (Current 8.5mA, including the cable potential drop).

There are two methods of external input for input signals: one is switch input with contacts, the connection is shown in Fig. 2-7-1:

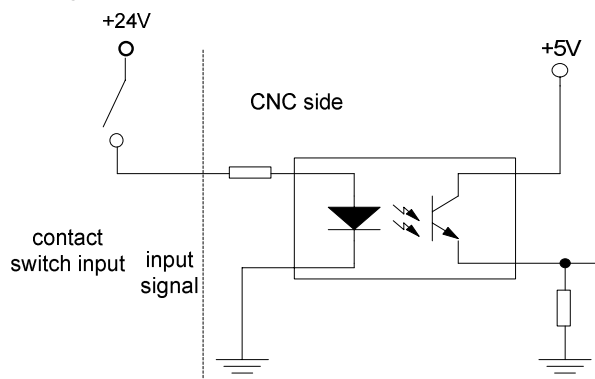

Fig. 2-7-1

The other is switch (transistor) input free of contacts; connection is shown in Fig. 2-7-2 and Fig. 2-7-3.

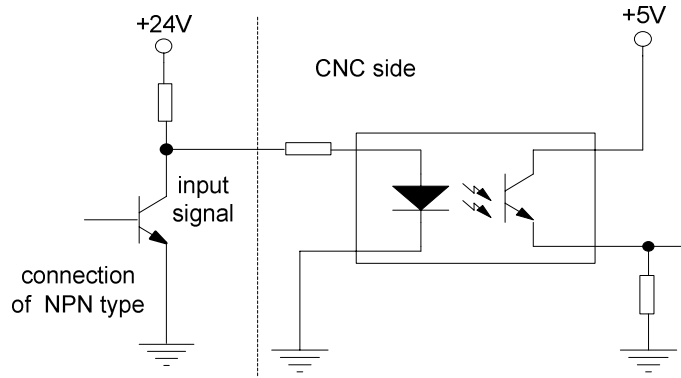

Fig. 2-7-2 NPN type

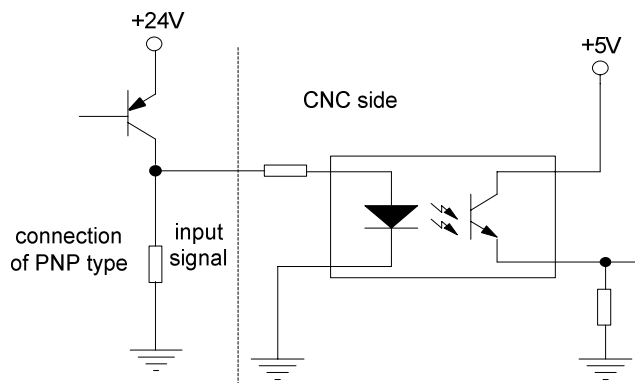

Fig. 2-7-3 PNP type

### 2.7.3 Output Signal

Output signal is used for the drive machine electrical wire side or the relay and the indicator on the machine panel side. When the output signal connects with 0V, the output function is valid (Y output signal is 1); cut off 0V, the output function is invalid (Y output signal is 0). The circuit is shown in the following Fig. 2-7-4:

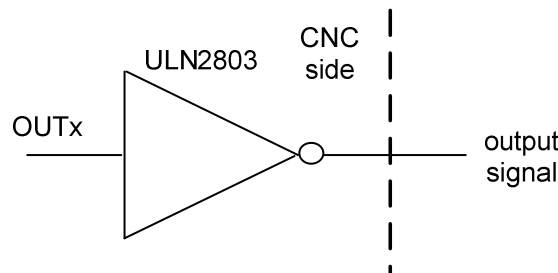

Fig. 2-7-4 Internal circuit of the output signals

Therefore, the signal has two output statuses: 0V output or high resistance. The typical application is as below:

- Drive light diode

Use ULN2803 to output drive light diode and need the serial connection with one resistance, limit the current from light diode (normally 10mA), which is shown in Fig. 2-7-5:

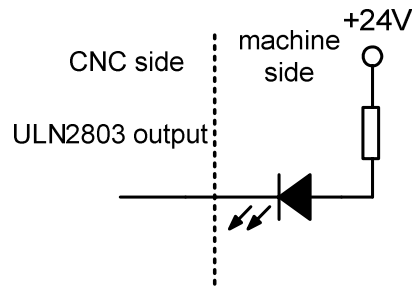

Fig. 2-7-5: Drive light diode

- Indicator in drive filament type

ULN2803 is used to output the indicator in drive filament type, and externally connect with one preheated resistance to reduce the current shock during break-over, and the value of the preheated resistance is based on that the indicator is off, which is shown in Fig. 2-7-6:

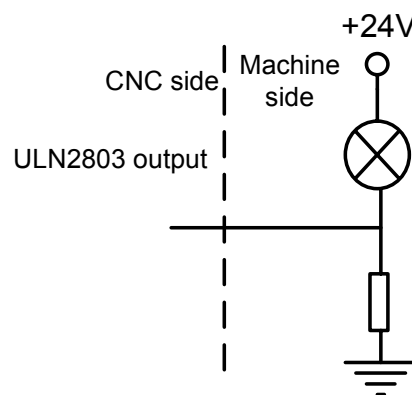

Fig. 2-7-6

- Drive inductive loading (such as the relay)

Output the drive inductive loading in ULN2803 type and it requires connecting the fly-wheel diode close to the circuit, which is to protect the output circuit and reduce the interference, which is shown in Fig. 2-7-7:

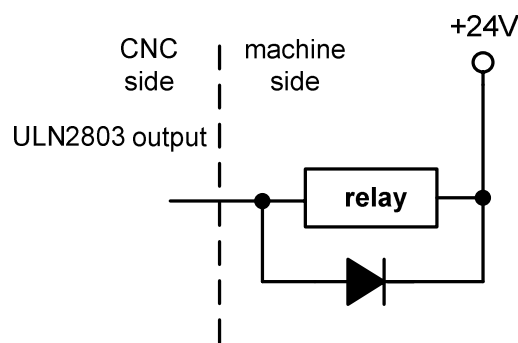

Fig. 2-7-7

## 2.8 Connection with the Power Supply

GSK988T uses GSK-PB2 power supply box, There are 4 groups of voltage: +5V (3A), +12V (1A), -12V (0.5A) and +24V (0.5A), and common port COM (0V).

### 2.8.1 Definition of Power Supply Interface

The interfaces of power supply are shown in Fig. 2-8-1 and 2-8-2:

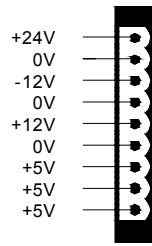

Fig. 2-8-1 power supply interface CN1

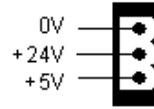

Fig. 2-8-2 power supply interface on the panel

### 2.8.2 Connection between GSK988T and GSK-PB2 Power Supply Box

When GSK988T is dispatched from the factory, GSK-PB2 power supply box and GSK988T power supply interface has been already connected, so the user just need to connect to 220V AC power supply. The connection between GSK-PB2 power supply box and GSK988T power supply interface is shown in Fig. 2-8-3:

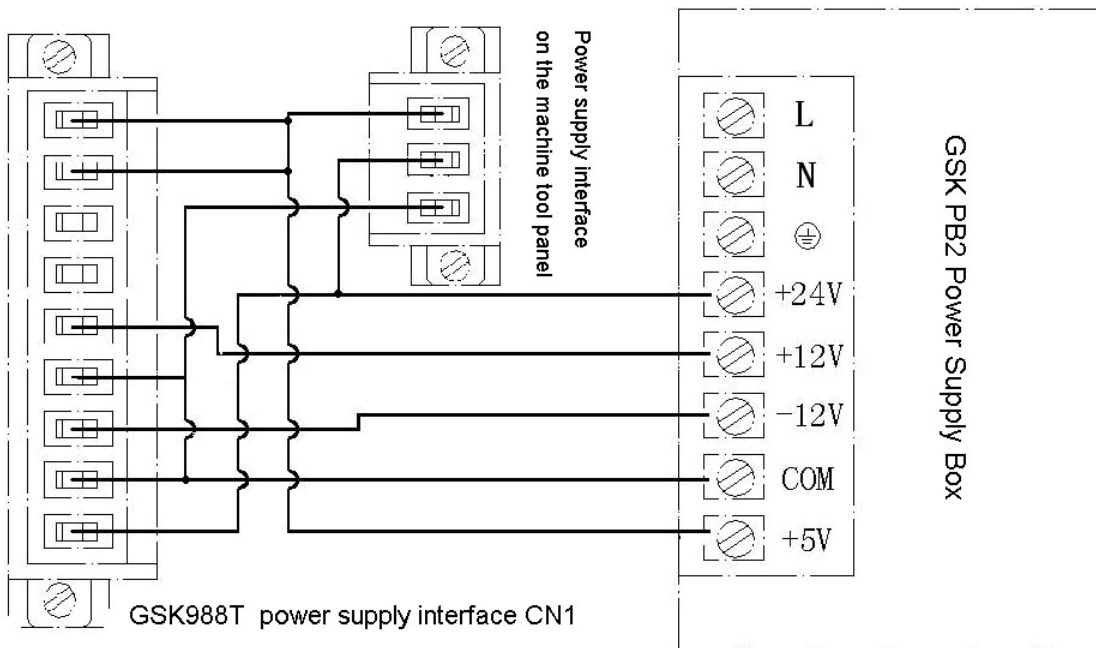

Fig. 2-8-3

### 2.9 Connection with the External Equipment

There are three interfaces on the left side of GSK988T LCD display screen: USB (flash driver), internet and RS-232 interfaces, which are shown in the following figure. All the three interfaces can be used for processing the file, two-way transmission between the system Para file and PLC file and upgrading the system software. Among them, the internet interface can also be used for remote monitor from PC to 988T system.

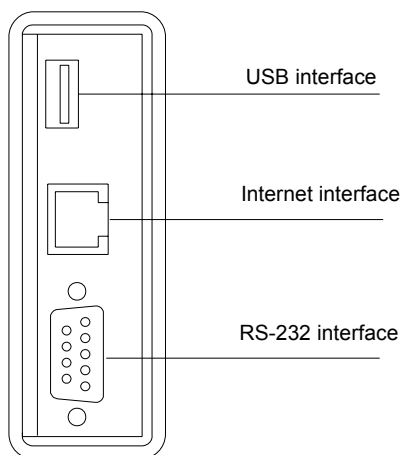

Fig. 2-9-1 GSK988T front panel interface

### 2.9.1 RS-232 Interface Definition

RS-232 communication interface:

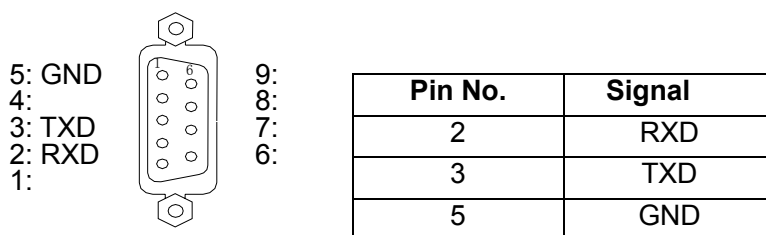

Fig. 2-9-2 RS-232 interface  
(9 holes, D type female )

GSK988T executes communication through RS232 with PC (GSKComm-M communication software should be installed). The connection is shown in Fig. 2-9-3:

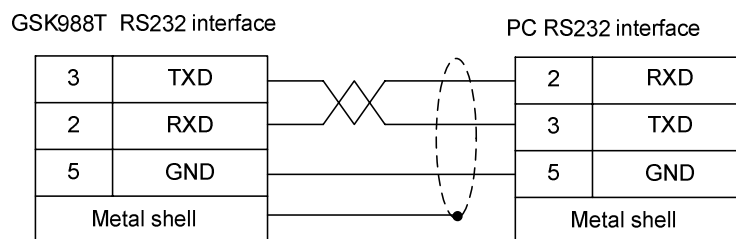

Fig. 2-9-3 Connection between GSK988T and PC

### 2.9.2 Definition of GSK-CAN Bus Interface

GSK988T is with GSK-CAN interfaces of two routes for connecting with the remote IO units and the servo drive unit with GSK-CAN communication function. Among them, CN53 (GSK-CAN serial bus A) is for communication between CNC and the servo drive unit to realize real-time monitor of servo parameter configuration and servo unit; CN52 (GSK-CAN serial bus B) is for communication between CNC and remote IO unit.

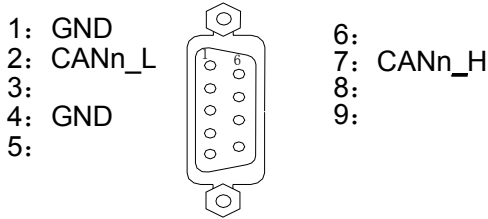

Fig 2-9-4 GSKLink bus interface CN53 and CN52 (9 holes, D type female)

Signal	Description
CANn_L	Low level of data difference signal
CANn_H	High level of data difference signal
GND	Signal ground

### 2.9.3 Network Interface Definition

Network interface (standard):

Pin No.	Signal	Pin No.	Signal
1	TXDLAN+	9	LINK_LED
2	TXDLAN-	11	LAN_LED
3	RXDLAN+	10, 12	VDD33
6	RXDLAN-	13, 14	Chassis ground

### 2.9.4 USB Interface Definition

Main USB interface (standard):

Pin No.	Signal
1	VCC(+5V)
2	USB_DN0
3	USB_DP0
4	GND
5, 6	Chassis ground

## CHAPTER III MACHINE TOOL DEBUGGING-OPERATION

### 3.1 Parameter Setting

The modification, backup and recovery of GSK988T system parameters and servo parameters can only be done under such conditions: higher than 3<sup>rd</sup> management level; parameter switch is ON and the system is in MDI mode. The operation of turning ON the parameter switch is shown as follows:

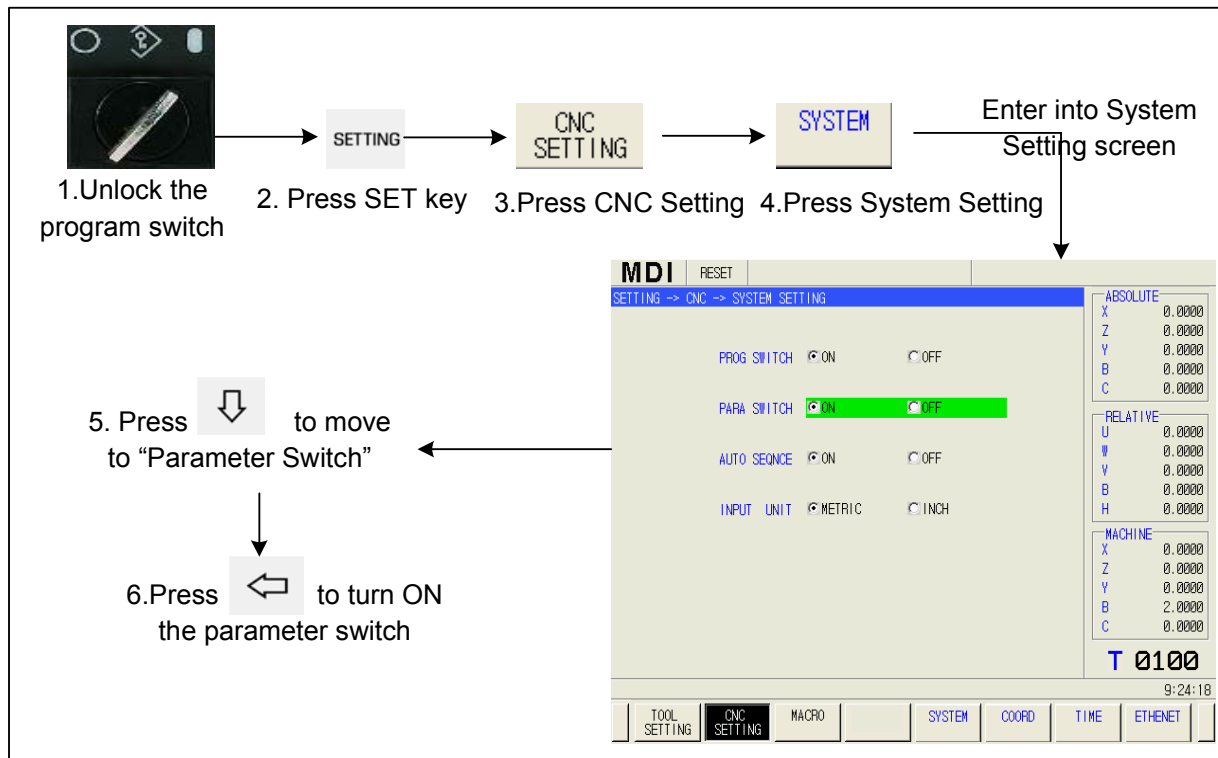

**Note 1:** After parameters are modified, the modification is valid to some parameters immediately; some will be valid only after power on again. For details, please refer to chapter 5 Parameter Instruction.

**Note 2:** To view or modify the servo parameters in CNC, please ensure the correctness of servo system connection and servo slave configuration.

#### 3.1.1 System Parameters

Press → → to enter into system parameter setting screen.

The system parameters can be set and modified on this screen. The current set parameters can be backed up, and system default parameter or backup parameters can be recovered.

(1) Configuration parameter calling

On system parameter page, press to extend the softkeys (shown in Fig. 1), then, press to enter into parameter configuration list (shown in Fig. 2). On this page, select proper default parameter according to axes configurations by pressing key or , then press

CONFIG  
PARAM

to call the selected parameter, and restart the system.

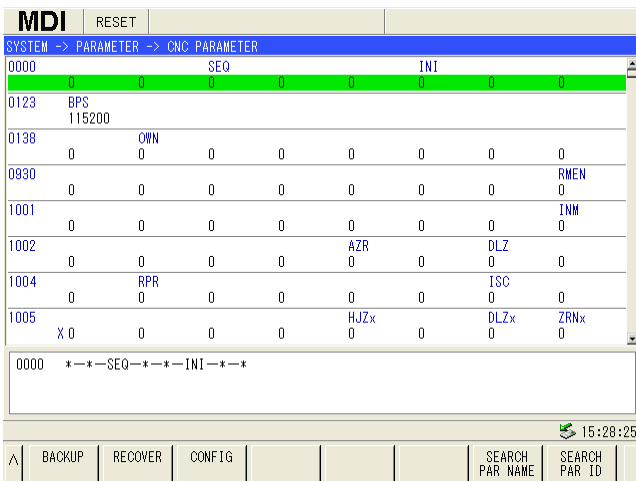

Fig. 1

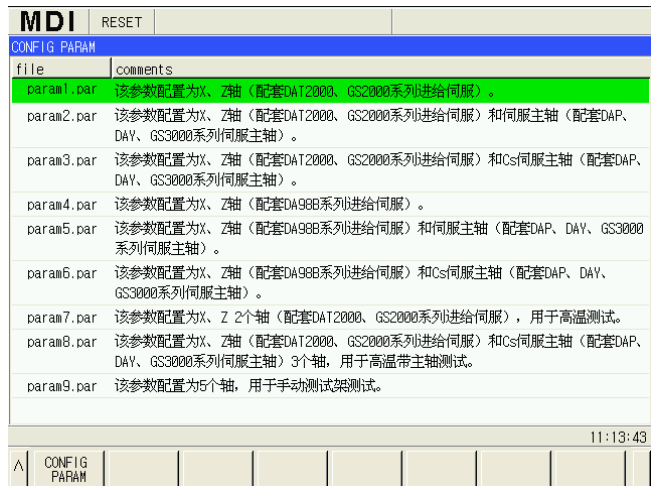

Fig.2

(2) Parameter searching

Method 1: Select a parameter to be viewed or modified through , , or ;

Method 2: Through parameter name: press softkey and enter a parameter name, then press , the cursor will locate to the desired parameter;

Method 3: Through parameter number: press softkey and enter a parameter number, then press , the cursor will locate to the desired parameter.

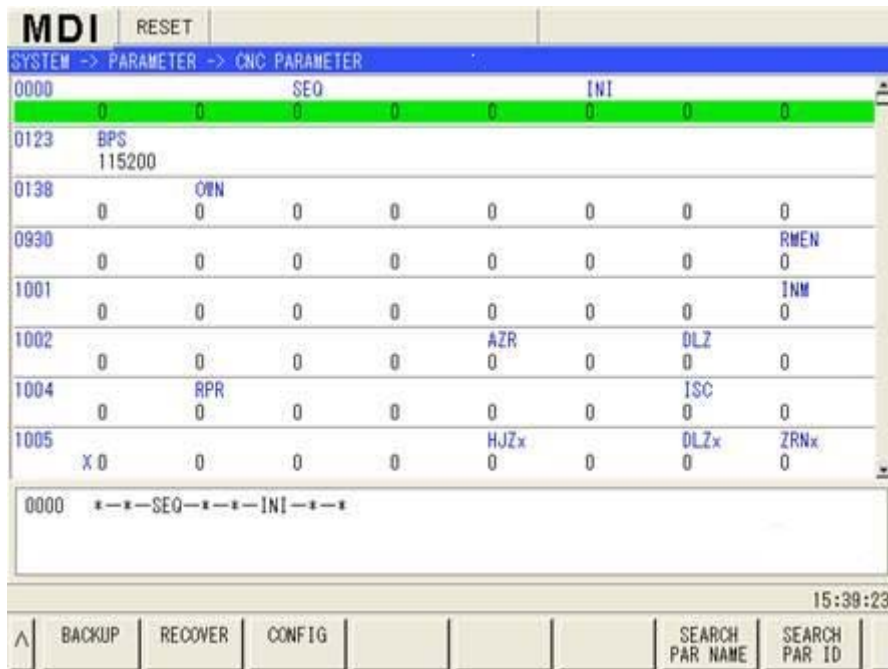



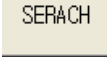
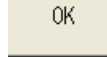



Fig. 3.1.1







**(3) Bit type parameters setting**

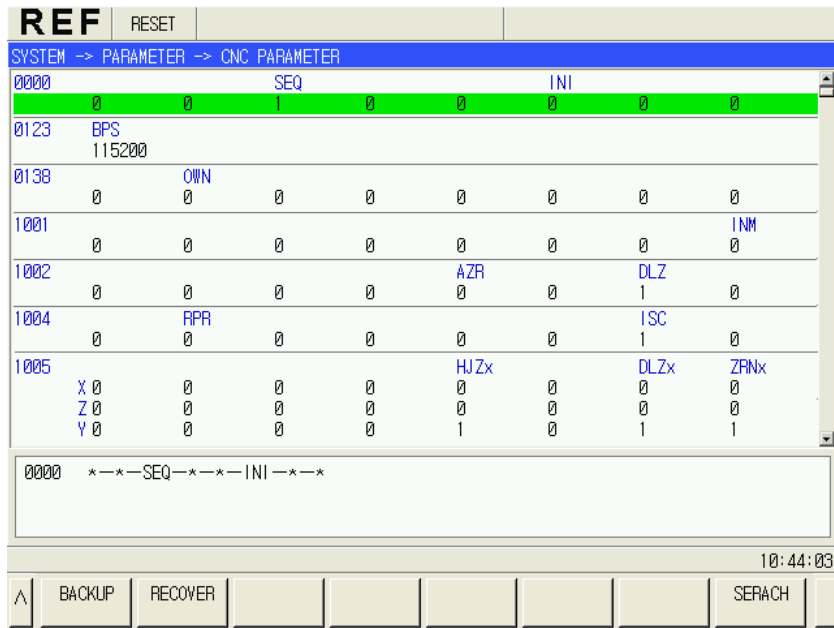









**Method 1:**

- ① Select the parameter to be modified through keys , , , ; or press  softkey and input the parameter number, then press  softkey, the cursor will move to the desired parameter.
- ② Press key  to make the selected parameter modifiable. For example, the No.0000 parameter in the figure below:









- ③ Press the numeric keys to input 8 binary values, and then, press  to complete the setting. (When the number input values is less than 8, fills the vacated bits with 0.)
- ④ Select other parameters through keys , , , .

**Method 2:**

- ① Select the parameter to be modified through keys , , , . Select the bits to be modified through keys  and .
- ② Press  repeatedly, to switch the parameter bit between 0 and 1.
- ③ Move the cursor to complete the setting.
- ④ Select other parameters through keys , , , .

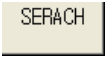
**(4) Numeric type parameter setting**

- ① Select the parameter to be modified through keys , , , ; or press  softkey and input the parameter number, then press  softkey, the cursor will move to the desired parameter.
- ② Press key  to make the selected parameter modifiable.

③ Input the numbers to be set through numeric keys, then press **INPUT** to complete the setting.

④ Select other parameters through keys **☰**, **☷**, **↑**, **↓**.

**(5) Parameters backup and recovery**

Before modification, the parameters can be backed up through **BACKUP** softkey. When the modification is erroneous or the parameter does not need to be modified, press **RECOVER** softkey, the backup parameters or system default parameters can be recovered.

➤ **Parameter backup**

① Press **BACKUP** on the parameter screen, **BACKUP PARAM** will be displayed.

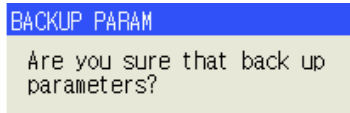

② Press **OK** to back up the current set parameters.

➤ **Parameter recovery:**

① Press **RECOVER**, **RECOVER PARAM** will be displayed.

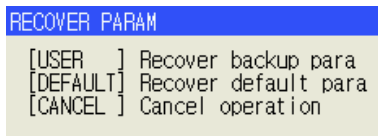

② Press **USER** key to restore the backup parameters; Press **DEFAULT** to restore the system default parameters; press **CANCEL** to exit from the parameter screen.

**3.1.2 Servo Parameters**

**(1) Modification and save**

When the GSK-CAN communication is in normal state, on system screen, press **PARAM** →

**SERVO PARAM**, to enter into servo parameter screen.

MDI		RESET					
SYSTEM → PARAMETER → SERVO PARAMETER X AXIS							
No.	data	No.	data	No.	data		
000	315	001	146	002	105		
003	0	004	0	005	300		
006	120	007	000	008	500		
009	40	010	0	011	2000		
012	1	013	1	014	2		
015	0	016	20	017	400		
018	0	019	0	020	1		
021	120	022	0	023	2500		
024	500	025	2000	026	-1000		
027	-1500	028	50	029	250		
030	1	031	1	032	0		

0000 Password  
[0, 9999]

11:46:59

^	X AXIS	Z AXIS	SAVE	BACKUP	RECOVER	NO.SRH
---	--------	--------	------	--------	---------	--------

Servo parameters can be viewed, modified, saved, backed up, restored and exported through

servo parameter screen on the CNC side. Default servo parameters can be restored.

**Axes switching:** Press  ,  or  to switch among the displayed servo parameters.

**Parameter modification:** Move the cursor to the desired position, then enter into a parameter value directly, and press  to complete the modification.

**Parameter saving:** after the modification, press  to save the parameter. The saved parameter remains the same after servo is turned ON again.

**Parameter backup:** Press  , the following dialogue box will pop up, then press  to back up the file.

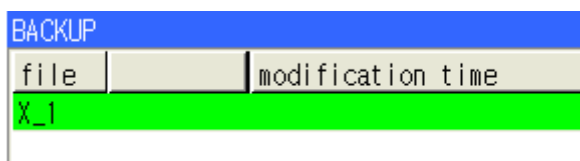

**Parameter recovery:** Press  , the following dialogue box will pop up, the press  to restore the backup file.

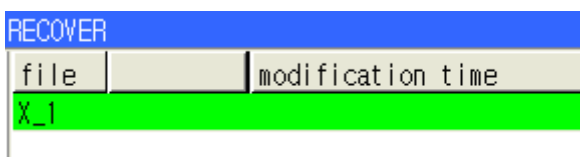

**Default parameter recovery:** Press  , then a default value will be restored according to the setting value in PA1.

**Select effective parameter:** if the parameters are modified on the servo, after power-on, the system will issue prompt No.5030 “the servo parameter in current parameter file of axis servo is inconsistent with the read servo parameter.” Switch to the servo parameter screen this time, see Fig.

3-1-6 , then press  , see Fig. 3-1-7.

MDI		RESET			
SYSTEM -> PARAMETER -> SERVO PARAMETER Z AXIS					
No.	data	No.	data	No.	data
000	1111	001	46	002	103
003	0	004	0	005	400
006	300	007	800	008	600
009	40	010	0	011	2000
012	1	013	2	014	0
015	0	016	20	017	5200
018	0	019	0	020	1
021	120	022	0	023	2500
024	500	025	2000	026	-1000
027	-1500	028	50	029	10
030	10	031	1	032	3
033	0	034	300	035	-300

0000 Password [0, 9999]

12:50:12

X AXIS Z AXIS NO. SRH SELECT EFF. PAR

Fig.3-1-6

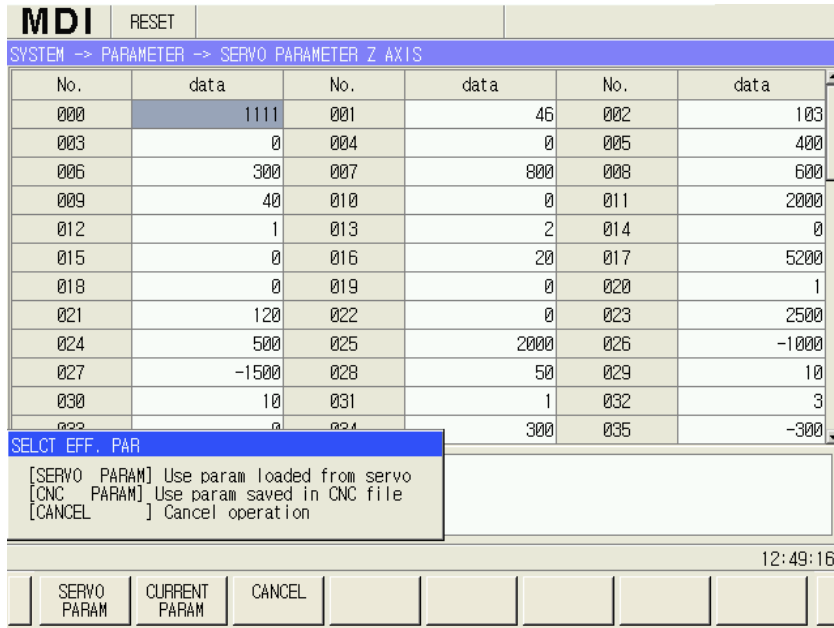

Fig. 3-1-7

Press **CURRENT PARAM** to validate the servo parameters in CNC; press **SERVO PARAM** to validate the parameters read from the servo; press **CANCEL** to return to the screen shown in Fig. 3-1-6.

**Note: CNC will read servo parameters directly, i.e. the parameters displayed on CNC servo page are the parameters on servo side;**

**(2) Restore motor default parameter**

**Method 1: Modify servo parameter PA1**

Refer to Appendix 2.1 (Feed Servo Motor Model List) and Appendix 2.2 (Spindle Servo Motor Model List) to find the index value in the current software version of drive unit which is connected to the motor according to the motor type given on the motor nameplate.

- a. Modify servo parameter PA1 to make it equal to the searched motor index value.
- b. After modifying PA1, the system automatically update the default parameter corresponding to the motor. The parameter value is valid immediately after modification.

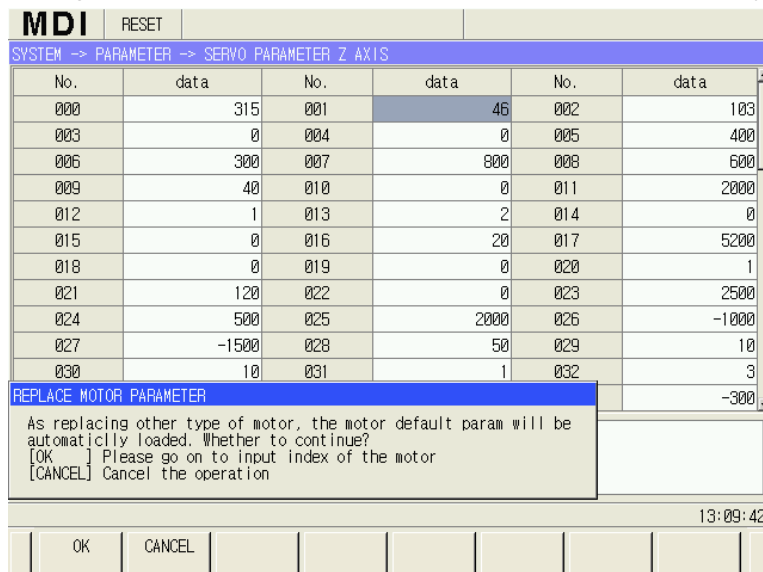

Fig. 3-1-8

**Method 2: Change motor model**

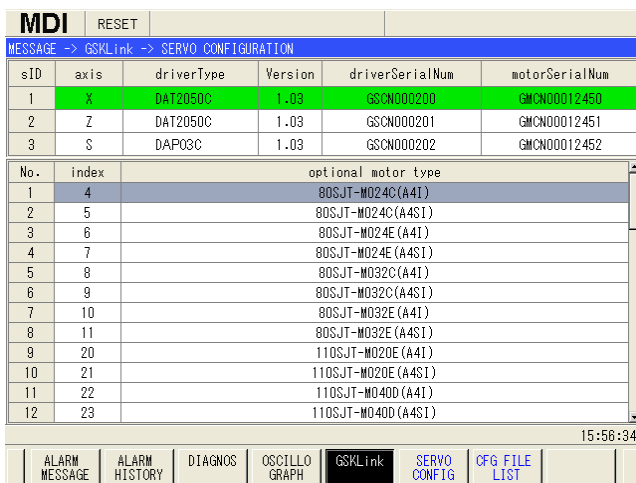

Fig. 1

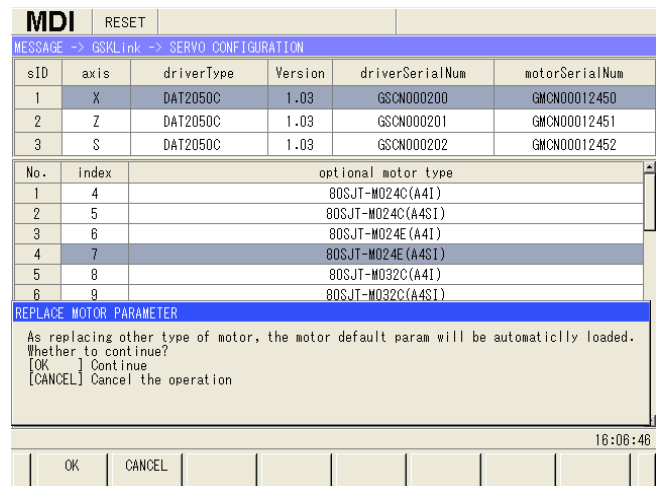

Fig. 2

- Press key MESSAGE to enter to information screen, then press GSKLink → SERVO CONFIG to enter to slave configuration page; shown in Fig.1;
- Press SWITCH LIST or key CHANGE on MDI panel, so that the cursor can move in the optional motor type.
- Select a desired motor model, and press softkey REPLACE MOTOR, shown in Fig. 2; press OK or INPUT key on MDI panel to change motor model; the system will automatically renew the default parameters and stored them; shown in Fig. 2 (the current model is displayed in red);

**3.2 Instruction of PC Communication Software GSKComm-M**

This section is a simple instruction for the usage of the GSKComm-M during machine tool debugging. For the details, please refer to the *GSKComm-M Instructions* on the CD.

GSKComm-M is communication management software especially provided for the machine tool builders. The GSKComm-M screen is shown as follows. It can realize the following functions: upload and download of files between PC and CNC, DNC communication, CNC parameter editing, part program management and editing, viewing tool compensation data and screw pitch error compensation data, ladder diagram editing, etc. It is convenient, efficient and reliable.

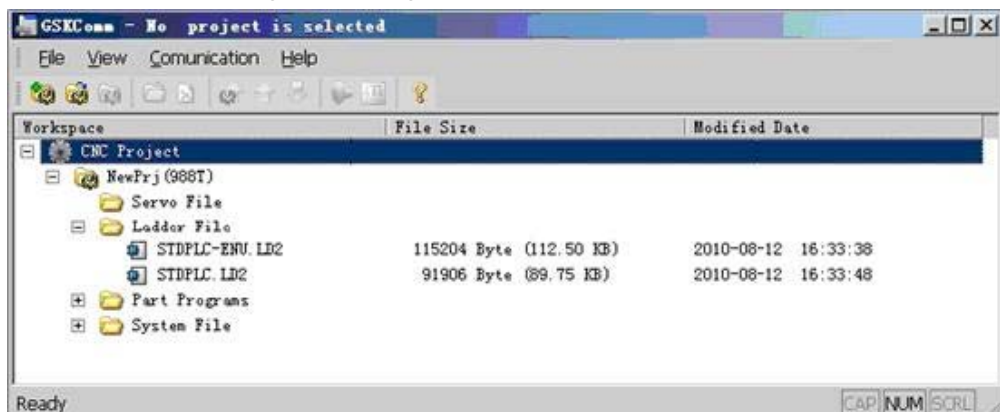

### 3.2.1 Preparation for GSKComm-M

#### (1) RS-232 series port connection

➤ **Connection between PC and CNC**

When both PC and CNC are power-off, the communication cable should be connected as follows: DB9 male is plugged into the RS-232 communication interface on the CNC; DB9 female is plugged into the 9 pins serial ports on the PC (COM0 or COM1).

➤ **Baudrate setting in CNC**

The baudrate is set by parameter No.0123. When data transmission is processed between CNC and PC, the setting value should not be less than 4800. (Ex-factory value:115200)

➤ **Baudrate setting in PC**

After the communication software is executed, left-click the menu and select “Communication—>Communication Setup”, shown in right figure.

**Setting:** select the serial port communication.

**Port selection:** select ports used for communication (COM1, COM2, COM3, COM4)

**Baudrate:** Select the baudrate (4800, 9600, 19200, 18400, 57600, 115200) (unit: bps)

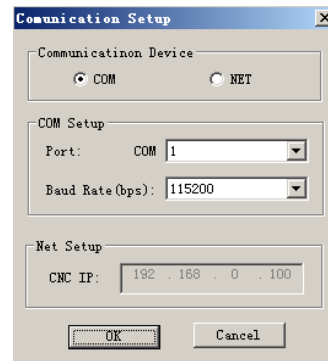

#### (2) Network connection

➤ **Connection between PC and CNC:**

Connect the network port of GSK988T to the PC or router with normal network cable.

➤ **IP setting on CNC:**

Press **SETTING** → **CNC SETTING** → **ETHERNET**, to enter into IP setting page to set the IP address and gateway.

➤ **IP setting on PC:**

After the communication software runs, left-click the menu, and select “Communication—>Communication Setup”, shown in right figure.

**Communication setting:** Select network communication.

**Network setting:** Fill in the IP set in CNC.

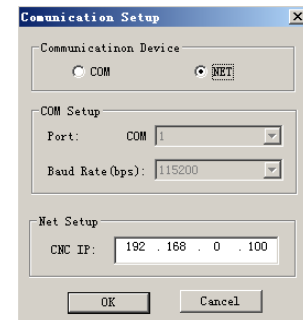

#### (3) Authority setting

During upload and download using GSKComm, corresponding authority should be set in advance, otherwise, the operation will fail.

Data to be downloaded	CNC least authority level	Remark
PLC files	2 level	
Parameters	3 level	Parameter switch is ON
Part programs	3 level	Program switch is ON
Macro variables	4 level	Program switch is ON
Tool compensation data	4 level	
Pitch error compensation data	5 level	Parameter switch is ON
Tool life files	5 level	

### 3.2.2 File Download (PC→CNC)

Through GSKComm, files in the PC can be transferred to CNC altogether or one by one.

#### (1) Add files

First, press the type of file to be added (for example, system file, part program file or ladder diagram file)

Then, press  or right-click, select "Add Files", a dialog box for adding file will pop up (shown in the left figure), select the desired file (hold down "shift" key to select more files), then click "Open" to complete the action.

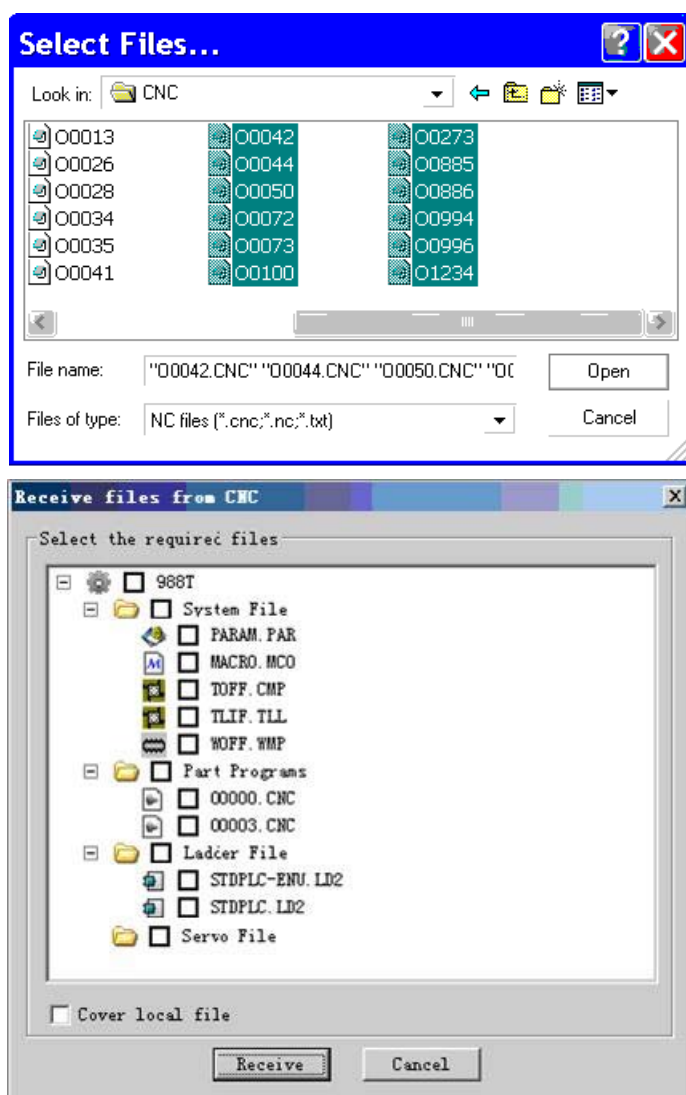

#### (2) Add multiple files

First, select the project to be transferred; then, click  or right-click the project and select "Send to CNC", the following dialog box will pop up. (Shown in the right figure above)

In this dialog box, click the left options to select the files to be transferred. Arrow "→" points to the file name saved in CNC, double-click it, you can change the file name.

Click “Start sending” you can transfer the selected file (with the saved file name) into CNC.

**(3) Download single file**

Select the file to be downloaded, and then click , or right-click the file and select “Send to CNC”, a dialog box will pop up. You can change the file name to be saved in the CNC, and then click “OK” to transfer the file.

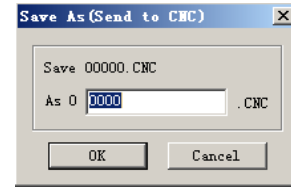

**3.2.3 Upload File (CNC→PC)**

First, select a project, then, click , or select menu "Communication→Receive Files from CNC", a dialog box will pop up, (shown in the left figure below). Select the file to be uploaded, and then click “Receive”, a “Browse File” dialog box pops up (shown in the right figure below).

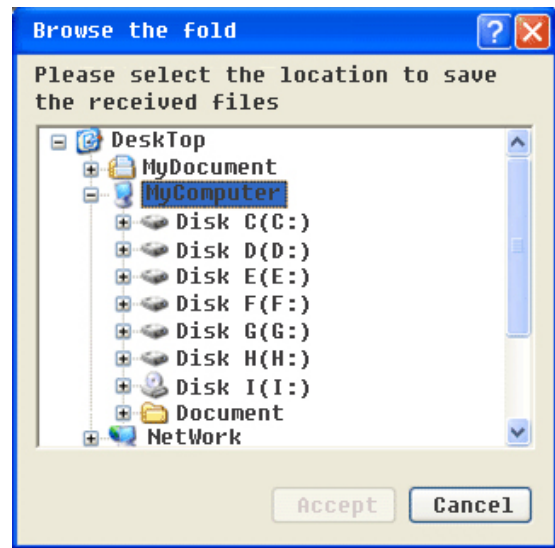
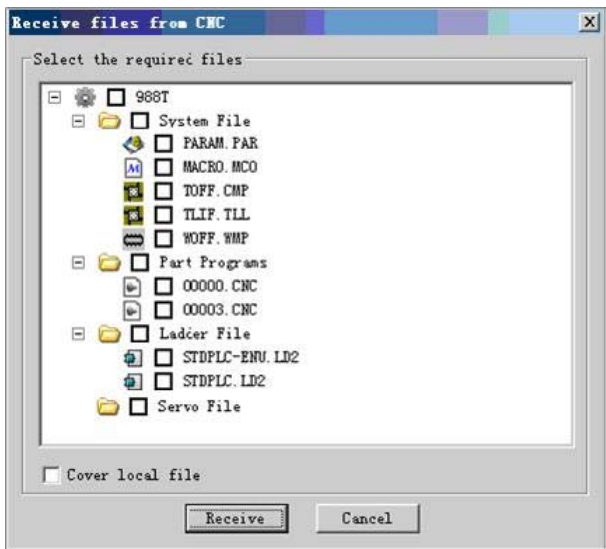

Select the file folder in which the uploaded file to be saved, and click “OK” to upload the selected file.

**3.3 Usage of U Disk**

The U disk function in GSK988T supports the bi-directional transmission of files involving machining program, PLC program, parameters, tool compensation data and pitch error compensation data. It can be operated on three screens: file management screen, program screen and ladder diagram screen.

**3.3.1 File Management Screen**

When U disk is already inserted in the USB port, press  →  to enter into file management screen.



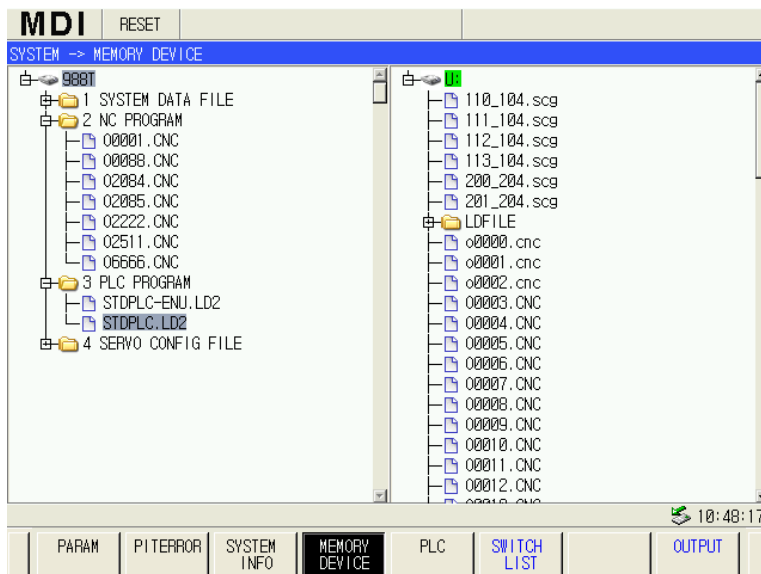

Under this screen, bi-directional transfer of system files (system parameters, tool compensation data, pitch error compensation data etc.), ladder diagrams and part programs can be executed. The procedure is shown as follows:

Press **SWITCH LIST** to switch between the system content and U disk content.

Press **OUTPUT** softkey to copy the selected program into local directory or U disk directory.

### 3.3.2 Program Screen

The operation of U disk directory is the same as in the local directory. In this section, we only introduce the program transfer in U disk. For details, please refer to *GSK988T User Manual*.

When the system USB port is inserted with U disk, press **PROGRAM** to enter into program directory (left figure below), press **↓**, the extended softkeys will be displayed. Then, press **USB** to enter into U disk directory screen, operations to the programs in U disk directory such as load, open, copy, paste, create, save as, delete, rename, search, etc. can be performed.

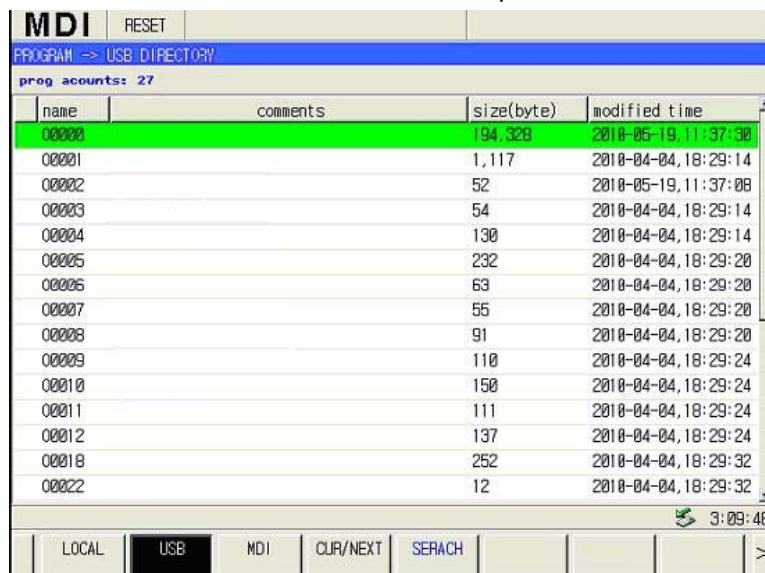

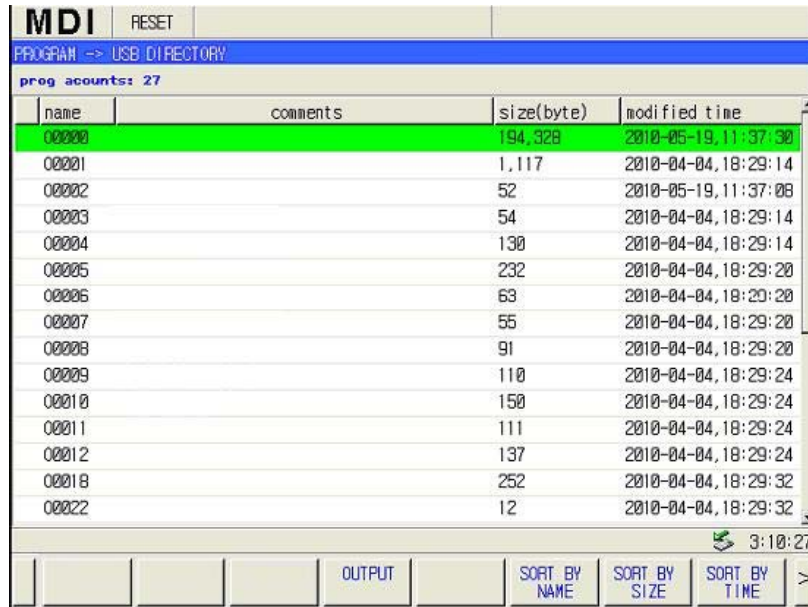

➤ Program bi-directional transmission

① Press LOCAL and USB to switch between the local directory and U disk directory.

② Move the cursor to the program to be copied through ↑ and ↓. Then, press V to view the extended softkeys (the right figure above),

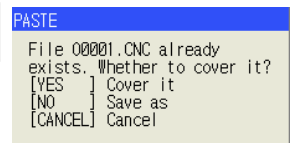

Press OUTPUT to copy the selected program into local directory or U disk directory.

③ When the copied program already exists, a dialog box pops up (see the right figure). Press

“Yes” softkey to cover the existed program; or press “No”, a dialog box COPY PRG00001 AS 0 0001 pops up, then input the program name for saving; press “Cancel” to cancel the operation.

**Note 1:** When transmission is made from the U disk directory to local directory, the machining programs can be read only when it is stored in the root directory “NCPROG” file in the U disk.

**Note 2:** When transmission is made from local directory to the U disk directory, if the “NCPROG” file does not exist in the U disk, the file will be created automatically, and the machining programs will be output to the files.

### 3.3.3 PLC Screen

When the USB port is inserted a U disk, press PROGRAM on the ladder diagram screen, the screen is shown in Fig. 3-3-4 (Local directory screen). Press USB to switch to the U disk directory screen, shown in Fig. 3-3-5.

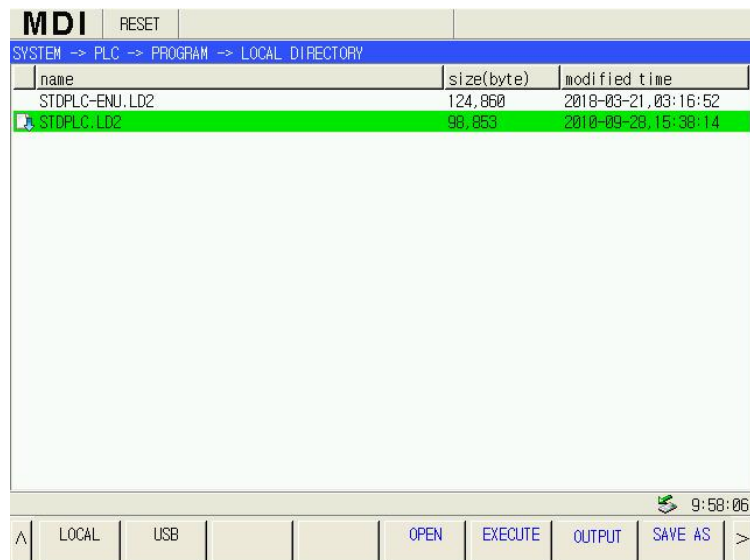



Fig. 3-3-4



Fig. 3-3-5

Programs in the U disk directory can be copied to local directory through softkey **OUTPUT**, vice versa.

Take the U disk for example, the procedures are shown as follows:

- ① Press softkey **USB** to enter into U disk directory;
- ② Select the ladder diagram programs to be copied through  and , then, press **OUTPUT** to copy it to the local directory.

**Note 1:** When PLC transmission is made from the U disk directory to local directory, the PLC programs can be read only when it is stored in the root directory "LDFILE" file in the U disk.

**Note 2:** When PLC transmission is made from local directory to the U disk directory, if the "LDFILE" file does not exist in the U disk, the file will be created automatically, and the PLC programs will be output to the files.

### 3.4 PLC Operation

Press function key **SYSTEM** and then press softkey **PLC** to enter into PLC screen. This screen includes pages such as version information, monitor, PLC data, PLC state, program directory. Press corresponding softkeys, you can view the desired content.

After entering the PLC screen, the contents of **VERSION** is displayed. The version page includes the information about the PLC version, current running PLC program and the running state, etc.



#### 3.4.1 PLC Execution and Stop

On PLC screen, press softkey **PROGRAM**, then press **LOCAL**, the following screen is displayed:





On this page, you can select PLC program through **↑** and **↓**, then operations such as edit, running, stop, save, create, delete and backup can be performed.

➤ **Execution of PLC programs**

Select the PLC program through **↑** and **↓**, then press **EXECUTE** to start running.

Note: The current running PLC program is marked with .

➤ Stop PLC program execution

Move the cursor to the current running program through  and , then press , the system will be in no PLC running state.



### 3.4.2 PLC Monitoring and Diagnosis

(1) Monitor the PLC program state

On the PLC screen, press softkey  to enter to the monitoring display screen for the current running PLC program.

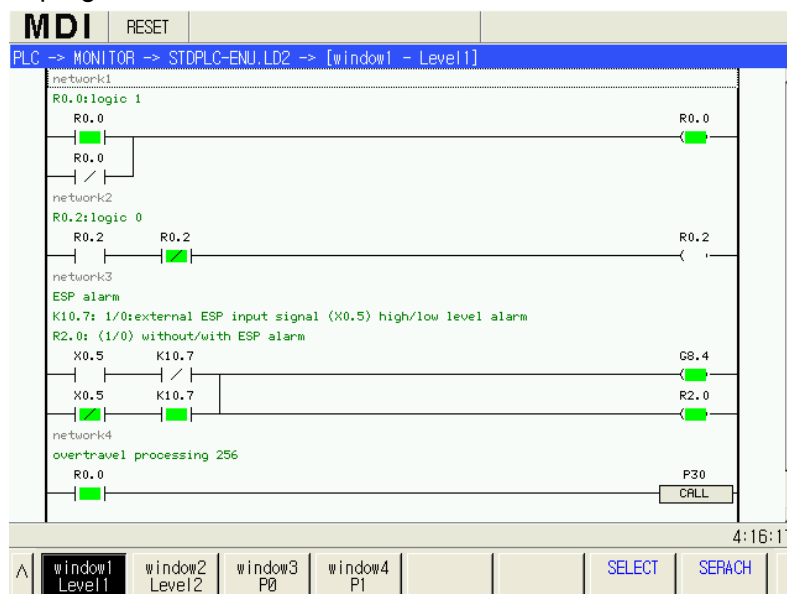

You can view the state of current contact, coil conducting ON/OFF and the current value of timer and counter. When the contact and coil conduction is ON, it is indicated by green color; if not, the color is the background color of the screen. For example:  $\overline{\text{X0.5}}$  means the contact X0.5 is conducted,  $\text{Y25.2}$  means the coil Y25.2 is not conducted.

➤ **View blocks**

On monitoring page, there are four softkeys for monitoring four blocks: window1  
Level1, window2  
Level2, window3  
P0, window4  
P1. Each of them corresponds to a block and the corresponding PLC will be displayed on the screen.

**Note 1:** Softkeys for windows 1~4 are shortcut keys which enable quick view of the corresponding blocks.  
**Note 2:** The blocks corresponding to windows 1~4 can be changed, but the change will not be effective after power-off. The default block after power-on is the first four blocks in the PLC programs.

➤ **Select block**

① Select the screen as needed.

② Press softkey SELECT, the following figure is displayed:

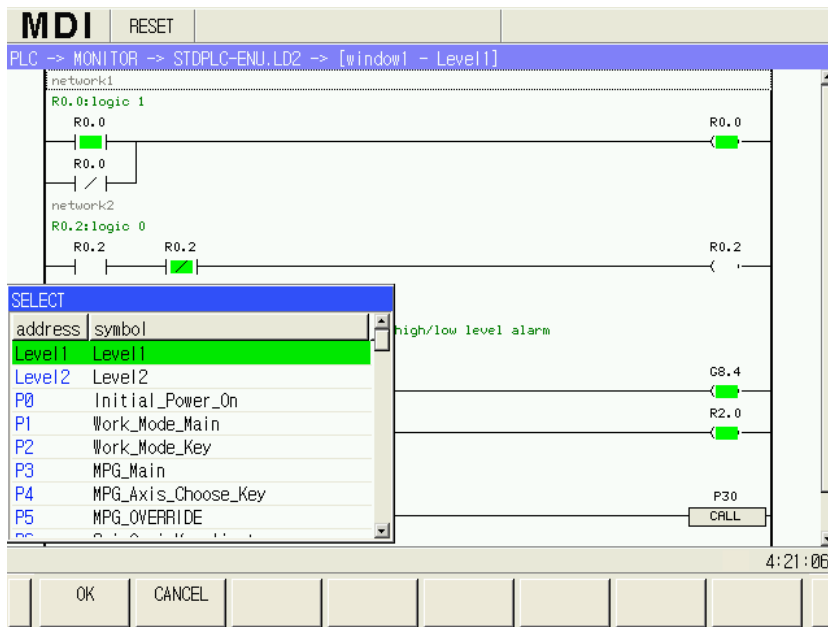

③ Press keys [List Icon], [List Icon], [Up Arrow], [Down Arrow] to select the desired window.

④ Press softkey OK to complete the selection, then, return to the previous menu; press softkey CANCEL to cancel the selection and return to the previous menu.

➤ **Search for parameters, commands and network**

① Select the window in which the command, parameter or network to be searched, i.e. press

window1  
Level1, window2  
Level2, window3  
P0, window4  
P1 to display the corresponding blocks of PLC program, then, search for the command, parameter or network.

② Press softkey SEARCH to enter to search page, shown as follows:

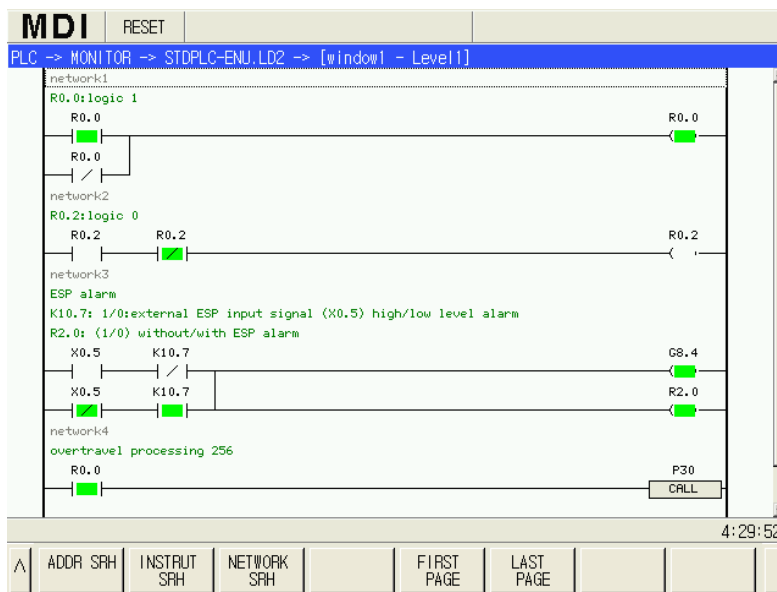

③ Press softkeys **ADDR SRH**, **INSTRUT SRH**, **NETWORK SRH** respectively you can search for the parameters, command, network on the corresponding screen, and move the cursor to the corresponding position.

④ Press **FIRST PAGE**, **LAST PAGE** to move the cursor to the first line and last line of the block.

## (2) PLC I/O state diagnosis

On PLC screen, press **>** and **PLC STATE** to enter to PLC state display page, as shown in the following figure.

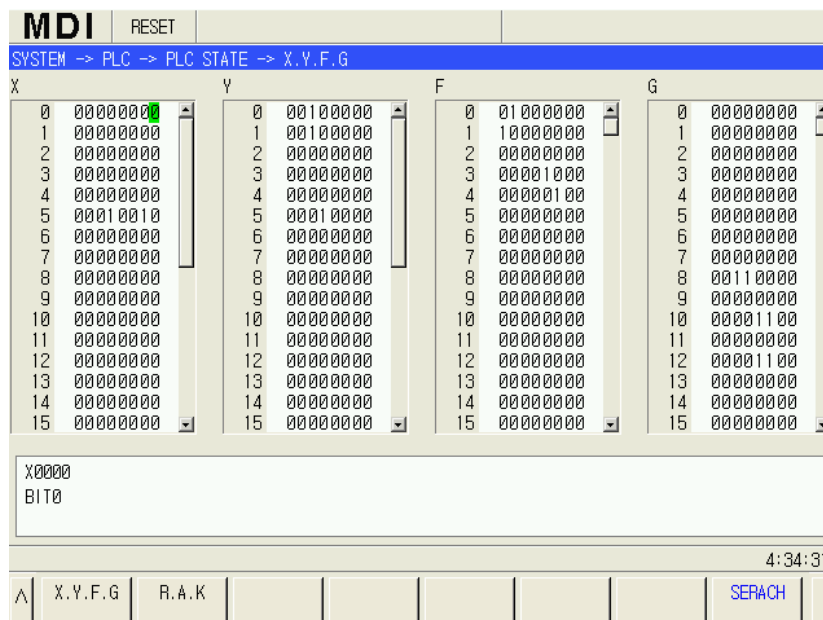

**Note:** The notes on diagnosis screen are information of current PLC; different diagnosis information corresponds to different PLC; the current displayed notes in the above figure is defined by PLC editor;

➤ **View the state of signals**

Press softkey **X.Y.F.G**, the state of signals X, Y, F, G will be displayed on the screen; press softkey **R.A.K**, the state of signals R, A, K will be displayed.

Press or to switch between softkeys X, Y, F, G signal and R, A, K signal.

Press , , , to view the information about X, Y, F,G signals or R, A, K signals.

### 3.4.3 PLC Data Viewing and Setting

On PLC screen, press **PLC DATA** to enter into PLC data state page. It includes the setting of K, D, DT, DC parameters.

	7	6	5	4	3	2	1	0
K0000	0	0	0	0	0	0	0	0
K0001	0	0	0	0	0	1	0	1
K0002	0	0	0	0	0	0	1	0
K0003	0	0	1	1	0	0	0	0
K0004	0	0	0	0	0	0	0	1
K0005	0	0	0	0	0	0	1	0
K0006	0	0	0	0	0	1	0	0
K0007	0	0	0	0	0	0	0	0
K0008	0	0	0	0	0	0	0	1
K0009	0	0	0	0	0	0	0	1
K0010	1	0	1	1	0	1	0	0
K0011	0	0	0	0	0	0	0	0

K0000 working memory  
BIT7

4:43:04

^ K D DT DC ADDR SPH

#### (1) PLC data saving

Through keys **K**, **D**, **DT**, **DC** to select the PLC parameter type, then press **SAVE** to write the parameter into PLC initial value.

**Note 1:** When a PLC parameter is modified, the modified value is saved in system rather than written in PLC; therefore, this PLC parameter will not be exported with PLC;









**Note 2:** After softkey **SAVE** is pressed, this PLC parameter can be exported with PLC.

#### (2) K parameter setting





On PLC data page, press **K** softkey to enter into parameter K setting page, shown in the figure above:



**Parameter setting method:**

① Press keys , , , , , , you can select the parameter status bit to be modified; or press softkey  to input the K variable to be selected, then press  and move the cursor to the parameter. The meaning of the status bit is displayed at the bottom of the screen.

② Press  repeatedly in K variable status bit to switch between 0 and 1, modify the status of the selected K parameter status bit.

③ Press , , ,  to move the cursor to complete the modification.

**(3) D parameter setting**

On PLC data page, press  to enter to the D parameter setting display page, shown in the following figure.









MDI		RESET		
SYSTEM -> PLC -> PLC DATA -> D				
	value	Min. value	Max. value	
D0000	4	1	16	
D0001	1	0	5	
D0002	3	0	5	
D0003	2	0	5	
D0004	0	0	5	
D0005	5	0	5	
D0006	361			
D0007	56			
D0008	5			
D0009	11			
D0010	1			
D0011	0			

D0000 total tool position of tool post

4:49:04

^ K D DT DC ADDR SRH

**Parameter setting method:**

① Press keys , , , , , , you can select the D parameter to be modified; or press softkey  to input the D parameter to be selected, then press  and move the cursor to the parameter. The meaning of the status bit is displayed at the bottom of the screen.

② Press  to enable the selected D parameter to be modifiable.

③ Input the modified value, and press  key again to finalize the modification.

**(4) DT parameter setting**

On PLC data page, press  to enter to the DT parameter setting display page, shown in the following figure.

MDI		RESET		
SYSTEM → PLC → PLC DATA → DT				
	value	Min. value	Max. value	
DT0000	1000	0	60000	
DT0001	0	0	60000	
DT0002	0	0	60000	
DT0003	5000	100	5000	
DT0004	60000	1000	60000	
DT0005	100	100	5000	
DT0006	100	100	5000	
DT0007	0	0	4000	
DT0008	0	0	4000	
DT0009	0	0	4000	
DT0010	0	0	10000	
DT0011	50	0	60000	

DT0000 spindle shift time 1 (ms)

4:52:41

^ K D DT DC ADDR SPH

**Parameter setting method:** the same as D parameter setting

**(5) DC parameter setting**

On PLC data page, press **DC** to enter to the DT parameter setting display page, shown in the following figure.

MDI		RESET		
SYSTEM → PLC → PLC DATA → DC				
	value	Min. value	Max. value	
DC0000	10	0	200	
DC0001	5	0	50	
DC0002	600			
DC0003	5			
DC0004	0			
DC0005	0			
DC0006	0			
DC0007	0			
DC0008	0			
DC0009	0			
DC0010	0			
DC0011	0			

DC0000 transducer voltage value output when spindle is JOG (unit:0.01V)

4:56:21

^ K D DT DC

**Parameter setting method:** the same as D parameter setting

**3.4.4 PLC On-line Modification**

On PLC screen, press **PROGRAM** → **LOCAL** to enter into PLC program directory page, press **↑** and **↓** to select the program to be edited, then press softkey **OPEN** to enter into edit page. You can edit the ladder diagram, symbol table, information display table, initialized data table.

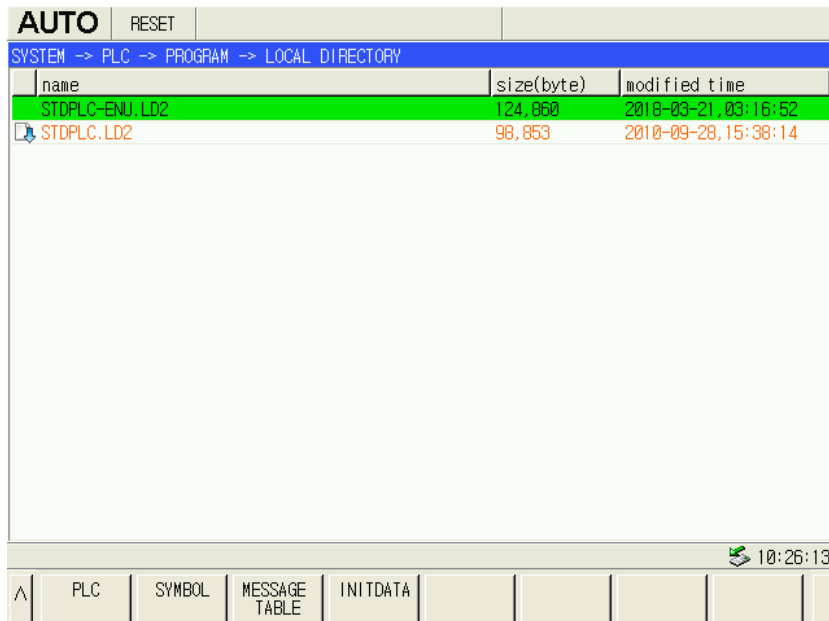



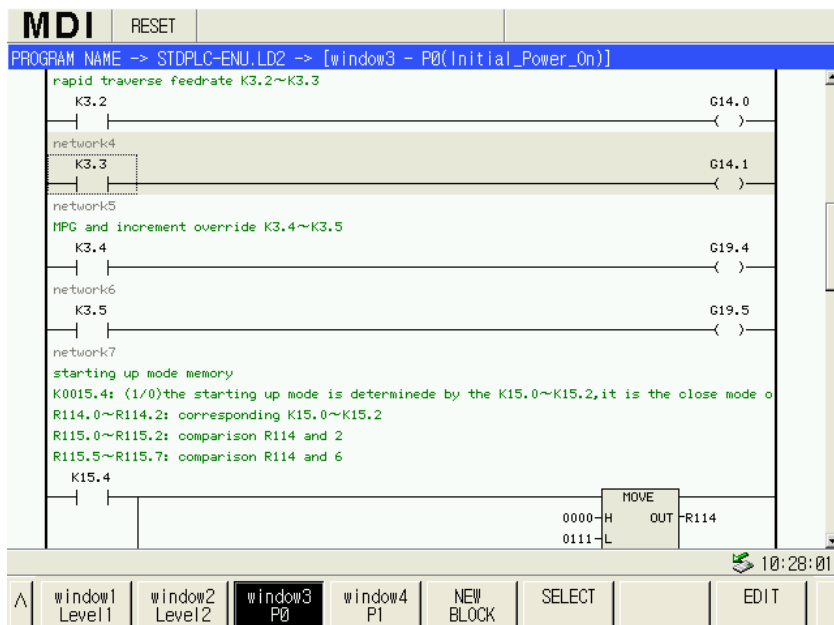

**(1) View and edit PLC**





On the page shown in the above figure, press  to enter into PLC display and editing pages. Shown as follows:







In this figure, the position where the cursor locates is indicated with dashed frame, and the background color of the network area is darker.

Press , , ,  respectively, the corresponding blocks will be displayed and the block name will be displayed on the upper area of the window.

**① Select blocks to the windows**

Press , , ,  according the block to be modified, and then, press  you can select a block to be displayed on the corresponding window.

Press , , ,  to select the block, then press  to complete the action and return. At this time, the address of corresponding block is shown on the screen. For example,

**window1 Level1** indicates that the window 1 corresponds to the Level 1 block, when **window1 Level1** is pressed, the content of Level 1 block is displayed on the screen.

② **Create a new block**

Press **window1 Level1**, **window2 Level2**, **window3 P0** or **window4 P1** to select a window on which a block is needed to be created, then, press **NEW BLOCK** and enter the block name, press **OK** to complete the action.

③ **Edit program**

Select a window to be modified, then press **EDIT** to enter into edit program page (see Fig. 3-4-14), press **V** to display the extended keys.

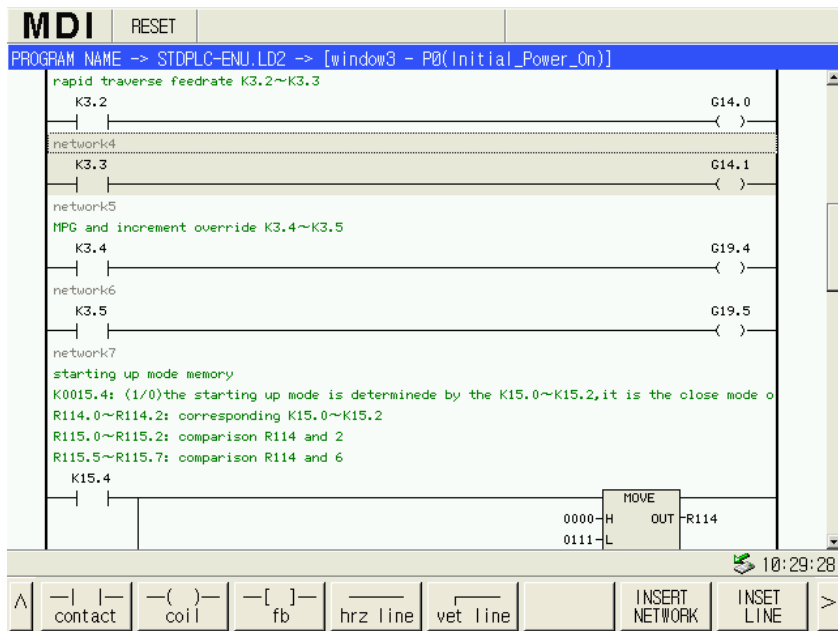

Fig. 3-4-14

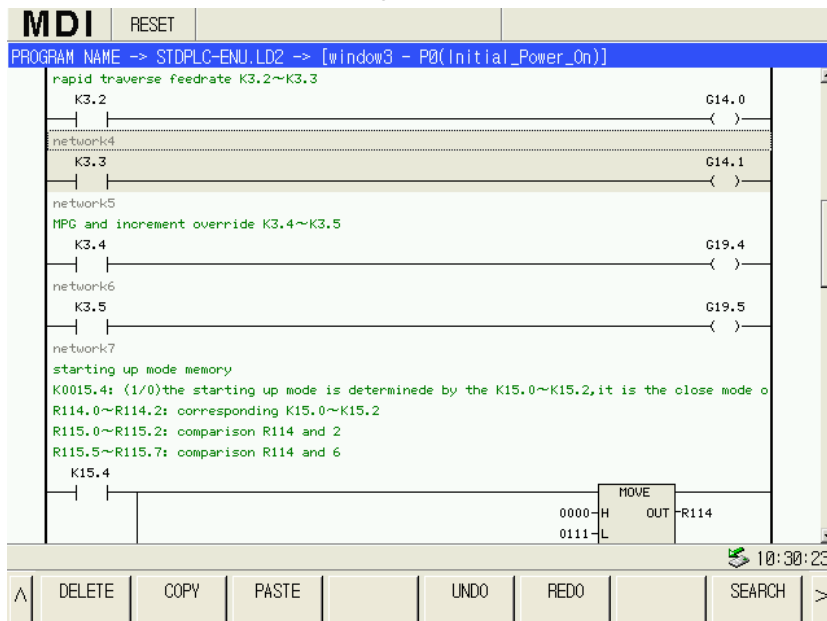



Fig. 3-4-15

A. Press **[Home]**, **[F1]**, **[Up]**, **[Down]** to move the cursor to the line to be modified, and press





 ,  keys to move the cursor to the position to be edited.



B. Press  to insert a network in front of the network where the cursor locates.

C. Press  to insert a line behind the line where the cursor locates.

For example:

- Press , the following figure is displayed.

Move the cursor to the “Type” selection box at this time, then, press , , ,  to switch between the normally-open contact and normally-closed contact.

Press  to switch to the “Add/Symb” edit box, and enter the address/symbol, then press  softkey or “Input” key to complete the action.

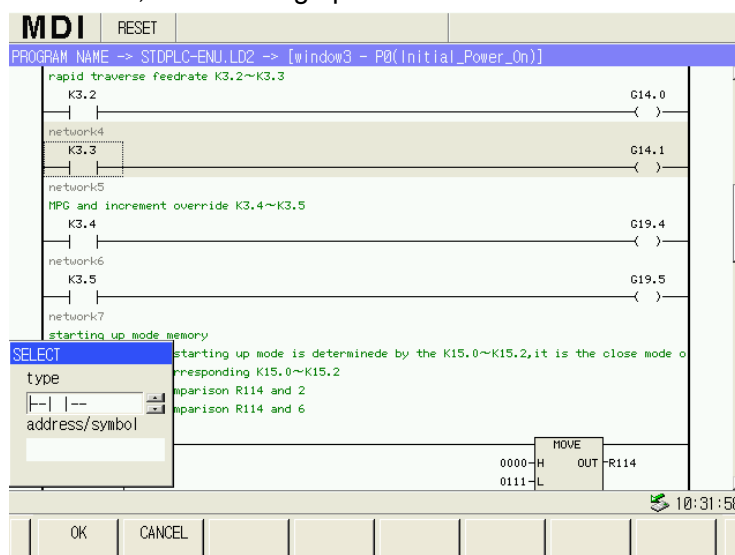

- Press softkey , the following operation is the same as  softkey.



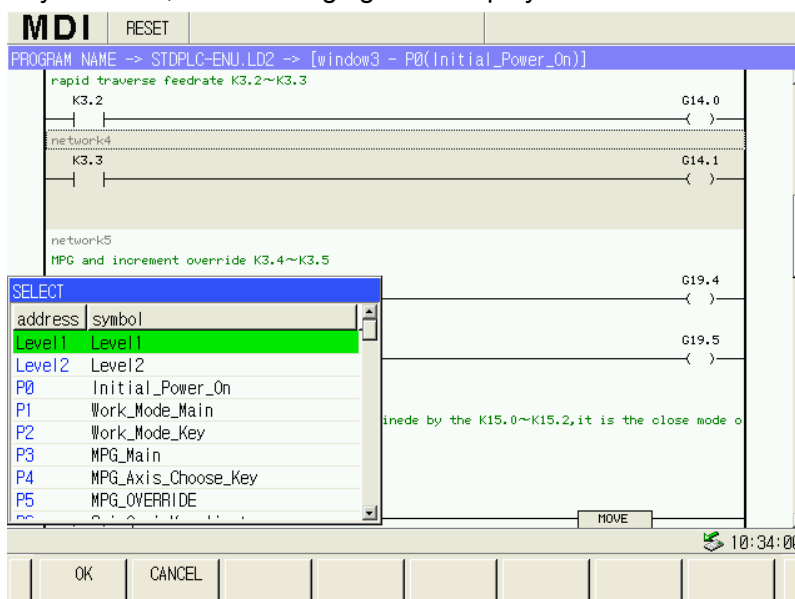

- Press softkey , the following figure is displayed:

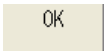

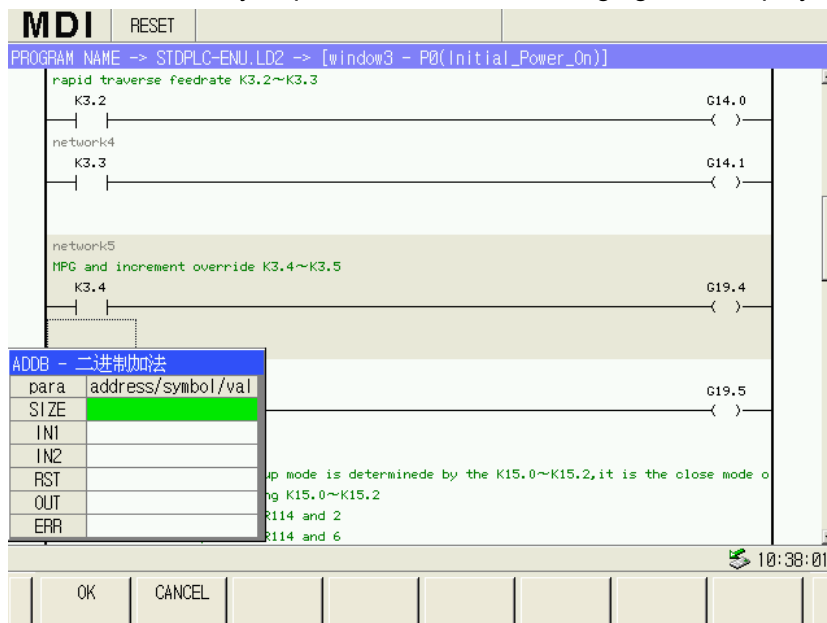

Press  ,  to select the function command to be inserted, for example, ADDB in the

figure above, press  softkey or press  , the following figure is displayed:









Press  or  in the edit box to select the parameter to be edited, then enter address or

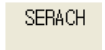
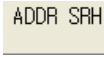

data, and press  to confirm the modification, after all the editing is done, press softkey  to complete the action.



- The operation of other function commands is the same as described above.

You can delete, copy, paste and edit all the components, lines and network at this time. You can cancel the last step or re-do the step.

- Press softkey  to switch to the search page, then you can press  ,  , or  and enter relevant parameters, command, or network. Move the cursor to the position where the searched parameter (or command, network) locates, then press  ,  or move the cursor to the head of a block or end of a block.

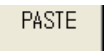
- In a similar way, press  to delete component, line or network.

- In a similar way, press  to copy component, line or network. After the copy is complete, press key  ,  to move the cursor to the desired network, line or component , then press .

- Press  to undo last operation. You can cancel up to 20 steps of operation.
- Press  to redo the cancellation.

**(2) View and set symbol table**

On PLC edit page, press **SYMBOL** to enter into symbol table display page:

MDI			
RESET			
window1(PRG BLK)			
symbol	address	comments	
1	Initial_Power_On	P0000	power on initial
2	Work_Mode_Main	P0001	main program shift in working
3	Work_Mode_Key	P0002	shift key processing in working
4	MPG_Main	P0003	main program control by MPG
5	MPG_Axis_Choose_	P0004	MPG optional key
6	MPG_OVERRIDE	P0005	MPG and incremental override
7	Spi_Ovri_Key_Aju	P0006	spindle override key-press debugging
8	Spi_Ovri_Compare	P0007	spindle override comparison
9	Spi_Ovri_Knob_Aj	P0008	spindle override knob debugging
10	Feedrate_Ovri_Aj	P0010	feedrate override debugging
11	Rapid_Traverse_M	P0011	main program processing in rapid traverse override
12	Rapid_Trav_Key	P0012	rapid traverse key processing
13	Jog_Main	P0013	main program move by manual
14	Jog_Move_Key	P0014	key move processing by manual
15	Jog_Return	P0015	manual zero return processing
16	Spi_Gear_Shift_M	P0016	main program processing in spindle shift
17	Spi_Automatic_Sh	P0017	spindle automatic shift

14:51:31

^ window1 PRG BLK window2 Sybmol window3 K window4 Sybmol D CREATE SELECT >

- ① Press softkeys **window1 PRG BLK**, **window2 Sybmol**, **window3 K**, **window4 Sybmol D** respectively, you can select the symbols to be displayed on the window. The window name and corresponding symbols table name is shown on the upper area of the screen.

Press softkey **SELECT** to select a symbol table for each window.

Press **CREATE** to create a new symbol table and it is displayed on the current window (Note: if there is an empty window, the created symbol table will be displayed on the empty window preferentially).

Press **window1 PRG BLK**, the block symbol table is displayed and the corresponding address table is displayed as well.

- ② Press **window2 Sybmol**, the symbol table is displayed, shown as follows:

MDI			
RESET			
window2(Sybmol)			
symbol	address	comments	
1	DC0	transducer voltage value output when spindle is JOG (ur	
2	DC1	transducer voltage value output when spindle shifts aut	
3	DT0	spindle shift time 1 (ms)	
4	DT1	spindle shfit time 2 (ms)	
5	DT2	low pressure alarm check time(ms)	
6	DT3	moving the upper time of single tool position in tool	
7	DT4	moving the upper time of max. tool position in tool che	
8	DT5	M code performing last time (ms)	
9	DT6	S code performing last time (ms)	
10	DT7	tool-post delay time from positive stop to reverse outp	
11	DT8	fail to receive the alarm time of tool-post lock *TCP s	
12	DT9	tool-post reverse lock time(0-4000ms)	
13	DT10	delay time both M05 and spindle brake output (ms)	
14	DT11	spindle brake output time (ms)	
15	DT12	spindle JOG time(0-60000ms)	
16	DT13	lubricating open time(0-60000ms)(0:lubricating is under	
17	DT14	spare	

14:56:25

^ window1 PRG BLK window2 Sybmol window3 K window4 Sybmol D DELETE CREATE SELECT >

Notes for parameter addresses X, Y, DC, DT, T, R are displayed in the symbol table.

Press , , , , , to select and view all parameter addresses.

Press softkey to delete the selected symbol table.

Press to show the extended softkeys.

Press and enter the parameter address to be searched, locate the cursor to the address.

Press to insert a null line below the line where the cursor locates.

Press to delete the line where the cursor locates.

③ The operation after pressing and is the same with .

④ Modify and edit the symbol table (the block symbol table cannot be modified here)

Select the symbol table to be modified, then press , , , , , to select the symbol (or address, annotation) to be modified, press and input symbol, address or annotation, then press again to complete the modification.

**(3) View and Modify the message table**

On edit page, press to enter to message table, shown as follows:

MDI		RESET
MESSAGE TABLE		
msg No.	display content	
A0000.0	1000	Excessive tool change time
A0000.1	1001	Current tool-position is inconsistent with the object one when tool change
A0000.2	1002	Tool change does not complete
A0000.3	1003	Tailstock function invalid,M10/M11 commands can not be performed.
A0000.4	1004	Tailstock can not be withdrawn when spindle rotates.
A0000.5	1005	Spindle startup enabling closes, the spindle can not be started
A0000.6	1006	The safety door does not close, the machining program/spindle is forbid
A0000.7	1007	Low hydraulic pressure of chuck
A0001.0	1008	Do not loose the chuck when spindle rotates.
A0001.1	1009	Spindle can not be started up if the chuck clamping is not generated.
A0001.2	1010	Chuck clamping signal is not detected when the spindle is rotated.
A0001.3	1011	Spindle can not be started up if the chuck is released.
A0001.4	1012	Chuck function can not being performed M12/M13 command, due to it is in
A0001.5	1013	Tool post lock signal is not detected when tool change is ended.
A0001.6	1014	The M code which is not define any function.
A0001.7	1015	undefined alarm
A0002.0	1016	The code M03 and M04 are specified wrongly.

10:40:28

^	ADDR SRH	MSG NO. SRH							
---	----------	-------------	--	--	--	--	--	--	--

In this information display table, PLC alarm information address A, corresponding information number and content are shown. Press , , , , , to check these information.

① **Modification of information number and content:**

Press , , , , , to select the information number or content to be



modified, then press **INPUT** and input the desired information number or content, press **INPUT** again to complete the modification.

② **Search for address and information number:**

Press **ADDR SRH** or **MSG NO. SRH**, enter the address or information number to be searched, press enter to start searching, then locate the cursor to the searched address or information number.

**(4) View and set initialized data table**

On edit page, press softkey **INITDATA** to enter to initialized data table display page:

	7	6	5	4	3	2	1	0
K0000	0	0	0	0	0	0	0	0
K0001	0	0	0	0	0	0	0	0
K0002	1	0	0	0	0	0	1	0
K0003	0	0	0	0	0	0	0	0
K0004	0	0	0	0	0	0	0	0
K0005	0	0	0	0	0	0	0	0
K0006	0	0	0	0	0	0	0	0
K0007	0	0	0	0	0	0	0	0
K0008	0	0	0	0	0	0	0	0
K0009	0	0	0	0	0	0	0	0
K0010	1	0	0	0	1	0	0	0
K0011	0	0	0	1	0	1	0	0

K0000 working memory  
BIT 7

10:45:50

^ K D DT DC SAVE ADDR SRH

① **K parameter setting**

Press **window1 K** to select the window 1 whose corresponding K parameter is shown in the above figure.

Press **list icon**, **list icon**, **up arrow**, **down arrow**, **left arrow**, **right arrow** to select a bit in the K parameter to be set or modified, the explanation for the bit in K parameter is displayed on the bottom area of the screen.

Press **INPUT** repeatedly, you can set the bit to 0 or 1.

② **Initialized data**

Press **window2 InitData** to enter the initData table display page corresponding to window 2.

MDI		RESET			
window2(InitData)					
	address	value	Min. value	Max. value	
1	DC0	10	0	200	
2	DC1	5	0	50	
3	DT0	1000	0	60000	
4	DT1	1000	0	60000	
5	DT2	3000	0	60000	
6	DT3	5000	100	5000	
7	DT4	15000	1000	60000	
8	DT5	500	100	5000	
9	DT6	500	100	5000	
10	DT7	500	0	4000	
11	DT8	500	0	4000	
12	DT9	1000	0	4000	

DC0000 transducer voltage value output when spindle is JOG (unit0.01V)

10:43:21

^ window1 window2 window3 window4 DELETED CREATE SELECT >

③ Data table modification and edit:

Select the desired page by pressing or ; press , , , to select the address or address value to be modified, the background of the selected value will turn to blue; press and input values through numerical keys (press backspace key to delete), then press key again to confirm the modification.

**Note:** The operation for modifying and editing the initialized data table is the same as the viewing and setting of symbol table. For details, please refer to the “3.4.3 (2) View and set symbol table”.

### 3.4.5 PLC Program Transmission

PLC program transmission is subject to authority above the 2<sup>nd</sup> level.

There are two method of PLC program transmission:

1. Transmit with GSKComm-M. For details, please refer to section 3.2 in this chapter.
2. Transmit PLC program one by one on PLC screen through U disk, or, make bulk transmission on file management screen. For details, please refer to section 3.3 in this chapter.

### 3.5 CNC Diagnosis







Press to enter to information screen, and then press to enter to diagnosis page, press to enter to CNC diagnosis page.

MDI		RESET							
MESSAGE -> DIAGNOSTICS -> CNC DIAGNOSTICS									
No.	7	6	5	4	3	2	1	0	
0000	RST	0	N	G		7	8	9	
	0	0	0	0	0	0	0	0	
0001	X	Z	F			4	5	6	
	0	0	0	0	0	0	0	0	
0002	M	S	T			1	2	3	
	0	0	0	0	0	0	0	0	
0003	U	W	EOB			-	0	.	
	0	0	0	0	0	0	0	0	
0004	CHG	BACKSPACE	DEL	SHIFT		CANCEL	INPUT		
	0	0	0	0	0	0	0	0	
0005	POS	PRG	SYS	SET	MSG	GRA	HELP		
	0	0	0	0	0	0	0	0	

0000 RST--0--N--G-- --7--8--9  
BIT7 RESET

8:02:07

ALARM MESSAGE    ALARM HISTORY    **DIAGNOS**    OSCILLO GRAPH    GSKLink    CNC DIAGNOS    SERVO DIAGNOS    LOCK SCREEN

On the system diagnosis page, contents such as keyboard diagnosis, state diagnosis, and auxiliary function parameter are included. They can be viewed through , , , , , . You can press  to lock to the current screen in case of mal-operation.

On CNC diagnosis display page, there are two lines at the bottom of the screen displaying the diagnosis details: the first line shows the diagnosis number; the second line shows the explanation of a bit in the parameter where the cursor locates.

**The diagnosis information and corresponding number is shown as follows:**

➤ **System keyboard diagnosis information (number: 0-7)**

It can diagnose all the keys on the system keyboard. Each key is in either pressed or released state. It is used to diagnose whether the keyboard is in good condition.

➤ **Feed axis diagnosis information (number:10-13)**

Diagnosis numbers 10-13 contain information of servo axes 1-5. This information include the input/output state of servo drive unit connected with the feed axis, the pulse sent from feed axis to FPGA, the pulse sent from FPGA to servo drive unit, and the accumulative errors of the feed axis pulse (the difference between the FPGA received and sent pulse). It is used to diagnose whether the feed axis is in good working condition.

**Note: Only diagnosis information for used servo axis is displayed on screen. As for the unused servo axis, the corresponding information is not displayed;**

➤ **Pulse encoder diagnosis information (number:30~33)**

It includes the rotation direction of the two-channel pulse encoder, Z signal state, A,B phase signal state and the current counting pulse value. It is used to diagnose whether the pulse encoder is in good working condition.

➤ **1<sup>st</sup> and 2<sup>nd</sup> MPG diagnosis information (number: 40-43)**

It includes the rotation direction of the two-channel MPG, A, B phase signal state and current counting pulse value. It is used to diagnose whether the encoder is in good working condition.

➤ **1<sup>st</sup> and 2<sup>nd</sup> spindle diagnosis information (number: 50, 55)**

It includes the analog voltage input value of two-channel spindle. DA conversion 16-bit input data; 0 represent 0V, and 65535 represents 10V.

➤ **Machine tool panel diagnosis information (number: 60-62)**

It includes the accumulative errors number, consecutive errors number and repeated number of the machine tool panel. It is used to diagnose whether the machine tool panel is in good working condition.

➤ **Edit keyboard diagnosis information (number: 63-65)**

It includes the accumulative errors number, consecutive errors number and repeated number of the edit keyboard reset. It is used to diagnose whether the edit keyboard is in good working condition.

### 3.6 Servo Diagnosis

On system screen, press **DIAGNOS** to enter to diagnosis page, then press **SERVO DIAGNOS** to enter to servo diagnosis page.

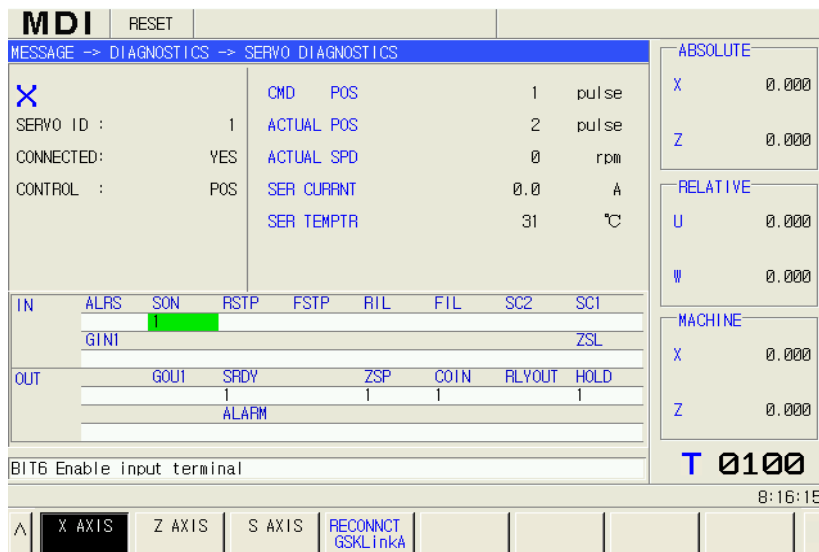

GSK988T servo diagnosis module provides the following functions:

It performs real-time monitoring to system controlled axes through servo communication feedback data, so the operator can know about the working state of some devices such as servo, motor etc.

- (1) When the servo is in position control mode, the information displayed includes the command pulses received by the servo, the feedback pulses obtained from the motor encoder, actual rotation speed of the motor, servo internal current, detected temperature in the servo.
- (2) When the servo is in speed control mode, the displayed information includes the specified rotation speed received by the servo, actual rotation speed obtained from the motor, command pulses received by the servo, servo internal current, detected temperature in the servo ( spindle encoder value is displayed).
- (3) The I/O state when servo is connected with system.

Explanations for various data items on servo diagnosis screen:

- X** : Current selected axis name
- SERVO ID** : The number of the slave connected to the axis
- CONNECTED** : The connection state of servo communication link layer
- CONTROL** : The servo control mode
- CMD POS** : The position pulses received from the system (in position control mode)
- CMD SPD** : The speed command value received from the system (in speed control mode)
- ACTUAL SPD** : The position pulses feedbacked by the servo

**ACTUAL POS**: The actual rotation speed of the motor

**ENCODER VAL**: The current value of spindle encoder (in spindle or C axis control mode)

**SER CURRNT**: The servo working current value at present

**SER TEMPTR**: The detected temperature of the servo inside

**IN**: The servo input point value

**OUT**: The servo output point value

**BIT6 Enable input terminal**: Details of the servo input and output points where the cursor located

**Axis switching**: Press **X AXIS**, **Z AXIS**, **S AXIS** to switch the displayed servo parameter among X, Z, S axis

**RECONNECT GSKLinkA**: When some axes are not connected or the servo communication is erroneous, press it to reset the communication link. If the connection still cannot be done, turn on the power of servo and system again.

**ACT. POS ÷ GEAR.R** or **ACT. POS ORIGINAL**: These two keys that can be switched freely; it can determine whether the pulse number displayed on **ACTUAL POS** is POS or actual value after gear ratio calculation.

## CHAPTER IV MACHINE DEBUGGING-FUNCTIONS

### 4.1 Emergency Stop and Hardware Limit

GSK988T is equipped with the software limit function; for safety, it is suggested to adopt the hardware limit function at the same time. Install the limit switches in positive and negative directions on axes; the connection is shown in the following figure:

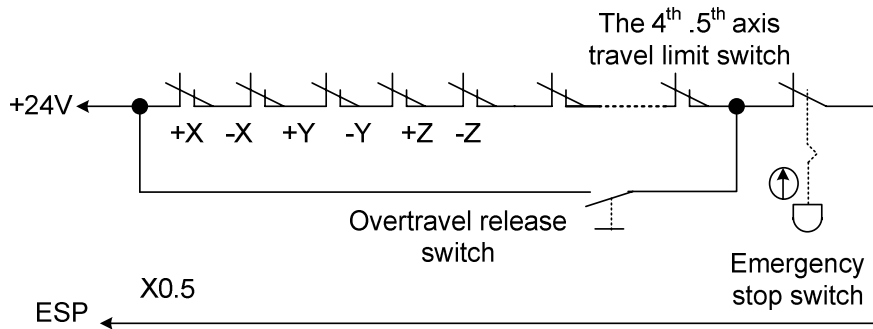





Fig. 4-1-1

In  or  mode, slowly move each axis to verify the validity of the overtravel limit switch, the correctness of the displayed alarm and the validity of the overtravel release button;

when it overruns or the emergency stop button is pressed, CNC alarms “emergency stop”. The alarm can be cleared through pressing the  and the axis moves in the reverse direction, or shield PLC emergency stop parameter which makes the switch invalid, and then press the resetting key to clear the emergency stop limit alarm, and the axis moves toward the worktable in the reverse direction and is off from the limit switch.

Relevant Parameter				
	Parameter No.	Bit	Meaning	Remark
CNC parameters	3003	#7	ESP emergency stop alarm signal (X0.5) 0: Emergency stop alarm occurs when the input signal is 0 (low-level signal) 1: Emergency stop alarm occurs when the input signal is 1 (high-level signal)	These two parameters should be set consistently.
Standard PLC parameters	K0010	#7	External emergency stop alarm signal (X0.5) 0: Emergency stop alarm occurs when the signal is low-level 1: Emergency stop alarm occurs when signal is high-level	









Incremental System						
	Input	Radius/ Diameter	IS—B		IS—C	
			Least setting increment	Least command increment	Least setting increment	Least command increment
Metric machine	Metric	Diameter	0.001mm	0.0005mm	0.0001mm	0.00005mm
		Radius	0.001mm	0.001mm	0.0001mm	0.0001mm
	Inch	Diameter	0.0001 inch	0.0005mm	0.00001 inch	0.00005mm
		Radius	0.0001 inch	0.001mm	0.00001 inch	0.0001mm
Inch machine	Metric	Diameter	0.001mm	0.00005 inch	0.0001mm	0.000005 inch
		Radius	0.001mm	0.0001 inch	0.0001mm	0.00001 inch
	Inch	Diameter	0.0001 inch	0.00005 inch	0.00001 inch	0.000005 inch
		Radius	0.0001 inch	0.0001 inch	0.00001 inch	0.00001 inch
Rotary axis			0.001deg	0.001deg	0.0001deg	0.0001deg

### 4.3.1 Gear Ratio Calculation

#### Formula

$$\text{Gear ratio} = \text{Least command increment} \times \frac{\text{encoder pulses per revolution}}{\text{Lead}} \times \frac{Z_M}{Z_D}$$

**Note:** Least command increment is the minimum unit of command from CNC to machine tool, and the minimum increment of tool movement.

$$\begin{aligned} \text{Pulse/rev} &= \text{Encoder line number} && (\text{absolute encoder}) \\ &= 4 \times \text{Encoder line number} && (\text{incremental encoder}) \end{aligned}$$

$Z_M$ : Teeth number of lead screw gear

$Z_D$ : Teeth number of motor gear

#### Example:

When a machine is equipped with GSK988T and DAT2050C, and the ISC system is applied, the X axis is programmed in diameter system, the lead is 6mm, Z axis is programmed in radius system, the lead is 8mm; the motor is connected with X, Z axis lead screw directly ( $Z_M: Z_D=1: 1$ ); 17-bit absolute encoder is applied (the encoder line number is  $2^{17}$ , i.e. 131072), the calculation of corresponding gear ratio of X, Z axis is as follows:

#### X axis:

Least command increment: 0.00005mm (ISC system, programmed in diameter)

$$\begin{aligned} \text{Gear ratio} &= \text{Least command increment} \times \frac{\text{encoder pulses per revolution}}{\text{Lead}} \times \frac{Z_M}{Z_D} \\ &= 0.00005 \times \frac{131072}{6} \times \frac{1}{1} = \frac{2048}{1875} \end{aligned}$$

#### Z axis:

Least command increment: 0.0001mm (ISC system, programmed in radius)

$$\begin{aligned} \text{Gear ratio} &= \text{Least command increment} \times \frac{\text{encoder pulses per revolution}}{\text{Lead}} \times \frac{Z_M}{Z_D} \\ &= 0.0001 \times \frac{131072}{8} \times \frac{1}{1} = \frac{1024}{625} \end{aligned}$$

### 4.3.2 Gear Ratio Setting

#### Parameter Setting of Gear Ratio

$$\text{CNC : Gear ratio} = \frac{\text{Command multiplying ratio (CMR : No.1820)}}{\text{Detect multiplying ratio (DMR : No.1816)}}$$

$$\text{Servo : Gear ratio} = \frac{\text{Position pulse command multiplying ratio (PA12)}}{\text{Position pulse command frequency division ratio (PA13)}}$$

When the numerator is greater than the dominator in CNC electronic gear ratio (CMR/DMR), the CNC permitted maximum speed will be decreased; when the numerator is smaller than the dominator, the CNC position accuracy will be decreased. To ensure the target accuracy and speed, when digital servo with electronic gear ratio function is matched, it is advised to set the CNC electronic gear ratio to 1:1, and set the calculated electronic gear ratio into digital servo.

**Example: (the gear ratio is the one in the example of Gear Ratio Calculation)**

#### X axis

##### CNC gear ratio setting

CNC electronic gear ratio is set as 1:1, i.e. CMR/DMR=1:1

Setting value of CMR (Parameter No. 1820) is 2.

Setting value of DMR (Parameter No.1816)(DM3x: DM2x: DM1x) is 001.

##### Servo gear ratio setting

The servo gear ratio is set as 2048 / 1875.

Setting value of PA12 is 2048.

Setting value of PA13 is 1875.

#### Z axis

##### CNC gear ratio setting

CNC electronic gear ratio is set as 1:1, i.e. CMR/DMR=1:1

Setting value of CMR (Parameter No. 1820) is 2.

Setting value of DMR (Parameter No.1816)(DM3x: DM2x: DM1x) is 001.

##### Servo gear ratio setting

The servo gear ratio is set as 1024 / 625.

Setting value of PA12 is 1024.

Setting value of PA13 is 625.

## 4.4 Servo Related Setting

### 4.4.1 CNC Servo Parameter Setting

After the connection between system and servo is done, and the power is on, you can set the high-level or low-level servo alarm, encoder type, pulse output type, pulse output direction of each axis and axis movement direction. The procedure is as follows:

- ① According to the alarm logic level of servo drive unit set corresponding alarm level of servo axis through parameter NO.1816#0 (ISAx).
- ② Select the pulse output method of current axis through parameter No.1811#0 (ABPx). GSK988T supports two methods of pulse command output, one is + direction pulse output; the other is orthogonal two phases (AB phase) pulse output. The parameter should be set correctly.
- ③ According to the encoder type of the servo motor set whether absolute encoder is used on servo through parameter No. 1815#5 (APCx).



**Note:** when parameter No.1601#4=0, at the intersection point of cutting feed paths, the feedrate should be decreased to the start speed of the acceleration/deceleration, then, increased to the specified speed of the adjacent block. Accurate position of intersection point can be achieved in this way, but it may lower down the machining efficiency.

When parameter No.1601#4=1, two adjacent cutting paths perform smooth transition in acceleration/deceleration method directly. The feedrate does not necessarily decrease to the start speed when the previous path ends. An arc transition is formed at the intersection point (inaccurate position). This kind of transition way allows great surface smoothness and higher machining efficiency.

Relevant Parameter		
No.	Bit	Meaning
1420		Rapid traverse rate of each axis
1421		The minimum speed of rapid traverse override
1422		Maximum cutting feedrate of all axes
1423		Manual feedrate of each axis
1424		Manual rapid traverse rate of each axis
1466		The feedrate of retraction during thread cutting
1601	#4	During rapid traverse, the blocks are: 0: not overlapped (accurate)      1: overlapped (smooth transition)
1610	#0	The acceleration/deceleration of cutting feedrate (including dry run feeding) is: 0: exponential type      1: linear type after interpolation
1610	#4	The acceleration/deceleration of manual feeding is : 0: exponential type      1: linear type or bell-shaped type after interpolation
1620		Constant T during linear acceleration/deceleration of each axis
1622		Acceleration/deceleration time constant of cutting feedrate after interpolation
1623		Exponential acceleration/deceleration FL speed of cutting feedrate
1624		Acceleration/deceleration time constant of manual feedrate after interpolation
1625		Exponential acceleration/deceleration FL speed of manual feedrate
1626		Acceleration/deceleration time constant during thread cutting cycle
1627		Exponential acceleration/deceleration FL speed during thread cutting cycle
1628		Acceleration/deceleration time constant of retraction during thread cutting

## 4.6 Reference Point and Software Limit

GSK988T supports three kinds of method to set machine zero point (also called reference point): reference point setting without dogs, reference point setting with dogs and absolute encoder reference point setting.

Reference Point Setting	System Parameter Setting
absolute encoder reference point setting	Parameter No.1815#5 (APCx) is set to 1
reference point setting without dogs	Parameter No.1815#5 (APCx) is set to 0 Parameter No.1002#1 (DLZ) is set to 1 or parameter No.1005#1 (DLZx) is set to 0 (either one of them is set to 1)
reference point setting with dogs	Parameter No.1815#5 (APCx) is set to 0 Parameter No.1002#1 DLZ is set to 0 and parameter No.1005#1 DLZx is set to 0.

**Note 1:** When absolute encoder is used, after a reference point is set, it will be saved automatically after power-off, so it is not necessary to set the reference point the next time.



**Note 2:** When reference point is set with/without dog, the setting should be executed every time after power-on.

Relevant Parameter			
	No.	Bit	Meaning
<b>GSK988T System Parameter</b>	1005	#0	When the reference point is not set, in AUTO (MEM, DNC OR MDI) mode, if movement commands other than G28 is specified, the system will 0: issue an alarm 1: not issue an alarm
	1006	#5	Set reference point return direction of each axis 0: positive direction 1: negative direction
	1201	#2	After the manual reference point return is done, the local coordinate system is: 0: not cancelled 1: cancelled
	1240		Set the coordinate value of the 1 <sup>st</sup> reference point in machine coordinate system
	1241		Set the coordinate value of the 2 <sup>nd</sup> reference point in machine coordinate system
	1242		Set the coordinate value of the 3 <sup>rd</sup> reference point in machine coordinate system
	1243		Set the coordinate value of the 4 <sup>th</sup> reference point in machine coordinate system
	1425		Set the FL speed after deceleration during reference point return
<b>PLC Data Parameter</b>	<b>K12.2</b>		Whether the direction keys of zero-return operation is automatically locked: 0: No 1: Yes

### 4.6.1 Reference Point of Absolute Encoder Setting

When the machine is equipped with the absolute position encoder and its reference point return function is valid, it requires setting the absolute position encoder reference point while the system doesn't set the reference point or readjust the reference point. After setting the reference point, the system automatically saves the reference point position after power-off, therefore, it doesn't require setting the reference point position, again when it powers on in the next time.

The steps of setting the reference point of absolute encoder are shows as follows:

1. In mode of  or  mode, the axis carriage is moved to the reference point to be set.
2. The system parameter APZx (NO.1815#4) is set as 0, cut off power supply, and power on, again, the system alarms.
3. Press  on the panel.



and ZRFx (reference point setting signal) to 1, the reference point return indicator

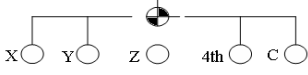

lights up, reference point return is done.

**Note:** Usually, the machine zero return dog is installed at the maximum stroke point. The effective stroke should be over 25mm to ensure enough deceleration distance and the accuracy of zero return. The higher the machine zero return speed is, the longer the zero return collision block will be. Otherwise, the carriage will go through the collision block due to CNC acceleration/deceleration or machine inertial, thus, affects the accuracy of zero return. In addition, make sure that during the process of zero return the carriage will not be intervened by other parts of the machine tool, for the sake of security.

The connection method of AC servo motor is shown in the following figure. Stroke switch and servo motor one-rotation signal are used.

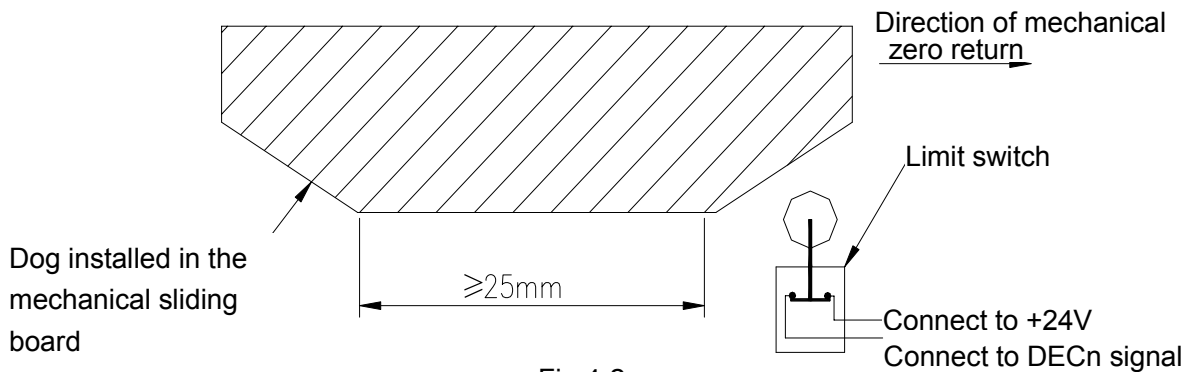



Fig 4-2

When machine zero return is performed after the deceleration switch is released, it should be noted that the encoder one-rotation signal should not be at the critical point, and be reached after half-revolution of the motor. This method is to improve the machine zero point return accuracy. The dog position can be tuned to reduce the error of zero point return.

### 4.6.3 Reference Point Setting without Dog

When the system sets reference point without dog function valid, the machine can perform reference point return without the installation of deceleration switch. After reference point return is done, the LED indicator lights up and the coordinate system is set automatically.

1. Axis moves along the reference point return direction, and stops close to the reference point, rather than surpasses it.

2. Press  and set the reference point selection signal ZRN to 1 manually;



3. Select corresponding feeding axis and direction on , and set the axis and direction signal Jx to 1, reference point return is executed.

4. The tools moves towards the reference point along the direction set by parameter No. 1006#5 at the speed set by parameter No. 1425.

5. After the first PC signal is detected, set ZPx (reference point return end signal) and ZRFx

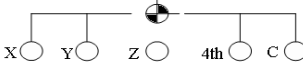
(reference point setting signal) to 1, the LED indicator  lights up and reference point return is done.



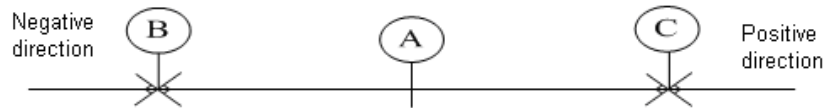

A: the position before the execution of reference point return without dog

B: the position after the reference point return is executed along the negative direction, i.e. the position where the first PC signal is generated after the A point moves along the negative direction.

C: the position after the reference point return is executed along the positive direction, i.e. the position where the first PC signal is generated after the A point moves along the positive direction.

Relevant Parameters		
No.	Bit	Meaning
1002	#1	The function of reference point return without dog is 0: invalid      1: valid (for all axes)
1002	#3	The G28 command when reference point is not set: 0: reference point return with dog      1: P/S alarm occurs
1005	#1	The function of reference point setting without dog is: 0: invalid      1: valid
1300	#6	Whether the first stroke check is performed before manual reference point return after LZR power-on: 0: Yes      1: No

#### 4.6.4 Setting of Stored Stroke Check

There are three stored stroke check are provided in GSK988T system: stored stroke check 1, stored stroke 2 and stored stroke 3. Tool cannot enter the areas specified by them.

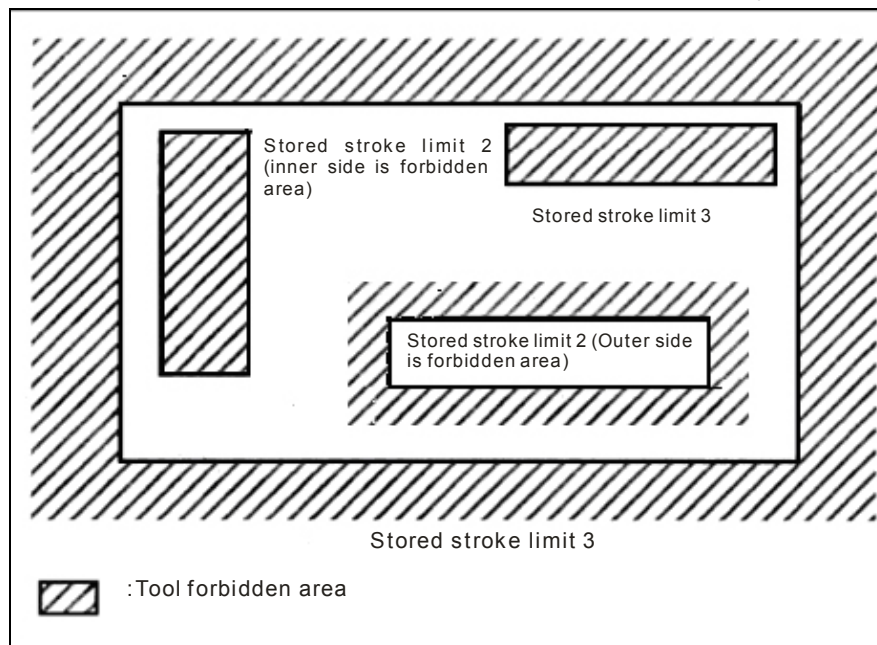

#### Stored stroke check 1:

Parameters (No.1320, 1321 or No. 1326, 1327) set the boundary. Outside the area of the set limits is a forbidden area. The machine tool builder usually sets this area to maximum stroke.



<b>1324</b>		Coordinates (PC3) of stored stroke check 3 positive boundary
<b>1325</b>		Coordinates (NC3) of stored stroke check 3 negative boundary
<b>1326</b>		Coordinates II (PC12) of stored stroke check 1 positive boundary
<b>1327</b>		Coordinates II (NC12) of stored stroke check 1 negative boundary

## 4.7 Pitch Error Compensation

If the pitch error compensation value is defined, the pitch error compensation of each axis can be compensated based on the detection units of each axis.

Set the pitch error compensation data for each compensation position, and its compensation position is set based on the space between each axis. The compensation origin is the reference position of the tool return.

When the pitch error compensation is performed, the following parameters must be set:

Parameter 3620: The position number of the compensation at the reference point of each axis.

Parameter 3621: The minimum position number of each axis pitch error compensation

Parameter 3622: The maximum position number of each axis pitch error compensation

Parameter 3623: The magnification of pitch error compensation

Parameter 3624: The interval of each compensation position.

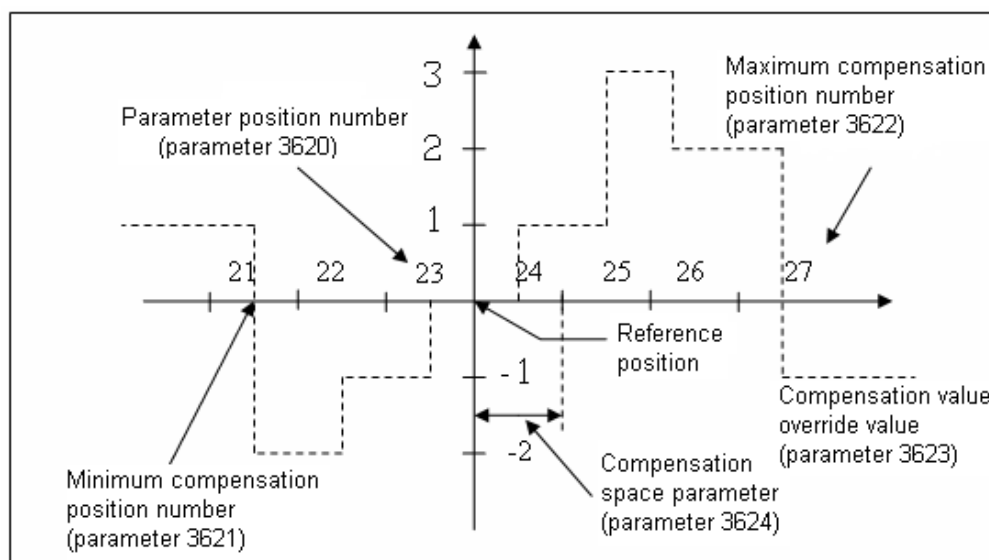

Compensation Position Number	21	22	23	24	25	26	27
Set Compensation Value	-3	+1	+1	+1	+2	-1	-3

**Define the compensation position:** To set the compensation position for each axis, specify the positive or negative direction for compensation based on the reference point. If the machine stroke exceeds the specified range in positive or negative direction, the screw pitch error compensation does not work.

**Compensation position number:** In screw pitch error compensation setting screen, there are 1024 compensation positions (0~1023) can be used. The parameter can be used to assign position number to each axis. Set compensation position number (parameter No.3620), minimum position number (parameter No. 3621) and maximum position number (parameter No. 3622) of each axis.

**For example:**

1. Linear axis

Machine stroke:  $-400\text{mm} \sim +800\text{mm}$

Interval of the screw pitch error compensation positions: 50mm

Compensation position number of the reference point: 70

After the above definition is finished, the furthest compensation position number in negative direction is as below:

The compensation position number of the reference point - (machine stroke in negative direction/space between compensation positions) =  $70 - 400/50 + 1 = 63$

The furthest compensation position number in positive direction is as below:

Compensation position number of the reference point + (machine stroke in positive direction/space between compensation positions) =  $70 + 800/50 = 86$

The corresponding relation between the machine and the compensation point position number is shown as follows:

Parameter	Setting Value
3620: Parameter point compensation number	70
3621: Minimum compensation position number	63
3622: Maximum compensation position number	86
3623: Compensation magnification	1
3624: Space between the screw pitch error compensation positions	50000

**2. Rotary axis**

Movement value/ revolution: 360°

Space between the screw pitch error compensation positions: 45°

Compensation position number of the reference point: 80

After defining the above parameter, the furthest compensation position number in negative direction of the rotary axis is the compensation position number of the reference point.

The furthest compensation position number in positive direction is as follows:

The compensation position number of the reference point + (movement value of each revolution/space between compensation positions) =  $80 + 360/45 = 88$

The corresponding relation between the machine coordinate and the compensation position number is as follows:

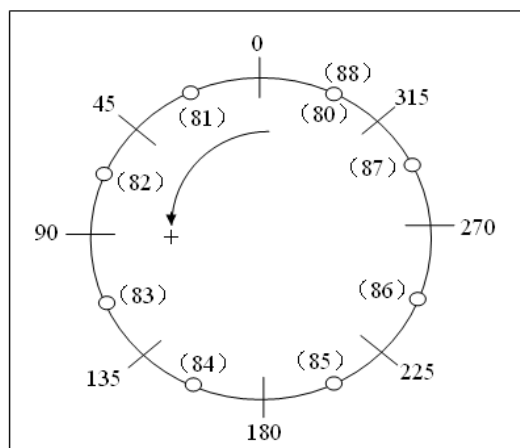

The parameter is set as follows:

Parameter	Setting value
3620: Compensation number of the reference point	80
3621: Minimum compensation position number	80

3622: Maximum compensation position number	88
3623: Compensation magnification	1
3624: Space between screw pitch error compensation positions	45000

For the rotary axis, there may result in the position offset if the sum of the compensation value of positions 81~88 is not 0. The sum is the accumulation of screw pitch error compensation value of each revolution. Moreover, at the compensation positions 80 and 88, the same compensation value must be set. For example:

No. of Compensation Position	80	81	82	83	84	85	86	87	88
Set Compensation value	+1	-2	+1	+3	-1	-1	-3	+2	+1

### Set pitch error compensation value

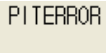
- In system window, press  to enter into pitch error compensation window, shown as follows:

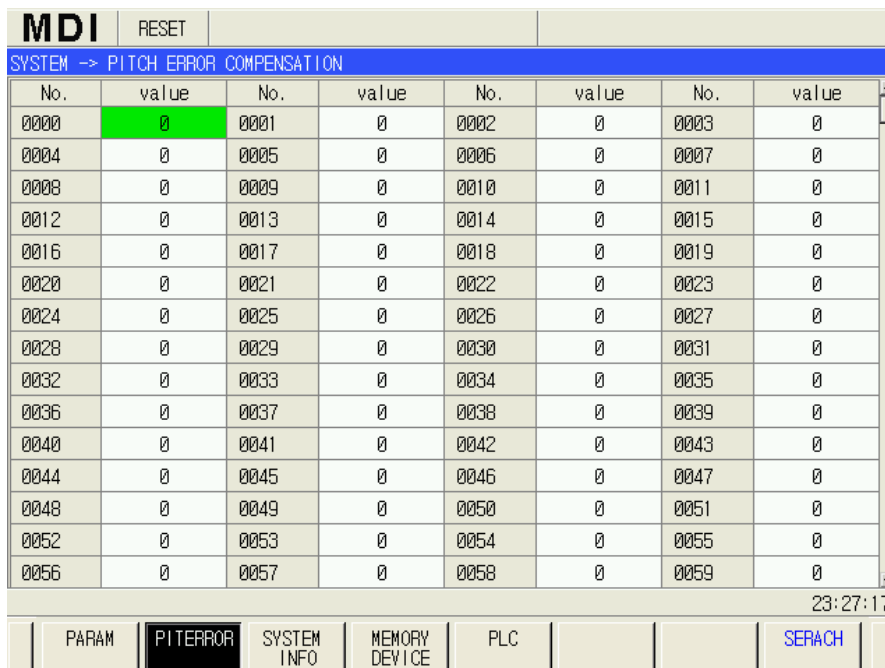









No.	value	No.	value	No.	value	No.	value
0000	0	0001	0	0002	0	0003	0
0004	0	0005	0	0006	0	0007	0
0008	0	0009	0	0010	0	0011	0
0012	0	0013	0	0014	0	0015	0
0016	0	0017	0	0018	0	0019	0
0020	0	0021	0	0022	0	0023	0
0024	0	0025	0	0026	0	0027	0
0028	0	0029	0	0030	0	0031	0
0032	0	0033	0	0034	0	0035	0
0036	0	0037	0	0038	0	0039	0
0040	0	0041	0	0042	0	0043	0
0044	0	0045	0	0046	0	0047	0
0048	0	0049	0	0050	0	0051	0
0052	0	0053	0	0054	0	0055	0
0056	0	0057	0	0058	0	0059	0

23:27:17

PARAM PITERROR SYSTEM INFO MEMORY DEVICE PLC SERACH

You can view and set corresponding pitch error compensation value in this window.

- Press ,  or move the cursor through , , ,  to select the value to be set; or, press  to search for the pitch error compensation number, and move the cursor to the value to be modified.
- Press , the selected compensation can be modified, input the desired value, then press  to complete the modification.

**Note:** The compensation value and interval of compensation point are related to the programming method (diameter programming/radius programming affects the least command increment). When the axis movement is programmed in diameter, the parameter value should be set in diameter; when the axis movement is programmed in radius, the parameter value should be set in radius. The unit should be detection unit.

Relevant Parameter		
No.	Bit	Meaning
3620		Pitch error compensation number of reference points
3621		Pitch error compensation number of the farthest ends in negative direction
3622		Pitch error compensation number of the farthest ends in positive direction
3623		Pitch error compensation magnification
3624		Intervals of compensation points
3628		Setting value of pitch error compensation pulse frequency

### 4.8 Backlash Compensation

When the machine tool moves backward inverse momentum loss will occur due to the error of transmission mechanism, thus affects the machining accuracy. To reduce such error, backlash compensation function is provided in this system.

The backlash compensation value is related to the programming method (diameter programming/radius programming affects the least command increment). When the axis movement is programmed in diameter, the parameter value should be set in diameter; when the axis movement is programmed in radius, the parameter value should be set in radius. The unit should be detection unit.

Detection Unit = Least command increment/command multiplication (CMR)

The backlash compensation should be performed in a proper way to improve the machining accuracy. It is advised to use dialgauge, micrometer or laser detector rather than MPG or step method to measure the backlash. The methods are shown as follows:

#### The setting method of backlash compensation during cutting feed

Programming:

```
O0001;
N10 G01 W10 F800;
N20 W15;
N30 W1;
N40 W-1;
N50 M30.
```

Set the backlash compensation value to 0 before measuring

Run a single block and find the measuring benchmark 1 after twice locations, record the current data, then, move further for 1mm and move backward for 1mm to benchmark 2, read the current data.

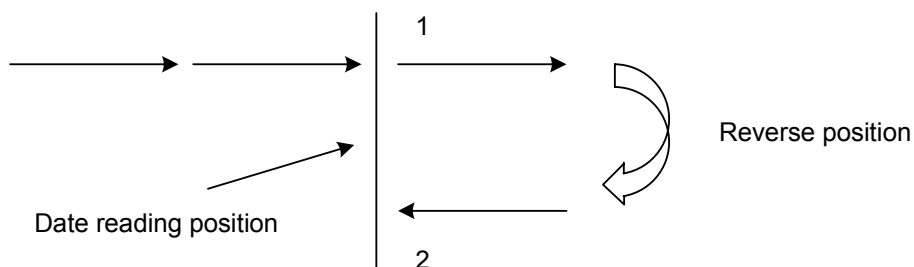

.Backlash compensation value=| data at benchmark 1- data at benchmark 2| ; then, convert the calculated data to detection unit and input the CNC data parameter No. 1851.

Data 1: the dialgauge data read at benchmark 1

Data 2: the dialgauge data read at benchmark 2

Detection unit= Least command increment/CMR

**For example:**

When IS-C system is set (parameter No.1004#1 ISC is set to 1) and the metric system is selected (parameter No.1001#0 INM is set to 0), if parameter No. 1820 (used to set the command multiplication) is set to 2, then, the system command multiplication CMR=1.

X axis: detection unit=least command increment/CMR=0.00005mm/1=0.00005mm

Z axis: detection unit=least command increment/CMR=0.0001mm/1=0.0001mm

If the backlash compensation value of X axis detected by dialgauge is 0.0150mm, the parameter No. 0851 is set to 300; If the backlash compensation value of Z axis detected by dialgauge is 0.0300mm, the parameter No. 0851 is set to 300;

To improve the compensation accuracy, the backlash compensation value can also be set to rapid traverse and cutting feed. First, set parameter No.1800#4 (RBK) to 1, (cutting feed and rapid traverse will be performed independently), then, set the backlash compensation value to rapid traverse through parameter No.1852.

For example,

If the detected backlash compensation during cutting feed is A, and the detected backlash compensation during rapid traverse is B, according to different feeding method and move direction, the compensation value is shown in the following table:

Feeding method	Cutting feed to cutting feed	Rapid traverse to rapid traverse	Rapid traverse to cutting feed	Cutting feed to rapid traverse
Move direction				
The same direction	0	0	±a	± (-a)
Opposite direction	±A	±B	± (B+a)	± (B+a)

1.  $a = (A-B)/2$

2. The positive or negative of the compensation value determines the move direction. (P80)

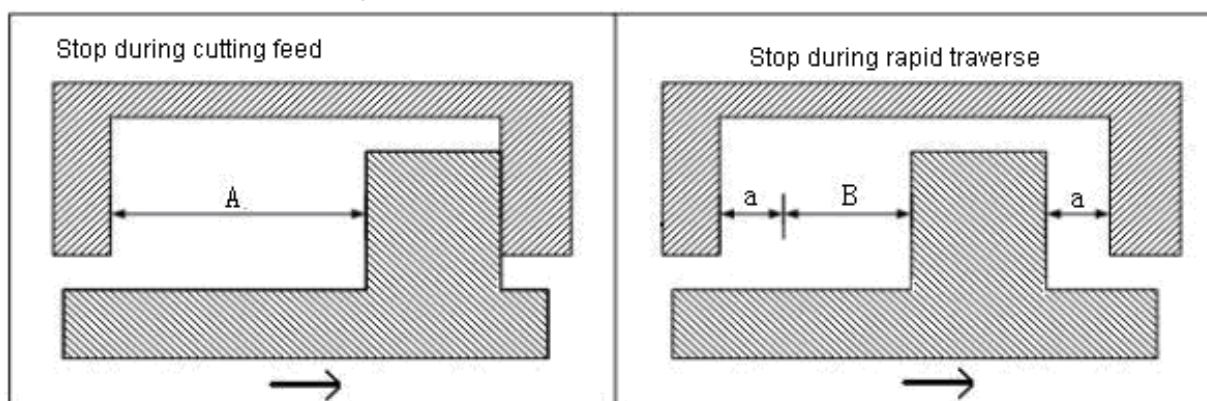

**The setting steps of backlash compensation parameters are shown as follows:**

- ① Whether the backlash compensation is performed respectively during cutting feed and rapid traverse determines the setting of parameter No.1800#4 (RBK).  
0: not performed    1: performed
- ② Measure the backlash compensation value in the above method, and save the results in parameter No. 1851 and No. 1852 (when parameter No. 1800#4 RBK is set to 1). Note that the parameter unit should be detection unit.
- ③ After the backlash compensation value is set, set the backlash compensation output method according to parameter No. 1800#7 (BDEC), 0: fixed pulse frequency output    1: output

according to acceleration/deceleration characteristics. No. 1800#4.

- ④ When the parameter No. 1800#7 (BDEC) is set to 0 (fixed pulse frequency output), parameter No. 1800#6 (BD8) sets the output pulse frequency.

0: the set frequency    1: 1/8 of the set frequency.

The set frequency for compensation is set by parameter No. 1853.

- ⑤ When parameter No. 1800#7 (BDEC) is set to 1 (according to acceleration/deceleration characteristic output), the valid time constant can be set by parameter No. 2071.

Relevant Parameter		
No.	Bit	Meaning
1800	#4	Whether backlash compensation is performed respectively during cutting feed and rapid traverse 0: No                      1: Yes
1800	#6	Output pulse frequency for backlash compensation is 0: the set frequency by parameter No. 1853 1: 1/8 of the set frequency.
1800	#7	Backlash compensation method 0: fixed pulse frequency output (set by parameter No. 1853 and No.1800#6) 1: output according to acceleration/deceleration characteristic
1851		Backlash compensation value
1852		Backlash compensation value during rapid traverse
1853		Setting value of backlash compensation pulse frequency
2071		Valid time constant of backlash compensation acceleration/deceleration

## 4.9 Spindle Function Adjustment

### 4.9.1 Spindle Encoder

GSK988T has two-channel encoder input interfaces (CN21 and CN22). CN21 interface is used for feedback input of spindle speed by default. The selection signal PC2SLC (G28.7) of spindle encoder in PLC selects the interface through which the feedback pulse is obtained and used for system control. When encoder interface 2 (CN22) is not connected to a encoder and the selection signal PC2SLC of position encoder is not set to 1, CN21 is always selected for the feedback input of spindle speed.

To read the actual spindle speed, relevant parameters and signals should be set correctly.

Relevant Parameter			
No.	Bit	Meaning	Remark
3720		Line number of each spindle encoder	The range is 1~9999;
3721		Teeth number of gear on one side of spindle position encoder;	These two parameters are used to set the gear ratio during speed control; the range is 1~9999;
3722		Teeth number of gear on one side of spindle;	



Relevant Parameter		
No.	Bit	Meaning
3706	#1, #0	Gear ratio between spindle encoder and position encoder 00: 1 01: 2 10: 4 11: 8
3707	#1, #0	Gear ratio between spindle encoder and the 2 <sup>nd</sup> position encoder 00: 1 01: 2 10: 4 11: 8
3773		Spindle encoder line number (CNT)
3803		The 2 <sup>nd</sup> spindle encoder line number (CNT2)

### 4.9.2 Spindle Speed Analog Voltage Control

Spindle speed analog voltage control can be set through CNC parameters. The interface outputs 0~10V analog voltage to control spindle servo drive unit or Inverter. For the 0V~+10V output control, the CNC calculates the spindle speed through S command and send M code to PLC to determine the spindle output direction.

Although the S command is for spindle speed, its actual control object is spindle motor. Therefore, the spindle motor speed and gear are related. In this system, the gear selection signal (GR1, GR2) determines the current gear on the machine; CNC outputs the spindle speed corresponding to the gear.

The spindle speed control procedure is shown as follows:

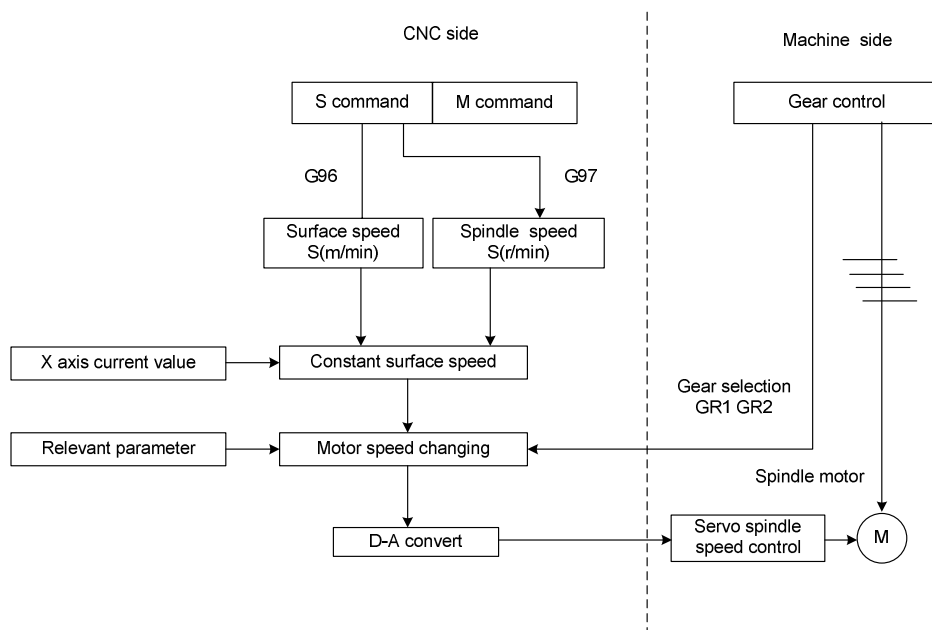

When the actual spindle speed is inconsistent with the programmed one, adjust it through parameter No. 3730, No. 3731. There are two adjust methods according to spindle encoder connection.

#### 1. The spindle encoder is not used:

- ① Set the parameter No. 3730 to 1000 (gain adjustment data of spindle speed analog output) and parameter No. 3731 to 0 (compensation value of spindle speed analog output offset voltage) before adjustment. Disconnect the CNC and spindle after power-off, and turn on the power again, then, specify a frequently-used M code (M41-M44) at spindle gear (the default first gear after power-on);
- ② In MDI mode, specify S code at the highest speed of current gear. For example, after the first gear

is selected, specify the highest speed of the first gear (parameter No. 3741) and press cycle start button;

- ③ Measure the output voltage SVC according to the interface definition in the above section.
- ④ Set the values in the following formula for parameter No. 3730

$$\text{setting value} = \frac{10V}{\text{Measured voltage (V)}} \times 1000$$

- ⑤ After the parameter is set, specify the speed analog output value of the first gear as the spindle speed of maximum voltage (parameter No. 3741), ensure that the output voltage is 10V;
- ⑥ Specify S0 in MDI mode;
- ⑦ Measure the output voltage SVC;

Set the values in the following formula for parameter No. 3731

$$\text{setting value} = \frac{-8191 \times \text{Offset voltage (V)}}{12.5}$$

Then, specify S0 again and ensure the voltage is 0V.

**2. The spindle encoder is used:**

- ① Set the parameter No. 3730 to 1000 (spindle speed analog output gain adjust data) and parameter No. 3731 to 0 (compensation value of spindle speed analog output offset voltage) before adjustment. Connect the CNC and spindle after power-off, and turn on the power again, then, specify a frequently-used M code (M41-M44) at spindle gear (the default first gear after power-on);
- ② In MDI mode, specify S code at the highest speed of current gear. For example, after the first gear is selected, specify the highest speed of the first gear (parameter No. 3741) and press cycle start button;
- ③ The actual speed is displayed in position screen, and it should be almost the same as the specified speed. If the value is too much different from the specified one, please check whether the encoder parameter setting is correct;
- ④ Set the values in the following formula for parameter No. 3730;

$$\text{setting value} = \frac{\text{Setting value of parameter No. 3741}}{\text{Actual rotation speed}} \times 1000$$

- ⑤ After the parameter is set, specify the speed analog output value of the first gear as the spindle speed of maximum voltage (parameter No. 3741), ensure that the actual speed is the value set by parameter No. 3741;
- ⑥ Specify S0 in MDI mode;
- ⑦ Record the actual speed in position screen;
- ⑧ Input the record actual speed in parameter No. 3731;
- ⑨ Specify command S0 again after the parameter is set, then, ensure that the output speed is 0;

Relevant Parameter			
No.	Bit	Meaning	Remark
3031		Set the permitted digits in S code	
3708	#0	It determines whether to check spindle speed arrival signal: 0: No 1: Yes	

<b>3708</b>	<b>#1</b>	When thread cutting execution starts, it determines whether to check spindle speed arrival signal 0: determined by SAR; 1: Check	
<b>3708</b>	<b>#6</b>	During threading or tapping cycle, the spindle override is: 0: Invalid (always 100%) 1: Valid;	
<b>3710</b>		CNC controlled spindle number	The range is 1~3;
<b>3717</b>		Amplifier number of each spindle	0~3 (1: 5 <sup>th</sup> axis; 2: analog axis; 3: channel B GSK-CAN axis)
<b>3720</b>		Line number of each spindle encoder	The range is 1~9999;
<b>3721</b>		Teeth number of gear on one side of spindle position encoder	These two parameters are used to set the gear ratio during speed control; the range is 1~9999;
<b>3722</b>		Teeth number of gear on one side of spindle	
<b>3723</b>		Channel number(1~3) corresponding to each spindle encoder	
<b>3725</b>		Servo axis number (0~5) corresponding to feeding axis during Cs contour control	
<b>3730</b>		Gain adjust data of spindle speed analog output	The range is 700~1250; the data unit is 0.1%;
<b>3731</b>		Compensation value of spindle speed analog output offset voltage	The range is -1024-1024
<b>3740</b>		The delay time of spindle speed arrival signal	
<b>3741</b>		The maximum spindle speed at gear 1	The range is 0~32767 r/min
<b>3742</b>		The maximum spindle speed at gear 2	
<b>3743</b>		The maximum spindle speed at gear 3	
<b>3744</b>		The maximum spindle speed at gear 4	
<b>3771</b>		Lowest speed of spindle during surface speed control	The range is 0~32767 r/min
<b>3772</b>		Upper limit spindle speed (0~32767 r/min)	

## CHAPTER V PARAMETER INSTRUCTION

This chapter mainly introduces CNC state and data parameters through setting different parameters to realize the different requirements of function. The parameter data mainly includes the following six types:

Data Type		Range
(1) Bit	1001 <span style="float:right">INM</span>	8 digits 0 or 1
(2) Bit axis	1006 <span style="float:right">ZM1x DIAx ROSx ROTx</span>	
(3) Bit spindle		
(4) Word	0123 BPS 115200	The exact data range is determined by specified parameters.
(5) Word axis	1020 CAN X 88 Z 90	
(6) Word spindle	3720 CNT S1 1024 S2 1024	

Each parameter should include the following information:

『Modification Authority』 : System authority (1<sup>st</sup> level), Machine authority (2<sup>nd</sup> level), Equipment management authority (3<sup>rd</sup> level), Operation authority (4<sup>th</sup> level), Limited authority (5<sup>th</sup> level)

『Way of Validating』 : Become valid immediately or after power-on

『Value Range』 : In interval, by enumerating or special judgment

『Default Setting』 : 8 digits in binary system, or 32-digit integral value

『Parameter Type』 : Bit, bit axis, bit spindle, word, word axis;

**Note 1:** The 『Value Range』 of bit type parameters is 0 or 1.

**Note 2:** When 『Way of Validating』 is not stated, the parameter will become valid immediately.

**Note 3:** When 『Parameter Type』 is not stated, the parameter is of bit type or word type.

### 5.1 Parameters of System Setting

	#7	#6	#5	#4	#3	#2	#1	#0
0000			SEQ			INI		

『Modification Authority』 : Equipment management authority

『Default Setting』 : 0000 0000

**#2 INI Input system**

0: Metric system

1: Inch system

**#5 SEQ whether insert the sequence number automatically**

0: No

1: Yes

**Note:** In EDIT or MDI mode, sequence number can be inserted automatically. The incremental value of sequence number is set in parameter No. 3216.

## 5.2 Parameters of the Interfaces of Input and Output

<b>0123</b>	<b>Baudrate of serial port (BPS)</b>
-------------	--------------------------------------

『Modification Authority』 : Equipment management

『Value Range』 : 4800, 9600, 19200, 38400, 57600, 115200

『Default Setting』 : 115200

	#7	#6	#5	#4	#3	#2	#1	#0
<b>0138</b>		<b>OWN</b>						

『Modification Authority』 : Equipment management authority

『Default Setting』 : 0000 0000

**#6 OWN** When NC data or the programs are input or output, whether the prompt box “Cover all files?” is displayed:

0: Yes

1: No

<b>0930</b>								<b>RMEN</b>
-------------	--	--	--	--	--	--	--	-------------

『Modification Authority』 : Machine authority

『Way of Validating』 : After power-on

『Default Setting』 : 0000 0000

**#0 RMEN** Use remote monitor or not:

0: No

1: Yes

## 5.3 Parameters of Axis Control/Setting Unit

	#7	#6	#5	#4	#3	#2	#1	#0
<b>1001</b>								<b>INM</b>

『Modification Authority』 : Machine authority

『Way of Validating』 : After power-on

『Default Setting』 : 0000 0000

**#0 INM** The least movement increment of linear axis is in:

0: Metric system (metric machine)

1: Inch system (inch machine)

	#7	#6	#5	#4	#3	#2	#1	#0
<b>1002</b>					<b>AZR</b>		<b>DLZ</b>	

『Modification Authority』 : Machine authority

『Default Setting』 : 0000 0000

**#1 DLZ** Whether reference setting without dog is valid:

0: Invalid

1: Valid (for all axes)

**Note:** When DLZ is 0, parameter 1005#1 (DLZx) can set valid/invalid for each axis.

**#3 AZR** G28 command when the reference point is not set:

0: Reference point return with deceleration dog

1: P/S alarm occurs

Note: The function of reference point return without dog (when parameter 1002#1 (DLZ) is 1 or parameter 1005#1 (DLZx) is 1) is not related to the setting of AZR.

	#7	#6	#5	#4	#3	#2	#1	#0
<b>1004</b>		<b>RPR</b>					<b>ISC</b>	

〔Modification Authority〕 : Machine authority

〔Way of Validating〕 : After power-on

〔Default Setting〕 : 0000 0000

**#1 ISC Set the least input increment and least command increment**

0: 0.001mm, 0.001deg or 0.0001inch (IS-B)

1: 0.0001mm, 0.0001deg or 0.00001inch (IS-C)

**#6 RPR Whether set the minimum input unit of the rotary axis 10 times larger than the minimum command increment**

0: No

1: Yes

	#7	#6	#5	#4	#3	#2	#1	#0
<b>1005</b>					<b>HJZx</b>		<b>DLZx</b>	<b>ZRNx</b>

〔Modification Authority〕 : Machine authority

〔Parameter Type〕 : Bit axis

〔Default Setting〕 : 0000 1000

**#0 ZRNx In AUTO running (AUTO, DNC or MDI), whether the system issues an alarm if the other traverse commands than G28 are specified before reference point is set**

0: Yes

1: No

**#1 DLZx Whether the reference point setting without dog is valid.**

0: Invalid

1: Valid

Note: Parameter DLZ (No.1002#1) is valid when it is "0". When DLZ (No.1002#1) is "1", the reference point setting without dog is valid for all axes.

**#3 HJZx After the reference point is set, manual reference point return:**

0: is performed by using the deceleration dog;

1: is performed without using the deceleration dog;

	#7	#6	#5	#4	#3	#2	#1	#0
<b>1006</b>			<b>ZMlx</b>		<b>DIAx</b>		<b>ROSx</b>	<b>ROTx</b>

〔Modification Authority〕 : Machine authority

〔Way of Validating〕 : After power-on

〔Parameter Type〕 : Bit axis

〔Default Setting〕 : 0000 0000

**#0, #1 ROTx, ROSx set linear axis or rotary axis**

ROSx	ROTx	Contents
0	0	Linear axis Metric/inch conversion All coordinate values are of the linear axis type. The stored pitch error compensation is of the linear axis type.
0	1	Rotary axis (type A) No metric/inch conversion The machine coordinate value displays in 0~360° cycle. The stored pitch error compensation is of the rotary axis type. Automatically return to the reference point at the direction of the reference point return (G28 and G30), the traverse amount cannot exceed one turn.
1	0	Invalid setting
1	1	Rotary axis (type B) No metric/inch conversion The machine coordinate value, the relative coordinate value and the absolute coordinate value are in the linear axis, which can't display in cycle of 0~360°. The stored pitch error compensation is of the linear axis type. The cycle function and the indexing function of the rotary axis cannot be used at the same time.

**#3 DIAx sets the movement amount of each axis**

0: specified by the radius

1: specified by the diameter

**#5 ZMlx sets the direction of reference point return for each axis**

0: positive direction

1: negative direction

	#7	#6	#5	#4	#3	#2	#1	#0
<b>1008</b>						<b>RRLx</b>	<b>RABx</b>	<b>ROAx</b>

『Modification Authority』 : Machine authority

『Way of Validating』 : After power-on

『Parameter Type』 : Bit axis

『Default Setting』 : 0000 0000

**#0 ROAx The roll-over function of a rotary axis is:**

0: Invalid

1: Valid

Note: ROAx is only valid for the rotary axis (parameter ROTx (No.1006#0) is 1).

**#1 RABx In the absolute commands, the axis rotates in the direction**

0: Which the distance to the target is shorter

1: Specified by the sign of command value

Note: RABx is valid only when parameter ROAx is 1.

**#2 RRLx Relative coordinate are**

0: Not rounded by the amount of the shift per one rotation

1: Rounded by the amount of the shift one rotation

Note1: RRLx is valid only when ROAx is 1.

Note2: Assign the amount of the shift per one rotation in parameter No. 1260.

**1010**                      **Quantity of CNC controlled axes (CCA)**

〔Modification Authority〕 : Machine authority

〔Way of Validating〕 : After power-on

〔Data Range〕 : 0~total number

Set the maximum number of axes which are directly controlled by CNC, the others are controlled by PLC.

	<b>#7</b>	<b>#6</b>	<b>#5</b>	<b>#4</b>	<b>#3</b>	<b>#2</b>	<b>#1</b>	<b>#0</b>
<b>1015</b>	<b>DWT</b>	<b>WIC</b>						

〔Modification Authority〕 : Equipment management authority

〔Default Setting〕 : 0000 0000

**#6 WIC Direct input of workpiece origin offset value is:**

0: Only valid for the selected work piece coordinate system

1: Valid for all coordinate systems

**#7 DWT When time for dwell per second is specified by P, the increment system:**

0: IS-B is 1ms, IS-C is 0.1ms.

1: 1 ms

**1020**                      **Programming name of each axis (CAN)**

〔Modification Authority〕 : Machine authority

〔Parameter Type〕 : Word axis

〔Value Range〕 : 88(X), 89(Y), 90(Z), 65(A), 66(B), 67(C)

Set the axial name of each controlled axis.

**Note: The axial name cannot be the same.**

**1022**                      **The property of each axis in the basic coordinate system**

〔Modification Authority〕 : Machine authority

〔Way of Validating〕 : After power-on

〔Parameter Type〕 : Word axis

〔Value Range〕 : 0~7

The planes of the arc interpolation, the tool offset and the tool nose radius, etc.

G17: X—Y plane; G18: Z—X plane; G19: Y—Z plane

There are four types of controlled axes: 1, X axis and its parallel axis; 2, Y axis and its parallel axis; 3 Z axis and its parallel axis; 4, rotary axis; There are only three basic axes (X, Y, Z) and more than two parallel axes;

Setting value	Meaning
0	They are neither basic three axes nor the parallel axes
1	X axis
2	Y axis
3	Z axis
5	Axis parallel to X axis
6	Axis parallel to Y axis
7	Axis parallel to Z axis



1023

Servo axis number of each axis (NSA)

『Modification Authority』 : Machine authority

『Way of Validating』 : After power-on

『Value Range』 : 1~6

『Parameter Type』 : Word axis

Set the servo numbers corresponding to controlled axis. Usually, the servo axis number is the same as the controlled axis number. Controlled axis number is the sequence number of axial parameter setting.

**Note:** Please set the servo axis number of the axis which is connected with B channel GSK-CAN to 6.

## 5.4 Parameters of the Coordinate System

	#7	#6	#5	#4	#3	#2	#1	#0
1201	WZR					ZCL		

『Modification Authority』 : Equipment management authority

『Default Setting』 : 0000 0000

**#2 ZCL After manual reference point return is performed, the local coordinate system is:**

0: Not cancelled

1: Cancelled

**#5 EWZ Upon power on, the coordinate system:**

0: Does not return to G54

1: Return to G54

**#7 WZR Upon reset, the workpiece coordinate system:**

0: Does not return to G54

1: Return to G54

	#7	#6	#5	#4	#3	#2	#1	#0
1202					RLC	G50	EWS	EWD

『Modification Authority』 : Equipment management authority

『Default Setting』 : 0000 0000

**#0 EWD The movement direction of coordinate system caused by external workpiece origin offset amount is:**

0: The same with the external workpiece origin offset direction;

1: Not the same with the external workpiece origin offset direction;

**#1 EWS The movement amount of workpiece coordinate system and movement amount of external workpiece zero point are:**

0: Stored in different memories

1: Stored in the same memory

**#2 G50 When G50 is commanded:**

0: An alarm is not issued and G50 is executed;

1: An alarm is issued;

**#3 RLC After resetting, the local coordinate system is:**

0: Not cancelled

1: Cancelled

	#7	#6	#5	#4	#3	#2	#1	#0
<b>1202</b>					<b>RLC</b>	<b>G50</b>	<b>EWS</b>	<b>EWD</b>

『Modification Authority』 : Equipment management authority

『Default Setting』 : 0000 0000

- #0 EWD The shift direction of the workpiece coordinate system is:**  
 0: The direction specified by the external workpiece zero point offset value  
 1: In the opposite direction to that specified by the external workpiece zero point offset value
- #1 EWS The external workpiece zero point offset is made:**  
 0: Valid  
 1: Invalid
- #2 G50 When G50 is commanded and the coordinate system is set,**  
 0: Not alarm, but execute G50  
 1: P/S alarms (No.010), not execute G50
- #3 RLC After resetting, the local coordinate system**  
 0: Not cancel  
 1: Cancel

	#7	#6	#5	#4	#3	#2	#1	#0
<b>1205</b>								<b>MCE</b>

『Modification Authority』 : Equipment management authority

『Default Setting』 : 0000 0000

- #0 MCE Whether the coordinate system is stored upon incremental encoder power-on**  
 0: No  
 1: Yes

<b>1206</b>	<b>Deviation limit of Machine coordination upon power-on(with absolute encoder)(MER)</b>
-------------	--

『Modification Authority』 : Equipment management authority

『Value Range』 : 0~9999

It is used for the deviation detection when coordinate system is established upon power-on. When it is 0, deviation detection is not performed.

<b>1220</b>	<b>The origin offset amount of external workpiece coordinate system of each axis (EWO)</b>
-------------	--

『Modification Authority』 : Equipment management authority

『Value Range』 : -9999 9999~9999 9999

『Parameter Type』 : Word axis

This parameter is to set the origin of the workpiece coordinate system (G54~G59). The parameter is the valid common offset amount for all workpiece coordinate system.

Setting unit	IS-B	IS-C	Unit
Linear axis (input in metric system)	0.001	0.0001	mm
Linear axis (input in inch system)	0.0001	0.00001	inch
Rotary axis	0.001	0.0001	deg

<b>1221</b>	Origin offset amount of each axis in G54 workpiece coordinate system (WO1)
-------------	--

<b>1222</b>	Origin offset amount of each axis in G55 workpiece coordinate system (WO2)
<b>1223</b>	Origin offset amount of each axis in G56 workpiece coordinate system (WO3)
<b>1224</b>	Origin offset amount of each axis in G57 workpiece coordinate system (WO4)
<b>1225</b>	Origin offset amount of each axis in G58 workpiece coordinate system (WO5)
<b>1226</b>	Origin offset amount of each axis in G59 workpiece coordinate system (WO6)

『Modification Authority』 : Equipment management authority

『Parameter Type』 : Word axis

『Value Range』 : -99 999 999~+99 999 999

This parameter is to set the origin of the workpiece coordinate system (G54~G59). The parameter is the valid common offset amount for all workpiece coordinate system.

SETTING UNIT	IS-B	IS-C	UNIT
Linear axis (input in metric system)	0.001	0.0001	Mm
Linear axis (input in inch system)	0.0001	0.00001	Inch
Rotary axis	0.001	0.0001	Deg

<b>1240</b>	<b>Machine coordinate value of the 1<sup>st</sup> reference point (RF1)</b>
<b>1241</b>	<b>Machine coordinate value of the 2<sup>nd</sup> reference point (RF2)</b>
<b>1242</b>	<b>Machine coordinate value of the 3<sup>rd</sup> reference point (RF3)</b>
<b>1243</b>	<b>Machine coordinate value of the 4<sup>th</sup> reference point (RF4)</b>

『Modification Authority』 : Equipment management authority

『Way of Validating』 : Parameter No. 1240 is valid after power-on; parameters No.1241~1243 are valid immediately.

『Parameter Type』 : Word axis

『Value Range』 : -99 999 999~+99 999 999

Set the coordinate values of the 1<sup>st</sup> to the 4<sup>th</sup> reference points in the mechanical coordinate system

SETTING UNITS	IS-B	IS-C	UNITS
Metric machine	0.001	0.0001	Mm
Inch machine	0.0001	0.00001	Inch
Rotary axis	0.001	0.0001	Deg

<b>1260</b>	<b>Movement amount per rotation of rotary axis(PRA)</b>
-------------	---

『Modification Authority』 : Equipment management authority

『Way of Validating』 : After power-on

『Parameter Type』 : Word axis

『Value Range』 : 1000~9 999 999

Set the movement amount per rotation of rotary axis.

### 5.5 Parameters of the Stroke Detection

Setting units of stroke parameter Nos.1320~1327 are shown in the following table:

SETTING UNIT	IS-B	IS-C	UNIT
Metric machine	0.001	0.0001	Mm
Inch machine	0.0001	0.00001	Inch
Rotary axis	0.001	0.0001	Deg

	#7	#6	#5	#4	#3	#2	#1	#0
<b>1300</b>	<b>BFA</b>	<b>LZR</b>	<b>RL3</b>			<b>LMS</b>		<b>OUT</b>

〔Modification Authority〕 : Equipment management authority

〔Default Setting〕 : 0000 0000

**#0 OUT** The inhibition area of stored stroke check 2 is set by parameter No.1322 or No.1323 is:

- 0: Internal area
- 1: External area

**#2 LMS** Whether the switch signal EXLM of the stored stroke check is valid:  
 0: Invalid  
 1: Valid

**Note:** There are two group parameters of inhibition area setting in stored stroke check 1. The stored stroke switch signal can be used to select the desired inhibition area.  
 (1)Inhibition area I: Parameter No.1320 or No.1321  
 (2)Inhibition area II: Parameter No.1326 or No.1327

**#5 RL3** Whether the stored stroke check 3 release signal RLSOT3 is valid:  
 0: Invalid  
 1: Valid

**#6 LZR** Whether the stored stroke 1 is performed after power-on and before manual reference point return:  
 0: Yes  
 1: No

**Note:** When an absolute encoder is used, reference point is already established after power-on. In this case, it is not related to this parameter setting, and stored stroke check is performed directly after power-on.

**#7 BFA** When an overtravel command is issued:  
 0: Alarm is raised after overtravel  
 1: Alarm is raised before overtravel

**Note:** The tool stops before or

	#7	#6	#5	#4	#3	#2	#1	#0
<b>1310</b>							<b>OT3x</b>	<b>OT2x</b>

〔Modification Authority〕 : Equipment management

〔Parameter Type〕 : Bit axis

〔Default Setting〕 : 0000 0000

**#0 OT2X** Whether stored stroke check 2 is performed on each axis:  
 0: No  
 1: Yes

**#1 OT3X** Whether stored stroke check 2 is performed on each axis:

0: No

1: Yes

<b>1320</b>	<b>Coordinate value of boundary in positive direction of stored stroke check 1 (PC1)</b>
-------------	--

<b>1321</b>	<b>Coordinate value of boundary in negative direction of stored stroke check 1 (PC1)</b>
-------------	--

『Modification Authority』 : Equipment management authority

『Parameter Type』 : Word axis

『Default Setting』 : No.1320 is 99 999 999, No.1321 is -99 999 999

『Value Range』 : -99 999 999~99 999 999

Set the mechanical coordinate values of boundaries in both positive and negative directions of stored stroke check 1. Set the outer area of boundary as the forbidden area.

**Note1:** The axes specified by diameter are set by diameter value.  
**Note2:** When (parameter No.1320) < (parameter No.1321), and the stroke is infinite, stored stroke check 1 cannot be performed. (The stored stroke limit switching signal is invalid.) If the absolute command is specified, the coordinate value may overflow, the normal movement cannot be performed.  
**Note3:** If parameter LMS (No. 1300#2) is "1", and the stored stroke limit switching signal EXLM is also "1", the forbidden area set by this parameter is invalid. Parameter No.1326 and No.1327 set the forbidden area.

<b>1322</b>	<b>Coordinate value of boundary in positive direction of stored stroke check 2 (PC2)</b>
-------------	--

<b>1323</b>	<b>Coordinate value of boundary in negative direction of stored stroke check 2 (PC2)</b>
-------------	--

『Modification Authority』 : Equipment management authority

『Parameter Type』 : Word axis

『Default Setting』 : 0

『Value Range』 : -99 999 999~99 999 999

Set the mechanical coordinate values of boundaries in both positive and negative directions of stored stroke check 2. Parameter No. 1300#0 sets the outer area of boundary as the forbidden area.

**Note:** The axis specified by diameter must be set by the diameter value.

<b>1324</b>	<b>Coordinate value of boundary in positive direction of stored stroke check 3 (PC3)</b>
-------------	--

<b>1325</b>	<b>Coordinate value of boundary in negative direction of stored stroke check 3 (PC3)</b>
-------------	--

『Modification Authority』 : Equipment management authority

『Parameter Type』 : Word axis

『Default Setting』 : No.1324 is 99 999 999, No.1325 is -99 999 999

『Value Range』 : -99 999 999~99 999 999

Set the mechanical coordinate values of boundaries in both positive and negative directions of stored stroke check 2. Set the outer area of boundary as the forbidden area.

**Note: The axis specified by the diameter must be set by the diameter value.**

<b>1326</b>	<b>Coordinate value II of boundary in positive direction of stored stroke check 1 (NC12)</b>
-------------	--

<b>1327</b>	<b>Coordinate value II of boundary in negative direction of stored stroke check 1 (NC12)</b>
-------------	--

〔Modification Authority〕 : Equipment management authority

〔Parameter Type〕 : Word axis

〔Default Setting〕 : 0

〔Value Range〕 : -99 999 999~99 999 999

Set the mechanical coordinate values of boundaries in both positive and negative directions of stored stroke check 1. Set the outer area of boundary as the forbidden area. Only when parameter No. 1300#2 (LMS) is 1, and the stored stroke limit switching signal EXLM (G7.6) is 1, the forbidden area set by this parameter is valid (the setting of parameter 1320 and 1321 is invalid).

**Note 1: The axes programmed by the diameter must be set by the diameter value.**  
**Note 2: The parameter is invalid when parameter LMS (No.1320#2) is "0", or the stored stroke limit switching signal EXLM (G7.6) is "0". Then, the forbidden area set by parameter No.1320 or No. 1321 is valid.**

**5.6 Parameters of the Feedrate**

	<b>#7</b>	<b>#6</b>	<b>#5</b>	<b>#4</b>	<b>#3</b>	<b>#2</b>	<b>#1</b>	<b>#0</b>
<b>1401</b>		<b>RDR</b>	<b>TDR</b>	<b>RF0</b>				<b>RPD</b>

〔Modification Authority〕 : Equipment management authority

〔Default Setting〕 : 0000 0000

**#0 RPD Manually rapid traverse from power-on to the reference point return is:**

- 0: Invalid (JOG speed)
- 1: Valid

**#4 RF0 When the cutting feedrate override is 0% during rapid traverse:**

- 0: tool does not stop moving
- 1: tool stops moving

**#5 TDR During thread cutting or tapping, dry run is:**

- 0: Valid
- 1: Invalid

**#6 RDR For rapid traverse command, dry run is:**

- 0: Invalid
- 1: valid

	<b>#7</b>	<b>#6</b>	<b>#5</b>	<b>#4</b>	<b>#3</b>	<b>#2</b>	<b>#1</b>	<b>#0</b>
<b>1402</b>						<b>JOV</b>		

〔Modification Authority〕 : Equipment management authority

〔Default Setting〕 : 0000 0000

**#2 JOV JOG override is:**

- 0: Valid
- 1: Invalid (always 100%)

	#7	#6	#5	#4	#3	#2	#1	#0
<b>1403</b>	<b>RTV</b>							<b>MIF</b>

『Modification Authority』 : Equipment management authority

『Default Setting』 : 0000 0000

**#0 MIF The minimum unit of F command (the cutting feedrate) for feeding per minute:**

0: 1mm/min (metric input) or 0.01inch/min (inch input)

1: 0.001mm/min (metric input) or 0.00001inch/min (inch input)

	#7	#6	#5	#4	#3	#2	#1	#0
<b>1404</b>						<b>F8A</b>	<b>DLF</b>	

『Modification Authority』 : Equipment management authority

『Default Setting』 : 0000 0000

**#1 DLF After reference point is established, manual reference point return is:**

0: Performed in rapid traverse rate (parameter No. 1420)

1: Performed in rapid traverse rate manually (parameter No. 1424)

**#2 F8A F command range for feeding per minute is:**

0: Set according to parameter MIF (No.1403#0)

1: According to the following table

SETTING UNITS	UNIT	IS-B	IS-C
Metric input	mm/min	0.001~60000	0.001~24000
Inch input	inch/min	0.00001~2400	0.00001~960
Rotary axis	deg/min	1~60000	1~24000

<b>1410</b>	<b>Dry run speed (DRR)</b>
-------------	----------------------------

『Modification Authority』 : Equipment management authority

『Value Range』 :

SETTING UNITS	DATA UNITS	VALID RANGE		DEFAULT SETTING
		IS-B	IS-C	
Metric machine	1mm/min	6~15000		1000
Inch machine	0.1inch/min			

Set the speed during dry run.

<b>1411</b>	<b>Feedrate in auto mode after power on (IFV)</b>
-------------	---

『Modification Authority』 : Equipment management authority

『Default Setting』 : 1000

『Value Range』 :

SETTING UNITS		DATA UNITS	VALID RANGE	DEFAULT SETTING
Metric machine	G98	1 mm/min	6~32767	1000
	G99	0.001 mm/rev		
Inch machine	G98	0.1 inch/min		
	G99	0.0001 inch/rev		

Machine that does not need cutting speed change can use this parameter to specify a cutting feedrate, so that the feedrate is not required to be specified in the program. However, the actual feedrate is affected by parameter No. 1422 (maximum cutting feedrate for all axes).

**1420**      **Each axis rapid traverse speed (RTT)**

〔Modification Authority〕 : Machine authority

〔Parameter Type〕 : Word axis

〔Value Range〕 :

SETTING UNITS	DATA UNITS	VALID RANGE		DEFAULT SETTING
		IS-B	IS-C	
Metric machine	1 mm/min	30~60000	6~24000	8000
Inch machine	0.1 inch/min	30~24000	6~9600	
Rotary axis	1 deg/min	30~60000	6~24000	

Set the rapid traverse speed of each axis when the rapid traverse override is 100%.

**1421**      **F0 rate of rapid traverse override for each axis(FOR)**

〔Modification Authority〕 : Equipment management authority

〔Parameter Type〕 : Word axis

〔Value Range〕 :

SETTING UNITS	DATA UNITS	VALID RANGE		DEFAULT SETTING
		IS-B	IS-C	
Machine in metric system	1 mm/min	30~15000	30~12000	400
Machine in inch system	0.1 inch/min	30~6000	30~4800	
Rotary axis	1 deg/min	30~15000	30~12000	

Set F0 rate of rapid traverse override for each axis.

**1422**      **Maximum cutting feedrate(MFR)for all axes**

〔Modification Authority〕 : Machine authority

〔Value Range〕 :

SETTING UNITS	DATA UNITS	VALID RANGE		DEFAULT SETTING
		IS-B	IS-C	
Metric machine	1mm/min	6~60000	6~24000	8000
Inch machine	0.1inch/min	6~24000	6~9600	

Set the maximum cutting feedrate.

**1423**      **Feedrate in manual continuous feed (JFR) for each axis**

〔Modification Authority〕 : Equipment management authority

〔Parameter Type〕 : Word axis

〔Value Range〕 :



SETTING UNITS	DATA UNITS	VALID RANGE		DEFAULT SETTING
		IS-B	IS-C	
Machine in metric system	1mm/min	6~32767		1000
Machine in inch system	0.1inch/min			
Rotary axis	1 deg/min			

Set the feedrate for each axis during continuous manual feed (JOG feeding); the actual feedrate is limited by parameter NO.1422 (the maximum cutting feedrate of all axes).

**1424****Manual rapid traverse rate(MRR)for each axis**

『Modification Authority』 : Equipment management authority

『Parameter Type』 : Word axis

『Value Range』 :

SETTING UNITS	DATA UNITS	VALID RANGE		DEFAULT SETTING
		IS-B	IS-C	
Metric machine	1 mm/min	30~ 60000	30~ 24000	8000
Inch machine	0.1 inch/min	30~ 24000	30~9600	
Rotary machine	1 deg/min	30~ 60000	30~ 24000	

Set rate of manual rapid traverse when the traverse override is 100%;

**Note: When it is set to 0, the setting value of parameter 1420 is used.**

**1425****FL rate of the reference position return for each axis (FLR)**

『Modification Authority』 : Equipment management authority

『Parameter Type』 : Word axis

『Value Range』 :

SETTING UNITS	DATA UNITS	VALID RANGE		DEFAULT SETTING
		IS-B	IS-C	
Metric machine	1 mm/min	6~15000	6~12000	200
Inch machine	0.1 inch/min	6~6000	6~4800	
Rotary axis	1 deg/min	6~15000	6~12000	

Set FL rate after deceleration when the reference position turn is performed for each axis;

## 5.7 Parameters of Control of Acceleration/Deceleration

#7 #6 #5 #4 #3 #2 #1 #0

**1601**

			RTO				
--	--	--	-----	--	--	--	--

『Modification Authority』 : Equipment management authority

『Default Setting』 : 0000 0000

**#4 RTO During rapid running, the block is**

- 0: Not overlapped
- 1: Overlapped

	<b>#7</b>	<b>#6</b>	<b>#5</b>	<b>#4</b>	<b>#3</b>	<b>#2</b>	<b>#1</b>	<b>#0</b>
<b>1610</b>			<b>THLx</b>	<b>JGLx</b>				<b>CTLx</b>

『Modification Authority』 : Equipment management authority

『Parameter Type』 : Bit axis

『Default Setting』 : 0000 0000

**#0 CTLx Acceleration/deceleration of cutting feed (include feeding during dry run) is:**

- 0: Exponential type
- 1: Linear type after interpolation

**#4 JGLx The acceleration/deceleration during JOG feeding**

- 0: Exponential type
- 1: Linear type after interpolation

**#5 THLx The acceleration/deceleration during thread cutting retraction is:**

- 0: Exponential type
- 1: Linear type

<b>1620</b>	<b>Time constant T used for linear acceleration/deceleration (TT1) for each axis</b>
-------------	--

『Modification Authority』 : Equipment management authority

『Parameter Type』 : Word axis

『Value Range』 : 0~4000 ms

『Default Setting』 : 100

Specify a time constant used for linear acceleration/deceleration in rapid traverse

<b>1622</b>	<b>Time constant for acceleration/deceleration after interpolation in cutting feed for each axis(ATC)</b>
-------------	---

『Modification Authority』 : Equipment management authority

『Parameter Type』 : Word axis

『Value Range』 : 0~4000 ms

『Default Setting』 : 100

Set time constant for acceleration/deceleration after interpolation in cutting feed for each axis(0~4000ms).

The actual used type is determined by parameter No. 1610#0 (CLTx). When CTLx set it to linear type, the maximum time constant of acceleration/deceleration is limited within 512ms; the exceeded value will also be reduced to 512ms.

**Note: Except for some special use, this parameter sets the same time constant for all axes. When different time constant is set, incorrect linear or circular shape will be formed.**

**1623****FL rate of exponential acceleration/deceleration in cutting feed (FLC)for each axis**

『Modification Authority』 : Equipment management authority

『Parameter Type』 : Word axis

『Value Range』 :

SETTING UNITS	DATA UNITS	VALID RANGE		DEFAULT SETTING
		IS-B	IS-C	
Metric machine	1 mm/min	0, 6~15000	0, 6~12000	30
Inch machine	0.1 inch/min	0, 6~6000	0, 6~4800	30
Rotary axis	1 deg/min	0, 6~15000	0, 6~12000	30

Set the lower limit of exponential acceleration/deceleration in cutting feed (FL rate).

**1624****Time constant for acceleration/deceleration after interpolation in JOG feed(JET)for each axis**

『Modification Authority』 : Equipment management authority

『Parameter Type』 : Word axis

『Value Range』 : 0~4000ms

『Default Setting』 : 100

Set time constant for acceleration/deceleration after interpolation in JOG feed(JET)for each axis(0~4000ms).

The actual used type is determined by parameter No. 1610#4 (JGLx). When CTLx set it to linear type, the maximum time constant of acceleration/deceleration is limited within 512ms; the exceeded value will also be reduced to 512ms.

**1625****FL rate of exponential acceleration/deceleration in JOG feed (FLJ)for each axis**

『Modification Authority』 : Equipment management authority

『Parameter Type』 : Word axis

『Value Range』 :

SETTING UNITS	DATA UNITS	VALID RANGE		DEFAULT SETTING
		IS-B	IS-C	
Metric machine	1 mm/min	0, 6~15000	0, 6~12000	30
Inch machine	0.1 inch/min	0, 6~6000	0, 6~4800	30
Rotary axis	1 deg/min	0, 6~15000	0, 6~12000	30

Set the lower limit of exponential acceleration/deceleration in JOG feed (FL rate).

**1626****Time constant of acceleration/deceleration in thread cutting cycle(TET)for each axis**

『Modification Authority』 : Equipment management authority

『Parameter Type』 : Word axis

『Value Range』 : 0~4000ms

〔Default Setting〕 : 40

Set time constant of acceleration/deceleration in thread cutting cycle.

<b>1627</b>	<b>FL rate of exponential acceleration/deceleration in thread cutting cycle(FLT) for each axis</b>
-------------	--

〔Modification Authority〕 : Equipment management authority

〔Parameter Type〕 : Word axis

〔Value Range〕 :

SETTING UNITS	DATA UNITS	VALID RANGE		DEFAULT SETTING
		IS-B	IS-C	
Machine in metric system	1 mm/min	0, 6~15000	0, 6~12000	30
Machine in inch system	0.1 inch/min	0, 6~6000	0, 6~4800	30

Set the lower limit (FL rate) of exponential acceleration/deceleration in thread cutting cycle.

### 5.8 Parameter of Servo and Backlash Compensation

	<b>#7</b>	<b>#6</b>	<b>#5</b>	<b>#4</b>	<b>#3</b>	<b>#2</b>	<b>#1</b>	<b>#0</b>
<b>1800</b>	<b>BDEC</b>	<b>BD8</b>		<b>RBK</b>				

〔Modification Authority〕 : Machine authority

〔Default Setting〕 : 1000 0000

- #4 RBK: Backlash compensation applied separately for cutting feed and rapid traverse**  
 0:Not performed  
 1:Performed

**Note:** When parameter #1800.4 is set to 1, it is valid after the reference point is established; before that, the backlash value set by parameter #1851 is valid, and the backlash compensation value set by #1852 is invalid.

- #6 BD8: Frequency of backlash compensation pulses output involved:**  
 0: Frequency set by parameter No. 1853  
 1: 1/8 of frequency set by parameter No. 1853
- #7 BDEC: Backlash compensation pulses are:**  
 0: f output in fixed pulse frequency (set by parameter No. 1853 and No. 1800.6)  
 1: output based on acceleration/deceleration

	<b>#7</b>	<b>#6</b>	<b>#5</b>	<b>#4</b>	<b>#3</b>	<b>#2</b>	<b>#1</b>	<b>#0</b>
<b>1811</b>						<b>POD</b>		<b>ABP</b>

〔Modification Authority〕 : Machine authority

〔Way of Validating〕 : After power-on

〔Parameter Type〕 : Bit axis

〔Default Setting〕 : 0000 0000

- #0 ABP Select pulse drive modes**  
 0: Pulse +direction mode  
 1: AB phases pulse mode
- #2 POD Selected output directions for each axis pulse**

0: Not reversed

1: Reversed

	<b>#7</b>	<b>#6</b>	<b>#5</b>	<b>#4</b>	<b>#3</b>	<b>#2</b>	<b>#1</b>	<b>#0</b>
<b>1815</b>			<b>APCx</b>	<b>APZx</b>				<b>APRx</b>

『Modification Authority』 : Machine authority

『Way of Validating』 : After power-on

『Parameter Type』 : Bit axis

『Default Setting』 : 0000 0000

**#0 APRx** Direction of position on absolute position detector when using absolute position encoder:

0: Not reversed

1: Reversed

**#4 APZx** Machine position and position on absolute position detector when the absolute position detector is used are:

0: Not the same

1: The same

**Note:** When the absolute position detector is used, this parameter should be set to 0 after initial setting or detector changing, then re-power on and perform manual reference point return. In this way, the mechanical position will be in accordance with the position of the detector, and this parameter will be set to 1 automatically.

**#5 APCx** Position detector is:

0: Other than absolute position detector

1: Absolute position detector

	<b>#7</b>	<b>#6</b>	<b>#5</b>	<b>#4</b>	<b>#3</b>	<b>#2</b>	<b>#1</b>	<b>#0</b>
<b>1816</b>		<b>DM3x</b>	<b>DM2x</b>	<b>DM1x</b>				<b>ISAx</b>

『Modification Authority』 : Machine authority

『Way of Validating』 : After power-on

『Parameter Type』 : Bit axis

『Default Setting』 : 0001 0001

**#0 ISAx** Servo alarm signal level is:

0: High

1: Low

**#4-#6 DM1x-DM3x:** The setting of detection multiplier ratio (DMR)

SETTING VALUE			DETECTION MULTIPLY RATIO (DMR)
DM3x	DM2x	DM1x	
0	0	0	1/2
0	0	1	1
0	1	0	3/2
0	1	1	2
1	0	0	5/2
1	0	1	3
1	1	0	7/2
1	1	1	4

**1820**

**Command multiply ratio of each axis (CMR)**

〔Modification Authority〕 : Machine authority

〔Parameter Type〕 : Word axis

〔Value Range〕 :

COMMAND MULTIPLY RATIO (CMR)	VALID RANGE OF VALUE SET BY NO.1820	DEFAULT SETTING
1/2~1/27	102~127	2
1 ~ 48	2~96	

Set the command multiply ratio (CMR) of each axis.

1. When the command multiply ratio (CMR) is 1/2~1/27, the setting value = 1 / CMR + 100;
2. When the command multiply ratio (CMR) is 1~48, the setting value = 2×CMR.

Gear ratio output by each axis = CMR / DMR

Detection unit = minimum movement unit / CMR

The relations between the setting units and the minimum movement units:

		IS-B		IS-C	
	Input	least input increment	Least command increment	least input increment	Least command increment
Metric machine	Metric	0.001mm (diameter)	0.0005mm	0.0001mm (diameter)	0.00005mm
		0.001mm (radius)	0.001mm	0.0001mm (radius)	0.0001mm
	Inch	0.0001 inch (diameter)	0.0005mm	0.00001 inch (diameter)	0.00005mm
		0.0001 inch (radius)	0.001mm	0.00001 inch (radius)	0.0001mm
Inch machine	Metric	0.001mm (diameter)	0.00005 inch	0.0001mm (diameter)	0.000005 inch
		0.001mm (radius)	0.0001 inch	0.0001mm (radius)	0.00001 inch
	Inch	0.0001 inch (diameter)	0.00005 inch	0.00001 inch (diameter)	0.000005 inch
		0.0001 inch (radius)	0.0001 inch	0.00001 inch (radius)	0.00001 inch
Rotary axis		0.001deg	0.001deg	0.0001deg	0.0001deg

**1851**

**Backlash compensation value (BCV) for each axis**

〔Modification Authority〕 : Machine authority

〔Parameter Type〕 : Word axis

〔Value Range〕 : -9999~+9999 (Detection unit)

〔Default Setting〕 : 0

Set the backlash compensation value.

After power-on, when the machine moves in a direction which is opposite to the reference point return, the backlash compensation is performed for the first time.

The detection unit is related to parameter No. 1820 and least command increment. Refer to the notes of parameter No. 1820 for the relations of setting unit and least command increment.

**1852**

**Backlash compensation value used for rapid traverse(BCVR)for each axis**

『Modification Authority』 : Machine authority

『Parameter Type』 : Word axis

『Value Range』 : -9999~+9999 (Detection units)

『Default Setting』 : 0

Set the backlash compensation value used for rapid traverse. It is valid when parameter NO.1800#4(RBK) is set to 1. It can change the backlash compensation value according to the cutting feedrate/rapid traverse speed for high-precision machining.

**Note 1: Manually continuous feeding (JOG) is taken as cutting feed.**

**Note 2: When parameter No.1800#4(RBK) is set to 1, parameter No.1851 is the backlash compensation value of cutting feed, parameter No.1852 is the backlash compensation value of rapid traverse. When parameter NO.1800#4(RBK) is set to 0, parameter No.1851 is the backlash compensation value of cutting feed/rapid traverse.**

**1853**

**The setting of pulse frequency for backlash compensation**

『Modification Authority』 : Machine authority

『Parameter Type』 : Word

『Value Range』 : 1~32

『Default Setting』 : 12

The setting of pulse frequency for backlash compensation(1~32)

**2071**

**Backlash acceleration effective duration (BAT)**

『Modification Authority』 : Machine authority

『Parameter Type』 : Word axis

『Value Range』 : 0~100 ms

『Default Setting』 : 40

Set backlash acceleration effective duration.

	#7	#6	#5	#4	#3	#2	#1	#0
<b>3001</b>						RWM		

『Modification Authority』 : Equipment management authority

『Parameter Type』 : Bit axis

『Value Range』 : 0~100 ms

『Default Setting』 : 0000 0100

**# 2 RWM** when a program is being rewound in program memory, RWD signal is:  
0: Not output  
1: Output

## 5.9 Parameter of Input/Output

	#7	#6	#5	#4	#3	#2	#1	#0
<b>3003</b>	ESP							

『Modification Authority』 : Machine authority

『Default Setting』 : 1000 0000

**#7 ESP** External emergency stop alarm input signal (X0.5)

0: When the signal is 0 (low level), emergency stop alarm occurs

1: When the signal is 1 (high level), emergency stop alarm does not occur

	#7	#6	#5	#4	#3	#2	#1	#0
<b>3004</b>			OTH					

『Modification Authority』 : Machine authority

『Default Setting』 : 0010 0000

**#5 OTH Check overtravel limit signal or not:**

0: Check

1: Not check

**Note: If this parameter is set to 1 (not check) after an overtravel alarm is issued, the alarm cannot be cleared by just pressing reset key; To clear the alarm, you need to move the workpiece within the limit and set this parameter to 0.**

	#7	#6	#5	#4	#3	#2	#1	#0
<b>3006</b>								GDC

『Modification Authority』 : Machine authority

『Default Setting』 : 0000 0000

**#0 GDC Deceleration signal of the reference point return**

0: Use X signal

1: Use G196 (X signal is invalid)

	#7	#6	#5	#4	#3	#2	#1	#0
<b>3009</b>			DECx					

『Modification Authority』 : Machine authority

『Parameter Type』 : Bit axis

『Default Setting』 : 0010 0000

**#5 DECx: Deceleration signal of the reference point return**

0: When the signal is 0 (low level), it means deceleration

1: When the signal is 1 (high level), it means deceleration;

<b>3010</b>	<b>Delay time of the strobe signals MT, TF and SF(MFT)</b>
-------------	--

『Modification Authority』 : Machine authority

『Value Range』 : 16 ms~32767 ms

『Default Setting』 : 16

Set the time from codes M, S, T and B being sent to MF, SF, TF and BF being sent.

<b>3011</b>	<b>Acceptable width(MAW) of M, T, S function completion signal</b>
-------------	--

『Modification Authority』 : Machine authority

『Parameter Type』 :Word type

『Default Setting』 : 16

Set the minimum width of the finish signals (FIN) of M, S, T and B function.

**Note: The time is 8ms or multiple of 12, or the value will be rounded to multiple of 12.**



**3017****Output time of reset signal (RST)**

『Modification Authority』 : Machine authority

『Value Range』 : 0~255

『Default Setting』 : 32

Set the delay time when the resetting signal RST is output.

RST signal output time = reset time + the parameter value X 16ms.

**3030****Allowable number of digits for M code (MCB)**

『Modification Authority』 : Machine authority

『Value Range』 : 2~8

『Default Setting』 : 4

Set the allowable digits of M code.

**3031****Allowable number of digits for S code(SCB)**

『Modification Authority』 : Machine authority

『Value Range』 : 1~5

『Default Setting』 : 4

Set the allowable number of digits for S code.

**3032****Allowable number of digits for T code(TCB)**

『Modification Authority』 : Machine authority

『Value Range』 : 2~8

『Default Setting』 : 4

Set the allowable number of digits for T code.

## 5.10 Parameter of Display and Editing

**3101**

#7 #6 #5 #4 #3 #2 #1 #0

BGD

『Modification Authority』 : Equipment management authority

『Default Setting』 : 0000 0000

**#4 BGD In background editing, a program currently selected in the foreground:**

0: Cannot be selected

1: Can be selected

**3102**

#7 #6 #5 #4 #3 #2 #1 #0

CHI

『Modification Authority』 : Machine authority

『Way of Validating』 : After power-on

『Default Setting』 : 0000 1000

**#3 CHI Select display language:**

0: English

1: Chinese

Set the display language;

	#7	#6	#5	#4	#3	#2	#1	#0
<b>3104</b>	<b>DAC</b>	<b>DAL</b>	<b>DRC</b>	<b>DRL</b>				<b>MCN</b>

〔Modification Authority〕 : Machine authority

〔Default Setting〕 : 1100 0000

**#0 MCN Machine position:**

- 0: Displayed according to the unit of output
- 1: Displayed according to the unit of input

**#4 DRL Relative position:**

- 0: The actual position displayed takes into account tool offset
- 1: The programmed position displayed does not take into account tool offset

**Note:** When tool geometry compensation of the T system is to be performed by shifting the coordinate system (with bit 4 (LGT) of parameter No. 5002 set to 0), the programmed position, ignoring tool offset, is displayed (with this parameter set to 1), but the programmed position, ignoring tool geometry compensation, cannot be displayed.

**#5 DRC Relative position:**

- 0: The actual position displayed takes into account tool nose radius compensation
- 1: The programmed position displayed does not take into account tool nose radius compensation

**#6 DAL Absolute position:**

- 0: The actual position displayed takes into account tool offset
- 1: The programmed position displayed does not take into account tool offset

**Note:** When tool geometry compensation of the T system is to be performed by shifting the coordinate system (with bit 4 (LGT) of parameter No. 5002 set to 0), the programmed position, ignoring tool offset, is displayed (with this parameter set to 1), but the programmed position, ignoring tool geometry compensation, cannot be displayed.

**#7 DAC: Absolute position:**

- 0: The actual position displayed takes into account tool nose radius compensation
- 1: The programmed position displayed does not take into account tool nose radius compensation

	#7	#6	#5	#4	#3	#2	#1	#0
<b>3107</b>				<b>SOR</b>	<b>REV</b>	<b>DNC</b>		

〔Modification Authority〕 : Equipment management authority

〔Default Setting〕 : 0001 0000

**#2 DNC Upon reset, the program displayed for DNC operation is:**

- 0: Not cleared
- 1: Cleared

**#3 REV The actual speed in feed per revolution mode is displayed in:**

- 0: mm/min or inch/min
- 1: mm/rev or inch/rev

**#4 SOR Display of the program directory:**

- 0: Programs are listed in the order of registration
- 1: Programs are listed in the order of program number

	#7	#6	#5	#4	#3	#2	#1	#0
<b>3110</b>						<b>AHC</b>		

『Modification Authority』 : Equipment management authority

『Default Setting』 : 0000 0000

**#2 AHC With a soft key, the alarm history:**

0: Can be cleared

1: Cannot be cleared

	#7	#6	#5	#4	#3	#2	#1	#0
<b>3111</b>	<b>NPA</b>							

『Modification Authority』 : Equipment management authority

『Default Setting』 : 0000 0000

**#7 AHC Action taken when an alarm is generated or when an operator message is entered:**

0: The display shifts to the alarm message screen

1: The display doesn't shift to the alarm message screen

	#7	#6	#5	#4	#3	#2	#1	#0
<b>3114</b>								<b>IPC</b>

『Modification Authority』 : Equipment management authority

『Default Setting』 : 0000 0000

**#0 IPC When the function key is pressed whose screen is being displayed:**

0: The screen is changed

1: The screen is not changed

	#7	#6	#5	#4	#3	#2	#1	#0
<b>3202</b>			<b>CPD</b>					

『Modification Authority』 : Equipment management authority

『Default Setting』 : 0000 0000

**#5 CPD When a NC program is deleted, a confirmation message and soft key are:**

0: Not output

1: Output

	#7	#6	#5	#4	#3	#2	#1	#0
<b>3203</b>	<b>MCL</b>	<b>MER</b>						

『Modification Authority』 : Equipment management authority

『Default Setting』 : 0000 0000

**#6 MER When the last block of a program has been executed in the MDI mode, the executed block is:**

0: Not deleted

1: Deleted

**Note:** Even MER is 0, when “%” (end code) is read in and executed, the program is also deleted (“%”is inserted in the end of the program automatically).

**#7 MCL Whether a prepared program in MDI mode is cleared by reset:**

0: Not deleted

1: Deleted

	#7	#6	#5	#4	#3	#2	#1	#0
<b>3209</b>								<b>MPD</b>

『Modification Authority』 : Equipment management authority

『Default Setting』 : 0000 0000

**#0 MPD** When a subprogram is executed, the main program number is:

0: Not displayed

1: Displayed

<b>3216</b>	Increment in sequence numbers inserted automatically(INC)

『Modification Authority』 :Equipment management authority

『Value Range』 : 0~9999

『Default Setting』 : 10

Set the increment value in automatic sequence number insertion (when Para NO.0000#5 SEQ is set to 1).

<b>3281</b>	Set display language (LANG)

『Modification Authority』 :Machine authority

『Way of Validating』 : After power-on

『Parameter Type』 : Word

『Value Range』 : 0~2

『Default Setting』 : 1

Select display language (LANG)r0: English 1: Chinese 2: Russian

### 5.11 Parameter of Programming

	#7	#6	#5	#4	#3	#2	#1	#0
<b>3401</b>						<b>NCK</b>		<b>DPI</b>

『Modification Authority』 : Equipment management authority

『Default Setting』 : 0000 0001

**#0 DPI** When a decimal point is omitted in an address that can include a decimal point:

0: The least input increment is assumed

1: The unit of mm, inch, second is assumed

**#2 NCK** The same sequence number is specified twice or more in a program:

0: An alarm is issued

1: Not alarm

	#7	#6	#5	#4	#3	#2	#1	#0
<b>3402</b>	<b>G23</b>	<b>CLR</b>		<b>FPM</b>				<b>G01</b>

『Modification Authority』 : Equipment management authority

『Default Setting』 : 0001 0000

**#0 G01** Mode entered when the power is turned on or when the control is cleared:

0: G00 mode (orientation)

1: G01 mode (linear interpolation)

**#4 FPM** When the power is turned on:

0: Feed per revolution mode

1: Feed per minute mode

**#6 CLR Reset button on the MDI panel, external reset signal, and emergency stop signal:**

0: Causes reset state

1: Causes clear state

**#7 G23 When the power is turned on:**

0: G22 mode(stored stroke check on)

1: G23 mode(stored stroke check off)

	#7	#6	#5	#4	#3	#2	#1	#0
<b>3403</b>		<b>AD2</b>	<b>CIR</b>	<b>RER</b>				

『Modification Authority』 : Equipment management authority

『Default Setting』 : 0000 0000

**#4 RER When arc radius(R) not out-of-tolerance is so small that end point is not on the arc in arc interpolation:**

0: Calculate new radius for semicircle

1: Alarm is issued

**#5 CIR When neither the distance(I,J,K)from the start point to the center nor an arc radius (R) is specified in circular interpolation:**

0: The tool moves to end point by linear interpolation

1: Alarm is issued

**#6 AD2 Specification of the same address two or more times in a block:**

0: Next specification is enabled

1: Alarm is issued

**Note: When AD2 is set to 1 and G codes in the same group are specified in a block, an alarm is issued.**

	#7	#6	#5	#4	#3	#2	#1	#0
<b>3404</b>	<b>M3B</b>	<b>EOR</b>	<b>M02</b>	<b>M30</b>				

『Modification Authority』 : Equipment management authority

『Default Setting』 : 0000 0000

**#4 M30 When M30 is executed in automatic operation:**

0: Control returns to the head of the program

1: Control does not return to the head of the program.

**#5 M02 When M02 is executed in automatic operation**

0:Control returns to the head of the program.

1: Control does not return to the head of the program.

**#6 EOR When an end-of-record mark(%) is read during program execution0: P/S alarms (stop auto running, display alarm state)**

1: Alarm occurs

1:No alarm occurs

**#7 M3B The number of M codes that can be specified in one block**

0: 1

1: Up to 3

<b>3410</b>	<b>Tolerance of arc radius(CRE)</b>
-------------	-------------------------------------

『Modification Authority』 : Equipment management authority

『Value Range』 : 0~9999 9999

『Default Setting』 : 0

SETTING UNITS	IS-B	IS-C	UNITS
input in mm	0.001	0.0001	mm
Input in inch system	0.0001	0.00001	inch

Set tolerance of radius between start point and end point in circular interpolation (G02, G03).When the difference of radius is larger than the setting value, an alarm is issued.

**Note: When the setting value is 0, the difference of radius is not checked.**

<b>3411</b>	<b>M code preventing buffering 1</b>
<b>3412</b>	<b>M code preventing buffering 2</b>
<b>3413</b>	<b>M code preventing buffering 3</b>
<b>3414</b>	<b>M code preventing buffering 4</b>
<b>3415</b>	<b>M code preventing buffering 5</b>
<b>3416</b>	<b>M code preventing buffering 6</b>
<b>3417</b>	<b>M code preventing buffering 7</b>
<b>3418</b>	<b>M code preventing buffering 8</b>

『Modification Authority』 : Equipment management authority

『Way of validating』 : Immediately

『Parameter Type』 : Word

『Value Range』 : 0~9999

『Default Setting』 : 0

This parameter sets M codes that prevent buffering the following blocks. If processing directed by an M code must be performed by the machine without buffering the following block, specify the M code.

<b>3440</b>	<b>Path error range in rough machining G64 mode (ARE)</b>
-------------	---

『Modification Authority』 : Equipment management authority

『Way of validating』 : Immediately

『Parameter Type』 : Word

『Value Range』 : 0~9999

『Default Setting』 : 10000

Set the error range of path in the mode of G64 rough machining. Setting unit: IS-B 0.001mm; IS-C: 0.0001mm (0~99999);

**3441****Path error range in finish machining G61 mode (APE)**

『Modification Authority』 : Equipment management authority

『Way of validating』 : Immediately

『Parameter Type』 : Word

『Value Range』 : 0~9999

『Default Setting』 : 0

Set the error range of path in the mode of G61 finish machining. Setting unit: IS-B 0.001mm; IS-C: 0.0001mm (0~99999);

## 5.12 Parameters of the Screw Pitch Error Compensation

**3620****Number of the pitch error compensation position for reference position(NPR) for each axis**

『Modification Authority』 : Machine authority

『Way of Validating』 : After power-on

『Parameter Type』 : Word axis

『Value Range』 : 0~1023

『Default Setting』 : 0

**3621****Number of pitch error compensation position at extremely negative position (NEN)for each axis**

『Modification Authority』 : Machine authority

『Way of Validating』 : After power-on

『Parameter Type』 : Word axis

『Value Range』 : 0~1023

『Default Setting』 : 0

Set the number of pitch error compensation position at extremely negative position.

**3622****Number of pitch error compensation position at extremely positive position (NEP)**

『Modification Authority』 : Machine authority

『Way of Validating』 : After power-on

『Parameter Type』 : Word axis

『Value Range』 : 0~1023

『Default Setting』 : 0

Set the number of pitch error compensation position at extremely positive position.

**3623****Magnification for pitch error compensation (PCM) for each axis**

『Modification Authority』 : Machine authority

『Way of Validating』 : After power-on

『Parameter Type』 : Word axis

『Value Range』 : 0~100

『Default Setting』 : 0

Set the magnification for pitch error compensation.

If the override is set to 1, the detection unit is the same as that of compensation.  
 If the override is set to 0, the override is the same as one when it is set to 1.

<b>3624</b>	<b>Interval between pitch error compensation positions (PCI) for each axis</b>
-------------	--

- 〔Modification Authority〕 : Machine authority
- 〔Way of Validating〕 : After power-on
- 〔Parameter Type〕 : Word axis
- 〔Value Range〕 : 0~100
- 〔Default Setting〕 : 0~99 999 999
- 〔Default Setting〕 : 0

SETTING UNITS	IS-B	IS-C	UNITS
Metric input	0.001	0.0001	mm
Inch input	0.0001	0.00001	inch
Rotary axis	0.001	0.0001	deg

The screw pitch compensation points are distributed in equal interval, and the interval value of each axis is set respectively. The minimum value of the interval is limited and set by the following formula: Minimum value = Maximum feedrate (rapid traverse feedrate) / 7500.

Unit: Screw pitch compensation minimum interval: mm, inch and deg.

Maximum feedrate: mm/min, inch/min and deg/min.

For example: When the maximum feedrate is 15000mm/min, the minimum value of the screw pitch error compensation interval is 2mm.

However, according to the setting magnification, when the absolute value of the compensation point value exceeds 100, the interval of the compensation point is magnified by the multiple which is calculated by the following formula:

Multiple = Max. compensation amount (absolute value)/128 (round up the digits after the decimal point)

Screw pitch compensation minimum interval = Value, which is obtained from the above maximum feedrate X multiple

**Note 1: The unit of the pitch error compensation value is the same as that of the detection. The detection unit is related to parameter No.1820 (command magnify ratio CMR) and the minimum movement unit. For the relation between the setting units and the minimum movement units, please refer to the introduction of parameter No.1820.**

<b>3628</b>	<b>Setting value of the pitch error compensation pulse frequency</b>
-------------	--

- 〔Modification Authority〕 : Machine authority
- 〔Parameter Type〕 : Word
- 〔Value Range〕 : 1~32
- 〔Default Setting〕 : 8

The setting value of pulse frequency for pitch error compensation.

### 5.13 Parameters of the Spindle Control

	<b>#7</b>	<b>#6</b>	<b>#5</b>	<b>#4</b>	<b>#3</b>	<b>#2</b>	<b>#1</b>	<b>#0</b>
<b>3700</b>							<b>NRF</b>	

〔Modification Authority〕 : Equipment management authority



〔Default Setting〕 : 0000 0000

- #1 NRF The first move command (G00) after the spindle is switched to Cs axis performs:**  
 0: Positioning after returning to the reference position;  
 1: Normal positioning

	#7	#6	#5	#4	#3	#2	#1	#0
<b>3704</b>	SCS3	SCS2						

〔Modification Authority〕 : Machine authority

〔Way of validating〕 : After power-on

〔Default Setting〕 : 0000 0000

- #6 SCS2 The Cs contour control of the 2<sup>nd</sup> spindle is:**  
 0: Invalid  
 1: Valid
- #7 SCS3 The Cs contour control of the 3<sup>rd</sup> spindle is:**  
 0: Invalid  
 1: Valid

**Note: Parameter SC2 and SC3 are valid only when Cs contour control is used (parameter No. 8133#2 is 1).**

	#7	#6	#5	#4	#3	#2	#1	#0
<b>3705</b>				EVS				

〔Modification Authority〕 : Equipment management authority

〔Default Setting〕 : 0000 0000

- #4 EVS When the spindle control function is used, S codes and SF are:**  
 0: Not output for an S command  
 1: Output for an S command

	#7	#6	#5	#4	#3	#2	#1	#0
<b>3708</b>		TSO					SAT	SAR

〔Modification Authority〕 : Equipment management authority

〔Default Setting〕 : 0000 0000

- #0 SAR The spindle speed arrival signal is:**  
 0: Not checked  
 1: Checked
- #1 SAT Check of the spindle speed arrival signal at the start of executing the thread cutting block:**  
 0: The signal is checked only when SAR is set  
 1: The signal is always checked irrespective of whether SAR is set

**Note: When the thread cutting block is executed continually, the spindle speed arrival signal is not checked after the 2<sup>nd</sup> block.**

- #6 TSO During a threading or tapping cycle, the spindle override is:**  
 0: Disabled (fixed to 100%)  
 1: Enabled

**Note: In rigid tapping, the override is fixed to 100%, and it is not related to the setting of the parameter.**

	#7	#6	#5	#4	#3	#2	#1	#0
<b>3709</b>						<b>MSI</b>		<b>SAM</b>

〔Modification Authority〕 : Equipment management authority

〔Default Setting〕 : 0000 0000

**#0 SAM The sampling frequency to obtain the average spindle speed:**

0: 4 (Normally, set to 0)

1: 1

**#2 MSI In multi-spindle control, the SIND signal is valid**

0: Only when the first spindle is valid

1: For each spindle irrespective of whether the spindle is selected

<b>3710</b>	<b>Number of CNC controlled spindles(CCS)</b>
-------------	---

〔Modification Authority〕 : System authority

〔Way of Validating〕 : After power-on

〔Value Range〕 : 1~3

〔Default Setting〕 : 1

Set the maximum number of spindles controlled by the CNC;

<b>3717</b>	<b>Number of amplifier for the spindle (NSS)</b>
-------------	--

〔Modification Authority〕 : Machine authority

〔Way of Validating〕 : After power-on

〔Parameter type〕 : Word spindle

〔Value Range〕 : 0~3

〔Default Setting〕 : 1

This parameter specifies the number of amplifier used for each spindle.

Setting value	Interface
0	None
1	1 <sup>st</sup> spindle interface
2	2 <sup>nd</sup> spindle interface
3	Channel B GSK-CAN extension interface

<b>3720</b>	<b>Encoder line number of each spindle (CNT)</b>
-------------	--

〔Modification Authority〕 : Machine authority

〔Way of Validating〕 : After power-on

〔Parameter type〕 : Word spindle

〔Value Range〕 : 100~99999999

〔Default Setting〕 : 1024

Set the line number of spindle encoder;

<b>3721</b>	<b>Number of gear teeth on the position encoder side for each spindle (GOE)</b>
-------------	---

〔Modification Authority〕 : Machine authority

〔Parameter type〕 : Word spindle

〔Value Range〕 : 1~9999

『Default Setting』 : 1

Set the number of gear teeth on the position encoder side in speed control (such as feed per revolution and threading).

**3722**

**Number of gear teeth on the spindle side (GOS)**

『Modification Authority』 : Machine authority

『Parameter type』 : Word spindle

『Value Range』 : 1~9999

『Default Setting』 : 1

Set the number of gear teeth on the spindle side in speed control (such as feed per revolution and threading) .

**3723**

**Channel number corresponding to each spindle encoder (CSE)**

『Modification Authority』 : Machine authority

『Way of Validating』 : After power-on

『Parameter type』 : Word spindle

『Value Range』 : 1~3

『Default Setting』 : 1

Set the channel number of each spindle encoder.

Setting Value	Interface
1	1 <sup>st</sup> encoder interface
2	2 <sup>nd</sup> encoder interface
3	Channel B GSK-CAN interface

**3725**

**Number of the servo axis which interpolated with the Cs contour axis (FCCS)**

『Modification Authority』 : Machine authority

『Way of Validating』 : After power-on

『Parameter type』 : Word spindle

『Value Range』 : 0~5

『Default Setting』 : 0

Set the servo axis number of corresponding feed axis during Cs contour control;

Setting Value	Servo Axis Number
0	None
1	1 <sup>st</sup> servo axis
2	2 <sup>nd</sup> servo axis
3	3 <sup>rd</sup> servo axis
4	4 <sup>th</sup> servo axis
5	5 <sup>th</sup> servo axis

**3730**

**Data used for adjusting the gain of analog output of spindle speed (AGS)**

『Modification Authority』 : Machine authority

『Parameter type』 : Word spindle

『Value Range』 : 700~1250

〔Default Setting〕 : 1000

〔Data unit〕 : 0.1%

Set the increment adjustment data of the spindle speed analog output. (Adjusting method)

- (1) Set the standard setting value 1000,
- (2) Specify the spindle speed when the spindle speed analog output maximum voltage is 10V.
- (3) Measure the output voltage.
- (4) Set the value in the following formula in parameter No.3730:

$$\text{Setting value} = \frac{10 (\text{V})}{\text{Measured voltage (V)}} \times 1000$$

- (5) After setting the parameter, specify the spindle speed analog output as the spindle speed of the maximum voltage again, and make sure the output voltage is 10V.

<b>3731</b>	<b>Compensation value of the spindle speed analog output offset voltage (CSS)</b>
-------------	---

〔Modification Authority〕 : Machine authority

〔Parameter type〕 : Word spindle

〔Value Range〕 : -1024~+1024

The parameter sets the compensation value of the spindle speed analog output offset voltage.

1. Set the standard setting value to 0.
2. Specify the analog output voltage to 0V, which is theoretical spindle speed.
3. Measure the output voltage.
4. Set the value in the following formula in parameter No.3731.

$$\text{Setting value} = \frac{-8191 \times \text{offset voltage (V)}}{12.5}$$

5. After setting the parameter, specify the analog output voltage to 0V again, which is the theoretical spindle speed, and make sure the voltage is 0V.

<b>3740</b>	<b>Time elapsed prior to checking the spindle speed arrival signal(SAD)</b>
-------------	---

〔Modification Authority〕 : Machine authority

〔Value Range〕 : 5~32767ms

〔Default Setting〕 :1000

Set the time elapsed from the execution of the S function up to the checking of the spindle speed arrival signal.

<b>3741</b>	<b>Maximum spindle speed for gear 1 (MSG1)</b>
-------------	--

<b>3742</b>	<b>Maximum spindle speed for gear 2 (MSG2)</b>
-------------	--

<b>3743</b>	<b>Maximum spindle speed for gear 3 (MSG3)</b>
-------------	--

3744

**Maximum spindle speed for gear 4 (MSG4)**

『Modification Authority』 : Machine authority

『Default Setting』 : 6000

『Parameter type』 : Word spindle

『Value Range』 : 0~32767r/min

『Default Setting』 : 6000

Set the maximum speed for each gear.

3770

**Axis as the calculation reference in constant surface speed control(ACS)**

『Modification Authority』 : Machine authority

『Default Setting』 : 0

『Value Range』 : 0~number of the controlled axes

Set the axis as the calculation reference in constant surface speed control.

**Note: When 0 is set, constant surface speed control is always applied to X axis. P value in G96 is invalid to constant surface control.**

3771

**Minimum spindle speed in constant surface speed control(G96) (CFL)**

『Modification Authority』 : Machine authority

『Value Range』 : 0~32767r/min

『Default Setting』 : 100

Set the minimum spindle speed in constant surface speed control. When constant surface control is performed, and the spindle speed is lower than the specified speed, the minimum spindle speed is used.

3772

**Maximum spindle speed(MSS)**

『Modification Authority』 : Machine authority

『Value Range』 : 0~32767r/min

『Default Setting』 : 6000

Set the maximum spindle speed. When specified spindle speed exceeds the upper limit of spindle speed, or the spindle speed override exceeds the upper limit, the actual spindle speed will be the maximum spindle speed.

**Note 1: When constant surface speed control is performed, the spindle speed will be limited by maximum speed no matter whether G96 or G97 is specified.**  
**Note 2: When the parameter is set to 0, there is no limit for spindle speed.**  
**Note 3: When the spindle is controlled by PLC, this parameter is disabled and there is no limit for spindle speed.**

**5.14 Parameters of the Tool Compensation**

	#7	#6	#5	#4	#3	#2	#1	#0
5001		EVO		EVR				

『Modification Authority』 : Equipment management authority

『Default Setting』 : 0000 0000

**#4 EVR In tool offset compensation mode, when the compensation value is changed:**

- 0: A block specifying the next T code and subsequent blocks become valid
- 1: A block to be buffered next and subsequent blocks become valid

**#6 EVO In tool offset compensation mode, when the compensation amount is changed:**

- 0: A block specifying the next T code and subsequent blocks become valid
- 1: A block to be buffered next and subsequent blocks become valid

	#7	#6	#5	#4	#3	#2	#1	#0
<b>5002</b>		LWM		LGT		LWT		LD1

『Modification Authority』 : Equipment management authority

『Default Setting』 : 0000 0000

**#0 LD1 Tool offset number is:**

- 0: Specified using the lower two digits of a T code
- 1: Specified using the lower one digit of a T code

**#2 LWT Tool wear compensation is performed by:**

- 0: Shifting the coordinate system
- 1: Moving the tool

**#4 LGT Tool offset compensation is:**

- 0: Compensated by the shift of the coordinate system
- 1: Compensated by the tool movement

**#6 LWM Tool offset (when LGT=1)**

- 0: Is done in the T code block
- 1: Is done together with the axis movement

**Note:** When LGT is 0, the offset is executed in T code block, and it has nothing to do with this parameter.

	#7	#6	#5	#4	#3	#2	#1	#0
<b>5003</b>		LVC				CCN		

『Modification Authority』 : Equipment management authority

『Default Setting』 : 0000 0000

**#2 CCN When automatic reference position return (G28) is specified in tool nose radius compensation:**

- 0: Compensation is cancelled in movement to the intermediate position
- 1: Compensation is not cancelled in movement to the intermediate position, but cancelled in movement to the reference position.

**#6 LVC Tool offset value is**

- 0: Not cleared during reset
- 1: Cleared during reset

**Note:** The function of tool offset clearing by reset is valid only in MDI mode.

	#7	#6	#5	#4	#3	#2	#1	#0
<b>5004</b>							ORC	

『Modification Authority』 : Equipment management authority

『Default Setting』 : 0000 0000

**#1 ORC Tool offset value**

- 0: Set by the diameter specification (Can be set in only the when axis is under diameter programming)  
 1: Set by the radius specification

	#7	#6	#5	#4	#3	#2	#1	#0
<b>5005</b>						PRC		

『Modification Authority』 : Equipment management authority

『Default Setting』 : 0000 0000

**#2 PRC Direct input of tool offset value:**

- 0: Not use a PRC signal  
 1: Use a PRC signal

	#7	#6	#5	#4	#3	#2	#1	#0
<b>5006</b>							TGC	OIM

『Modification Authority』 : Equipment management authority

『Way of Validating』 : After power-on

『Default Setting』 : 0000 0000

**#0 OIM When the unit is switched between the inch and metric systems, automatic tool offset value conversation is:**

- 0: Not performed  
 1: Performed

**#1 TGC When a T code is specified in G50, G04 or G10:**

- 0: No alarm occurs  
 1: Alarm occurs

	#7	#6	#5	#4	#3	#2	#1	#0
<b>5008</b>		CNS	CNF	MCR	CNV		CNC	CNI

『Modification Authority』 : Equipment management authority

『Default Setting』 : 0000 0000

**#0 CNI Interference check for tool nose radius compensation is:**

- 0: Performed  
 1: Not performed

**#1 During interference check of tool nose radius compensation, when the direction of movement after application of offset differs from the programmed direction by between 90 and 270 degrees:**

- 0: An alarm is issued  
 1: No alarm is issued

**#3 CNV Interference check and vector erasure of tool nose radius compensation are:**

- 0: Performed  
 1: Not performed

**#4 MCR If G41/G42(tool nose radius compensation) is specified in MDI mode, an alarm is:**

- 0: Not raised  
 1: Raised

**Note:** In MDI mode, the tool nose radius compensation is not performed regardless the parameter setting.

**#5 CNF Interference checks for tool nose radius compensation when machining the inner side of full circle:**

- 0: An alarm is issued
- 1: No alarm is issued

**#6 CNS As a step is smaller than the tool radius compensation, interference check of tool nose radius compensation:**

- 0: An alarm is issued
- 1: No alarm is issued

<b>5010</b>	<b>During the tool nose compensation, the limit value of the vector is ignored when the tool traverses along the corner outside (CLV)</b>
-------------	---

〔Modification Authority〕 : Equipment management authority

〔Value Range〕 : 0~16383

SETTING UNITS	IS-B	IS-C	UNITS
Metric input	0.001	0.0001	mm
Inch input	0.0001	0.00001	inch

〔Default Setting〕 : 0

Set the limit value of the slight move which is ignored on the outside of the corner during tool nose radius compensation.

<b>5013</b>	<b>Maximum value of tool wear compensation (MTW)</b>
-------------	--

〔Modification Authority〕 : Equipment management authority

〔Default Setting〕 : 10

〔Value Range〕 :

		IS-B	IS-C
Setting unit	Metric input	0.001 mm	0.0001 mm
	Inch input	0.0001 inch	0.00001 inch
Setting range	Metric input	0~9 999 999	0~99 999 999
	Inch input		

Set the maximum allowable tool wear compensation value.

**Note: When the absolute value of tool wear compensation exceeds this maximum value, the following alarms are issued:**

- MDI input alarm: too many digits (XXXX—XXXX) (input range in the bracket).**
- G10 input alarm: the offset value input by G10 exceeds the specified range.**

	<b>#7</b>	<b>#6</b>	<b>#5</b>	<b>#4</b>	<b>#3</b>	<b>#2</b>	<b>#1</b>	<b>#0</b>
<b>5050</b>								<b>STV</b>

〔Modification Authority〕 : Machine authority

〔Default Setting〕 : 0000 0000

〔Way of validating〕 : After power-on

- #0 STV** Whether the tool offset of current axis is valid;
- 0: Valid
  - 1: Invalid



## 5.15 Parameters of Tool Life Management

	#7	#6	#5	#4	#3	#2	#1	#0
<b>6800</b>				<b>GPS</b>	<b>SIG</b>	<b>LTM</b>	<b>GS2</b>	<b>GS1</b>

『Default Setting』 : 0000 0000

『Modification Authority』 : Equipment management authority

『Way of Validating』 : After power-on

**#0 GS1, GS2** This parameter sets the combination of the number of tool life groups which can be entered, and the number of tools which can be entered per group; shown in the table below:

GS2	GS1	Group number	Tool number
0	0	1~1/8 of the maximum group number (No. 6813)	1~16
0	1	1~1/4 of the maximum group number (No. 6813)	1~8
1	0	1~1/2 of the maximum group number (No. 6813)	1~4
1	1	1~ the maximum group number (No. 6813)	1~2

**#2 LTM** Tool life is:

0: Specified by the number of times

1: Specified by time

**#3 SIG** Tool group selection signal for the input of tool skip signal is:

0: Ignored

1: Enabled

**#4 GRS** Tool change reset signal:

0: Clear only the execution data of a specified group

1: Clear the execution data of all entered groups;

	#7	#6	#5	#4	#3	#2	#1	#0
<b>6801</b>						<b>LVF</b>	<b>TSM</b>	<b>0</b>

『Default Setting』 : 0000 0000

『Modification Authority』 : Equipment management authority

**#1 TSM** When a tool takes several tool numbers, tool life is counted:

0: For each of the same tool number

1: For each tool

**#2 LVF** Specifies whether life count override is enabled or disabled when the extended tool life management function is used:

0: Disabled

1: Enabled

	#7	#6	#5	#4	#3	#2	#1	#0
<b>6802</b>	<b>PMT</b>							

『Default Setting』 : 0000 0000

『Modification Authority』 : Equipment management authority

『Way of Validating』 : Immediately

**#7 PMT** Tool life arrival notice signal TLCHB

0: The actual remaining life is longer than that specified in a parameter

1: The actual remaining life is not equal to that specified in a parameter

	#7	#6	#5	#4	#3	#2	#1	#0
<b>6804</b>		<b>LFI</b>						

『Default Setting』 : 0000 0000

『Modification Authority』 : Equipment management authority

『Way of Validating』 : Immediately

**#6 LFI** Tool life management for selected tool is:

0: Enabled:

1: Selected by tool life disable signal LFCIV<G048.2>;

	#7	#6	#5	#4	#3	#2	#1	#0
<b>6805</b>							<b>FGL</b>	

『Default Setting』 : 0000 0000

『Modification Authority』 : Equipment management authority

『Way of Validating』 : Immediately

**#1 FGL** When tool life is specified by time, entered data of G10 is in unit of:

0: 1 minute

1: 0.1 second

<b>6810</b>	<b>Tool life management ignored number (TLC)</b>
-------------	--

『Default Setting』 : 0

『Modification Authority』 : Equipment management authority

『Value Range』 : 0~99999999

『Way of Validating』 : Immediately

When the set value is subtracted from a T code, a remainder is used as the tool group number.

<b>6811</b>	<b>Tool life count restart M code (MRN)</b>
-------------	---

『Default Setting』 : 0

『Modification Authority』 : Equipment management authority

『Value Range』 : 0~127

『Way of Validating』 : Immediately

When the life is specified by the number of times, the tool exchange signal is output when this M code is specified if tool life of at least one tool group is expired. When 0 is set, it is ignored.

<b>6813</b>	<b>Max. tool groups (MTN)</b>
-------------	-------------------------------

『Default Setting』 : 0

『Modification Authority』 : Equipment management authority

『Value Range』 : 0, 8, 16, 32, 64, 128

『Way of Validating』 : After power-on

Set max. tool groups that can be entered. Turn off the power after setting this parameter.

<b>6844</b>	<b>Remaining tool life (used count) (TLP)</b>
-------------	---

『Default Setting』 : 0

『Modification Authority』 : Equipment management authority

〔Value Range〕 : 0~65535

〔Way of Validating〕 : Immediately

Set a remaining tool life (use count) used to output tool arrival notice signal

<b>6845</b>	<b>Remaining tool life (use duration) (TLR)</b>
-------------	---

〔Default Setting〕 : 0

〔Modification Authority〕 : Equipment management authority

〔Value Range〕 : 0~4300

〔Way of Validating〕 : Immediately

Set remaining tool life (use duration) which is used to output tool arrival notice signal.

## 5.16 Parameters of the Canned Cycle

The setting unit of canned cycle parameter is shown as follows:

	IS-B	IS-C	UNITS
Metric input	0.001	0.0001	mm
Inch input	0.0001	0.00001	inch

### 5.16.1 Parameters of the Drilling Canned Cycle

	#7	#6	#5	#4	#3	#2	#1	#0
<b>5101</b>						<b>RTR</b>		

〔Modification Authority〕 : Equipment management authority

〔Default Setting〕 : 0000 0000

**#2 MRC In G83 and G87:**

0: High-speed peck drilling cycle

1: Peck drilling cycle

	#7	#6	#5	#4	#3	#2	#1	#0
<b>5102</b>							<b>MRC</b>	

〔Modification Authority〕 : Equipment management authority

〔Default Setting〕 : 0000 0000

**#1 MRC** A target figure other than monotonically increasing or monotonically decreasing in G71 and G72 or that on Z axis in G73:

0: No alarm is issued;

1: An alarm is issued;

	#7	#6	#5	#4	#3	#2	#1	#0
<b>5104</b>						<b>FCK</b>		

〔Modification Authority〕 : Equipment management authority

〔Default Setting〕 : 0000 0000

**#2 FCK : In combined canned cycles (G71, G72 and G73), the profile is**

0: Not checked

1: Checked

**5110**

**M code locking C axis in the canned drilling cycle (CMD)**

〔Modification Authority〕 :Equipment management authority

〔Default Setting〕 : 0

〔Value Range〕 : 0~99

Set M code which can lock C axis during the canned drilling cycle.

**5114**

**High-speed peck drilling cycle retract distance (HPDCRD)**

〔Modification Authority〕 : Equipment management authority

〔Value Range〕 : 0~99 999 999× (least increment unit)

〔Default Setting〕 : 1000

Set high-speed peck drilling cycle retract distance (d).

**5115**

**Clearance of peck drilling(PDCRD)**

〔Modification Authority〕 : Equipment management authority

〔Value Range〕 : 0~99 999 999× (least increment unit)

〔Default Setting〕 : 1000

Set clearance of peck drilling (d) in G83/G87.

### 5.16.2 Parameters of the Thread Cutting Cycle

**5130**

**Chamfering value of the thread cutting cycle (G76, G92)(THD)**

〔Modification Authority〕 :Equipment management authority

〔Default Setting〕 : 0

〔Value Range〕 : 0~99× (0.1 screw pitch)

The parameter sets the chamfering value of G76 and G92 thread cutting cycle.

**5131**

**Chamfering angle in threading cycle (G92, G76) (CAT)**

〔Modification Authority〕 : Equipment management authority

〔Value Range〕 : 0~89

〔Default Setting〕 : 2

Set the chamfering angle in threading cycle. When the parameter is set to 0, a value of 45 degree is determined.

### 5.16.3 Parameters of the Combined Canned Cycle

**5132**

**Cut-in value of the combined canned cycle G71 and G72 (THC)**

〔Modification Authority〕 :Equipment management authority

〔Default Setting〕 : 1000

〔Value Range〕 : 1~99 999 999

Set the cut-in value of G71 and G72 combined canned cycle.

**5133**

**Retraction amount of G71 and G72 combined canned cycle (MCE)**

〔Modification Authority〕 :Equipment management authority

〔Default Setting〕 : 0

〔Value Range〕 : 0~99 999 999

Set the retraction amount of G71 and G72 combined canned cycle.

5135

**Retraction amount of G73 combined  
canned cycle along X axis direction (G73XE)**

5136

**Retraction amount of G73 combined  
canned cycle along Z axis direction (G73ZE)**

『Modification Authority』 : Equipment management authority

『Default Setting』 : 0

『Value Range』 : -99 999 999~99 999 999

Set the retraction amount of G73 combined canned cycle along with X and Z axes direction.

5137

**Partition times of G73 combined canned cycle (G73DC)**

『Modification Authority』 : Equipment management authority

『Default Setting』 : 1

『Value Range』 : 1~999

Set the partition times of G73 combined canned cycle.

5139

**Retraction amount of G74 and G75 combined canned cycles  
(G74G75R)**

『Modification Authority』 : Equipment management authority

『Default Setting』 : 1000

『Value Range』 : 0~99 999 999

Set the retraction amount of G74 and G75 combined canned cycle.

5140

**Minimum cut-in value of G76 combined canned cycle (G76MID)**

『Modification Authority』 : Equipment management authority

『Default Setting』 : 0

『Value Range』 : 0~99 999 999

Set the minimum cut-in value of G76 combined canned cycle.

5141

**Finishing allowance of G76 combined canned cycle (G76FA)**

『Modification Authority』 : Equipment management authority

『Default Setting』 : 500

『Value Range』 : 1~99 999 999

Set the finishing allowance of G76 combined canned cycle.

5142

**Finishing cycle times of G76 combined canned cycle (G76FC)**

『Modification Authority』 : Equipment management authority

『Default Setting』 : 1

『Value Range』 : 1~99

Set the finishing cycle times of G76 combined canned cycle.

5143

**Tool nose angle of G76 combined canned cycle (G76TNA)**

〔Modification Authority〕 :Equipment management authority

〔Default Setting〕 : 60

〔Value Range〕 : 0~99 (deg)

Set the tool nose angle of G76 combined canned cycle.

<b>5149</b>	<b>Override of retraction in boring cycle G85 /G89 (BCRDOV)</b>
-------------	---

〔Modification Authority〕 : Equipment management authority

〔Value Range〕 : 0~2000

〔Default Setting〕 : 200

Set override (%) of retraction in boring cycle G85/G89, independent of feedrate override. When set to 0, 200% of feedrate is used.

### 5.17 Parameters of the Rigid Tapping

	#7	#6	#5	#4	#3	#2	#1	#0
<b>5200</b>		<b>FHD</b>		<b>DOV</b>		<b>CRG</b>		<b>G84</b>

〔Modification Authority〕 :Equipment management authority

〔Default Setting〕 : 0000 0000

**#0 G84 Method of specifying the rigid tapping**

0: An M code specifying the rigid tapping mode is specified prior to the issue of the G84 (or G74) command. (See parameter No. 5210)

1: An M code specifying the rigid tapping mode is not used. (G84 cannot be used as a G code for the tapping cycle; G74 cannot be used for the reverse tapping cycle.)

**#2 CRG Rigid mode when a rigid mode cancel command is specified (G80, G01 group G code, reset, etc.)**

0: Cancelled after rigid tapping signal RGTAP is set to 0.

1: Cancelled before rigid tapping signal RGTAP is set to 0.

**#4 DOV Override during extraction in rigid tapping is:**

0: Invalidated

1: Validated (the override value is set in parameter No. 5211)

**#5 when specified Q, PCP Tapping or rigid tapping is:**

0: Used as a high-speed peck tapping cycle

1: Used as a peck tapping cycle

**#6 FHD Feed hold and single block in rigid tapping is:**

0: Invalidated

1: Validated

**#7 SRS To select a spindle used for rigid tapping in multi-spindle control**

0:The spindle selection signal SWS1~SWS3 are used

1:The rigid tapping selection signal RGTSP1~RGTSP3 are used

	#7	#6	#5	#4	#3	#2	#1	#0
<b>5201</b>				<b>OV3</b>	<b>OVU</b>	<b>TDR</b>		

〔Modification Authority〕 :Equipment management authority

〔Default Setting〕 : 0000 0000

**#2 TDR: Cutting time constant in rigid tapping:**

- 0: Is the same during cutting and extraction  
 1: Not the same during cutting and extraction

**#3 OVU: The increment unit of the override parameter (No.5211) for tool rigid tapping extraction is:**

- 0: 1%  
 1: 10%

**#4 OV3: The spindle speed for tool extraction is specified by program so that the override of spindle speed is:**

- 0: Disabled  
 1: Enabled

	#7	#6	#5	#4	#3	#2	#1	#0
<b>5202</b>		<b>OVE</b>						<b>ORI</b>

『Modification Authority』 : Equipment management authority

『Default Setting』 : 0000 0000

**#0 ORI When rigid tapping is started, Spindle orientation is:**

- 0: Not performed  
 1: Performed

**#6 OVE Valid data range of override for tool extraction command (address J) in rigid tapping is**

- 0: 100%~200%  
 1: 100%~2000%

	#7	#6	#5	#4	#3	#2	#1	#0
<b>5203</b>				<b>OVS</b>				

『Modification Authority』 : Equipment management authority

『Default Setting』 : 0000 0000

**#4 OVS In rigid tapping, override by the feedrate override signal and invalidation of override by the override cancel signal is:**

- 0: Invalid  
 1: Valid

**Note 1: When the feedrate override is valid, the tool extraction override is invalid;**  
**Note 2: When the spindle override is fixed to 100% during rigid tapping, it is not related to this parameter;**

	#7	#6	#5	#4	#3	#2	#1	#0
<b>5209</b>								<b>RTX</b>

『Modification Authority』 : Equipment management authority

『Default Setting』 : 0000 0000

**#0 RTX Tapping axis in rigid tapping is:**

- 0: Changed by plane selection command  
 1: Fixed to Z axis for G84, X axis for G88 G84

<b>5210</b>	<b>M code commanding the rigid tapping (RTMC)</b>
-------------	---

『Modification Authority』 : Equipment management authority

『Default Setting』 : 29

〔Value Range〕 : 0~255

M code is set to specify the rigid tapping method. When it is set as 0, CNC takes it as M29.

**5211**

**Override value during rigid tapping extraction (RTOV)**

〔Modification Authority〕 :Equipment management authority

〔Default Setting〕 : 120

〔Data unit〕 : 1% or 10%

〔Value Range〕 : 0~200

Set the override value during the rigid tapping run-out

**Note 1:** The override value is valid when DOV in parameter No. 5200#4 is 1.  
**Note 2:** When bit 3 of parameter No. 5201 (OVU) is 1, the unit of set data is 10%. An override of up to 200% can be applied to extraction.

**5213**

**Return or clearance in peck tapping cycle(PRTRD)**

〔Modification Authority〕 : Equipment management authority

〔Value Range〕 : 0~99999999

〔Data Unit〕 :

SETTING UNITS	IS-B	IS-C	UNITS
Linear axis (metric input)	0.001	0.0001	mm
Linear axis (inch input)	0.0001	0.00001	Inch

〔Default Setting〕 : 2000

Set the return in high-speed peck tapping or clearance in peck tapping cycle.

**5241**

**Maximum spindle speed in rigid tapping(RTMS)**

〔Modification Authority〕 :Equipment management authority

〔Default Setting〕 : 1000

〔Value Range〕 : 0~9999r/min

Set the maximum spindle speed in rigid tapping.

**5261**

**The linear acceleration/deceleration time constant for spindle and tapping axis(RTLT) in rigid tapping (RTLT)**

〔Modification Authority〕 :Equipment management authority

〔Default Setting〕 : 200

〔Value Range〕 : 0~4000ms

Set the linear acceleration/deceleration time constant for spindle and tapping axis.

**5271**

**Time constant for spindle and tapping axis in extraction operation (RTET)**

〔Modification Authority〕 :Equipment management authority

〔Default Setting〕 : 200

〔Value Range〕 : 0~4000ms

Set a linear acceleration/deceleration time constant for the spindle and tapping axis in extraction operation.

**Note:** This parameter is valid when bit 2 of parameter No. 5201 (TDR) is 1.



5275

**Compensation of encoder sampling delay in period for tapping  
axis in G84/G88 threading(ZBK)**

『Modification Authority』 : Equipment management authority

『Value Range』 : 0~10

『Default Setting』 : 2

Set compensation of encoder sampling delay for tapping axis in G84/G88 threading.  
This parameter determined the in-position precision before tool exatrction. A value range of 4~8 is preferred.

## 5.18 Parameters of the Polar Coordinates Interpolation

5450

#7    #6    #5    #4    #3    #2    #1    #0

							<b>AFC</b>	
--	--	--	--	--	--	--	------------	--

『Modification Authority』 :Equipment management authority

『Default Setting』 : 0000 0000

**#0 AFC: In polar coordinate interpolation mode, automatic override and feedrate clamp are:**

0: Not performed

1: Performed

**Note:** In polar coordinate interpolation mode, the feedrate component for a rotational axis increases as the tool moves closer to the center of a workpiece. Near the center of a workpiece, the maximum cutting feedrate may be exceeded, causing servo alarm No. 411 to be issued. the automatic feedrate override function and automatic feedrate clamp function automatically control the feedrate to prevent the feedrate component on a rotation axis from exceeding a specified maximum cutting feedrate.

5460

**Axis (linear axis) specification for polar coordinate interpolation  
(LAI)**

5461

**Axis(rotary axis) specification for polar coordinate interpolation  
(RAI)**

『Modification Authority』 :Machine authority

『Value Range』 : 1~number of the controlled axes

『Default Setting』 : No.5460 is 0; NO.5461 is 5

Set control axis number of rotary axis and rotary axis to execute polar interpolation.

5462

**Maximum cutting feedrate of the polar coordinates interpolation (MFI)**

『Modification Authority』 :Machine authority

『Default Setting』 : 8000

『Value Range』 :

	IS-B	IS-C	UNITS
Metric machine	0, 6~24 000	0, 6~10 000	mm/min
Inch machine	0, 6~9 600	0, 6~4 800	inch/min
Rotary axis	0, 6~24 000	0, 6~10 000	deg/min

Set the upper limit of the cutting feedrate that is effective during polar coordinate interpolation.

When the specified speed is larger than this value, it is limited at this maximum feedrate. When this parameter is set to 0, the upper limit is the usual maximum cutting feedrate (set by parameter No. 1422) during polar coordinate interpolation.

<b>5463</b>	<b>Allowable automatic override percentage in polar coordinate interpolation (API)</b>
-------------	--

〔Modification Authority〕 : Equipment management authority

〔Value Range〕 : 1~number of the controlled axes

〔Default Setting〕 : 0

〔Value Range〕 : 0~100 (%)

Set the allowable percentage to find an allowable feedrate on rotary axis in polar coordinate interpolation.

Allowable feedrate on rotation axis = maximum cutting feedrate×allowable percentage

In polar coordinate interpolation mode, the feedrate component on a rotation axis increases as the tool moves closer to the center of a workpiece. Near the center of a workpiece, the maximum allowable feedrate (parameter No. 5462) may be exceeded. To prevent the feedrate component on a rotation axis from exceeding the maximum allowable feedrate in polar coordinate interpolation mode, the following override is automatically applied to the feedrate (automatic override):

Override = allowable feedrate on rotation axis/feedrate component on rotation axis×100%

If the override feedrate component for a rotation axis still exceeds the allowable feedrate, the feedrate is clamped to prevent the feedrate component on a rotation axis from exceeding a maximum cutting feedrate.

**Note: When 0 is set in this parameter, a specification of 90% is assumed. Before the automatic override function and automatic feedrate clamp function can be used, bit 1 (AFC) of parameter No. 5450 must be set to 1.**

### 5.19 Parameters of the User Macro Program

	#7	#6	#5	#4	#3	#2	#1	#0
<b>6000</b>			<b>SBM</b>					<b>G67</b>

〔Modification Authority〕 :Equipment management authority

〔Default Setting〕 : 0000 0000

**#0 G67 If G67 is specified while G66 is not set:**

0: An alarm is issued (No. 122)

1: G66 is ignored

**#5 SBM Custom macro statement:**

0: Does not stop the single block

1: Stops the single block

	#7	#6	#5	#4	#3	#2	#1	#0
<b>6001</b>	<b>CLV</b>	<b>CCV</b>						

〔Modification Authority〕 :Equipment management authority

〔Default Setting〕 : 0100 0000

**#6 CCV Custom macro's common variables Nos.100~199 are:**

0: Cleared to vacant by reset

1: Not cleared by reset

**Note: In MDI mode, the macro public variables are not cleared after reset.**

**#7 CLV Custom macro's local variables Nos.1~13 are:**

0: Cleared to vacant by reset

1: Not cleared by reset

	#7	#6	#5	#4	#3	#2	#1	#0
<b>6004</b>							<b>MFZ</b>	<b>NAT</b>

〔Modification Authority〕 : Equipment management authority

〔Default Setting〕 : 0000 0000

**#0 NAT Specification of the results of custom macro function ATAN & ASIN:**

0: The result is 0~360 & 270~90

1: The result is -180~180 & -90~90

**#1 MFZ If the angle of a custom macro operation command SIN, COS or TAN is  $1.0 \times 10^{-8}$  or below, the result is :**

0: Handled as underflow      1: Normalized to 0

## 5.20 Parameters of the Skip Function

	#7	#6	#5	#4	#3	#2	#1	#0
<b>6200</b>	<b>SKF</b>						<b>SK0</b>	

〔Modification Authority〕 : Machine authority

〔Default Setting〕 : 0000 0000

**SK0: Specify when the skip signal is valid:**

0: Skip signal is valid when the signal is set to 1

1: Skip signal is valid when the signal is set to 0

**SKF: Dry run and override for G31 skip command are:**

0: Disabled

1: Enabled

	#7	#6	#5	#4	#3	#2	#1	#0
<b>6210</b>		<b>MDC</b>						

〔Modification Authority〕 : Equipment management authority

〔Default Setting〕 : 0000 0000

**#6 MDC The value of the automatic tool compensation is:**

0: Added to current tool offset

1: Subtracted from current tool offset

	#7	#6	#5	#4	#3	#2	#1	#0
<b>6240</b>	<b>IGA</b>							<b>AE0</b>

〔Modification Authority〕 : Machine authority

〔Way of Validating〕 : After power-on

〔Default Setting〕 : 0000 0000

**#0 AE0 Measurement position arrival is assumed when the automatic tool compensation signal (X3.6) and XAE2 (X3.7) is:**

- 0: 1
- 1: 0

**#7 IGA Automatic tool compensation is:**

- 0: Enabled
- 1: Disabled

<b>6242</b>	<b>Feedrate during measurement of automatic tool compensation(used with signal XAE2) (ATOF2)</b>
-------------	--

『Modification Authority』 : Machine authority

『Default Setting』 : 1000

『Data setting』 :

SETTIN UNIT	DATA UNIT	VALID RANGE (IS-B/ IS-C)		DEFAULT SETTING
		IS-B	IS-C	
Metric machine	1mm/min	6~15000	6~12000	1000
Inch machine	0.1inch/min	6~6000	6~4800	

These two parameters set the feedrate during measurement of automatic tool compensation.

**Note: When the setting value of parameter No. 6242 is set to 0, the setting value of parameter No. 6241 is valid.**

<b>6251</b>	<b>γ value on X axis during automatic tool compensation (ATOR1)</b>
-------------	---

<b>6252</b>	<b>γ value on Z axis during automatic tool compensation (ATOR2)</b>
-------------	---

『Modification Authority』 : Equipment management authority

『Default Setting』 : 1000

『Data range』 : 1~99999999

These two parameters set the γ value during automatic tool compensation.

**Note: The value is set in radius no matter diameter or radius programming is specified.**

<b>6254</b>	<b>ε value on X axis during automatic tool compensation(ATOE1)</b>
-------------	--

<b>6255</b>	<b>ε value on Z axis during automatic tool compensation(ATOE2)</b>
-------------	--

『Modification Authority』 : Equipment management authority

『Data range』 : 1~99999999

SETTING UNIT	IS-B	IS-C	unit
Linear axis (metric input)	0.001	0.0001	mm
Linear axis (inch input)	0.0001	0.00001	inch
Rotary axis	0.001	0.0001	deg

These two parameters set the ε value during automatic tool compensation.

**Note: The value is set in radius no matter diameter or radius programming is specified.**

## 5.21 Parameters of the Graphic Display

	#7	#6	#5	#4	#3	#2	#1	#0
<b>6500</b>					DPA			

〔Modification Authority〕 : Equipment management authority

〔Default Setting〕 : 0000 0000

### #3 DPA Current position display on the graphic display screen:

0: Display the actual position to ensure tool nose radius compensation

1: Display the programmed position

## 5.22 Parameter of Run Hour and Parts Count Display

	#7	#6	#5	#4	#3	#2	#1	#0
<b>6700</b>							PRT	PCM

〔Modification Authority〕 : Equipment management authority

〔Default Setting〕 : 0000 0000

### #0 PCM M code that counts the total number of machined parts and the number of machined parts:

0: M02, or M30, or M code specified by parameter No.6710

1: M codes only specified by parameter No.6710

### #1 PRT Upon reset, signal PRTSF (F62.7), which indicates that a required number of parts have been reached is:

0: Turned off

1: Not turned off

<b>6710</b>	<b>M code that counts the total number of machined parts and the number of machined parts (MPC)</b>
-------------	---

〔Modification Authority〕 : Machine authority

〔Value Range〕 : 0~9999

〔Default Setting〕 : 0

Set the M code that counts the total number of machined parts and the number of machined parts.

**Note: It is invalid when the setting value is 0 (M00 cannot count parts), 98 and 99.**

<b>6713</b>	<b>Number of required parts (RPM)</b>
-------------	---------------------------------------

〔Modification Authority〕 : Machine authority

〔Value Range〕 : 0~9 999

〔Default Setting〕 : 0

Required parts finish signal PRTSF (F62.7) is output when the number of machined parts reaches the number of required parts.

**Note: When the setting value is 0, the machined parts number is regarded as infinite, and PRTSF is not output.**

### 5.23 Parameter of MPG Feed

	#7	#6	#5	#4	#3	#2	#1	#0
<b>7100</b>				<b>HPF</b>				<b>JHD</b>

〔Modification Authority〕 : Machine authority

〔Default Setting〕 : 0000 0000

**#0 JHD Manual handle feed in JOG feed mode and incremental feed in the manual handle feed:**

- 0: Invalid
- 1: Valid

	JHD=0		JHD=1	
	JOG MODE	MPG MODE	JOG MODE	MPG MODE
JOG feed	○	×	○	×
MPG feed	×	○	○	○
Increment feed	×	×	×	○

**#4 HPF When a manual handle feedrate exceeds the rapid traverse feedrate:**

- 0: The excess are ignored (manual MPG value is not corresponding to actual movement amount);
- 1: The excess are not ignored (although the MPG stops, the machine still moves with the pulse amount that is stored in CNC system, then stops);

	#7	#6	#5	#4	#3	#2	#1	#0
<b>7102</b>								<b>HNGx</b>

〔Modification Authority〕 : Machine authority

〔Parameter Type〕 : Bit axis

〔Default Setting〕 : 0000 0000

**#0 HNGx Axis movement direction for rotation direction of manual pulse generator:**

- 0: Same in direction
- 1: Reverse in direction

	#7	#6	#5	#4	#3	#2	#1	#0
<b>7103</b>						<b>HNT</b>		

〔Modification Authority〕 : Machine authority

〔Default Setting〕 : 0000 0000

**#2 HNT The manual handle feed/incremental feed magnification is:**

- 0: Multiplied by 1
- 1: Multiplied by 10

<b>7110</b>	<b>Number of manual pulse generators used (NMP)</b>
-------------	---

〔Modification Authority〕 : Machine authority

〔Value Range〕 : 0~2

〔Default Setting〕 : 1

Set the number of manual pulse generators.

**7113****Manual handle feed magnification M (MFM)**

『Modification Authority』 : Machine authority

『Value Range』 : 1~127

『Default Setting』 : 100

Set the magnification when manual handle feed movement selection signal MP1=0, MP2=1.

**7114****Manual handle feed magnification N (MFN)**

『Modification Authority』 :Machine authority

『Value Range』 :1~1000

『Default Setting』 :1000

Set the magnification when manual handle feed movement selection signal MP1=1, MP2=1.

MOVEMENT VALUE SELECTING SIGNAL		MOVEMENT VALUE (MPG FEED)
MP2	MP1	
0	0	Least input increment × 1
0	1	Least input increment × 10
1	0	Least input increment × M
1	1	Least input increment × N

**7117****Allowable numbers of pulses that can be accumulated during manual handle feed (APM)**

『Modification Authority』 : Machine authority

『Value Range』 : 0~99999999

『Default Setting』 : 10000

If manual handle feed is specified such that the rapid traverse rate will be exceeded momentarily, those pulses received from the manual pulse generator that exceed the rapid traverse rate are accumulated rather than canceled. This parameter sets the maximum number of pulses which can be accumulated in such a case.

Note: when the manual pulse generator is rotated at high speed with a large magnification such as 100, the axis feedrate is clamped at the rapid traverse rate and those pulses received from the manual pulse generator that exceed the rapid traverse rate are ignored. In such a case, therefore, the scale on the manual pulse generator may differ from the actual amount of travel. If such a difference is not acceptable, this parameter can be set to temporarily accumulate the excess pulses in the CNC, rather than ignoring them, up to the specified maximum (pulses in excess of the set maximum are ignored). The accumulated pulses are output and converted to a move command once the feedrate falls below the rapid traverse rate by reducing the rotational speed of the manual pulse generator or stopping its rotation altogether. Note, however, that if the maximum number of pulses to be accumulated is too large, stopping the rotation of the manual pulse generator does not stop feeding until the tool moves by an amount corresponding to the pulses accumulated in the CNC.

**5.24 Parameter of PLC Axis Control**

	#7	#6	#5	#4	#3	#2	#1	#0
<b>8001</b>			NCC		RDE	OVE		MLE

『Modification Authority』 : Machine authority

『Default Setting』 : 0000 0000

**#0 MLE** Whether axis machine lock signal MLK is valid for PLC-controlled axes:  
 0: Valid  
 1: Invalid

**#2 OVE** Signals related to dry run and override used in PLC axis control are:  
 0: Same signals as those used for the CNC  
 1: Signal specific to the PLC

**#3 RDE** Whether dry run is valid for rapid traverse in PLC axis control:  
 0: Invalid  
 1: Valid

**#5 NCC** When a travel command is issued for the PLC-controlled axis according to the program:

0: An alarm is issued when PLC controls the axis with an axis control command. When the PLC does not control the axis, a CNC command is enabled.

1: PS alarm No. 139 is issued.

**#6 AUX** The number of bytes for the code of an auxiliary function to be output is:  
 0: 1  
 1: 2

	<b>#7</b>	<b>#6</b>	<b>#5</b>	<b>#4</b>	<b>#3</b>	<b>#2</b>	<b>#1</b>	<b>#0</b>
<b>8002</b>	<b>FR2</b>	<b>FR1</b>	<b>PF2</b>	<b>PF1</b>	<b>F10</b>		<b>DWE</b>	<b>RPD</b>

『Modification Authority』 : Machine authority

『Default Setting』 : 0000 0000

**#0 RPD** Rapid traverse rate for PLC-controlled axes:

0: Rapid traverse rate for PLC-controlled axes

1: Feedrate specified with the feedrate data in an axis control command

**#1 DWE** Minimum time which can be specified in a dwell command in PLC axis control when the increment system is IS-C is:

0: 1ms

1: 0.1ms

**#3 F10** Least increment for the feedrate for cutting feed (per minute) in PLC axis control:

<b>F10</b>	<b>METRIC INPUT</b>	<b>INCH INPUT</b>
0	1mm/min	0.01inch/min
1	10mm/min	0.1inch/min

**#4,#5 PR1, PR2** Set the feedrate of feed per rotation in PLC axis control:

<b>PR2</b>	<b>PR1</b>	<b>SPEED</b>
0	0	1/1
0	1	1/10
1	0	1/100
1	1	1/1000

**#6,#7 FR1, FR2** Set the feedrate unit of feed per rotation in PLC axis control:

<b>FR2</b>	<b>FR1</b>	<b>METRIC INPUT</b>	<b>INCH INPUT</b>
0	0	0.0001mm/rev	0.000001inch/rev
1	1		
0	1	0.001mm/rev	0.00001inch/rev
1	0	0.01mm/rev	0.0001inch/rev



	#7	#6	#5	#4	#3	#2	#1	#0
<b>8004</b>		<b>NCI</b>	<b>DSL</b>			<b>JFM</b>		

『Modification Authority』 : Machine authority

『Default Setting』 : 0000 0000

**#2 JFM Set the feedrate unit of continuous feed in PLC axis control:**

INCREMENT SYSTEM	JFM	METRIC INPUT	INCH INPUT	ROTARY AXIS
IS-B	0	1mm/min	0.01inch/min	1deg/min
	1	200mm/min	2.00inch/min	200deg/min
IS-C	0	0.1mm/min	0.001inch/min	0.1deg/min
	1	20mm/min	0.200inch/min	20deg/min

**#5 DSL If the selection of an axis is changed when PLC axis selection is disabled:**

0: An alarm is issued (P/S232)

1: The changed is valid, and no alarm is issued for an unspecified system

**#6 NCI In axis control by the PLC, a position check at the time of deceleration is:**

0: Performed

1: Not performed

	#7	#6	#5	#4	#3	#2	#1	#0
<b>8005</b>						<b>R10</b>	<b>CDI</b>	

『Modification Authority』 : Machine authority

『Default Setting』 : 0000 0000

**#1 CDI For PLC axis control, when diameter programming is specified for a PLC-controlled axis:**

0: The amount of travel is specified in radius

1: The amount of travel is specified in diameter

**#2 R10 When the RPD parameter (No.8002#0) is set to "1", the unit for specifying a rapid traverse rate for the PLC axis is:**

0: ×1

1: ×10

	#7	#6	#5	#4	#3	#2	#1	#0
<b>8006</b>	<b>EAL</b>			<b>EFD</b>				

『Modification Authority』 : Machine authority

『Default Setting』 : 0000 0000

**#4 EFD In axis control by PLC, the unit for specifying feed cutting for PLC axis is:**

0: ×1

1: ×100

**#7 EAL In axis control by PLC, the function that allows the alarm signal to be reset by a CNC reset operation is:**

0: Disabled

1: Enabled

<b>8010</b>	<b>Selection of the DI/DO group for each axis controlled by PLC (PSA)</b>
-------------	---

『Modification Authority』 : Machine authority

『Parameter Type』 : Word axis

〔Default Setting〕 :0

〔Value Range〕 :0~4

Specify the DI/DO group to be used for each PLC-controlled axis;

NUMBER	INSTRUCTION
0	The axis is not controlled by PLC
1	DI/DO in group A is used
2	DI/DO in group B is used
3	DI/DO in group C is used
4	DI/DO in group D is used

**8022**

**Upper-limit of feedrate per rotation during PLC axis control (PAMS)**

〔Modification Authority〕 : Machine authority

〔Parameter Type〕 : Word axis

〔Default Setting〕 : 6

〔Value Range〕 :

INCREMENT SYSTEM	DATA UNITS	VALID DATA RANGE	
		IS-B	IS-C
Metric machine	1mm/min	6~15000	6~12000
Inch machine	0.1inch/min	6~6000	6~4800
Rotary axis	1deg/min	6~15000	6~12000

Set the maximum feedrate of feeding/per rotation controlled by PLC axis.

**8028**

**Linear acceleration/deceleration time constant of speed command for PLC axis control (PALT)**

〔Modification Authority〕 : Machine authority

〔Parameter Type〕 : Word axis

〔Default Setting〕 : 200

〔Value Range〕 : 0~3000ms

Set the time required for the servo motor rotation speed to increase or decrease in JOG feed.

**Note: If it is specified as "0", the system does not perform acceleration/deceleration control.**

## 5.25 Parameters of the Basic Function

**8130**

**Total number of controlled axes(TCA)**

〔Modification Authority〕 : System authority

〔Way of Validating〕 : After power-on

〔Default Setting〕 : 2

〔Data Range〕 : 2~6

Set the total number of controlled axes by the CNC and PLC.

#7 #6 #5 #4 #3 #2 #1 #0

**8131**

**HPG**

〔Modification Authority〕 : Machine authority

〔Way of Validating〕 : After power-on

〔Default Setting〕 : 0000 0001

**#0 HPG MPG is:**

0: Not used

1: Used

	#7	#6	#5	#4	#3	#2	#1	#0
<b>8132</b>								<b>TLF</b>

『Modification Authority』 : Machine authority

『Way of Validating』 : After power-on

『Default Setting』 : 0000 0000

**#0 TLF : Tool life management is:**

0: Not used

1: Used

	#7	#6	#5	#4	#3	#2	#1	#0
<b>8133</b>					<b>MSP</b>	<b>SCS</b>	<b>AXC</b>	<b>SSC</b>

『Modification Authority』 : Machine authority

『Way of Validating』 : After power-on

『Default Setting』 : 0000 0001

**#0 SSC Constant surface speed control is:**

0: Not used

1: Used

**#1 AXC Spindle positioning is:**

0: Not used

1: Used

**#2 SCS CS contour control is:**

0: Not used

1: Used

**#3 MSP Multi-spindle control is:**

0: Not used

1: Used

**5.26 Parameters of GSK-CAN Communication Function**

	#7	#6	#5	#4	#3	#2	#1	#0
<b>9000</b>							<b>BCAN</b>	<b>ACAN</b>

『Modification Authority』 : Machine authority

『Way of Validating』 : After power-on

『Default Setting』 : 0000 0000

**#0 ACAN GSKLinkA function on all system is:**

0: Invalid

1: Valid

**#1 BCAN GSKLinkB function on all system is:**

0: Invalid

1: Valid

<b>9010</b>	<b>Communication baudrate of GSK-CAN channel A (ABPS)</b>
-------------	---

- 〔Modification Authority〕 : Machine authority
- 〔Way of Validating〕 : After power-on
- 〔Default Setting〕 : 500 (kbps)
- 〔Data Range〕 ; 500, 600, 800 or 1000 (kbps)

**Set communication baudrate of GSKLinkA function on system.**

**Note: The baudrate of servo drive unit that connected with GSK-CANA should be in accordance with this parameter setting.**

**9011                      Communication baudrate of GSK-CAN channel B (BBPS)**

- 〔Modification Authority〕 : Machine authority
- 〔Way of Validating〕 : After power-on
- 〔Value Range〕 : 500, 600, 800, 1000 (kbps)
- 〔Default Setting〕 : 500 (kbps)

**Set communication baudrate of GSKLinkB function on system.**

**Note: The baudrate of servo drive unit that connected with GSK-CANB should be in accordance with this parameter setting.**

**9020                      Servo slave number of all axes communication (SIDx)**

- 〔Modification Authority〕 :Machine authority
- 〔Parameter Type〕 :Word axis
- 〔Way of Validating〕 :After power-on
- 〔Value Range〕 :0~5, 11~12
- 〔Default Setting〕 :0

**Set the servo slave number of axes;**

**Note 1: “0” represents that the axis is not connected with servo slave;  
 Note 2: “1~5” represents that this axis is connected with channel A GSK-CAN, and the corresponding servo slave numbers are 1~5;  
 Note 3: “11~12” represents that this axis is connected with channel B GSK-CAN, and the corresponding servo slave numbers are 6~7;**

**9030                      Servo slave number of all spindles communication(SIDS)**

- 〔Modification Authority〕 :Machine authority
- 〔Parameter Type〕 :Word axis
- 〔Way of Validating〕 : After power-on
- 〔Value Range〕 : 0~5, 11~12
- 〔Default Setting〕 : 0

**Set the servo slave number of all spindles communication;**

**Note 1: “0” represents that the axis is not connected with servo slave;  
 Note 2: “1~5” represents that this axis is connected with channel A GSK-CAN, and the corresponding servo slave numbers are 1~5;  
 Note 3: “11~12” represents that this axis is connected with channel B GSK-CAN, and the corresponding servo slave numbers are 6~7;**

## CHAPTER VI STANDARD PLC FUNCTION CONFIGURATION

### 6.1 Standard Panel on the Machine Tool



Fig. 6-1-1 Standard layout of operation panel

## 6.2 Addresses X, Y Definition

**Caution:**

The general I/O signal (except those signals marked for fixed addresses) in GSK988T CNC system is defined by the embedded PLC (ladder diagram) program. When this CNC system is installed, the exact I/O functions are determined by the machine tool builder. Please refer to the manual from machine tool builder for details.

Pay attention that in this chapter, the functions of general I/O signal (i.e. X,Y addresses) are just described for GSK988T standard PLC program.

### 6.2.1 General I/O Interface on Machine Tool

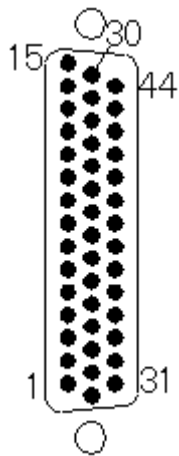

Fig 6-2-1 CN61 (male) input

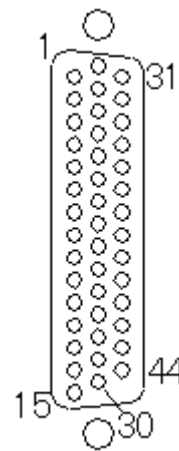

Fig. 6-2-2 CN62 (female) output

DB Pin	PLC address	Function defined by standard PLC address		Remark
CN61.1	X0.0	SAGT	Protection door detection signal	
CN61.2	X0.1		Reserved	
CN61.3	X0.2	DIQP	Chuck input signal	
CN61.4	X0.3	DEC1	The 1 <sup>st</sup> axis deceleration signal	Fixed address
CN61.5	X0.4	DITW	Tailstock control signal	
CN61.6	X0.5	ESP	Emergency stop input signal	Fixed address
CN61.7	X0.6	PRES	Pressure detection signal	
CN61.8	X0.7	T05	Tool position signal 5/ tool post pre-indexing signal (Yantai AK31)/Sensor E (Liuxin Tool Post)	
CN61.9	X1.0	T06	Tool position signal 6/ tool post pre-indexing signal (Yantai AK31)/Sensor F (Liuxin Tool Post)	

DB Pin	PLC address	Function defined by standard PLC address		Remark
CN61.10	X1.1	T07	Tool position signal 7/ tool post overheat signal (Yantai AK31)	
CN61.11	X1.2	T08	Tool position signal 8	
CN61.12	X1.3	DEC3	The 3 <sup>rd</sup> axis deceleration signal	Fixed address
CN61.13	X1.4		Reserved	
CN61.14	X1.5	M41I	The 1 <sup>st</sup> gear stage in-position	
CN61.15	X1.6	M42I	The 2 <sup>nd</sup> gear stage in-position	
CN61.16	X1.7	T01	Tool position signal 1/T1 (Yantai AK31)/Sensor A (Liuxin Tool Post)	
CN61.29	X2.0	T02	Tool position signal 2/T2 (Yantai AK31)/ Sensor B (Liuxin Tool Post) Sensor A (Liuxin Tool Post)	
CN61.30	X2.1	T03	Tool position signal 3/T3 (Yantai AK31)/Sensor C (Liuxin Tool Post)	
CN61.31	X2.2	T04	Tool position signal 4/T4 (Yantai AK31)/Sensor D (Liuxin Tool Post)	
CN61.32	X2.3	DEC2	The 2 <sup>nd</sup> axis deceleration signal	Fixed address
CN61.33	X2.4	DEC4	The 4 <sup>th</sup> deceleration signal	Fixed address
CN61.34	X2.5	DEC5	The 5 <sup>th</sup> deceleration signal	Fixed address
CN61.35	X2.6	TCP	Tool post lock signal Tool post proximity switch signal (Yantai AK31)	
CN61.36	X2.7	COIN	Spindle orientation completed signal	
CN61.37	X3.0	LMI1+	The 1 <sup>st</sup> axis + side overtravel signal	
CN61.38	X3.1	LMI2+	The 2 <sup>nd</sup> axis + side overtravel signal	
CN61.39	X3.2	LMI3+	The 3 <sup>rd</sup> axis + side overtravel signal	
CN61.40	X3.3	WQPJ	Chuck in-position signal (outer chuck clamping and inner chuck unclamping)	
CN61.41	X3.4	NQPJ	Chuck in-position signal (inner chuck clamping and outer chuck unclamping)	
CN61.42	X3.5	SKIP	G31 skip signal	Fixed address
CN61.43	X3.6	G36	G36 skip signal	Fixed address
CN61.44	X3.7	G37	G37 skip signal	Fixed address

DB Pin	PLC address	Function defined by standard PLC address		Remark
CN61.17	X4.0	LMI1-	The 1 <sup>st</sup> axis – direction overtravel signal	
CN61.18	X4.1	LMI2-	The 2 <sup>nd</sup> axis – direction overtravel signal	
CN61.19	X4.2	LMI3-	The 3 <sup>rd</sup> axis – direction overtravel signal	
CN61.20	X4.3	LMI4+	The 4 <sup>th</sup> axis + direction overtravel signal	
CN61.25	X4.4	LMI4-	The 4 <sup>th</sup> axis - direction overtravel signal	
CN61.26	X4.5	LMI5+	The 5 <sup>th</sup> axis + direction overtravel signal	
CN61.27	X4.6	LMI5-	The 5 <sup>th</sup> axis - direction overtravel signal	
CN61.28	X4.7		Reserved	
CN61.21~CN61.24	0V			
CN62.1	Y0.0	M08	Cooling output signal	
CN62.2	Y0.1	M32	Lubrication output signal	
CN62.3	Y0.2		Reserved	
CN62.4	Y0.3	M03	Spindle CCW signal	
CN62.5	Y0.4	M04	Spindle CW signal	
CN62.6	Y0.5	M05	Spindle stop signal	
CN62.7	Y0.6		Reserved	
CN62.8	Y0.7	SPZD	Spindle braking output signal	
CN62.9	Y1.0	M41	Spindle gear 1 output signal	
CN62.10	Y1.1	M42	Spindle gear 2 output signal	
CN62.11	Y1.2	M43	Spindle gear 3 output signal	
CN62.12	Y1.3	M44	Spindle gear 4 output signal	
CN62.13	Y1.4	M12(DOQPJ)	Outer chuck clamping output / Inner chuck unclamping output signal	
CN62.14	Y1.5	M13(DOQPS)	Outer chuck unclamping output /inner chuck clamping output signal	
CN62.15	Y1.6	TL+	Tool post forward rotation output signal	
CN62.16	Y1.7	TL-	Tool post reverse rotation output signal	
CN62.29	Y2.0		Tool post motor braking signal (Yantai AK31)/ tool post unclamping output (Liuxin Tool Post)	



DB Pin	PLC address	Function defined by standard PLC address		Remark
CN62.30	Y2.1		Tool post pre-indexing electromagnet signal (Yantai AK31)/ Tool post lock output (Liuxin Tool Post)	
CN62.31	Y2.2	YLAMP	Tri-colored lamp – yellow (normal state, non-running, non-alarm)	
CN62.32	Y2.3	GLAMP	Tri-colored lamp – green (running state)	
CN62.33	Y2.4	RLAMP	Tri-colored lamp – red (alarm state)	
CN62.34	Y2.5	M10	Tailstock advancing output signal	
CN62.35	Y2.6	M11	Tailstock retracting output signal	
CN62.36	Y2.7		Reserved	
CN62.37	Y3.0		Reserved	
CN62.38	Y3.1		Reserved	
CN62.39	Y3.2		Reserved	
CN62.40	Y3.3		Reserved	
CN62.41	Y3.4	SORI	Spindle orientation signal	
CN62.42	Y3.5	SEC0	Spindle orientation selection signal 1	
CN62.43	Y3.6	SEC1	Spindle orientation selection signal 2	
CN62.44	Y3.7	SEC2	Spindle orientation selection signal 3	
CN62.17~CN62.19 CN62.26~ CN62.28			0V	
CN62.20~CN62.25			+24V	

**Note1:** Addresses X0.0~X0.7,X1.0~X1.7,X2.0~X2.7,X3.0~X3.7 are valid at a high-level, i.e. when the input signal +24V is connected, the state of address X signal is 1; when disconnected, the state is 0.

**Note 2:** When the state of address Y signal is 1, the output signal is connected to 0V (0V output); when the state of address Y signal is 0, the output signal is at high-impedance state.

## 6.2.2 MPG Interface

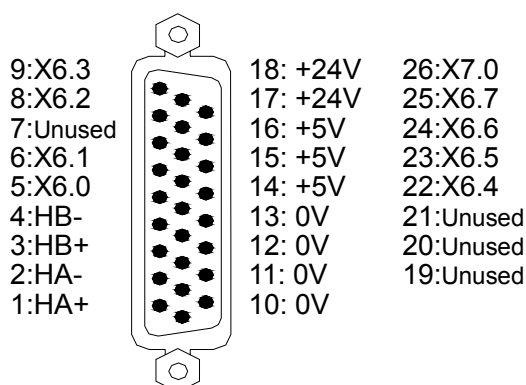

Fig. 6.2.3 CN31 MPG (26-pin, D type, Male)

DB Pin	Signal Definition	Signal Instruction	Function defined by standard PLC address
CN31.1,CN31.2	HA+, HA-	MPG phase A signal input	/
CN31.3,CN31.4	HB+, HB-	MPG phase B signal input	/
CN31.5	X6.0	PLC signal address, binary input	External hand-held unit X axis selection signal
CN31.6	X6.1	PLC signal address, binary input	External hand-held unit Y axis selection signal
CN31.8	X6.2	PLC signal address, binary input	External hand-held unit Z axis selection signal
CN31.9	X6.3	PLC signal address, binary input	External hand-held unit ×1 gear signal
CN31.22	X6.4	PLC signal address, binary input	External hand-held unit ×10 gear signal
CN31.23	X6.5	PLC signal address, binary input	External hand-held unit ×100 gear signal
CN31.24	X6.6	PLC signal address, binary input	External hand-held unit ×1000 gear signal
CN31.25	X6.7	PLC signal address, binary input	External hand-held unit the 4th axis selection signal
CN31.26	X7.0	PLC signal address, binary input	External hand-held unit the 5th axis selection signal
CN31.10, CN31.11 CN31.12, CN31.13	0V	0V	/
CN31.14, CN31.15 CN31.16	+5V	+5V	/
CN31.17,CN31.18	+24V	+24V	/

**Note:** X6.0~X7.0 input are valid at high-level, i.e. when the input signal is connected to +24V, the input is valid and the state of X address is 1; when disconnected, the state of X address is 0.

### 6.2.3 Spindle Interface

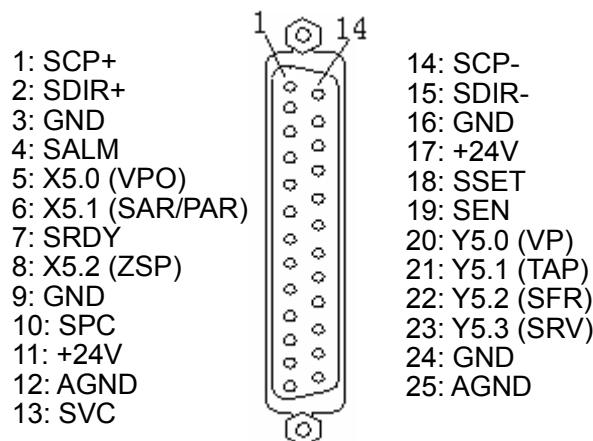

Fig. 6.2.4 CN15 the 5<sup>th</sup> axis spindle interface (25-pin, D type, female)

DB Pin	Signal Definition	Signal Instruction	Function defined by standard PLC address
CN15.1,CN15.14	SCP+, SCP-	Command pulse signal	/
CN15.2,CN15.15	SDIR+,SDIR-	Command direction signal	/
CN15.4	X5.3 (SALM)	Drive unit alarm signal	/
CN15.7	SRDY	Servo ready signal	/
CN15.18	SSET	Pulse disabled signal	/
CN15.19	SEN	Axis enable signal	/
CN15.10	SPC	Zero point signal	/
CN15.13	SVC	Spindle analog voltage output	/
CN15.12,CN15.25	AGND	Spindle analog voltage output common port	/
CN15.5	X5.0(VPO)	PLC signal address, binary input	Spindle speed/position state signal
CN15.6	X5.1(SAR/PAR)	PLC signal address, binary input	Spindle position/speed arrival signal
CN15.8	X5.2(ZSP)	PLC signal address, binary input	Spindle zero-speed output signal
CN15.20	Y5.0(VP)	PLC signal address, binary input	Spindle speed/position switch signal
CN15.21	Y5.1(TAP)	PLC signal address, binary input	Spindle speed loop gain 2 selection signal, used for tapping
CN15.22	Y5.2(SFR)	PLC signal address, binary input	Spindle CCW signal
CN15.23	Y5.3(SRV)	PLC signal address, binary input	Spindle CW signal
CN15.11,CN15.17	+24V	+24V	/
CN15.3,CN15.9, CN15.16,CN15.24	GND	0V Binary signal grounding	/

**Note 1:** X5.0, X5.1, X5.2 input are valid at a low level, i.e. when the input signal is connected to 0V, the input is valid and X address state is 1; when disconnected, the state is 0. Please note that the valid low-level input is different with the I/O addresses X0~X3 in general machine.

**Note 2:** When the state of Y address signal is 1, the output signal is connected to 0V (0V output); when the state is 0, the output signal is at high-impedance state.

## 6.2.4 Standard Operation Panel

### (1) Address X

Address defined by PLC	Corresponding Key on the Panel	Remark
X18.0	Block skip	
X18.1	Auxiliary lock	

X18.2	Spindle override increase	
X18.3	Single block	
X18.4	Machine tool lock	
X18.5	Dry run	
X18.6	Spindle override decrease	
X18.7	Spindle override 100%	
X19.0	C axis moves along – direction(C -) /MPG C	
X19.1	C/S switch	
X19.2	Cycle start	
X19.3	Tailstock	
X19.4	The 4 <sup>th</sup> axis moves along – direction (4 <sup>th</sup> -)/MPG 4 <sup>th</sup>	
X19.5	Z axis moves along – direction (Z-)/ MPG Z	
X19.6	Y axis moves along – direction (Y-)/ MPG Y	
X19.7	X axis moves along – direction (X-)/ MPG X	
X20.0	Protection door	
X20.1	Tool post forward rotation	
X20.2	Tool offset	
X20.3	Tool post reverse rotation	
X20.4	Cooling	
X20.5	Spindle stop	
X20.6	Manual rapid traverse	
X20.7	Optional stop	
X21.0	Program restart	
X21.1	Spindle CW	
X21.2	Spindle jog	
X21.3	Spindle CCW	
X21.4	The 4 <sup>th</sup> axis moves along + direction (4th+)	
X21.5	C axis moves along + direction (C+)	
X21.6	Spindle exact stop	
X21.7	Feed hold	
X22.0	MPG mode	
X22.1	Space key on the right of DNC	
X22.2	MANUAL mode	
X22.3	MDI mode	
X22.4	DNC mode	
X22.5	AUTO mode	

X22.6	REFERENCE POINT RETURN mode	
X22.7	EDIT mode	
X23.0	Rapid traverse override 100%/MPG×1000	
X23.1	Z axis moves along + direction (Z+)	
X23.2	Rapid traverse 50%/ MPG×100	
X23.3	Rapid traverse 25%/ MPG×10	
X23.4	Y axis moves along + direction (Y+)	
X23.5	Rapid traverse F0/ MPG×1	
X23.6	X axis moves along + direction (X+)	
X23.7	Hydraulic pressure	
X24.0	Space key below the cycle start	
X24.1	Chuck	
X24.2	Lubrication	
X24.3	Space key on the right of spindle CCW	
X24.4 ~ X24.7	Undefined	System reserved
X25.0 ~ X25.7	Connected to terminal strip	Reserved for user
X26.0 ~ X26.7	Connected to terminal strip	Reserved for user
X27.0 ~ X27.7	Connected to terminal strip	Reserved for user
X28.0	Connected to terminal strip	Connected to panel baud switch (spindle override OV 1)
X28.1	Connected to terminal strip	Connected to panel baud switch (spindle override OV 2)
X28.2	Connected to terminal strip	Connected to panel baud switch (spindle override OV 3)
X28.3	Connected to terminal strip	Connected to panel baud switch (spindle override OV 4)
X28.4	Connected to terminal strip	Connected to panel baud switch (feedrate override OV1)
X28.5	Connected to terminal strip	Connected to panel baud switch (feedrate override OV2)
X28.6	Connected to terminal strip	Connected to panel baud switch (feedrate override OV3)
X28.7	Connected to terminal strip	Connected to panel baud switch (feedrate override OV4)
X29.0	Connected to terminal strip	Connected to panel button (cycle start)
X29.1	Connected to terminal strip	Connected to panel button (feed hold)
X29.2	Connected to terminal strip	Connected to panel key switch button (program protection lock)

X29.3	Connected to terminal strip	Connected to panel knob normally-open terminal (spindle rotation allowed)
X29.4	Connected to terminal strip	Connected to panel knob normally-closed terminal (feed allowed)
X29.5 ~ X29.7	Connected to terminal strip	Reserved for user

**Note:** The PLC address X18~X24 are the fixed addresses input by keys on the panel, and their functions are fixed. Addresses X25~X29 are lead to the terminal strip on the backboard of the panel, the exact functions are defined by the PLC run in the system.

## (2) Address Y

Address defined by PLC	Corresponding key on the panel	Remark
Y18.0	Block skip indicator	
Y18.1	Auxiliary lock key indicator	
Y18.2	L5 indicator	
Y18.3	Single block indicator	
Y18.4	Machine lock key indicator	
Y18.5	Dry run key indicator	
Y18.6	C/S switch key indicator	
Y18.7	C/S axis – direction key indicator	
Y19.0	C axis + direction (C+) key indicator	
Y19.1	The 4 <sup>th</sup> axis + direction (4 <sup>th</sup> +) key indicator	
Y19.2	Cycle start key indicator	
Y19.3	Feed hold key indicator	
Y19.4	Program restart key indicator	
Y19.5	Optional stop key indicator	
Y19.6	Spindle override decrease key indicator	
Y19.7	Spindle override 100% key indicator	
Y20.0	Spindle override increase indicator	
Y20.1	Hydraulic pressure key indicator	
Y20.2	Tailstock key indicator	
Y20.3	Lubrication key indicator	
Y20.4	Protection door key indicator	
Y20.5	Tool post forward rotation key indicator	
Y20.6	Tool offset key indicator	
Y20.7	Tool post reverse rotation key indicator	
Y21.0	Digitron (right) output ( value 1)	
Y21.1	Digitron (right) output (value 2)	
Y21.2	Digitron (right) output ( value 4)	

Y21.3	Digitron (right) output (value 8)	
Y21.4	Digitron (left) output (value 1)	
Y21.5	Digitron (left) output (value 2)	
Y21.6	Digitron (left) output (value 4)	
Y21.7	Digitron (left) output (value 8)	
Y22.0	MPG mode indicator	
Y22.1	Indicator of space key on the right of DNC	
Y22.2	MANUAL mode indicator	
Y22.3	MDI mode indicator	
Y22.4	DNC mode indicator	
Y22.5	AUTO mode indicator	
Y22.6	REF. mode indicator	
Y22.7	EDIT mode indicator	
Y23.0	Rapid traverse override 100% indicator	
Y23.1	Z axis + direction indicator	
Y23.2	Rapid traverse override 50% indicator	
Y23.3	Rapid traverse override 25% indicator	
Y23.4	Y axis + direction indicator	
Y23.5	Rapid traverse override F0 indicator	
Y23.6	X axis + direction indicator	
Y23.7	System alarm (ALM) indicator	
Y24.0	Cooling key indicator	
Y24.1	Chuck key indicator	
Y24.2	Indicator of space key on the right of the spindle CCW key	
Y24.3	Spindle exact stop key indicator	
Y24.4	Spindle stop key indicator	
Y24.5	Spindle CW key indicator	
Y24.6	Spindle jog key indicator	
Y24.7	Spindle CCW key indicator	
Y25.0	The 4 <sup>th</sup> – direction key indicator	
Y25.1	Z axis – direction (Z-) key indicator	
Y25.2	Y axis – direction (Y-) key indicator	
Y25.3	Z axis machine zero point indicator	
Y25.4	Y axis machine zero point indicator	
Y25.5	Z axis machine zero point indicator	
Y25.6	X axis – direction (X-) key indicator	
Y25.7	Rapid traverse key indicator	
Y26.0	Indicator of space key below the cycle start key	
Y26.1	L4 indicator	

Y26.2	L3 indicator	
Y26.3	L2 indicator	
Y26.4	L1 indicator	
Y26.5	System running (RUN) indicator	
Y26.6	C axis machine zero point indicator	
Y26.7	4 <sup>th</sup> axis machine zero point indicator	
Y27.0~Y27.7	Connected to terminal strip	Reserved for user
Y28.0~Y28.7	Connected to terminal strip	Reserved for user
Y29.0	Connected to terminal strip	Connected to panel button indicator (cycle start)
Y29.1	Connected to terminal strip	Connected to panel button indicator (feed hold)
Y29.2~Y29.7	Connected to terminal strip	Reserved for user

**Note:** The PLC addresses Y18~Y26 are the fixed addresses of indicator output on the panel; their functions fixed. Addresses Y27~Y29 are lead to the terminal strip on the backboard of the panel; the exact functions are defined by PLC.

### 6.3 Standard PLC Functions

#### 6.3.1 M Commands

Command	Function	Remark
M00	Program stop	
M03	Spindle CW	Function interlocked and state retains
M04	Spindle CCW	
*M05	Spindle stop	
M08	Coolant ON	Function interlocked and state retains
*M09	Coolant OFF	
M10	Tailstock advance	Function interlocked and state retains
*M11	Tailstock retreat	
M12	Chuck clamp	Function interlocked and state retains
M13	Chuck release	
M32	Lubrication ON	Function interlocked and state retains
*M33	Lubrication OFF	
M41, M42 M43, M44	Spindle automatic gear change	Function interlocked and state retains
M51 ~ M58	Spindle 8-point positioning	Function interlocked and state retains

Note: Commands with "\*" in the standard PLC commands are valid after power-on.

#### 6.3.2 Cycle Start and Feed Hold

The standard operation panel consists of a group of keys and a group of external buttons which is used to realize the function of cycle start and feed hold. Please note the difference between addresses of keys and buttons.

➤ **Address definition**

X0019						BIT2		
X0021		BIT7						



X19.2: Input address of cycle start key on the panel

X21.7: Input address of feed hold key on the panel

Y0019					BIT3	BIT2		
-------	--	--	--	--	------	------	--	--

Y19.2: Output address of cycle start indicator on the panel

Y19.3: Output address of feed hold indicator on the panel

X0029							BIT1	BIT0
-------	--	--	--	--	--	--	------	------

X29.0: Input address of external cycle start button

X29.1: Input address of external feed hold button

Y0029							BIT1	BIT0
-------	--	--	--	--	--	--	------	------

Y29.0: Output address of external feed hold button indicator

Y29.1: Output address of external cycle start button indicator

**Control logic**

When the system is in automatic running state, press feed hold key or external feed hold button, the running process will be suspended.

When the system is in stop or suspended state, press cycle start key or external cycle start button, the automatic running will be performed.

**6.3.3 Feed/Spindle Hold**

➤ **Address definition**

X0029				BIT4	BIT3			
-------	--	--	--	------	------	--	--	--

X29.3: Input address of feed enabled (connected to the feed/spindle knob)

X29.4: Input address of spindle knob enabled (connected to the feed/spindle knob)

➤ **Control parameter**

K0010					KNEN			
-------	--	--	--	--	------	--	--	--

K10.3 =1: The function of feed hold knob on the machine tool is enabled;

=0: The function of feed hold knob on the machine tool is disabled;

**Control logic**

The feed/spindle hold knob can enable the spindle rotation and cycle start;

When the spindle is rotating, and the knob is set to the spindle hold position, the spindle output is disabled.

When the spindle is not rotating, and the knob is set to the spindle hold position, the spindle cannot be started.

When the knob is set to feed hold position during automatic running, the feed stops and “Dwell” is displayed.

When the knob is set to feed hold position during automatic running, press “Cycle Start” button, the program execution is disabled.

**6.3.4 Program Lock**

➤ **Address definition**

X0029						BIT2		
-------	--	--	--	--	--	------	--	--

X29.2: Input address of program protection signal

**Control parameter**

K0009								RPRT
-------	--	--	--	--	--	--	--	------

K9.0 =1: Program lock is shielded  
 =0: Program lock is not shielded

➤ **Control logic**

When K9.0 is set to 1, the program lock is disabled, regardless of the signal X39.2; and both the program and parameter writing are enabled.

When K9.0 is set to 0, the program lock is enabled.

When signal X29.2 is valid, both program and parameter writing are enabled.

When signal X29.2 is invalid, both program and parameter writing are disabled.

### 6.3.5 Feedrate Override

➤ **Address definition**

X0028	BIT7	BIT6	BIT5	BIT4				
-------	------	------	------	------	--	--	--	--

X28.4: Feedrate override signal OV0

X28.5: Feedrate override signal OV1

X28.6: Feedrate override signal OV2

X28.7: Feedrate override signal OV3

➤ **Control logic**

It adopts digital code rotary switch; the code is two's complement.

### 6.3.6 Spindle Override

➤ **Address definition**

X0018	BIT7	BIT6				BIT2		
-------	------	------	--	--	--	------	--	--

X18.2: + Spindle override +

X18.6: Spindle override -

X18.7: 100% Spindle override 100%

Y0019	BIT7	BIT6						
Y0020								BIT0

Y19.6: Spindle override – key indicator

Y19.7: Spindle override 100% key indicator

Y20.0: Spindle override + key indicator

**Relevant parameter**

DT0023	Spindle override indicator flicker period (100-1000ms)
--------	--

➤ **Control logic**

① When the spindle override is greater than 100%:

Override <120%: spindle override+indicator flickers; the flicker period is set by DT23

Override = 120%: spindle override + indicator normally lights up.

② When the spindle override equals to 100%

Spindle override 100% key indicator normally lights up;

③ when spindle override is less than 100%:

Override > 50%: spindle override – key indicator flickers, the flicker period is set by DT23;

Override= 50%: spindle override – key indicator normally lights up;

**Note: When thread cutting is being performed, spindle override is disabled.**

## 6.3.7 Spindle CCW/CW Control

## ➤ Address definition

Y0000	SPZD		M5	M4	M3			
-------	------	--	----	----	----	--	--	--

Y0.3: Spindle CCW output signal (M3)

Y0.4: Spindle CW output signal (M4)

Y0.5: Spindle stop signal (M5)

Y0.7: Spindle braking output signal (SPZD)

X0020			BIT5					
X0021					BIT3		BIT1	

X20.5: Spindle stop key

X21.1: Spindle CW key

X21.3: Spindle CCW key

Y0024	BIT7		BIT5	BIT4				
-------	------	--	------	------	--	--	--	--

Y24.4: Spindle stop indicator

Y24.5: Spindle CW indicator

Y24.7: Spindle CCW indicator

## ➤ Control parameter

K0010							BIT1	
-------	--	--	--	--	--	--	------	--

K10.1 =1: When the system is reset, the output signals M03, M04, M08, M32 are NOT OFF

K10.1 =0: When the system is reset, the output signals M03, M04, M08, M32 are OFF.

DT0005	MTIME							
DT0010	SPDDLTIME							
DT0011	SPZDTIME							

DT05: the execution time of M code (ms); value range: 100~5000ms

DT10: M05 and the delay time (ms) of spindle braking output; value range:0~10000ms

DT11: Spindle braking output time; value range: 50~60000ms

## ➤ Motion sequence

The sequence of spindle motion is shown as follows:

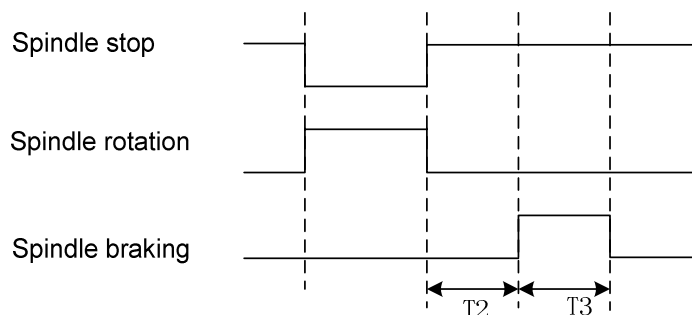

Fig. 6-3-1 Sequence diagram of spindle CCW/CW

**Note:** T2 is the delay time counting from the issuing of spindle stop signal to spindle braking signal; T3 is the spindle braking duration.

## ➤ Logic control

After power-on, M05 output is enabled.

When M05 is enabled, and M03 or M04 is executed, M03 or M04 output is enabled and remains

unchanged; meanwhile, M05 output is disabled.

When M03 or M04 is enabled, and M05 is executed, M03 or M04 output is disabled and M05 output is enabled and remains unchanged.

When M03 or M04 output is enabled, the execution of M04 or M03 will lead to system alarm.

The delay time of spindle braking signal SPZD is set by parameter DT0010, and the duration is set by DT0011.

**Note: when CNC performs emergency stop, signal M03 or M04 output is disabled, and signal M05 is output at the same time.**

### 6.3.8 Spindle Jog

➤ **Address definition**



X0024		BIT6							
-------	--	------	--	--	--	--	--	--	--

X24.6: Spindle jog mode signal

➤ **Control parameter**

DT12	spindle jog duration (ms)
------	---------------------------

➤ **Logic control**

In increment, MPG or MANUAL mode, press  to enable the spindle jog mode; press key  the spindle rotates CCW; press , spindle rotates CW; the rotating duration is set by PLC parameter DT12.

**Note: Spindle JOG speed is the rotation speed corresponding to analog voltage value set by DC00.**

### 6.3.9 Spindle 8-Point Pre-Orientation

➤ **Address definition**

Y0003		SEC2	SEC1	SEC0	SORI				
-------	--	------	------	------	------	--	--	--	--

Y3.4: Spindle orientation signal

Y3.5~Y3.7: Spindle orientation selection signal

X0002		COIN							
-------	--	------	--	--	--	--	--	--	--

X2.7: Spindle orientation completed signal

➤ **Control logic**

- ① After commands M51~M58 are executed, PLC issues orientation selection signals SEC0, SEC1, SEC2 to Drive to determine the position.
- ② After 40ms delay, PLC issues spindle orientation signal SORI to Drive;
- ③ Drive starts orientation;
- ④ After the orientation is finished. Drive sent the spindle orientation completed signal COIN to PLC;
- ⑤ If the PLC does not receive the COIN signal in 6000ms after the orientation selection signal is issued, the system will issue an alarm “spindle orientation time is too long”.
- ⑥ The spindle can be in rotating or stop state before the orientation, and it will be in stop state after the orientation.

➤ **Control sequence diagram**

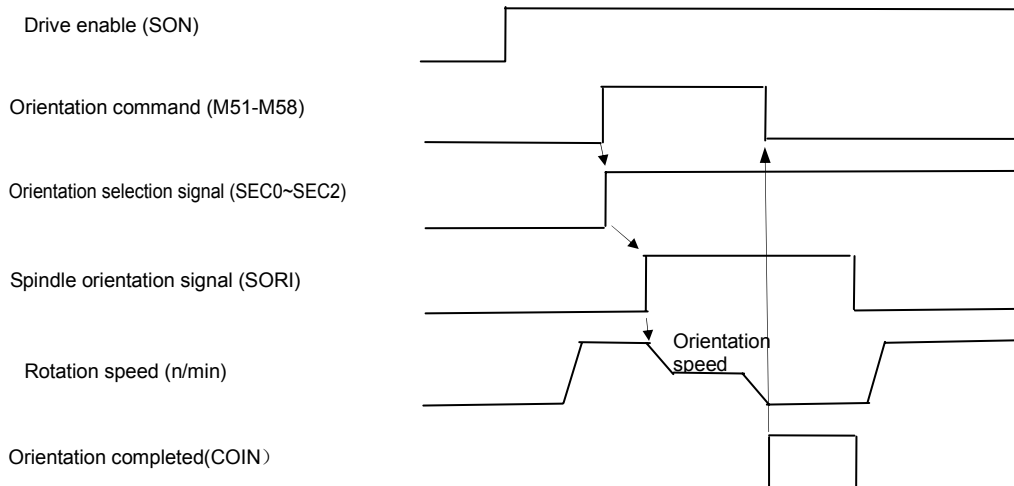

Fig. 6-3-2 Pre-orientation sequence

➤ **8-Point Pre-Orientation Method:**

- ① Connect the system and servo drive unit correctly. The interfaces includes: enable signal interface (SON), forward/reverse rotation interface (SRF/SRV), position start signal interface (STAO), position completed signal interface (COIN) and multi-point orientation selection input signal (SP0~SP2). Refer to the spindle servo manual for details.
- ② First, set the parameters related to servo spindle drive unit correctly.
  - a) Set the servo spindle drive unit parameter No. PA4 (i.e. speed control mode) to 1.
  - b) PA55 sets the spindle speed during orientation.
  - c) PA56 sets the position screen during orientation.
  - d) When PA66 selects the orientation, the signal of selected encode is used as position feedback input signal;
  - e) PA67 sets the spindle encoder line numbers according to the actual machine tool configuration.
- ③ Bring up the monitoring menu dP-APo, and press , then, E 0000 is displayed; symbol “E” means the spindle is at an uncertain position, its value cannot be the reference value for orientation.
- ④ The spindle should rotate one circle at least. After the drive unit detects the Z pulse signal of the spindle encoder, and finds the right position, dP-APo will turn into F 0000, which indicates that the position of current encoder is right.
- ⑤ Adjust the spindle to orientation point gradually, then record the displayed position in dP-APo; write it in parameter PA58, then save the parameter. This reference value is position 1.
- ⑥ User can adjust 8 orientation points continuously and the position of the points will be recorded and written in parameters PA58~65 by sequence. In this method, multi-point orientation is performed.

The relationship between speed selection input signals(SP0, SP1, SP2) and parameters PA58~PA56 is shown in the table below:

Output signals Commands	SEC2 (Y3.7)	SEC1 (Y3.6)	SEC0 (Y3.5)	Corresponding positions
M51	0	0	0	Orientated position 1 ( PA58)

M52	0	0	1	Orientated position 2 ( PA59)
M53	0	1	0	Orientated position 3 (PA60)
M54	0	1	1	Orientated position 4 (PA61)
M55	1	0	0	Orientated position 5 (PA62)
M56	1	0	1	Orientated position 6 (PA63)
M57	1	1	0	Orientated position 7 (PA64)
M58	1	1	1	Orientated position 8 (PA65)

- ⑦ Enable the drive unit (input SON signal and SFR signal), input the orientation start signal (STAO), and keep the low-level signal valid, the servo motor runs at the speed set by PA55; after the orientation point is found (determined by SP0~SP2), the servo motor keeps at the position and outputs orientation completed signal (COIN).
- ⑧ After the system detected COIN signal, the orientation completion is confirmed. Cancel the orientation start signal to proceed to the next operation.

### 6.3.10 Spindle Gear Control

➤ **Address definition**

Y0001					S04/M4	S03/M4	S02/M4	S01/M4
					4	3	2	1

M41~M44: Automatic spindle gear change output signal

X0001		M42I	M41I					
-------	--	------	------	--	--	--	--	--

M41I~M42I: The in-position signal when spindle changes to 1 or 2 gear automatically.

**Control parameter**

K0010				BIT4				
K0013	AGER	AGIN	AGIM	ASTR				

K10.4 =1: Gear spindle—the spindle speed is controlled by gear stage.

K10.4 =0: Analog spindle—the spindle speed is controlled by analog voltage control.

K13.4 =1: Automatic spindle gear change is valid.

K13.4 =0: Automatic spindle gear change is invalid.

K13.5 =1: Checks the gear change in-position signal during automatic spindle gear change

K13.5 =0: Does not check the gear change in-position signal during automatic spindle gear change.

K13.6 =1: Gear change in-position signal is valid when connected to +24V

K13.6 =0: Gear in-position signal is valid when disconnected to +24V.

K13.7 =1: Spindle gear stage is stored when power-off.

K13.7 =0: Spindle gear stage is not stored when power-off.

3741	The maximum spindle speed at gear stage 1 (MSG1)
3742	The maximum spindle speed at gear stage 2 (MSG2)

3743	The maximum spindle speed at gear stage 3 (MSG3)
3744	The maximum spindle speed at gear stage 4 (MSG4)

MSG1, MSG2, MSG3, MSG4: When spindle analog voltage output is 10V, they correspond to the maximum spindle speeds at gear stages 1, 2, 3, 4. When spindle automatic gear change is valid, they corresponds to the spindle speed commanded by M41, M42, M43, M44; when the spindle gear stage is not stored after power-off, the default setting is gear stage 1 after CNC is power-on.

DT0000	Automatic gear change signal output delay time 1 (SFT1TME)
DT0001	Automatic gear change signal output delay time 2 (SFT2TME)

➤ **Function description**

The spindle automatic gear change function is used to control the spindle mechanical gear automatic switch; when CNC executes S..... command, it calculates the analog voltage which is output to spindle servo or inverter, according to the parameters (No. 3741~No. 3744) of current gear stages controlled by M4n.

### 6.3.11 Cooling Control

➤ **Address definition**

Y0000								M08
X0020				BIT4				
Y0024								BIT0

Y0.0: Cooling signal output (M08)

X20.4: Cooling key input

Y24.0: Cooling key indicator

➤ **Function description**

After CNC is power-on, M09 is valid, which means M08 output is disabled.

When M08 is executed, M08 output is enabled and the cooling pump is ON; when M09 is executed, M08 output is cancelled and the cooling pump is OFF.

Press the cooling key  on the operation panel, the M08 output state is inverted.

**Note 1:** When emergency stop or M30 is executed, M08 output is cancelled and cooling is OFF.  
**Note 2:** When CNC is reset, the bit 1 of K10 sets whether the M08 output is cancelled or not.  
**Note 3:** M09 corresponds to no output signal. When M09 is executed, M08 output is cancelled and the cooling is OFF.

### 6.3.12 Lubricating Control

➤ **Address definition**

Y0000							M32	
X0024						BIT2		
Y0020					BIT3			

Y0.1: Lubrication output signal (M32)

X24.2: Lubrication key

Y20.3: Lubrication key indicator

DT0013	Manual lubrication output time
DT0016	Automatic lubrication interval time

DT0017	Automatic lubrication output time
--------	-----------------------------------

DT13: Lubrication duration (0~60000ms); when it is set to 0, lubrication output state is unchanged.

DT16: Automatic lubrication interval time (0~60000ms)

DT17: Automatic lubrication output time (0~60000ms)

➤ **Function description**

The lubrication function defined by GSK988T standard PLC program includes two kinds: non-auto-lubrication and auto-lubrication. When DT16=0 or DT17=0, the auto-lubrication function is disabled.

**a) Non-auto-lubrication**

When DT>0, lubrication output is executed at regular time. The key  on the panel is enabled or when M32 is executed, lubrication Y0.1 output is valid, meanwhile, the indicator signal Y20.3 output is valid. When the time set by DT13 ends, lubrication Y0.1 and Y20.3 output is cancelled; if M33 is executed before the time approaches, the lubrication Y0.1 output and Y20.3 output is cancelled.

When DT13=0, the lubrication output is inverted. The key  is enabled or when M32 is executed, lubrication Y0.1 output is valid, meanwhile, indicator signal Y20.3 output is valid;

When key  is enabled again or M33 is executed, lubrication Y0.1 output is OFF, meanwhile, indicator signal Y20.3 is OFF.

**b) Auto-lubrication**

When DT16 > 0, DT17>0, the system starts to countdown for the duration set by DT16 after system power-on, then, the lubrication output is performed. When the time set by DT17 ends, the lubricating stops, and so forth. During automatic lubrication,  key and M32, M33 commands are valid in the interval time, and they are disabled in the lubrication output time.

**Note 1:** During emergency stop or the execution of M30, M32 output will be cancelled and the lubrication is OFF.

**Note 2:** When CNC is reset, the bit 1 of K10 sets whether the M32 output is cancelled or not.

**Note 3:** M33 corresponds to no output signal. When M33 is executed , M32 output is cancelled and the cooling is OFF.

**6.3.13 Chuck Control**

➤ **Address definition**

Y0001			DOQPS	DOQPJ				
-------	--	--	-------	-------	--	--	--	--

Y1.4: Outer chuck clamping/inner chuck unclamping output

Y1.5: Outer chuck unclamping/inner chuck clamping output signal

X0000						DIQP		
X0003			NQPS	WQPJ				

X0.2 : Chuck control input signal (DIQP)

X3.3: Outer chuck clamping in-position/inner chuck unclamping in-position signal (WQPJ)

X3.4: Outer chuck unclamping in-position/inner chuck clamping in-position signal (NQPJ)

X0024						BIT1		
-------	--	--	--	--	--	------	--	--



Y0024							BIT1	
-------	--	--	--	--	--	--	------	--

X24.1: Chuck key

Y24.1: Chuck key indicator

➤ **Control parameter**

K0013							SLSP	SLQP
-------	--	--	--	--	--	--	------	------

K13.0 = 1: Chuck control function is enabled.

K13.0=0: Chuck control function is disabled.

K13.1=1: When chuck function is enabled, the system checks whether the chuck is clamping.

K13.1=0: When the chuck function is enabled, the system does not check whether the chuck is clamping or not; If the chuck is unclamping, the spindle cannot be started.

K0014						PB2		PB1
-------	--	--	--	--	--	-----	--	-----

K14.0 = 1: Check chuck in-position signal

K14.0 =0: Does not check chuck in-position signal

K14.2 = 0: Outer chuck mode, WQPJ is outer chuck clamping signal, NQPJ is outer chuck unclamping signal

K14.2 =1: Inner chuck mode, NQPJ is inner chuck clamping signal, WQPJ is inner chuck unclamping signal.

➤ **Control logic**

Signals in outer chuck mode	Clamping	WQPJ(X3.3): Chuck clamping in-position signal
		DOQPJ (Y1.4): Chuck clamping output signal
	Unclamping	NQPJ(X3.4): Chuck unclamping in-position signal
		DOQPS (Y1.5): Chuck unclamping output signal
Signals in inner chuck mode	Clamping	NQPJ(X3.4): Chuck clamping in-position signal
		DOQPS (Y1.5): Chuck clamping output signal
	Unclamping	WQPJ(X3.3): Chuck unclamping in-position signal
		DOQPJ (Y1.4): Chuck unclamping output signal

When then system is power-on, the signals DOQPJ and DOQPS is the state before power-off last time. i.e. DOQPJ and DOQPS are stored when power-off.

When chuck control input (DIQP) is valid or the key  is pressed, the chuck clamping/unclamping signal is output alternatively, i.e. each time the chuck control input signal is enabled, the output state changes.

When the spindle is rotating, DIQP input and chuck key on the panel are disabled; M13 cannot be executed, and an alarm will occur. The output state will not change.

In reset or emergency stop state, the output state of DOQPJ, DOQPS remain unchanged.

➤ **Sequence diagram:**

Chuck control input signal: DIQP

Output signal: DOQPJ (outer chuck clamping/inner chuck unclamping)

Input signal: WQPJ (outer chuck clamping in-position/inner chuck unclamping in-position)

Output signal: DOQPS (outer chuck unclamping/inner chuck clamping)

Input signal: NQPJ (outer chuck unclamping in-position/inner chuck clamping in-position)

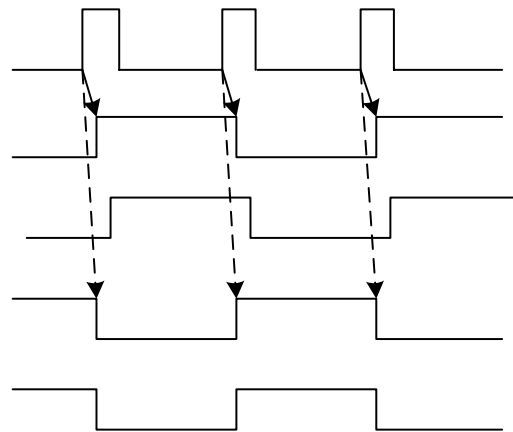

Fig.6-3-2 Chuck control sequence diagram

The control logic for signals K13.1 and K14.0:

When K13.1=1, K14.0=0:

After chuck clamping signal is output, the spindle can be started, otherwise, system alarm will be issued.

When K13.1=1, K14.0=1:

When the chuck clamping signal and in-position signal are valid, the spindle can be started, otherwise, system alarm will be issued.

When K13.1=0, K14.0=0:

No matter the chuck is clamping or not, spindle can be started.

When K13.1=0, K14.0=1:

When the chuck in-position signal is valid, the spindle can be started, otherwise, system alarm will be issued.

### 6.3.14 Tailstock Control

➤ **Address definition**

Y0002		M11	M10					
-------	--	-----	-----	--	--	--	--	--

Y2.5: Tailstock advancing output signal (DOTWJ)

Y2.6: Tailstock retracting output signal (DOTWS)

X0000				DITW				
-------	--	--	--	------	--	--	--	--

X0.4: Tailstock control input signal

X0019					BIT3			
-------	--	--	--	--	------	--	--	--

X19.3: Tailstock key on the panel

Y0020						BIT2		
-------	--	--	--	--	--	------	--	--

Y20.2: Tailstock key indicator on the panel

➤ **Control parameter**

K0013						SLTW		
-------	--	--	--	--	--	------	--	--

K13.2 =1: Tailstock control function enabled

K13.2 =0: Tailstock control function disabled

➤ **Sequence diagram**

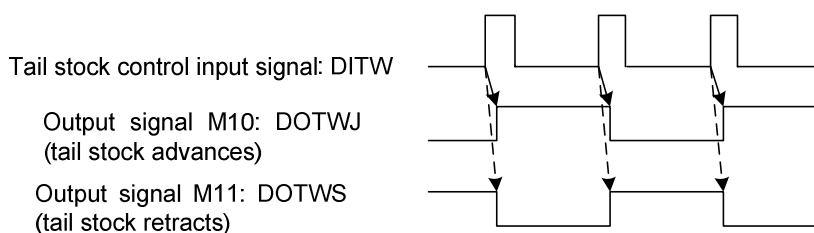



Fig. 6-3-3 Tail stock control sequence diagram

After power-on, the signals DOTWJ and DOTWS remain the state when power-off the previous time, i.e. DOTWJ and DOTWS are stored when power-off.

When tailstock control input (DITW) or the key  are enabled, the tailstock advance/retract signal is output alternatively, i.e. each time when the tailstock control input signal is valid, the output state changes.

After M10 is executed, the signal DOTWJ is output, and the tailstock advances; after M11 is executed, signal DOTWS is output, and the tailstock retracts.

When the spindle is rotating, the tailstock control DITW input and tailstock key on the panel are disabled; the execution of M11 is invalid and will trigger an alarm. The output state keeps the same.

When CNC is reset or in emergency stop state, the output state of signal DOTWJ/DOTWS remains unchanged.

### 6.3.15 Low Pressure Detection

➤ **Address definition**

X0000		PRES						
-------	--	------	--	--	--	--	--	--

X0.6: Low pressure detection signal (PRES)

➤ **Control parameter**

K0014			BIT5	BIT4				
-------	--	--	------	------	--	--	--	--

K14.4 =0: High-level alarm; When PRES is connected to 24V, the low pressure alarm is issued.

K14.4 =1: Low-level alarm; When PRES is disconnected with 24V, the low pressure alarm is issued.

K14.5 =0: Low pressure detection function is disabled.

K14.5 =1: Low pressure detection function is enabled.

DT0002	Low pressure alarm detection time							
--------	-----------------------------------	--	--	--	--	--	--	--

The delay time before the low pressure alarm is issued: 0~60000ms

➤ **Function description**

When the low pressure detection function is selected, the PRES signal is valid. As the delay time set by DT0002 passed, CNC issues an alarm; meanwhile, the feed axis stops, spindle stops and the automatic cycle function cannot be started. Press RESET key or turn off the power to cancel the alarm.

### 6.3.16 Overtravel Signal of Axes

➤ **Address definition**

X0003						LMI3+	LMI2+	LMI1+
X0004		LMI5-	LMI5+	LMI4-	LMI4+	LMI3-	LMI2-	LMI1-

- X3.0: 1<sup>st</sup> axis + direction overtravel signal
- X3.1: 2<sup>nd</sup> axis + direction overtravel signal
- X3.2: 3<sup>rd</sup> axis + direction overtravel signal
- X4.3: 4<sup>th</sup> axis + direction overtravel signal
- X4.5: 5<sup>th</sup> axis + direction overtravel signal
- X4.0: 1<sup>st</sup> axis – direction overtravel signal
- X4.1: 2<sup>nd</sup> axis – direction overtravel signal
- X4.2: 3<sup>rd</sup> axis – direction overtravel signal
- X4.4: 4<sup>th</sup> axis – direction overtravel signal
- X4.6: 5<sup>th</sup> axis – direction overtravel signal

➤ **Control parameter**

K0010						BIT2		
-------	--	--	--	--	--	------	--	--

- K10.2 =1: Low-level signal of each axis is valid
- K10.2=0: High-level signal of each axis is valid

### 6.3.17 Tool Change Control

The tool post control logic supported by standard ladder diagram is realized through the combination of Bit 7, Bit 6, and Bit2 of parameter K.

K0011	BIT7	BIT6				BIT2		
-------	------	------	--	--	--	------	--	--

- K11.6=0, K11.7=0: Standard tool change method (select tool change method A or B by K11.2)
- K11.2=1: Tool change method A (adopts Jingcheng Tool Post)
- K11.2=0: Tool change method B (adopts Changzhou Tool Post)
- K11.6=1, K11.7=0: Adopts Yantai Tool Post AK31 Series (8-position, 10-position, 12-position tool post)
- K11.6=0, K11.7=1: Adopts Taiwan Liuxin 8-position hydraulic tool post
- K11.6=1, K11.7=1: Adopts Changzhou Yaxing HLT hydraulic tool post (6-position, 8-position, and 12-position tool post);

➤ **Control parameter**

K0011	BIT7	BIT6	BIT5	BIT4	BIT3	BIT2	BIT1	BIT0
-------	------	------	------	------	------	------	------	------

- K11.0= 1: The tool post lock signal is low-level;
- K11.0 = 0: The tool post lock signal is high-level;
- K11.1= 1: The tool position signal is low-level;
- K11.1 = 0: The tool position signal is high-level;
- K11.3= 1: Check the tool position signal after tool change
- K11.3=0: Does not check the tool position signal after tool change
- K11.4 = 1: Check tool post lock signal
- K11.4 = 0: Does not check tool post lock signal

DT0007	Delay time from the tool post forward rotation to reverse rotation output (0-1000ms)
DT0008	Alarm time when the TCP signal is not received (0-1000ms)
DT0009	Tool post reverse rotation lock time (0-1000ms)

**Note:** K11.0,K11.1 ,K11.3, K11.4,DT0007,DT0008,DT0009 are used for the control in standard tool change method only (when the standard tool change mode is selected i.e. K11.6=0, K11.7=0, these parameters are valid).

## ➤ Address definition

K11.7	K11.6	K11.2	Tool Post Type	Address to be Used
0	0	1	Tool change method A	X1.7(T1),X2.0(T2),X2.1(T3),X2.2(T4),X0.7(T5),X1.0(T6),X1.1(T7),X1.2(T8),X2.6(TCP),Y1.6(TL+),Y1.7(TL-)
0	0	0	Tool change method B	
0	1	/	Yantai Tool Post AK31 Series (8, 10, 12-position)	X1.7(T1), X2.0(T2), X2.1(T3), X2.2(T4), X2.6 (lock proximity switch signal), X0.7(tool post pre-indexing proximity switch), X1.0 (tool table strobe signal), X1.1(tool table overheat detection), Y1.6(TL+), Y1.7(TL-), Y2.0(TZD tool table braking),Y2.1(tool table pre-indexing electromagnet)
1	0	/	Liuxin Hydraulic Tool Post LS120 (8-position)	X1.7(T1), X2.0(T2), X2.1(T3), X2.2(T4), X0.7(tool post stop and lock sensor),X1.0(tool post releasing/lock output sensor),Y2.0(tool post releasing output) ,Y2.1(tool post lock output),Y1.6(tool post forward rotation output),Y1.7(tool post reverse rotation output)

## ➤ Control logic

## A) K11.7=0, K11.6=0, K11.2=1: Tool change method A

## 1) Control parameters

K0011	BIT7	BIT6	BIT5	BIT4	BIT3	BIT2	BIT1	BIT0
-------	------	------	------	------	------	------	------	------

K11.0 1: Tool post lock signal is at low level;

0: Tool post lock signal is at high level;

K11.1 1: Tool post position signal is at low level;

0: Tool post position signal is at high level;

K11.3 1: Check tool position signal after tool change;

0: Does not check tool position signal after tool change;

K11.4 1: Check tool post lock signal;

0: Does not check tool post lock signal;

DT0007	Delay time of tool post rotating from CW stop to CCW output (0~1000ms)
DT0008	Alarm duration when tool clamping TCP signal is not received (0~1000ms)
DT0009	Tool post CCW rotation clamping time (0~1000ms)

## 2) Process of tool change

- In MANUAL, MDI or AUTO mode, tool change is executed, CNC outputs the tool post forward rotation signal (TL+) and detects the tool position signal. After the tool position signal is detected, CNC turns OFF the tool post forward rotation signal (TL+), and check whether the tool position signal transition occurs, if it does, the tool post reverse rotation signal (TL-) is output and then turned OFF after the time set by PLC parameter DT009 ends.
- If the Bit 4 of K0011 is set to 1 (lock detection signal), the system detects the tool post

lock signal. If the TCP signal is not received within the time set by PLC parameter DT008, a system alarm will be generated.

- If the Bit 3 of K0011 is set to 1 (tool position check signal after the tool change), when the tool post reverse rotation time ends, confirm the consistency of the current tool position input signal and current tool number; if they are not consistent, the system will issue an alarm.
- The tool change is finished.

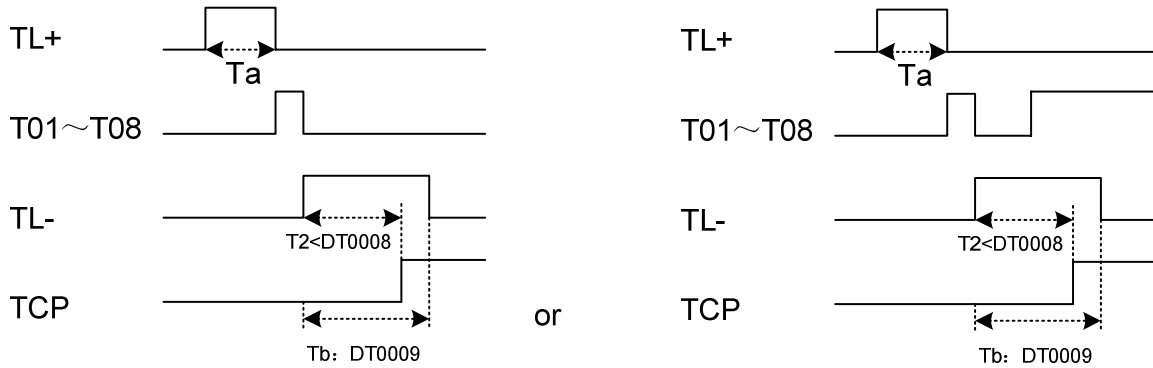

Fig. 6-3-4 Tool change A sequence diagram

**B) K11.7=0, K11.6=0, K11.2=0: B Tool change method B**

**1) Process of tool change**

- When the tool change is executed, the system outputs the tool post forward rotation signal TL+, and detects the tool position signal. After the tool position signal is detected; TL+ output is turned OFF. When the time set by PLC parameter DT007 ends, the tool post reverse rotation signal TL- is output; when the time set by parameter DT009 ends, the tool post reverse signal TL- is turned OFF.
- If the Bit 4 of K0011 is set to 1 (lock detection signal), the system starts to detect the tool post lock signal; if the system does not receive TCP signal within the time set by parameter DT008, an alarm will be generated.
- If the Bit3 of K0011 is set to 1 (tool position check signal after tool change), when the tool post reverse rotation time ends, confirm the consistency of the current tool position input signal and current tool number; if they are not consistent, the system will issue an alarm.
- The tool change is finished.

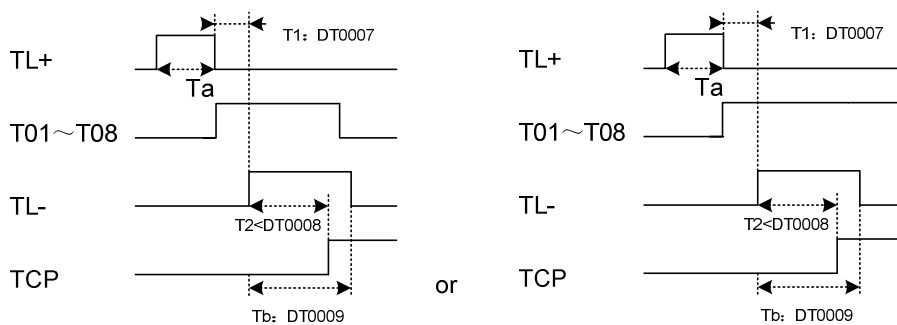

Fig. 6-3-5 Tool change B sequence diagram

**C) K11.7=0, K11.6=1: Yantai Tool Post AK31 Series****1) Control parameter**

DT0034	Upper limit of tool change duration for AK31 tool post (ms)
DT0035	Upper limit of proximity switch signal detection for AK31 tool post

**2) Process of tool change**

- Confirm that the tool post braking signal TZD is OFF.
- The system determines the shortest path according to object tool number and current tool number, and selects the output rotation direction under the principle of “select the nearest tool”, and determines the output signal is TL+ or TL-. Then, as the tool post rotates, the tool selection begins.
- In the process of rotation, the system decodes according to the tool position encode signal T1~T4, and identifies the current tool number. When the tool post rotates to the position before the object one, the system starts to detect the transition of tool post strobe signal. The strobe signal transition of the tool position before the object position is from on to off. The system outputs the tool post pre-indexing electromagnet signal, the tool post pre-indexing electromagnet supplies power.
- When the detected tool post pre-indexing proximity switch input signal is at high level, turn off the tool post rotation output signal (TL+ or TL-), and the motor stops running.
- After delaying 50ms, the system outputs a signal (TL- or TL+) which is inverted to the original rotation direction, then, the tool post rotates in a reversed direction.
- When the detected tool post lock proximity switch input signal is at high level, turn off the tool post rotation output signal (TL+ or TL-), the motor stops running, then, the system outputs tool post braking signal (TZD), the motor braking device is energized.
- After delaying 200ms, turn off the tool post pre-indexing electromagnet output signal, the tool post pre-indexing electromagnet is de-energized.
- When the current tool number is detected again, confirm the consistency of the current tool position encoder signal and object tool number.
- Confirm that the lock proximity switch signal is at high level again.
- If the steps listed above are correct, turn off the tool braking signal TZD, the tool change is finished.
- In the process of tool change, if the motor overheat signal is detected, an alarm is raised, and all signals output are turned OFF.

3) Tool change flow chart

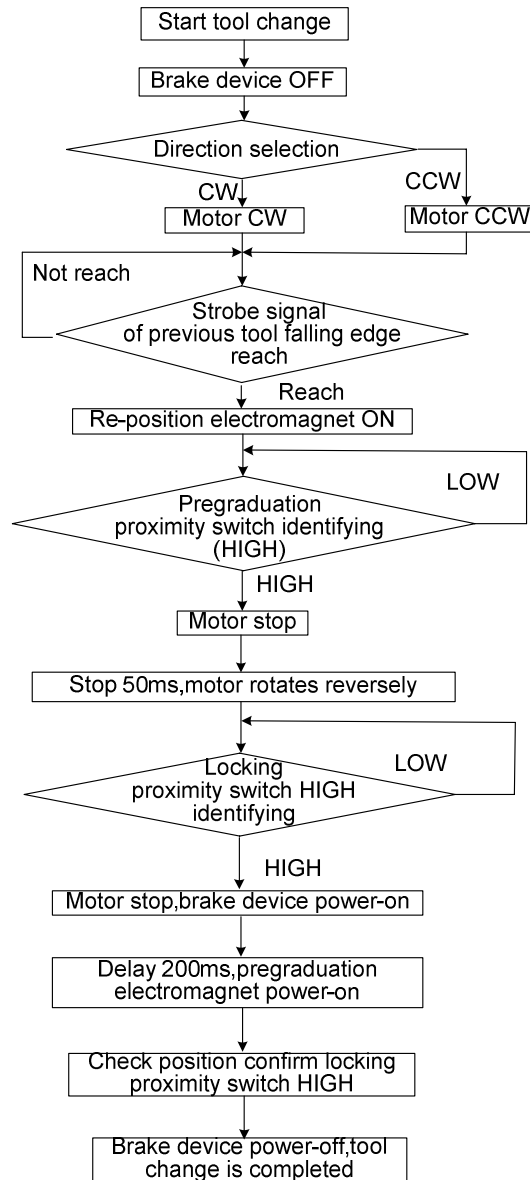

Fig. 6-3-6 AK31 Tool change flow chart

D) K11.7=1, K11.6=0: Liuxin 8-position hydraulic tool post

1) Control parameter

DT0032	Upper limit of tool change duration (ms)
--------	--

2) Input/output configuration

Sensor A: Tool position detection sensor→T1(X1.7): tool position signal

Sensor B: Tool position detection sensor→T2(X2.0): tool position signal

Sensor C: Tool position detection sensor→T3(X2.1): tool position signal

Sensor D: Tool position detection senso→T4(X2.2): tool position signal

Sensor E: Tool post rotation stop and lock sensor→SSE(X0.7): tool post rotation stop and lock signal

Sensor F: tool post release/lock signal output sensor→SSF(X1.0): tool post release/lock signal

Sol A: tool post release/lock magnetic valve→ Y2.0: tool post release output

Y2.1: tool post lock output

Sol B: tool post forward/reverse rotation magnetic valve→TL+(Y1.6):tool post forward rotation output

→TL-(Y1.7): tool post reverse rotation output



**3) Position and signal table**

	1	2	3	4	5	6	7	8
A			●		●	●	●	
B	●				●		●	●
C				●	●	●		●
D		●				●	●	●
E	●	●	●	●	●	●	●	●

**4) Signal instruction**

Sensor A,B,C,D: provide tool position detection; but no motion signal is issued.

Sensor E: each time a tool is changed, the tool post stop and lock signal is issued. When the tool post rotates to the desired position, Sensor E induces and cut off the power of rotation magnetic valve, making the tool post rotation stopped, then, it starts the tool post lock magnetic valve to ensure that the tool post is locked.

Sensor F: Release/lock confirmation signal; When Sensor F does not induce, i.e. the tool post is released, tool post rotation can be started; when Sensor F induces, i.e. the tool post is locked, the tool change is finished.

Sol A: Controls the tool post release/lock

Sol B: Controls the tool post forward/reverse rotation

**5) Description of tool change process**

Example: Tool is changed from No.1 to No. 4

Step 1: Sol A is energized (tool post released)

Step 2: Confirm that the Sensor F does not induce, Sol B is energized, oil hydraulic motor rotates.

Step 3: Start to detects the tool position signal (Note: Sensor E induces at tool position 1, 2, 3, but when the position 4 is not reached, the motion of lock is not performed; when the tool position 3 signal is confirmed, set the anticipation of Sensor E, when the tool post rotates to the position 4, Sensor E induces i.e. cut off the power of Sol B, tool post stops rotation; meanwhile Sensor E controls the Sol A to lock the tool post.

**(E) Changzhou Yaxing HLT Hydraulic Tool Post: K11.7=1, K11.6=1****1) Process of tool change**

1. After receiving tool change signal, the system issues tool post release signal, and then the tool post release magnetic valve is energized;
2. The system determines the shortest path according to object tool number and current tool number under the principle of "select the nearest tool", selects the output rotation direction, and determines the output signal is TL+ or TL-. Then, as the tool post rotates, the tool selection begins.
3. In the process of rotation, the system decodes according to the tool position encode signal T1~T4, and identifies the current tool number. When the tool post rotates to the position before the object one, the system starts to detect the transition of tool post strobe signal. The strobe signal transition of the tool position before the object position is from on to off. The system outputs the tool post lock signal, the tool post release electromagnet supplies power (tool post lock and release value is controlled by electromagnet).
4. When the detected tool post lock switch signal is at low level, turn off the tool post rotation output signal (TL+ or TL-), and the motor stops running.
5. When the current tool number is detected again, confirm the consistency of the current tool position encoder signal and object tool number.
6. Confirm that the lock proximity switch signal is at low level. The tool change is finished.

2) Tool change flow chart

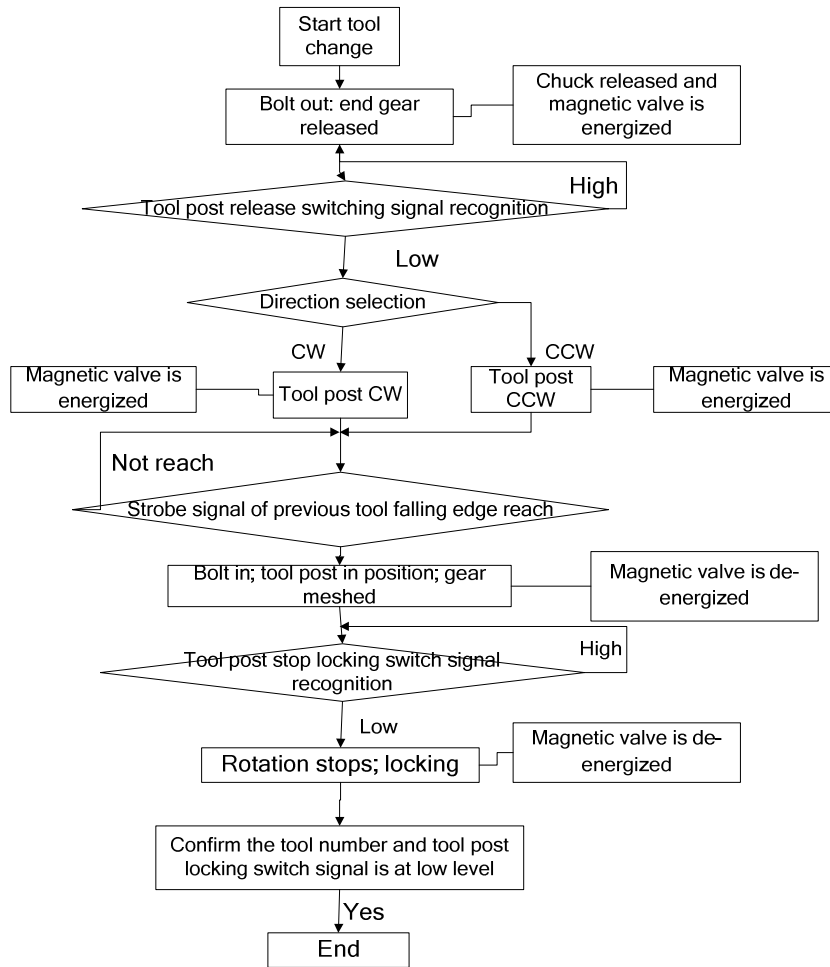

6.3.18 Emergency Stop

➤ Address definition

X0000			ESP					
-------	--	--	-----	--	--	--	--	--

X0.5: Emergency stop input signal

➤ Control parameter

K0010	ESP							
-------	-----	--	--	--	--	--	--	--

K10.7 =1: External emergency stop input signal (X0.5) high-level alarm

K10.7 =0: External emergency stop input signal (X0.5) low-level alarm

3009	ESP							
------	-----	--	--	--	--	--	--	--

3009#7 =1: Emergency stop alarm is raised when external emergency stop signal (X0.5) is 1.

3009#7 =0: Emergency stop alarm is raised when external emergency stop signal (X0.5) is 0.

**Note: The values of k10.7 and No. 3003#7 should be set consistently.**

6.3.19 Tri-Colored Lamp

➤ Address definition

Y0002					BIT4	BIT3	BIT2	
-------	--	--	--	--	------	------	------	--

Y2.2: Tri-colored lamp –yellow, normal state (non-running, non-alarm state)

Y2.3: Tri-colored lamp – green, running state

Y2.4: Tri-colored lamp – red, alarm state

➤ **Control parameter**

K0012			LAMP					
-------	--	--	------	--	--	--	--	--

K12.5 =1: Tri-colored lamp output function is valid

K12.5=0: Tri-colored lamp output function is invalid.

## 6.4 Standard PLC Parameter Instruction

### 6.4.1 Parameter K

**Note: K0~K7 do not need to be set.**

Address	Parameter meaning	Initial value
K8.0	X axis manual movement direction (1: reversed, 0: not reversed)	0
K8.1	Y axis manual movement direction (1: reversed, 0: not reversed)	0
K8.2	Z axis manual movement direction (1: reversed, 0: not reversed)	0
K8.3	The 4 <sup>th</sup> axis manual movement direction (1: reversed, 0: not reversed )	0
K8.4	C axis manual movement direction (1: reversed, 0: not reversed)	0
K9.0	Shield program protection lock (1: shield, 0: does not shield)	0
K9.7	Alarm occurs when invalid M code is commanded (1: yes, 0: no)	0
K10.0	Feed override (1: inverted, 0: not inverted)	0
K10.1	Turn off the spindle, cooling and lubrication output during reset (1: No, 0: Yes)	0
K10.2	Axes overtravel input signal alarm level (1:low-level alarm, 0: high-level alarm)	0
K10.3	Machine panel feed/spindle enable knob (1:valid, 0: invalid)	1
K10.4	Spindle type (1: gear, 0: analog)	0
K10.7	External emergency stop input signal (X0.5) (1: high-level alarm, 0: low-level alarm)	0
K11.0	Tool post lock signal (1: low-level, 0: high-level)	0
K11.1	Tool position signal (1: low-level, 0: high-level)	0
K11.2	Tool change method when standard tool change mode is selected (1: method A, 0: method B)	1
K11.3	Check tool position signal after tool change (1: Yes, 0: No)	0
K11.4	Check tool post lock signal (1: Yes, 0: No)	1
K11.6	Tool post selection (PB8 PB7: 00 standard tool post/01 Yantai Tool Post/10 Liuxin Tool post)	0
K11.7	Tool post selection (PB8 PB7: 00 standard tool post/01 Yantai Tool Post/10 Liuxin Tool post)	0
K12.0	1/0: manual inverted tool change is valid/invalid	0

K12.2	Zero return direction locked automatically (1: Yes, 0: No)	0
K12.5	Tri-colored lamp output function (1: enabled, 0: disabled)	0
K12.6	External hand-held unit (1: enabled, 0: disabled)	0
K12.7	Machine tool operation panel (1: MPU02B, 0: MPU02A)	0
K13.0	Chuck control function (1:enabled, 0:disabled)	1
K13.1	If the chuck function is valid, check the chuck clamping state when the spindle is started (1: Yes, 0: No)	1
K13.2	Tailstock control function (1: valid, 0: invalid)	0
K13.4	Spindle gear stage is stored when power-off (1: Yes, 0: No)	1
K13.5	Spindle automatic gear change in-position signal active level (1: low-level, 0: high-level)	0
K13.6	Check spindle automatic gear change in-position signal (1: Yes, 0: No)	0
K13.7	Spindle automatic gear change function (1: valid, 0: invalid)	0
K14.0	Check chuck clamping/unclamping signal (1:Yes, 0: No)	0
K14.2	Chuck mode (1: inner chuck, 0: outer chuck)	0
K14.4	Low-pressure alarm signal level (1: low-level alarm, 0: high-level alarm)	0
K14.5	Low-pressure alarm function (1: valid, 0: invalid)	0
K14.6	Protection door input signal alarm level (1: low-level alarm, 0: high-level alarm)	0
K14.7	Protection door alarm function (1: valid, 0: invalid)	0
K15.0	Starting up operation mode MD1	0
K15.1	Starting up operation mode MD2	0
K15.2	Starting up operation mode MD4	0
K15.4	Starting up operation mode (1: MD2, MD2, MD4, 0: the mode when power-off the last time)	0
K15.6	Servo spindle 8-point orientation function (1: valid, 0: invalid)	0
K15.7	Issue an alarm when spindle servo alarm signal is at low/high level	0

#### 6.4.2 Parameter DT

DT Address	PLC Initial Value	Minimum Input Value	Maximum Input Value	Meaning
DT0000	1000	0	60000	Spindle gear change time 1 (ms)
DT0001	1000	0	60000	Spindle gear change time 2 (ms)
DT0002	3000	0	60000	Low-pressure alarm detection time (ms)
DT0003	5000	100	5000	Tool change (for one tool position) time upper limit (ms)
DT0004	15000	1000	60000	Tool change (for maximum tool positions) time upper limit (ms)
DT0005	500	100	5000	M code execution duration (ms)

DT0006	500	100	5000	S code execution duration (ms)
DT0007	500	0	4000	Delay time of the tool post from forward rotation stop to reverse rotation output (ms)
DT0008	500	0	4000	Alarm time when the TCP signal is not received (ms)
DT0009	1000	0	4000	Tool post reverse rotation lock time (ms)
DT0010	0	0	10000	Delay time of M05 and spindle braking output (ms)
DT0011	50	0	60000	Spindle braking output time (ms)
DT0012	100	0	60000	Spindle jog time (ms)
DT0013	0	0	60000	Lubricating start time (0-60000ms) (0: no limit)
DT0016	0	0	60000	Automatic lubricating interval time (ms)
DT0017	0	0	60000	Automatic lubricating output time (ms)
DT0019	1000	100	60000	Chuck function execution duration when in-position signal is not checked (ms)
DT0021	1000	100	60000	Spindle stop, chuck operation enable delay time (ms)
DT0022	500	100	1000	Alarm indicator flickering period (100-1000) (ms)
DT0023	500	100	1000	Spindle override indicator flickering period (100-1000) (ms)
DT0024	400	100	2000	Feed override knob debounce time (ms)
DT0025	400	100	2000	Spindle override knob debounce time (ms); valid when the machine tool panel is MPU02B
DT0032	10000	0	60000	Liuxin 8-Position Hydraulic Tool Change alarm time (ms)
DT0034	10000	0	60000	AD31 Series Tool Post allowable continuous time upper limit (ms)
DT0035	1000	0	4000	AK31 Series Tool Post lock proximity switch signal detection time upper limit (ms)
DT0036	10000	0	60000	Upper limit of tool change duration for Changzhou Yaxing HLT hydraulic tool post (ms)

### 6.4.3 Parameter DC

DC Address	PLC Initial Value	Minimum Input Value	Maximum Input Value	Meaning
DC0000	50	0	200	The output voltage value of inverter during spindle jog (0.01V)
DC0001	5	0	50	The output voltage value of inverter during spindle automatic gear change (0.01V)

### 6.4.4 Parameter D

D Address	PLC Initial Value	Minimum Input Value	Maximum Input Value	Meaning
D0	4	1	16	Number of tools on a tool post
D1	1	0	5	Internal controlled axis number corresponding to X axis manual movement key (the key is invalid when it is set to 0)
D2	0	0	5	Internal controlled axis number corresponding to Y axis manual movement key (the key is invalid when it is set to 0)
D3	2	0	5	Internal controlled axis number corresponding to Z axis manual movement key (the key is invalid when it is set to 0)
D4	0	0	5	Internal controlled axis number corresponding to the 4th axis manual movement key (the key is invalid when it is set to 0)
D5	0	0	5	Internal controlled axis number corresponding to C axis manual movement key (the key is invalid when it is set to 0)

## 6.5 Signals G, F Used in Standard PLC

### 6.5.1 Signal G

Address	Function	Symbol
G4.3	Auxiliary function end signal	FIN
G4.4	The 2M function end signal	MFIN2
G4.5	The 3M function end signal	MFIN3
G5.0	Miscellaneous function end signal	MFIN
G5.2	Spindle function end signal	SFIN
G5.3	Tool function end signal	TFIN
G5.6	Auxiliary function lock signal	AFL
G6.2	Manual absolute value signal	ABSM
G6.4	Override cancel signal	OVC
G7.2	Cycle start signal	ST
G7.4	Stroke check 3 release signal	RLSOT3
G7.6	Stored stroke limit selection signal	EXLM
G8.4	Emergency stop signal	ESP
G8.5	Feed dwell signal	SP
G8.7	External reset signal	ERS

Address	Function	Symbol
G10,G11	Manual feedrate override signal	JV0~JV15
G12	Feedrate override signal	FV0~FV7
G14.0, G14.1	Rapid traverse override signal	ROV1,ROV2
G18.0~G18.3	MPG 1 feed axis selection signal	HS1A~HS1D
G18.4~G18.7	MPG 2 feed axis selection signal	HS2A~HS2D
G19.4, G19.5	MPG/STEP override signal	MP1,MP2
G19.7	Manual rapid traverse selection signal	RT
G27.0~G27.2	Spindle selection signal	SSW1~SSW3
G27.3~G27.5	Spindle stop signal	SSTP1~SSTP3
G28.1, G28.2	The 1 <sup>st</sup> spindle gear selection signal	GR11, GR12
G29.0, G29.1	The 2 <sup>nd</sup> spindle gear selection signal	GR21, GR22
G29.2, G29.2	3 <sup>rd</sup> spindle gear selection signal	GR31, GR32
G26.0, G28.7	Position encoder selection signal	PC3SLC, PC2SLC
G29.6	Spindle stop signal	SSTP
G30	Spindle override signal	SOV0~SOV7
G32.0~G32.7 G33.0~G33.3	Signal of the 1 <sup>st</sup> spindle motor speed command input by PLC	R011~R12I
G34.0~G34.7 G35.0~G35.3	Signal of the 2 <sup>nd</sup> spindle motor speed command input by PLC	R01I2~R12I2
G36.0~G36.7 G37.0~G37.3	3 <sup>rd</sup> spindle motor speed command signal from PLC	R01I3~R12I3
G33.7	The 1 <sup>st</sup> spindle motor speed selection command signal	SIND
G35.7	The 2 <sup>nd</sup> spindle motor speed selection command signal	SIND2
G37.7	3 <sup>rd</sup> spindle motor speed selection command signal	SIND3
G43.0~ G43.2,G43.5,G43 .7	Mode selection signal	MD1,MD2,MD4, DNC1,ZRN
G44.0	Optional block skip signal	BDT1
G44.1	Machine lock for all axes signal	MIK
G46.1	Signal block signal	SBK
G46.7	Dry run signal	DRN
G100.0~G100.4	Feed axis and direction selection signal	+J1~+J5
G102.0~G102.4		-J1~-J5
G114.0~G114.4	Overtravel signal	+L1~+L5
G116.0~G116.4		-L1~-L5
G136.0~G136.4	PLC controlled axis selection signal	EAX1~EAX5
G137.0, G137.1	PLC axis rapid traverse override signal	ROV1E, ROV2E
G137.5	PLC axis override cancel signal	OVCE
G137.6	PLC axis manual rapid traverse selection signal	RTE
G137.7	PLC axis dry run signal	DRNE
G138	PLC axis feedrate override signal	FV0E~FV7E
G140.0	PLC axis miscellaneous function completion signal	EFINA

Address	Function	Symbol
G140.2	PLC axis buffering inhibited signal	EMBUFA
G140.3	PLC block end signal (group 1)	ESBKA
G140.5	PLC axis control pause signal (group 1)	ESTPA
G140.6	PLC reset signal (group 1)	ECLRA
G140.7	PLC control command read signal (group 1)	EBUFA
G141.0~G141.6	PLC axis control signal (group 1)	EC0A~EC6A
G141.7	PLC block stop disabled signal (group 1)	EMSBKA
G142, G143	PLC axis control feedrate signal (group 1)	EIF0A~EIF15A
G144~G147	PLC axis control data signal (group 1)	EID0A~EID31A
G150.0	PLC axis miscellaneous function completion signal	EFINB
G150.2	PLC axis buffering inhibited signal	EMBUFB
G150.3	PLC block end signal (group 2)	ESBKB
G150.5	PLC axis control pause signal (group 2)	ESTPB
G150.6	PLC reset signal (group 2)	ECLRB
G150.7	PLC control command read signal (group 2)	EBUFB EC0B~EC6B
G151.0~G151.6	PLC axis control signal (group 2)	
G151.7	PLC block stop disabled signal (group 2)	EMSBKB
G152, G153	PLC axis control feedrate signal (group 2)	EIF0B~EIF15B
G154~G157	PLC axis control data signal (group 2)	EID0B~EID31B
G160.0	PLC axis miscellaneous function completion signal	EFINC
G160.2	PLC buffering inhibited signal	EMBUFC
G160.3	PLC block end signal (group 3)	ESBKC
G160.5	PLC axis control pause signal (group 3)	ESTPC
G160.6	PLC reset signal (group 3)	ECLRC
G160.7	PLC control command read signal (group 3)	EBUFC
G161.0~G161.6	PLC axis control signal (group 3)	EC0C~EC6C
G161.7	PLC block stop disabled signal (group 3)	EMSBKC
G162, G163	PLC axis control feedrate signal (group 3)	EIF0C~EIF15C
G164~G167	PLC axis control data signal (group 3)	EID0C~EID31C
G170.0	PLC axis miscellaneous function completion signal	EFIND
G170.2	PLC buffering inhibited signal	EMBUFD
G170.3	PLC block end signal (group 4)	ESBKD
G170.5	PLC axis control pause signal (group 4)	ESTPD
G170.6	PLC reset signal (group 4)	ECLRD
G170.7	PLC control command read signal (group 4)	EBUFD
G171.0~G171.6	PLC axis control signal (group 4)	EC0D~EC6D
G171.7	PLC block stop disabled signal (group 4)	EMSBKD
G172, G173	PLC axis control feedrate signal (group 4)	EIF0D~EIF15D
G174~G177	PLC axis control data signal (group 4)	EID0D~EID31D
G200.0	Spindle jog function signal	SPHD

## 6.5.2 Signal F

Address	Function	Symbol
F0.4	Feed dwell signal	SPL
F0.5	Cycle start signal	STL
F0.6	Servo ready signal	SA
F0.7	Automatic running signal	OP
F1.0	Alarm signal	AL
F1.1	Reset signal	RST



Address	Function	Symbol
F1.3	Assignment end signal	DEN
F1.4	The 1 <sup>st</sup> spindle enable signal	ENB
F1.7	CNC ready signal	MA
F2.0	Inch input signal	INCH
F2.1	Rapid traverse signal	RPDO
F2.2	Constant surface speed cutting signal	CSS
F2.3	Thread cutting signal	THRD
F2.7	Dry run detection signal	MDRN
F3.0	STEP mode detection signal	MINC
F3.1	MPG mode detection signal	MH
F3.2	MANUAL mode detection signal	MJ
F3.3	MDI mode detection signal	MDI
F3.4	DNC mode detection signal	MRMT
F3.5	AUTO mode detection signal	MMEM
F3.6	EDIT mode detection signal	MEDT
F4.0	Optional block skip detection signal	MBDT1
F4.1	Machine lock for all axes detection signal	MMLK
F4.2	Manual absolute detection signal	MABSM
F4.3	Single block detection signal	MSBK
F4.4	Auxiliary function lock detection signal	MAFL
F4.5	Machine zero return mode detection signal	MREF
F7.0	Auxiliary function strobe signal	MF
F7.2	Spindle speed function strobe signal	SF
F7.3	Tool function strobe signal	TF
F8.4	The 2M auxiliary function strobe signal	MF2
F8.5	The 3M auxiliary function strobe signal	MF3
F9.4	M decoding signal	DM30
F9.5		DM02
F9.6		DM01
F9.7		DM00
F10~F13	Auxiliary function code signal	M00~M99
F14~F15	The 2M auxiliary function code signal	M200~M299
F16~F17	The 3M auxiliary function code signal	M300~M399
F22~F25	Spindle speed code signal	S00~S31
F26~F29	Tool function code signal	T00~T31
F36.0~F26.7 F37.0~F37.3	The 1 <sup>st</sup> spindle S12-digit code signal	R010~R120
F38.2	The 2 <sup>nd</sup> spindle enable signal	ENB2
F38.3	3 <sup>rd</sup> spindle enable signal	ENB3
F40~F41	The 1 <sup>st</sup> spindle actual speed signal	AR00~AR15
F62.7	Object parts counting reach signal	PRTSF
F94.0~ F94.4	Machine zero return end signal	ZP1~ZP5
F96.0~ F96.4	The 2 <sup>nd</sup> reference point machine zero return end signal	ZP21~ZP25

Address	Function	Symbol
F98.0~F98.4	The 3 <sup>rd</sup> reference point machine zero return end signal	ZP31~ZP35
F100.0~F100.4	The 4 <sup>th</sup> reference point machine zero return end signal	ZP41~ZP45
F102.0~F102.4	Axis movement signal	MV1~MV5
F129.5	PLC axis override 0% signal	EOV0
F129.7	PLC controlled axis selection status signal	EAXSL
F140.0	PLC axis in-position signal	EINPA
F140.1	PLC axis following error zero checking signal	ECKZA
F140.2	PLC axis alarm signal	EIALA
F140.3	PLC miscellaneous function execution signal	EDENA
F140.4	PLC axis move signal	EGENA
F140.5	PLC axis + direction overtravel signal	EOTPA
F140.6	PLC axis - direction overtravel signal	EOTNA
F140.7	Axis control command read completed signal (PLC axis control group 1)	EBSYA
F141.0	PLC miscellaneous function strobe signal	EMFA
F141.1	PLC buffer full signal	EABUFA
F141.2	PLC miscellaneous function 2 strobe signal	EMF2A
F141.3	PLC miscellaneous function 3 strobe signal	EMF3A
F142, F143	PLC miscellaneous function code signal	EM11A~EM48A
F150.0	PLC axis in-position signal	EINPB
F150.1	PLC axis following error zero checking signal	ECKZB
F150.2	PLC axis alarm signal	EIALB
F150.3	PLC miscellaneous function execution signal	EDENB
F150.4	PLC axis move signal	EGENB
F150.5	PLC axis + direction overtravel signal	EOTPB
F150.6	PLC axis - axis direction overtravel signal	EOTNB
F150.7	Axis control command read completed signal (PLC axis control group 2)	EBSYB
F151.0	PLC miscellaneous function strobe signal	EMFB
F151.1	PLC buffer full signal	EABUFB
F151.2	PLC miscellaneous function 2 strobe signal	EMF2B
F151.3	PLC miscellaneous function 3 strobe signal	EMF3B
F152, F153	PLC miscellaneous function code signal	EM11B~EM48B
F160.0	PLC axis in-position signal	EINPC
F160.1	PLC axis following error zero checking signal	ECKZC
F160.2	PL axis alarm signal	EIALC
F160.3	PLC miscellaneous function execution signal	EDENC
F160.4	PLC axis move signal	EGENC
F160.5	PLC axis + direction overtravel signal	EOTPC
F160.6	PLC axis - direction overtravel signal	EOTNC
F160.7	Axis control command read completed signal (PLC axis control group 3)	EBSYC
F161.0	PLC miscellaneous function strobe signal	EMFC
F161.1	PLC buffer full signal	EABUFC
F161.2	PLC miscellaneous function 2 strobe signal	EMF2C
F161.3	PLC miscellaneous function 3 strobe signal	EMF3C
F200.0~F200.7 F201.0~F201.3	2nd spindle S12-digit code signal	R0102~R1202
F204.0~F204.7 F205.0~F205.3	3rd spindle S12-digit signal	R0103~R1203
F202~F203	2nd spindle actual speed signal	AR002~AR152
F206~F207	3rd spindle actual speed signal	AR003~AR153

## APPENDIX A ALARM LIST

## A.1 Program Alarms (P/S Alarms)

No.	Message	Contents
000	Emergency stop alarm, ESP input open circuit	Recover ESP signal input to clear the alarm.
001	Part program open failure	Press RESET key to cancel the alarm, or turn on the power again.
002	More than 256 character in a program line	Too many characters in a program line; modify the program.
003	Data exceeds permissive range	Input data exceeds permissive range, or the specified data exceeds 8 digits. Modify the data.
004	Address not found	No address but only digits or characters are input at the head of a block. Modify the program.
005	No data follows address	No data follow address or expression format which follows the address is wrong (no brackets). Modify the program.
006	Illegal use of negative sign	Sign "-" was input after an address or two or more "-" was input. Modify the program.
007	Illegal use of decimal point	Decimal point "." was input after an address or two or more "." was input. Modify the program.
008	Input illegal address	Unusable address is input in significant area. Modify the program.
009	Incorrect G code	Unusable G code or G code with functions not provided is specified. Modify the program.
010	Address repetition error	Specified same address twice or more in a block, or specified two or more G codes in same group in a block. Refer to parameter No. 3403#6 AD2. Modify the program.
011	Command cannot run in DNC mode exists.	Command cannot run in DNC mode exists. Modify the program.
012	Too many M codes	Multiple M codes cannot be specified in a block. Refer to parameter No.3404#7 M3B to modify the program.
014	Divided by zero	Divisor was 0 (including $\tan 90^\circ$ ). Modify the program.
017	Parameter modified failure.	Check that whether the parameter file is abnormal. The customer area may be ruined!
018	Part program operation failure	Reset to clear alarm.
019	End of record	Specify end symbol (%) of record, or not specify end of program. Refer to parameter No. 3404#6 EOR to modify the program.
020	DNC time out	DNC transmission failure, please check it.
021	Feedrate out of range	Feedrate was not commanded to a cutting feed or the feedrate was inadequate. The meaning of F is determined by G98/G99, please check current modal of G98/G99. Modify the program.
022	Spindle speed out of range	Improper spindle speed or spindle surface speed value. Refer to parameter No.3031 SCB to modify the program.
023	Number followed M code out	Specified undefined M code. Refer to parameter No.

No.	Message	Contents
	of range	3030 MCB to modify the program.
024	Improper G code	The G code cannot be in the same block with other G codes. Modify the program.
025	Illegal tool number	Specify a tool number which does not exist, Refer to parameter No. 3032 TCB to modify the program.
026	Illegal offset number	Tool offset number selected by T code is too large. Modify the program.
027	Illegal offset value	Tool offset value selected by T code too large. Modify the program.
028	T code not allowed in the block	T code cannot be specified in the block where G50, G10, G04 are specified. Modify the program according to parameter No. 5006#1 TGC.
029	Tool life data running error.	Tool group number exceeds the maximum allowable value, or the tool group commanded in the machine program is not set. Modify the program or modify the tool life data.
031	Too many axes commanded	Attempt was made to move the tool along more than maximum number of simultaneously controlled axes. Modify the program.
032	Illegal axis for interpolation	An axis not included in selected plane commanded in interpolation command, or basic axis with its parallel axis is commanded simultaneously that impossible to interpolate. Modify the program.
033	Illegal plane axis commanded	An axis not included in selected plane commanded in circular interpolation. Modify the program.
034	No radius commanded	In circular interpolation, R, I, J, K has not been specified, referring to Para. 3403#5 CIR. Modify the program.
035	Illegal radius	In circular interpolation, address R value is wrong. Please refer to parameter 3403#4 RER and modify the program.
036	Exceeds the radius difference range	In circular interpolation, the difference between the distance from the start point to the center point and distance from the end point to the center point exceeds the value set by parameter. Please refer to parameter and modify the program.
037	Thread run-out length J, K value commanded incorrectly in thread cutting.	The run-out length exceeds the permitted range. K value is less than zero in G32, G34 commands; J value or K value is less than zero in G92 and G76. Modify the program.
038	Illegal lead command	Lead command value F is out of the range; or in variable lead thread cutting, the lead variation exceeds the range. Modify the program.
039	In thread cutting command, the thread run-out length of long axis is excessive.	The thread run-out length of long axis exceeds the thread cutting length. Modify the program.
040	Chamfering amount too large of latitude axis in threading.	Chamfering amount of latitude axis in G92 was greater than the distance between start point and end point. Modify the program.
041	Illegal plane selection	In plane selection command, more than one parallel axes are specified in the same direction. Modify the program.
042	Metric/inch conversion command error	The metric/inch conversion command is not specified alone in a line, or is not specified in the first line. Metric/inch conversion is performed when a subprogram is called. Modify the program.
043	Reference point return	The reference point return cannot be performed

No.	Message	Contents
	uncompleted	normally because the reference point return start point is too close to the reference point or the speed is too slow. Separate the start point far enough from the reference point, or specify a sufficient fast speed for reference point return.
044	Reference point return uncompleted	When automatic operation dwells, manual reference point return cannot be performed.
045	Axes not on reference point	During the reference point return check (G27), the specified axis does not return to the reference point. Modify the program.
046	G28 found in sequence return	A program restart command is specified without the execution of reference point return after power-on or emergency stop, and G28 is found during research. Perform the reference point return.
047	The specified axis does not return to the reference point.	The specified axis does not return to the reference point by cycle start. Please perform reference point return.
048	Wrong reference point commanded	In G30 block, a value other than 2~4 is specified by P. Modify the program.
051	G37 reach signal not acquainted	In the automatic tool compensation function (G36, G37), the measurement position reach signal (XAE or EAE) is not turned on in the area specified by parameter. This may be caused by a setting or operation error.
052	Offset number not found in G37	G36, G37 automatic tool compensation is specified without T code. Modify the program.
053	T coded not allowed in G37	T code and automatic tool compensation (G36, G37) are specified in the same block. Modify the program.
054	Illegal axis command in automatic tool compensation	In auto tool compensation function (G36,G37),an invalid axis is specified or the command is incremental. Modify the program.
055	G37 command invalid	The automatic tool compensation function (G36, G37) is invalid. Check parameter No. 6240#7 IGA and modify the program.
056	G31 cannot be used in feed-per-rotation mode	In feed-per-rotation mode, skip cutting command is specified. Modify the program.
058	G31 cannot be used in feed-per-rotation mode	In feed-per-rotation mode, skip cutting command is specified. Modify the program.
059	G31 cannot be used in tool nose radius compensation mode	Skip cutting command is specified in tool nose radius compensation mode. Modify the program.
061	Illegal P specified in G10	The P value which specifies the offset value is too large, or no P value is specified. Modify the program.
062	Illegal compensation value in G10	The specified offset value is too large. Modify the program.
063	Format error in G10 or L50	G10 and G11 are not matched or G10 is not specified before G11. Modify the program.
064	Illegal command in Entering data from program	Axis or G code is specified in Entering data from program. Modify the program.
065	The offset value are accumulated excessively	In G50 offset accumulation, the accumulated offset exceeds the permitted range. Modify the program.
068	Stroke check range setting error	In the stroke check range set by command G22, the specified positive coordinate value or parameter value is not greater than the negative coordinate value, or the differential between them is less than 2000 least

No.	Message	Contents
		input increment. Check parameter No. 1322 or No. 1323, and modify the program.
071	Spindle orientation unexecuted	Without any spindle orientation, an attempt was made for spindle indexing. Perform spindle orientation.
072	C/H code and movement command in the same block	Spindle indexing command C, H and other axis movement command are in the same block. Modify the program.
073	M code and movement command in the same block	Spindle indexing M code and other axis movement command are in the same block. Modify the program.
074	Illegal command G12.1/G13.1	When the polar coordinate interpolation is started or cancelled, the condition is wrong. 1). G12.1/G13.1 is specified in the mode that is not specified by G40. 2). Error is found in plane selection. The parameter specifying is erroneous. Modify the program or the parameter.
075	An unusable G code is specified in polar coordinate interpolation	An unusable G code is specified in polar coordinate interpolation. Modify the program or the parameter.
076	Illegal G07.1 command	Specified axis not used for circular interpolation, or incorrect radius of cylinder, or Tool compensation C is used. Modify the program.
077	Improper G-code in circular interpolation	Specified improper G-code in circular interpolation. Modify the program.
081	Undefined address P	In the programs commanded by M98, G65, G66, the address P (program number) is not defined. Modify the program.
082	Subprogram nesting error	The nested subprogram exceeds 12 levels.
083	Program number not found	The program number was not found specified by P in M98,M99,G65 or G66. Modify the program.
084	Subprogram call error	A higher-level program or the subprogram itself is called by M98, G66 or G66. Modify the program.
085	Program call statement cannot be run in MDI and DNC modes.	Macro program call and subprogram call in MDI and DNC modes are not supported. Modify the program.
090	Axis specified error in constant surface speed control	In G96 modal, the specified axis by parameter is wrong. Modify the parameter.
101	Over-speed of spindle in threading	In threading, the spindle speed specified is too fast for the threading axis. Modify the program.
102	Spindle speed too low in threading	S command was not specified or is set to zero. Spindle encoder feedback is abnormal. Modify the program or check the status of encoder.
103	Signal of 1-rotation not detected	Signal of 1-rotation timed out in threading. Check the status of encoder.
105	Spindle encoder lines out of 100~5000.	This type of encoder is not support in taping. Check the set of Para No.3773, or replace the encoder.
106	Spindle rotation signal (SFR,SRV) detected error in taping.	Check the output of G signal SFR,SRV. Modify the program or PLC.
107	Spindle speed too low in taping	S command specified a value equal to zero or out of range; Encoder feedback abnormal. Modify the program or check the status of encoder.
110	Machine coordinate system initial error	Machine coordination established immediately after power on varies beyond the deviation limit comparing with the memorized one. Possible reasons were that: 1) Machine table moved when power off; 2) The

No.	Message	Contents
		deviation limit set in Para. No.1206 (MER) is too small. Please re-establish machine reference position.
121	Canned cycle command is specified in non-ZX plane.	The canned cycle command is not specified in the basic ZX coordinate system. Modify the program.
122	Axis not included in the basic ZX coordinate system is specified in canned cycle.	Axis not included in the ZX coordinate system is specified in canned cycle. Modify the program.
123	The R value (radius value) is greater than the U value (absolute value) in G90, G92 commands.	In G90, G92 commands, when the plus or minus signs for the R and U are different, the absolute value of R value (radius value) is greater the U value (absolute value). Modify the program.
124	In G94 command, the R absolute value is greater than W absolute value	In G94 command, when the plus or minus signs for the R and W are different, the absolute value of R is greater that of the W value. Modify the program.
126	Illegal plane selection in multiple-cycle command	Cycle command is not specified in ZX plane. Modify the program.
127	Axis not included in the ZX plane is specified in G70~G76.	Axis not included in the ZX plane is specified in G70~G76 commands or the G70~G76 loop. Modify the program.
128	Incorrect G code in G70~G73	An unusable G code is commanded between the two blocks which is specified by addresses P and Q in G70~G73. Modify the program.
129	G70~G73 commands cannot be run in MDI mode	G70~G73 commands including addresses P, Q are specified in MDI mode.
130	Macro statement execution is not allowed in G70~G73 loop	Macro statement execution is not allowed in G70~G73 loop. Modify the program.
131	Subprogram is called in G70~G73 loop	Subprogram cannot be called in G70~G73 loop. Modify the program.
132	Subprogram is called in G70~G73 command lines	Subprogram cannot be called in G70~G73 command lines. Modify the program.
133	In G70~G73 commands, the addresses P or Q is out of the range	In G70~G73 commands, the addresses P or Q is undefined or out of the range. Modify the program.
134	The sequence number not found in G70~G73 commands	The sequence number specified by address P or Q is not found in G70~G73 commands. Modify the program.
135	P and Q commands error in G70~G73 commands	In G70~G73 commands, the command values of P and Q are the same. Modify the program.
136	Two continuous blocks is not found in G71~G73 commands	Two continuous blocks is not found in G71~G73 commands, which will cause error. Modify the program.
137	In G71~G73 commands, the number of Ns-Nf blocks exceeds 100.	In G71~G73 commands, the Ns-Nf blocks are excessive. Modify the program.
138	In G71~G73 commands, the Ns-Nf blocks are non-monotonic	In multiple cycle command (G71 or G72), a non-monotonic object structure is defined; or in G73 cycle, the Z axis is non-monotonic; when the Z axis is set with retraction amount or finishing allowance, the X axis is non-monotonic. Please refer to parameter 5102#1 MRC and modify the program.
139	The orientation point commanded by G71~G73 is within the cutting range	When the orientation point commanded by G71~G73 is within the cutting range, tool collision may occur. Please refer to parameter 5104#2 FCK and modify the program.

No.	Message	Contents
140	Too many concaves in G71 type II	More than 10 concaves are specified in G71 type II. Modify the program.
141	In G73 cycle, the tool retraction direction of X axis is inconsistent with the finishing allowance direction.	In G73 cycle, the tool retraction direction of X axis is opposite to the finishing allowance direction. Modify the program.
142	In G73 cycle, the tool retraction direction of Z axis is inconsistent with the finishing allowance direction.	In G73 cycle, the tools retraction direction of Z axis is opposite to the finishing allowance direction. Modify the program.
143	Finishing allowance in G70~G73 exceeds the range	Finishing allowance of G70~G73 exceeds the range. Modify the program.
144	G00 or G01 is not commanded in starting block of the G71~G72 loop.	G00 or G01 needs to be commanded in starting block of the G71~G72 loop. Modify the program.
145	None of G00-G03 is commanded in starting block of the G73 loop	G00, G01, G02 or G03 is not commanded in the starting block of the G73 loop. Modify the program.
146	Only X axis increment is needed in the starting block of G71 loop	X axis is not commanded in the starting block of the G71 loop, or the X axis increment is zero, or X axis is not commanded. Modify the program.
147	Only Z axis increment is needed in the starting block of G72 loop	Z axis is not commanded in the starting block of the G71 loop, or the Z axis increment is zero, or X axis is commanded. Modify the program.
148	The single feeding amount in G71 or G72 command is less than zero	The single feeding amount in G71 or G72 command is less than zero. Modify the program.
149	The single tool retraction amount R(e) in G71 or G72 command is less than zero	The single retraction amount R(e) in G71 or G72 command is less than zero. Modify the program.
150	The total cutting amount in G73 exceeds the permitted range	The total cutting amount in G73 exceeds the permitted range. Modify the program.
151	The number of repetition R(d) in G73 command is out of the permitted range	The number of repetition R(d) in G73 command is less than 1 or greater than 000 after rounding. Modify the program.
152	The orientation point specified by G73 is out the cutting range, which may lead to overcut	The orientation point specified by G73 is out the cutting range, which may lead to overcut. Modify the program.
153	Q value in G74 is not in the range	Q value in G74 is not in the needed range. Modify the program.
154	X axis command is not input in G75	X axis command is not input in G75. Modify the program.
155	P value in G75 is not in the range	The P value in G75 is not in the needed range. Modify the program.
156	R(e) is less than zero in G74 or G75 command	Single tool retraction amount R(e) is less than zero in G74 or G75 command. Modify the program.
157	R( $\Delta$ d) is less than zero in G74 or G75 command	The tool retraction amount R( $\Delta$ d) is less than zero in G74 or G75 command when the cutting feed reaches the end point. Modify the program.
158	In G74 or G75, single cutting amount exceeds the range	In G74 or G75, the single cutting amount along Z or Z direction exceeds the permitted range. Modify the program.
160	In G76, X or Z axis movement amount is 0	In G76, X or Z axis movement amount is 0. Modify the program



No.	Message	Contents
161	The repetition number of G76 is less than 1 or greater than 99	The repetition number of G76 is less than 1 or greater than 99. Modify the program.
162	In G76, the thread chamfering angle exceeds the permitted range	In G76, the thread chamfering angle exceeds the permitted range. Modify the program.
163	In G76, the tool nose angle exceeds the permitted range	In G76, the tool nose angle exceeds the permitted range. Modify the program.
164	In G76, Q( $\Delta$ dmin) exceeds the permitted range	In G76, the minimum cut-in amount Q( $\Delta$ dmin) exceeds the permitted range. Modify the program.
165	The G76 finishing allowance R(d) exceeds the permitted range	The G76 finishing allowance R(d) is less than a minimum increment. Modify the program.
166	During taper thread cutting commanded by G76, the R value and U value are unmatched	During taper thread cutting commanded by G76, the start point of machining is between the thread start point and thread end point. Modify the program.
167	Thread height P value is not specified in G76 command	Thread height P value is not specified in G76 command. Modify the program.
168	The G76 thread height is less than the finishing allowance or the minimum cutting amount	The G76 thread height is less than the finishing allowance or the minimum cutting amount. Modify the program.
169	The Q value in G76 command is not within the range	The first cutting depth is not defined in G76 command: the Q value is not within the range or not input. Modify the program.
170	Taper of thread is larger than 45 in G76	Taper of thread is larger than 45 in G76. Modify the program.
171	Taper is paralleled to the tool nose in G76	Taper is paralleled to the tool nose in G76. Modify the program.
172	Improper G76 specified	Unusual angel of tool nose or thread taper is specified. Modify the program.
180	Illegal S command in rigid tapping	The S code in rigid tapping is undefined or out of the range. Modify the program.
181	Illegal K command in rigid tapping	The specified repetition number K value is out of the range in rigid tapping. Modify the program.
182	Illegal F command in rigid tapping	The cutting feedrate value is F is out of the range in rigid tapping. Please check the modal G98 and G99 and modify the program.
183	Program error in rigid tapping	The M code and S value is not in the same block in rigid tapping. Modify the program.
184	Illegal axis operation in rigid tapping	A move axis is specified between the M code and G84 command in rigid tapping. Modify the program.
185	The spindle cannot perform rigid tapping	In rigid tapping, the spindle is not selected. Modify the parameter.
186	Plane alteration during rigid tapping	During rigid tapping, a non-G18 plane is switched or the rigid tapping is enabled in non-G18 plane. Modify the program.
187	Data error in rigid tapping	The specified distance is too short or too long in rigid tapping. Modify the program.
188	Data repetition in rigid tapping	The same M code or S code is repeated between M code and G84 in rigid tapping. Modify the program.
189	M code repetition in rigid tapping	In rigid tapping, the M code cannot be in the same block with the M code which locks C axis in drilling canned cycle. Modify the program.
190	Servo spindle command	The increment of the servo spindle occurs in

No.	Message	Contents
	occurs in rigid tapping	orientation command in rigid tapping. Modify the program.
191	Rigid tapping signal is off	Possible reason: 1. RGTAP signal is not detected or rigid tapping mode is not specified before tapping; 2. The spindle selection signal for rigid tapping is not sent properly; 3. Rigid tapping is not specified by M29 or other M codes, or parameter No. 5200 is not set to 1; 4. In spindle Cs contour control, the corresponding servo axis number is incorrect. Please refer to parameter 8133#2 or 3704#7, #6. Modify the program or check the PLC.
197	C axis command error in spindle mode	When signal CON (G27#7) is OFF, CS contour controlled axis is commanded to move. Modify the program or find the reason why the signal is not ON in ladder diagram.
198	Spindle speed arrival signal not found	During cutting feed, the spindle speed arrival signal SAR is not valid. Modify the program or check the ladder diagram.
201	Incorrect command used in macro program	An unusable function is specified in custom macro program. Modify the program.
202	Format error in macro program	There is a format error in <Formula>. Modify the program.
203	Illegal variable number is used in macro program.	A value not defined as variable number is designated in the custom macro. Modify the program.
204	Macro program call repetition	M98, G65 or G66 is called in G66 modal state in the same program. Modify the program.
205	Bracket nesting error	The number of bracket nesting level exceeds 5. Modify the program.
206	Illegal operation data	The argument of SQRT is a negative value; The arguments of BCD and BIN are negative values, or the BIN argument value cannot convert to correct BCD code. Modify the program.
207	Excessive macro program modal call	Macro call or macro program modal call nesting exceeds 4 levels. Modify the program.
208	Branch of macro program cannot used in DNC and MDI operation	Branch of macro program is used in DNC and MDI operation. Modify the program.
209	End statement absent	DO-END is not 1: 1; the END block contains other illegal command or the branch cannot be made to a location within the loop. Modify the program.
210	Limited authority	Argument assignment cannot be executed in MDI or DNC mode due to limited authority. Modify the program.
211	Illegal repetition number	Condition $1 \leq n \leq 3$ is not fulfilled (n in Don). Modify the program.
212	NC statement and macro call statement coexist in the same block	NC statement and macro call statement are used. Modify the program.
213	Illegal macro sequence number	The defined sequence number in branch command is not within 1~99999, or they cannot be searched. Modify the program.
214	Illegal argument address	An unallowable address is specified in <argument>. Modify the program.
215	Tool radius direction data error	The custom macro data used for tool radius direction input should be in the range of 0~9 after rounded. Please modify the macro statement.

No.	Message	Contents
216	Illegal argument value	The argument value is erroneous or illegal. Modify the program.
217	Data error in logical operation command	The data in logical operation command OR, XOR, AND are negative values. Modify the program.
218	G67 modal call cancel is commanded	When G66 macro modal call is not specified, G67 modal call cancel is commanded. Check if it is necessary to write G66 command. Please refer to parameter 6000#0G67 and modify the program.
231	The axis commands of NC and PLC compete with each other	The axis commands of NC and PLC compete with each other. Modify the program or ladder diagram.
232	PLC controlled axis unchangeable	PLC axis selection has been made among the PLC controlled axes. Modify the Ladder Diagram.
251	The intersection point cannot be determined in tool nose radius compensation mode	The intersection point cannot be determined in tool nose radius compensation mode. Modify the program.
252	Tool nose radius compensation mode cannot be set or canceled in circular interpolation	Tool nose radius compensation mode is set or canceled in circular interpolation. Modify the program.
253	Compensation plane switching is not allowed in tool nose radius compensation	Compensation plane is changed in tool nose radius compensation mode. Modify the program.
254	Interference is generated in circular block in tool nose radius compensation mode	In tool nose radius compensation mode, the start point or end point of an arc is the same as the center point, or the end point is not on the arc, which may cause overcut. Modify the program.
255	In tool nose radius compensation mode, interference occurs in G90 or G94 block	Overcut may occur when tool nose radius compensation is commanded in G90 or G94 block. Modify the program.
256	Overcut occurs during interference check in tool nose radius compensation mode	The overcut may occur in tool nose radius compensation mode. Modify the program.
257	The cutter path direction is different with the programmed path direction in tool nose radius compensation mode.	The tool path direction is different with the programmed path direction in tool nose radius compensation mode (90°~270° difference). Overcut may occur. Modify the program.
258	G41 or G42 execution is not allowed in MDI mode	G41 or G42 (tool nose radius compensation) is specified in MDI mode. Please refer to parameter 5008#4 MCR and modify the program.
259	Overcut is produced within the cutting full circle	Overcut is produced within the cutting full circle in tool nose radius compensation mode. Please refer to parameter 5008#5 CNF and modify the program.
260	Overcut may be produced when a step less than the tool radius is machined	In tool nose radius compensation mode, overcut may be produced when a step less than the tool radius is machined. Please refer to parameter 5008#6 CNS and modify the program.
261	The circular radius is less than the tool radius when an inner circle is machined	In tool nose radius compensation mode, overcut may occur if the circular radius is less than the tool radius when an inner circle is machined. Modify the program.
262	Circular command occurs when tool nose radius	In tool nose radius compensation mode, when G command for which the compensation mode needs to

No.	Message	Contents
	compensation is temporarily cancelled or set	be temporarily cancelled is specified, circular command is specified to set or cancel the compensation mode. Modify the program.
263	Error is found in tool nose radius compensation mode	Programming error or operation error is found in tool nose radius compensation mode. Modify the program.
271	Chamfering or corner R cannot be specified in the current block	Chamfering or corner R is needed to be specified in G01, G02, G03 modal commands.
272	Chamfering or corner R is not followed by G01G02/G03 modal commands	Commands other than G01G02/G03 are specified after chamfering or corner R blocks. Modify the program.
273	Unneeded axis address follows chamfering or corner R	The movement axis in the block which is behind the block that specifies chamfering or corner R is not the axis specified by panel. Modify the program.
274	Panel selection command is specified after chamfering or corner R	Panel selection command is specified after chamfering or corner R. Modify the program.
275	The movement amount in chamfering block or corner R block is too small	The movement amount in chamfering block or corner R block is smaller than chamfering amount or corner R. Modify the program.
276	Data error in chamfering or corner R	Data is erroneous in chamfering or corner R. Modify the program.
281	Illegal tool group number	The tool group number is larger than permitted. Modify the program.
282	Tool group number not found	The specified tool is not set. Modify the program or parameter.
283	Low capacity for tool storage	The tool number in one group exceeds the maximum amount. Modify the program.
284	T code not found	In tool lift management storage, specified T code is not stored. Modify the program.
285	P/L command not found	P and L commands are not at the head of the program which sets the tool group. Modify the program.
286	Too many tool groups	The set tool group number exceeds the maximum amount. Modify the program.
287	Illegal tool life data	The tool life value is too large. Modify the setting value.
288	Tool data setting uncompleted	When the tool life data is setting, the power is turned off. Set the data again.
289	Tool life management command not matched	T $\square\square$ 99 is not specified or T $\square\square$ 99 is incorrect before T $\square\square$ 88 is used. Modify the program.

## A.2 Parameter Alarms

No.	Message	Contents
400	Parameter writing is enabled	Press <b>【RESET】</b> key to cancel the alarm.
401	The same servo communication property is set.	Please modify parameter No.9020.
402	Parameter backup failure	Please check the memory or re-power on.
403	Parameter recovery failure	Please check if the parameter is being writing, or re-power on and try it again.

No.	Message	Contents
404	The same axis name is set.	Modify the parameter NO.1020.
406	The slave numbers of non-Cs axis and spindle are set the same	Modify parameter No. 3704, No.8133, No.9020, No.9030.
407	The slave numbers Cs axis and spindle are inconsistent	Modify parameter No.3704, No.8133, No.9020, No.9030
408	The slave numbers of spindle is set the same	Modify parameter No. 9030
450	Parameter modification is done, please re-power on.	The input parameter is valid only after re-power-on.
452	The CNC controlled axis number is greater than the total axis number.	Please check parameter No. 1010 and 8130.
453	The same axis property is set.	Modify parameter No. 1022.
454	The same servo axis number is set.	Modify parameter No. 1023.
455	The rotary axis is conflicting with the axis property.	Parameter No.1006 conflicts with parameter No. 1022. The axis property of rotary axis cannot be non-0 value. Modify parameters No. 1006 or No. 1022.

### A.3 Pulse Encoder Alarms

No.	Message	Contents
500	n-th axis origin return (n represents axis number)	Manual reference position return is required for the n-th axis.
501	The n-th axis communication error	n-th axis absolute pulse encoder (APC) communication error; Failure in data transmission. Possible causes include a faulty APC, cable, or servo interface module.
502	The n-th axis overtime	n-th axis APC overtime error; Failure in data transmission. Possible causes include a faulty APC, cable or servo interface module.

### A.4 Servo Alarms

No.	Message	Contents
604	n-th axis servo alarm	Faulty digital servo system of n-th axis
650	Power failure alarm	The power is turned off when the movement command is executed by the servo. It may lead to incorrect coordinate position. Please perform reference point return again.

## A.5 Overtravel Alarms

No.	Message	Contents
700	n axis + side stroke limit 1	The positive stored stroke limit 1 has been exceeded. Modify the parameter No. 1320 or 1326.
701	n axis - side stroke limit 1	The negative stored stroke limit 1 has been exceeded. Modify the parameter No. 1321 or 1327.
702	n axis + side stroke limit 2	The positive stored stroke limit 2 has been exceeded. Modify the parameter No. 1322.
703	n axis - side stroke limit 2	The negative stored stroke limit 2 has been exceeded. Modify the parameter No. 1323.
704	n axis + side stroke limit 3	The positive stored stroke limit 3 has been exceeded. Modify the parameter No. 1324.
705	n axis - side stroke limit 3	The negative stored stroke limit 3 has been exceeded. Modify the parameter No. 1325.
706	Overtravel: +n	The positive hardware stroke limit has been exceeded. Please press overtravel release or modify parameter No. 3004.
707	Overtravel : -n	The negative hardware stroke limit has been exceeded. Please press overtravel release or modify parameter No. 3004.
708	Excessive shift	Pulses exceed the limit that FPGA can manage. Please specify a lower speed or modify the CMR.

## A.6 Spindle Alarms

No.	Message	Contents
800	Spindle 1 alarm	Spindle 1 alarm occurs.
810	Spindle 2 alarm	Spindle 2 alarm occurs.
850	GSKLinkB spindle speed command communication error.	
851	GSKLinkB feed axis command communication error.	
852	GSKLinkB feed axis command execution error.	

## A.7 System Alarms

No.	Message	Contents
900	Memory alarm	Memory distribution error
908	NVRAM data error	NVRA data is not exit or ruined. Data that backed up has been recovered automatically.
909	The running time is up. The system cannot work normally	Please contact the sales personnel.
910	Initialized parameter error	Parameter file is not existed or the data is corrupted. The default configuration is used.
911	Initialized CNC configuration error	CNC configuration file is not existed or the data is corrupted. The default configuration is used.
912	Initialized tool compensation data error	The tool compensation file is not existed or the data is corrupted. The default data is used.

913	Initialized tool life data error	Tool life file is not existed or the data is corrupted. The default data is used.
914	Initialized pitch error compensation data error	The pitch error compensation data file is not existed or the data is corrupted. The default data is used.
915	Initialized PLC program error	File read failure or compilation error during loading
916	CNC initialization failure	Turn ON the power again
917	GSK-CAN initialization failure	(1). Check whether the baudrates of CNC and slave is consistent (parameter No. 9010 and 9011). (2). Check whether the slave number is consistent (parameter No. 9020 and 9030). (3). Check whether the communication interface is loose, power well grounded or end resistor installed. Press <b>【RESET】</b> key to cancel the alarm or re-power on.
918	Editing keyboard or panel fault	Press <b>【RESET】</b> key to cancel the alarm, or re-power on.
919	Memory fault	Remove the alarm by pressing RESET key. Please re-power on or resort to depot repair.
920	Too many alarms or prompts	The total number of alarms exceeds 14 or prompts exceed 20.
921	Unrecognized alarm number	There is no alarm content corresponds to the alarm number.
922	Data error in alarm information	In alarm information or operation information, some data are erroneous.
923	PLC alarm information table error	The alarm num specified is not found in PLC alarm information table or out of the range 1000~2999. Modify the PLC alarm information table.
950	The pulse number inconsistent	The FPGA pulse number send from the system is inconsistent with the actual feedback pulse number.
998	Abnormal data	Please contact system developer.

## A.8 Operation Panel Communication Prompts

No.	Message	Contents
4200	Panel communication error	Check the connection between panel and the system.
4201	Edit keyboard communication error	Edit keyboard and system communication error;

## A.9 GSK-CAN Communication Prompts

No.	Message	Contents
5000	GSK-CAN slave configuration method error	GSK-CAN extended function unusable.
5001	I/O unit missing in GSK-CAN communication	The IO unit control function is unusable.
5002	Extended slave is missing in GSK-CAN communication	The extended axis function is unusable.
5003	GSK-CANA	Please check whether the communication interface is

No.	Message	Contents
	communication error	loose, the power supply grounded properly, or the end resistance installed, then, turn on the power.
5004	GSK-CAN slave ID number conflicted	Modify the parameter for slave number and re-power on (cut off the GSK-CAN connection before parameter modification at the server side)
5005	All GSK-CAN slaves connections failure	Check the setting of parameter No.9000-No.9030 and check whether the communication interface is loose, the power supply grounded properly or the end resistance installed, then turn ON the power again.
5006	n-th axis GSK-CAN slave connection failure	Check whether the communication interface is loose or the power supply grounded properly.
5020	n-th servo parameter read failure	Please check whether the communication interface is loose or the power supply grounded
5021	IO unit is missing in GSK-CANB communication	GSK-CANIO unit control function cannot be used.
5022	Slave is missing in GSK-CANB communication	GSK-CAN extension axis cannot be used.
5023	GSK-CANB communication error	Check whether the communication interface is loose, the power grounded or terminating resistor installed. Then, re-connect the interface or re-power on.
5024	GSK-CANB slave ID repetition	Re-power on after modifying the slave number on drive unit (disconnect with GSK-CAN before modification)
5025	n-th axis GSK-CANB slave connection failure	Check the setting of parameters No. 9000-9030; then check whether the communication interface is loose, power is grounded or the terminating resistor is installed; then try to re-power on or re-connect the interface.
5026	n-th axis GSK-CANB slave connection failure	Check whether the communication interface is loose, power is grounded or the terminating resistor is installed; then try to re-power on or re-connect the interface.
5027	Physical disconnection between CNC and servo slave	Check whether the servo is in normal state; then check whether the communication interface is loose, power is grounded or the terminating resistor is installed; then try to re-power on or re-connect the interface.
5028	n-th axis servo dsp hardware reset	Check whether the servo is in normal state. Re-power on or re-connect after troubleshooting.
5029	Communication overtime	Servo does not receive data from master in n millisecond (n=200)
5030	n-th axis servo slave communication failure	Check whether the servo is in normal state.
5050	n-th axis servo type and software version read failure	Try to re-connect or re-power on.
5051	n-th axis servo configuration failure	Update corresponding servo configuration files and re-connect or re-power on.
5052	n-th axis servo configuration file has updated	The corresponding configuration file is being used. Reconnect or re-power on to validate it.
5060	n-th axis servo parameter read failure	Try to re-connect or re-power on.
5061	Nth axis servo parameter	Validate the servo parameters in the imported



No.	Message	Contents
	has imported	parameter files. Before that, the current running parameters cannot be saved.
5070	n-th axis CNC servo parameter is inconsistent with the read parameter	Select a valid servo parameter.
5071	n-th production servo parameter inconsistent	The detected production parameter in CNC servo parameter file is inconsistent with the read servo parameter (such as encoder zero-shift, driver version etc.).
5080	Parameter is changing in double speed motor	Data is in processing, please wait.

## A.10 Servo Internal Alarms

- Note:** (1). n represents the sequence number of GSK-CAN servo slaves set by system parameters (ranges from 1~9).
- (2). The examples shown in the following table are feed servo V1.03 and spindle V2.02. Previous versions are compatible.
- (3). The following content is valid till this user manual is issued and it is changed without further notice. Please refer to the latest servo manual.

Feed Servo	DAT2030C, DAT2050C, DAT2075C, DAT2100C (V1.03)	
No.	Message	Contents
5n00	Normal	
5n01	Overspeed	The speed of servo motor exceeds the setting value.
5n02	Overvoltage	The main voltage is too high.
5n03	Undervoltage	The main voltage is too low.
5n04	Excess position deviation	The position deviation value exceeds the setting value.
5n05	Overheat	The temperature of the motor is too high.
5n06	Speed amplifier saturated	The speed regulator is saturated for a long time.
5n07	Drive unit inhabitation abnormal	The drive unit input inhabitation is OFF.
5n08	Position deviation counter overflow	The absolute value of position deviation counter value exceeds $2^{30}$ .
5n09	Coder fault	Coder signal error
5n10	Undervoltage of control power	The voltage of the control power is less than $\pm 12V$ .
5n11	IPM module fault	IPM intelligent module fault
5n12	Overcurrent	The current of the motor is excessive.
5n13	Unused	
5n14	Braking fault	Braking circuit fault
5n15	Unused	
5n16	Motor overheat	The heat value of the motor exceeds the setting

		value. (I <sup>2</sup> t detection)
5n17	Unused	
5n18	Unused	
5n19	Unused	
5n20	EEPROM error	(EEPROM) error
5n21	Phase lose alarm	Phase lose during the three-phase AC current input
5n22	Coder zeroing alarm	The encoder cannot perform normal regulation.
5n23	Current sampling circuit fault	A/D chip or current sensor error
5n24	Unused	
5n25	Unused	
5n27	Unused	
5n28	Software upgrade prompt alarm	The alarm is issued when the system software is upgrading.
5n29	Parameter error	The parameter is out of the controllable range.
5n30	Unused	
5n31	Unused	
5n32	Illegal code in UVW signal	Full high-level or full low-level exists in UVW signal.
5n33	Power charging fault	Charging circuit is damaged.
5n34	Pulse electronic gear ratio excessive	The parameter of pulse electronic gear ratio is incorrect.
5n35	No externally connected brake pipe	There is no externally connected brake pipe or the pipe is faulty.
5n36	Three-phase power OFF	Three-phase power OFF or three-phase power detection circuit is faulty.
5n37	The temperature of the radiator is too low	
5n38	The temperature of the radiator is too high	
5n39	Absolute encoder single-ring read alarm	
5n40	Absolute encoder multi-ring read alarm	
5n41	Encoder type configuration error	The encoder type set by drive unit is inconsistent with the encoder type of the motor.
5n42	EEPROM alarm in absolute encoder	
5n43	EEPROM check error in absolute encoder	
5n44	Coder type error	Please check parameter No.PA97.
5n45	Data check error in absolute encoder	Data check error in sensor mode.

Spindle Servo	DAY3025C, DAY3100C, DAP03C		
	No.	Message	Contents
	5n00	Normal	
	5n01	Motor overspeed	The speed of the spindle motor exceeds the setting value.
	5n02	Main circuit overvoltage	The voltage of the main circuit power is excessive.
	5n03	Main circuit undervoltage	The voltage of the main circuit power is too low.
	5n04	Excess position deviation	The position deviation value exceeds the setting value.
	5n05	Motor overheat	The temperature of the motor is too high.
	5n06	Unused	
	5n07	Unused	
	5n08	Position deviation counter overflow	The absolute value of position deviation counter value exceeds 2 <sup>30</sup> .
	5n09	Motor encoder fault	The signal of motor encoder is faulty.
	5n10	Unused	
	5n11	IPM module fault	IPM intelligent module fault
	5n12	Unused	
	5n13	Overload	The current of the motor is excessive.
	5n14	Unused	
	5n15	Unused	
	5n16	Motor overheat	The spindle servo drive unit and motor are overloaded (temporary overheat).
	5n17	Excess braking time	This alarm is issued when the discharging time is too long.
	5n18	Braking circuit fault 1	No braking signal, no braking feedback
	5n19	Braking circuit fault 2	No braking signal, no braking feedback
	5n20	EEPROM error	EEPROM error
	5n21	Phase lose alarm	At least one of the R,S,T of three-phase power is off.
	5n22	Unused	
	5n23	Excessive current error	The zero drift is excessive.
	5n24	Spindle encoding disk fault	The spindle encoder signal error
	5n25	Orientation failure	The position cannot be found.
	5n26	Cooling fans overheated	The cooling fans are overheated.
	5n27	U, V, W connection error	The three-phase (U, V, W) sequence is wrong
	5n28	The parameters are not re-adjusted or stored after upgrading	
	5n29	The parameter value detected after power-on is out of the range	
	5n30	Communication error	The connection between servo and CNC is failed.

5n31	Unused	
5n32	Unused	
5n33	Charging alarm fault	The input voltage is less than 304V (DC bus voltage 430V).
5n34	Abnormal thermistor status	TEP-OH (TEM higher than 90°) or TEP-OL(TEP lower than -30°), the thermistor is short-circuited or cut off.

## APPENDIX B MOTOR TYPE CODE LIST

## B.1 DAT2000C Series Motor Model Code List

DAT2050C(5.03)			
Model Code Value	Model	Model Code Value	Model
PA001=0	130SJT-M075D(A4)	PA001=3	130SJT-M100D(A4S)
PA001=1	130SJT-M075D(A4S)	PA001=4	130SJT-M150D(A4)
PA001=2	130SJT-M100D(A4)	PA001=5	130SJT-M150D(A4S)

DAT2075C(5.03)			
Model Code Value	Model	Model Code Value	Model
PA001=0	130SJT-M075D(A4)	PA001=3	130SJT-M100D(A4S)
PA001=1	130SJT-M075D(A4S)	PA001=4	175SJT-M300D(A4)
PA001=2	130SJT-M100D(A4)	PA001=5	175SJT-M300D(A4S)

DAT2000C(V1.03)			
Model Code Value	Model	Model Code Value	Model
PA001=0	Reserved	PA001=43	130SJT-M050D(A4SI)
PA001=1	Reserved	PA001=44	130SJT-M060D(A4I)
PA001=2	Reserved	PA001=45	130SJT-M060D(A4SI)
PA001=3	Reserved	PA001=46	130SJT-M075D(A4I)
PA001=4	80SJT-M024C(A4I)	PA001=47	130SJT-M075D(A4SI)
PA001=5	80SJT-M024C(A4SI)	PA001=48	130SJT-M100B(A4I)
PA001=6	80SJT-M024E(A4I)	PA001=49	130SJT-M100B(A4SI)
PA001=7	80SJT-M024E(A4SI)	PA001=50	130SJT-M100D(A4I)
PA001=8	80SJT-M032C(A4I)	PA001=51	130SJT-M100D(A4SI)
PA001=9	80SJT-M032C(A4SI)	PA001=52	130SJT-M150B(A4I)
PA001=10	80SJT-M032E(A4I)	PA001=53	130SJT-M150B(A4SI)
PA001=11	80SJT-M032E(A4SI)	PA001=54	130SJT-M150D(A4I)
PA001=12	Reserved	PA001=55	130SJT-M150D(A4SI)
PA001=13	Reserved	PA001=56	Reserved
PA001=14	Reserved	PA001=57	Reserved
PA001=15	Reserved	PA001=58	Reserved
PA001=16	Reserved	PA001=59	Reserved
PA001=17	Reserved	PA001=60	Reserved
PA001=18	Reserved	PA001=61	Reserved
PA001=19	Reserved	PA001=62	Reserved
PA001=20	110SJT-M020E(A4I)	PA001=63	Reserved
PA001=21	110SJT-M020E(A4SI)	PA001=64	Reserved
PA001=22	110SJT-M040D(A4I)	PA001=65	Reserved
PA001=23	110SJT-M040D(A4SI)	PA001=66	Reserved
PA001=24	110SJT-M040E(A4I)	PA001=67	Reserved

PA001=25	110SJT-M040E(A4SI)	PA001=68	175SJT-M150D(A4I)
PA001=26	110SJT-M060D(A4I)	PA001=69	175SJT-M150D(A4SI)
PA001=27	110SJT-M060D(A4SI)	PA001=70	175SJT-M180B(A4I)
PA001=28	110SJT-M060E(A4I)	PA001=71	175SJT-M180B(A4SI)
PA001=29	110SJT-M060E(A4SI)	PA001=72	175SJT-M180D(A4I)
PA001=30	Reserved	PA001=73	175SJT-M180D(A4SI)
PA001=31	Reserved	PA001=74	175SJT-M220B(A4I)
PA001=32	Reserved	PA001=75	175SJT-M220B(A4SI)
PA001=33	Reserved	PA001=76	175SJT-M220D(A4I)
PA001=34	Reserved	PA001=77	175SJT-M220D(A4SI)
PA001=35	Reserved	PA001=78	175SJT-M300B(A4I)
PA001=36	Reserved	PA001=79	175SJT-M300B(A4SI)
PA001=37	Reserved	PA001=80	175SJT-M300D(A4I)
PA001=38	Reserved	PA001=81	175SJT-M300D(A4SI)
PA001=39	Reserved	PA001=82	175SJT-M380B(A4I)
PA001=40	130SJT-M040D(A4I)	PA001=83	175SJT-M380B(A4SI)
PA001=41	130SJT-M040D(A4SI)	PA001=84	Reserved
PA001=42	130SJT-M050D(A4I)	PA001=85	Reserved

## B.2 DAP03C, DAY3025C Model Code List

DAP03C, DAY3025C			
Model Code Value	Model	Model Code Value	Model
PA001=0	GM7101-4SB61, 3.7kW	PA001=16	ZJY265-7.5A-B3(21.0A)
PA001=1	GM7103-4SB61, 5.5kW	PA001=17	ZJY182-1.5B-B35(7.3A)
PA001=2	GM7105-4SB61, 7.5kW	PA001=18	ZJY182-2.2B-B35(7.5A)
PA001=3	GM7131-4SB61, 11kW	PA001=19	ZJY182-3.7B-B35(15.5A)
PA001=4	GM7103-4SC61, 7.5kW	PA001=20	ZJY208-2.2B-B5(B3)(6.3A),
PA001=5	GM7100-4SB61, 2.2kW	PA001=21	ZJY208-2.2B-B5(B3)(9.3A)
PA001=6	GM7109-4SB61, 11kW	PA001=22	ZJY208-3.7B-B5(B3)(9.1A)
PA001=9	YPNC-50-2.2-B, 2.2kW	PA001=23	ZJY208-5.5B-B5(B3)(13.2A)
PA001=10	YPNC-50-3.7-B, 3.7kW	PA001=24	ZJY208-7.5B-B5(B3)(17.3A)
PA001=11	YPNC-50-5.5-B, 5.5kW	PA001=25	ZJY265-7.5B-B5(B3)(18A)
PA001=12	YPNC-50-7.5-B, 7.5kW	PA001=26	ZJY265-11B-B5(B3)(26A)
PA001=13	YPNC-50-11-B, 11kW	PA001=27	ZJY265-15B-B5(B3)
PA001=14	YPNC-50-15-B, 15kW	PA001=28	ZJY265-15A-B5(B3)(48.3A)

## APPENDIX C COMMON ALARM REMEDY

## C.1 CNC Common Alarm Remedy

No.	Meaning	Possible Reason	Remedy
000	Emergency stop, ESP open circuit	1. Whether the emergency button is pressed.	Modify the parameter or check the connection status.
		2. Incorrect connection	
		3. Parameter No. 3007#7 (ESP) is set different from the actual connection.	
		4. Parameter K10.7 is set different from the actual connection.	
001	Part program open failure	Program is not downloaded before the running in AUTO mode.	Download the program to be executed.
400	Parameter writing enabled	Parameter writing is enabled.	Press RESET key to cancel the alarm
450	Parameter modification finished, turn ON the power again	Parameter is modified and is only valid after power-on again.	Turn ON the power again.
500	The nth axis reference point return	The feed axis whose motor adopts absolute encoder did not perform manual reference point operation after power-on.	Execute reference point return for corresponding axis.
604	The nth axis servo alarm	Digital servo system fault	Check and cancel servo alarm.
917	GSK-CAN initialization failure	1. The servo slave number set by system parameter is inconsistent with the one set in servo system.	Modify the parameter and check the communication line status.
		2. GSK-CAN Communication line is connected improperly.	

## C.2 GSK-CAN Communication Prompts

No.	Message	Possible Reason
5003	GSK-CANA communication error	During GSK-CAN communication, if error continuously occurs in all slaves, this prompt is displayed. Try re-connect, or power on again;
5004	GSK-CANA slave ID number conflicted	This prompt is displayed when two slave numbers of servos are set the same. Modify the servo slave number;
5005	All GSK-CANA slaves connections failure	When GSK-CAN is restarted or re-connected, all the slaves are cut OFF. The possible reasons are: (1). Parameter Nos. 9000-9003 setting error;

No.	Message	Possible Reason
		(2). Poor contact of system GSK-CAN communication interface; (3). Poor contact of servo slave GSK-CAN communication interface; (4). End resistor is not installed on the servo slave which is the farthest from the system; (5). GSK-CAN communication is interrupted; (6). Power supply is not grounded;
5006	n-th axis GSK-CANA slave connection failure	The same as the prompt No. 5005, but this prompt indicates that only some slaves' connection is failed.
5023	GSK-CANB communication error	During GSK-CAN communication, if error continuously occurs in all slaves, this prompt is displayed. Try re-connect, or power on again;
5024	GSK-CANB slave ID number conflicted	This prompt is displayed when two slave numbers of servos are set the same. Modify the servo slave number;
5025	All GSK-CANB slaves connections failure	When GSK-CAN is restarted or re-connected, all the slaves are cut OFF. The possible reasons are: (1). Parameter No. 9000-9003 setting error; (2). Poor contact of system GSK-CAN communication interface; (3). Poor contact of servo slave GSK-CAN communication interface; (4). End resistor is not installed on the servo slave which is the farthest from the system; (5). GSK-CAN communication is interrupted; (6). Power supply is not grounded;
5026	n-th axis GSK-CANB slave connection failure	The same as the prompt No. 5025, but this prompt indicates that only some slaves' connection is failed.
5027	Physical connection between CNC and servo slave failure	Check whether the servo is in normal state, the communication cable connected, the power supply grounding, or the terminal resistance installed. Then try re-connect, or power on again.
5028	n-th axis servo DSP reset	Check whether the servo is in normal state and correct the fault. Then try re-connect, or power on again.

### C.3 DAT Feed Servo Alarm Remedy

No.	Meaning	Main Reason	Remedy
<b>Err-1</b>	AC current motor speed exceeds the value set by PA23 (refer to the speed upper limit set by parameter PA23)	1, Encoder feedback signal abnormal	Check the motor encoder and its signal connection status.
		2. The specified command exceeds the limit set by PA23.	Check the electronic gear ratio and PA23 setting.
<b>Err-2</b>	Main circuit DC bus voltage excessive	1. Braking resistor is disconnected or damaged.	Check braking resistor and its connection.



No.	Meaning	Main Reason	Remedy
		2. Braking resistor is unmatched (resistance value is excessive) Note: Smaller resistance means greater current, which will easily cause damage to the braking pipe of the braking circuit.	A, Change to a new braking resistor whose resistance is matched with the power. B, Reduce the ON/OFF frequency according to actual usage.
		3. Power supply voltage instable;	Check the power supply.
		4. Internal braking circuit damaged.	Change the drive unit.
<b>Err-3</b>	Main circuit DC bus voltage too low	1. If it occurs when the motor is running, the line of input power is cut off or the connection is improper.	Check the input power line
		2. If it occurs when the motor is running, it means the input power voltage is lower than AC180V.	Check the power voltage
		3. If it occurs when the power is turned ON, it means the braking transistor of drive unit is damaged.	Change the drive unit
<b>Err-4</b>	The value in position difference counter exceeds the setting value (refer to the range set by parameter PA17); (When PA18=0, detects the position difference alarm, when PA18=1, does not detect the position difference alarm)	1. The pulse command frequency is too high or the electronic gear ratio is too large.	Check the command frequency of principal computer; check the electronic gear ratio set by PA12/PA13.
		2. The load inertial is excessive or the drive unit torque is insufficient.	A, Check the setting of motor torque limit. B, Improve the drive unit and motor power. C, Lighten the load.
		3. Motor encoder fault or encoder zeroing error.	A, Check the motor encoder and its connection. B, re-zeroing the encoder.
		4. In position mode, the motor U, V, W phase sequence is wrong.	Correct the connection.
		5. position loop or speed loop gain setting is too small (refer to parameter PA5, PA6, PA9)	Adjust the speed loop or position loop gain.
		6. The valid range of position difference is set too small.	Set the PA17 correctly.
<b>Err-5</b>	Motor overheat alarm; the drive unit	1. No temperature detection device in the motor.	Set PA57=0, shield the motor overheat alarm.

No.	Meaning	Main Reason	Remedy
	detects the overheat alarm signal output by the motor. (when PA57=0, the motor overheat alarm is not detected)	2. The temperature detection device type is different with the one set by parameter PA57.	Set the temperature detection device type correctly by PA57.
		3. Overload leads to severe heat of the motor.	Increase the power of drive unit or reduce the load.
		4. In case of severe load, the start/stop frequency is too high.	Reduce the start/stop frequency, and improve the heat radiation condition.
		5. The temperature detection device in the motor is damaged, or the motor inner fault occurs.	Change the AC servo motor.
		6. If the motor temperature detection signal is normal, the drive unit is faulty.	Change the drive unit.
<b>Err-6</b>	Speed amplifier saturation fault	1. Insufficient motor rigidness due to small torque limitation.	Increase the torque limitation value so as to increase the rigidness.
		2. In speed mode, U, V, W phase sequence is reversed.	Connect the U, V, W correctly.
<b>Err-7</b>	Drive prohibition abnormal	The drive prohibition input end terminals FSTP, RSTP are cut OFF.	A. Check the connection and the 24V power of input point.
<b>Err-9</b>	Motor encoder signal feedback abnormal	1. PA48 parameter setting is erroneous.	According to the matched encoder type, set the PA48 correctly and adjust to the default setting.
		2. The motor encoder signal is poor connectedly or the connection is wrong.	Check the connection and signal line welding status.
		3. Motor encoder signal feedback cable is too long, which reduces the signal voltage.	Shorten the cable length within 30m.
		4. Motor encoder is damaged.	Change the motor or encoder.
		5. Drive unit fault.	Change the drive unit.
<b>Err-11</b>	Drive unit inner IPM module fault	1. It occurs when the power is ON, and the drive unit is not enabled. It cannot be removed after power-on. A, drive unit fault B, Short circuit occurs when braking resistor terminal is grounding	Remedy for reason A is to change to a new drive unit. Remedy for reason B is to check the correct the braking resistor connection.

No.	Meaning	Main Reason	Remedy
		2. It occurs when the power is ON, and the drive unit is not enabled. It is removed after power-on again.	It may be caused by external interference or poor grounding. Check the grounding status and interference source.
		3. It occurs when the power is turned ON, and the drive unit is enabled. It cannot be removed after power-on. A. short circuit occurs among motor power line U, V, W, or between U, V, W and PE. B. Drive unit IPM module is damaged. C. Current sampling circuit of drive unit is cut off.	The remedy for reason A is to change the motor line or the motor. The remedy for reasons B, C is to change the drive unit.
		4. It occurs when the motor is starting or stopping and it can be removed after power-on. A, The default parameter of the motor set by drive unit is wrong. B. The load inertial is too large, the commanded accelerated speed is too large when starting or stopping.	The remedy for reason A is to recover the motor default parameter. The remedy for reason B is to increase the acceleration/deceleration time, lower down the accelerated speed or load inertial.
<b>Err-14</b>	Braking circuit fault	1. The braking circuit is low in capacity.	A. Reduce the load. B. Change to a new drive device of higher power. C, Lower down the braking frequency.
		2. The inner braking circuit is damaged.	Change to a new drive unit.
		3. Braking resistor is cut off.	Re-connect the braking resistor line.
<b>Err-16</b>	Motor thermal overheat	1. The rated current parameter is set incorrectly.	Set the parameter according to the motor nameplate.
		2. The motor is running with excess current for a long time.	A. Reduce the load. B. Change to a drive device and motor of higher power. C Check whether the mechanical part is abnormal.
<b>Err-20</b>	When the power is ON, EEPROM alarm occurs in the	1. When the power is ON, the drive unit fails to read the data in EEPROM.	Recover the motor default parameter.

No.	Meaning	Main Reason	Remedy
	inner driver unit.	2, EEPROM chips or circuit board fault;	Change the servo drive unit.
<b>Err-21</b>	Power open-phase alarm	Power open phase occurs.	Check the input power.
<b>Err-23</b>	Current sampling error	1. The current sensor's working voltage is abnormal or the device is damaged.	Change the drive unit.
		2. Current sampling circuit resistor is damaged.	
<b>Err-25</b>	Power failure alarm	1. The main power is cut OFF after it is ON.	Check the power supply line.
		2. The rectification part of the drive unit is damaged.	Change the drive unit.
<b>Err-32</b>	Illegal code of encoder signals U,V,W	1. PA48 parameter setting is erroneous.	According to the matched encoder type, set the PA48 correctly and adjust to the default setting.
		2. The interface is poorly contacted or the cable is poorly shielded.	Check the encoder interface and shielding line.
		3. Encoder U,V,W signals are damaged.	Change a new encoder.
		5. Encoder interface circuit fault.	Change to a new drive unit.
<b>Err-33</b>	Power charging fault	The charging circuit is damaged.	Change the drive unit.
<b>Err-34</b>	Pulse electronic gear ratio	The parameter setting of pulse electronic gear ratio is irrational.	Set the PA12/PA13 correctly.
<b>Err-35</b>	Alarm for the absence of external brake pipe	The external brake pipe is loose, or the external brake pipe is faulty.	Re-connect the brake pipe, or change the brake pipe.
<b>Err-36</b>	Three-phase main power OFF	1. The three-phase power is OFF.	Check the main power and ensure the three-phase AC220V input.
		2. The power detection circuit is faulty.	Change the drive unit.
<b>Err-37</b>	Alarm occurs when the temperature of radiator is below -30°C.	The environmental temperature is too low.	Improve the environmental temperature.
<b>Err-38</b>	Alarm occurs when the temperature is higher than 75°C.	1. The motor overload running for a long time.	Reduce the load.
		2. The environmental temperature is too high.	Improve the ventilation condition.
		3. The drive unit is damaged.	Change the drive unit.

No.	Meaning	Main Reason	Remedy
<b>Err-39</b>	Data read error in sensor mode of absolute encoder	1. PA48 parameter setting error;	Set the value of PA48 according to the matched encoder type of the motor, then, adjust to the default value.
		2. Encoder feedback signal CN2 is disconnected or poorly connected.	Check the CN2 line connection status.
		3. The absolute encoder is damaged.	Change the motor.
<b>Err-41</b>	Encoder type configuration error	The encoder type set by the drive unit is inconsistent with the actual type.	Change the encoder or change the encoder type of drive unit.
<b>Err-42</b>	EEPROM error read in absolute encoder	1. PA48 parameter setting error.	Set the value of PA48 according to the matched encoder type of the motor, then, adjust to the default value.
		2. When the power is ON, the drive unit reads encoder EEPROM error.	Check the CN2 line connection status.
		3. Motor encoder EEPROM is damaged.	Change the motor.
<b>Err-43</b>	Check error when EEPROM is read	1. PA48 parameter setting error;	Set the value of PA48 according to the matched encoder type of the motor, then, adjust to the default value.
		2. After the drive unit reads the encoder EEPROM, data check error occurs.	Execute the Ab-Set encoder write operation.
<b>Err-44</b>	Encoder single-ring/multi-ring configuration error	PA48 parameter setting error;	Set the value of PA48 according to the matched encoder type of the motor, then, adjust to the default value.
<b>Err-45</b>	Encoder data check error	In sensor mode, data check error occurs when the encoder current position is read.	Check the grounding status.

## C.4 Spindle Servo Alarm Remedy

No.	Meaning	Main Reason	Remedy
<b>Err-1</b>	The spindle motor speed exceeds the setting value (refer to the upper limit set by parameter PA23)	1. Encoder feedback signal is abnormal.	Check the motor or the second position encoder and its signal connection status.
		2. In speed mode, the acceleration/deceleration time constant is set too small, which lead to excessive speed overshoot.	Increase the accelerated time (PA39) or the decelerated time (PA40).
		3. Setting value of PA23 (maximum speed limit) is too small or the setting value of PA49 (motor encoder line number) is smaller than the actual encoder line number.	Set the PA23, PA49 value according to the motor nameplate.
		4. Control board is faulty.	Change the drive unit.
<b>Err-2</b>	The DC bus voltage of main circuit is too high	1. The brake resistor is disconnected or damaged.	Check brake resistor and its connection.
		2. The brake resistor is not matched (resistance is too large) Note: The smaller the brake resistance is, the larger the current of the brake circuit is, which will easily cause damage to the brake pipe.	A. Change to a brake motor whose resistor is matched with the power. B. Reduce the start/stop frequency according to the usage. C. Adjust the acceleration/deceleration time and speed mode according to the usage.
		3. The power voltage is instable.	Check the power supply.
		4. The internal brake circuit is damaged.	Change the drive unit.
<b>Err-3</b>	The DC bus voltage of main circuit is too low	1. The input voltage capacity is not enough, which leads to the low voltage.	Check the power capacity and electric part of the control cabinet.
		2. If it occurs when the power is ON, it means the drive unit control board is faulty.	Change the drive unit.
<b>Err-4</b>	The value of position deviation counter exceeds the setting value (refer to the	1. The pulse command frequency is too high or the set electronic gear ratio is too large.	Check the command frequency on principal computer and the electronic gear ratio set by PA12/PA13.

No.	Meaning	Main Reason	Remedy
	position deviation detection range set by PA17) (PA18=0: detects the alarm of position deviation; PA18=1 : does not detect the alarm of position deviation)	2. The load inertial is excessive, or the torque is insufficient.	A. Check the overload magnification setting of the motor. (refer to PA34) B. Increase the power of the drive unit and the motor. C. Reduce the load.
		3. The motor encoder is faulty or the encoder line number setting is erroneous.	Check the motor encoder and its connection status; check the setting of PA49.
		4. The U, V, W phase sequence is erroneous, and	Exchange any two phases.
		5. When the second position encoder is used, PA68 is set incorrectly; the feedback signal is abnormal.	Check the setting of PA68.
		6. The position loop or speed loop gain setting is too small. (refer to PA5, PA6, PA9);	Adjust the speed loop or position loop gain.
		7. The valid range of position deviation is set too small.	Set PA17 correctly.
<b>Err-5</b>		Motor overheat alarm; the drive unit detects the overheat alarm signal output by the motor. (PA73=0: detects the motor overheat alarm; PA73=1: does not detect the overheat alarm)	1. There is no temperature detection device in the motor.
	2. Overload leads to severe heat of the motor.		Increase the power of drive unit and motor or reduce the load.
	3. In overload condition, the start/stop frequency is too high.		Reduce the start/stop frequency, and improve the motor heat radiation condition.
	4. The motor temperature detection device is damaged, or the motor inner is faulty, or the cooling fan is damaged.		Change the spindle servo motor.
	5. If the temperature detection signal is normal, the drive unit control board is faulty.		Change the drive unit.
<b>Err-8</b>	Position deviation counter overflow	1. The electronic gear ratio is too large.	Check the setting of parameters PA12, PA13.
		2. Input command pulse is abnormal.	Check the principal command pulse frequency.
<b>Err-9</b>	The encode signal feedback is abnormal.	1. The motor encoder signal is poorly connected or the connection is erroneous.	Check the connector and signal line welding status.
		2. The motor encoder signal feedback cable is too long, leading to low signal voltage.	Shorten the cable length within 30m.

No.	Meaning	Main Reason	Remedy
		3. Motor encoder is damaged.	Change the motor or the encoder.
		4. Drive unit control board is faulty.	Change the drive unit.
<b>Err-11</b>	Drive unit inner IPM module fault	1. It occurs when the power is ON, and the drive unit is not enabled. It cannot be removed after power-on. A, drive unit fault B, Short circuit occurs when braking resistor terminal is grounding	Remedy for reason A is to change to a new drive unit. Remedy for reason B is to check the correct the braking resistor connection.
		2. It occurs when the power is ON, and the drive unit is not enabled. It is removed after power-on again.	It may be caused by external interference or poor grounding. Check the grounding status and interference source.
		3. It occurs when the power is turned ON, and the drive unit is enabled. It cannot be removed after power-on. A. short circuit occurs among motor power line U, V, W, or between U, V, W and PE. B. Drive unit IPM module is damaged.	The remedy for reason A is to change the motor line or the motor. The remedy for reasons B is to change the drive unit.
		4. It occurs when the motor is started or stopped, and can be removed after power-on. A. The default parameter set by the drive unit is erroneous. B. The load inertia is too large; the command accelerated speed during start/stop is too large.	The remedy for reason A is to recover the motor default parameter. (refer to 4.4 section for the procedures); The remedy for reason B is to increase the acceleration/ deceleration time so as to reduce the command speed rate or the load inertia.
<b>Err-13</b>	Overload alarm when the motor is running	1. long time overcurrent;	Reduce the load.
		2. The parameter is set incorrectly. The motor may be accompanied with vibration or noise.	Adjust the parameter related to the motor performance (refer to the instruction to PA5, PA6, PA8, PA9, PA34)
		3. The setting value of PA49 is larger than the actual encoder line number.	Set the line number correctly.



No.	Meaning	Main Reason	Remedy
		4. Lines for U, V, W are connected incorrectly. The status after power-on is similar to the description in Err-27.	Exchange any two phases.
<b>Err-16</b>	Overload alarm when the motor is running	The motor is running in overload state for a long time (longer than the time in Err-13).	A. Reduce the load. B. Change to a drive device with higher power.
<b>Err-17</b>	Excessive braking time	1. The voltage of input power is too high for a long time.	Supply with the power which meets the need of drive unit working condition.
		2. The braking resistance is too large, and the energy cannot be released during braking, leading to the rise of inner DC voltage.	Change to a new braking resistor (refer to section 1.4.3);
<b>Err-18</b>	No feedback for the braking start signal	1. The brake circuit is faulty.	Change the drive unit.
		2. The braking resistance is too large.	Measure the resistance with a universal meter and adjust the resistance.
<b>Err-19</b>	Excessive DC bus voltage without braking	1. Braking circuit is faulty.	Change the drive unit.
		2. The braking resistor is loose or disconnected.	Check the connection status of the braking resistor.
<b>Err-20</b>	EEPROM alarm when the power is ON	1. When the power is ON, the drive unit fails to read the data in EEPROM.	Recover the motor default parameter. Refer to section 4.4 for the procedures.
		2. EEPROM chip or circuit is faulty.	Change the servo drive unit.
<b>Err-21</b>	R, S, T open phase alarm	1. The input power line is disconnected or the power is open-phase	A. Check the input power line; B. Check the input three-phase power.
		2. The input power circuit of drive unit is faulty.	Change the drive unit.
<b>Err-23</b>	Excessive current error	1. The current detection circuit is faulty.	Change the drive unit.
		2. The current sensor is damaged.	
		3. The voltage of control power supply is faulty.	
<b>Err-24</b>	The second position input signal of CN3 interface is abnormal.	1. Parameter PA66 is set to 1 when no second position feedback signal is received.	Set the PA66 to 0.
		2. The spindle encoder feedback signal is abnormal. (The reason is the same as described in Err-9)	A. Check the second position encoder signal connection line, welding status and plug connection status. B. Shorten the cable within 30m.

No.	Meaning	Main Reason	Remedy
<b>Err-25</b>	Drive unit positioning failure	1. No Z pulse signal is detected.	Check the connection of feedback input signal.
		2. Because of excess load inertia, the corresponding parameter is set incorrectly or the gain setting is too large.	Check relevant motor parameter values PA49, PA66, PA67. Relevant gain parameter PA5, PA6, PA8, PA9. (Refer to section 6.1 for the adjustment method.)
		3. When the positioning is performed with the second position input signal, the A/B phase sequence of spindle encoder is inconsistent with that of the motor encoder.	Modify parameter PA68 and reconcile the phase. Refer to instruction of parameter PA68 for details.
<b>Err-26</b>	Drive unit radiator overheat alarm	1. The radiator temperature is too high or the radiator fan is damaged.	Turn OFF the power and start the motor after cooling down. Check the radiator fan, clean the radiation passage and reduce the load.
		2. The temperature detection switch or circuit is damaged.	Change the drive unit.
<b>Err-27</b>	U, V, W connection error	The phase sequence of U, V, W is incorrect.	Exchange any two phases.
<b>Err-28</b>	Parameter for updating software erroneous	Parameters are not adjusted or saved after programming or software updating.	Re-call the default parameter and save them, then, turn on the power again.
<b>Err-29</b>	Parameter detection error after power-on	Conflict arises when the old version software is replaced by the new one.	Re-writer the parameter and turn ON the power again.
<b>Err-33</b>	Voltage of the main circuit is abnormal when the power is ON	1. At the power-on moment, the input power voltage is too low or it fluctuates greatly.	Check the input power.
		2. The rectifier is damaged or the soft-start circuit is faulty.	Change the drive unit.
<b>Err-34</b>	The temperature of radiating fan is abnormal. (Applied to DAY3025, DAY3100)	1. The temperature of the radiating fan is out of the range $-30^{\circ}\text{C} \sim 90^{\circ}\text{C}$ .	Lower down the temperature.
		2. The thermistor is abnormal.	Change the drive unit.