

May 1997  
Raleigh, NC USA



**MAGELiS™**  
**XBT Terminal and**  
**XBT-L1000 Software**

***Self-Teach Manual***

**CONTENTS**

INTRODUCTION .....	7
Objectives of This Manual .....	7
Conventions Used In This Manual .....	7
What You Need to Use This Manual .....	7
MAGELiS Terminology .....	8
MAGELiS Concepts .....	8
What Will I Use MAGELiS For? .....	8
What's Next? .....	9
MODULE 1: LEARNING ABOUT MAGELiS MODELS .....	11
MODULE 2: INSTALLING THE XBT-L1000 SOFTWARE .....	13
MODULE 3: CREATING AN APPLICATION .....	15
Step 1. Launch the XBT-L1000 Software .....	15
Step 2. Open a New Application .....	15
Step 3. Select an XBT Type .....	16
Step 4. Select a Protocol .....	16
Step 5. Enter Text on an Application Page .....	17
Step 6. Enter Variable Fields .....	18
Step 7. Create Links to Other Pages .....	19
Step 8. Entering Text and Variable Fields in Other Pages .....	20
Step 9. Modifying Variable Fields .....	22
Step 10. Create Alarm Pages .....	24
Step 11. Configure Terminal Parameters .....	25
Step 12. Configuring the Dialogue Table .....	26
Step 13. Setting Alarm Priority .....	27
Step 14. Saving the Application .....	28
Step 15. Using the XBT-L1000 Software to Work with Function Keys .....	28
MODULE 4: SIMULATING AN APPLICATION .....	29
MODULE 5: CONNECTING THE PC TO THE MAGELiS TERMINAL .....	31
MODULE 6: UPLOADING THE APPLICATION TO THE MAGELiS TERMINAL ...	33
MODULE 7: CONNECTING THE MAGELiS TERMINAL TO A PLC .....	35
MODULE 8: VIEWING AND ACKNOWLEDGING ALARMS .....	37
General Information About Alarm Pages .....	37
What Happens If an Alarm Occurs? .....	37
How Does Alarm Priority Work? .....	38
Viewing the Alarm List .....	38
MODULE 9: VIEWING AND PRINTING AN ALARM OR APPLICATION LOG .....	39
MODULE 10: PRINTING .....	41

APPENDIX A: MAGELIS CABLING .....	43
Electrical Connections .....	44
Serial Communication .....	45
Cable Pinouts .....	46
MAGELiS Terminal to PC (XBTZ905) Cable .....	47
MAGELiS to PC (XBTZ9052) Cable .....	47
MAGELiS to PC (XBTZ915) Cable .....	48
TSX17 to MAGELiS (XBTZ958) Cable .....	48
TSX07 to MAGELiS (XBTZ968) Cable .....	49
Modicon Micro to MAGELiS Cable .....	49
Compact 984 to MAGELiS Cable .....	50
Quantum (Modbus Port) to MAGELiS Cable .....	50
MAGELiS to Siemens Cable (RS 232 C, with 3964/3964R Protocol) .....	51
MAGELiS to Siemens Cable (RS 232 C, with AS 511 Protocol) .....	52
MAGELiS to Siemens Cable (RS 422, with 3964/3964R Protocol) .....	53
MAGELiS to Omron Cable (RS 232 C) .....	53
MAGELiS to Omron Cable (RS 422) .....	54
MAGELiS to Allen-Bradley Cable (RS 232 C) .....	55
MAGELiS to Modicon Cable (RS 232 C, with Modbus/JBUS Protocol) .....	55
MAGELiS to Modicon Cable (RS 422/485, with Modbus/JBUS Protocol) .....	56
APPENDIX B: ABOUT DIALOGUE TABLES .....	57
Contents of the Dialogue Table .....	58
Detailed Description of Dialogue Table Words .....	60
Wn to Wn+3: Terminal Keypad Image Table to PLC .....	60
Wn+4: Communication Control .....	60
Wn+5 to Wn+8: Terminal Date and Time To Be Sent To The PLC .....	61
Wn+9: Number of Page to be Displayed .....	61
Wn+10: Number of Last Field Entered .....	61
Wn+11: Last Alarm Accepted .....	61
Wn+12: Status .....	61
Wn+13: Log Occupancy Rate .....	62
Wn+14: Page Number to be Processed .....	62
Wn+15: Field to Enter .....	62
Wn+16: Print Command .....	62
Wn+17: Authorization .....	63
Wn+18: Reset Log .....	63
Wn+19 to Wn+20: LED Control .....	63
Wn+21 to Wn+22 .....	63
Wn+23: Lock System Keys .....	64
Wn+24: Lock Numeric Keys .....	64
Wn+25 to Wn+40: Alarm Table .....	65

Wn+41 to Wn+44: Terminal Date and Time To Be Sent To The PLC . . . . .	65
Wn+46: Free Format Printing Table . . . . .	65
Dialogue Functions . . . . .	65
Authorization Word . . . . .	66
Communication Control Word . . . . .	66
Real-Time Clock Control Words . . . . .	66
APPENDIX C: CHART OF XBT TERMINAL FUNCTIONS BY MODEL . . . . .	69
APPENDIX D: COMMUNICATION PROTOCOL INFORMATION . . . . .	71
XBT/PLC Communication Using UNI-TELWAY Protocol on RS-232 or RS-485 Links . . . . .	71
XBT/PLC Communication Using UNI-TELWAY Protocol on an XBT-Z 958 Link . . . . .	71
XBT/PLC Communication Using MODBUS or JBUS Protocol . . . . .	71
XBT/PLC Communication Using Siemens (3964/3964R) Protocol . . . . .	72
XBT/PLC Communication Using Allen-Bradley (DF1) Protocol . . . . .	72
XBT/PLC Communication Using OMRON (SYSMAC-WAY) Protocol . . . . .	73
APPENDIX E: SAMPLE APPLICATION . . . . .	75
APPENDIX F: MENUS AND ICONS USED IN XBT-L1000 SOFTWARE . . . . .	83
APPENDIX G: PC KEYBOARD SHORTCUTS FOR USING XBT-L1000 SOFTWARE . . . . .	85
System Keys . . . . .	85
Menu Keys . . . . .	85
Dialog Box Keys . . . . .	85
APPENDIX H: XBT-L1000 SOFTWARE MENU TREE . . . . .	87
The MAGELiS Software Menu Options . . . . .	87
File Options . . . . .	87
Edit Options . . . . .	87
View Options . . . . .	87
Page Options . . . . .	88
Configuration Options . . . . .	88
Transfer Options . . . . .	89
Simulation Options . . . . .	89
Window Options . . . . .	89
MAGELiS Application Configuration Options . . . . .	90
APPENDIX I: ERROR MESSAGES AND ELEMENTARY TROUBLESHOOTING . . . . .	91
Error Messages . . . . .	91
Possible Problems . . . . .	93
APPENDIX J: WHERE TO GET MORE INFORMATION AND MAGELIS TECHNICAL ASSISTANCE . . . . .	95



## INTRODUCTION

This brief manual will help you learn how to use the MAGELiS™ XBT Terminals and the XBT-L1000 programming software.

Use this manual with the Telemecanique *XBT MAGELiS Range User Manual* (#XBTX000US). As you proceed through the lessons in this book, look for this icon:



This symbol points you to certain pages or sections of that manual which explain concepts or background information in detail.

### Objectives of This Manual

When you have completed the modules in this manual, you will have learned how to:

- Load the XBT-L1000 software on a PC
- Create a new MAGELiS application using the software
- Connect the PC containing the new application to a programmable logic controller (PLC)
- Simulate the application on the PC
- Upload the application to the MAGELiS terminal
- Connect the MAGELiS terminal to a PLC
- View and acknowledge alarms
- Print alarm logs and application pages

### Conventions Used In This Manual

The following typographical conventions are used in this manual:

- **Bold face type** indicates a menu option or selection to be made.
- *Italic type* indicates a window or dialog box name. *Italics* are also used for the titles of documents.

### What You Need to Use This Manual

This manual is designed to be used as a companion to the Telemecanique *XBT MAGELiS Range User Manual* (#XBTX000US).

To use this self-teach manual most effectively, you should have the following:

- Knowledge of the PLC memory layout, register identification, and program structure

- An IBM®-compatible PC, 386 SX, 386 DX, 486 SX, 486 DX, or Pentium®
  - A hard disk with a minimum of 40 Mb available
  - A minimum of 4 Mb of RAM
  - A high-density floppy disk drive (1.44 Mb)
  - VGA or Super VGA monitor
  - Serial port for terminal connection
  - Mouse
  - DOS (minimum: DOS 3.31, 4.0, or 5.0; recommended: 6.0, 6.2, or 6.22)
  - Windows® 3.1, 3.11, or Windows 95
- XBT-L1000 programming software
- A PLC not being used for an active process (for simulating applications)
- Cables: for the appropriate cable part number, please refer to Appendix A in this manual.
- An XBT-P model message display (the -P models provide a wide array of function and service keys for general use)

## MAGELiS Terminology

An elementary glossary of some terms commonly encountered when you are using XBT-L1000 software and MAGELiS products is included in the Telemecanique *XBT MAGELiS Range User Manual* (#XBTX000US).

## MAGELiS Concepts



To learn more about...	Read this section of the <i>XBT MAGELiS Range User Manual</i>
MAGELiS application structure	Section A
Application pages	Section A
Alarm pages	Section A
XBT operating modes	Section A, Pages C-10 through C-17
MAGELiS functions	Page C-5
Keys and LEDs	Pages C-7 through C-9

## What Will I Use MAGELiS For?

The XBT-H models of MAGELiS terminals provide operators with a message center to access information about a process or about alarms that may be occurring. The XBT-H also allows an operator to change values in PLC registers by ramping values up or down. The XBT-P and XBT-E models provide operators an interface with the process that allows changes to be entered for various PLC registers. These changes can be specific entries as well as ramping.

The registers that can be changed contain process parameters such as set points that may require occasional modifications.

### What's Next?

**Module 1** briefly introduces you to the range of MAGELiS terminals. For the purposes of this self-teach manual, you will want to use the XBT-P021010 or the XBT-P021110, which has a printer link.

**Module 2** guides you through the XBT-L1000 software installation process.

**Module 3** is a detailed walk-through of the process of creating a MAGELiS application, including entering variable fields, creating links to other application pages, creating alarm pages, and saving the application.

**Module 4** briefly guides you through the process of simulating your application with the XBT-L1000 software.

**Modules 5 and 6** discuss transfer of the application to the MAGELiS terminal.

**Module 7** discusses connecting the MAGELiS terminal to a PLC.

**Module 8** introduces alarm pages and how alarms work.

**Module 9** guides you through the process of viewing and printing an alarm or application log.

**Module 10** briefly discusses how to print with the XBT-L1000 software.

At the back of this manual are a number of appendices which may prove useful for background information and reference.

You may want to refer to other available documentation about the MAGELiS terminals and the XBT-L1000 software. Appendix J on page 95 provides a list of documentation, and also lists the phone number for MAGELiS technical support.





## MODULE 1: LEARNING ABOUT MAGELiS MODELS

In this module, you will learn about the MAGELiS XBT terminals and their different features.

The MAGELiS range is divided into three product lines:

**XBT-H** Primarily used as an operator display; simple faceplate

- Few function or service keys
- No numeric or alphanumeric keys
- 128 Kb of flash EEPROM (about 200 application pages)
- 2-line by 20-character display.

**XBT-P** A mid-range product with a much wider variety of function and service keys than the -H models

- Numeric keys available
- 256 Kb of flash EEPROM (about 400 application pages)
- Same display as -H models.

**XBT-E** Higher-end models with a very wide variety of function, service, alphanumeric and numeric keys

- 384 Kb of flash EEPROM (about 800 application pages for 2-line display or 400 application pages for 4-line display)
- Either 2-line by 20-character or 4-line by 20-character displays
- Real-time clock
- Alarm relay



A full comparison of features and capabilities of each model is contained in Section E of the Telemecanique *XBT MAGELiS Range User Manual*.



## MODULE 2: INSTALLING THE XBT-L1000 SOFTWARE

In this module, you will learn how to install the XBT-L1000 software and protocol drivers.

To install the XBT-L1000 software, follow these steps:

1. Start Windows.
2. Insert the diskette marked "Disk 1" into the A: drive.
3. From Program Manager, select the **File** menu header and then select **Run**.
4. Type **A:\SETUP** and press the **Enter** key.
5. Follow the prompts that appear on the screen.
6. After installation is complete, save the Windows Program Manager or Application Manager, or the XBT-L1000 icon will not appear when you reboot the system (Step 7).
7. After installation is complete, reboot the PC (**Ctrl+Alt+Delete**).

Note that the AUTOEXEC.BAT and CONFIG.SYS files are altered when you install the XBT-L1000 software on your PC.

To install protocol drivers you need for your PLC, follow these steps:

1. In the Windows Program Manager, make sure that the XBT-L1000 icon appears on the screen.
2. Place the diskette containing the driver files in the A: (floppy) drive.
3. Launch the MAGELiS XBT-L1000 software by clicking on the XBT-L1000 icon.

If this is the first time you have used the XBT-L1000 software, go on to Step 4 now. If it is not the first time the software has been used, go onto Step 5.

4. If this is the first time the software has been used, the *Install Protocol* dialog box automatically appears:

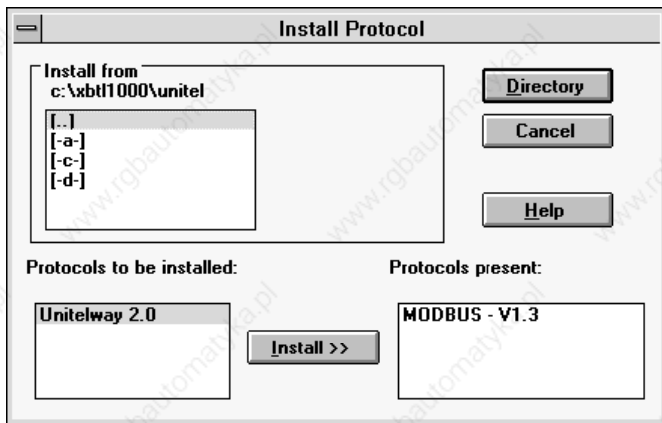

Figure 1: Install Protocol Dialog Box

In the *Install from* box, select the directory in which the driver files reside. Click on the **Directory** button to navigate to a different drive or directory.

File	View	Transfers	?
New...			Ctrl+N
Open...			Ctrl+O
<b>Install Protocol...</b>			
1 C:\XBTL1000\MJB1.DOP			
2 APP_T37.DOP			
3 TSX_DEMO.DOP			
4 C:\XBTL1000\TEST1.DOP			
Exit			

5. If this is not the first time the software has been used, the *Install Protocol* dialog box will not automatically appear, and you will need to do the following:
  - a. Make sure that no MAGELiS applications are open.
  - b. Select the **File** menu header and then select **Install Protocol**. (See Figure 2.)  
The *Install Protocol* dialog box appears (Figure 1).

Figure 2: Install Protocol Option

6. In the *Protocols to be installed* box, select the appropriate protocol.
7. Click on the **Install>>** button. You will see a prompt asking if you wish to install the protocol. Select **Yes**.
8. When the protocol is installed, select the **Close** option in the *Install Protocol* dialog box. Exit when complete.

## MODULE 3: CREATING AN APPLICATION

In this module, you will learn how to:

- Start the XBT-L1000 software
- Create a new application

An application is a set of application pages and alarm pages that act together to provide information about some process and to control that process. To create an application, you need to perform the tasks outlined in the following steps.

### Step 1. Launch the XBT-L1000 Software

To start the XBT-L1000 software, locate the icon for it in the Windows Program Manager. Click on the icon for the XBT-L1000 software to launch it.

### Step 2. Open a New Application

The first time you use the newly-installed XBT-L1000 software, no other applications will have been developed. You will be automatically prompted to select the correct terminal type configuration (go on to Step 3).

If this is not the first time the software has been used, an application window automatically appears when you start the software. If you want to open another application than the one showing, select **File/Close** to close the one that opened automatically, then select **File/New...** (see Figure 3).

File	View	Transfers	?
<u>N</u> ew...			Ctrl+N
<u>O</u> pen...			Ctrl+O
Install Protocol...			
<u>T</u> EST1.DOP			
E <u>x</u> it			

Figure 3: Opening a New Application

### Step 3. Select an XBT Type

In the window that appears next, you will select the XBT terminal type that you are using, for example, the **XBT-P021110**.

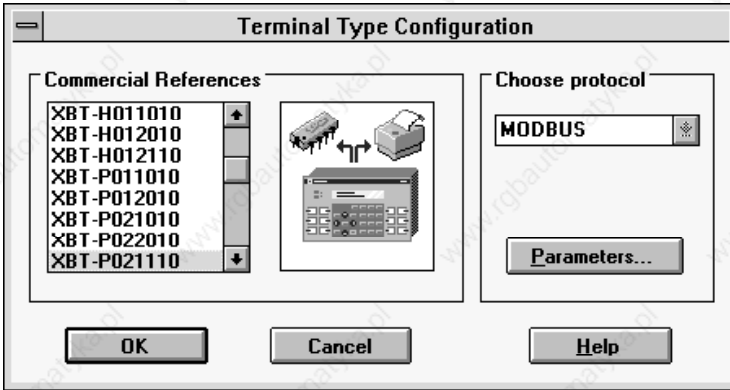

Figure 4: Terminal Type Configuration Window

In the *Commercial References* box, try highlighting different XBT models. Notice how each one is pictured, showing its function keys and whether or not it has a printer link.

### Step 4. Select a Protocol

In the same window, you will need to select the protocol that you will be using. The protocol you select depends on the type of PLC you will be connecting to the MAGELiS XBT terminal. In many cases, the selections in the dialog box will be appropriate and you will not need to change them. If you should need to change the communication baud rate, parity, or time-out value later on, however, this is where you would change these values.

- a. For the purposes of this example, be sure that **MODBUS** is selected, and then click on the **Parameters** button. The following dialog box appears:

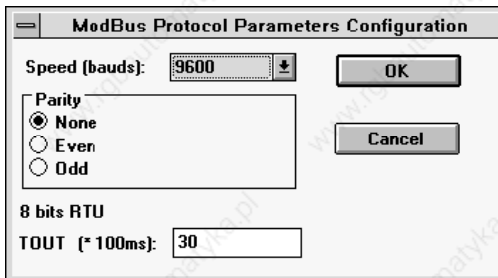

Figure 5: Protocol Parameters Configuration Dialog Box

- b. Note that for Modbus<sup>®</sup> protocol, you will need to change the Parity setting to **Even**.
- c. Click on **[OK]** to confirm your selection in the *Parameters Configuration* window.
- d. Click on **[OK]** in the *Terminal Type Configuration* window if you have selected the appropriate XBT model and protocol.

### Step 5. Enter Text on an Application Page

After you have clicked on **[OK]** in the *Terminal Type Configuration* window, the page editor window is visible, with page 1 showing (see Figure 6).

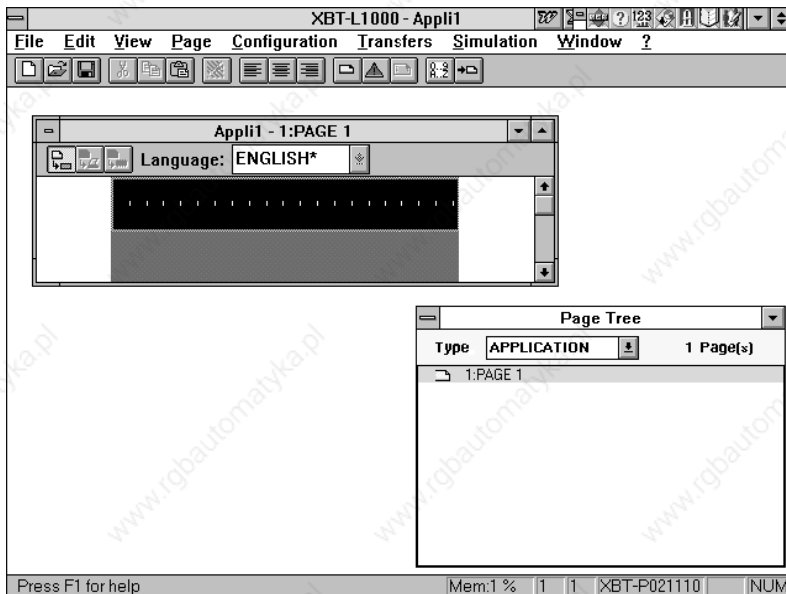

Figure 6: Page Editor Window

In page 1, type:

#### Parts to be made

Press the **Enter** key to go on to the next line.



## Step 6. Enter Variable Fields

Now try typing:

### Quantity:

After the quantity, you might want to put in a *variable field* for a changing value. To create a variable field:

- With the cursor where you want the variable field to be, click on the  icon. The *Insert Field* dialog box appears:

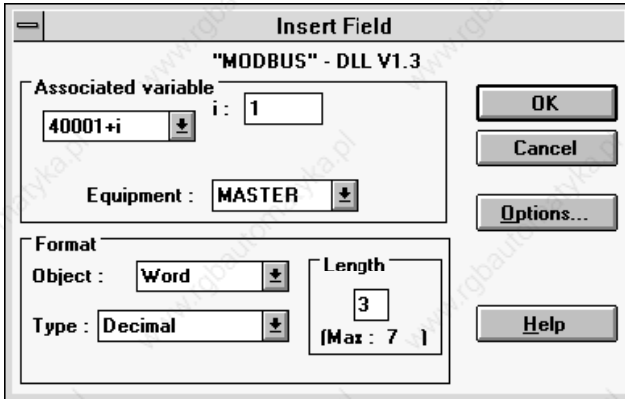

Figure 7: Insert Field Dialog Box

- Modify the word number by typing **1** in the *Associated variable* box, in the “i” field. This means that you are assigning PLC Register 40002 to this field.
- Modify the field length by typing **3** in the *Length* box.
- Confirm your entries by clicking on the [OK] button.

The “Quantity” line should now look something like this:



Figure 8: Entering Text in the Page Editor Window

### Step 7. Create Links to Other Pages

Now create a link from page 1 to page 2 by following these steps:

- a. Click on the  icon. The following window appears:

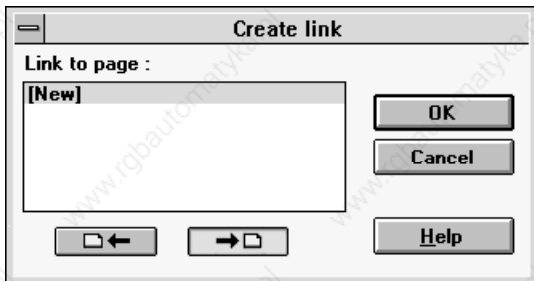



Figure 9: Create Link Window

- b. Click on [OK] to automatically create a link to the right, or page 2. (This has the same effect as pressing the  button and then clicking on [OK].) The *Create Application page* window appears.

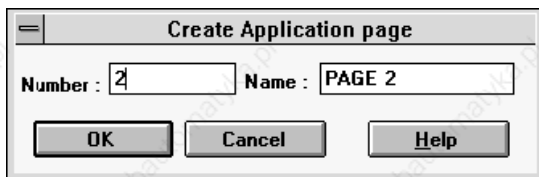

Figure 10: Create Application Page Window

- c. You can create a page with any page number, but under most circumstances, you would probably want to have pages in sequential order. You can also change the name of the application page if you want to name it something more descriptive. For this purposes of this example, leave the **Number** and **Name** fields as they are, and click on [OK]. The application page 1 reappears:

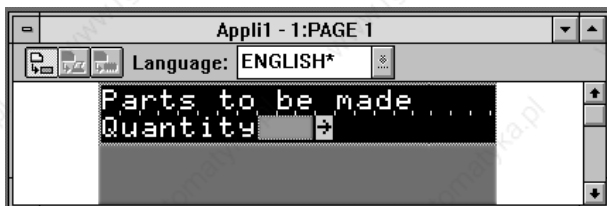

Figure 11: Creating a Link in the Page Editor Window

Notice that since you linked a page to application page 1, there is a symbol to the right of the **Quantity** field that indicates another page is linked. You can see what page is linked by looking at the *Page Tree* window.

Window ?
Cascade
Title
Page Tree
Field Information
✓ 1 Appli1 - 1:PAGE 1

To view the *Page Tree* window, if it is not already displayed on the screen, select the **Window** menu header and then select **Page Tree**.

The *Page Tree* window appears on the screen (Figure 12), showing a hierarchy of the application pages.

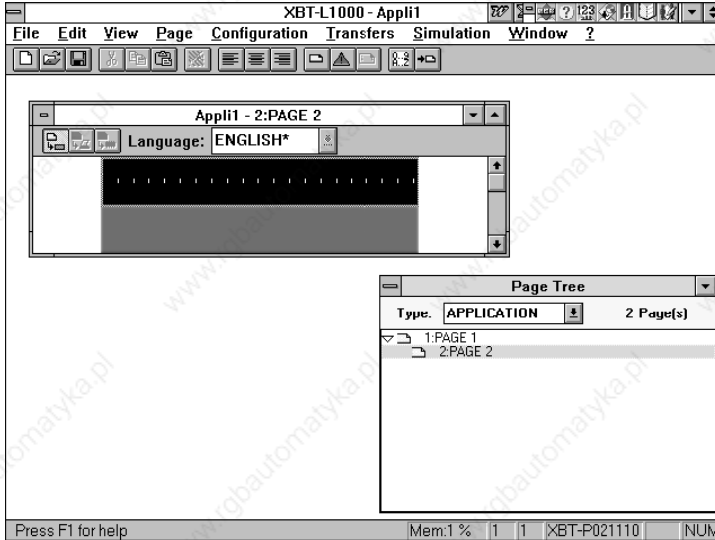

Figure 12: Page Tree Window

## Step 8. Entering Text and Variable Fields in Other Pages



You may first want to read pages C-22 through C-25 in the *XBT MAGELiS Range User Manual* for information about entering and modifying variables.

To enter text in the newly-created application page 2, follow these steps:

- Click on **Page 2** in the *Page Tree* window.
- Place the cursor back in the *Appli 1* window, on the first line. Type the following lines:

**Production Control**

**No. of Products =**

*Note:* For this example, be sure to put spaces around the equals sign.

- c. To enter a variable field after “No. of Products = ” as you did in Step 6, follow the same process, but this time you will use a different word number.

First, click on the  icon. The *Insert Field* dialog box appears:

Figure 13: Insert Field Window

*Note:* Whenever the *Insert Field* window appears, check that the *Associated variable* box shows **40001+i**. If it has changed to show **40001+i,j**, the *Object* box shows **Bit** instead of **Word**. If you want to assign a word and not a bit, be sure to change the *Associated variable* box back to **40001+i**, which will assign a word instead of a bit.

- d. Check to be sure that the *Object* box shows **Word**, and that the *Type* is **Decimal**.
- e. Modify the word number by typing **2** in the *Associated variable* box, in the “i” field. This will point to Register 40003. You must press the **Enter** key to complete this step.
- f. Try to modify the field length by typing **3** in the *Length* box.

Notice that you cannot enter **3**; the maximum you can enter is **2**. What should you do to get a three-character field?

You need to go back to the *Appli 1* window and change the text line so that a three-character field will fit.

To change the text line in the *Appli 1* window, first return to the *Insert Field* dialog box by clicking on the **Cancel** button. Then adjust the text field; for example, you could remove the spaces from around the equals (=) sign:

**No. of Products=**

Once you've done that, go back to the *Insert Field* dialog box and change the field length to 3. Notice that the maximum length is now 4, and you can have a three-character field. (See Figure 14.)

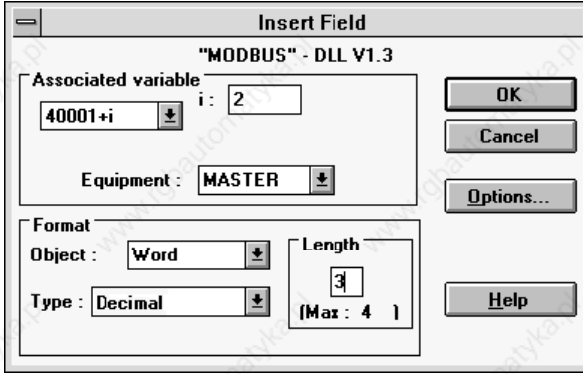



Figure 14: Modifying Field Length

- g. Confirm your entries by clicking on the [OK] button.

### Step 9. Modifying Variable Fields

You can make a field a “read-only” field (no one will be able to edit or change values in that field). To do so:

- a. Double-click on the field you want to change.
- b. Click on the  icon. A *Modify Field* window appears:

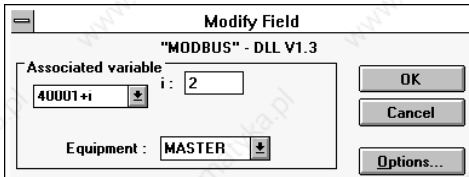

Figure 15: Modify Field Window

- c. Click on the **Options** button to bring up the *Options* window:

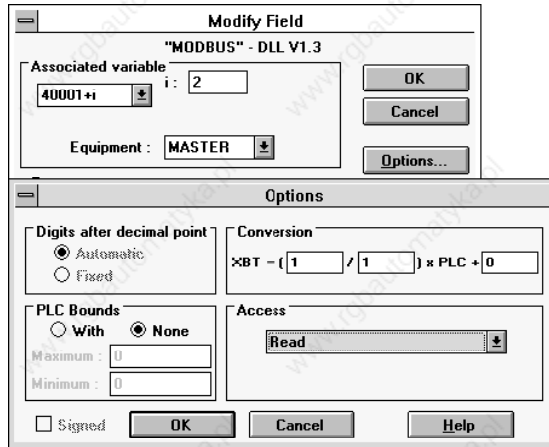

Figure 16: Modify Field Options Window

- d. In the Access box, select **Read**.
- e. Click on [OK] to confirm your selection.
- f. Click on [OK] in the *Modify Field* window.

The "No. of Products =" line should now look something like this:



Figure 17: Editing Text on Sample Application Page 2

### Step 10. Create Alarm Pages



You may first want to read about alarms and alarm pages in the *XBT MAGELiS Range User Manual*, pages A-13 through A-14, and C-26 through C-34.

Now that you have created two application pages, you might want to create an alarm page. To do so, follow these steps:

- a. Click on the  icon. The *Create Alarm Page* window appears.

Word	F	E	D	C	B	A	9	8	7	6	5	4	3	2	1	0		
n+0																		
n+1																		
n+2																		
n+3																		
n+4																		
n+5																		
n+6																		
n+7																		
n+8																		

Figure 18: Create Alarm Page Window

- b. Click on [OK] to accept the default. The default is to associate the alarm page you are creating with bit 0 of the first alarm word. The alarm page editor window (*Appli 1-1: Alarm 1*) appears.

(Note: The number of this PLC word is created when you configure the dialogue table. Alarms must be identified in the dialogue table or they will not work. See Section D in the *XBT MAGELiS Range User Manual* for information about the dialogue table.)



Appli 1 - 1:ALARM 1

Language: ENGLISH\* Priority: 1

Figure 19: Alarm Page Editor Window

- c. The first line of an alarm page is already created and reserved for the time initiation of the alarms. Starting on line 2, enter the text of the alarm, for example:

**Fault: Jam at exit**

**Step 11. Configure Terminal Parameters**



- a. To have an application page displayed by default, select the **Configuration** menu header, then select the **Terminal Parameters** option. The *Terminal Parameters Configuration* window appears (see Figure 20):

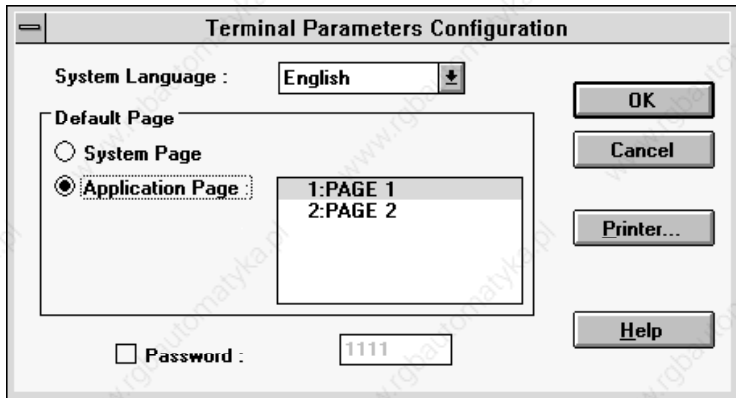

**Figure 20: Configuring Terminal Parameters**

- b. Deselect **System Page** by selecting **Application Page** instead.
- c. Make sure that **1:PAGE 1** is highlighted.
- d. Verify that the appropriate language selection for system messages is correct.
- e. Confirm by clicking on [OK].



## Step 12. Configuring the Dialogue Table

If you want to have some or all functions of the MAGELiS terminal to be handled automatically by the PLC, you must use the dialogue table. The dialogue table is set up as a series of contiguous PLC registers where values are stored. The PLC can modify these values to control the MAGELiS unit.



You may first want to read more about the dialogue table in Section D of the *XBT MAGELiS Range User Manual*.

To configure the dialogue table, follow these steps:

Configuration	Transfers
Terminal Type...	
Terminal Parameters...	
Protocol Parameters...	
Equipment Symbols...	
Dialogue Table...	
Application Languages...	
Special Characters...	
Function Keys...	

- a. From the **Configuration** menu header, select the **Dialogue Table** option. The *Dialogue Table Configuration* window appears (see Figure 21, following):

Dialogue Table (Selected functions)	Access
n+0 Function Keys	XBT ->PLC
n+1 Number of displayed page	XBT ->PLC
n+2 History occupancy percentage	XBT ->PLC
n+3 Number of page to be processed	XBT <->PLC
n+4 Print command	XBT <->PLC
n+5 Authorization	XBT <- PLC
n+6 Reset history	XBT <- PLC
n+7 LEDs command	XBT <- PLC
n+8 Alarm table	XBT <- PLC

Use Dialogue Table

Total Size: 9 word(s)

Size Selected Function: 1 word(s)

Cycle: 400 ms

Address (n): 40101

Available Functions	Size (words)
System Keys	(1)
Numeric Keys	(1)
Communication control	(1)
Set PLC clock	(4)
Number of last field filled	(1)

Figure 21: Configuring the Dialogue Table

- b. Select **Number of the displayed page** from the *Dialogue Table (Selected functions)* box, then click on the **Delete** button. This moves the selected function into the lower box, *Available Functions*.

*Note:* Double-clicking on the function also moves it from one box to the other.

- c. For more practice in moving functions, try moving **Authorization** to the *Available Functions* box.

- d. Click on the **Modify** button to change the address. The *Type Dialog Table Address* window appears.

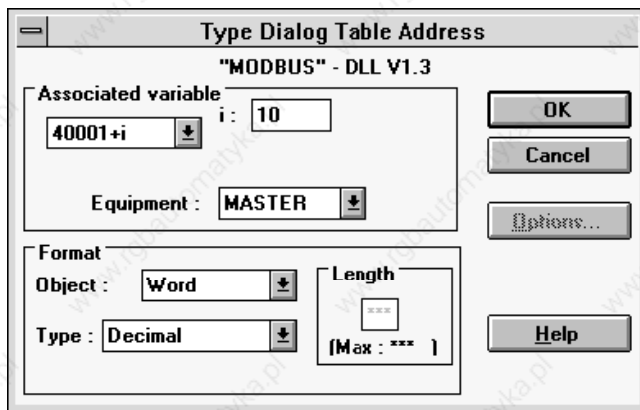

Figure 22: Type Dialog Table Address Window

- e. Type **10** in the *Associated variable* box next to the **i**. This designates the beginning of the dialogue table to be at W10.
- f. Click on **[OK]**. The *Dialogue Table Configuration* window reappears.
- g. Select **Alarm table** from the *Dialogue Table (Selected functions)* box.
- h. In the *Size Selected Function* box, check that **1** appears in the **Words** field (1 is the default).
- i. Confirm your dialogue table selections and entries by clicking on the **[OK]** button.

### Step 13. Setting Alarm Priority

You can set the priority of an alarm from 1 to 16, with 1 being the highest priority. Alarms are by default set to priority 1. If you want to change the priority of an alarm, do the following:

- a. From the **Page** menu header, select **Priority...**. The *Priority* dialog box appears.

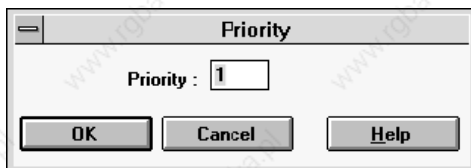

Figure 23: Priority Dialog Box

- b. Change the alarm priority value as needed, and click on **[OK]**.

## Step 14. Saving the Application

To save the application, select **File**, then select **Save As...**. The *Save as* window appears. Change the directory and file name as needed. The default name for an application is "Appli1.dop".

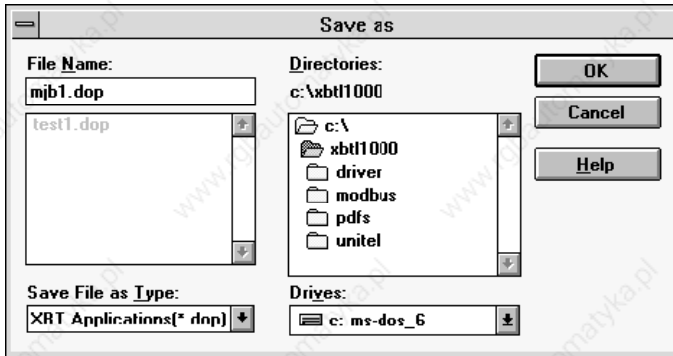

Figure 24: Save As... Window

## Step 15. Using the XBT-L1000 Software to Work with Function Keys



**Assigning function keys to certain PLC words and bits** is described on pages C-38 through C-39 of the *XBT MAGELiS Range User Manual*.

**Use of the MAGELiS terminal function keys** is described on pages C-20 and C-38 of the *XBT MAGELiS Range User Manual*.

**Locking function keys** is described on pages C-40 and C-41 of the *XBT MAGELiS Range User Manual*.

## MODULE 4: SIMULATING AN APPLICATION

Once you have created an application, you can test it with the XBT-L1000 software without having to connect your PC to a MAGELiS terminal.

**Before you simulate the application**, if your PLC has an address other than 1, you will first need to change the address in the *Equipment Symbols* window. To do so, follow these steps:

1. Select **Configuration** from the main menu bar.
2. From the pull-down menu, select **Equipment Symbols**.
3. From the *Equipment Symbols Configuration* window that appears, click on the **Modify** button. The *Equipment* window appears (see Figure 25).
4. In the **Address** field of the *Equipment* window, change the address and click on **[OK]**.

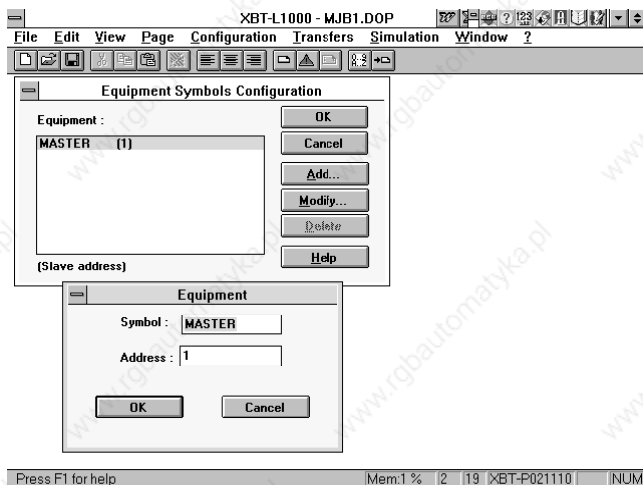

**Figure 25: Changing a PLC Address in the Equipment Symbols Windows**

To now simulate the application, you need to connect the PC to a PLC that is not being used for an active process. Use the appropriate cable (this depends on your type of PLC) between the PLC and the PC. Refer to the pinouts provided in Appendix A of this manual if you need information about specific connections.

### To set a port for simulation:



Figure 26: Simulating an Application: Configuring a Port

1. From the main menu bar (shown in Figure 26), select **Simulation**, then select **Configuration**. The *Simulation Configuration* window appears:

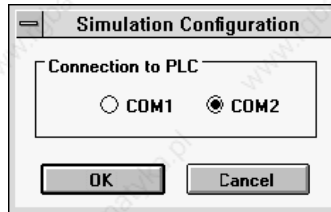

Figure 27: Simulation Configuration Window

2. Select either **COM1** or **COM2**, as appropriate, and click [OK].

### To simulate an application:

1. From the main menu bar (Figure 26), select **Simulation**, then select **Simulation Application**. The screen goes black, and then a representation of the XBT faceplate appears. After a few seconds, you will see what the XBT would actually look like if your application were active. System messages will also appear if there are problems with the application.
2. To leave the simulation screen, hold down the **Alt** key and press **X**. If you need to troubleshoot the application (if you received error messages), make any necessary changes and then run the simulation again.

*Note:* Simulation uses almost all of the PC hardware resources. It is advisable to close all active Windows applications before you begin the simulation. If you have a screen saver running on the PC, you may avoid problems by turning it off before simulating applications.

For information on common troubleshooting problems and procedures, see Appendix I of this manual.

## MODULE 5: CONNECTING THE PC TO A MAGELiS TERMINAL

Once you have created an application and simulated it so that you are satisfied with its operation, you can then connect the PC to the MAGELiS terminal and upload the application into the terminal. This module explains how to connect the PC to the MAGELiS terminal. Module 6 explains how to upload the application.

1. To connect the PC to a MAGELiS XBT terminal, first power up the terminal.
2. Connect the appropriate cable (for example, the XBT-Z 915 cable, Version 2.2) between the PC and the terminal.



## MODULE 6: UPLOADING THE APPLICATION TO A MAGELiS TERMINAL

To load an application into the MAGELiS terminal, from the XBT-L1000 software main menu bar, select **Transfer**, then select **Export**.

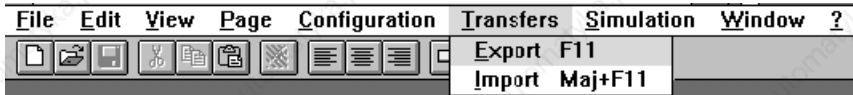

**Figure 28: Transfer Menu**

*NOTE: On some menu items, you may see a shortcut key sequence like **Maj+F11**. Wherever you see **Maj**, simply press the **Shift** key instead.*

During a transfer, the terminal displays the message “Download in progress.” When the transfer is completed, the message “Download completed” appears.





## MODULE 7: CONNECTING THE MAGELiS TERMINAL TO A PLC

Once you have uploaded an application to the MAGELiS terminal, you can then connect the PLC to the terminal for data transfer. This module explains how to connect the PLC to the MAGELiS terminal.

1. To connect the PLC to a MAGELiS XBT terminal, first power up the terminal.
2. Connect the appropriate cable (this depends on your type of PLC) between the PLC and the terminal. Refer to the pinouts provided in Appendix A of this manual if you need information about specific connections.



## MODULE 8: VIEWING AND ACKNOWLEDGING ALARMS



**General information about alarms** appears on pages C-26 through C-27 of the *XBT MAGELiS Range User Manual*.

**Alarm display priority** and what happens when an alarm occurs is described on pages C-29 and C-30 of the *XBT MAGELiS Range User Manual*.

**Viewing and acknowledgment of alarms** is discussed in detail on pages C-31 through C-34 of the *XBT MAGELiS Range User Manual*.

### General Information About Alarm Pages

An alarm page has a maximum of 25 lines and is associated to a word bit through the dialogue table. Up to 256 alarm pages may be used.

The first line of an alarm page is for display of the date and time of the alarm as well as its priority and the number of active alarms. The alarm page can contain variable fields, but they are not modifiable by users.

For each alarm page, there are two other parameters in addition to the display priority:

- Acknowledgment (ACK)
- Alarm relay (only on the XBT-E model)

If the alarm is configured so that a user must acknowledge the alarm, the alarm remains active until it is acknowledged by the user. Users can choose to ignore alarms by pressing the **ESC** key, which causes the alarm display to disappear and the application page to be displayed.

### What Happens If an Alarm Occurs?

If an alarm occurs, the ALARM LED flashes and the alarm page is displayed, unless an entry is being made at the time. If no alarm is active, the ALARM LED is not lit. It is lit continuously if an alarm is active and the user chooses to ignore it by pressing the **ESC** key.

**If the cause of the alarm is cleared, then:**

- If the ACK parameter has been selected, the alarm remains in the list.
- If the ACK parameter has not been selected, the alarm disappears from the buffer and the display.

**If the cause of the alarm is not cleared, then:**

- If the ACK parameter has been selected, the alarm must be acknowledged by pressing the **Enter** key. If the cause of the alarm still remains, the alarm is logged and remains in the alarm list.
- If the ACK parameter has not been selected, pressing the **Enter** key logs the alarm and it remains in the alarm list.

After the last alarm has been acknowledged and all alarms are cleared, the LED goes out.

**How Does Alarm Priority Work?**

Each alarm page has a display priority from 1 to 16, with 1 the highest priority. For example, if the terminal displays an alarm page of priority 5 and another alarm with priority 5 to 16 occurs, the original alarm page continues to be displayed. If an alarm with priority 1 to 4 occurs, the alarm page with the highest priority is displayed.

**Viewing the Alarm List**

The alarm list consists of all the current or unacknowledged alarms that have occurred. Use the **Shift + Enter** key combination to view the alarm list. Use the left and right arrow keys to scroll through the alarms.

## MODULE 9: VIEWING AND PRINTING AN ALARM OR APPLICATION LOG

The alarm log is a history of all past alarms, and is available on selected models of MAGELiS terminals. The alarm log is stored in RAM and is **not saved** if a power failure occurs.



Section C, pages C-35 through C-37, of the *XBT MAGELiS Range User Manual* describes:

- What alarm and application logs are and what they record
- How to view logs
- How to print logs



## MODULE 10: PRINTING

On the XBT terminal, use the **SHIFT + MOD** keys to initiate printing. You can print:

- Application pages
- Alarm pages
- Application logs
- Alarm logs



Printing procedures are described on page C-42 of the *XBT MAGELiS Range User Manual*.





## APPENDIX A: MAGELiS CABLING

The following information provides specific details for one electrical connection and two serial communication ports of the XBT terminals. Figure 29 shows the location of the electrical connection and the serial communications ports.

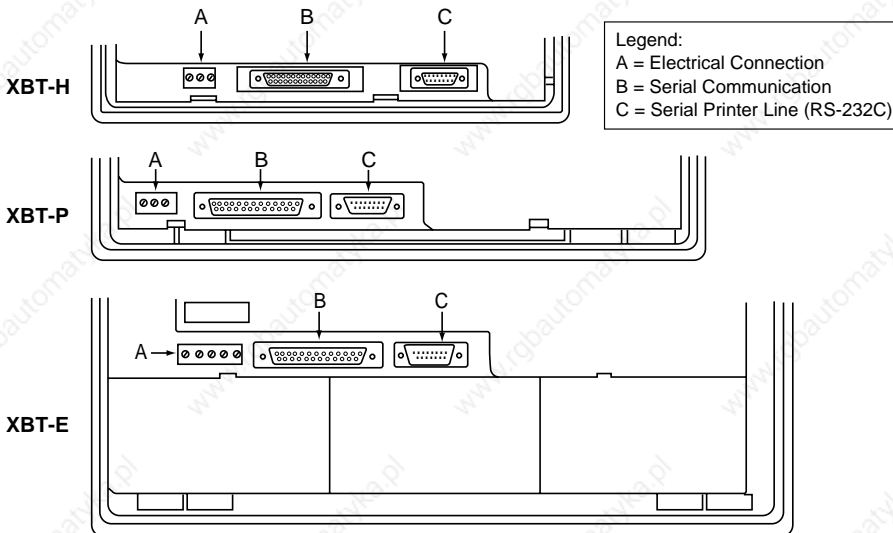
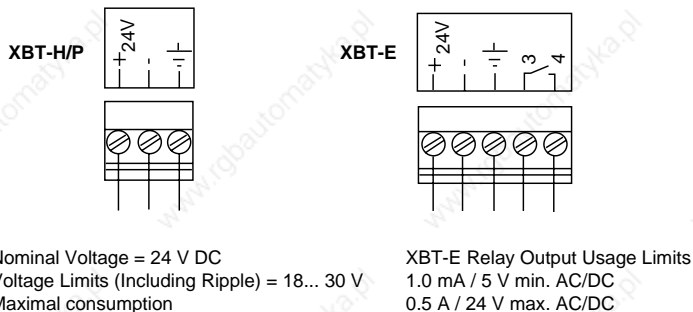

Figure 29: Electrical Connections and Serial Communications

## Electrical Connections

The power supply and relay connections (XBT-E only) should be made following the connection scheme shown in Figure 30.



**Figure 30: Power Supply and Relay Connections**

**Serial Communication**

The serial communication link and the serial printer link pin arrangement are shown in Figure 31 and Figure 32.

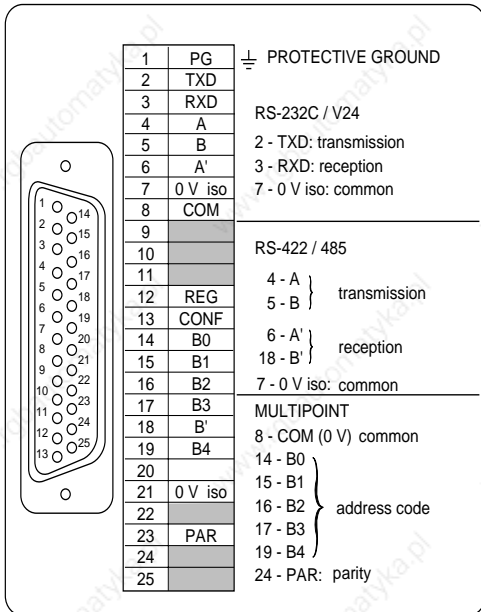

**Figure 31: Serial Link: 25-Pin, Female Subminiature (Sub-D) Connector**

**⚠ DANGER**

**HAZARD OF SHOCK, BURN, OR EXPLOSION**

- Disconnect all power before connecting the serial link connector.
- Employ only one type of serial communication at a time.
- Tighten fixing screws.

**Failure to observe these precautions will cause death or severe injury.**

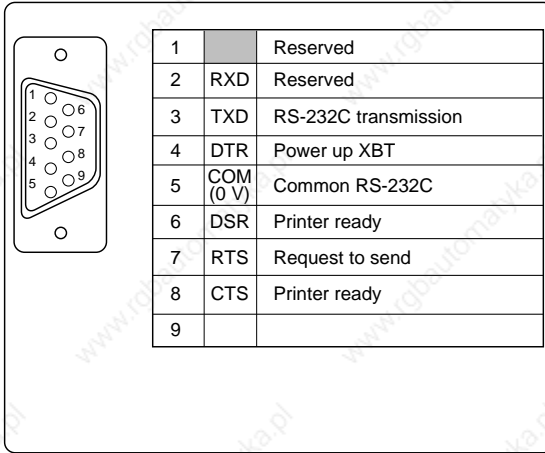

**Figure 32: Printer Link: 9-Pin, Female Subminiature (Sub-D) Connector**

### Cable Pinouts

On the following pages are cable pinout diagrams for XBT MAGELiS terminal cables.

**MAGELiS Terminal to PC (XBTZ905) Cable**

XBT-Z905 cable, Version 2.2  
(2.5 meters)

MAGELiS XBT  
Sub D 25-pin female

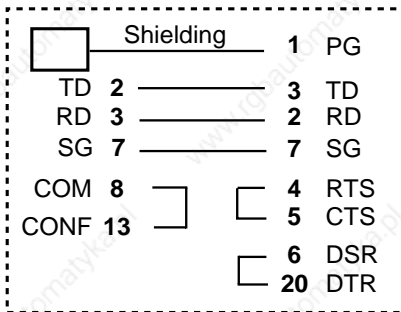
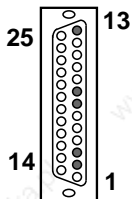

PC  
Sub D 25-pin male

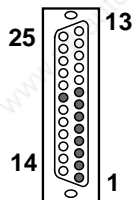

**MAGELiS to PC (XBTZ9052) Cable**

XBT-Z9052 cable, Version 2.2  
(2.5 meters)

MAGELiS XBT  
Sub D 25-pin female

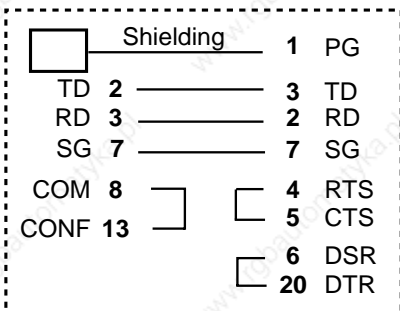
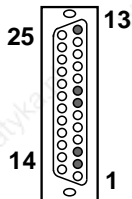

PC  
Sub D 25-pin female

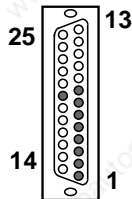

### MAGELiS to PC (XBTZ915) Cable

XBT-Z915 cable, Version 2.2  
 (2.5 meters)

MAGELiS XBT  
 Sub D 25-pin female

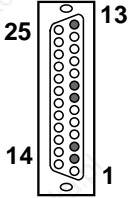

PC  
 Sub D 9-pin male

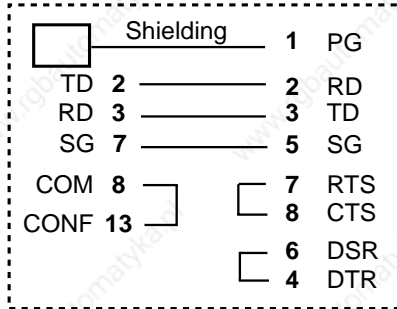
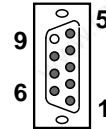

### TSX17 to MAGELiS (XBTZ958) Cable

XBT-Z958 cable (5 meters)

TSX17  
 Sub D 15-pin male  
 programming port

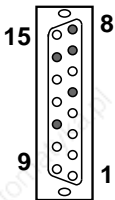

XBT  
 Sub D 25-pin male

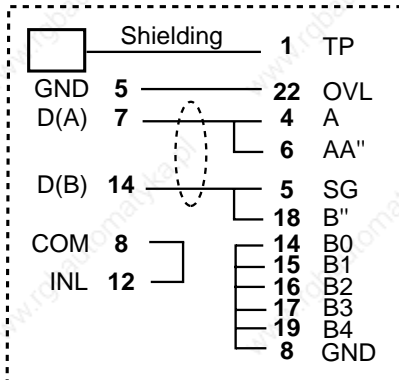
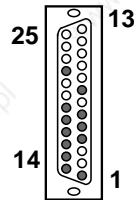

**TSX07 to MAGELiS (XBTZ968) Cable**

XBT-Z968 cable (2.5 meters)

TSX07  
Mini DIN 8-pin male  
programming port

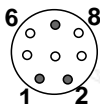

XBT  
Sub D 25-pin male

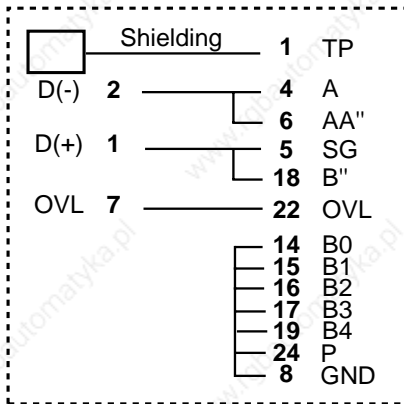
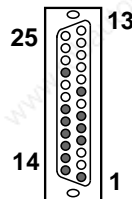

**Modicon Micro to MAGELiS Cable**

Modicon Micro to XBT cable  
(110XCA28202)

MAGELiS XBT  
Sub D 25-pin male

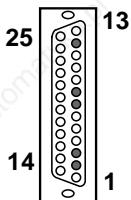

Modular Jack  
RJ45

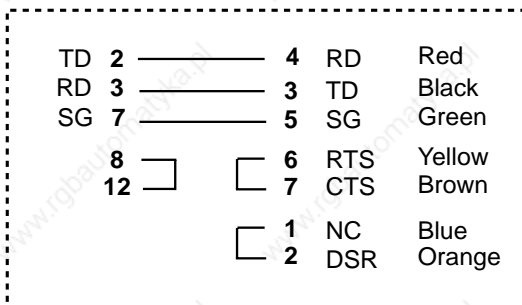
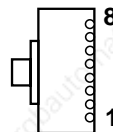



**Compact 984 (984-120/130-131/141-145) to MAGELiS Cable**

Compact 984 to XBT cable  
 110XCA28202

MAGELiS XBT  
 Sub D 25-pin

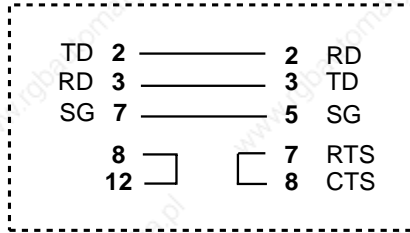
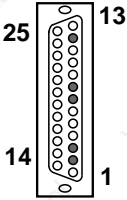

Compact 984  
 Sub D 9-pin male

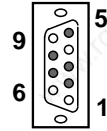

**Quantum (Modbus Port) to MAGELiS Cable**

Quantum (Modbus port) to XBT cable

MAGELiS XBT  
 Sub D 25-pin

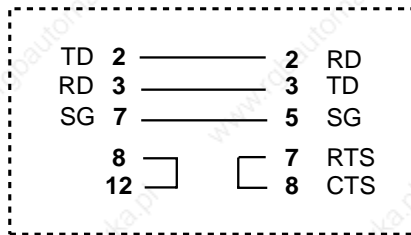
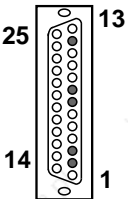

Quantum  
 Sub D 9-pin

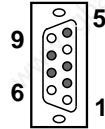

### MAGELiS to Siemens Cable (RS 232 C, with 3964/3964R Protocol)

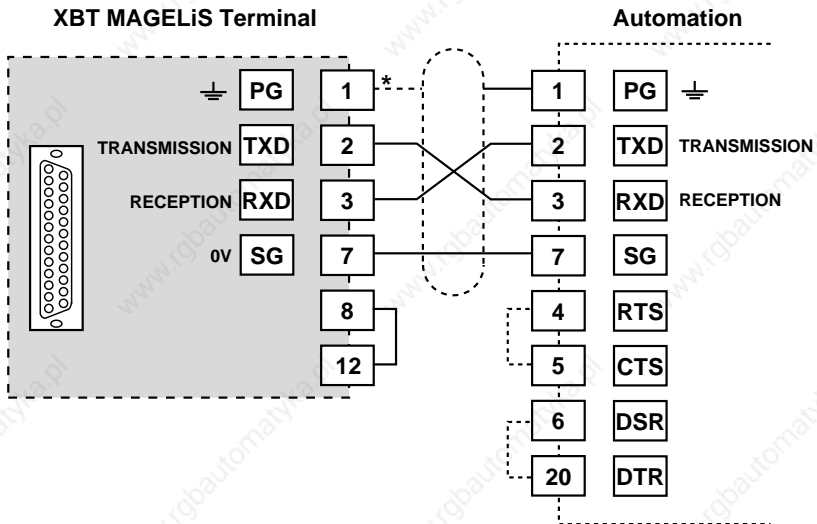

\* Connection of shielding to both cable ends depends on the electrical constraints of the installation.

In some configurations it is not necessary to reverse pins 2 and 3. Consult the appropriate PLC documentation.

## MAGELiS to Siemens Cable (RS 232 C, with AS 511 Protocol)

### XBT MAGELiS Terminal

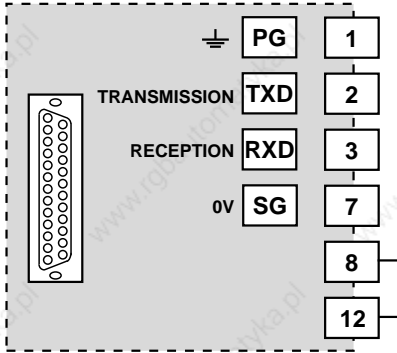

For PLC communication, use 15 - 25 pin cable with RS 232 - cc 20 mA adapter.

Connection of shielding to both cable ends depends on the electrical constraints of the installation.

In some configurations it is not necessary to reverse pins 2 and 3. Consult the appropriate PLC documentation.

### MAGELiS to Siemens Cable (RS 422, with 3964/3964R Protocol)

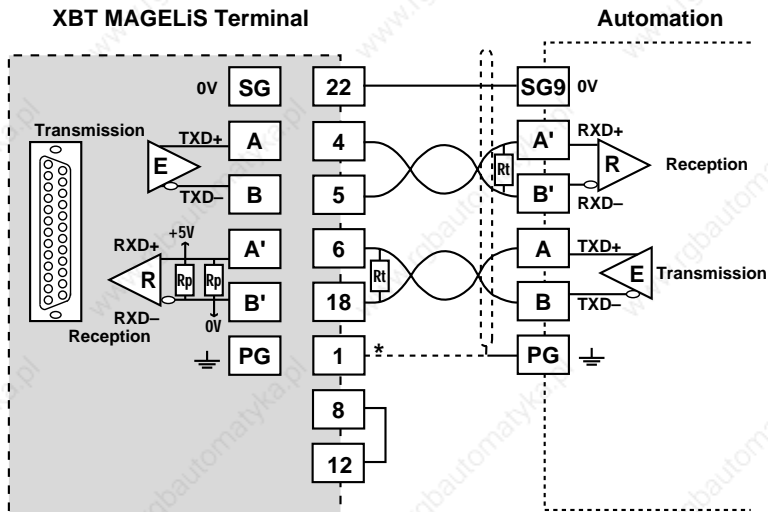

\* Connection of shielding to both cable ends depends on the electrical constraints of the installation.

Rt: Line matching resistance (normally 110 W)

Note: The Rp resistors (4.7 kW) are integrated in the XBT.

### MAGELiS to Omron Cable (RS 232 C)

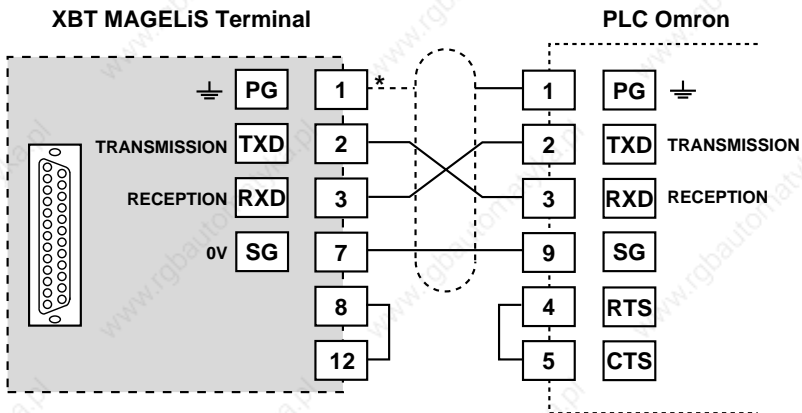

• Connection of shielding to both cable ends depends on the electrical operating conditions.

•The Omron connector is of the DB9 type.

**MAGELiS to Omron Cable (RS 422)**

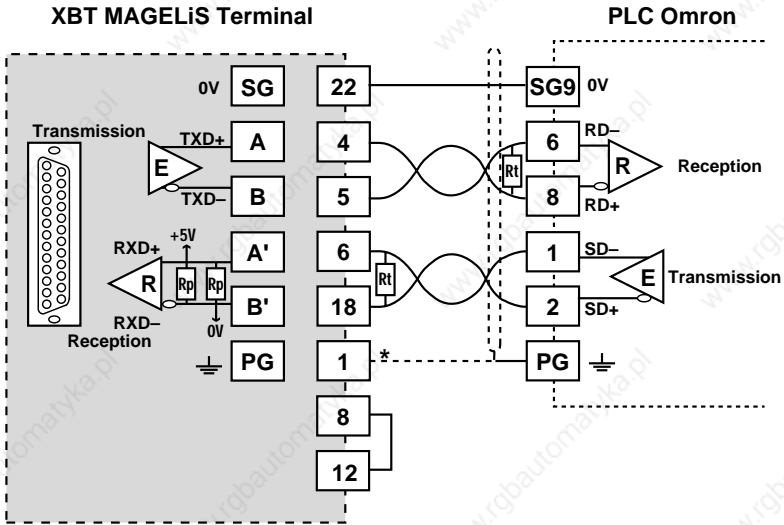

\* Connection of shielding to both cable ends depends on the electrical operating conditions.

Rt: Link termination resistors (normally 110 Ω)

Note: The Rp resistors (4.7 kΩ) are integrated in the XBT.

**MAGELiS to Allen-Bradley Cable (RS 232 C)**

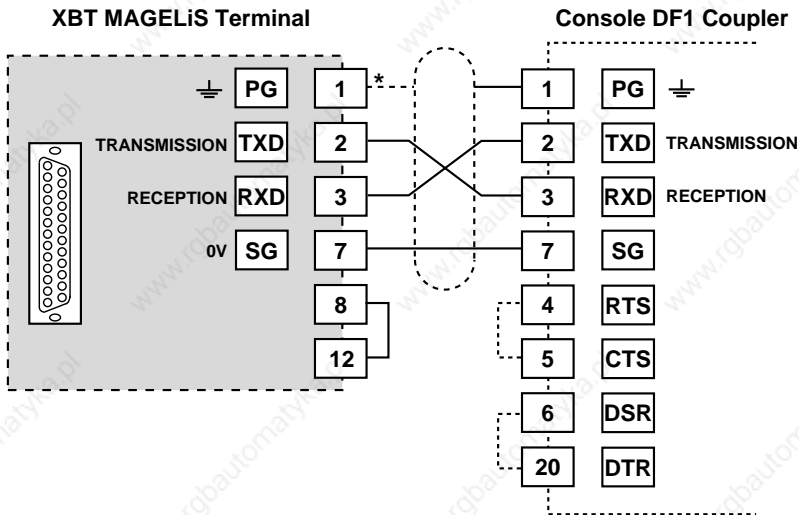

- Connection of shielding to both cable ends depends on the electrical constraints of the installation.
- In certain configurations, it is not necessary to reverse pins 2 and 3. Consult the appropriate PLC documentation.

**MAGELiS to Modicon Cable (RS 232 C, with Modbus/JBUS Protocol)**

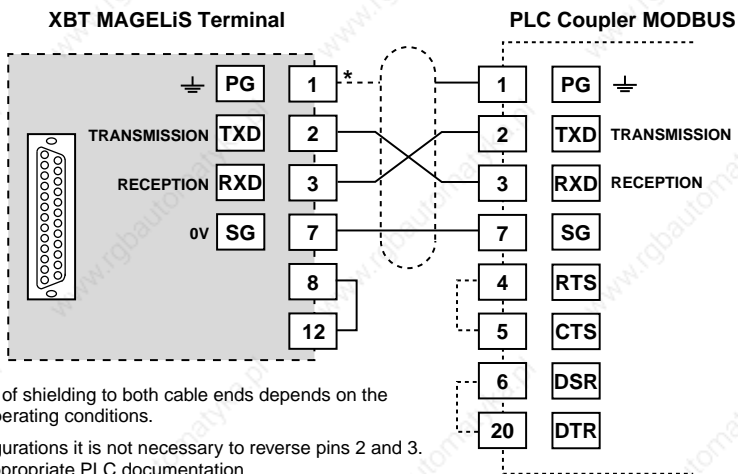

\* Connection of shielding to both cable ends depends on the electrical operating conditions.

In some configurations it is not necessary to reverse pins 2 and 3. Consult the appropriate PLC documentation.

**MAGELiS to Modicon Cable (RS 422/485, with Modbus/JBUS Protocol)**

**RS 422 LINK**

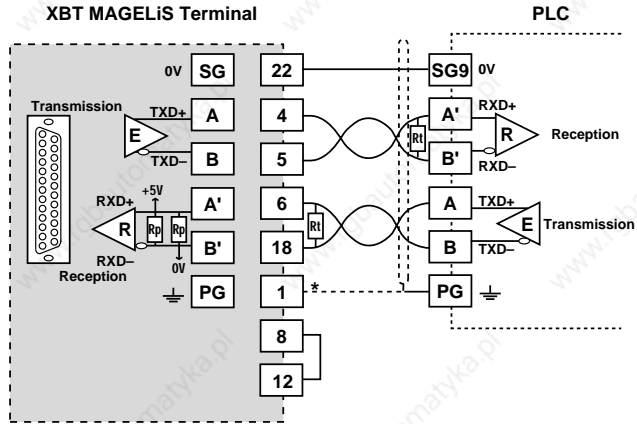

**RS 485 LINK**

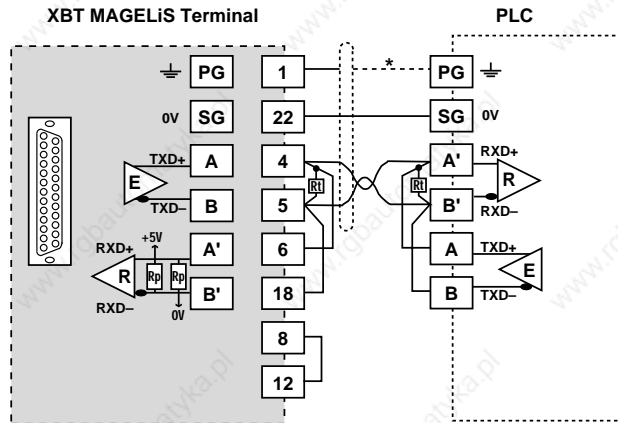

\* Connection of shielding to both cable ends depends on the electrical operating conditions.

Rt: Link termination resistors (normally 110 Ω)

Note: The Rp resistors (4.7 kΩ) are integrated in the XBT.

## APPENDIX B: ABOUT DIALOGUE TABLES



More information about dialogue tables is contained in the *XBT MAGELiS Range User Manual*. The information presented here may help to illustrate the material presented in that manual.

To simplify the communication between a MAGELiS terminal and a PLC, all data commands from the PLC to the terminal and status data from the terminal to the PLC are grouped together in a table called the dialogue table.

Composed of  $n$  consecutive words (16-bit words), the dialogue table has three parts, as shown in Figure 33:

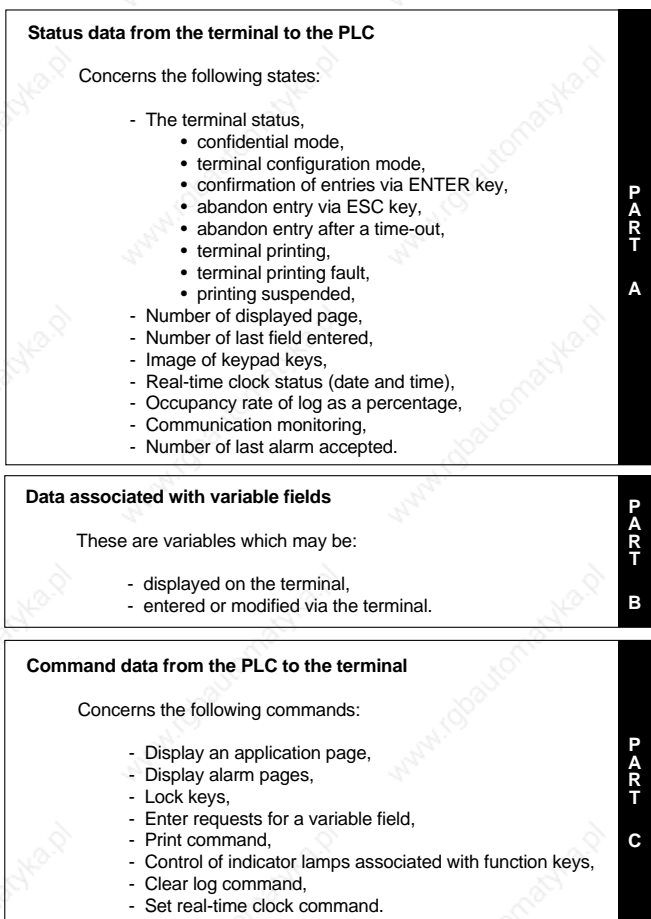

**Figure 33: Dialogue Table Structure**



The number of words in the table depends on the choice of status data and commands that are to be processed via the dialogue table. The XBT-L1000 software is used to make this choice.

The dialogue table is a word table consisting of three parts (A, B, and C). It is located in the PLC. The terminal reads and writes the table to the PLC (see Figure 34). You do not have to write an additional PLC program for the communication link.

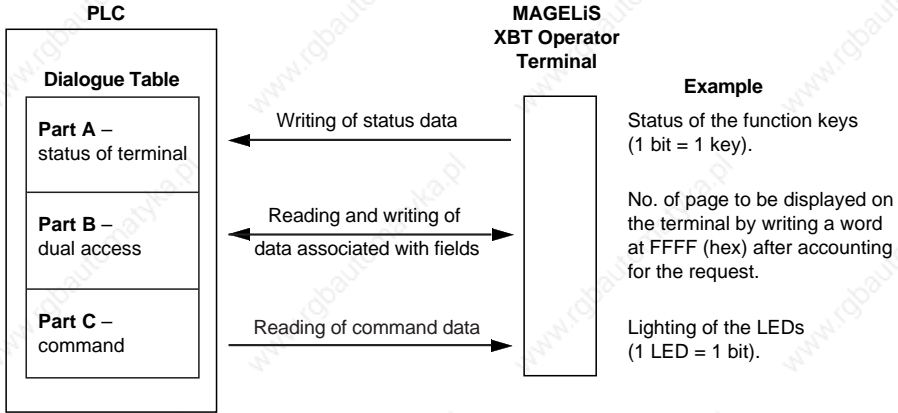



Figure 34: Dialogue Table Data Exchange

 <b>WARNING</b>
<b>UNINTENTIONAL EQUIPMENT OPERATION</b>
The PLC memory zone allocated for the XBT dialog table must NOT be used for anything else. The designer must program PLC logic properly.
<b>Failure to observe this precaution can cause death, severe injury or equipment damage.</b>

When the terminal is powered up or communication is restarted, it reads from the command table and writes to the status table.

In the event of a problem, a message box appears on the screen.

### Contents of the Dialogue Table

The number of words in the table depends on the choice of states and commands that are to be processed via the dialogue table.

The notation convention for describing the table is:

- $W_n$ : word of 16 bits
- $W_n, i$ : bit  $i$  of word  $n$
- The address  $n$  is taken as the start of table address.
- The table has a maximum of 46 words.

Table 1 defines the dialogue table words.

**Table 1: Dialogue Table Words**

$W_{n+0}$ to $W_{n+1}$	Function keys	PLC <- XBT
$W_{n+2}$	System keys	PLC <- XBT
$W_{n+3}$	Numeric keys	PLC <- XBT
$W_{n+4}$	Communication control	PLC <- XBT
$W_{n+5}$ to $W_{n+8}$	Set PLC time	PLC <- XBT
$W_{n+9}$	Number of displayed page	PLC <- XBT
$W_{n+10}$	Number of last field	PLC <- XBT
$W_{n+11}$	Last alarm accepted	PLC <- XBT
$W_{n+12}$	Confirmation report	PLC <- XBT
$W_{n+13}$	Log occupancy rate	PLC <- XBT
$W_{n+14}$	Number of page to be processed	PLC <-> XBT
$W_{n+15}$	Field to be entered	PLC <-> XBT
$W_{n+16}$	Print command	PLC <-> XBT
$W_{n+17}$	Authorization	PLC -> XBT
$W_{n+18}$	Reset log	PLC -> XBT
$W_{n+19}$ to $W_{n+20}$	LED commands	PLC -> XBT
$W_{n+21}$ to $W_{n+22}$	Lock function keys	PLC -> XBT
$W_{n+23}$	Lock system keys	PLC -> XBT
$W_{n+24}$	Lock numeric keys	PLC -> XBT
$W_{n+25}$ to $W_{n+40}$	Alarm table	PLC -> XBT
$W_{n+41}$ to $W_{n+45}$	PLC date and time to terminal	PLC -> XBT
$W_{n+46}$	Printout table in free format (max. of 40 words on one line of printout)	PLC -> XBT

The following section describes the content of the various dialogue table words. You may also find it helpful to refer to the XBT-L1000 software on-line help for more detailed information.

## Detailed Description of Dialogue Table Words

Wn to Wn+3: Terminal Keypad Image Table to PLC

Table 2 provides information on the terminal keys to the PLC. Bit at 1 = key pressed.

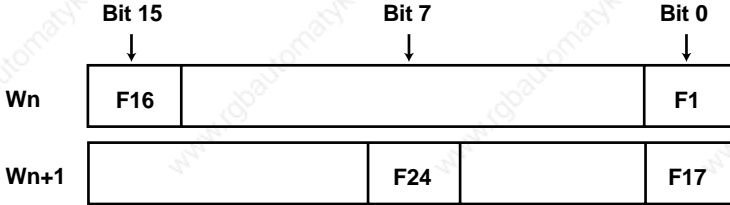

Figure 35: Wn and Wn+1, Word Structure

Table 2: Wn+2 and Wn+3, Bit Definitions

Wn+2	Wn+3
Bit 0: Up arrow	Bit 0: 0
Bit 1: Down arrow	Bit 1: 1
Bit 2: Right arrow	Bit 2: 2
Bit 3: Left arrow	Bit 3: 3
Bit 4: MOD	Bit 4: 4
Bit 5: PRINT	Bit 5: 5
Bit 6: MENU	Bit 6: 6
Bit 7: SYST	Bit 7: 7
Bit 8: ALARM	Bit 8: 8
Bit 9: EXIT	Bit 9: 9
Bit 10: HOME	Bit 10: .
Bit 11: +1	Bit 11: +/-
Bit 12: -	Bit 12: LED
Bit 13: ENTER	Bit 13:
Bit 14:	Bit 14:
Bit 15:	Bit 15:

Wn+4: Communication Control

This word, which monitors correct operation of the terminal, is incremented by 1 at each communication request made by the terminal. It is sent to the PLC.

## Wn+5 to Wn+8: Terminal Date and Time To Be Sent To The PLC

**Table 3: Wn+5 to Wn+8, Definitions**

	Bits 15-8	Bits 7-0
<b>Wn+5</b>	Seconds	Reserved
<b>Wn+6</b>	Hours	Minutes
<b>Wn+7</b>	Months	Day of month
<b>Wn+8</b>	Century	Year

Only the XBT-E terminal possesses a protected real-time clock. The XBT terminal writes the time and date periodically to the PLC (approximately every second).

## Wn+9: Number of Page To Be Displayed

Number of page displayed on the terminal and to be sent to the PLC. It contains 'FFFF' (hex) if it is a system page or a displayed alarm.

## Wn+10: Number of Last Field Entered

Number of last field entered on the terminal to be sent to the PLC.

## Wn+11: Last Alarm Accepted

This information is only present on one PLC scan. It then returns to 'FFFF' (hex).

## Wn+12: Status

**Table 4: Wn+12, Bit Definitions**

Bit 0	Confidential Mode
Bit 1	Configuration Mode
Bit 2	ENTER on entry
Bit 3	ESC on entry
Bit 4	End of entry on TIME-OUT
Bit 5	Printing
Bit 6	Printing fault
Bit 7	Printing suspended
Bit 8	Reserved
Bit 9	Reserved
Bit 10	Reserved
Bit 11	Reserved
Bit 12	Reserved
Bit 13	Reserved
Bit 14	Reserved
Bit 15	Reserved

### Wn+13: Log Occupancy Rate

The occupancy rate of the alarm log as a percentage (%) on the terminal and to be sent to the PLC.

### Wn+14: Page Number To Be Processed

- To process page 22, insert **page 22-> Wn+14**
- When  $Wn+9=22$  and  $Wn+14=H'FFFF'$ , the command is OK.
- When  $Wn+9<>22$  and  $Wn+14=H'FFFF'$ , the command is not OK.

### Wn+15: Field to Enter

If the value 20 is to be entered on page 10:

- confirm that  $Wn+9=10$
- then 20 ->  $Wn+15$

When  $Wn+10=20$  and  $Wn+15=H'FFFF'$ , the command is OK.

- $Wn+12$  then gives more detail: **Enter**.

When  $Wn+10<>20$  and  $Wn+15=H'FFFF'$ , the command is OK.

- $Wn+12$  then gives more detail: **ESC Time-out**.

### Wn+16: Print Command

**Table 5: Wn+16, Bit Definitions**

Bits 15-8	Bits 7-0
MSB : Print code	LSB: Long tab

(MSB = most significant bit; LSB = least significant bit)

Wn+16 contains the print command information. The print code designates the type of print function:

- Free format print: 01
- Print sheet: 02
- Print log: 03

For free format printing, the PLC gives the length in bytes of the information to be printed (maximum 40 words) in the LSB. The terminal reads the length given in word table to the end of dialogue table address + 1. For sheet printing, the LSB represents the number of sheets.

The word "print required" is written by the PLC. The PLC may write 'FFFF' (hex) to this word, thus stopping any printing in progress. The same word is

written to 'FFFF' (hex) by the XBT terminal, to acknowledge the end of the command. The designer may choose this printing function.

Wn+17: Authorization

**Table 6: Wn+17, Bit Definitions**

MSB	LSB
-----	-----

For a table 23 words long, the PLC can write to the authorization word 'A517' (hex).

Wn+18: Reset Log

The PLC writes '00FF' (hex) in the word. Afterwards, it is reset to zero by the XBT when the command is executed.

Wn+19 to Wn+20: LED Control

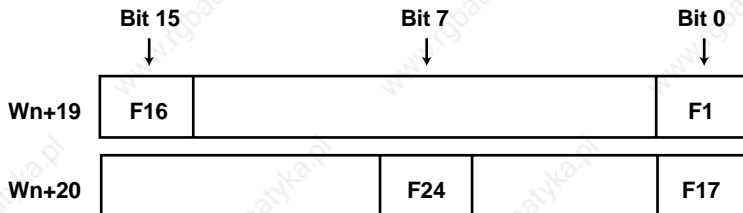

**Figure 36: Wn+19 to Wn+20, Word Structure**

Wn+21 to Wn+22

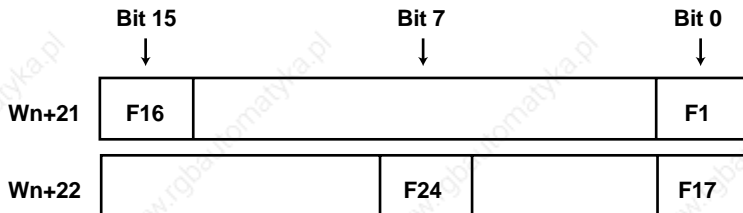

**Figure 37: Wn+21 to Wn+22, Word Structure**

## Wn+23: Lock System Keys

**Table 7: Wn+23, Bit Definitions**

Bit 0: Up arrow
Bit 1: Down arrow
Bit 2: Right arrow
Bit 3: Left arrow
Bit 4: MOD
Bit 5: PRINT
Bit 6: MENU
Bit 7: SYST
Bit 8: ALARM
Bit 9: EXIT
Bit 10: HOME
Bit 11: +1
Bit 12: -1
Bit 13: ENTER
Bit 14:
Bit 15:

## Wn+24: Lock Numeric Keys

**Table 8: Wn+24, Bit Definitions**

Bit 0: 0
Bit 1: 1
Bit 2: 2
Bit 3: 3
Bit 4: 4
Bit 5: 5
Bit 6: 6
Bit 7: 7
Bit 8: 8
Bit 9: 9
Bit 10: .
Bit 11: +/-
Bit 12: LED
Bit 13:
Bit 14:
Bit 15:

Wn+25 to Wn+40: Alarm Table

The alarm table contains the commands to display alarm pages.

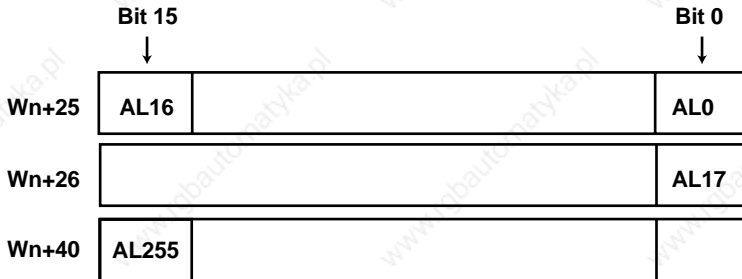

Figure 38: Wn+25 to Wn+40, Word Structure

Wn+41 to Wn+44: Terminal Date and Time To Be Sent To The PLC

Table 9: Wn+41 through Wn+44, Definitions

	Bits 15-8	Bits 7-0
Wn+41	Seconds	Reserved
Wn+42	Hours	Minutes
Wn+43	Months	Day of month
Wn+44	Century	Year

Only the XBT-E model has a protected real-time clock. Each time one of these words is modified, the XBT sets itself to the date and time given in this table.

Wn+46: Free Format Printing Table

This table contains information for free format printing.

Dialogue Functions

Depending on the MAGELiS XBT terminal selected, the dialogue table in the XBT-L 1000 software will be different. See “Appendix C: Chart of XBT Terminal Functions by Model” on page 69 for a list of the accessible functions as well as the functions selected by the default table for each type of terminal.



## Authorization Word

The Authorization word is the first word of the command part of the dialogue table (Part C). This word provides security for the PLC. If this word does not contain the correct value, the PLC will not permit the XBT terminal to write any word to the PLC. Figure 39 shows the structure of the Authorization word.

Wn:	MSB = H'A5	LSB = Length of the dialogue table
-----	------------	------------------------------------

**Figure 39: Authorization Word**

*Note:* Using the "Authorization" word is a verification for the PLC. If this word is not at the correct value, the terminal cannot write any word to the PLC.

- The authorization word is not compulsory.
- It is systematically present in the dialogue table offered by the XBT-L1000 software.
- You should retain the word in the dialogue table as long as the table contains at least one word to be written by the XBT terminal.

## Communication Control Word

The communication control word is incremented regularly by the MAGELiS XBT terminal. If this word is configured by the XBT-L1000 software, it allows the PLC to know if the terminal is powered and properly connected.

 <b>WARNING</b>
<b>UNINTENTIONAL EQUIPMENT OPERATION</b>
If communications between XBT and PLC are lost, the operator's control over the machine may be lost completely or partially. It is the designer's responsibility to program PLC logic that accounts for this situation. An appropriate method is to monitor Wn+4 of the dialogue table from the PLC program.
<b>Failure to observe this precaution can cause death, severe injury or equipment damage.</b>

## Real-Time Clock Control Words

The configuration of these 4 words is useful if the MAGELiS XBT terminal is not equipped with a hardware real-time clock. If the PLC has a real-time clock, it can update the software real-time clock of the XBT terminal.

*Note:* If the terminal is not equipped with a hardware real-time clock, you can adjust the time of the terminal by entering internal XBT words (in an application page) or by entering the date/time in the *Configuration* menu.



## CAUTION

### **EQUIPMENT DAMAGE HAZARD**

Since all alarms are always time/date stamped and the control program may rely on the XBT terminal's real-time clock, you must set or verify the XBT terminal's date and time after every new installation, repair, disassembly, shipping, or battery charge.



**Failure to observe this precaution can cause equipment damage or production loss.**



## APPENDIX C: CHART OF XBT TERMINAL FUNCTIONS BY MODEL

Depending on the MAGELiS XBT terminal selected, the dialogue table in the XBT-L1000 software will be different. The following table lists the accessible functions as well as the function selected by default table for each type of terminal.

Functions	XBT H 00x010	XBT H 02x010	XBT H 01x010	XBT H 01x110	XBT P 01x010	XBT P 02x010	XBT P 02x110	XBT E 01x010	XBT E 01x110
Situation function keys									
Situation system keys									
Situation numeric keys									
Communication control									
Set PLC clock									
No. of displayed page									
No. of last field filled									
Last acknowledged alarm									
Status report									
History occupancy %									
Pg no. to be processed									
No. of field to be filled									
Print command									
Authorization "read table"									
Reset history									
LED command									
Function keys lock									
System keys lock									
Numeric keys lock									
Alarm table									
Set XBT clock									
Table of free fmt. printing									

-  Functions selected by default in the XBT-L1000 Operator Terminal
-  Other available functions



## APPENDIX D: COMMUNICATION PROTOCOL INFORMATION

The information provided in this appendix is intended only to be a general guideline. It should not be used as a substitute for the process controller manuals. Be sure to refer to the individual product documentation.

### **XBT/PLC Communication Using UNI-TELWAY™ Protocol on RS-232 or RS-485 Links**

Communication is established through the programming port of the TSX 17.

The MAGELiS terminal occupies two addresses on the bus (cable address and cable address +1):

- The cable address is the server address; the MAGELiS terminal responds to the PLC commands. It is used for the UNI-TELWAY “service commands” (for example, identification request, mirror request).
- The cable address + 1 is the client address; the MAGELiS terminal sends commands to the PLC. This address is used for reading/writing variables that are displayed on the application and alarm pages. It is equally used for reading/writing to or from the dialogue table.

Note that the MAGELiS terminal is self-configured at the transmission speed of the UNI-TELWAY master.

### **XBT/PLC Communication Using UNI-TELWAY Protocol on an XBT-Z 958 Link**

The physical link is made by way of an XBT-Z 958 cable.

You must configure the UNI-TELWAY address for the programming port (address 1) in the TSX 17 module. Effectively, it is the terminal that carries out the polling of the slaves (2 slaves polled at 9600 baud). The XBT terminal is a pseudo-master (it is not defined actually as the true master because it does not assure the transmission from one slave to another). In this case, the equipment address in the MAGELiS application is 0,254,0,254101.

### **XBT/PLC Communication Using MODBUS® or JBUS Protocol**

The MAGELiS terminal can only be a MODBUS or JBUS master. The transmission speed, parity, and time-out are configured by the XBT-L1000 software.

- Speed: 600, 1200, 2400, 4800, 9600, or 19200 baud
- Parity: even, odd, or without
- Time-out: default value = 30 (3 seconds)

## XBT/PLC Communication Using Siemens (3964/3964R) Protocol

The XBT is a master; the process controller is a slave. The dialogue table controls operation, and resides in the controller. The XBT, as a master, performs three types of actions:

- At the initiative of the automated system
- At the initiative of the operator
- At its own initiative

The dialogue is of the question/reply type, with the MAGELiS terminal as master (requester) transmitting messages to the slaves.

Communications between a controller's processor and the MAGELiS terminal with the 3964/3964R procedures are performed by exchanging messages in both directions, point-to-point, and by means of an asynchronous serial link coupler.

Communications link characteristics:

- Speed: 300, 600, 1200, 2400, 4800, 9600, or 19200 baud
- Parity: even, odd, or none
- 1 stop bit
- RS232C, RS422, RS485 interface
- Time-out: default value=220 ms
- Encoding: 8 bit binary

The transmission speed, parity, and time-out are configured by the XBT-L1000 software.

## XBT/PLC Communication Using Allen-Bradley (DF1) Protocol

The XBT is a client; the process controller is a server. The dialogue table controls operation, and resides in the server. The XBT, as a client, performs three types of actions:

- At the initiative of the automated system
- At the initiative of the operator
- At its own initiative

The DF1 protocol (the communication protocol for Allen-Bradley controllers) developed on the MAGELiS terminal can be used to communicate with the following Allen-Bradley process controllers:

- SLC-500
- PLC-5
- PLC-2, PLC-3, and PLC-4

Communications link characteristics:

- Speed: 300, 600, 1200, 2400, 4800, 9600, or 19200 baud; 9600 by default
- Parity: none (default) or even
- 1 stop bit
- RS-232C interface
- Encoding: 8 bit binary

Depending on the type of process controllers in the range, the dialogue will be supported by different types of frames:

- Specific SLC-500 frames (if only SLC-500 controllers are addressed)
- Specific PLC-5 frames (if only PLC-5 controllers are addressed)
- “Basic Command Set” generic frames (if different types of equipment such as SLC-500, PLC-5, PLC-4, PLC-3, and PLC-2 are addressed without distinction)

Certain restrictions apply to the access to the controller’s data depending on the type of frame selected.

**CAUTION:** If using the Basic Command Set, you cannot write to an odd address when linked to a PLC-5. Consequently, it is best not to use the dialogue table.

The dialogue is of the question/reply type, with the MAGELiS terminal as client (requester) sending messages to the servers.

**Half/Full Duplex Link.** The XBT can be connected in point-to-point mode, or the network of 254 possible PLCs can be used via the polling system. This characteristic is transparent to the user, and the XBT functions remain the same except for addressing, which in the case of a point-to-point link is limited to the directly connected controller (master).

### **XBT/PLC Communication Using OMRON (SYSMAC<sup>®</sup>-WAY) Protocol**

The XBT is a client; the process controller is a server. The dialogue table controls operation, and resides in the server. The XBT, as a client, performs three types of actions:

- At the initiative of the automated system
- At the initiative of the operator
- At its own initiative

All OMRON controllers use the SYSMAC-WAY communication protocol. In this protocol, the terminal communicates in ASCII mode.

The transmission speed, parity, and time-out are configured by the XBT-L1000 software.



Communication link characteristics:

- Speed: 1200, 2400, 4800, 9600 (default), or 19200 baud
- Parity: even, odd or none
- 2 stop bits
- RS-232C or RS422 interface
- Encoding: 7/8 bits ASCII

The XBT can be connected to the controller in point-to-point mode via the RS-232 connector, or an RS422 network can be used on which you can connect up to 32 PLCs.

The dialogue between the higher processing levels and the MAGELiS terminal is of the request/reply type. The requester (XBT master) transmits the messages to the slave (PLC).

**CAUTION:** If you connect an XBT requiring writes to PLC memory in Run mode, the PLC will switch to Monitor mode.

The configuration of the slave, addressed by default by the XBT-L1000 software, is 0. Slaves are numbered 0 to 31 in SYSMAC-WAY protocol.

## APPENDIX E: SAMPLE APPLICATION

This appendix contains screen shots of a sample application.



Figure 40: Application Page 1

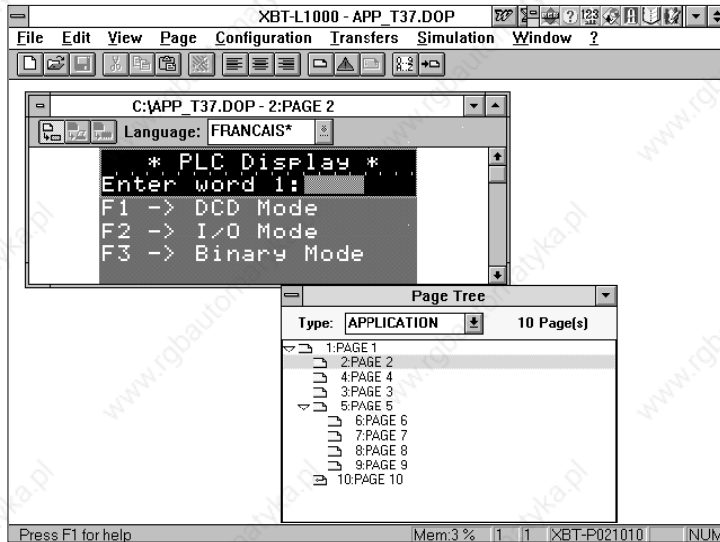

Figure 41: Application Page 2

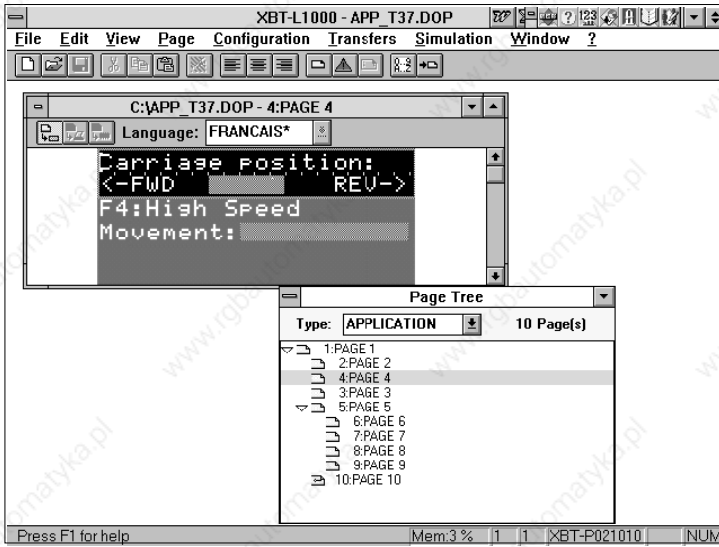

Figure 42: Application Page 3

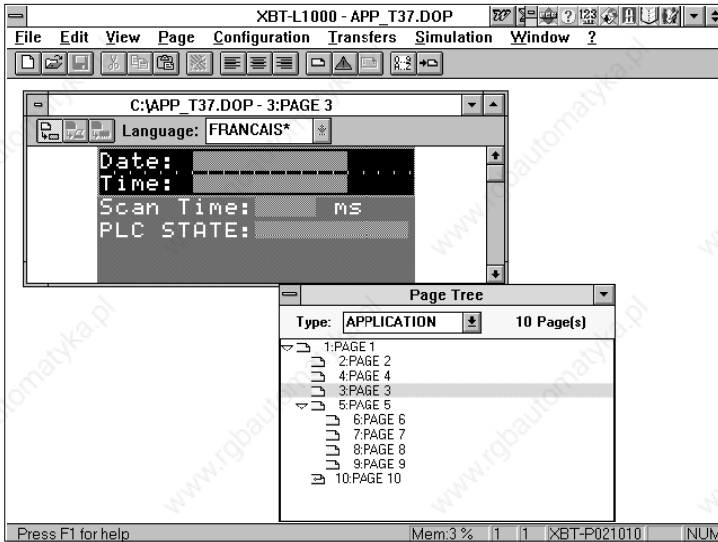

Figure 43: Application Page 4

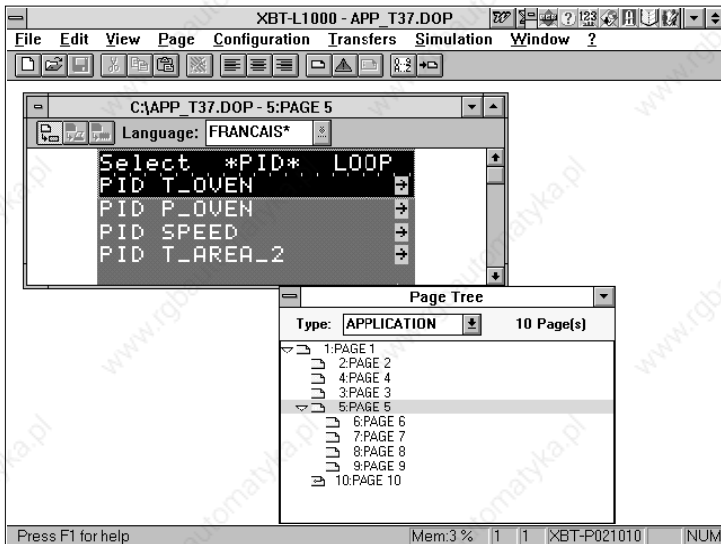

Figure 44: Application Page 5

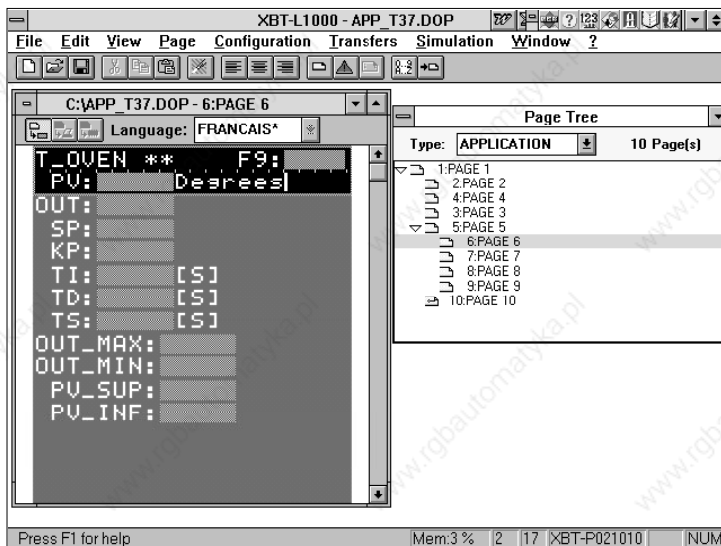

Figure 45: Application Page 6

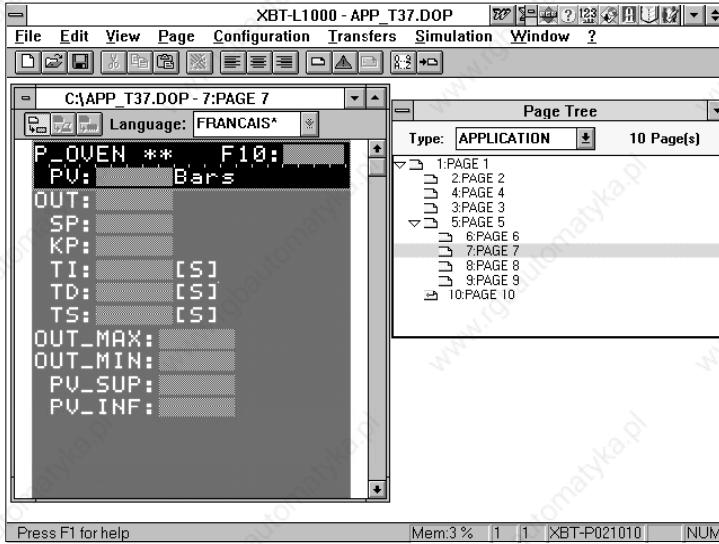

Figure 46: Application Page 7

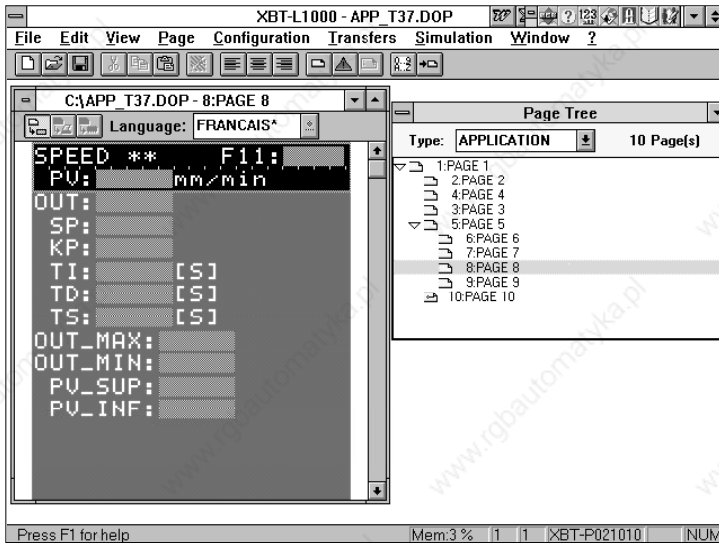

Figure 47: Application Page 8

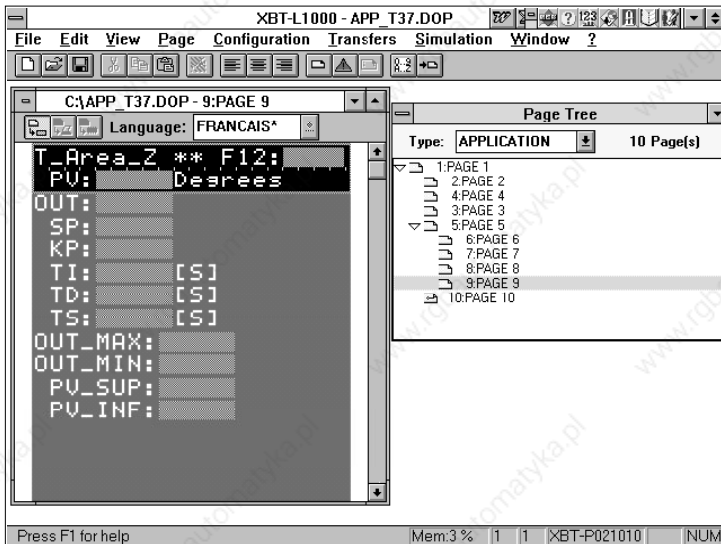

Figure 48: Application Page 9

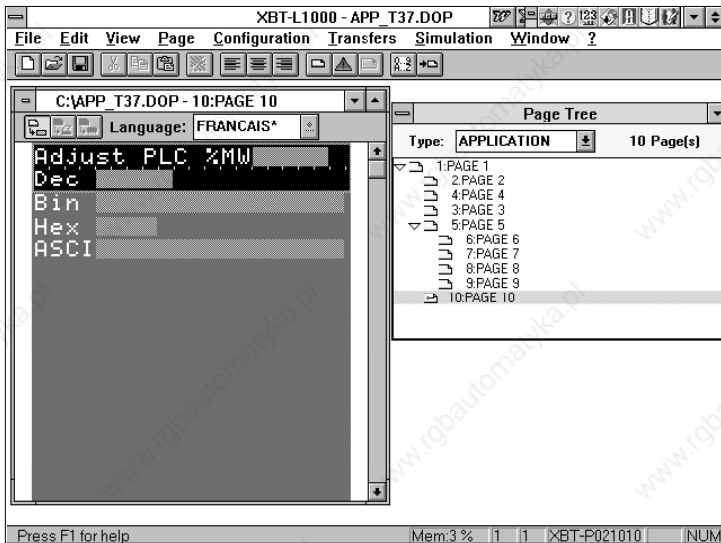

Figure 49: Application Page 10

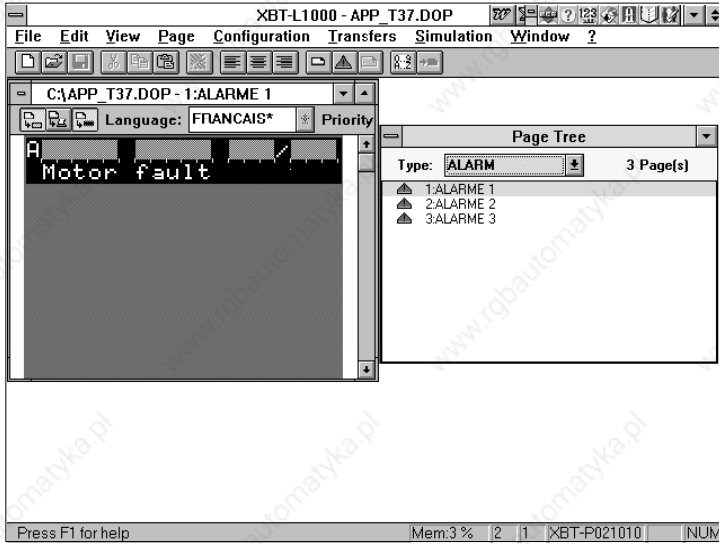

Figure 50: Alarm Page 1

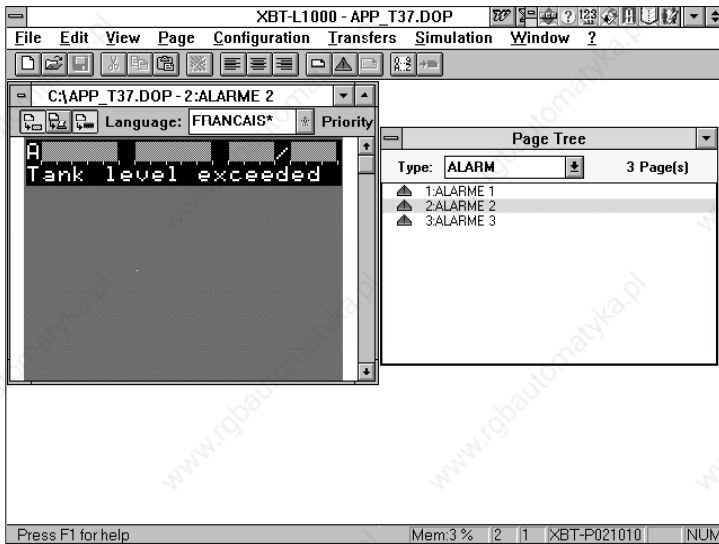

Figure 51: Alarm Page 2

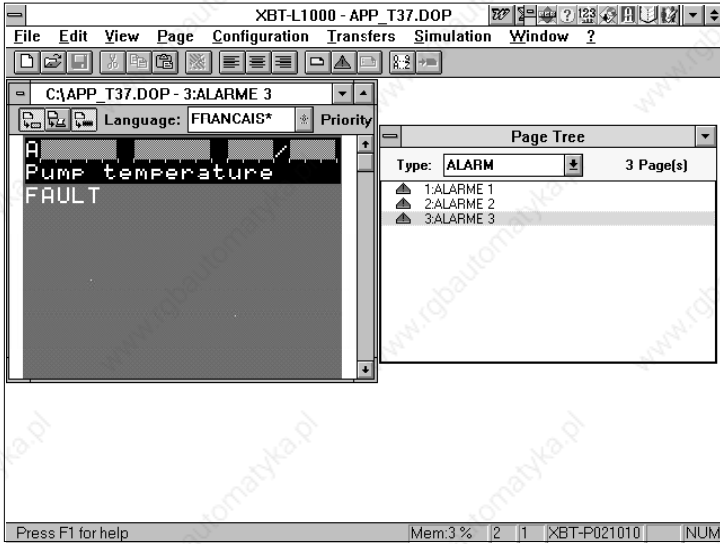
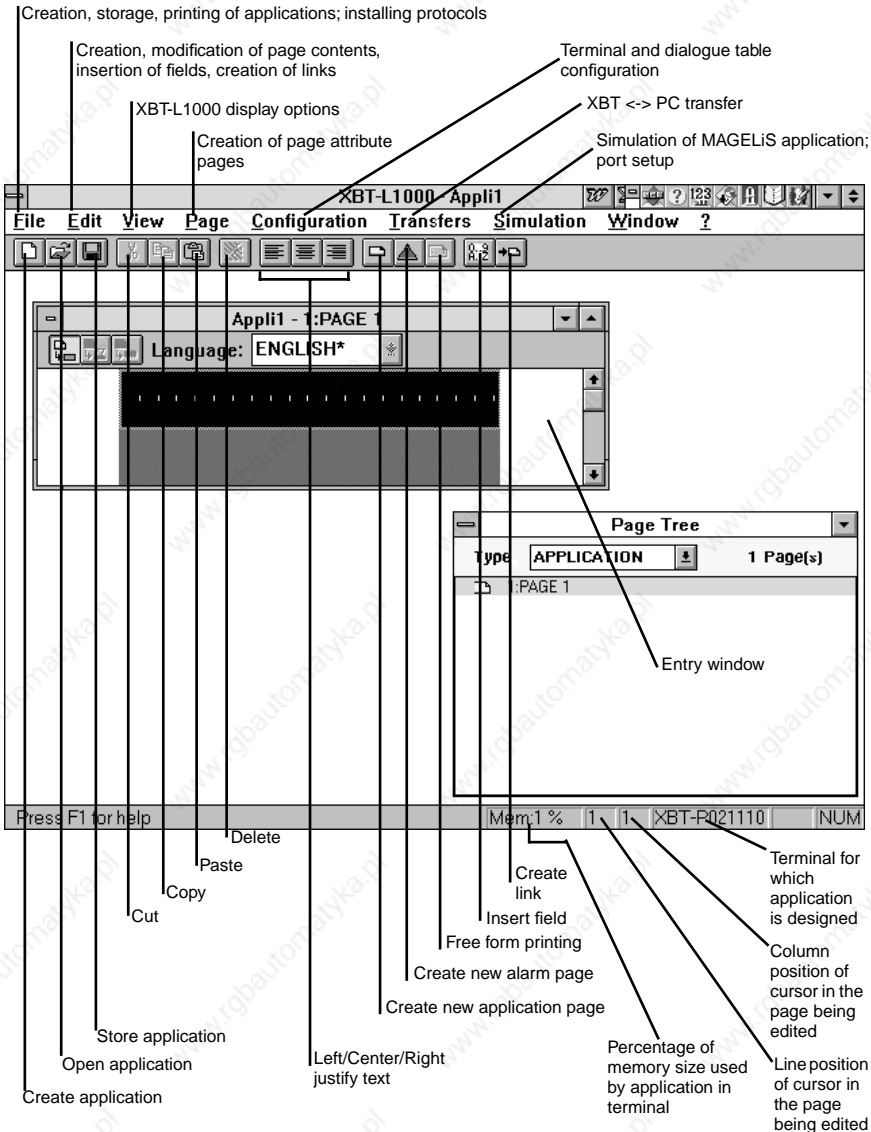

Figure 52: Alarm Page 3





# APPENDIX F: MENUS AND ICONS USED IN XBT-L1000 SOFTWARE





APPENDIX G: PC KEYBOARD SHORTCUTS FOR USING  
XBT-L1000 SOFTWARE**System Keys**

<b>Press</b>	<b>To</b>
F1	Access context-sensitive help
Ctrl + ESC	Go the list of active Windows applications
Alt + ESC	Go to the next Windows application, whether it is executed in a window or as an icon
Alt + Tab	Go from one application to another
Print Screen	Copy an image of the screen onto the clipboard
Alt + Print Screen	Copy an image of the active window onto the clipboard
Alt + Spacebar	Open the System menu of an application window
Alt + F4	Exit an application or close a window
Ctrl + F4	Close the active group or document window

**Menu Keys**

<b>Press</b>	<b>To</b>
Alt + underlined letter (in the menu)	Choose the menu
+ a character key (in the menu)	Choose the command within a menu
Left or right arrow	Go from one menu to another
Up or down arrow	Go from one command to another
É	Choose the name of the selected menu command
ESC	Cancel the selected menu name or close the open menu

**Dialog Box Keys**

<b>Press</b>	<b>To</b>
Tab	Go from one option to another
Shift + Tab	Go from one option to another in the opposite direction
An arrow key	Move the cursor around a list



## APPENDIX H: XBT-L1000 SOFTWARE MENU TREE

### The MAGELiS Software Menu Options

#### File Options

File	Edit	View	Page	Configurati
<b>N</b> ew...				Ctrl+N
<b>O</b> pen...				Ctrl+O
<b>C</b> lose				
<b>S</b> ave				Ctrl+S
<b>S</b> ave As...				
<b>P</b> rint...				Ctrl+P
<b>P</b> rint Setup...				
<b>I</b> nstall Protocol...				
1 C:\XBTL1000\MJB1.DOP				
2 APP_T37.DOP				
3 TSX_DEMO.DOP				
4 C:\XBTL1000\TEST1.DOP				
<b>E</b> xit				

#### Edit Options

XBT-L1000 - MJB1.DOP						
File	Edit	View	Page	Configuration	Transfers	Simulation
	<b>U</b> ndo			Ctrl+Z		
	<b>C</b> ut			Ctrl+X		
	<b>C</b> opy			Ctrl+C		
	<b>P</b> aste			Ctrl+V		
	<b>F</b> ind...			Ctrl+F		
	<b>I</b> nsert Field...			F9		
	<b>I</b> nsert Link...			Maj+F9		
	<b>I</b> nsert Character...			Ctrl+Maj+F9		
	<b>R</b> enumber Fields					
	<b>A</b> lignment				<b>L</b> eft	Ctrl+Maj+G
					<b>C</b> entered	Ctrl+Maj+C
					<b>R</b> ight	Ctrl+Maj+D

#### View Options

<b>V</b> iew
<b>F</b> ield Numbers Ctrl+*
<input checked="" type="checkbox"/> <b>T</b> oolbar
<input checked="" type="checkbox"/> <b>S</b> tatus Bar

Page Options

<b>Page</b>	
<b>New</b>	<b>Application F7</b>
<b>Go To</b>	<b>Alarm Maj+F7</b>
<b>Rename...</b>	<b>Form Ctrl+Maj+F7</b>
<b>Delete DEL</b>	
<b>Output Type</b>	
<b>Protection</b>	
<b>Priority...</b>	
<b>Alarm Relay</b>	
<b>Acknowledgment</b>	

<b>Page</b>	
<b>New</b>	
<b>Go To</b>	<b>Application F5</b>
<b>Rename...</b>	<b>Alarm Maj+F5</b>
<b>Delete DEL</b>	<b>Form Ctrl+Maj+F5</b>
<b>Output Type</b>	
<b>Protection</b>	
<b>Priority...</b>	
<b>Alarm Relay</b>	
<b>Acknowledgment</b>	

<b>Page</b>	
<b>New</b>	
<b>Go To</b>	
<b>Rename...</b>	
<b>Delete DEL</b>	
<b>Output Type</b>	<b>√ Screen</b>
<b>Protection</b>	<b>Print</b>
<b>Priority...</b>	<b>File</b>
<b>Alarm Relay</b>	
<b>Acknowledgment</b>	

Configuration Options

<b>Configuration</b>
<b>Terminal Type...</b>
<b>Terminal Parameters...</b>
<b>Protocol Parameters...</b>
<b>Equipment Symbols...</b>
<b>Dialogue Table...</b>
<b>Application Languages...</b>
<b>Special Characters...</b>
<b>Function Keys...</b>

Transfer Options

<b>Transfers</b>	
<b>E</b> xport	<b>F11</b>
<b>I</b> mport	<b>Maj+F11</b>

Simulation Options

<b>Simulation</b>	
<b>C</b> onfiguration	
<b>S</b> imulation Application	

Window Options

<b>Window</b>	
<b>C</b> ascade	
<b>T</b> ile	
<input checked="" type="checkbox"/> <b>P</b> age Tree	
<b>F</b> ield Information	
<input checked="" type="checkbox"/> <b>1</b> C:\XBTL1000\MJB1.DOP - 1:PAGE 1	



## MAGELiS Application Configuration Options

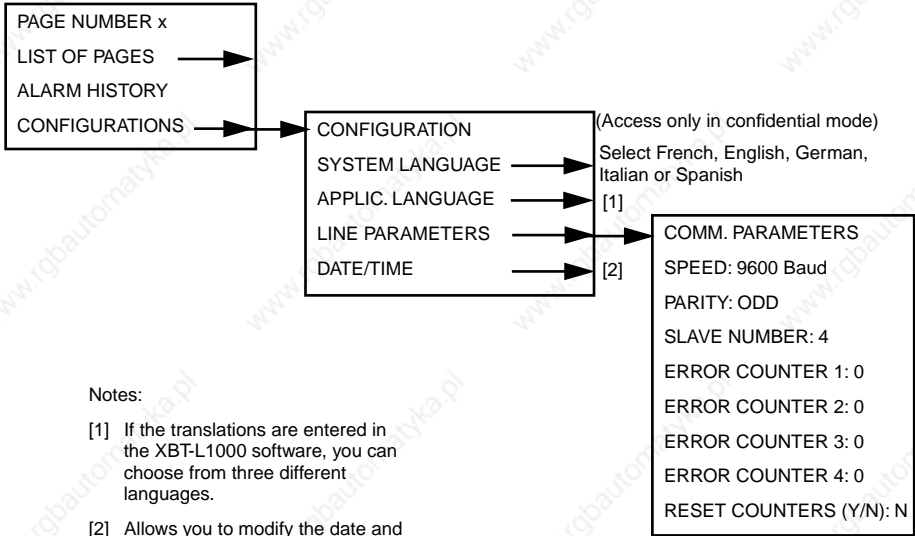

Notes:

- [1] If the translations are entered in the XBT-L1000 software, you can choose from three different languages.
- [2] Allows you to modify the date and time.

The displayed communication parameters depend on the protocol used. For example, on MODBUS there are 8 diagnostic counters.

## APPENDIX I: ERROR MESSAGES AND ELEMENTARY TROUBLESHOOTING

Several resources are available to help you with questions and problems that may be encountered as you are using the MAGELiS terminals and XBT-L1000 software.

- The XBT-L1000 software on-line help utility offers some general guidelines as to how options are used and what information should be entered in fields.
- An additional Help file utility for MAGELiS is available that offers troubleshooting advice as well as setup information, cable pinouts, and step-by-step procedures for programming the MAGELiS terminal and creating dialogue tables.
- The Technical Support group phone and fax numbers are listed on page 95 of this manual.

### Error Messages

Message text	Meaning/Action Needed
Wiring fault	Incorrect wiring. Switch power off.
Waiting for transfer	Waiting for remote loading.
No program	Product has no application.
Download in progress	Download to the XBT is occurring.
Download aborted	Download to the XBT was cancelled by the user.
Download failed	Download to the XBT was unsuccessful.
Download completed	Download to the XBT was successfully completed.
Upload in progress	Upload to the PC is occurring.
Upload aborted	Upload to the PC was cancelled by the user.
Upload failed	Upload to the PC was unsuccessful.
Upload completed	Upload to the PC was successfully completed.
Connecting...	The XBT-L1000 software is reading the cable and searching for the communication configuration.
Application fault	The application contains an error.
Wrong password	An invalid password was entered.
Page does not exist	A non-existent page number was called.

Message text	Meaning/Action Needed
Protected access page	A protected (read/write) page was called.
Impossible to write variable in PLC	An attempt was made to write a variable to a protected zone.
Overflow Min<= Value <= Max	An attempt was made to write a value outside the allowed range.
Dialogue table authoriz.	The Authorization word is incorrect.
Dialog table reading impossible	There is a connection problem between the XBT and the PLC. Check cabling; check PLC address.
Dialog table writing impossible	<ul style="list-style-type: none"> <li>• There may be a connection problem between the XBT and the PLC. Check cabling; check that cable wiring is correct.</li> <li>• There may have been an attempt to write to a protected zone. The PLC program may be read or write protected.</li> </ul>
Printing impossible	This is a momentary and transient display that may occur while printing is in progress or after a menu option has been selected.
Faulty printer	This message flashes if there is a printing problem. Check that printer connections are normal, paper tray is full, paper jam has not occurred.
Empty log	Transient message; the log display was empty when the user requested that the log be displayed or printed.
Cannot read XBTL1000.INI	The file VER.DLL delivered with certain PCs and pre-installed with Windows does not always conform to the Microsoft standard Windows file VER.DLL. Replace the VER.DLL file (WINDOWS\SYSTEM) with an original Microsoft version.

### Possible Problems

Problem	Possible Cause	Solution
<p>After you install and start the XBT-L1000 software, your computer locks up.</p>	<p>Norton Antivirus software on your computer</p>	<p>Mask (using REM statement), or delete the following line in the file CONFIG.SYS: <b>DEVICE=... \NAV\AVTSR.EXE</b> Reboot the system and restart the XBT-L1000 software.  Use another antivirus software, for example, IBMAV, Microsoft VSafe).</p>
<p>When transferring a program from a laptop to the MAGELiS terminal, communication errors occur.</p>	<p>Driver problem</p>	<p>XBT-L1000 software uses a driver called <b>DUNTLW.EXE</b>, which loads as a TSR in the CONFIG.SYS file. It gets its profile from file <b>DUNTLW.001</b>. This file has many parameters which can be adjusted with a text editor, such as Notepad. For laptops, a parameter under the heading <b>Advanced Parameters</b> should be adjusted. It is usually the last parameter and reads: <b>RXTX=Default</b>. Change the parameter to <b>RXTX=0</b>.</p>
<p>When an alarm is received from the PLC, the alarm page stays displayed even after you acknowledge the alarm.</p>	<p>Normal operation</p>	<p>The alarm page remains displayed as long as the condition exists. You must set a bit in the alarm table to call an alarm page. As long as the bit remains set to 1, the page remains displayed. If you want to remove the page, you must choose to ignore the alarm.</p>
<p>Simulation does not seem to work; LED polling between the PC and PLC blinks, but variables in numeric fields are not refreshed. The display shows ?????? instead of the correct variable contents.</p>	<p>Older model of PC (80386) being used</p>	<p>Using simulation with PCs that have an 80386 or earlier processor, data exchange is slow because of simulation in the Windows environment. To remedy the situation, note the name of the application you want to simulate (<i>filename.DOP</i>), then quit the XBT-L1000 software. Then quit Windows. Under DOS, in the directory XBTL1000, write the following sequence: <b>SIMU application_name.DOP port number</b>  For example: SIMU C:\XBTL1000\XBT_PMETER.DOP 1</p>
<p>TSX07 nano-PLC doesn't work</p>	<p>TSX07 firmware needs to be updated</p>	<p>Version 1.0 of the TSX07 firmware will not work; use Version 2.x or higher.</p>



## APPENDIX J: WHERE TO GET MAGELIS TECHNICAL ASSISTANCE

The MAGELiS Technical Support phone and fax numbers are:

**Phone:**       **1-800-468-5342**

**FAX:**           **(508) 975-9301**



MAGELiS and UNITELWAY are trademarks of Telemecanique S.A. or its successor-in-interest, Schneider Electric S.A.  
MODBUS and SY/MAX are registered trademarks of AEG Schneider Automation, Inc.  
Windows is a registered trademark of Microsoft Corporation.  
Pentium is a registered trademark of Intel Corporation.  
SYSMAC is a registered trademark of Omron Corporation.

© 1997 Schneider S.A. All rights reserved. This document may not be copied in whole or in part, or transferred to any other media, without the written permission of Schneider S.A.

Electrical equipment should be serviced only by qualified electrical maintenance personnel. No responsibility is assumed by Schneider S.A. for any consequences arising out of the use of this material.





**GROUPE SCHNEIDER**

■ Merlin Gerin ■ Square D ■ Telemecanique

June 1997 Printed in USA

© 1997 Schneider S.A. All Rights Reserved