

**Digital**  
*Human Machine Interface* —

**Pro-face**

**GP-2400/2500/2600 Series  
User Manual**

# Preface

---

Thank you for purchasing the Pro-face GP-2400/2500/2600 Series programmable operator interface (hereafter referred to as the "GP unit").

This GP unit, with its expanded functionality and improved overall performance, is an upgrade of Pro-face's previous GP series panels. GP-2400/2500/2600 Series units allow you to use the Ethernet, CF Card, and Sound Output features without attaching separately sold expansion units.

Please read this manual carefully as it explains, step by step, how to use the GP correctly and safely.

Also, in this manual's examples, the Mitsubishi MELSEC-AnA Series PLC is used whenever possible, connected in a one-to-one relationship with a GP.

<Note>

- 1) It is forbidden to copy the contents of this manual, in whole or in part, except for the user's personal use, without the express permission of Digital Electronics Corporation of Japan.
- 2) The information provided in this manual is subject to change without notice.
- 3) This manual has been written with care and attention to detail; however, should you find any errors or omissions, please contact Digital and inform them of your findings.
- 4) Please be aware that Digital shall not be held liable by the user for any damages, losses, or third party claims arising from any uses of this product.

All Company/Manufacturer names used in this manual are the registered trademarks of those companies.

© 2002, Digital Electronics Corporation

# Table of Contents

---

<b>Preface</b> .....	<b>1</b>
<b>Table of Contents</b> .....	<b>2</b>
<b>Essential Safety Precautions</b> .....	<b>6</b>
<b>General Safety Precautions</b> .....	<b>10</b>
<b>GP-2400/2500/2600 Series Models</b> .....	<b>12</b>
<b>Package Contents</b> .....	<b>12</b>
<b>UL/c-UL (CSA) Application Notes</b> .....	<b>13</b>
<b>CE Marking Notes</b> .....	<b>14</b>
<b>Revision Version</b> .....	<b>15</b>
<b>Documentation Conventions</b> .....	<b>15</b>

## CHAPTER 1 INTRODUCTION

<b>1.1 Prior to Operating the GP</b> .....	<b>1-1</b>
<b>1.2 System Design</b> .....	<b>1-2</b>
<b>1.3 Accessories</b> .....	<b>1-6</b>
<b>1.4 GP-2400/2500/2600 Series Overview</b> .....	<b>1-10</b>
1.4.1 Ethernet Connectivity .....	1-11
1.4.2 CF Card .....	1-12
1.4.3 Sound Output .....	1-13
1.4.4 Expansion Serial I/F .....	1-13
1.4.5 Internal 2-Port Feature .....	1-14
1.4.6 Backlight Burnout Detection Feature .....	1-15

## CHAPTER 2 SPECIFICATIONS

<b>2.1 General Specifications</b> .....	<b>2-1</b>
2.1.1 Electrical .....	2-1
2.1.2 Environmental .....	2-2
2.1.3 Structural .....	2-3
<b>2.2 Functional Specifications</b> .....	<b>2-4</b>
2.2.1 Display .....	2-4
2.2.2 Memory .....	2-5
2.2.3 Touch Panel • Clock .....	2-5
2.2.4 Interfaces .....	2-6
<b>2.3 Interface Specifications</b> .....	<b>2-7</b>
2.3.1 Serial Interfaces .....	2-7
2.3.2 Printer Interface .....	2-9
2.3.3 AUX I/O and Sound Output .....	2-10

---

<b>2.4</b>	<b>Part Names and Functions .....</b>	<b>2-12</b>
<b>2.5</b>	<b>Dimensions .....</b>	<b>2-14</b>
2.5.1	GP-2400 Series External Dimensions .....	2-14
2.5.2	GP-2500 Series External Dimensions .....	2-14
2.5.3	GP-2600 Series External Dimensions .....	2-15
2.5.4	Panel Cut Dimensions .....	2-15
2.5.5	Installation Fasteners .....	2-16

### **CHAPTER 3 INSTALLATION AND WIRING**

<b>3.1</b>	<b>Installation .....</b>	<b>3-1</b>
3.1.1	Installation Procedures .....	3-1
<b>3.2</b>	<b>Wiring Cautions .....</b>	<b>3-6</b>
3.2.1	Connecting the Power Cord .....	3-6
3.2.2	Connecting the Power Supply .....	3-8
3.2.3	Grounding .....	3-9
3.2.4	I/O Signal Line Placement .....	3-9
<b>3.3</b>	<b>Tool Connector .....</b>	<b>3-10</b>
<b>3.4</b>	<b>Ethernet Cable Connector .....</b>	<b>3-10</b>
<b>3.5</b>	<b>CF Card Installation and Removal .....</b>	<b>3-11</b>
3.5.1	CF Card Handling .....	3-13
<b>3.6</b>	<b>Sound Output .....</b>	<b>3-14</b>
3.6.1	Connecting Speaker Lines .....	3-14
3.6.2	Sound Volume Adjustment .....	3-15

### **CHAPTER 4 DATA TRANSFER**

<b>4.1</b>	<b>Serial Data Transfer .....</b>	<b>4-1</b>
<b>4.2</b>	<b>Ethernet Data Transfer .....</b>	<b>4-4</b>
4.2.1	Checking the IP Address .....	4-5
<b>4.3</b>	<b>CF Memory Loader Tool.....</b>	<b>4-7</b>
4.3.1	Data Upload and Download .....	4-8

### **CHAPTER 5 OFFLINE MODE**

<b>5.1</b>	<b>Entering OFFLINE Mode .....</b>	<b>5-1</b>
5.1.1	After Plugging in the Power Cord .....	5-1
5.1.2	From the Menu Bar .....	5-2
<b>5.2</b>	<b>OFFLINE Mode Main Menu .....</b>	<b>5-3</b>
<b>5.3</b>	<b>INITIALIZATION.....</b>	<b>5-4</b>
<b>5.4</b>	<b>SELF-DIAGNOSIS.....</b>	<b>5-6</b>

**CHAPTER 6 INITIALIZING THE GP**

- 6.1 Initialization Screen ..... 6-1**
- 6.2 Initialization Items ..... 6-2**
- 6.3 SYSTEM ENVIRONMENT SETUP ..... 6-3**
  - 6.3.1 SYSTEM SETUP ..... 6-3
  - 6.3.2 SYSTEM AREA SETUP ..... 6-4
  - 6.3.3 GLOBAL WINDOW SETUP ..... 6-6
  - 6.3.4 CHARACTER STRING DATA SETUP ..... 6-7
- 6.4 SET UP I/O ..... 6-10**
  - 6.4.1 SET UP SIO ..... 6-10
  - 6.4.2 SET UP PRINTER ..... 6-12
  - 6.4.3 SET UP TOUCH PANEL ..... 6-15
  - 6.4.4 COMMUNICATION SETUP ..... 6-18
  - 6.4.5 Sound Settings ..... 6-18
  - 6.4.6 EXPANSION SERIAL COMMUNICATION SETUP ..... 6-19
  - 6.4.7 EXPANSION SERIAL ENVIRONMENT SETUP ..... 6-21
  - 6.4.8 SET UP CAPTURE OPERATION ..... 6-22
  - 6.4.9 SET UP DISPLAY DEVICE ..... 6-23
  - 6.4.10 FUNCTION SETUP ..... 6-23
  - 6.4.11 COMMUNICATION PORT SETUP ..... 6-24
- 6.5 PLC SETUP ..... 6-25**
  - 6.5.1 SET UP OPERATION SURROUNDINGS(1:1/n:1) ..... 6-25
  - 6.5.2 STATION SETUP(n:1) ..... 6-26
  - 6.5.3 CUSTOMIZE SETUP (n:1) ..... 6-28
  - 6.5.4 ETHERNET SETUP ..... 6-30
  - 6.5.5 SYSLOG SETUP ..... 6-31
  - 6.5.6 OtherS Setup ..... 6-32
  - 6.5.7 SELF DIAGNOSIS ..... 6-33
- 6.6 INITIALIZE INTERNAL MEMORY ..... 6-34**
  - 6.6.1 INITIALIZE GP MEMORY ..... 6-34
  - 6.6.2 INITIALIZE CF CARD ..... 6-34
  - 6.6.3 CSV DATA INDEX ..... 6-35
- 6.7 SET UP TIME ..... 6-36**
- 6.8 SET UP SCREEN ..... 6-37**

## CHAPTER 7 RUN MODE AND ERRORS

<b>7.1 RUN Mode .....</b>	<b>7-1</b>
7.1.1 After Connecting the Power Cord .....	7-1
7.1.2 Via OFFLINE Mode .....	7-2
<b>7.2 SELF-DIAGNOSIS .....</b>	<b>7-3</b>
7.2.1 SELF-DIAGNOSIS ITEM LIST .....	7-3
7.2.2 SELF-DIAGNOSIS - Details .....	7-4
<b>7.3 Troubleshooting.....</b>	<b>7-8</b>
7.3.1 Possible Types of Trouble .....	7-8
7.3.2 No Display .....	7-9
7.3.3 No GP/Host Communication .....	7-12
7.3.4 Touch Panel Does Not Respond .....	7-14
7.3.5 Buzzer Sounds when GP power is turned ON .....	7-15
7.3.6 Clock Settings Cannot be Entered .....	7-16
7.3.7 Error Screens .....	7-16
<b>7.4 Error Messages .....</b>	<b>7-17</b>
7.4.1 Error Message List .....	7-17
<b>7.5 Error Message Details .....</b>	<b>7-19</b>
7.5.1 SYSTEM ERRORS .....	7-19
7.5.2 ILLEGAL ADDRESS IN SCREEN DATA .....	7-21
7.5.3 PLC COM. ERROR .....	7-22
7.5.4 CLOCK SET UP ERROR .....	7-23
7.5.5 SCREEN TAG LIMIT EXCEEDED (max. of 384) .....	7-23
7.5.6 OBJ. PLC HAS NOT BEEN SETUP .....	7-23
7.5.7 D-Script and Global D-Script Errors .....	7-24
7.5.8 Extended SIO Script Error .....	7-25
7.5.9 Serial I/F Change Error .....	7-25

## CHAPTER 8 MAINTENANCE

<b>8.1 Regular Cleaning .....</b>	<b>8-1</b>
8.1.1 Cleaning the Display .....	8-1
8.1.2 Installation Gasket Check/Replacement .....	8-1
<b>8.2 Periodic Check Points .....</b>	<b>8-3</b>
<b>8.3 Replacing the Backlight .....</b>	<b>8-4</b>
8.3.1 Replacing CA3-BLU12-01 .....	8-6

## INDEX

# Essential Safety Precautions

This manual includes procedures that must be followed to operate the GP correctly and safely. Be sure to read this manual and any related materials thoroughly to understand the correct operation and functions of this unit.

## Safety Icons

Throughout this manual the following icons are provided next to GP operation procedures requiring special attention, and provide essential safety information. These icons indicate the following levels of danger:



Indicates situations where severe bodily injury, death or major equipment damage can occur.



Indicates situations where slight bodily injury or machine damage can occur.

## WARNINGS

### System Design

- **Do not create GP touch panel switches that could possibly endanger the safety of equipment and personnel. Damage to the GP, its I/O unit(s), cable(s), and other related equipment can cause an output signal to remain continuously ON or OFF and possibly cause a major accident. Therefore, design all monitoring circuits using limit switches, etc. to detect incorrect device movement. To prevent accidents related to incorrect signal output or operation, design all switches used to control vital machine operations so they are operated via a separate control system.**
- **Please design your system so that equipment will not malfunction due to a communication fault between the GP and its host controller. This is to prevent any possibility of bodily injury or material damage.**
- **Do not use the PS unit as a warning device for critical alarms that can cause serious operator injury, machine damage or production stoppage. Critical alarm indicators and their control/activator units must be designed using stand-alone hardware and/or mechanical interlocks.**
- **The GP is not appropriate for use with aircraft control devices, aerospace equipment, central trunk data transmission (communication) devices, nuclear power control devices, or medical life support equipment, due to these devices' inherent requirements of extremely high levels of safety and reliability.**



## WARNINGS

- Do not create switches used to control machine safety operations, such as an emergency stop switch, as a GP touch screen icon. Be sure to install these switches as separate hardware switches, otherwise severe bodily injury or equipment damage can occur.
- When using the GP with transportation vehicles (trains, cars and ships), disaster and crime prevention devices, various types of safety equipment, non-life support related medical devices, etc. redundant and/or failsafe system designs should be used to ensure the proper degree of reliability and safety.

### Touch Panel

- After the GP's backlight burns out, unlike the GP's "Standby Mode", the touch panel is still active. If the operator fails to notice that the backlight is burned out and touches the panel, a potentially dangerous machine operation error can occur.

If your GP's backlight suddenly turns OFF, use the following steps to determine if the backlight is actually burned out.

- 1) If your GP is not set to "Standby Mode" and the screen has gone blank, your backlight is burned out.
- 2) Or, if your GP is set to Standby Mode, but touching the screen does not cause the display to reappear, your backlight is burned out.

Also, use the GP's built-in "USE TOUCH PANEL AFTER BACKLIGHT BURNOUT" feature to prevent an accidental machine operation error. This feature can automatically detect a burnout and disable the touch screen.

### Wiring

- To prevent an electric shock, be sure to confirm that the GP's power cord is not connected to the main power when connecting power lines to the GP.
- Be sure to replace the GP's plastic terminal block cover after wiring is completed, since operating the GP without the cover may lead to an electric shock.
- Do not use power beyond the GP's specified voltage range. Doing so may cause a fire or an electric shock.





## WARNINGS

### Battery Replacement

- The GP uses a lithium battery for backing up its internal clock data. If the battery is incorrectly replaced, the battery may explode. To prevent this, please do not replace the battery yourself. When the battery needs to be replaced, please contact your local GP distributor.

### Installation/Maintenance

- High voltage runs through the GP. Except for replacing the backlight, never take apart the GP, otherwise an electrical shock can occur.
- Do not modify the GP unit. Doing so may cause a fire or an electric shock.
- Do not use the GP in an environment where flammable gasses are present, since operating the GP may cause an explosion.



## CAUTIONS

### Installation/Maintenance

- Be sure to securely connect all cable connectors to the GP. A loose connection may cause incorrect input or output.

### Wiring

- Ground the GP's FG line separately from other units' FG lines. Putting these FG lines too close may cause an electric shock or unit malfunction. Be sure to use a grounding resistance of 100Ω or less and a 2mm<sup>2</sup> or thicker wire, or your country's applicable standard.
- Correctly wire the GP, be sure that the rated voltage and terminal layout are within the designated range. If the voltage supplied differs from the rated voltage, or incorrect wiring or grounding is performed, it may cause a fire or unit malfunction.



## CAUTIONS

- Use only the designated torque to tighten the GP's terminal block screws. If these screws are not tightened firmly, it may cause a short-circuit, fire, or GP malfunction.
- Be careful that metal filings and wiring debris do not fall inside the GP, since they can cause a fire, GP malfunction, or incorrect operation.

### Touch Panel/CF Card

- The liquid crystal panel contains a powerful irritant and if for any reason the panel is damaged and this liquid contacts any part of your body, be sure to wash that area with running water for 15 minutes. If any of this liquid enters your eye, flush your eye for 15 minutes with running water and contact a physician.
- Prior to inserting or removing a CF Card, be sure to turn the GP's CF Card ACCESS switch OFF and to confirm that the ACCESS lamp is not lit. If you do not, CF Card internal data may be damaged or lost.
- While a CF Card is being accessed, NEVER turn OFF or reset the GP, or insert or remove the CF Card. Prior to performing these operations, create and use a special GP application screen that will prevent access to the CF Card.

**▼Reference▲** Refer to *GP-PRO/PB III for Windows Tag Reference Manual* (included in the screen editor software package)

### Unit Disposal

- When this unit is disposed of, it should be done so according to your country's regulations for similar types of industrial waste.

# General Safety Precautions

---



- *Do not strike the touch panel with a hard or pointed object, or press on the touch panel with too much force, since it may damage the touch panel or the display.*
- *Do not install the GP where the ambient temperature can exceed the allowed range. Doing so may cause the GP to malfunction or shorten its operation life.*
- *Do not restrict or limit the GP's naturally occurring rear-face ventilation, or storing or using the GP in an environment that is too hot.*
- *Do not use this unit in areas where large, sudden temperature changes can occur. These changes can cause condensation to form inside the unit., possibly causing the unit to malfunction.*
- *Do not allow water, liquids, metal or charged particles to enter inside the GP's case, since they can cause either a GP malfunction or an electrical shock. The allowable pollution degree is 2.*
- *Do not use or store the GP in direct sunlight, or in excessively dusty or dirty environments.*
- *Do not store or use the unit where strong jolting or excessive vibration can occur.*
- *Do not store or use the GP where chemicals (such as organic solvents, etc.) and acids can evaporate, or where chemicals and acids are present in the air.*

*Corrosive chemicals: Acids, alkalines, liquids containing salt*

*Flammable chemicals: Organic Solvents*

- *Do not use paint thinner or organic solvents to clean the GP. Otherwise, discoloration or a malfunction may result.*
- *Do not store or operate the LCD display in areas receiving direct sunlight, since the sun's UV rays may cause the LCD display's quality to deteriorate.*
- *Storing this unit in areas at a temperature lower than is recommended in this manual's specifications may cause the LCD display's liquid to congeal, which may damage the panel. Conversely, if the storage area's temperature becomes higher than the allowed level, the LCD's liquid will become isotropic, causing irreversible damage to the LCD. Therefore, be sure to store the panel only in areas where temperatures are within those specified in this manual.*
- *Do not connect or disconnect the communication cable between the GP and the host while power is ON.*



- *Due to the possibility of unexpected accidents, be sure to back up the GP's screen data regularly.*

## ■ About the GP's Display Panel

- *The GP's currently displayed data, its voltage<sup>\*1</sup> and brightness setting each affect the intensity of Contouring. (i.e, when some parts of the screen are brighter than others, creating a wavelike pattern)*
- *There are minute grid-points (dark and light) on the Display Panel's surface. This is part of the GP's design and not a defect.*
- *Extended shadows, or "Crosstalk" may appear on the sides of screen images. This is normal for an LCD display.*
- *Sometimes the display area may look as if the display colors have changed. This is a common attribute of LCD's and is not a defect.*
- *Displaying a single image for long periods can cause an afterimage to remain when the display is changed to another screen.*

To prevent this effect:

- *Use the GP's "Stand-by Mode", which automatically turns the screen OFF when there is no input for a specified period of time.*

### ▼Reference▲ 6.3.1 System Setup

- *Write "FFFFh" to the System Data Area's "Screen Display Off" address<sup>\*2</sup> to turn the screen display OFF when the following actions are not performed for the user's designated period of time.*
  - *Change Screen*
  - *Touch Screen*
  - *Alarm Display*
- *Do not display any single screen for a long period of time. Try to periodically change the screen display.*

---

*\*1 If the GP's voltage is at the very low end of its allowable range, it may effect the intensity of contouring.*

*\*2 The following addresses assume all System Data Area settings are entered. If they are not all entered, the correct word address may be different from those given here.*

*With the Direct Access Method — use System Data Area word address +9*

*With the Memory Link Method — use System Data Area word address +12*

▼Reference▲ *GP-PRO/PBIII for Windows Device/PLC Connection Manual*

---

# GP-2400/2500/2600 Series Models

The GP-2400/2500/2600 Series refers to the following GP model numbers:

Series		Model Name	Model Type	Comments	GP Type in Screen Creation Software	
GP2000 Series	GP-2400 Series	GP-2400T	GP2400-TC41-24V	UL/cUL Approved, CE Marked	GP2400	
	GP-2500 Series	GP-2500L	GP2500-LG41-24V	UL/cUL Approved, CE Marked	GP2500L	
		GP-2500S	GP2500-SC41-24V	UL/cUL Approved, CE Marked	GP2500S	
		GP-2500T		GP2500-TC11	*1	GP2500
			GP2500-TC41-24V	UL/cUL Approved, CE Marked		
	GP-2600 Series	GP-2600T		GP2600-TC11	*1	GP2600
				GP2600-TC41-24V	UL/cUL Approved, CE Marked	

*\*1 Revised models may or may not conform to UL/c-UL (CSA) and CE Markings, depending on the revision version.*

**Reference** For information on how to determine the revision version, see "Revision Version" (page 15).

## Package Contents

The GP's packing box contains the items listed below. Please check to confirm that all items shown below have been included.

■ **GP Unit (1)**

GP2400-TC41-24V,  
 GP2500-LG41-24V,GP2500-SC41-24V  
 GP2500-TC11,GP2500-TC41-24V  
 GP2600-TC11, GP2600-TC41-24V

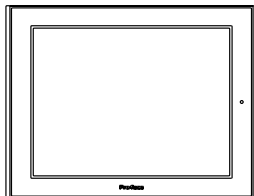

■ **Installation Gasket (1)**



■ **Installation Guide (1)**

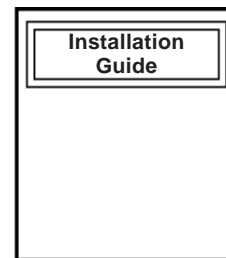

■ **Installation Fasteners (4/set)**

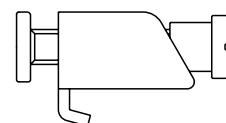

This unit has been carefully packed, with special attention to quality. However, should you find anything damaged or missing, please contact your local GP distributor immediately for prompt service.

# UL/c-UL (CSA) Application Notes

The GP2500-TC11\*<sup>1</sup>, GP2600-TC11\*<sup>1</sup> are UL/c-UL (CSA) recognized components. (UL file No.E231702)

The GP2400-TC41-24V, GP2500-LG41-24V, GP2500-SC41-24V, GP2500-TC41-24V, and GP2600-TC41-24V are UL/c-UL (CSA) listed products. (UL file No.E182139)

Model	UL registered format	Standards						
		A	B	C	D	E	F	G
GP2400-TC41-24V	2880061	○		○	○			
GP2500-LG41-24V	2980078-01	○		○		○		
GP2500-SC41-24V	2980078-02	○		○		○		
GP2500-TC11* <sup>1</sup>	3180021-01		○	○			○	○
GP2500-TC41-24V	2880045-01	○		○		○		
GP2600-TC11* <sup>1</sup>	3180021-02		○	○			○	○
GP2600-TC41-24V	2880045-02	○		○		○		

## These units conform to the following standards:

\*1 All GP units marked Revision "3" conform to UL/c-UL standard requirements.

**Reference** For more information on how to determine the revision version, see "Revision Version" (page 15).

- A) **UL508** Industrial Control Equipment
- B) **UL60950** Safety Standard for Information Technology Equipment (3rd Edition, issued December 1, 2001)
- C) **UL1604** Electrical Equipment for use in Class 1 & 2 - Division 2, or Class 3 Hazardous Locations.
- D) **CAN/CSA-C22.2, Nos. 142, and 213-M1987** Safety Standard for Information Technology and Electrical Business Equipment
- E) **CAN/CSA-C22.2, No. 1010-1** Safety Requirement for Electrical Equipment for Measurement, Control and Laboratory Use
- F) **CAN/CSA-C22.2, No. 60950-00** Safety Standard for Information Technology Equipment (3rd Edition, issued December 1, 2001)
- G) **CAN/CSA-C22.2, No. 213-M1987** Safety Standard for Information Technology and Electrical Business Equipment

## <Cautions>

- The GP must be used as a built-in component of an end-use product.
- The GP units must be used indoors only.
- This unit should be installed in the front face of a metal panel.
- If this unit is installed so as to cool itself naturally, be sure to install it in a vertical panel. Also, be sure that the GP unit is mounted at least 100 mm away from any adjacent structures or equipment. If these requirements are not met, the heat generated by the GP unit's internal components may cause the unit to fail to meet UL/c-UL standard requirements.
- Be sure to create a power ON/OFF switch for the GP on or in the end-use product that the GP unit is built-in. Make sure to consider the current and voltage when installing the switch.
- Be sure that the end-use the product uses a UL60950 approved structure.

### UL1604 Conditions of Acceptability and Handling Cautions:

1. Power, input and output (I/O) wiring must be in accordance with Class I, Division 2 wiring methods - Article 501- 4(b) of the National Electrical Code, NFPA 70 within the United States, and in accordance with Section 18-152 of the Canadian Electrical Code for units installed within Canada.
2. Suitable for use in Class I, Division 2, Groups A, B, C and D, Hazardous Locations.
3. WARNING: Explosion hazard - substitution of components may impair suitability for Class I, Division 2.
4. WARNING: Explosion hazard - when in hazardous locations, turn power OFF before replacing or wiring modules.
5. WARNING: Explosion hazard - do not disconnect equipment unless power has been switched OFF, or the area is known to be non-hazardous.
6. WARNING: Explosion hazard - do not connect/disconnect equipment unless area is known to be nonhazardous. Port is for system set up and diagnostics.

## CE Marking Notes

---

The GP2400-TC41-24V, GP2500-LG41-24V, GP2500-SC41-24V, GP2500-TC41-24V, and GP2600-TC41-24V are CE marked products that conform to EMC directives EN55011 Class A and EN61000-6-2.

The GP2500-TC11\*<sup>1</sup> and GP2600-TC11\*<sup>1</sup> are CE marked products that conform to EMC directives and the Low-voltage directive EN55011 Class A, EN61000-3-2, EN61000-3-3, EN61000-6-2 and EN60950.

*For detailed CE marking information, please contact your local GP distributor.*

### <Cautions>

- The GP must be used as a built-in component of an end-use product.
- The GP units must be used indoors only.
- This unit should be installed in the front face of a metal panel.
- If this unit is installed so as to cool itself naturally, be sure to install it in a vertical panel. Also, be sure that the GP unit is mounted at least 100 mm away from any adjacent structures or equipment. If these requirements are not met, the heat generated by the GP unit's internal components may cause the unit to fail to meet the standard requirements.
- Be sure to create a power ON/OFF switch for the GP on or in the end-use product that the GP unit is built-in. Make sure to consider the current and voltage when installing the switch.
- Be sure that the end-use the product uses a EN60950 approved structure.

---

\*I All GP units marked Revision "3" conform to CE Marking standard requirements.

**Reference** For more information on how to determine the revision version, see "Revision Version" (page 15).

# Revision Version

The revision version can be determined by the identification label or revision stickers that are placed on the main unit of the GP. The characters and numerals in the "REV" area that are replaced with asterisks (\*), or marked with a marker indicate the revision version.

In the example below, the asterisks "\*" are placed at positions "D", "1", and "2", which indicates the revision version as "D, 1, 2".

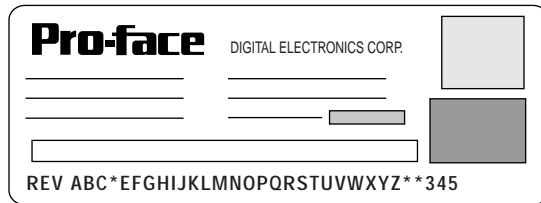



Identification Label



Revision Sticker

# Documentation Conventions

The list below describes the documentation conventions used in this manual.

Symbol	Meaning
	Indicates important information or procedures that must be followed for correct and risk-free software/device operation.
*1	Indicates useful or important supplemental information.
1) , 2)	Indicates steps in a procedure. Be sure to perform these steps in the order given.
	Refers to useful or important supplemental information.
	Provides useful or important supplemental information.
<b>GP Screen Editor</b>	Indicates the GP-PRO/PBIII for Windows screen editor software (version 6.10 or higher).
<b>PLC</b>	Abbreviation for Programmable Logic Controller.
<b>n:1</b>	Indicates a multi-link type connection is used.



# *Memo*

# Chapter

# 1 Introduction

1. Prior to Operating the GP
2. System Design
3. Accessories
4. GP-2400/2500/2600 Series Overview

## 1.1 Prior to Operating the GP

---

Be sure to follow these steps when creating projects for the GP unit.

- 1 Preparation** Before using the GP, check that all required hardware is present and read all specification, wiring, and installation information.  
**Reference** *Chapter 2, "Specifications" and Chapter 3, "Installation and Wiring"*
- 2 Screen Design** Create a sample screen and design a Tag layout, with the Screen layout sheets and Tag lists provided in the Editor software.  
**Reference** *GP-PRO/PBIII for Windows Operation Manual*
- 3 Select GP and PLC types** Using the input areas provided, select the GP and the PLC types to be used.  
**Reference** *GP-PRO/PBIII for Windows Operation Manual and Tag Reference Manual*
- 4 Create Screen/ Run Screen Setup** Setup the screen and tags in your screen editing software according to your Screen Design.  
**Reference** *GP-PRO/PBIII for Windows Operation Manual and Tag Reference Manual*
- 5 Transfer Screen Data** Transfer the data from the Screen design software on your PC to the GP unit using the Downloading Cable.  
**Reference** *GP-PRO/PBIII for Windows Operation Manual*
- 6 GP/Host Connection** Set up the GP so that it can receive data from the Host (PLC).  
**Reference** *Chapter 6, "Initialize the GP", and GP-PRO/PBIII for Windows Device/PLC Connection Manual*
- 7 Connect the GP** Link the GP with the host (PLC) using the appropriate connection cable (different cables may be necessary for different hosts), and then operate the unit.  
**Reference** *GP-PRO/PBIII for Windows Device/PLC Connection Manual*

# 1.2 System Design

The following diagram represents the main selection of devices connectable to the GP.

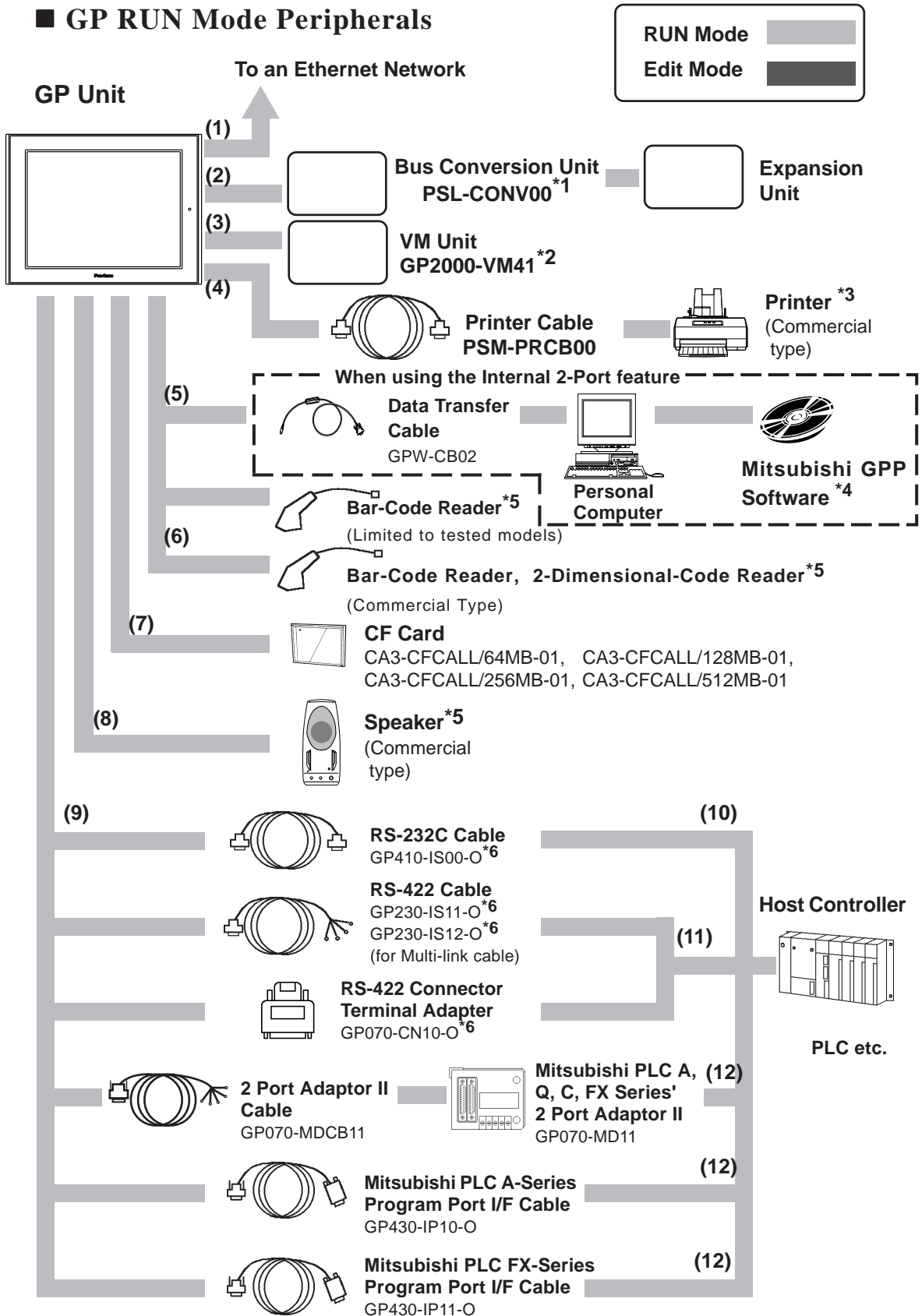

## ■ GP Edit Mode Peripherals

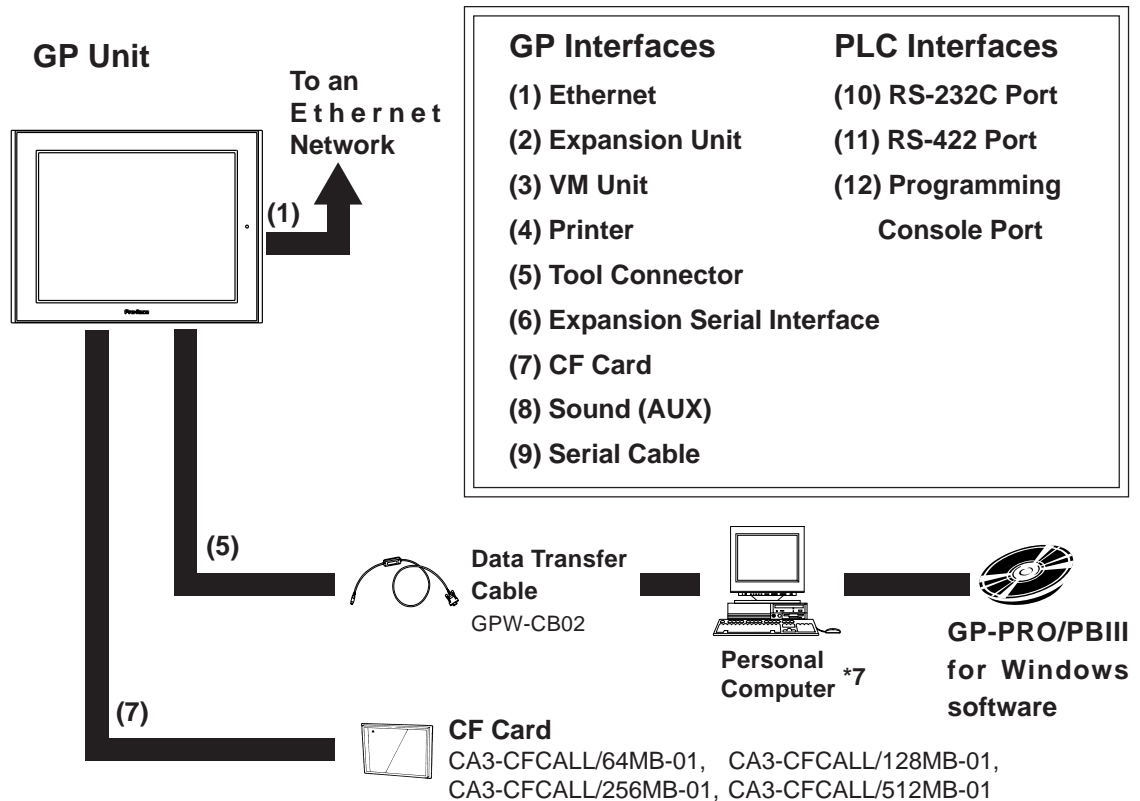

\*1 GP-2500 Series and 2600 Series units can use this unit, however the GP-2400 Series can not.

\*2 GP-2500T and GP-2600 Series units can use this unit, however the GP-2400 Series, GP-2500L and GP-2500S can not.

\*3 Compatible with NECPC-PR201/PL, EPSON ESC/P24-J84(C), HP Laser Jet PCL 4 command printers, EPSON PM/Stylus (6-color ink), EPSON Stylus (4-color ink) printers or their equivalent that are designed for MS-DOS. Printers designed solely for Windows may not be used. Certain printers containing both Windows and DOS drivers may be used. For details, please contact your printer's manufacturer or sales outlet.

\*4 For information about compatible PLC types and software, please refer to

**Reference** GP-PRO/PBIII for Windows Device/PLC Connection Manual (included with the screen creation software)

\*5 For information about recommended units, please refer to the following page.

\*6 Certain types and models of PLCs cannot be connected.

**Reference** GP-PRO/PBIII for Windows Device/PLC Connection Manual (included with the screen creation software)

\*7 For the full range of compatible PCs, refer to the following manual.

**Reference** GP-PRO/PBIII for Windows Operation Manual (included with the screen creation software)

# Chapter 1 - Introduction

## ■ Recommended Units

The following tables list I/O devices that have been confirmed to be compatible with the GP. If you connect a device other than those listed below, be sure to confirm that the connection functions correctly using the actual unit.



**Recommended units are subject to additions/changes without notice.**

### ◆ Bar code readers (Connected to Tool Connector)

Manufacturer	Model	Type	Description
Aimex Corporation	BR-331 PC2	Pen	
OPT Electronics	OPT-1105-RSK 98 Set	Touch Scanner (Read Width: 60mm)	
	OPT-5105-RSK 98 Set	Touch Scanner (Read Width: 80mm)	
	OPL-6735-RSK 98 Set	Touch Scanner (Read Width: 100mm)	
Tohken	TCD-5510M	Touch Scanner (Read Width: 65mm)	
	TCD-5510L	Touch Scanner (Read Width: 82mm)	
	TCD-5510W	Touch Scanner (Read Width: 105mm)	
NEC Infrontia	BCK5435-STA	Touch Scanner (Read Width: 56mm) <sup>*1*2</sup>	Includes Y cable for connection cable
	BCK5535-STA	Touch Scanner (Read Width: 85mm) <sup>*1*2</sup>	Includes Y cable for connection cable

\*1 Be sure to use the Y cable included with the unit and connect it between the GP unit and a bar code reader. Data cannot be read correctly, if a non-"Y" cable is used, or if the bar code reader is connected directly to the GP unit.

\*2 The following settings must be entered prior to using the bar code reader with a GP unit.

1) Set the CAPS.

2) Add the Carriage Return (CR) in the Postamble's settings.

For the details about these settings, please refer to the Installation Guide included with the bar code reader unit.

## ◆ Bar Code Reader (Connected to Expansion Serial Interface)

Manufacturer	Model	Type	Remarks
Aimex Corporation	BR-730RS	Pen	Battery powered
	BR-530RS	Pen	Requires separately sold BB-60 for power.
	BW-665RS	Touch Scanner (Read Width: 65mm)	
OPT Electronics	OPT-1125-RS232C	Touch Scanner (Read Width: 60mm)	Requires separately sold DC5300T for power.
	OPT-5125-RS232C	Touch Scanner (Read Width: 80mm)	
	NFT-7175-L-RS232C	Fixed Type (Read width: 60mm)	
Symbol Technologies, Inc	LS4004	Laser Scanner	Includes power supply.
	LS4004i	Laser Scanner	Includes power supply.
	LS6004	Laser Scanner	Includes power supply.
	LSH3502AHV	Laser Scanner	Includes power supply.
Keyence Co.	BL-80R	Touch Scanner (Read Width: 105mm)	Includes power supply.
Denso Co.	HC36TR	Touch Scanner (Read Width: 61mm)	For power: separately sold P-200 unit.
	HC61TR	Touch Scanner (Read Width: 61mm)	For connector cable: separately sold KRS-423-XF1K (Sanwa Supply)

\*1 Confirm that the Expansion serial interface's settings match those of the connected device.

▼ **Reference** ▼ See 6.4.6 Expansion Serial Communication Setup.

## ◆ Serial Code Reader (Connected to Expansion Serial Interface)

Manufacturer	Model	Power Supply
Tohken	THIR-3000	ESA-1220A (Sold separately)
	THIR-3000H	
Denso	QS20H	Supplied with the main unit
	QS20H-I	

\*1 Confirm that the Expansion serial interface's settings match those of the connected device.

▼ **Reference** ▼ See 6.4.6 Expansion Serial Communication Setup.

## ◆ Speaker

Models to be connected to LINE OUT require a separate amplifier.

Manufacturer	Model	Connection Port
Arrow Electronics	NS-38	SP OUT, GND
	NS-105	

## 1.3 Accessories

All optional equipment listed here is produced by Digital Electronics Corporation.

### ■ Available Software

Product Name	Model No.	Description
GP-PRO/PB III C-Package02 (GP-PRO/PB III for Windows Ver. 6.10 or later)	GPPRO-CNT01W-P02	Software to be used to create the GP's screen data. Installed in a personal computer.

### ■ Tool Connector

Product Name	Model No.	Description
Screen Data Transfer Cable	GPW-CB02	Connects the GP to a personal computer. Transfers screen data and user program(s).

### ■ Serial Interfaces

Product Name	Model No.	Description
RS-232C cable*1	GP410-IS00-O	Interface cables between the host (PLC) and the GP.
RS-422C cables*1	GP230-IS11-O	
	GP230-IS12-O (for Multi-link)	
RS-422C*1 (Connector terminal block conversion adapter)	GP070-CN10-O	Conversion adapter to convert serial data to RS-422 format
2 Port Adapter II	GP070-MD11	Interface unit that allows use of both GP and Mitsubishi A, Q, C and FX series equipment in the same location.
2 Port Adapter II Cable	GP070-MDCB11	Connects the GP to 2 Port Adapter II.
Mitsubishi A Series Programming Port I/F cable	GP430-IP10-O	Connects directly to Mitsubishi's PLC I/F Programming Console. Simultaneous use of program console, however, is not possible.
Mitsubishi FX Series Programming Port I/F cable	GP430-IP11-O	

\*1 For detailed information about range of connectable PLC.

**Reference** *GP-PRO/PBIII for Windows Device/PLC Connection Manual*

## ■ Printer Interface Cable

Product Name	Model No.	Description
Printer Cable	PSM-PRCB00	Cable designed to connect the GP and a commercial type printer.

## ■ Expansion Units

Product Name	Model No.	Description
T-Link Unit <sup>*1*2</sup>	GP450-ZB21	Interface (I/F) unit to connect the GP to a Fuji Electric Co. T-Link Unit.
DeviceNet Unit <sup>*1*2</sup>	GP070-DN41	Interface (I/F) unit to connect the GP to a DeviceNet Network.
Profibus-DP Unit <sup>*1*2</sup>	GP070-PF11	Interface (I/F) unit to connect the GP to a Profibus-DP Network.
INTERBUS Unit <sup>*1*2</sup>	GP070-IB41	Interface (I/F) unit to connect the GP to an INTERBUS Network.
CC-Link Unit <sup>*1*2</sup>	GP070-CL11	Interface (I/F) unit to connect the GP to a CC-Link unit.
MELSECNET/10 Unit <sup>*1*2</sup>	GP070-MNL11 GP070-MNB11	Interface (I/F) unit to connect the GP to a MELSECNET/10 unit.
VM Unit <sup>*3</sup>	GP2000-VM41	Used with GP-2500T/2600T Video capture unit.

*\*1 When using this unit with a GP-2500/GP-2600 Series display, the optional Bus Conversion Unit (PSL-CONV00) is required. When this unit is used, however, the CF Card Front Maintenance Unit (GP077-CFFM10) cannot be used.*

*\*2 The GP-2400 Series unit cannot use this device.*

*\*3 The GP-2400 Series, GP-2500L and GP-2500S unit cannot use this device.*

## ■ Conversion Unit

Product Name	Model No.	Description
Bus Conversion Unit <sup>*1</sup>	PSL-CONV00	Required when using a GP70/77R Series Expansion Unit with a GP-2500/2600 series unit

*\*1 When using a GP70/77R Series Expansion Unit with a GP-2500/GP-2600 Series unit, the optional Bus Conversion Unit (PSL-CONV00) is required. When this unit is used, however, the CF Card Front Maintenance Unit (GP077-CFFM10) cannot be used.*



## Chapter 1 - Introduction

### ■ CF Card Items

Product Name	Model No.	Description
CF Cards	CA3-CFCALL/64MB-01	GP Series CF Card (64MB)
	CA3-CFCALL/128MB-01	GP Series CF Card (128MB)
	CA3-CFCALL/256MB-01	GP Series CF Card (256MB)
	CA3-CFCALL/512MB-01	GP Series CF Card (512MB)
CF Card Adaptor	GP077-CFAD10	CF Card Adaptor for standard PC Card Slot.
CF Card Front Maintenance Unit <sup>*1*2</sup>	GP077-CFFM10	Allows CF Card to be inserted into the front face of GP-2500/2600. (inside Maintenance Cover)

*\*1 When using a GP70/77R Series Expansion Unit with a GP-2500/GP-2600 Series unit, the optional Bus Conversion Unit (PSL-CONV00) is required. When this unit is used, however, the CF Card Front Maintenance Unit (GP077-CFFM10) cannot be used.*

*\*2 The GP-2400 Series unit cannot use this device.*

### ■ Screen Protection

Product Name	Model No.	Description
Screen Protection Sheet	PS400-DF00 (GP-2400 Series)	Disposable protective and dirtresistant sheet for the GP's screen. The GP's touch panel can be used with this cover sheet attached. (5 sheets/set)
	PSL-DF00 (GP-2500/2600 Series)	

## ■ Maintenance Items

They are available separately as optional maintenance items.

Product Name	Model No.	Corresponding GP	Rev.	Description
Backlight	PS400-BU00-MS	GP-2400T Series	-	Replacement Backlight
	GP577RT-BL00-MS	GP-2500T Series	-	
	CA3-BLU12-01	GP2600-TC11	Rev.4 is marked.*1	
		GP2600-TC41-24V	Rev.3 is marked.*1	
	PS600-BU00	GP2600-TC11	Rev.4 is not marked.*1	
		GP2600-TC41-24V	Rev.3 is not marked.*1	
Installation Fastener	GP070-AT01	GP-2400 Series GP-2500 Series GP-2600 Series	-	Fasteners to attach the GP to a panel. (4 fasteners/set)
Installation Gasket	PS400-WP00-MS	GP-2400 Series	-	Provides a moisture resistant seal when installing the GP.
	GP570-WP10-MS	GP-2500 Series GP-2600 Series	-	Same as the seal include in the GP's original equipment package.
Connector Cover	PS-BH00	GP-2400 Series GP-2500 Series GP-2600 Series	-	Attaches to GP rear face connectors.
Screw Lock Terminal Block	GPM-AXCN01	GP-2400 Series GP-2500 Series GP-2600 Series	-	This Connector is used for external reset, alarm output, buzzer output, or sound output.

---

*\*1 The corresponding backlight unit differs depending on GP-2600 Series unit's marked Revision.*

**▼ Reference ▲** *For more information on how to determine the revision version, see "Revision Version" (page 15).*

---

# 1.4 GP-2400/2500/2600 Series Overview

---

The GP-2400T/2500T/2600T are equipped with a variety of new and useful items, such as an Ethernet, CF Card, Sound and Expansion Serial interfaces as standard equipment. The following explanation describes these and other new GP features.

### ■ Ethernet Feature

Your GP-2400/2500/2600 series unit comes with an Ethernet 10BASE-T connector as standard equipment. In addition to sending screen data to the GP, this feature can also be used to set up the GP, even if you are using the unit for the first time\*1.

Also, Digital's separately sold Pro-Server software can be used to read out data collected in the GP to a central PC server, via an Ethernet LAN network. This collected data can then be processed for production information management, via a variety of popular software applications.

### ■ CF Card Feature

This interface allows you to use the CF Card instead of the optional Memory Loader II to store GP setup\*1 and screen data, and then transfer it to the GP.

You can also read and write data to your existing (optional) Multi-Unit's CF Card, since the GP-2400/2500/2600's card is the same type.

The CF Card can also be used for the storage and transfer of recipe, logging, alarm history and bmp data files. The GP can read these files from the CF Card, or use the CF Card to store data read out from the host (PLC).

### ■ Sound Output I/F

With the GP-2400/2500/2600, you only need to connect a speaker to the GP's sound output Terminal to enable sound output, without connecting the optional Multi Unit.

### ■ Expansion Serial Interface

This interface allows you to connect a variety of equipment, including a bar-coder reader, a serial code reader or an I/O device.

### ■ Internal 2-Port Feature \*2

The GP's built-in 2-Port feature allows you to enjoy 2-Port operation with a Mitsubishi brand PLC, without using the optional 2-Port Adapter II unit.

### ■ Backlight Burnout Detection Feature \*2

When the GP's backlight burns out, it will be automatically detected. The GP's "Status LED" will alert you that the backlight is burned out so that you can disable GP Touch Panel Operation and prevent a possible GP operation mistake.

(Please read the following sections for detailed information about each feature.)

---

\*1 *Setting up the GP means downloading the required system and protocol programs from the GP screen creation software to the GP.*

\*2 *These features are supported by certain earlier GP types.*

---

## 1.4.1 Ethernet Connectivity

The GP-2400/2500/2600 can be connected to a LAN or an Ethernet compatible PLC without using Pro-face's optional Ethernet I/F unit. The GP-2400/2500/2600 also supports the 2-Way function. \*1

This feature allows you to setup a GP and to also perform screen data transfer. You can even set up a completely new GP.

For details about setting up the GP via an Ethernet network, refer to

**Reference** **GP-PRO/PBIII for Windows Operation Manual**

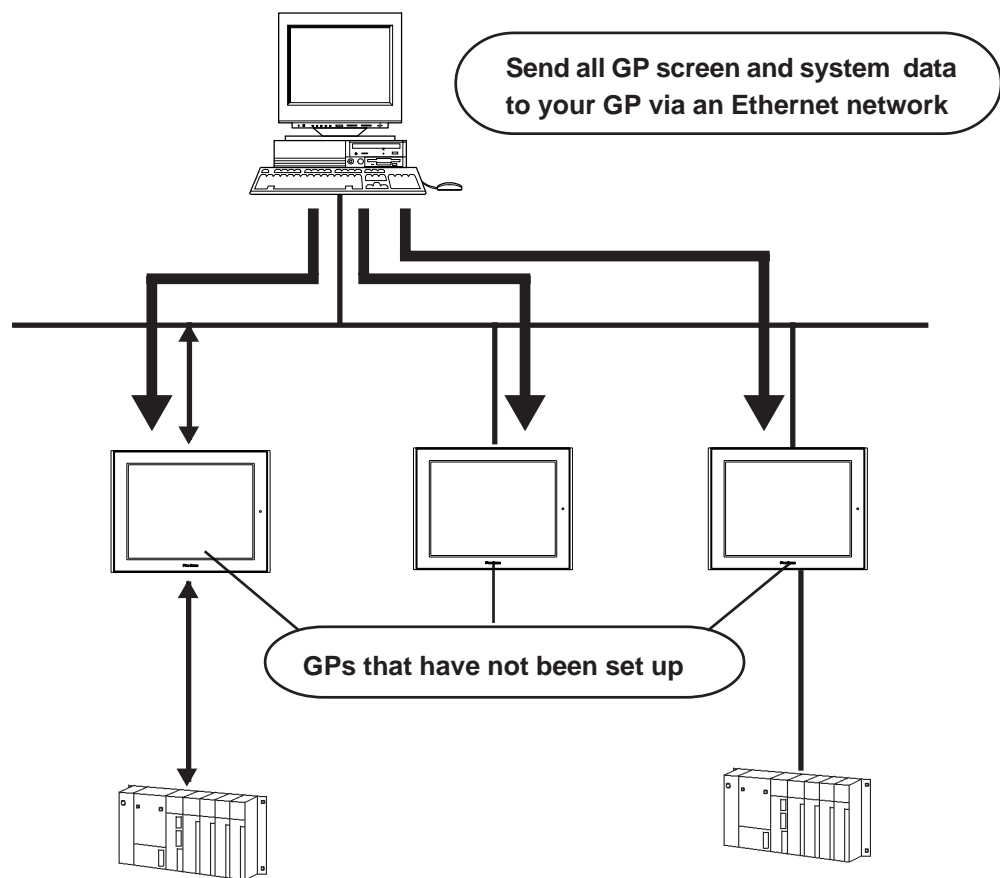

\*1 To use this feature, Pro-face's "Pro-Server with Pro-Studio for Windows" software (sold separately) is required. For details, contact your local GP distributor.

## 1.4.2 CF Card

The new GP-2400/2500/2600 series unit allows you to use a CF Card without installing the separately sold Multi Unit. You can set up the GP or send screen data by saving backup data (i.e. all necessary data for GP operation) in the CF Card using the GP's CF Memory Loader Tool feature. As with the Multi Unit, all the following features are available with a GP-2400/2500/2600 series unit.

- Read filing data from CF Card
- Write logging data to CF Card
- Read image data or sound data from CF Card
- Write Graph data or Alarm data to CF Card
- Back up screen data to CF Card

For details about creating / saving backup data (i.e. all necessary data for GP operation) and sending GP data, refer to

**Reference** *GP-PRO/PBIII for Windows Operation Manual*

For details about CF Memory Loader Tool's data upload and download, refer to

**Reference** *4.3 Memory Loader Tool*



**When using the "CF Memory Loader Tool", Digital's GP077-CF20 (16MB) or GP077-CF30 (32MB) Memory Card is required.**

### ■ Send GP Screen Data to a CF card, then to other GPs

The CF Card allows you to set up multiple GPs, using a single GP's data.

Copy your GP data and the "CF Memory Loader Tool" to your GP's CF Card, then insert that CF Card in another GP and transfer that data using the the CF Memory Loader Tool.

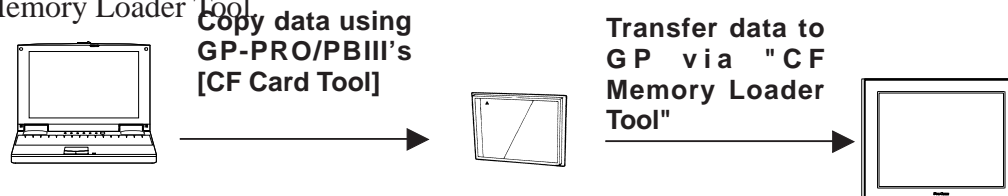

### ■ Send GP Screen Data to a GP, then to the CF card

You can also use the GP as a CF Card drive for your PC, by sending data from your PC directly to your GP's CF Card, . Simply connect your PC and the GP using the data transfer cable, and send your backup data and the CF Memory Loader Tool to the CF Card installed in the GP.

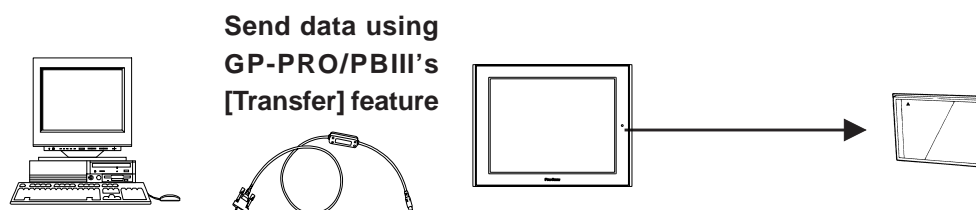

**At a transmission speed of 115.2kbps, it takes approximately fifteen minutes to transfer screen and system data to a GP.**

## ■ Send Data from a GP to a CF Card, then to another GP

The CF Card allows you to use backup data saved in a GP for setting up another GP. First, upload (transfer) your GP's backup data to your CF Card. Next, remove the CF Card, insert it in a different GP and download (transfer) the CF Card's data to that GP. Be sure that the CF Memory Loader Tool is saved on the CF Card prior to using this method.

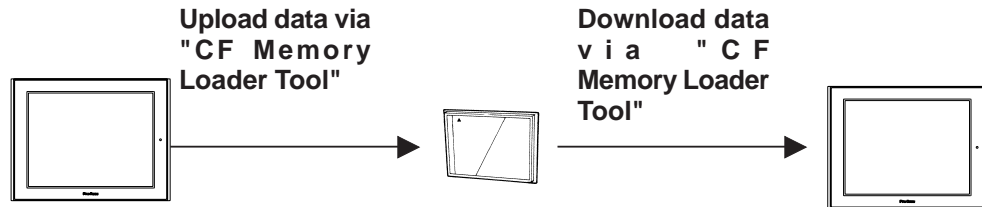

### 1.4.3 Sound Output

---

This feature allows you to connect a speaker to the GP's Sound Output Terminal to produce sound output without using Pro-face's optional Multi Unit.

This feature can be used when an operator wishes to create a sound-alarm or a sound-message, rather than only checking alarms or messages via the GP screen. It can be also used as a machinery operation guide, or for multimedia.

**Reference** *“GP-PRO/PBIII for Windows Tag Reference Manual” (included in the GP screen creation software package)*

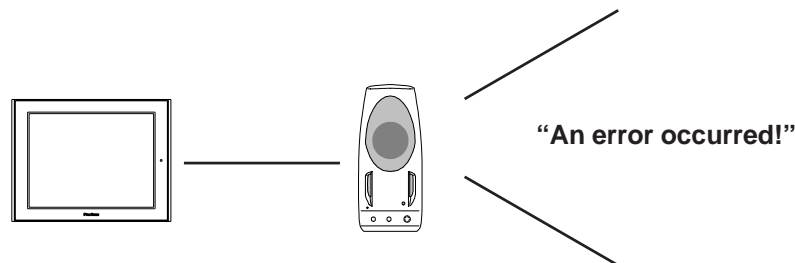

### 1.4.4 Expansion Serial I/F

---

The Expansion Serial Interface allows you to connect a bar-code reader, a serial-code reader, or other type of I/O device. It enables the input/output of large volumes of data which cannot be handled with a conventional bar code reader interface.

**Reference** *“GP-PRO/PBIII for Windows Operation Manual” (included in the GP screen creation software package)*

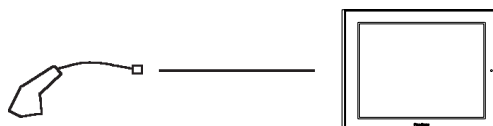

## 1.4.5 Internal 2-Port Feature

The 2-Port feature allows you to use Mitsubishi's GPP software package (ladder programming software) on your PC while the GP is connected to a PLC. With a GP-2400/2500/2600 Series unit, you can use the 2-Port feature in the following two ways:

- Via the internal 2-Port feature  
The GP's Tool Connector and a PC are connected via a data transfer cable (GPW-CB02).
- Via the external 2-Port Adapter II

Pro-face's 2-Port Adapter II (GP070-MD11) is used.  
For information about PLC types and GP compatibility with GP-2400/2500/2600 Series units, refer to **Reference** *GP-PRO/PBIII for Windows Device/PLC Connection Manual* (included with the GP screen creation software)

### ■ When Using Internal 2-Port feature \*1

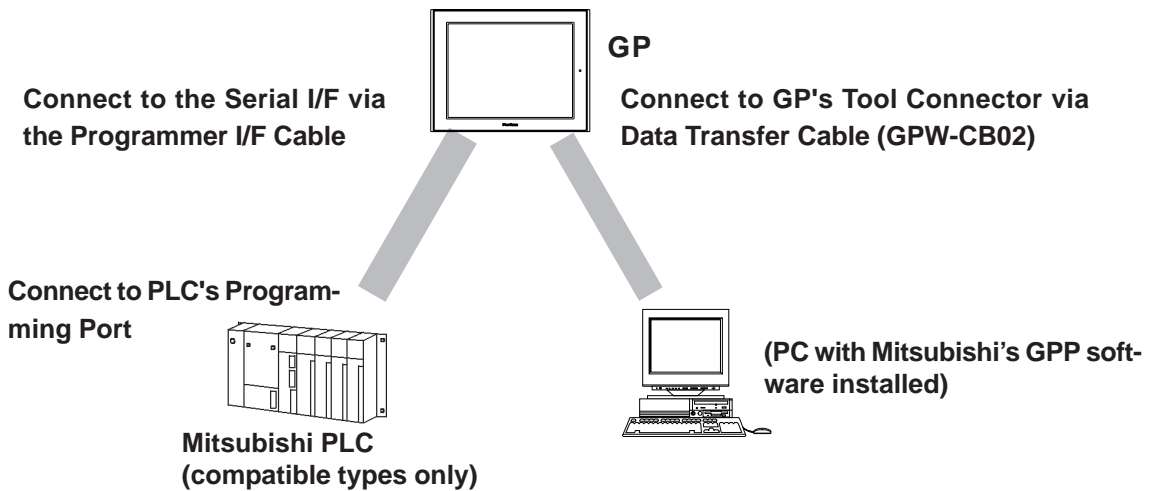

### ■ When Using the External 2-Port Adapter \*2

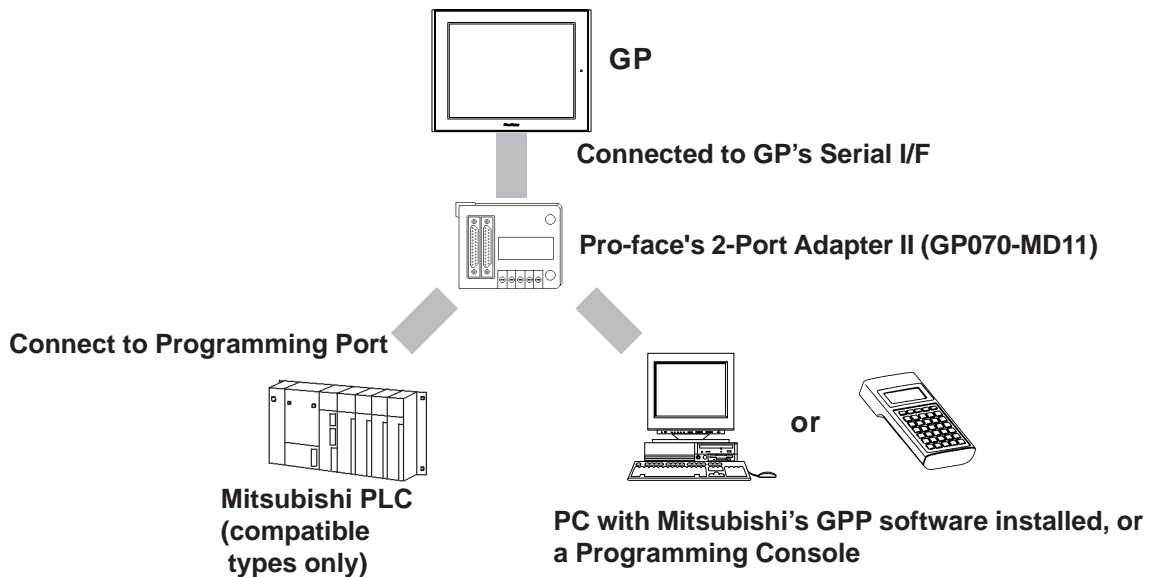

\*1 The Device Monitor feature can also be used at the same time. For details about the device monitor function, refer to **Reference** *GP-PRO/PBIII for Windows Device/PLC Connection Manual* (included with the GP screen creation software)

\*2 GP-2400/2500/2600 Series units can also use the 2-Port Adapter II. For details, refer to **Reference** *GP-PRO/PBIII for Windows Device/PLC Connection Manual* (included with the GP screen creation software)

## ■ Internal 2-Port Feature Usage Notes

- To use the Internal 2-Port feature, you will need to adjust your GP's settings. For information about these settings, refer to  
**▼Reference▲** *GP-PRO/PBIII for Windows Device/PLC Connection Manual* (included with the GP Screen creation software)
- This feature can be used only while the GP is in ONLINE mode.
- Since the internal 2-Port feature uses the GP's single tool connector, you will not be able to use equipment which requires the tool connector (i.e. a Barcode Reader, Optional Items, etc.)
- If you transfer screen data while the GP is in ONLINE mode, the screen will not change to the data transfer screen automatically. Thus, you will need to change the screen manually to the OFFLINE mode's [Main Menu/ Transfer] screen.  
**▼Reference▲** *4.1 Serial Data Transfer*
- Peripheral equipment, such as a Programming Console, is not compatible with the GP's Internal 2-Port feature. To use this type of equipment, you will need to use the external 2- Port Adapter II.

### **1.4.6 Backlight Burnout Detection Feature**

---

When the GP's backlight burns out, it will be automatically detected. The GP's Status LED will alert you that the backlight is burned out so that you can disable GP Touch Panel Operation and prevent a possible GP operation mistake. When Backlight Burnout is detected the GP's Status LED will turn orange. Also, the system data area's "Status" bit10 \*1 will turn ON.

**▼Reference▲** *For details about touch panel operation when the backlight burned out, refer to 6.4.3 SET UP TOUCH PANEL.*

---

\*1 When using the Direct Access method, bit +6 will turn ON. The using Memory Link method, bit 11 will turn ON. For details, refer to **▼Reference▲** *GP-PRO/PBIII for Windows Device/PLC Connection Manual* (included with the GP screen creation software)

---



*Memo*

# Chapter

## 2 Specifications

1. General Specifications
2. Functional Specifications
3. Interface Specifications
4. Part Names and Functions
5. Dimensions

### 2.1 General Specifications

---

#### 2.1.1 Electrical

---

##### ■ GP2500-TC11/GP2600-TC11

Rated Voltage	AC100V	AC100V to AC240V <sup>*1</sup>
Rated Voltage Range	AC85V to AC132V	AC85V to AC265V <sup>*1</sup>
Power Consumption	50VA or less	50VA or less (ACIN100V) <sup>*1</sup> 85VA or less (ACIN240V) <sup>*1</sup>
Allowable Voltage Drop	20ms or less	
Voltage Endurance	AC1500V 20mA for 1 minute (between charging and FG terminals)	
Insulation Resistance	10M $\Omega$ or higher at DC500V (between charging and FG terminals)	

\*1 All GP units marked Revision "3" conform to the specifications.

▼Reference▲ For more information on how to determine the revision version, see "Revision Version" (page 15).

##### ■ GP2400-TC41-24V/GP2500-LG41-24V/GP2500-SC41-24V/ GP2500-TC41-24V/GP2600-TC41-24V

	GP2400-TC41-24V	GP2500-LG41-24V, GP2500-SC41-24V, GP2500-TC41-24V, GP2600-TC41-24V
Rated Voltage	DC 24V	
Rated Voltage Range	DC19.2V to DC28.8V	
Power Consumption	28W or less	50W or less
Allowable Voltage Drop	10ms or less	
In-rush Current	30A or less	
Voltage Endurance	AC1000V 20mA for 1 minute (between charging and FG terminals)	
Insulation Resistance	10M $\Omega$ or higher at DC500V (between charging and FG terminals)	

## Chapter 2 - Specifications

### 2.1.2 Environmental

	GP2400-TC41-24V GP2500-LG41-24V GP2500-SC41-24V GP2500-TC41-24V GP2600-TC41-24V	GP2500-TC11 GP2600-TC11
<b>Ambient Operating Temperature (Cabinet Interior) (Panel Face)</b>	0°C to +50°C <sup>*1</sup>	
<b>Storage Temperature</b>	-20°C to +60°C	
<b>Operating Humidity</b>	10%RH to 90%RH (Non condensing, wet bulb temperature: 39°C or less)	
<b>Storage Humidity</b>	10%RH to 90%RH (Non condensing, wet bulb temperature: 39°C or less)	
<b>Atmospheric Endurance (GP Operation Altitude)</b>	800hPa to 1114hPa (2000 meters or lower)	
<b>Air Purity (Dust)</b>	0.1mg/m <sup>3</sup> or less (non-conductive levels)	
<b>Pollution Degree</b>	Pollution Degree 2	
<b>Corrosive Gasses</b>	Free of corrosive gasses	
<b>Vibration Resistance</b>	IEC61131-2 (JIS B 3501) compliant	
	When vibration is NOT continuous 10Hz to 57Hz 0.075mm, 57Hz to 150Hz 9.8m/s <sup>2</sup> When vibration is continuous 10Hz to 57Hz 0.035mm, 57Hz to 150Hz 4.9m/s <sup>2</sup> X, Y, Z directions for 10 times (80min.)	
<b>Noise Immunity (via noise simulator)</b>	Noise Voltage: 1000Vp-p Pulse Duration: 1μs Rise Time: 1ns	Noise Voltage: 1500Vp-p Pulse Duration: 1μs Rise Time: 1ns
<b>Electrostatic Discharge Immunity</b>	6kV (complies with IEC 61000-4-2 Level 3)	

*\*1 When using GP-2500L/GP-2500S/GP-2600T in an environment where the temperature becomes or exceeds 40 °C for an extended period of time, the screen contrast level may decrease from its original level of brightness.*

### 2.1.3 Structural

	GP-2400 Series	GP-2500 Series	GP-2600 Series
<b>Grounding</b>	100Ω or less, or your country's applicable standard		
<b>Ratings</b> *1 (For front panel of installed unit)	Equivalent to IP65f (JEM 1030) NEMA#250 Type4X/12		
<b>Weight</b>	1.7 kg (5.5lb) or less	3.5kg (7.7lb) or less	
<b>Cooling Method</b>	Natural air circulation		
<b>External Dimensions</b>	W215mm [8.46in] x H170mm [6.69in] x D60mm [2.36in]	W317mm [12.48in] x H243mm [9.57in] x D58mm [2.28in]	

*\*1 The front face of the GP unit, installed in a solid panel, has been tested using conditions equivalent to the standards shown in the specification. Even though the GP unit's level of resistance is equivalent to these standards, oils that should have no effect on the GP can possibly harm the unit. This can occur in areas where either vaporized oils are present, or where low viscosity cutting oils are allowed to adhere to the unit for long periods of time. If the GP's front face protection sheet becomes peeled off, these conditions can lead to the ingress of oil into the GP and separate protection measures are suggested. Also, if non-approved oils are present, it may cause deformation or corrosion of the front panel's plastic cover. Therefore, prior to installing the GP be sure to confirm the type of conditions that will be present in the GP's operating environment. If the installation gasket is used for a long period of time, or if the unit and its gasket are removed from the panel, the original level of the protection cannot be guaranteed. To maintain the original protection level, you need to replace the installation gasket regularly.*

## 2.2 Functional Specifications

### 2.2.1 Display

	GP-2400 Series	GP-2500 Series	GP-2600 Series
<b>Type</b>	TFT type color LCD	GP-2500L Monochrome LCD GP-2500S STN type color LCD GP-2500T TFT type color LCD	TFT type color LCD
<b>Colors</b>	256 / No blink* <sup>1</sup> , 64 colors / 3-speed blink (Color switching is done via software)	GP-2500L Black and White, 2 levels of gray/ Black and White, 8 levels of gray* <sup>3</sup> (Color switching is done via software) GP-2500S 64 colors / 3-speed blink GP-2500T 256 / No blink* <sup>1</sup> , 64 colors / 3-speed blink (Color switching is done via software)	256 / No blink* <sup>1</sup> , 64 colors / 3-speed blink (Color switching is done via software)
<b>Resolution</b>	640 x 480pixels		800 x 600pixels
<b>Effective Display Area</b>	W149.8mm [5.90in.] x H112.3mm [4.42in.]	W211.2mm [8.34in.] x H158.4mm [6.24in.]	W246mm [9.69in.] x H184.5mm [7.26in.]
<b>Language Fonts</b>	ASCII: (Code page 850) Alphanumeric (incl. Eur. characters) Chinese: (GB2312-80 codes) simplified Chinese fonts Japanese: ANK 158, Kanji : 6962 (JIS Standards 1 & 2) Korean: (KSC5601 - 1992 codes) Hangul fonts Taiwanese: (Big 5 codes) traditional Chinese fonts		
<b>Text</b>	8x8 dots	80 Char. x 60 rows	100 Char. x 75 rows
	8x16 dots	80 Char. x 30 rows	100 Char. x 37 rows
	16x16 dots	40 Char. x 30 rows	50 Char. x 37 rows
	32x32 dots	20 Char. x 15 rows	25 Char. x 18 rows
<b>Font Sizes</b>	Hight can be expanded 1 to 8 times. Width can be expanded 1/2* <sup>4</sup> , 1 to 8 times.		
<b>Character Sizes</b> * <sup>2</sup>	8X8 dot font, 8X16 dot font, 16X16 dot font and 32X32 dot font		
<b>Backlight</b>	CCFL (Service life: 50,000 hrs. at 25°C and 24hr. operation)		
<b>Brightness Control</b>	4 levels of adjustment available via touch panel.		
<b>Contrast Adjustment</b>		8 levels of adjustment available via touch panel. (GP-2500L/S Only)	

- \*1 Changing the “Colors” setting to “256 colors” will disable the blink feature on all of your project’s screens. If you wish to use the blink feature, do not change this setting to “256 colors”.
- \*2 The display font will differ depending on which (language) character, or which size you select.  
▼Reference▲ *Chapter 6.8 SET UP SCREEN.*
- \*3 In order to set the monochrome (eight levels of gray) mode, GP-PRO/PB III for Windows Ver. 6.2 or later is required. Depending on the color used, selecting MONOCHROME 8 HUES may cause the GP unit’s screen to flicker and make it difficult to distinguish colors. Confirm that all colors display as expected prior to using this mode.
- \*4 Only available when using “Half-2 Byte Character” settings via software.  
 (Only Chinese, Taiwanese and Korean OS)

### 2.2.2 Memory

<b>Application</b>	4MB FLASH EPROM (Approx. 1280 screens at 3.2KB/screen)
<b>Data Backup</b>	256KB SRAM (uses lithium battery) <sup>*1</sup>

- \*1 A Lithium battery's lifetime is:
- 10 years when the battery's ambient temperature is under 40 °C
  - 4.1 years when the battery's ambient temperature is under 50 °C
  - 1.5 years when the battery's ambient temperature is under 60 °C
- When used for backup:
- Approximately 60 days, with a fully charged battery
  - Approximately 6 days, with a half-charged battery

### 2.2.3 Touch Panel • Clock

	GP-2400/GP-2500 Series	GP-2600 Series
<b>Touch Panel Resolution</b>	32 x 24 keys/ screen (1 or 2 point touch)	40 x 30 keys/ screen (1 or 2 point touch)
<b>Clock Accuracy</b>	± 65 seconds/ month (at room temperature)	



**Note:**

The GP's internal clock has a slight error. At normal operating temperatures and conditions, with the GP operating from its lithium battery, the degree of error is 65 seconds per month. Variations in operating conditions and battery life can cause this error to vary from -380 to +90 seconds per month. For systems where this degree of error will be a problem, the user should be sure to monitor this error and make adjustments when required.

▼Reference▲ *Chapter 6.7 SET UP CLOCK*

## Chapter 2 - Specifications

### 2.2.4 Interfaces

<b>Serial Interface</b>	Asynchronous Transmission: RS-232C/RS-422 Data Length: 7 or 8 bits Stop Bit: 1 or 2 bits Parity: None, Odd or Even Data Transmission Speed: 2,400bps to 115.2kbps																				
<b>Expansion Serial Interface</b>	Asynchronous Transmission: RS-232C Data Length: 7 or 8 bits Stop Bit: 1 or 2 bits Parity: None, Odd or Even Data Transmission Speed: 2,400 to 38,400bps																				
<b>Ethernet Interface</b>	IEEE802.3, 10BASE-T																				
<b>Tool Connector</b>	Asynchronous TTL level nonprocedural command I/F <During screen file development> Used for transferring data to and from the GP application software and the GP. Used for data transfer with the 2-Port feature. <During Operation> Used for a variety of devices, including a bar-code reader.																				
<b>CF Card Interface</b>	1 slot																				
<b>CF Card Expansion Interface</b>	CF Card Front Maintenance Unit Connector (GP-2500T/GP-2600T Only. GP-2400T is not equipped with a CF Card Expansion Interface)																				
<b>Printer Interface</b>	Compatible with NECPC-PR201/PL , EPSON ESC/P24-J84(C), HP Laser Jet PCL 4 command, EPSON PM/Stylus (6-color ink), EPSON Stylus (4-color ink) compatible printers <sup>*1</sup>																				
<b>AUX Input/Output</b>	<table> <tr> <td>Remote Reset Input</td> <td>1 point</td> </tr> <tr> <td>Input Voltage</td> <td>DC24V +10%</td> </tr> <tr> <td>Input Current</td> <td>4mA (TYP)</td> </tr> <tr> <td>Min. Input Pulse Width</td> <td>2ms</td> </tr> <tr> <td>Operating Voltage</td> <td>(When ON) Min. DC21.1V (When OFF) Max. DC3V</td> </tr> <tr> <td>Isolation Method</td> <td>Photocoupler Isolation</td> </tr> <tr> <td>Output - 3 Points</td> <td>RUN Output - 1 point System Alarm Output - 1 point External Buzzer Output - 1 point</td> </tr> <tr> <td>Rated Voltage</td> <td>DC24V</td> </tr> <tr> <td>Max. Rated Current</td> <td>50mA/point</td> </tr> <tr> <td>Wire Gauge:</td> <td>AWG28 to AWG16</td> </tr> </table>	Remote Reset Input	1 point	Input Voltage	DC24V +10%	Input Current	4mA (TYP)	Min. Input Pulse Width	2ms	Operating Voltage	(When ON) Min. DC21.1V (When OFF) Max. DC3V	Isolation Method	Photocoupler Isolation	Output - 3 Points	RUN Output - 1 point System Alarm Output - 1 point External Buzzer Output - 1 point	Rated Voltage	DC24V	Max. Rated Current	50mA/point	Wire Gauge:	AWG28 to AWG16
Remote Reset Input	1 point																				
Input Voltage	DC24V +10%																				
Input Current	4mA (TYP)																				
Min. Input Pulse Width	2ms																				
Operating Voltage	(When ON) Min. DC21.1V (When OFF) Max. DC3V																				
Isolation Method	Photocoupler Isolation																				
Output - 3 Points	RUN Output - 1 point System Alarm Output - 1 point External Buzzer Output - 1 point																				
Rated Voltage	DC24V																				
Max. Rated Current	50mA/point																				
Wire Gauge:	AWG28 to AWG16																				
<b>Sound Output</b>	External Speaker Connection (Terminal Block) Monaural 1CH Speaker Output 70mW (Rated Load: 8W, Frequency: 1kHz) Sound Line Out Output 2.7Vp-p (Rated Load:10kW)																				

*\*1 Printers with only Windows drivers cannot be used. However, certain types of printers with both Windows and DOS drivers can be used. For details, contact your local GP distributor.*

## 2.3 Interface Specifications

### 2.3.1 Serial Interfaces

This interface can be either RS-232C or RS-422. Connects GP to Host (PLC).

This interface uses a socket-type connector.

Pin Assignments	Pin #	Signal Name	Condition
<p>(D-Sub 25pin female)</p> <p>SIO</p>	1	FG	Frame ground
	2	SD	Send data (RS-232C)
	3	RD	Receive data (RS-232C)
	4	RS	Request send (RS-232C)
	5	CS	Clear send (RS-232C)
	6	DR	Data Set Ready (RS-232C)
	7	SG	Signal ground
	8	CD	Carrier detect (RS-232C)
	9	TRMX	Termination (RS-422)
	10	RDA	Receive data A (RS-422)
	11	SDA	Send data A (RS-422)
	12	NC	No connection (Reserved)
	13	NC	No connection (Reserved)
	14	VCC	5V±5% output 0.25A
	15	SDB	Send data B (RS-422)
	16	RDB	Receive data B (RS-422)
	17	RI	Ring Indicate (RS-232C)
	18	CSB	Clear send B (RS-422)
	19	ERB	Enable receive B (RS-422)
	20	ER	Enable receive (RS-232C)
	21	CSA	Clear send A (RS-422)
	22	ERA	Enable receive A (RS-422)
	23	NC	No connection (Reserved)
	24	NC	No connection (Reserved)
	25	NC	No connection (Reserved)

Recommended Connector: Dsub25pin plug XM2A-2501<made by OMRON>

Recommended Cover: Dsub25pin cover XM2S-2511<made by OMRON>

Jack Screws: XM2Z-0071<made by OMRON>



- Use rough metric type M2.6x0.45 p threads used to secure the cable's set screws.

Recommended Cable: CO-MA-VV-SB5PX 28AWG <made by HITACHI Cable Ltd.>

- To confirm your PLC's connection specifications , refer to

**Reference** *GP-PRO/PBIII for Windows Device/PLC Connection Manual*  
(included with the screen creation software)



## Chapter 2 - Specifications

When creating your own cable, follow the instructions listed below:

<With RS-422>



- The following pairs of pin #'s must be connected to each other.
  - #18 (CSB) <—> #19 (ERB)
  - #21 (CSA) <—> #22 (ERA)
- When connecting the RS-422 cable and the #9 (TRMX) and #10 (RDA) points, a termination resistance of 100Ω is added between RDA and RDB.
- When making a cable for a Memory Link system, be sure to use a 4-wire type.

<With RS-232C>



- Do not use the following pins: 9 (TRMX), 10 (RDA), 11 (SDA), 15 (SDB), 16 (RDB), 18 (CSB), 19 (ERB), 21 (CSA), 22 (ERA).
- The #1 (FG) terminal should only be connected if it is required by the device being connected to.
- ***This unit's serial port is not isolated, therefore, it is important that you connect the SG (Signal Ground) terminals. If this is not done, the RS422 circuit may be damaged.***
- ***Pin 14 (VCC) DC5V output is not protected. To prevent damage or unit malfunction, be sure to use only the designated level of current.***

### ■ Expansion Serial Interface

This interface is used for RS-232C data transfer, and uses a plug-type connector.

Pin Assignments	Pin No.	Signal Name	Signal Direction	Condition
(D-Sub 9pin male) 	1	CD	Input	Carrier detect (RS-232C)
	2	RD	Input	Receive data (RS-232C)
	3	SD	Output	Send data (RS-232C)
	4	ER	Output	Enable receive (RS-232C)
	5	SG	—	Signal Ground
	6	DR	Input	Data Set Ready (RS-232C)
	7	RS	Output	Request Send (RS-232C)
	8	CS	Input	Clear send (RS-232C)
	9	RI/VCC	Input/Output	Ring Indicate (RS-232C) +5V+5% 0.25A

Recommended Connector: Dsub9pin socket XM2D-0901<made by OMRON>

Recommended Cover: Dsub9pin cover XM2S-0913<made by OMRON>

Jack Screws: XM2Z-0073<made by OMRON>



**Note:** Use inch type screws (#4-40UNC) as set screws.



***Since Pin#9(RI/VCC) is unprotected, be sure to keep the output current in the rated range.***

### 2.3.2 Printer Interface

When connecting a printer, use Digital's printer cable (PSM-PRCB00).

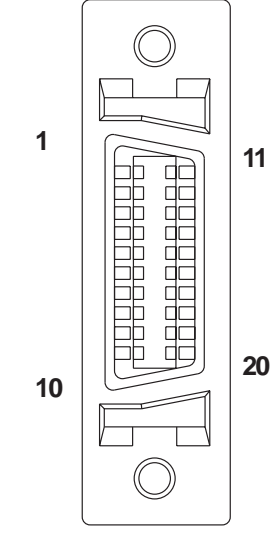
Pin Assignments	Pin #	Signal Name	Condition
	1	GND	Ground
	2	RESERVE	Reserved
	3	PDB5	Data Signal
	4	PDB4	Data Signal
	5	PDB3	Data Signal
	6	GND	Ground
	7	SLCT	Select Status (Input)
	8	PDB0	Data Signal
	9	<del>PSTB</del>	Strobe Signal (Output)
	10	BUSY	Busy Signal (Input)
	11	PDB7	Data Signal
	12	PDB6	Data Signal
	13	GND	Ground
	14	<del>ERROR</del>	Printer Error (Input)
	15	GND	Ground
	16	PDB2	Data Signal
	17	PDB1	Data Signal
	18	PE	Paper Runout
	19	<del>TINT</del>	Initialization Signal (Output)
	20	GND	Ground

## Chapter 2 - Specifications

### 2.3.3 AUX I/O and Sound Output

This interface is used for external reset, alarm output, buzzer output, or sound output.

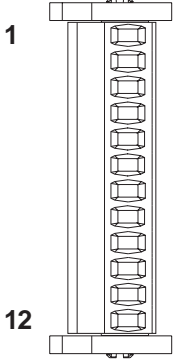
Pin Assingments	Pin #	Signal Name	Condition
	1	AUXCOM	External Reset Common
	2	AUXRESET	External Reset Input
	3	RUN	ONLINE Operation
	4	ALARM	System Alarm Output
	5	OUTCP	DC24V
	6	BUZZ	External Buzzer Output
	7	RESERVE	Reserved
	8	OUTCN	0V
	9	RESERVE	Reserved
	10	SP OUT	Speaker Output
	11	GND	Ground
	12	LINE OUT	Sound Lineout Output

Torque: 0.2 to 0.4N•m

Wire Gauge: AWG16 to AWG 28

Removed Wire Length: 7 +/- 0.5mm [0.28 +/- 0.02 in.]

#### ■ Input Circuit

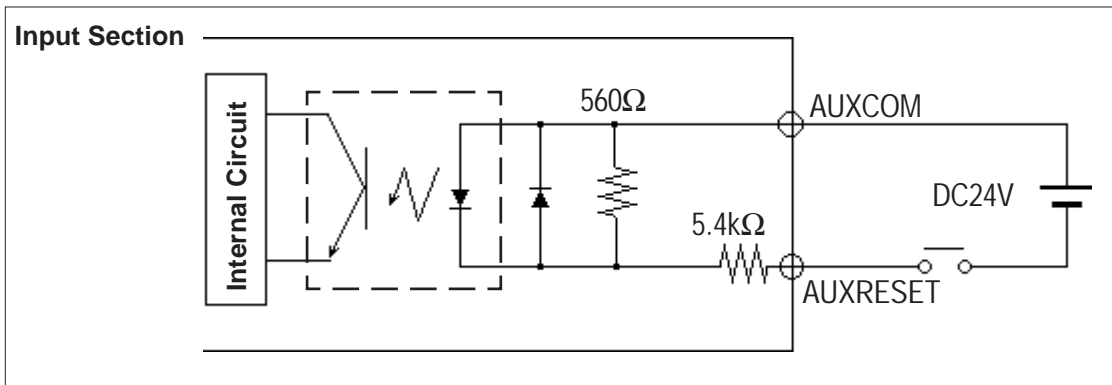

**Input Voltage** DC24V +/- 10%

**Input Current** 4mA/DC24V (TYP)

**Min. Input Pulse Width** 2ms

**Operating Voltage** ON Voltage min. DC21.2V

OFF Voltage max. DC 3V

**Termination Type** Photo-Coupler Isolation

## ■ Output Circuit

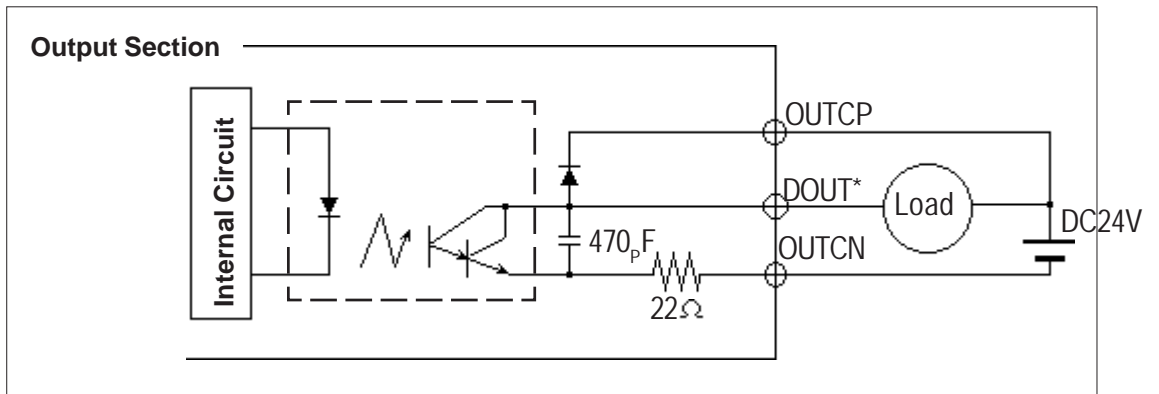

\* DOUT is used for RUN, ALARM, and BUZZ.

**Max. Load Current**      **50mA/point**  
**Rated Load Voltage**    **DC24V (TYP)**

The following chart illustrates the relationship between the Load Voltage and the Load Current:

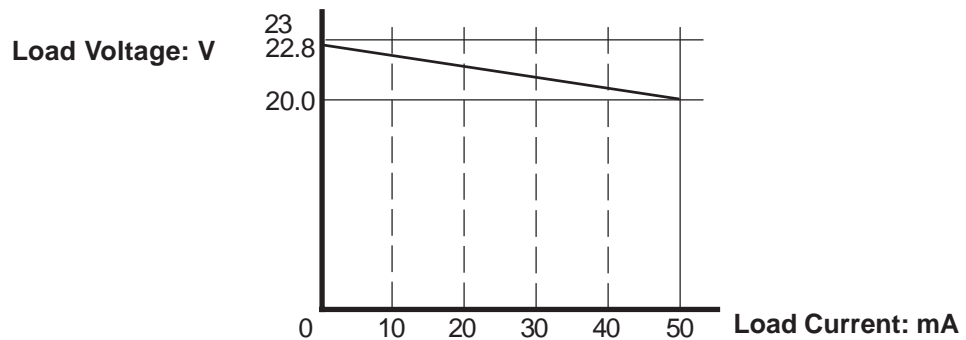

## 2.4 Part Names and Functions

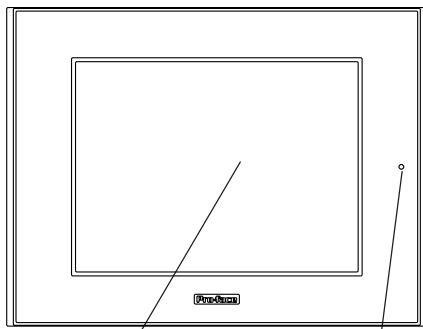

A,B  
Front

### A: Display Panel

The GP monitor screen displays the screen setup and corresponding host (PLC) data.

(All units)

### B: Touch Panel

Performs any screen change operations and sends data to the PLC.

### C: Status LED

This LED reflects the GP's condition.

Color	Indicates
OFF	No power input
Green	Normal operation
Orange	Backlight is burned out

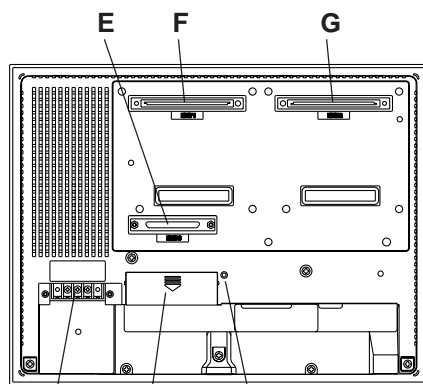

Rear  
(GP-2500/2600 Series)

### D: Power Input Terminal Block

Connects the power cord.

### E: CF Card Expansion Interface \*1

Used for connecting the CF Card Front Maintenance Unit.

(GP-2500 Series, GP-2600 Series only)

### F: Expansion Unit Interface 1

Connects expansion units with communication features.

### G: Expansion Unit Interface 2 \*1

Connects expansion units with display features.  
(GP-2500T, GP-2600 Series only)

### H: CF Card Cover

Open this cover to see the CF Card Slot. When accessing the CF Card, this cover must be closed.

### I: CF Card Access Lamp

If the CF Card Cover is closed when the CF Card is inserted, the LED lamp turns ON. The LED lamp will remain turned ON even if the CF Card Cover is opened while the GP accesses the CF Card.

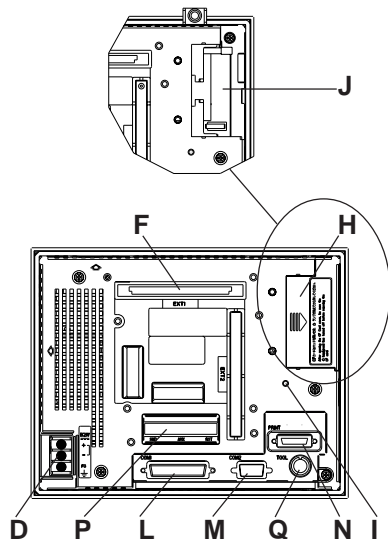

(GP-2400 Series)

\*1 When a unit is attached to this interface, the bus conversion unit (PSL-CONV00) cannot be used, since there are no connectors available for it.

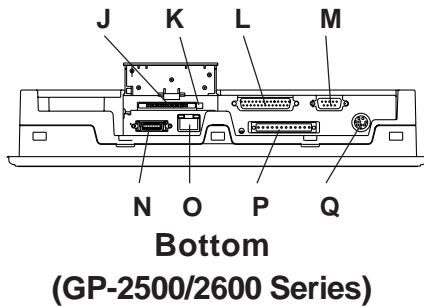

**J: CF Card Slot**

Insert the CF Card in this slot.

**K: Dip Switches**

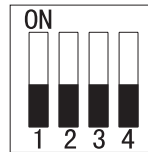

Dip Switch	Function	ON	OFF	Note
1	This Dip switch setting controls the startup from a CF Card.	Startup from CF Card is enabled.	Startup from CF Card is disabled.	CF Card with startup data required.
2	Reserved	—	—	Keep these switches OFF
3	Reserved	—	—	
4	This setting controls the forced closing of the CF Card cover.	Forced close enabled.	Forced close disabled.	Used when CF Card cover is damaged.

**L: Serial Interface**

Used for the RS-232C and RS-422 cables. Is connected to the Host (PLC.)

**M: Expansion Serial Interface**

Uses RS-232C cable.

**N: Printer Interface**

Connect the printer cable here. Recommended cable: Digital Electronic Corporation PSM-PRCB00 Cable.

**O: Ethernet Interface**

Used for Ethernet (10BASE-T).

The LED will change (turn ON, blink) according to the GP's status.

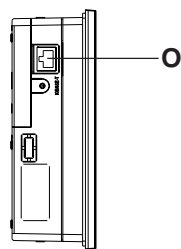

**Side**  
**(GP-2400 Series)**

Color	Indicates
<b>Orange</b>	Lights when power is turned ON, blinks during data transfer.
<b>Green</b>	Turns ON when linked.

**P: Screw Lock Terminal Block**

Used for external reset, alarm output, buzzer output, and sound output.

**Q: Tool Connector**

The Data Transfer cable, or Bar Code Reader can be connected here.

## 2.5 Dimensions

---

### 2.5.1 GP-2400 Series External Dimensions

---

Unit: mm [in.]

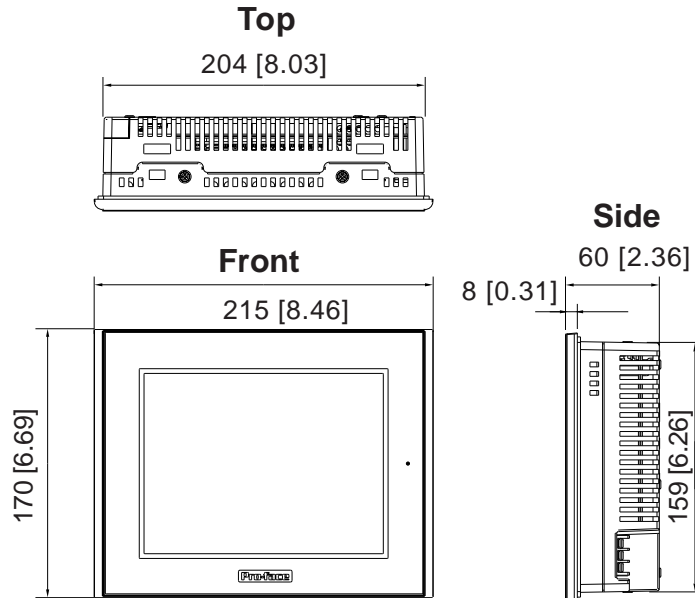

### 2.5.2 GP-2500 Series External Dimensions

---

Unit: mm [in.]

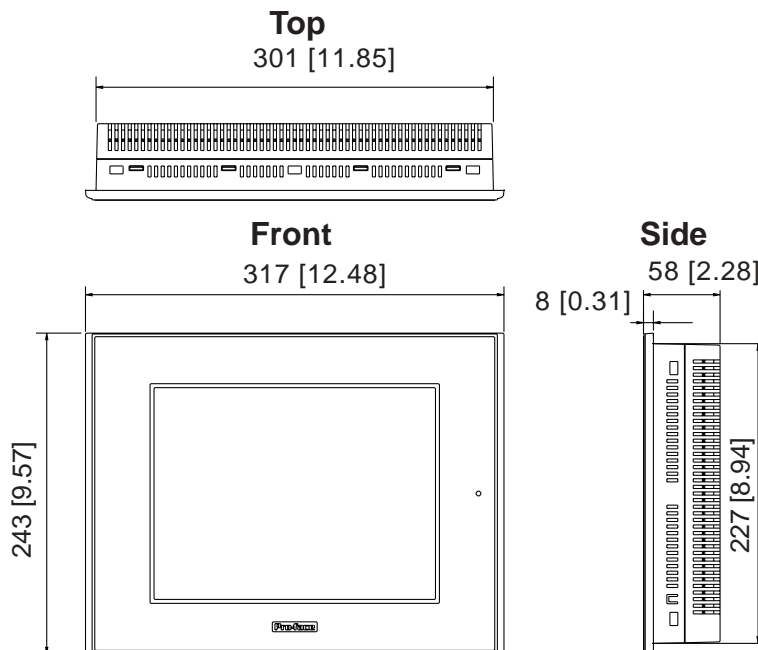

2.5.3 GP-2600 Series External Dimensions

Unit: mm [in.]

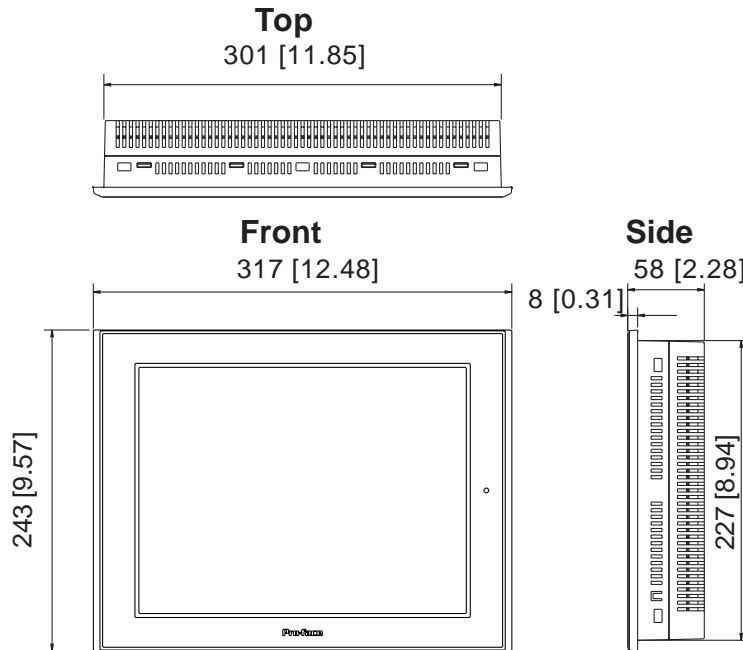

2.5.4 Panel Cut Dimensions

■ GP-2400 Series

Unit: mm [in.]

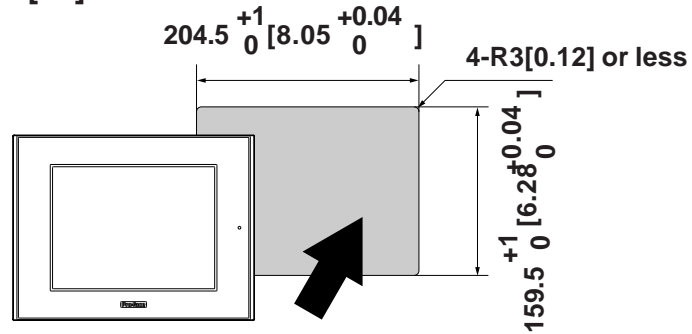

■ GP-2500/2600 Series

Unit: mm [in.]

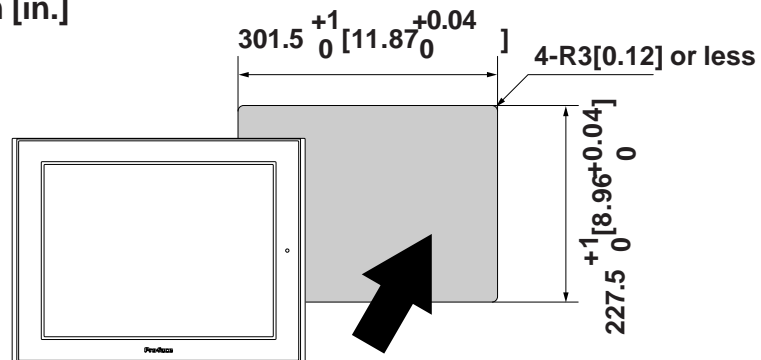



## Chapter 2 - Specifications

### 2.5.5 Installation Fasteners

---

Unit: mm [in.]

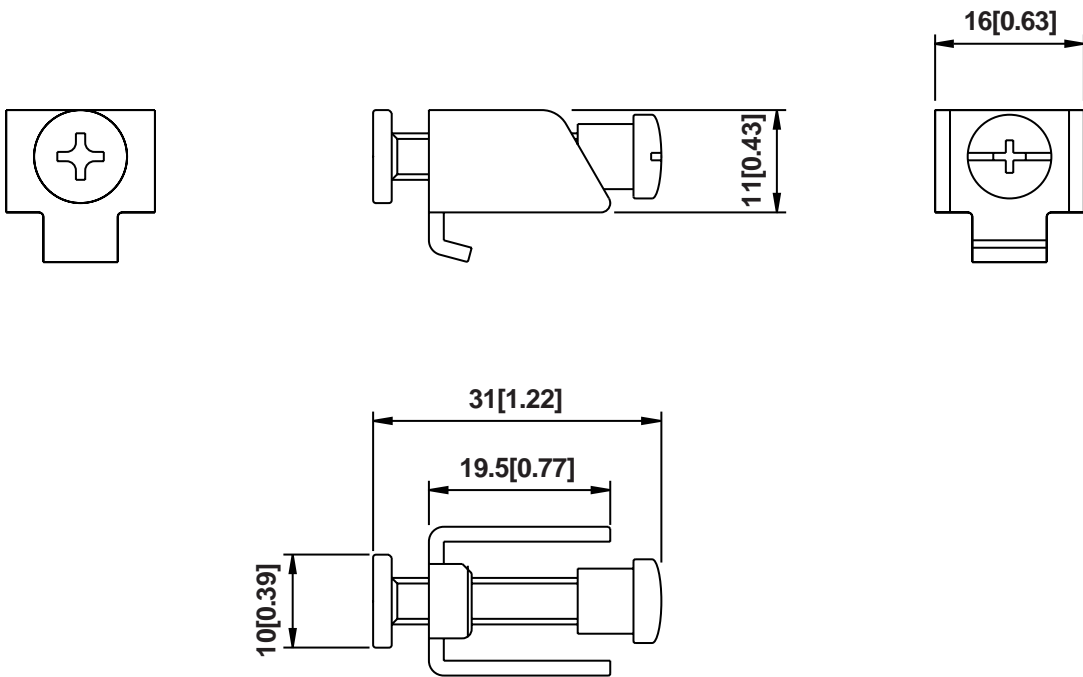

# Chapter

## 3 Installation and Wiring

1. Installation
2. Wiring Cautions
3. Tool Connector
4. Ethernet Cable Connector
5. CF Card Insertion and Removal
6. Sound Output

### 3.1 Installation

---

#### 3.1.1 Installation Procedures

---

Follow the steps given below when installing the GP.

##### ■ Check the Installation Gasket's Seating

It is strongly recommended that you use the installation gasket, since it absorbs vibration in addition to repelling water.

Place the GP on a level surface with the display panel facing downward. Check that the GP's installation gasket is seated securely into the gasket's groove, which runs around the perimeter of the panel's frame.

For details about installing the gasket, refer to

**Reference** [8.1.2 Installation Gasket Check/Replacement](#)



- **Before installing the GP into a cabinet or panel, check that the Installation gasket is securely attached to the unit.**
- **A gasket which has been used for a long period of time may have scratches or dirt on it, and could have lost much of its dust and drip resistance. Be sure to change the gasket periodically, or when scratches or dirt become visible.**
- **Be sure to use gasket model PS400-WP00-MS (GP-2400 Series)/ GP570-WP10-MS (GP-2500/2600 Series).**
- **Be sure the gasket's seam is not inserted into any of the unit's corners, only in the straight sections of the groove. Inserting it into a corner may lead to its eventually tearing.**

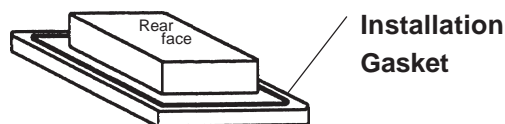

## Chapter 3 - Installation and Wiring

### ■ Creating a Panel Cut

Create the correct sized opening required to install the GP, using the installation dimensions given.

#### **Reference** 2.5.4 GP Panel Cut Dimensions

The installation gasket, installation brackets and attachment screws are all required when installing the GP.

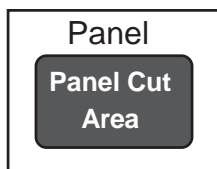

Check that the installation panel or cabinet's surface is flat, in good condition and has no jagged edges. Also, if desired, metal reinforcing strips can be attached to the inside of the panel, near the Panel Cut, to increase the panel's strength.



**Panel thickness should be from 1.6mm [0.06in.] to 10mm [0.4in.]. Decide the panel's thickness based on the level of panel strength required.**

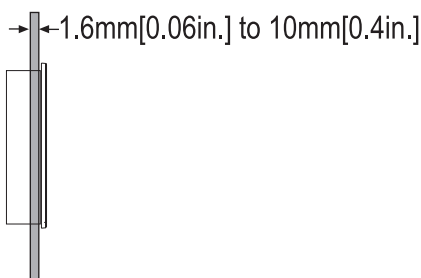

**For easier maintenance, operation, and improved ventilation, be sure to install the GP at least 100 mm [3.94 in.] away from adjacent structures and other equipment.**

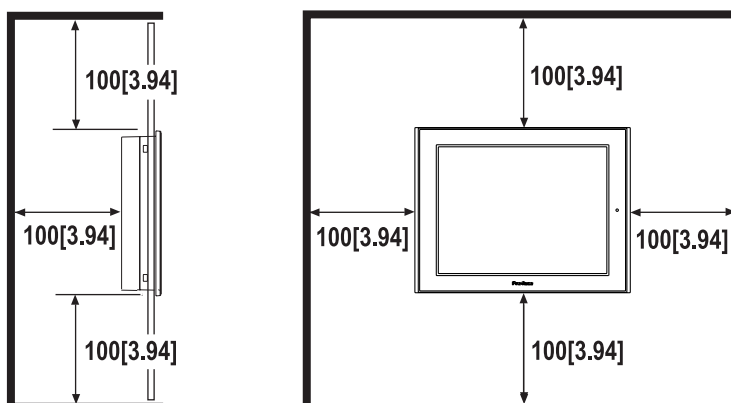

## Chapter 3 - Installation and Wiring



- **Be sure that the ambient operation temperature and the ambient humidity are within their designated ranges. (When installing the GP in a cabinet or enclosure, the term “ambient operation temperature” indicates the cabinet or enclosure’s internal temperature.**

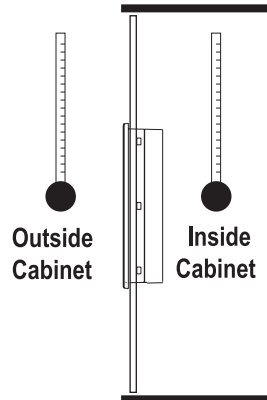

- **Be sure that heat from surrounding equipment does not cause the GP to exceed its standard operating temperature.**
- **When installing the GP in a slanted panel, the panel face should not incline more than 30°.**

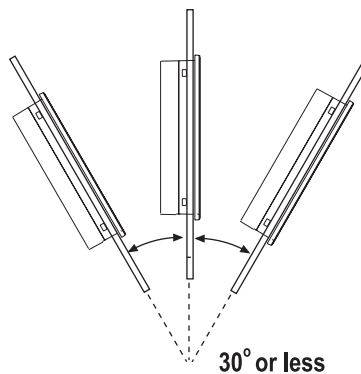

- **When installing the GP in a slanted panel, and the panel face inclines more than 30°, the ambient temperature must not exceed 40 °C. You may need to use forced air cooling (fan, A/C) to ensure the ambient operating temperature is 40 °C or below.**
- **When installing the GP vertically, position the unit so that the Power Input Terminal Block is also vertical.**

## Chapter 3 - Installation and Wiring

### ■ Installing the GP

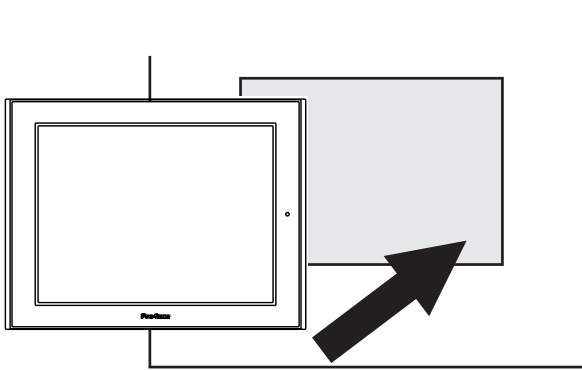

- 1) Insert the GP into the panel cut out, as shown here.

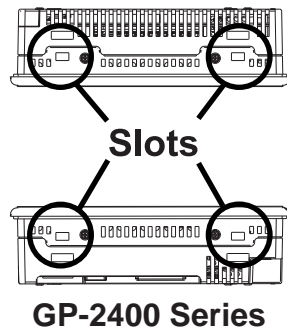

- 2) Insert the installation fasteners into the GP's insertion slots, at the top and bottom of the unit.  
(total: 4 slots)

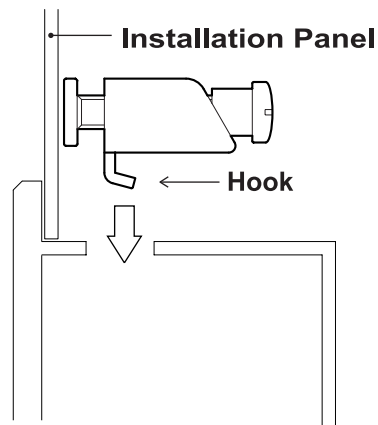
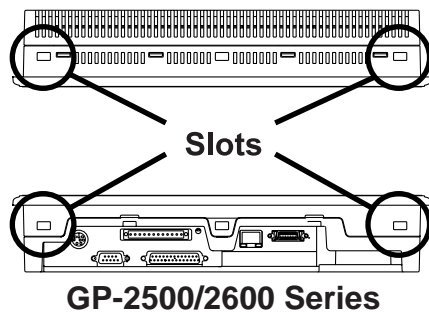

## Chapter 3 - Installation and Wiring

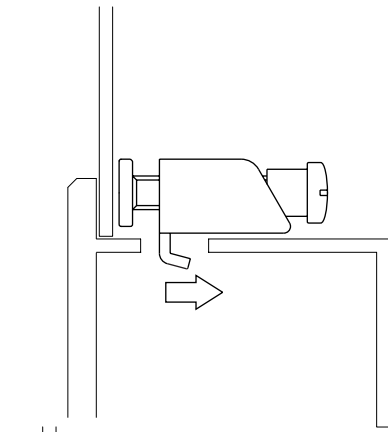

- 3) Insert each of the fasteners shown below. Be sure to pull the fastener back until it is flush with the rear of the attachment hole.

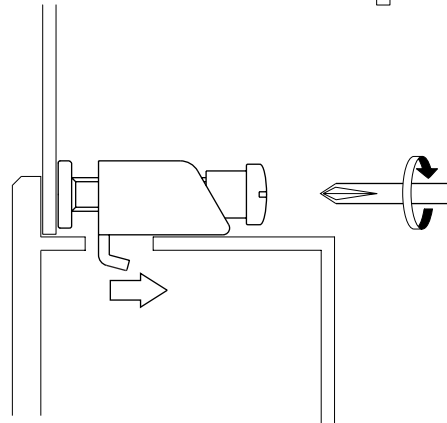

- 4) Use a Phillips screw driver to tighten each fastener screw and secure the GP in place.



**A torque of only 0.5 N•m is sufficient to tighten these screws. Do not use too much force, since it may damage the GP unit.**



Depending on the installation panel's thickness, etc., the number of installation fasteners used on a GP-2500 Series or GP-2600 Series can be increased to provide a higher level of moisture resistance. (The GP-2400T is limited to four (4)).

## 3.2 Wiring Cautions

### 3.2.1 Connecting the Power Cord



## WARNINGS

- To avoid an electric shock, be sure the power cord is unplugged from the power outlet when connecting the power terminals to the GP unit.
- GP2400-TC41-24V, GP2500-TC41-24V and GP2600-TC41-24V are designed to use only with DC24V power. Using any other level of power can damage both the power supply and the GP unit.
- For models GP2500-TC11 and GP2600-TC11, products on which REV "3" is not marked are designed to use only with AC100V power. Using any other level of power can damage both the power supply and the GP unit.
- Since the GP is not equipped with the power switch, be sure to connect a breaker type power switch to the GP's power cord.
- Be sure to ground the GP's FG terminal. Failure to do so can lead to an electrical shock or GP malfunction.



- *To prevent the Ring Terminals from causing a short when the terminal block attachment screws are loosened, be sure to use sleeve-type Ring Terminals.*
- *When the FG terminal is connected, be sure the wire is grounded. Not grounding the GP unit will result in excessive noise. Use your country's applicable standard for grounding.*

**Reference** 3.2.3 Grounding

- *The SG and FG terminals are connected internally in the GP unit.*
- *When connecting the SG line to another device, be sure that the design of the system/connection does not produce a shorting loop in your system.*



- Wherever possible, use thick wires (max 2mm<sup>2</sup>) for power terminals, and twist the exposed wire ends when connecting the Ring Terminals.
- Please use the following size crimp-on type Ring Terminals.

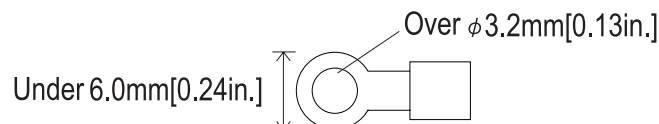

## ■ Connecting the Power Supply Terminals

### ◆ GP2500-TC11, GP2600-TC11

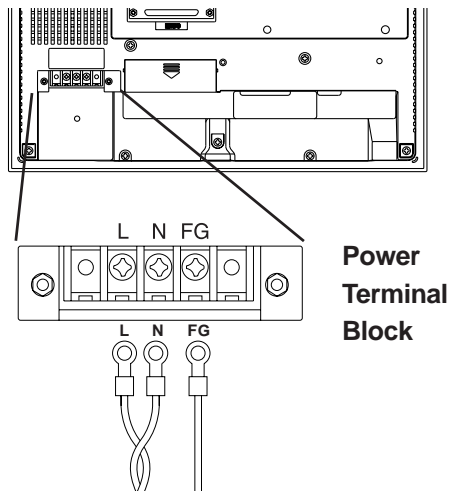

<b>L</b>	AC Input Live Line
<b>N</b>	AC Input Neutral Line
<b>FG</b>	Grounding Terminal connected to the GP chassis.

### ◆ GP2400-TC41-24V

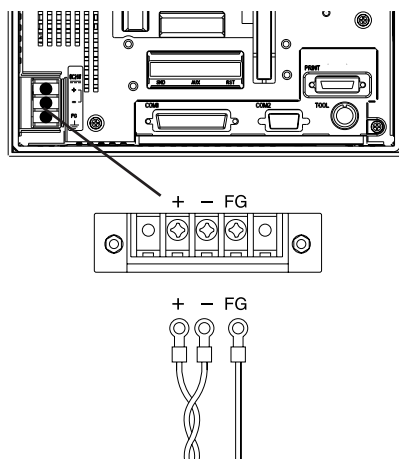

<b>+</b>	Positive electrode
<b>-</b>	Negative electrode
<b>FG</b>	Grounding Terminal connected to the GP chassis.

### ◆ GP2500-LG41-24V, GP2500-SC41-24V, GP2500-TC41-24V, GP2600-TC41-24V

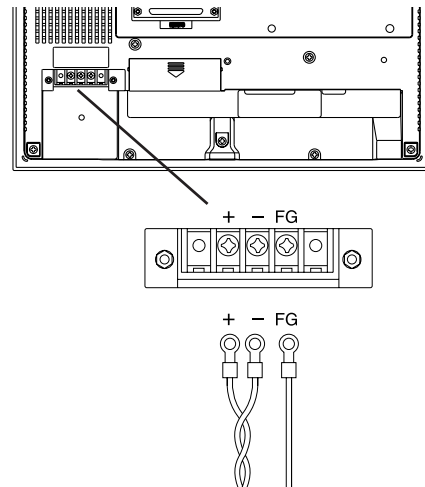

- 1) Be sure that the GP's power cord is not plugged in to the power supply.
- 2) Remove the Terminal Strip's clear plastic cover.
- 3) Remove the screws from the three (3) middle terminals, position the Ring Terminals as shown above and reattach the screws. (Check each wire to make sure the connections are correct)
- 4) Reattach the Terminal Strip's clear plastic cover.



**A torque of only 0.5 to 0.6 N•m is required to tighten an attachment screw.**



# Chapter 3 - Installation and Wiring

## 3.2.2 Connecting the Power Supply

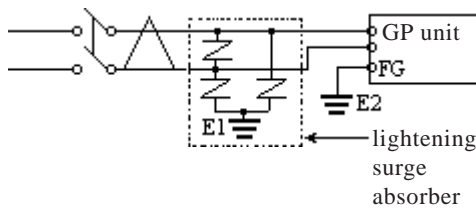
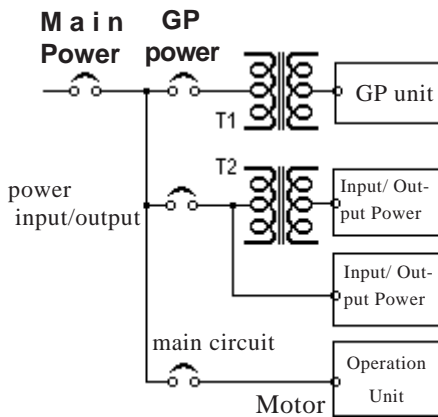
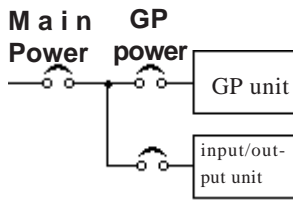
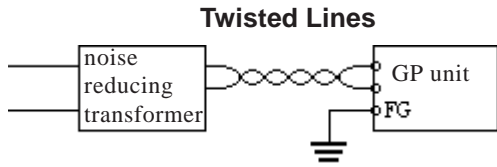
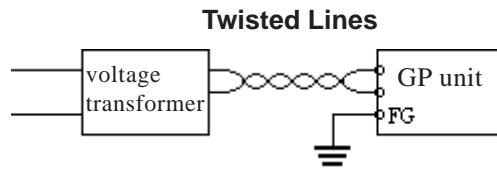

- If the supplied voltage exceeds the GP unit's range, connect a voltage transformer.

**Reference** Chapter 2 Specifications for the allowable voltage range.

- For between the line and ground, select a power supply that is low in noise. If there is an excess amount of noise, connect a noise reducing transformer.



**Use Voltage and Noise Reducing transformers with capacities exceeding 100VA.**

- When supplying power to the GP unit, please separate the input/output and operation unit lines, as shown.

- To increase the noise resistance quality of the power cable, simply twist each power wire before attaching the Ring Terminal.

- The power supply cable must not be bundled or positioned close to main circuit lines (high voltage, high current), or input/output signal lines.

- Connect a lightning surge absorber, as shown in the diagram, to deal with power surges.

- To avoid excess noise, make the power cable as short as possible.



- **Be sure to ground the surge absorber (E1) separately from the GP unit (E2).**

- **Select a surge absorber that has a maximum circuit voltage greater than that of the peak voltage of the power supply.**

3.2.3 Grounding



## CAUTION

**Do not use common grounding, since it can lead to an accident or machine breakdown.**

(a) Exclusive Grounding (BEST) \*1

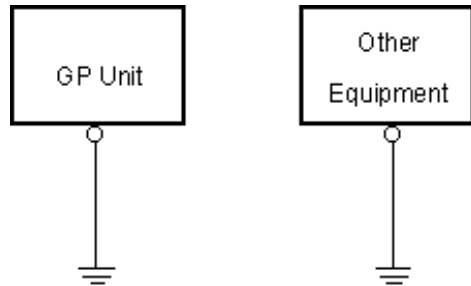

Connect the FG terminal found at the back of the GP to an exclusive ground. [diagram (a)].



- **Check that the grounding resistance is less than 100Ω.**
- **The SG and FG terminals are connected internally in the GP unit.**
- **When connecting the SG line to another device, be sure that the design of the system/connection does not produce a shorting loop.**
- **The grounding wire should have a cross sectional area greater than 2mm<sup>2</sup>. Create the connection point as close to the GP unit as possible, and make the wire as short, as possible. When using a long grounding wire, replace the thin wire with a thicker wire, and place it in a duct.**

(b) Common Grounding (OK) \*1

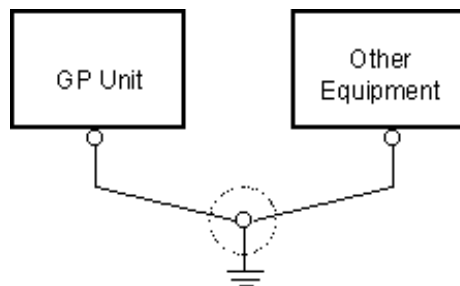

(c) Common Grounding (Not OK)

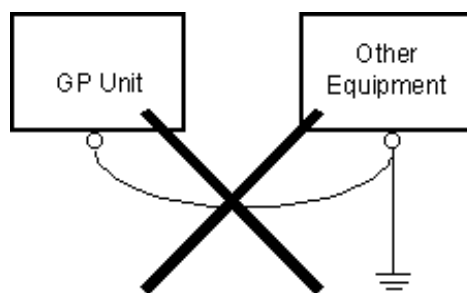

If exclusive grounding is not possible, use a common connection point. [diagram (b)]



**If the equipment does not function properly when grounded, disconnect the ground wire from the FG terminal.**

3.2.4 I/O Signal Line Placement

- Input and output signal lines must be separated from the power control cables for operating circuits.
- If this is not possible, use a shielded cable and connect the shield to the GP's frame.

*\*1 Use a grounding resistance of less than 100Ω and a 2mm<sup>2</sup> or greater thickness wire, or your country's applicable standard. For details, contact your local GP distributor.*

### 3.3 Tool Connector

The GP's Data Transfer Cable, Memory Loader, or the Bar Code Reader can be attached to the GP unit's Tool Connector.

 **WARNING**

**To prevent an electric shock, unplug the GP unit's power cord from the main power supply prior to attaching or detaching any connector(s) to or from the GP.**

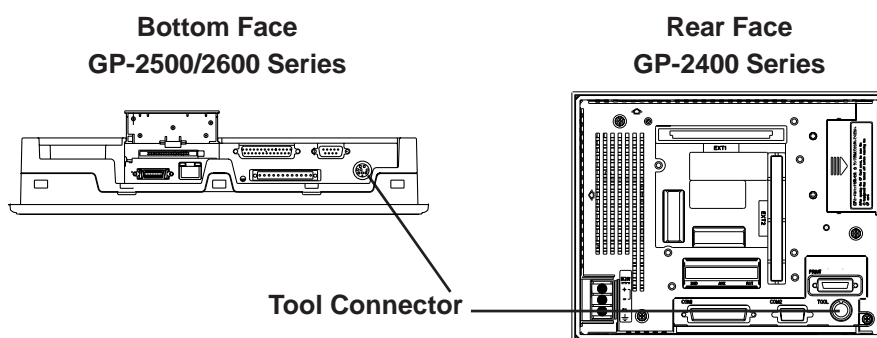

*When the Bar Code Reader uses a separate power supply:*

- *Turn the Bar Code Reader ON before turning the GP ON.*
- *Turn the GP OFF before turning the Bar Code Reader OFF.*

### 3.4 Ethernet Cable Connector

Use the following drawing to locate your GP unit's Ethernet connector. The GP Ethernet interface is IEEE802.3 compliant, and transmits data at 10Mbps.

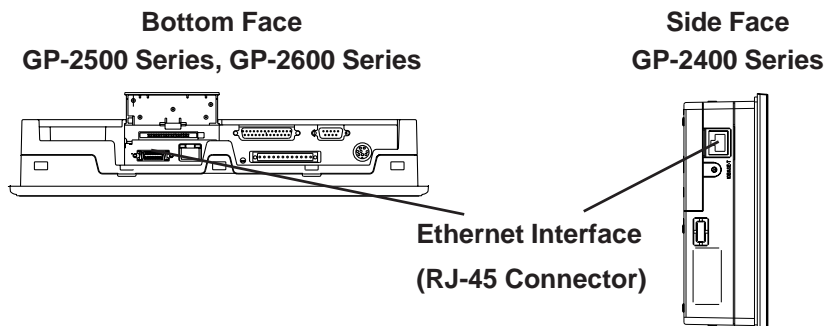

- It is strongly recommended that your Ethernet network is installed by a trained engineer.
- 1:1 connections using a cross cable may not be possible depending on the type of personal computer and network card you are using. Make sure to use a hub for connection.

## 3.5 CF Card Installation and Removal



### CAUTIONS

When using the GP Unit and a CF Card, follow the precautions below:

- Prior to inserting or removing a CF Card, be sure to turn the GP unit's CF Card ACCESS switch OFF and to confirm that the ACCESS lamp is not lit. If you do not, CF Card internal data may be damaged or lost.
- While a CF Card is being accessed, NEVER turn OFF or reset the GP, or insert or remove the CF Card. Prior to performing these operations, create and use a special GP application screen that will prevent access to the CF Card.

**Reference** Refer to GP-PRO/PB III for Windows Tag Reference Manual (included in the screen editor software package)

- Prior to inserting a CF Card, familiarize yourself with the CF Card's front and rear face orientation, as well as the CF Card connector's position. If the CF Card is not correctly positioned when it is inserted into the Mulit Unit, the CF Card's internal data and the GP unit may be damaged or broken.
- Be sure to use only CF Cards manufactured by the Digital Electronics Corporation. GP unit performance cannot be guaranteed when using another manufacturer's CF Card.
- Once GP data is lost, it cannot be recovered. Since accidental data loss can occur at any time, be sure to back up all GP screen and CF Card data regularly.
- Be sure to follow the instructions given below to prevent the CF Card's internal data from being destroyed or a CF Card malfunction from occurring:
  - DO NOT bend the CF Card.
  - DO NOT drop or strike the CF Card against another object.
  - Keep the CF Card dry.
  - DO NOT touch the CF Card connectors.
  - DO NOT disassemble or modify the CF Card.

## Chapter 3 - Installation and Wiring

### ■ Inserting the CF Card

Use the following steps to insert the CF Card in the GP.

(The illustrations below show the procedures for the GP-2500/2600 Series models. However, these procedures are also the same for the GP-2400 Series.)

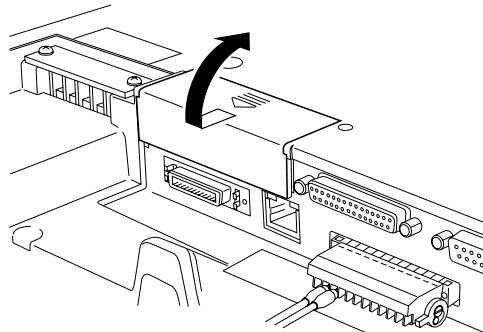

- 1) Slide the CF Card Cover in the direction shown here, then upwards to open the cover.

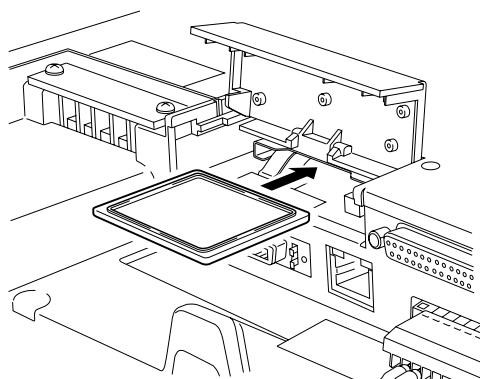

- 2) Insert the CF Card in the CF Card Slot, until the ejector button is pushed forward.

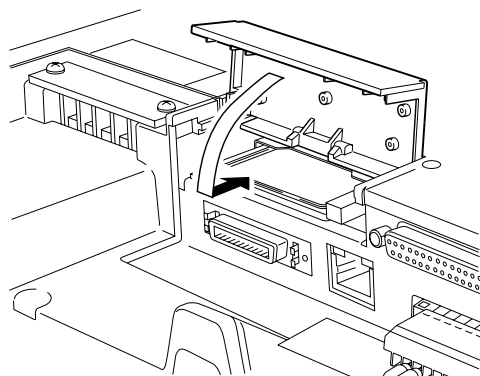

- 3) Close the cover. (As shown.)
- 4) Confirm that the CF Card Access LED turns ON.



**The GP cannot access the CF Card if the CF Card cover is already opened. If however, the CF Card Cover is opened while the GP is accessing the CF Card, access will not be interrupted.**

### ■ Removing the CF Card

Simply reverse the steps shown in the previous “Inserting CF Card” explanation. Prior to removing the CF Card, confirm that the CF Card Access LED is turned OFF.

### 3.5.1 CF Card Handling

---

The CF Card has a data overwrite limit of approximately 100,000 times. Therefore, be

sure to back up all CF Card data regularly to another storage media. (100,000 times

assumes the overwriting of 500KB of data in DOS format)

Two methods are available for backing up data. After using either method 1) or method 2), use your PC to save your data to the CF Card.

**(1) If your PC is equipped with a PC Card Slot**

To view CF Card data on a personal computer, first, insert the CF Card into a CF Card

Adapter.

**(2) If your PC is NOT equipped with a PC Card slot**

Use a commercially available PC Card Reader, or a CF Card Reader.

### 3.6 Sound Output

---

#### 3.6.1 Connecting Speaker Lines

---

Use the following steps to connect the speaker.

(The illustrations below show the procedures for the GP-2500/2600 Series models. However, these procedures are also the same for the GP-2400 Series.)

- 1) Rotate the screw lock terminal block's two (2) levers in the direction shown (downward), and remove the screw lock terminal block.

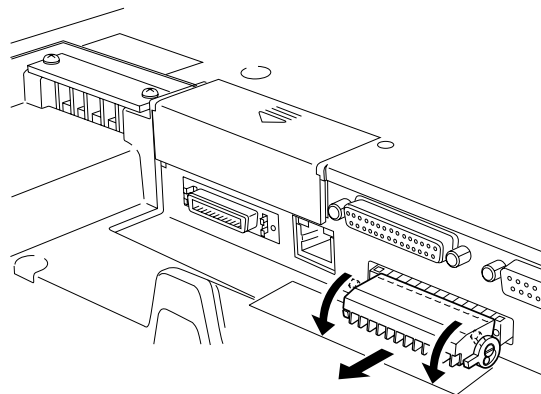

- 2) Unscrew #11 pin and #10 pin set screws (2nd and 3rd screws from the left).

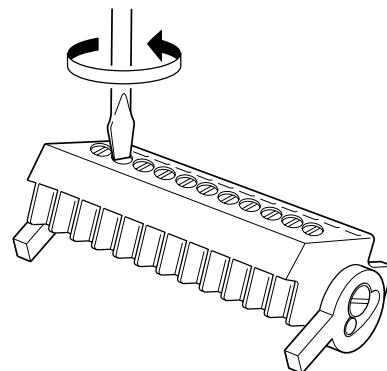

- 3) Insert the Speaker's GND line in #11 pin connector, and the SP OUT line in #10 pin connector.

Wire Gauge: AWG 16 to AWG 28

Removed Wire Length: 7 +/- 0.5mm

[0.28 +/- 0.02 in.]

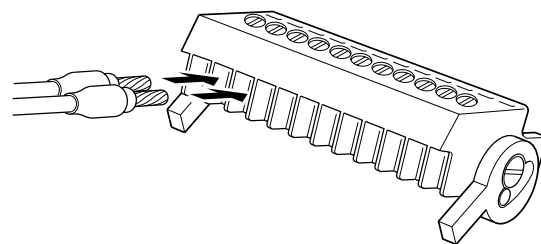

- 4) Confirm that each line (cable) is inserted completely, and retighten the two (2) set screws.

Torque: 0.2 to 0.4 N•m

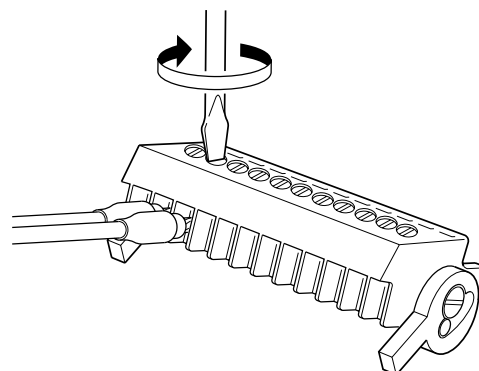

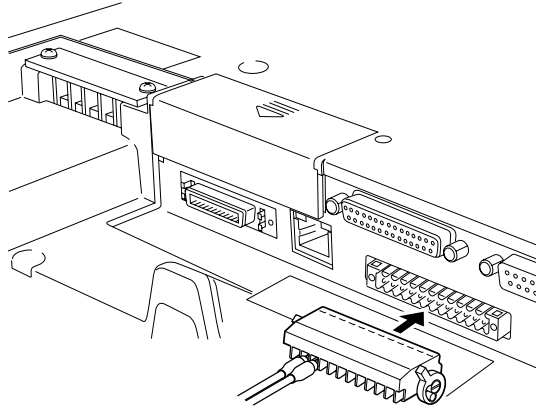

- 5) Reattach the screw lock terminal block to the GP.

### 3.6.2 Sound Volume Adjustment

- 1) Call up the GP menu bar.

**Reference** 6.4.3 *SETUP TOUCH PANEL*

- 2) Touch the left-most  key to call up the next menu.



- 3) Touch the  and  keys to adjust the sound volume to the desired level.

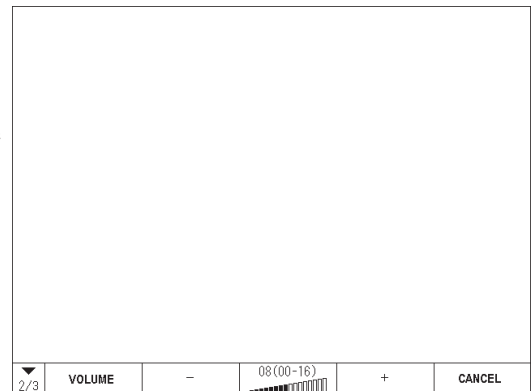



# *Memo*

# Chapter

## 4 Data Transfer

1. Serial Data Transfer
2. Ethernet Data Transfer
3. CF Memory Loader Tool

This chapter explains following three (3) methods of transferring data created with the the GP screen creation software to or from the GP.

- Transfer data via the data transfer cable to or from your GP.
- Transfer data via an Ethernet network to the GP.
- Transfer data via the CF Card to or from your GP using the CF Memory Loader Tool.

### 4.1 Serial Data Transfer

---

The following explains how to connect Pro-face's data transfer cable to your PC and to the GP.

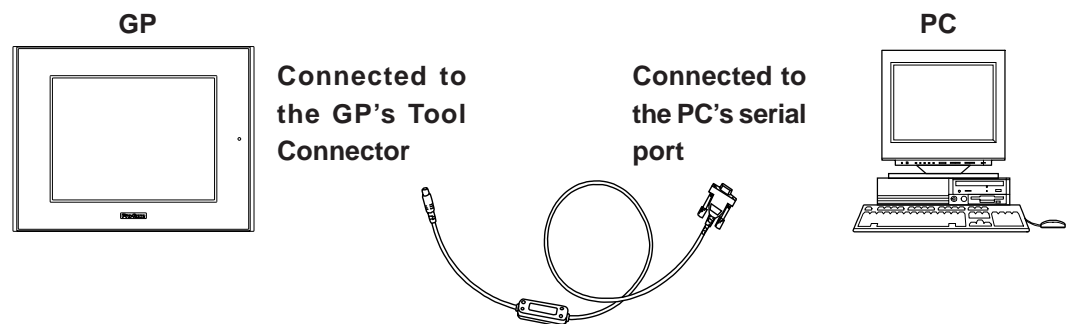

**Note:**

- Pro-face's transfer cable (GPW-CB02) is sold separately. The transfer cable package does not include the PC's interface converting adapter.
- When using the PC with the Dsub 25pin socket side interface, a connector conversion adapter is required. Use the straight line type conversion adapter.

**Recommended units:**

Abel Co. AA833

Sanwa Supply Co. D09-9F25F

- When using a PC equipped with a half-pitch 14pin socket interface, a conversion adapter is required.

**Recommended unit:**

Arroz Co. ZR01-024

## Chapter 4 - Transfer Screen Data

Transfer screen data from your PC, via the GP screen creation software.

**Reference** For details about the GP screen creation software, refer to **GP-PRO/PBIII for Windows Operation Manual** (included in the GP screen creation software)

### ■ To Transfer Data to a Completely New GP

Connect the GP to your PC via the data transfer cable, and then turn the GP ON. The “Initial Start Mode” screen will appear on the GP and you can transfer screen from your PC. The screen will change to the “Transfer” screen automatically.

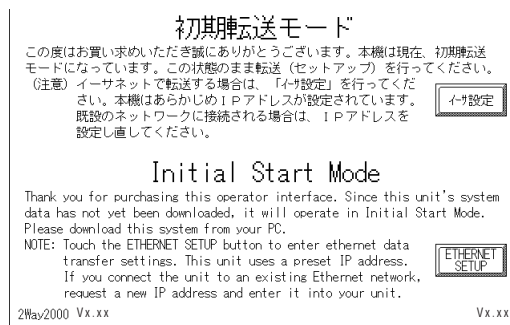

### ■ After Completing Data Transfer using GP setup\*1

Transfer screen data from the GP screen creation software, and select the “Transfer” mode.

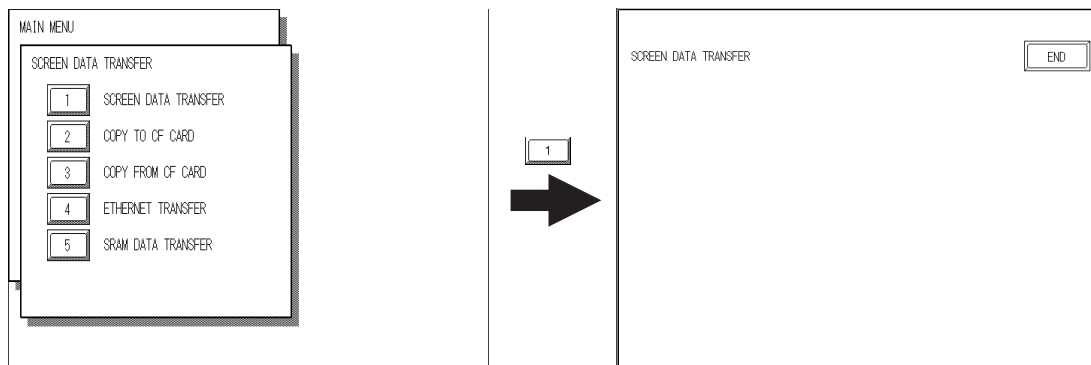

During data transfer, the “SETUP Transfer” and “Now Transferring - Please Wait” messages will appear. When these messages disappear, screen data transfer is completed.

If you wish to stop data transfer, simply cancel it from your PC’s GP screen creation software.

If you try to set up the GP after data transfer, the OFFLINE mode’s “Main Menu” will appear. If you do NOT set up the GP, the screen designated in “INITIAL SETTINGS/SCREEN SETUP/INITIAL SCREEN FILE NO.” will appear and the screen will change to operation (RUN) mode.

---

*1\* Here, the term “Set up” refers to the process of sending GP screen, system program and protocol program information to the GP via the screen creation software, so that the GP can be used as an operator interface.*



***Do NOT disconnect the GP's power supply, turn OFF the PC, or disconnect the GP's transfer cable during the data transfer. If you do, an error may occur when the GP is started.***



***If the GP screen creation software's "GP SYSTEM SETTINGS" data is transferred to the GP, the OFFLINE mode "INITIAL SETTINGS" data will be overwritten.***

## 4.2 Ethernet Data Transfer

The GP-2400/2500/2600 is equipped with the Ethernet I/F which allows you to set up the GP via an Ethernet network, as well as transfer GP screen data.



**When using the Ethernet communication protocol, you must specify the port number for the protocol as +10 or higher than the value specified in this section. Otherwise, the setup or screen data transfer via Ethernet is disabled.**

After you connect an Ethernet cable to the GP's Ethernet I/F, the GP will appear on the Ethernet network.

### ■ Transferring Data to a Completely New GP

#### ◆ Setting Up the IP Address Manually and sending data to a GP

Touch the “Ethernet Setup” button on the GP2000 Initial Start Mode screen.

#### ▼ Reference ▲ 6.5.4 ETHERNET SETUP

Use this method if the GP has been previously set up and data transferred to it.

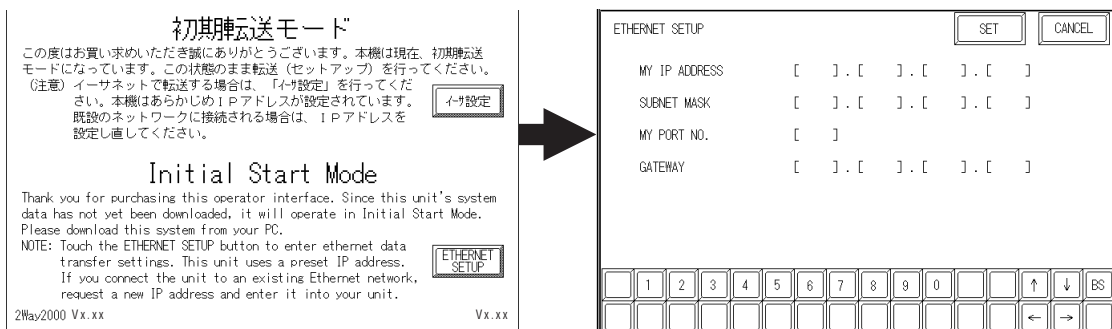

#### ◆ Using a previously set up IP Address to send data \*1

When the settings in the “Ethernet Setup” screen are not specified and data is sent, the GP unit’s factory-set IP Address settings are used.

If you choose to use the factory-set IP address, be sure to designate the PC’s IP Address from “10.255.255.001” to “10.255.255.254” and the subnet mask as “255.0.0.0”.

Use the GP-PRO/PBIII for Windows software to transfer the data.

▼ Reference ▲ “GP-PRO/PBIII for Windows Operation Manual” (included in the GP screen creation software package)

\*1 Be sure to use 2-Way2000 version 3.00 or higher. This version data can be seen in the bottom left-hand corner of the [Initial Start Mode] screen.

### ■ When transferring data using the GP setup\*1 is completed

When you transfer screen creation software data from your PC to the GP while the GP is in RUN mode, the screen will change automatically to “Ethernet Mode”. If it does not, you will need to manually change the GP screen to Ethernet Mode, via the following screen.

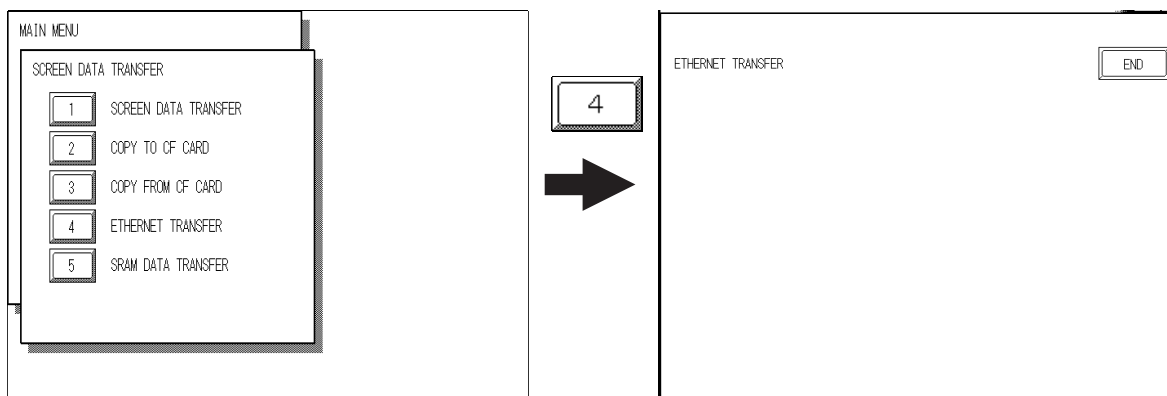

You can now transfer data from your PC’s screen creation software.

**Reference** *GP-PRO/PBIII for Windows Operation Manual*

### 4.2.1 Checking the IP Address

Use the following procedure to check the IP Address assigned to the GP and some consideration/precautions.

- 1) Display the menu bar. For instructions on how to display the menu bar,

**Reference** *6.4.3 Touch Panel Setting*

- 2) Click on the left-side 1/3 cell of the menu bar to display the next menu.

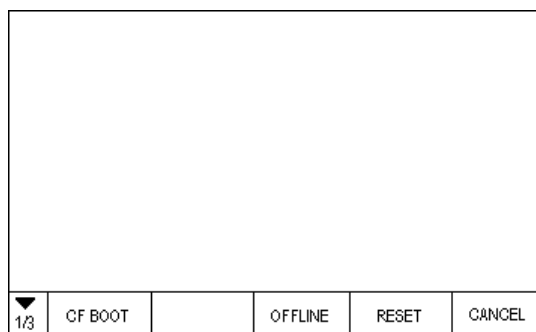

*1\* Here, the term “Set up” refers to the process of sending GP screen, system program and protocol program information to the GP via the screen creation software, so that the GP can be used as an operator interface.*

## Chapter 4 - Transfer Screen Data

- 3) Next, click on the 2/3 cell to display the following menu.

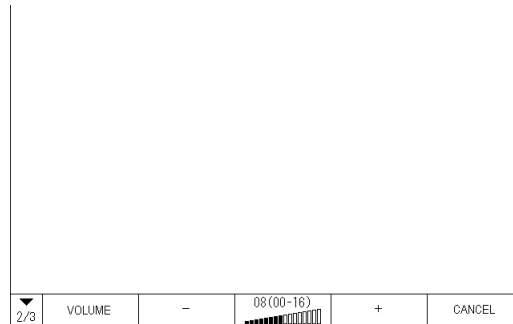

- 4) The IP Address assigned to the GP will appear in the menu bar.

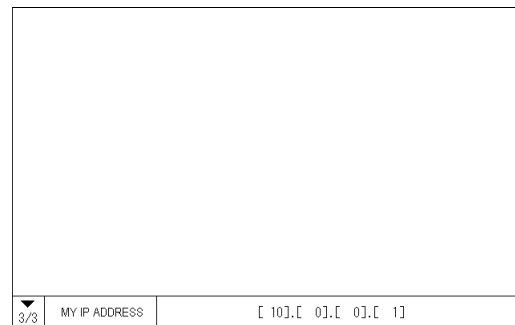

**Note:** IP Address will not be reflected unless GP was reset or power cord was re-connected. After changing “Ethernet Setup” settings, the GP must then be reset or power cord must be re-connected.

## 4.3 CF Memory Loader Tool

The GP2000 allows you to use the CF Memory Loader Tool in the CF Card to set up the GP, transfer screen data, and upload GP internal data to its internal CF Card.



- You need to transfer the CF Memory Loader Tool to the CF Card prior to using the CF Memory Loader Tool.

**Reference** GP-PRO/PBIII for Windows Operation Manual

- The CF Memory Loader Tool and Backup Data require at least 8MB of CF Card memory. Use Digital's CF Card "GP077-CF20 (16MB)" or "GP077-CF30 (32MB)".

### Starting the CF Memory Loader Tool

There are two methods for starting this program via the CF Card.

#### 1. Menu Bar: Using the GP's [CF BOOT] menu

Insert the CF Card with the CF Memory Loader Tool saved into the GP and touch the menu screen's [CF BOOT] selection. The GP will be reset, and after it restarts, the CF card's "CF Memory Loader Tool" will start.

**Reference** For how to display the Menu bar, refer to **6.4.3 ETHERNET SETUP**

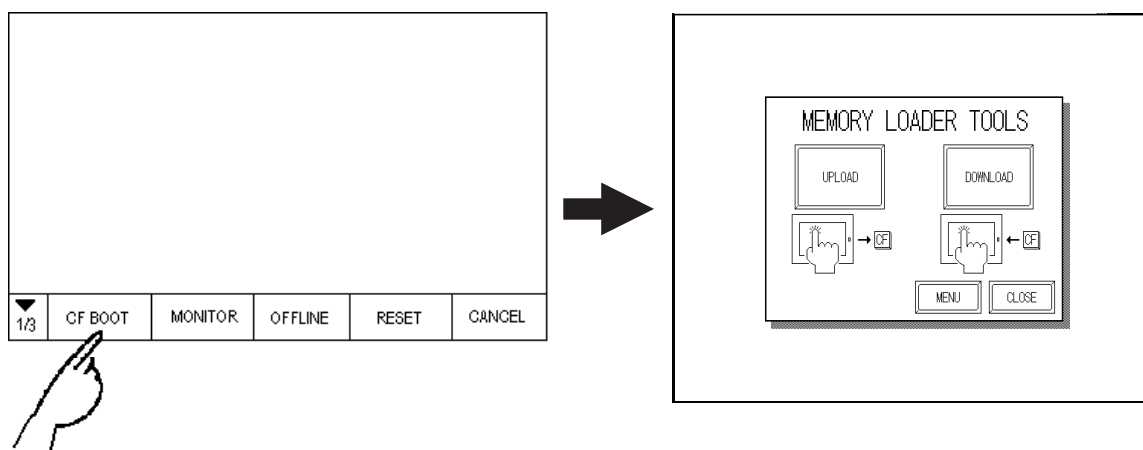

#### 2. GP Dip Switches: Forced Start via GP Dip Switches

You can also use the Dip Switches on the rear of the GP, next to the CF Card Slot. If you turn ON Dip Switch No.1 (raise it) and then connect the GP unit's power cord, the "CF Memory Loader Tool" will automatically start.

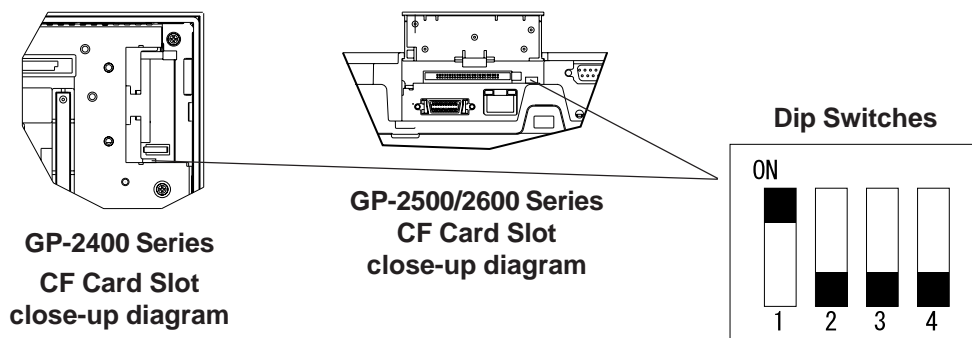

When you finish using the CF Memory Loader Tool, turn OFF this dip switch.



# Chapter 4 - Transfer Screen Data

## 4.3.1 Data Upload and Download

When the Memory Loader Tool program starts, the following screen will appear.

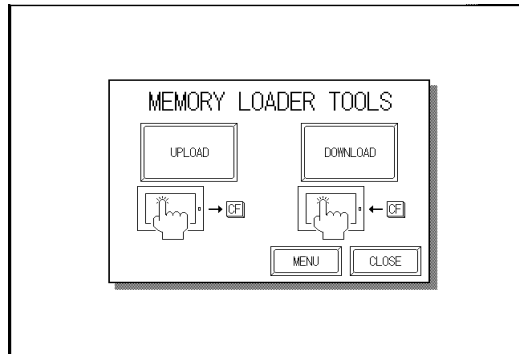

### ■ UPLOAD (From GP to CF Card)

This feature is for saving all GP internal data (i.e. system program, communication protocol, expansion program, screen data and Backup SRAM data) in the CF Card as backup data.

To start data upload, enter the password you designated in the GP screen creation software's "Transfer" screen, and then touch the "START" key. If you have not designated a password however, simply touch the "START" key.



**When *UPLOAD* is performed, the CF Card's current Backup Data will be completely overwritten.**

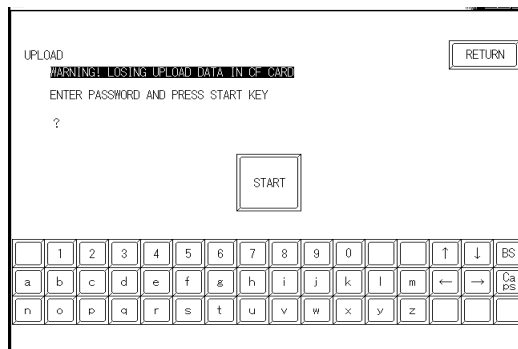

### ■ DOWNLOAD (From CF Card to GP)

This feature is used for writing CF Card backup data to the GP's Internal SRAM Memory.

To start data download, enter the password you designated in the GP screen creation software's "Transfer" screen, and touch the "START" key. If you have not designated a password, simply touch the "START" key.



**When *DOWNLOAD* is performed, the GP's Internal Memory data (i.e. system program, communication protocol, expansion program, screen data and Backup SRAM data) will be completely overwritten.**

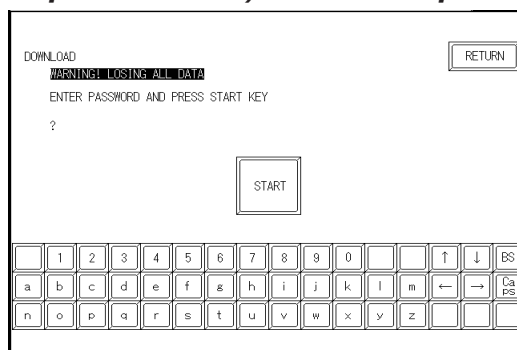

# Chapter

## 5 OFFLINE Mode

1. Entering OFFLINE Mode
2. OFFLINE Mode Main Menu
3. INITIALIZATION
4. SELF-DIAGNOSIS

OFFLINE Mode provides access to the Initialize, Self-Diagnosis, and other features built into the GP. Before you can use any of these features, however, you will need to change the GP to OFFLINE mode.



**OFFLINE mode is unavailable in a completely new GP until the necessary GP system data has been transferred from your PC's screen editor software. To do this, be sure the GP's power cord is plugged in and when you transfer screen data from your PC to the GP, your GP's system data will be automatically sent.**

**Reference** For information about transferring data to the GP, refer to Chapter 4-Transfer, or the *GP-PRO/PBIII for Windows Operation Manual* (included in the screen creation software)

### 5.1 Entering OFFLINE Mode

To INITIALIZE your GP or perform SELF-DIAGNOSIS, you must first switch the GP to OFFLINE mode. There are two ways to enter OFFLINE mode. First, is immediately after plugging in the GP's power cord, and second, by using the Forced Reset feature.

#### 5.1.1 After Plugging in the Power Cord

Touch the upper left-hand corner of the GP screen within 10 seconds of plugging in the GP's power cord and the GP will change to OFFLINE mode.

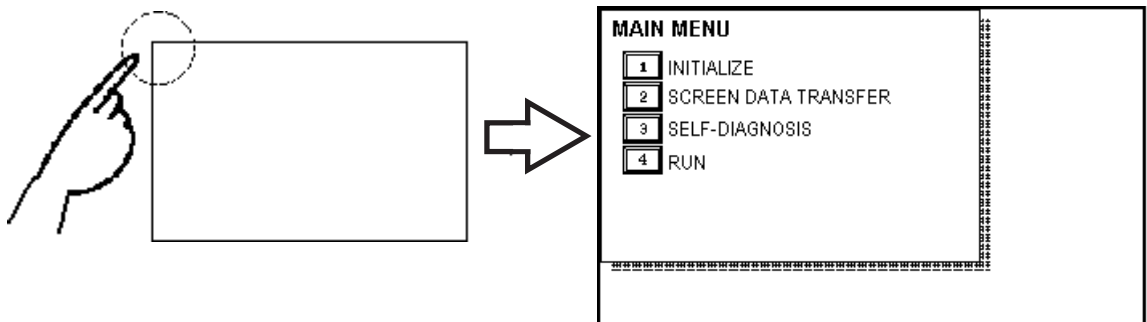

## 5.1.2 From the Menu Bar

From the GP unit's Menu Bar, touch the OFFLINE square and the OFFLINE mode Main Menu will appear.

**Reference** For instructions on how to call up the Menu Bar, refer to 6.4.3 "SET UP TOUCH PANEL; FORCED RESET"

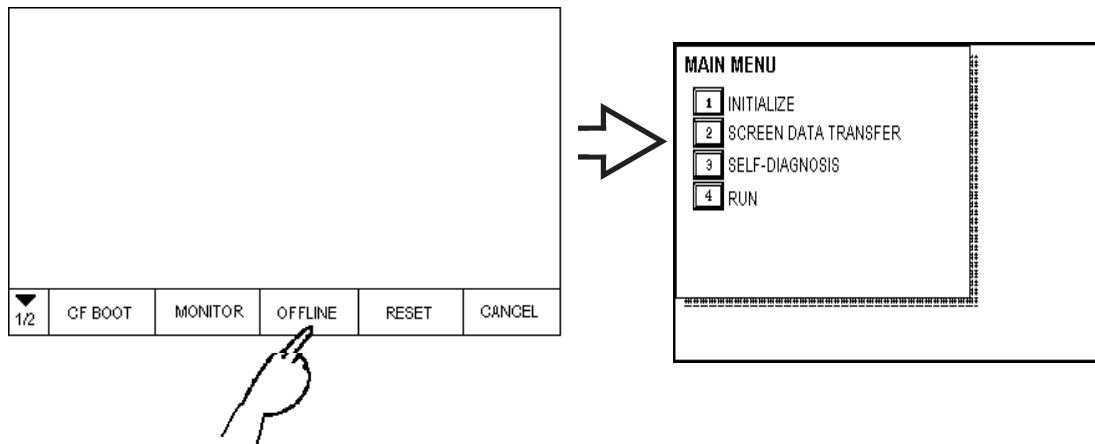

**Note:** If your GP unit has the Device Monitor feature, the "Monitor" square will also appear.

**Reference** GP-PRO/PBIII for Windows Device/PLC Connection Manual (included with the screen creation software), Appendix 3 - Device Monitor

If a Password has been entered in the INITIALIZE/ SET UP SYSTEM area, before entering the OFFLINE mode, the following screen appears. Here, enter the password, then touch *Set* to enter OFFLINE mode.

**Reference** For more information about Passwords, Chapter 6.3.1, "SYSTEM SETUP" and Chapter 5.3, "Initialize-Standard Operation"

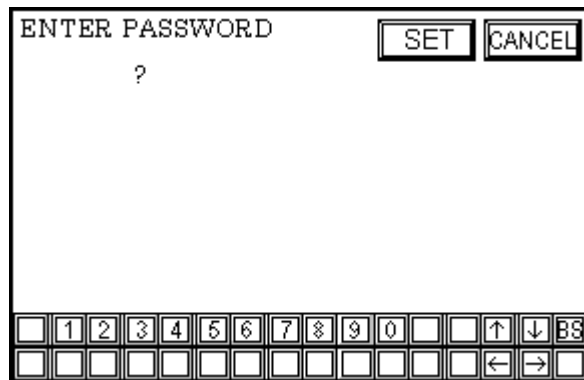

## 5.2 OFFLINE Mode Main Menu

---

Each menu item shown below has different settings that must be set to match the corresponding PLC in order for the GP to communicate properly.

Entering OFFLINE mode calls up the following screen.

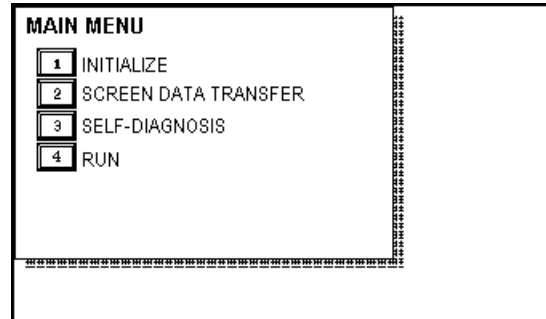

Select the desired menu item by touching the corresponding screen item bar.

Each Main Menu item is used as follows.

### INITIALIZE

The setup items contained in this menu are used to control the GP unit.

### SCREEN DATA TRANSFER

Select to transfer screen data to and from the screen editing software.

### SELF-DIAGNOSIS

Checks to see if there are any problems with the GP System or Interface (I/F).

### RUN

Starts GP operation.

### ▼ Reference ▲

*For more information about INITIALIZE, refer to **Chapter 6***

*For more information about TRANSFER SCREEN DATA, refer to **Chapter 4** or **GP-PRO/PBIII for Windows Operation Manual** (included with the screen creation software)*

*For more information about SELF-DIAGNOSIS and RUN, refer to **Chapter 7**.*

## 5.3 INITIALIZATION

### ■ Selecting A Menu

Touch the menu number to select it.

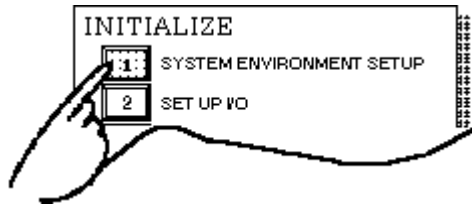

Touch the menu to select it.

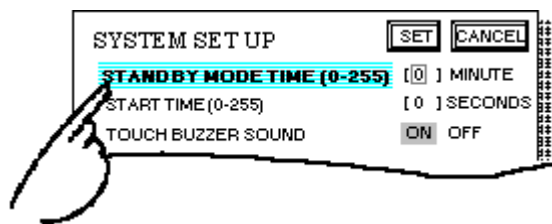

### ■ Entering Numbers

Touching a menu item or an enter field enables you to enter the numeric values. Use the numeric touch keys located at the bottom of the screen to enter numeric values.

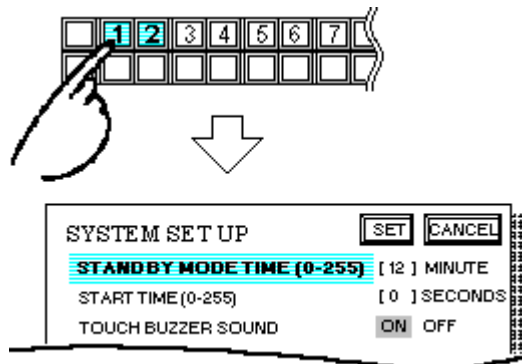

### ■ Selecting Setup Conditions

After selecting a menu item and entering that area, touch the option you would like to setup. The selected item becomes highlighted. In this example, the TOUCH BUZZER SOUND has been set to OFF.

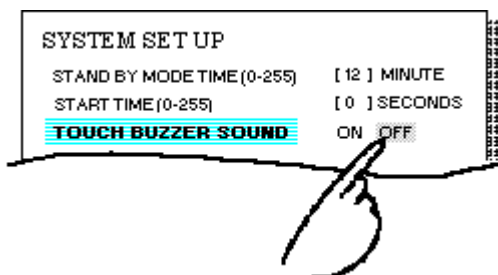

■ **After All Setting Data is Entered**

Touch the top-left [SET] key.

If you wish to exit the screen without saving the changes, touch the [CANCEL] key.

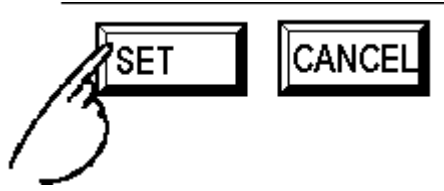

- Press the [SET] key to write the Setup conditions to the Internal FEEPROM, which will require a short period of time. Until this processing is completed, do not touch the screen until the previous menu reappears.
- Press the [CANCEL] key to return to the previous menu, without writing the Setup conditions to the Internal FEEPROM.

■ **Return To Previous Screen**

Touch the title of the screen you would like to return to.

E.g. To return to the MAIN MENU from the SYS.ENVIRONMENT screen, simply touch the MAIN MENU title.

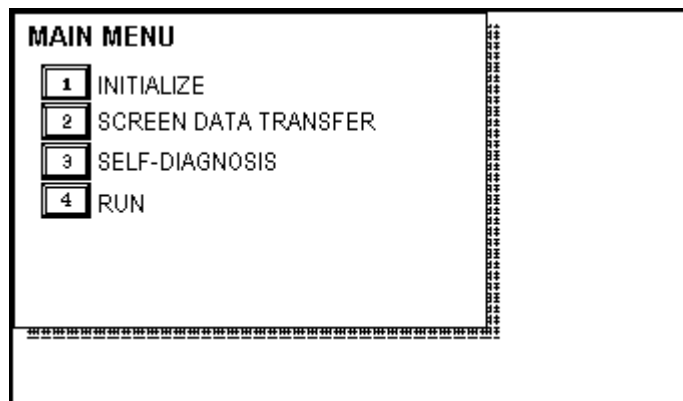
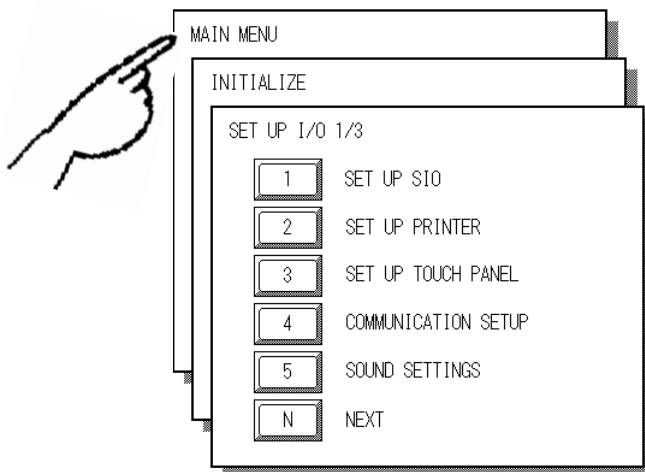

## 5.4 SELF-DIAGNOSIS

---

### ■ Selecting a Sub-Display

Touch the desired the menu item and that sub-display will appear.

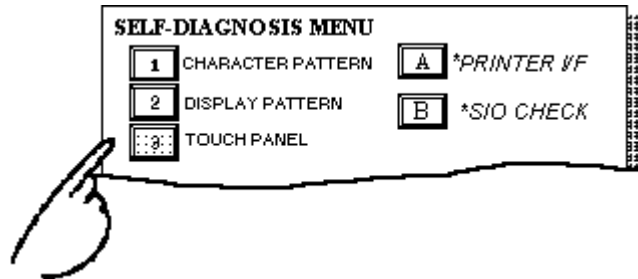

### ■ [CONFIRM], [START] and [CANCEL] Keys

After selecting the Self Diagnosis item, the [CONFIRM], [START], and [CANCEL] keys may appear at different times at the top of the screen.

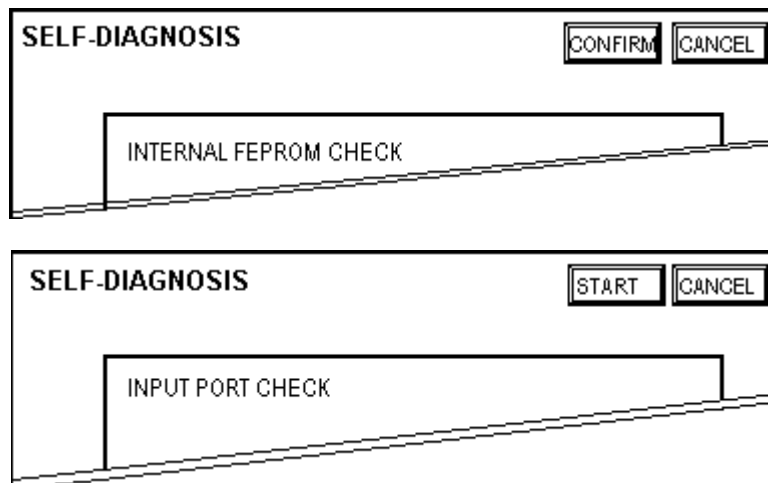

#### [CONFIRM] Key

Touching this key informs the GP that you have completed all the necessary steps prior to running “Self Diagnosis”. All these steps will be shown in the GP’s message dialogs.

#### [START] Key

Touch this key to start the checking process.

#### [CANCEL] Key

Press this key to cancel the Self-Diagnosis test. Control will then return to the SELF-DIAGNOSIS menu.

■ After Check - To Return To SELF-DIAGNOSIS MENU

When OK displays,

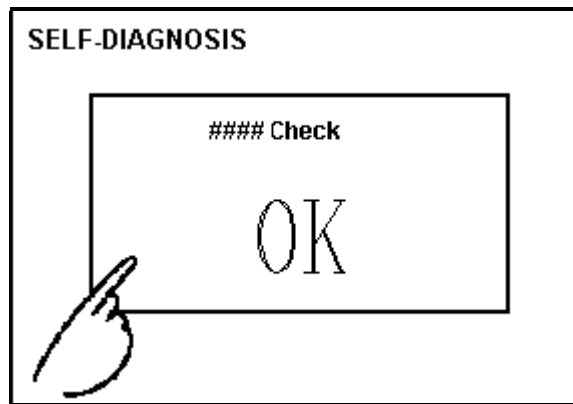

Pressing once anywhere on the display screen returns you to the SELF-DIAGNOSIS MENU.

■ When an Error Message displays

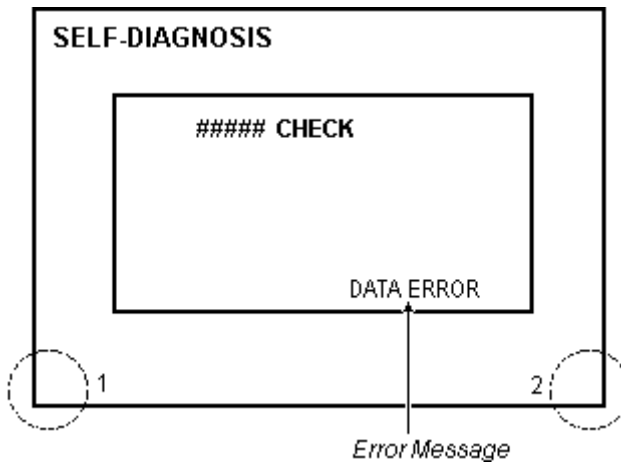

Touch the bottom two corners of the panel (1, 2) to return to the SELF-DIAGNOSIS MENU.

■ Return To Main Menu

Touch the "RETURN" key to return to the main menu screen.

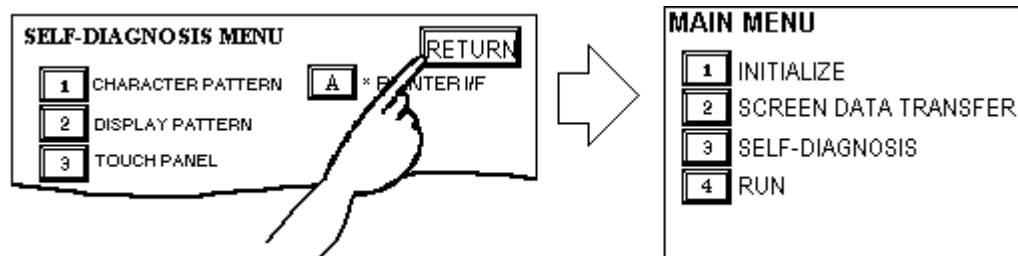



# *Memo*

# Chapter

## 6

# Initializing the GP

1. Initialization Screen

2. Initialization Items

3. SYSTEM ENVIRONMENT SETUP

4. SET UP I/O

5. PLC SETUP

6. INITIALIZE INTERNAL MEMORY

7. SET UP TIME

8. SET UP SCREEN

## 6.1 Initialization Screen

---

Occasionally, you may want to change your GP's general operation settings. The settings used for this are found in the INITIALIZE option in the GP OFFLINE mode's MAIN MENU.

This chapter explains each of the OFFLINE mode's INITIALIZE items. However, there are 2 types of INITIALIZE settings, those for the 1:1 connection and those for the n:1 (multi-link) connection\*1.

The n:1 mark appears on original menu items related to n:1 multi-link connection items. If there is no mark, the menu item is common to both 1:1 and n:1 connections.

**1:1** A single (1) GP is connected with a single (1) PLC.

**n:1** Multiple GPs are connected with a single PLC. The GPs successively pass a *PLC Access Token* (exclusive PLC interaction key) among themselves to designate which unit can communicate with the PLC.

**If you transfer the GP's system file data to the GP via your screen design software\*2, the GP operates using that data. If the GP System file has been correctly setup and transferred, the setting of INITIALIZE items become unnecessary.**

**Reference** *For more information about GP System files*

*GP-PRO/PB III for Windows Operation Manual, 1.1.2 "Screen Types" (included with screen creation software)*

---

\*1 PLC's that support the n:1 (multi-link) connection are limited.

**Reference** *GP-PRO/PBIII for Windows Device/PLC Connection Manual (included with the screen creation software)*

\*2 Refer to GP screen creation software's "SYSTEM SETTINGS" area.

---

## 6.2 Initialization Items

This chapter explains the contents of the Initialize setup items listed below. For information about screen operations and numeric input.

**Reference** Chapter 5, "OFFLINE Mode"

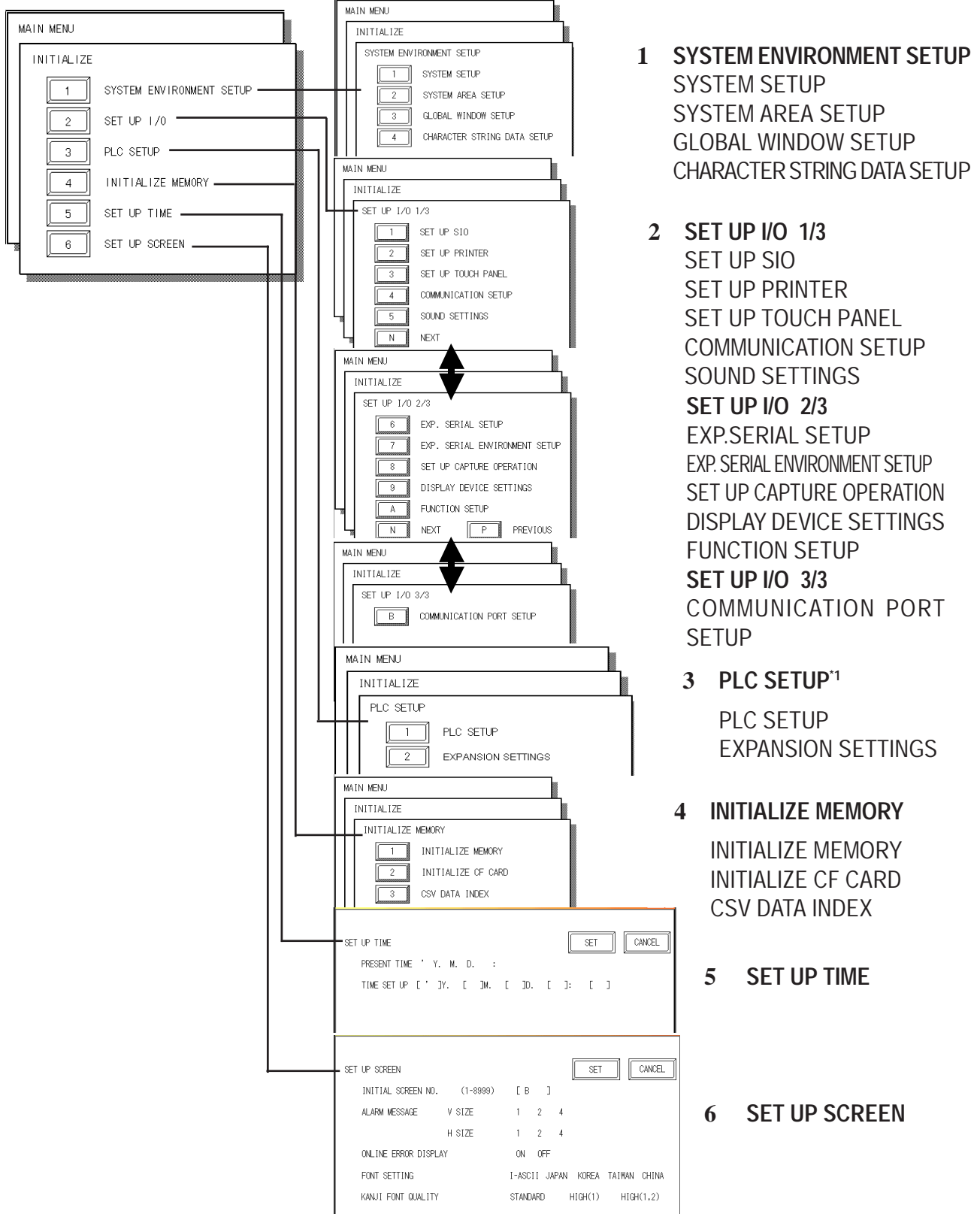

\*1 Note that, depending on the Device/PLC type selected, the screens that appear in your GP's screen editor software will vary.

## 6.3 SYSTEM ENVIRONMENT SETUP

These settings allow you to adjust the GP's operation environment. SYSTEM ENVIRONMENT SETUP includes the SYSTEM SETUP, SYSTEM DATA AREA, GLOBAL WINDOW SETUP, and CHARACTER STRING DATA SETUP screens.

### 6.3.1 SYSTEM SETUP

SYSTEM SETUP		SET	CANCEL
STAND BY MODE TIME (0-255)	[ ]	MINUTE	
START TIME (0-255)	[ ]	SECOND	
TOUCH BUZZER SOUND	ON	OFF	
BUZZER TERMINAL OUTPUT	ON	OFF	
PASSWORD (0-9999)	[ ]		
DATA TYPE OF SCREEN NO.	BIN	BCD	

#### STAND-BY MODE TIME (0-255)

To extend the life of the GP's backlight, the GP is equipped with a screen saver function that automatically turns the unit's backlight(s) OFF when no operations have occurred for a designated period of time. A "0" entered in this field causes a normal display, i.e. the screen is cleared after the GP's standard default time elapses.

When SYSTEM DATA AREA's ( **Reference** *GP-PRO/PBIII for Windows Device/PLC Connection Manual* - included with the screen creation software) SCREEN DISPLAY OFF\*1 data is **0000h**, and the following operations are *not* performed on the screen for the User's designated period of time, the GP's current display is turned OFF.

- Change Screen
- Alarm Messages (scrolling display)
- Error Message Display (Except for 2Way Error)
- Menu Bar (for forced reset) display
- Touch Screen
- Japanese (FEP) System window

#### START TIME (0-255)

This setup determines the start-up time of the GP. Use this setup to adjust the power up sequence so that the GP starts up after the PLC.

#### TOUCH BUZZER SOUND

Setup whether or not the GP beeps when pressed.

#### BUZZER TERMINAL OUTPUT

Turns the GP AUX Input I/F BUZZ signal output ON or OFF. Used when connecting an external buzzer to the GP.

\*1 When using the Direct Access or the Memory Link formats, the object address becomes +9 or +12, respectively. (Only when all items are set within the System Data Area.)  
**Reference** *GP-PRO/PBIII for Windows Device/PLC Connection Manual* (included with the screen creation software)

## Chapter 6 - Initializing the GP

### PASSWORD SETUP(0-9999)

The password setting is used when changing to the Initialize Memory or Initialize (OFFLINE mode) Screens. The password (*from 0 to 9999*) ensures protection of the GP settings, since the use of OFFLINE mode is controlled. If you do not wish to use this feature, enter the default value, **0**.

### DATA TYPE OF SCREEN NO.

This setup controls whether BIN or BCD format numbers are used when making screen changes. Screen numbers 1 to 8999 are available for binary format; screen numbers 1 to 1999 are available for BCD format.

## 6.3.2 SYSTEM AREA SETUP

The System Data Area is used by the PLC to control its GP-related data, and is contained in the PLC. The types of devices that can be set up in the System Data Area differ depending the PLC type.

**When the GP uses Memory Link format, this setting is unnecessary.**

**Reference** *GP-PRO/PBIII for Windows Device/PLC Connection Manual (included with the screen creation software)*

Simply touch the number for the item desired. The item will change to reverse video, to show it has been selected.

Item	Item Name	Item Size
1	CURRENT SCREEN NO.	(1 WORD)
2	ERROR STATUS	(1 WORD)
3	CLOCK DATA (CURRENT)	(4 WORDS)
4	STATUS	(1 WORD)
5	RESERVED	(1 WORD)
6	CHANGE SCREEN NO.	(1 WORD)
7	DISPLAY ON/OFF	(1 WORD)
8	CLOCK DATA (SET)	(4 WORDS)
9	CONTROL	(1 WORD)
A	RESERVED	(1 WORD)
B	WINDOW CONTROL	(1 WORD)
C	WINDOW REG. NO.	(1 WORD)
D	WINDOW LOCATION	(2 WORDS)

SYSTEM AREA SIZE: WORD(S)

(Item numbers displayed in reverse mode are selected.)

### System Area Size

#### ◆ System Area Size

This field displays the total number of words used for the items selected from the SYSTEM AREA SETUP (**Write:** from 1 to 5 and **Read:** from 6 to D).

When you press the Confirm key, the SYSTEM AREA CONTENTS screen appears to confirm the selected items



**Note:**

- These settings are enabled only when using Direct Access format.
- The selected System Area items, as displayed on the screen, become the System Data Area.

## Chapter 6 - Initializing the GP

When these five items, "Current Screen Number", "Error Status", "Clock Data (Current)", "Change Screen Number", and "Display ON/Off", have been selected, word addresses are assigned to each item, in order, as shown here.

SYSTEM AREA CONTENTS	WORD	BYTE	SET	CANCEL
	+0	+0, 1		
	+1	+2, 3		
	+2	+4, 5		
	+3	+6, 7		
	+4	+8, 9		
	+5	+10, 11		
	+6	+12, 13		
	+7	+14, 15		
	+8	+16, 17		
	+9	+18, 19		
	+10	+20, 21		
	+11	+22, 23		
	+12	+24, 25		
	+13	+26, 27		
	+14	+28, 29		
	+15	+30, 31		
	+16	+32, 33		
	+17	+34, 35		
	+18	+36, 37		
	+19	+38, 39		

In the screen above, the device address used for [SET UP OPERATION SURROUNDINGS]'s "SYSTEM AREA START DEV / START ADR" is "+0". Thus, in the example shown above, when the "SYSTEM AREA START DEV / START ADR" is "D00200", and the [CHANGE SCREEN NO.] has been designated, the address is shown as "+6" and you will need to then enter "D00206" (i.e. "D00200" + 6) to use this address.

For details about setting "SYSTEM AREA START DEV / START ADR", refer to

**Reference** [6.5.1 SET UP OPERATION SURROUNDINGS\(1:1/n:1\)](#)

## Chapter 6 - Initializing the GP

### 6.3.3 GLOBAL WINDOW SETUP

A GP2000 Series unit can display one *Global Window* and two *Local Windows* at any one time. The Global Window is common to all the display screens. The Local Window displays exclusively on a designated base screen. The GLOBAL WINDOW SETUP is described here.

GLOBAL WINDOW SETUP		SET	CANCEL
GLOBAL WINDOW	USE	DO NOT USE	
GLOBAL WINDOW ACCESS	DIRECT	INDIRECT	
DATA FORMAT	BIN	BCD	
REGISTRATION NO. (1-256)	[	] (DIRECT MODE ONLY)	
WINDOW LOCATION	X POSITION (0- )	[	] (DIRECT MODE ONLY)
	Y POSITION (0- )	[	] (DIRECT MODE ONLY)

The items in this area are only valid when using the Global Window.

#### GLOBAL WINDOW

Two options are available: **Use** and **Do Not Use**. If you select **Do Not Use**, ignore the items described below. Selecting **Use** enables the following options.

#### GLOBAL WINDOW ACCESS

Use this feature to designate whether values used by the GP are DIRECT or INDIRECT, i.e. the REGISTRATION NO. and the LOCATION values. When set as Direct, the REGISTRATION NO. and LOCATION selections are fixed to the values entered here. When set to Indirect, the WINDOW REG. NO.'s word address is used by the SYSTEM AREA as a variable. This means the REGISTRATION NO. written to it changes and, as a result, can call up multiple window screens as Global windows. You can also use this method to adjust the Global window's position by writing the desired X,Y coordinates to the SYSTEM AREA's LOCATION word addresses.

#### DATA FORMAT

Setup whether the REGISTRATION NO. and the LOCATION values are BIN or BCD values. This field is related only to indirect values.

#### REGISTRATION NO.

Enter the Window Screen Number used by the Global Window. This field is enabled only when GLOBAL WINDOW ACCESS is set to direct.

#### WINDOW LOCATION

Enter the value used for the (Global WINDOW) LOCATION. This field is enabled only when GLOBAL WINDOW ACCESS is set to direct. Use this setting to designate the top left coordinate on the screen registered as a Global Window. If you are installing the GP vertically, i.e. in portrait not landscape mode, designate the bottom left coordinate instead

## 6.3.4 CHARACTER STRING DATA SETUP

Character String Data ordering varies from manufacturer to manufacturer. Setup the Character String Data order here to match the corresponding PLC.



**Setup the CHARACTER STRING DATA MODE to match the PLC type. Device type and Tag settings are unavailable.**

### ■ CHARACTER STRING DATA MODE

Find the data storage order for your PLC in the following table, and setup the CHARACTER STRING DATA MODE.

- (I) Data Device Storage Order
- (II) Internal Word Byte LH/HL Storage Order
- (III) Internal Double-word Word LH/HL Storage Order

#### CHARACTER STRING DATA MODE(1-8) List

(I) Data Device Storage Order	(II) Internal Word, Byte LH/HL Storage Order	(III) Double-word Internal Word LH/HL Storage Order	Character String Data Mode
Storage from Initial data	LH order	LH order	4
		HL order	2
	HL order	LH order	5
		HL order	1
Storage from End data	LH order	LH order	6
		HL order	7
	HL order	LH order	8
		HL order	3



## Chapter 6 - Initializing the GP

### I) Data Device Storage Order

E.g. Characters    A B C D E F G H  
                           └─┘ └─┘ └─┘ └─┘  
                           ①    ②    ③    ④

#### • Storage from Start Data

①	D100
②	D101
③	D102
④	D103

#### • Storage from End Data

④	D100
③	D101
②	D102
①	D103

### II) Word Byte LH/HL Order

E.g. Characters    A B C D  
                           ① ② ③ ④

#### • 16 bit Device LH Order

②	①	D100
④	③	D101

#### • 16 bit Device HL Order

①	②	D100
③	④	D101

#### • 32 bit Device LH Order

②	①	④	③	D100
---	---	---	---	------

#### • 32 bit Device HL Order

①	②	③	④	D100
---	---	---	---	------

## III) Double-word Word LH/HL Order

E.g. Characters ABCDEFGHIJ"  
 ① ② ③ ④ ⑤

### • 16 bit Device LH Order

②	D100
①	D101
④	D102
③	D103
⑤	D104

### • 16 bit Device HL Order

①	D100
②	D101
③	D102
④	D103
⑤	D104

E.g. Characters "ABCDEFGHIJKLMNOPQRST"  
 ① ② ③ ④ ⑤ ⑥ ⑦ ⑧ ⑨ ⑩

### • 32 bit Device LH Order

②	①	D100
④	③	D101
⑥	⑤	D102
⑧	⑦	D103
⑩	⑨	D104

### • 32 bit Device HL Order

①	②	D100
③	④	D101
⑤	⑥	D102
⑦	⑧	D103
⑨	⑩	D104

### Relationship between K-tag Write Character Value and PLC Device

#### ◆ 16 bit Devices

The GP stores the character string from the start, as groups of 2, into one PLC Device.

When there are nine characters, they are arranged as shown below.

1 2 3 4 5 6 7 8 9 Null  
1 2 3 4 5 6 7 8 9 Null



**Note:** When the characters do not divide into 2 evenly, NULL is added at the end.

#### ◆ 32 bit Devices

The GP stores the character string from the start, as groups of 4, into one PLC Device.

When there are nine characters, they are arranged as shown below.

1 2 3 4 5 6 7 8 9 Null  
1 2 3 4 5 6 7 8 9 Null



**Note:** When the characters do not divide into 4 evenly, NULL is added at the end.

## 6.4 SET UP I/O

This section describes the communication setup with the Host (PLC) and the setup for any peripheral equipment. The SET UP I/O menu includes the SET UP SIO, SET UP PRINTER, SET UP TOUCH PANEL, COMMUNICATION SETUP, SOUND SETTINGS, EXPANSION SERIAL SETUP, EXPANSION SERIAL ENVIRONMENT SETUP, SETUP CAPTURE OPERATION, DISPLAY DEVICE SETTINGS, FUNCTION SETUP, and COMMUNICATION PORT SETUP menus.

### 6.4.1 SET UP SIO

This menu runs the settings related to Device/PLC communication. Be sure to match the settings listed below with the SIO setup on the Host (PLC). The settings will vary depending on the Device/PLC type.

**Reference** *GP-PRO/PBIII for Windows Device/PLC Connection Manual (included with screen creation software)*

SET UP SIO		SET	CANCEL
COMMUNICATION RATE	2400 4800 9600 19200 38400 57600 115200		
DATA LENGTH	7 8		
STOP BIT	1 2		
PARITY	OFF ODD EVEN		
CONTROL	X-CNTRL ER-CNTRL		
COMMUNICATION FORMAT	RS232C 4 LINE 2 LINE		

(Some PLCs may not be able to communicate at 57600 or 115200bps.)



**Note:** *If you have selected "YES" for the [SERIAL I/F CHANGE] on the [COMMUNICATION PORT SETUP] screen, or "Yes" for the [Serial I/F Switch] settings in the [Change Extend SIO Type] command, in the GP Screen Editor's [Project] menu, do not enter all of the settings related to device communication using the Extended SIO Script Protocol here. ([SET UP SIO] screen) These settings are required to set using the [EXPANSION SERIAL COMMUNICATION SETUP] screen.*

**Reference** *6.4.6 EXPANSION SERIAL COMMUNICATION SETUP*

#### COMMUNICATION RATE

The COMMUNICATION RATE (baud rate) is the data communication speed, measured in bits per second (bps), between the GP and PLC. Match the COMMUNICATION RATE values in both the PLC and GP. Depending on the rate selected, certain PLCs may not be able to be used.

**Reference** *GP-PRO/PBIII for Windows Device/PLC Connection Manual*

#### DATA LENGTH/STOP BIT

For data communication, the DATA LENGTH must be set up as 7-bit or 8-bit data, and set up also the STOP BIT as either a 1-bit or 2-bit value.

#### PARITY

Set up whether no parity check, or an odd or even number parity check will take place during communication.

### CONTROL

CONTROL prevents the overflow of data sent and received. Select either XON/XOFF control or ER (DTR) control.

### COMMUNICATION FORMAT

Select one of the following options for the communication format: RS-232C, RS-422 (4 line), or RS-422 (2 line).



**Note:**

- When using an RS422 cable and the Memory Link format, be sure to select the 4-line option.

**Reference** *GP-PRO/PBIII for Windows Device/PLC Connection Manual*  
(included with screen creation software)

- If you have selected "YES" for the [SERIAL I/F CHANGE] on the [COMMUNICATION PORT SETUP] screen, or "Yes" for the [Serial I/F Switch] settings in the [Change Extend SIO Type] command, in the GP Screen Editor's [Project] menu, be sure to select RS-232C.

## 6.4.2 SET UP PRINTER

This setting is used to designate the type of printer that will be connected to the GP.

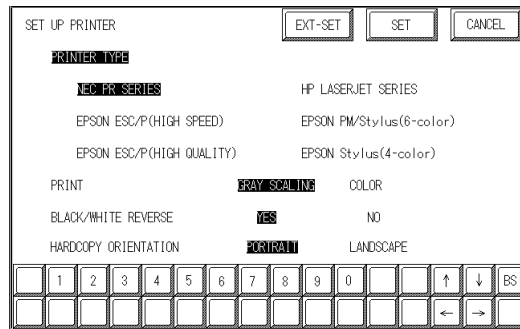

### ■ PRINTER TYPE

Printers that are compatible with NECPC-PR201/PL , EPSON ESC/P24-J84(C), HP Laser Jet PCL 4 commands, EPSON PM/Stylus (6-color ink), and EPSON Stylus (4-color ink) printers can be used.



- **Note:** There is no difference in the quality and printing speed between EPSON ESC/P (High Speed) and EPSON ESC/P (High Quality) when the GP (corresponding to 64 colors or more) is used to print out hard copy of screen images.
- Using EPSON PM/Stylus (6-color ink), EPSON Stylus (4-color ink) printers, GP-PRO/PBIII for Windows Ver.6.2 or later is required. For details,

**Reference** ■ EPSON PM Series / EPSON Stylus Series

### ■ PRINT

Two selections [GREY SCALING] and [COLOR] are available. If you select [GREY SCALING], the same pattern will be applied to:

- Blue and Green • Light blue and Red • Purple and Yellow



- **Note:** Since HP LaserJet Series printers do not support color printing, be sure to designate [GREY SCALING].
- With the [GREY SCALING] feature, printing patterns are reduced to 5 levels of gray from 256 or 64 colors. Colors that do not appear in the printout are ones that have been converted to white.

### ■ BLACK/WHITE REVERSE

This setting is used for reversing the background and display color black/white color attributes. When the color is reversed, the background color is printed as black and the character color is printed as white.

<e.g.> When the background color is black and the display color is white.

When “BLACK/WHITE REVERSE” is selected.



When “BLACK/WHITE REVERSE” is **not** selected.



**Note:** This setting is enabled only when a screen display is printed. Alarm or Recovery data output is printed always as black, regardless of the setting selected.

### ■ HARD COPY ORIENTATION (available with GP-2600T only)

This setting designates the direction of the screen copy printout (horizontal or vertical). This setting is available with the GP-2600T unit only.

**Note:** EPSON PM/Stylus (6-color ink) and EPSON Stylus (4-color ink) models do not support "Vertical" printing. When "Vertical" is selected, printing is not performed correctly.

### ■ EPSON PM Series / EPSON Stylus Series

#### ◆ Restrictions for using EPSON PM / EPSON Stylus Series printers

- EPSON PM/Stylus (6-color ink) and EPSON Stylus (4-color ink) printers do not support "Vertical" printing for "HARD COPY ORIENTATION" (screen copy printout.)
- When printing using an EPSON PM/Stylus (6-color) or an EPSON Stylus (4-color) printer, GP screen updating (tag processing, etc.) will be slower.
- Since OFFLINE Self-diagnosis (Printer I/F Check) is used only for ASCII code output, it will not produce a correct printout.
- A magnification value of 1 to 4 can be specified while printing out screen hard copy. With GP-2600T units, a magnification value of 4 may cause the printout to exceed the width of an A4 size paper.
- When screen data printout uses levels of shading, printout from these printers will differ from a different type printer (PR201, etc.). This is because colors are recognized based on shading level patterns and not on the density of shading.

#### ◆ Extension Settings

When specifying EPSON PM/Stylus (6-color) or EPSON Stylus (4-color) as "PRINTER TYPE", "PRINT MAGNIFY" feature for screen data printout can be specified in the [SET UP PRINTER (EXT-SET)] screen.

Specify either EPSON PM/Stylus (6-color) or EPSON Stylus (4-color) as "PRINTER TYPE", and touch the **EXT-SET** key.

[SET UP PRINTER (EXT-SET)] screen will appear. Touch the desired magnification.

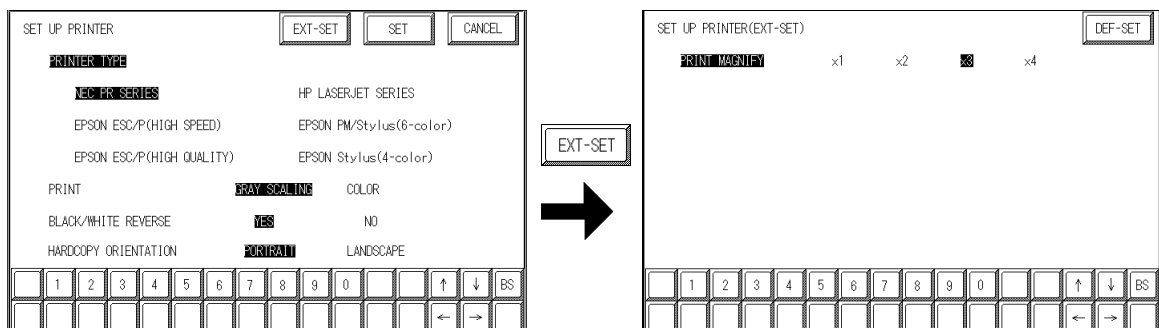

**Note:** With GP-2600T units, a magnification value of 4 may cause the printout to exceed the width of an A4 size paper.

## Chapter 6 - Initializing the GP

When specifying "PRINTER TYPE", except for EPSON PM/Stylus (6-color), EPSON Stylus (4-color) printers, touching the **EXT-SET** key causes the following screen to appear. Touch the **CANCEL** key, and the [SET UP PRINTER] screen will reappear.

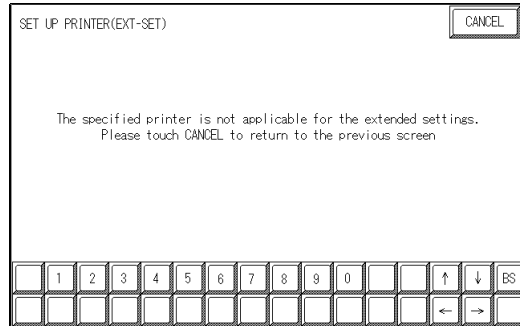

### 6.4.3 SET UP TOUCH PANEL

Touch operation and Force Reset setup, and Display Device adjustments are made here. There may be differences on these settings depending of the GP type.

SET UP TOUCH PANEL			SET	CANCEL																														
TOUCH OPERATION MODE	ONE POINT	<b>TWO POINTS</b>	NO SLIDE																															
FORCE RESET	<input checked="" type="checkbox"/>	OFF																																
CONTRAST ADJUSTMENT	<input checked="" type="checkbox"/>	OFF	(STN/Mono.LCD type only)																															
BRIGHTNESS ADJUSTMENT	<input checked="" type="checkbox"/>	OFF																																
USE TOUCH PANEL AFTER BACKLIGHT BURNOUT	YES	<input checked="" type="checkbox"/>																																
SET UP LCD	<b>NORMAL</b>	REVERSE	(Mono.LCD type only)																															
<small>(Contrast and brightness settings are not applicable for some display devices.)</small>																																		
<table border="1" style="width:100%; text-align:center;"> <tr> <td>1</td><td>2</td><td>3</td><td>4</td><td>5</td><td>6</td><td>7</td><td>8</td><td>9</td><td>0</td><td></td><td></td><td>↑</td><td>↓</td><td>BS</td> </tr> <tr> <td></td><td></td><td></td><td></td><td></td><td></td><td></td><td></td><td></td><td></td><td></td><td></td><td>←</td><td>→</td><td></td> </tr> </table>					1	2	3	4	5	6	7	8	9	0			↑	↓	BS													←	→	
1	2	3	4	5	6	7	8	9	0			↑	↓	BS																				
												←	→																					

#### TOUCH OPERATION MODE

Designates either One Point, Two Point or No Slide. When No Slide is selected, dragging one's finger across the touch screen creates no screen response and only individually selected points will register.

#### FORCE RESET

Designates whether to display or hide the Menu Bar. The Menu Bar can be displayed using the following procedure when "ON" is selected.

#### ◆ To Display the Menu Bar

While pressing down on the bottom right corner (1) of the screen, press the upper right corner (2). At the same time, press the bottom left corner (3) to enter the FORCE RESET mode. To activate Reset, press the **RESET** button, and to change to OFFLINE Mode, press **OFFLINE**.

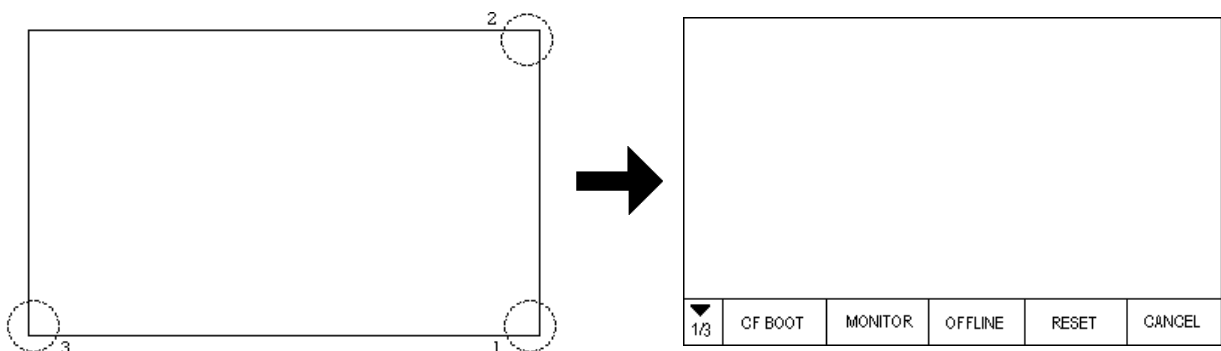

**Important**

**You can perform FORCE RESET in either RUN mode or OFFLINE mode.**



**Note:**

- While the GP is starting up, the Menu Bar will not display.
- Entering SYSTEM RESET is possible even when the PLC and GP are not communicating.



## Chapter 6 - Initializing the GP

### ■ CONTRAST ADJUSTMENT (GP-2500L/GP-2500S only)

When this option is set ON, CONTRAST ADJUSTMENTS can be made through touch input. This setting is not available with GP-2400T/2500T/2600T units.



**Be sure to press the GP corners in the order shown. If only corner (2) is pressed OFFLINE mode will start.**

While pressing the upper right hand corner (1) of the screen, press the upper left corner (2) to enter CONTRAST ADJUSTMENT mode. Press the desired setting and the screen's contrast will change accordingly.

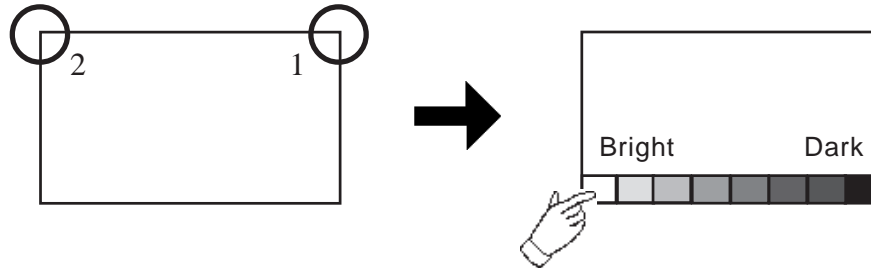

- To end CONTRAST ADJUSTMENT mode, touch anywhere on the screen, except the bottom section.
- CONTRAST ADJUSTMENT mode cannot be entered while waiting for GP to start up.
- CONTRAST ADJUSTMENTS can be made even in the middle of RUN mode (PLC<-->GP communication).
- Regardless of a normal and reversed display, the left side of the contrast adjustment bar, displayed at the bottom area of the screen, is always "Bright".

### ■ BRIGHTNESS ADJUSTMENT

When set to ON, BRIGHTNESS ADJUSTMENT can be performed via touch input. Press the bottom left corner (2) of the screen while holding down the bottom right corner (1) to enter BRIGHTNESS ADJUSTMENT mode. Touch the left-side of the bar to brighten the display; touch the right-side of the bar to dim the display. This unit has four levels of adjustment.

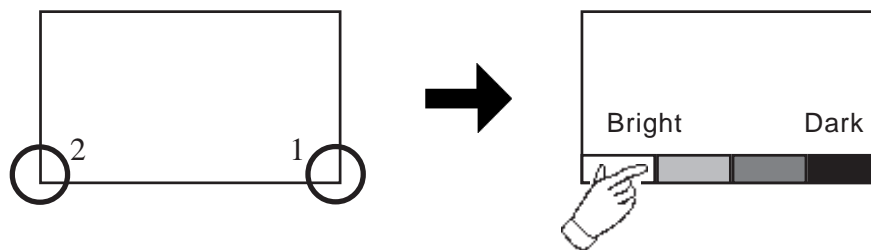

- With the GP units, reducing the display brightness may cause flicker. Adjust it by changing the display device settings.

#### ▼ Reference ▲ 6.4.9 DISPLAY DEVICE SETTINGS

- To end BRIGHTNESS ADJUSTMENT mode, touch anywhere on the screen, except the bottom section.
- BRIGHTNESS ADJUSTMENT mode cannot be entered while the GP is starting up.
- BRIGHTNESS ADJUSTMENT can be used even during RUN mode (PLC<-->GP communication).
- Regardless of a normal and reversed display, the left side of the contrast adjustment bar, displayed at the bottom area of the screen, is always "Bright".

### ■SET UP LCD (GP-2500L only)

To reverse the screen display colors, touch SET UP LCD on the SET UP I/O screen to change the setting from "NORMAL" to "REVERSE", and then touch the "SET" key. The display color will be reversed and the previous screen will reappear.

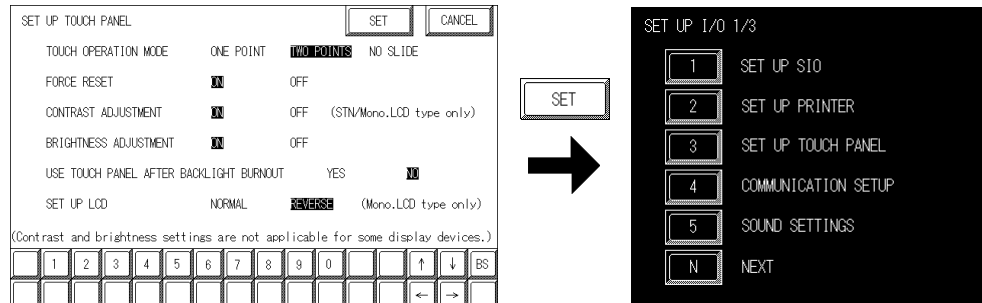

### ■USE TOUCH PANEL AFTER BACKLIGHT BURNOUT

This option designates whether touch-operation is disabled or not when the backlight burns out.

If this selection is set to [OFF], touch-operation will be disabled when the backlight burns out, which prevents the GP from sending input signals to the PLC.



**Note:**

- When the backlight burns out, the Status LED's orange light turns ON, and the System Data Area's "Status" bit 10\*1 will turn ON.
- The GP-2400/2500/2600 series models use two backlights (CCFL). The GP detects backlight burnout when one of the two backlights burns out, and disables touch-operations.
- If the [SYSTEM RESET] option is set to [ON], only "System Reset" can still be performed by touch-operation in case of backlight burnout.
- If the backlight burns out when the GP is OFFLINE, touch-panel operation is enabled, regardless of these settings.



**Important**

**Normally, the GP unit detects a backlight burnout by monitoring the backlight's current flow, however, the GP may fail to detect this condition, depending on the type of backlight problem, and also the GP may detect the condition before the backlight burns out.**

\*1 Bit +6 (when using the Direct Access method), and bit +11 (when using the Memory Link method), will turn ON.

▶ **Reference** ▶ GP-PRO/PBIII for Windows Device/PLC Connection Manual (included with screen creation software)

## Chapter 6 - Initializing the GP

### 6.4.4 COMMUNICATION SETUP

---

The following explains the use of the retry command to deal with errors, including those that occur during GP and PLC communication.

COMMUNICATION SETUP		SET	CANCEL
RECEIVE TIMEOUT (1-127)	[   ]	SECOND	
RETRY COUNT (0-255)	[   ]		

#### RECEIVE TIMEOUT (1 to 127)

Sets the value used for the data reception timeout (PLC <--> GP).

If the cable is not connected, data communication will Timeout after one second, regardless of this setting's value. The default is "10" seconds.



**An error message may appear on your personal computer if:**

- You transfer screens from your PC to the GP after a PLC communication error has occurred and the error is not yet cleared.
- Your GP's RECEIVE TIMEOUT value is set to 30 seconds or more.

#### RETRY COUNT (0 to 255)

Designates how many times the GP tries to send data to the PLC when a PLC communication error occurs. An Error Message will appear on the GP after the GP tries to send data to the PLC the number of times set by this option. The default is "2".

### 6.4.5 SOUND SETTINGS

---

SOUND SETTINGS			SET	CANCEL
START-UP SOUND	BUZZER	SOUND		

#### START UP SOUND

Select the type of sound that is output when the GP starts. If "BUZZER" is selected, the GP's internal buzzer will be sound. If "SOUND" is selected, a sound will output from the speaker connected to the GP.

**6.4.6 EXPANSION SERIAL COMMUNICATION SETUP**

The following explains the setup for communicating with a device connected to the Expansion Serial Interface. This setup screen will not display unless the communication protocol for the Expansion Serial Interface (specified with “SET UP EXPANSION SIO” of the GP screen creation software package) is transferred to the GP.



***If you have selected "YES" for the [SERIAL I/F CHANGE] on the [COMMUNICATION PORT SETUP] screen, or "Yes" for the [Serial I/F Switch] settings [Change Extend SIO Type] command, in the GP Screen Editor' [Project] menu, enter all of the settings related to device communication using the Extended SIO Script Protocol here, [EXPANSION SERIAL COMMUNICATION SETUP] screen.***

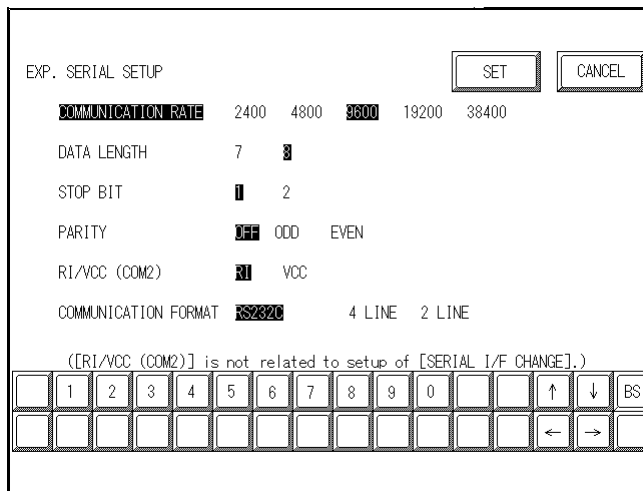

**COMMUNICATION RATE**

The COMMUNICATION RATE refer to the data communication speed, measured in bits per second (bps), between the GP and the device connected to the Expansion Serial Interface.

The supported communication rates vary depending on the connected device. Refer to the instruction manual of the connected device for more information. The initial setting varies depending on the communication protocol for the Expansion Serial Interface being transferred.

**DATA LENGTH**

Set the DATA LENGTH to 7-bit or 8-bit data.

**STOP BIT**

Set the STOP BIT to either 1- or 2-bit.

**PARITY**

Set the parity to no parity (OFF), or an ODD or EVEN parity check.

## Chapter 6 - Initializing the GP

### RI/VCC (COM2)

This setting designates if the Serial Interface's #9 pin is used for RI or for VCC.

VCC is only enabled in RUN mode, and if the mode is changed from RUN to OFFLINE, this will change to RI. When an Expansion Serial protocol is not used, this setting is fixed at RI.



***There is a danger that the SIO circuit can be damaged if the VCC setting is used and the Expansion Serial Interface's check tool is connected. [Reference](#) 7.2.2 Self-Diagnosis - Details***

### COMMUNICATION FORMAT

Select one of the following options for the communication format: RS-232C, RS-422 (4 line), or RS-422 (2 line).

## 6.4.7 EXPANSION SERIAL ENVIRONMENT SETUP

The following setting varies depending on the communication protocol for the Expansion Serial Interface being transferred.

This section explains the case where “SERIAL CODE READER(LS)” is transferred. Use this setting when a serial code reader is connected to the Expansion Serial Interface to read serial code data.

### READ MODE

Select the READ MODE according to the scanner settings.

The communication format for each mode is shown below:

- Standard

Code data	Terminator (CR)
-----------	-----------------

- QR code scanner manufactured by Denso

Header (STX)	Code mark (7 bytes)	No. of digits (4 bytes)	Code data	Terminator (CR)	BCC (7 bytes)
--------------	------------------------	----------------------------	-----------	--------------------	------------------

- Code scanner manufactured by Tohken

Header (STX)	Code data	Terminator (CR + LF)
--------------	-----------	----------------------

### 6.4.8 SET UP CAPTURE OPERATION

---

Save the captured image of the GP unit's screen as a JPEG file in the CF Card.

**Reference** Refer to the *GP-PRO/PBIII for Windows Tag Reference Manual*, 4.7.10 – “Screen Capture” (included in the GP screen creation software).

SET UP CAPTURE OPERATION

SET CANCEL

QUALITY (1-100) ( )

BLACK/WHITE REVERSE YES NO

1 2 3 4 5 6 7 8 9 0 ↑ ↓ BS

← →

#### QUALITY (1–100)

Sets the captured image quality. The image quality can be set from 1 to 100. 100 is the highest quality.

#### BLACK/WHITE REVERSE

The white portion of the image that is created in the screen creation program is reversed to black, and the black portion is reversed to white. This reversed white-and-black image can be captured and saved.



**Note:** Only black and white colors are reversed.

#### ◆ TFT Color LCD

The Color LCD GP captures a B/W reverse image and saves it to the CF Card. The white portion of the image is converted to black, and the black portion of the image is converted to white. Only black and white colors are converted.

**6.4.9 SET UP DISPLAY DEVICE**

Depending on the GP's Environment and Brightness settings, sometimes the screen's display will seem to flicker. This may be because the brightness setting is too low, or that the GP's surrounding environment has become either too hot or too cold. In order to correct this problem, please use the following setting.

- STN color LCD (GP-2500S)

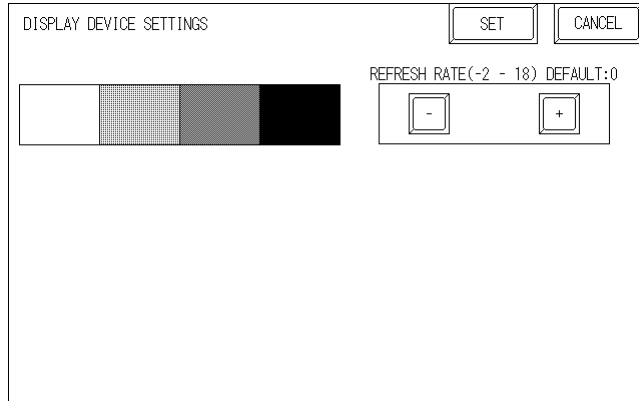

- Monochrome LCD (GP-2500L)

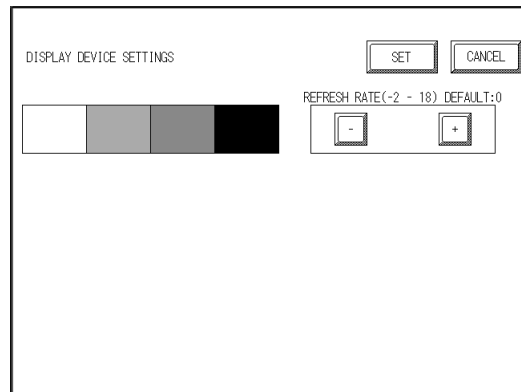

<When using 8 levels of gray>

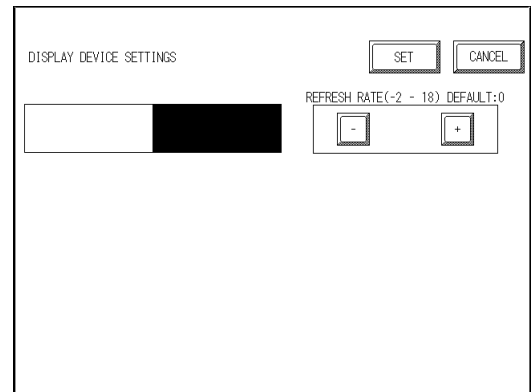

<When using Black and White>

**REFRESH RATE**

Refer to the samples shown on the GP unit's screen to gauge whether the "+" or "-" adjustments help to correct the problem. While the normal setting value is "0", there are two levels available in the minus direction (from "0") and 18 levels available in the "+" direction (from "0").

**6.4.10 FUNCTION SETUP**

This setting is not supported by the GP-2400/2500/2600 Series unit. Return to the previous screen by touching the CANCEL button.

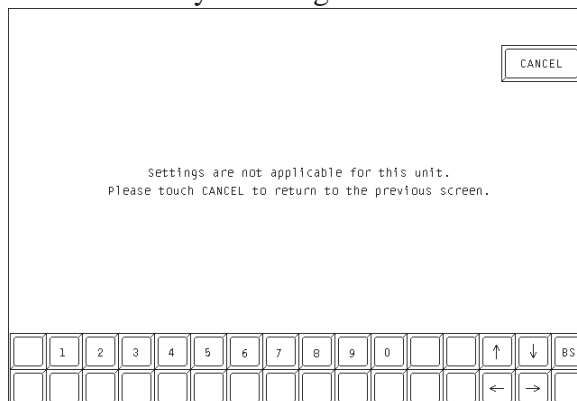



### 6.4.11 COMMUNICATION PORT SETUP

---

This screen allows you to set up the connection environment of the GP's communication port.

COMMUNICATION PORT SETUP

SERIAL I/F CHANGE NO YES (COM1 <-> COM2)

RI/VCC (COM2) RI VCC

[[RI/VCC (COM2)] is not related to setup of [SERIAL I/F CHANGE].]

1 2 3 4 5 6 7 8 9 0 ↑ ↓ BS

← →

#### SERIAL I/F CHANGE

Selecting "YES (COM1 <->COM2)" designates that the communication used for the Extended SIO Script Protocol starts at the Serial I/F (COM1). Also, the communication used for the device/PLC starts at the Expansion Serial I/F (COM2).

In OFFLINE mode, the SERIAL I/F CHANGE setting is set to "NO".



**Note:**

- After selecting "YES (COM1 <->COM2)", enter all of the settings related to device communication using the Extended SIO Script Protocol, [EXPANSION SERIAL COMMUNICATION SETUP] screen. Enter all of the settings related to Device/PLC communication, [SETUP SIO] screen.
- To use the "SERIAL I/F CHANGE" feature, the system of GP-PRO/PB III for Windows Ver.6.2 or later is required to be transferred to the GP.

#### RI/VCC (COM2)

This setting designates if the Serial Interface's #9 pin is used for RI or for VCC.

## 6.5 PLC SETUP

Set up the GP System Area and the Unit number in this screen. Because 1:1 and n:1 GP connections utilize different settings, confirm your connection's needs before using any settings. The following assumes that the Direct Access format is used.



**Note:** The screens that appear will depend on the PLC type you selected in the screen creation software.

**Reference** *GP-PRO/PBIII for Windows Device/PLC Connection Manual (included with screen creation software)*

- When the GP-PRO/PBIII for Windows Ver 3.0 "Simulation" feature is used, the OPERATION SURROUNDINGS menu cannot be used.

### 6.5.1 SET UP OPERATION SURROUNDINGS(1:1/n:1)

Enter the PLC System Data Area and the Unit Number settings here. The same options are available for both 1:1 and n:1 (Multi-link) connections.

For an n:1 (Multi-link) Connection, System Data Area settings must be setup for each GP connected to the PLC.

**Reference** *GP-PRO/PBIII for Windows Device/PLC Connection Manual (included with screen creation software)*

#### STARTING ADDRESS OF SYSTEM DATA AREA

Setup the System Data Area's Start Address. Device addresses that can be allocated will differ depending on the type of PLC used.

**Reference** *GP-PRO/PBIII for Windows Device/PLC Connection Manual (included with screen creation software)*

#### UNIT NO.

Enter the PLC UNIT number here. Check that it matches the one set up in the PLC.

#### SYSTEM AREA READING AREA SIZE (0-256)

When using a Block Display Trend Graph, setup the Reading Area Size (in word units) to match the Trend Graph's data size. Use this feature when you wish to allocate the Reading Area in the PLC Data Register (D), or Data Memory (DM).



**Note:** If you are not using the Reading Area, leave the 0 default values intact. This will allow you to perform high speed data communication.

#### RESET GP ON DATA WRITE ERROR

Designates the mode which enables you to cancel the error from the error display when the Write error occurs.

## 6.5.2 STATION SETUP(n:1)

STATION SETUP, required with an n:1 (Multi-link) setup, checks whether data communication is being performed correctly between the GP and the PLC.

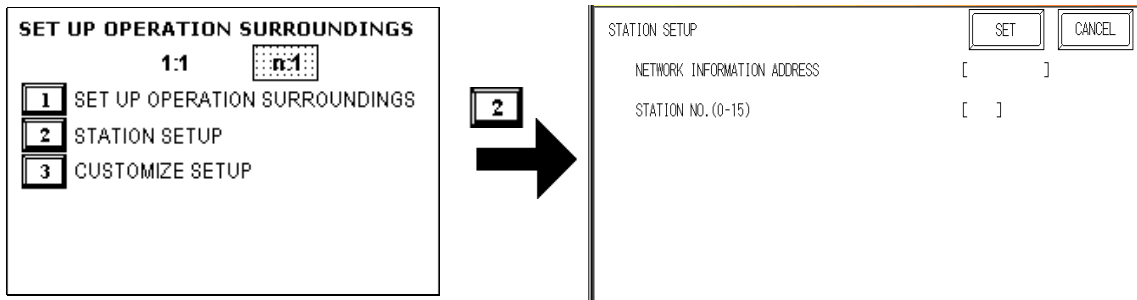

### NETWORK INFORMATION ADDRESS

With an n:1 (multi-link) connection, the Network Information setting uses 2 words for its data. These two (2) words consist of a Connection List and a Validation List (described later in this section). These areas are allocated in the PLC's Data Register (D) or Data Memory (DM). Addresses which can be allocated will differ depending on the PLC type.

**Reference** *GP-PRO/PBIII for Windows Device/PLC Connection Manual* (included with screen creation software)

#### PLC Data Register

+0	CONNECTION LIST	PLC-->GP
+1	VALIDATION LIST	GP-->PLC



**In the NETWORK INFORMATION ADDRESS, setup the same address to all the GP's connected to the same link unit. Also, when the link unit has 2 ports, be sure they do not use the same address.**

#### ◆ Connection List

The word address for the Connection List sets up the number of GP's connected to the PLC, which must be previously entered in the PLC. When these GP's are connected to the PLC, the corresponding PLC bit number for each GP station should be turned on by the PLC.



**When the GP is connected to the PLC, and the option of GP-only correspondence ends and OFFLINE mode is entered, the GP Station Number then turns the corresponding PLC bit OFF.**



For example, when 4 GP units— shown by bits 0, 2, 3, and 5—are connected, 002D (h) is written here.

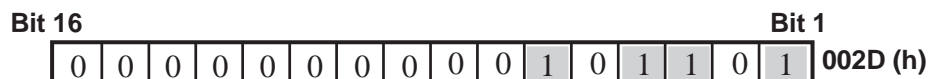



- **Be certain to setup this data before running.**
- **Turn all bits not related to the GP OFF.**

◆ **Validation List**

This area responds to the correspondence from each connected GP. In the Validation List, when the same bit numbers as the Connection List turn ON, the correspondence is accepted. The Station Numbers of the communicating GPs turn their corresponding PLC bit number ON.

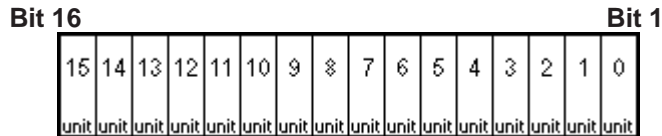

If the correspondence between the GP and PLC is correct, the same value as in the Connection List is written to the Validation List.

For example, the value 002D (h) in the Connection List, setup as the 0 bit, 2 bit, 3 bit, and 5 bit, writes to the Validation List.

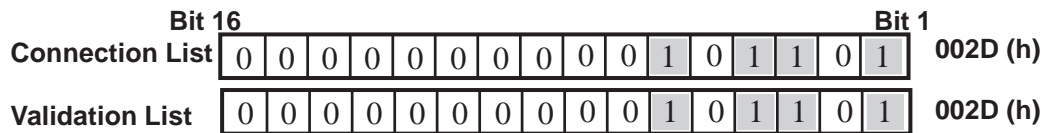

- **When the Connection List and Validation List do not match, a COMMUNICATION ERROR occurs. Check the setup again.**
- **When changing the connection, first turn all the bits OFF.**

STATION NO. (0-15)

This is the setup for the GP Station Number mentioned above. The setup range is from 0 to 15, and the only other restriction is the GP STATION NO. must be unique in the system. If STATION NO.'s are repeated, a COMMUNICATION ERROR occurs.



**Note:** The STATION NO. is the number allocated to the particular GP unit. This number is not related to the Link Unit Machine number.

### 6.5.3 CUSTOMIZE SETUP (n:1)

The Customize function modifies the n:1 (multi-link) connection's communication method to make it more efficient. To perform GP<-->PLC communication efficiently, the user should first determine whether they wish to have Operation or Display priority set for the GP. Based on this, the communication response speed can be upgraded. (However, this also depends on the complexity of the screen information displayed.)

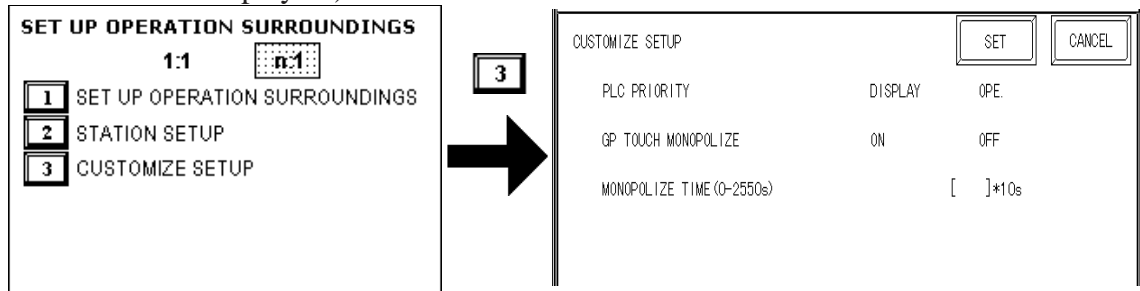

#### PLC PRIORITY

According to how the GP is used, select either Operation priority (OPE.) or Display priority (DISPLAY).

#### Display

Setup the GP to this option when using the GP mainly as a monitor screen. The GP will command a higher display speed as a result; however, the response time for the touch panel's operations will slow.

#### Operation

Set up the GP to this option when using the GP mainly as a monitor screen. The touch panel's numeric value input or switch function response speed will become higher as a result.

When "OPE" is selected, the response time for the touch panel's operation is quicker than the response time when the "DISPLAY." is selected, however, the display refresh cycle time will slow.



- ***In a standard network setup, use the same settings for all connected GP's.***
- ***To increase the display speed, be sure the addresses used are consecutive addresses. When bit addresses are used, use addresses that are consecutive to word units.***

### Speed Difference between Display Priority and Operation Priority

When using the Mitsubishi Electric Corporation A3A PLC, with consecutive addresses (80 words, not including the System Area), the difference in reading speed is as shown in the following graphs.

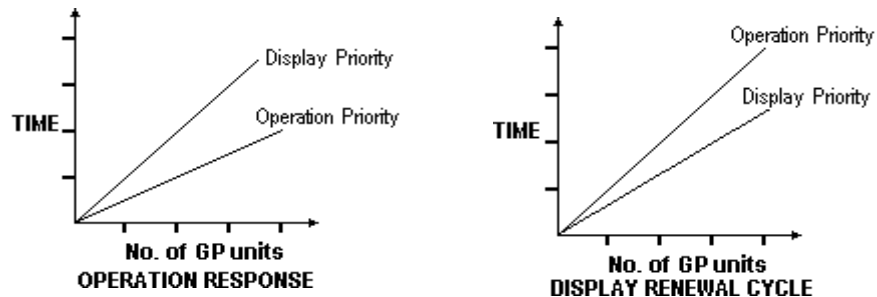

### GP TOUCH MONOPOLIZE

The monopolizing of touch panel use can be set ON or OFF. When you want to use the PLC exclusively with a Momentary operation setup on the touch panel, turn GP TOUCH MONOPOLIZE ON.

When this setup is ON, the touch panel uses the PLC exclusively whenever the momentary operation setup on the panel is pressed. In this way, you can use the inching operation with a momentary switch. When you stop pressing the panel, exclusive use ends.

**Reference** *GP-PRO/PBIII for Windows Device/PLC Connection Manual (included with screen creation software)*

### MONOPOLIZE TIME (0-2550S)

This field controls the length of time for the monopolize process when no other touch panel operations are performed. The Monopolize process ends when the time set here elapses, and the 7th bit of word address LS14 turns OFF.

- **Pressing the touch panel in the middle of the monopolize process interrupts the MONOPOLIZE TIME function, and ends exclusive use.**



**Note:** When MONOPOLIZE TIME is set to 0, the monopolize function does not end automatically.

**Reference** *For further information about the contents of System Data Area LS6 (status) and LS14 (control), refer to GP-PRO/PBIII for Windows Device/PLC Connection Manual (included with screen creation software)*

## Chapter 6 - Initializing the GP

### 6.5.4 ETHERNET SETUP

This menu is for Ethernet settings. This information is used as setting data during GP setup or screen transfer, or, if the Pro-Server software is used, for the 2-Way Driver.

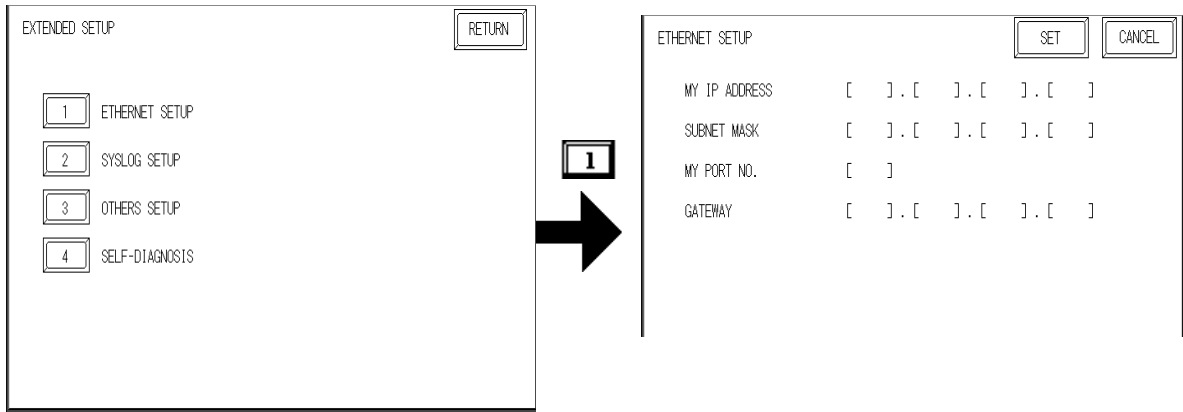

- Enter the “ETHERNET SETUP” settings after receiving information from your network's system administrator.
- Be sure to enter a unique IP address, not one used for other GPs or by the host.

#### MY IP ADDRESS

Sets up the GP's IP address. The IP address is 32 bits and designated in four 8-bit units, entered in decimal.



To use Ethernet networking, click on [Initial Settings], [PLC Setup], [PLC Setup] and [Ethernet Setup].

#### SUBNET MASK

Sets the subnet mask. If you are not using a subnet mask, designate “0”.



To use Ethernet networking, click on [Initial Settings], [PLC Setup], [PLC Setup] and [Ethernet Setup].

#### MY PORT NO.

Sets the 2-Way Driver Port No. using a value from 1024 to 65535. Starting from the value entered here, a total of 10 consecutive ports can be used. The default setting is [8000].



To use Ethernet networking, click on [Initial Settings], [PLC Setup], [PLC Setup] and [Ethernet Setup] and select the corresponding Ethernet protocol Port No.

#### GATEWAY

Sets up the gateway's IP address. Only a single gateway can be set up. If you are not using a gateway, enter “0”.

### 6.5.5 SYSLOG SETUP

---

These settings are used for outputting 2-Way driver's operation logs. Therefore, if you are not using the Pro-Server software, these settings are not necessary.

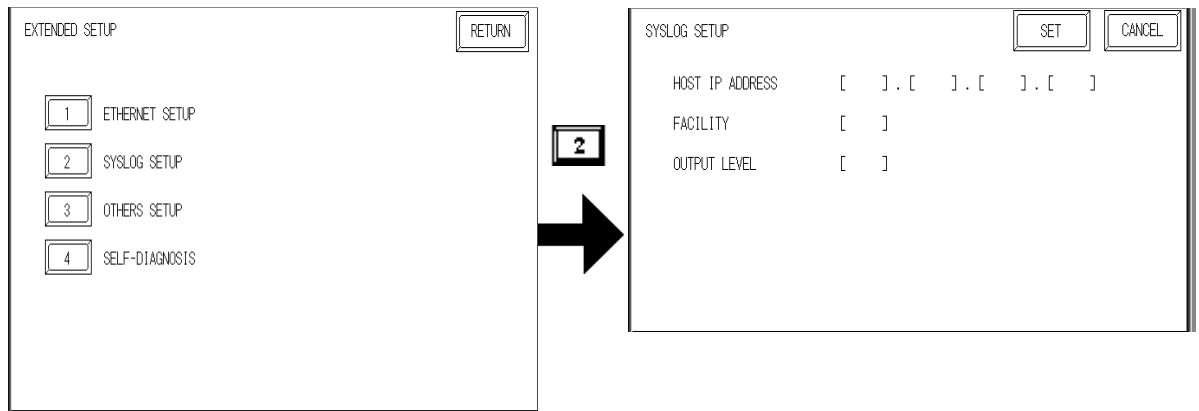

#### HOST IP ADDRESS

Sets up the IP address of the host computer, where the 2-Way driver's operation logs will be output.

#### FACILITY

Sets up the facility.

#### OUTPUT LEVEL

Sets up the output level.

**Reference** For details about Pro-Server and SYSLOG, refer to *Pro-Server with Pro-Studio for Windows Operation Manual* (included in the Pro-Server with Pro-Studio for Windows software package)



## Chapter 6 - Initializing the GP

### 6.5.6 OTHERS SETUP

---

Designates the GP operation performed when a 2-Way driver error occurs.

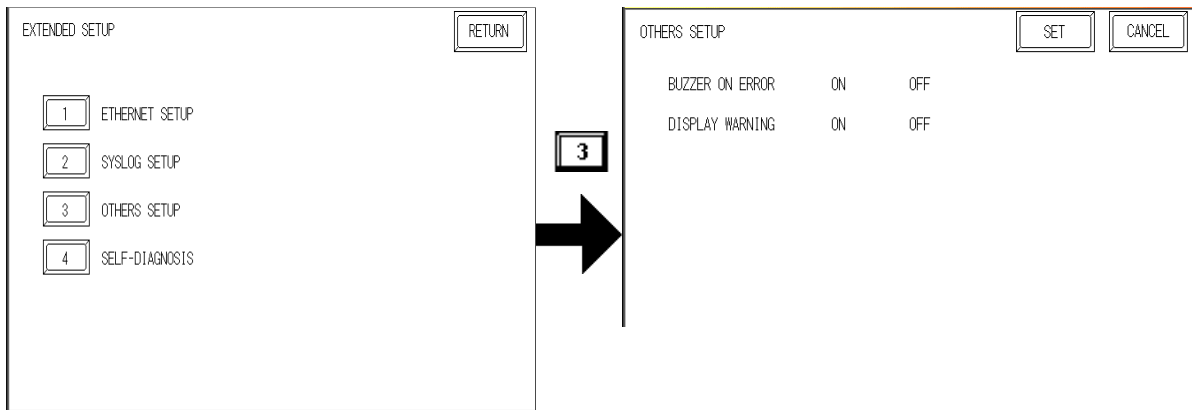

#### **BUZZER ON ERROR**

Enables/disables the buzzer sound output produced when an error related to the 2-Way driver operation occurs.

#### **DISPLAY WARNING**

Enables/disables the warning message display used when an error related to the 2-Way driver operation occurs.

### 6.5.7 SELF DIAGNOSIS

---

Runs the Self Diagnosis program for the Ethernet operation. The GP must be connected to the Ethernet network prior to running this program.

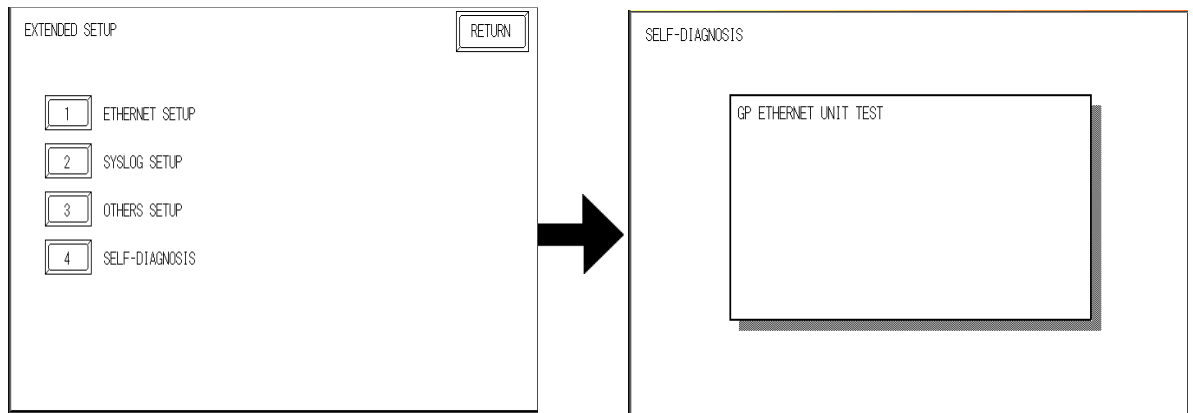

When there is no error detected, the message “OK” will appear. If an error is detected, the message “NG” will appear.

Be sure that this Self Diagnosis program is used only for the Ethernet operation. If you wish to run the general Self Diagnosis program, use [Main Menu]’s [Self Diagnosis] feature.

**▼Reference ▲ 7.3 Self Diagnosis**

# 6.6 INITIALIZE INTERNAL MEMORY

---

This section explains how to initialize the GP's internal data or a CF card inserted in the GP. Select one of the menu items, [INITIALIZE MEMORY], [INITIALIZE CF CARD] and [CSV DATA INDEX] selections in the [INITIALIZE MEMORY] menu.

## 6.6.1 INITIALIZE GP MEMORY

---

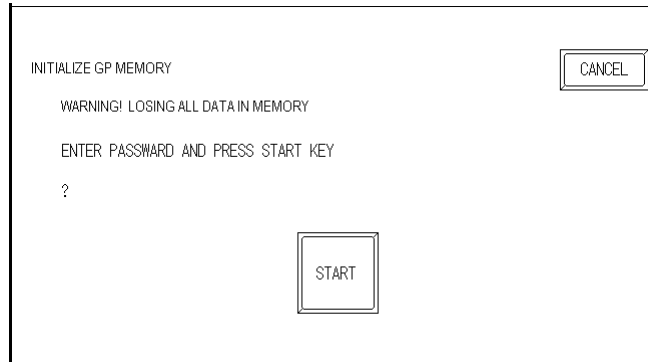

**Important**

- **You cannot cancel the Initialization procedure after pressing the Start key.**
- **All data in SRAM will be erased.**
- **Initialization does not erase the SYSTEM SET UP, the SIO protocol, or the internal clock settings.**

To initialize the GP internal memory, enter the common password **1101**, or the password entered in the SYSTEM SET UP screen.

**Reference** Chapter 5.3, "INITIALIZE-Standard Operation"



**Note:** The time required for Initialization is between 10 and 20 seconds.

## 6.6.2 INITIALIZE CF CARD

---

Deletes all data in the CF Card installed in the GP.



**Important**

**Initialization cannot be canceled once the START switch is touched.**

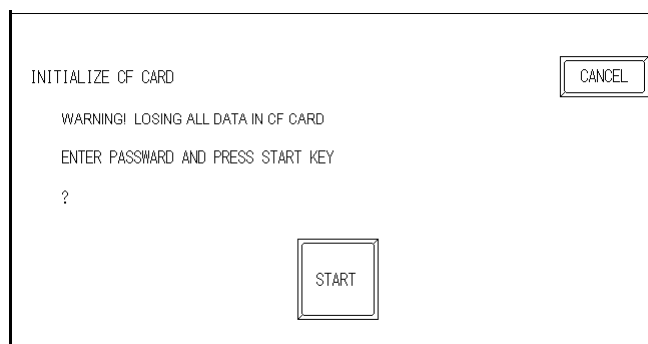

Initializes the CF Card. Enter the common password "1101" or the password you designated in the "SYSTEM SET UP" menu.

**Reference** For details about entering the password's numeric values, refer to 5.3 **INITIALIZATION**

### 6.6.3 CSV DATA INDEX

Specific data-transfer CSV files (ZR\*\*\*\*\*.CSV) on the CF Card can be transferred from the CF Card directly to the PLC (filing) or from the PLC directly to the CF Card (logging). For the details about the CSV Data Transfer Function, **Reference** *GP-PRO/PB III for Windows Tag Reference Manual*.

Here creates the index file of the CSV files that are saved into the CF card with the CSV data transfer function.

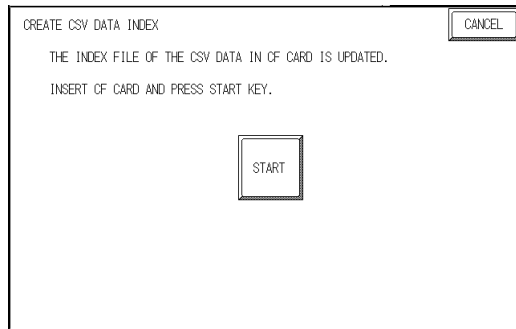

Touch the [START] key, then the operation to create the index file will start.



**Do not open the CF card cover during the operation to create the index file. The data may be damaged.**



**Too many number of CSV files may cause a time loss for creating the index file. It will take about 10 minutes for creating an index file of the 4,000 CSV files.**

If you touch the [CANCEL] key during the operation to create the index file, the operation will stop, then the following screen will appear.

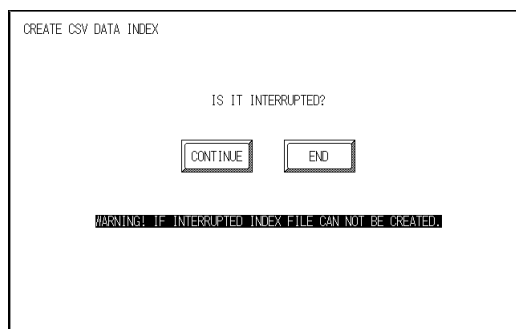

#### CONTINUE

The operation restarts. When the message "CREATED INDEX FILE. PLEASE PRESS END KEY" appears, finish the program.

#### END

Deletes the creating index file, then the [INITIALIZE MEMORY] screen will reappear.

### 6.7 SET UP TIME

---

```
SET UP TIME
PRESENT TIME  Y. M. D.  :
TIME SET UP  [ ]Y. [ ]M. [ ]D. [ ]: [ ]
```

Sets the GP's internal clock.

#### SET UP TIME

Enter date and time corrections to the date and time displayed in the PRESENT TIME.



**Note:**

The GP's internal clock has a slight error. At normal operating temperatures and conditions, with the GP operating from its lithium battery, the degree of error is 65 seconds per month. Variations in operating conditions and battery life can cause this error to vary from -350 to +90 seconds per month. For systems where this degree of error will be a problem, the user should be sure to monitor this error and make adjustments when required. "Hour" and "Minute" display on the screen but "Second" does not display.

## 6.8 SET UP SCREEN

This screen is used to enter the number for the initial screen displayed after powering up, the character size when in RUN mode, and other general screen items.

SET UP SCREEN		<input type="button" value="SET"/>		<input type="button" value="CANCEL"/>	
INITIAL SCREEN NO.	(1-8999)	[	B	]	
ALARM MESSAGE	V SIZE	1	2	4	
	H SIZE	1	2	4	
ONLINE ERROR DISPLAY		ON	OFF		
FONT SETTING		I-ASCII	JAPAN	KOREA	TAIWAN CHINA
KANJI FONT QUALITY		STANDARD	HIGH(1)	HIGH(1,2)	

### INITIAL SCREEN NO. (1-8999)

Set up the screen file number that will display first upon powering up. If the BIN option for DATA TYPE OF SCREEN NO in SYSTEM SET UP had been selected, enter a number from 1 to 8999. Or, if BCD was the option set up, then input a number from 1 to 1999.

### ALARM MESSAGE

Set up the character size of the ALARM MESSAGE when the Alarm Bulletin is activated.

<When using single-byte characters>

1	2	4
V size=1; H size=1 16×8 pixels	V size=2; H size=2 32×16 pixels	V size=4; H size=4 64×32 pixels

<When using double-byte characters>

V size=1; H size=1 16×16 pixels	V size=2; H size=2 32×32 pixels	V size=4; H size=4 64×64 pixels
------------------------------------	------------------------------------	------------------------------------

### ONLINE ERROR DISPLAY

Set up whether or not error messages display during RUN mode.

## Chapter 6 - Initializing the GP

### FONT SETTING

Selects the font type displayed on the GP screen during operation.

### KANJI FONT QUALITY

Designates the font display quality for enlarged characters.

#### ◆ When [FONT SETTING] is set to [JAPAN]

Single-byte characters will remain 8x16-dot characters when they are enlarged.

Double-byte characters are displayed as:

- |            |   |
|------------|---|
| [Standard] | Here, characters are displayed using 16x16-dot “blocks”. When enlarged, this font will remain a 16x16-dot character. (Compatible with GP-*30 series units.)   |
| [HIGH]     | When enlarged to double size, Level 1 JIS Kanji Code characters are displayed as 32x32-dot characters. Level 2 JIS Kanji Code characters remain 16x16-dot characters. (Compatible with GP-*50 series and GP-70 series units.) |
| [1,2]      | When enlarged to double size, both Level 1 and Level 2 JIS Kanji Code characters are displayed as 32x32-dot characters.   |

#### ◆ When [FONT SETTING] is set to any other type (i.e. CHINESE, I-ASCII, KOREA or TAIWAN)

- |             |  |
|-------------|--|
| [Standard]  | Half-size (single-byte) characters are displayed as 16x8-dot characters. Full-size characters, regardless of the display size used, will always be displayed as 16x16-dot characters. When enlarged, this font will stay as 16x16-dot character. (Compatible with GP-*30 Series units)   |
| [HIGH(1)]   | All half-size (single-byte) characters (ASCII code: 21h to 7Dh, i.e. alphanumeric characters) except “^” and “‘” will display as high quality characters. <ul style="list-style-type: none"><li>• 16x16-dot or larger characters will display as high quality 16x16 fonts.</li><li>• 32x32 or larger characters will display as high quality 32x32 fonts.</li></ul> Full-sized (double-byte) characters will display as 16x16-dot characters and remain 16x16-dot characters when enlarged.  |
| [HIGH(1,2)] | All single-byte characters (ASCII code: 21h to 7Dh, i.e. alphanumeric characters) except “^” and “‘” will display as high quality characters. <ul style="list-style-type: none"><li>• When 16x16 dots are used for a character, it will display as a high quality 16x16 character.</li><li>• When 32x32 or larger dots are used for a character, the character will display as a high quality 32x32-character.</li></ul> Full-sized (double-byte) characters (i.e. [KOREA], [TAIWANESE] and [CHINESE]) will display as 32x32-dot characters when enlarged to 32x32-dot or larger characters. |

# Chapter

## 7 RUN Mode and Errors

1. RUN Mode
2. SELF-DIAGNOSIS
3. Troubleshooting
4. Error Messages
5. Error Message Details

### 7.1 RUN Mode

There are two ways of entering the GP's RUN mode; immediately after plugging in the unit's power cord, or from the GP's OFFLINE mode.

#### 7.1.1 After Connecting the Power Cord

The method of GP startup will vary, depending on the "START TIME" setting in the "Initialization Settings" / "System Setup" area.

##### ■ When START TIME is set to "0"

When the GP's power cord is connected, the version information screen shown below will appear. Next, the screen designated by the initialization screen file number ("Initialization Settings" / "System Setup" area) will appear, and the GP will start to communicate with the PLC.

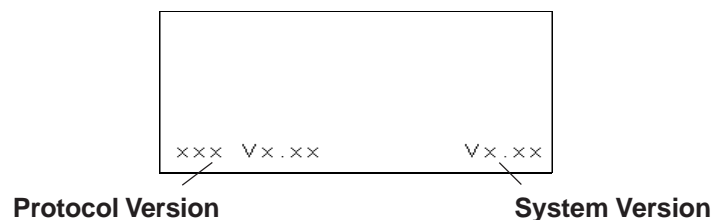

##### ■ When START TIME is set to any value other than "0"

In this case, when the GP's power cord is connected, the following version information screen will appear. In the top right corner of the screen, a value will appear and count down the number of seconds designated by the "START TIME" setting. Next, the screen designated by the initialization screen file number ("Initialization Settings" / "System Setup" area) will appear, and the GP will start to communicate with the PLC.

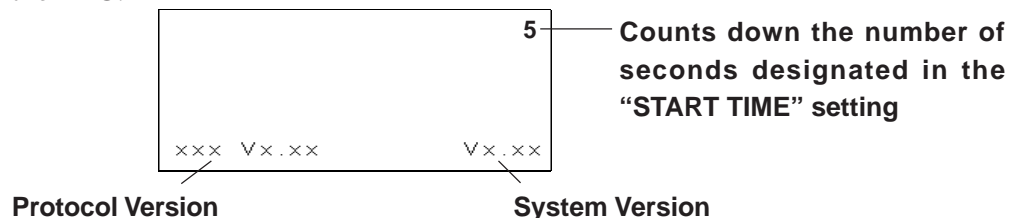

If the initialization screen's file number is not designated, or a number is designated that does not exist, the version information screen will remain.



**Note:** There is a possibility that the screens shown above may not display in the beginning depending on the display device's start-up time.



## Chapter 7 - RUN Mode and Errors

### 7.1.2 Via OFFLINE Mode

Touch the MAIN MENU's RUN selection to start your downloaded "project". The INITIALIZE area's SET UP SCREEN feature designates the first screen that appears in RUN mode, and, after this screen appears, communication with the PLC begins. If, however, the designated initial screen has not been created, or does not exist, the above display will remain.

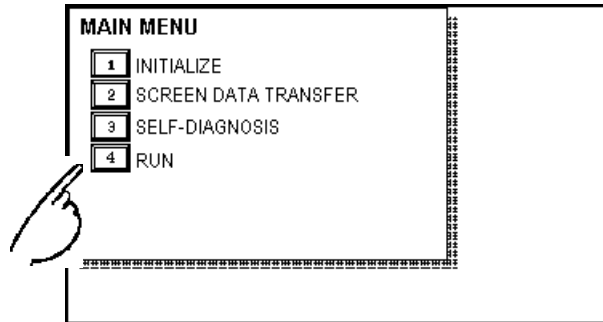

**Note:**

To enter OFFLINE Mode, simply touch the top left corner of the GP's screen within 10 seconds after connecting the GP's power cord.

E.g. After powering up the GP, the initial screen that appears is equipped with a built-in (invisible) switch in the top left corner. Touch this switch within 10 seconds to change the GP from RUN to OFFLINE mode.

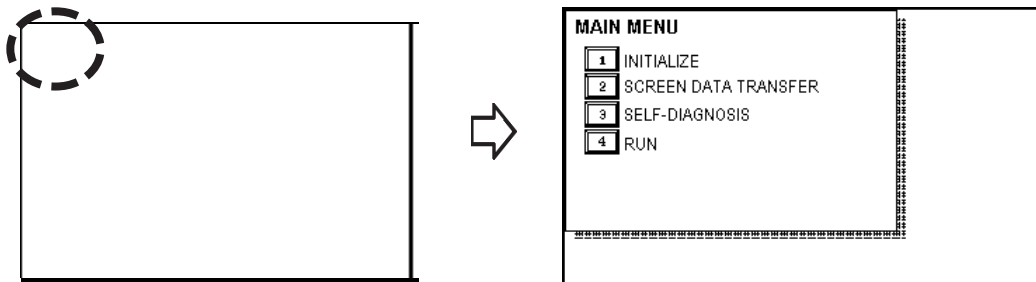

## 7.2 SELF-DIAGNOSIS

The GP unit is equipped with a number of self-Diagnosis features used to check its System and Interfaces for any problems.

### 7.2.1 SELF-DIAGNOSIS ITEM LIST

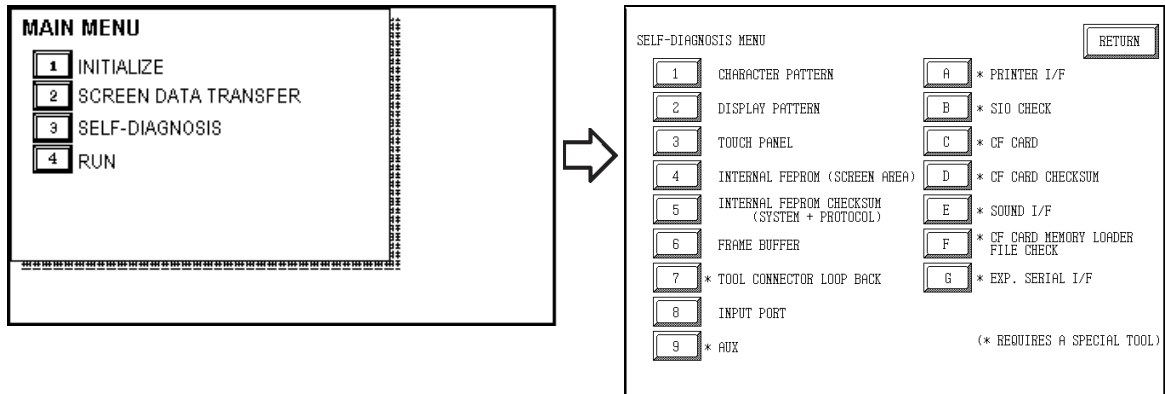

- 1 Checks the characters inside the internal Character ROM.
- 2 Checks all the figures and tiling patterns.
- 3 Checks each GP touch panel square.
- 4 Checks the internal hard disk contents (FEPRM).
- 5 Checks the System and Protocol of the GP Internal Memory (FEPRM).
- 6 Checks the internal display memory (Frame Buffer).
- 7 \*1Checks the Tool Connector control lines and send/receive lines.
- 8 Checks the Input Port. (for Digital's maintenance use only)
- 9 \*1Checks the AUX control line.
- A \*1Checks the printer interface.
- B \*1Checks the RS-232C and RS-422 send/receive lines.
- C \*1Checks the status of the CF Card.
- D \*1CF Card Checksum.
- E \*1Checks the status of the GP's Sound Output feature.
- F \*1Checks the status of the CF Card Memory Loader File.
- G \*1Checks the status of the Expansion Serial I/F.

\*1 This item requires that the user special equipment (cable, connector, etc.).

## Chapter 7 - RUN Mode and Errors

### 7.2.2 SELF-DIAGNOSIS - Details

---

This section explains the contents of SELF-DIAGNOSIS. For information on how to operate the Screen, **Reference** Chapter 5, "OFFLINE Mode"; for information about how to set up the Special Tools, **Reference** Chapter 3, "Installation and Wiring".

#### CHARACTER PATTERN

Checks each font's pattern and kanji-characters' ROM. Used when kanji-characters do not display. If there is no error, the message [OK] will appear, if there is an error, the message [NG] will appear.

#### DISPLAY PATTERN

Used when the buzzer will not sound and when the device contents will not display correctly to check the drawing function. It does this by running checks on the various screen pattern displays (8 screens), the ON/OFF Display, and KANJIROM CHECKSUM. When the ON/OFF Display is checked, the Buzzer ON/OFF check is run simultaneously. If KANJIROM CHECKSUM is normal, **OK** displays; if there is a problem, **NG** displays.

#### TOUCH PANEL

Touch Panel check. Checks if each touch cell highlights when pressed.

#### INTERNAL FEPROM (Display Area)



- ***If you run this check menu, all screen data that have been created will be deleted. Therefore, be sure to back up data prior to running this check.***
- ***When this check menu is completed, you need to initialize the internal memory (FEPROM).***

This menu is used for checking the internal FEPROM. Use this check menu when an error related to screen display occurred. When using this check menu, you need to enter the password <sup>\*1</sup>.

While checking, the screen display will change in the following order.

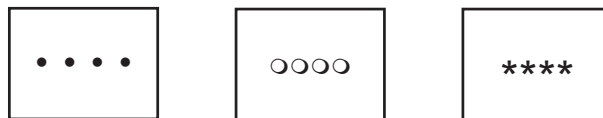

If there is no error, the message [OK] will appear, if there is an error, an error message will appear.

The number of the symbol marks (i.e. "OOOO", etc.) shown on the screen may vary depending on the GP type.

The symbol mark "O" indicates the GP is operating the erase checking.

The symbol mark "\*" indicates the GP is operating the R/W checking.

---

<sup>\*1</sup> Enter either the password you have designated in the "INITIALIZE" screen or the common password "1101".

## Chapter 7 - RUN Mode and Errors

### INTERNAL FEPROM CHECKSUM (System & Protocol)

The Internal FEPROM System and Protocol check searches for any problems that may arise during operations. When running the check, the screen will change as follows.

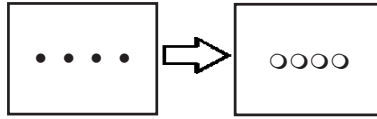

When the FEPROM is normal, **OK** displays; if there is a problem, the screen stops in the middle of operation. This check does not erase the System or Protocol.

### FRAME BUFFER

The Frame Buffer (display memory) Check looks for any display problems that may develop. When everything is normal, **OK** displays; when there is a problem, an error message displays.

### TOOL CONNECTOR

Use the Tool Connector Control line and Send/Receive line check when the GP cannot send and receive data from the PC. To run the check, connecting a *Tool Connector Check Loop Back Cable* (Dsub9 pin, pin-side) mounted to the *Downloading Cable* (provided in the software package) is necessary.

When everything is normal, **OK** displays; when there is a problem, an error message displays.

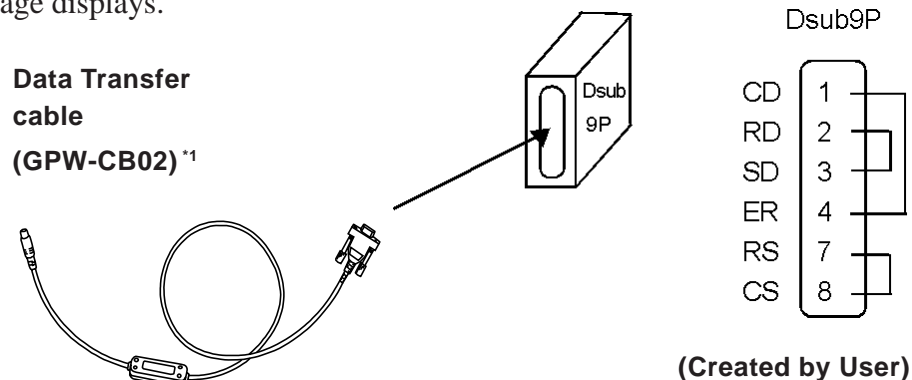

### INPUT PORT

Used for Digital's maintenance.

### AUX

Checks the AUX control line. Used when an inching output error or a monitor output error occurred. To enable this check menu, you need to connect the PLC input unit.

#### ▼ Reference ▲ 2.3.3 AUX I/O and Sound Output

This check uses the input unit's LED.

The LED turns ON in the following order.

- 1) RUN, ALARM, and then BUZZ.
- 2) When all LED turn ON, they start to turn OFF in the same order as they turned ON.
- 3) When all LED turn OFF, the check has been completed.

## Chapter 7 - RUN Mode and Errors

### PRINTER I/F

Checks the printer I/F. Used when the printer does not function properly. You need to connect the printer prior to using this checking menu.

Connecting the printer buffer may cause an error, therefore, connect the GP and the printer directly.

If there is no error, (ASCII Code: 20 to 7D<HEX> and A0 to DF<HEX>) will be output (printed) and the message [OK] will appear on the screen. If there is an error, an error message will appear.

### SIO CHECK

Checks the RS-232C and RS-422 SIO lines for areas where communication problems develop. In the menu, select which check to run. To run the check, connecting the SIO cable is necessary. If all is normal, **OK** displays; if there is a problem, an error message appears.

The SIO cable wiring is as shown below. (RS-232C, RS-422 common)

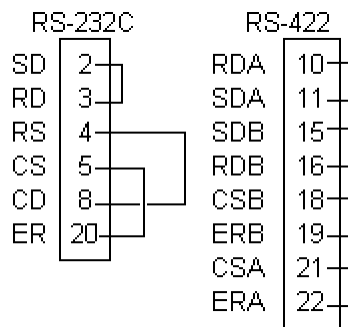

### CF CARD

Checks the CF Card's Read/Write. Prior to using this check menu, you need to insert the CF Card in the GP. The CF Card needs to have more than 1K bytes usable space. If there is no error, the message [OK] will appear. If there is an error, an error message will appear.

### CF CARD CHECKSUM

Takes the Checksum of the CF Card's files and operates the check. Prior to using this check menu, you need to insert the CF Card in the GP.

This check menu can check the following files.

- Filing Data
- CF Card's Image Data
- CF Card's Sound Data

When the check is finished, the following items will appear on the screen.

- The number of checked files
- The number of files that have an error
- The file name where the most recent error occurred

## Chapter 7 - RUN Mode and Errors

### SOUND I/F

Checks if Sound Output operates. Prior to using this check menu, connect the speaker to the GP. The first three notes of the musical scale (do, re,mi) will sound.

### CF CARD MEMORY LOADER FILE CHECK

Checks the CF Card's Memory Loader Tool when it does not start. If there is no error, the message [OK] will appear. If there is an error, the message [NG] will appear.

### EXPANSION SERIAL I/F

Checks the Send/Receive line of the Expansion Serial Interface when an abnormality occurs. To run the check, you must connect the SIO cable. If all is normal, the message [OK] appears. If there is a problem, an error message appears.

The SIO cable wiring is as shown below.

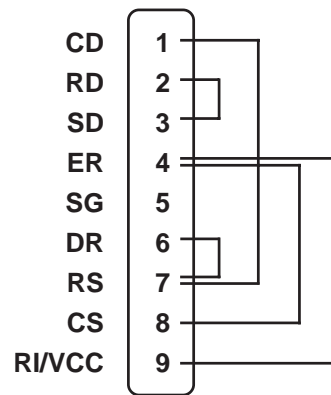

### 7.3 Troubleshooting

---

This section describes how to find and resolve problems that may occur on the GP. If there is a problem with the PLC, please refer to the corresponding PLC manual.

#### 7.3.1 Possible Types of Trouble

---

The following items are problems that may occur while using this unit.

**(A) No Display**

The screen will not display even when the unit is powered On. Also, during RUN mode, the screen disappears.

**(B) No GP/HOST Communication**

The GP unit cannot extract data from the host. An error message may appear on the screen as a result.

**▼Reference▲** *Chapter 7.4 "Error Messages"*

**(C) Touch Panel Does Not Respond**

The touch panel does not react when pressed, or the reaction time is very slow.

**(D) Buzzer Sounds when GP power is turned ON**

The GP goes to the OFFLINE mode unexpectedly while operating, or the GP automatically goes to the OFFLINE mode when the power is turned ON.

**(E) Clock Settings Cannot be Entered**

Even after clock settings are entered, the GP unit's clock settings remain eg.) 00/01/01.

**(F) OFFLINE displays During RUN Mode**

The GP's buzzer will sound intermittently after power is first turned ON.

For these first five problems, see the troubleshooting tables on the following pages.

For the last problem (F), a SYSTEM ERROR may have developed while displaying the OFFLINE mode screen.

**▼Reference▲** *Chapter 7.5 "Error Messages"*

Be sure that no object has touched the screen accidentally if the GP goes to the OFFLINE mode without displaying an error message when the power turned ON. If any object may have possibly touched the top left corner of the screen within 10 seconds after the power turned ON, that may cause the GP to go OFFLINE.

---

## 7.3.2 No Display

Follow the flowchart below when the screen does not display when powering up, or the screen turns OFF by itself during RUN mode, to find an appropriate solution.

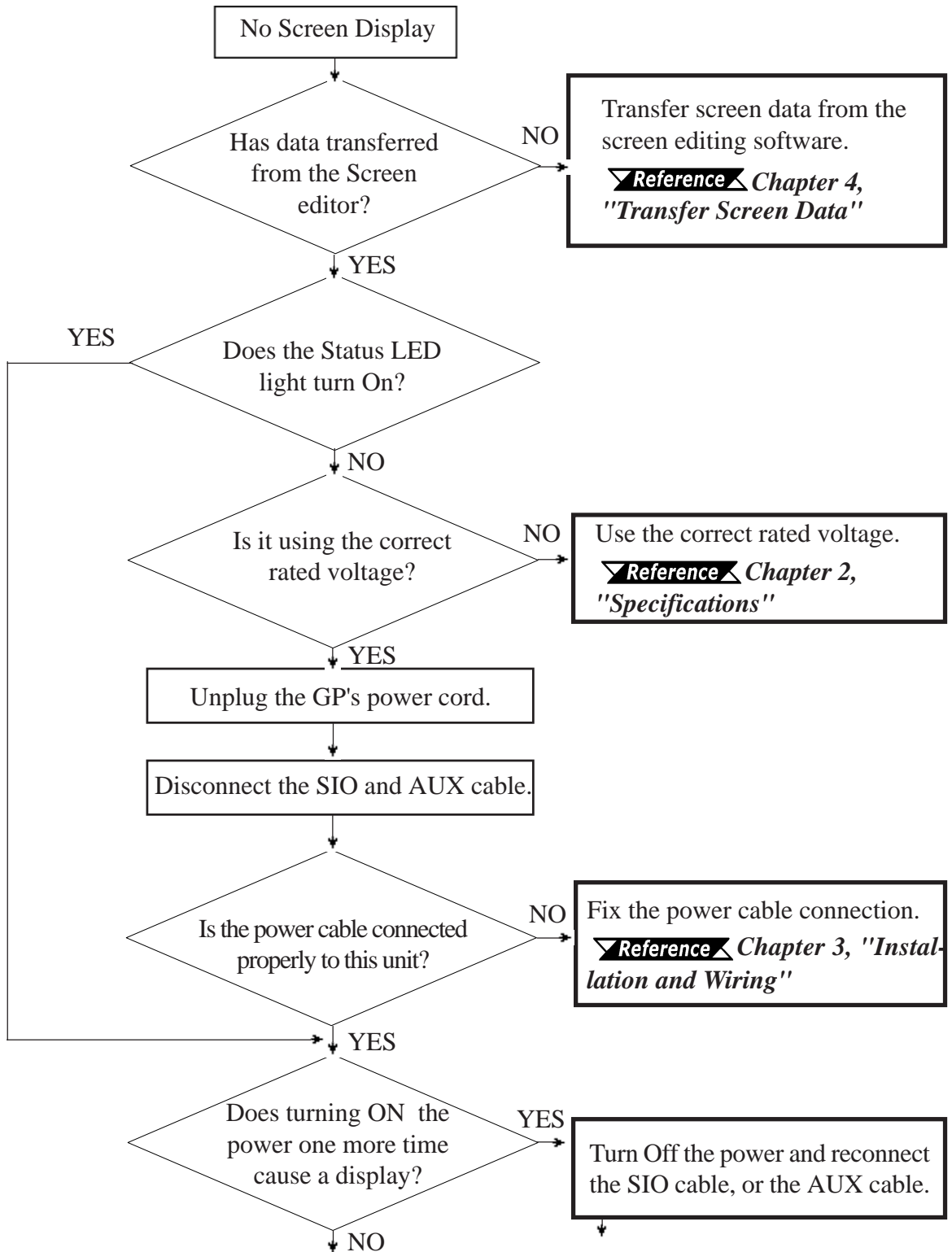



# Chapter 7 - RUN Mode and Errors

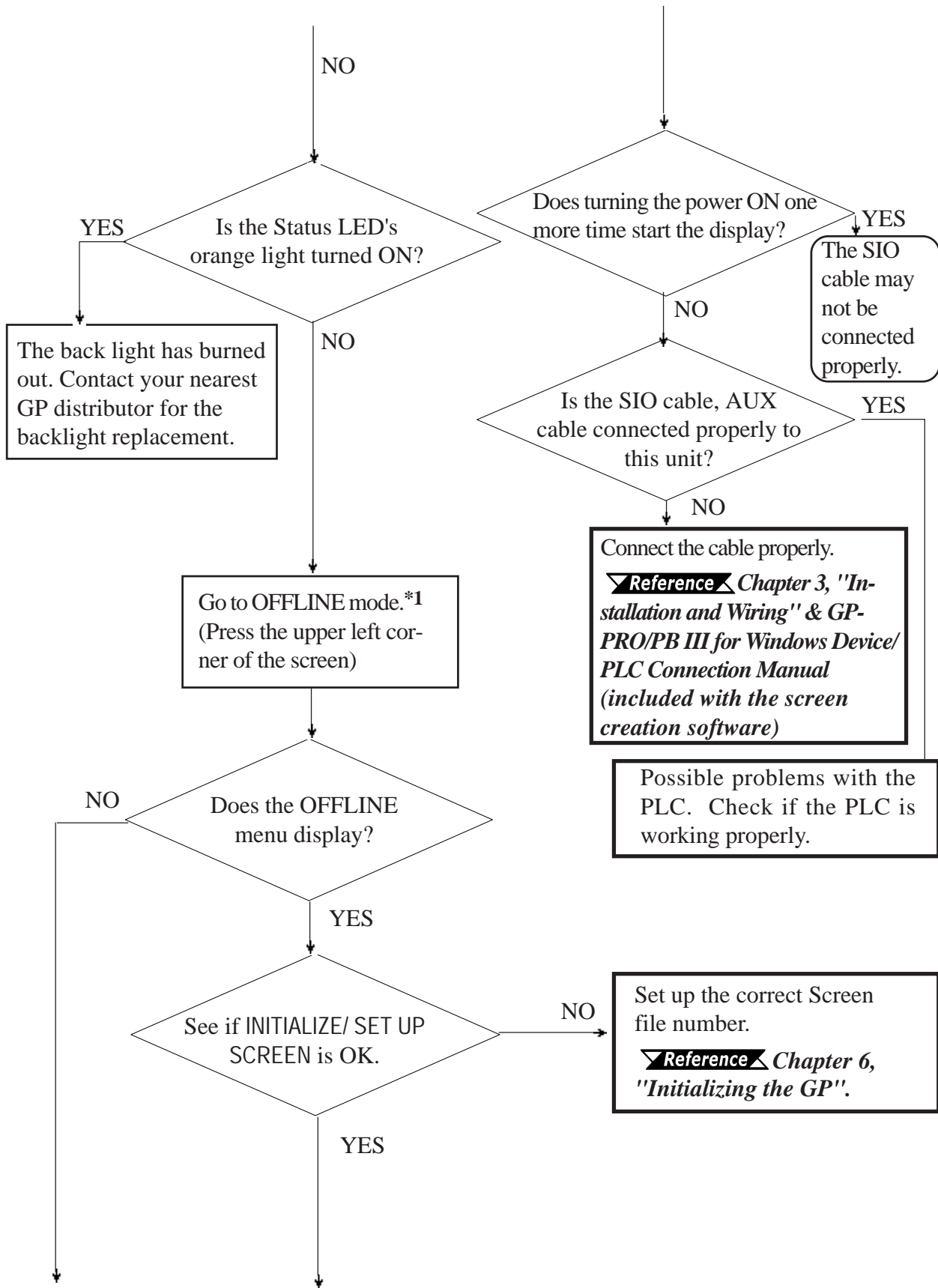

*\*1 To make the OFFLINE screen appear, turn the power OFF, then ON, and press the upper left corner of the screen within 10 seconds.*

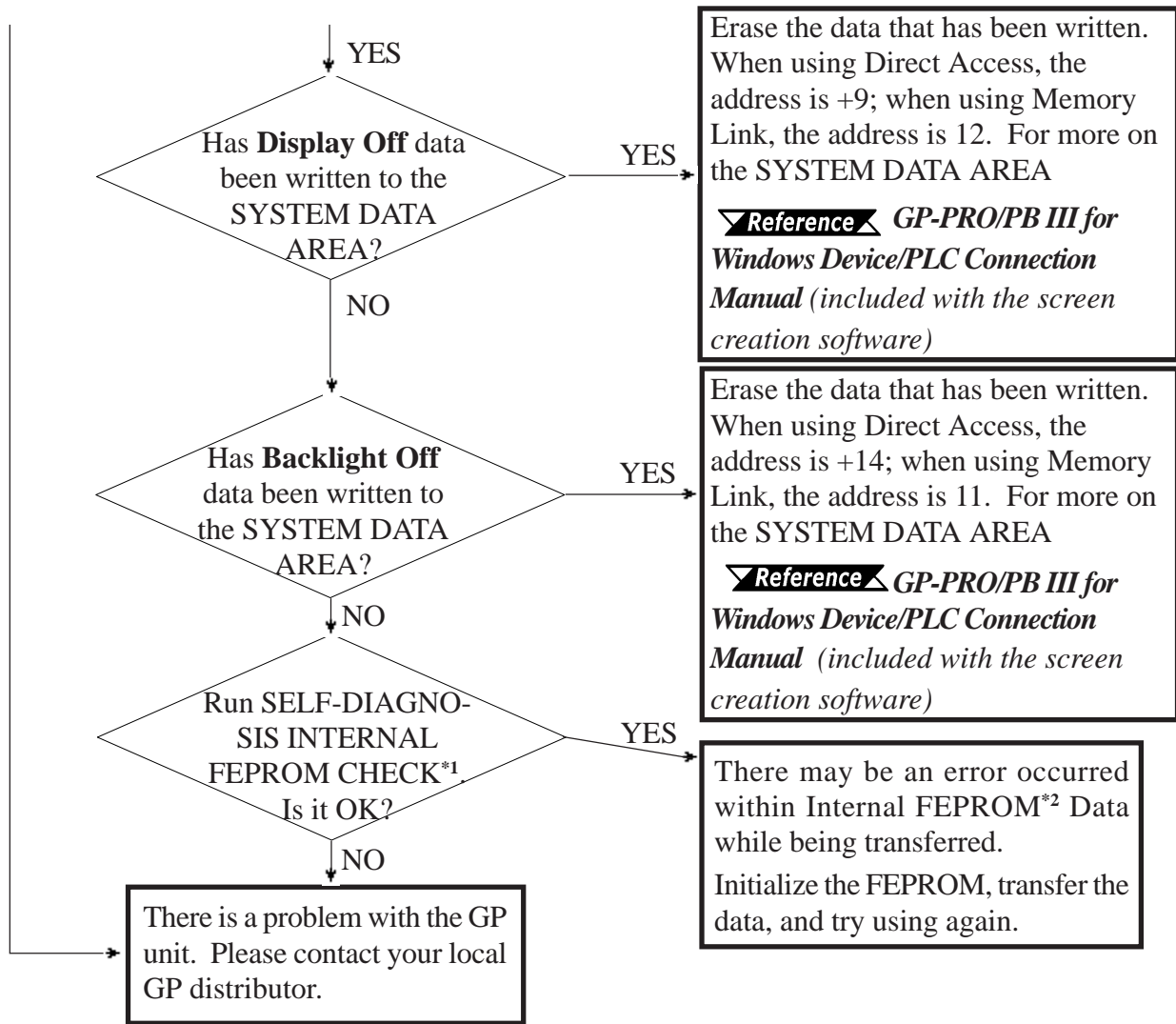

*\*1 When you run the SELF-DIAGNOSIS area's FEPRM CHECK , all screen data is erased. Therefore, be sure to make a backup of all GP screens prior to performing this check.*

*\*2 Also known as "FEPRM" (Flash Electronic Erasable Programmable Read Only Memory).*

# Chapter 7 - RUN Mode and Errors

## 7.3.3 No GP/Host Communication

When the GP will not communicate with the host PLC, follow the flowchart below to find both the cause of the problem and a suitable response.

Or, if an error message displays on the screen, check the error code (refer to the *Error Messages* section in this chapter) to find the appropriate solution.

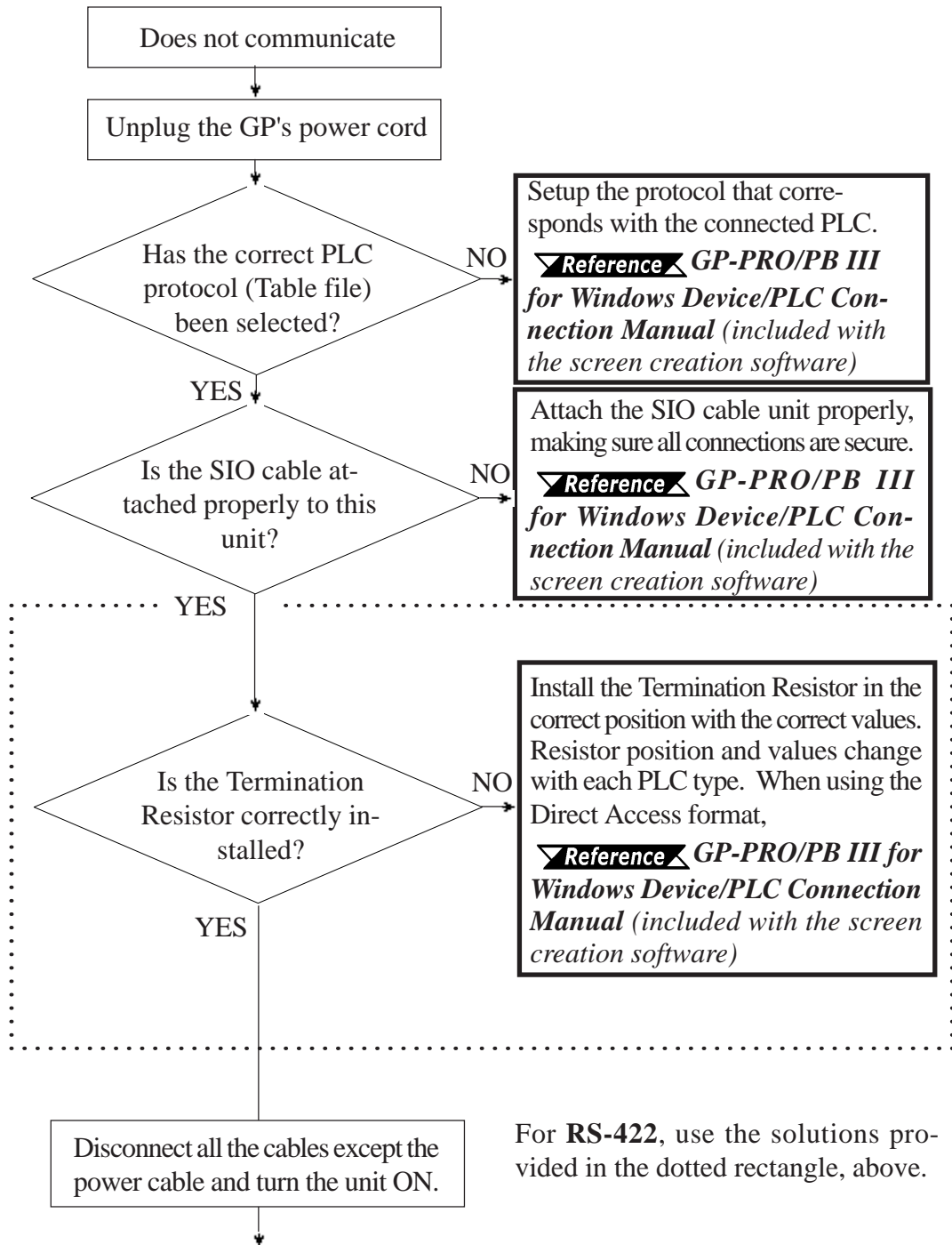

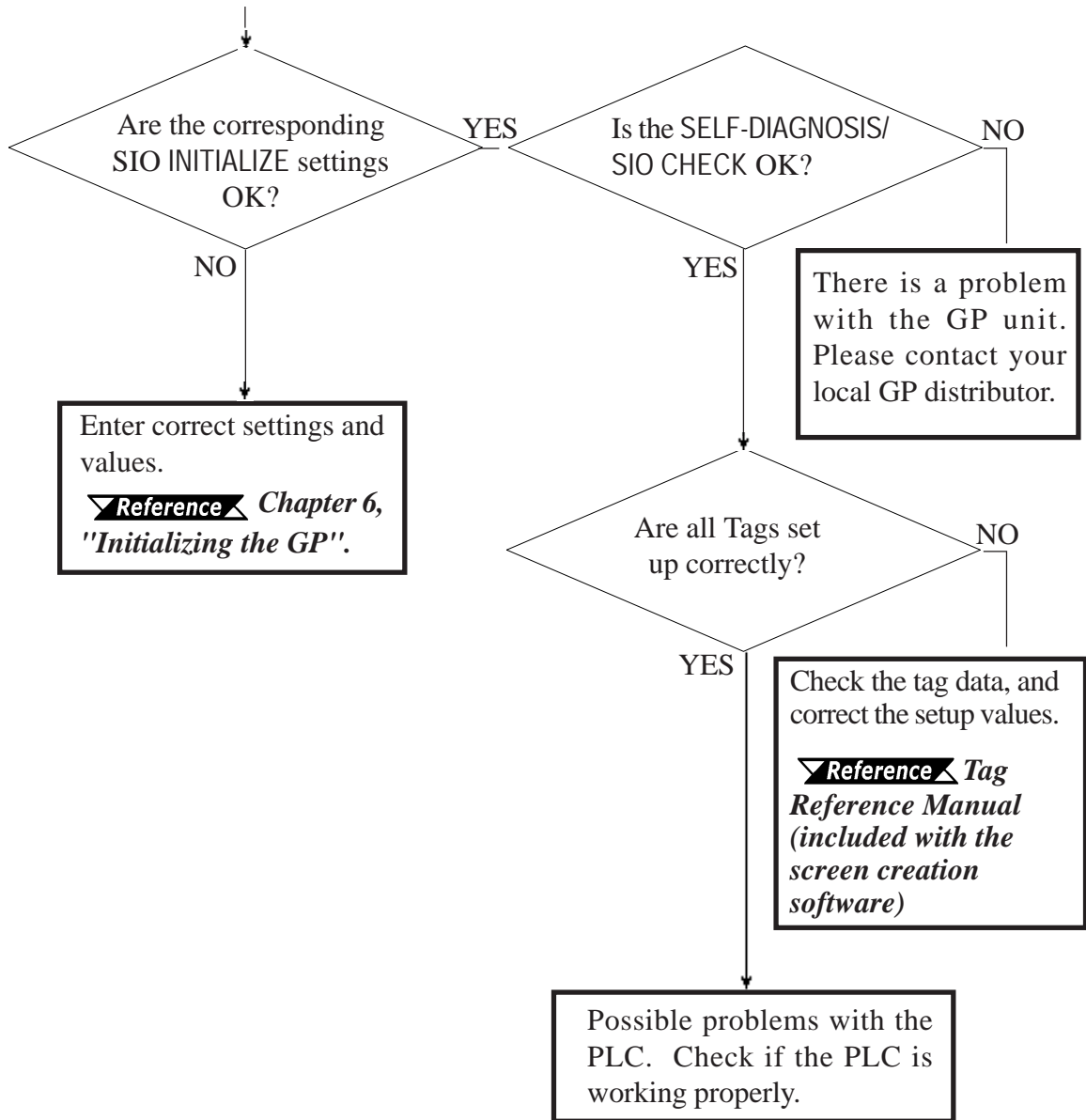

# Chapter 7 - RUN Mode and Errors

## 7.3.4 Touch Panel Does Not Respond

When the touch panel does not respond, or its response time is very slow after it is pressed, please use the flowchart below to find the origin of the problem, and the appropriate solution.

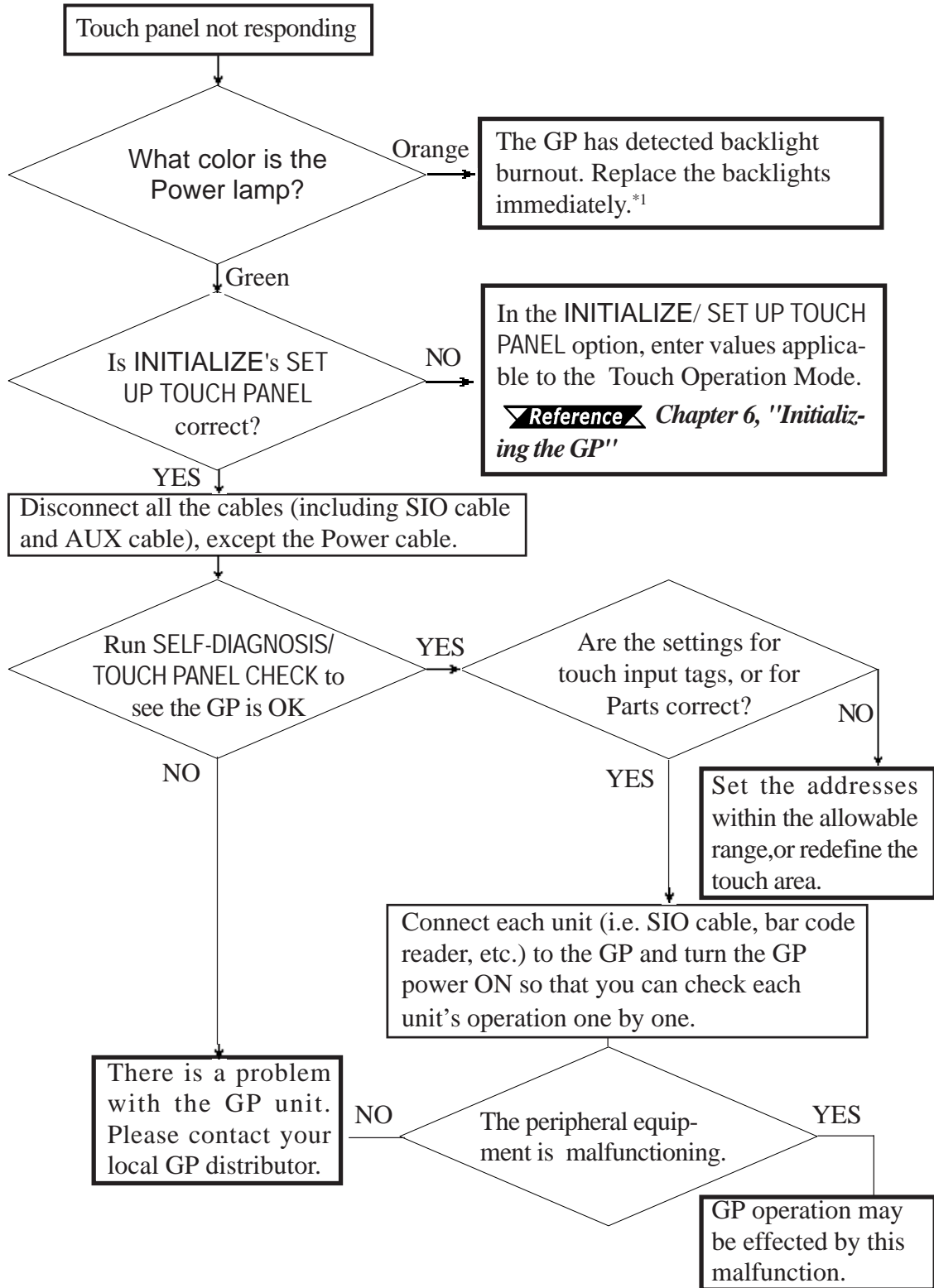

*\*1 If the screen is visible after backlight burnout is detected, only one of the two backlights is burnt out. In this case, touch-operations can be enabled by changing the initial settings (touch-operation mode settings) to enable touch-operations. However, it is recommended that the backlight be immediately replaced.*

**▼Reference▲ 6.4.3 SET UP TOUCH PANEL, 8.3 Replacing the Backlight**

### 7.3.5 Buzzer Sounds when GP power is turned ON

If you start the GP unit and the internal buzzer sounds, use the following chart to find the reason and the appropriate solution.

Buzzer Sound	Timing	Reason	Solution
Continuous beep (approx. 1 sec. intervals)	When power to the GP is turned ON	The GP's system program is destroyed.	Send the correct GP system program from the screen creation software to the GP, via the Transfer screen's "Forced Setup" feature.
			Turn on the GP's dip switch #1 (next to CF Card slot) and use the CF Memory Loader Tool to set up the GP.
Two beeps - Repeating (approx. 1 sec. intervals)	When power to the GP is turned ON	A different GP unit's system program has been accidentally installed in this GP.	Send the correct GP system program from the screen creation software to the GP, via the Transfer screen's "Forced Setup" feature. At this time an error will appear on the Screen Creation Software's screen, however, simply turn the GP's power supply OFF and then ON, and data transfer will automatically start.
			Turn on the GP's dip switch #1 (next to CF Card slot) and use the CF Memory Loader Tool to set up the GP.
Three beeps - Repeating (approx. 1 sec. intervals)	When the GP's dip switch #1 is turned on (next to CF Card slot) and power to the GP is turned ON.	The CF Card's Memory Loader Tool (MLD****.SYS) file is missing, or destroyed.	Reformat the CF Card and replace the CF Card's Memory Loader Tool file.
	When the GP is started via the Menu Bar's "CF BOOT" key.	The CF Card's Memory Loader Tool (MLD****.SYS) file is missing.	
Three beeps - Repeating (approx. 1 sec. intervals)	When the GP is started via the Menu Bar's "CF BOOT" key.	The CF Card's internal boot program (IPL.SYS) is destroyed.	Reformat the CF Card and replace the CF Card's Memory Loader Tool file.

If the CF Card's boot-up program (IPL.SYS) or the Memory Loader Tool (MLD\*\*\*\*.SYS) programs appear to be damaged or destroyed, use the GP's internal diagnostic program "CF Card Memory Loader File Check" utility to confirm the condition of these files.

**Reference** *7.2 Self Diagnosis*

## Chapter 7 - RUN Mode and Errors

### 7.3.6 Clock Settings Cannot be Entered

---

This problem occurs when the lithium backup battery's voltage, used for the internal clock, runs out. To enter the clock settings, please read the CLOCK SET UP ERROR directions.

▼**Reference**▲ 7.5.4 CLOCK SET UP ERROR

### 7.3.7 Error Screens

---

If the following error screen appears when you start the GP, it indicates an error has occurred and the GP is not set up correctly. Be sure to perform screen transfer (Force System Setup) again.



This unit's system data was not down loaded. Please download the system data again (Force System Setup)

## 7.4 Error Messages

This section explains the messages that appear when an error has occurred in the GP unit during RUN mode. The problem causing the error message and its related countermeasure are explained in the table below.

After a problem has been solved, unplug the GP's power cord and then reattach it.  
(Only the latest error message will appear on the GP screen)

### 7.4.1 Error Message List

Error Message	Problem	Countermeasure
<b>SYSTEM ERROR</b> (03 : **)	During screen data transfer, an unrecoverable error occurred.	 <b>Reference</b> 7.5 Error Message Details
<b>SYSTEM ERROR</b> (*** : *** : ***)	During screen data transfer, an unrecoverable error occurred.	 <b>Reference</b> 7.5 Error Message Details
<b>ILLEGAL ADDRESS IN SCREEN DATA</b>	Settings are used that overlap addresses.	Set the addresses correctly after checking the screen data.
<b>UNSUPPORTED TAG IN SCREEN DATA</b>	The GP currently in use does not support the desired Tag.	Set the Tag correctly after checking the screen data.
<b>PLC NOT CONNECTED</b> (02 : FF) and (02 : F7)	The communication cable is not connected correctly.	Re-connect the communication cable correctly.
<b>PLC NOT RESPONDING</b> (02 : FE)	PLC's power is not turned ON.	Turn ON the PLC's power.
	GP unit INITIALIZE settings (Setup I/O, PLC Setting) are incorrect.	Check the INITIALIZE settings and make any necessary corrections.
	The host and GP Powering up sequence was incorrect.	Turn ON the PLC's power and wait for 2-3 seconds, then turn ON the GP's power.
	The communication cable is not connected properly.	Check the communication cable and connect it correctly.
<b>RECEIVE DATA ERROR</b> (02 : FD)	The communication cable was disconnected while the GP was ON.	Turn the GP OFF and then ON again.
	The GP is powered OFF, then ON during communication with PLC.	Turn the GP OFF and then ON again.
	Noise occurred in the communication cable.	Check the communication cable and connect it correctly.
<b>GP STATION NO. DUPLICATION ERROR</b> (02 : F9)	This GP's station number is same as another GP.	Check all GP station numbers, and set them so they are all unique.
	PLC is powered OFF, then ON during communication with GP.	Turn the GP OFF and then ON again.



## Chapter 7 - RUN Mode and Errors

Error Message	Problem	Counter Measure
<b>NETWORK ADDRESS ERROR (02 : F8)</b>	The SIO address used for this GP is different from other GP's. (Only for the Multi-Link connection)	Check all GP's SIO address settings, and correct any that are incorrect.
<b>PLC COM. ERROR (02 : **)</b>	Specific PLC related error, or an error has occurred with the PLC.	<b>▼ Reference ▲</b> 7.5 Error Message Details
<b>SCREEN MEMORY DATA IS CORRUPT (nnnn:mmmm)</b>	ScreenData is corrupted: *nnnn indicates the Screen Number that has an error. *mmmm indicates the number of screens that have errors.(Decimal)	Check the screens that have errors, correct all errors, and then transfer the screen data again.
<b>CLOCK SETUP ERROR*<sup>1</sup></b>	The backup battery for the internal clock is running low.	<b>▼ Reference ▲</b> 7.5 Error Message Details
<b>SCREEN TRANSFER ERROR</b>	An error occurred in the data transmission from the screen editor to the GPpanel.	Re-transfer the screen data.
<b>SCREEN TAG LIMIT EXCEEDED</b>	T tags are setup beyond the tag limit (max. of 385.)	<b>▼ Reference ▲</b> 7.5 Error Message Details
<b>OBJ. PLC HAS NOT BEEN SETUP (**)</b>	The host PLC set up in the Editor program does not match the PLC in use.	<b>▼ Reference ▲</b> 7.5 Error Message Details
<b>CF CARD RECOGNITION ERROR</b>	The CF Card is not a GP compatible type.	Use Pro-face's optional CF Card.
	The timing of the CF Card's insertion was incorrect, and the GP unit cannot recognize it.	Reinsert the CF Card, or turn the GP ON/OFF with the CF Card inserted.
<b>D-SCRIPT ERROR (***)</b>	D-Script settings (data) are incorrect.	<b>▼ Reference ▲</b> 7.5 Error Message Details
<b>GLOBAL D-SCRIPT ERROR (***)</b>	Global D-Script settings (data) are incorrect.	<b>▼ Reference ▲</b> 7.5 Error Message Details
<b>EXTENDED SIO SCRIPT ERROR (***)</b>	Extended SIO script settings (data) are incorrect.	<b>▼ Reference ▲</b> 7.5 Error Message Details
<b>SERIAL I/F CHANGE ERROR</b>	The GP currently in use does not support the "Serial I/F Switch" feature, however in the GP screen editor, "Yes" has been specified for the switch.	<b>▼ Reference ▲</b> 7.5 Error Message Details

## 7.5 Error Message Details

### 7.5.1 SYSTEM ERRORS

Indicates a fault in the basic operations of the GP.

Following the error message, an error code, as shown below, will appear. Report the error number and details on how the error developed to your local GP distributor.

#### ■ SYSTEM ERROR ( 03 : x x )

An unrecoverable error occurred during screen data transfer.

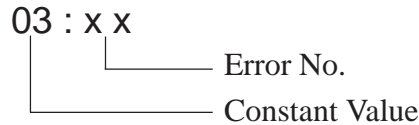

#### ■ SYSTEM ERROR ( x x x : x x x : x x x )

An unrecoverable error occurred during screen data transfer.

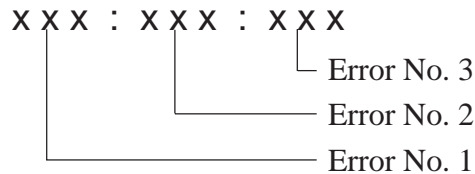

#### Possible Solutions

- Check if the GP's Power Cord and the Input signal line have been wired separately from each other.
- Check that the FG line has been grounded correctly, according to your country's standards.
- Re-send the screen data from the PC to the GP.
- If other types of communication errors, such as [RECIEVE DATA ERROR], [PLC COM. ERROR], have also occurred, try to correct those problems also.

**Reference** 7.4.1 Error Message List

If the above mentioned methods do not solve the problem, please contact your local GP distributor.

## Chapter 7 - RUN Mode and Errors

### ■ When the GP changes to OFFLINE mode during RUN mode

When the GP changes to OFFLINE mode without the user first pressing the screen, there is a possibility that the screen data has been damaged. In this case, after the SYSTEM ERROR displays, the screen automatically reverts to OFFLINE mode after about 10 seconds. Run the INITIALIZE MEMORY command and transfer the GP screen data again from your PC.

In most cases, system errors are related to the problems mentioned below.

### ■ Factors that may cause System Errors

#### Environment Related Problems

If an error occurs which has no apparent connection to the GP's current operation, the error may be due to the condition of GP's operating environment. This can include noise or electrostatic interference in the power code or the communication line. In this case you need to check if the power code and the communication line wiring and FG grounding are correct.

#### Screen Data or Project Data Related Problems

If an error seems to be caused by a particular GP operation, the error may be related to the screen or project data transferred to the GP. In this case, try sending screen data via the FORCE SYSTEM SETUP feature, which will transfer both the screen data and the project data to the GP.

**Reference** For details about the FORCE SYSTEM SETUP feature, refer to **GP-PRO/PBIII for Windows Operation Manual, Transfer Settings section.**

#### GP Unit Related Problems

If disconnecting and then re-connecting the power code corrects an error, the problem may not be related to the GP unit itself. However, to identify if the GP unit has any problems, run the OFFLINE mode's SELF-DIAGNOSIS program.

#### Peripheral Equipment Related Problems

##### (When the GP is equipped with a printer I/F)

If an error occurs only during printout, there may be a problem with the printer. Check the printer cable wiring and the FG line as well as the printer itself.

#### When a communication error occurs continuously

##### (When using the Direct Access method)

If a communication error occurs continuously, the GP may define the error as a system error. In this case you need to solve the problem causing the original communication error.

## 7.5.2 ILLEGAL ADDRESS IN SCREEN DATA

Caused by an overlap of addresses.

After the error message, error codes, as listed below will appear. If the error cannot be fixed, please report the error code and details on how the error developed to your local GP distributor.

ILLEGAL ADDRESS IN SCREEN AREA (00B:XXX:XXX)

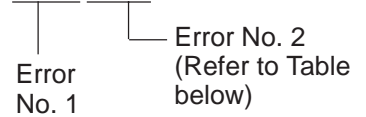

### ■ Overlapping Addresses

Error 1	Error 2	Meaning
0C1	191	All or part of the T-tag <sup>*1</sup> or S-tag address range overlap the addresses of System Data Area.
	192	
	193	
0C2	194	All or part of the System Data Area address, A-tag, or S-tag address range overlap the addresses setup in a T-tag. <sup>*1</sup>
	195	
	196	
0C3	197	All or part of a T-tag <sup>*1</sup> , S-tag or K-tag address range overlap the address range set in an A-tag (Alarm Message.)
	198	
	199	
0C9	19B	All or part of a T-tag <sup>*1</sup> , S-tag or K-tag address range overlap the address range set in an A-tag (Log alarm.)

<sup>\*1</sup> For details about the T-tag (trend graph) and A-tag (alarm messages),

**Reference** *GP-PRO/PBIII for Windows Tag Reference Manual (included with the screen creation software)*



**Note:** Overlapping addresses, other than the ones mentioned above, can also cause the Illegal Address message.

E.g. When the starting address of the System Data Area is set to 100, and the tag below is setup:

Tag Name/ Part ID No.	Word Address	Tag Format
N1	99	BCD32

Starting from addresses 99, two(2) words are used, which causes it to overlap address 100.

## Chapter 7 - RUN Mode and Errors

### 7.5.3 PLC COM. ERROR

Appears when the address setup for tags exceeds the address range used in the host (PLC.) Check the Error Number that appears and use the following table to solve the problem.

#### PLC COM. ERROR ( 02 : x x )

└─ Error code (see the table below)

└─ Constant Value

Error #	Problem	Countermeasure
FC	The communication settings for this unit and the host do not match.	For Memory Link type, check the data or settings the host sends. For the PLC communication, check the communication speed.
FB	The address set on a tag, the address used for storing data for Trend graph, or the address set by an alarm message is out of a set range. * Memory to Memory Link type. * Siemen's PLC Series.	* When using Memory Link type: Set the addresses within the set range of the System Data Area (0 to 2047), and re-send correct data. * When using a Toyoda Machine Works PLC: Set the addresses within the set range of the devices. * When using a Yaskawa PLC: Set the addresses within the set range of the devices.
FA	Address range error	Set the addresses within the allowable range.
53	When using a Matsushita Electronics PLC, and there are too many screen tags, the PLC will not receive data.	Decrease the number of tags on the screen.
51	The tag addresses, Trend graph data storage address, Alarm message Registry address, do not exist in the PLC's internal memory.	* When using a Fuji Electric PLC: Setup the addresses in a device range that exists.
Others	The Error code for each PLC can be found in the table on the last page of this chapter. Then, look up the Error Number in the indicated PLC manual. Or, report the Error Number to the PLC manufacturer.	



**Note:** In Hitachi's HIDIC H (HIZAC H) Series, the error code is divided into 2 bytes, whereas the GP Error Number is composed of 1 byte codes.

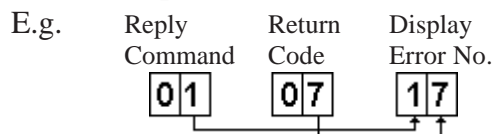

When the Display Error Number is 8\*, or 5\*, use only the left column as the error number.



- In Toshiba's PROSEC T Series, the Error Code is 4 characters long; on the GP, Error Numbers are changed to and displayed in Hexadecimal.
- With the Allen-Bradley PLC-5 and SLC-500 Series, the EXT/STS error codes have been re-mapped to start at D0 HEX, so they will not conflict with other error codes. When looking up the error number in the PLC manual, subtract D0 h from the GP error code to find its error value.

E.g.	<b>GP Error Code</b>		<b>PLC Error Code</b>
	D1	—>	01
	EA	—>	1A

### 7.5.4 CLOCK SET UP ERROR

---

This message displays when the lithium backup battery's voltage for the internal clock runs low. To reset the error, you need to turn the GP's power OFF and then ON again. Leave the GP ON continuously and the battery's charge will become sufficient for backup after 24 hours, and will be fully charged in approximately 96 hours. If the battery is incorrectly replaced, the battery may explode. To avoid the danger, please do not replace the battery yourself. When the battery needs a replacement, please consult with your local GP distributor.

After changing the backup battery, set up the internal clock.

**Reference** *Chapter 6 - Initializing the GP*

The lifetime of the backup battery depends on the ambient temperature and the amount of current being charged and used. The table below gives a general indication of how long the battery will last.

<b>Battery Temperature</b>	40°C or lower	50°C or lower	60°C or lower
<b>Expected Lifetime</b>	10 years or longer	4.1 years or longer	1.5 years or longer

### 7.5.5 SCREEN TAG LIMIT EXCEEDED (max. of 384)

---

When tags are setup beyond the tag limit, all tags in excess of number 384 will be disabled. Plus, when tags involve registered Windows and loaded screens, they are disabled in this order: Window Registry, Load Screen.

1. Disabled registered windows start from the last screen used.
2. Disabled loaded screens start from the last screen used.

To correct this problem, reduce the number of tags to within the allowed limit.

### 7.5.6 OBJ. PLC HAS NOT BEEN SETUP

---

The host PLC setup in the Editor program (i.e. the .prw file) does not match the PLC in use. Use the Error Code that follows the error message to select the proper PLC type and correct the GP's INITIALIZE setup data so that it matches this.

OBJ. PLC HAS NOT BEEN SETUP ( x x )

|  
The PLC number (*Hexadecimal*)  
written to the GP's System File

## Chapter 7 - RUN Mode and Errors

### 7.5.7 D-Script and Global D-Script Errors

---

The following error messages are displayed when D-Scripts and Global D-Scripts are not correctly set up. The GP-2400/2500/2600 Series unit displays the error message at the bottom of the GP screen.

	Error Message
D-Script	D-Script Error (***)
Global D-Script	Global D-Script Error (***)

The following table lists the numbers assigned to (\*\*\*) in the above error messages. Error Nos. "001" and "002" are displayed at power-on, and Error Nos. "003" and "004" are displayed when an error occurs during the script processing.

No.	Description	Type Script
001	The total number of Global D-Scripts exceeds the limit. The maximum number of Global D-Scripts is 32. Note that functions are included in the counts.	Global D-Script
002	The total of all devices in the Global D-Script exceeds the limit of 255 devices.	Global D-Script
003	Either the function being called does not exist, or that function has caused an error.	D-Script Global D-Script
004	Function cannot be nested more than 10 levels.	D-Script Global D-Script

### 7.5.8 Extended SIO Script Error

The following error message is displayed when an Extended SIO Script is not correctly set up. The GP-2400/2500/2600 Series unit displays the error message at the bottom of the GP screen.

	Error Message
Extended SIO Script	EXTENDED SIO SCRIPT ERROR (***)

The following table lists the numbers assigned to (\*\*\*) in the above error message. Error No. 001 is displayed at power-on, and Error Nos. 003 and 004 are displayed when an error occurs during the script processing.

No.	Description
001	The total number of the Functions of Extended SIO Scripts exceeds the limit. The maximum number of Extended SIO Scripts is 254.
002	Reserved
003	The function that is being called does not exist.
004	Functions cannot be nested more than 10 levels.
005	An old Extended SIO Script protocol is being used for the GP system. Extended SIO Script cannot be run when this error occurs. Be sure to install and run a new Extended SIO protocol (Version 1.12 or later).
006	An incompatible function was found in the screen data's Extended SIO Script. Be sure to install and run a new GP system.

### 7.5.9 Serial I/F Change Error

The following error message is displayed when the GP currently in use does not support the "Serial I/F Switch" feature, however in the GP screen editor, "Yes" has been specified for the switch. GP-2400/2500/2600 Series units display the error message at the bottom of the screen.

	Error Message
Serial I/F Change	SERIAL I/F CHANGE ERROR (***)

The following table shows the unit revision codes that correspond to the "Serial I/F Switch" function.

Built-in Standard	Product Name	Unit	Corresponding Revision
Serial Interface (Dsub25 Pin)	GP-2400T	GP2400-TC41-24V	Rev.H and later
	GP-2500L	GP2500-LG41-24V	Rev.B and later
	GP-2500S	GP2500-SC41-24V	Rev.A and later
Expansion Serial Interface (Dsub 9 Pin)	GP-2500T	GP2500-TC11	Rev.G and later
		GP2500-TC41-24V	Rev.C and later
	GP-2600T	GP2600-TC11	Rev.F and later
		GP2600-TC41-24V	Rev.C and later



# *Memo*

# Chapter

# 8 Maintenance

1. Regular Cleaning
2. Periodic Check Points
3. Changing the Backlight

## 8.1 Regular Cleaning

---

### 8.1.1 Cleaning the Display

---

When the surface or the frame of the display gets dirty, soak a soft cloth in water with a neutral detergent, wring the cloth tightly, and wipe the display.



- Do not use paint thinner, organic solvents, or a strong acid compound to clean the unit.
- Do not use hard or pointed objects to operate the touch-screen panel, since it can damage the panel surface.

### 8.1.2 Installation Gasket Check/Replacement

---

The installation gasket protects the GP and improves its water resistance. For instructions on installing the GP's gasket, refer to

**Reference** *Chapter 3 "Installation and Wiring"*



***A gasket which has been used for a long period of time may have scratches or dirt on it, and could have lost much of its water resistance. Be sure to change the gasket at least once a year, or when scratches or dirt become visible.***

#### ■ Installation Gasket Attachment Procedure (all units)

1) Place the GP on a flat, level surface facing the display face downwards.

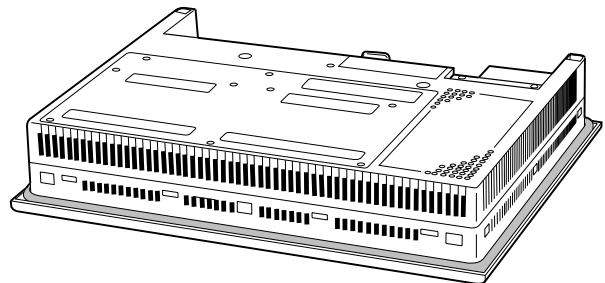

2) Remove the gasket from the GP.

## Chapter 8 - Maintenance

- 3) Attach the new gasket to the GP.  
Be sure to insert the gasket into the GP's groove so that the gasket's groove sides are vertical.

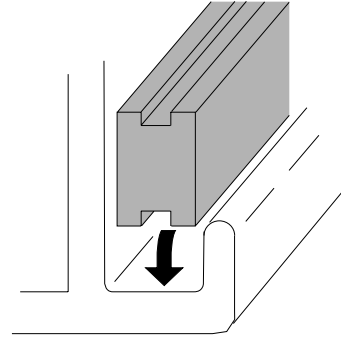

- 4) Check if the gasket is attached to the GP correctly.



- ***The gasket must be inserted correctly into the groove for the GP's moisture resistance to be equivalent to IP65f.***
- ***The upper surface of the gasket should protrude approximately 2mm out from the groove. Be sure to check that the gasket is correctly inserted before installing the GP into a panel.***

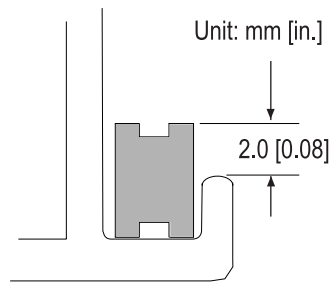

## 8.2 Periodic Check Points

---

To keep your GP unit in its best condition, please inspect the following points periodically.

### GP Operation Environment

- Is the operating temperature within the allowable range (0°C to 50°C )?
- Is the operating humidity within the specified range (10%RH to 90%RH, dry bulb temperature of 39°C or less)?
- Is the operating atmosphere free of corrosive gasses?

### Electrical Specifications

- Is the input voltage appropriate?  
GP2500-TC11, GP2600-TC11: AC85V to AC132V or AC85 to AC265V \*1  
GP2400-TC41-24V, GP2500-LG41-24V, GP2500-SC41-24V, GP2500-TC41-24V,  
GP2600-TC41-24V: DC19.2V to DC28.8V

### Related Items

- Are all power cords and cables connected properly? Have any become loose?
- Are all mounting brackets holding the unit securely?
- Are there many scratches or traces of dirt on the installation gasket?

---

*\*1 All GP units marked Revision "3" conform to the specifications.*

**▼Reference▲** For more information on how to determine the revision version, see "Revision Version" (page 15).

### 8.3 Replacing the Backlight

---

When the unit's backlight burns out, the unit's status LED will turn orange. If the OFFLINE menu's "USE TOUCHPANEL AFTER BACKLIGHT BURNS OUT" feature is set to "NO", the GP's touch panel will be disabled. \*1

**Reference** 6.4.3 SET UP TOUCH PANEL

GP2000 Series units use a CFL, long-life type backlight. The actual life of the backlight however, will vary depending on the GP's operating conditions, and replacement may be required. A GP2000 Series backlight has a life of 50,000 hours (approx. 5.7 years, at 25°C and 24 hour operation), when the backlight is lit continuously (time required for brightness to fall to half its normal level.)



## WARNINGS

- **To prevent an electric shock, be sure the GP's power cord is unplugged from the power outlet prior to replacing the backlight.**
- **When the power has just been turned OFF, the unit and backlight are still very hot. Be sure to use gloves to prevent burns.**
- **The backlight is very fragile. Do not touch the glass tube directly or try to remove its power cord. If the glass tube breaks you may be injured.**

---

\*1 If "NO" has been selected for the OFFLINE menu's "FORCE RESET" feature, Touch-Panel operation is disabled.

**Reference** 6.4.3 SET UP TOUCH PANEL

---



**Note:** Use the following table to check that you have ordered the correct backlight.

GP Model	Rev.	Backlight Model
GP-2400T Series	-	PS400-BU00-MS
GP-2500T Series	-	GP577RT-BL00-MS
GP2600-TC11	Rev.4 is marked. <sup>*1</sup>	CA3-BLU12-01
GP2600-TC41-24V	Rev.3 is marked. <sup>*1</sup>	
GP2600-TC11	Rev.4 is not marked. <sup>*1</sup>	PS600-BU00
GP2600-TC41-24V	Rev.3 is not marked. <sup>*1</sup>	



**The GP2500L's backlights cannot be replaced by the customer.**

**When the backlights need to be replaced, please contact your local GP distributor.**

For backlight replacement details of PS400-BU00-MS, PS600-BU00, GP577RT-BL00-MS, refer to the replacement backlight unit's installation guide.

---

<sup>\*1</sup> The corresponding backlight unit differs depending on GP-2600 Series unit's marked Revision.

**Reference** For more information on how to determine the revision version, see "Revision Version" (page 15).

### 8.3.1 Replacing CA3-BLU12-01

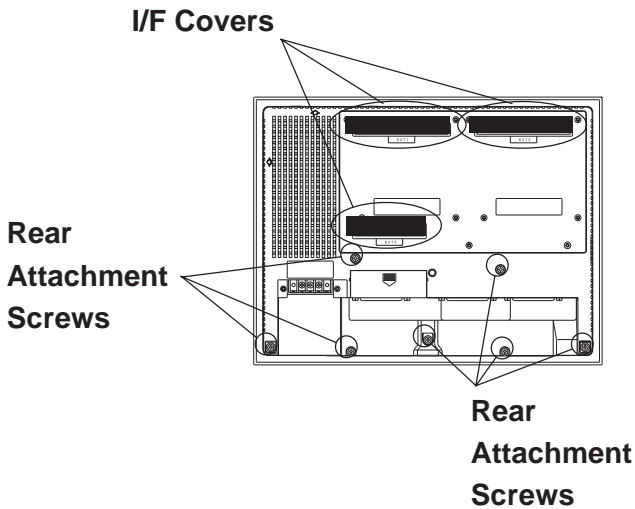

- 1) Turn the GP's power OFF (i.e. disconnect the GP's power cord). Remove the three (3) I/F covers, and use a Phillips screwdriver to remove the case's seven (7) rear attachment screws. Pivot the rear cover open, starting from the top of the unit.



*Since the attachment screws are small, be sure not to lose them or allow them to fall inside the GP's case.*

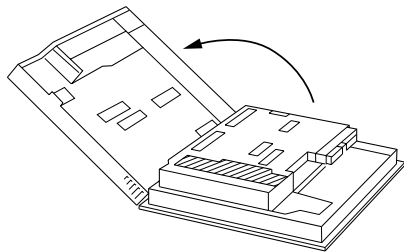

- 2) The cover is fastened at the bottom, and hinges open.



*Be sure not to break the rear cover's four (4) alignment tabs when you open it.*

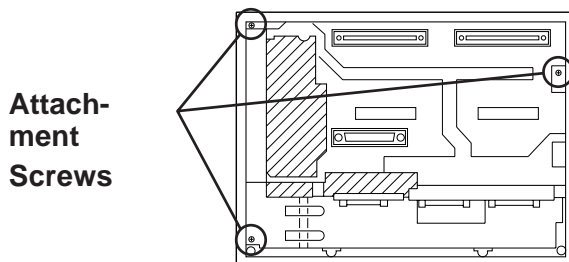

- 3) Loosen the three (3) circuit board attachment screws.

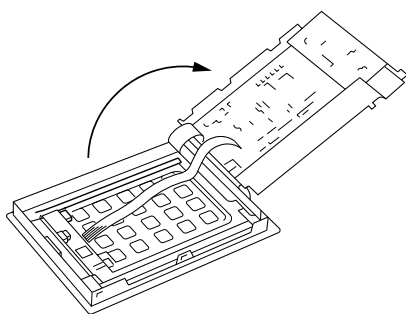

- 4) The circuit board is attached on one side, and hinges open.



*When the GP's power has just been turned OFF, the circuit board chassis is still very hot! Be sure to wear gloves to prevent being burned.*

Attachment Screw

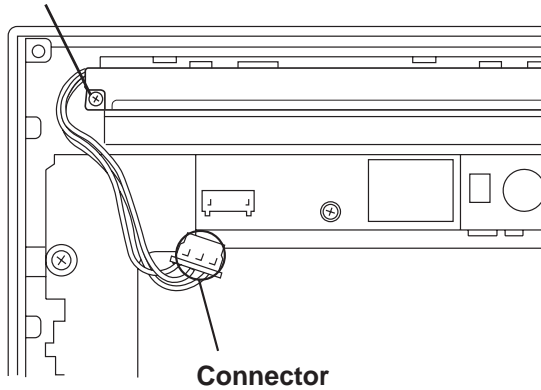

- 5) Disconnect the backlight's one (1) power connectors.

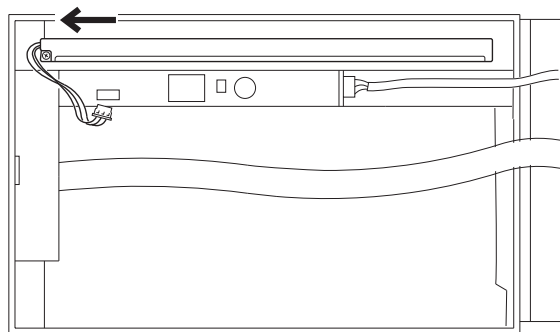

- 6) Loosen the backlight unit attachment screw. Next, slide the backlight in the direction shown and lift it forward and remove it from the GP.

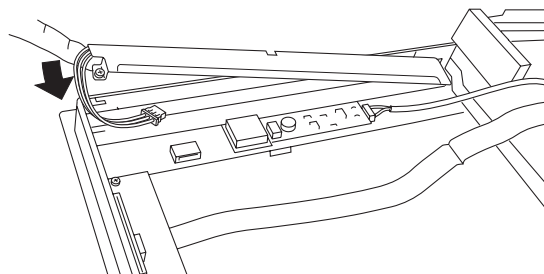

- 7) Insert the new backlight in the GP. Insert the unit by sliding it in the direction shown in step 6), then, tighten the unit's attachment screw.

- 8) Connect the backlight's one (1) power connector. Next, close the circuit board and secure the rear case in place using the attachment screws removed in steps 1), 2) and 3).



- Be sure not to pinch or cut any of the GP unit's internal wiring when closing the case.
- If any of the attachment screws becomes misplaced, check to be sure that they have not fallen inside the GP. If a screw has fallen inside the GP, do not connect the unit's power cord until it has been removed.



*Memo*

# Index

**A**

About GP-2400/2500/2600 Series Models ..... 12  
 ACCESS lamp ..... 9, 3-10  
 aerospace equipment ..... 6  
 ALARM MESSAGE ..... 6-37  
 Available Software ..... 1-6, 1-7, 1-8, 1-11

**B**

Backlight Burnout Detection Feature ..... 1-9  
 BUZZER TERMINAL OUTPUT ..... 6-3

**C**

CAUTIONS ..... 3-9, 3-10  
 CF Card ..... 3-10  
 CF Card Access Lamp ..... 2-12  
 CF Card ACCESS switch OFF ..... 9, 3-10  
 CF Card Handling ..... 3-13  
 CF Memory Loader Feature ..... 1-9  
 Changing the Backlight ..... 8-4  
 CHARACTER STRING DATA Mode List ..... 6-7  
 CHARACTER STRING DATA SETUP ..... 6-7  
 Cleaning the Display ..... 8-1  
 COMMUNICATION INTERFACE ..... 6-11  
 COMMUNICATION PORT SETUP ..... 6-24  
 Communication Port Setup ..... 6-24  
 COMMUNICATION RATE ..... 6-10  
 COMMUNICATION SETUP ..... 6-18  
 Connecting the GP's Power Cord .....  
     ..... 3-6, 3-8, 3-14, 3-15  
 CONTROL ..... 6-11  
 Copyright ..... 1  
 Creating installation openings ..... 3-2  
 crime prevention devices ..... 7  
 CSV DATA INDEX ..... 6-35  
 CSV Data Index ..... 6-35  
 CUSTOMIZE SETUP (n:1) .....  
     ..... 6-28, 6-31, 6-32, 6-33, 6-34, 6-35

**D**

DATA FORMAT ..... 6-6  
 DATA LENGTH ..... 6-10  
 Display Features ..... 2-4  
 Display Panel ..... 2-12  
 DISPLAY PATTERN ..... 7-4

**E**

Electrical Specifications ..... 2-1  
 Environmental Specifications ..... 2-2  
 Error Message Details ..... 7-19  
 Error Message List ..... 7-17  
 Error Messages ..... 7-17  
 Error Screens ..... 7-16  
 errors or omissions ..... 1  
 Ethernet Feature ..... 1-9  
 Expansion Interface ..... 2-12  
 Extended SIO Script Error ..... 7-25

**F**

failsafe system design ..... 7  
 Features and Performance ..... 2-4  
 FRAME BUFFER ..... 7-5  
 FUNCTION SETUP ..... 6-23

**G**

Global D-Script Error ..... 7-24  
 GLOBAL WINDOW ..... 6-6  
 GLOBAL WINDOW ACCESS ..... 6-6  
 GLOBAL WINDOW SETUP ..... 6-6  
 GP data ..... 3-10  
 GP Edit Mode Peripherals ..... 1-3  
 GP RUN Mode Peripherals ..... 1-2  
 GP Start-up and Maintenance Precautions ..... 9  
 GP TOUCH MONOPOLIZE ..... 6-29  
 GP's Display Panel ..... 11  
 GP-2400/2500/2600 Series Overview ..... 1-9  
 GP-2400T ..... 12  
 GP-2500T ..... 12  
 GP-2600T ..... 12  
 Graphic Panel Dimensions ..... 2-14  
 Grounding the GP ..... 3-9, 3-13

# Index

## H

High quality fonts (32 dot) ..... 1-9

## I

In-rush Current ..... 2-1

INITIAL SCREEN NO. .... 6-37

INITIALIZATION ..... 5-4

Initialization Items ..... 6-2

Initialization Screen ..... 6-1

INITIALIZE INTERNAL MEMORY ..... 6-34

INITIALIZE MEMORY ..... 6-2

Installation ..... 3-1, 3-10, 3-11

Installation Fasteners ..... 2-16

Interface Specifications ..... 2-7

INTERNAL FEPROM CHECKSUM  
(System & Protocol) ..... 7-4, 7-5

## M

medical devices ..... 7

Mitsubishi MELSEC-AnA Series PLC ..... 1

Moisture Resistant Gasket ..... 3-1

Moisture Resistant Gasket Replacement ... 3-1, 8-1

moisture resistant seal ..... 3-1

MONOPOLIZE TIME (0 to 2550s) ..... 6-29

## N

NETWORK INFORMATION (DEV/ADR) ..... 6-26

No Display ..... 7-8

No GP/HOST Communication ..... 7-8

No GP/Host Communication ..... 7-12

nuclear power control devices ..... 6

## O

OFFLINE displays During RUN Mode ..... 7-8

ONLINE ERror Display ..... 6-37

Optional Maintenance Items ..... 1-8

Options ..... 1-7, 1-8

Output Circuit ..... 2-10

Overlapping Addresses ..... 7-21

## P

PARITY ..... 6-10, 6-24

PASSWORD SETUP(0-9999) ..... 6-4

Periodic Check Points ..... 8-3

Placement of I/O Signal Lines ..... 3-9

PLC PRIORITY ..... 6-28

PLC SETUP ..... 6-25

Possible Types of Trouble ..... 7-8

Power Input Terminal Block ..... 2-12

## R

REGISTRATION NO. (1-256) ..... 6-6

Regular Cleaning ..... 8-1

RESET GP ON WRITE ERROR ..... 6-25

RETRY COUNT ..... 6-18

Revision Version ..... 15

RI/VCC ..... 6-20

## S

SELF-DIAGNOSIS - Details ..... 7-4

Safety Symbols and Terms ..... 1-9

Safety Precautions ..... 6, 12

Screen Data or Project Data Related Problems 7-20

SELF-DIAGNOSIS ..... 5-6, 7-3

SELF-DIAGNOSIS - Details ..... 7-4

SELF-DIAGNOSIS-tandard Operation ..... 5-6

Serial I/F Change Error ..... 7-25

Serial Interface ..... 1-6, 2-7, 2-9, 2-12

SET UP CAPTURE OPERATION ..... 6-22

SET UP DISPLAY DEVICE ..... 6-23

SET UP I/O ..... 6-10

SET UP SCREEN ..... 6-2, 6-37

SET UP TIME ..... 6-2, 6-36

SET UP TOUCH PANEL ..... 6-15

SIO CHECK ..... 7-6

Sound Output ..... 2-10

Sound Output I/F ..... 1-9

STAND-BY MODE TIME (0-255) ..... 6-3

START TIME (0-255) ..... 6-3

STATION NO. (0-15) ..... 6-27

Status LED ..... 2-12

Steps to run SYSTEM RESET ..... 6-13, 6-15

Structural Specifications ..... 2-3

SYSTEM AREA READ SIZE (0-256) ..... 6-25

SYSTEM AREA SETUP ..... 6-4

System Area Size ..... 6-4, 6-9

SYSTEM AREA START (DEV/ ADR) ..... 6-25

SYSTEM ENVIRONMENT SETUP ..... 6-2, 6-3

SYSTEM RESET MODE ..... 6-15  
SYSTEM SETUP ..... 6-3

## T

TOOLCONNECTOR ..... 7-5  
Tool Connector ..... 1-6, 2-12, 3-10, 3-11  
TOUCHBUZZER SOUND ..... 6-3  
TOUCH OPERATION MODE ..... 6-15  
TOUCH PANEL ..... 7-4  
Touch Panel ..... 2-12  
Touch Panel / Clock Accuracy ..... 2-5, 2-6  
Touch Panel Does Not Respond  
..... 7-8, 7-14, 7-15, 7-16  
transportation vehicles ..... 7  
Troubleshooting ..... 7-8  
Turning the GP's Power ON ..... 5-1

## V

Validation List ..... 6-27

## W

WARNINGS ..... 3-6, 3-10, 8-4  
WINDOW LOCATION ..... 6-6  
Wiring Cautions ..... 3-6, 3-14

# *Memo*