

Absolute Maximum Ratings		Values			Units
Symbol	Conditions <sup>1)</sup>				
V <sub>CES</sub>		1200			V
V <sub>CGR</sub>	R <sub>GE</sub> = 20 kΩ	1200			V
I <sub>C</sub>	T <sub>case</sub> = 25/80 °C	100 / 90			A
I <sub>CM</sub>	T <sub>case</sub> = 25/80 °C; t <sub>p</sub> = 1 ms	200 / 180			A
V <sub>GES</sub>		± 20			V
P <sub>tot</sub>	per IGBT/D1/D8, T <sub>case</sub> =25 °C	690 / 125 / 125			W
T <sub>j</sub> , (T <sub>stg</sub> )		- 40 ... +150 (125)			°C
V <sub>isol</sub>	AC, 1 min.	2 500			V
humidity	DIN 40 040	Class F			
climate	DIN IEC 68 T.1	40/125/56			
Diodes <sup>9)</sup>		D1-6	D7	D8	
I <sub>F</sub>	T <sub>case</sub> = 80 °C	<sup>9)</sup>	30	30	A
I <sub>FM</sub> = - I <sub>CM</sub>	T <sub>case</sub> = 80 °C; t <sub>p</sub> = 1 ms		60	60	A
I <sub>FSM</sub>	t <sub>p</sub> = 10 ms; sin.; T <sub>j</sub> = 150 °C	720	350	350	A
I <sup>2</sup> t	t <sub>p</sub> = 10 ms; T <sub>j</sub> = 150 °C	2600	600	600	A <sup>2</sup> s

## SEMITRANS® M IGBT Modules SKD 100 GAL 123 D Input bridge B6U with brake chopper

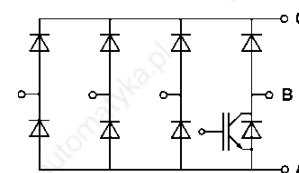

### 7D-Pack = 7 Diodes Pack



SKD 100 GAL

### Features

- Round main terminals (2 mm Ø)
- Easy drilling of PCB
- Input diodes glass passivated
- 1400 V PIV
- High I<sup>2</sup>t rating (inrush current)
- IGBT is latch-up free, homogeneous NPT silicon-structure
- High short circuit capability, self limiting to 6 \* I<sub>cnom</sub><sup>8)</sup>
- Fast & soft CAL diodes<sup>8)</sup>
- Isolated copper baseplate using DCB Direct Copper Bonding Technology
- Large clearance (9 mm) and creepage distances (13 mm).

### Typical Applications:

Input rectifier bridge (B6U) with brake chopper for PWM inverter drives using SEMITRANS SKM 75GD123D

- <sup>1)</sup> T<sub>case</sub> = 25 °C, unless otherwise specified
- <sup>2)</sup> I<sub>F</sub> = - I<sub>C</sub>, V<sub>R</sub> = 600 V, - di<sub>F</sub>/dt = 800 A/μs, V<sub>GE</sub> = 0 V
- <sup>3)</sup> Use V<sub>GEoff</sub> = -5 ... - 15 V
- <sup>8)</sup> CAL = Controlled Axial Lifetime Technology.
- <sup>9)</sup> **Data D1 - D6, case and mech. data → B 6 – 232**

Characteristics		min.	typ.	max.	Units
Symbol	Conditions <sup>1)</sup>				
V <sub>(BR)CES</sub>	V <sub>GE</sub> = 0, I <sub>C</sub> = 4 mA	≥ V <sub>CES</sub>	-	-	V
V <sub>GE(th)</sub>	V <sub>GE</sub> = V <sub>CE</sub> , I <sub>C</sub> = 2 mA	4,5	5,5	6,5	V
I <sub>CES</sub>	V <sub>GE</sub> = 0 } T <sub>j</sub> = 25 °C	-	0,8	1,5	mA
	V <sub>CE</sub> = V <sub>CES</sub> } T <sub>j</sub> = 125 °C	-	6	-	mA
I <sub>GES</sub>	V <sub>GE</sub> = 20 V, V <sub>CE</sub> = 0	-	-	300	nA
V <sub>CEsat</sub>	I <sub>C</sub> = 75 A } V <sub>GE</sub> = 15 V;	-	2,5(3,1)	3(3,7)	V
V <sub>CEsat</sub>	I <sub>C</sub> = 100 A } T <sub>j</sub> = 25 (125) °C }	-	2,8(3,6)	-	V
g <sub>fs</sub>	V <sub>CE</sub> = 20 V, I <sub>C</sub> = 75 A	31	-	-	S
C <sub>CHC</sub>	per IGBT	-	-	350	pF
C <sub>ies</sub>	V <sub>GE</sub> = 0	-	5	6,6	nF
C <sub>oes</sub>	V <sub>CE</sub> = 25 V	-	720	900	pF
C <sub>res</sub>	f = 1 MHz	-	380	500	pF
t <sub>d(on)</sub>	V <sub>CC</sub> = 600 V	-	30	60	ns
t <sub>r</sub>	V <sub>GE</sub> = + 15 V / - 15 V <sup>3)</sup>	-	70	140	ns
t <sub>d(off)</sub>	I <sub>C</sub> = 75 A, ind. load	-	450	600	ns
t <sub>f</sub>	R <sub>Gon</sub> = R <sub>Goff</sub> = 15 Ω	-	70	100	ns
E <sub>on</sub>	T <sub>j</sub> = 125 °C	-	10	-	mWs
E <sub>off</sub>		-	8	-	mWs
Inverse Diode D7 <sup>8)</sup> of brake chopper					
V <sub>F</sub> = V <sub>EC</sub>	I <sub>F</sub> = 25 A } V <sub>GE</sub> = 0 V;	-	2,0(1,8)	2,5	V
V <sub>F</sub> = V <sub>EC</sub>	I <sub>F</sub> = 40 A } T <sub>j</sub> = 25 (125) °C }	-	2,2(2,1)	-	V
V <sub>TO</sub>	T <sub>j</sub> = 125 °C	-	1,1	1,2	V
r <sub>T</sub>	T <sub>j</sub> = 125 °C	-	25	44	mΩ
I <sub>RRM</sub>	I <sub>F</sub> = 25 A; T <sub>j</sub> = 25 (125) °C <sup>2)</sup>	-	(25)	-	A
Q <sub>rr</sub>	I <sub>F</sub> = 25 A; T <sub>j</sub> = 25 (125) °C <sup>2)</sup>	-	2(4,5)	-	μC
FWD D8 of "GAL" brake chopper <sup>8)</sup>					
V <sub>F</sub> = V <sub>EC</sub>	I <sub>F</sub> = 25 A } V <sub>GE</sub> = 0 V;	-	2,0 (1,8)	2,5	V
V <sub>F</sub> = V <sub>EC</sub>	I <sub>F</sub> = 40 A } T <sub>j</sub> = 25 (125) °C }	-	2,3 (2,1)	-	V
V <sub>TO</sub>	T <sub>j</sub> = 125 °C	-	-	1,2	V
r <sub>T</sub>	T <sub>j</sub> = 125 °C	-	25	44	mΩ
I <sub>RRM</sub>	I <sub>F</sub> = 25 A; T <sub>j</sub> = 25 (125) °C <sup>2)</sup>	-	19(25)	-	A
Q <sub>rr</sub>	I <sub>F</sub> = 25 A; T <sub>j</sub> = 25 (125) °C <sup>2)</sup>	-	1,5(4,5)	-	μC
Thermal Characteristics					
R <sub>thjc</sub>	per IGBT / diode D1..6 <sup>9)</sup>	-	-	0,18 / 1	°C/W
R <sub>thjc</sub>	per diode D7 / D8	-	-	1,0 / 1,0	°C/W
R <sub>thch</sub>	per module / diode; IGBT	-	-	0,05 / 0,4	°C/W

**SEMITRANS**

**7D-Pack = Seven Diodes Pack**  
**(Sixpack modified)**

Case D 69 A

CASED69A

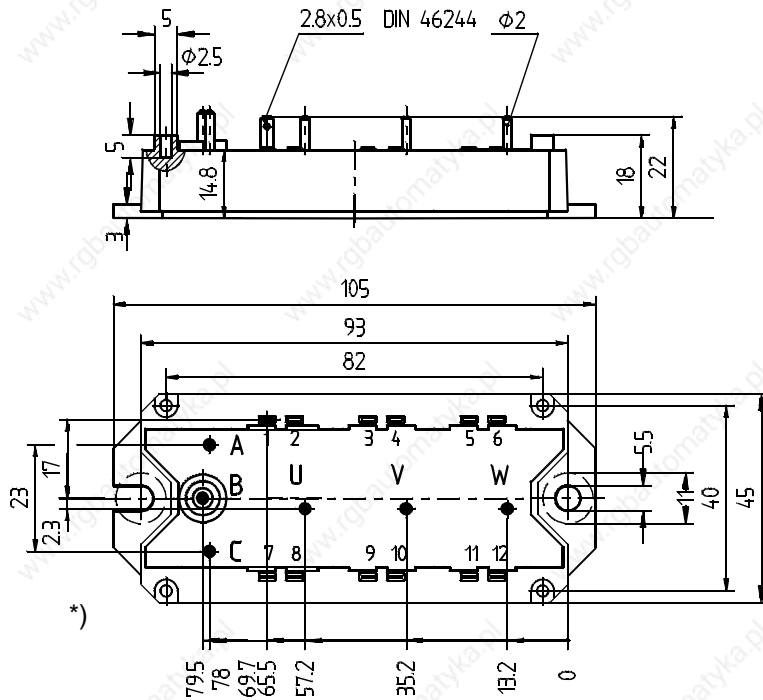

\*) Plastic collar around pin B for UL creepage distance of > 12,7 mm

GCIGDAL

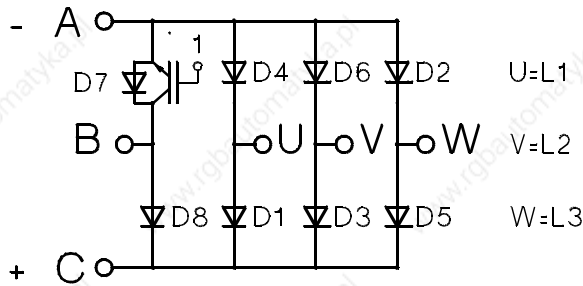

Dimensions in mm

Case outline and circuit diagram

Characteristics continued		Values			Units
Symbol	Conditions <sup>1)</sup>	min.	typ.	max.	
Input	Bridge Rectifier D1...D6				
V <sub>RRM</sub>		1400	-	-	V
I <sub>D</sub>	T <sub>case</sub> = 80 °C;	-	-	100	A
V <sub>F</sub>	T <sub>vj</sub> = 25 °C; I <sub>F</sub> = 75 A	-	-	1,45	V
V <sub>TO</sub>	T <sub>vj</sub> = 150 °C	-	-	0,8	V
r <sub>T</sub>	T <sub>vj</sub> = 150 °C	-	-	8,5	mΩ
R <sub>thjc</sub>	D1...D6	-	-	1,0	K/W
T <sub>solder</sub>	> 5 s, max. 15 sec. (transfer)	-	180	250	°C
Mechanical Data					
M1	to heatsink, SI Units (M5)	4	-	5	Nm
	to heatsink, US Units	35	-	44	lb.in.
a		-	-	5x9,81	m/s <sup>2</sup>
w		-	-	175	g

**This is an electrostatic discharge sensitive device (ESD). Please observe the international standard IEC 747-1, Chapter IX.**

Two devices are supplied in one SEMIBOX A without mounting hardware. Larger Packing units (≥ 10) are used if suitable. SEMIBOX → C - 1.

For the IGBT use diagrams of type SKM 100 GB 123 D → B 6 - 112 etc.

For diodes D7/D8 use diode diagrams of type SKM 40 GD 123 D, → B 6 - 72

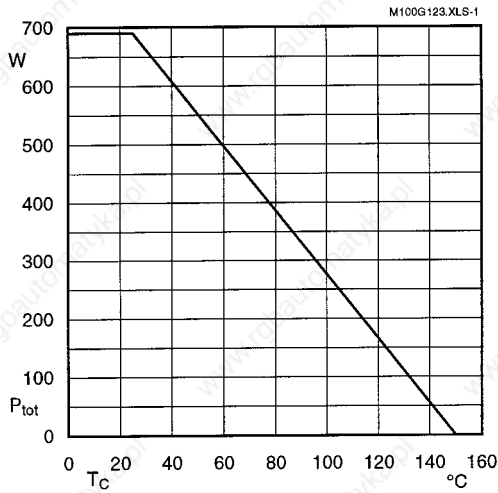

Fig. 1 Rated power dissipation  $P_{tot} = f(T_C)$

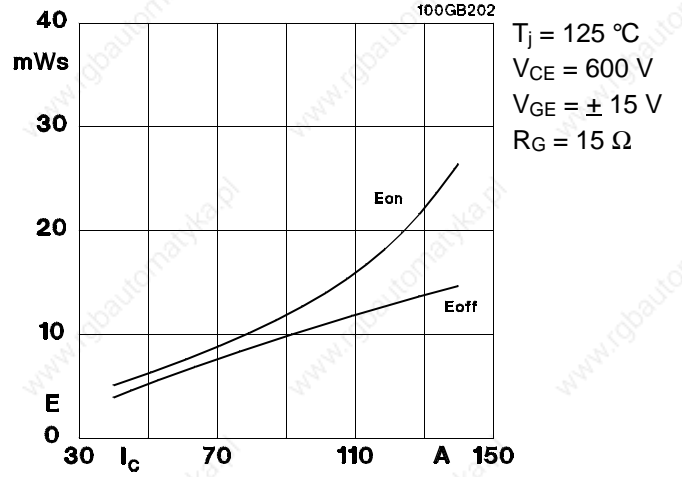

Fig. 2 Turn-on /-off energy  $= f(I_C)$

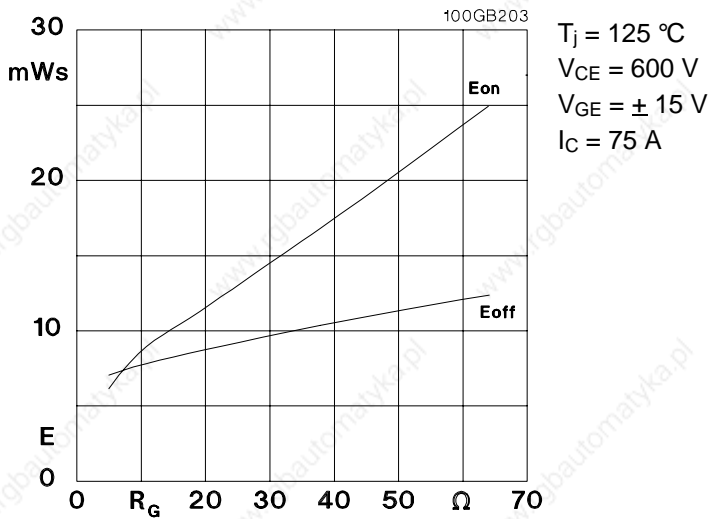

Fig. 3 Turn-on /-off energy  $= f(R_G)$

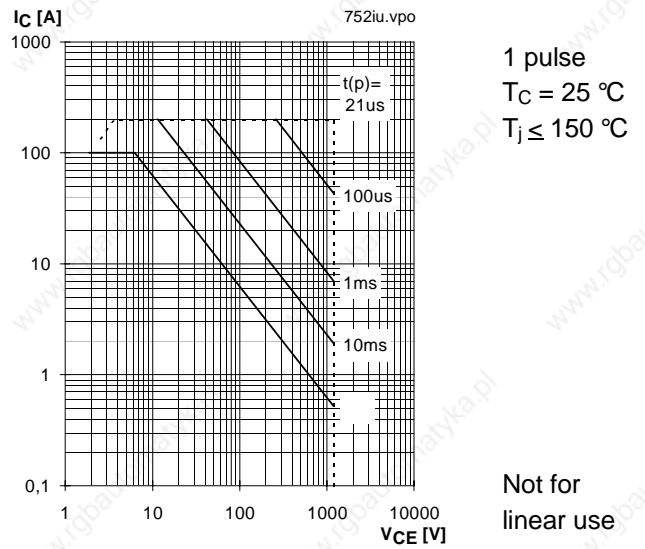

Fig. 4 Maximum safe operating area (SOA)  $I_C = f(V_{CE})$

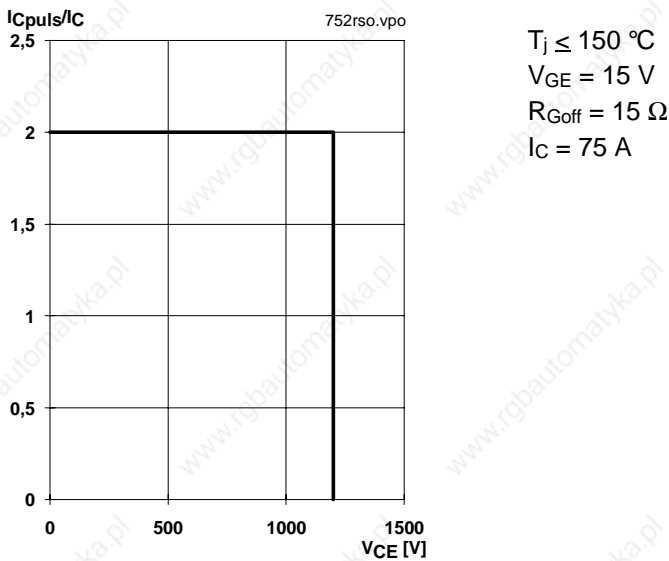

Fig. 5 Turn-off safe operating area (RBSOA)

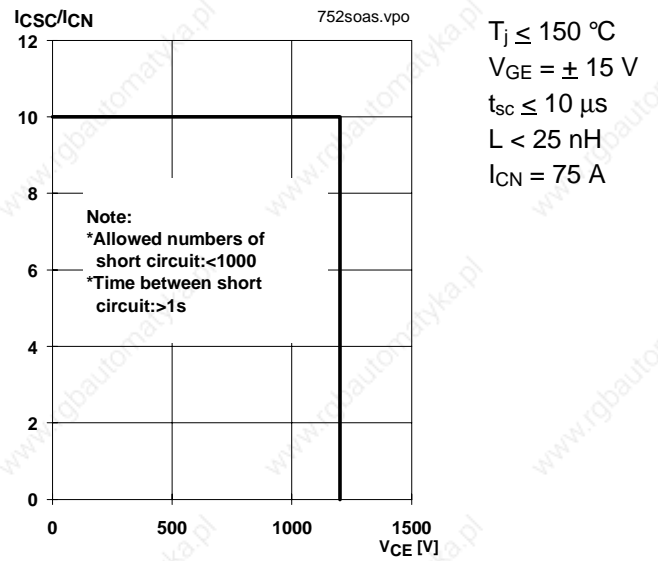

Fig. 6 Safe operating area at short circuit  $I_C = f(V_{CE})$

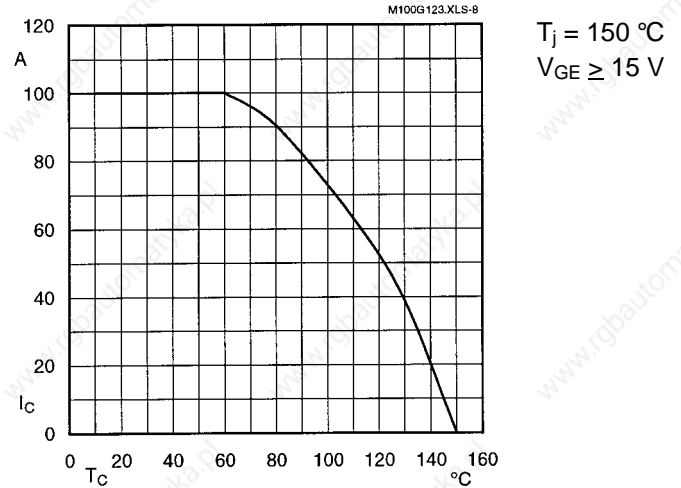

Fig. 8 Rated current vs. temperature  $I_C = f(T_C)$

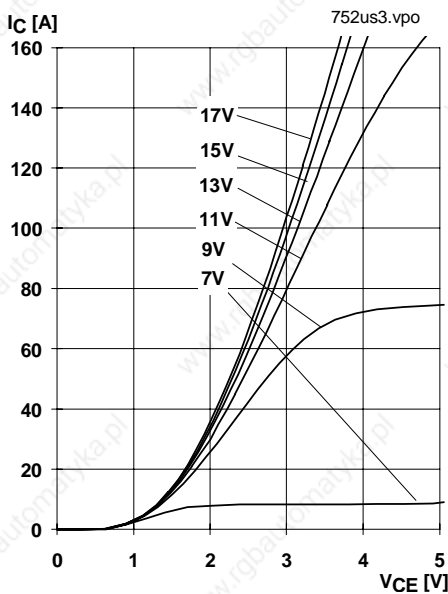

Fig. 9 Typ. output characteristic,  $t_p = 80\text{ }\mu\text{s}$ ;  $25\text{ }^\circ\text{C}$

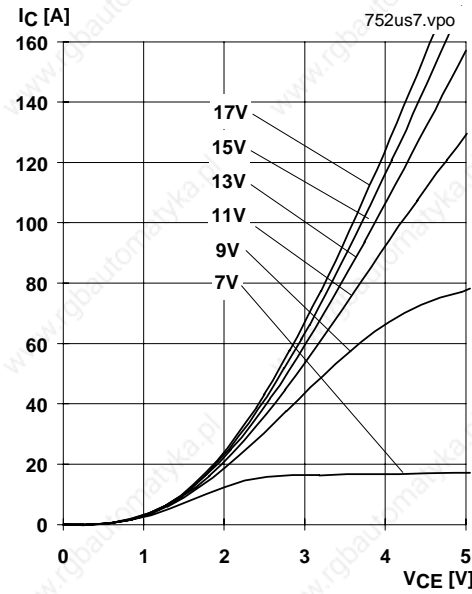

Fig. 10 Typ. output characteristic,  $t_p = 80\text{ }\mu\text{s}$ ;  $125\text{ }^\circ\text{C}$

$$P_{\text{cond}(t)} = V_{\text{CEsat}(t)} \cdot I_C(t)$$

$$V_{\text{CEsat}(t)} = V_{\text{CE(TO)(Tj)}} + r_{\text{CE(Tj)}} \cdot I_C(t)$$

$$V_{\text{CE(TO)(Tj)}} \leq 1,5 + 0,002 (T_j - 25) \text{ [V]}$$

$$\text{typ.: } r_{\text{CE(Tj)}} = 0,013 + 0,00005 (T_j - 25) \text{ [\Omega]}$$

$$\text{max.: } r_{\text{CE(Tj)}} = 0,020 + 0,00007 (T_j - 25) \text{ [\Omega]}$$

$$\text{valid for } V_{\text{GE}} = +15 \frac{+2}{-1} \text{ [V]; } I_C > 0,3 I_{\text{Cnom}}$$

Fig. 11 Saturation characteristic (IGBT)  
Calculation elements and equations

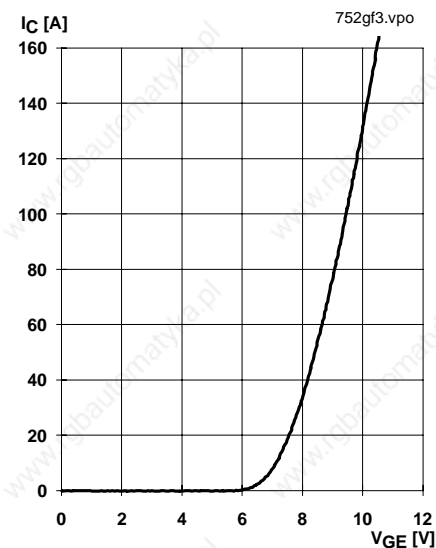
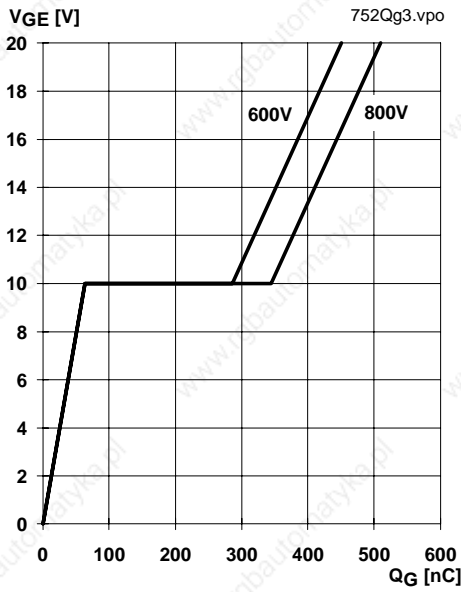
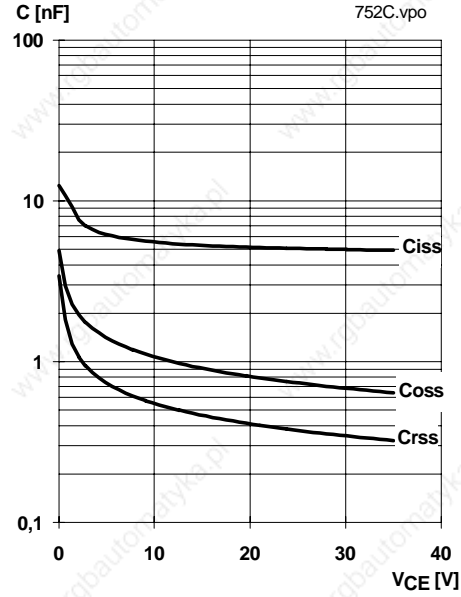

Fig. 12 Typ. transfer characteristic,  $t_p = 80\text{ }\mu\text{s}$ ;  $V_{CE} = 20\text{ V}$



$I_{Cpuls} = 75 \text{ A}$



$V_{GE} = 0 \text{ V}$   
 $f = 1 \text{ MHz}$

Fig. 13 Typ. gate charge characteristic

Fig. 14 Typ. capacitances vs.  $V_{CE}$

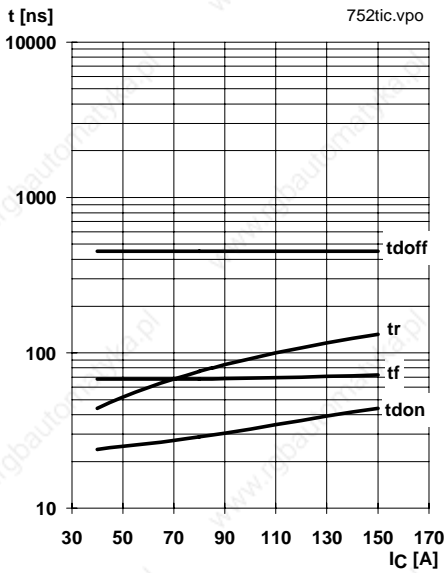

$T_j = 125 \text{ }^\circ\text{C}$   
 $V_{CE} = 600 \text{ V}$   
 $V_{GE} = \pm 15 \text{ V}$   
 $R_{Gon} = 15 \text{ } \Omega$   
 $R_{Goff} = 15 \text{ } \Omega$   
induct. load

Fig. 15 Typ. switching times vs.  $I_C$

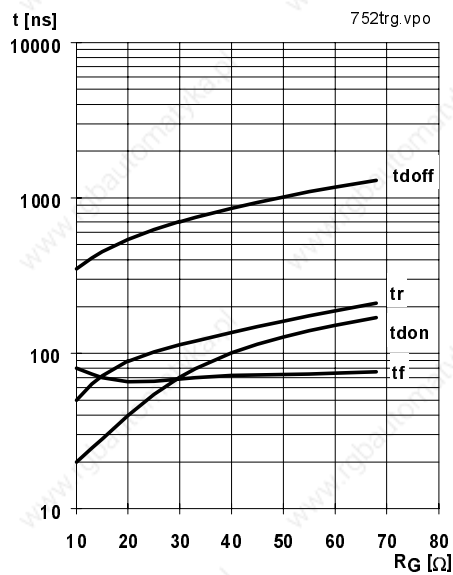

$T_j = 125 \text{ }^\circ\text{C}$   
 $V_{CE} = 600 \text{ V}$   
 $V_{GE} = \pm 15 \text{ V}$   
 $I_C = 75 \text{ A}$   
induct. load

Fig. 16 Typ. switching times vs. gate resistor  $R_G$

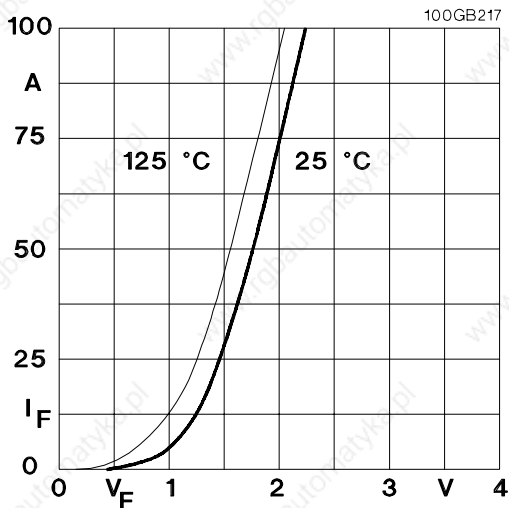

Fig. 17 Typ. CAL diode forward characteristic

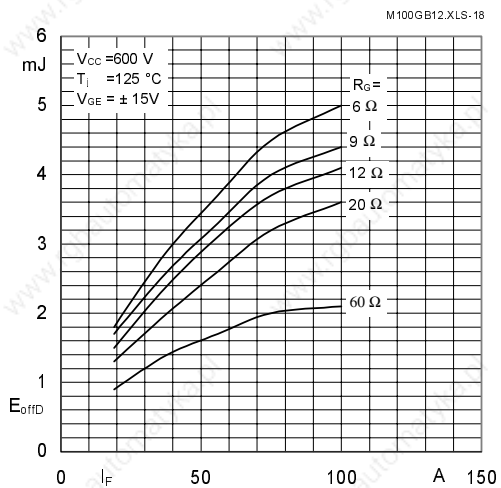

Fig. 18 Diode turn-off energy dissipation per pulse

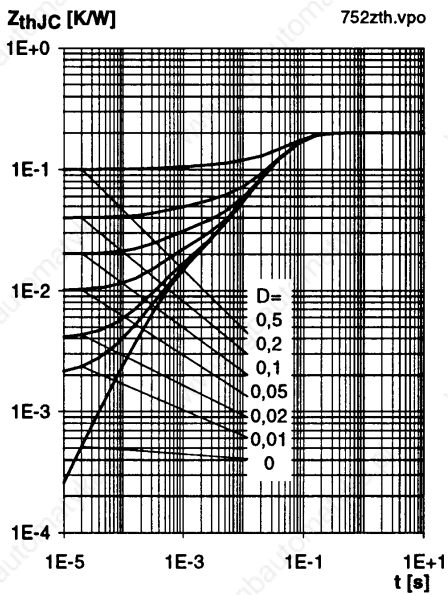

Fig. 19 Transient thermal impedance of IGBT  
 $Z_{thJC} = f(t_p)$ ;  $D = t_p / t_c = t_p \cdot f$

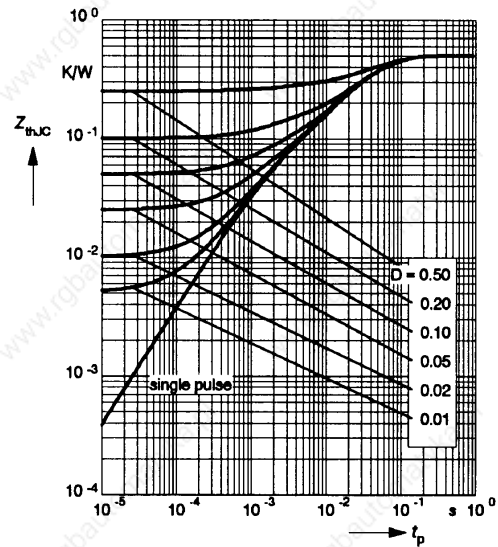

Fig. 20 Transient thermal impedance of inverse CAL diodes  
 $Z_{thJC} = f(t_p)$ ;  $D = t_p / t_c = t_p \cdot f$

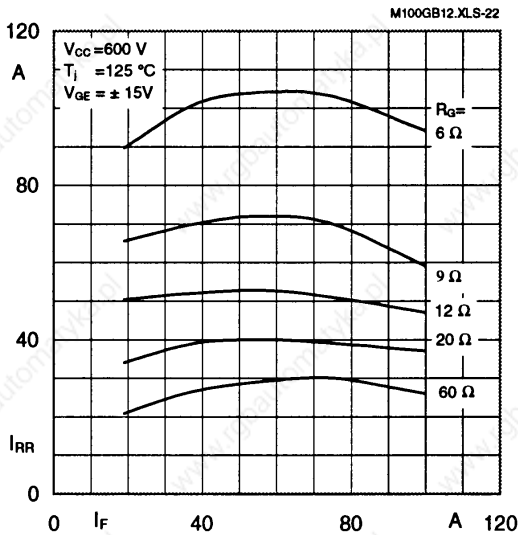

Fig. 22 Typ. CAL diode peak reverse recovery current  $I_{RR} = f(I_F; R_G)$

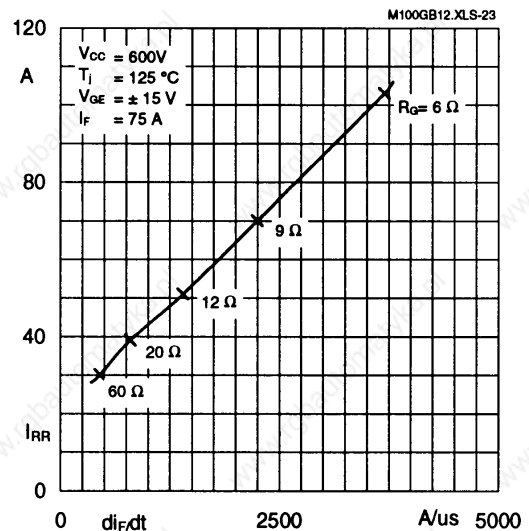

Fig. 23 Typ. CAL diode peak reverse recovery current  $I_{RR} = f(di_F/dt)$

## Typical Applications

### include

- Switched mode power supplies
- DC servo and robot drives
- Inverters
- DC choppers (versions GAR; GAL)
- AC motor speed control
- Inductive heating
- UPS Uninterruptable power supplies
- General power switching applications
- Electronic (also portable) welders
- Pulse frequencies also above 15 kHz

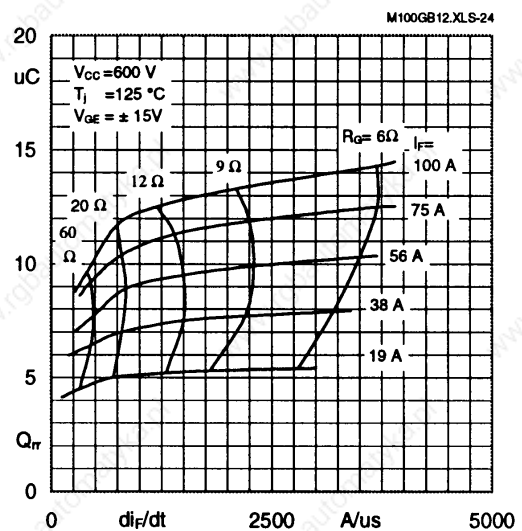

Fig. 24 Typ. CAL diode recovered charge  $Q_{rr} = f(di/dt)$