

FALOWNIK JX

Kompaktowy i kompletny



» Jakość i niezawodność, na której można polegać

» Wbudowany moduł komunikacyjny

» Oszczędny i przyjazny dla środowiska

Tak niewielki, a jednak kompletny...

Firma Omron rozumie potrzeby swoich klientów i dlatego na pierwszym miejscu stawia jakość i niezawodność.

Słuchając z uwagą odbiorców naszych produktów, dbamy o to, by były one wyposażone w funkcje, które pozwalają oszczędzać czas i ograniczać koszty.

Dzięki wbudowanemu filtrowi RFI i modułowi komunikacyjnemu w standardzie, falownik JX stanowi kompletne, a zarazem kompaktowe rozwiązanie, które sprawdza się w szeregu prostych zastosowań, jak choćby sterowanie typowymi przenośnikami.

Najważniejsze cechy:

- Maks. moc 7,5 kW
- Wbudowany interfejs Modbus RS485
- Możliwość montażu „side-by-side”
- Wbudowany filtr EMC
- Regulator PID
- Zabezpieczenie przeciwprzepięciowe
- Automatyczne oszczędzanie energii
- Wyłącznik bezpieczeństwa
- Konfiguracja dwóch silników
- Automatyczna redukcja częstotliwości nośnej
- Wejście termistora PTC
- Przełącznik sterujący wentylatorem chłodzącym
- Zgodność z wymaganiami RoHS



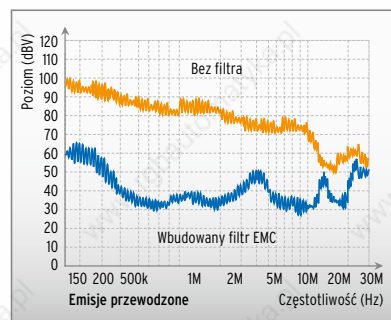
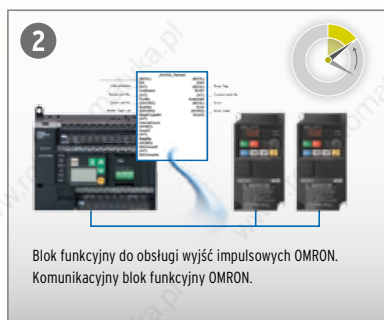
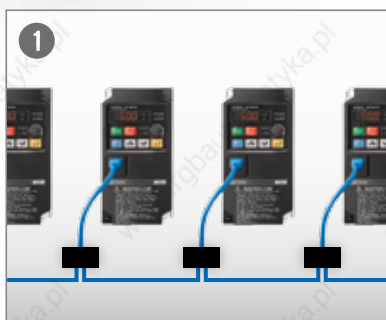
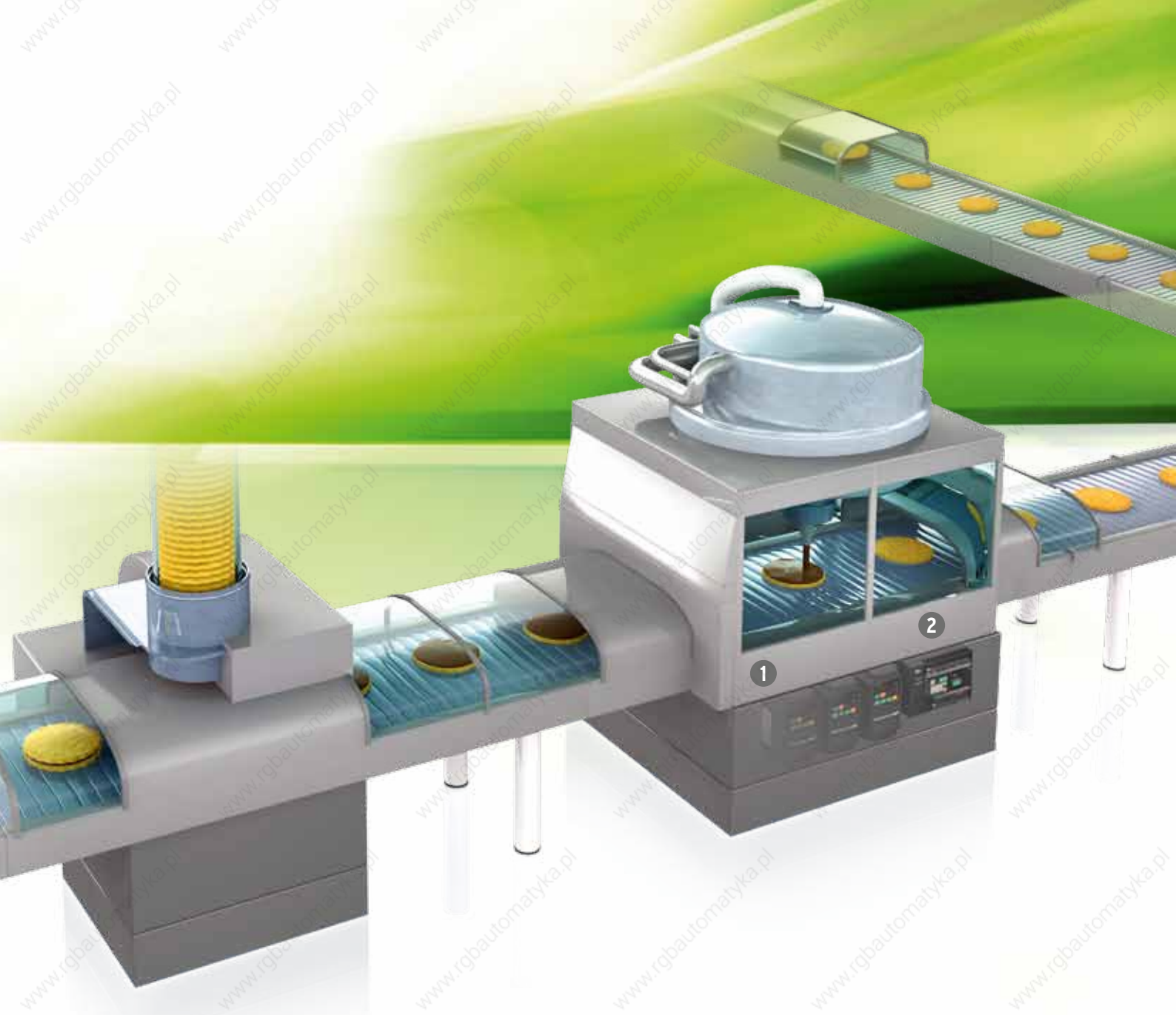

Łatwa integracja z siecią

Interfejs szeregowy Modbus RS485 został wbudowany w port RJ45 z przodu falownika, co ułatwia podłączanie urządzenia do sieci bez potrzeby korzystania z dodatkowych modułów. Oznacza to ograniczenie kosztów i potrzebnej przestrzeni.

Prosta komunikacja

Polecenia Modbus zostały wdrożone nawet w ekonomicznych sterownikach PLC CP1 dzięki funkcji Easy Master Modbus-RTU, co jeszcze bardziej upraszcza integrację falowników z siecią.

Oszczędność przestrzeni i kosztów

Nowy falownik JX posiada wbudowany filtr EMC, który w porównaniu ze standardowym filtrem zewnętrznym pozwala ograniczyć koszty i potrzebną przestrzeń.

Wej. 1-fazowe: EN61800-3 kat. C1
Wej. 3-fazowe: EN61800-3 kat. C2

Wszystko, czego potrzebujesz

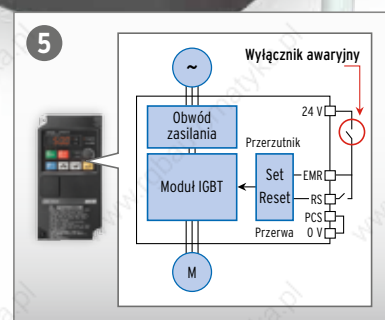

Brak konieczności instalacji dodatkowych urządzeń

Falownik JX został standardowo wyposażony w zaawansowane funkcje, np. regulator PID, co sprawia, iż nadaje się on doskonale do obsługi pomp i wentylatorów, gdzie wymagana jest kontrola ciśnienia, prędkości przepływu i innych parametrów.

Wygoda i skuteczność

Istnieje możliwość zapisania ustawień parametrów dwóch różnych silników, co pozwala napędzać różne silniki o indywidualnej konfiguracji. W danym czasie może pracować tylko jeden silnik.

Niezawodny wyłącznik bezpieczeństwa

Wyjście modułu IGBT jest bezpośrednio odłączane od zewnętrznego wejścia, co zapewnia odcięcie zasilania silnika. To sprzętowe rozwiązanie okazuje się bardziej niezawodne niż rozwiązania bazujące na procesorze.



Cicha praca

Wyłączenie wentylatora, zależnie od temperatury falownika, ogranicza hałas i przedłuża żywotność urządzenia.

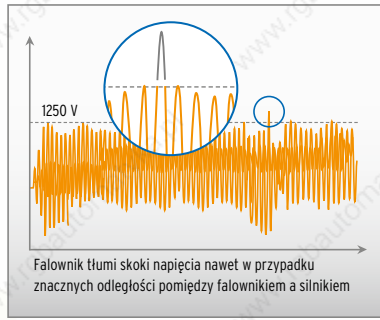

Większa żywotność silnika

Zaawansowane sterowanie PWM umożliwia tłumienie mikroprzebiegów, które mogą powodować awarie silników 400 V. Zapewnia to potrzebną ochronę oraz wydłuża żywotność silnika.

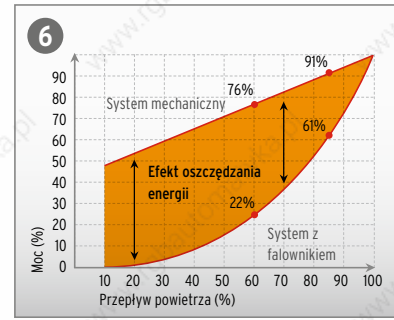

Automatyczne oszczędzanie energii

W zastosowaniach takich jak wentylatory i pompy falownik korzysta zawsze z optymalnego programu oszczędzania energii celem ograniczenia kosztów. W porównaniu ze standardowymi systemami mechanicznymi falownik może ograniczyć zużycie energii o 61%.



Niezawodność z myślą o środowisku

Firma Omron słynie z niezawodności swoich produktów. Poza tym, zgodnie z obowiązującą polityką, są one bezpieczne dla środowiska ze względu na brak jakichkolwiek niedozwolonych substancji.



JX

Compact & Complete

- V/f controlled inverter
- Side by side mounting
- Built-in EMC filter
- Built-in RS-485 Modbus
- Overload detection function (150% during 60s)
- PID
- Micro-surge voltage suppression
- Automatic energy saving
- Emergency shut-off
- Second motor setting
- Auto carrier-frequency reduction
- PTC thermistor input
- Cooling fan switch control
- PC configuration tool: CX-Drive
- CE, UL, cUL, RoHS

Ratings

- 200 V Class single-phase 0.2 to 2.2 kW
- 200 V Class three-phase 0.2 to 7.5 kW
- 400 V Class three-phase 0.4 to 7.5 kW



System configuration

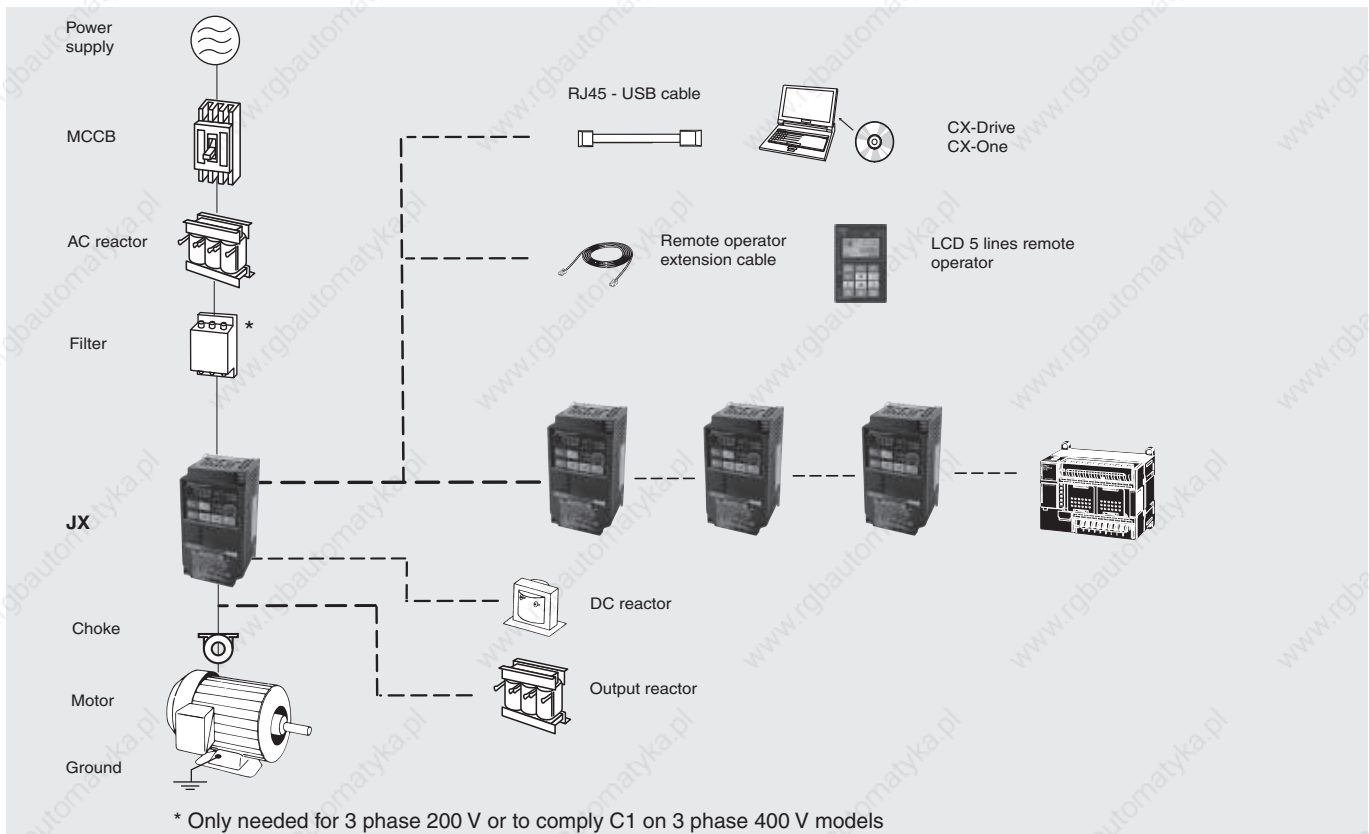

Specifications

Type designation

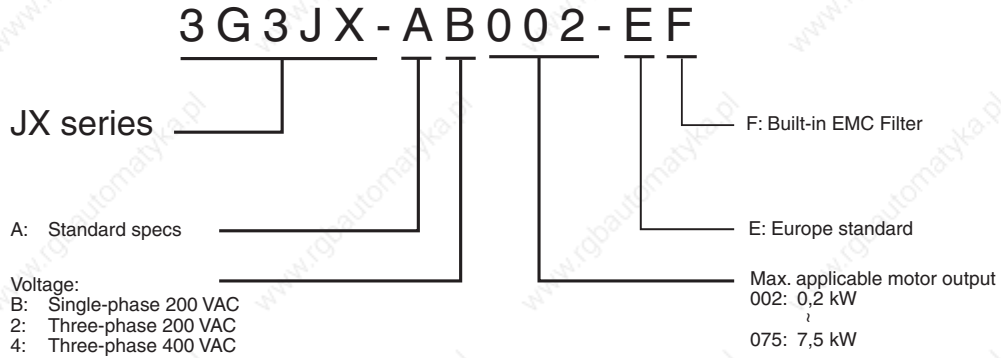

200 V class

Single-phase: 3G3JX□		AB002	AB004	AB007	AB015	AB022	-	-	-	
Three-phase: 3G3JX□		A2002	A2004	A2007	A2015	A2022	A2037	A2055	A2075	
Motor kW ^{*1}	Applicable motor capacity	0.2	0.4	0.75	1.5	2.2	3.7	5.5	7.5	
Output characteristics	Inverter capacity kVA	200 V	0.4	0.9	1.3	2.4	3.4	5.5	8.3	11.0
		240 V	0.5	1.0	1.6	2.9	4.1	6.6	9.9	13.3
	Rated output current (A)		1.4	2.6	4.0	7.1	10.0	15.9	24.0	32.0
Max. output voltage		Proportional to input voltage: 0...240 V								
Max. output frequency		400 Hz								
Power supply	Rated input voltage and frequency		Single-phase 200...240 V 50/60 Hz 3-phase 200...240 V 50/60 Hz							
	Rated input current (A) Three-phase 200 V		1.8	3.4	5.2	9.3	13.0	20.0	30.0	40.0
	Rated input current (A) Single-phase 200 V		3.1	5.8	9.0	16.0	22.5	-	-	-
	Allowable voltage fluctuation		-15%...+10%							
Allowable frequency fluctuation		+5%								
Built-in filter		EMC filter (C1 single phase)								
Braking torque		At short-time deceleration At capacitor feedback		Approx. 50%		50% for 3-phase 20 to 40% for 1-phase		Approx 20% to 40%		Approx 20%
Cooling method		Self cooling			Forced-air-cooling					

*1 Based on a standard 3-Phase standard motor.

400 V class

Three-phase: 3G3JX□		A4004	A4007	A4015	A4022	A4040	A4055	A4075		
Motor kW ^{*1}	Applicable motor capacity	0.4	0.75	1.5	2.2	4.0	5.5	7.5		
Output characteristics	Inverter capacity kVA	380 V	0.9	1.6	2.5	3.6	5.6	8.5	10.5	
		480 V	1.2	2.0	3.1	4.5	7.1	10.8	13.3	
	Rated output current (A)		1.5	2.5	3.8	5.5	8.6	13.0	16.0	
Max. output voltage		Proportional to input voltage: 0...480 V								
Max. output frequency		400 Hz								
Power supply	Rated input voltage and frequency		3-phase 380...480 V 50/60 Hz							
	Rated input current (A)		2.0	3.3	5.0	7.0	11.0	16.5	20.0	
	Allowable voltage fluctuation		-15%...+10%							
	Allowable frequency fluctuation		+5%							
Built-in filter		EMC filter C2 class								
Braking torque		At short-time deceleration At capacitor feedback		Approx. 50%		Approx. 20% to 40%		Approx. 20%		
Cooling method		Self cooling			Forced-air-cooling					

*1 Based on a standard 3-Phase standard motor.

Specifications

Common specifications

Model number 3G3JX□		Specifications
Control functions	Control methods	Phase-to-phase sinusoidal modulation PWM (V/f)
	Output frequency range	0.5..400 Hz
	Frequency precision	Digital set value: ±0.01% of the max. frequency Analogue set value: ±0.4% of the max. frequency (25 ±10 °C)
	Resolution of frequency set value	Digital set value: 0.1 Hz Analogue set value: 1/1000 of maximum frequency
	Resolution of output frequency	0.1 Hz
	Overload capability	150% rated output current for one minute
	Frequency set value	0 to 10 VDC (10 kΩ), 4 to 20 mA (250 Ω), frequency setting volume (selectable), RS485 Modbus
	V/f Characteristics	Constant/ reduced torque
Functionality	Inputs signals	FW (forward), RV (reverse), CF1 to CF4 (multi-step speed), JG (jogging), DB (external DC injection braking), SET (2nd function), 2CH (2-step acceleration/deceleration), FRS (free run), EXT (external trip), USP (USP function), SFT (soft lock), AT (analog current input function selection), RS (reset), PTC (thermistor input), STA (3-wire startup), STP (3-wire stop), F/R (3-wire forward/reverse), PID (PID selection), PIDC (PID integral reset), UP (UP of UP/DWN function), DWN (DWN of UP/DWN function), UDC (data clear of UP/DWN function), OPE (forced OPE mode), ADD (frequency addition), F-TM (forced terminal block), RDY (operation ready), SP-SET (special setting), EMR (emergency shutoff)
	Output signals	RUN (signal during operation), FA1 (frequency arrival signal 1), FA2 (frequency arrival signal 2), OL (overload warning signal), OD (PID excess deviation signal), AL (alarm signal), DC (analog input disconnection detection signal), FBV (PID FB status output), NDc (network error), LOG (logical operation result), ODc (communication option disconnected), LOC (light load signal)
	Standard functions	AVR function, V/f characteristic selection, upper/lower limit, 16-step speeds, starting frequency adjustment, jogging operation, carrier frequency adjustment, PID control, frequency jump, analog gain/bias adjustment, S-shape acceleration/deceleration, electronic thermal characteristics/level adjustment, retry function, simplified torque boost, trip monitor, soft lock function, frequency conversion display, USP function, 2nd control function, motor rotation speed UP/DOWN, overcurrent suppression function
	Analogue inputs	2 analogue inputs 0 to 10 V (20 kΩ), 4 to 20 mA (250 Ω)
	Accel/Decel times	0.01 to 3000 s (line/curve selection), 2nd accel/decel setting available
	Display	Status indicator LED's Run, Program, Power, Alarm, Power, Hz, Amps, Volume Led indicator Digital operator: Available to monitor frequency reference, output current, output frequency
	Motor overload protection	Electronic Thermal overload relay and PTC thermistor input
	Instantaneous overcurrent	180% of rated current
Protection functions	Overload	150% for 1 minute
	Overvoltage	790 V for 400 V type and 395 for 200 V type
	Momentary power loss	Following items are selectable: Alarm, 0 Hz start, frequency output at interruption, maximum frequency
	Cooling fin overheat	Temperature monitor and error detection
	Stall prevention level	Selectable level applicable only at constant speed or during acceleration and constant speed
	Ground fault	Detected at power-on
	Power charge indication	On when power is supplied to the control part
	Degree of protection	IP20
Ambient conditions	Ambient humidity	90% RH or less (without condensation)
	Storage temperature	-20°C..+65 °C (short-term temperature during transportation)
	Ambient temperature	-10°C to 50°C (Both the carrier frequency and output current need to be reduced at over 40°C.)
	Installation	Indoor (no corrosive gas, dust, etc.)
	Installation height	Max. 1000 m
	Vibration	5.9 m/s ² (0.6 G), 10 to 55 Hz (Complies with the test method specified in JIS C0040 (1999).)

Dimensions

IP 20 type 0.2 to 7.5 kW

Figure 1



Figure 2

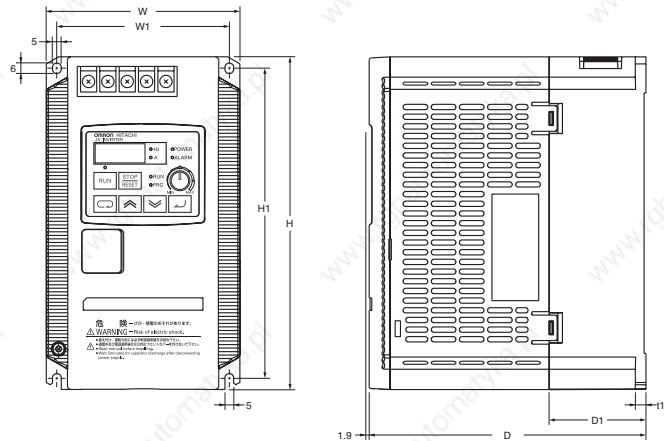

Voltage class	Max. applicable motor output kW	Inverter model 3G3JX□	Figure	Dimensions in mm							
				W1	H1	W	H	D	t1	D1	Weight
Single-phase 200 V	0.2	AB002	1	67	143	80	155	95.5	2.6	13	0.8
	0.4	AB004	1					109.5		27	0.9
	0.75	AB007	2					130.5		28	1.5
	1.5	AB015	2	98	176	110	189	157.5	6	55	2.3
	2.2	AB022	2							55	2.4
Three-phase 200 V	0.2	A2002	1	67	143	80	155	95.5	2.6	13	0.8
	0.4	A2004	1					109.5		27	0.9
	0.75	A2007	1					132.5		50	1.1
	1.5	A2015	2	98	176	110	189	157.5	6	55	2.2
	2.2	A2022	2							55	2.4
	3.7	A2037	2	164	235	180	250	167.5	1.6	77.5	4.2
	5.5	A2055	2							77.5	4.2
7.5	A2075	2	77.5							4.2	
Three-phase 400 V	0.4	A4004	2	98	176	110	189	130.5	2.6	28	1.5
	0.75	A4007	2					157.5		23	2.3
	1.5	A4015	2					157.5		55	2.4
	2.2	A4022	2	164	235	180	250	167.5	1.6	77.5	4.2
	4.0	A4040	2							77.5	4.2
	5.5	A4055	2							77.5	4.2
	7.5	A4075	2							77.5	4.2

Rasmi footprint Filters

Filter only needed by the 1-phase 200 V or 3-phase 400 V to comply with C1 EMC class.

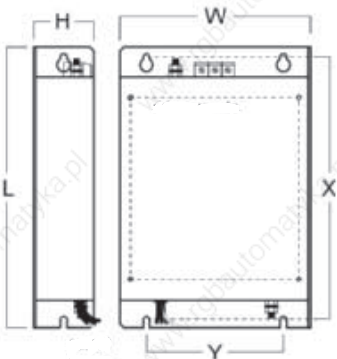

Rasmi model		Dimensions						Weight kg
		W	H	L	X	Y	M	
1x200 V	AX-FIJ1006-RE	81	40	193	183	57	M4	0.5
	AX-FIJ1010-RE	112	47	226	216	88	M4	0.6
	AX-FIJ1026-RE	112	47	226	216	88	M4	0.8
3x200 V	AX-FIJ2006-RE	81	50	193	183	57	M4	1.0
	AX-FIJ2020-RE	112	50	226	216	88	M4	1.3
3x400 V	AX-FIJ2040-RE	182	55	289	279	150	M5	2.3
	AX-FIJ3005-RE	112	45	226	216	88	M4	0.9
	AX-FIJ3011-RE	112	45	226	216	88	M4	1.1
	AX-FIJ3020-RE	182	45	289	279	150	M4	1.7

Input AC Reactor



Voltage	Reference	Dimensions						Weight kg
		A	B2	C2	D	E	F	
200 V	AX-RAI02800080-DE	120	70	120	80	52	5.5	1.78
	AX-RAI00880175-DE	120	80	120	80	62	5.5	2.35
	AX-RAI00350335-DE	180	85	190	140	55	6	5.5
400 V	AX-RAI07700042-DE	120	70	120	80	52	5.5	1.78
	AX-RAI03500090-DE	120	80	120	80	62	5.5	2.35
	AX-RAI01300170-DE	120	80	120	80	62	5.5	2.50

DC Reactor

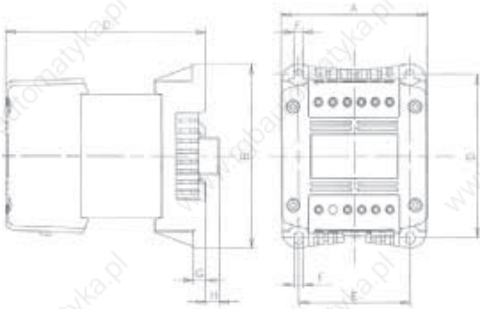

Voltage	Reference	Dimensions								Weight kg
		A	B	C	D	E	F	G	H	
200 V	AX-RC21400016-DE	84	113	96	101	66	5	7.5	2	1.22
	AX-RC10700032-DE			105						1.60
	AX-RC06750061-DE			116						1.95
	AX-RC03510093-DE	120	152	124	135	82	6.5	9.5	-	3.20
	AX-RC02510138-DE			136						5.20
	AX-RC01600223-DE			146						6.00
	AX-RC01110309-DE			135						94
AX-RC00840437-DE	146	6.00								
400 V	AX-RC43000020-DE	84	113	96	101	66	5	7.5	2	1.22
	AX-RC27000030-DE			105						1.60
	AX-RC14000047-DE			116						1.95
	AX-RC10100069-DE	120	152	133	135	82	6.5	9.5	-	3.70
	AX-RC06400116-DE			136						5.20
	AX-RC04410167-DE			146						6.00
	AX-RC03350219-DE			135						94

Output AC Reactor



Voltage	Reference	Dimensions						Weight kg
		A	B2	C2	D	E	F	
200 V	AX-RAO11500026-DE	120	70	120	80	52	5.5	1.78
	AX-RAO07600042-DE	120	70	120	80	52	5.5	1.78
	AX-RAO04100075-DE	120	80	120	80	62	5.5	2.35
	AX-RAO03000105-DE	120	80	120	80	62	5.5	2.35
	AX-RAO01830180-DE	180	85	190	140	55	6	5.5
	AX-RAO01150220-DE	180	85	190	140	55	6	5.5
	AX-RAO00950320-DE	180	85	205	140	55	6	6.5
400 V	AX-RAO16300038-DE	120	70	120	80	52	5.5	1.78
	AX-RAO11800053-DE	120	80	120	80	52	5.5	2.35
	AX-RAO07300080-DE	120	80	120	80	62	5.5	2.35
	AX-RAO04600110-DE	180	85	190	140	55	6	5.5
	AX-RAO03600160-DE	180	85	205	140	55	6	6.5

Chokes



Reference	D diameter	Motor KW	Dimensions						Weight kg
			L	W	H	X	Y	m	
AX-FER2102-RE	21	< 2.2	85	22	46	70	-	5	0.1
AX-FER2515-RE	25	< 15	105	25	62	90	-	5	0.2

Installation

Standard connections

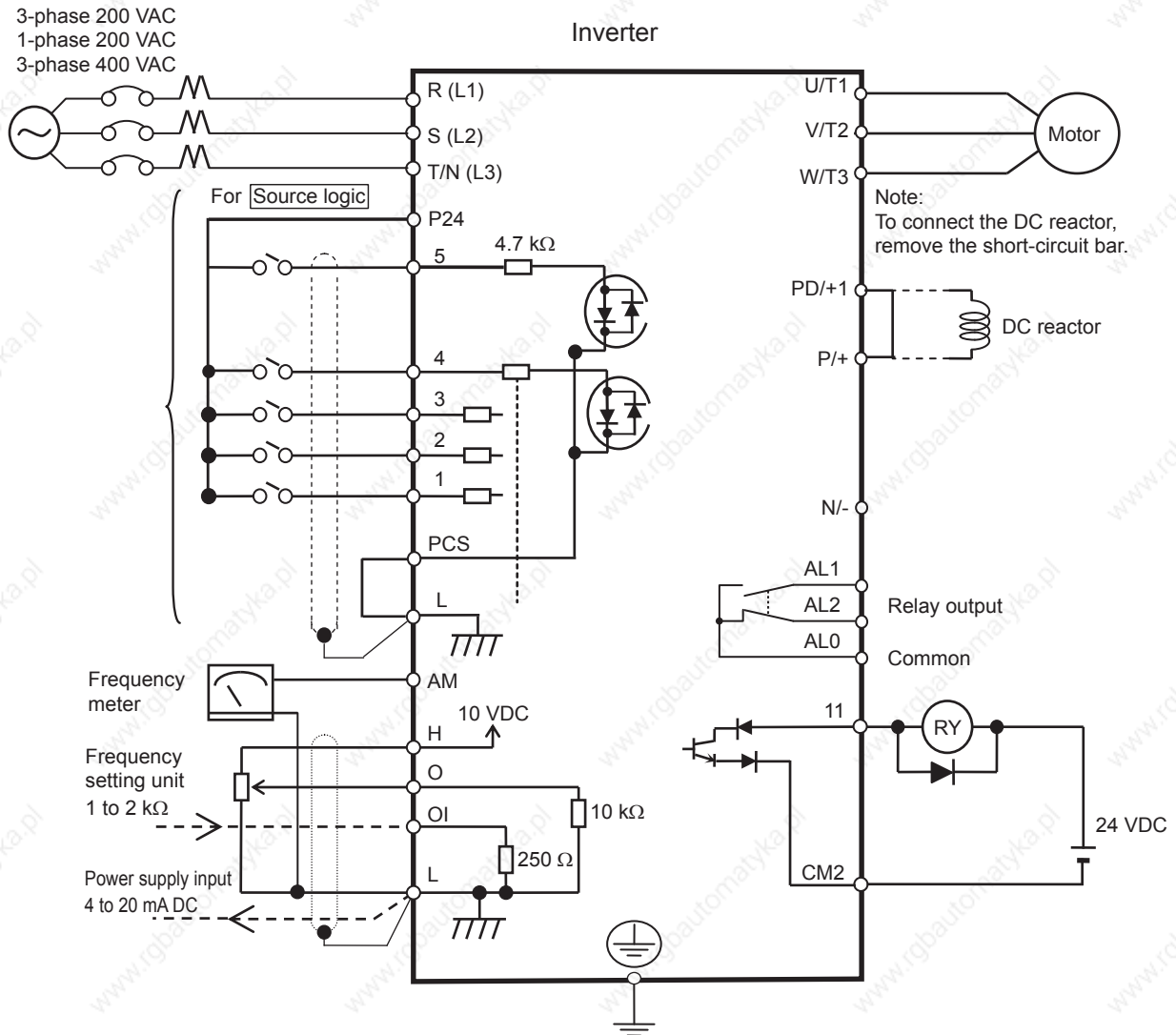

Terminal Block Specifications

Terminal	Name	Function (signal level)
R/L1, S/L2, T/N/L3	Main circuit power supply input	Used to connect line power to the drive. Drives with single-phase 200 V input power use only terminals R/L1 and N (T/L3), terminal S/L2 is not available for these units
U/T1, V/T2, W/T3	Inverter output	Used to connect the motor
PD/+1, P/+	External DC reactor terminal	Normally connected by the short-circuit bar. Remove the short-circuit bar between +1 and P/+2 when a DC reactor is connected.
P/+, N/-	Regenerative braking unit connection terminal	Connect optional regenerative braking units (If a braking torque is required)
⊕	Grounding	For grounding (grounding should conform to the local grounding code.)

Control Circuit

Type	No.	Signal name	Function	Signal level
Digital input signals	PCS	Input power supply	External power supply terminal for input signal (input) ...At sink logic Internal power supply output terminal for input signal (output) ...At source logic	24 VDC ±10%
	P24	Internal 24 VDC	24 VDC internal power supply	24 VDC±10% 100 mA
	1	Multi-function Input selection 1	Factory setting: Forward/ Stop	
	2	Multi-function Input selection 2	Factory setting: Reverse/ Stop	
	3	Multi-function Input selection 3	Factory setting: Fault reset	
	4	Multi-function Input selection 4	Factory setting: Emergency stop fault	
	5	Multi-function Input selection 5	Factory setting: Multi-step speed reference 1	
	L	Multi-function Input selection common	--	--
Analog input signal	H	Frequency reference power supply	10 VDC 10 mA max	
	O	Voltage frequency reference signal	0 to 10 VDC (10 KΩ)	
	OI	Current frequency reference signal	4 to 20 mA (250 Ω)	
	L	Frequency reference common	--	
Digital output signals	AL2	NC output	Factory default relay settings Under normal operation: AL2-AL0 Closed Under abnormal operation or power shutdown: AL1-AL0 Open	250 VAC 2.5 A 30 VDC 3 A
	AL1	NO output		
	AL0	Relay Output common		250 VAC 1 A 30 VDC 1 A
	11	Multi-function output terminal	Factory setting: Frequency arrival signal at a constant speed	27 VDC 50 mA max
	CM2	Output signal common	--	
Monitor Signal	AM	Analog frequency monitor/Analog output current monitor	Factory setting: Analog frequency monitor	0 to 10 VDC 1 mA

Side by side mounting

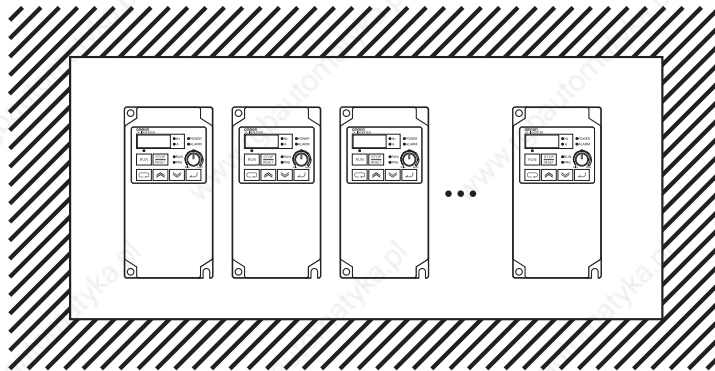

Input AC Reactor

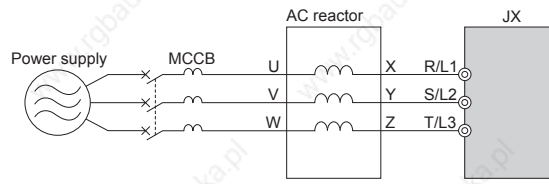

3 phase 200 V class				400 V class			
Max. applicable motor output kW	Reference	Current value A	Inductance mH	Max. applicable motor output kW	Reference	Current value A	Inductance mH
0.1 to 1.5	AX-RAI02800080-DE	8.0	2.8	0.4 to 1.5	AX-RAI07700042-DE	4.2	7.7
2.2 to 3.7	AX-RAI00880175-DE	17.5	0.88	2.2 to 4.0	AX-RAI03500090-DE	9.0	3.5
5.5 to 7.5	AX-RAI00350335-DE	33.5	0.35	5.5 to 7.5	AX-RAI01300170-DE	17.0	1.3

DC Reactor

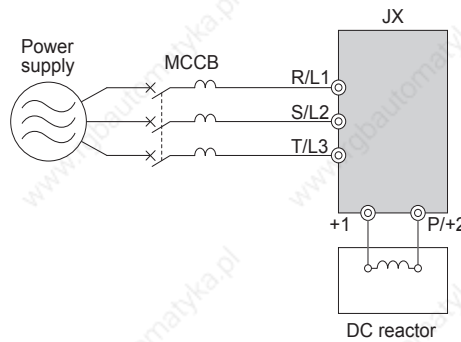

200 V class				400 V class			
Max. applicable motor output kW	Reference	Current value A	Inductance mH	Max. applicable motor output kW	Reference	Current value A	Inductance mH
0.2	AX-RC21400016-DE	1.6	21.4	-	-	-	-
0.4	AX-RC10700032-DE	3.2	10.7	0.4	AX-RC43000020-DE	2.0	43.0
0.7	AX-RC06750061-DE	6.1	6.75	0.7	AX-RC27000030-DE	3.0	27.0
1.5	AX-RC03510093-DE	9.3	3.51	1.5	AX-RC14000047-DE	4.7	14.0
2.2	AX-RC02510138-DE	13.8	2.51	2.2	AX-RC10100069-DE	6.9	10.1
3.7	AX-RC01600223-DE	22.3	1.60	4.0	AX-RC06400116-DE	11.6	6.40
5.5	AX-RC01110309-DE	30.9	1.11	5.5	AX-RC04410167-DE	16.7	4.41
7.5	AX-RC00840437-DE	43.7	0.84	7.5	AX-RC03350219-DE	21.9	3.35

Output AC Reactor

200 V class				400 V class			
Max. applicable motor output kW	Reference	Current value A	Inductance mH	Max. applicable motor output kW	Reference	Current value A	Inductance mH
0.1 to 0.4	AX-RAO11500026-DE	2.6	11.50	0.4 to 1.5	AX-RAO16300038-DE	3.8	16.30
0.75	AX-RAO07600042-DE	4.2	7.60	2.2	AX-RAO11800053-DE	5.3	11.80
1.5	AX-RAO04100075-DE	7.5	4.10	4.0	AX-RAO07300080-DE	8.0	7.30
2.2	AX-RAO03000105-DE	10.5	3.00	5.5	AX-RAO04600110-DE	11.0	4.60
3.7	AX-RAO01830160-DE	16.0	1.83	7.5	AX-RAO03600160-DE	16.0	3.60
5.5	AX-RAO01150220-DE	22.0	1.15	-	-	-	-
7.5	AX-RAO00950320-DE	32.0	0.95	-	-	-	-

Ordering information

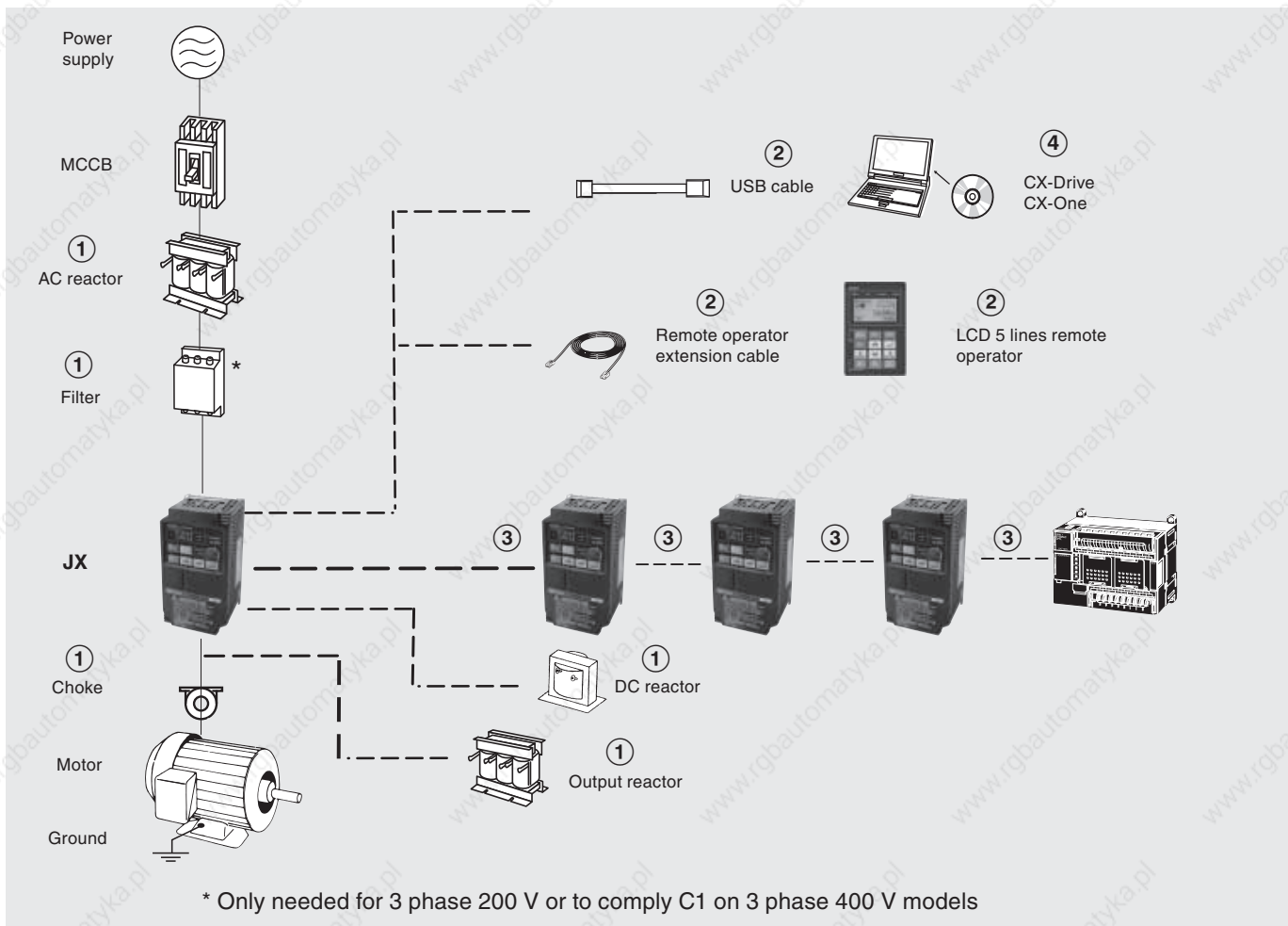

3G3JX

Specifications			Model
Voltage class	Max. applicable motor output kW	Rated output current (A)	Standard
Single-phase 200 V	0.2	1.4	3G3JX-AB002-EF
	0.4	2.6	3G3JX-AB004-EF
	0.75	4	3G3JX-AB007-EF
	1.5	7.1	3G3JX-AB015-EF
	2.2	10	3G3JX-AB022-EF
Three-phase 200 V	0.2	1.4	3G3JX-A2002-E
	0.4	2.6	3G3JX-A2004-E
	0.75	4	3G3JX-A2007-E
	1.5	7.1	3G3JX-A2015-E
	2.2	10	3G3JX-A2022-E
	3.7	15.9	3G3JX-A2037-E
	5.5	24	3G3JX-A2055-E
Three-phase 400 V	0.4	1.5	3G3JX-A4004-EF
	0.75	2.5	3G3JX-A4007-EF
	1.5	3.8	3G3JX-A4015-EF
	2.2	5.5	3G3JX-A4022-EF
	4.0	8.6	3G3JX-A4040-EF
	5.5	13	3G3JXA4055-EF
	7.5	16	3G3JXA4075-EF

① Line filters

Inverter		Line filter Rasmi		
Voltage	Model 3G3JX-□	Reference	Rated current (A)	Weight (kg)
1-Phase 200 VAC	AB002 / AB004	AX-FIJ1006-RE	6	0.5
	AB007	AX-FIJ1010-RE	10	0.6
	AB015 / AB022	AX-FIJ1026-RE	26	0.8
3-Phase 200 VAC	A2002 / A2004 / A2007	AX-FIJ2006-RE	6	1.0
	A2015 / A2022 / A2037	AX-FIJ2020-RE	20	1.3
	A2055 / A2075	AX-FIJ2040-RE	40	2.3
3-Phase 400 VAC	A4004 / A4007 / A4015	AX-FIJ3005-RE	5	0.9
	A4022 / A4040	AX-FIJ3011-RE	11	1.1
	A4055 / A4075	AX-FIJ3020-RE	20	1.7

① Input AC Reactors

Inverter		AC Reactor
Voltage	Model 3G3JX-□	Reference
3-Phase 200 VAC	A2002 / A2004 / A2007	AX-RAI02800080-DE
	A2015 / A2022 / A2037	AX-RAI00880175-DE
	A2055 / A2075	AX-RAI00350335-DE
1-Phase 200 VAC	AB002 / AB004	Under development
	AB007	
	AB015 / AB022	
3-Phase 400 VAC	A4004 / A4007 / A4015	AX-RAI07700042-DE
	A4022 / A4040	AX-RAI03500090-DE
	A4055 / A4075	AX-RAI01300170-DE

① DC Reactors

200V single phase		200V 3-phase		400V 3-phase	
Inverter	DC Reactor	Inverter	DC Reactor	Inverter	DC Reactor
3G3JX-AB002	AX-RC10700032-DE	3G3JX-A2002	AX-RC21400016-DE	-	-
3G3JX-AB004	AX-RC06750061-DE	3G3JX-A2004	AX-RC10700032-DE	3G3JX-A4004	AX-RC43000020-DE
3G3JX-AB007	AX-RC03510093-DE	3G3JX-A2007	AX-RC06750061-DE	3G3JX-A4007	AX-RC27000030-DE
3G3JX-AB015	AX-RC02510138-DE	3G3JX-A2015	AX-RC03510093-DE	3G3JX-A4015	AX-RC14000047-DE
3G3JX-AB022	AX-RC01600223-DE	3G3JX-A2022	AX-RC02510138-DE	3G3JX-A4022	AX-RC10100069-DE
-	-	3G3JX-A2037	AX-RC01600223-DE	3G3JX-A4040	AX-RC06400116-DE
-	-	3G3JX-A2055	AX-RC01110309-DE	3G3JX-A4055	AX-RC04410167-DE
-	-	3G3JX-A2075	AX-RC00840437-DE	3G3JX-A4075	AX-RC03350219-DE

① Chokes

Model	Diameter	Description
AX-FER2102-RE	21	For 2.2 KW motors or below
AX-FER2515-RE	25	For 7.5 KW motors or below

① Output AC Reactors

Inverter		AC Reactor
Voltage	Model 3G3JX-□	Reference
200 VAC	A2001 / A2002 / A2004 AB001 / AB002 / AB004	AX-RAO11500026-DE
	A2007/AB007	AX-RAO07600042-DE
	A2015 / AB015	AX-RAO04100075-DE
	A2022 / AB022	AX-RAO03000105-DE
	A2037	AX-RAO01830160-DE
	A2055	AX-RAO01150220-DE
	A2075	AX-RAO00950320-DE
400 VAC	A4004 / A4007 / A4015	AX-RAO16300038-DE
	A4022	AX-RAO11800053-DE
	A4040	AX-RAO07300080-DE
	A4055	AX-RAO04600110-DE
	A4075	AX-RAO03600160-DE

② Accessories

Types	Model	Description	Functions
Digital operator	AX-OP05-E	LCD remote operator	5 Line LCD remote operator with copy function, cable length max. 3m. *1
	3G3AX-CAJOP300-EE	Remote operator cable	3 meters cable for connecting remote operator
	3G3AX-OP01	LED remote operator	LED remote operator, cable length max. 3m
	4X-KITMINI	Mounting kit for LED operator	Mounting kit for LED operator on panel
Accessories	3G3AX-PCACN2	USB converter / USB cable	RJ45 to USB connection cable
	3G3AX-CTB020-EE	RJ45 T-Branch cable	T cable for RS-422 connection
	3G3AX-CTR150-EE	RJ45 Terminator resistor	Terminator resistor for RS-422 connection

*1 Please note, for 3G3JX inverters models, the operator will only display 2 lines of text.

④ Computer software

Types	Model	Description	Installation
Software	CX-Drive	Computer software	Configuration and monitoring software tool
	CX-One	Computer software	Configuration and monitoring software tool
	€Saver	Computer software	Software tool for Energy Saving calculation

ALL DIMENSIONS SHOWN ARE IN MILLIMETERS.

To convert millimeters into inches, multiply by 0.03937. To convert grams into ounces, multiply by 0.03527.

OMRON EUROPE B.V. Wegalaan 67-69, NL-2132 JD, Hoofddorp, Holandia. Tel: +31 (0) 23 568 13 00 Fax: +31 (0) 23 568 13 88 www.industrial.omron.eu

POLSKA

OMRON ELECTRONICS Sp. z o.o.

ul. Cybernetyki 7A
Budynek LUMINAR
01-001 Warszawa
Tel. +48 22 458 66 66
Fax. +48 22 458 66 60
www.industrial.omron.pl

Austria

Tel: +43 (0) 2236 377 800
www.industrial.omron.at

Belgia

Tel: +32 (0) 2 466 24 80
www.industrial.omron.be

Dania

Tel: +45 43 44 00 11
www.industrial.omron.dk

Finlandia

Tel: +358 (0) 207 464 200
www.industrial.omron.fi

Francja

Tel: +33 (0) 1 56 63 70 00
www.industrial.omron.fr

Hiszpania

Tel: +34 913 777 900
www.industrial.omron.es

Holandia

Tel: +31 (0) 23 568 11 00
www.industrial.omron.nl

Niemcy

Tel: +49 (0) 2173 680 00
www.industrial.omron.de

Norwegia

Tel: +47 (0) 22 65 75 00
www.industrial.omron.no

Portugalia

Tel: +351 21 942 94 00
www.industrial.omron.pt

Republika Czeska

Tel: +420 234 602 602
www.industrial.omron.cz

Republika Południowej Afryki

Tel: +27 (0)11 579 2600
www.industrial.omron.co.za

Rosja

Tel: +7 495 648 94 50
www.industrial.omron.ru

Szwajcaria

Tel: +41 (0) 41 748 13 13
www.industrial.omron.ch

Szwecja

Tel: +46 (0) 8 632 35 00
www.industrial.omron.se

Turcja

Tel: +90 212 467 30 00
www.industrial.omron.com.tr

Węgry

Tel: +36 1 399 30 50
www.industrial.omron.hu

Wielka Brytania

Tel: +44 (0) 870 752 08 61
www.industrial.omron.co.uk

Włochy

Tel: +39 02 326 81
www.industrial.omron.it

Inne przedstawicielstwa

firmy Omron
www.industrial.omron.eu

Systemy automatyki

- Programowalne sterowniki logiczne (PLC) • Panele operatorskie (HMI) • Zdalne moduły We/Wy
- Przemysłowe komputery PC • Oprogramowanie

Sterowniki i napędy

- Kontrolery ruchu • Serwonapędy • Falowniki • Roboty

Komponenty sterujące

- Regulatory temperatury • Zasilacze • Przełączniki czasowe • Liczniki
- Przełączniki programowalne • Cyfrowe wskaźniki panelowe
- Przełączniki elektromechaniczne • Przełączniki monitorująco-kontrolne
- Przełączniki półprzewodnikowe • Wyłączniki krańcowe • Przyciski
- Niskonapięciowa aparatura przełączająca

Czujniki i urządzenia bezpieczeństwa

- Czujniki fotoelektryczne • Czujniki indukcyjne • Czujniki ciśnienia i pojemnościowe
- Kable połączeniowe • Czujniki przemieszczania i pomiaru szerokości
- Systemy wizyjne • Sieci bezpieczeństwa • Czujniki bezpieczeństwa
- Moduły bezpieczeństwa/moduły przełącznikowe • Zamki bezpieczeństwa/zamki ryglujące