



GE Fanuc Automation

Computer Numerical Control Products

***α Series Control Motor Amplifier
Servo Amplifier Unit***

Maintenance Manual

GFZ-65195EN/01

August 1995

PREFACE

This manual provides information necessary for maintenance of the FANUC Control Motor Amplifier α series (servo amplifier units SVU and SVUC). There are two servo amplifier unit types, as listed below.

Name	Designation	Remark
SVU	A06B-6089-H***	<ul style="list-style-type: none"> The specification of this type is partly different from that of the C series servo amplifier. Conforms to VDE0160.
SVUC	A06B-6090-H***	<ul style="list-style-type: none"> This type is designed to satisfy the compatibility with the C series servo amplifier. Does not conform to VDE0160.

Part I describes the procedure to start up the servo amplifier unit. Part II describes the error recovery procedure.

Part III describes the cautions that should be observed in switching from the C series servo amplifier to the α series servo amplifier unit SVU or SVUC.

This document uses the abbreviations listed below.

Model	Abbreviation
A06B-6089-H***	SVU
A06B-6090-H***	SVUC
FANUC Series <input type="checkbox"/>	FS- <input type="checkbox"/>
FANUC Power Mate MODEL <input type="checkbox"/>	PM- <input type="checkbox"/>

In this manual, the servo parameter numbers are arranged as shown below.

Examples

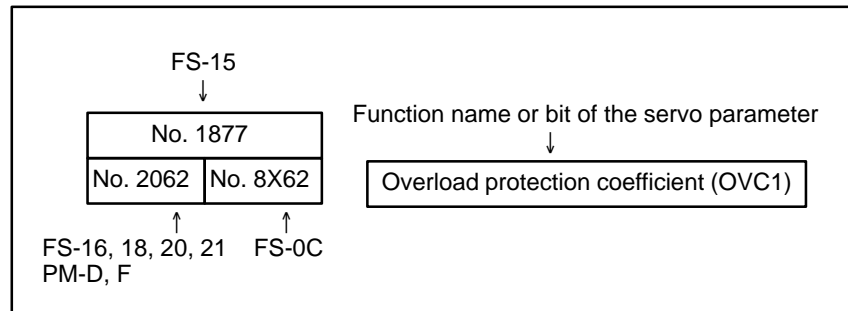

In addition to this manual, those listed below are provided for the FANUC Control Motor Amplifier α series (servo amplifier unit).

- 1) FANUC CONTROL MOTOR AMPLIFIER α series
SERVO AMPLIFIER UNIT DESCRIPTIONS B-65192EN
- 2) FANUC AC SERVO MOTOR α series
DESCRIPTIONS B-65142E
- 3) FANUC AC SERVO MOTOR α series
PARAMETER MANUAL B-65150E

IMPORTANT

When maintaining or inspecting the servo amplifiers, keep the power supply switched off.
Also make sure that the “CHARGING” LED (red) beside the circuit breaker on the front panel of the servo amplifier is off.
(See Appendix A.)

I. START-UP PROCEDURE

1. OVERVIEW	3
2. CONFIGURATION	4
2.1 BASIC CONFIGURATION	5
2.2 MAJOR COMPONENTS	6
2.2.1 SVU	6
2.2.2 SVUC	7
3. START-UP PROCEDURE	8
3.1 OVERVIEW OF THE START-UP PROCEDURE	9
3.2 CONNECTING THE POWER SUPPLY	10
3.2.1 Confirming the Line Voltage and Power Requirements	10
3.2.2 Connecting to the Protection Ground	10
3.2.3 Leakage Current and Selecting a Ground Fault Interrupter	10
3.3 SWITCH SETTING	12
3.4 CONNECTING THE BATTERY FOR AN ABSOLUTE PULSE CODER	14
3.5 CONNECTING THE SEPARATE REGENERATIVE DISCHARGE UNIT	15
3.6 INITIALIZING SERVO PARAMETERS	18
4. OPERATION CONFIRMATION METHOD	25
4.1 CONFIRMATION PROCEDURE	26
4.2 SERVO AMPLIFIER UNIT CHECK PINS	27
4.2.1 Checking the +5V Power Supply Voltage	27
4.2.2 Checking the Motor Instantaneous Current	27
4.3 STATUS INDICATOR	29
5. AXIS LEFT UNUSED IN A MULTI-AXIS AMPLIFIER	30
6. SERVO CHECK BOARD	31

II. TROUBLESHOOTING AND RECOVERY

1. OVERVIEW	37
2. ALARM NUMBER AND BRIEF DESCRIPTIONS	38
2.1 ALARM NUMBER IN SERIES 15 (SERVO ALARMS)	39
2.2 ALARM NUMBER IN SERIES 0-C (SERVO ALARMS)	40
2.3 ALARM NUMBER IN SERIES 16, 18, 20 (SERVO ALARMS)	41
3. TROUBLESHOOTING AND RECOVERY PROCEDURES	42
3.1 SERVO AMPLIFIER UNIT	43
3.1.1 LED Indications and Meanings	43
3.1.2 Actions to be Taken on Each Alarm	44
3.2 CURRENT CONVERSION FAILURE ALARM	48
3.3 SERVO SOFTWARE	49

3.3.1	Servo Adjustment Screen	49
3.3.2	Overload Alarm	50
3.3.3	Feedback Disconnected Alarm	50
3.3.4	Motor Overheat Alarm	51
3.3.5	Invalid Servo Parameter Setting Parameters	51
3.3.6	Pulse Coder Error Alarm	57
3.3.7	Rotation Speed Data Error Alarm	57
3.3.8	Pulse Coder Communication Error Alarm	58
4.	REPLACING THE FUSE	59
III.	COMPATIBILITY OF THE SVU AND SVUC WITH THE C SERIES AMPLIFIER	
1.	OVERVIEW	63
2.	COMPATIBILITY OF THE SVU AND SVUC WITH THE C SERIES AMPLIFIER	64
3.	SVUC SPECIFICATION CODE	66
APPENDIX		
A.	SERVO AMPLIFIER UNIT FRONT PANEL	69
B.	MOTOR GROUNDING CONNECTION	70

I. START-UP PROCEDURE

1

OVERVIEW



This part provides information necessary to confirm the system configuration and start up the servo amplifier units :

- Configuration
- Start- up procedure
- Operation confirmation procedure

2 CONFIGURATION



2.1 BASIC CONFIGURATION

The basic configuration is shown below.

Refer to “FANUC CONTROL MOTOR AMPLIFIER α Series (SERVO AMPLIFIER UNIT) Descriptions” (B-65192EN) for detail.

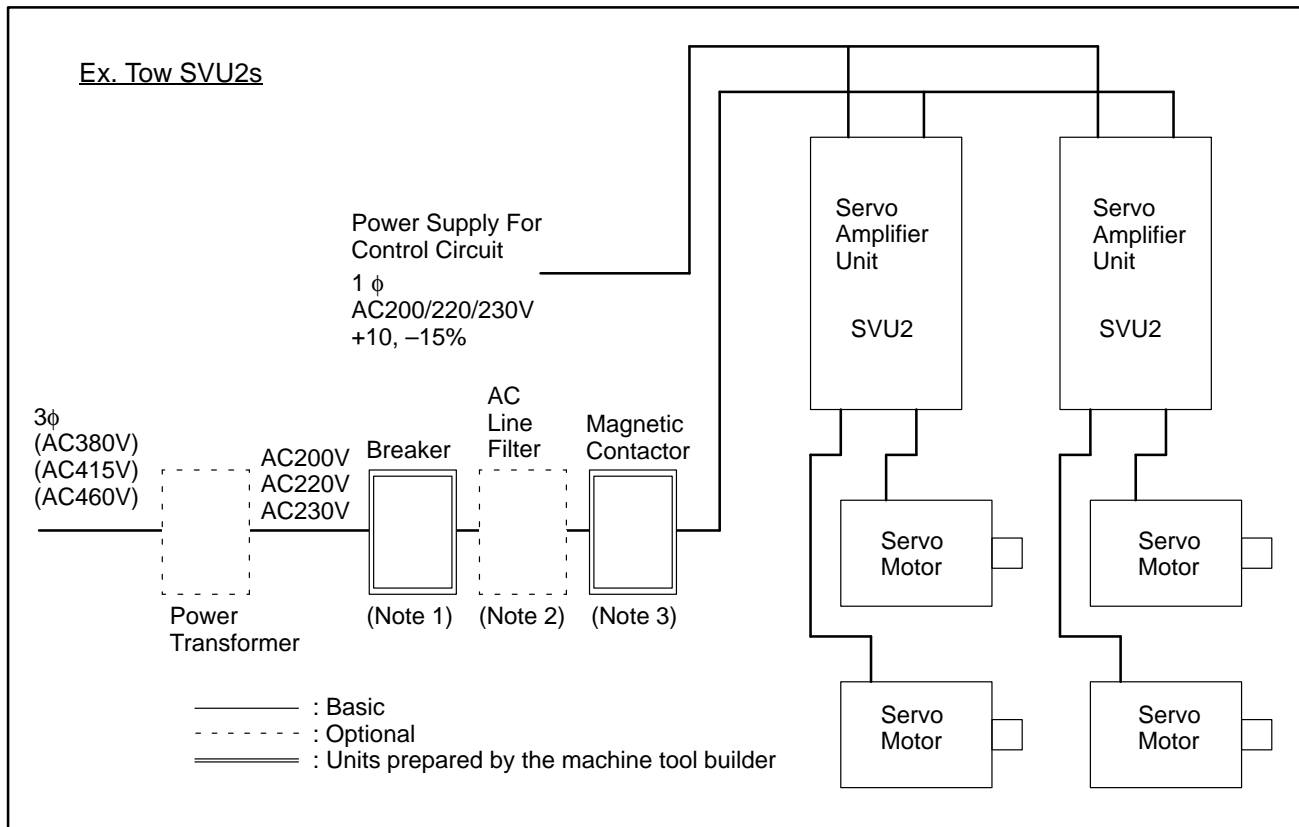

Notes

- 1 This circuit breaker is intended to protect the power cord and related equipment. A circuit breaker to protect a servo amplifier unit is provided within the servo amplifier unit.
- 2 This AC line filter should always be used, so influence by harmonic noise to the power supply can be reduced. When the line voltage is out of specification, and a power transformer (isolation type) is used, the AC line filter can be omitted.
If the AC line filter is ineffective in making the servo amplifier unit satisfy EMC standards, use an appropriate commercial noise filter.
- 3 The magnetic contactor is required if it is necessary to qualify for European CE marking.
- 4 When using the SVU, install a surge absorber between the power lines and between a power line and a ground line at the entrance of the power magnetic cabinet in order to protect the equipment from a surge voltage. For the SVUC, it is unnecessary to install an external surge absorber because the SVUC has a built-in surge absorber as the C series amplifier.

2.2 MAJOR COMPONENTS

2.2.1 SVU

(1) SVU 1

Model	Oder specification	Wiring board specification	P. C. B. specification	Remark
SVU1-12	A06B-6089-H101	A16B-2202-0950	A20B-2002-0030	
SVU1-20	A06B-6089-H102	A16B-2202-0951		
SVU1-40	A06B-6089-H104	A20B-2002-0040	A20B-2002-0031	
SVU1-80	A06B-6089-H105	A20B-2002-0041		
SVU1-130	A06B-6089-H106	A20B-2002-0050		

(2) SVU 2

Model	Oder specification	Wiring board specification	P. C. B. specification	Remark
SVU2-12/12	A06B-6089-H201	A20B-2002-0060	A20B-2002-0032	
SVU2-12/20	A06B-6089-H202	A20B-2002-0061		
SVU2-20/20	A06B-6089-H203	A20B-2002-0062		
SVU2-12/40	A06B-6089-H204	A20B-2002-0063		
SVU2-20/40	A06B-6089-H205	A20B-2002-0064		
SVU2-40/40	A06B-6089-H206	A20B-2002-0065		
SVU2-40/80	A06B-6089-H207	A20B-2002-0066		
SVU2-80/80	A06B-6089-H208	A20B-2002-0067		
SVU2-12/80	A06B-6089-H209	A20B-2002-0068		
SVU2-20/80	A06B-6089-H210	A20B-2002-0069		

2.2.2 SVUC

(1) SVUC 1

Model	Oder specification	Wiring board specification	P. C. B. specification	Remark
SVUC1-4	A06B-6090-H002	A16B-2202-0955	A20B-2002-0030 /03B or later	
SVUC1-12	A06B-6090-H003	A16B-2202-0956		
SVUC1-40	A06B-6090-H004	A20B-2002-0045	A20B-2002-0031 /03B or later	
SVUC1-80	A06B-6090-H006	A20B-2002-0047		
SVUC1-130	A06B-6090-H008	A20B-2002-0055		

(2) SVUC 2

Model	Oder specification	Wiring board specification	P. C. B. specification	Remark
SVUC2-4/4	A06B-6090-H222	A20B-2002-0151	A20B-2002-0032 /03B or later	
SVUC2-4/12	A06B-6090-H223	A20B-2002-0152		
SVUC2-4/40	A06B-6090-H224	A20B-2002-0153		
SVUC2-12/12	A06B-6090-H233	A20B-2002-0154		
SVUC2-12/40	A06B-6090-H234	A20B-2002-0155		
SVUC2-12/80	A06B-6090-H236	A20B-2002-0156		
SVUC2-40/40	A06B-6090-H244	A20B-2002-0157		
SVUC2-40/80	A06B-6090-H246	A20B-2002-0158		
SVUC2-80/80	A06B-6090-H266	A20B-2002-0159		

3

START-UP PROCEDURE



3.1 OVERVIEW OF THE START-UP PROCEDURE

Start-up procedure

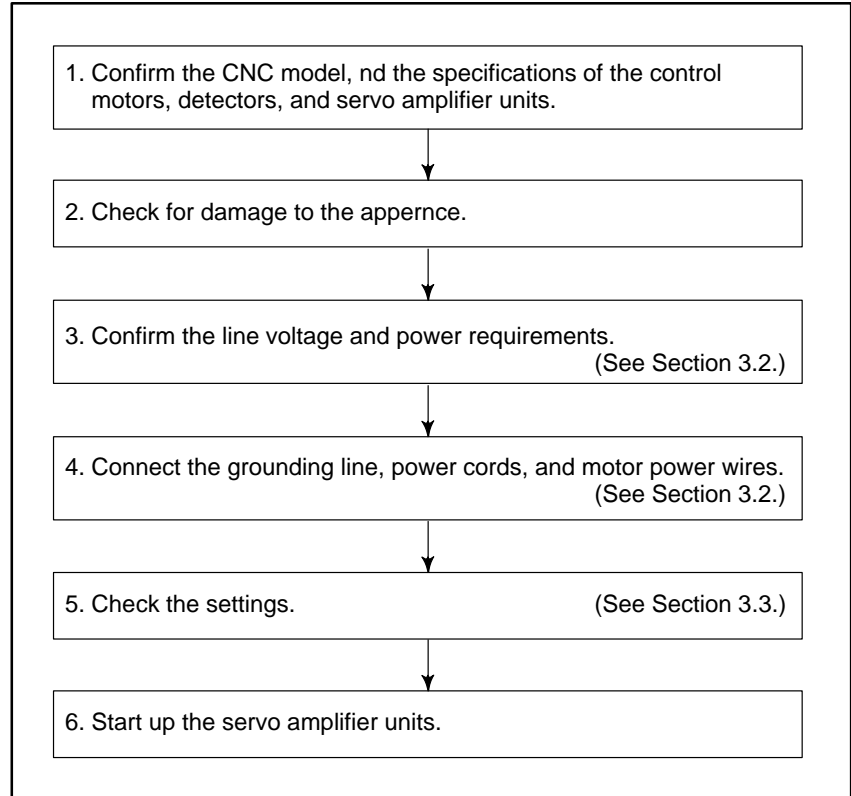

3.2 CONNECTING THE POWER SUPPLY

3.2.1 Confirming the Line Voltage and Power Requirements

- (1) Line voltage
Before connecting the power source to the machine, check the voltage of the power source.

Item	Specification
Three-phase input for power	Voltage 200/220/230 VAC+10%, -15% Frequency 50Hz, 60Hz \pm 2Hz Voltage deviation due to load (at maximum output) shall be 7% or less.
Single-phase input for control power	Voltage 200/220/230 VAC+10%, -15% Frequency 50Hz, 60Hz \pm 2Hz
Single-phase input for ESP of SVUC	[Voltage 100VAC +10%, -15% Frequency 50Hz \pm 2Hz OR [Voltage 100/110VAC +10%, -15% Frequency 60Hz \pm 2Hz)

- (2) Power requirements
- The power requirement of the servo amplifier unit is the sum of the power requirements of individual servo motors.
 - When servo motor accelerates or decelerates rapidly, it may require power twice as much as the continuous rating momentarily. Check on the input voltage required when more than one servo motor accelerates or decelerates simultaneously, and keep the voltage above 170 VAC.
 - Refer to Chapter 5 of “SERVO AMPLIFIER UNIT Descriptions” (B-65192EN) for details of the power requirements.
- (3) When motor power and control power are input separately from each other. When supplying motor power and control power separately from each other, be sure to remove a jumper connecting L1C and L1, and a jumper connecting L2C and L2. (These jumpers have been factory-installed.)

3.2.2 Connecting to the Protection Ground

When it is necessary to make a motor operating with the SVU qualify for European CE marking, ground the motor using the accessory plate terminal.

Note that installing more than one protection ground line with single screw makes it impossible for the motor to qualify for European CE marking. (See Appendix NO TAG.)

3.2.3 Leakage Current and Selecting a Ground Fault Interrupter

Because the drive circuit for the servo amplifier unit operates by pulse width modulation control system using IGBTs, high-frequency leakage current flows from the motor windings and power lines to the ground through stray capacitance. This leakage current may cause the ground fault interrupter or leakage protection relay installed in the power line on the power supply side to malfunction. So they must have a measure against influence from inverters so that they do not malfunction.

- (1) Leakage current from the motor
Determine the leakage current from each motor according to the table below.

Motor model	Leakage current of commercial power frequency component
$\alpha 0.5$ to $\alpha 6$	1.8 mA
$\alpha 12$ to $\alpha 22$	2.0 mA
$\alpha 30$ to $\alpha 40$	2.5 mA

3.3 SWITCH SETTING

There are four channel switches above the 7-segment LED behind the terminal board cover on the front of the servo amplifier. These switches should be set as described below before use of the servo amplifier.

(1) Positions

The switches are sequentially numbered 1, 2, 3, and 4 with the one at the bottom as switch 1. The OFF position is on the left, and the ON position on the right.

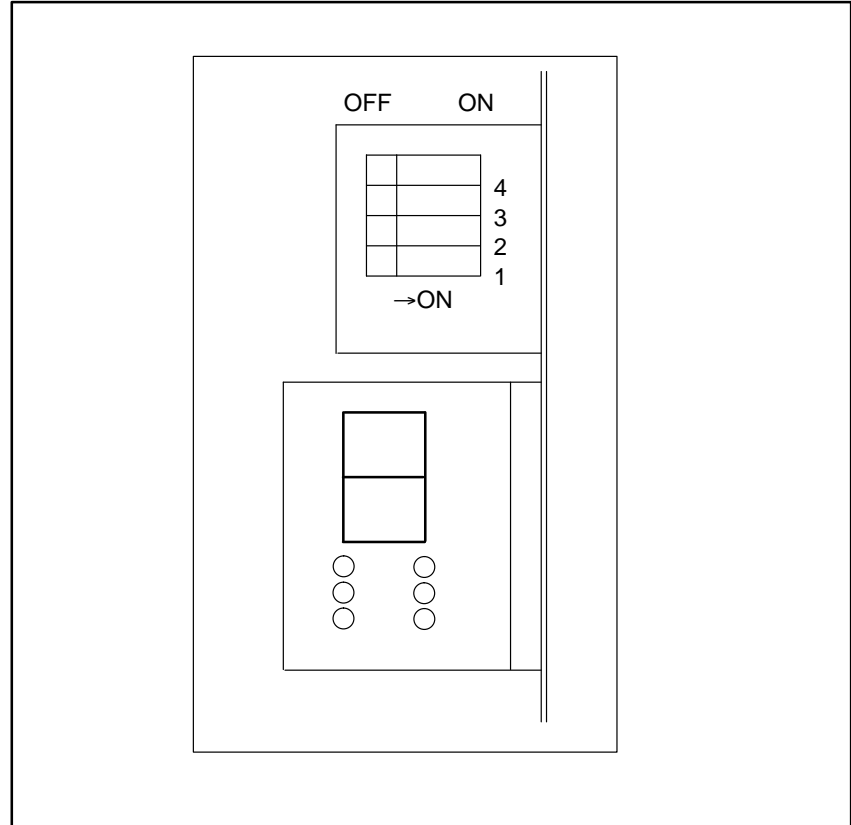

(2) Switch 1 setting

The setting of switch 1 varies with the interface type used between the NC and servo amplifier.

- If the setting is incorrect, an alarm occurs.
- If the load is light, the motor may keep running.

ON	Type B interface
OFF	Type A interface

- The following NC unit has the type interface.
FS-0C, FS-15A, FS-15B, FS-16A, FS-16B, FS-18A, FS-21TA, PM-D, PM-F
- The following NC unit has the type B interface.
FS-20, FS-21TB, FS-21GA, FS-16B, FS-18B, PM-H

(3) Switch 2 setting

For the SVU, set switch 2 to off.
For the SVUC, set switch 2 to on.

- If the setting is incorrect, the VRDY OFF alarm may occur.

(4) Switch 3 and 4 setting

The setting varies depending on the regenerative discharge resistance used.

→ If the setting is incorrect, the regenerative discharge control circuit failure alarm (DCSW) cannot be detected correctly.

● SVU1- (12, 20)

3	4	Regenerative Discharge Resistor
ON	ON	Built-in
ON	OFF	Separate A06B-6089-H510
OFF	OFF	Separate A06B-6089-H500

● SVUC1- (4, 12)

3	4	Regenerative Discharge Resistor
ON	ON	Built-in

● SVU1- (40, 80), SVU2-□/□
SVUC1- (40, 80), SVUC2-□/□

3	4	Regenerative Discharge Resistor
ON	ON	Built-in
ON	OFF	Separate A06B-6089-H500
OFF	OFF	Separate A06B-6089-H713 (800W), A06B-6089-H714 (1200W)

● SVU1-130
SVUC1-130

ON	ON	Built-in
ON	OFF	Separate A06B-6089-H711
OFF	OFF	Separate A06B-6089-H712

3.4 CONNECTING THE BATTERY FOR AN ABSOLUTE PULSE CODER

Use of an absolute pulse coder requires a battery. The way the battery is connected varies with the type (A or B) of the interface used between the NC and the servo amplifier unit.

- (1) Type A
The battery is connected on the NC side.
(Refer to the applicable NC manual for details.)
- (2) Type B
The battery is connected on the servo amplifier unit side.

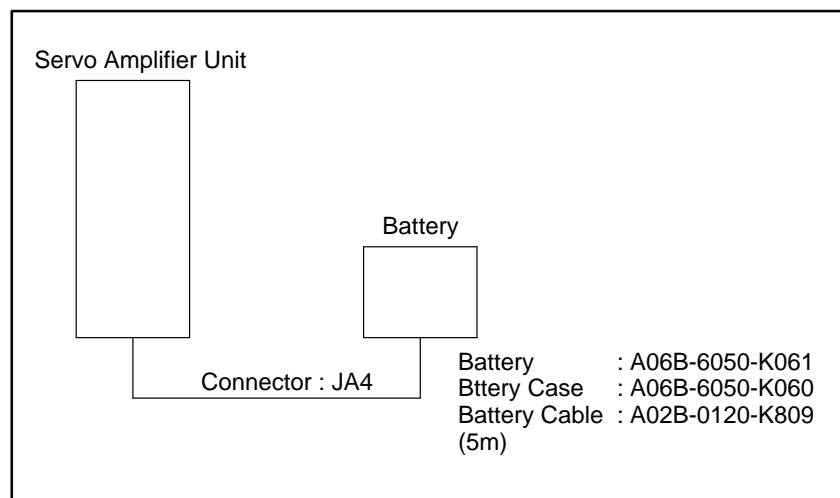

3.5 CONNECTING THE SEPARATE REGENERATIVE DISCHARGE UNIT

(1) Type

● For SVU

A06B-6089-H101 to H102 (16Ω/100W, with natural cooling)	A06B-6089-H510
A06B-6089-H101 to H105, H201 to H210 (16Ω/200W, with natural cooling)	A06B-6089-H500 (A06B-6066-H500) Note 1)
A06B-6089-H103 to H105, H201 to H210 (16Ω/800W, with cooling fan)	A06B-6089-H713 (A06B-6066-H713) Note 1)
A06B-6089-H103 to H105, H201 to H210 (16Ω/1200W, with cooling fan)	A06B-6089-H714 (A06B-6066-H714) Note 1)
A06B-6089-H106 (8Ω/800W, with cooling fan)	A06B-6089-H711 (A06B-6066-H711) Note 1)
A06B-6066-H106 (8Ω/1200W, with cooling fan)	A06B-6089-H712 (A06B-6066-H712) Note 1)

● For SVUC

A06B-6090-H004 to H006, H2** (16Ω/200W, with natural cooling)	A06B-6089-H500 (A06B-6066-H500) Note 1)
A06B-6090-H004 to H006, H2** (16Ω/800W, with cooling fan)	A06B-6089-H713 (A06B-6066-H713) Note 1)
A06B-6090-H004 to H006, H2** (16Ω/1200W, with cooling fan)	A06B-6089-H714 (A06B-6066-H714) Note 1)
A06B-6090-H008 (8Ω/800W, with cooling fan)	A06B-6089-H711 (A06B-6066-H711) Note 1)
A06B-6090-H008 (8Ω/1200W, with cooling fan)	A06B-6089-H712 (A06B-6066-H712) Note 1)

Notes

If it is unnecessary to conform to safety standards, separate regenerative discharge unit for the C series servo amplifier indicated in parentheses can be used in place of the formal model.

(2) Connecting

1. A06B-6089-H500, H510

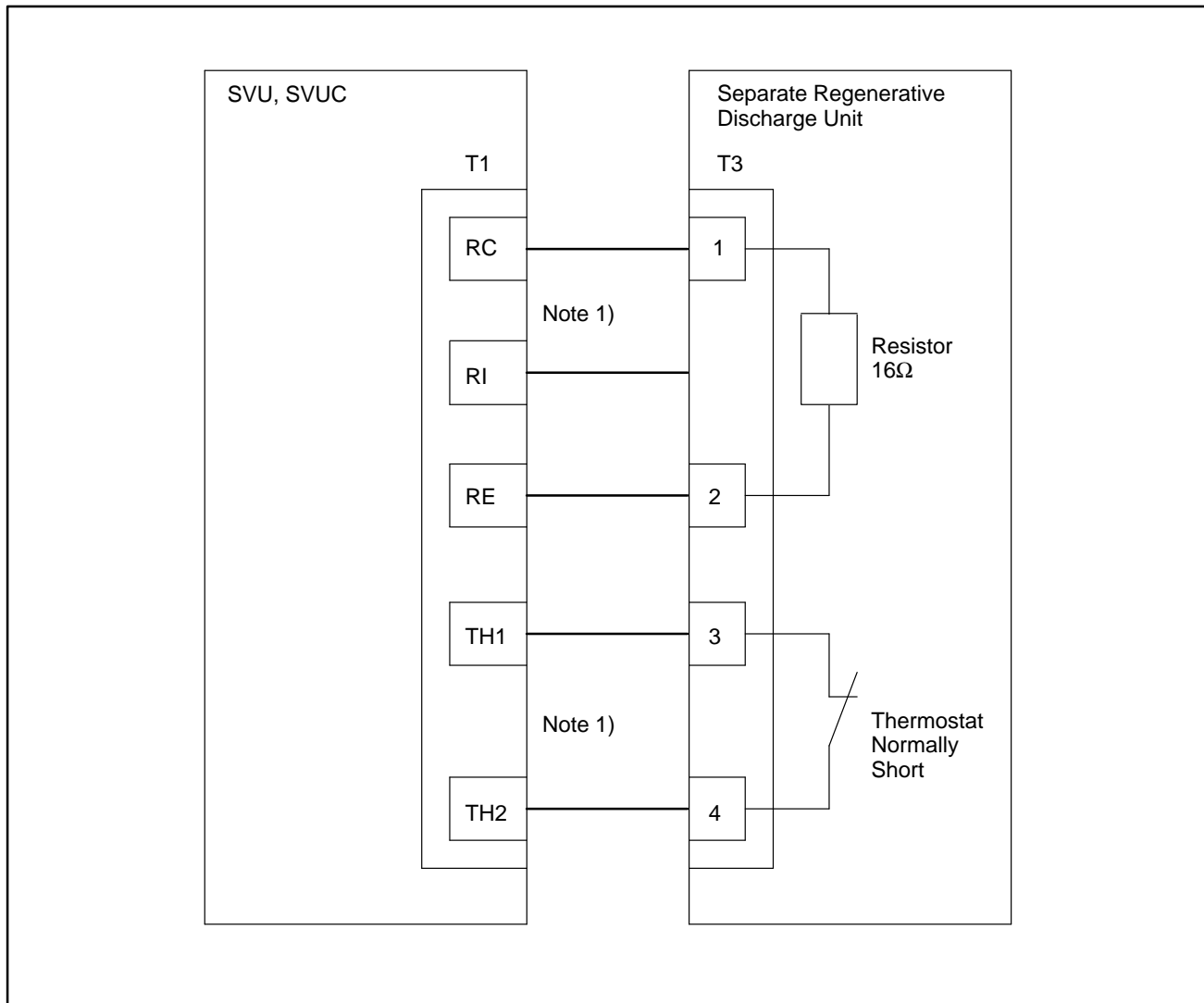
**Notes**

To connect a separate regenerative discharge unit, remove jumper connecting RC and RI and jumper connecting TH1 and TH2.
(These jumpers have been factory-installed.)

2. A06B-6089-H711, H712, H713, H714

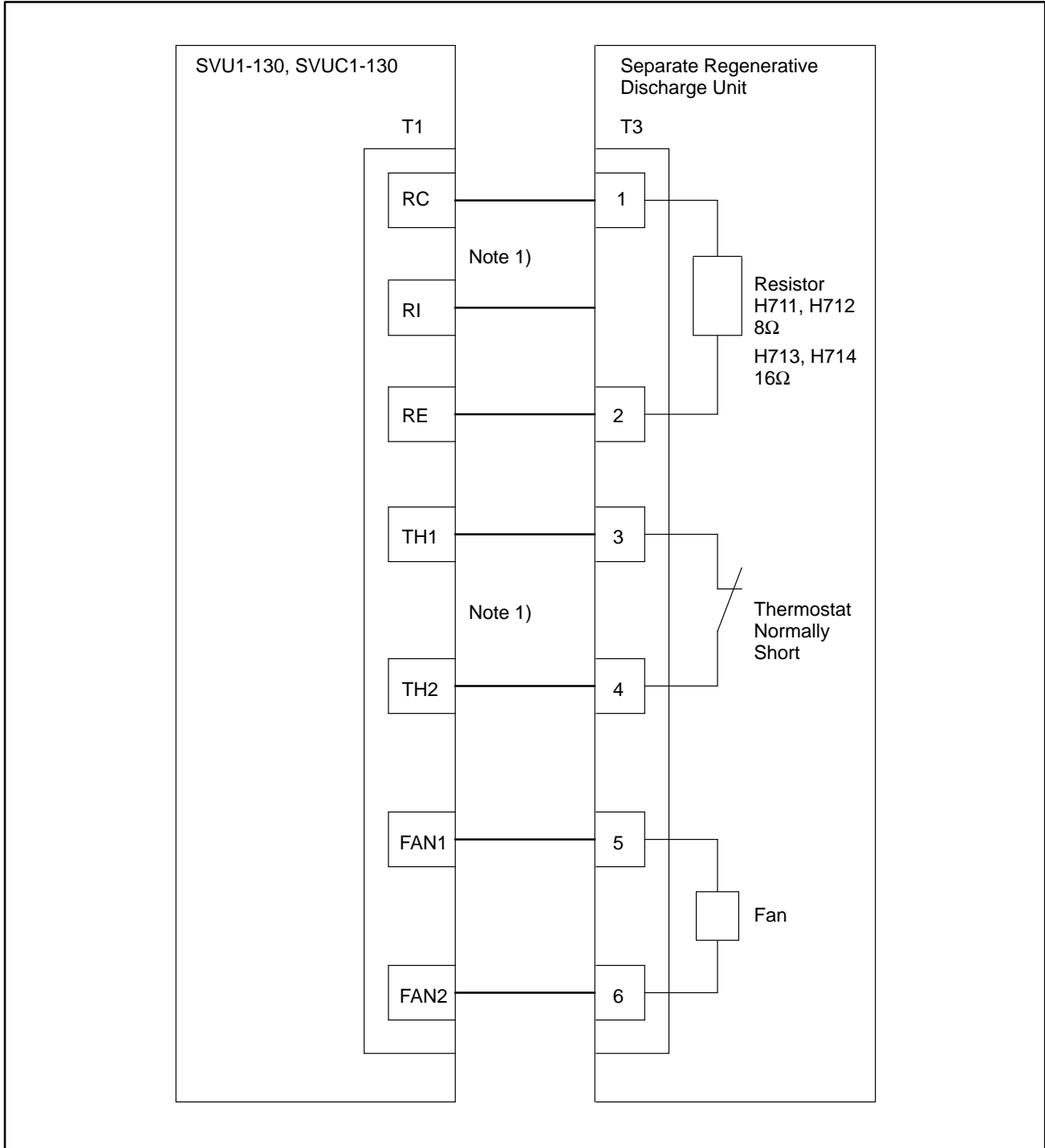

Notes

To connect separate regenerative discharge unit, remove jumper connecting RC and RI and jumper connecting TH1 and TH2.

3.6 INITIALIZING SERVO PARAMETERS

- (1) Before servo parameter initialization
Before starting servo parameter initialization, confirm the following:

1. NC model (Example: Series 15-B)
2. Servo motor model (Example: α 6/2000)
3. Pulse coder built in a motor (Example: α pulse coder)
4. Whether a separate position detector is used or not (Example: Not used)
5. Distance the machine tool moves per revolution of the motor (Example: 10 mm per one revolution)
6. Machine detection unit (Example: 0.001 mm)
7. NC command unit (Example: 0.001 mm)

- (2) Servo parameter initialization procedure

1. Switch on the NC in an emergency stop state.
Enable parameter writing (PWE = 1).

2. Initialize servo parameters on the servo setting screen.

To display the servo setting screen, follow the procedure below, using the key on the NC.

- Series 15

Press the SERVICE key several times, and the servo setting screen will appear.

- Series 16, 18, 20, and 21

SYSTEM \Rightarrow [SYSTEM] \Rightarrow [\Rightarrow [SV-PRM]

If no servo screen appears, set the following parameter as shown, and switch the NC off and on again.

	b7	b6	b5	b4	b3	b2	b1	b0
3111								SVS

SVS (b0)=1 (to display the servo screen)

- Series 0-C

Press the PARAM key several times, and the servo setting screen will appear.

If no servo screen appears, set the following parameter as shown, and switch the NC off and on again.

	b7	b6	b5	b4	b3	b2	b1	b0
389								SVS

SVS (b0)=0 (to display the servo screen)

When the following menu appears on the screen, move the cursor to the item you want to set and enter data directly.

Servo set		01000	N0000
		X axis	Z axis
INITIAL SET BITS		00001010	00001011
Motor ID No.		16	16
AMR		00000000	00000000
CMR		2	2
Feed gear	N	1	1
	(N/M)	100	1
Direction Set		111	-111
Velocity Pulse No.		8192	819
Position Pulse No.		12500	1250
Ref. counter		10000	10000
Value SETTING =			

Servo setting menu

3. Start initializing

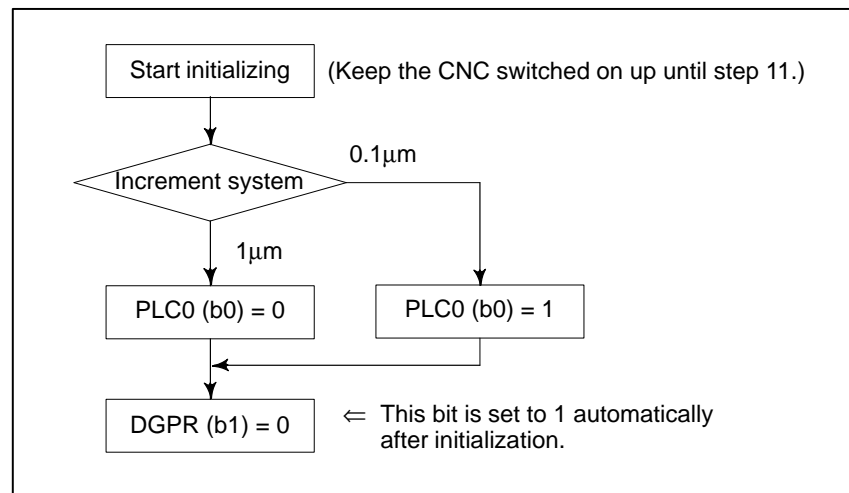
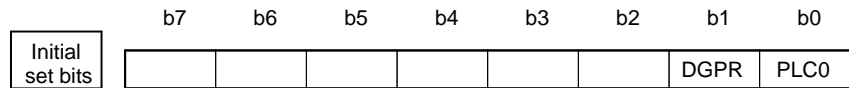

4. Specify the motor ID No.

Select the motor ID No. according to the model and specification (four digits in the middle segment of A06B-XXXX-BXXX) of your motor.

Motor model	α 12HV	α 22HV	α 30HV	α C3/2000	α C6/2000	α C12/2000	α C22/1500
Motor specification	0176	0177	0178	0142	0123	0127	0128
Motor type No.	3	4	5	7	8	9	10
α 0.5	α 3/3000	α 6/2000	α 6/3000	α 12/2000	α 12/3000	α 22/2000	α 22/3000
0142	0123	0127	0128	0142	0143	0147	0148
13	15	16	17	18	19	20	21
α 30/2000	α 30/3000	α M3/3000	α M6/3000	α M9/3000			
0152	0153	0161	0162	0163			
22	23	24	25	26			
α 22/1500	α 30/1200	α 40/2000 with FAN	α 40/2000 without FAN	E6/2000	E1/3000	E2/3000	
0146	0151	0158	0157	0106	0101	0102	
27	28	29	30	34	35	36	
α 2/2000	α L3/2000	α L6/3000	α L9/3000	α L25/3000	α L50/2000	α 1/3000	α 2/3000
0372	0561	0562	0564	0571	0572	0371	0373
46	56	57	58	59	60	61	62

5. Set AMR as described below. The setting does not depend on the model of the motor.

α pulse coder	00000000
----------------------	----------

6. Set CMR with the scale of a distance the NC instructs the machine to move.

CMR = Command unit/Detection unit

CMR 1/2 to 48	Setting value = CMR \times 2
---------------	--------------------------------

Usually, CMR=1, so specify 2.

7. Specify the flexible feed gear (F.FG). This function makes it easy to specify a detection unit for the leads and gear reduction ratios of various ball screws by changing the number of position feedback pulses from the pulse coder and separate detector.

Setting for the α pulse coder and serial pulse coder A in the semi-closed mode

$$\frac{\text{F.FG numerator } (\leq 32767)}{\text{F.FG denominator } (\leq 32767)} = \frac{\text{Number of position pulses necessary for each revolution of the motor}}{1000000} \quad (\text{as irreducible fraction})$$

(Note1)

NOTE1

For both F.FG numerator and denominator, the maximum setting value (after reduced) is 32767.

(Example of setting) For detection in 1 μm units, specify as follows:

Ball screw lead	Number of necessary position pulses	F&FG
10 (mm/rev)	10000 (pulses/rev)	1/100
20	20000	2/100 or 1/50
30	30000	3/100

(Example of setting)

If the machine is set to detection in 1,000 degree units with a gear reduction ratio of 100:1 for the rotation axis, the table rotates by 360/100 degrees each time the motor makes one turn. 1000 position pulses are necessary for the table to rotate through one degree. The number of position pulses necessary for the motor to make one turn is:

$$360/100 \times 1000 = 3600$$

$$\frac{\text{F.FG numerator}}{\text{F.FG denominator}} = \frac{3600}{1000000} = \frac{36}{100000}$$

Setting for use of a separate detector (full-closed)

$$\frac{\text{F.FG numerator } (\leq 32767)}{\text{F.FG denominator } (\leq 32767)} = \frac{\text{Number of position pulses necessary for the motor to make one turn}}{\text{Number of position pulses from the separate detector when the motor makes one turn}} \quad (\text{as irreducible fraction})$$

NOTE2

DMR can also be used with the separate position detector, provided that F.FG = 0.

(Example of setting) When the separate detector detects 1 μm for 10000 (pulses/rev)

Ball screw lead	Number of necessary position pulses	F&FG	DMR
1 (mm/rev)	1000 (pulses/rev)	1/10	–
5	5000	1/2	2
10	10000	1/1	4

8. Specify the direction in which the motor rotates.

111	Clockwise as viewed from the pulse coder
-111	Counterclockwise as viewed from the pulse coder

9. Specify the number of velocity pulses and the number of position pulses.

	Semi-closed		Full-closed	
	1	0.1	1	0.1
Command unit (μm)	1	0.1	1	0.1
Initialization bit	b0=0	b0=1	b0=0	b0=1
Number of velocity pulses	8192	819	8192	819
Number of position pulses	12500	1250	Np	Np/10

Np: Number of position pulses from the separate detector when the motor makes one turn

When using a separate detector (full-closed mode), also specify the following parameters:

- Series 15, 16, 18, 20, 21

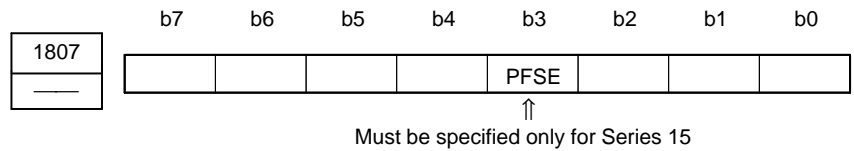

PFSE(b3) The separate position detector is:

- 0:Not used
- 1:Used

NOTE
This parameter is used only for Series 15.



OPTX(b1) The separate position detector is:

- 0:Not used
- 1:Used

NOTE
For Series 16, 18, 20, and 21, setting this parameter causes bit 3 of parameter No. 2002 to be set to 1 automatically.

- Series 0-C

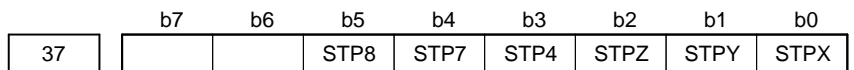

STPX to 8 The separate position detector is:

- 0:Not used for the X-axis, Y-axis, Z-axis, fourth axis, seventh axis, or eighth axis
- 1:Used for the X-axis, Y-axis, Z-axis, fourth axis, seventh axis, and eighth axis

10. Specify the reference counter. The reference counter is used in making a return to the reference position by a grid method. The value to be specified is the number of pulses necessary for the

motor to make one turn, or a value obtained by dividing the number by an integer.

(Example of setting)

α pulse coder, semi-closed (detection in 1 μ m units)

Ball screw lead	Number of necessary position pulses	Reference counter	Grid width
10mm/rev	10000pulses/rev	10000	10mm
20	20000	20000	20
30	30000	30000	30

11. Switch the NC off and on again.

This completes servo parameter initialization.

If a servo alarm related to pulse coders occurs for an axis for which a servo motor or amplifier is not connected, specify the following parameter.

1953		b7	b6	b5	b4	b3	b2	b1	b0
2009	8X09								SERD

SERD(b0) The serial feedback dummy function is:

0:Not used

1:Used

12. When you are going to use an α pulse coder as an absolute pulse coder, use the following procedure.

The procedure for setting absolute position communication using the α pulse coder is somewhat different from the procedure using serial pulse coder A.

1. Set the following parameter, and switch the CNC off.

– Series 15, 16, 18, 20, 21

1815		b7	b6	b5	b4	b3	b2	b1	b0
				APCX					

Bit 5 (APCX)

0:Does not perform as absolute position pulsecoder.

1:Performs absolute position as communication pulsecoder.

– Series 0-C

21		b7	b6	b5	b4	b3	b2	b1	b0
				APC8	APC7	APC4	APCZ	APCY	APCX

STPX to 8

0:Does not perform absolute position communication for the X-, Y-, Z-, 4-, 7-, or 8-axis.

1:Performs absolute position communication for the X-, Y-, Z-, 4-, 7-, or 8-axis.

2. After making sure that the battery for the pulse coder is connected, switch the NC on.

3. Absolute position communication is performed, and a request to return to the reference position is displayed.
4. Move motor more than one revolution by JOG Feed.
5. Turn off and on the CNC.

← These steps were added.

6. Absolute position communication is performed, and a request to return to the reference position is displayed.
7. Return to the reference position.

4

OPERATION CONFIRMATION METHOD



4.1 CONFIRMATION PROCEDURE

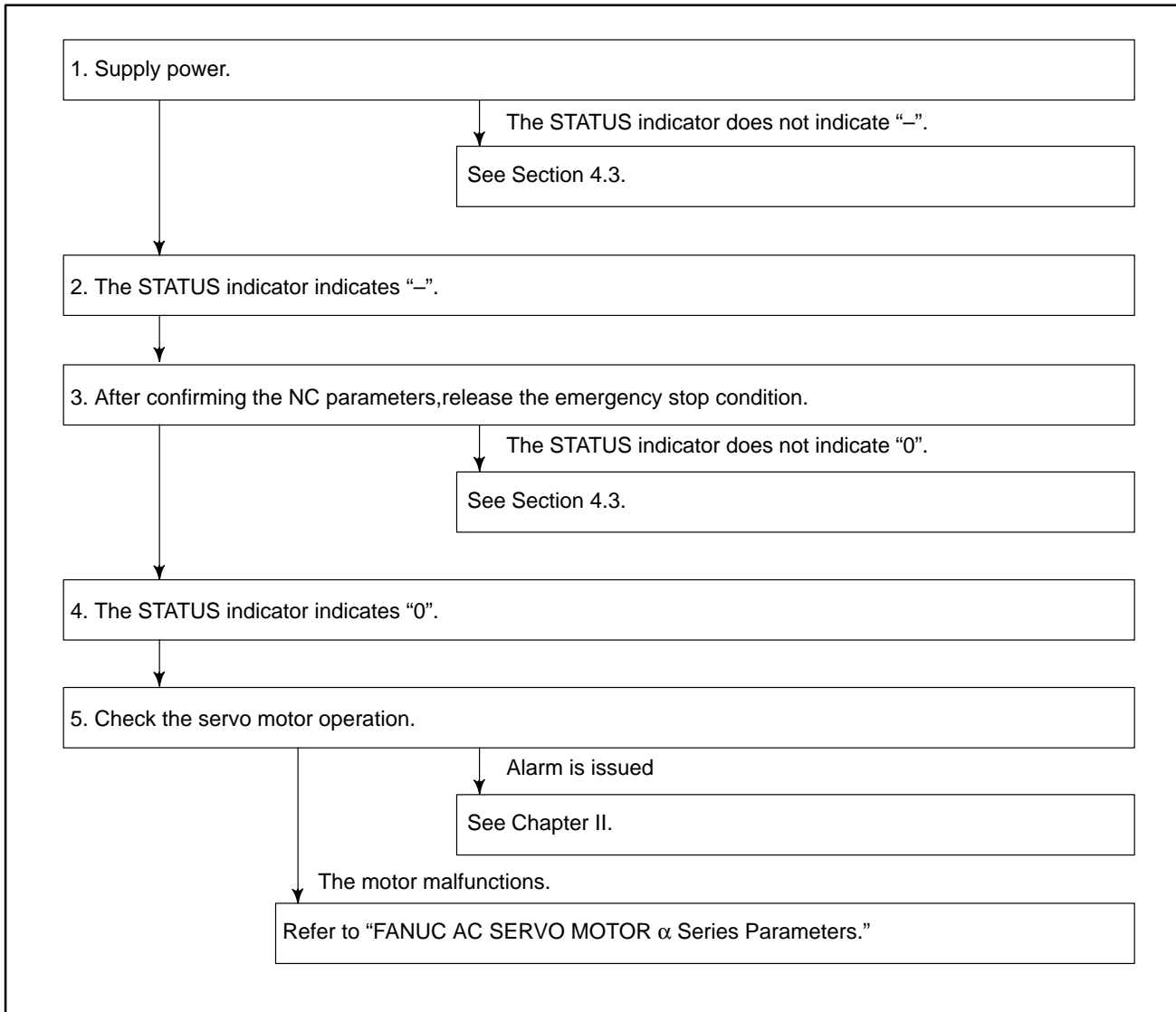

4.2 SERVO AMPLIFIER UNIT CHECK PINS

The check pins in the servo amplifier unit enable checking the control power supply voltage and motor current. There are six check pins in the servo amplifier unit. Open the terminal cover on the servo amplifier unit front panel, and you will see the six check pins below the 7-segment LED. (See Appendix NO TAG.)

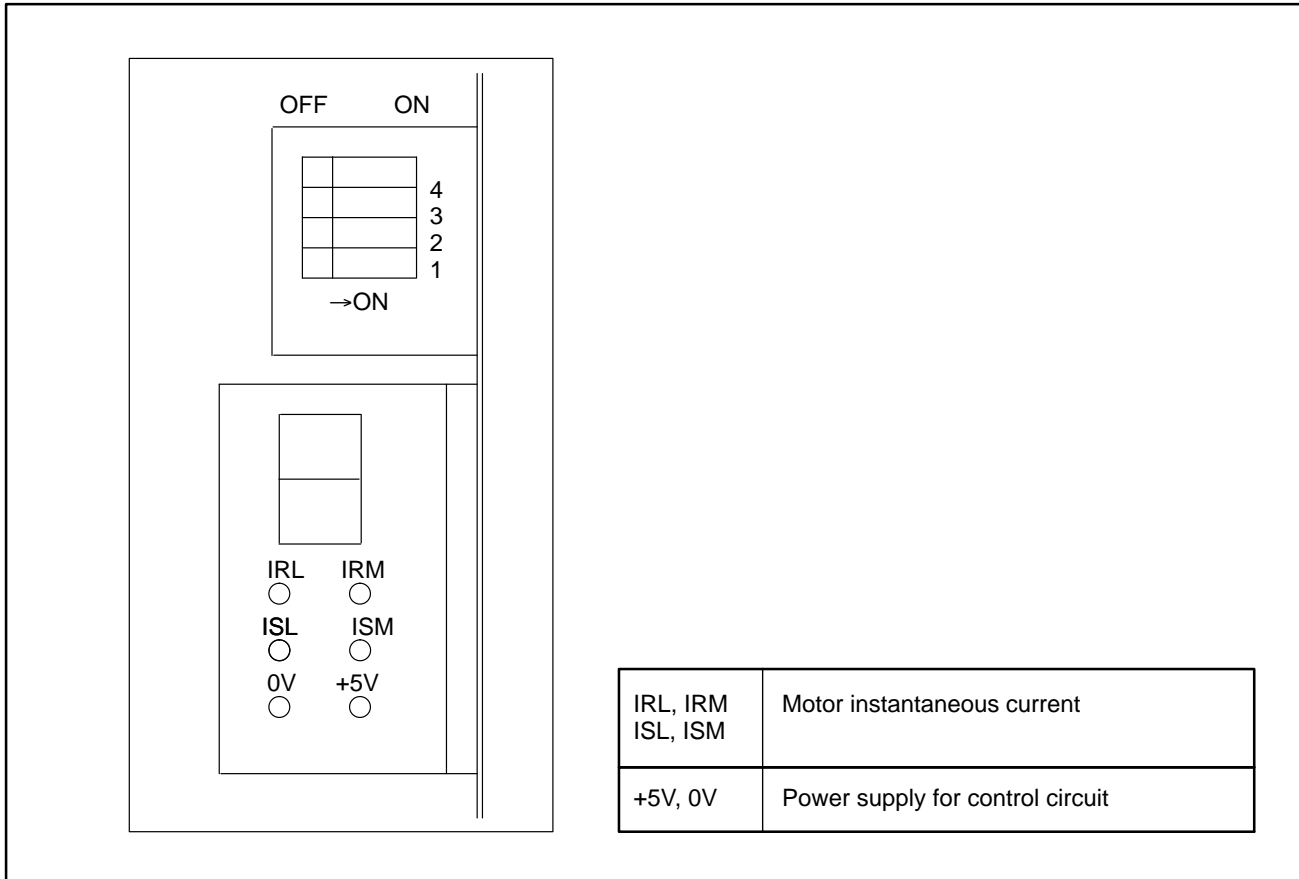

4.2.1 Checking the +5V Power Supply Voltage

The voltage across the 0V and +5V check pins should be 5V +5%.

4.2.2 Checking the Motor Instantaneous Current

The motor instantaneous current can be measured by observing the voltage across the 0V and IRL, IRM, ISL, or ISM check pins on an oscilloscope. This measurement cannot be done correctly with a volt-ohm-milliammeter.

The relationships between the motor instantaneous current and the measured voltage are as described below. The servo amplifier name has a number enclosed in a box “□”. This number is a limit to the motor instantaneous current. It is determined so that when the motor current reaches the limit, the measured voltage is ±4V.

Therefore, the coefficient to calculate the motor current is obtained as follows.

$$\text{Coefficient to calculate the motor current} = \frac{\text{Limit to Motor instantaneous current}}{4V} \quad [A/V]$$

Then the motor instantaneous current can be obtained by multiplying this coefficient to the voltage observed on the check-pin.

For example SVU1-40

$$\text{Coefficient to calculate the motor current} = \frac{40\text{A}}{4\text{V}} = 10 \text{ [A/V]}$$

The servo amplifier name

SVU (C) 1-□



└── Limit to Motor instantaneous current

SVU (C) 2-□/□



└── M axis : Limit to Motor instantaneous current

└── L axis : Limit to Motor instantaneous current

Limit to Motor instantaneous current [A]	Coefficient to calculate the motor current [A/V]
4	1
12	3
20	5
40	10
80	20
130	32.5

4.3 STATUS INDICATOR

The STATUS indicator is a 7-segment LED indicator above the check pins.

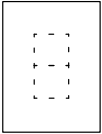
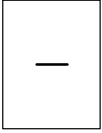
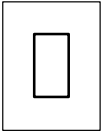
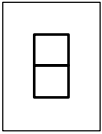
Indication	Description
	<p>The 7-segment indicator is off.</p> <ul style="list-style-type: none"> – The control power is not supplied. – The power supply circuit in the servo amplifier unit is defective. (Replace the fuse if necessary. If the indicator is still off, replace the servo amplifier unit.)
	<p>The servo amplifier unit is waiting for the ready signal from the NC. (The name of the ready signal is *MCON.)</p>
	<p>The servo amplifier unit is in a ready state. The motor is being energized.</p>
<p>ex.</p> 	<p>All indications other than those described above mean an alarm condition.</p> <ul style="list-style-type: none"> – See chapter II for the troubleshooting and recovery procedures.

5

AXIS LEFT UNUSED IN A MULTI-AXIS AMPLIFIER

If an axis is left unused, for example, in a two-axis amplifier, remove the cable between the NC and servo amplifier unit, and insert a dummy connector, with pins 8 and 10 strapped, into the JV*B (for type A interface) or JS*B (for type B interface) connector of that axis.

If a dummy connector is inserted, it prevents the motor of the corresponding axis from being energized. In this state, the dynamic brake is not applied to the motor, leaving it in a free state. Be careful especially about vertical-axis motors in this situation.

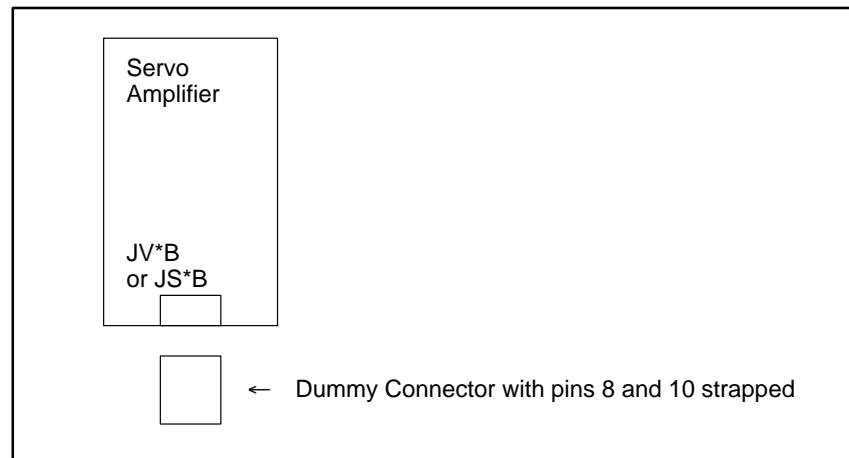

6

SERVO CHECK BOARD

(1) General

The servo check board receives the digital value used for control inside the digital servo as numerical data and converts it to an analog form.

(2) Servo check board specifications

Specification	Name
A06B-6057-H602	Servo check board (with a cable having a provision to prevent incorrect insertion)
A02B-0120-C211	Servo adaptor board (not required for Series 0-C or 15-A)

(3) Connecting the servo check board

When connecting the check board, always keep the NC switched off. If you do not obtain a correct waveform, install strapping on the 5 MHz side of clock pin S1 on the check board.

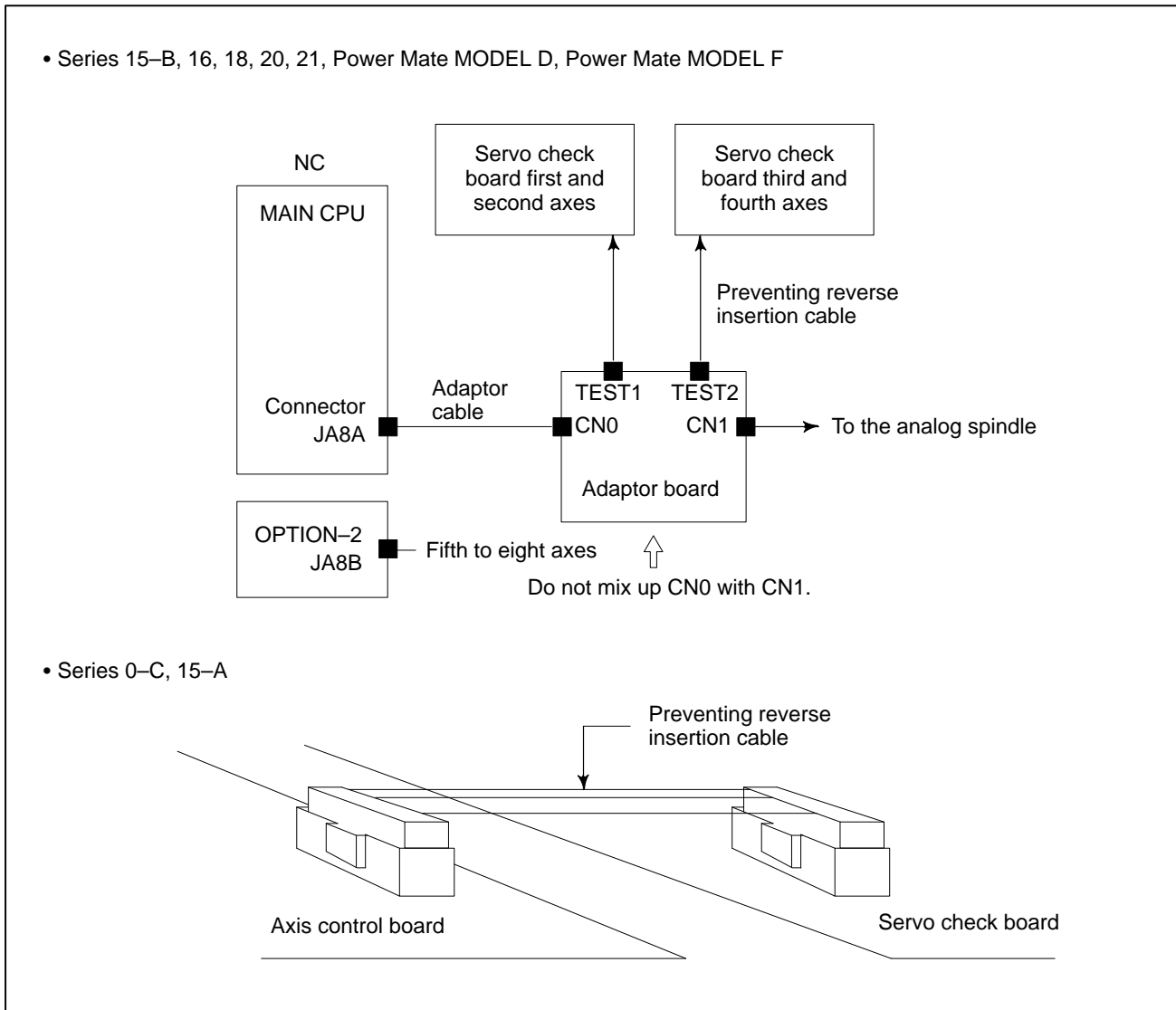

(4) Location of signal output

Check pin	TSAL	TSAM	CH1	CH2	CH3	CH4	CH5	CH6
Signal	—	—	L axis VCMD	L axis TCMD	M axis VCMD	M axis TCMD	L axis TSA	M axis TSA

(Check terminal TSAL or TSAM is not used.)

(5) VCMD signal

The VCMD signal is used to output a speed command. It can also be used to measure a very small vibration or uneven movement of the motor. The VCMD signal conversion mode can be switched by a parameter. Because the VCMD signal is clamped at +5 V, the waveform may become difficult to observe. In such a case, switch for easier observation.

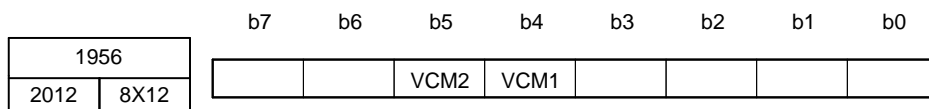

VCM2	VCM1	Specified speed / 5V
0	0	0.9155 rpm
0	1	14 rpm
1	0	234 rpm
1	1	3750 rpm

To check small vibrations, monitor the entire vibration on the DC mode of the oscilloscope then enlarge monitor the desired range on the AC mode.

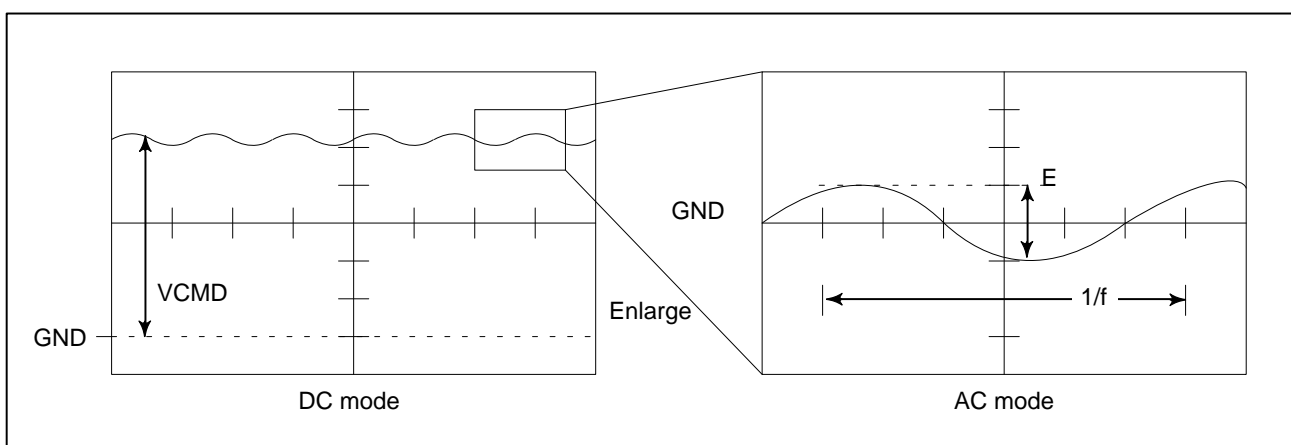

When the signal conversion result for the VCMD waveform is W (rpm/5 V), the voltage per positional shift pulse is:

$$\text{Voltage (V) per positional deviation pulse} = \frac{300 _ \text{Position gain (S}^{-1}\text{)}}{\text{Number of positional feedback pulses/motor revolution} _ W}$$

(Example)

Assume the conditions: Position gain = 30 (S⁻¹), the number of positional feedback pulses/motor revolution = 1000 pulses, and signal conversion result for the VCMD waveform = 14 rpm/5 V with 1 μm/pulse)

Under these conditions, if you observe E = 300 mV and 1/f = 20 ms:

Voltage per positional deviation pulse = 64 mv/pulse

Therefore, table vibration = 300 _ 1/64 = 4.6 μm, with a vibration period of 50 Hz

(6) TCMD signal

The TCMD signal outputs a motor torque command. It may be different from the actual current (IR, IS) of the motor rotating at high speed, because the motor produces a back electromotive force.

Maximum current	Signal output for maximum current	Ap/V	Applicable servo motor
12Ap	4.44V	2.7	α 0.5, α 1/3000 α 2/2000, α 2/3000
20Ap	4.44V	4.5	α C3/2000, α C6/2000, α C12/2000
40Ap	4.44V	9	α 12HV, α 22HV, α 30HV α C22/1500, α C30/1200 α M3/3000 α 3/3000, α 6/2000 α 12/2000, α 22/1500 α L3/3000
80Ap	4.44V	18	α M6/3000, α M9/3000 α 6/3000, α 12/3000 α 22/2000, α 30/1200 α L6/3000, α L9/3000
130Ap	4.44V	29	α 22/3000, α 30/2000, α 30/3000 α 40/2000 α L25/3000, α L50/2000

Root mean square value (RMS) = TCMD signal output (Ap) \times 0.71

(7) TSA signal

The TSA signal outputs a motor speed.

Signal Conversion	3750 rpm/5V
-------------------	-------------

If the TSA signal is clamped at 5 V, check whether the following parameter is specified.

1726	
2115	—

Not used

Be sure to specify 0.

II. TROUBLESHOOTING AND RECOVERY

1 OVERVIEW



This part describes troubleshooting and recovery procedures. Each item should be carefully followed to find the cause of trouble and take necessary actions.

First, check the alarm No. (displayed on the CNC) and the STATUS indicator in the servo amplifier unit to find the cause of trouble by referring to Chapter 2. Second, take appropriate actions according to Chapter 3.

2

ALARM NUMBER AND BRIEF DESCRIPTIONS



2.1 ALARM NUMBER IN Series 15 (SERVO ALARMS)

Alarm No.	SVU, SVUC	Description	Remark
SV001	—————	Overload alarm (OVC)	3.3.2
SV003	8	L axis over-current alarm (HCL)	3.1.2
	8.	L axis IPM alarm (IPML)	3.1.2
	9	M axis over-current alarm (HCM)	3.1.2
	9.	M axis IPM alarm (IPMM)	3.1.2
	b	L, M axis over-current alarm (HCLM)	3.1.2
	b.	L, M axis IPM alarm (IPMLM)	3.1.2
SV004	1	DC link over-voltage alarm (HV)	3.1.2
SV005	4	Regenerative discharge control circuit failure alarm (DCSW)	3.1.2
	5	Over-Regenerative discharge alarm (DCOH)	3.1.2
SV005 SV006	7	Dynamic brake circuit failure alarm (DBRLY)	3.1.2
SV006	2	Low control power voltage alarm (LV)	3.1.2
	3	Low DC link voltage (LVDC)	3.1.2
SV015	—————	Feedback disconnected alarm	3.3.3
SV023	—————	Overheat alarm (motor)	3.3.4
SV027	—————	Invalid servo parameter setting alarm	3.3.5
SV110	—————	α pulse coder error alarm	3.3.6
SV114	—————	Rotation speed data error alarm	3.3.7
SV115	—————	Pulse coder communication error alarm	3.3.8
SV117	—————	Current conversion error alarm	3.2

2.2 ALARM NUMBER IN Series 0-C (SERVO ALARMS)

Alarm No.	SVU, SVUC	Description	Remark
309 Alarm 3	—————	α pulse coder error alarm (OVC)	3.3.6
309 Alarm 4	—————	Pulse coder communication error alarm	3.3.8
400 Alarm1 Bit7	—————	Overheat alarm (motor)	3.3.4
414 Alarm1 Bit5	—————	Overload alarm (OVC)	3.3.2
414 Alarm1 Bit3	1	DC link over- voltage alarm (HV)	3.1.2
414 Alarm1 Bit6	2	Low control power voltage alarm (LV)	3.1.2
	3	Low DC link voltage (LVDC)	3.1.2
414 Alarm1 Bit 2	4	Regenerative discharge control circuit failure alarm (DCSW)	3.1.2
	5	Over-Regenerative discharge alarm (DCOH)	3.1.2
414 Alarm1 Bit2 Alarm1 Bit6	7	Dynamic brake circuit failure alarm (DBRLY)	3.1.2
414 Alarm1 Bit4	8	L axis over- current alarm (HCL)	3.1.2
	8.	L axis IPM alarm (IPML)	3.1.2
	9	M axis over- current alarm (HCM)	3.1.2
	9.	M axis IPM alarm (IPMM)	3.1.2
	b	L, M axis over-current alarm (HCLM)	3.1.2
	b.	L, M axis IPM alarm (IPMLM)	3.1.2
416 Alarm1 Bit1	—————	Feedback disconnected alarm	3.3.3
417	—————	Invalid servo parameter setting alarm	3.3.5

↑ To interpret alarms 1 to 4, see Section 3.3.1
or diagnose No. listed on the right.

Alarm1 Diagnose No. 720 to 723
Alarm2 Diagnose No. 730 to 733
Alarm3 Diagnose No. 760 to 763
Alarm4 Diagnose No. 770 to 773

2.3

ALARM NUMBER IN Series 16, 18, 20 (SERVO ALARMS)

Alarm No.	SVU, SVUC	Description	Remark
350 Alarm3	————	α pulse coder error alarm	3.3.6
350 Alarm4 bit6	————	Rotation speed data error alarm	3.3.7
351 Alarm4	————	Pulse coder communication error alarm	3.3.8
400 Alarm1 bit7	————	Overheat alarm (motor)	3.3.4
414 Alarm5 bit6	————	Current conversion error alarm	3.2
414 Alarm1 bit5	————	Overload alarm (OVC)	3.3.2
414 Alarm1 bit3	1	DC link over-voltage alarm (HV)	3.1.2
414 Alarm1 bit6	2	Low control power voltage alarm (LV)	3.1.2
	3	Low DC link voltage (LVDC)	3.1.2
	4	Regenerative discharge control circuit failure alarm (DCSW)	3.1.2
414 Alarm1 bit2	5	Over-Regenerative discharge alarm (DCOH)	3.1.2
	7	Dynamic brake circuit failure alarm (DBRLY)	3.1.2
414 Alarm1 bit4	8	L axis over- current alarm (HCL)	3.1.2
	8.	L axis IPM alarm (IPML)	3.1.2
	9	M axis over- current alarm (HCM)	3.1.2
	9.	M axis IPM alarm (IPMM)	3.1.2
	b	L, M axis over- current alarm (HCLM)	3.1.2
	b.	L, M axis IPM alarm (IPMLM)	3.1.2
416 Alarm1 bit1	————	Feedback disconnected alarm	3.3.3
417	————	Invalid servo parameter setting alarm	3.3.5

↑ To interpret alarms 1 to 5, see Section 3.3.1
or diagnose No. listed on the right.

Alarm1 Diagnose No. 200
Alarm3 Diagnose No. 202
Alarm4 Diagnose No. 203
Alarm5 Diagnose No. 204

3



TROUBLESHOOTING AND RECOVERY PROCEDURES



3.1 SERVO AMPLIFIER UNIT

3.1.1 LED Indications and Meanings

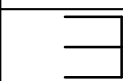
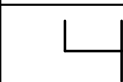
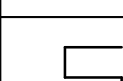
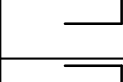
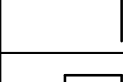
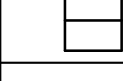
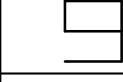
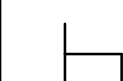
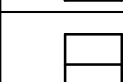
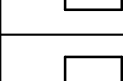

If an alarm condition related to the servo amplifier unit occurs, the 7-segment LED indicator on the amplifier front panel behaves as listed below.



Type	LED indication	Description
Over-voltage alarm (HV)		This alarm occurs if the DC voltage of the main circuit power supply is abnormally high.
Low control power voltage alarm (LV)		This alarm occurs if the control power voltage is abnormally low.
Low DC link voltage alarm (LVDC)		This alarm occurs if the DC voltage of the main circuit power supply is abnormally low or the circuit breaker trips.
Regenerative discharge control circuit failure alarm (DCSW)		This alarm occurs if : – The short-time regenerative discharge energy is too high. – The regenerative discharge circuit is abnormal.
Over-regenerative discharge alarm (DCOH)		This alarm occurs if : – The average regenerative discharge energy is too high (too frequent acceleration/deacceleration). – The transformer overheats.
Dynamic brake circuit failure alarm (DBRLY)		This alarm occurs if the relay contacts of the dynamic brake welds together.
L-axis over-current alarm (HCL)		This alarm occurs if an abnormally high current flows in the L-axis motor.
M-axis over-current alarm (HCM)		This alarm occurs if an abnormally high current flows in the M-axis motor.
L-and M-axis over-current alarm (HCM)		This alarm occurs if an abnormally high current flows in the L-and M-axes motor.
L-axis IPM alarm (IPML)		This alarm is detected by the IPM (intelligent power module) of the L-axis. (Note 1)
M-axis IPM alarm (IPML)		This alarm is detected by the IPM (intelligent power module) of the M- axis. (Note 1)
L-and M-axis IPM alarm (IPMLM)		This alarm is detected by the IPM (intelligent power module) of the L-and M-axes. (Note 1)
Circuit breaker	Trips	The circuit breaker trips if an abnormally high current (exceeding the working current of the circuit breaker) flows through it. Note 2)



Notes

- 1 The IPM can detect the following alarms.
 - Over-current
 - Over-heat
 - Drop in IPM control power voltage
- 2 When the control power is separated from the main power, if the circuit breaker of the servo amplifier is off, low DC link voltage alarm (LVDC) is detected.

3.1.2 Actions to be Taken on Each Alarm

Type	LED	Action
Over-voltage alarm (HV)		(1) The three-phase input voltage is probably higher than the rating. Check the voltage and correct it as required. (2) The connection of the separate regenerative discharge unit is probably incorrect. Check the connection. (3) The resistor of the separate regenerative discharge unit is probably defective. Disconnect the wiring of the regenerative discharge unit and check the resistance. If it is not within +20% of the rating (described in Section 3. 5), replace the regenerative discharge unit. → If any of the above three items does not fit the case, replace the servo amplifier.
Low control power voltage alarm (LV)		(1) The single-phase input voltage (for control circuit) is probably lower than the rating. Check the voltage and correct it as required. (2) The emergency stop input signal is probably short-circuited. Remove the CX4 connector from the amplifier. If the alarm condition disappears, check the connection of the external cable. (3) For the type B interface, the pulse coder is probably short-circuited. Remove the JF* connector from the amplifier. If the alarm condition disappears, check the connection of the external cable. → If any of the above three items does not fit the case, replace the servo amplifier.
Low DC link voltage alarm (LVDC)		(1) The circuit breaker is probably off. Check the circuit breaker. (2) The three-phase input voltage is probably lower than the rating. Check the voltage and correct it as required. → If either of the above two items does not fit the case, replace the servo amplifier
Regenerative discharge control circuit failure alarm (DCSW)		(1) The connection of the separate regenerative discharge unit is probably incorrect. Check the connection. (2) The resistor of the separate regenerative discharge unit is probably defective. Disconnect the wiring of the regenerative discharge unit and check the resistance. If it is not within +20% of the rating (described in Section 3. 5), replace the regenerative discharge unit. → If either of the above two items does not fit the case, replace the servo amplifier

Type	LED	Action
Over-regenerative discharge alarm (DCOH)		<p>(1) The average regenerative discharge energy is probably too high. Reduce the frequency of acceleration/deceleration.</p> <p>(2) The connection of the thermostat line to the separate regenerative discharge unit is probably incorrect. Check the connection.</p> <p>(3) The thermostat of the separate regenerative discharge unit is probably defective. Disconnect the wiring of the regenerative discharge unit, and check the thermostat. If the thermostat is open when the regenerative discharge unit is not hot, replace the regenerative discharge unit.</p> <p>(4) The transformer has probably overheated. Check the ambient temperature, motor output, and transform rating.</p> <p>→ If any of the above four items does not fit the case, replace the servo amplifier.</p>
Dynamic brake circuit failure alarm (DBRLY)		<p>The connection between the NC and servo amplifier is probably incorrect. Check the connection.</p> <p>→ If the above items does not fit the case, replace the servo amplifier.</p>



Type	LED	Type	LED	Type	LED
L-axis over-current alarm (HCL)		M-axis over-current alarm (HCM)		L-and M-axes over-current alarm (HCL)	

Action

- (1) Check that following parameters are set to standard values. If they are not, normal current control is impossible.

No. 1809		No. 1884		No. 1954 (15-A), 1955 (15-B)	
No. 2004	No. 8X04	No. 2006	No. 8X06	No. 2011	No. 8X10
No. 1852		No. 1853			
No. 2040	No. 8X40	No. 2041	No. 8X41		
No. 1967		No. 1991			
No. 2074	No. 8X74	No. 2098	No. 8X98		

- (2) Disconnect the power wires from the amplifier terminals, and release the emergency stop condition.
- If an overcurrent alarm is issued, replace the amplifier.
 - If an overcurrent alarm is not issued, go to (3).
- (3) Disconnect the power wires from the amplifier terminals, and check the U, V, and W wires for isolation from the grounding wire sequentially.
- If they are isolated from the grounding wire, go to (4) and (5).
- If any of the power wires is short-circuited to the grounding wire, disconnect the power wires from the motor connector, and check the U, V, and W terminals of the motor for isolation from the ground terminal sequentially.
- If the U, V, or W terminal of the motor is short-circuited to the ground terminal, replace the motor.
 - If they are isolated from the ground terminal, replace the power wires.
- (4) Connect the wires again, and observe the motor current (IR, IS) waveforms when the motor is accelerating or decelerating. (See Subsec. 4.2.2 in Part I for how to measure)
- If the motor current waveforms are abnormal, replace the amplifier.
- (5) Check that noise is induced on the motor current (IR, IS) waveforms.
- If there is noise, shield the wires and ground the shielding.
 - If there is no noise, replace the amplifier.
- (6) If any of the above five items does not fit the case, the pulse coder, command cable or the hardware inside the CNC is probably defective.

Type	LED	Type	LED	Type	LED	Remarks
L-axis IPM alarm (IPML)		M-axis IPM alarm (IPMM)		L-and M-axes IPM alarm (IPMLM)		Both figure and period appear simultaneously.

Action

- (1) Only the SVU1- 20(A06B- 6089- H102)has a built- in fan. If this fan stops,an IPM alarm (“8.” in the LED indicator) is issued. So, if this alarm is issued on the SVU1- 20, first check that the fan is rotating. A spare of the fan motor can be ordered using the spare list code A06P- 6089- H102.
- (2) After keeping the amplifier switched off for about ten minutes, release the emergency stop condition.
 - If the alarm was due to IPM overheat, it will not be issued this time because the IPM is not hot any longer. The probable causes of IPM overheat include high ambient temperature and excessively strict operating condition for the motor.Check for these conditions.
 - If the IPM alarm is still issued, go to (3).
- (3) Disconnect the power wires from the amplifier terminals, and release the emergency stop condition.
 - If the IPM alarm is still issued, the probable cause is the operation of the IPM protection function (overcurrent or power supply failure). Replace the IPM or amplifier.
 - If the IPM alarm is not issued, go to (4).
- (4) Disconnect the power wires from the amplifier terminals, and check the U, V, and W wires for isolation from the grounding wire sequentially.
 - If they are isolated from the grounding wire, go to (5) and (6).
If any of the power wires is short- circuited to the grounding wire, disconnect the power wires from the motor connector, and check the U, V, and W terminals of the motor for isolation from the ground terminal sequentially.
 - If the U, V, or W terminal of the motor is short-circuited to the ground terminal, replace the motor.
 - If they are isolated from the ground terminal, replace the power wires.
- (5) Connect the wires again,and observe the motor current (IR, IS) waveforms when the motor is accelerating or decelerating. (See Section 4.2.2 for how to measure.)
 - If the motor current waveforms are abnormal, replace the amplifier.
- (6) Check to see if noise is induced on the motor current (IR, IS) waveforms.
 - If there is noise, shield the wires and ground the shielding.
 - If there is no noise, replace the amplifier.
- (7) Any of the above six items does not fit the case,the pulse coder, command cable or the hardware inside the CNC is probably defective.

3.2 CURRENT CONVERSION FAILURE ALARM

- (1) Exchange the command cables as shown in the example below. Turn on CNC in an emergency stage.
 - If the alarm is issued on the same axis, go to (2).
 - If the alarm is issued now on the axis that was normal, go to (3).
- (2) The module for current conversion in the CNC is defective.
- (3) Disconnect the command cable from the axis on which the alarm was issued, and connect it to a normal axis.
 - If the alarm is issued on the same axis, go to (4)
 - If the alarm is issued now on the axis that was normal, go to (5).
- (4) The servo amplifier is defective.
- (5) The command cable is defective. Replace it.

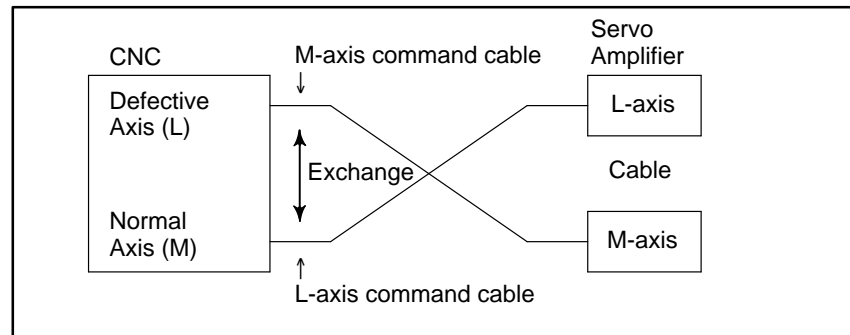



3.3 SERVO SOFTWARE

3.3.1 Servo Adjustment Screen

Cause the servo adjustment screen to appear, and check the position error, actual current, and actual speed on it.

Using the keys on the CNC, enter the required value according to the following procedure.

- Series 15-B
Press the SERVICE key several times to cause the servo setting screen to appear. Then press the  key, and the servo adjustment screen will appear.
- Series 0-C, 16, 18, 20, or 21
SYSTEM ⇒ [SYSTEM] ⇒ [] ⇒ [SV-TUM]
If the servo setting screen does not appear, specify the following parameter, then switch the NC off and on again.

Series 16, 18, 20, 21

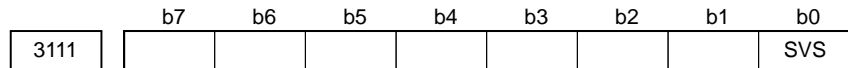

SVS (b0)=1 (to display the servo setting screen)

Series 0-C

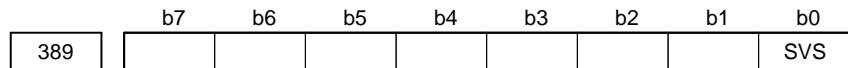

SVS (b0)=0 (to display the servo setting screen)

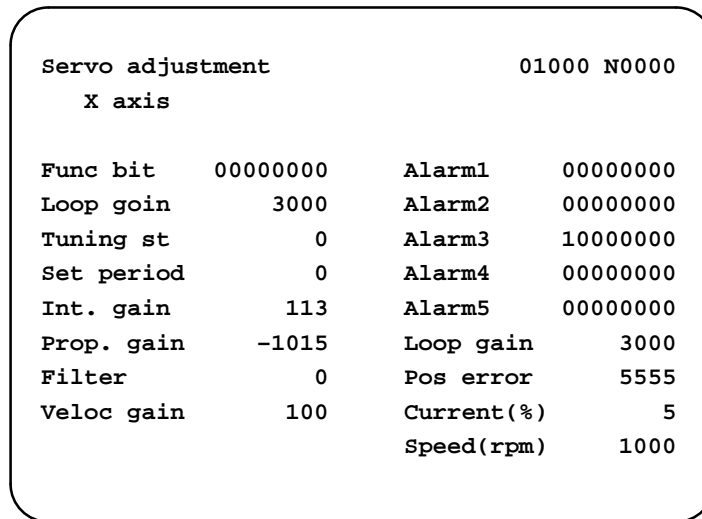

Servo adjustment screen

The cause and detailed information of servo alarms are indicated with alarms 1 to 5.

3.3.2 Overload Alarm

- (1) Make sure that the motor is not vibrating.
 - ⇒ If a motor vibrates, the current flowing in it becomes more than necessary, resulting in an alarm.
- (2) Make sure that the power line to the motor is connected correctly.
 - ⇒ If the connection is incorrect, an abnormal current flows in the motor, resulting in an alarm.
- (3) Make sure that the following parameters are set correctly.
 - ⇒ An overload alarm is issued based on the result of calculation of these parameters. Be sure to set them to the standard values.

1877	Overload protection coefficient (OVC1)	
2062	8X62	
1878	Overload protection coefficient (OVC2)	
2063	8X63	
1893	Overload protection coefficient (OVCLMT)	
2065	8X65	

- (4) Attach the check board (A06B-6071-K290) to connector JX5 to measure the waveform of the actual current (IR and IS) of the servo amplifier module. Start the motor and measure the actual current (IR and IS).
 - ⇒ If the actual current exceeds 1.4 times the rated current, the constant for the acceleration/deceleration duration is too small, or the load on the machine is too heavy for the capacity of the motor.
 - ⇒ If the actual current exceeds 1.4 times the rated current during normal operation, the load on the machine is too heavy for the capacity of the motor.

3.3.3 Feedback Disconnected Alarm

This alarm is detailed with alarms 1 and 2 on the servo adjustment screen (⇒ 3.3.1).

Alarm1		Alarm details	Alarm2	
b7	b2		b7	b4
0	1	CM alarm (α pulse coder)	1	1
0	1	Pulse coder disconnected (soft ware)	0	0
0	1	Separate pulse coder disconnected (hard ware)	1	1

For the CM alarm, go to 3.3.7.
 For software disconnected, go to (1).
 For hardware disconnected, go to (3).

- (1) For a full-closed Series 0-C system, make sure that the phase C signal is not connected to full-closed feedback pins 10 to 13. When the connection is correct, or when the system is not a Series 0-C, go to (2).
- (2) If there is a large backlash; or if the number of position feedback pulses divided by the motor one-rotation signal is equal to or less than 640, and a software disconnected alarm is detected when it should not, change the alarm level.

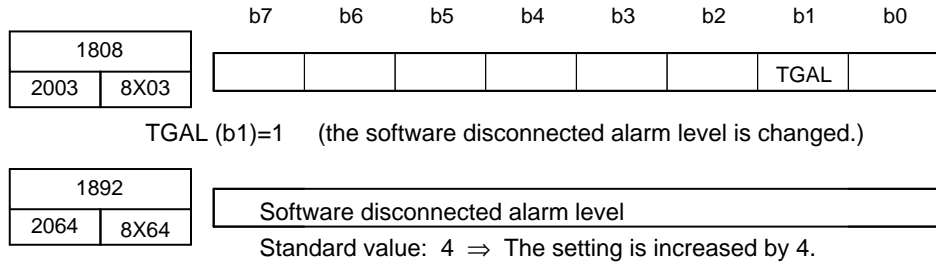

- (3) If the alarm is a separate detector hardware disconnected alarm, check the specification and wiring of the separate detector.

3.3.4 Motor Overheat Alarm

- (1) Check whether the motor has overheated; **it is dangerous to touch the motor by the hand or any other part of you body.** If the motor is overheated, use it less frequently.
- (2) When the motor is cooled enough, check whether an overheat alarm occurs.
 - ⇒ If it occurs, the thermostat is defective.
 - ⇒ If not, use the motor less frequently.

3.3.5 Invalid Servo Parameter Setting Parameters

The following table contains actions to be taken for invalid servo parameter setting alarms. Find the relevant guideline under "Decision criterion," and proceed to the corresponding "Adjustment item."

Alarm	Decision criterion	Adjustment item
POA1 overflow	Try resetting POA1 to 0. Parameter: No. 8X47-1859-2047-1047 = 0	Adjustment1
1 pulse suppression level overflow	Disable the pulse suppression function. Function bit: No. 8X03-1808-2003-1003,B4 = 0	Adjustment2
Feed-forward coefficient overflow	Reset the feed-forward coefficient to 0. Parameter: No. 8X68-1961-2068 = 0 No. 8X92-1985-2092 (advance) = 0	Adjustment3
Position gain overflow	Reset the position gain to 0. Parameter: No. 517-1825-1825 = 0	Adjustment4
Number of position pulses overflow	The number of position pulses is greater than 13100 (No. 8X00-1804-2000, bit 0 = 1). Parameter: No. 8X00-1804-2000, B0	Adjustment5
Motor ID No.	Check whether the motor ID No. is correct. Parameter: No. 8X20-1874-2020	Adjustment6
Invalid axis selection parameter setting	Check whether the setting is correct. Series 0-C: No. 269 to 274 Series 15, 16: No. 1023	
Others	Number of position pulses ≤ 0 Number of velocity pulses ≤ 0 Direction of travel = 0 Feed gear numerator ≤ 0, denominator ≤ 0 Numerator > denominator (Serial A, α and semi-closed mode)	

NOTE

The parameter numbers in the table are in the following order:

No. (Series 0-C)-(Series 15)-(Series 16, 18, 20, 21)

Survey

If the adjustments described below cannot eliminate overflow, let us work out the setting procedure individually.

Adjustment 1: POA1 overflow (No. 8X47-1859-2047)

Use the tenfold POA1 setting function.

Note) This function is available for 9060/L, 9070/C, 9046/A, and later versions.

• How to use the tenfold POA1 setting function

If POA1 is specified as a negative value, the absolute value is internally multiplied by 10. If the value you want to set is a positive value, specify as follows:

$$(-1) \times \text{the desired setting}/10$$

Adjustment 2: One-pulse suppress (No. 1992-2099)

Reduce the setting according to the flowchart shown below. If an overflow occurs in the FS0C, stop using it, because the level parameter is fixed at a standard value of 400.

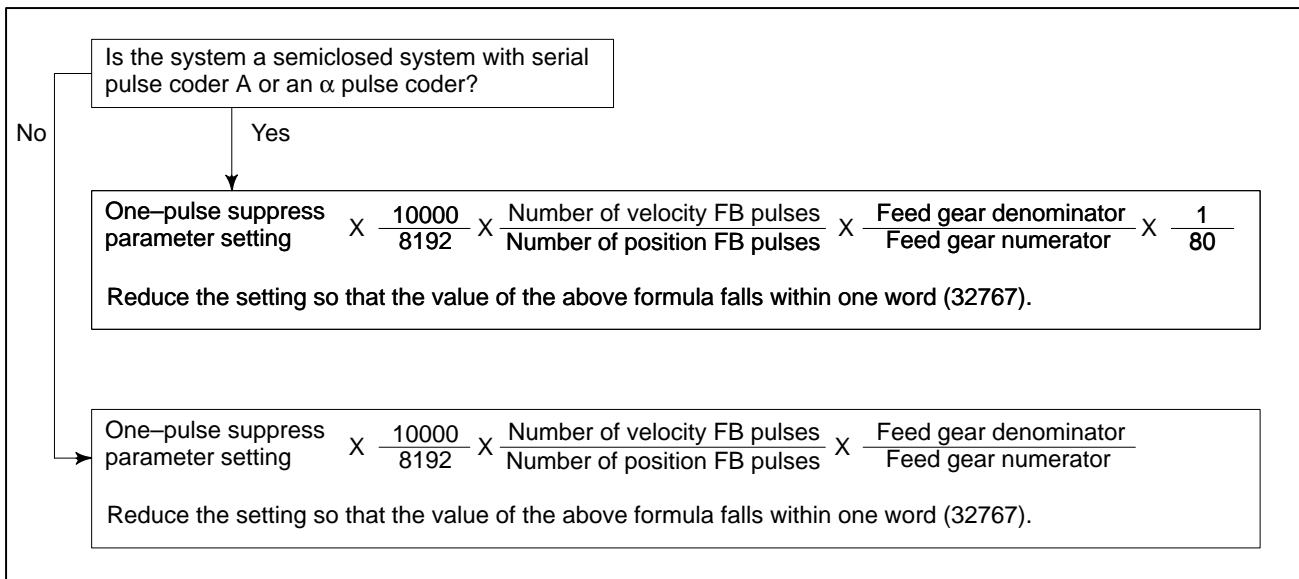

NOTE

Number of velocity FB pulses (No. 8X23-1876-2023)

Number of position FB pulses (No. 8X24-1891-2024)

Feed gear numerator (No. 8X84-1977-2084)

Feed gear denominator (No. 8X85-1978-2085)

Adjustment 3: Feed forward coefficient (No. 8X68–1961–2068, No. 8X92–1985–2092 (advance))
[9060, 9070, Series]

Specify the position gain setting range expansion function.

Function bit: No. 1804–2000–1000, B4=1
(Series 15–B, 16, 18, 20, 21)

- The function also expands the feed–forward coefficient range.
[9046 Series]

If a negative number is specified for the feed–forward coefficient, the internal processing assumes a value ten times the absolute number of the specified number.

If the calculation result obtained during parameter setting exceeds 32767, specify as follows:

(–1) x calculation result/10

Adjustment 4: Position gain

Use the position gain setting range expansion function.

Setting: No. 8X11–1955, B5 = 1 (Series 0–C, 15–A)

Multiply 8X24–1891 by 8 and re–enter it.

No. 2000–1804, B4 = 1 (Series 15–B, 16, 18, 20, 21)

↓ If an overflow still occurs :

1. Multiply the feed gear (or DMR) value by an integer.
2. Increase the following values by the same integer.

Parameter	Series 0–C	Series 15	Series 16, 18, 20, 21
CMR	No. 100–103	No. 1820	No. 1820
Effective area	500–503	1826,27	1826,27
Limit to a position error during travel	504–507	1828	1828
Limit to a position error at a halt	593–596	1829	1829
Backlash	535–538	1851,52	1851,52
Reference counter	570–573	1896	1821

(Example) The position gain overflows internally under the following conditions:

α pulse coder, Reduction gear ratio: 1/20, Ball screw: 1 mm/rev,
Position gain: 30 (with 1 μ scale)

In this case, specify the position gain setting range expansion function. For 9046 series, multiply the number of position pulses by 8.

Number of position pulses (No. 8X24–1891) 50 $\xrightarrow{\times 8}$ 400

Adjustment 5: Number of position pulses

Make the changes listed below. Value E must satisfy the following:

Number of current position pulses/E < 13100

Current setting value/E			Current setting value/E		
Series 0-C	Series 15	Series 16	Series 0-C	Series 15	Series 16
No. 8X23	No. 1876	No. 2023	No. 8X53	No. 1865	No. 2053
8X24	1891	2024	8X74	1967	2074
8X43	1855	2043	8X76	1969	2076
8X44	1856	2044			
8X54	1866	2054			
8X56	1868	2056			
8X57	1869	2057			

Adjustment 6: Motor ID No.

The motor ID numbers valid for each series of models are listed below.

9046 series	15-89 (edition A)
9060 series	15-89 (edition K)
	3-89 (edition L)
9070 series	3-89 (edition C)

Reference

Feed-forward coefficient overflow check (9060, 9070 series)

If the result of any of the following calculations exceed 32767, an overflow occurs.

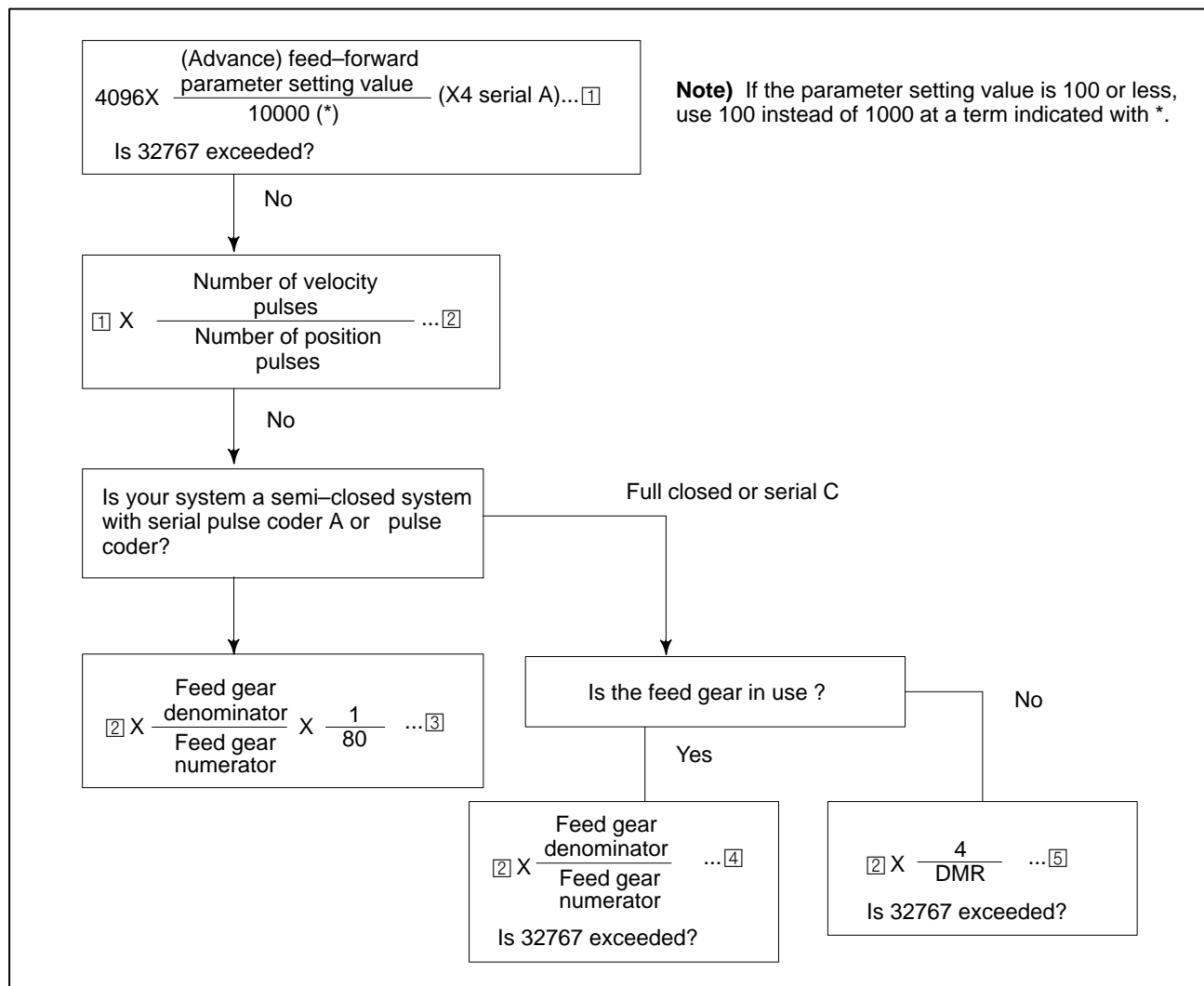

Position gain overflow check

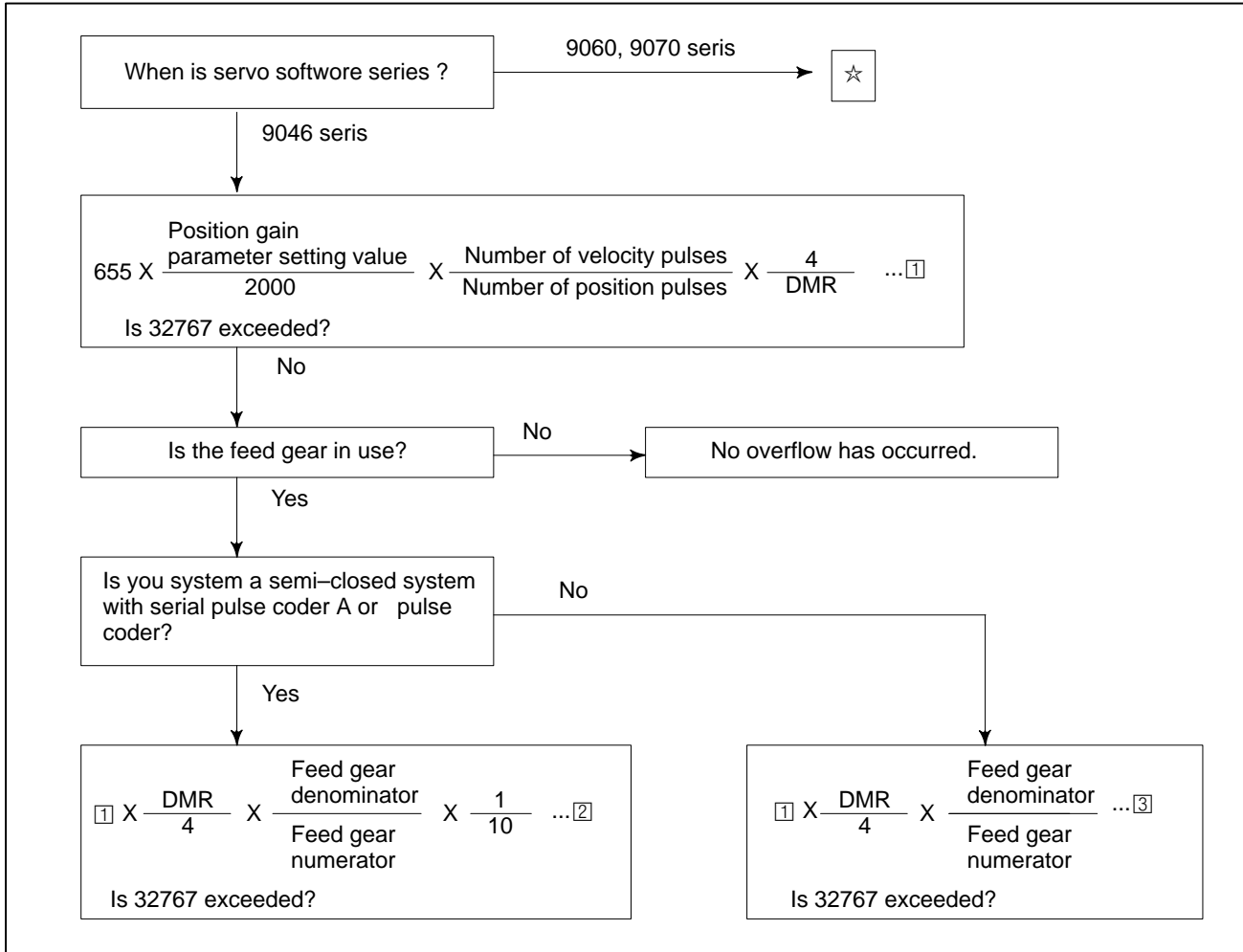

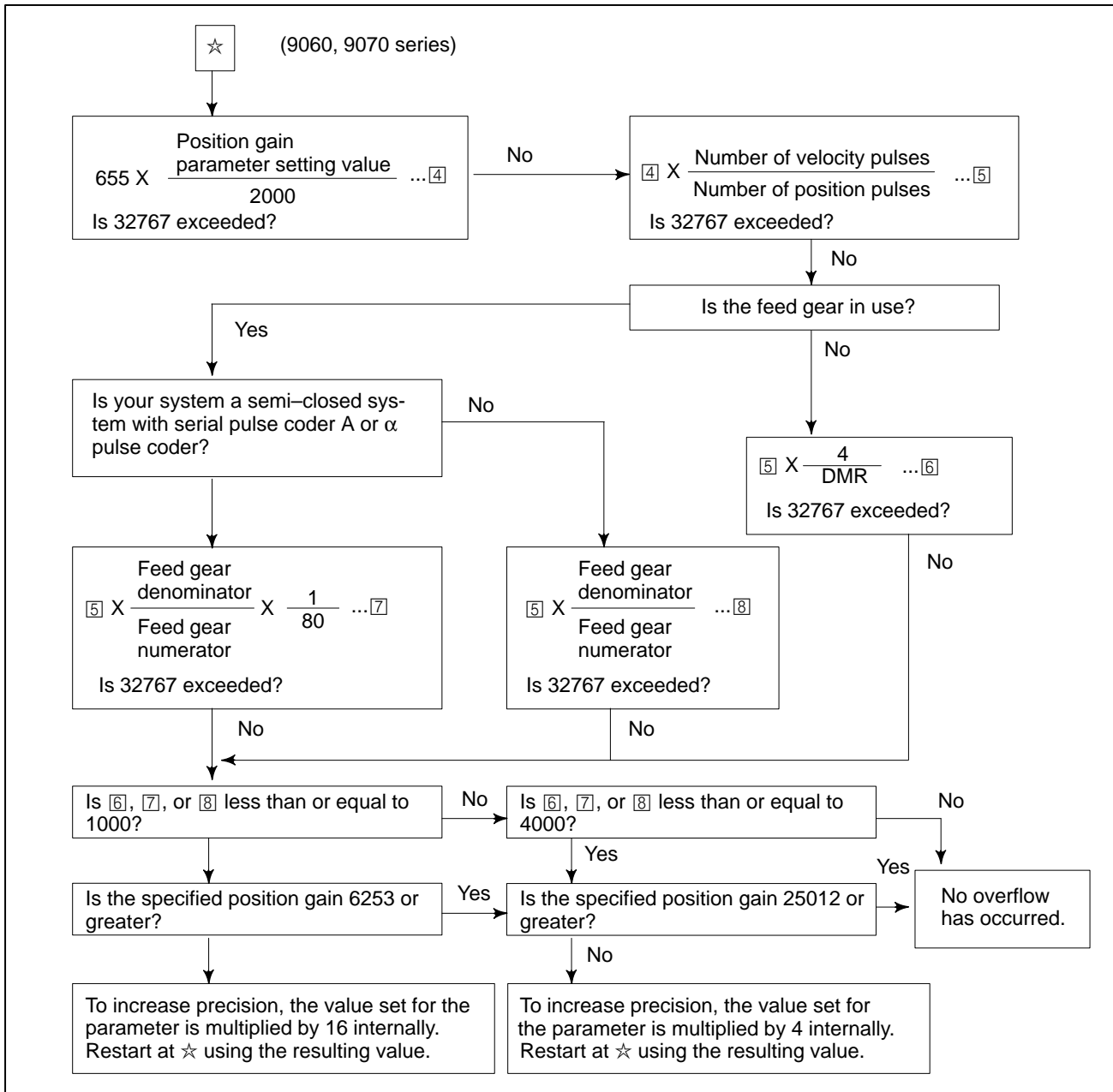

3.3.6 Pulse Coder Error Alarm

	b7	b6	b5	b4	b3	b2	b1	b0
Alarm 3		CSAL	BLAL	PHAL		BZAL	CKAL	SPH

(⇒ See Section 3.3.1.)

Whether the alarm occurs in each pulse coder
α pulse coder
Serial A

			α pulse coder	Serial A
SPH	(b0)	Probably, pulse coder or feedback cable is abnormal, or noise	<input type="radio"/>	<input type="radio"/>
CKAL	(b1)	For serial pulse coder A, a clock alarm has occurred. For α pulse coder, the pulse coder or feedback cable is abnormal.	X	<input type="radio"/>
BZAL	(b2)	The voltage of the pulse coder battery is 0 V. Replace the battery and cause a return to the reference position.	<input type="radio"/>	<input type="radio"/>
PHAL	(b4)	Pulse coder or feedback cable is abnormal	X	<input type="radio"/>
BLAL	(b5)	The voltage of the pulse coder battery is dropping (warning).	<input type="radio"/>	<input type="radio"/>
CSAL	(b6)	For serial pulse coder A, a check sum alarm has occurred. For α pulse coder, an LED error has occurred.	X	<input type="radio"/>
	(b7)	This is not an alarm.		

	b7	b6	b5	b4	b3	b2	b1	b0
Alarm 5				LDAL	PMAL			

(⇒ See Section 3.3.1.)

PMAL	(b3)	The pulse coder or feedback cable is abnormal.	<input type="radio"/>	X
LDAL	(b4)	The pulse coder LED is abnormal.	<input type="radio"/>	X

3.3.7 Rotation Speed Data Error Alarm

- Serial pulse coder A

	b7	b6	b5	b4	b3	b2	b1	b0
Alarm 3					RCAL			

(⇒ See Section 3.3.1.)

RCAL	(b3)	A rotation speed data error alarm occurred.
------	------	---

● α pulse coder

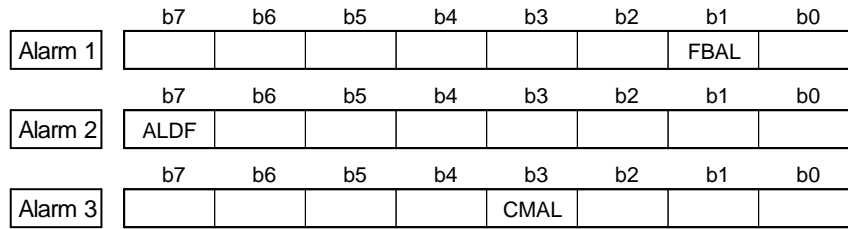

(⇒ See Section 3.3.1.)

- CMAL (b3) A pulse count error occurred. If the CNC software does not correspond to α Series, this bit is not used for a mode other than the APC MODE. If a built-in pulse coder hardware discontinued alarm (bit 1 of alarm 1 = 1 and bit 7 of alarm 2 = 1) occurs in a system with an α pulse coder, a pulse count error has occurred.

3.3.8 Pulse Coder Communication Error Alarm

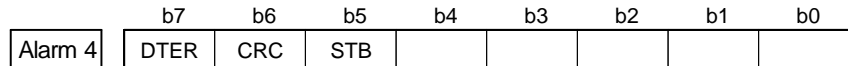

(⇒ See Section 3.3.1.)

- STB (b5) A communication error occurred from the pulse coder
The pulse coder or feedback cable is abnormal, or the servo module is defective.
- CRC (b6) A communication error occurred from the pulse coder
The pulse coder or feedback cable is abnormal, or the servo module is defective.
- DTER (b7) The pulse coder does not communicate.
The pulse coder or feedback cable is abnormal.

4 REPLACING THE FUSE

When replacing the fuse,keep the power supply switched off. Also make sure that the “CHARGING” LED (red) beside the circuit breaker on the servo amplifier front panel is off.

IMPORTANT

When replacing the fuse,keep the power supply switched off. Also make sure that the “CHARGING” LED (red) beside the circuit breaker on the servo amplifier front panel is off.

Replacement procedure

- ① Remove the plastic cover on the left hand side.
- ↓
- ② Replace the fuse near the 7-segment LED.
(See Appendix NO TAG.)

- For SVU-130, SVUC-130

Use	Name	Qty.	Specification
For control power supply	FU2	1	FANUC : A06B-6089-K250
For fan	FU1	1	MAKER : HM50 250V F5.0A Daito

- For all

Use	Name	Qty.	Specification
For control power supply	FU1	1	FANUC : A06B-6089-K250 MAKER : HM50 250V F5.0A Daito

III. COMPATIBILITY OF THE SVU AND SVUC WITH THE C SERIES AMPLIFIER

1

OVERVIEW



This part describes the cautions to be observed when replacing the C series amplifier with SVU or SVUC.

2

COMPATIBILITY OF THE SVU AND SVUC WITH THE C SERIES AMPLIFIER

Table 1 lists the differences of the SVU and SVUC from the C series amplifier. When replacing the C series amplifier with the SVU or SVUC, observe the cautions listed below.

Table 1

Item	SVUC	SVU	
Outline	Common to C series.	Common to C series.	
Interface of ESP	Common to C series.	DC24V (Connector : CX4)	Note 1
Interface of NC	Type A interface Type B interface	Type A interface Type B interface	Note 2
Surge absorber to protect Input	Common to C series.	None. External surge absorber is required.	
MCC confirmation contact	b contact except for SVUC1-130	b contact except for SVUC1-130	Note 3
TUV	Not qualified	Qualified	Note 4
UL/CSA	Qualified	Qualified	
Connection and cables	Common to C series.	Common to C series except for ESP.	
Connector location	Much the same as C series.	Much the same as C series.	
Terminal location	Common to C series.	Common to C series.	
Application to S series motor	Allowed	Not allowed	

Note 1 : Interface of ESP (Emergency Stop)

Type	Input	Terminal	Signal Name
C series amplifier	1 ϕ AC100V	T1 (5-6)	100A-100B
SVU	DC24	CX4 (2-3)	ESP, +24V
SVUC	1 ϕ AC100V	T1 (5-6)	(100A) - (100B)

Note 2 : Interface of NC

C series amplifier is available to Type A interface only.

The connectors JV1B (L-axis) and JV2B (M-axis) in SVU and SVUC correspond to the connectors CN1 (L- axis) and CN2 (M-axis) in C series amplifier.

Note 3 : Specification of the MCC (RELAY) confirmation contact

The C series amplifier makes the auxiliary contact (b-contact) of the MCC, installed on the three-phase power line for motor power, accessible to the outside. It is used to indicate when the power to the motor is shut off. On the other hand, the SVU and SVUC make the auxiliary contact of the dynamic brake circuit relay (in the SVU1-130 and SVUC1-130, a-contact, and for others, b-contact) accessible to the outside, in order to indicate when the motor power is shut off.

Type	Auxiliary Contact	Terminal	Signal Name
C series amplifier	b contact	T1 (7-8)	MC1-MC2
SVU1-130, SVUC1-130	a contact	T1 (7-8)	RL1-RL2
Other SVU and SVUC	b contact	T1 (7-8)	RL2-RL3

a contact : In dynamic brake, its contact is open.

b contact : In dynamic brake, its contact is short.

Note 4 : Conformance to TUV

Like the C series amplifier, the SVUC is not qualified for TUV (because it has a built-in surge absorber for input protection). When it is necessary to acquire qualification for CE marking, use the SVU.

3 SVUC SPECIFICATION CODE

“H□□□” in the specification code is common to both C series amplifier and SVUC. (It is not common to the SVU.)

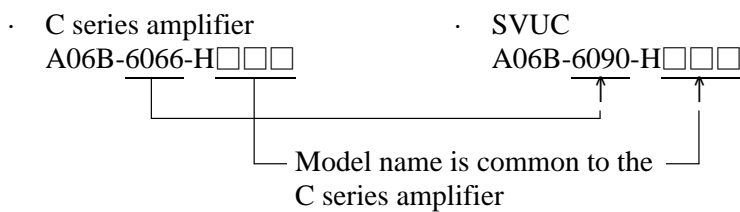

APPENDIX

A SERVO AMPLIFIER UNIT FRONT PANEL

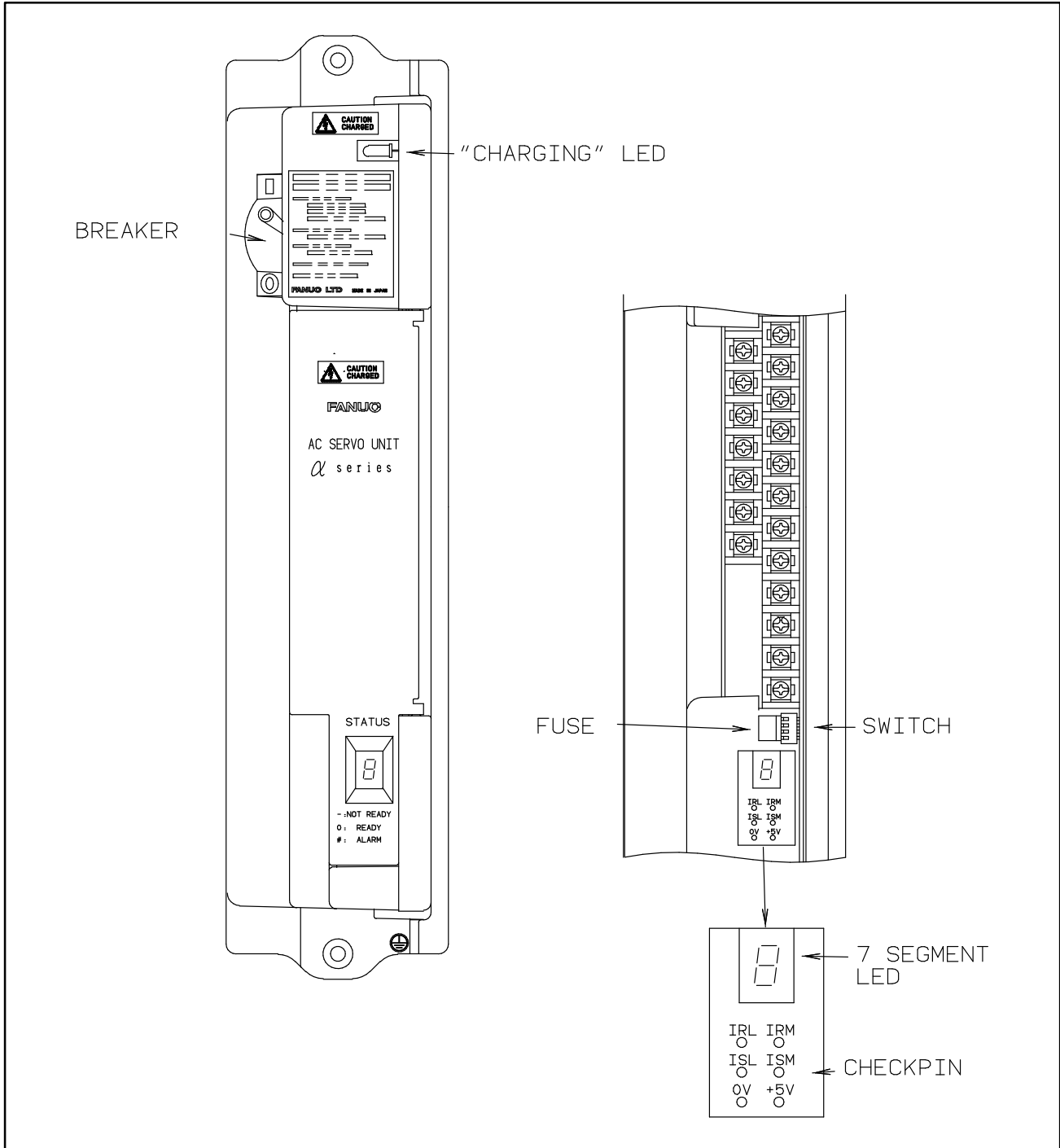

B MOTOR GROUNDING CONNECTION

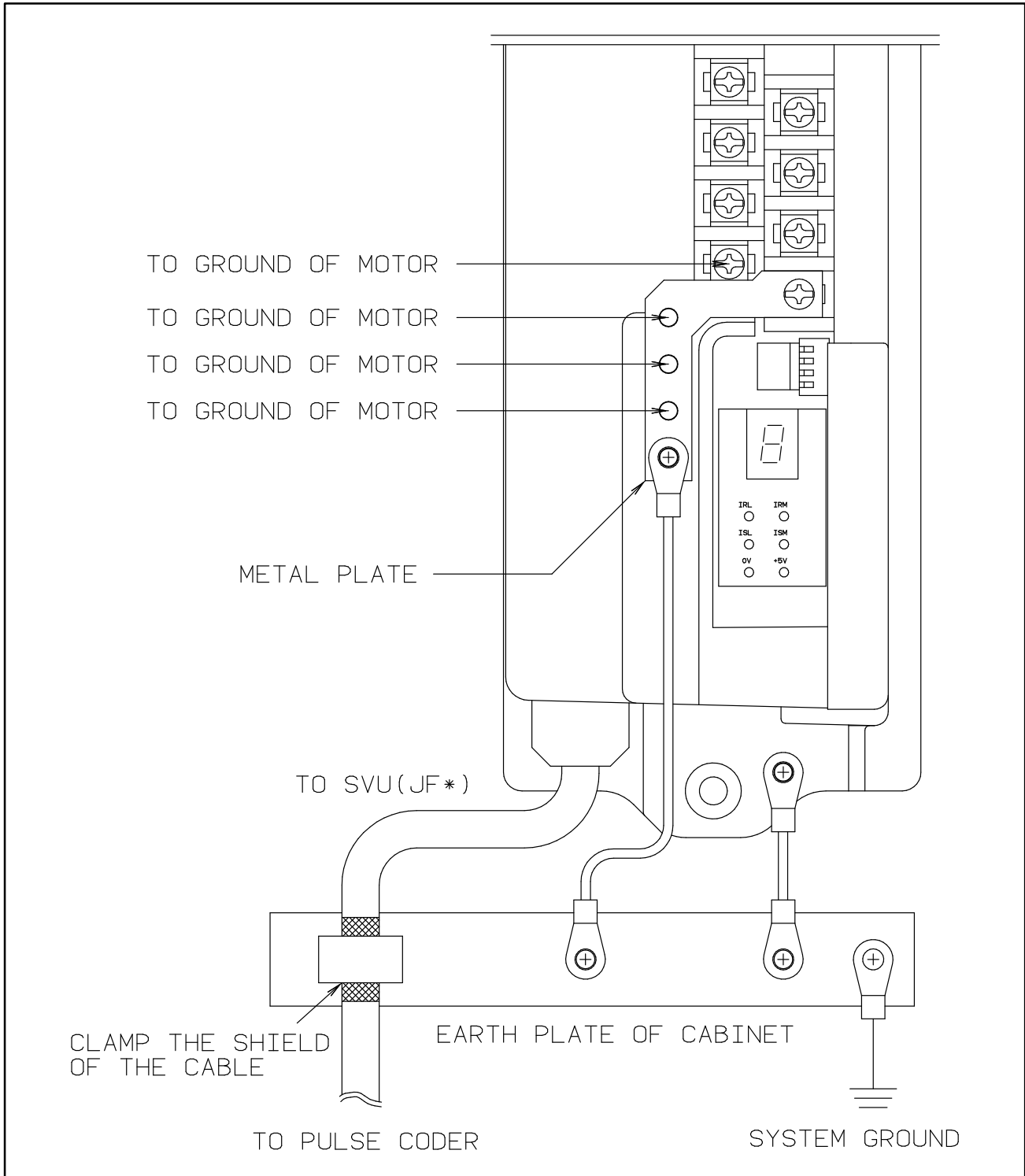

[A]

Actions to be Taken on Each Alarm, 44
 Alarm Number and Brief Descriptions, 38
 Alarm Number in Series 0-C (Servo Alarms), 40
 Alarm Number in Series 15 (Servo Alarms), 39
 Alarm Number in Series 16, 18, 20 (Servo Alarms), 41
 Axis Left Unused in a Multi-axis Amplifier, 30

[B]

Basic Configuration, 5

[C]

Checking the +5V Power Supply Voltage, 27
 Checking the Motor Instantaneous Current, 27
 Compatibility of the SVU and SVUC with the C Series Amplifier, 64
 Confirmation Procedure, 26
 Confirming the Line Voltage and Power Requirements, 10
 Connecting the Battery for an Absolute Pulse Coder, 14
 Connecting the Power Supply, 10
 Connecting the Separate Regenerative Discharge Unit, 15
 Connecting to the Protection Ground, 10
 Current Conversion Failure Alarm, 48

[F]

Feedback Disconnected Alarm, 50

[I]

Initializing Servo Parameters, 18
 Invalid Servo Parameter Setting Parameters, 51

[L]

Leakage Current and Selecting a Ground Fault Interrupter, 10
 LED Indications and Meanings, 43

[M]

Major Components, 6
 Motor Grounding Connection, 70
 Motor Overheat Alarm, 51

[O]

Operation Confirmation Method, 25
 Overload Alarm, 50
 Overview of the Start-up Procedure, 9

[P]

Pulse Coder Communication Error Alarm, 58
 Pulse Coder Error Alarm, 57

[R]

Replacing the Fuse, 59
 Rotation Speed Data Error Alarm, 57

[S]

Servo Adjustment Screen, 49
 Servo Amplifier Unit, 43
 Servo Amplifier Unit Check Pins, 27
 Servo Amplifier Unit Front Panel, 69
 Servo Check Board, 31
 Servo Software, 49
 Start-up Procedure, 8
 STATUS Indicator, 29
 SVU, 6
 SVUC, 7
 SVUC Specification Code, 66
 Switch Setting, 12

[T]

Troubleshooting and Recovery Procedures, 42

Revision Record

FANUC CONTROL MOTOR AMPLIFIER α series SERVO AMPLIFIER UNIT MAINTENANCE MANUAL (B-65195EN)

Edition	Date	Contents	Edition	Date	Contents
01	Aug., '95	_____			