

***tyco*** / *Electronics*

*The Technology Company*



**AMP**

**Hollow Shaft Resolver**

## Tyco Electronics

### Growing to meet your electronic component and system needs

Tyco Electronics, the largest division of Tyco International Ltd., was established in September 1999 when Tyco merged with Elcon Products, Raychem and AMP, all acquired earlier the same year. Combined with further acquisitions such as the Electromechanical Components division of Siemens, the Electronic OEM division of Thomas & Betts, Critchley and others, Tyco Electronics is now the world's largest passive component supplier, with product ranges in 21 passive and active product segments.

Recently, our capabilities expanded considerably with the acquisition of the Power Systems division of Lucent Technologies. This allows Tyco Electronics to offer you high-quality AC-DC and DC-DC power solutions for a broad range of applications, from small power modules for laptop computers to very large stand-alone systems capable of handling up to 10,000 amperes.

Today, in addition to power systems, our product portfolio encompasses connector systems and application tooling, active and passive fiberoptic devices, wireless components (including ICs, radar sensors and complete communications systems), heat shrink products, PolySwitch circuit protection devices, magnetic components, wire and cable systems, touchscreens, PC boards and backplanes, relays, sensors, electronic modules, battery packs, terminal blocks and switches. Our goal is to be the market leader in each of these segments.

A significant result of our continued growth and a real benefit to our customers is that Tyco Electronics' technology leadership has become even stronger. Our expertise and synergies in materials science, product design and process engineering, coupled with our network of well-trained application engineers and sales representatives, allows us not only to provide superior customer service, but also to better assist you in making your next generation of products successful.

Call us – we're ready to help.



### Tyco Electronics AMP @online

**Internet Homepage:** <http://www.tycoelectronics.com>  
<http://www.amp.com>

**Electronic Catalog in the Internet:** <http://connect.amp.com>

To be close to our customers worldwide is an essential part of our success. The Tyco Electronics AMP Website is more than merely an Internet-guide. It is an innovative and interactive source for application tips, product update and technical information. This Website is available in eight languages. With our StepSearch-Software you can easily surf through all of our product lines.

### Product Information Center (PIC)

You can rely on our PIC Team's support.

Our experienced staff is an additional information source, and the team has been particularly trained to answer your technical questions.

To reach our PIC, please contact your local Tyco Electronics AMP company.



### Product and Machine Literature

Product and machine literature quick and easy by fax.

A wide range of products also requires an extensive literature stock. We can provide you with brochures, catalogs and flyers for every product program of your interest.

Our catalog service team supports you in selecting and ordering the appropriate catalog. To get product and application tooling catalogs quickly and easily, please contact your local Tyco Electronics company.

# Content

|   | Page |
|---|------|
| <b>General Description</b> .....                                      | 2    |
| <b>General Terms</b> .....  | 3    |
| <b>Overview of Standard Types</b> .....                               | 4    |
| <b>Hollow Shaft Resolver Size 15</b> .....                            | 5    |
| Technical Data .....  | 5    |
| Dimensioned drawing .....   | 6    |
| V23401-D1001-B1.. .....   | 7    |
| V23401-D1008-B1.. 3-speed .....                                       | 10   |
| V23401-D1009-B1.. with low output impedance .....                     | 13   |
| V23401-S1001-B1.. .....   | 16   |
| <b>Hollow Shaft Resolver Size 21</b> .....                            | 19   |
| Technical Data .....  | 19   |
| Dimensioned drawing .....   | 20   |
| V23401-T1002-B1.. / V23401-H1002-B1.. 3-speed .....                   | 22   |
| V23401-T1005-B1.. / V23401-H1005-B1.. .....                           | 25   |
| V23401-T1009-B1.. / V23401-H1009-B1.. with low output impedance ..... | 28   |
| V23401-T2001-B2.. / V23401-H2001-B2.. .....                           | 31   |
| V23401-T2009-B2.. / V23401-H2009-B2.. with low output impedance ..... | 34   |
| V23401-T2010-B2.. / V23401-H2010-B2.. 3-speed .....                   | 37   |
| V23401-T2014-B2.. / V23401-H2014-B2.. 4-speed .....                   | 40   |
| V23401-T2015-B2.. / V23401-H2015-B2.. 2-speed .....                   | 43   |
| V23401-U1016-B1.. .....   | 46   |
| V23401-U2017-B2.. .....   | 49   |
| V23401-U2020-B2.. 3-speed .....                                       | 52   |

# Hollow Shaft Resolver

## General Description

The use of sensors for determining angles increases with progressive automation. The hollow shaft resolver has long won its own steady position on the market and can nowadays be found in many modern, high-precision control systems.

Due to its design, the hollow shaft resolver boasts of a service life above average. Reliability as well as high precision and low space requirements supplement its favorable characteristics. It remains fully operable even under extreme environmental conditions.

Essentially, the resolver mechanically consists of a stationary stator and a movable rotor. Electrically it consists of a transformer for supplying the rotor with power and a second transformer for determining angles.

The first transformer has a concentric design and is functionally independent of angle values. The second, angle-dependent transformer is made of a stator winding and a rotor winding. The windings of these two transformer components are designed such that the number of windings in the grooves correspond to the values of a sinoid.

Negative values are realized by reversing the direction of the winding. The stator coils consist of two similar windings that are fitted in a relative position to each other rotated by 90°.

If the rotor winding is energized, a sinusoidal magnetic flux is created that induces voltages in the stator coils as a function of the relative angular position of the rotor and stator. The amplitudes of the two voltages correspond to the sine or cosine. Thus, using a suitable evaluation circuit, it is possible to obtain the absolute angle data.

The term used for the basic version is a resolver with one pair of poles (1-speed-resolver).

The number of pairs of poles indicates how often the sine distribution of the rotor and stator windings is repeated during one revolution. The higher the number of pairs of poles, the higher the mechanical precision of the resolver. The location deviation of the radial offset increases. With multiple pairs of poles, the absolute angle data are lost, but a higher resolution is possible after digital conversion of the resolver-signals.

## Operational diagram

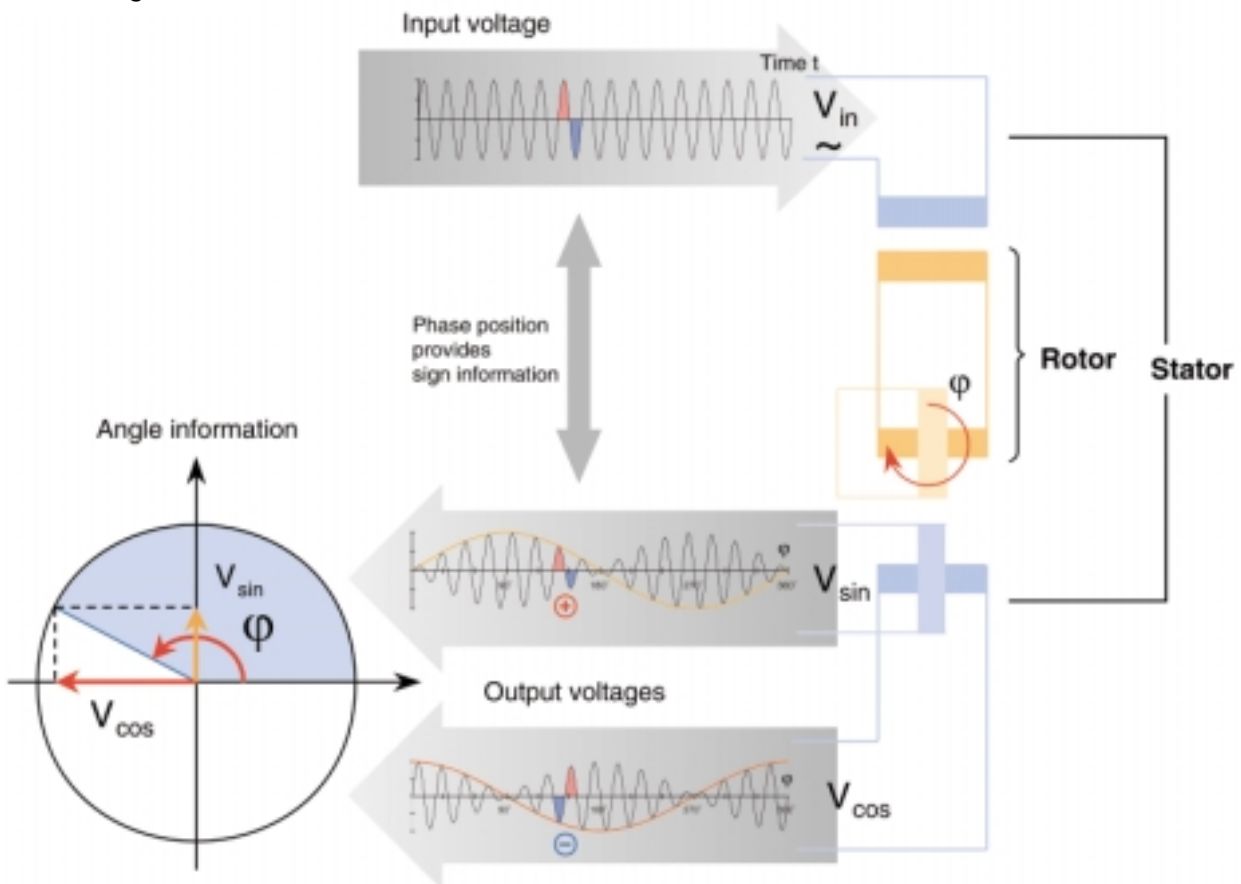

ECLO380-J

# Hollow Shaft Resolver

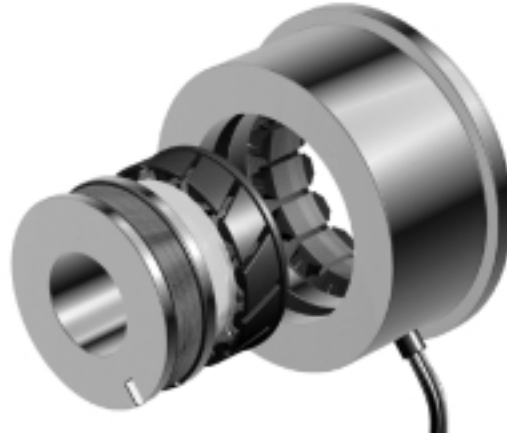

## General Terms

### Pairs of poles $p$ (speed)

The number of electrical sine and cosine cycles per mechanical revolution.

### Residual voltage $V_{\text{residual}}$

The residual voltage is the actual value of the voltage remaining when  $V_{S1-S3}$  or  $V_{S2-S4}$  takes on the nominal value of zero.

$$V_{\text{residual}} < 0.7 \% \text{ of } r_T \cdot V_{R1-R2}$$

### Angle error spread $\Delta\varphi$

The angle error spread is the deviation (unit: arcmin = ') of the angle represented by the electrical signals from the corresponding actual mechanical angle.

$$\Delta\varphi = \varphi_{\text{el}} - \varphi_{\text{mech}} \cdot p \quad \text{with } p = \text{pairs of poles}$$

Applicable definition: the angle error spread lies within  $\pm n$  arc minutes in any angular position of the specified band.

### DC resistance values

The ohmic resistance values are based on an ambient temperature of 22 °C and change with temperature by 0.39 % / K.

### Phase shift $\psi$

The phase shift  $\psi$  is the lag between the input signal and output signal.

### Transformation ratio $r_T$

The transformation ratio  $r_T$  is the ratio between the input voltage and the maximum output voltage.

$$\begin{aligned} r_T &= V_{S1-S3 \text{ max}} / V_{R1-R2} \\ &= V_{S2-S4 \text{ max}} / V_{R1-R2} \end{aligned}$$

### Impedance values $Z_{RO}$ ; $Z_{RS}$ ; $Z_{SO}$ ; $Z_{SS}$

The impedance values are the ac resistance values and depend on the frequency. Especially  $Z_{SO}$  is the value relevant for the output capability of the resolver, while  $Z_{RS}$  is decisive for the load on the energizing signal source.

# Hollow Shaft Resolver

## Overview of Standard Types

| Size | Pairs of poles (speed) | Housing material    | Angular error range                    | ± 4' | ± 6' | ± 7' | ± 8' | ± 10' | ± 15' | ± 20' | Trans-formation ratio | Notes                     |  |
|------|------------------------|---------------------|--|------|------|------|------|-------|-------|-------|-----------------------|---------------------------|--|
|      |                        |                     | Ordering number                        | ..33 | ..10 | ..02 | ..09 | ..01  | ..22  | ..14  |                       |                           |  |
| 15   | 1                      | CrNi-steel          | V23401-D1001-B1..                      |      |      | X    |      | X     | X     | X     | 0.5                   |                           |  |
|      | 3                      | CrNi-steel          | V23401-D1008-B1..                      |      |      | X    |      | X     | X     | X     | 0.5                   | 3-speed                   |  |
|      | 1                      | CrNi-steel          | V23401-D1009-B1..                      |      |      | X    |      | X     | X     | X     | 0.5                   | with low output impedance |  |
|      | 1                      | CrMo-steel          | V23401-S1001-B1..                      |      | X    |      | X    | X     | X     |       | 0.5                   |                           |  |
| 21   | 3                      | Aluminum CrNi-steel | V23401-T1002-B1..<br>V23401-H1002-B1.. |      |      | X    |      | X     | X     | X     | 0.5                   | 3-speed                   |  |
|      | 1                      | Aluminum CrNi-steel | V23401-T1005-B1..<br>V23401-H1005-B1.. |      |      | X    |      | X     | X     | X     | 0.5                   |                           |  |
|      | 1                      | Aluminum CrNi-steel | V23401-T1009-B1..<br>V23401-H1009-B1.. |      |      | X    |      | X     | X     | X     | 0.5                   | with low output impedance |  |
|      | 1                      | Aluminum CrNi-steel | V23401-T2001-B2..<br>V23401-H2001-B2.. |      |      | X    |      | X     | X     | X     | 0.5                   |                           |  |
|      | 1                      | Aluminum CrNi-steel | V23401-T2009-B2..<br>V23401-H2009-B2.. |      |      | X    |      | X     | X     | X     | 0.5                   | with low output impedance |  |
|      | 3                      | Aluminum CrNi-steel | V23401-T2010-B2..<br>V23401-H2010-B2.. |      |      | X    |      | X     | X     | X     | 0.46                  | 3-speed                   |  |
|      | 4                      | Aluminum CrNi-steel | V23401-T2014-B2..<br>V23401-H2014-B2.. |      |      | X    |      | X     | X     | X     | 0.46                  | 4-speed                   |  |
|      | 2                      | Aluminum CrNi-steel | V23401-T2015-B2..<br>V23401-H2015-B2.. |      |      | X    |      | X     | X     | X     | 0.5                   | 2-speed                   |  |
|      | 1                      | CrMo-steel          | V23401-U1016-B1..                      | X    | X    |      | X    | X     |       |       |                       | 0.5                       |  |
|      | 1                      | CrMo-steel          | V23401-U2017-B2..                      | X    |      | X    |      | X     |       |       |                       | 0.5                       |  |
| 3    | CrMo-steel             | V23401-U2020-B2..   |  | X    |      | X    | X    |       |       |       | 0.46                  | 3-speed                   |  |

| Transfer function  |   |
|--|---|
| <p><b>Function</b></p> $V_{S1-S3} = +\Gamma_T \cdot V_{R1-R2} \cdot \cos(p \cdot \alpha)$ $V_{S2-S4} = +\Gamma_T \cdot V_{R1-R2} \cdot \sin(p \cdot \alpha)$ <p><math>p</math> = pairs of poles</p> <p>This function applies to the clockwise rotation of the rotor when looking at the (grooveless) transformer component from the top.</p> | <div style="display: flex; justify-content: space-between;"> <div style="text-align: left;"> <p>Input</p> <p><math>V_{R1-R2}</math></p> <p>(red / white)<br/>(yellow / white<br/>resp.<br/>black / white)</p> </div> <div style="text-align: center;"> <p>Resolver Section</p> <p>Transformer Section</p> <p>Rotor</p> <p>Stator</p> <p><math>\alpha</math></p> </div> <div style="text-align: right;"> <p>Output</p> <p>(yellow) <math>V_{S2-S4}</math></p> <p>(blue)</p> <p>(red)</p> <p>(black) <math>V_{S1-S3}</math></p> </div> </div> <p style="text-align: right; font-size: small;">ECL0379-G</p> |

| Electrical and thermal limits  |  |
|--|--|
| <p>High-voltage test</p> <p>Windings to housing</p> <p>Windings to each other</p>  | <p>250 V<sub>AC</sub>, 50 Hz</p> <p>250 V<sub>AC</sub>, 50 Hz</p>                |
| <p>Insulation resistance</p> <p>Windings to housing and windings to each other</p> | <p><math>R_{insulation} &gt; 50 \text{ M}\Omega</math> at 500 V<sub>DC</sub></p> |
| <p>Operating temperature range</p>   | <p>-55 °C ... +150 °C</p>  |

| Mechanical data  |   |
|--|---|
| <p>Weight</p> <p>V23401-D...</p> <p>V23401-S...</p>                    | <p>approx. 90 g</p> <p>approx. 90 g</p> |
| <p>Momentum of inertia of the rotor</p>                                | <p>approx. 20 g · cm<sup>2</sup></p>    |
| <p>Maximum rational speed</p>  | <p>20 000 rpm</p>                       |
| <p>Maximum angular acceleration</p>                                    | <p>150 000 rad/s<sup>2</sup></p>        |
| <p>Torsional strength of rotor components</p>                          | <p>0.25 Nm</p>                          |
| <p>Shock resistance (11 ms sine)</p>                                   | <p>1000 m/s<sup>2</sup></p>             |
| <p>Vibration fatigue limit (0 ... 2 kHz)</p>                           | <p>200 m/s<sup>2</sup></p>              |
| <p>Permissible radial runout<br/>(see Dimensioned drawing: Note 1)</p> | <p>0.075 mm</p>                         |
| <p>Permissible axial offset<br/>(see Dimensioned drawing: Note 2)</p>  | <p>± 0.25 mm</p>                        |

Size 15

Dimensioned drawing

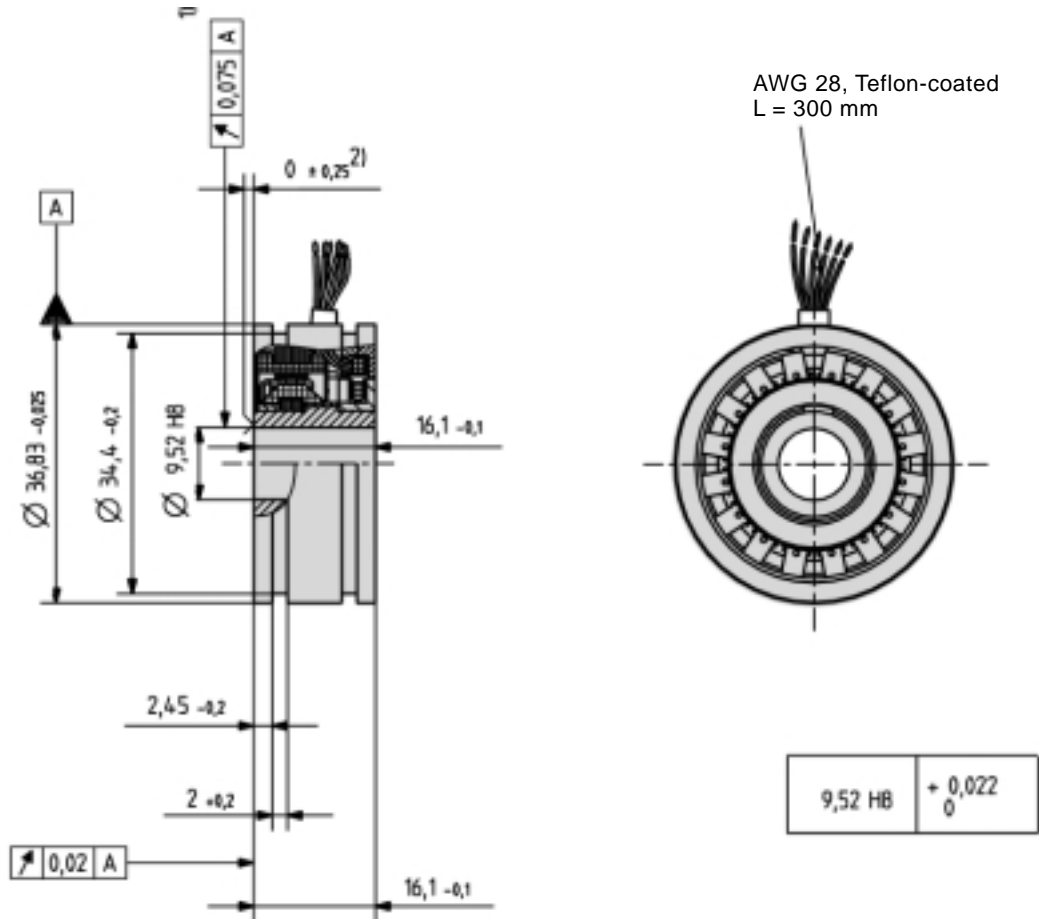

- 1) Total runout when installed
- 2) Axial offset



Housing CrNi-steel

**Electrical error / Ordering information**

|   |   |
|---|---|
| <p><b>Angular error spread <math>\Delta\phi</math></b><br/> <math>\pm 20'</math><br/> <math>\pm 15'</math><br/> <math>\pm 10'</math><br/> <math>\pm 7'</math></p> | <p><b>Ordering code</b><br/> V23401-D1001-B114<br/> V23401-D1001-B122<br/> V23401-D1001-B101<br/> V23401-D1001-B102</p> |
| <p><b>Residual voltage <math>V_{\text{residual}}</math></b></p>   | <p>25 mV at <math>V_{R1-R2} = 7\text{ V}</math></p>   |

Electrical data at 22 °C.

**Transfer function**

Pairs of poles p  $p = 1$

**Transformation ratio  $r_T$**

$$r_T = V_{S1-S3 \text{ max}} / V_{R1-R2}$$

$$= V_{S2-S4 \text{ max}} / V_{R1-R2}$$

= 0.5  $\pm$  10 % within 4 ... 20 kHz  
 = 0.5  $\pm$  5 % at 5 kHz

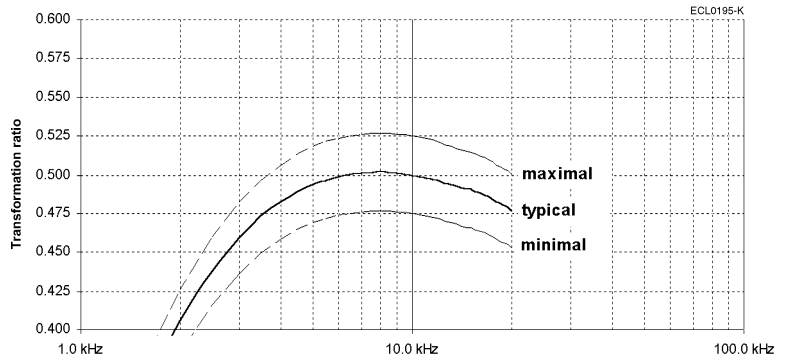

**Phase shift  $\psi$**

$$V_{R1-R2}(t) = V_{R1-R2 \text{ max}} \cdot \sin(2 \cdot \pi \cdot f \cdot t)$$

$$V_{S1-S3}(t) = V_{S1-S3 \text{ max}} \cdot \sin(2 \cdot \pi \cdot f \cdot t - \psi)$$

for  $-90^\circ < \alpha < +90^\circ$

Tolerance:  $\pm 5^\circ$

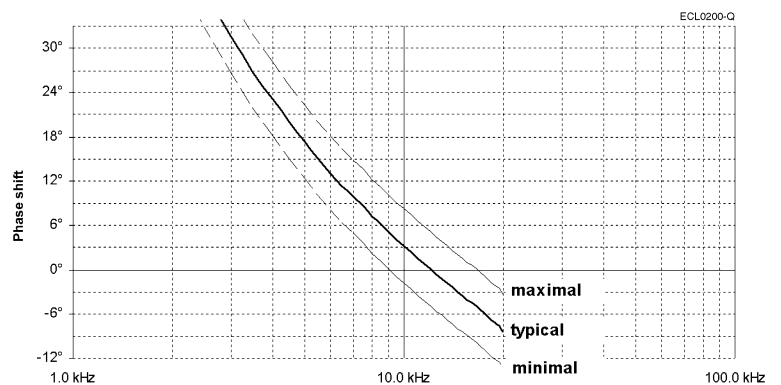

Size 15

**Resistance, impedance and operating parameters**

|  |                                      |
|--|--------------------------------------|
| <b>Input voltage <math>V_{R1-R2}</math>, typical</b> | $2 V_{rms} \dots 10 V_{rms}$         |
| <b>Frequency <math>f</math>, typical</b>             | $4 \text{ kHz} \dots 20 \text{ kHz}$ |

When choosing the values of these parameters take into account power dissipation, max. ambient temperature and the heat dissipation. Including self heating a maximum operating temperature of 150 °C must not be exceeded. Generally a power dissipation of  $P \leq 0.3 \text{ W}$  is not critical.

**Input current I**

The adjacent figure applies to  $V_{R1-R2} = 7 \text{ V}$ .

For other input voltages, the input current changes follows as:

$$I = I_{\text{Figure}} \cdot V_{R1-R2} / 7 \text{ V}$$

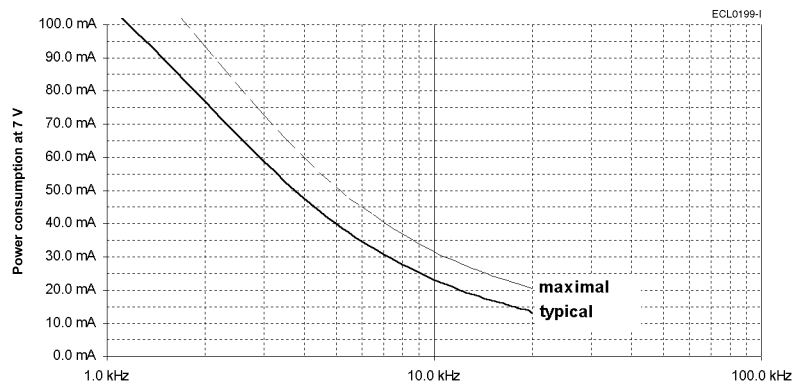

**Power consumption P**

The adjacent figure applies to  $V_{R1-R2} = 7 \text{ V}$ .

For other input voltages, the power consumption changes follows as:

$$P = P_{\text{Figure}} \cdot (V_{R1-R2} / 7 \text{ V})^2$$

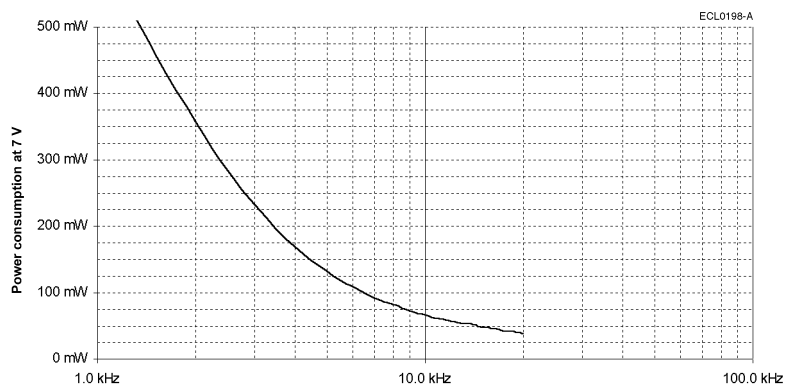

Size 15

**Resistance, impedance and operating parameters (continued)**

**DC resistance**

The ohmic resistance values are based on an ambient temperature of 22 °C and change with temperature by 0.39 % / K

$R_{R1-R2} = 46 \Omega$   
 $R_{S1-S3} = R_{S2-S4} = 63 \Omega$   
 Tolerance:  $\pm 10 \%$

**Input impedance**

Tolerance:  $\pm 15 \%$

$Z_{RO}$  ... Impedance between R1 and R2 with open outputs

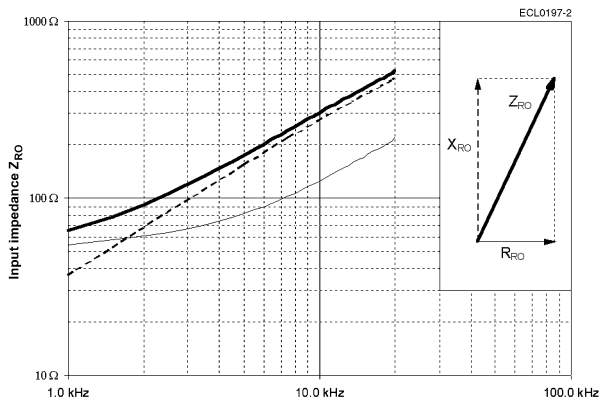

Tolerance:  $\pm 15 \%$

$Z_{RS}$  ... Impedance between R1 and R2 with short circuits between S1 and S3 as well as between S2 and S4

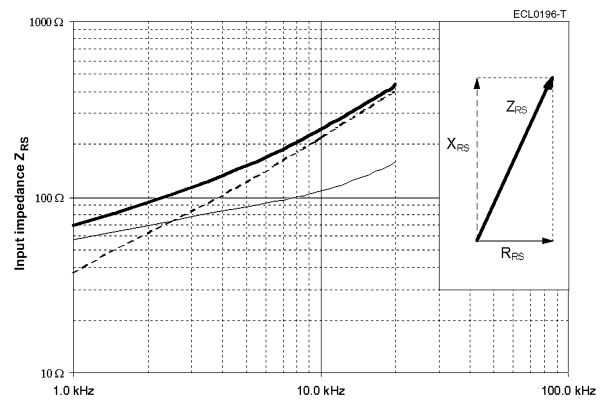

**Output impedance**

Tolerance:  $\pm 15 \%$

$Z_{SO}$  ... Impedance between S2 and S4 in a position of 0° (minimal coupling) with open outputs

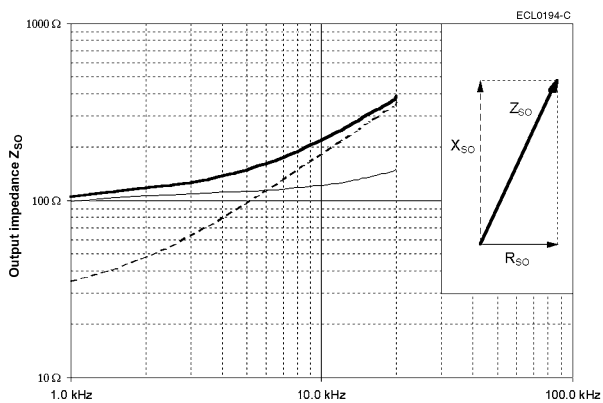

Tolerance:  $\pm 15 \%$

$Z_{SS}$  ... Impedance between S1 and S3 in a position of 0° (max. coupling) with short circuits between R1 and R2

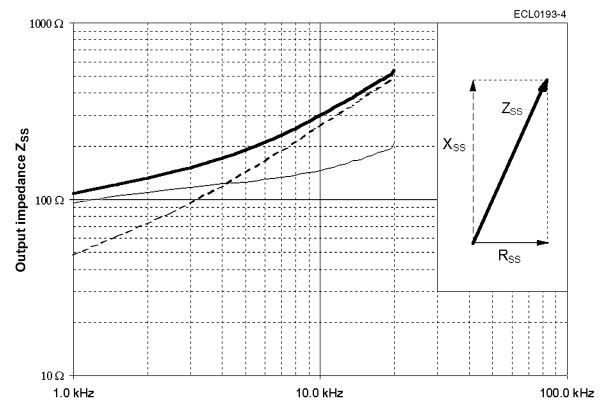

**Inductance L**

$L = X / (2 \cdot \pi \cdot f)$   
 at  $f = 10 \text{ kHz}$

$L_{RO} = 4.4 \text{ mH}$   
 $L_{SS} = 4.1 \text{ mH}$

Size 15

Housing

CrNi-steel

**Electrical error / Ordering information**

**Angular error spread  $\Delta\phi$**

- $\pm 20'$
- $\pm 15'$
- $\pm 10'$
- $\pm 7'$

**Ordering code**

- V23401-D1008-B114
- V23401-D1008-B122
- V23401-D1008-B101
- V23401-D1008-B102

**Residual voltage  $V_{\text{residual}}$**

14 mV at  $V_{R1-R2} = 4 V$

Electrical data at 22 °C.

**Transfer function**

**Pairs of poles p**

p = 3

**Transformation ratio  $r_T$**

$$r_T = \frac{V_{S1-S3 \text{ max}}}{V_{R1-R2}}$$

$$= \frac{V_{S2-S4 \text{ max}}}{V_{R1-R2}}$$

- = 0.5  $\pm$  10 % within 5 ... 20 kHz
- = 0.5  $\pm$  5 % at 10 kHz

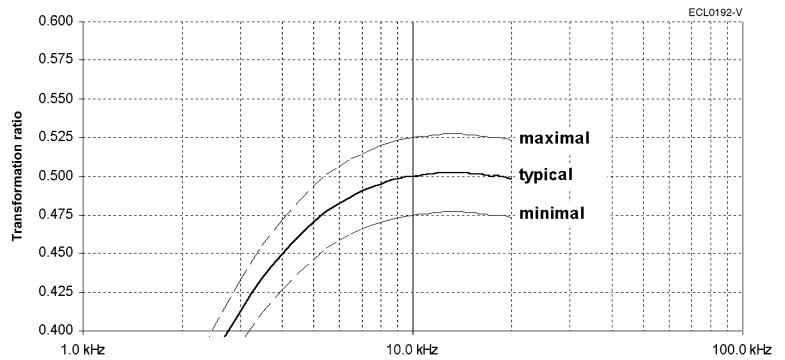

**Phase shift  $\psi$**

$$V_{R1-R2}(t) = V_{R1-R2 \text{ max}} \cdot \sin(2 \cdot \pi \cdot f \cdot t)$$

$$V_{S1-S3}(t) = V_{S1-S3 \text{ max}} \cdot \sin(2 \cdot \pi \cdot f \cdot t - \psi)$$

for  $-90^\circ < \alpha < +90^\circ$

Tolerance:  $\pm 5^\circ$

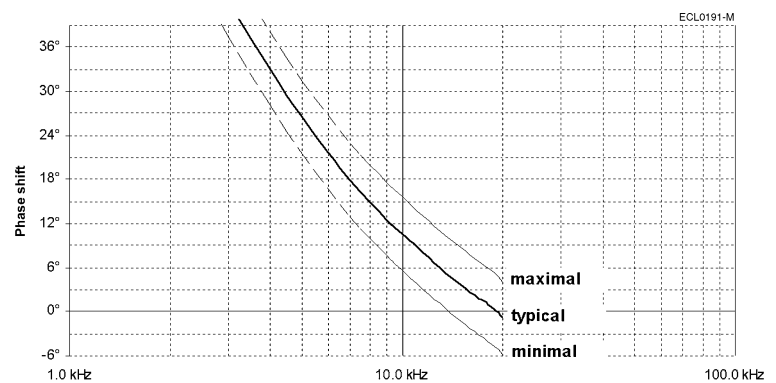

**Resistance, impedance and operating parameters**

|  |                             |
|--|-----------------------------|
| <b>Input voltage <math>V_{R1-R2}</math>, typical</b> | $2 V_{rms} \dots 8 V_{rms}$ |
| <b>Frequency <math>f</math>, typical</b>             | 5 kHz ... 20 kHz            |

When choosing the values of these parameters take into account power dissipation, max. ambient temperature and the heat dissipation. Including self heating a maximum operating temperature of 150 °C must not be exceeded. Generally a power dissipation of  $P \leq 0.3 \text{ W}$  is not critical.

**Input current I**

The adjacent figure applies to  $V_{R1-R2} = 4 \text{ V}$ .

For other input voltages, the input current changes follows as:

$$I = I_{\text{Figure}} \cdot V_{R1-R2} / 4 \text{ V}$$

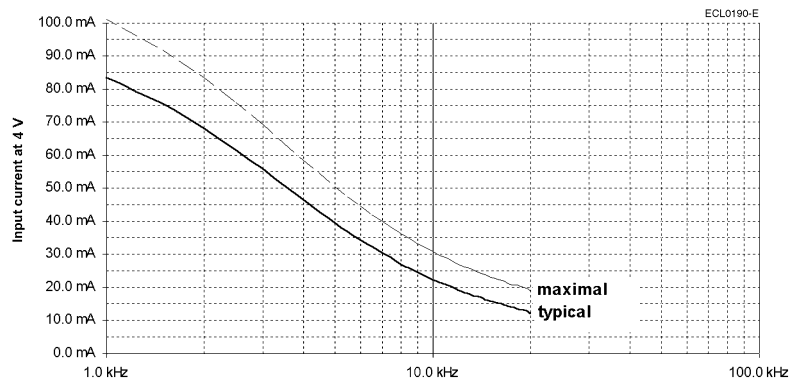

**Power consumption P**

The adjacent figure applies to  $V_{R1-R2} = 4 \text{ V}$ .

For other input voltages, the power consumption changes follows as:

$$P = P_{\text{Figure}} \cdot (V_{R1-R2} / 4 \text{ V})^2$$

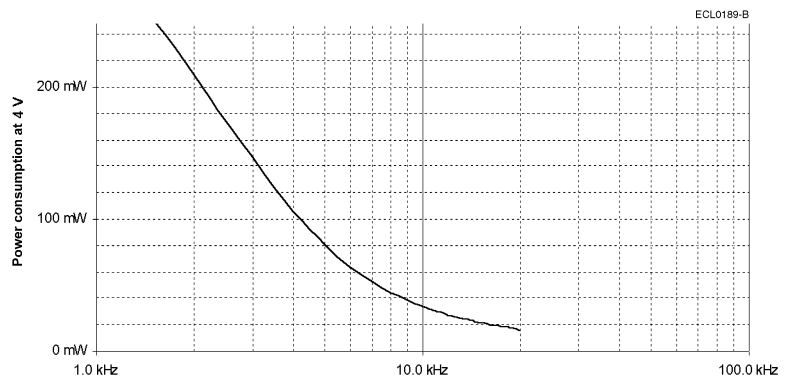

**Resistance, impedance and operating parameters (continued)**

**DC resistance**

The ohmic resistance values are based on an ambient temperature of 22 °C and change with temperature by 0.39 % / K

$R_{R1-R2} = 33 \Omega$   
 $R_{S1-S3} = R_{S2-S4} = 70 \Omega$   
 Tolerance:  $\pm 10 \%$

**Input impedance**

Tolerance:  $\pm 15 \%$

$Z_{RO}$  ... Impedance between R1 and R2 with open outputs

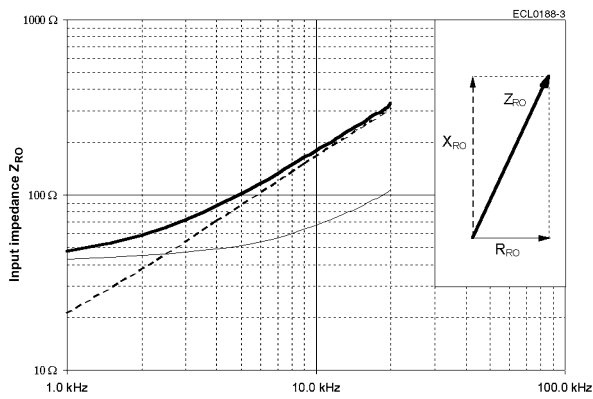

Tolerance:  $\pm 15 \%$

$Z_{RS}$  ... Impedance between R1 and R2 with short circuits between S1 and S3 as well as between S2 and S4

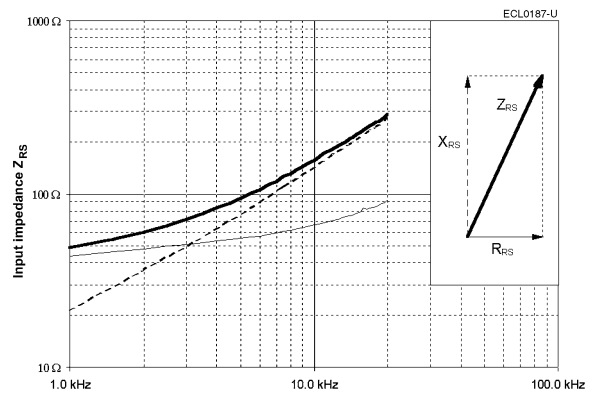

**Output impedance**

Tolerance:  $\pm 15 \%$

$Z_{SO}$  ... Impedance between S2 and S4 in a position of 0° (minimal coupling) with open outputs

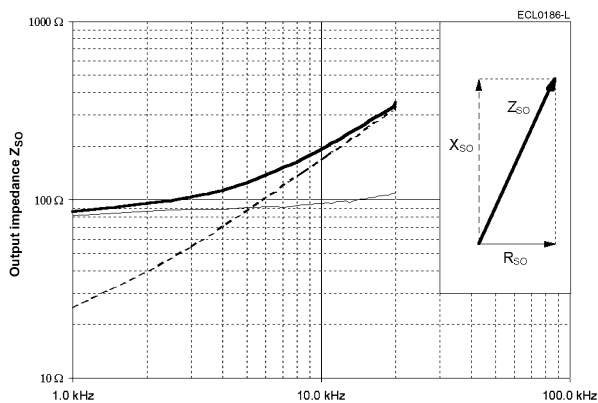

Tolerance:  $\pm 15 \%$

$Z_{SS}$  ... Impedance between S1 and S3 in a position of 0° (max. coupling) with short circuits between R1 and R2

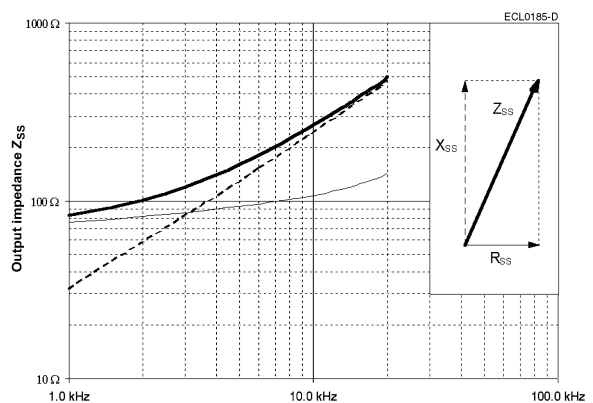

**Inductance L**

$L = X / (2 \cdot \pi \cdot f)$   
 at  $f = 10 \text{ kHz}$

$L_{RO} = 2.6 \text{ mH}$   
 $L_{SS} = 3.9 \text{ mH}$

Housing CrNi-steel

**Electrical error / Ordering information**

|  |  |
|--|--|
| <b>Angular error spread <math>\Delta\phi</math></b><br>$\pm 20'$<br>$\pm 15'$<br>$\pm 10'$<br>$\pm 7'$ | <b>Ordering code</b><br>V23401-D1009-B114<br>V23401-D1009-B122<br>V23401-D1009-B101<br>V23401-D1009-B102 |
| <b>Residual voltage <math>V_{\text{residual}}</math></b>   | 14 mV at $V_{R1-R2} = 4 \text{ V}$   |

Electrical data at 22 °C.

**Transfer function**

Pairs of poles  $p$   $p = 1$

**Transformation ratio  $r_T$**

$$r_T = \frac{V_{S1-S3 \text{ max}}}{V_{R1-R2}}$$

$$= \frac{V_{S2-S4 \text{ max}}}{V_{R1-R2}}$$

$= 0.5 \pm 10 \% \text{ within } 4 \dots 20 \text{ kHz}$   
 $= 0.5 \pm 5 \% \text{ at } 5 \text{ kHz}$

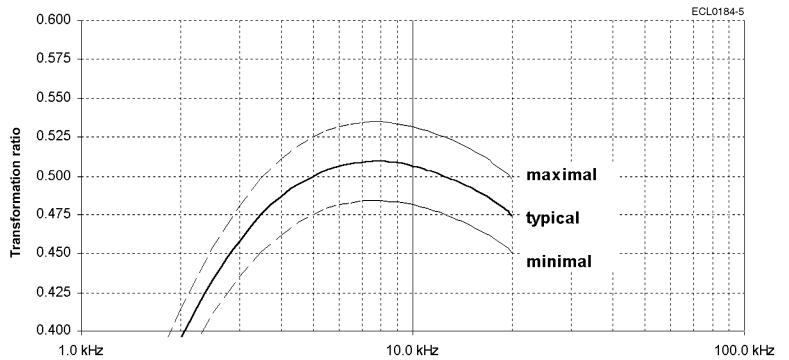

**Phase shift  $\psi$**

$$V_{R1-R2}(t) = V_{R1-R2 \text{ max}} \cdot \sin(2 \cdot \pi \cdot f \cdot t)$$

$$V_{S1-S3}(t) = V_{S1-S3 \text{ max}} \cdot \sin(2 \cdot \pi \cdot f \cdot t - \psi)$$

for  $-90^\circ < \alpha < +90^\circ$

Tolerance:  $\pm 5^\circ$

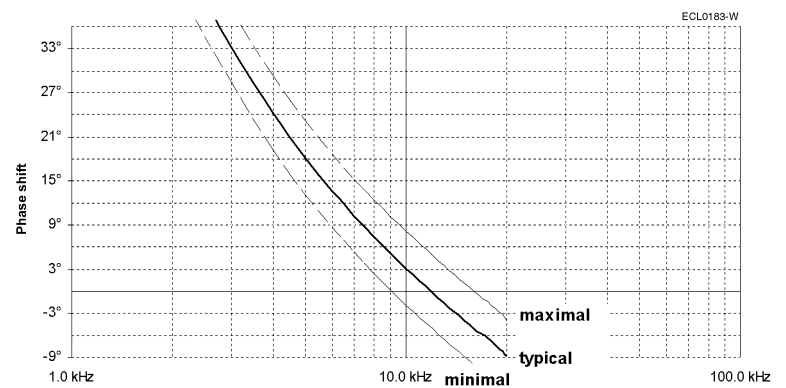

Size 15

**Resistance, impedance and operating parameters**

|  |                             |
|--|-----------------------------|
| <b>Input voltage <math>V_{R1-R2}</math>, typical</b> | $2 V_{rms} \dots 8 V_{rms}$ |
| <b>Frequency <math>f</math>, typical</b>             | 4 kHz ... 20 kHz            |

When choosing the values of these parameters take into account power dissipation, max. ambient temperature and the heat dissipation. Including self heating a maximum operating temperature of 150 °C must not be exceeded. Generally a power dissipation of  $P \leq 0.3 W$  is not critical.

**Input current I**

The adjacent figure applies to  $V_{R1-R2} = 4 V$ .

For other input voltages, the input current changes follows as:

$$I = I_{Figure} \cdot V_{R1-R2} / 4 V$$

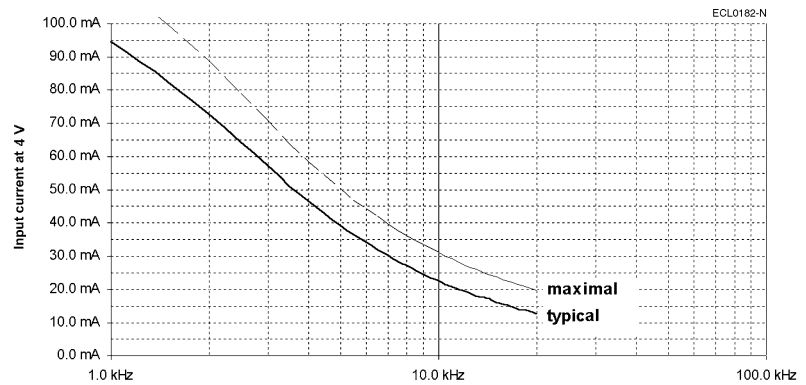

**Power consumption P**

The adjacent figure applies to  $V_{R1-R2} = 4 V$ .

For other input voltages, the power consumption changes follows as:

$$P = P_{Figure} \cdot (V_{R1-R2} / 4 V)^2$$

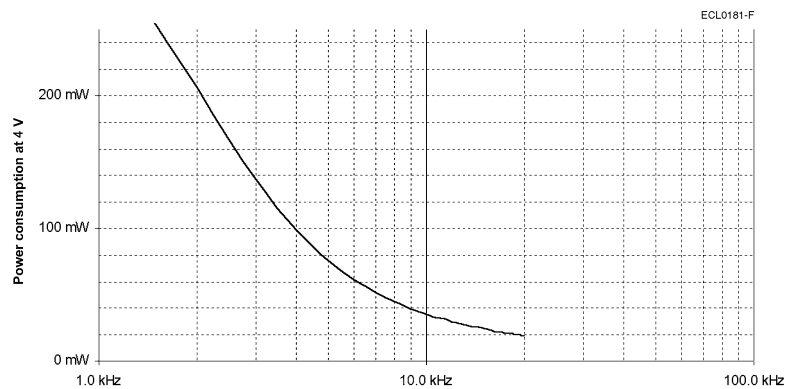

Size 15



Resistance, impedance and operating parameters (continued)

DC resistance

The ohmic resistance values are based on an ambient temperature of 22 °C and change with temperature by 0.39 % / K

$R_{R1-R2} = 31 \Omega$   
 $R_{S1-S3} = R_{S2-S4} = 28 \Omega$   
Tolerance:  $\pm 10 \%$

Input impedance

Tolerance:  $\pm 15 \%$

$Z_{RO}$  ... Impedance between R1 and R2 with open outputs

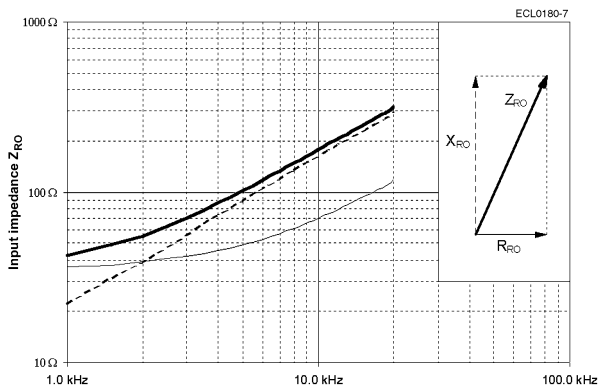

Tolerance:  $\pm 15 \%$

$Z_{RS}$  ... Impedance between R1 and R2 with short circuits between S1 and S3 as well as between S2 and S4

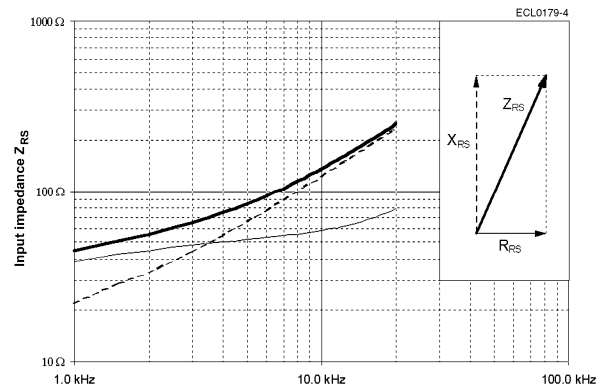

Output impedance

Tolerance:  $\pm 15 \%$

$Z_{SO}$  ... Impedance between S2 and S4 in a position of 0° (minimal coupling) with open outputs

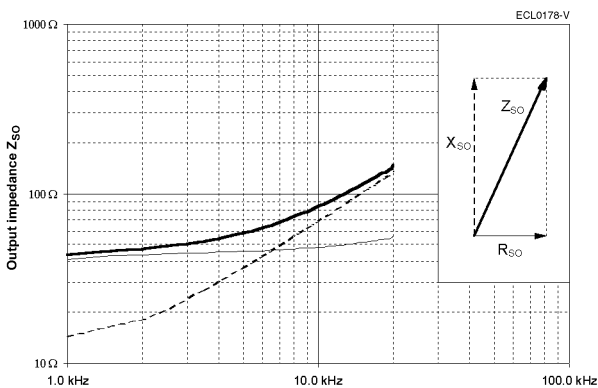

Tolerance:  $\pm 15 \%$

$Z_{SS}$  ... Impedance between S1 and S3 in a position of 0° (max. coupling) with short circuits between R1 and R2

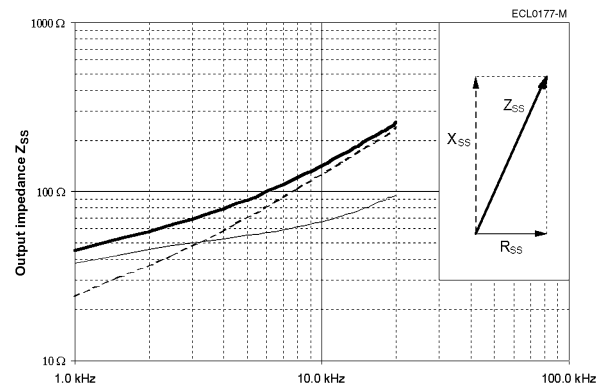

Inductance L

$L = X / (2 \cdot \pi \cdot f)$   
at  $f = 10 \text{ kHz}$

$L_{RO} = 2.6 \text{ mH}$   
 $L_{SS} = 2.0 \text{ mH}$

Size 15

Housing

CrMo-steel

**Electrical error / Ordering information**

**Angular error spread  $\Delta\phi$**

- $\pm 15'$
- $\pm 10'$
- $\pm 8'$
- $\pm 6'$

**Ordering code**

- V23401-S1001-B122
- V23401-S1001-B101
- V23401-S1001-B109
- V23401-S1001-B110

**Residual voltage  $V_{\text{residual}}$**

25 mV at  $V_{R1-R2} = 7 \text{ V}$

Electrical data at 22 °C.

**Transfer function**

**Pairs of poles p**

p = 1

**Transformation ratio  $r_T$**

$$r_T = \frac{V_{S1-S3 \text{ max}}}{V_{R1-R2}}$$

$$= \frac{V_{S2-S4 \text{ max}}}{V_{R1-R2}}$$

- = 0.5 ± 10 % within 4 ... 20 kHz
- = 0.5 ± 5 % at 5 kHz

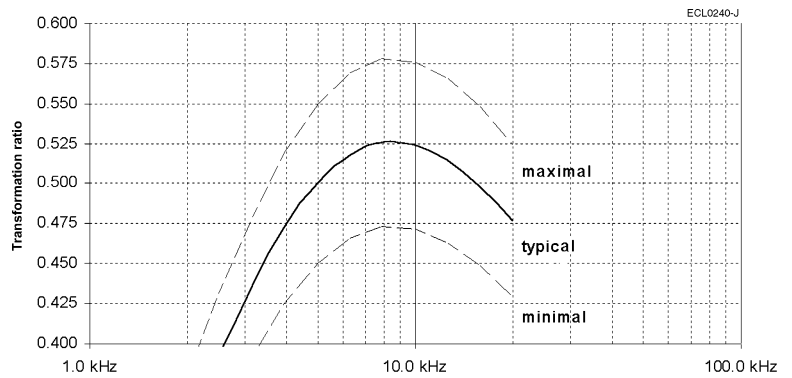

**Phase shift  $\psi$**

$$V_{R1-R2}(t) = V_{R1-R2 \text{ max}} \cdot \sin(2 \cdot \pi \cdot f \cdot t)$$

$$V_{S1-S3}(t) = V_{S1-S3 \text{ max}} \cdot \sin(2 \cdot \pi \cdot f \cdot t - \psi)$$

for  $-90^\circ < \alpha < +90^\circ$

Tolerance: ± 5°

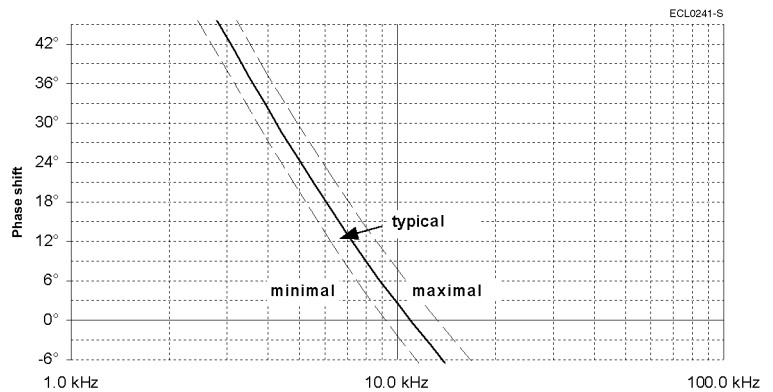

Size 15

**Resistance, impedance and operating parameters**

|  |                              |  |
|--|------------------------------|--|
| <b>Input voltage <math>V_{R1-R2}</math>, typical</b> | $2 V_{rms} \dots 10 V_{rms}$ | When choosing the values of these parameters take into account power dissipation, max. ambient temperature and the heat dissipation. Including self heating a maximum operating temperature of 150 °C must not be exceeded. Generally a power dissipation of $P \leq 0.3 W$ is not critical. |
| <b>Frequency <math>f</math>, typical</b>             | 4 kHz ... 20 kHz             |  |

**Input current I**

The adjacent figure applies to  $V_{R1-R2} = 7 V$ .

For other input voltages, the input current changes follows as:

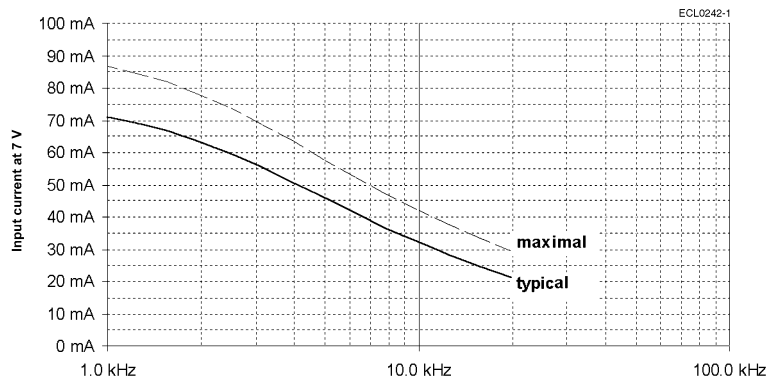
$$I = I_{Figure} \cdot V_{R1-R2} / 7 V$$

**Power consumption P**

The adjacent figure applies to  $V_{R1-R2} = 7 V$ .

For other input voltages, the power consumption changes follows as:

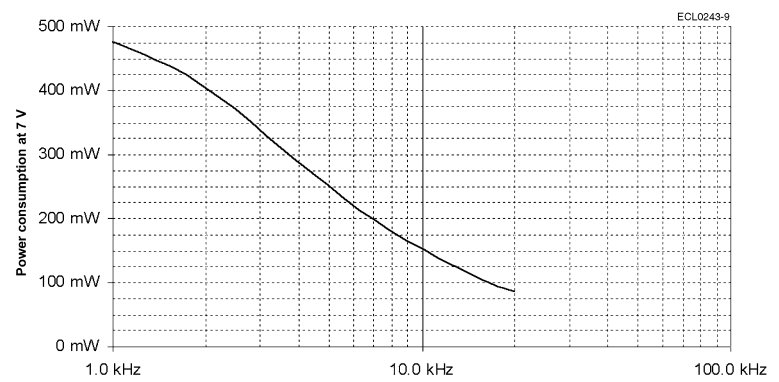
$$P = P_{Figure} \cdot (V_{R1-R2} / 7 V)^2$$

**Resistance, impedance and operating parameters (continued)**

**DC resistance**

The ohmic resistance values are based on an ambient temperature of 22 °C and change with temperature by 0.39 % / K

$R_{R1-R2} = 82 \Omega$   
 $R_{S1-S3} = R_{S2-S4} = 68 \Omega$   
 Tolerance:  $\pm 10 \%$

**Input impedance**

Tolerance:  $\pm 15 \%$

$Z_{RO}$  ... Impedance between R1 and R2 with open outputs

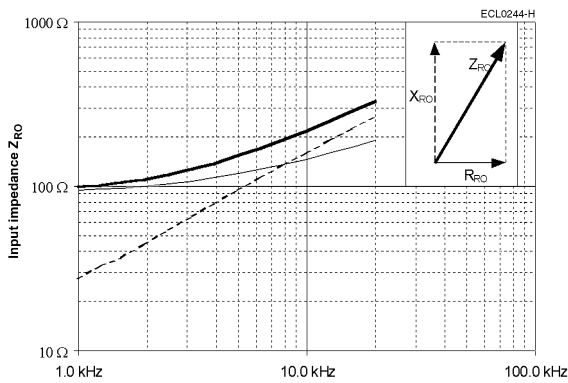

Tolerance:  $\pm 15 \%$

$Z_{RS}$  ... Impedance between R1 and R2 with short circuits between S1 and S3 as well as between S2 and S4

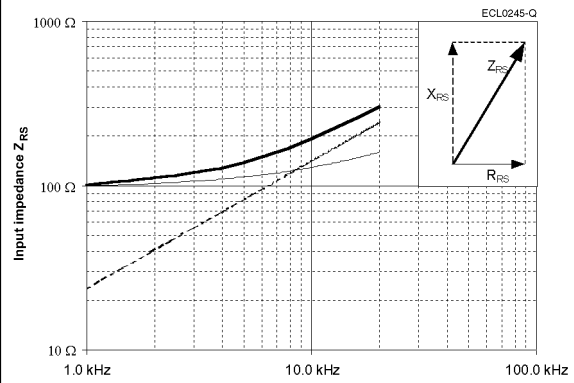

**Output impedance**

Tolerance:  $\pm 15 \%$

$Z_{SO}$  ... Impedance between S2 and S4 in a position of 0° (minimal coupling) with open outputs

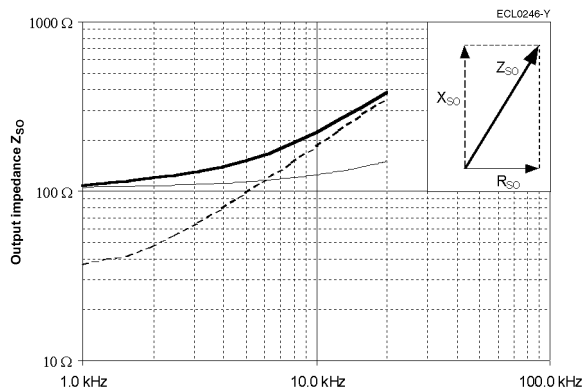

Tolerance:  $\pm 15 \%$

$Z_{SS}$  ... Impedance between S1 and S3 in a position of 0° (max. coupling) with short circuits between R1 and R2

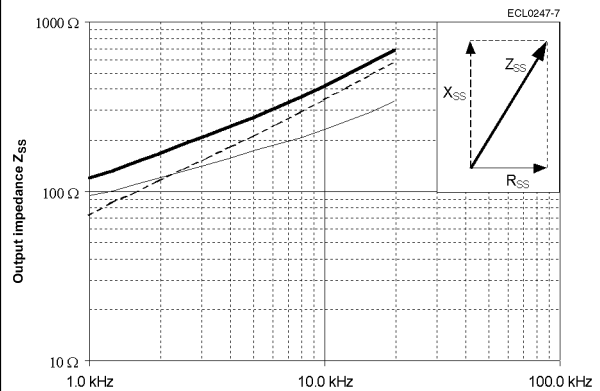

**Inductance L**

$L = X / (2 \cdot \pi \cdot f)$   
 at  $f = 5 \text{ kHz}$

$L_{RO} = 2.5 \text{ mH}$   
 $L_{SS} = 5.8 \text{ mH}$

| Transfer function  |   |        |  |        |
|--|---|--------|--|--------|
| <p><b>Function</b></p> $V_{S1-S3} = +\Gamma_T \cdot V_{R1-R2} \cdot \cos(p \cdot \alpha)$ $V_{S2-S4} = +\Gamma_T \cdot V_{R1-R2} \cdot \sin(p \cdot \alpha)$ <p><math>p</math> = pairs of poles</p> <p>This function applies to the clockwise rotation of the rotor when looking at the (grooveless) transformer component from the top.</p> | <table border="0" style="width: 100%;"> <tr> <td style="text-align: left; vertical-align: top;">Input</td> <td style="text-align: center; vertical-align: top;"> </td> <td style="text-align: right; vertical-align: top;">Output</td> </tr> </table> <p style="text-align: right; font-size: small;">ECL0379-G</p> | Input  |  | Output |
| Input  |   | Output |  |        |

| Electrical and thermal limits   |   |
|---|---|
| High-voltage test<br>Windings to housing<br>Windings to each other      | 500 V <sub>AC</sub> , 50 Hz<br>250 V <sub>AC</sub> , 50 Hz          |
| Insulation resistance<br>Windings to housing and windings to each other | $R_{\text{insulation}} > 50 \text{ M}\Omega$ at 500 V <sub>DC</sub> |
| Operating temperature range   | -55 °C ... +150 °C  |

| Mechanical data  |  |
|--|--|
| Weight<br>V23401-T 10...<br>V23401-H 10...<br>V23401-U 10...<br>V23401-T 20...<br>V23401-H 20...<br>V23401-U 20... | approx. 240 g<br>approx. 290 g<br>approx. 290 g<br>approx. 210 g<br>approx. 260 g<br>approx. 260 g |
| Momentum of inertia of the rotor   | approx. 200 g · cm <sup>2</sup>  |
| Maximum rational speed   | 20 000 rpm   |
| Maximum angular acceleration   | 64 000 rad/s <sup>2</sup>  |
| Torsional strength of rotor components   | 1 Nm   |
| Shock resistance (11 ms sine)  | 1000 m/s <sup>2</sup>  |
| Vibration fatigue limit (0 ... 2 kHz)  | 200 m/s <sup>2</sup>   |
| Permissible radial runout<br>(see Dimensioned drawing: Note 1)   | 0.075 mm   |
| Permissible axial offset<br>(see Dimensioned drawing: Note 2)  | ± 0.5 mm   |

Dimensioned drawing

V23401-T1... / H1... / U1...

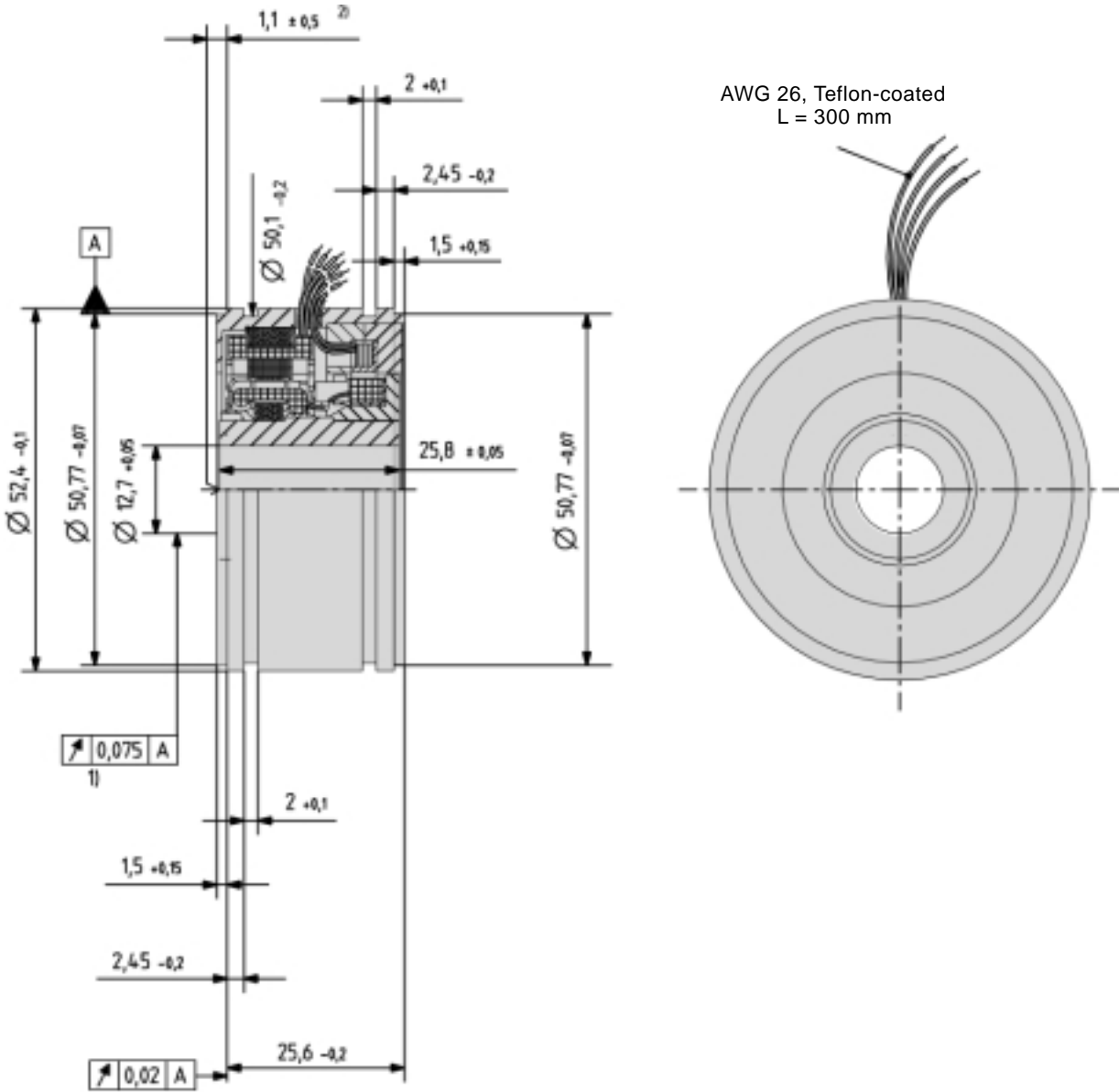

- 1) Total runout when installed
- 2) Axial offset

**Dimensioned drawing**

V23401-T2... / H2... / U2...

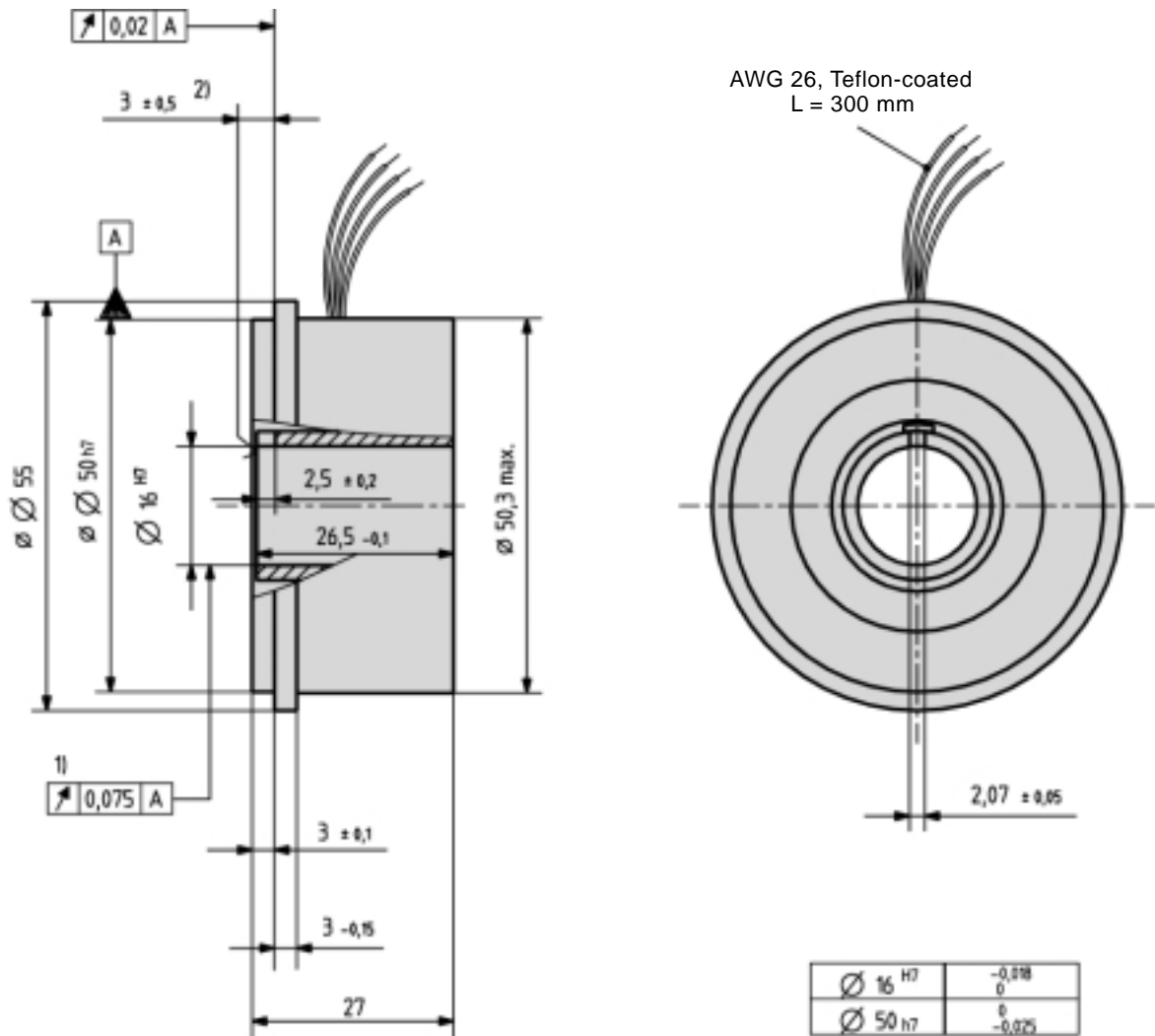

- 1) Total runout when installed
- 2) Axial offset

|                |            |                    |
|----------------|------------|--------------------|
| <b>Housing</b> | Aluminum   | V23401-T 1002-B1.. |
|                | CrNi-steel | V23401-H1002-B1..  |

**Electrical error / Ordering information**

|   |                            |                    |
|---|----------------------------|--------------------|
| <b>Angular error spread <math>\Delta\phi</math></b> | <b>Ordering code</b>       |                    |
|   | Aluminum housing           | CrNi-steel housing |
|   | $\pm 20'$                  | V23401-T1002-B114  |
|   | $\pm 15'$                  | V23401-T1002-B122  |
|   | $\pm 10'$                  | V23401-T1002-B101  |
| $\pm 7'$  | V23401-T1002-B102          | V23401-H1002-B102  |
| <b>Residual voltage <math>V_{residual}</math></b>   | 25 mV at $V_{R1-R2} = 7 V$ |                    |

Electrical data at 22 °C.

**Transfer function**

**Pairs of poles p**  $p = 3$

**Transformation ratio  $r_T$**

$$r_T = V_{S1-S3 \max} / V_{R1-R2}$$

$$= V_{S2-S4 \max} / V_{R1-R2}$$

$= 0.5 \pm 10 \% \text{ within } 3 \dots 20 \text{ kHz}$   
 $= 0.5 \pm 5 \% \text{ at } 5 \text{ kHz}$

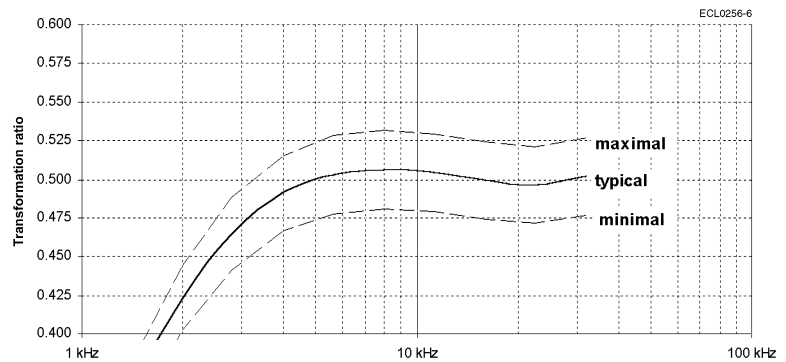

**Phase shift  $\psi$**

$$V_{R1-R2}(t) = V_{R1-R2 \max} \cdot \sin(2 \cdot \pi \cdot f \cdot t)$$

$$V_{S1-S3}(t) = V_{S1-S3 \max} \cdot \sin(2 \cdot \pi \cdot f \cdot t - \psi)$$

for  $-90^\circ < \alpha < +90^\circ$

Tolerance:  $\pm 5^\circ$

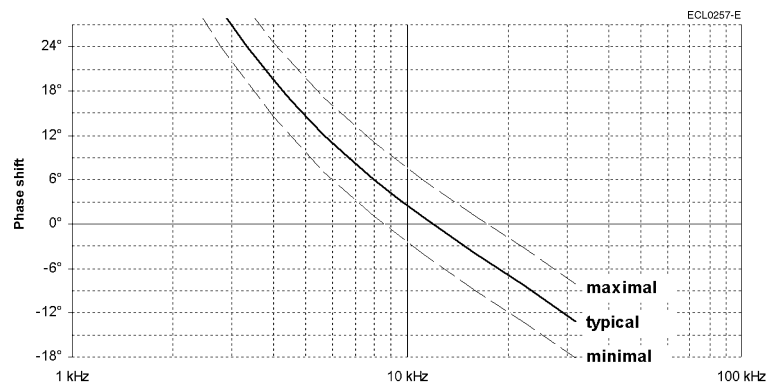



**Resistance, impedance and operating parameters**

|  |                              |
|--|------------------------------|
| <b>Input voltage <math>V_{R1-R2}</math>, typical</b> | $4 V_{rms} \dots 10 V_{rms}$ |
| <b>Frequency <math>f</math>, typical</b>             | 3 kHz ... 15 kHz             |

When choosing the values of these parameters take into account power dissipation, max. ambient temperature and the heat dissipation. Including self heating a maximum operating temperature of 150 °C must not be exceeded. Generally a power dissipation of  $P \leq 0.5 \text{ W}$  is not critical.

**Input current I**

The adjacent figure applies to  $V_{R1-R2} = 7 \text{ V}$ .

For other input voltages, the input current changes follows as:

$$I = I_{\text{Figure}} \cdot V_{R1-R2} / 7 \text{ V}$$

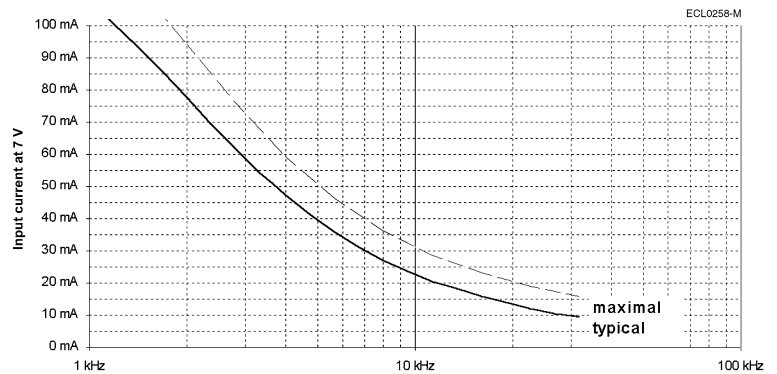

**Power consumption P**

The adjacent figure applies to  $V_{R1-R2} = 7 \text{ V}$ .

For other input voltages, the power consumption changes follows as:

$$P = P_{\text{Figure}} \cdot (V_{R1-R2} / 7 \text{ V})^2$$

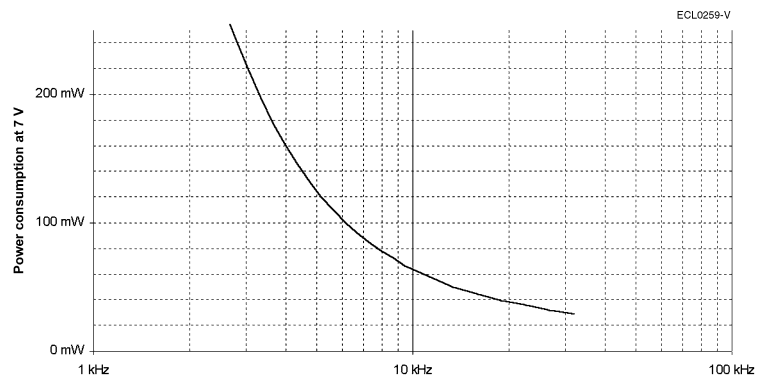

**Resistance, impedance and operating parameters (continued)**

**DC resistance**

The ohmic resistance values are based on an ambient temperature of 22 °C and change with temperature by 0.39 % / K

$R_{R1-R2} = 39 \Omega$   
 $R_{S1-S3} = R_{S2-S4} = 94 \Omega$   
 Tolerance:  $\pm 10 \%$

**Input impedance**

Tolerance:  $\pm 15 \%$

$Z_{RO}$  ... Impedance between R1 and R2 with open outputs

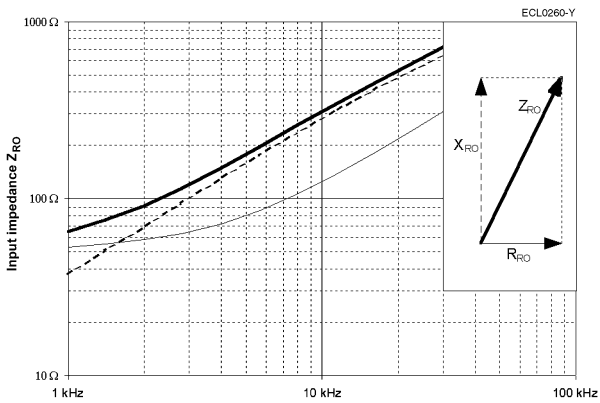

Tolerance:  $\pm 15 \%$

$Z_{RS}$  ... Impedance between R1 and R2 with short circuits between S1 and S3 as well as between S2 and S4

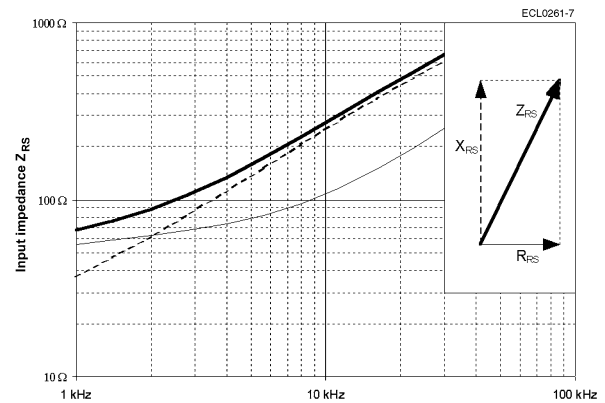

**Output impedance**

Tolerance:  $\pm 15 \%$

$Z_{SO}$  ... Impedance between S2 and S4 in a position of 0° (minimal coupling) with open outputs

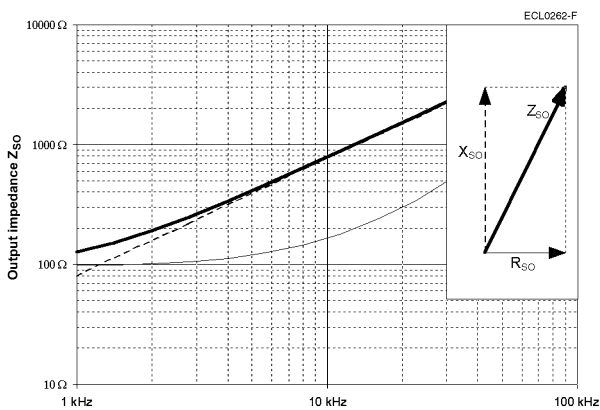

Tolerance:  $\pm 15 \%$

$Z_{SS}$  ... Impedance between S1 and S3 in a position of 0° (max. coupling) with short circuits between R1 and R2

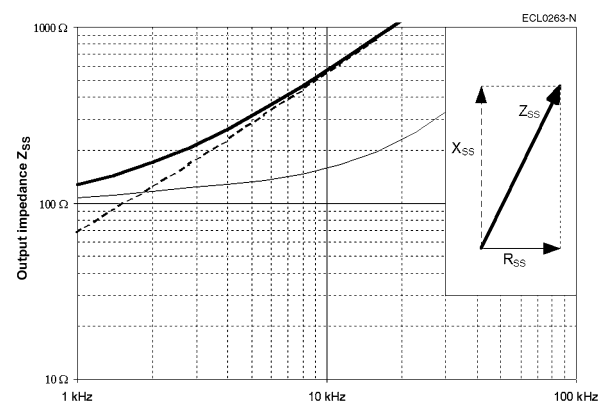

**Inductance L**

$L = X / (2 \cdot \pi \cdot f)$   
 at  $f = 8 \text{ kHz}$

$L_{RO} = 4.7 \text{ mH}$   
 $L_{SS} = 8.8 \text{ mH}$

|                |            |                    |
|----------------|------------|--------------------|
| <b>Housing</b> | Aluminum   | V23401-T 1005-B1.. |
|                | CrNi-steel | V23401-H1005-B1..  |

**Electrical error / Ordering information**

|   |                            |                    |
|---|----------------------------|--------------------|
| <b>Angular error spread <math>\Delta\phi</math></b> | <b>Ordering code</b>       |                    |
|   | Aluminum housing           | CrNi-steel housing |
|   | $\pm 20'$                  | V23401-T1005-B114  |
|   | $\pm 15'$                  | V23401-H1005-B114  |
|   | $\pm 10'$                  | V23401-T1005-B122  |
| $\pm 10'$   | V23401-H1005-B122          |                    |
| $\pm 7'$  | V23401-T1005-B101          |                    |
|   | V23401-H1005-B101          |                    |
|   | V23401-T1005-B102          |                    |
|   | V23401-H1005-B102          |                    |
| <b>Residual voltage <math>V_{residual}</math></b>   | 25 mV at $V_{R1-R2} = 7 V$ |                    |

Electrical data at 22 °C.

**Transfer function**

|  |       |
|--|-------|
| <b>Pairs of poles p</b>  | p = 1 |
| <p><b>Transformation ratio <math>r_T</math></b></p> $r_T = V_{S1-S3 \max} / V_{R1-R2}$ $= V_{S2-S4 \max} / V_{R1-R2}$ <p>= 0.5 ± 10 % within 2 ... 10 kHz<br/>= 0.5 ± 5 % at 5 kHz</p>   |       |
| <p><b>Phase shift <math>\psi</math></b></p> $V_{R1-R2}(t) = V_{R1-R2 \max} \cdot \sin(2 \cdot \pi \cdot f \cdot t)$ $V_{S1-S3}(t) = V_{S1-S3 \max} \cdot \sin(2 \cdot \pi \cdot f \cdot t - \psi)$ <p>for <math>-90^\circ &lt; \alpha &lt; +90^\circ</math></p> <p>Tolerance: ± 5°</p> |       |

**Resistance, impedance and operating parameters**

|  |                              |
|--|------------------------------|
| <b>Input voltage <math>V_{R1-R2}</math>, typical</b> | $4 V_{rms} \dots 12 V_{rms}$ |
| <b>Frequency <math>f</math>, typical</b>             | 2 kHz ... 10 kHz             |

When choosing the values of these parameters take into account power dissipation, max. ambient temperature and the heat dissipation. Including self heating a maximum operating temperature of 150 °C must not be exceeded. Generally a power dissipation of  $P \leq 0.5 W$  is not critical.

**Input current I**

The adjacent figure applies to  $V_{R1-R2} = 7 V$ .

For other input voltages, the input current changes follows as:

$$I = I_{Figure} \cdot V_{R1-R2} / 7 V$$

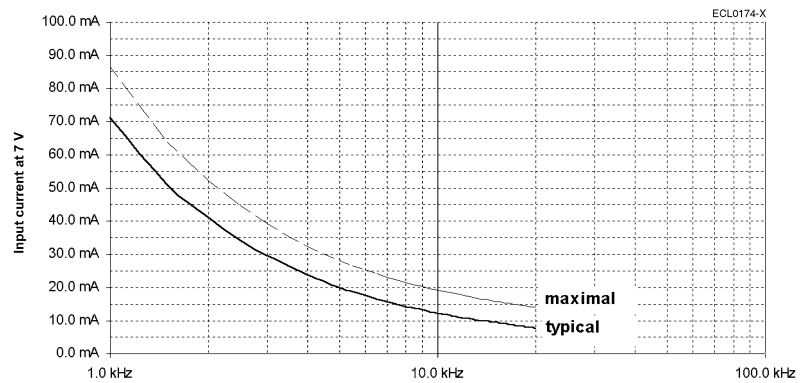

**Power consumption P**

The adjacent figure applies to  $V_{R1-R2} = 7 V$ .

For other input voltages, the power consumption changes follows as:

$$P = P_{Figure} \cdot (V_{R1-R2} / 7 V)^2$$

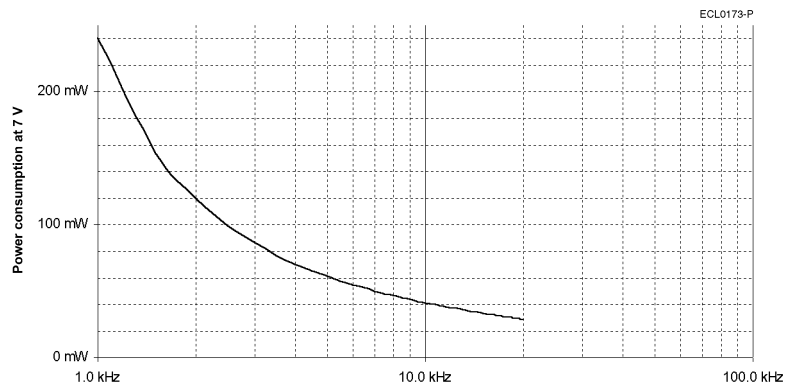

**Resistance, impedance and operating parameters (continued)**

**DC resistance**

The ohmic resistance values are based on an ambient temperature of 22 °C and change with temperature by 0.39 % / K

$R_{R1-R2} = 24 \Omega$   
 $R_{S1-S3} = R_{S2-S4} = 58 \Omega$   
Tolerance:  $\pm 10 \%$

**Input impedance**

Tolerance:  $\pm 15 \%$

$Z_{RO}$  ... Impedance between R1 and R2 with open outputs

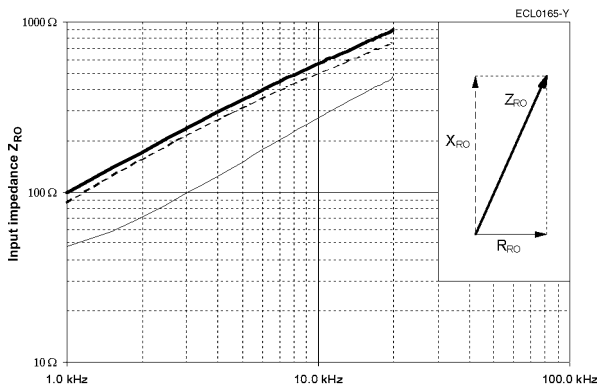

Tolerance:  $\pm 15 \%$

$Z_{RS}$  ... Impedance between R1 and R2 with short circuits between S1 and S3 as well as between S2 and S4

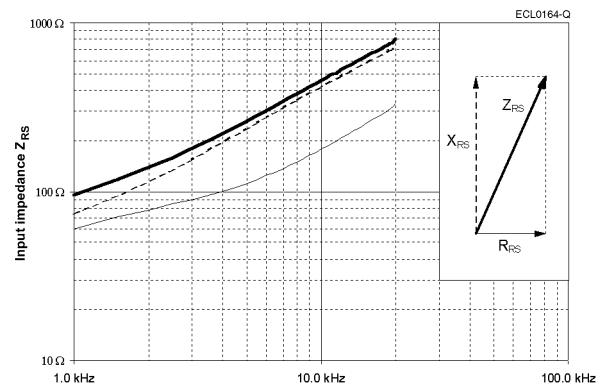

**Output impedance**

Tolerance:  $\pm 15 \%$

$Z_{SO}$  ... Impedance between S2 and S4 in a position of 0° (minimal coupling) with open outputs

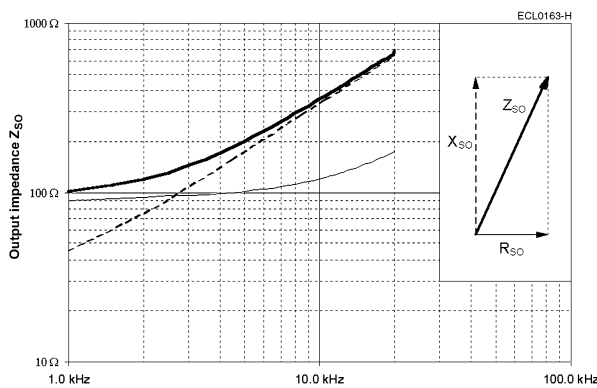

Tolerance:  $\pm 15 \%$

$Z_{SS}$  ... Impedance between S1 and S3 in a position of 0° (max. coupling) with short circuits between R1 and R2

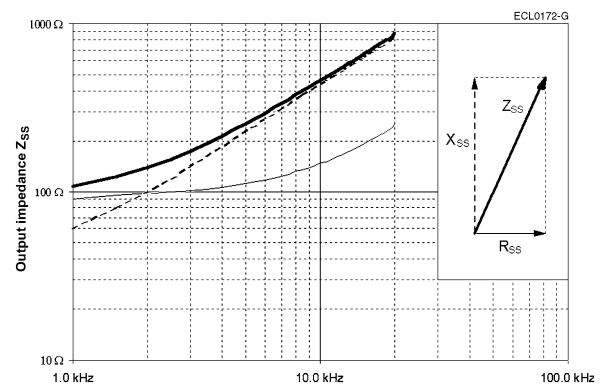

**Inductance L**

$L = X / (2 \cdot \pi \cdot f)$   
at  $f = 10 \text{ kHz}$

$L_{RO} = 7.9 \text{ mH}$   
 $L_{SS} = 6.9 \text{ mH}$

|                |            |                    |
|----------------|------------|--------------------|
| <b>Housing</b> | Aluminum   | V23401-T 1009-B1.. |
|                | CrNi-steel | V23401-H1009-B1..  |

**Electrical error / Ordering information**

|  |                                    |                    |
|--|------------------------------------|--------------------|
| <b>Angular error spread <math>\Delta\phi</math></b>      | <b>Ordering code</b>               |                    |
|  | Aluminum housing                   | CrNi-steel housing |
|  | $\pm 20'$                          | V23401-T1009-B114  |
|  | $\pm 15'$                          | V23401-T1009-B122  |
|  | $\pm 10'$                          | V23401-T1009-B101  |
| $\pm 7'$   | V23401-T1009-B102                  | V23401-H1009-B102  |
| <b>Residual voltage <math>V_{\text{residual}}</math></b> | 14 mV at $V_{R1-R2} = 4 \text{ V}$ |                    |

Electrical data at 22 °C.

**Transfer function**

**Pairs of poles p**  $\rho = 1$

**Transformation ratio  $r_T$**

$$r_T = V_{S1-S3 \text{ max}} / V_{R1-R2}$$

$$= V_{S2-S4 \text{ max}} / V_{R1-R2}$$

$= 0.5 \pm 10\%$  within 2 ... 8 kHz  
 $= 0.5 \pm 5\%$  at 5 kHz

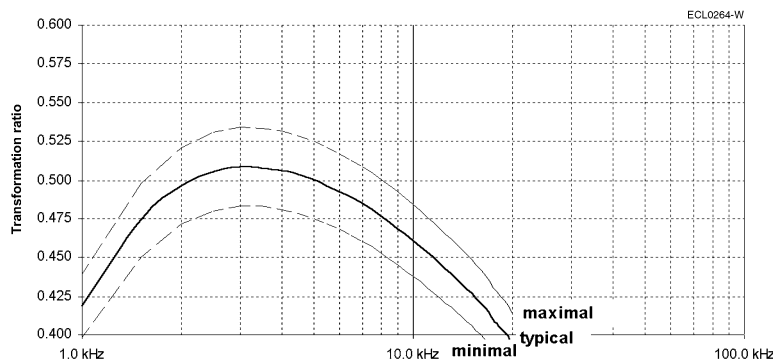

**Phase shift  $\psi$**

$$V_{R1-R2}(t) = V_{R1-R2 \text{ max}} \cdot \sin(2 \cdot \pi \cdot f \cdot t)$$

$$V_{S1-S3}(t) = V_{S1-S3 \text{ max}} \cdot \sin(2 \cdot \pi \cdot f \cdot t - \psi)$$

for  $-90^\circ < \alpha < +90^\circ$

Tolerance:  $\pm 5^\circ$

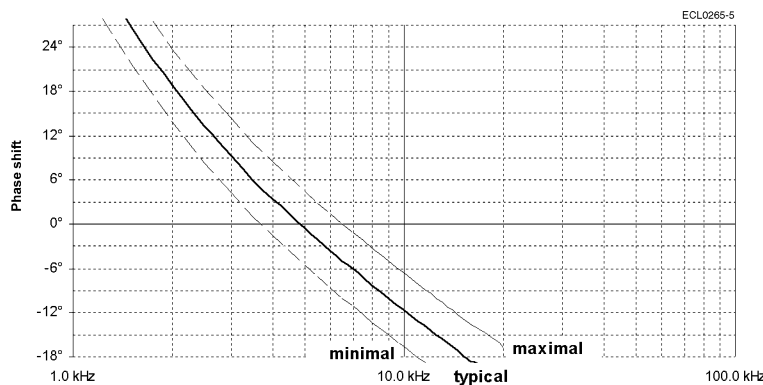

**Resistance, impedance and operating parameters**

|  |                             |  |
|--|-----------------------------|--|
| <b>Input voltage <math>V_{R1-R2}</math>, typical</b> | $2 V_{rms} \dots 8 V_{rms}$ | When choosing the values of these parameters take into account power dissipation, max. ambient temperature and the heat dissipation. Including self heating a maximum operating temperature of 150 °C must not be exceeded. Generally a power dissipation of $P \leq 0.5 W$ is not critical. |
| <b>Frequency <math>f</math>, typical</b>             | 2 kHz ... 10 kHz            |  |

**Input current I**

The adjacent figure applies to  $V_{R1-R2} = 4 V$ .

For other input voltages, the input current changes follows as:

$$I = I_{Figure} \cdot V_{R1-R2} / 4 V$$

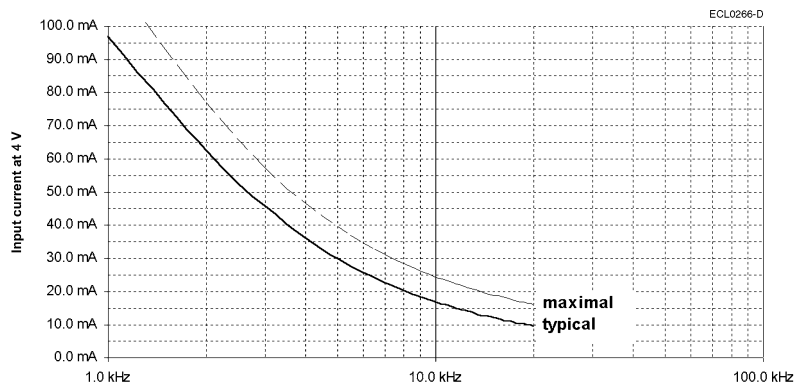

**Power consumption P**

The adjacent figure applies to  $V_{R1-R2} = 4 V$ .

For other input voltages, the power consumption changes follows as:

$$P = P_{Figure} \cdot (V_{R1-R2} / 4 V)^2$$

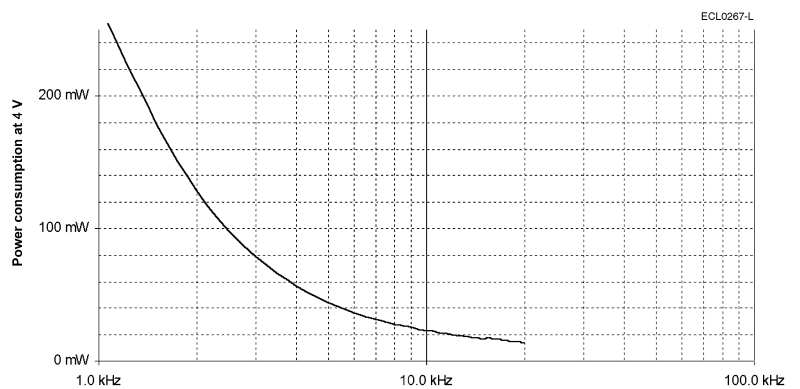

**Resistance, impedance and operating parameters (continued)**

**DC resistance**

The ohmic resistance values are based on an ambient temperature of 22 °C and change with temperature by 0.39 % / K

$R_{R1-R2} = 21 \Omega$   
 $R_{S1-S3} = R_{S2-S4} = 22 \Omega$   
 Tolerance:  $\pm 10 \%$

**Input impedance**

Tolerance:  $\pm 15 \%$

$Z_{RO}$  ... Impedance between R1 and R2 with open outputs

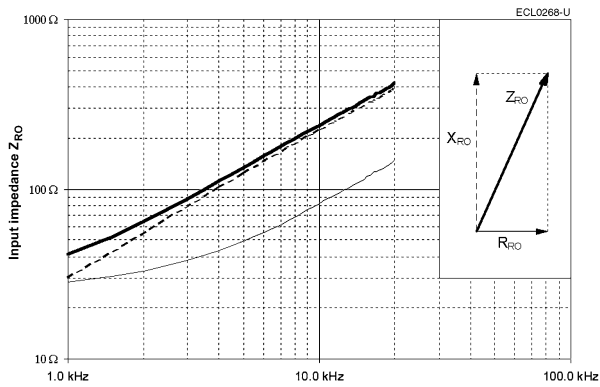

Tolerance:  $\pm 15 \%$

$Z_{RS}$  ... Impedance between R1 and R2 with short circuits between S1 and S3 as well as between S2 and S4

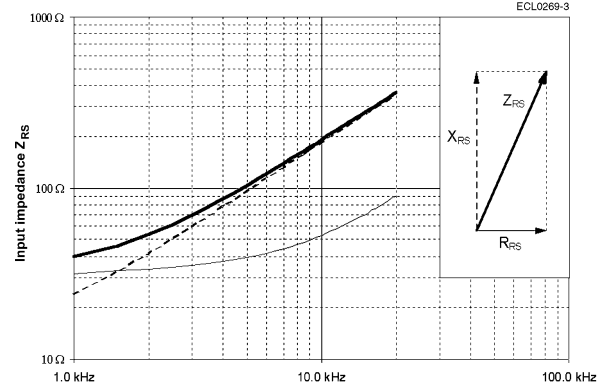

**Output impedance**

Tolerance:  $\pm 15 \%$

$Z_{SO}$  ... Impedance between S2 and S4 in a position of 0° (minimal coupling) with open outputs

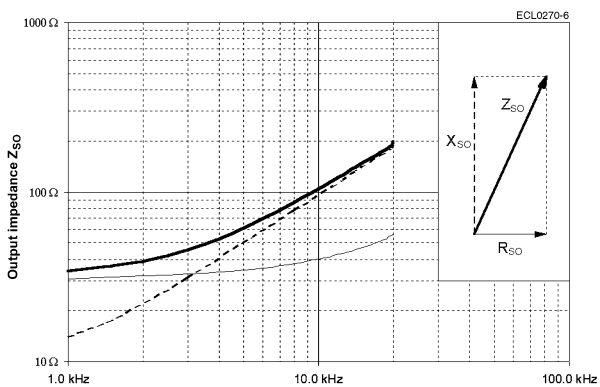

Tolerance:  $\pm 15 \%$

$Z_{SS}$  ... Impedance between S1 and S3 in a position of 0° (max. coupling) with short circuits between R1 and R2

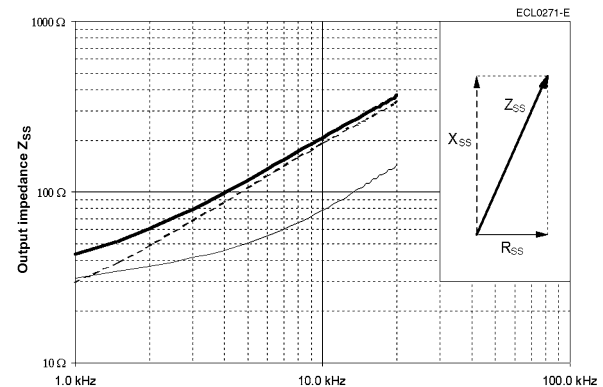

**Inductance L**

$L = X / (2 \cdot \pi \cdot f)$   
 at  $f = 10 \text{ kHz}$

$L_{RO} = 3.5 \text{ mH}$   
 $L_{SS} = 3.1 \text{ mH}$



|                |            |                    |
|----------------|------------|--------------------|
| <b>Housing</b> | Aluminum   | V23401-T 2001-B2.. |
|                | CrNi-steel | V23401-H2001-B2..  |

**Electrical error / Ordering information**

|  |                                   |                    |
|--|-----------------------------------|--------------------|
| <b>Angular error spread <math>\Delta\phi</math></b>      | <b>Ordering code</b>              |                    |
|  | Aluminum housing                  | CrNi-steel housing |
|  | $\pm 20'$                         | V23401-T2001-B214  |
|  | $\pm 15'$                         | V23401-H2001-B214  |
|  | $\pm 10'$                         | V23401-T2001-B222  |
| $\pm 10'$  | V23401-H2001-B222                 |                    |
| $\pm 7'$   | V23401-T2001-B201                 |                    |
|  | V23401-H2001-B201                 |                    |
|  | V23401-T2001-B202                 |                    |
|  | V23401-H2001-B202                 |                    |
| <b>Residual voltage <math>V_{\text{residual}}</math></b> | 25 mV at $V_{R1-R2} = 7\text{ V}$ |                    |

Electrical data at 22 °C.

**Transfer function**

|  |   |
|--|---|
| <b>Pairs of poles p</b>  | $p = 1$                                     |
| <p><b>Transformation ratio <math>r_T</math></b></p> $r_T = V_{S1-S3 \text{ max}} / V_{R1-R2}$ $= V_{S2-S4 \text{ max}} / V_{R1-R2}$ <p><math>= 0.5 \pm 10\%</math> within 2 ... 10 kHz<br/> <math>= 0.5 \pm 5\%</math> at 5 kHz</p>  | <p style="text-align: right;">ECL0272-M</p> |
| <p><b>Phase shift <math>\psi</math></b></p> $V_{R1-R2}(t) = V_{R1-R2 \text{ max}} \cdot \sin(2 \cdot \pi \cdot f \cdot t)$ $V_{S1-S3}(t) = V_{S1-S3 \text{ max}} \cdot \sin(2 \cdot \pi \cdot f \cdot t - \psi)$ <p>for <math>-90^\circ &lt; \alpha &lt; +90^\circ</math></p> <p>Tolerance: <math>\pm 5^\circ</math></p> | <p style="text-align: right;">ECL0273-V</p> |

**Resistance, impedance and operating parameters**

|  |                              |
|--|------------------------------|
| <b>Input voltage <math>V_{R1-R2}</math>, typical</b> | $4 V_{rms} \dots 12 V_{rms}$ |
| <b>Frequency <math>f</math>, typical</b>             | 2 kHz ... 10 kHz             |

When choosing the values of these parameters take into account power dissipation, max. ambient temperature and the heat dissipation. Including self heating a maximum operating temperature of 150 °C must not be exceeded. Generally a power dissipation of  $P \leq 0.5 W$  is not critical.

**Input current I**

The adjacent figure applies to  $V_{R1-R2} = 7 V$ .

For other input voltages, the input current changes follows as:

$$I = I_{Figure} \cdot V_{R1-R2} / 7 V$$

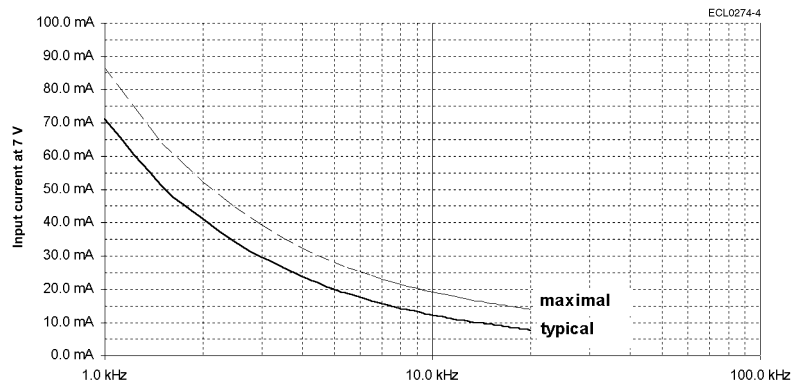

**Power consumption P**

The adjacent figure applies to  $V_{R1-R2} = 7 V$ .

For other input voltages, the power consumption changes follows as:

$$P = P_{Figure} \cdot (V_{R1-R2} / 7 V)^2$$

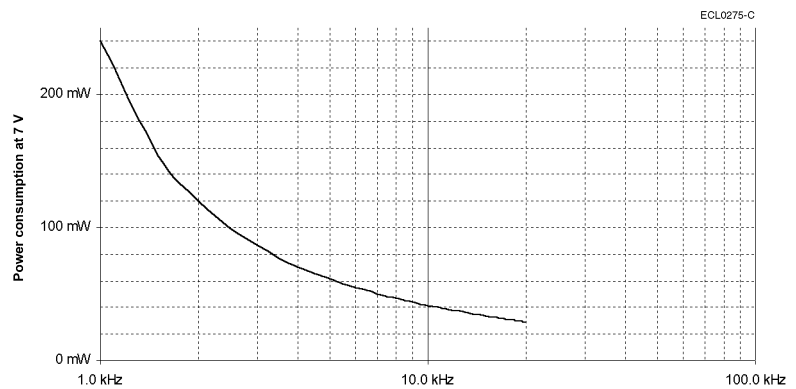

**Resistance, impedance and operating parameters (continued)**

**DC resistance**

The ohmic resistance values are based on an ambient temperature of 22 °C and change with temperature by 0.39 % / K

$R_{R1-R2} = 24 \Omega$   
 $R_{S1-S3} = R_{S2-S4} = 58 \Omega$   
Tolerance:  $\pm 10 \%$

**Input impedance**

Tolerance:  $\pm 15 \%$

$Z_{RO}$  ... Impedance between R1 and R2 with open outputs

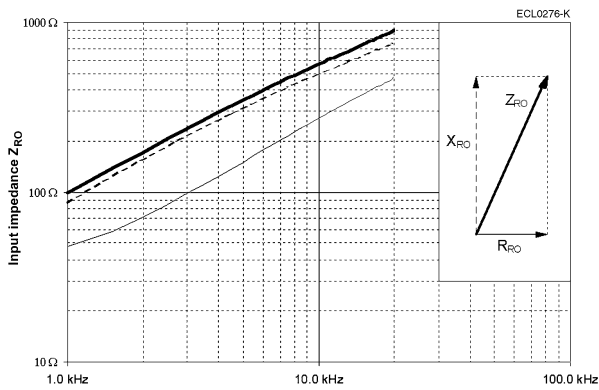

Tolerance:  $\pm 15 \%$

$Z_{RS}$  ... Impedance between R1 and R2 with short circuits between S1 and S3 as well as between S2 and S4

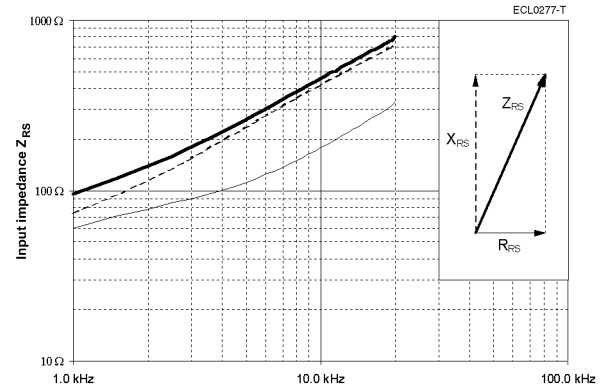

**Output impedance**

Tolerance:  $\pm 15 \%$

$Z_{SO}$  ... Impedance between S2 and S4 in a position of 0° (minimal coupling) with open outputs

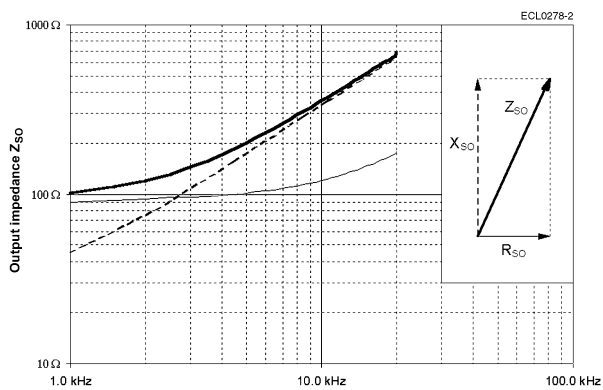

Tolerance:  $\pm 15 \%$

$Z_{SS}$  ... Impedance between S1 and S3 in a position of 0° (max. coupling) with short circuits between R1 and R2

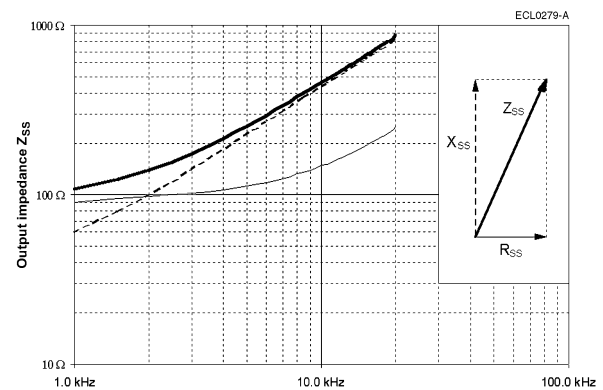

**Inductance L**

$L = X / (2 \cdot \pi \cdot f)$   
at  $f = 10 \text{ kHz}$

$L_{RO} = 7.9 \text{ mH}$   
 $L_{SS} = 6.9 \text{ mH}$

|                |            |                    |
|----------------|------------|--------------------|
| <b>Housing</b> | Aluminum   | V23401-T 2009-B2.. |
|                | CrNi-steel | V23401-H 2009-B2.. |

**Electrical error / Ordering information**

|  |                                    |                    |
|--|------------------------------------|--------------------|
| <b>Angular error spread <math>\Delta\phi</math></b>      | <b>Ordering code</b>               |                    |
|  | Aluminum housing                   | CrNi-steel housing |
|  | $\pm 20'$                          | V23401-T2009-B214  |
|  | $\pm 15'$                          | V23401-H2009-B214  |
|  | $\pm 10'$                          | V23401-T2009-B222  |
| $\pm 10'$  | V23401-H2009-B222                  |                    |
| $\pm 7'$   | V23401-T2009-B201                  |                    |
|  | V23401-H2009-B201                  |                    |
|  | V23401-T2009-B202                  |                    |
|  | V23401-H2009-B202                  |                    |
| <b>Residual voltage <math>V_{\text{residual}}</math></b> | 14 mV at $V_{R1-R2} = 4 \text{ V}$ |                    |

Electrical data at 22 °C.

**Transfer function**

|  |         |
|--|---------|
| <b>Pairs of poles p</b>  | $p = 1$ |
| <p><b>Transformation ratio <math>r_T</math></b></p> $r_T = V_{S1-S3 \text{ max}} / V_{R1-R2}$ $= V_{S2-S4 \text{ max}} / V_{R1-R2}$ <p><math>= 0.5 \pm 10 \% \text{ within } 2 \dots 8 \text{ kHz}</math><br/> <math>= 0.5 \pm 5 \% \text{ at } 5 \text{ kHz}</math></p>   |         |
| <p><b>Phase shift <math>\psi</math></b></p> $V_{R1-R2}(t) = V_{R1-R2 \text{ max}} \cdot \sin(2 \cdot \pi \cdot f \cdot t)$ $V_{S1-S3}(t) = V_{S1-S3 \text{ max}} \cdot \sin(2 \cdot \pi \cdot f \cdot t - \psi)$ <p>for <math>-90^\circ &lt; \alpha &lt; +90^\circ</math></p> <p>Tolerance: <math>\pm 5^\circ</math></p> |         |

**Resistance, impedance and operating parameters**

|  |                             |
|--|-----------------------------|
| <b>Input voltage <math>V_{R1-R2}</math>, typical</b> | $2 V_{rms} \dots 8 V_{rms}$ |
| <b>Frequency <math>f</math>, typical</b>             | 2 kHz ... 10 kHz            |

When choosing the values of these parameters take into account power dissipation, max. ambient temperature and the heat dissipation. Including self heating a maximum operating temperature of 150 °C must not be exceeded. Generally a power dissipation of  $P \leq 0.5 \text{ W}$  is not critical.

**Input current I**

The adjacent figure applies to  $V_{R1-R2} = 4 \text{ V}$ .

For other input voltages, the input current changes follows as:

$$I = I_{\text{Figure}} \cdot V_{R1-R2} / 4 \text{ V}$$

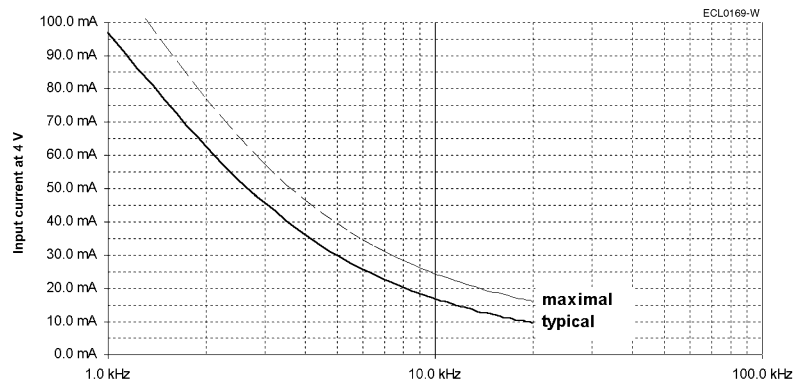

**Power consumption P**

The adjacent figure applies to  $V_{R1-R2} = 4 \text{ V}$ .

For other input voltages, the power consumption changes follows as:

$$P = P_{\text{Figure}} \cdot (V_{R1-R2} / 4 \text{ V})^2$$

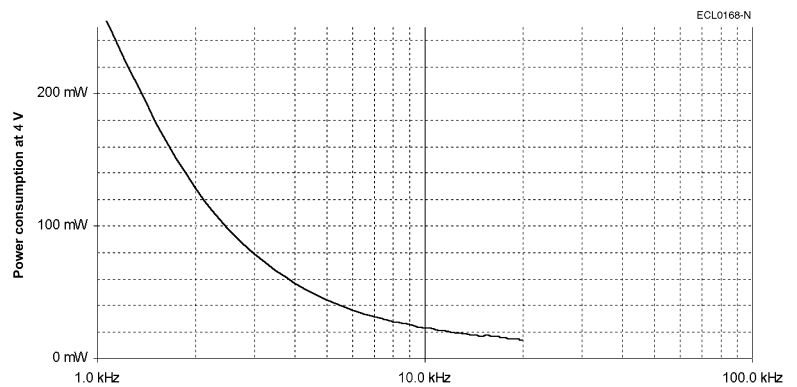

**Resistance, impedance and operating parameters (continued)**

**DC resistance**

The ohmic resistance values are based on an ambient temperature of 22 °C and change with temperature by 0.39 % / K

$R_{R1-R2} = 21 \Omega$   
 $R_{S1-S3} = R_{S2-S4} = 22 \Omega$   
 Tolerance:  $\pm 10 \%$

**Input impedance**

Tolerance:  $\pm 15 \%$

$Z_{RO}$  ... Impedance between R1 and R2 with open outputs

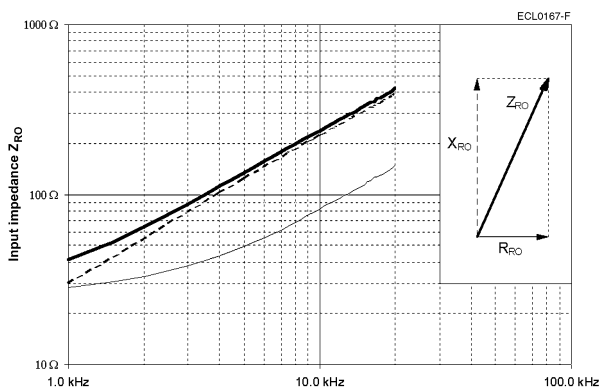

Tolerance:  $\pm 15 \%$

$Z_{RS}$  ... Impedance between R1 and R2 with short circuits between S1 and S3 as well as between S2 and S4

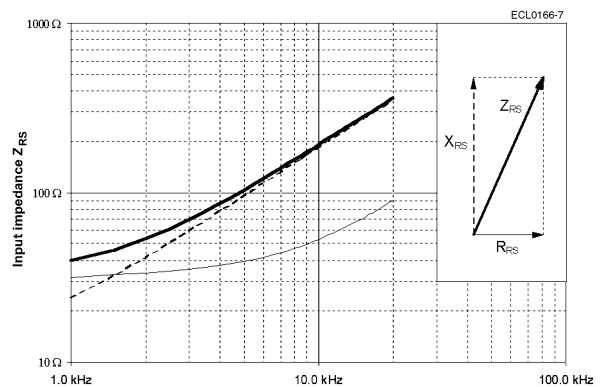

**Output impedance**

Tolerance:  $\pm 15 \%$

$Z_{SO}$  ... Impedance between S2 and S4 in a position of 0° (minimal coupling) with open outputs

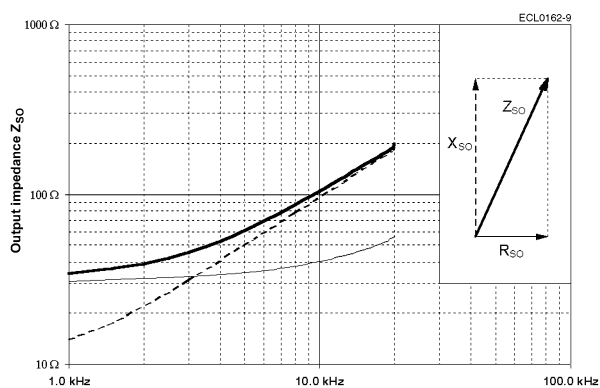

Tolerance:  $\pm 15 \%$

$Z_{SS}$  ... Impedance between S1 and S3 in a position of 0° (max. coupling) with short circuits between R1 and R2

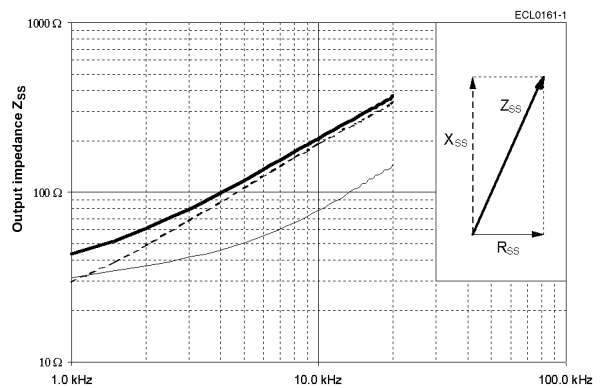

**Inductance L**

$L = X / (2 \cdot \pi \cdot f)$   
 at  $f = 10 \text{ kHz}$

$L_{RO} = 3.5 \text{ mH}$   
 $L_{SS} = 3.1 \text{ mH}$

|                |            |                    |
|----------------|------------|--------------------|
| <b>Housing</b> | Aluminum   | V23401-T 2010-B2.. |
|                | CrNi-steel | V23401-H 2010-B2.. |

**Electrical error / Ordering information**

|  |                            |                    |
|--|----------------------------|--------------------|
| <b>Angular error spread <math>\Delta\phi</math></b>      | <b>Ordering code</b>       |                    |
|  | Aluminum housing           | CrNi-steel housing |
|  | $\pm 20'$                  | V23401-T 2010-B214 |
|  | $\pm 15'$                  | V23401-H 2010-B214 |
|  | $\pm 10'$                  | V23401-T 2010-B222 |
| $\pm 10'$  | V23401-H 2010-B222         |                    |
| $\pm 7'$   | V23401-T 2010-B201         |                    |
|  | V23401-H 2010-B201         |                    |
|  | V23401-T 2010-B202         |                    |
|  | V23401-H 2010-B202         |                    |
| <b>Residual voltage <math>V_{\text{residual}}</math></b> | 20 mV at $V_{R1-R2} = 6 V$ |                    |

Electrical data at 22 °C.

**Transfer function**

|  |       |
|--|-------|
| <b>Pairs of poles p</b>  | p = 3 |
| <p><b>Transformation ratio <math>r_T</math></b></p> $r_T = V_{S1-S3 \text{ max}} / V_{R1-R2}$ $= V_{S2-S4 \text{ max}} / V_{R1-R2}$ <p>= 0.46 ± 10 % within 3 ... 20 kHz<br/>                 = 0.46 ± 5 % at 6 kHz</p>  |       |
| <p><b>Phase shift <math>\psi</math></b></p> $V_{R1-R2}(t) = V_{R1-R2 \text{ max}} \cdot \sin(2 \cdot \pi \cdot f \cdot t)$ $V_{S1-S3}(t) = V_{S1-S3 \text{ max}} \cdot \sin(2 \cdot \pi \cdot f \cdot t - \psi)$ <p>for <math>-90^\circ &lt; \alpha &lt; +90^\circ</math></p> <p>Tolerance: ± 5°</p> |       |

**Resistance, impedance and operating parameters**

|  |                              |
|--|------------------------------|
| <b>Input voltage <math>V_{R1-R2}</math>, typical</b> | $2 V_{rms} \dots 10 V_{rms}$ |
| <b>Frequency <math>f</math>, typical</b>             | 4 kHz ... 15 kHz             |

When choosing the values of these parameters take into account power dissipation, max. ambient temperature and the heat dissipation. Including self heating a maximum operating temperature of 150 °C must not be exceeded. Generally a power dissipation of  $P \leq 0.5 \text{ W}$  is not critical.

**Input current I**

The adjacent figure applies to  $V_{R1-R2} = 6 \text{ V}$ .

For other input voltages, the input current changes follows as:

$$I = I_{\text{Figure}} \cdot V_{R1-R2} / 6 \text{ V}$$

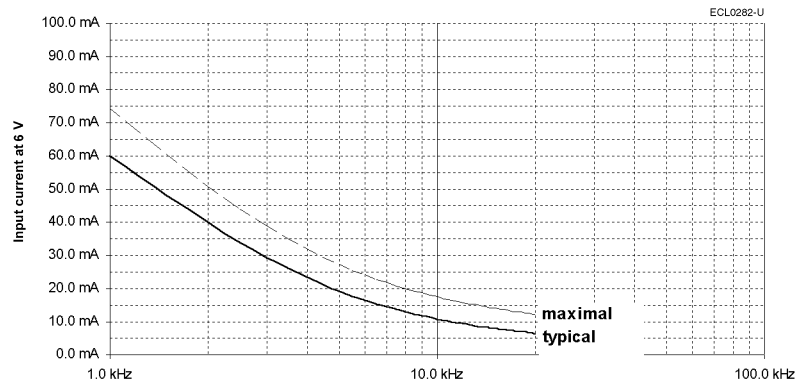

**Power consumption P**

The adjacent figure applies to  $V_{R1-R2} = 6 \text{ V}$ .

For other input voltages, the power consumption changes follows as:

$$P = P_{\text{Figure}} \cdot (V_{R1-R2} / 6 \text{ V})^2$$

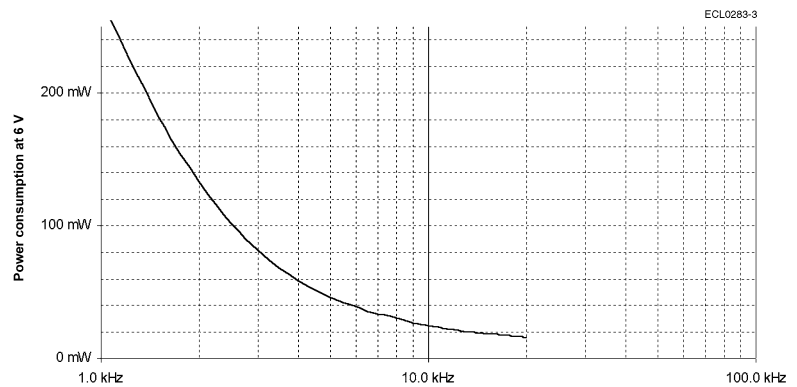



**Resistance, impedance and operating parameters (continued)**

**DC resistance**

The ohmic resistance values are based on an ambient temperature of 22 °C and change with temperature by 0.39 % / K

$R_{R1-R2} = 55 \Omega$   
 $R_{S1-S3} = R_{S2-S4} = 173 \Omega$   
 Tolerance:  $\pm 10 \%$

**Input impedance**

Tolerance:  $\pm 15 \%$

$Z_{RO}$  ... Impedance between R1 and R2 with open outputs

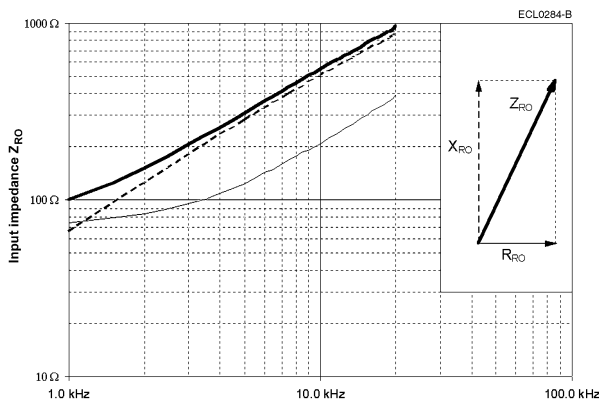

Tolerance:  $\pm 15 \%$

$Z_{RS}$  ... Impedance between R1 and R2 with short circuits between S1 and S3 as well as between S2 and S4

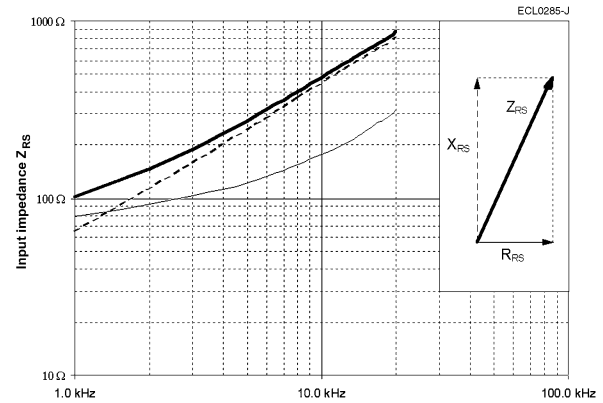

**Output impedance**

Tolerance:  $\pm 15 \%$

$Z_{SO}$  ... Impedance between S2 and S4 in a position of 0° (minimal coupling) with open outputs

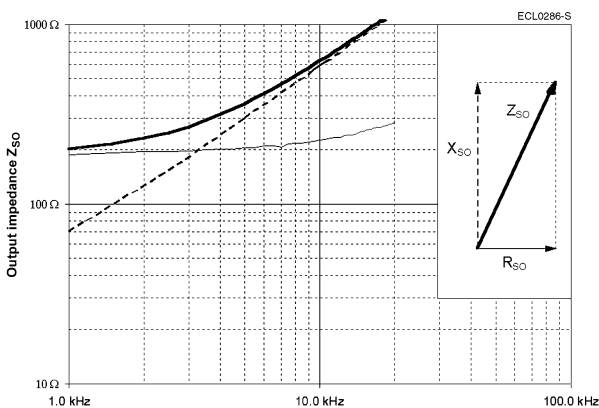

Tolerance:  $\pm 15 \%$

$Z_{SS}$  ... Impedance between S1 and S3 in a position of 0° (max. coupling) with short circuits between R1 and R2

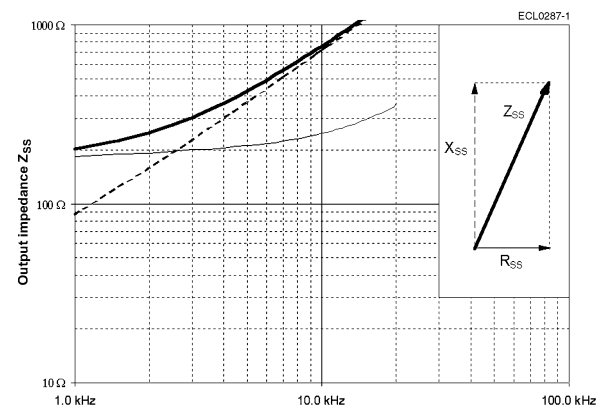

**Inductance L**

$L = X / (2 \cdot \pi \cdot f)$   
 at  $f = 10 \text{ kHz}$

$L_{RO} = 8.1 \text{ mH}$   
 $L_{SS} = 11.4 \text{ mH}$

|                |            |                   |
|----------------|------------|-------------------|
| <b>Housing</b> | Aluminum   | V23401-T2014-B2.. |
|                | CrNi-steel | V23401-H2014-B2.. |

**Electrical error / Ordering information**

|   |                            |                    |
|---|----------------------------|--------------------|
| <b>Angular error spread <math>\Delta\phi</math></b> | <b>Ordering code</b>       |                    |
|   | Aluminum housing           | CrNi-steel housing |
|   | $\pm 20'$                  | V23401-T2014-B214  |
|   | $\pm 15'$                  | V23401-H2014-B214  |
|   | $\pm 10'$                  | V23401-T2014-B222  |
| $\pm 10'$   | V23401-H2014-B222          |                    |
| $\pm 7'$  | V23401-T2014-B201          |                    |
|   | V23401-H2014-B201          |                    |
|   | V23401-T2014-B202          |                    |
|   | V23401-H2014-B202          |                    |
| <b>Residual voltage <math>V_{residual}</math></b>   | 20 mV at $V_{R1-R2} = 6 V$ |                    |

Electrical data at 22 °C.

**Transfer function**

|  |         |
|--|---------|
| <b>Pairs of poles p</b>  | $p = 4$ |
| <p><b>Transformation ratio <math>r_T</math></b></p> $r_T = V_{S1-S3 \max} / V_{R1-R2}$ $= V_{S2-S4 \max} / V_{R1-R2}$ <p><math>= 0.46 \pm 10 \% \text{ within } 4 \dots 15 \text{ kHz}</math><br/> <math>= 0.46 \pm 5 \% \text{ at } 6 \text{ kHz}</math></p>  |         |
| <p><b>Phase shift <math>\psi</math></b></p> $V_{R1-R2}(t) = V_{R1-R2 \max} \cdot \sin(2 \cdot \pi \cdot f \cdot t)$ $V_{S1-S3}(t) = V_{S1-S3 \max} \cdot \sin(2 \cdot \pi \cdot f \cdot t - \psi)$ <p>for <math>-90^\circ &lt; \alpha &lt; +90^\circ</math></p> <p>Tolerance: <math>\pm 5^\circ</math></p> |         |

Size 21

**Resistance, impedance and operating parameters**

|  |                              |
|--|------------------------------|
| <b>Input voltage <math>V_{R1-R2}</math>, typical</b> | $2 V_{rms} \dots 10 V_{rms}$ |
| <b>Frequency <math>f</math>, typical</b>             | 4 kHz ... 15 kHz             |

When choosing the values of these parameters take into account power dissipation, max. ambient temperature and the heat dissipation. Including self heating a maximum operating temperature of 150 °C must not be exceeded. Generally a power dissipation of  $P \leq 0.5 \text{ W}$  is not critical.

**Input current I**

The adjacent figure applies to  $V_{R1-R2} = 6 \text{ V}$ .

For other input voltages, the input current changes follows as:

$$I = I_{\text{Figure}} \cdot V_{R1-R2} / 6 \text{ V}$$

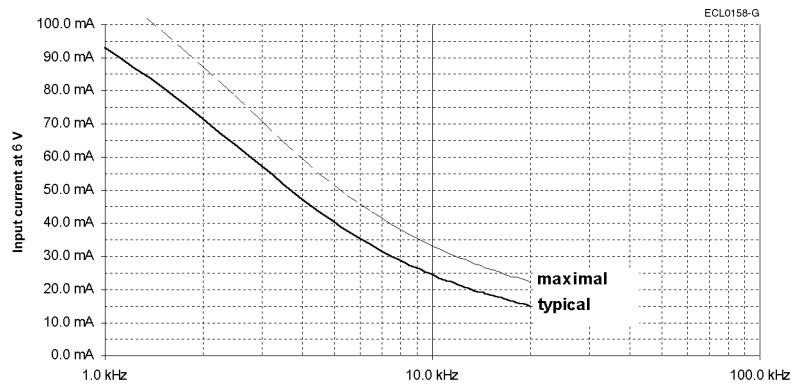

**Power consumption P**

The adjacent figure applies to  $V_{R1-R2} = 6 \text{ V}$ .

For other input voltages, the power consumption changes follows as:

$$P = P_{\text{Figure}} \cdot (V_{R1-R2} / 6 \text{ V})^2$$

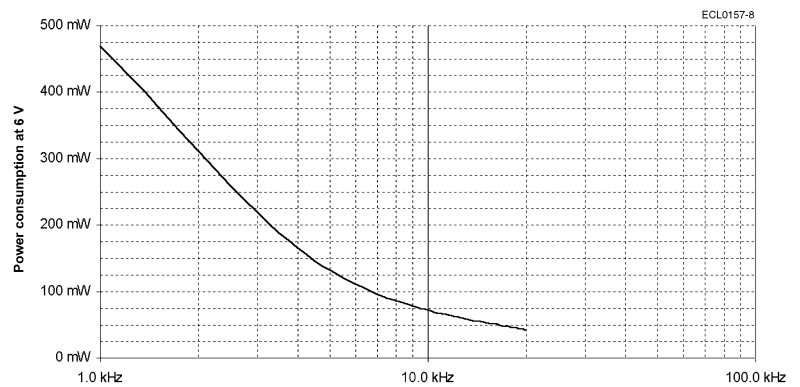

**Resistance, impedance and operating parameters (continued)**

**DC resistance**

The ohmic resistance values are based on an ambient temperature of 22 °C and change with temperature by 0.39 % / K

$R_{R1-R2} = 36 \Omega$   
 $R_{S1-S3} = R_{S2-S4} = 48 \Omega$   
 Tolerance:  $\pm 10 \%$

**Input impedance**

Tolerance:  $\pm 15 \%$

$Z_{RO}$  ... Impedance between R1 and R2 with open outputs

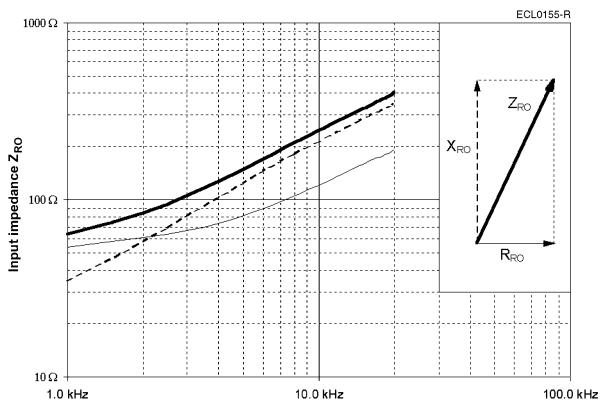

Tolerance:  $\pm 15 \%$

$Z_{RS}$  ... Impedance between R1 and R2 with short circuits between S1 and S3 as well as between S2 and S4

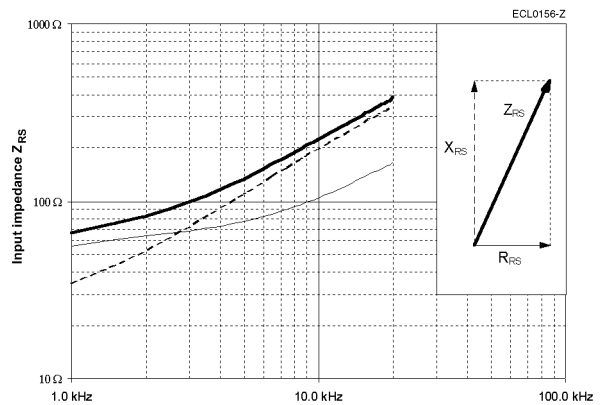

**Output impedance**

Tolerance:  $\pm 15 \%$

$Z_{SO}$  ... Impedance between S2 and S4 in a position of 0° (minimal coupling) with open outputs

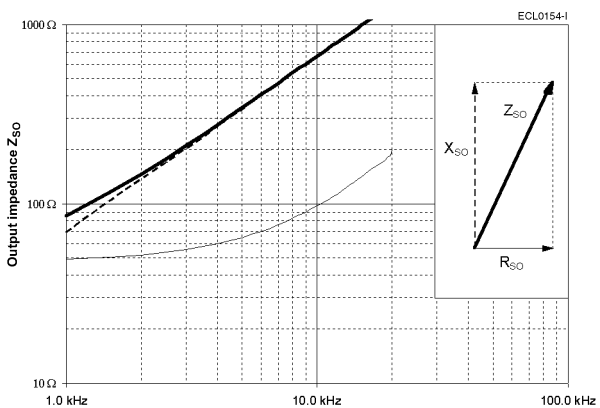

Tolerance:  $\pm 15 \%$

$Z_{SS}$  ... Impedance between S1 and S3 in a position of 0° (max. coupling) with short circuits between R1 and R2

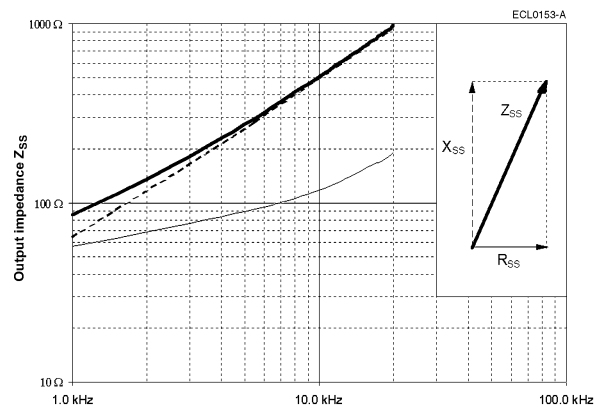

**Inductance L**

$L = X / (2 \cdot \pi \cdot f)$   
 at  $f = 10 \text{ kHz}$

$L_{RO} = 3.4 \text{ mH}$   
 $L_{SS} = 7.8 \text{ mH}$

|                |            |                    |
|----------------|------------|--------------------|
| <b>Housing</b> | Aluminum   | V23401-T 2015-B2.. |
|                | CrNi-steel | V23401-H 2015-B2.. |

**Electrical error / Ordering information**

|  |                                   |                    |
|--|-----------------------------------|--------------------|
| <b>Angular error spread <math>\Delta\phi</math></b>      | <b>Ordering code</b>              |                    |
|  | Aluminum housing                  | CrNi-steel housing |
|  | $\pm 20'$                         | V23401-T 2015-B214 |
|  | $\pm 15'$                         | V23401-H 2015-B214 |
|  | $\pm 10'$                         | V23401-T 2015-B222 |
| $\pm 10'$  | V23401-H 2015-B222                |                    |
| $\pm 7'$   | V23401-T 2015-B201                |                    |
|  | V23401-H 2015-B201                |                    |
|  | V23401-T 2015-B202                |                    |
|  | V23401-H 2015-B202                |                    |
| <b>Residual voltage <math>V_{\text{residual}}</math></b> | 21 mV at $V_{R1-R2} = 6\text{ V}$ |                    |

Electrical data at 22 °C.

**Transfer function**

|  |         |
|--|---------|
| <b>Pairs of poles p</b>  | $p = 2$ |
| <p><b>Transformation ratio <math>r_T</math></b></p> $r_T = V_{S1-S3 \text{ max}} / V_{R1-R2}$ $= V_{S2-S4 \text{ max}} / V_{R1-R2}$ <p><math>= 0.5 \pm 10\%</math> within 4 ... 20 kHz<br/> <math>= 0.5 \pm 5\%</math> at 10 kHz</p>   |         |
| <p><b>Phase shift <math>\psi</math></b></p> $V_{R1-R2}(t) = V_{R1-R2 \text{ max}} \cdot \sin(2 \cdot \pi \cdot f \cdot t)$ $V_{S1-S3}(t) = V_{S1-S3 \text{ max}} \cdot \sin(2 \cdot \pi \cdot f \cdot t - \psi)$ <p>for <math>-90^\circ &lt; \alpha &lt; +90^\circ</math></p> <p>Tolerance: <math>\pm 5^\circ</math></p> |         |

**Resistance, impedance and operating parameters**

|  |                              |
|--|------------------------------|
| <b>Input voltage <math>V_{R1-R2}</math>, typical</b> | $2 V_{rms} \dots 10 V_{rms}$ |
| <b>Frequency <math>f</math>, typical</b>             | 4 kHz ... 15 kHz             |

When choosing the values of these parameters take into account power dissipation, max. ambient temperature and the heat dissipation. Including self heating a maximum operating temperature of 150 °C must not be exceeded. Generally a power dissipation of  $P \leq 0.5 W$  is not critical.

**Input current I**

The adjacent figure applies to  $V_{R1-R2} = 6 V$ .

For other input voltages, the input current changes follows as:

$$I = I_{Figure} \cdot V_{R1-R2} / 6 V$$

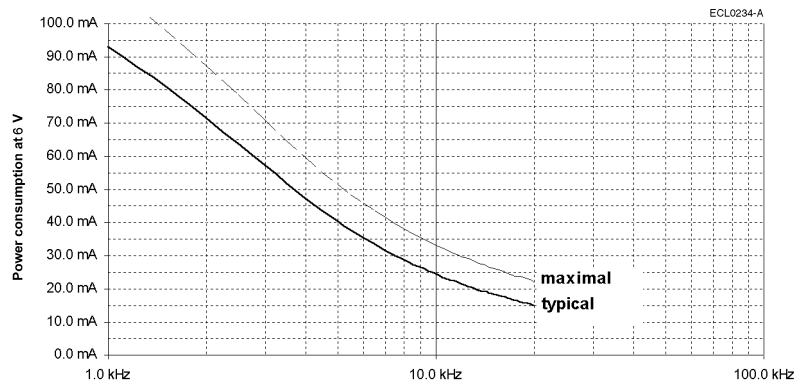

**Power consumption P**

The adjacent figure applies to  $V_{R1-R2} = 6 V$ .

For other input voltages, the power consumption changes follows as:

$$P = P_{Figure} \cdot (V_{R1-R2} / 6 V)^2$$

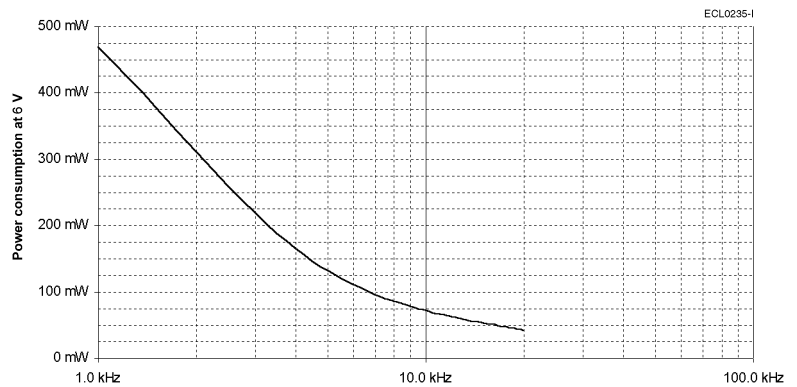

**Resistance, impedance and operating parameters (continued)**

**DC resistance**

The ohmic resistance values are based on an ambient temperature of 22 °C and change with temperature by 0.39 % / K

$R_{R1-R2} = 33 \Omega$   
 $R_{S1-S3} = R_{S2-S4} = 30 \Omega$   
 Tolerance:  $\pm 10 \%$

**Input impedance**

Tolerance:  $\pm 15 \%$

$Z_{RO}$  ... Impedance between R1 and R2 with open outputs

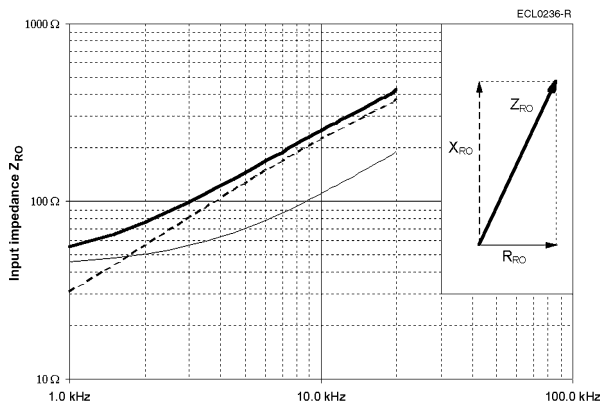

Tolerance:  $\pm 15 \%$

$Z_{RS}$  ... Impedance between R1 and R2 with short circuits between S1 and S3 as well as between S2 and S4

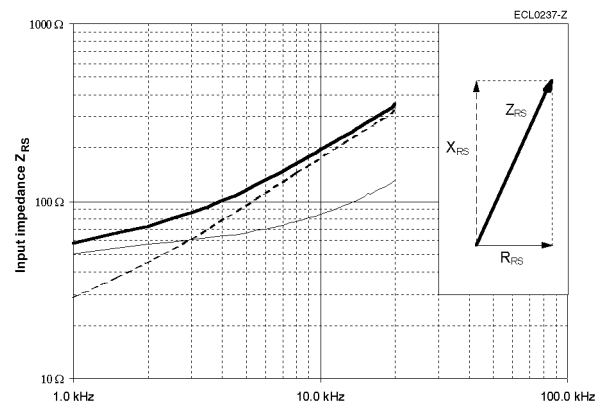

**Output impedance**

Tolerance:  $\pm 15 \%$

$Z_{SO}$  ... Impedance between S2 and S4 in a position of 0° (minimal coupling) with open outputs

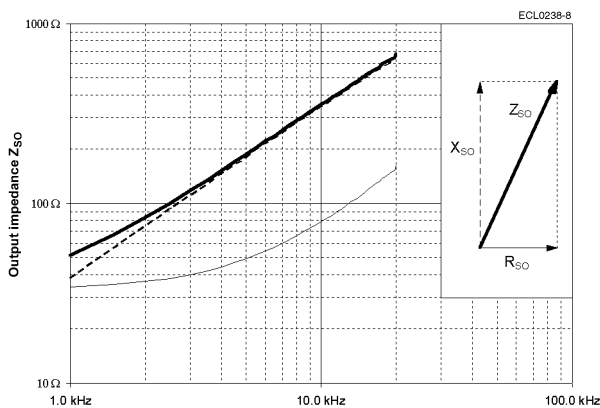

Tolerance:  $\pm 15 \%$

$Z_{SS}$  ... Impedance between S1 and S3 in a position of 0° (max. coupling) with short circuits between R1 and R2

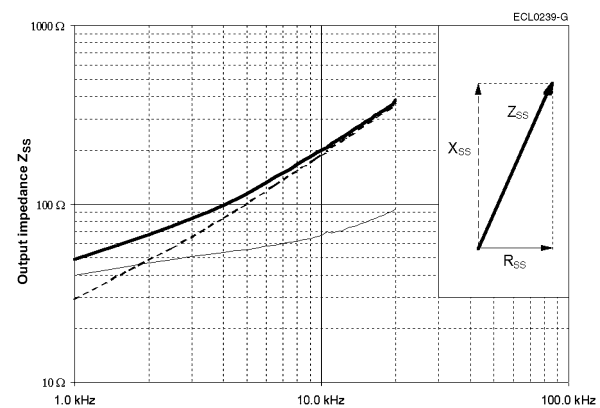

**Inductance L**

$L = X / (2 \cdot \pi \cdot f)$   
 at  $f = 10 \text{ kHz}$

$L_{RO} = 3.6 \text{ mH}$   
 $L_{SS} = 3.0 \text{ mH}$

Housing

CrMo-steel

**Electrical error / Ordering information**

Angular error spread  $\Delta\phi$

- $\pm 10'$
- $\pm 8'$
- $\pm 6'$
- $\pm 4'$

Ordering code

- V23401-U1016-B101
- V23401-U1016-B109
- V23401-U1016-B110
- V23401-U1016-B133

Residual voltage  $V_{\text{residual}}$

14 mV at  $V_{R1-R2} = 4 V$

Electrical data at 22 °C.

**Transfer function**

Pairs of poles p

p = 1

Transformation ratio  $r_T$

$$r_T = \frac{V_{S1-S3 \text{ max}}}{V_{R1-R2}}$$

$$= \frac{V_{S2-S4 \text{ max}}}{V_{R1-R2}}$$

- = 0.5  $\pm$  20 % within 1.5 ... 10 kHz
- = 0.5  $\pm$  10 % at 5 kHz

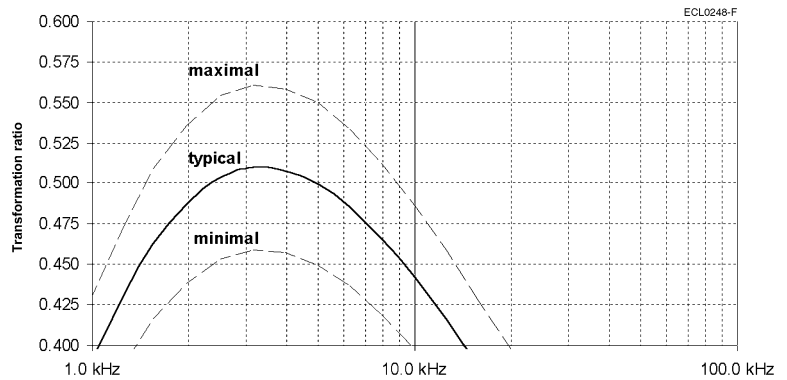

Phase shift  $\psi$

$$V_{R1-R2}(t) = V_{R1-R2 \text{ max}} \cdot \sin(2 \cdot \pi \cdot f \cdot t)$$

$$V_{S1-S3}(t) = V_{S1-S3 \text{ max}} \cdot \sin(2 \cdot \pi \cdot f \cdot t - \psi)$$

for  $-90^\circ < \alpha < +90^\circ$

Tolerance:  $\pm 5^\circ$

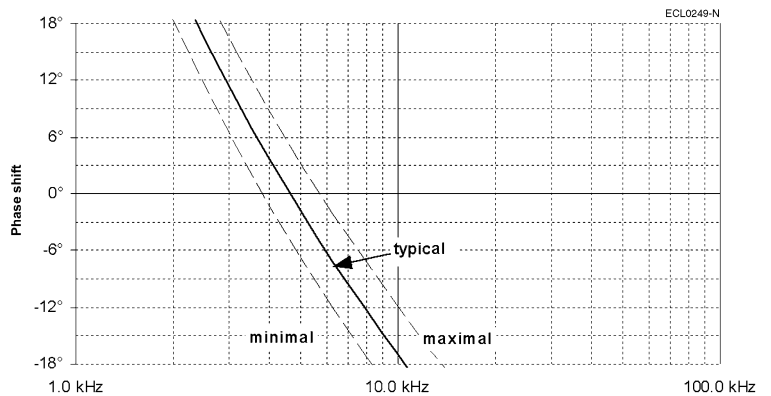



**Resistance, impedance and operating parameters**

|  |                              |
|--|------------------------------|
| <b>Input voltage <math>V_{R1-R2}</math>, typical</b> | $2 V_{rms} \dots 20 V_{rms}$ |
| <b>Frequency <math>f</math>, typical</b>             | 2 kHz ... 10 kHz             |

When choosing the values of these parameters take into account power dissipation, max. ambient temperature and the heat dissipation. Including self heating a maximum operating temperature of 150 °C must not be exceeded. Generally a power dissipation of  $P \leq 0.5 \text{ W}$  is not critical.

**Input current I**

The adjacent figure applies to  $V_{R1-R2} = 4 \text{ V}$ .

For other input voltages, the input current changes follows as:

$$I = I_{\text{Figure}} \cdot V_{R1-R2} / 4 \text{ V}$$

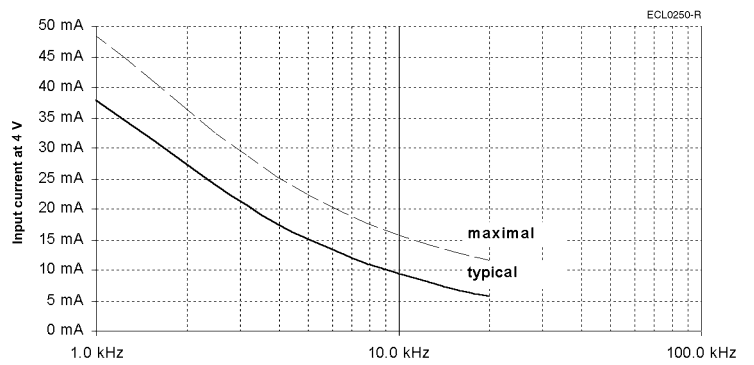

**Power consumption P**

The adjacent figure applies to  $V_{R1-R2} = 4 \text{ V}$ .

For other input voltages, the power consumption changes follows as:

$$P = P_{\text{Figure}} \cdot (V_{R1-R2} / 4 \text{ V})^2$$

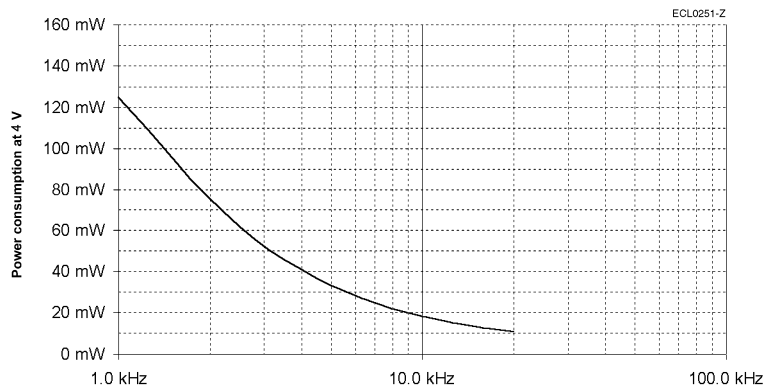

**Resistance, impedance and operating parameters (continued)**

**DC resistance**

The ohmic resistance values are based on an ambient temperature of 22 °C and change with temperature by 0.39 % / K

$R_{R1-R2} = 65 \Omega$   
 $R_{S1-S3} = R_{S2-S4} = 81 \Omega$   
 Tolerance:  $\pm 15 \%$

**Input impedance**

Tolerance:  $\pm 20 \%$

$Z_{RO}$  ... Impedance between R1 and R2 with open outputs

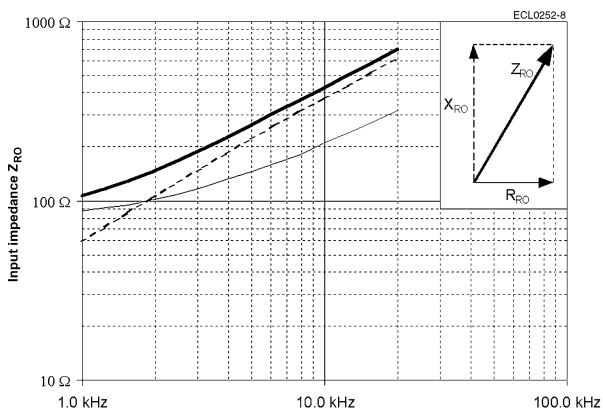

Tolerance:  $\pm 20 \%$

$Z_{RS}$  ... Impedance between R1 and R2 with short circuits between S1 and S3 as well as between S2 and S4

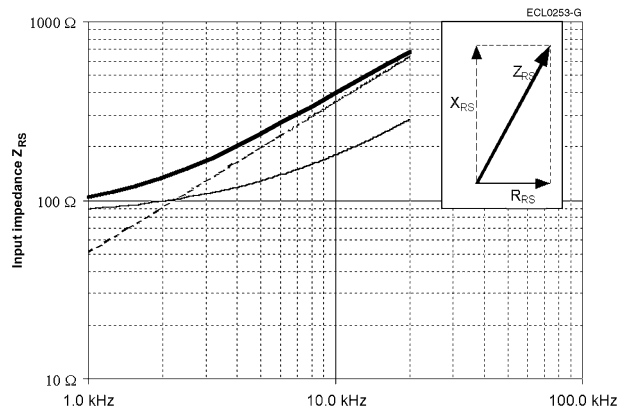

**Output impedance**

Tolerance:  $\pm 20 \%$

$Z_{SO}$  ... Impedance between S2 and S4 in a position of 0° (minimal coupling) with open outputs

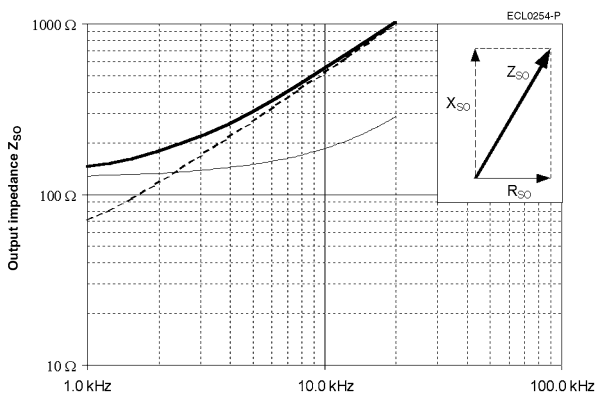

Tolerance:  $\pm 20 \%$

$Z_{SS}$  ... Impedance between S1 and S3 in a position of 0° (max. coupling) with short circuits between R1 and R2

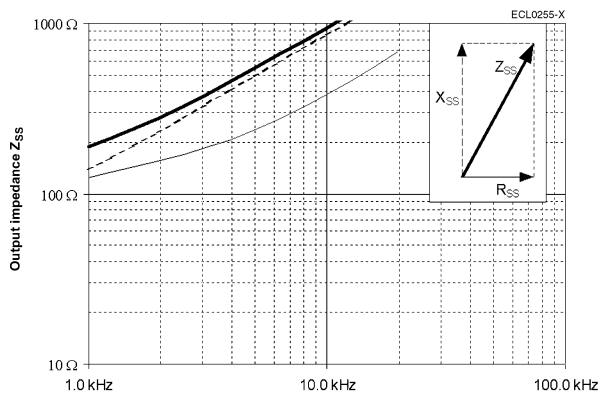

**Inductance L**

$L = X / (2 \cdot \pi \cdot f)$   
 at  $f = 5 \text{ kHz}$

$L_{RO} = 6 \text{ mH}$   
 $L_{SS} = 13 \text{ mH}$

Housing

CrMo-steel

**Electrical error / Ordering information**

**Angular error spread  $\Delta\phi$**   
 $\pm 10'$   
 $\pm 7'$   
 $\pm 4'$

**Ordering code**  
 V23401-U2017-B201  
 V23401-U2017-B202  
 V23401-U2017-B233

**Residual voltage  $V_{\text{residual}}$**

18 mV at  $V_{R1-R2} = 5 \text{ V}$

Electrical data at 22 °C.

**Transfer function**

**Pairs of poles p**

$p = 1$

**Transformation ratio  $r_T$**

$$r_T = \frac{V_{S1-S3 \text{ max}}}{V_{R1-R2}}$$

$$= \frac{V_{S2-S4 \text{ max}}}{V_{R1-R2}}$$

=  $0.5 \pm 20\%$  within 1 ... 10 kHz  
 =  $0.5 \pm 10\%$  at 4 kHz

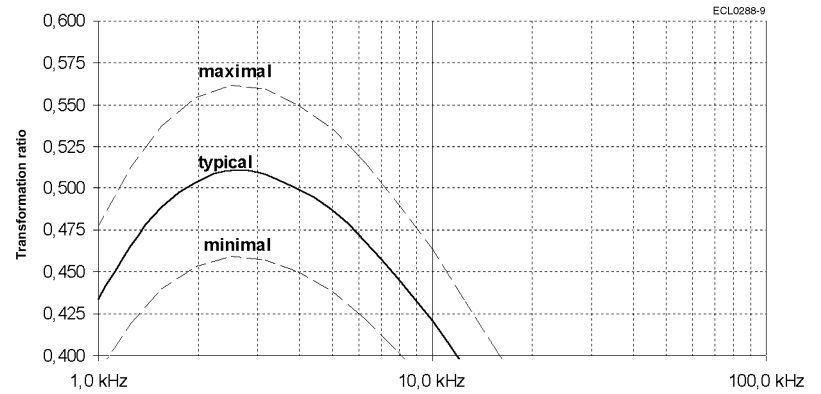

**Phase shift  $\psi$**

$$V_{R1-R2}(t) = V_{R1-R2 \text{ max}} \cdot \sin(2 \cdot \pi \cdot f \cdot t)$$

$$V_{S1-S3}(t) = V_{S1-S3 \text{ max}} \cdot \sin(2 \cdot \pi \cdot f \cdot t - \psi)$$

for  $-90^\circ < \alpha < +90^\circ$

Tolerance:  $\pm 5^\circ$

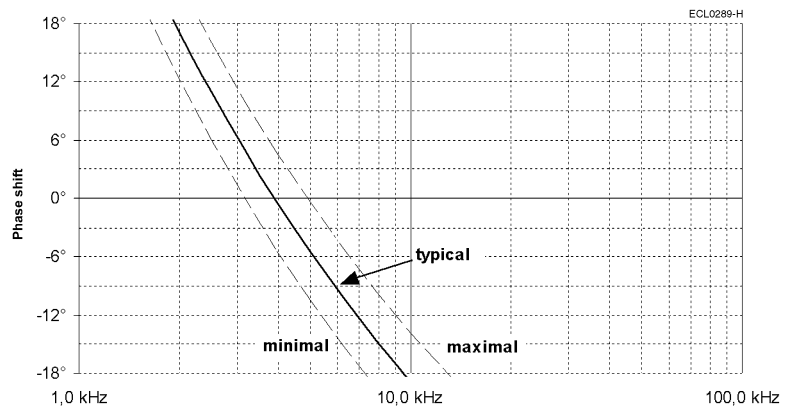

Size 21

**Resistance, impedance and operating parameters**

|  |                              |
|--|------------------------------|
| <b>Input voltage <math>V_{R1-R2}</math>, typical</b> | 4 $V_{rms}$ ... 20 $V_{rms}$ |
| <b>Frequency <math>f</math>, typical</b>             | 2 kHz ... 10 kHz             |

When choosing the values of these parameters take into account power dissipation, max. ambient temperature and the heat dissipation. Including self heating a maximum operating temperature of 150 °C must not be exceeded. Generally a power dissipation of  $P \leq 0.5$  W is not critical.

**Input current I**

The adjacent figure applies to  $V_{R1-R2} = 5$  V.

For other input voltages, the input current changes follows as:

$$I = I_{Figure} \cdot V_{R1-R2} / 5$$

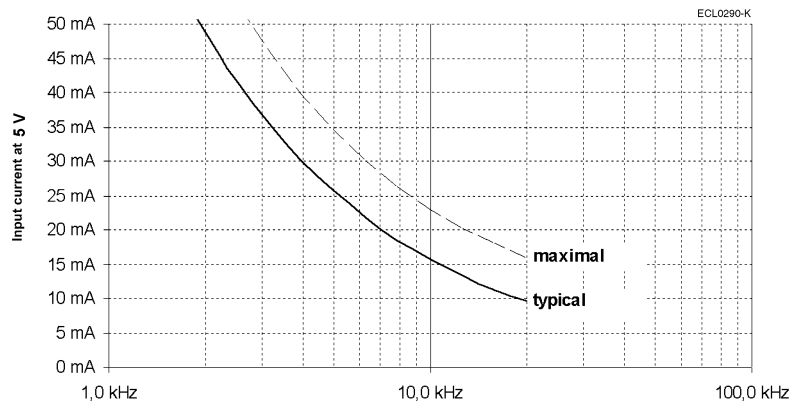

**Power consumption P**

The adjacent figure applies to  $V_{R1-R2} = 5$  V.

For other input voltages, the power consumption changes follows as:

$$P = P_{Figure} \cdot (V_{R1-R2} / 5)^2$$

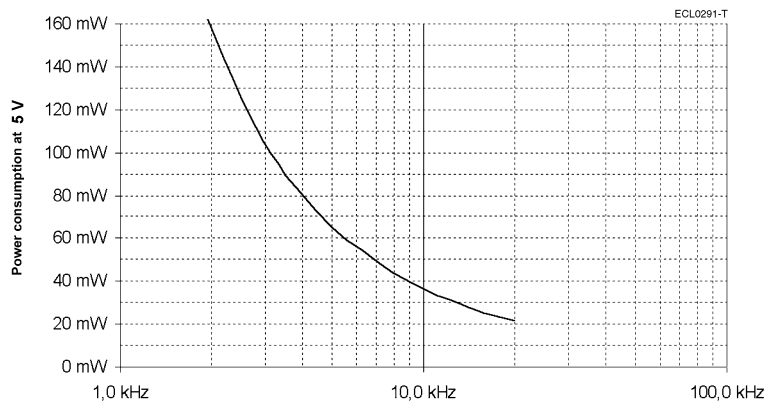

**Resistance, impedance and operating parameters (continued)**

**DC resistance**

The ohmic resistance values are based on an ambient temperature of 22 °C and change with temperature by 0.39 % / K

$R_{R1-R2} = 36 \Omega$   
 $R_{S1-S3} = R_{S2-S4} = 56 \Omega$   
 Tolerance:  $\pm 15 \%$

**Input impedance**

Tolerance:  $\pm 20 \%$

$Z_{RO}$  ... Impedance between R1 and R2 with open outputs

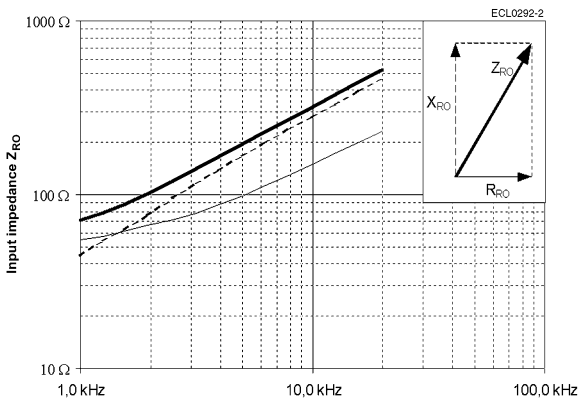

Tolerance:  $\pm 20 \%$

$Z_{RS}$  ... Impedance between R1 and R2 with short circuits between S1 and S3 as well as between S2 and S4

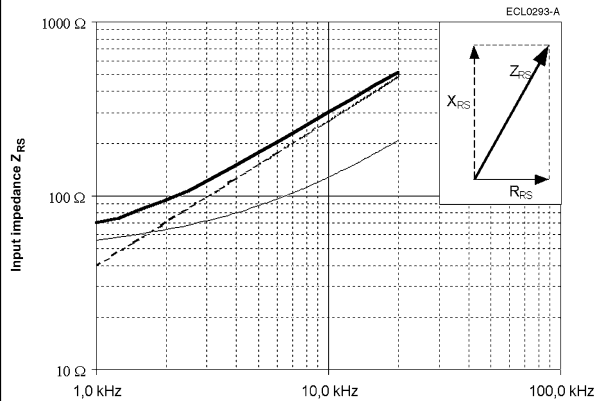

**Output impedance**

Tolerance:  $\pm 20 \%$

$Z_{SO}$  ... Impedance between S2 and S4 in a position of 0° (minimal coupling) with open outputs

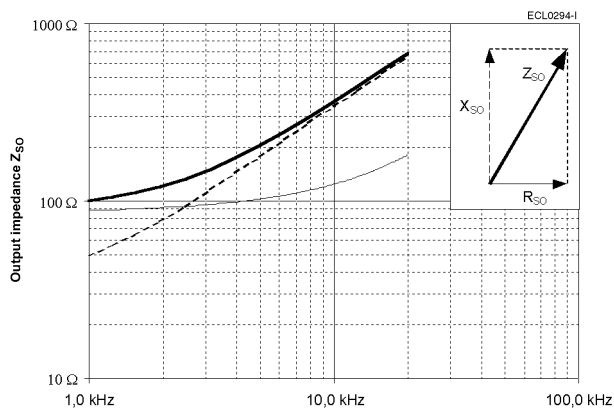

Tolerance:  $\pm 20 \%$

$Z_{SS}$  ... Impedance between S1 and S3 in a position of 0° (max. coupling) with short circuits between R1 and R2

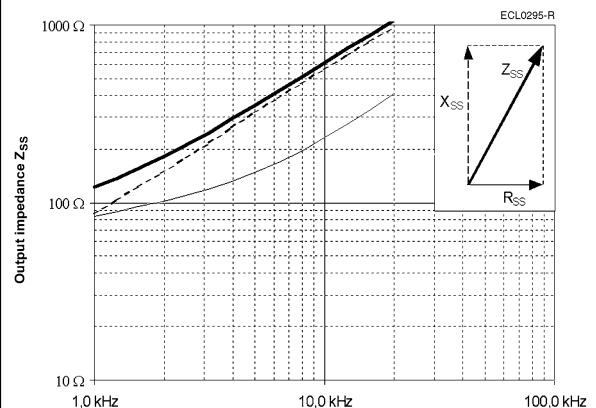

**Inductance L**

$L = X / (2 \cdot \pi \cdot f)$   
 at  $f = 4 \text{ kHz}$

$L_{RO} = 5.5 \text{ mH}$   
 $L_{SS} = 10.5 \text{ mH}$

Housing

CrMo-steel

**Electrical error / Ordering information**

**Angular error spread  $\Delta\phi$**   
 $\pm 10'$   
 $\pm 8'$   
 $\pm 6'$

**Ordering code**  
 V23401-U2020-B201  
 V23401-U2020-B209  
 V23401-U2020-B210

**Residual voltage  $V_{\text{residual}}$**

20 mV at  $V_{R1-R2} = 6 V$

Electrical data at 22 °C.

**Transfer function**

**Pairs of poles p**

$p = 3$

**Transformation ratio  $r_T$**

$$r_T = V_{S1-S3 \text{ max}} / V_{R1-R2}$$

$$= V_{S2-S4 \text{ max}} / V_{R1-R2}$$

$= 0.5 \pm 10 \% \text{ within } 3 \dots 10 \text{ kHz}$   
 $= 0.5 \pm 5 \% \text{ at } 6 \text{ kHz}$

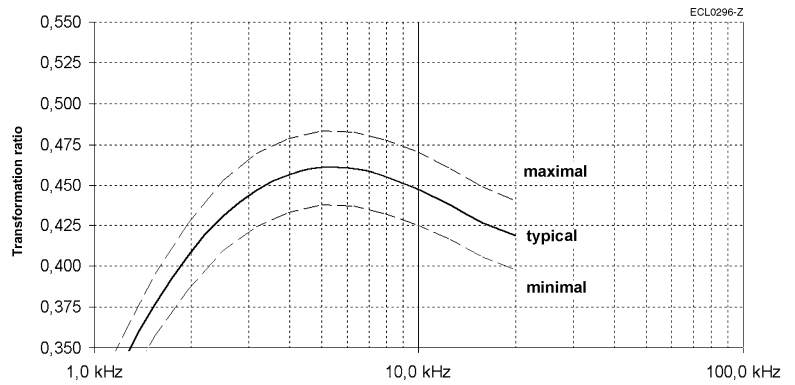

**Phase shift  $\psi$**

$$V_{R1-R2}(t) = V_{R1-R2 \text{ max}} \cdot \sin(2 \cdot \pi \cdot f \cdot t)$$

$$V_{S1-S3}(t) = V_{S1-S3 \text{ max}} \cdot \sin(2 \cdot \pi \cdot f \cdot t - \psi)$$

for  $-90^\circ < \alpha < +90^\circ$

Tolerance:  $\pm 5^\circ$

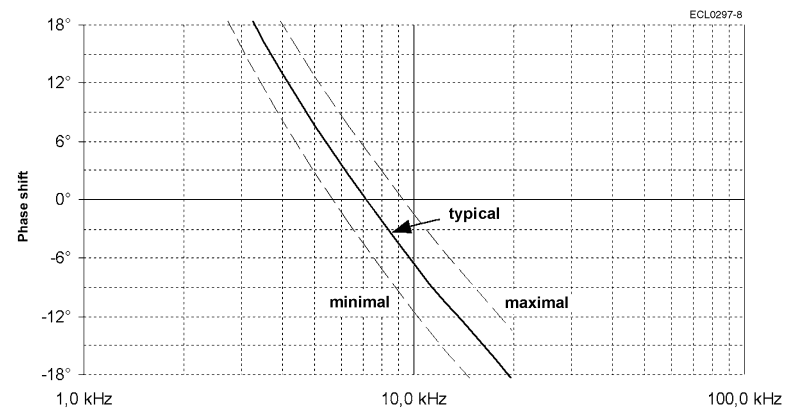

**Resistance, impedance and operating parameters**

|  |                              |  |
|--|------------------------------|--|
| <b>Input voltage <math>V_{R1-R2}</math>, typical</b> | $2 V_{rms} \dots 10 V_{rms}$ | When choosing the values of these parameters take into account power dissipation, max. ambient temperature and the heat dissipation. Including self heating a maximum operating temperature of 150 °C must not be exceeded. Generally a power dissipation of $P \leq 0.5 W$ is not critical. |
| <b>Frequency <math>f</math>, typical</b>             | 4 kHz ... 10 kHz             |  |

**Input current I**

The adjacent figure applies to  $V_{R1-R2} = 6 V$ .

For other input voltages, the input current changes follows as:

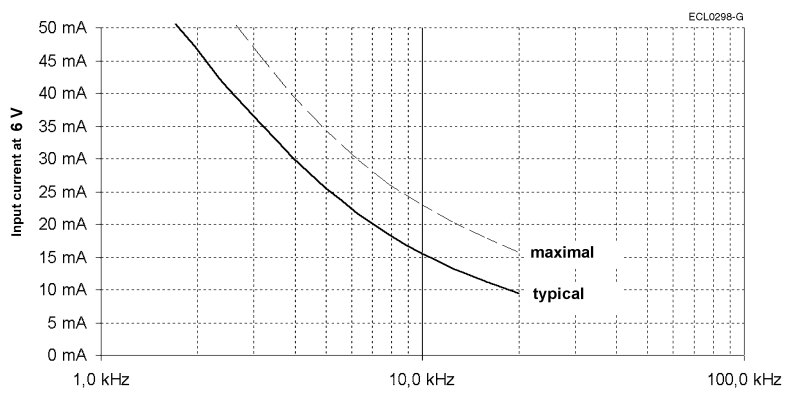
$$I = I_{Figure} \cdot V_{R1-R2} / 6 V$$

**Power consumption P**

The adjacent figure applies to  $V_{R1-R2} = 6 V$ .

For other input voltages, the power consumption changes follows as:

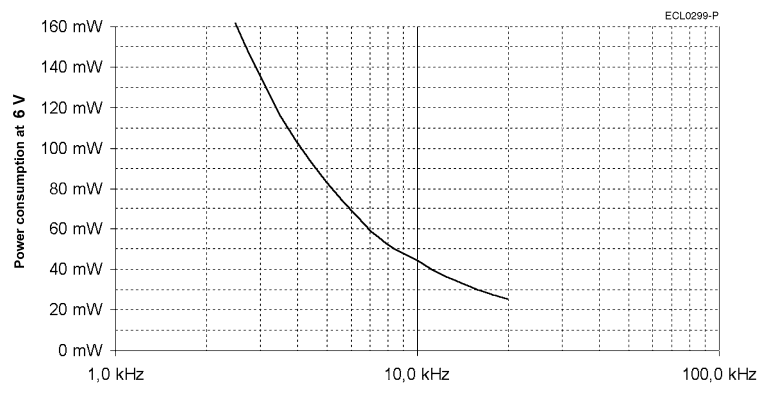
$$P = P_{Figure} \cdot (V_{R1-R2} / 6 V)^2$$

**Resistance, impedance and operating parameters (continued)**

**DC resistance**

The ohmic resistance values are based on an ambient temperature of 22 °C and change with temperature by 0.39 % / K

$R_{R1-R2} = 62 \Omega$   
 $R_{S1-S3} = R_{S2-S4} = 186 \Omega$   
 Tolerance:  $\pm 10 \%$

**Input impedance**

Tolerance:  $\pm 15 \%$

$Z_{RO}$  ... Impedance between R1 and R2 with open outputs

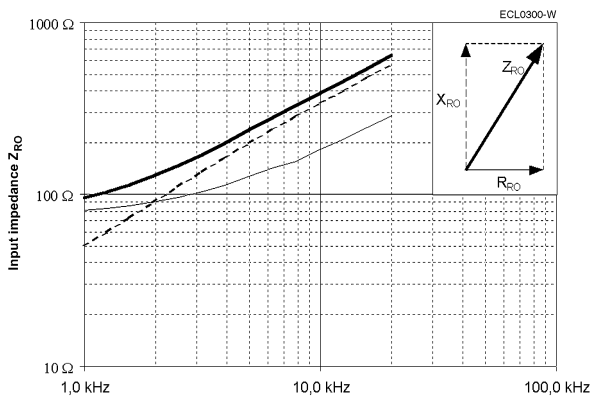

Tolerance:  $\pm 15 \%$

$Z_{RS}$  ... Impedance between R1 and R2 with short circuits between S1 and S3 as well as between S2 and S4

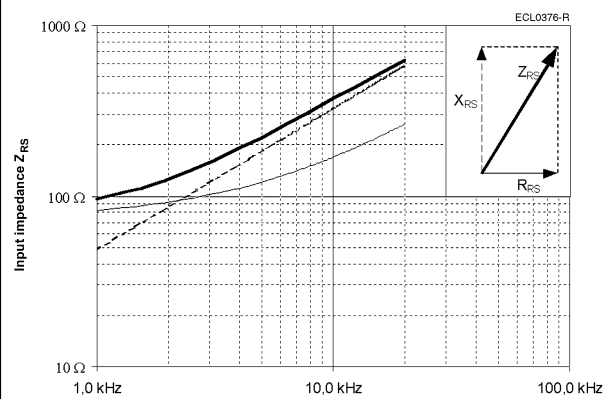

**Output impedance**

Tolerance:  $\pm 15 \%$

$Z_{SO}$  ... Impedance between S2 and S4 in a position of 0° (minimal coupling) with open outputs

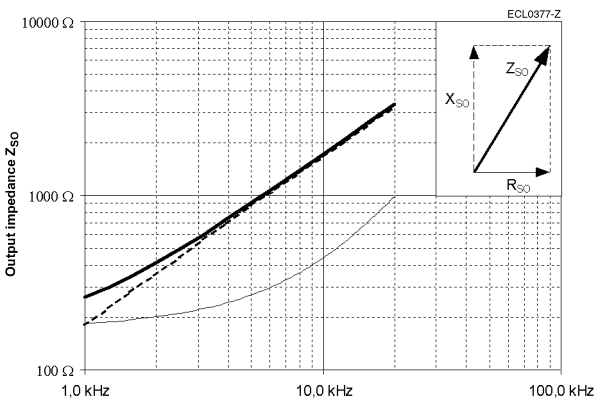

Tolerance:  $\pm 15 \%$

$Z_{SS}$  ... Impedance between S1 and S3 in a position of 0° (max. coupling) with short circuits between R1 and R2

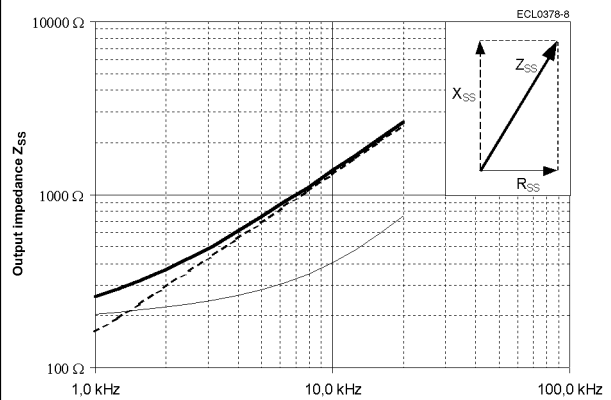

**Inductance L**

$L = X / (2 \cdot \pi \cdot f)$   
 at  $f = 6 \text{ kHz}$

$L_{RO} = 4 \text{ mH}$   
 $L_{SS} = 14 \text{ mH}$



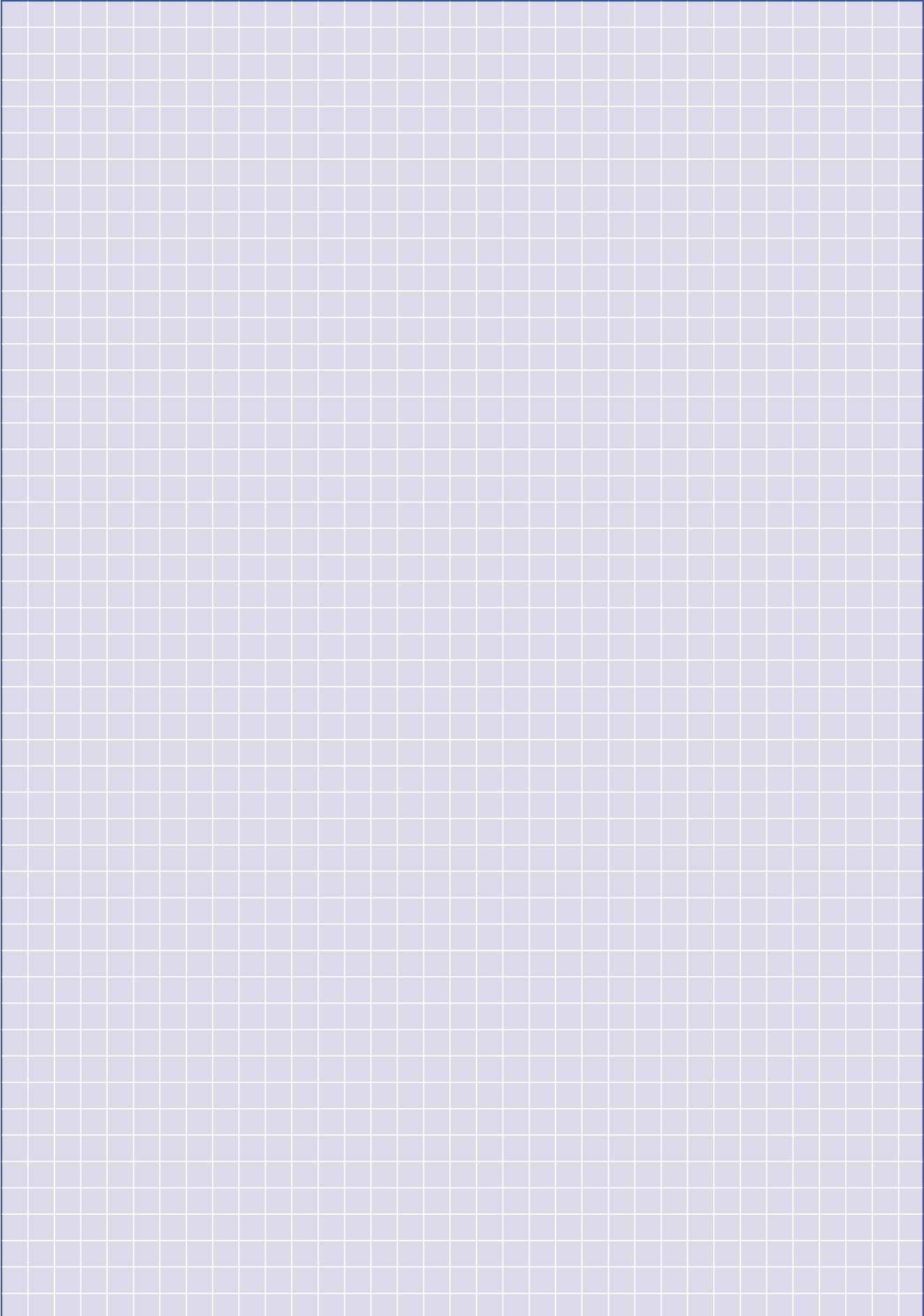

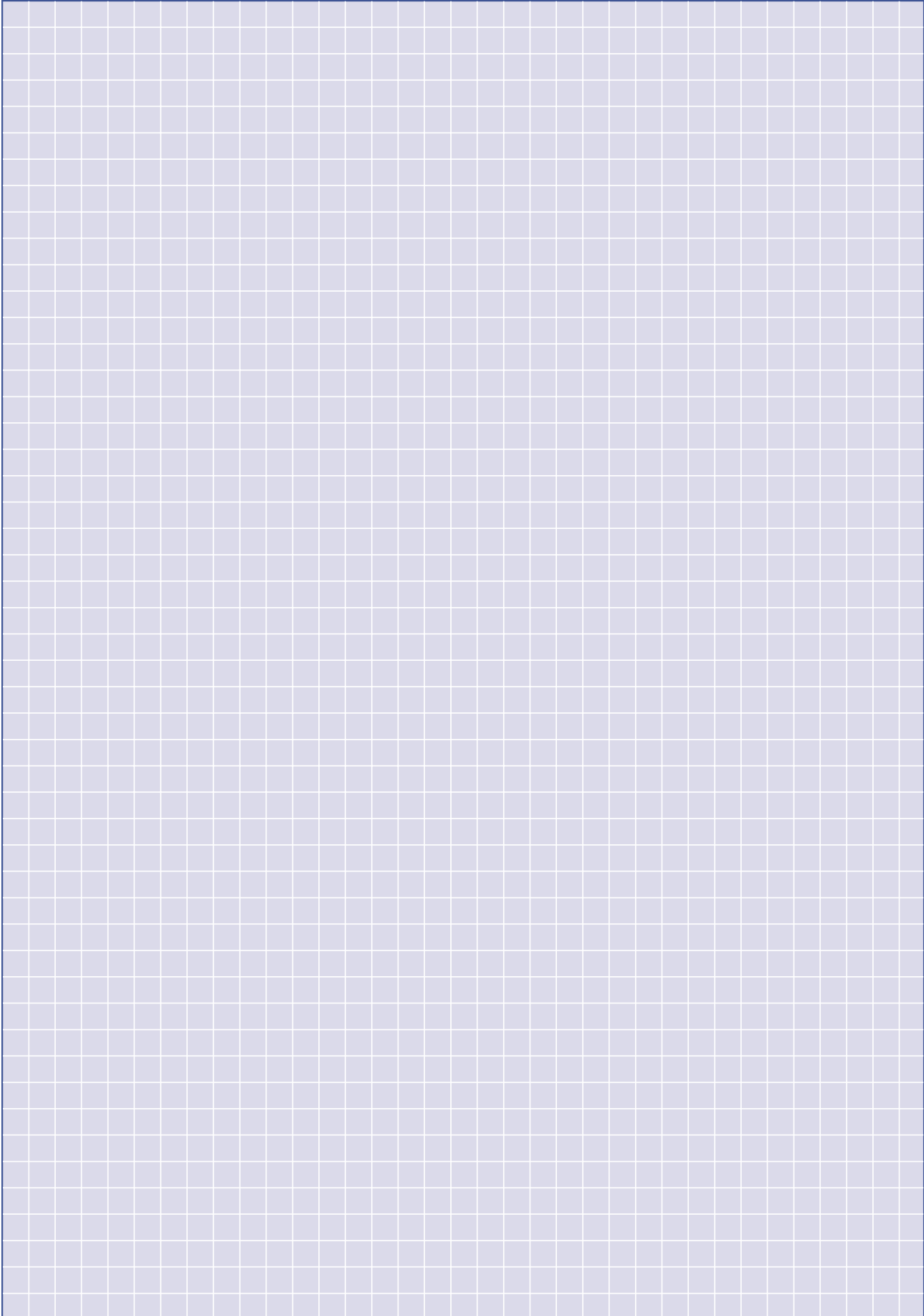

Size 21

**Americas**

**Argentina** – Buenos Aires  
Phone: +54-1-733-2000  
Fax: +54-1-717-0988

**Brasil** – São Paulo  
Phone: +55-11-3611-1311  
Fax: +55-11-3611-0397

**Canada** – Toronto  
Phone: +905-475-6222  
Fax: +905-474-5520

**Chile** – Santiago  
Phone: +56-2-739-1230  
Fax: +56-2-739-1227

**Colombia** – Bogota  
Phone: +57-1-231-9398  
Fax: +57-1-240-3769

**Mexico** – Mexico City  
Phone: +52-5-729-0400  
Fax: +52-5-361-8545

**United States** – Harrisburg, PA  
Phone: +717-564-0100  
Fax: +717-986-7575

**Venezuela** – Caracas  
Phone: +58-2-986-7774  
Fax: +58-2-986-9739

**For Latin/South American Countries not shown**  
Phone: +54-11-4733-2015  
Fax: +54-11-4733-2083

**Asia/Pacific**

**Australia** – Sydney  
Phone: +61-2-9840-8200  
Fax: +61-2-9899-5649

**India** – Bangalore  
Phone: +91-80-841-0200  
Fax: +91-80-841-0210

**Indonesia** – Jakarta  
Phone: +6221-526-7852  
Fax: +6221-526-7856

**Japan** – Kawasaki, Kanagawa  
Phone: +81-44-844-8079  
Fax: +81-44-844-8733

**Korea** – Seoul  
Phone: +82-2-3274-0535  
Fax: +82-2-3274-0524/0531

**Malaysia** – Selangor  
Phone: +60-3-7053055  
Fax: +60-3-7053066

**New Zealand** – Auckland  
Phone: +64-9-634-4580  
Fax: +64-9-634-4586

**Philippines** – Makati City  
Phone: +632-867-8641  
Fax: +632-867-8661

**People's Republic of China**  
Hong Kong  
Phone: +852-2735-1628  
Fax: +852-2735-0243

Shanghai  
Phone: +86-21-6485-0602  
Fax: +86-21-6485-0728

Shunde  
Phone: +86-765-775-1368  
Fax: +86-765-775-2823

**Singapore** – Singapore  
Phone: +65-482-0311  
Fax: +65-482-1012

**Taiwan** – Taipei  
Phone: +886-2-2664-9977  
Fax: +886-2-2664-9900

**Thailand** – Bangkok  
Phone: +66-2-955-0500  
Fax: +66-2-955-0505

**Vietnam** – Ho Chi Minh City  
Phone: +84-8-8232-546/7  
Fax: +84-8-8221-443

**Europe/Middle East/Africa**

**Austria** – Vienna  
Phone: +43-1-90-560-0  
Fax: +43-1-90-560-1333

**Belgium** – Kessel-Lo  
Phone: +32-16-352-300  
Fax: +32-16-352-352

**Bulgaria** – Sofia  
Phone: +359-2-971-2152  
Fax: +359-2-971-2153

**Croatia** – Zagreb  
Phone: +385-1-67-04-46  
Fax: +385-1-69-16-04

**Czech Republic** – Kurim  
Phone: +420-5-41-162-111  
Fax: +420-5-41-162-223

**Denmark** – Viby  
Phone: +45-86-295-055  
Fax: +45-86-295-133

**England** – Stanmore Middlesex  
Phone: +44-181-954-2356  
Fax: +44-181-954-6234

**Egypt** – Cairo  
Phone: +20-2-417-76-47  
Fax: +20-2-419-23-34

**Estonia** – Haabneeme  
Phone: +372-6205-900  
Fax: +372-6205-980

**Finland** – Helsinki  
Phone: +358-9-512-3420  
Fax: +358-9-512-34250

**France** – Cergy-Pontoise Cedex  
Phone: +33-1-3420-8888  
Fax: +33-1-3420-8600

**France Export** – St Ouen L'Aumone  
Phone: +33-1-3440-7200  
Fax: +33-1-3440-7220 or  
+33-1-3440-7230

**France SIMEL** – Gevrey-Chambertin  
Phone: +33-3-8058-3200  
Fax: +33-3-8034-1015

**Germany** – Bensheim  
Phone: +49-6251-133-0  
Fax: +49-6251-133-1600

**Germany HTS** – Neunkirchen  
Phone: +49-2247-305-0  
Fax: +49-2247-305-122

**Greece** – Athens  
Phone: +30-1-9370-396/397  
Fax: +30-1-9370-655

**Hungary** – Budapest  
Phone: +36-1-289-1000  
Fax: +36-1-289-1010

**Ireland** – Dublin  
Phone: +353-1-820-3000  
Fax: +353-1-820-9790

**Israel** – Tel Aviv  
Phone: +972-3-649-1482  
Fax: +972-3-648-4041

**Italy** – Collegno (Torino)  
Phone: +39-011-4012-111  
Fax: +39-011-403-11-16

**Lithuania** – Vilnius  
Phone: +370-2-231-402  
Fax: +370-2-231-403

**The Netherlands** – 's-Hertogenbosch  
Phone: +31-73-6246-246  
Fax: +31-73-6246-935

**Norway** – Nesbru  
Phone: +47-66-77-8899  
Fax: +47-66-77-8855

**Poland** – Warsaw  
Phone: +48-22-54-90-888  
Fax: +48-22-54-90-880

**Portugal** – Lisbon  
Phone: +351-21-384-58-90  
Fax: +351-21-387-71-72

**Romania** – Bucharest  
Phone: +40-1-311-3479 + 3596  
Fax: +40-1-312-0574

**Russia** – Moscow  
Phone: +7-095-926-55-06...09  
Fax: +7-095-926-55-05

**Russia** – St. Petersburg  
Phone: +7-812-325-30-83  
Fax: +7-812-325-32-88

**Slovakia** – Banská Bystrica  
Phone: +421-88-415-20-11/12  
Fax: +421-88-415-20-13

**Slovenia** – Ljubljana  
Phone: +386-61-161-3270  
Fax: +386-61-161-3240

**South Africa** – Midrand  
Phone: +27-11-314-10-89  
Fax: +27-11-314-19-10

**Spain** – Barcelona  
Phone: +34-93-291-0330  
Fax: +34-93-201-7879

**Sweden** – Upplands Väsby  
Phone: +46-8-50-72-50-00  
Fax: +46-8-50-72-50-01

**Switzerland** – Steinach  
Phone: +41-71-447-0447  
Fax: +41-71-447-0444

**Turkey** – Istanbul  
Phone: +90-212-281-8181...3  
Fax: +90-212-281-8184

**Ukraine** – Kiev  
Phone: +38-044-238-6908  
Fax: +38-044-238-6596



**Tyco Electronics AMP GmbH certified according ISO 9001, QS 9000/VDA 6.1,  
ISO 14000 certification is in preparation**

© 2001 Tyco Electronics AMP GmbH · Industrial · Siemensstr. 13 · D-67346 Speyer  
Product Information Center: Tel. +49-6251-133-1999, Fax +49-6251-133-1988