

International IOR Rectifier

43CTQ... 43CTQ...S 43CTQ...-1

SCHOTTKY RECTIFIER

40 Amp

$I_{F(AV)} = 40\text{Amp}$
 $V_R = 80\text{-}100\text{V}$





Major Ratings and Characteristics

Characteristics	Values	Units
$I_{F(AV)}$ Rectangular waveform	40	A
V_{RRM}	80 - 100	V
I_{FSM} @ tp = 5 μs sine	850	A
V_F @ 20 Apk, $T_J = 125^\circ\text{C}$ (per leg)	0.67	V
T_J range	-55 to 175	$^\circ\text{C}$

Description/ Features

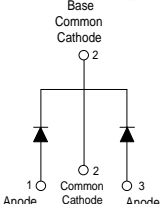
This center tap Schottky rectifier series has been optimized for low reverse leakage at high temperature. The proprietary barrier technology allows for reliable operation up to 175°C junction temperature. Typical applications are in switching power supplies, converters, free-wheeling diodes, and reverse battery protection.

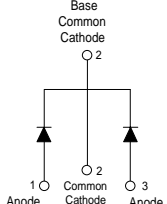
- 175° C T_J operation
- Center tap configuration
- Low forward voltage drop
- High purity, high temperature epoxy encapsulation for enhanced mechanical strength and moisture resistance
- High frequency operation
- Guard ring for enhanced ruggedness and long term reliability

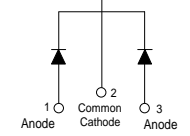
Case Styles		
<p>43CTQ...</p>  <p>Base Common Cathode 2</p>  <p>1 Anode 2 Common Cathode 3 Anode</p> <p>TO-220</p>	<p>43CTQ... S</p>  <p>Base Common Cathode 2</p>  <p>1 Anode 2 Common Cathode 3 Anode</p> <p>D²PAK</p>	<p>43CTQ... -1</p>  <p>Base Common Cathode 2</p>  <p>1 Anode 2 Common Cathode 3 Anode</p> <p>TO-262</p>

Voltage Ratings

Parameters	43CTQ080 43CTQ080S 43CTQ080-1	43CTQ100 43CTQ100S 43CTQ100-1
V_R Max. DC Reverse Voltage (V)	80	100
V_{RWM} Max. Working Peak Reverse Voltage (V)		

Absolute Maximum Ratings

Parameters	Values	Units	Conditions
$I_{F(AV)}$ Max. Average Forward (Per Leg) Current * See Fig. 5 (Per Device)	20	A	50% duty cycle @ $T_C = 135^\circ\text{C}$, rectangular wave form
	40		
I_{FSM} Max. Peak One Cycle Non-Repetitive Surge Current (Per Leg) * See Fig. 7	850	A	5 μs Sine or 3 μs Rect. pulse 10ms Sine or 6ms Rect. pulse Following any rated load condition and with rated V_{RRM} applied
	275		
E_{AS} Non-Repetitive Avalanche Energy (Per Leg)	7.50	mJ	$T_J = 25^\circ\text{C}$, $I_{AS} = 0.50$ Amps, $L = 60$ mH
I_{AR} Repetitive Avalanche Current (Per Leg)	0.50	A	Current decaying linearly to zero in 1 μsec Frequency limited by T_J max. $V_A = 1.5 \times V_R$ typical

Electrical Specifications

Parameters	Values	Units	Conditions
V_{FM} Max. Forward Voltage Drop (Per Leg) * See Fig. 1 (1)	0.81	V	@ 20A $T_J = 25^\circ\text{C}$
	0.98	V	@ 40A
	0.67	V	@ 20A $T_J = 125^\circ\text{C}$
	0.81	V	@ 40A
I_{RM} Max. Reverse Leakage Current (Per Leg) * See Fig. 2 (1)	1	mA	$T_J = 25^\circ\text{C}$
	11	mA	$T_J = 125^\circ\text{C}$ $V_R = \text{rated } V_R$
$V_{F(TO)}$ Threshold Voltage	0.71	V	$T_J = T_J \text{ max.}$
r_t Forward Slope Resistance	0.43	m Ω	
C_T Max. Junction Capacitance (Per Leg)	1480	pF	$V_R = 5V_{DC}$, (test signal range 100Khz to 1Mhz) 25°C
L_S Typical Series Inductance (Per Leg)	8.0	nH	Measured lead to lead 5mm from package body
dv/dt Max. Voltage Rate of Change (Rated V_R)	10000	V/ μs	

(1) Pulse Width < 300 μs , Duty Cycle < 2%

Thermal-Mechanical Specifications

Parameters	Values	Units	Conditions
T_J Max. Junction Temperature Range	-55 to 175	$^\circ\text{C}$	
T_{stg} Max. Storage Temperature Range	-55 to 175	$^\circ\text{C}$	
R_{thJC} Max. Thermal Resistance Junction to Case (Per Leg)	2.0	$^\circ\text{C/W}$	DC operation
R_{thJC} Max. Thermal Resistance Junction to Case (Per Package)	1.0	$^\circ\text{C/W}$	DC operation
R_{thCS} Typical Thermal Resistance, Case to Heatsink	0.50	$^\circ\text{C/W}$	Mounting surface, smooth and greased (only for TO-220)
wt Approximate Weight	2 (0.07)	g (oz.)	
T Mounting Torque	Min.	6 (5)	Kg-cm (lbf-in)
	Max.	12 (10)	

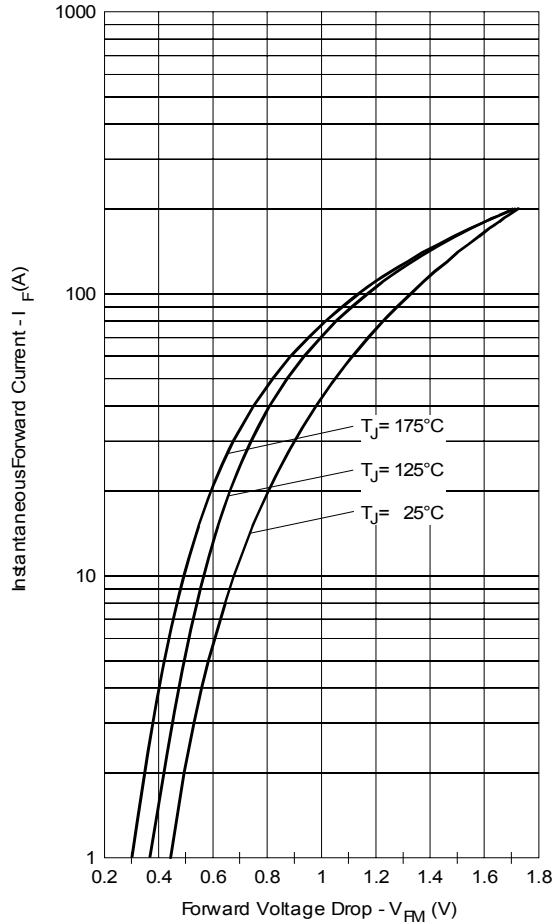

Fig. 1 - Max. Forward Voltage Drop Characteristics (Per Leg)

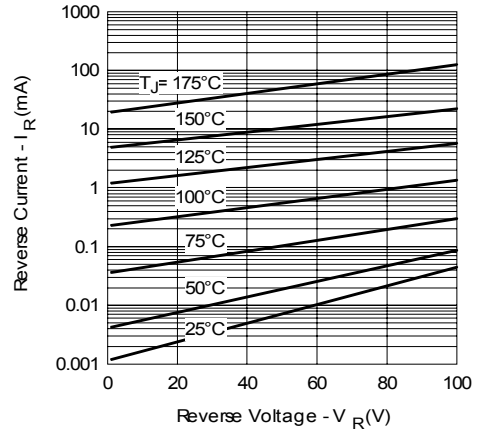

Fig. 2 - Typical Values Of Reverse Current Vs. Reverse Voltage (Per Leg)

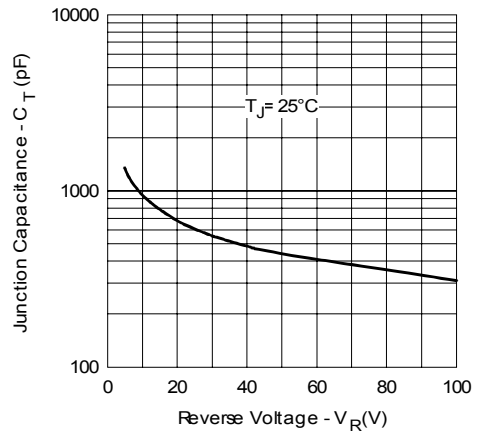

Fig. 3 - Typical Junction Capacitance Vs. Reverse Voltage (Per Leg)

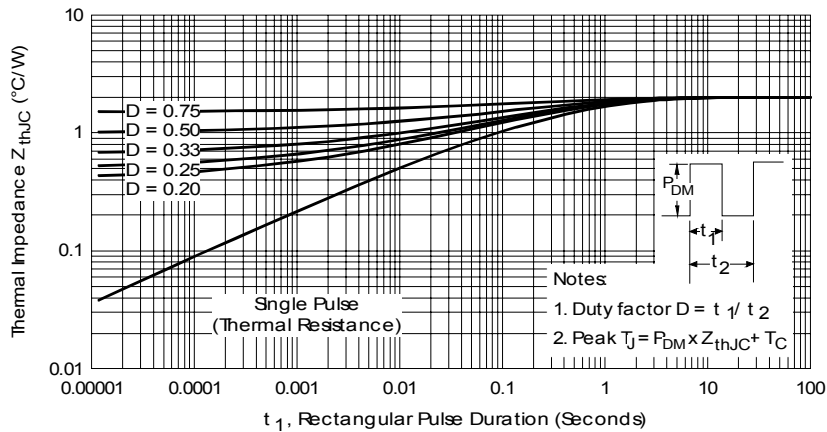

Fig. 4 - Max. Thermal Impedance Z_{thJC} Characteristics (Per Leg)

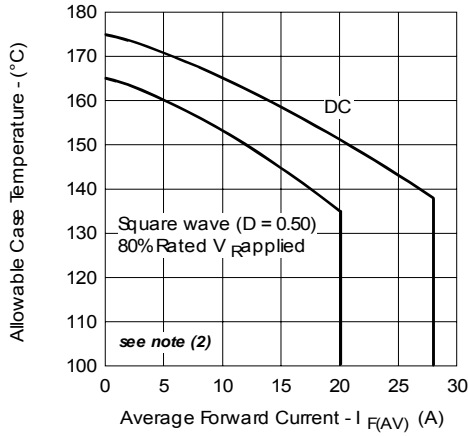

Fig. 5 - Max. Allowable Case Temperature Vs. Average Forward Current (Per Leg)

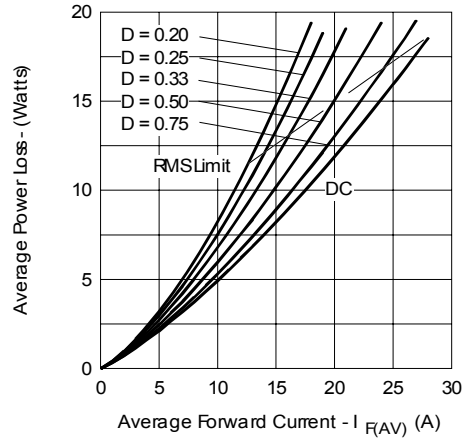

Fig. 6 - Forward Power Loss Characteristics (Per Leg)

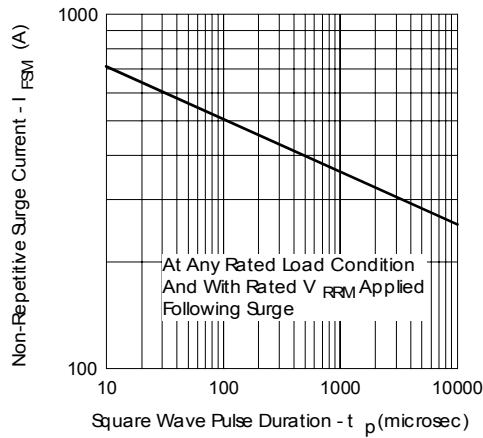

Fig. 7 - Max. Non-Repetitive Surge Current (Per Leg)

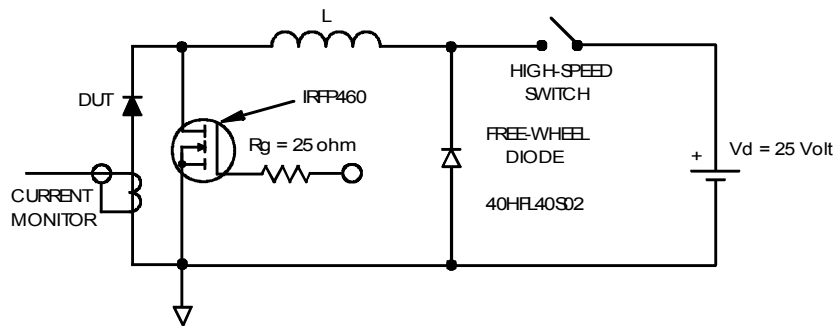

Fig. 8 - Unclamped Inductive Test Circuit

(2) Formula used: $T_C = T_J - (P_d + P_{d_{REV}}) \times R_{thJC}$;

P_d = Forward Power Loss = $I_{F(AV)} \times V_{FM} @ (I_{F(AV)} / D)$ (see Fig. 6);

$P_{d_{REV}}$ = Inverse Power Loss = $V_{R1} \times I_R (1 - D)$; $I_R @ V_{R1} = 10V$

Outline Table

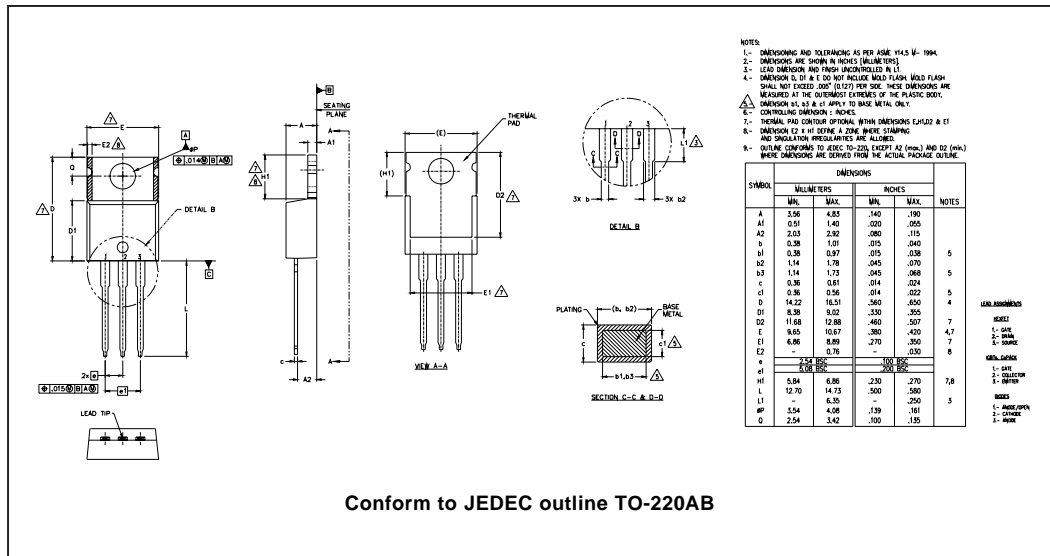

Conform to JEDEC outline TO-220AB

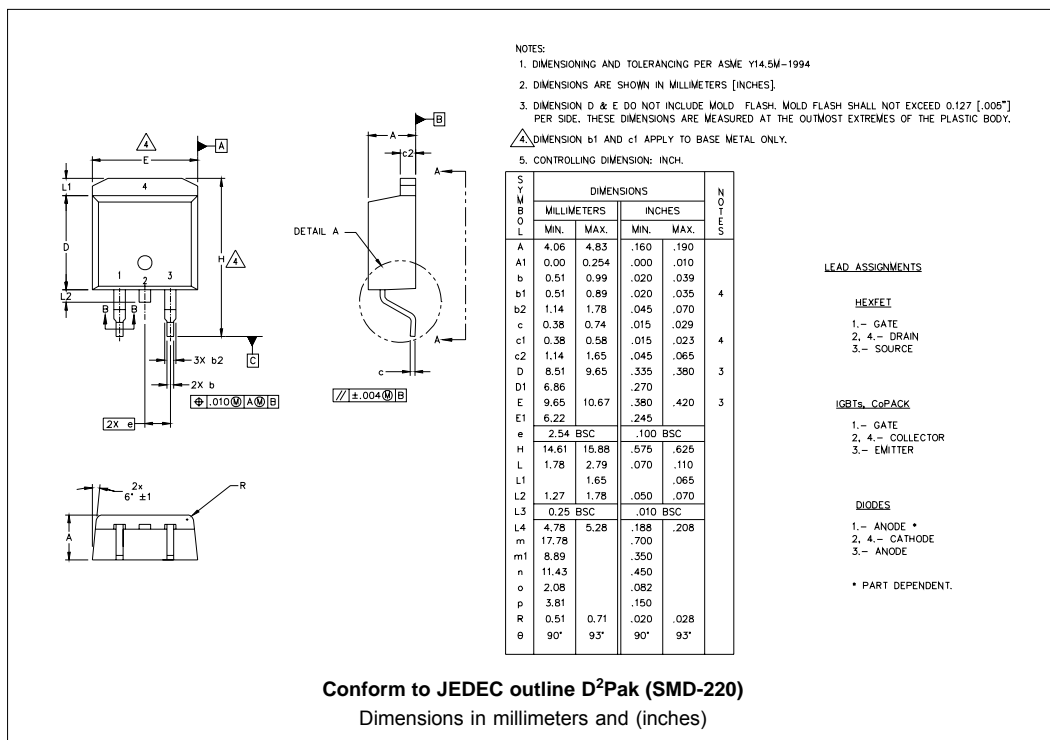

Conform to JEDEC outline D²Pak (SMD-220)
 Dimensions in millimeters and (inches)

Outline Table

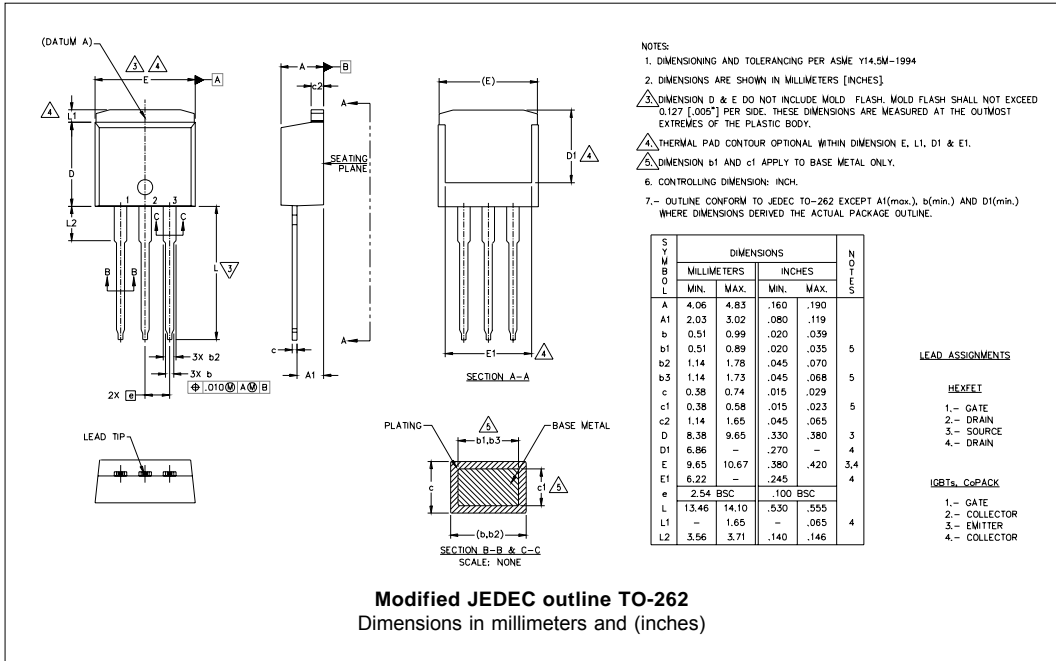

Tape & Reel Information

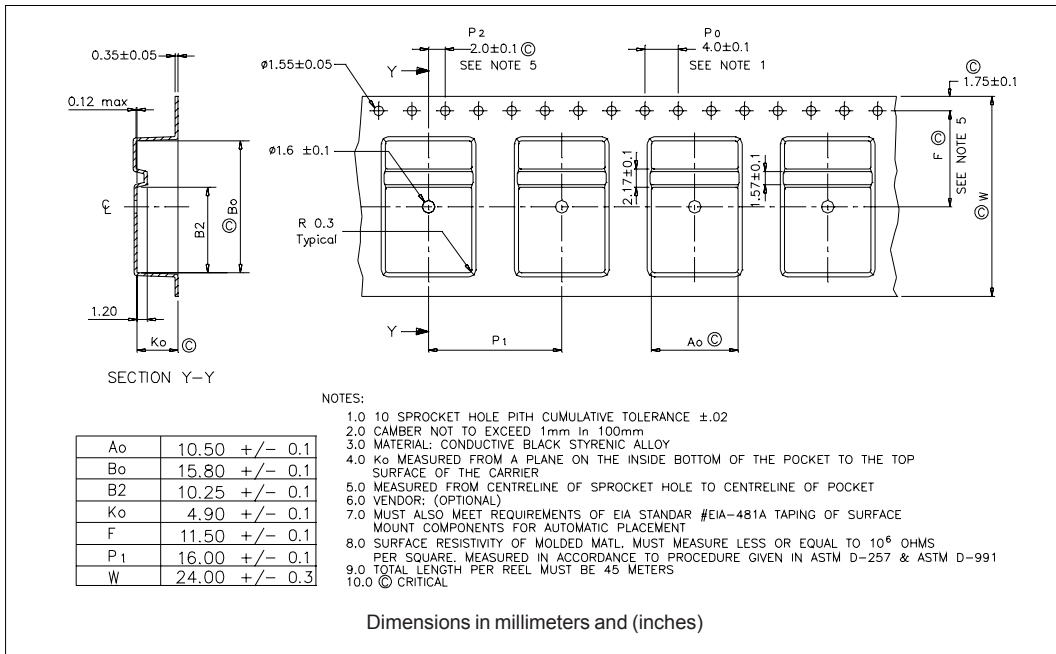

Part Marking Information

<p>TO-220</p>	<p>EXAMPLE: THIS IS A 43CTQ100 LOT CODE 1789 ASSEMBLED ON WW 19, 2000 IN THE ASSEMBLY LINE "C"</p>		<p>PART NUMBER DATE CODE YEAR 0 = 2000 WEEK 19 LINE C</p>
<p>D²PAK</p>	<p>EXAMPLE: THIS IS A 43CTQ100S LOT CODE 8024 ASSEMBLED ON WW 02, 2003 IN ASSEMBLY LINE "C"</p>		<p>PART NUMBER DATE CODE YEAR 3 = 2003 WEEK 02 LINE C</p>
<p>TO-262</p>	<p>EXAMPLE: THIS IS A 43CTQ100-1 LOT CODE 1789 ASSEMBLED ON WW 19, 2002 IN ASSEMBLY LINE "C"</p>		<p>PART NUMBER DATE CODE YEAR 2 = 2002 WEEK 19 LINE C</p>

Ordering Information Table

Device Code																	
	<table border="1" style="margin: auto;"> <tr> <td style="padding: 5px;">43</td> <td style="padding: 5px;">C</td> <td style="padding: 5px;">T</td> <td style="padding: 5px;">Q</td> <td style="padding: 5px;">100</td> <td style="padding: 5px;">S</td> <td style="padding: 5px;">TRL</td> <td style="padding: 5px;">-</td> </tr> <tr> <td style="text-align: center;">①</td> <td style="text-align: center;">②</td> <td style="text-align: center;">③</td> <td style="text-align: center;">④</td> <td style="text-align: center;">⑤</td> <td style="text-align: center;">⑥</td> <td style="text-align: center;">⑦</td> <td style="text-align: center;">⑧</td> </tr> </table>	43	C	T	Q	100	S	TRL	-	①	②	③	④	⑤	⑥	⑦	⑧
43	C	T	Q	100	S	TRL	-										
①	②	③	④	⑤	⑥	⑦	⑧										
1	- Current Rating (40A)																
2	- Circuit Configuration C = Common Cathode																
3	- T = TO-220																
4	- Schottky "Q" Series																
5	- Voltage Ratings																
6	- <ul style="list-style-type: none"> • S = D²Pak • -1= TO-262 																
7	- <ul style="list-style-type: none"> • none = Tube (50 pieces) • TRL = Tape & Reel (Left Oriented - for D²Pak only) • TRR = Tape & Reel (Right Oriented - for D²Pak only) 																
8	- <ul style="list-style-type: none"> • none = Standard Production • PbF = Lead-Free 																

080 = 80V
 100 = 100V

Data and specifications subject to change without notice.
 This product has been designed and qualified for Industrial Level.
 Qualification Standards can be found on IR's Web site.