

Applications

Monitoring the gradual change in liquid densities

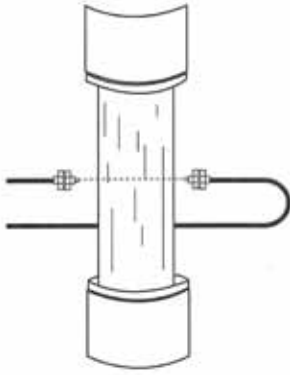

Detecting the roundness of rollers



Sensing position or alignment

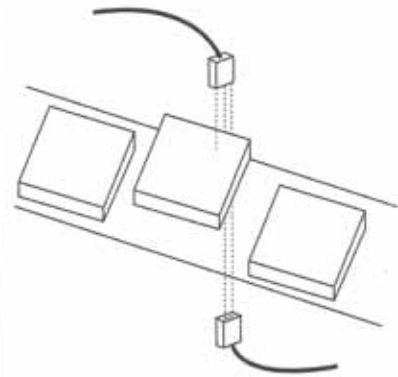

Checking size

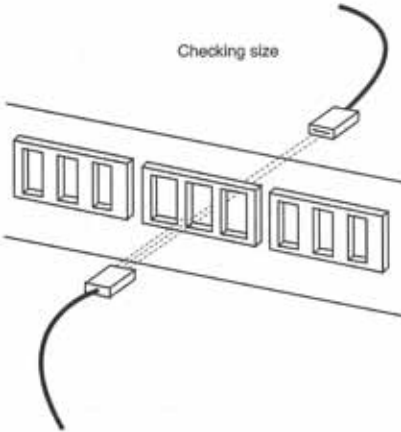

Checking height

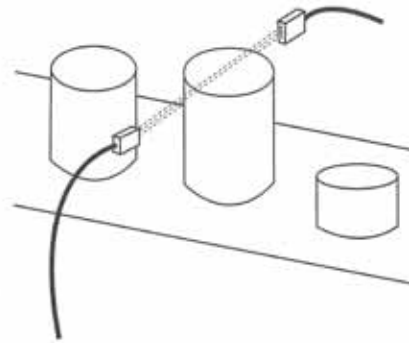

Controlling web tension



Sensing color marks

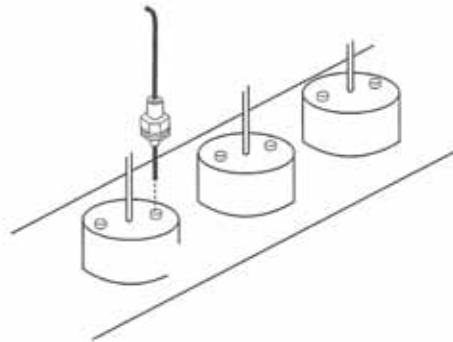

01 Touchscreens

PLCs

Automation Software

Power Supplies











Sensors

Communication







Barriers

## Accessories

## Reflectors

| Appearance  | Item                        | Use with | Part Number |         |
|---|-----------------------------|----------|-------------|---------|
|  | Standard reflector          | SA1E     | IAC-R5      |         |
|  | Small reflector             |          | IAC-R6      |         |
|  | Large reflector             |          | IAC-R8      |         |
|  | Narrow (rear/side mounting) |          | IAC-R7M     |         |
|  | Narrow (side mounting)      |          | IAC-R7S     |         |
|  | Narrow (rear mounting)      |          | IAC-R7B     |         |
|  | Tape (35 x 40mm)            |          | IAC-RS1     |         |
|  | Tape (70 x 80mm)            |          | IAC-RS2     |         |
|  | Standard                    |          | SA1E-X      | IAC-R9  |
|  | Small                       |          |             | IAC-R10 |
|  | Ultra-small                 | IAC-R11  |             |         |



## Brackets

| Appearance  | Item                        | Use with | Part Number |
|---|-----------------------------|----------|-------------|
|   | Vertical mounting bracket   | SA1E     | SA9Z-K01    |
|  | Horizontal mounting bracket |          | SA9Z-K02    |
|  | Cover mounting bracket      |          | SA9Z-K03    |
|  | Back mounting bracket       |          | SA9Z-K04    |
|  | Reflector mounting bracket  |          | IAC-L2      |
|  | Reflector mounting bracket  |          | IAC-L3      |
|  | Reflector mounting bracket  |          | IAC-L5      |

## Slits

| Appearance  | Item            | Slit Size     | Use with | Part Number | Min. Order Qty |          |
|---|-----------------|---------------|----------|-------------|----------------|----------|
|  | Vertical slit   | 0.5mm x 18mm  | SA1E     | SA9Z-S06    | 2              |          |
|   |                 | 1.0mm x 18mm  |          | SA9Z-S07    |                |          |
|   |                 | 2.0mm x 18mm  |          | SA9Z-S08    |                |          |
|   | Horizontal slit | 0.5mm x 6.5mm |          | SA9Z-S09    |                |          |
|   |                 | 1.0mm x 6.5mm |          | SA9Z-S10    |                |          |
|   |                 | 2.0mm x 6.5mm |          | SA9Z-S11    |                |          |
|   |                 | Round slit    |          | ø0.5mm      |                | SA9Z-S12 |
|   |                 |               |          | ø1.0mm      |                | SA9Z-S13 |
|   |                 |               |          | ø2.0mm      |                | SA9Z-S14 |

## Connector Cables (for connector model sensors)

| Appearance  | Number of Core Wires | Type & Length   | Use with | Part No.      |
|---|----------------------|-----------------|----------|---------------|
|  | 4                    | Straight, 2m    | SA1E     | SA9Z-CM8K-4S2 |
|   |                      | Straight, 5m    |          | SA9Z-CM8K-4S5 |
|  |                      | Right angle, 2m |          | SA9Z-CM8K-4L2 |
|   |                      | Right angle, 5m |          | SA9Z-CM8K-4L5 |
|  | 4                    | 2m              | SA1C-F   | SA9C-CA4D2    |
|   |                      | 5m              |          | SA9C-CA4D5    |
|   |                      | 2m              |          | SA9C-CA4D2S   |
|   |                      | 5m              |          | SA9C-CA4D5S   |

## Air Blower Mounting Blocks

| Appearance  | Item                      | Use with | Part Number |
|---|---------------------------|----------|-------------|
|  | Air blower mounting block | SA1E     | SA9Z-A02    |

## Sensitivity Control Screwdriver

| Item   | Part No.  | Package Quantity |
|--|-----------|------------------|
|  | SA9Z-AD01 | 1                |