

SEMPACK® 1 Thyristor/ Diode Modules

SKKT 26 **SKKH 26**
SKKT 27 **SKKH 27**
SKKT 27B

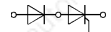
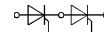

SKKT 26

SKKH 26

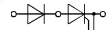
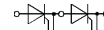

SKKT 27

SKKH 27

Features

- Heat transfer through aluminium oxide ceramic isolated metal baseplate
- Hard soldered joints for high reliability
- UL recognized, file no. E 63 532

Typical Applications

- DC motor control (e. g. for machine tools)
- AC motor soft starters
- Temperature control (e. g. for ovens, chemical processes)
- Professional light dimming (studios, theaters)

1) Also available in SKKT 27 B configuration (case A 48)

2) See the assembly instructions

V _{VRSM}	V _{VRRM}	(dv/dt) _{cr}	I _{TRMS} (maximum value for continuous operation)			
			50 A			
V	V	V/μs	I _{TAV} (sin. 180; T _{case} = 68 °C)			
			32 A			
500	400	500	-	-	SKKH 26/04 D	-
700	600	500	SKKT 26/06 D	-	SKKH 26/06 D	SKKH 27/06 D
900	800	500	SKKT 26/08 D	SKKT 27/08 D ¹⁾	SKKH 26/08 D	SKKH 27/08 D
1300	1200	1000	SKKT 26/12 E	SKKT 27/12 E ¹⁾	SKKH 26/12 E	SKKH 27/12 E
1500	1400	1000	SKKT 26/14 E	SKKT 27/14 E ¹⁾	SKKH 26/14 E	SKKH 27/14 E
1700	1600	1000	SKKT 26/16 E	SKKT 27/16 E ¹⁾	SKKH 26/16 E	SKKH 27/16 E

Symbol	Conditions	SKKT 26 SKKH 26	SKKT 27 SKKT 27B SKKH 27
I _{TAV}	sin. 180; T _{case} = 68 °C T _{case} = 85 °C		32 A 25 A
I _D	B2/B6 T _{amb} = 45 °C; P 3/180 T _{amb} = 35 °C; P 3/180 F		38 A/50 A 60 A/77 A
I _{RMS}	W1/W3 T _{amb} = 45 °C; P 3/180		52 A/3 x 37 A
I _{TSM}	T _{vj} = 25 °C; 10 ms T _{vj} = 125 °C; 10 ms;		550 A 480 A
i ² t	T _{vj} = 25 °C; 8,3 ... 10 ms T _{vj} = 125 °C; 8,3 ... 10 ms		1 500 A ² s 1 150 A ² s
t _{gd}	T _{vj} = 25 °C; I _G = 1 A; di _G /dt = 1 A/μs		1 μs
t _{gr}	V _D = 0,67 · V _{DRM}		1 μs
(di/dt) _{cr}	T _{vj} = 125 °C		150 A/μs
t _q	T _{vj} = 125 °C		typ. 80 μs
I _H	T _{vj} = 25 °C; typ./max.		100/200 mA
I _L	T _{vj} = 25 °C; R _G = 33 Ω; typ./max.		250/400 mA
V _T	T _{vj} = 25 °C; I _T = 75 A		max. 1,8 V
V _{T(TO)}	T _{vj} = 125 °C		0,9 V
r _T	T _{vj} = 125 °C		12 mΩ
I _{DD} ; I _{RD}	T _{vj} = 125 °C; V _{DD} = V _{DRM} ; V _{RD} = V _{RRM}		max. 10 mA
V _{GT}	T _{vj} = 25 °C; d. c.		3 V
I _{GT}	T _{vj} = 25 °C; d. c.		150 mA
V _{GD}	T _{vj} = 125 °C; d. c.		0,25 V
I _{GD}	T _{vj} = 125 °C; d. c.		5 mA
R _{thjc}	cont. sin. 180 rec.120	} per thyristor/per module	0,9 °C/W / 0,45 °C/W 0,95 °C/W / 0,48 °C/W 1,0 °C/W / 0,5 °C/W 0,2 °C/W / 0,1 °C/W
R _{thch}			- 40 ... + 125 °C
T _{vj}			- 40 ... + 125 °C
T _{stg}			- 40 ... + 125 °C
V _{isol}	a. c. 50 Hz; r.m.s.; 1 s/1 min	} SI units / US units	3600 V- / 3000 V ~
M ₁	to heatsink		5 Nm/44 lb. in. ± 15 % ²⁾
M ₂	to terminals		3 Nm/26 lb. in. ± 15 %
a			5 · 9,81 m/s ²
w	approx.		120 g
Case	→ page B 1 – 93	SKKT 26: A 5 SKKH 26: A 6	SKKT 27: A 46 SKKT 27B: A 48 SKKH 27: A 47

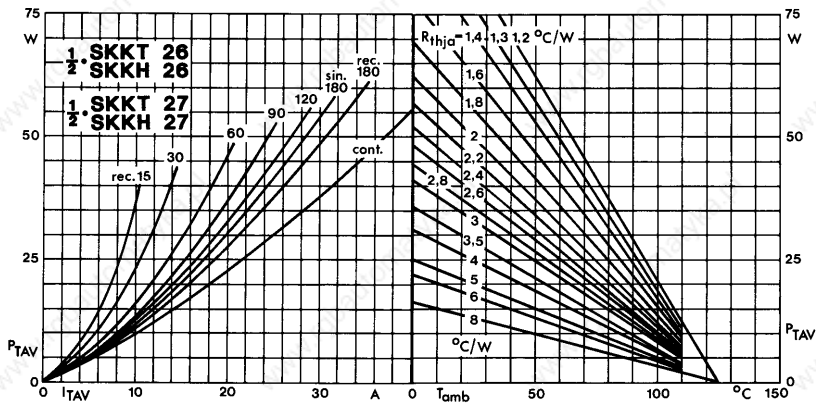

Fig. 1 Power dissipation per thyristor vs. on-state current and ambient temperature

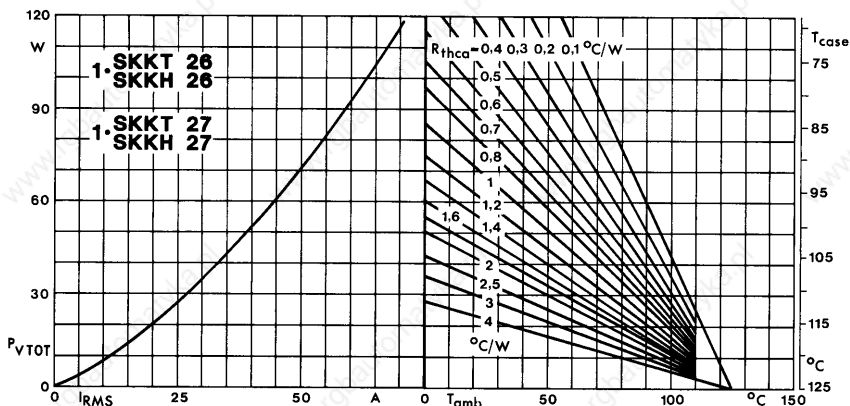

Fig. 2 Power dissipation per module vs. rms current and case temperature

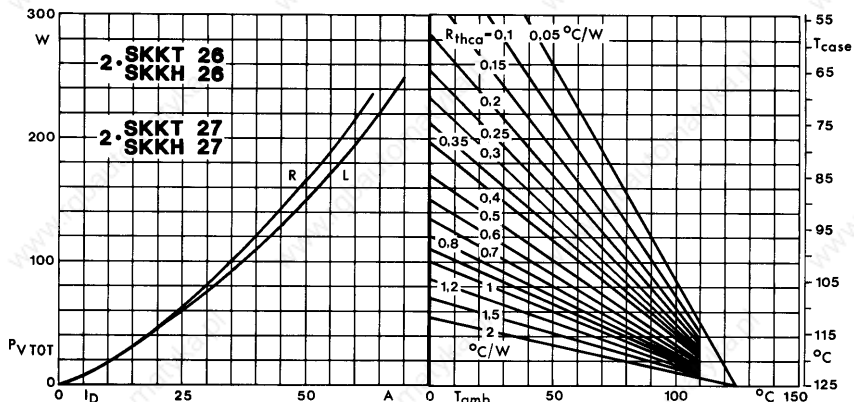

Fig. 3 Power dissipation of two modules vs. direct current and case temperature

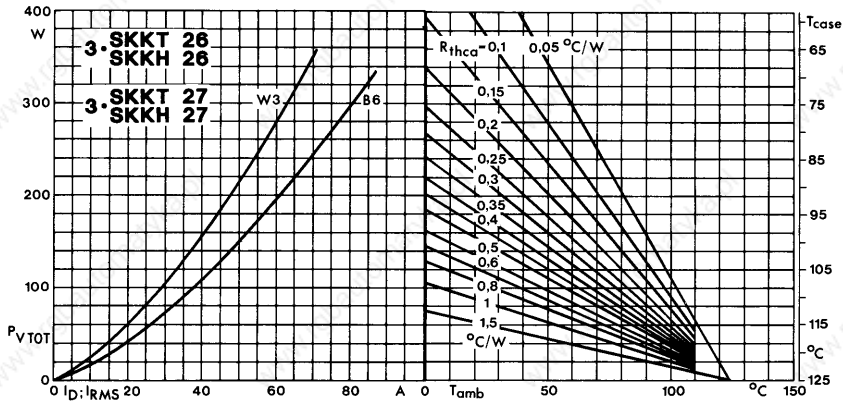

Fig. 4 Power dissipation of three modules vs. direct and rms current and case temperature

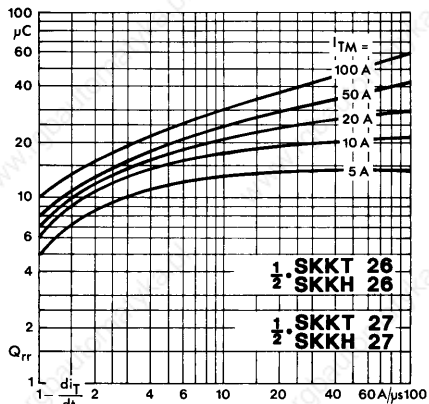

Fig. 5 Recovered charge vs. current decrease

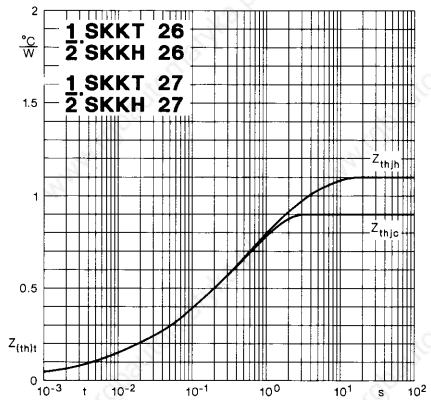

Fig. 6 Transient thermal impedance vs. time

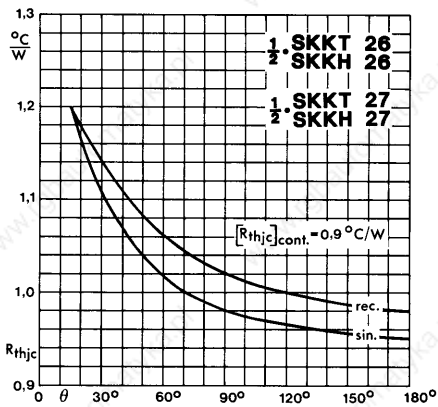

Fig. 7 Thermal resistance vs. conduction angle

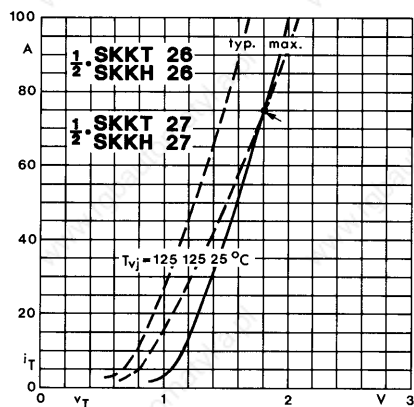

Fig. 8 On-state characteristics

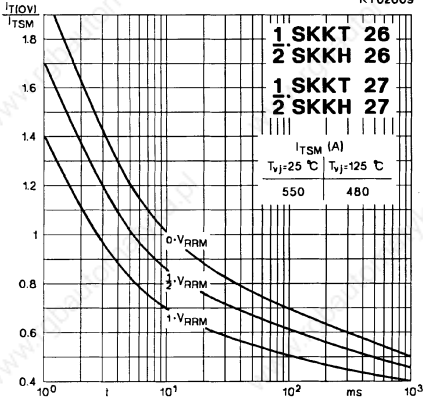

Fig. 9 Surge overload current vs. time

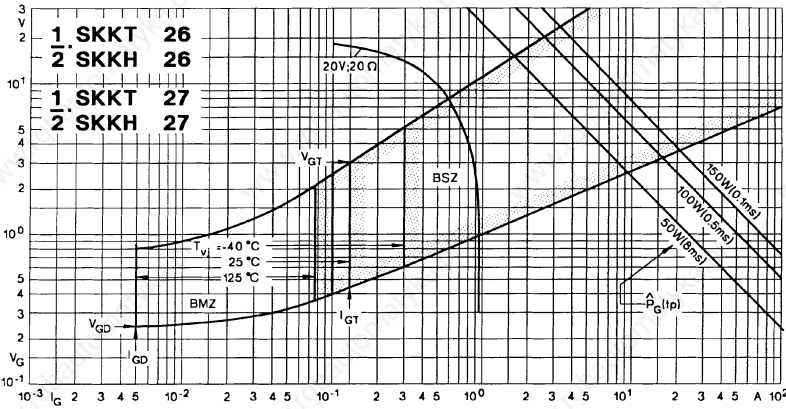
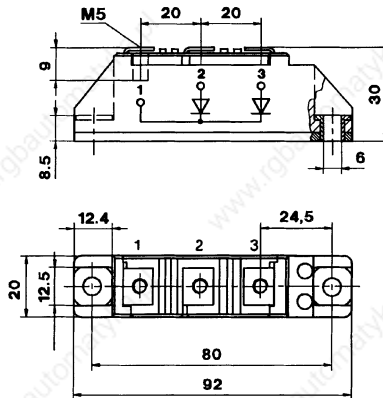

Fig. 10 Gate trigger characteristics

SKMD 100

Case A 33

SEMIPACK® 1



Dimensions in mm