

**BLC, CR and CS types**  
**Super Rapid Fuses**

150–1500 Volts AC  
 10–4700 Amps

■ **Description**

The FUJI BLC, CR and CS types are extremely reliable fuses which have been specially developed to provide protection for silicon diodes and thyristors and are suitable for inverters using semiconductors or transformer-rectifiers. FUJI Super Rapid Fuses are designed with a very small total  $I^2t$  value which gives them a high speed interrupting action in the face of abnormal currents.

In addition the arc voltage generated at the time of interruption has a low value so that faults will not influence related electric machinery and equipment. These fuses can carry out the protection of many types of circuits rating from the semiconductor overcurrents to destructive short-circuiting faults-i.e. when the

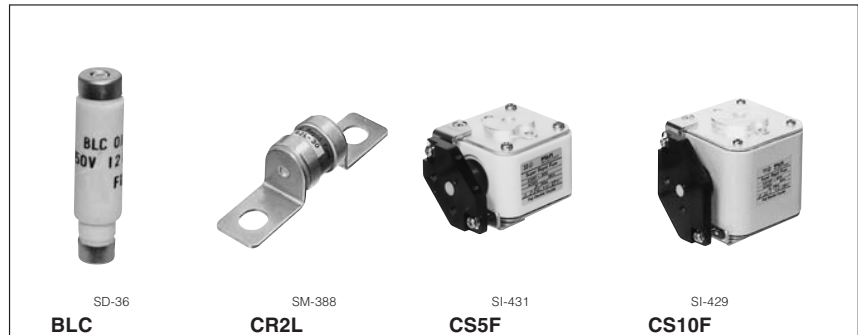

semiconductors short or circuits fail the sound elements will be quickly isolated from the fault circuits.

■ **Features**

- The total clearing  $I^2t$  is small and the semiconductor circuit is completely protected.
- Since the peak arc voltage at the time of interruption is low damage to other equipment does not occur.

- High interrupting capacity of 200kA at 1000V AC
- The CS type is provided with a blown fuse indicator. An alarm contact block (1NO or 1NC) can also be attached.

■ **UL recognized:** CR2L/UL, CR2LS/UL, CR6L/UL

(File No. E92312)

**CSA certified:** CR2LS/UL

(File No. LO4000-4090)

**TÜV:** CR2LS/UL (10-100A),  
 CR2L/UL (150-350A)  
 (Rep. No. E9450643E02)  
 CR6L/UL (50-300A)  
 (Rep. No. E9560543E02)

■ **Specifications**

Rated current (A)	Rated voltage (V)	Peak arc voltage (V)	Max. interrupting $I^2t$ ( $\text{Amp}^2\text{sec.}$ ) $\times 10^3$	Watt loss (W)	Fuse-link Type
12	550V AC	1550	0.09	5.1	<b>BLC012-1</b>
20		1550	0.27	8.5	<b>BLC020-1</b>
23		1550	0.39	10	<b>BLC023-1</b>
45		1380	1.8	19	<b>BLC045-1</b>
75		1250	5	32	<b>BLC075-1</b>
90		1250	11.5	38	<b>BLC090-1</b>
120		1200	33	51	<b>BLC120-1</b>
140	1200	100	59	<b>BLC140-1</b>	
30	250V AC	Max. 500	0.35	4.0	<b>CR2L-30</b>
50			0.85	6.0	<b>CR2L-50</b>
75			2.3	9.0	<b>CR2L-75</b>
100			4.0	12.0	<b>CR2L-100</b>
125			6.5	14.0	<b>CR2L-125</b>
140			7.0	16.0	<b>CR2L-140</b>
150			9.5	18.0	<b>CR2L-150</b>
175			13	21.0	<b>CR2L-175</b>
200			17	23.0	<b>CR2L-200</b>
225			22	26.0	<b>CR2L-225</b>
260			27	30.0	<b>CR2L-260</b>
300			38	35.0	<b>CR2L-300</b>
325			49	37.0	<b>CR2L-325</b>
350			60	37.0	<b>CR2L-350</b>
400			103	39.0	<b>CR2L-400</b>
450			140	46.0	<b>CR2L-450</b>
500			160	48.0	<b>CR2L-500</b>
550	200	51.0	<b>CR2L-550</b>		
600	215	56.0	<b>CR2L-600</b>		

Interrupting capacity  
 BLC ..... 100kA at 550V AC  
 CR2L .... 100kA at 250V AC

Rated current (A)	Rated voltage (V)	Peak arc voltage (V)	Max. interrupting $I^2t$ ( $\text{Amp}^2\text{sec.}$ ) $\times 10^3$	Watt loss (W)	Fuse-link Type
10	250V AC	Max. 500	0.04	1.2	<b>CR2LS-10</b>
20			0.17	3.0	<b>CR2LS-20</b>
30			0.35	4.0	<b>CR2LS-30</b>
50			0.85	6.0	<b>CR2LS-50</b>
75			2.3	9.0	<b>CR2LS-75</b>
100			4.0	12.0	<b>CR2LS-100</b>
20			600V AC	Max. 1200	0.14
30	0.35	7.0			<b>CR6L-30</b>
50	1.8	9.0			<b>CR6L-50</b>
75	3.0	12.5			<b>CR6L-75</b>
100	7.0	15			<b>CR6L-100</b>
150	18	22.0			<b>CR6L-150</b>
200	30	34.0			<b>CR6L-200</b>
250	70	37.0			<b>CR6L-250</b>
300	95	40.0			<b>CR6L-300</b>
350	150	45.0			<b>CR6L-350</b>
400	200	55	<b>CR6L-400</b>		
500	390	60	<b>CR6L-500</b>		
600	700	70	<b>CR6L-600</b>		

Interrupting capacity  
 CR2LS . 100kA at 250V AC  
 CR6L .... 100kA at 600V AC

# Low Voltage Fuses BLC, CR and CS types Super Rapid Fuses

## ■ Specifications

Rated current	Inter-rupting capacity	Max. interrupting I <sup>2</sup> t (Amp <sup>2</sup> ×sec.) × 10 <sup>3</sup>	Watt loss	Fuse-link Type
(A)	(kA)		(W)	
4700	150 at 125V AC	14000	310	<b>CS1F-4700</b>
2000	150 at 250V AC	1950	124	<b>CS2F-2000</b>
3000	250V AC	5500	216	<b>CS2F-3000</b>
40	200 at 500V AC	1	6.4	<b>CS5F-40</b>
75		3.5	12	<b>CS5F-75</b>
100		5	17	<b>CS5F-100</b>
150		10	25	<b>CS5F-150</b>
200		18.5	34	<b>CS5F-200</b>
250		33	42	<b>CS5F-250</b>
300		64	45	<b>CS5F-300</b>
350		85	56	<b>CS5F-350</b>
400		122	57	<b>CS5F-400</b>
450		131	62	<b>CS5F-450</b>
500		159	73	<b>CS5F-500</b>
600		257	80	<b>CS5F-600</b>
800		600	114	<b>CS5F-800</b>
1000		1200	110	<b>CS5F-1000</b>
1000		843	167	<b>CS5F-1000-P</b>
1200		1800	114	<b>CS5F-1200</b>
1200		1311	200	<b>CS5F-1200-P</b>
1500		3600	209	<b>CS5F-1500</b>
1000	200 at 800V AC	1800	125	<b>CS8F-1000</b>
1200		2500	176	<b>CS8F-1200</b>
1500		4400	220	<b>CS8F-1500</b>
80	200 at 1000V AC	10	17	<b>CS10F-80</b>
100		16	21	<b>CS10F-100</b>
150		37	27	<b>CS10F-150</b>
200		63	37	<b>CS10F-200</b>
250		110	44	<b>CS10F-250</b>
300		148	53	<b>CS10F-300</b>
350		211	70	<b>CS10F-350</b>
400		307	74	<b>CS10F-400</b>
500		420	90	<b>CS10F-500</b>
560		410	102	<b>CS10F-560</b>
630		450	135	<b>CS10F-630</b>
750		640	156	<b>CS10F-750</b>
800		1259	211	<b>CS10F-800-P</b>
1000		1722	245	<b>CS10F-1000-P</b>
1250		2250	330	<b>CS10F-1250-P</b>
1500		3200	334	<b>CS10F-1500-C</b>
450	100 at 1500V AC	350	134	<b>CS15F-450</b>
630		760	170	<b>CS15F-630</b>
900		1400	280	<b>CS15F-900-P</b>
1250		3050	350	<b>CS15F-1250-P</b>

- Note:
- Peak arc voltage  
CS1F ..... Max. 450V  
CS2F ..... Max. 750V  
CS5F ..... Max. 1000V  
CS8F ..... Max. 2000V  
CS10F ... Max. 2000V  
CS15F ... Less than 3000V
  - An alarm contact block AHX2905 (1NO) or AHX2915 (1NC) can be attached to CS type. (Sold separately) See page 08/44.

Note: UL recognized fuse  
In the UL recognized fuses, a fuse with a blown indication fuse, or a fuse both with a blown indication fuse and a precision switch is also UL recognized.  
Examples: CR2L-200G/UL  
CR2LS-30S/UL  
CR6L-100G/UL

## ■ Specifications (UL-recognized, CSA certified, TÜV)

Rated current	Rated voltage	Inter-rupting capacity	Max. interrupting I <sup>2</sup> t (Amp <sup>2</sup> ×sec.) × 10 <sup>3</sup>	Watt loss	Fuse-link Type
(A)		(kA)		(W)	
10	250V AC 400V DC	10 at AC (pf: 0.8) 10 at DC (L/R: 2ms)	0.04	1.2	<b>CR2LS-10/UL</b>
20			0.17	3.0	<b>CR2LS-20/UL</b>
30			0.35	4.0	<b>CR2LS-30/UL</b>
50			0.85	6.0	<b>CR2LS-50/UL</b>
75			2.3	9.0	<b>CR2LS-75/UL</b>
100			4.0	12.0	<b>CR2LS-100/UL</b>
150			9.5	18.0	<b>CR2L-150/UL</b>
200			17	23.0	<b>CR2L-200/UL</b>
260			27	30.0	<b>CR2L-260/UL</b>
350			60	37.0	<b>CR2L-350/UL</b>
400	103	39.0	<b>CR2L-400/UL</b>		
450	140	46.0	<b>CR2L-450/UL</b>		
500	160	48.0	<b>CR2L-500/UL</b>		
550	200	51.0	<b>CR2L-550/UL</b>		
600	215	56.0	<b>CR2L-600/UL</b>		
20	600V AC 680V DC	100 at AC (pf: 0.8) 10 at DC (L/R: 2ms)	0.14	4.0	<b>CR6L-20/UL</b>
30			0.35	7.0	<b>CR6L-30/UL</b>
50			1.8	9.0	<b>CR6L-50/UL</b>
75			3.0	12.5	<b>CR6L-75/UL</b>
100			7.0	15.0	<b>CR6L-100/UL</b>
150			18	22.0	<b>CR6L-150/UL</b>
200			30	34.0	<b>CR6L-200/UL</b>
300			95	40.0	<b>CR6L-300/UL</b>

- Note:
- Peak arc voltage  
CR2LS, CR2L ..... Max. 500V  
CR6L ..... Max. 1200V
  - The peak arc voltage is obtained by interruption caused by the listed interrupting current at rated voltage.
  - This indicates the values when the conductors specified in UL Standards are connected and rated current apply.
  - TÜV: CR2LS, 2L: Up to 350A  
CR6L: 50 to 300A

## ■ CR type fuse with optional accessory Fuse with blown indication fuse CR2L (S)- □ G

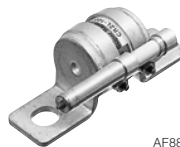

AF88-446

## Fuse with blown indication fuse and precision switch CR2L (S)- □ S Precision switch (SPDT) CRX-1

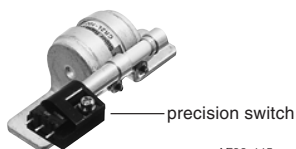

AF88-445

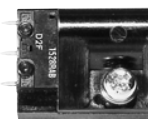

AF88-442

# Low Voltage Fuses BLC, CR and CS types Super Rapid Fuses

## ■ Dimensions, mm

### ● BLC

BLC012, 020, 023

BLC045

BLC075 to 140

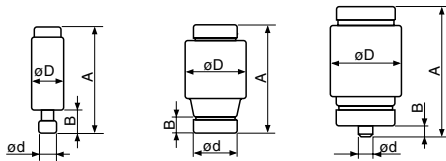

Type	Rated current (A)	A	B	øD	ød	Color of indicator	Mass (g)
BLC012-1	12	50	10	13	10	Grey	12
BLC020-1	20	50	10	13	14	Yellow	12
BLC023-1	23	50	10	13	14	Violet	12
BLC045-1	45	50	10	27	20	White	62
BLC075-1	75	63	6	34	5	Silver	120
BLC090-1	90	63	6	34	8	Red	120
BLC120-1	120	63	6	47	8	Yellow	120
BLC140-1	140	63	6	47	8	Light red	215

Note: The BLC type fuse link requires a holder in use. The size of the holder differs according to the fuse ratings. Select the most suitable one after referring to the Table on page 08/44. For drawings see page 08/32.

## ■ Ordering information

Specify the following:

1. Type number

## ■ Type number nomenclature

**BLC 012-1**

Rated current: 12 to 140A

Plug-in type super rapid fuse

**CS 10F-1000 □-P/ UL**

UL recognized (CR2L, CR2LS, CR6L)  
CSA certificated (CR2LS)  
TÜV (CR2LS, CR2L, CR6L)

2-fuse connected parallel

Optional accessory (See page 08/44)

G: With blown indication fuse

S: With blown indication fuse and precision switch

Rated current

10 to 4700A

Rated voltage

2L, 2LS: 250V AC, 6L: 600V AC

1F: 150V AC, 2F: 250V AC

5F: 500V AC, 8F: 800V AC

10F: 1000V AC, 15F: 1500V AC

CR: Barrel-shaped super rapid fuse

CS: Cubic-shaped super rapid fuse

## ● CR2L-450 or smaller, CR2LS

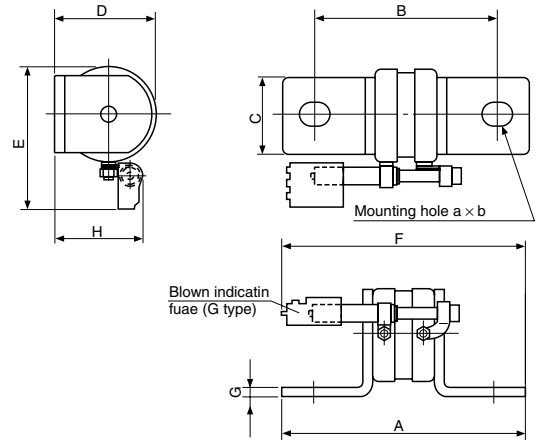

Type	A	B	C	D	E	a×b	F	G	H	Mass
CR2L-30	80	58	18	21.5	37	9×11	90	1.5	26.5	42g
CR2L-50										
CR2L-75	80	58	20	30.5	44	9×11	90	3	32.5	100g
CR2L-100										
CR2L-125										
CR2L-140										
CR2L-150										
CR2L-175										
CR2L-200	85	60	25	33.5	47	11×13	93	3.2	33.5	130g
CR2L-225										
CR2L-260										
CR2L-300										
CR2L-325										
CR2L-350	95	70	30	42	54	11×13	98	4	39	220g
CR2L-400										
CR2L-450										
CR2LS-10	56	42	12	18.5	34.5	6.5×8.5	78	2	25	28g
CR2LS-20										
CR2LS-30										
CR2LS-50										
CR2LS-75										
CR2LS-100										

## ● CR2L-500 to -600

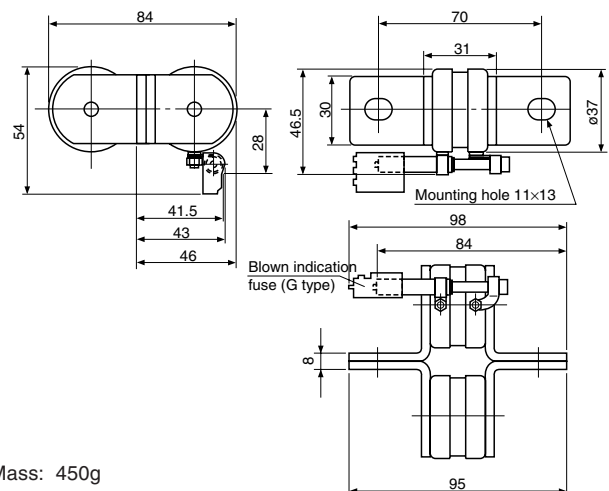

Mass: 450g

Dimensions for reference only. Confirm before construction begins.

Note: The dimensions of the fuses with suffix. UL are the same as those of the standard ones.

# Low Voltage Fuses

## BLC, CR and CS types

### Super Rapid Fuses

#### ■ Dimensions, mm

##### ● CR6L-20, CR6L-30, CR6L-50

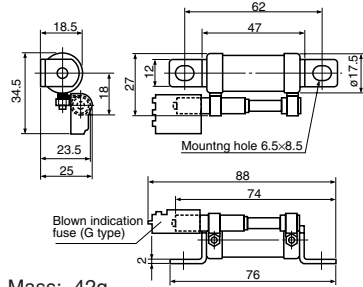

Mass: 42g

Type	A	B	C	D	E	F	G	H	a×b	Mass (g)
CR6L-75	95	70	25	34	47	102	3.2	33.5	11×13	150
CR6L-100										
CR6L-150										
CR6L-200	107	82	30	42	54	107	4	39	11×13	246
CR6L-250										
CR6L-300										

##### ● CR6L-75 to 300

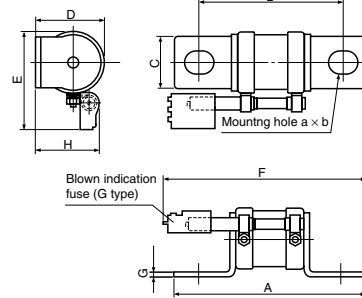

##### ● CR6L-350 to 600

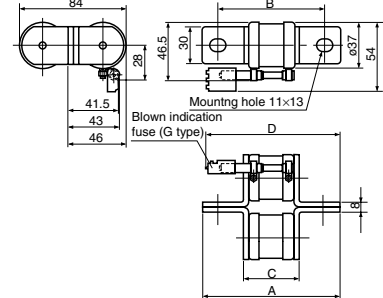

Type	A	B	C	D	Mass (g)
CR6L-350	107	82	43	107	493
CR6L-400	121	96	43	114	522
CR6L-500					
CR6L-600	121	96	47.4	114	545

##### ● CS1F-4700 CS2F-2000, 3000

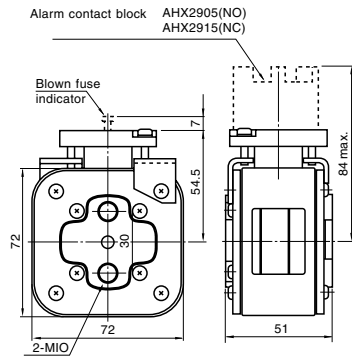

Mass: 800g

Voltage	Type	A	B	C	D	M	Mass (g)
500V	CS5F-40	47	47	42.5	65.5	M8	320
	CS5F-75						
	CS5F-100						
	CS5F-150						
	CS5F-200						
	CS5F-250	57	51	47	70	M8	510
	CS5F-300						
	CS5F-350						
	CS5F-400	72	51	54.5	77	M10	800
	CS5F-450						
CS5F-500							
CS5F-600							
CS5F-800							
CS5F-1000	72	51	54.5	77	M12	830	
CS5F-1200							
CS5F-1500							

##### ● CS5F-40 to 1500 CS10F-80 to 750 CS15F-450, 630

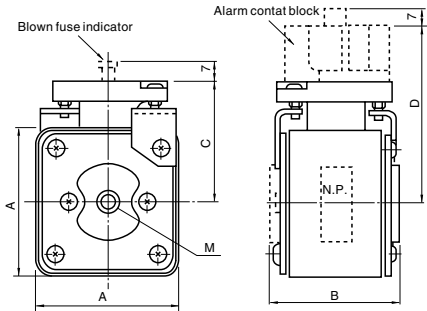

##### ● CS8F-1000, 1200, 1500

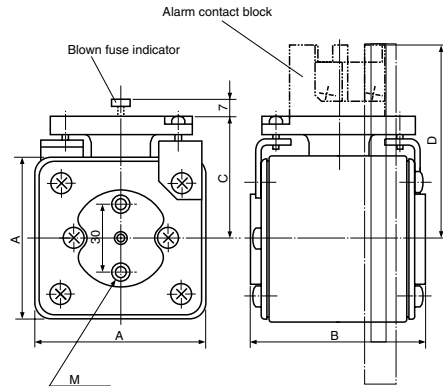

Voltage	Type	A	B	C	D	M	Mass (g)
800V	CS8F-1000	72	74	54.5	84	M12	1060
	CS8F-1200						
1000V	CS8F-1500	72	82	54.5	84	M8	1150
	CS10F-80	47	71	42.5	65.5	M8	420
	CS10F-100						
1000V	CS10F-150	57	74	47	70	M8	690
	CS10F-200						
	CS10F-250						
	CS10F-300	72	74	54.5	77	M10	1060
	CS10F-350						
	CS10F-400						
	CS10F-500						
1500V	CS10F-630						
	CS10F-750						
	CS15F-450	72	105	54.7	77	M10	1400
CS15F-630							

■ Dimensions, mm

● CS5F-P CS10F-P, CS15F-P

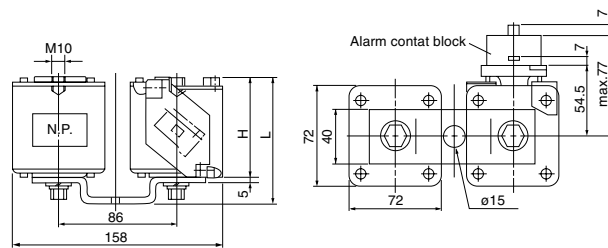

Voltage	Type	H	L	Mass (g)
500V	CS5F-1000-P	51	69	1900
	CS5F-1200-P			
1000V	CS10F-800-P	74	92	2420
	CS10F-1000-P			
	CS10F-1250-P			
1500V	CS15F-900-P	105	123	3100
	CS15F-1250-P			

● CS10F-1500-C

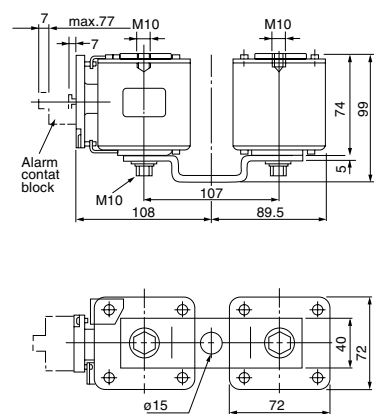

Mass: 2500g

■ Characteristic curves

**BLC**

Melting time-current characteristic

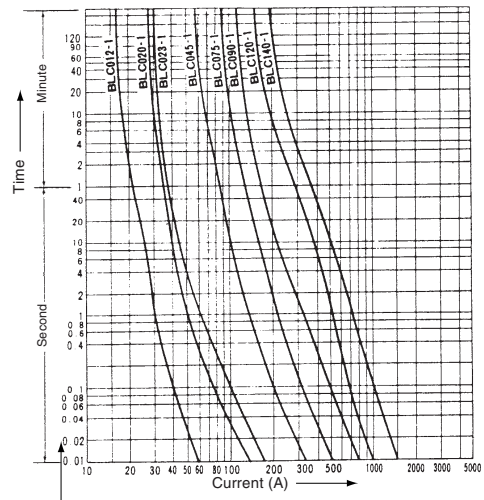

Operating time-current characteristic

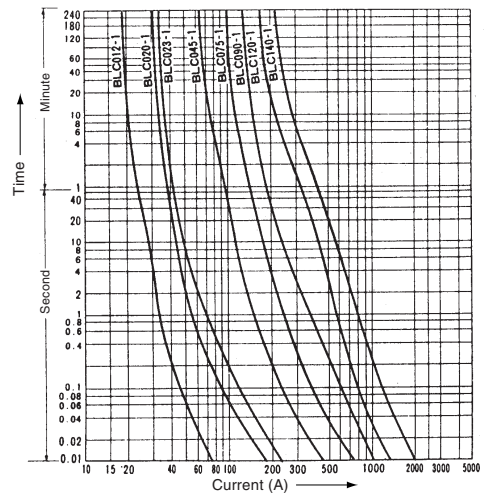

Current-limiting characteristic

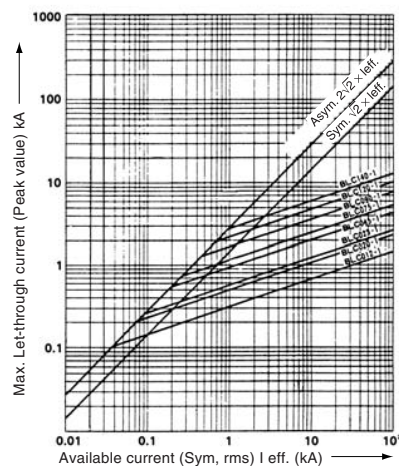

# Low Voltage Fuses BLC, CR and CS types Super Rapid Fuses

## ■ Characteristic curves

### CR2L, CR2LS

#### Melting time-current characteristic

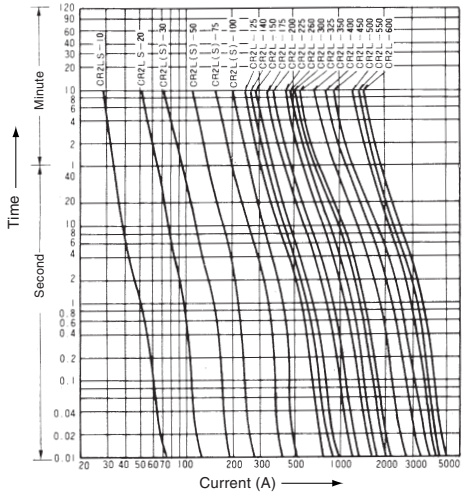

#### Operating time-current characteristic

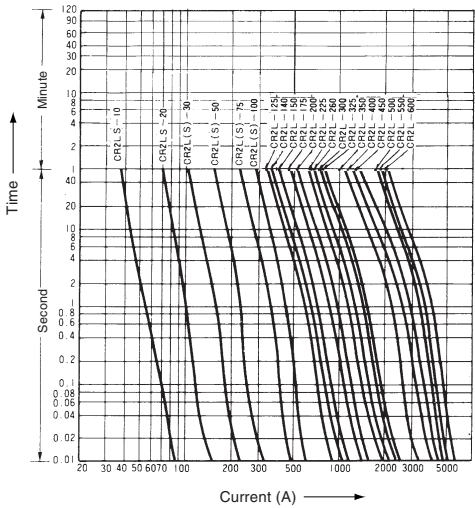

#### Current-limiting characteristic

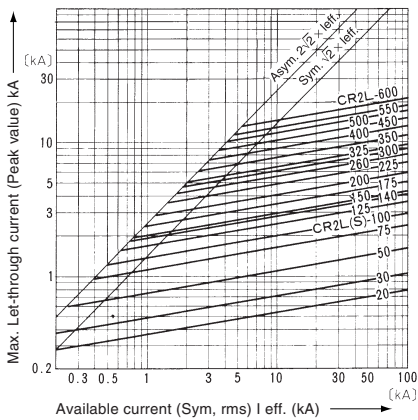

### CR6L

#### Melting time-current characteristic

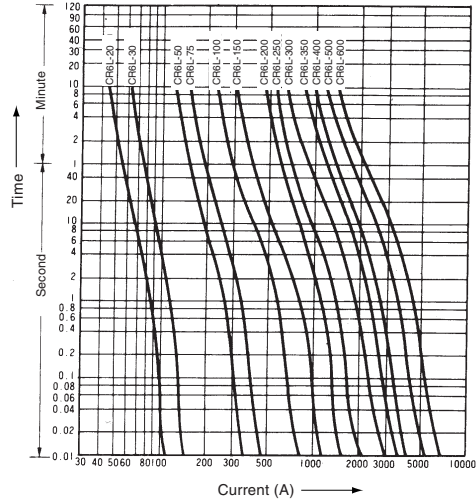

#### Operating time-current characteristic

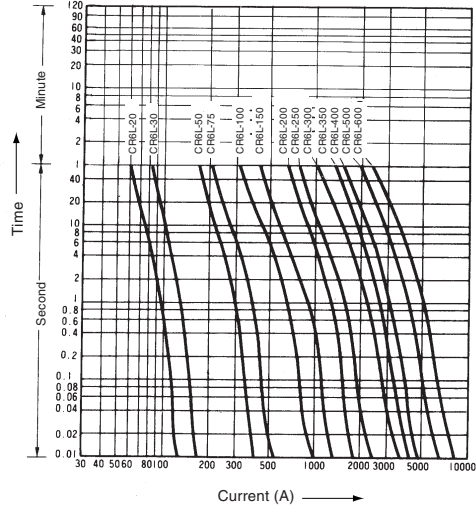

#### Current-limiting characteristic

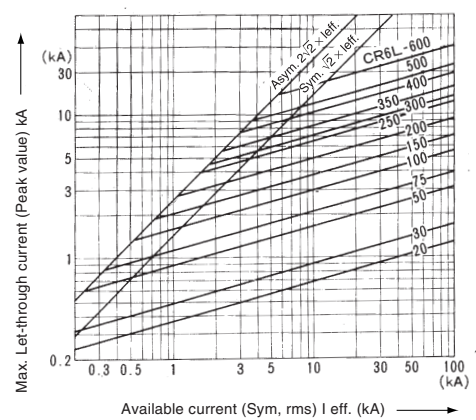

■ Characteristic curves

**CS1F**

**Melting time-current characteristic**

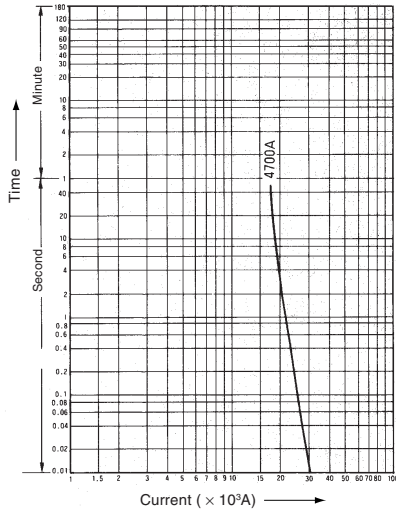

**Operating time-current characteristic**

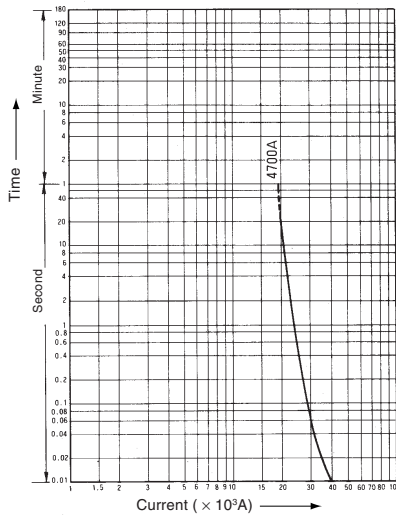

**Current-limiting characteristic**

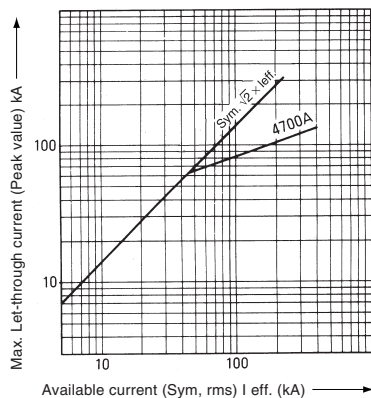

**CS2F**

**Melting time-current characteristic**

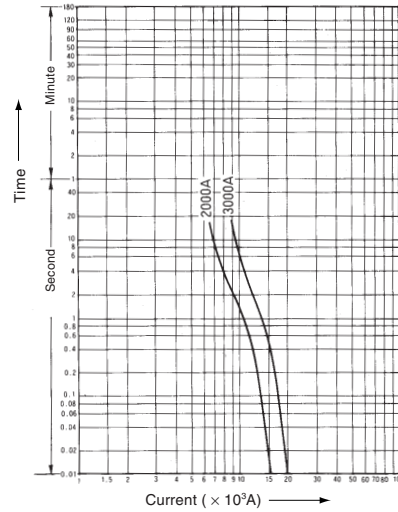

**Operating time-current characteristic**

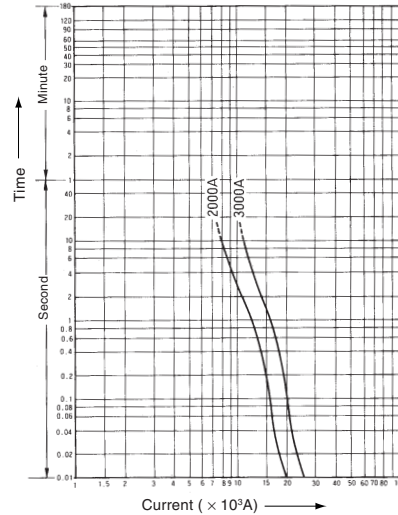

**Current-limiting characteristic**

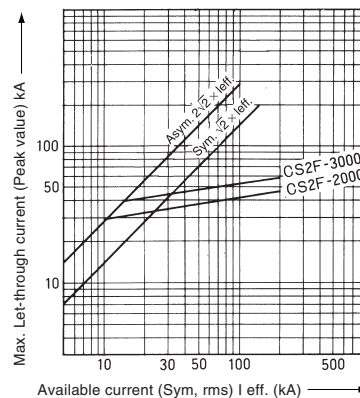

08

# Low Voltage Fuses

## BLC, CR and CS types

### Super Rapid Fuses

#### ■ Characteristic curves

##### CS5F

##### Melting time-current characteristic

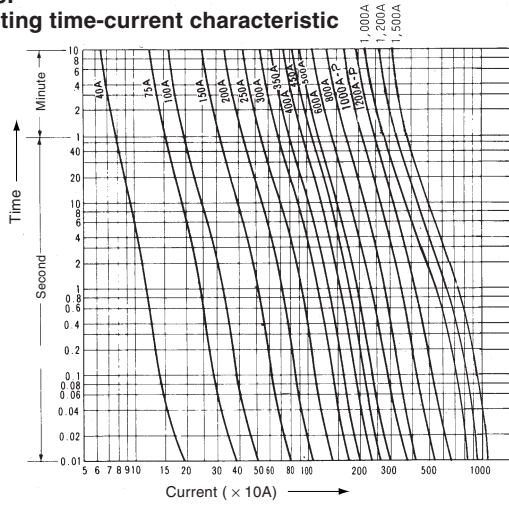

##### Operating time-current characteristic

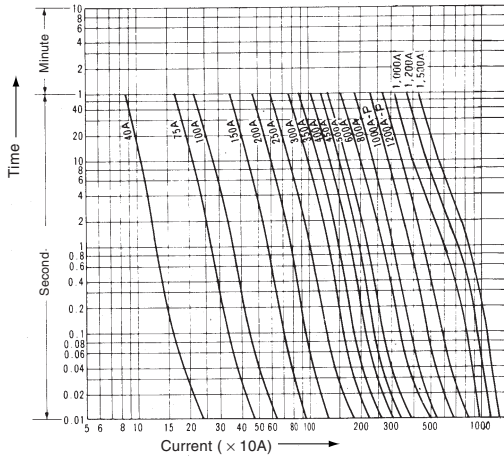

##### Current-limiting characteristic

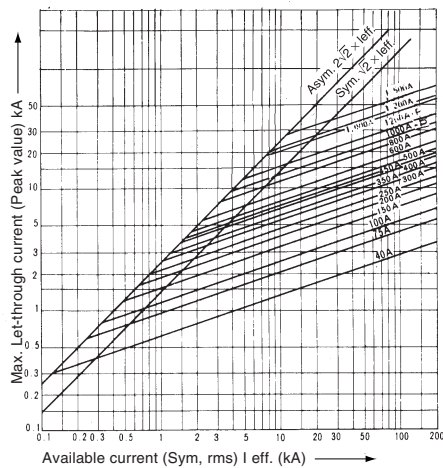

##### CS8F

##### Melting time-current characteristic

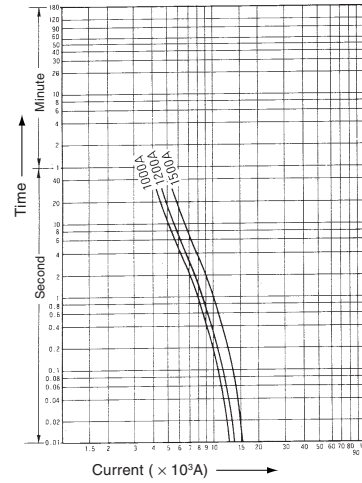

##### Operating time-current characteristic

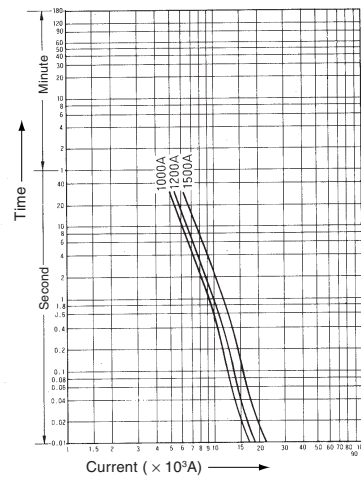

##### Current-limiting characteristic

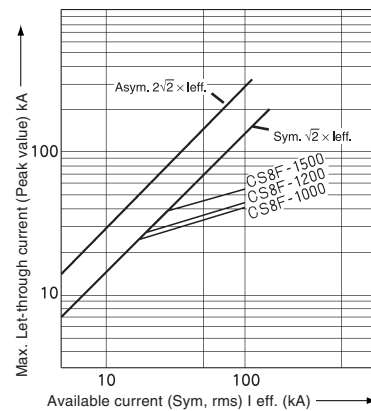



■ Characteristic curves  
CS10F

Melting time-current characteristic

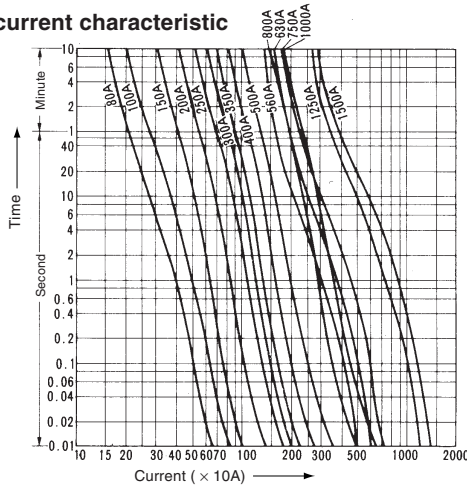

CS15F

Melting time-current characteristic

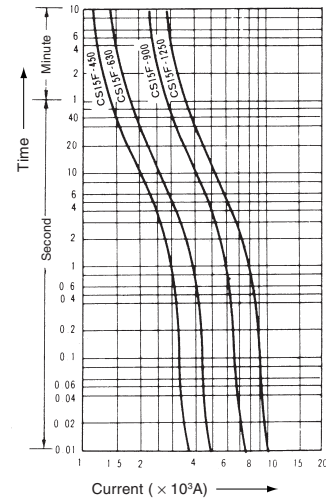

Operating time-current characteristic

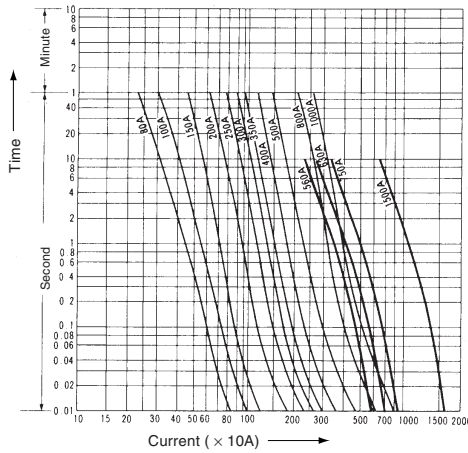

Operating time-current characteristic

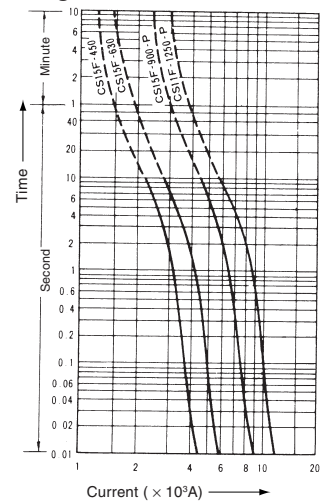

Current-limiting characteristic

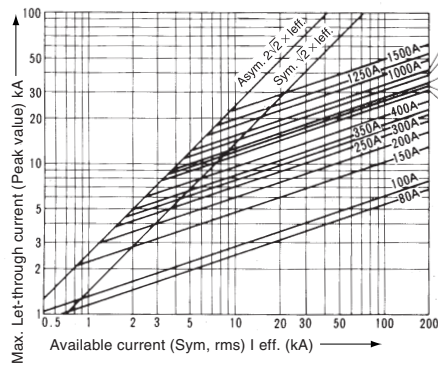

Current-limiting characteristic

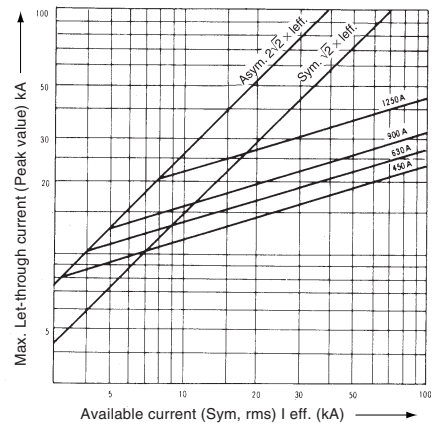

08

# Low Voltage Fuses BLC, CR and CS types Super Rapid Fuses

## ■ Operating indication

### ● Blown fuse indication

FUJI Super Rapid Fuses are available in BLC, CR and CS types. These types have different methods of indicating a blown fuse.

### ● BLC type

A blown fuse is indicated by the color tip on the ferrule of the fuse being ejected as shown in Fig. 1. This can be seen through the window of the fuse holder.

### ● CR type

This fuse does not have a blown indicator but if a trigger fuse is connected as shown in Fig. 2 this will provide the alarm for blown fuse.

### ● CS type

This fuse is provided with a blown fuse indicator. In this case a pin in the contact pad is ejected after the fuse has been blown. If electrical connections for lamps or alarms are required fit the contact block (1NO or 1NC) to the pad as shown in Fig. 3.

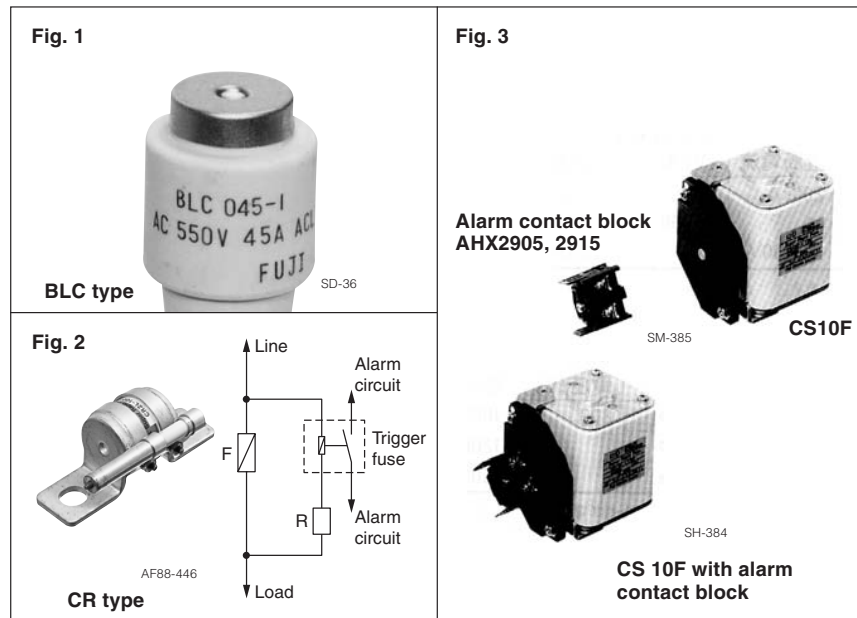

## ■ Alarm contact block ratings

Type	Contact	Rated voltage (V)	AC		DC			
			Inductive $\cos\phi=0.3\sim 1$		Resistive load		Inductive load	
			Rated operational current (A)	Rated capacity (VA)	Rated operational current (A)	Rated capacity (W)	Rated operational current (A)	Rated capacity (W)
AHX2905	1NO	24	6	150	6	150	6	150
		110	6	660	2.5	275	1.3	140
		220	6	1320	1	220	0.45	100
AHX2915	1NC	440	2.5	1100	0.4	175	0.2	85
		550	2	1100	0.3	165	0.15	85

## ■ Fuse holder for BLC type fuse

FUJI BLC fuses require special holders. Select the most suitable one which corresponds to the rated current of the fuse.

Dimensions: See page 08/32.



SD-36

Fuse link  
BLC



AF88-439

Fuse holder  
Surface connection

Fuse link Type	Rated current (A)	Base connection		Screw cap Type	Adaptor ring Type
		Surface connection Type	Rear connection Type		
BLC012-1	12	AFa30	Ba30	Pa30	R20
BLC020-1	20	AFa30	Ba30	Pa30	-
BLC023-1	23	AFa30	Ba30	Pa30	-
BLC045-1	45	AFa60	Ba60	Pa60	-
BLC075-1	75	AFa100	Ba100	Pa100	R75
BLC090-1	90	AFa100	Ba100	Pa100	-
BLC120-1	120	AFa200	Ba200	Pa200	-
BLC140-1	140	AFa200	Ba200	Pa200	-

### ■ Application and selection guide BLC, CR and CS-type – Super rapid fuse

When selecting fuses for semiconductor rectifier circuit protection the following conditions must be satisfied.  
For additional details contact FUJI.

#### ■ Conditions of application

1. The rated interrupting current of the fuse must be greater than the estimated short circuit current of the circuit.

$$\text{Available short circuit current of rectifier circuit} < \text{Rated interrupting current of fuse}$$

2. The let-thru current value of fuse must be less than the allowable 1/2 cycle surge current value.

$$\text{Fuse let-thru current value} \leq \text{Semiconductor - 1/2 cycle allowable surge current 10ms (at 50Hz)}$$

3. The total clearing  $I^2t$  value which the fuse requires to complete interruption must be less than the allowable  $I^2t$  value of semiconductor.

$$\text{Fuse - total clearing } I^2t \leq \text{Semiconductor - } I^2t$$

4. The rated current of the fuse must be greater than the average forward current of the semiconductor.

$$\text{Fuse - rated current} > \text{Semiconductor - average forward current}$$

5. The rated current and voltage of the fuse must be greater than those of the rectifier circuit.

$$\text{Fuse - rated current and voltage} > \text{Rectifier circuit - current and voltage}$$

#### Method of application

Semiconductor rectifier equipment has a variety of rectifier circuits. Taking the 3-phase bridge rectifier circuit as an example – Fig. (a) and (b) as shown in the following.

Although the number of fuses used in the line fuse method (a) is half the number used in the element fuse method (b), the fuses must have a larger current capacity.

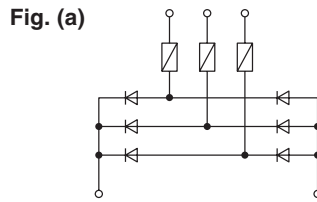

**Line fuse method**  
In this method the fuses are connected to the AC line side.

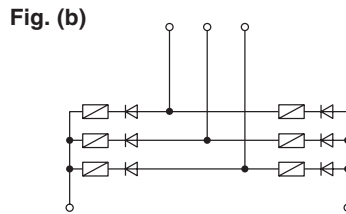

**Element fuse method**  
In this method the fuses are connected in series to the semiconductor element.

#### ■ Fuse ratings

When selecting fuses various factors such as protection, coordination and load, etc. must be considered. However, in this catalog the main matters such as voltage, current and  $I^2t$  only are explained.

#### ● Rated voltage

The rated voltage of the fuse indicates the maximum operational voltage and this also indicates the root-mean-square value of the AC sinusoidal wave voltage. Select fuses having a rated voltage exceeding the voltage obtained by the formula shown in the following table. (Fig. 1)

Do not select current-limiting fuses with rated voltages drastically exceeding the rectifier circuit voltage. It is necessary to consider the arc voltage.

**Fig. 1 Rated voltage required by fuses**

Wire connection type	Wiring diagram	Rated voltage of Fuse ( $V_{FN}$ rms)	
		For line fuse	For element fuse
Single-phase bridge		$V_{FN} \geq a \cdot E_a$	$V_{FN} \geq a \cdot E_a$
3-phase bridge		$V_{FN} \geq a \cdot E_a$	$V_{FN} \geq a \cdot E_a$
3-phase, double star		$V_{FN} \geq a \cdot \sqrt{3} \cdot E_a$	$V_{FN} \geq a \cdot \sqrt{3} \cdot E_a$

Remarks: The 'a' is a coefficient where the regulation of the AC input voltage is taken into account. This is a=1.1 in case of voltage regulation  $\pm 10\%$ .

**Fig. 2 Element current and line current**

Wire connection type	Wiring diagram	Element fuse method Element current $I_a$	Line fuse method Line current $I_l$
Single-phase bridge		$I_a = \frac{I_d}{\sqrt{2}}$ $= 0.707d$	$I_l = d$
3-phase bridge		$I_a = \frac{I_d}{\sqrt{3}}$ $= 0.577d$	$I_l = \sqrt{\frac{2}{3}} I_d$ $= 0.816d$
3-phase, double star		$I_l = I_a = \frac{I_d}{2\sqrt{3}}$ $= 0.289d$	

# Low Voltage Fuses BLC, CR and CS types Super Rapid Fuses

## • Rated current

The current values in fuses in the line fuse system and the element fuse system are different. Obtain the correct current value from the table on page 08/48 (Fig. 2).

When selecting the rated current of a fuse choose a fuse having an amperage rating greater than the current which flows in the semiconductor if the load is continuous and a fixed current.

If the current which flows in the semiconductor is greater than the rated current of the fuse connect the fuses in parallel. However, in this case, if the numbers of fuses arranged in parallel are 'n', then the I<sup>2</sup>t value of the fuse will be n<sup>2</sup>·I<sup>2</sup>t and n<sup>2</sup> times the I<sup>2</sup>t value of one fuse. This should be taken into consideration when protective coordination is taken into account.

In the case of the circuit where the load rapidly varies the fuse element will suffer from mechanical deterioration and be damaged by thermal stress. In loads of this type the deterioration characteristics of the fuse must be closely considered.

Moreover if the fuse current – time characteristics of the fuse selected is less than the overload characteristics of the semiconductor element then complete protection can be obtained. However, if the semiconductor element has a large capacity then protective cooperation is very difficult to arrange. The fuses are used to isolate the shorted semiconductor element circuit from sound operating circuits.

## ■ Total clearing I<sup>2</sup>t

The total clearing I<sup>2</sup>t of fuse is a very important factor when considering the protective coordination of the semiconductor. This total clearing I<sup>2</sup>t is the value where the arcing I<sup>2</sup>t is added to the melting I<sup>2</sup>t. Therefore it is necessary to satisfy the following formula.

$$\text{Fuse – total clearing } I^2t \leq \text{Semiconductor } I^2t$$

The total clearing I<sup>2</sup>t of fuse depends upon the operational voltage and interrupting current.

Therefore, for this reason if a 500 Volts fuse is used in a 300 Volts circuit the total clearing I<sup>2</sup>t is reduced by 50–70%. However, the reduction rate varies according to the type of fuse construction. This must be checked and confirmed once more.

## Example

I<sup>2</sup>t

All I<sup>2</sup>t values are ampere<sup>2</sup> seconds.

The I<sup>2</sup>t data for silicon diodes or thyristor elements are normally given in their respective catalogs. If the A<sup>2</sup>S data is not given in their catalog obtain the value in the following manner. If protection is needed for a 250V, 150A (I<sub>o</sub>) diode having a maximum allowable peak half sine wave current of 2700A, it is important that the fuse has a total I<sup>2</sup>t value lower than that of the diode.

## Calculation

$$\begin{aligned} \text{Maximum } I^2t \text{ diode} &= \left(\frac{1 \text{ Peak}}{2}\right)^2 0.0167 \\ &= \left(\frac{2700}{2}\right)^2 0.0167 \\ &= 30,400A^2 \text{ Sec.} \end{aligned}$$

From the table (Page 08/38), the fuse with a total I<sup>2</sup>t nearest to 30,400A<sup>2</sup> Sec. is the 260 Ampere fuse (CR 2L-260).

## ■ Interrupting current

The rated interrupting current of the fuse must exceed the maximum value (Symmetrical RMS value) of the estimated circuit fault current.

## ■ Peak arc voltage

In the case of the current-limiting fuse an arc voltage (overvoltage) is generated at the time of interruption due to its fusible element construction. It is necessary to check that this peak arc voltage does not exceed the semiconductor's maximum (Non-repetitive peak) reverse voltage value.

## ■ Current limitation

Select a fuse whose let-thru current value does not exceed the allowable 1/2 cycle surge current of the semiconductor. The allowable surge current is the peak value of the current which in case at 50Hz is allowed to flow for 10ms. In the current-limiting fuse the fault must be cleared in the shortest possible time or in the first 1/2 cycle.

Available current is the current which would flow if the fuse were not current-limiting.

This would cause damage to equipment. Let-thru current is the actual current allowed to flow by the current limiting action of the fuse. A number of let-thru current graphs are given in this catalog and example is given in the following paragraph. The method of reading this graph is provided for your reference.

## How to find a let-thru current

### – Example

Fuse: 200 Amps 500V

Available R.M.S symmetrical current:  
100,000 Amps

Let-thru peak current (Instantaneous):  
11,600 Amps

Let-thru R.M.S. current

11,600 ÷ 1.7 = 6,800 Amps

This example clearly shows that while a 100kA (rms, sym) current is available, the fuse limits the current let-thru to 6,800 Amperes (rms, sym).

