

V_{RSM}	V_{RRM}	$(dv/dt)_{cr}$	I_{TRMS} (maximum value for continuous operation)			
	V_{DRM}		50 A			
			I_{TAV} (sin. 180; $T_{case} = 68\text{ °C}$)			
V	V	V/ μ s	32 A			
500	400	500	–	–	SKKH 26/04 D	–
700	600	500	SKKT 26/06 D	–	SKKH 26/06 D	SKKH 27/06 D
900	800	500	SKKT 26/08 D	SKKT 27/08 D ¹⁾	SKKH 26/08 D	SKKH 27/08 D
1300	1200	1000	SKKT 26/12 E	SKKT 27/12 E ¹⁾	SKKH 26/12 E	SKKH 27/12 E
1500	1400	1000	SKKT 26/14 E	SKKT 27/14 E ¹⁾	SKKH 26/14 E	SKKH 27/14 E
1700	1600	1000	SKKT 26/16 E	SKKT 27/16 E ¹⁾	SKKH 26/16 E	SKKH 27/16 E

SEMIPACK® 1 Thyristor / Diode Modules

SKKT 26 **SKKH 26**
SKKT 27 **SKKH 27**
SKKT 27B

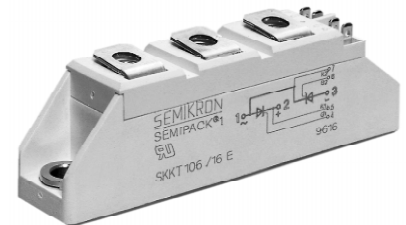

Symbol	Conditions	SKKT 26 SKKH 26	SKKT 27 SKKT 27B SKKH 27	Units
I_{TAV}	sin. 180; $T_{case} = 68\text{ °C}$	32		A
	$T_{case} = 85\text{ °C}$	25		A
I_D	B2/B6 $T_{amb} = 45\text{ °C}$; P 3/180	38 / 50		A
	$T_{amb} = 35\text{ °C}$; P 3/180 F	60 / 77		A
I_{RMS}	W1/W3 $T_{amb} = 45\text{ °C}$; P 3/180	52 / 3 x 37		A
I_{TSM}	$T_{vj} = 25\text{ °C}$; 10 ms	550		A
	$T_{vj} = 125\text{ °C}$; 10 ms	480		A
i^2t	$T_{vj} = 25\text{ °C}$; 8,3 ... 10 ms	1 500		A ² s
	$T_{vj} = 125\text{ °C}$; 8,3 ... 10 ms	1 150		A ² s
t_{gd}	$T_{vj} = 25\text{ °C}$; $I_G = 1\text{ A}$ $di_G/dt = 1\text{ A}/\mu\text{s}$	1		μs
t_{gr}	$V_D = 0,67 \cdot V_{DRM}$	1		μs
$(di/dt)_{cr}$	$T_{vj} = 125\text{ °C}$	150		A/ μs
t_q	$T_{vj} = 125\text{ °C}$	typ. 80		μs
I_H	$T_{vj} = 25\text{ °C}$; typ./max.	100 / 200		mA
I_L	$T_{vj} = 25\text{ °C}$; $R_G = 33\ \Omega$; typ./max.	250 / 400		mA
V_T	$T_{vj} = 25\text{ °C}$; $I_T = 75\text{ A}$	max. 1,8		V
$V_{T(TO)}$	$T_{vj} = 125\text{ °C}$	0,9		V
r_T	$T_{vj} = 125\text{ °C}$	12		m Ω
I_{DD} ; I_{RD}	$T_{vj} = 125\text{ °C}$; $V_{RD} = V_{RRM}$ $V_{DD} = V_{DRM}$	max. 10		mA
V_{GT}	$T_{vj} = 25\text{ °C}$; d.c.	3		V
I_{GT}	$T_{vj} = 25\text{ °C}$; d.c.	150		mA
V_{GD}	$T_{vj} = 125\text{ °C}$; d.c.	0,25		V
I_{GD}	$T_{vj} = 125\text{ °C}$; d.c.	5		mA
R_{thjc}	cont.	0,9 / 0,45		$^{\circ}\text{C}/\text{W}$
	sin. 180	0,95 / 0,48		$^{\circ}\text{C}/\text{W}$
	rec. 120	1,0 / 0,5		$^{\circ}\text{C}/\text{W}$
R_{thch}	} per thyristor / per module	0,2 / 0,1		$^{\circ}\text{C}/\text{W}$
T_{vj}		– 40 ... + 125		$^{\circ}\text{C}$
T_{stg}		– 40 ... + 125		$^{\circ}\text{C}$
V_{isol}	a. c. 50 Hz; r.m.s.; 1 s/1 min	3600 / 3000		V~
M_1	} to heatsink to terminals	5 (44 lb. in.) $\pm 15\%$ ²⁾		Nm
M_2		3 (26 lb. in.) $\pm 15\%$		Nm
a		5 · 9,81		m/s ²
w	approx.	95		g
Case	→ page B 1 – 95	SKKT 26: A 5 SKKH 26: A 6	SKKT 27: A 46 SKKT 27B: A 48 SKKH 27: A 47	

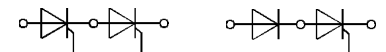

SKKT 26

SKKH 26



SKKT 27
SKKT 27B

SKKH 27

Features

- Heat transfer through aluminium oxide ceramic isolated metal baseplate
- Hard soldered joints for high reliability
- UL recognized, file no. E 63 532

Typical Applications

- DC motor control (e.g. for machine tools)
- AC motor soft starters
- Temperature control (e.g. for ovens, chemical processes)
- Professional light dimming (studios, theaters)

¹⁾ Also available in SKKT 27B configuration (case A 48)

²⁾ See the assembly instructions

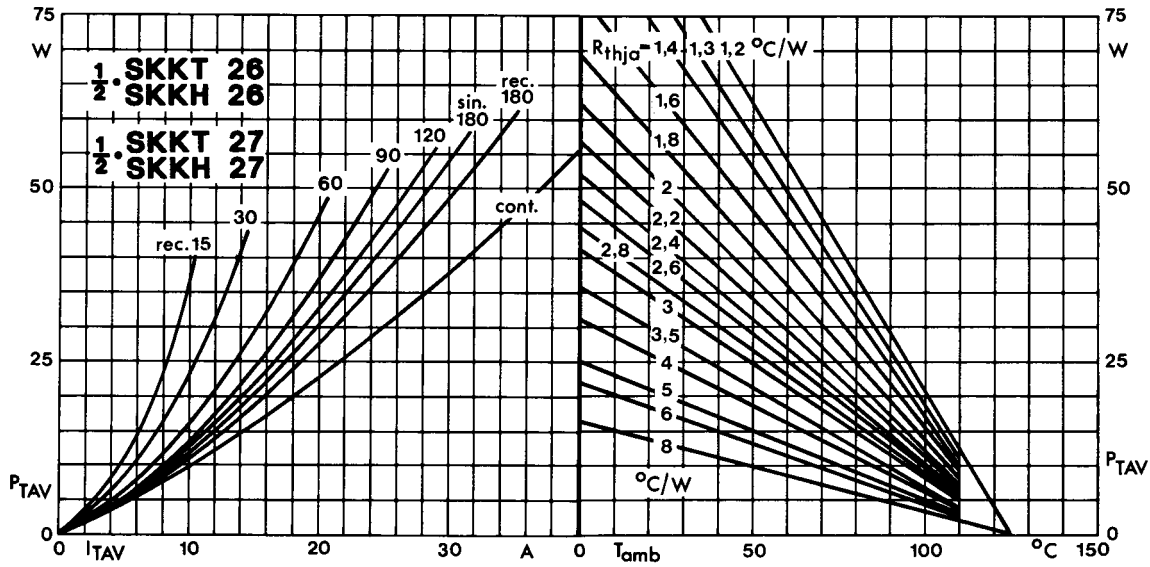

Fig. 1 Power dissipation per thyristor vs. on-state current and ambient temperature

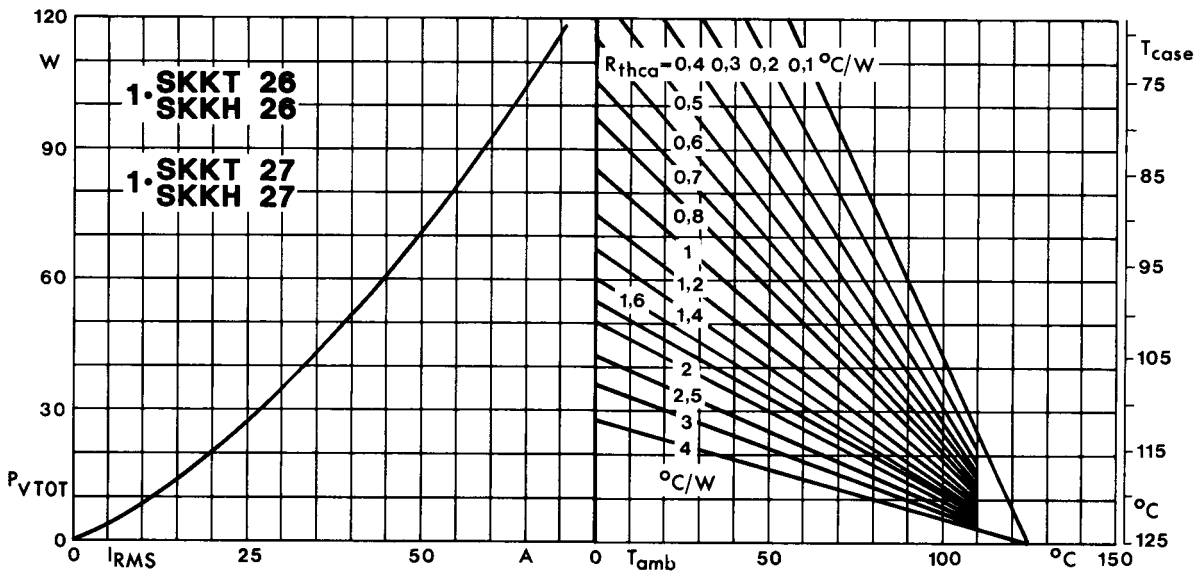

Fig. 2 Power dissipation per module vs. rms current and case temperature

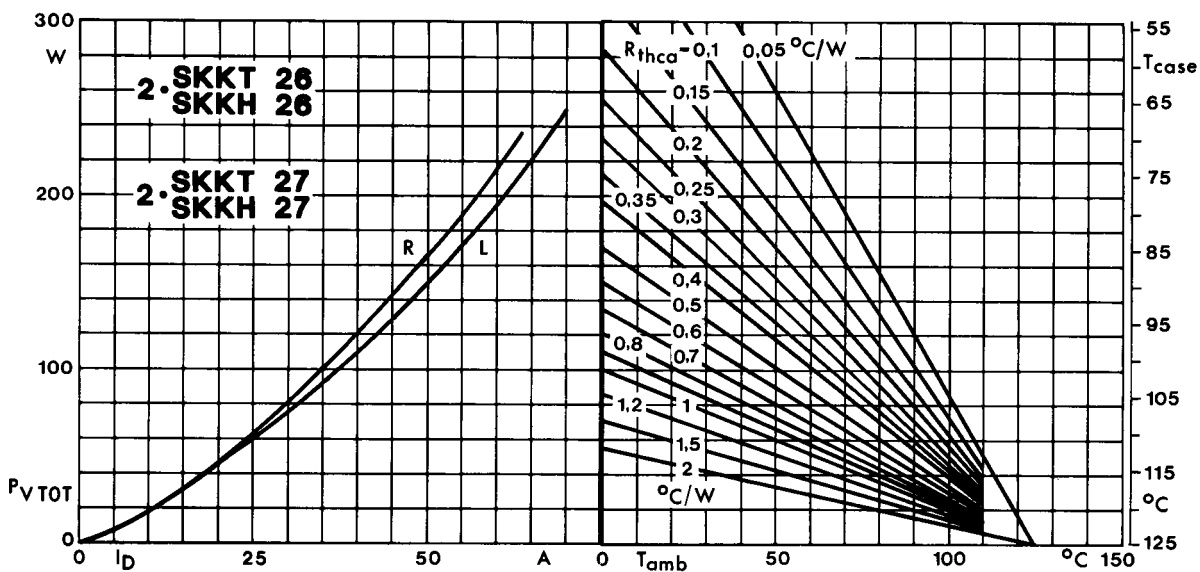

Fig. 3 Power dissipation of two modules vs. direct current and case temperature

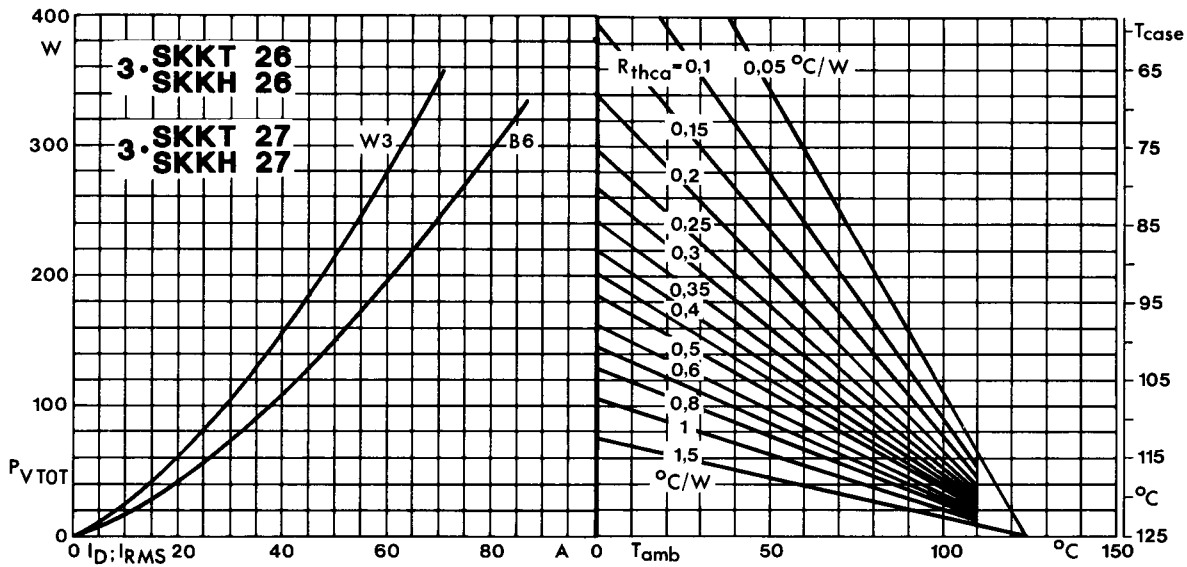

Fig. 4 Power dissipation of three modules vs. direct and rms current and case temperature

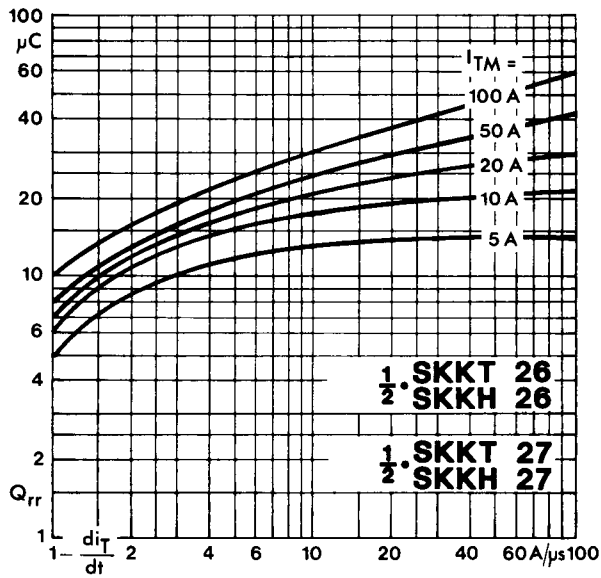

Fig. 5 Recovered charge vs. current decrease

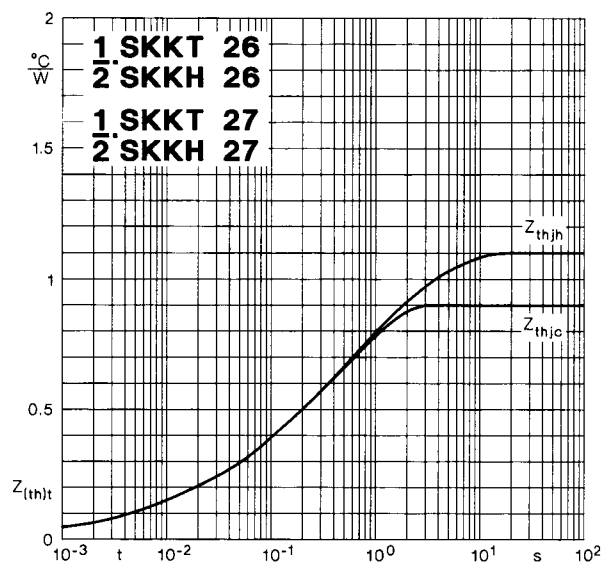

Fig. 6 Transient thermal impedance vs. time

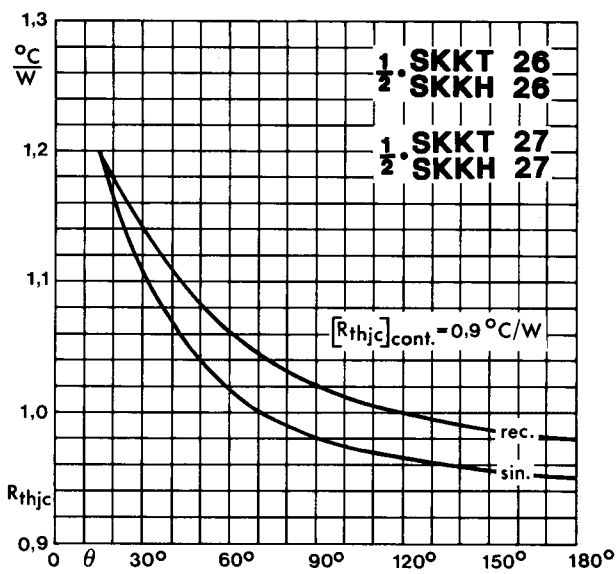

Fig. 7 Thermal resistance vs. conduction angle

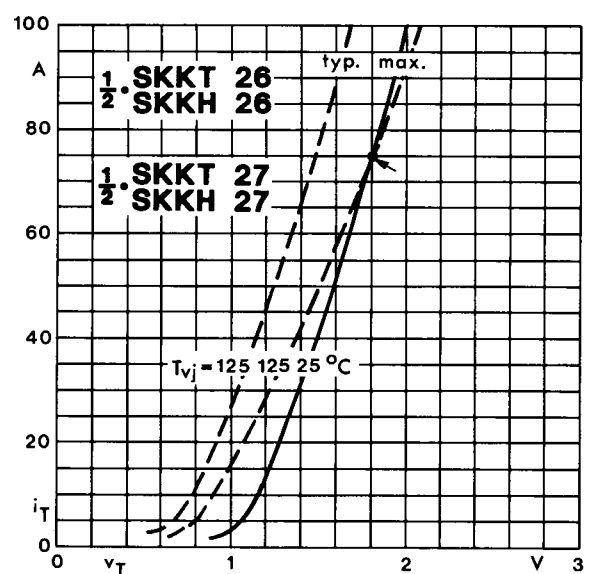

Fig. 8 On-state characteristics

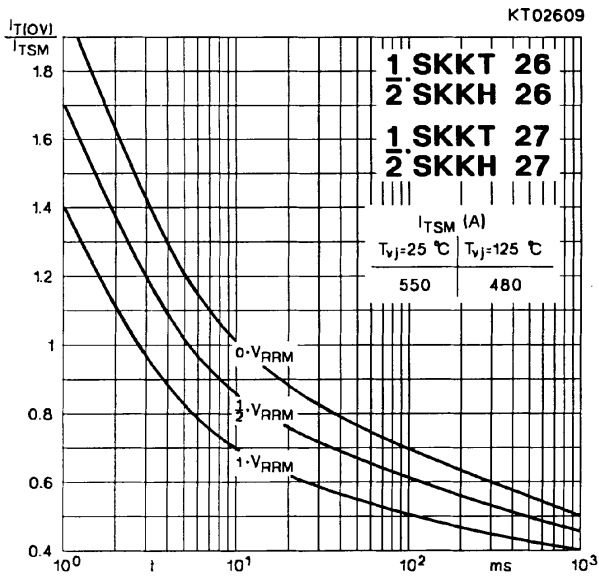

Fig. 9 Surge overload current vs. time

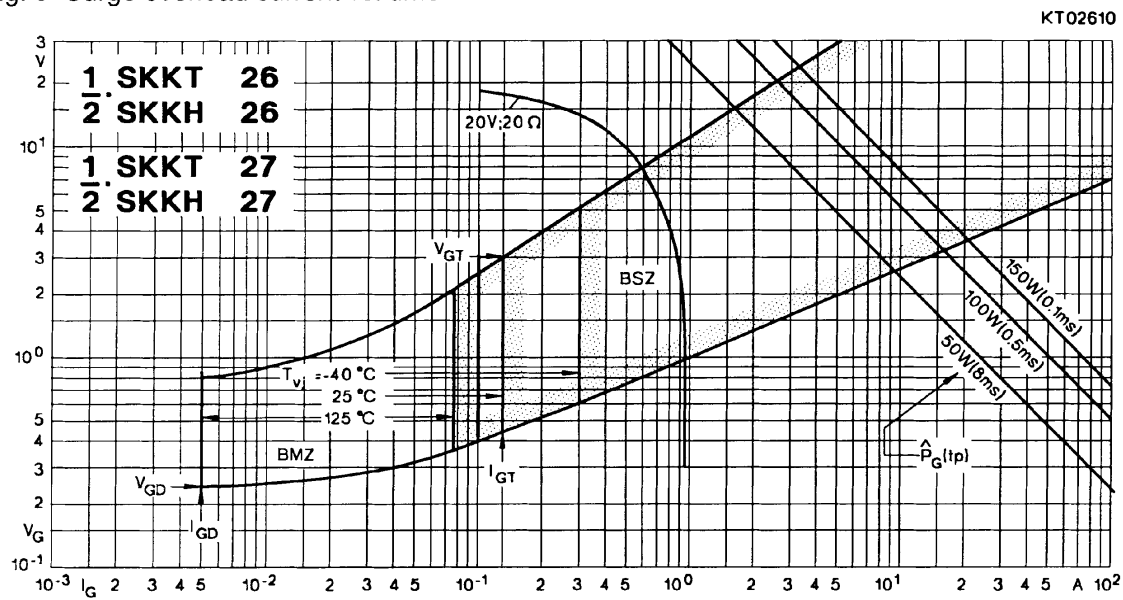
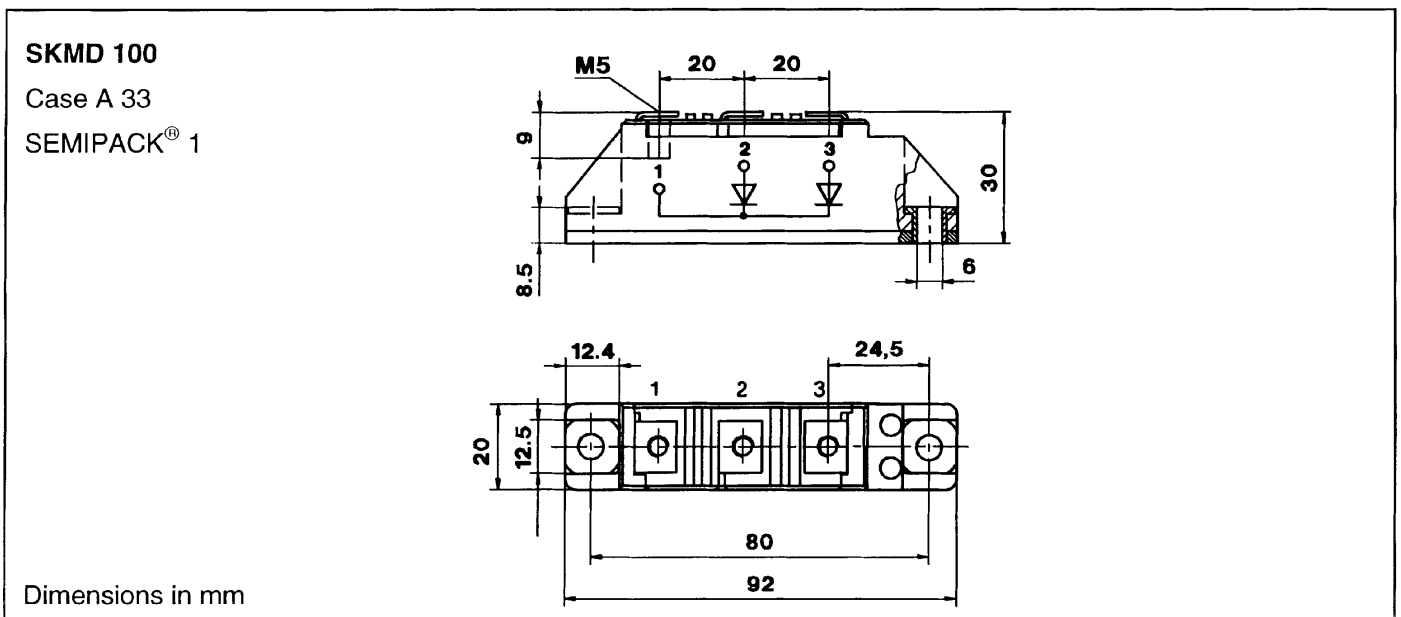

Fig. 10 Gate trigger characteristics



SKKT 19 ... 105

Case A 5

IEC 192-2: A 77 A

JEDEC: TO-240 AA

SEMIPACK® 1

UL recognized, file no. E 63 532

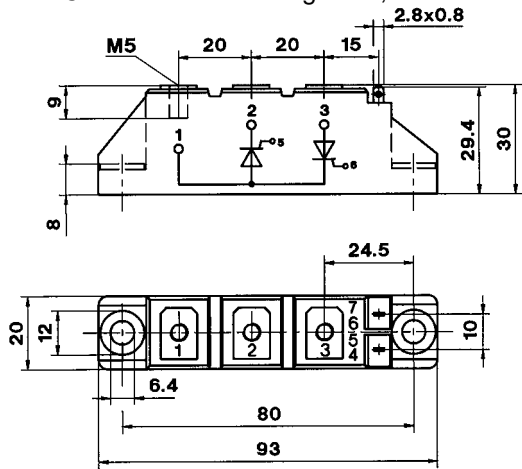

Dimensions in mm

SKKT 20/ ... 106/

Case A 46

IEC 192-2: A 77 A

JEDEC: TO-240 AA

SEMIPACK® 1

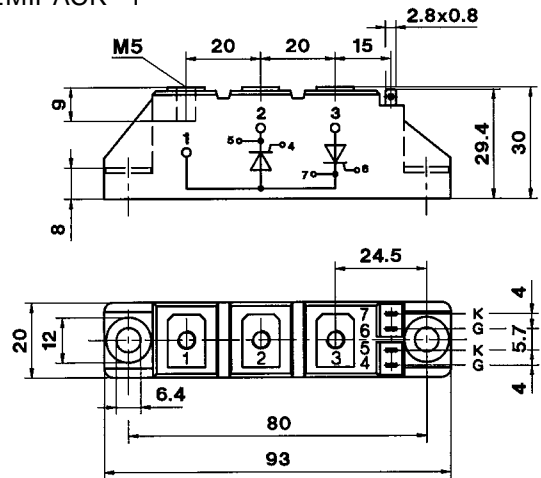

Dimensions in mm

SKKH 26 ... 105

Case A 6

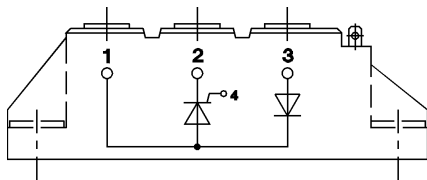

SKKD 26 ... 100

Case A 10

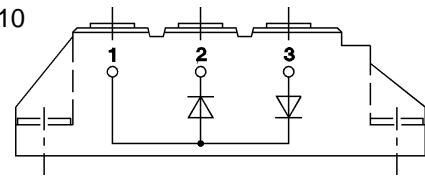

SKNH 56 ... 91

Case A 7

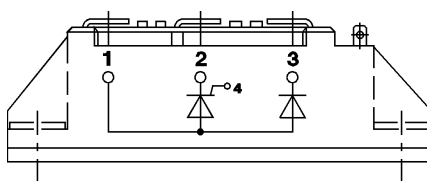

SKKE 81

Case A 12

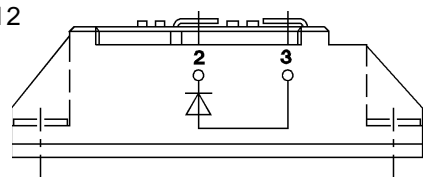

SKKL 56 ... 105

Case A 9

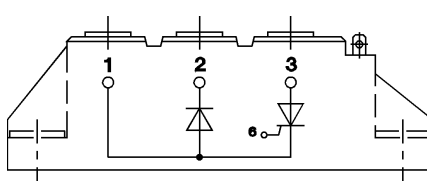

SKKH 27 ... 106

Case A 47

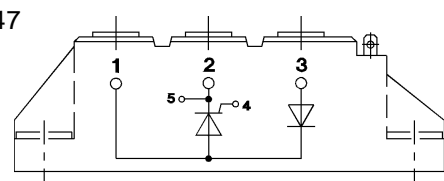

SKND 46 ... 81

Case A 19

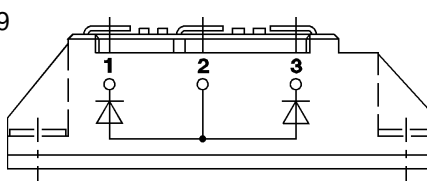

SKKT 20 B ... 106 B

Case A 48

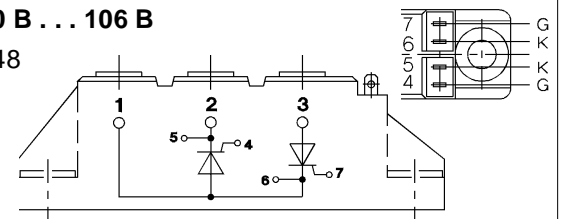

SKMT 92

Case A 72

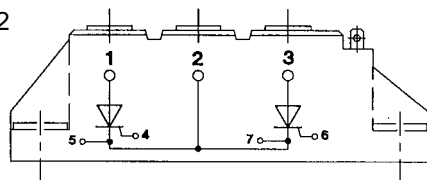

SKKL 42 ... 106

Case A 59

