

SIMATIC S5

S5-90U/S5-95U Programmable Controller

System Manual

EWA 4NEB 812 6115-02b

Edition 03

STEP ® SINEC ® and SIMATIC ® are registered trademarks of Siemens AG.
LINESTRA® is a registered trademark of the OSRAM Company.
Subject to change without prior notice.

The reproduction, transmission or use of this document or its contents is not permitted without express written authority. Offenders will be liable for damages. All rights, including rights created by patent grant or registration of a utility model or design, are reserved.

Copyright© **Siemens AG 1994**

Introduction	
System Description	1
Technical Description	2
Installation Guidelines	3
Start-Up and Program Tests	4
Diagnostics and Troubleshooting	5
Addressing and Access to I/Os	6
Introduction to STEP 5	7
STEP 5 Operations	8
Integrated Blocks and Their Functions	9
Onboard Interrupt Inputs	10
Onboard Counter Inputs	11
Analog Value Processing	12
Integral Real-Time Clock (only in the S5-95U)	13
Communication via SINEC L1 LAN	14
Module Spectrum	15
Function Modules	16
Appendices	A/B/C/ D/E/F
Index	

www.rgbautomatyka.pl

Contents

Page

How to Use This System Manual	xv
1 System Description	1 - 1
2 Technical Description	2 - 1
2.1 Programmable Controller Design - without External I/Os	2 - 1
2.1.1 Design of the S5-90U	2 - 1
2.1.2 Design of the S5-95U	2 - 3
2.2 Internal Electrical Configuration	2 - 5
2.2.1 Internal Electrical Configuration of the S5-90U	2 - 5
2.2.2 Internal Electrical Configuration of the S5-95U	2 - 6
2.3 Principle of Operation of the PLCs	2 - 7
2.3.1 Functional Units	2 - 7
2.3.2 Peculiarities of the PLCs	2 - 10
3 A Installation Guidelines	3 - 1
3.1 Mounting the PLC	3 - 1
3.2 Mounting the PLCs with External I/Os	3 - 5
3.2.1 Mounting the S5-90U with External I/Os	3 - 5
3.2.2 Mounting the S5-95U with External I/Os	3 - 7
3.2.3 How to Plug External I/O Modules into the Bus Units	3 - 9
3.2.4 Multi-Tier Expansion	3 - 11
3.2.5 Cabinet Mounting	3 - 13
3.3 Wiring	3 - 15
3.3.1 Connection Methods	3 - 15
3.3.2 Connecting the Power Supply to the S5-90U	3 - 19
3.3.3 Connecting the Power Supply to the S5-95U	3 - 19
3.3.4 Connecting the Onboard I/Os of the S5-90U	3 - 20
3.3.5 Connecting the Onboard I/Os of the S5-95U	3 - 22
3.3.6 Connecting External I/Os	3 - 24
3.4 Electrical Configuration with External I/Os	3 - 25
3.4.1 Electrical Configuration of the S5-90U with External I/Os	3 - 25
3.4.2 Electrical Configuration of the S5-95U with External I/Os	3 - 27
3.4.3 Connecting Non-Floating and Floating Modules	3 - 30

	Page
3.5 Wiring Arrangement, Shielding and Measures against Electromagnetic Interference	3 - 33
3.5.1 Running Cables Inside and Outside a Cabinet	3 - 33
3.5.2 Running Cables Outside Buildings	3 - 34
3.5.3 Equipotential Bonding	3 - 35
3.5.4 Shielding Cables	3 - 36
3.5.5 Special Measures for Interference-Free Operations	3 - 37
4 Start-Up and Programmer Functions	4 - 1
4.1 Operating Instructions	4 - 1
4.1.1 Programmable Controller Operator Panel	4 - 1
4.1.2 Operating Modes	4 - 2
4.1.3 Performing an Overall Reset of the Programmable Controller	4 - 3
4.2 Starting Up a System	4 - 4
4.2.1 Suggestions for Configuring and Installing the Programmable Controller	4 - 4
4.2.2 Steps for Starting Up the Programmable Controller	4 - 5
4.3 Loading the Program into the PLC	4 - 8
4.3.1 Loading the Program Automatically	4 - 8
4.3.2 Loading the Program Manually	4 - 9
4.4 Saving a Program	4 - 10
4.4.1 Saving a Program to a Memory Submodule	4 - 10
4.4.2 Function of the Back-Up Battery	4 - 11
4.5 Programmer Functions	4 - 11
4.5.1 Overview of Programmer Functions	4 - 12
4.5.2 Peculiarities of the Programmer Functions for the S5-90U and S5-95U	4 - 13
4.5.3 Performance Characteristics When Using the Programmer Interface	4 - 13
5 Diagnostics and Trouble Shooting	5 - 1
5.1 Diagnostic Byte	5 - 1
5.2 LED Error Display	5 - 3
5.3 Interrupt Analysis Using the Programmer	5 - 4
5.3.1 "ISTACK" Analysis Function	5 - 4
5.3.2 Meanings of the ISTACK Displays for Errors Occurring During Restart and Program Execution	5 - 7
5.3.3 Meanings of the ISTACK Displays in the Case of Errors During Copying the Program	5 - 8

	Page
5.4 Program Errors	5 - 9
5.4.1 Determining an Error Address	5 - 9
5.4.2 Program Tracing with the "BSTACK" Function	5 - 10
5.5 Faults in the External I/Os	5 - 12
5.6 System Parameters	5 - 13
5.7 The PLC does not Enter the "RUN" Mode	5 - 13
6 Addressing and Access to I/Os	6 - 1
6.1 Addressing the Onboard I/Os	6 - 1
6.2 Addressing the External I/Os	6 - 2
6.2.1 Slot Numbering	6 - 2
6.2.2 Digital Modules	6 - 5
6.2.3 Analog Modules	6 - 7
6.2.4 Function Modules	6 - 8
6.3 Process Image and Access to I/Os	6 - 9
6.3.1 Access to I/Os During Cyclic Program Execution	6 - 11
6.3.2 Access to I/Os During Time-Controlled Program Execution (for S5-95U only)	6 - 13
6.4 Calculating the Scan Time and Response Time	6 - 15
6.5 Start-Up with/without External I/Os and Parameterization of Internal Timers (S5-95U only)	6 - 23
7 Introduction to STEP 5	7 - 1
7.1 Writing a Program	7 - 1
7.1.1 Methods of Representation	7 - 1
7.1.2 Operand Areas	7 - 2
7.2 Program Structure	7 - 3
7.2.1 Linear Programming	7 - 3
7.2.2 Structured Programming	7 - 4

	Page
7.3 Block Types	7 - 6
7.3.1 Organization Blocks (OBs)	7 - 8
7.3.2 Program Blocks (PBs)	7 - 10
7.3.3 Sequence Blocks (SBs; only for S5-95U)	7 - 10
7.3.4 Function Blocks (FBs)	7 - 10
7.3.5 Data Blocks (DBs)	7 - 15
7.4 Processing Blocks	7 - 17
7.4.1 Changing Programs	7 - 17
7.4.2 Changing Blocks	7 - 17
7.4.3 Compressing the Program Memory	7 - 17
7.5 Number Representation	7 - 18
8 STEP 5 Operations	8 - 1
8.1 Basic Operations	8 - 1
8.1.1 Boolean Logic Operations	8 - 2
8.1.2 Set/Reset Operations	8 - 7
8.1.3 Load and Transfer Operations	8 - 10
8.1.4 Timer Operations	8 - 15
8.1.5 Counter Operations	8 - 25
8.1.6 Comparison Operations	8 - 30
8.1.7 Arithmetic Operations	8 - 31
8.1.8 Block Call Operations	8 - 33
8.1.9 Other Operations	8 - 38
8.2 Supplementary Operations	8 - 39
8.2.1 Load Operation (only for the S5-95U)	8 - 40
8.2.2 Enable Operation (only for the S5-95U)	8 - 41
8.2.3 Bit Test Operations (only for the S5-95U)	8 - 42
8.2.4 Digital Logic Operations	8 - 44
8.2.5 Shift Operations	8 - 48
8.2.6 Conversion Operations	8 - 50
8.2.7 Decrement/Increment (only for the S5-95U)	8 - 52
8.2.8 Disable/Enable Interrupt	8 - 53
8.2.9 DO Operation (only for the S5-95U)	8 - 54
8.2.10 Jump Operations	8 - 56
8.2.11 Substitution Operations (only for the S5-95U)	8 - 58
8.3 System Operations (only for the S5-95U)	8 - 64
8.3.1 Set Operations (only for the S5-95U)	8 - 64
8.3.2 Load and Transfer Operations	8 - 64
8.3.3 Arithmetic Operation (only for the S5-95U)	8 - 67
8.3.4 Other Operations (only for the S5-95U)	8 - 68

	Page
8.4 Condition Code Generation	8 - 69
8.5 Sample Programs	8 - 71
8.5.1 Momentary-Contact Relay (Edge Evaluation)	8 - 71
8.5.2 Binary Scaler (Binary Divider)	8 - 71
8.5.3 Clock (Clock-Pulse Generator)	8 - 73
9 Integrated Blocks and Their Functions	9 - 1
9.1 Integrated Organization Blocks (OBs)	9 - 1
9.1.1 Cyclic Program Execution (OB1)	9 - 2
9.1.2 Interrupt-Driven Program Execution (OB3)	9 - 3
9.1.3 Time-Controlled Program Execution (OB13; for S5-95U only)	9 - 3
9.1.4 Restart Processing (OB21, OB22)	9 - 5
9.1.5 Retriggering the Scan Time (OB31; for S5-95U only)	9 - 6
9.1.6 Procedure after Battery Failure (OB34; for S5-95U only)	9 - 7
9.1.7 OB251 PID Algorithm (for S5-95U only)	9 - 8
9.2 Integrated Function Blocks (FBs)	9 - 20
9.2.1 Code Converter : B4 - FB240 -	9 - 20
9.2.2 Code Converter : 16 - FB 241-	9 - 21
9.2.3 Multiplier : 16 - FB242 -	9 - 22
9.2.4 Divider : 16 - FB243 -	9 - 23
9.2.5 Reading of Analog Values (FB250)	9 - 24
9.2.6 Output of Analog Values (FB251)	9 - 24
9.3 Integrated Sequence Block 2 (SB2)	9 - 24
9.4 Integrated Data Block 1 (DB1)	9 - 25
9.4.1 Parameter Blocks	9 - 26
9.4.2 Rules to Observe When Generating DB1	9 - 27
9.4.3 Transferring DB1 Parameters to the Programmable Controller	9 - 30
9.4.4 Procedure for Parameterizing the PLC	9 - 30
9.4.5 How to Recognize and Correct Parameter Errors	9 - 31
10 Onboard Interrupt Inputs	10 - 1
10.1 Setting Parameters for Interrupt Inputs in DB1	10 - 1
10.2 Interrogating the Cause for an Interrupt in the Diagnostic Byte	10 - 2
10.3 Interrupt Priority	10 - 4
10.4 Calculating Interrupt Reaction Times	10 - 7

	Page
11 Onboard Counter Inputs	11 - 1
11.1 Setting Parameters for Counter Inputs in DB1	11 - 3
11.2 Programming the Reaction to Interrupts in OB3	11 - 4
11.3 Scanning the Actual Counter Status	11 - 5
11.4 Entering the Comparison Value and Resetting the Counter	11 - 5
11.5 Cascading Counters (with the S5-95U only)	11 - 7
11.6 Calculating the Counter Frequency Limit	11 - 9
12 Analog Value Processing	12 - 1
12.1 Reading in Analog Values	12 - 2
12.1.1 General Representation of Analog Input Values	12 - 3
12.1.2 Reading in and Scaling an Analog Value -FB250-	12 - 5
12.1.3 Time Required for Reading and Accuracy of the Analog Value Read in	12 - 7
12.1.4 Using Analog Inputs of the S5-95U as Additional Digital Inputs	12 - 8
12.2 Output of Analog Values	12 - 9
12.2.1 General Representation of Analog Output Values	12 - 9
12.2.2 Outputting Analog Values -FB251-	12 - 10
12.2.3 Time Required for Output and Accuracy of the Analog Value Output	12 - 12
12.3 Example: Analog Value Processing with FB250 and FB251	12 - 14
13 Integral Real-Time Clock (only in the S5-95U)	13 - 1
13.1 Function	13 - 1
13.2 Structure of the Clock Data Area	13 - 2
13.3 Structure of the Status Word and How to Scan it	13 - 5
13.4 Backup of the Hardware Clock	13 - 7

	Page
13.5 Setting Parameters in DB1	13 - 8
13.5.1 Setting the Clock in DB1	13 - 10
13.5.2 Setting the Prompt Time in DB1	13 - 10
13.5.3 Setting the Operating Hours Counter in DB1	13 - 11
13.5.4 Entering the Clock Time Correction Factor in DB1	13 - 11
13.6 Programming the Integral Real-Time Clock in the User Program	13 - 12
13.6.1 Reading and Setting the Clock	13 - 12
13.6.2 Programming the Prompt Function	13 - 16
13.6.3 Programming the Operating Hours Counter	13 - 21
13.6.4 Entering the Clock Time Correction Factor	13-26
14 Communication via SINEC L1 LAN	14 - 1
14.1 Connection of the Programmable Controllers to the L1 Bus Cable	14 - 1
14.2 Basic Principle of Data Interchange	14 - 2
14.3 Parameterization of the PLC for Data Interchange in DB1	14 - 3
14.4 Sending Data	14 - 5
14.5 Receiving Data	14 - 7
14.6 Program Example	14 - 9
15 Module Spectrum	15 - 1
15.1 General Technical Specifications	15 - 3
15.2 Power Supply Modules	15 - 4
15.3 Bus Units	15 - 6
15.4 Interface Modules	15 - 8
15.5 Digital Modules	15 - 11
15.5.1 Digital Input Modules	15 - 13
15.5.2 Digital Output Modules	15 - 23
15.5.3 Digital Input/Output Modules	15 - 34
15.6 Analog Modules	15 - 36
15.6.1 Analog Input Modules	15 - 37
15.6.2 Analog Output Modules	15 - 92

	Page
16 Function Modules	16 - 1
16.1 Comparator Module	16 -1
16.2 Timer Module	16 -4
16.3 Simulator and Simulator Module	16 -7
16.3.1 Simulator only for the S5-90U	16 -7
16.3.2 Simulator Module	16 -8
16.4 Diagnostic Module	16 -10
16.5 Counter Module 2x0 to 500 Hz	16 -13
16.6 Counter Module 25/500 kHz	16 -18
16.6.1 Installation Guidelines	16 -21
16.6.2 Data Transfer	16 -26
16.6.3 Functional Description of the Counter Mode	16 -28
16.6.4 Functional Description of the Position Decoder	16 -30
16.6.5 Entering New Setpoints for the Counter and Position Decoder	16 -39
16.6.6 Addressing	16 -40
16.7 IP 262 Closed-Loop Control Module	16 -42
16.8 IP 263 Positioning Module	16 -46
16.9 IP 264 Electronic Cam Controller Module	16 -50
16.10 IP 265 High Speed Sub Control	16 -53
16.11 IP 266 Positioning Module	16 -53
16.12 IP 267 Stepper Motor Control Module	16 -56
16.13 CP 521 SI Communications Processor	16-63
16.14 CP 521 BASIC Communications Module	16-66

Page

Appendices

A	Operations List, Machine Code and List of Abbreviations	A - 1
A.1	Operations List	A - 1
A.1.1	Basic Operations	A - 1
A.1.2	Supplementary Operations	A - 8
A.1.3	System Operations	A - 13
A.1.4	Evaluation of CC 1 and CC 0	A - 14
A.2	Machine Code Listing	A - 15
A.3	List of Abbreviations	A - 18
B	Technical Specifications, DB1 Parameters, RAM Address Assignment ...	B - 1
B.1	Technical Specifications	B - 1
B.1.1	General Technical Specifications S5-90U and S5-95U	B - 1
B.1.2	Technical Specifications S5-90U	B - 2
B.1.3	Technical Specifications S5-95U	B - 3
B.2	DB1 Parameters	B - 5
B.2.1	DB1 Parameters of S5-90U	B - 5
B.2.2	DB1 Parameters of S5-95U	B - 6
B.3	RAM Address Assignment	B - 8
B.3.1	RAM Address Assignment in the S5-90U	B - 8
B.3.2	RAM Address Assignment in the S5-95U	B - 10
C	Dimension Drawings	C - 1
D	Active and Passive Faults in Automation Equipment/ Guidelines for Handling Electrostatic Sensitive Devices (ESD)	D - 1
E	Information for Ordering Accessories	E - 1
F	Reference Materials	F - 1

Index

www.rgbautomatyka.pl

How to Use This System Manual

The S5-90U and S5-95U are programmable controllers for lower and medium performance ranges. They meet all the requirements for a modern programmable controller. To use these controllers optimally, you need detailed information.

In this system manual we have attempted to present this information as completely and as well organized as possible.

This How to Use This System Manual section gives you information that will make it easier for you to find what you need. This section explains how the manual is organized.

Contents of This System Manual

- **Hardware Description (Chapters 1, 2, and 3)**
These chapters describe the controllers: how they fit into the SIMATIC® S5 family of programmable controllers, how they function, and how you install them.
- **Start-Up Information (Chapters 4, 5, and 6)**
These chapters summarize the information you need to start up your programmable controller.
- **The Programming Language of the Programmable Controllers (Chapters 7, 8, and 9)**
These chapters describe the structure, operations, and structuring aids of the STEP® 5 programming language.
- **Functions of the Programmable Controllers (Chapters 10, 11, 12, 13, and 14)**
Each of these chapters contains a complete description of a particular function, from wiring to programming. Subjects include analog value processing, counter and interrupt inputs, integral clock, and the programmable controller as a SINEC® L1 slave.
- **Module Spectrum (Chapters 15 and 16)**
These chapters contain information about all the currently available S5-100U modules that you can use to expand your controller. Chapter 16, Function Modules, includes the modules that require an extensive description (i.e., more than just technical specifications).
- **Overviews (Appendices)**
In these chapters you will find not only a complete list of operations but also the technical specifications of the PLCs, RAM address assignments, system data assignments, dimension drawings, a description of errors that may occur during operation of the programmable controller, maintenance and repair procedures, guidelines for handling electrostatic sensitive devices, a list of accessories, and reference literature about programmable controllers.

You will find correction pages at the end of the system manual. Use them to indicate any corrections, additions, or suggestions for improvement you might have. Send these suggestions to us. They will help us to improve the next edition of this system manual.

Conventions

This system manual is organized in menu form to make it easier for you to find information. This means the following:

- Each chapter is marked with printed tabs.
- At the front of the system manual is an overview page that lists the title of each chapter. Following this page, you will find a table of contents.
- At the beginning of each chapter is a table of contents for that chapter. Each chapter has three level headings that are numbered. The fourth level heading is not numbered but appears in **boldface type**.
- Pages, figures, and tables are numbered separately for each chapter. On the back of the table of contents for each chapter you will find a list of the figures and tables that appear in that chapter.

This system manual employs the following specific structuring devices:

- Specific terms have characteristic abbreviations (e.g., OP for operator panel). Appendix A contains a list of abbreviations.
- Footnotes are marked with a raised number (e.g., "1") or a raised asterisk ("**"). You will find the corresponding explanations in the lower margin of the page or under a figure or table if the footnote appears in one of these.
Lists are designated with bullets (• as in this particular listing) or with hyphens (-).
Procedures are marked with black triangles () and must be performed in the sequence presented.
- Cross references are indicated as follows: "(see Section 7.3.2)". There are no references to specific page numbers.
- Dimensions in drawings are indicated in millimeters and inches.
- Value ranges are indicated as follows: 17 to 21.
- Especially important information appears in framed boxes such as the following:



Warning

You will find definitions for the terms "Warning," "Danger," "Caution," and "Note" in the Safety-Related Guidelines for the User at the end of the introduction.

Scope of the S5-90U/S5-95U System Manual

The S5-90U/S5-95U System Manual is valid for the following programmable controllers:

- S5-90U from Order No. 6ES5 090-8MA01, Edition 02
- S5-95U from Order No. 6ES5 095-8MA04, Edition 01
- S5-95U from Order No. 6ES5 095-8MB03, Edition 01
- S5-95U from Order No. 6ES5 095-8MC02, Edition 01
- S5-95U from Order No. 6ES5 095-8MD02, Edition 01

The Manuals listed below are required for starting up the S5-90U and the various versions of the S5-95U programmable controller.

Programmable Controller	Manuals Required for Start-Up
S5-90U Order No. 6ES5 090-8MA01	<ul style="list-style-type: none"> • S5-90U/S5-95U System Manual, Order No. 6ES5 998-8MA22
S5-95U (basic unit), Order No. 6ES5 095-8MA04	<ul style="list-style-type: none"> • S5-90U/S5-95U System Manual, Order No. 6ES5 998-8MA22
S5-95U, SINEC L2 Interface, Order No. 6ES5 095-8MB03	<ul style="list-style-type: none"> • S5-90U/S5-95U System Manual, Order No. 6ES6 998-8MA22 • SINEC L2 Interface of the S5-95U Manual, Order No. 6ES5 998-8MB22
S5-95U, Second Serial Interface, Order No. 6ES5 095-8MC02	<ul style="list-style-type: none"> • S5-90U/S5-95U System Manual, Order No. 6ES5 998-8MA22 • Second Serial Interface of the S5-95U Manual Order No. 6ES5 998-8MC21
S5-95U, SINEC L2-DP Interface, Order No. 6ES5 095-8MD02	<ul style="list-style-type: none"> • S5-90U/S5-95U System Manual, Order No. 6ES5 998-8MA22 • SINEC L2-DP Interface of the S5-95U Manual, Order No. 6ES5 998-8MD21

Training

Siemens offers a wide range of training courses for SIMATIC S5 users. Contact your Siemens representative for more information.

Safety-Related Guidelines for the User

This document provides the information required for the intended use of the particular product. The documentation is written for technically qualified personnel.

Qualified personnel as referred to in the safety guidelines in this document as well as on the product itself are defined as follows.

- System planning and design engineers who are familiar with the safety concepts of automation equipment.
- Operating personnel who have been trained to work with automation equipment and are conversant with the contents of the document in as far as it is connected with the actual operation of the plant.
- Commissioning and service personnel who are trained to repair such automation equipment and who are authorized to energize, de-energize, clear, ground, and tag circuits, equipment, and systems in accordance with established safety practice.

Danger Notices

The notices and guidelines that follow are intended to ensure personal safety, as well as protect the products and connected equipment against damage.

The safety notices and warnings for protection against loss of life (the users or service personnel) or for protection against damage to property are highlighted in this document by the terms and pictograms defined here. The terms used in this document and marked on the equipment itself have the following significance.

Danger

indicates that death, severe personal injury or substantial property damage will result if proper precautions are not taken.

Warning

indicates that death, severe personal injury or substantial property damage can result if proper precautions are not taken.

Caution

indicates that minor personal injury or property damage can result if proper precautions are not taken.

Note

contains important information about the product, its operation or a part of the document to which special attention is drawn.

Proper Usage



Warning

- The equipment/system or the system components may only be used for the applications described in the catalog or the technical description, and only in combination with the equipment, components, and devices of other manufacturers as far as this is recommended or permitted by Siemens.
- The product will function correctly and safely only if it is transported, stored, set up, and installed as intended, and operated and maintained with care.

1

System Description

Figures		
1-1	S5-90U, S5-95U and S5-100U Programmable Controllers	1 - 1
1-2	Communications Capabilities	1 - 7
1-3	STEP Programming Language	1 - 8
Tables		
1-1	Dimensions	1 - 3
1-2	All Inputs and Outputs	1 - 4
1-3	Retentive and Non-Retentive Operands	1 - 5
1-4	Software Overview	1 - 6

1 System Description

The SIMATIC S5 system family includes programmable controllers of all performance levels, i.e. from the simplest and smallest to high-end PLCs.

The following SIMATIC programmable controllers (PLCs) are suited especially for automation tasks where only little space is available for the controller:

- S5-90U,
- S5-95U and
- S5-100U

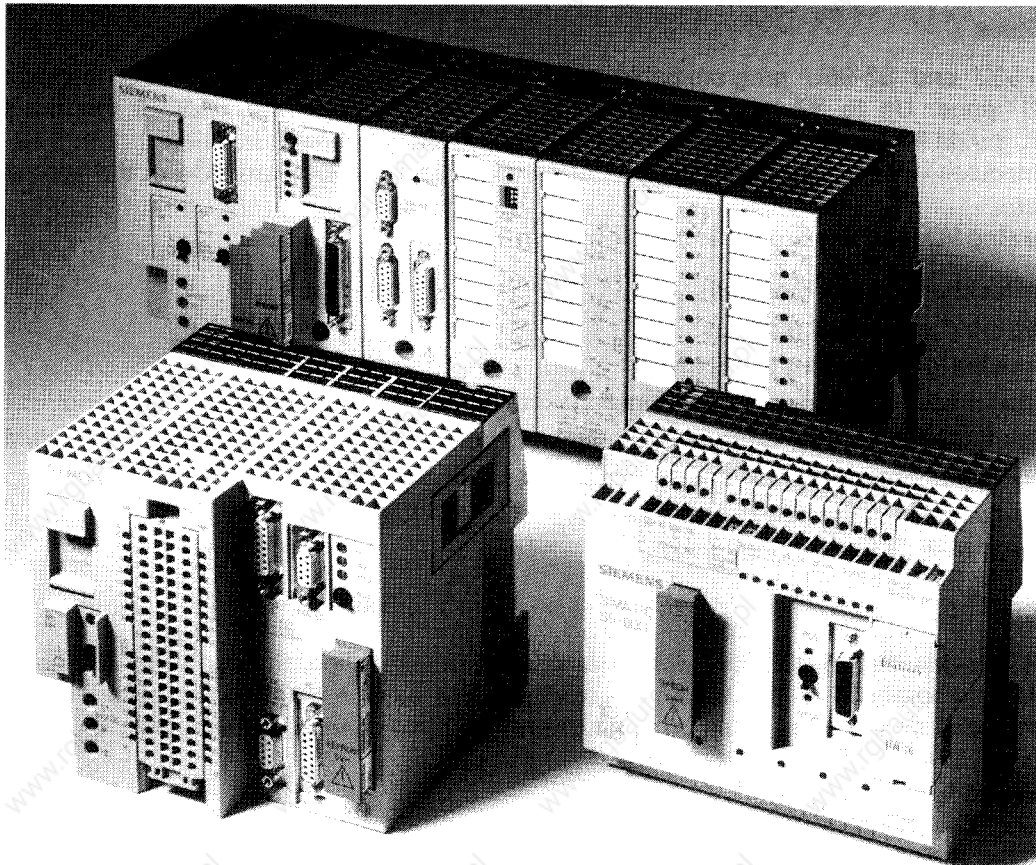

Figure 1-1. S5-90U, S5-95U and S5-100U Programmable Controllers

S5-90U Programmable Controller

The S5-90U is the most economical option for solving simple automation tasks requiring only ten inputs and six outputs.

It is mainly used for automation tasks which could previously only be solved by means of contactors and relays for reasons of space and cost. Even circuits with only four contactors can now be implemented more economically with the S5-90U.

Salient features of the S5-90U:

- Modular expansion capability
- Networking capability (via SINEC L1)
- Battery for data maintenance

S5-95U Programmable Controller

The S5-95U is a fast and compact PLC designed for complex applications with digital and analog inputs and outputs where space is a crucial factor.

It is suitable for small control tasks with high demands regarding response times and supplementary functions.

Salient features of the S5-95U:

- Onboard analog inputs/outputs with extremely short conversion times
- PID controller
- Networking capability as active or passive station in the SINEC L2 LAN

I/O Modules

The S5-90U and S5-95U programmable controllers can be expanded with I/O modules of the S5-100U range. Up to 32 modules can be connected directly to the S5-95U. For the S5-90U, however, the IM 90 interface module is required for connecting up to six modules.

These modules offer a variety of functions that supplement the onboard I/Os of the programmable controllers.

The following I/O modules are available:

- Digital input and output modules
- Analog input and output modules
- Ex modules for hazardous applications
- Function modules for external timer functions, fast counters and analog limit monitoring
- Intelligent I/O modules for closed-loop control and positioning tasks and for cam mechanisms
- Intelligent programmable modules for fast preprocessing functions
- Diagnostic modules for monitoring the I/O bus of the S5-100U
- Simulator modules for program testing.

Bus Units

Bus units provide the S5-90U/95U with extra-discrete configuration and expansion capabilities. The bus units incorporate the signal leads for communication between I/O modules and CPU. They are simply mounted on a 35 mm standard mounting rail and interconnected using the integral flat ribbon cable connectors.

Each bus unit has

- Two module slots
- Rotatable coding "locks" to avoid confusing of modules
- A terminal block for the signal leads.

Communications Capabilities

The SINEC L1 and SINEC L2 (S5-95U only) LANs offer extensive communications functions for data interchange with various devices and stations. The internal 20 mA (TTY) interfaces and the CP modules additionally permit point-to-point connections, for instance, to

- Printers
- Terminals
- Personal computers
- Other programmable controllers.

Dimensions

The S5-90U and S5-95U programmable controllers are distinguished by their low space requirement. They can be used even in places too small for accommodating a conventional control consisting of contactors and relays. They are thus the ideal solution if a controller for a small control task must additionally be fitted in a control cabinet already containing a complete configuration.

The two PLCs can also be operated without any I/O modules. They constitute, of course, the most economical solution with regard to space requirements if the onboard I/Os are sufficient for implementing the control task.

The number of bus units used for external I/Os determines the space requirement.

Table 1-1. Dimensions

Programmable Controller	Width	Height	Depth	
S5-90U programmable controller	145 mm	135 mm	97 mm	
S5-95U programmable controller	145 mm	135 mm	146 mm	
Bus unit with two I/O modules, with terminal block for	screw-type connection	91.5 mm	162 mm	137.8 mm
	crimp snap-in connection	91.5 mm	135 mm	137.8 mm

Mounting

The S5-90U can be mounted directly on walls or mounting plates. For this purpose, you need four **wall brackets** that can be pushed into the four openings on the rear of the casing and then mounted on the wall using screws.

The S5-95U snaps onto a 35 mm **standard mounting rail** which also accommodates the bus units for the external I/O modules. Optionally, the S5-90U can also be fitted on a 35 mm standard mounting rail.

Power Supply

When configuring a system or plant, you have to make sure the PLC is provided with the supply voltage required.

The S5-90U can be connected directly to the 115/230 V AC mains supply.

The S5-95U can be connected directly to a 24 V DC voltage supply. Power supply modules providing 1 A to 10 A (at 24 V) are available for connection to 115/230 V AC.

Digital Inputs/Outputs

Due to their wide range of applications, the number of inputs and outputs required by the PLCs varies considerably.

The two PLCs permit different configurations. You can therefore select the PLC that suits your specific task.

Table 1-2. All Inputs and Outputs

Inputs/Outputs	S5-90U		S5-95U	
	Onboard	Maximum	Onboard	Maximum
Digital inputs/outputs	16	208	32	480
Analog inputs/outputs	0	16	9	41
Counter inputs	1	13	2	66
Interrupt inputs	1	1	4	4

The PLCs offer onboard digital inputs and outputs to which the required number of I/O modules of the S5-100U range can be added.

Analog Inputs/Outputs

The PLCs also feature analog inputs and outputs. Analog inputs and outputs are incorporated on the S5-95U board. Both the S5-90U and S5-95U can be expanded using the relevant I/O modules of the S5-100U spectrum.

Interrupt Inputs

In addition to the above-mentioned inputs and outputs, the S5-90U and S5-95U feature onboard inputs for interrupt processing.

Counter Inputs

Many applications require the use of counters. The onboard counter inputs of the S5-90U and S5-95U are adequate for a great variety of counter functions.

The following onboard counter inputs are available:

- S5-90U One up counter (16-bit) Counting frequency: 1 kHz
- S5-95U One up counter (16-bit) Counting frequency: 2 kHz,
One up counter (16-bit) Counting frequency: 5 kHz.

Both up counters can be combined in a cascade to form one 32-bit up counter.

If these inputs do not meet your requirements, e.g. with respect to the counting frequency, they can be supplemented with counter modules of the S5-100U range.

Three different counter modules are available:

- A two-channel counter module for up to 500 Hz, two down counters;
- A fast, single-channel counter module for counting frequencies up to 500 kHz, with two comparison values, for both counting and position decoding;
- An intelligent I/O module with two counter channels for up to 58 kHz, up or down counters.

Your PLC needs a program to carry out its control task. Depending on the task involved, these programs can vary and place various demands on the PLCs.

User Memory

The program is loaded into the user memory when the PLC is started up. The memory capacity represents a limiting factor for the size of the program so that, for instance, extensive programs cannot be executed in every PLC. If data from the process is additionally stored, the memory space available for the program is again reduced.

Execution Time

The execution time of the program determines the response time of the programmable controller to signals from the process. Since execution times vary from program to program, the execution times specified in Table 1-4 are referred to 1024 binary statements (1 statement corresponds to 2 bytes).

Flags/Counters/Timers

Internal flags, counters and timers are available for solving your task.

Table 1-3 gives information about the number and retentive characteristics (internal memory contents are retained/not retained after POWER ON) of flags, counters and timers.

Table 1-3. Retentive and Non-Retentive Operands

Operand	S5-90U		S5-95U	
	Retentive	Non-Retentive	Retentive	Non-Retentive
Flags	0.0 to 63.7	64.0 to 127.7	0.0 to 63.7	64.0 to 255.7
Counters	0 to 7	8 to 31	0 to 7	8 to 127
Timers	_____	0 to 31	_____	0 to 127

Structured Programming

Programs can be kept manageable if a linear sequence of operations is broken down into individual technologically related sections that are combined to form software blocks. Organization blocks can be used in which the reaction of the system to interrupts in cyclic program execution can be programmed.

Interrupt-Driven Program Execution

Some applications require an immediate and adequate response of the system to signals from the process (process interrupts). Normal program execution must therefore be suspended in order to process these interrupts. This is initiated by the operating system which calls an organization block in which the appropriate response has been programmed.

Time-Controlled Programming

You can use time-controlled programming if you wish to interrupt cyclic program execution at fixed intervals in order to execute another routine. When the cyclic program is interrupted, an organization block including the routine to be processed is called.

PID Controller

Many applications require PID control functions in addition to the usual control tasks. For this purpose, the operating system of the S5-95U has a PID controller which can be called up from the program. The PID controller forms an integral part of the PLC's operating system and therefore takes up no space in the user memory.

Standard Function Blocks

Besides the performance capabilities of a program, programming overheads are of great importance. Standard function blocks including standardized program structures for recurrent, usually complex functions can be loaded in the S5-95U. These software blocks can easily be linked into the program and facilitate the task of programming considerably.

Table 1-4. Software Overview

Software Overview	S5-90U	S5-95U
User memory (1 statement=2 bytes)	4 KB	16 KB
Execution time for 1024 binary statements	2 ms	2 ms
Flags (512 retentive)	1024	2048
Counters (8 retentive)	32	128
Timers	32	128
Program organization:		
• Structured programming	Yes	Yes
• Interrupt-driven program execution	Yes	Yes
• Time-controlled program execution	No	Yes
• PID controller	No	Yes
• Standard function blocks	No	Yes

In addition to process control, production processes often require supplementary functions, such as closed-loop control or communication with I/Os. Special function modules are available for these tasks.

Intelligent I/O Modules (IPs)

Intelligent I/O modules process open-loop and closed-loop control functions and positioning tasks mainly autonomously. They can thus offload the CPU of the PLC.

Communications Processors (CPs)

Communications processors enable point-to-point connections between the PLC and printers, peripherals or other computers via integral serial interfaces. They also permit interfacing with the SINEC L1 LAN.

Operator Control and Process Monitoring Equipment (TDs, OPs)

Processes and functions in your plant can be visualized with the help of operator control and process monitoring equipment especially tuned to SIMATIC S5 programmable controllers. Text displays (TDs) can be used for process monitoring; operator panels (OPs) enable spontaneous intervention in the process if necessary.

Communications

Complex applications sometimes make it necessary for the programmable controller to communicate with other PLCs or peripherals. SIMATIC S5 PLCs offer two possibilities:

- Point-to-point connections or
- Networking via SINEC L1 and SINEC L2 LANs.

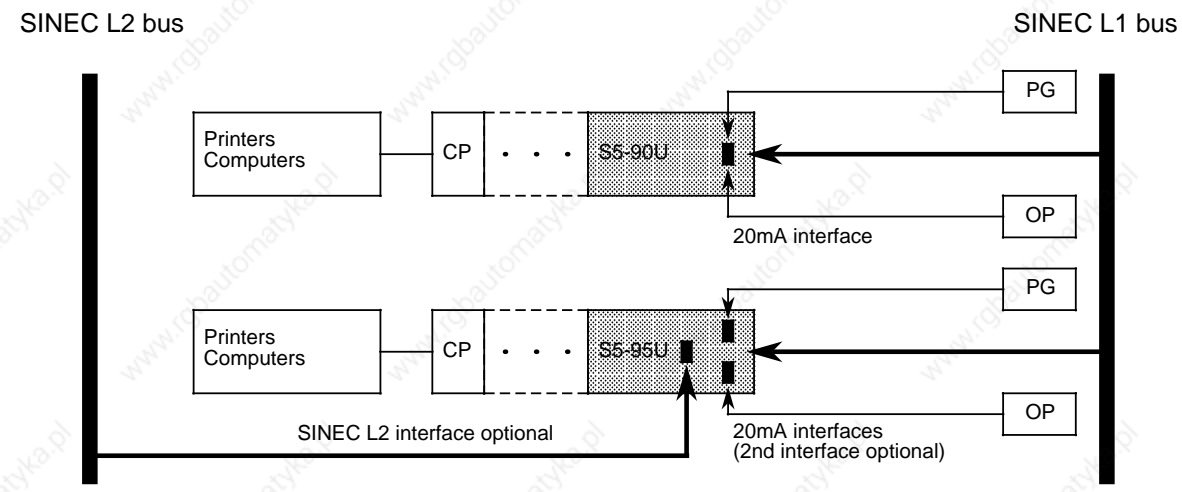

Figure 1-2. Communications Capabilities

Point-to-point connections are the ideal solution for connecting up only two devices. They are both economical and very efficient. The integral 20 mA (TTY) interface (programmer interface) can be used to connect a programmer (PG) or operator panel (OP).

The optional second serial interface (20 mA) of the S5-95U permits the simultaneous connection of programmers and operator panels. Additionally, the following devices can be linked:

- Other SIMATIC PLCs (SINEC L1 protocol, S5-95U as point-to-point master)
- Siemens devices (3964(R) protocol) or
- Third-party devices (ASCII protocol).

Communications processors (CPs) offer additional communications possibilities.

If more than two devices are to be interconnected, the use of a LAN is recommendable. The low-cost **SINEC L1 LAN** for applications that are not critical with regard to time can connect devices over distances of up to 50 km via a four-wire cable. It can easily be expanded for a maximum of 31 stations.

S5-90U and S5-95U programmable controllers can be connected as slaves to this LAN via the integral 20 mA (TTY) interface (programmer interface) or the CP 521 SI communications processor.

The S5-95U is optionally available with SINEC L2 interface. **SINEC L2** is the LAN type required for the lower and medium-range cell and field levels in industrial environments and conforms to the PROFIBUS standard (DIN 19245).

The open LAN architecture permits the connection of non-Siemens field devices. However, it is also possible to link S5-95U PLCs only.

The S5-95U with SINEC L2 interface can communicate both as active and passive station on the bus.

Conventional controls using relays or contactors are hardwired. Their functions are implemented by wiring the switching elements. If the control task changes, time-consuming modifications of the wiring have to be made.

In a programmable controller, however, rewiring is taken over by the program. Modifications of functions, testing and start-up are thus considerably facilitated.

STEP 5 programming language

It enables the first-time user to become quickly familiar with PLC technology. The SIMATIC PLCs can be programmed using the STEP 5 language. STEP 5 is easy to comprehend and makes developing of programs user-friendly, flexible and economical.

Methods of representation

STEP 5 features four methods of representation:

- Statement list (STL)
- Control system flowchart (CSF)
- Ladder diagram (LAD)
- GRAPH 5, GRAPH Mini.

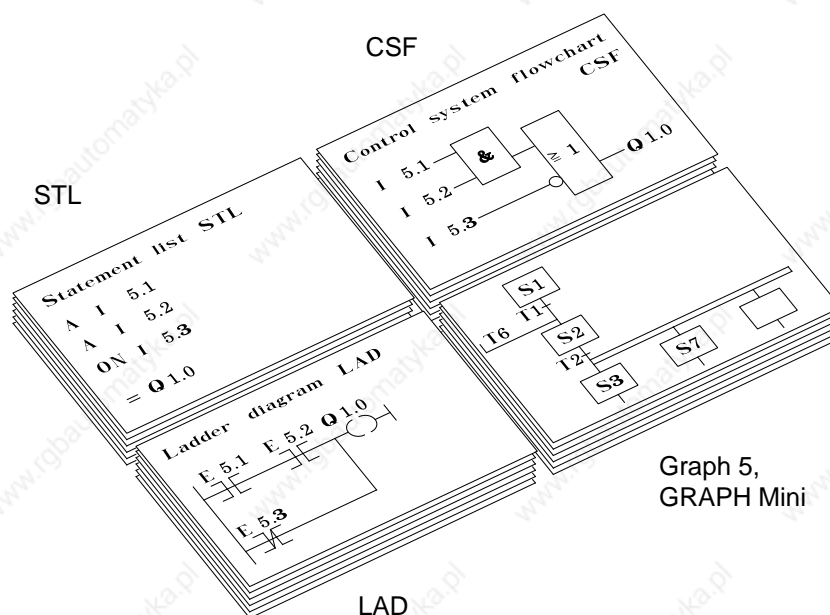

Figure 1-3. STEP 5 Programming Language

The **statement list** uses mnemonics for statements.

The **control system flowchart** is ideal for those who prefer the logic representation of machine functions and processes.

If you are accustomed to working with circuit diagrams, the use of the **ladder diagram** is recommendable.

The following packages are additionally available for programming sequential controls:

- **GRAPH Mini** and
- **GRAPH 5** (limited use only; for S5-95U only)

STEP 5 Versions

STEP 5 is available in two different versions to come up to the various demands placed on the software:

- **STEP 5 for mini PLCs** is designed especially for programming the S5-90U, S5-95U and S5-100U programmable controllers.
The software is supplied with the PG 710 programmer and also executes on AT-compatible PCs.
- **STEP 5 as basic package** is the most powerful STEP 5 version. It can be used for all SIMATIC PLCs - from mini PLCs to high-end PLCs.

Programmers

For programming, modifications, testing and start-up, the SIMATIC range offers a wide selection of programmers with graded performance which can be used for any of the PLCs:

- **PG 605**, the hand-held unit for programming and servicing;
(for S5-90U: 6ES5 605-0UA12)
- **PG 710**, light and handy like a laptop; the PG 710 I variant is specially matched to mini PLCs.
- **PG 730**, the mobile power pack; full programming performance always at hand.
- **PG 750**, rugged, compact and expandable; ideal for use in the workshop and in the plant.
- **PG 770**, the desktop programmer for configuring and programming, process monitoring and diagnostics.

www.rgbautomatyka.pl

2 Technical Description		
2.1	Programmable Controller Design - without External I/Os	2 - 1
2.1.1	Design of the S5-90U	2 - 1
2.1.2	Design of the S5-95U	2 - 3
2.2	Internal Electrical Configuration	2 - 5
2.2.1	Internal Electrical Configuration of the S5-90U	2 - 5
2.2.2	Internal Electrical Configuration of the S5-95U	2 - 6
2.3	Principle of Operation of the PLCs	2 - 7
2.3.1	Functional Units	2 - 7
2.3.2	Peculiarities of the PLCs	2 - 10

Figures

2-1	S5-90U: LEDs, Controls and Interfaces	2 - 1
2-2	S5-90U: Pin Assignments of the Programmer Interface	2 - 2
2-3	S5-95U: LEDs, Controls and Interfaces	2 - 3
2-4	S5-95U: Pin Assignments of the Programmer Interface	2 - 4
2-5	A Simplified Display of the Floating Onboard I/Os	2 - 5
2-6	A Simplified Display of the S5-95U with Non-Floating and Floating Onboard I/Os	2 - 6
2-7	Functional Units of the PLCs	2 - 7
2-8	STEP 5 Program and Compiled Program	2 - 10

2 Technical Description

This chapter describes the design and principle of operation for the PLCs.

2.1 Programmable Controller Design - without External I/Os

The following sections discuss programmable controllers but do not discuss external modules. Both controllers have a limited number of inputs and outputs available on board.

2.1.1 Design of the S5-90U

S5-90U: LEDs, Controls and Interfaces

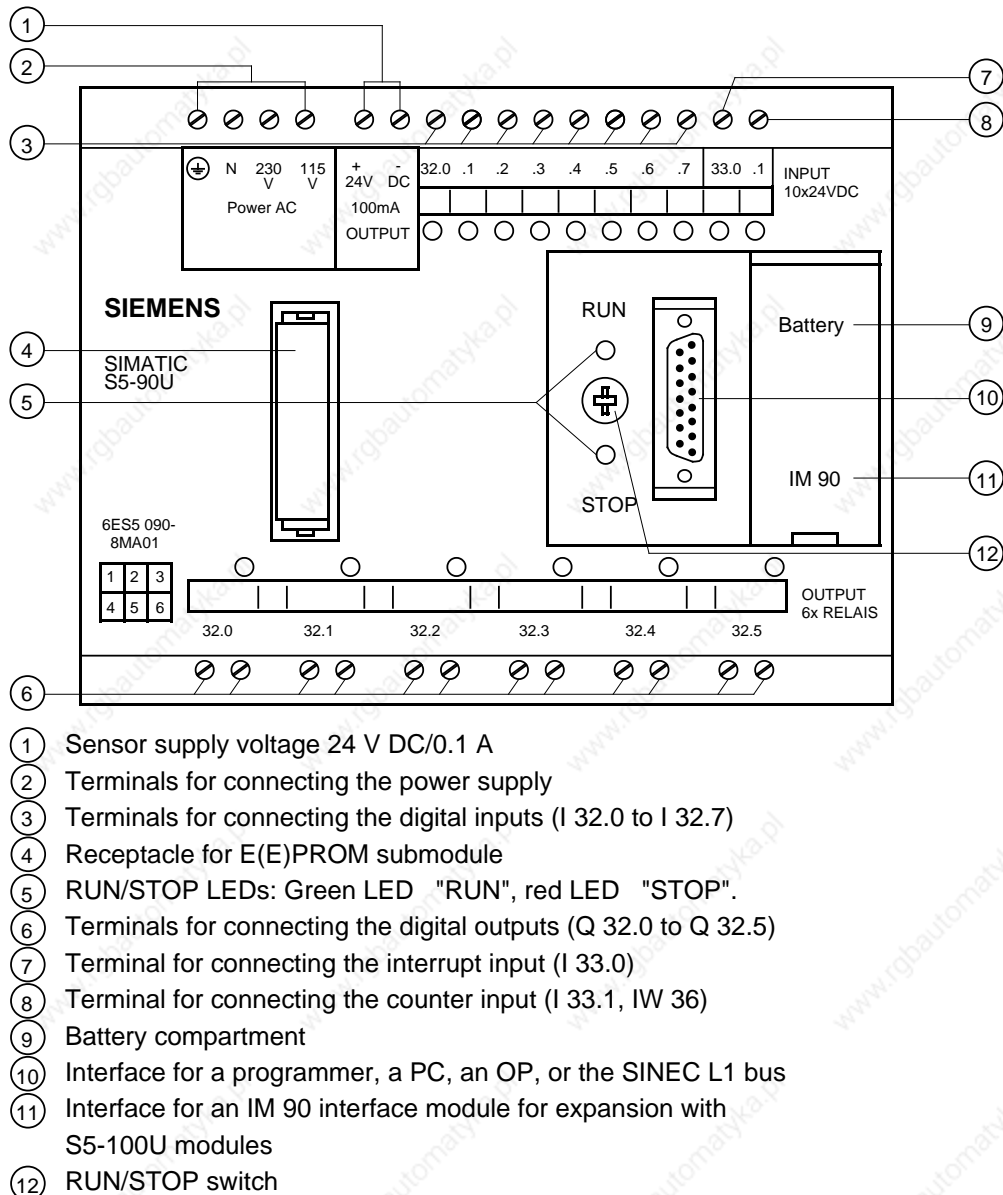

Figure 2-1. S5-90U LEDs, Controls and Interfaces

S5-90U: Pin Assignments of the Programmer Interface

The programmer interface is non-floating. The signal lines are connected to a 15-pin sub D socket.

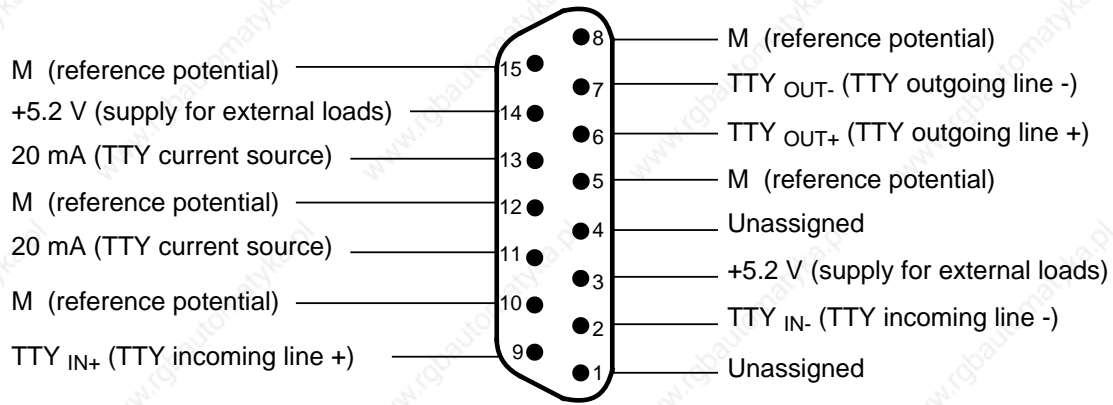
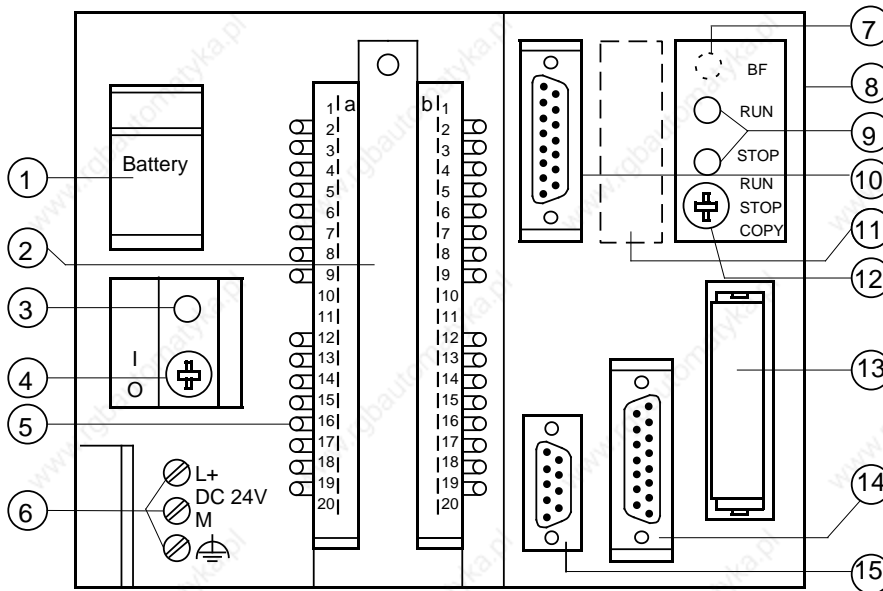

Figure 2-2. Pin Assignments of the Programmer Interface of the S5-90U

2.1.2 Design of the S5-95U

S5-95U: LEDs, Controls and Interfaces



- ① Battery compartment
- ② Front panel connector for digital inputs (I 32.0 to I 33.7) and for digital outputs (Q 32.0 to Q 33.7)
- ③ Battery low LED
- ④ ON/OFF switch
- ⑤ LED display for digital inputs and outputs
- ⑥ Terminals for connecting the power supply
- ⑦ SINEC L2 bus fault LED for S5-95U, Order Nos. 6ES5 095-8MB... ; SINEC L2-DP bus fault LED for S5-95U, Order Nos. 6ES5 095-8MD...
- ⑧ Cable connector for S5-100U modules
- ⑨ RUN/STOP LEDs: Green LED "RUN", red LED "STOP".
- ⑩ Interface for analog inputs (IW 40 to IW 54) and for analog output (QW 40)
- ⑪ SINEC L2 interface for S5-95U, Order Nos. 6ES5 095-8MB...; 2nd serial interface for S5-95U, Order Nos. 6ES5 095-8MC...; SINEC L2-DP interface for S5-95U, Order Nos. 6ES5 095-8MD...
- ⑫ RUN/STOP/COPY switch
- ⑬ Receptacle for E(E)PROM submodule
- ⑭ Interface for a programmer, PC, OP or SINEC L1 bus
- ⑮ Interface for interrupt inputs (I 34.0 to 34.3) and for counter inputs (IW 36, IW 38)

Figure 2-3. S5-95U LEDs, Controls and Interfaces

S5-95U : Pin Assignments of the Programmer Interface

The programmer interface is non-floating. The signal lines are connected to a 15-pin sub D socket.

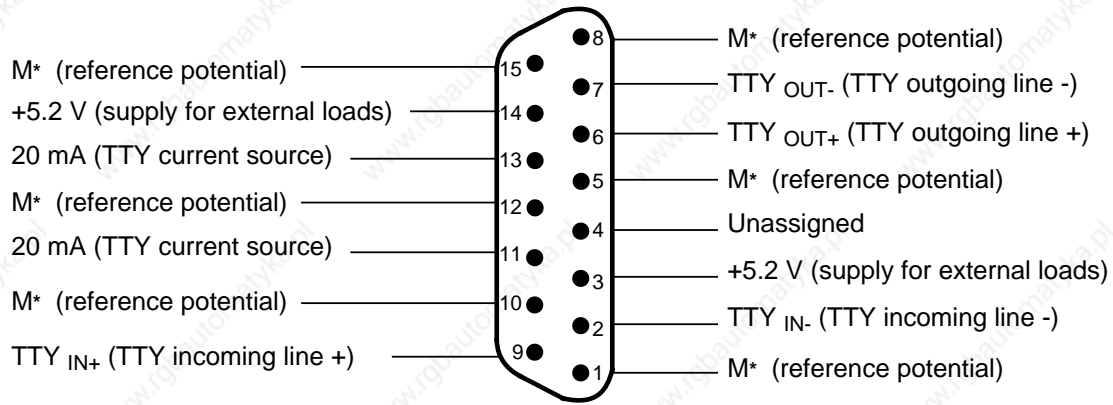

* M 6 M internal (also available at SI12 interface)

Figure 2-4. Pin Assignments of the Programmer Interface of the S5-95U

2.2 Internal Electrical Configuration

2.2.1 Internal Electrical Configuration of the S5-90U

The S5-90U's onboard I/Os allow a floating configuration.

The ten onboard inputs have a common ground connection. The ground connection is attached to the negative pole of the PLC's 24 V DC voltage source. Optocouplers separate all inputs from the control circuit's ground.

The six onboard outputs are relay outputs. The connections for the relay contacts are separate and do not have a mutual connection.

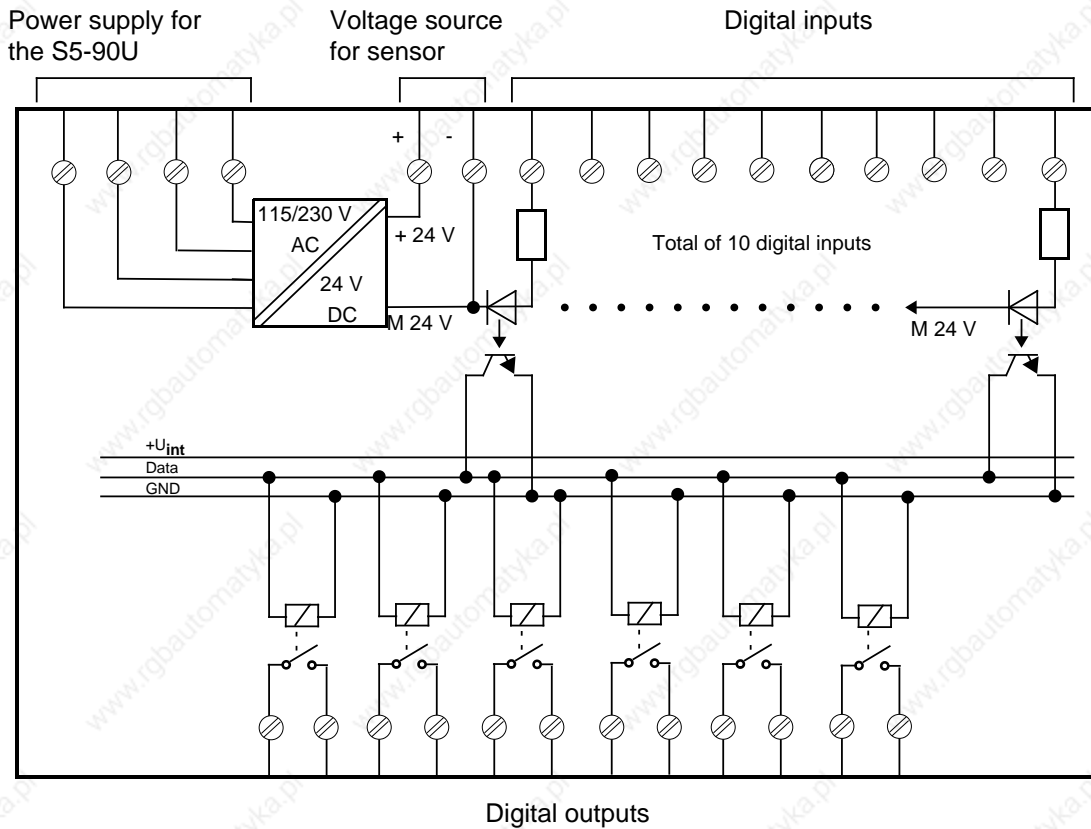

Figure 2-5. A Simplified Display of the Floating Onboard I/Os

2.2.2 Internal Electrical Configuration of the S5-95U

The digital onboard I/Os for the S5-95U are galvanically isolated from the control circuit by optocouplers and allow a floating configuration.

The digital onboard I/Os are divided into groups (= number of inputs and outputs with separate 24 V DC connection)

- Two groups with 8 outputs each
- One group with 16 inputs

All digital inputs and outputs are connected to a common ground, i.e. they are non-floating with respect to each other.

The chassis ground of the analog inputs and outputs and the ground for the control circuit are connected. The counter and interrupt inputs are also not electrically isolated from the control circuit. All these inputs and outputs are therefore suitable for non-floating configurations only.

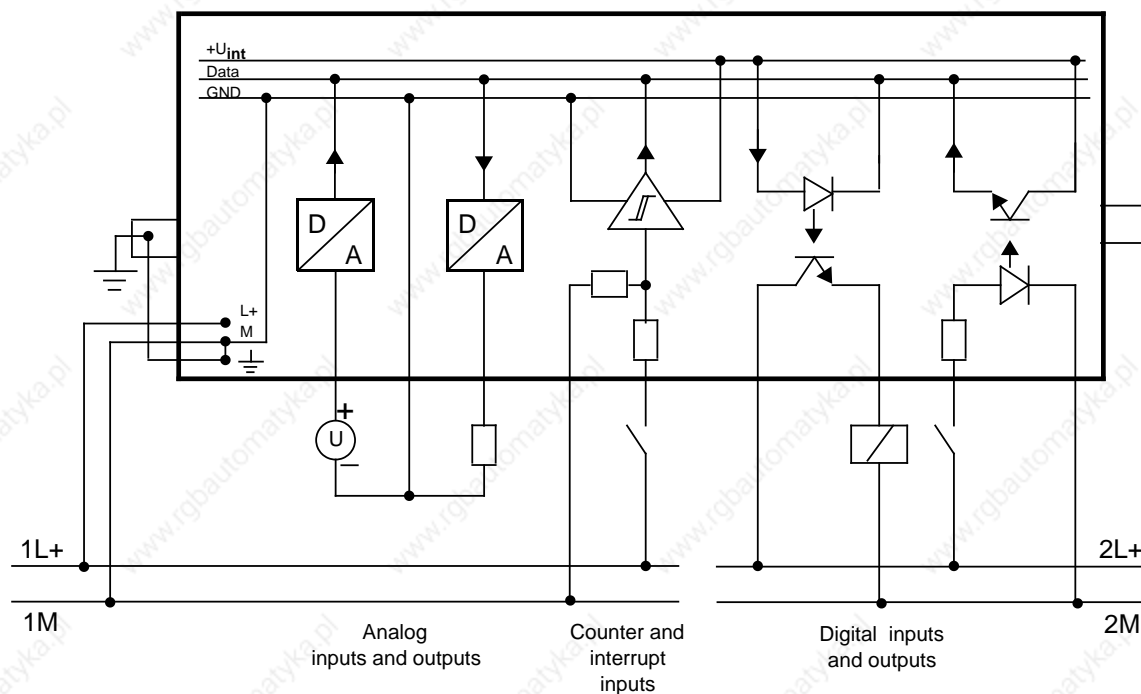

Figure 2-6. A Simplified Display of the S5-95U with Non-Floating and Floating Onboard I/Os

2.3 Principle of Operation of the PLCs

This section briefly describes the PLC's functional units processing your STEP 5 program.

2.3.1 Functional Units

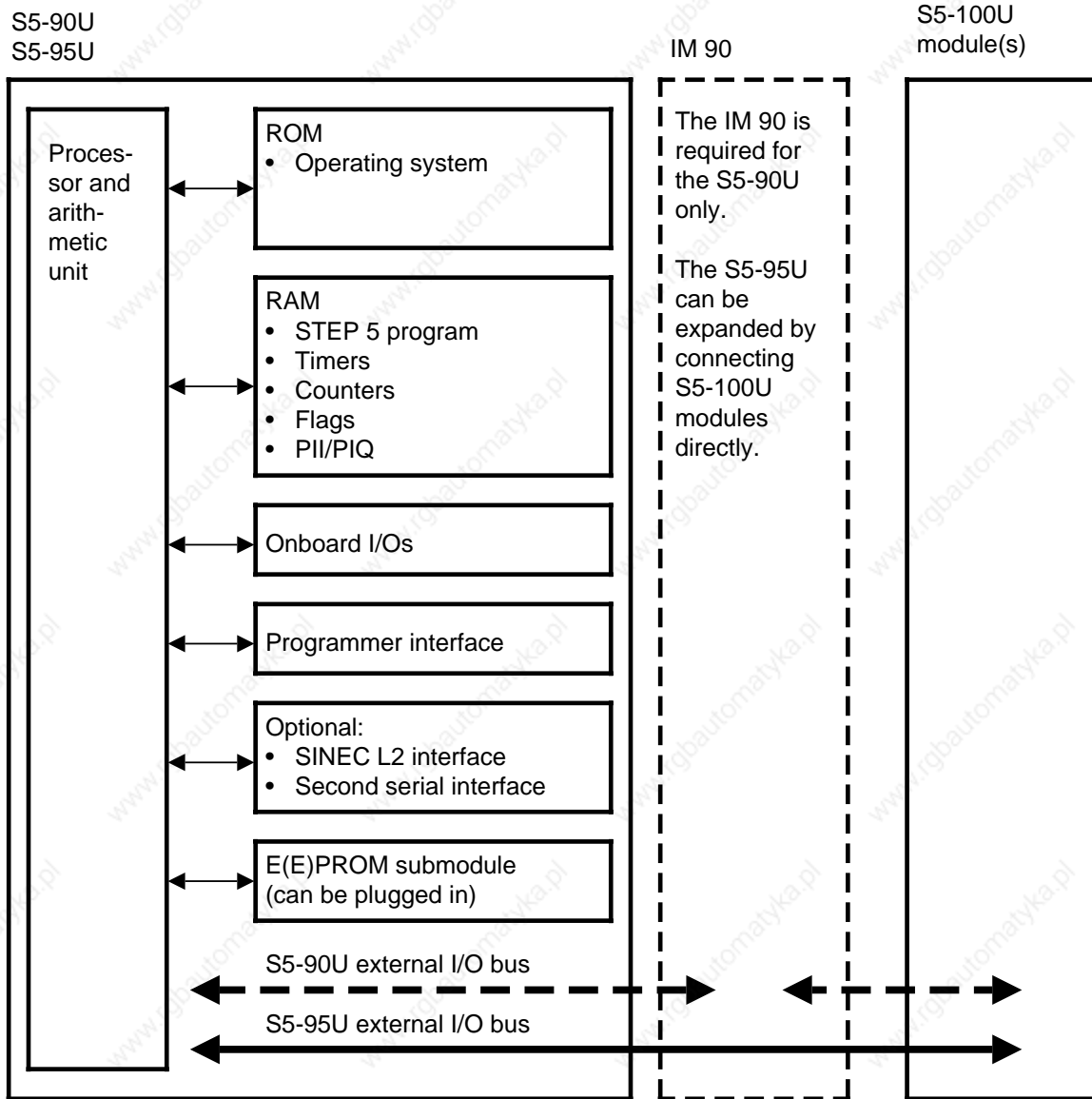

Figure 2-7. Functional Units of the PLCs

ROM

The operating system is stored in a ROM. It is thus fixed and cannot be changed.

RAM

All dynamic variables are stored in the RAM.

These are the following:

- STEP 5 program and compiled program.
The STEP 5 program cannot be processed unless it is transformed by a compiler into a form that can be interpreted by the processor and arithmetic unit.
- Process image and interrupt process image
The statuses of all inputs are cyclically read into the process input image (PII) and stored there until the next read-in cycle starts. The STEP 5 program reads the statuses of the inputs from the PII.
The process output image (PIQ) is written by the STEP 5 program.
The PIQ is cyclically written to the outputs.
The interrupt process image takes over the function of the process image during time-controlled program execution.
- Timers and counters
Timers are used for time measurement in the range of 10 ms to 9990 s with a resolution of 10 ms. Counters can be used for counting up or down in the range of 0 to 999.
Provided a backup battery is available, certain counters are saved in the RAM if the power supply breaks down or the PLC is switched off. These counters are called retentive counters.
- System data
The operating system stores intermediate results and certain PLC parameters in the system data.
- Flags
Flags are used by the STEP 5 program for buffering intermediate results. Provided a backup battery is available, certain flags are saved in the RAM if the power supply breaks down or the PLC is switched off. These flags are called retentive flags.

If no backup battery is available, the complete RAM contents are lost in the event of a power failure or when the PLC is switched off.

Onboard I/Os

The onboard I/Os include the following:

S5-90U:

- 10 digital inputs
(1 digital input can be used as interrupt input)
(1 digital input can be used as counter input)
- 6 digital outputs

S5-95U:

- 16 digital inputs
- 16 digital outputs
- 4 interrupt inputs
- 8 analog inputs
- 1 analog output
- 2 counter inputs

Note

An interference pulse lasting approximately 150 μ s is generated on switching on the supply voltage to the onboard I/O. "Normal" inputs do not accept this pulse. High-speed inputs (e. g. counters) recognize this pulse as a signal.

Programmer Interface

Interface for a programmer or operator control and monitoring device (TD or OP). The programmer interface can also be used for connecting the S5-90U and S5-95U as slaves to the SINEC L1 LAN.

SINEC L2 Interface or Second Serial Interface (Optional)

The S5-95U is also available with a SINEC L2 interface or a second serial interface.

The SINEC L2 interface enables the PLC to be linked with the SINEC L2 LAN either as active or passive station. In this way, for instance, several S5-95U PLCs can be networked.

The second serial interface represents an additional TTY interface with the following characteristics:

- SINEC L1 point-to-point master and SINEC L1 slave
- 3964(R) computer link
- ASCII driver
- Programmer functions

E(P)ROM Submodule (for Plugging in)

EPROMs or EEPROMs are non-volatile memory types for permanent storage of the control program. After an overall reset of the PLC or a power failure without battery backup, the control program is automatically loaded from the memory submodule into the RAM when the PLC is switched to POWER ON.

External I/O Bus

The external I/O bus forms the electrical connection between the PLC and the S5-100U modules used for expanding the PLC.

Processor and Arithmetic Unit

The processor executes the statements of the user program. The arithmetic unit consists of two registers, accumulators 1 and 2, and the condition codes. All arithmetic operations are processed in the accumulators. The condition codes provide information on unusual events during an arithmetic operation, such as violations of the permissible value range.

2.3.2 Peculiarities of the PLCs

The STEP 5 program developed by the user is not directly executed by the processor and arithmetic unit. It must first be translated by a compiler so that it can be interpreted by the processor and arithmetic unit.

The internal RAM therefore includes two separate areas for the STEP 5 program and the compiled program (see Figure 2-8).

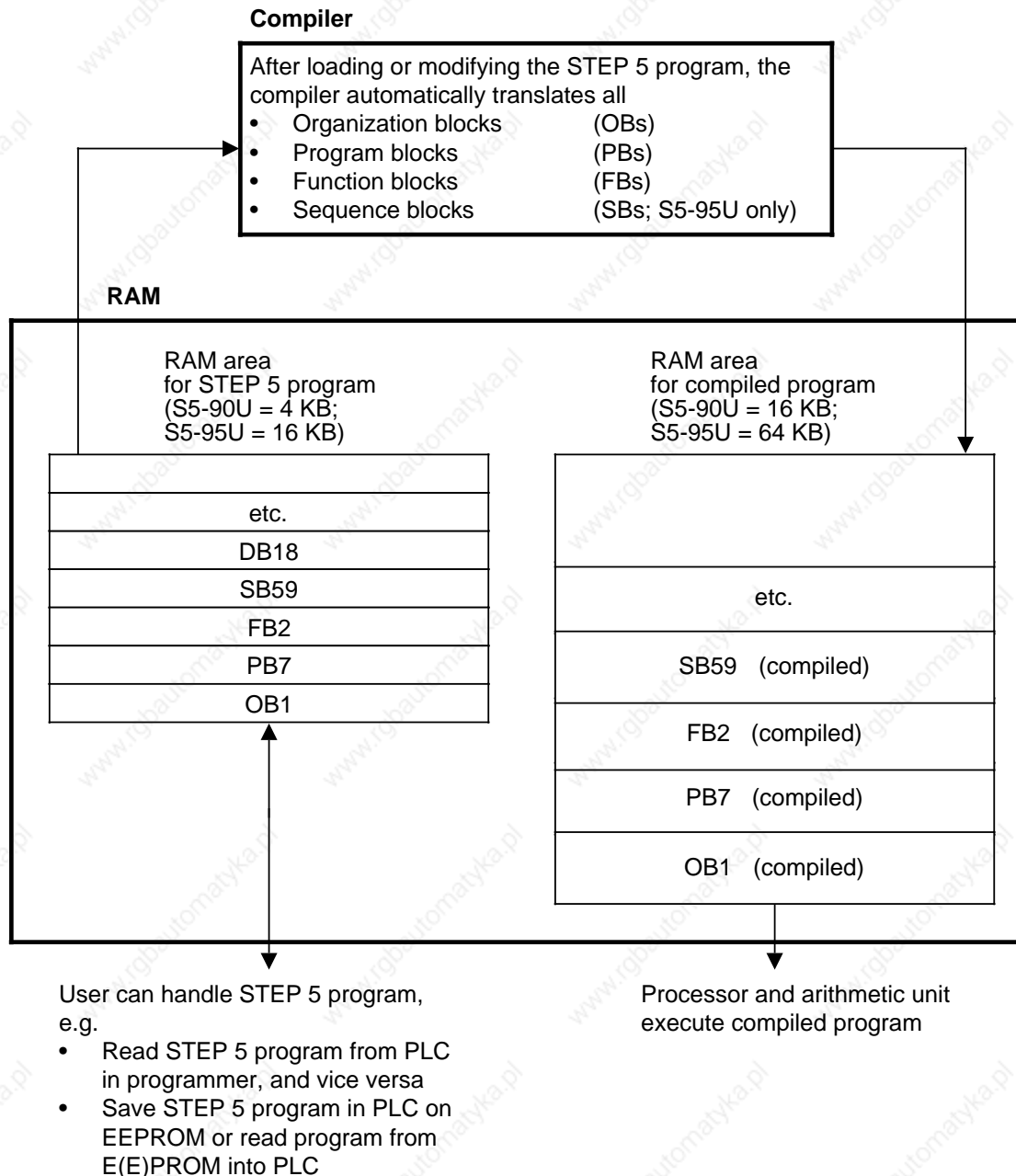

Figure 2-8. STEP 5 Program and Compiled Program

Only the compiled program is executed by the processor and arithmetic unit whereas the STEP 5 program remains in the RAM. It can be read back into the programmer.

In comparison with other PLCs whose processors and arithmetic units are able to process the STEP 5 program, this procedure involves some peculiarities when using the S5-90U/95U PLCs. These peculiarities are specially referred to in the relevant sections of this System Manual.

Note

Only the compiler, processor and arithmetic unit have access to the RAM area for the compiled program. It **cannot** be accessed via the programmer or STEP 5 program.

Under extreme conditions, the RAM area for the compiled program in the S5-95U might overflow although the STEP 5 program takes up less than 16 KB.

Result: PLC enters the STOP state (STOP LED flashes)

Remedy: Divide long blocks into smaller ones.

www.rgbautomatyka.pl

3 Installation Guidelines

3.1	Mounting the PLC	3 - 1
3.2	Mounting the PLCs with External I/Os	3 - 5
3.2.1	Mounting the S5-90U with External I/Os	3 - 5
3.2.2	Mounting the S5-95U with External I/Os	3 - 7
3.2.3	How to Plug External I/O Modules into the Bus Units	3 - 9
3.2.4	Multi-Tier Expansion	3 - 11
3.2.5	Cabinet Mounting	3 - 13
3.3	Wiring	3 - 15
3.3.1	Connection Methods	3 - 15
3.3.2	Connecting the Power Supply to the S5-90U	3 - 19
3.3.3	Connecting the Power Supply to the S5-95U	3 - 19
3.3.4	Connecting the Onboard I/Os of the S5-90U	3 - 20
3.3.5	Connecting the Onboard I/Os of the S5-95U	3 - 22
3.3.6	Connecting External I/Os	3 - 24
3.4	Electrical Configuration with External I/Os	3 - 25
3.4.1	Electrical Configuration of the S5-90U with External I/Os	3 - 25
3.4.2	Electrical Configuration of the S5-95U with External I/Os	3 - 27
3.4.3	Connecting Non-Floating and Floating Modules	3 - 30
3.5	Wiring Arrangement, Shielding and Measures against Electromagnetic Interference	3 - 33
3.5.1	Running Cables Inside and Outside a Cabinet	3 - 33
3.5.2	Running Cables Outside Buildings	3 - 34
3.5.3	Equipotential Bonding	3 - 35
3.5.4	Shielding Cables	3 - 36
3.5.5	Special Measures for Interference-Free Operations	3 - 37

Figures		
3-1	Mounting the S5-90U on a Wall	3 - 2
3-2	Drilling Template for Mounting the S5-90U Using Wall Brackets	3 - 2
3-3	Mounting the Programmable Controller on a Standard Mounting Rail	3 - 3
3-4	Removing the Programmable Controller	3 - 4
3-5	Installation with External I/Os for an S5-90U	3 - 5
3-6	Connecting the IM 90 to the S5-90U and the Bus Units	3 - 6
3-7	Installation with External I/Os for an S5-95U	3 - 7
3-8	Connecting the Bus Units	3 - 9
3-9	Coding System to Prevent Inadvertent Confusing of Modules	3 - 10
3-10	Interconnecting Tiers with Interface Modules (6ES5 316-8MA12)	3 - 11
3-11	Minimum Clearances for a Multi-Tier Configuration Mounted in a Cabinet; PLC without/with Wiring Devices/Cable Duct	3 - 13
3-12	Vertically Mounting a PLC	3 - 14
3-13	Standard Screw-Type Terminals	3 - 15
3-14	SIGUT Screw-Type Connection	3 - 16
3-15	Crimp Snap-in Contacts	3 - 17
3-16	Connecting and Disconnecting Crimp Snap-in Contacts	3 - 18
3-17	Connecting the S5-90U to the Supply Mains	3 - 19
3-18	Connecting the S5-95U and the PS 931 Power Supply Module	3 - 19
3-19	Example of How Digital Inputs Can Be Connected	3 - 20
3-20	Example of How Digital Outputs Can Be Connected	3 - 20
3-21	Connecting the Interrupt Input and the Counter Input	3 - 21
3-22	Wirings of the Front Connector for Digital Inputs and Outputs	3 - 22
3-23	An Example of an Analog Input and an Analog Output Connection	3 - 23
3-24	Connecting the Interrupt Inputs	3 - 24
3-25	Connecting a Counter Input	3 - 24
3-26	Configuration for the S5-90U with External I/Os and a 115/230 V AC Power Supply	3 - 26
3-27	Grounded Configuration for the S5-95U with a 24 V DC Power Supply with Safe Electrical Isolation in Accordance with VDE 0160 for a Programmable Controller and Non-floating, External I/Os	3 - 28
3-28	Ungrounded Configuration: 24 VDC Power Supply with Safe Electrical Isolation according to VDE 0160 - For Use with a Programmable Controller and External I/Os	3 - 29
3-29	Simplified Representation of an Installation with Non-floating Modules	3 - 30
3-30	Simplified Representation of an Installation with Floating Modules	3 - 31
3-31	Laying Equipotential Bonding Conductor and Signal Cable	3 - 35
3-32	Fixing Shielded Cables with Various Types of Cable Clamps	3 - 37
3-33	Wiring Coils	3 - 37
3-34	Measures for Suppressing Interference from Fluorescent Lamps in the Cabinet	3 - 38
Tables		
3-1	Mounting Options for the PLCs	3 - 1
3-2	Mounting, Removing and Replacing the Hardware	3 - 1
3-3	Rules for Common Running of Lines	3 - 33

3 Installation Guidelines

3.1 Mounting the PLC

The PLC can either be mounted to a wall using wall brackets or snapped onto a standard mounting rail.

Table 3-1. Mounting Options for the PLCs

Fixing part	S5-90U		S5-95U	
	Without external I/Os	With external I/Os	Without external I/Os	With external I/Os
Wall bracket	X	-	-	-
Mounting rail	X	X	X	X

Use the following table when installing or removing the PLC, or when changing the configuration.

Table 3-2. Mounting, Removing and Replacing the Hardware

Mounting, Removing, and Changing of:	Status of PLC Power Supply	PLC Operating Mode	Load Voltage
S5-90U, S5-95U	Power OFF	Not relevant	OFF
I/O modules	Not relevant	STOP	OFF
Bus units Interface modules	Power OFF	Not relevant	Not relevant

Mounting with Wall Brackets

If you use the S5-90U without external I/O modules, you can mount the controller directly on walls or mounting plates.

Mounting (see Figure 3-1)

Fix the lower wall brackets using screws of size M5.

Push the PLC into the wall brackets until it snaps into place.

Push the upper wall brackets into the appropriate openings on the controller until the brackets snap into place.

Fix the upper wall brackets using screws of size M5.

Removing

Remove all connected supply cables and signal cables.

Carry out the four steps described for mounting in reverse order.

Figure 3-1 shows you how to mount the S5-90U using wall brackets

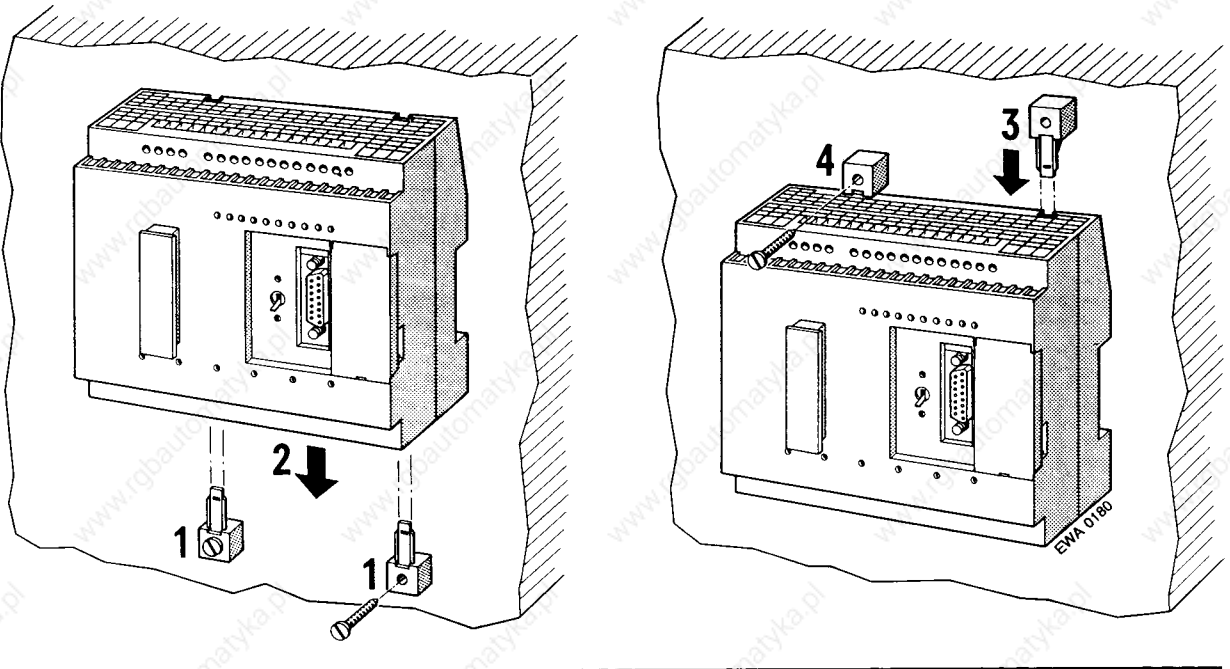

Figure 3-1. Mounting the S5-90U on a Wall

Figure 3-2 specifies the spacings for the drill holes required for the wall brackets.

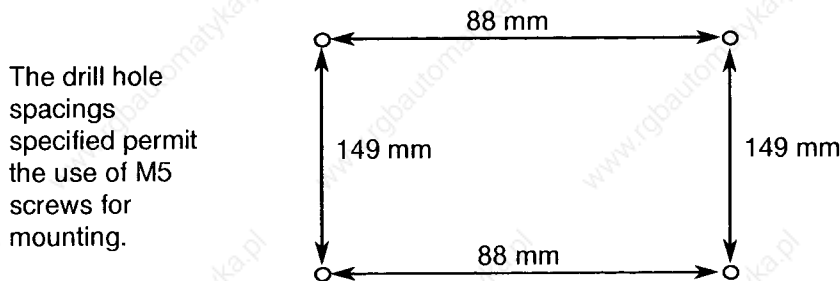

Figure 3-2. Drilling Template for Mounting the S5-90U Using Wall Brackets

Mounting the PLCs on Standard Mounting Rails

Installation

- ▶ Hook the PLC onto the standard mounting rail.
- ▶ Swing the PLC back until the slide on the bottom of the controller audibly snaps into place.

Figure 3-3 shows the installation of the S5-95U using a standard mounting rail.

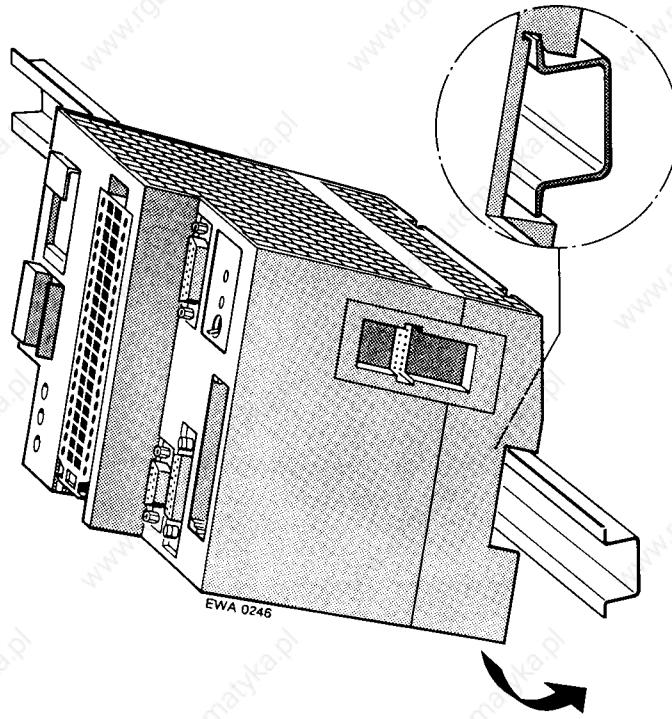

Figure 3-3. Mounting the Programmable Controller on a Standard Mounting Rail

Removal:

- ▶ Remove all connected supply cables and signal cables.
- ▶ Using a screwdriver, press down on the slide on the bottom of the PLC.
- ▶ Swing the PLC up and out of the standard mounting rail.

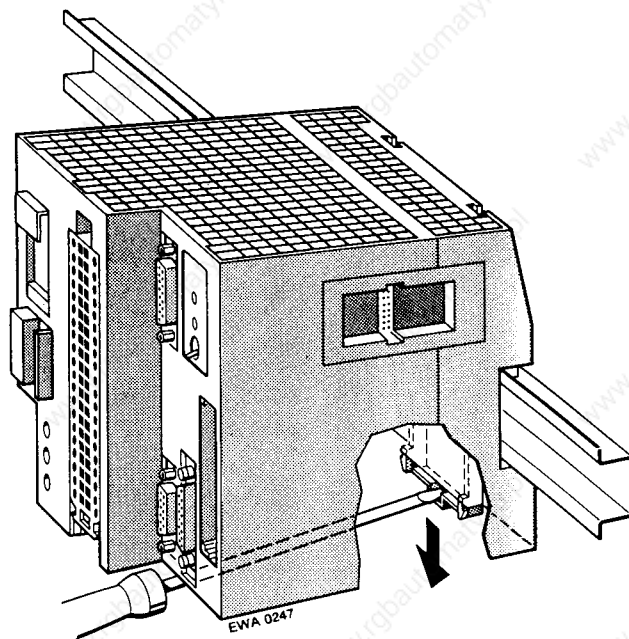

Figure 3-4. Removing the Programmable Controller

3.2 Mounting the PLCs with External I/Os

You can expand the programmable controllers by using S5-100U external I/O modules. If you install S5-100U external I/O modules, mount the PLC, bus units, and interface module on a 35-mm standard mounting rail and connect them to each other. Each bus unit has room available for two I/O modules.

3.2.1 Mounting the S5-90U with External I/Os

To assemble a tier with the S5-90U, you need the following parts:

- An S5-90U
- IM 90 interface module
- Bus units (maximum of three)
- I/O modules
- Standard mounting rail

Mount the first module on the far left end and then add the other modules to the right of the first module.

Figure 3-5 shows an installation with external I/Os for the S5-90U.

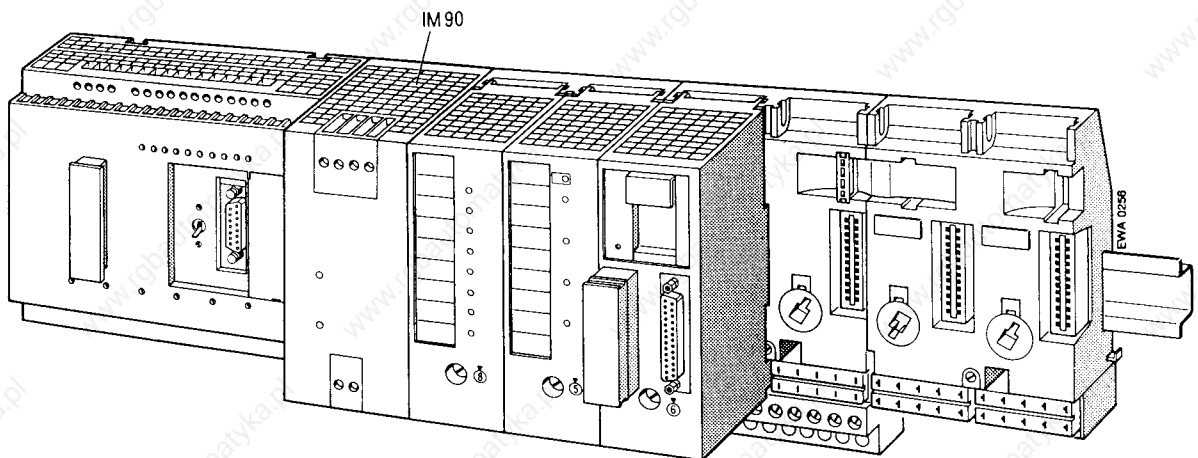

Figure 3-5. Installation with External I/Os for an S5-90U

Mounting and Removing the Bus Units

Bus units are also mounted on a standard mounting rail. Mount the bus units in the same way you mounted the controller or a power supply module.

There are small hooks on the sides of the bus units that interlock them.

Mounting the Bus Units

- ▶ Hook the bus unit onto the standard mounting rail.
- ▶ Press the bus unit down firmly until the slide audibly snaps into place.
- ▶ Pull the flat ribbon cable connector (top left on the bus unit) out of its holder.
- ▶ Plug the connector into the receptacle on the right side of the PLC or into the receptacle of the adjacent bus unit on the left side (see Figure 3-6).

Removing the Bus Units

- ▶ Loosen the connections (flat ribbon cable) to the adjoining devices.
- ▶ Using a screwdriver, press down on the slide.
- ▶ Swing the bus unit up and out of the standard mounting rail.

How to Connect the S5-90U to the IM 90

- ▶ Open the cover on the front of the S5-90U (plug connector will be visible).
- ▶ Pull the plug with the flat ribbon cable out of the IM 90 mount.
- ▶ Connect the plug to the S5-90U's plug connector (see Figure 3-6).
- ▶ Close the cover.

How to Connect the IM 90 to the Bus Unit

- ▶ Pull the plug with the flat ribbon cable out of the bus unit mount.
- ▶ Connect the plug to the plug connector on the right side of the IM 90 (see Figure 3-6).

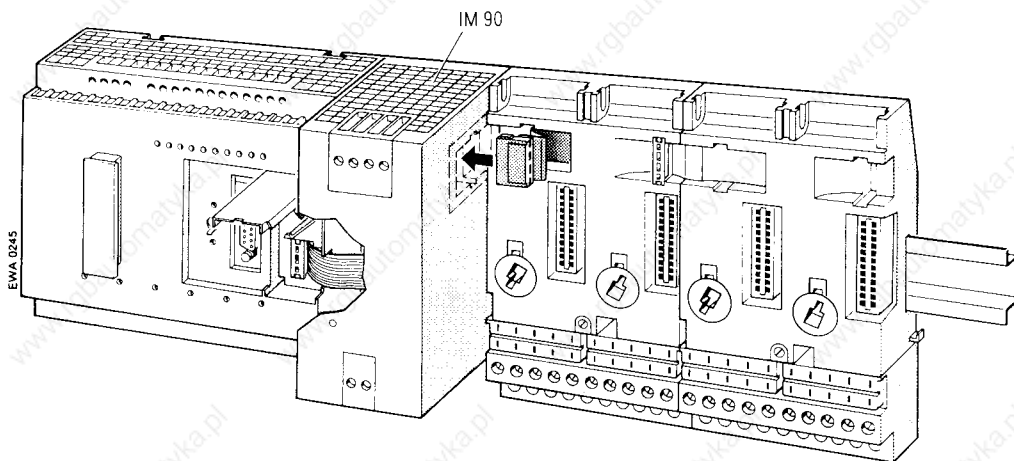

Figure 3-6. Connecting the IM 90 to the S5-90U and the Bus Unit

Removing the S5-90U

- ▶ Disconnect the PLC from the 115 V/230 V AC power supply.
- ▶ Remove all connected signal cables and supply cables.
- ▶ Disconnect the PLC from the IM 90 (flat ribbon cable).
- ▶ Using a screwdriver, press down on the slide on the bottom of the PLC.
- ▶ Swing the PLC up and out of the standard mounting rail.

3.2.2 Mounting the S5-95U with External I/Os

To assemble a tier with the S5-95U, you need the following parts:

- An S5-95U
- A power supply module (such as the PS 931) - if you do not have a 24 V DC power supply available
- Bus units (maximum of 16)
- I/O modules
- Standard mounting rail

Mount the first module on the far left end of the standard mounting rail and then add the other modules to the right of the first module.

Figure 3-7 shows an installation with external I/Os for the S5-95U.

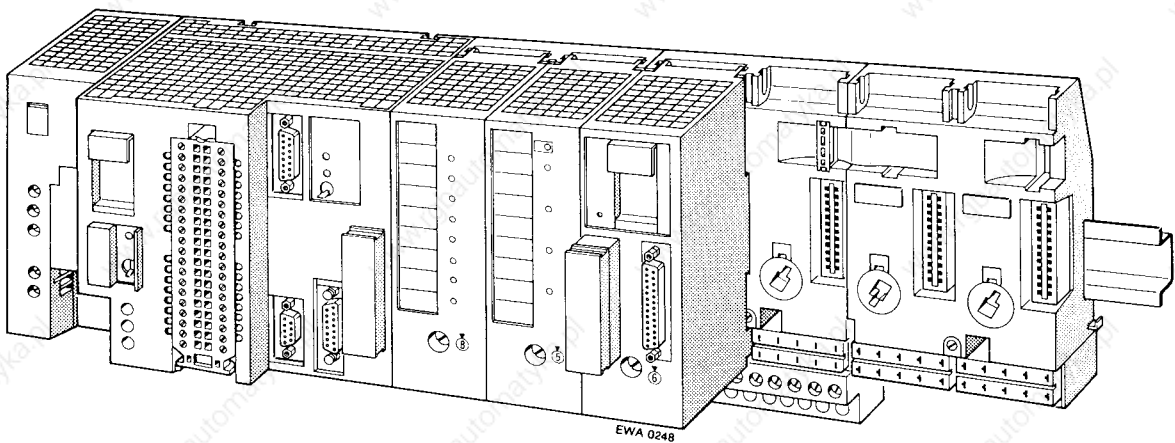

Figure 3-7. Installation with External I/Os for an S5-95U

Mounting the PS 931 Power Supply Module

Hook the power supply module onto the standard mounting rail.
Press the module down firmly until the slide snaps onto the rail.

Removal:

Turn off the 115 V/230 V AC power supply.
Loosen the connections between the PLC and the power supply module.
Using a screwdriver, press down on the slide on the bottom of the module.
Swing the module up and out of the standard mounting rail.

How to Connect Bus Units to the S5-95U

Bus units are also mounted on a standard mounting rail. Mount the bus units in the same way you mounted the controller or a power supply module.
There are small hooks on the sides of the bus units that interlock them.

Mounting the bus units

Hook the bus unit onto the standard mounting rail.
Press the bus unit down firmly until the slide audibly snaps into place.
Pull the flat ribbon cable connector (top left on the bus unit) out of its holder.
Plug the connector into the receptacle on the right side of the controller or into the receptacle of the adjacent bus unit on the left side (see Figure 3-8).

Removing the bus units

Loosen the connections (flat ribbon cable) to the adjoining devices.
Using a screwdriver, press down on the slide.
Swing the bus unit up and out of the standard mounting rail.

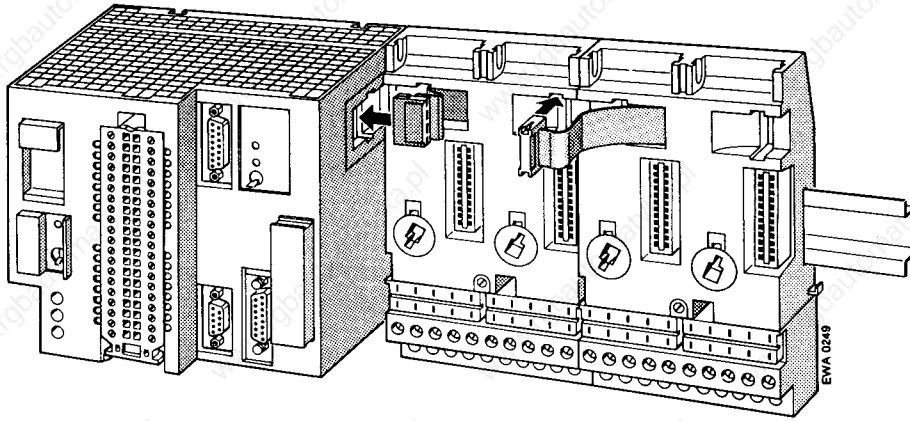

Figure 3-8. Connecting the Bus Units

To remove the S5-95U, proceed as follows:

- ▶ Turn off the 24 V DC power supply.
- ▶ Remove all connected signal cables and supply cables.
- ▶ Remove the I/O module that is in slot 0.
- ▶ Loosen the connection (flat ribbon cable) between the controller and the first bus unit.
- ▶ Using a screwdriver, press down on the slide located on the bottom of the controller.
- ▶ Swing the controller up and out of the standard mounting rail.

3.2.3 How to Plug External I/O Modules into the Bus Units

Before you mount an input or output module, you must set the coding element on the bus unit to match the module type. The coding element keeps you from confusing module types when exchanging modules.

Use the following information to set the coding element:

A code number is printed on the frontplate of every I/O module. The number is between two and eight, depending on the particular module type. There is a white, mechanical coding key located on the back of each module. The position of the coding key is determined by the module type and cannot be changed. The bus unit has a mating component for each key, a white rotating coding element or "lock" (see Figure 3-9).

Attaching the I/O module

- ▶ Use a screwdriver to set the "lock" on the bus unit to the corresponding I/O module code number.

The 6ES5 788-8MA11 simulator module does not have a coding key. You can plug in this simulator module in place of any module.

- ▶ Hook the module onto the top of the bus unit.
- ▶ Swing the module down onto the bus unit.
- ▶ Press the module down firmly.
- ▶ Tighten the hold-down screw on the front of the module to attach the module to the bus unit.

Detaching I/O modules:

- ▶ Loosen the hold-down screw and swing the module up and out of the bus unit.

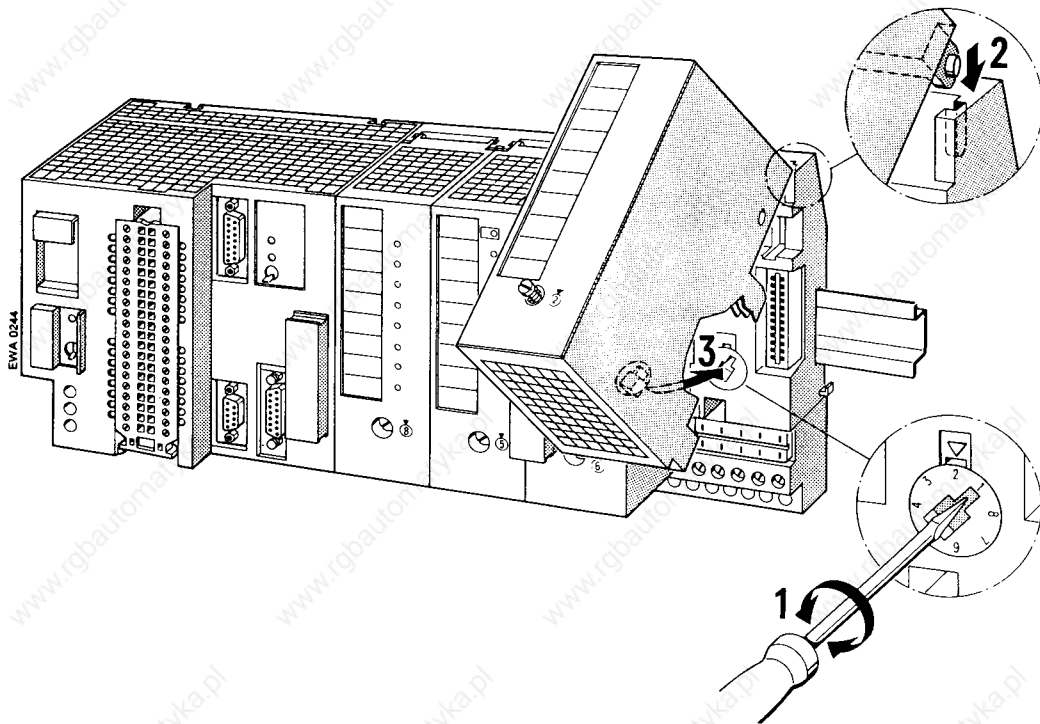

Figure 3-9. Coding System to Prevent Inadvertent Confusing of Modules

Note

Firmly tighten the screw connecting the module to the bus unit to preclude any malfunction.

3.2.4 Multi-Tier Expansion

If it is not possible to have all of the modules located on one tier, then you can expand the configuration up to four tiers. You need one interface module per tier to connect the tiers one to the other.

Install an interface module as you would install a bus unit. You must connect each interface module to the last bus unit via the flat ribbon cable.

Use the IM 315 interface module for two-tier configurations. The IM 315 consists of two modules permanently connected via a 0.5 m (20-in.) cable.

Use the IM 316 interface modules for multi-tier configurations. Use the 712-8 connecting cable to connect the IM 316 interface modules.

The standard mounting rails must have a common reference potential if they are mounted in different cabinets.

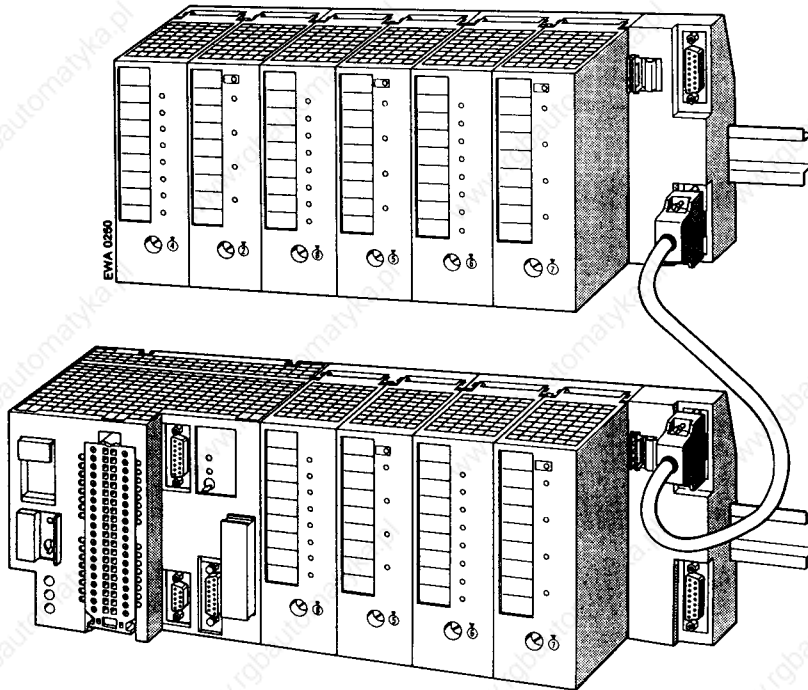

Figure 3-10. Interconnecting Tiers with Interface Modules (6ES5 316-8MA12)

At least one bus unit must be mounted on a tier. However, the maximum permissible number of bus units must not be exceeded (S5-90U: maximum 3 bus units; S5-95U: maximum 16 bus units).

Installing the interface module

Hook the interface module to the standard mounting rail.

Swing the interface module back until the slide on the bottom snaps into place on the rail.

Use the flat ribbon cable to connect the module to the last bus unit.

Use connecting cable 712-8 to join the two interface modules (in the case of the IM 318).

Connect the cable to the "out" socket on the PLC tier and to the "in" socket on the expansion tier.

Securely screw the connecting cable plugs in place.

Removing the interface module

Only for IM 316: Loosen the hold-down screws of the plugs and remove the connecting cable.

Remove the connecting flat ribbon cable from the adjacent bus unit.

Use a screwdriver to press down on the slide located on the bottom of the interface module.

Swing the module up and out of the standard mounting rail.

3.2.5 Cabinet Mounting

To help prevent noise, mount the programmable controller on a metal plate. The connections between the mounting rails should have a low impedance. Make sure that the system is bonded to earth.

You can use the 8LW system or the 8LX system mounting plates (see Catalog NV 21).

A minimum clearance of 210 mm between two mounting rails should be adhered to. Please refer to the dimension drawings in the Appendix.

Locate the programmable controller and the power supply on the lowest tier to provide adequate ventilation.

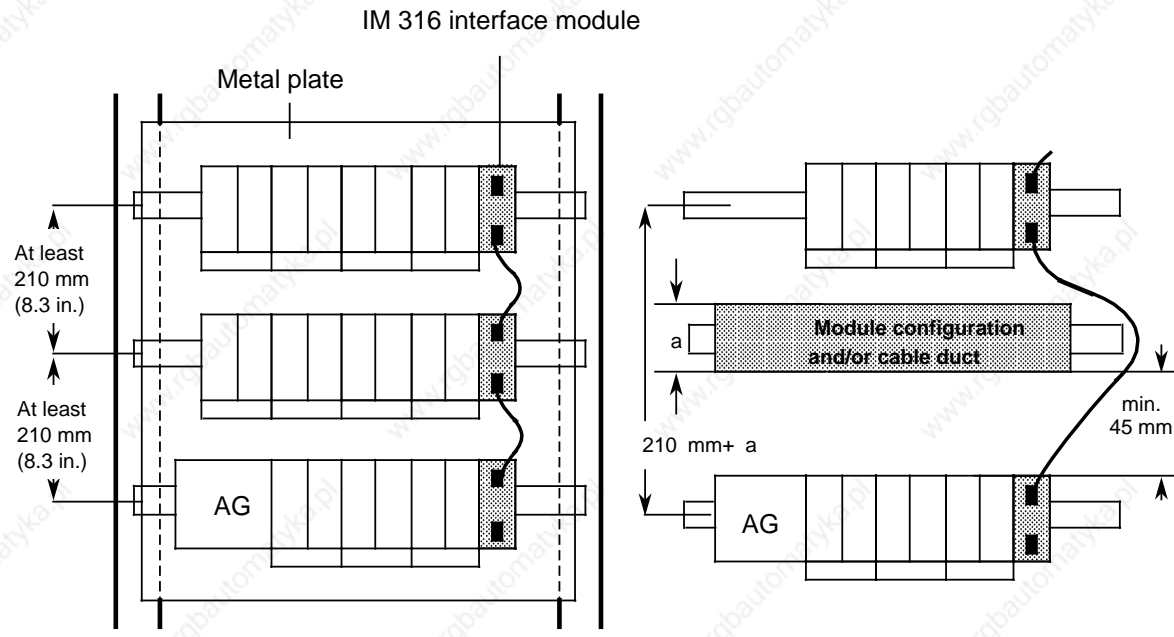

Figure 3-11. Minimum Clearances for a Multi-Tier Configuration Mounted in a Cabinet; PLC without/with Module Configuration/Cable Duct

Vertical Mounting

You can also mount the standard mounting rails vertically and then attach the modules one over the other. Because heat dissipation by convection is less effective in this case, the maximum ambient temperature allowed is 40° C (104° F).

Use the same minimum clearances for a vertical configuration as for a horizontal configuration.

You must install a clamp (see Catalog SA 2) on the lower end of the PLC tier to hold the modules in position.

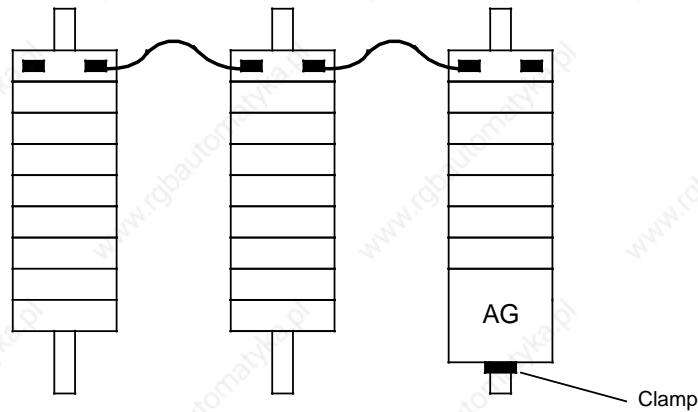

Figure 3-12. Vertically Mounting a PLC

3.3 Wiring

3.3.1 Connection Methods

The following wiring techniques can be used for the S5-90U and S5-95U:

- Standard screw-type connection
- SIGUT screw-type connection
- Crimp snap-in connection

Examples of Standard Screw-Type Terminals:

- Screw-type terminals of the S5-90U
- Screw-type terminals of the front connector of the S5-95U.

Screw-type terminals for power supply modules and inputs of the S5-90U:

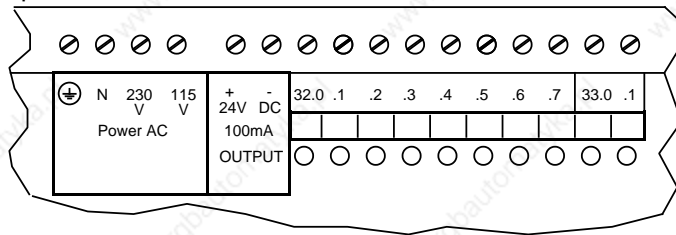

Front connector of the S5-95U:

((Bild v. BPZ))

Screw-type terminals for the outputs of the S5-90U:

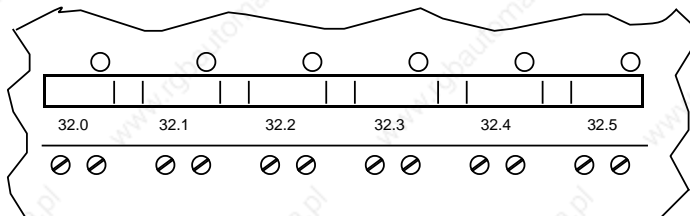

Figure 3-13. Standard Screw-Type Terminals

For standard screw-type connections, one cable per terminal can be connected. It is best to use a 3.5 mm screwdriver to tighten the screws.

Permissible cable cross-sections:

- Stranded conductor with core end sleeve: 1 x 0.25 to 1.5 mm²
- Solid conductor: 1 x 0.25 to 1.5 mm²

Examples of SIGUT Screw-Type Terminals:

- Screw-type terminals for the S5-95U PLC's power supply
- Screw-type terminals of the PS 931 power supply unit
- Screw-type terminals of the bus units

Screw-type terminals for the S5-95U PLC's power supply and screw-type terminals of the PS 931 power supply module:

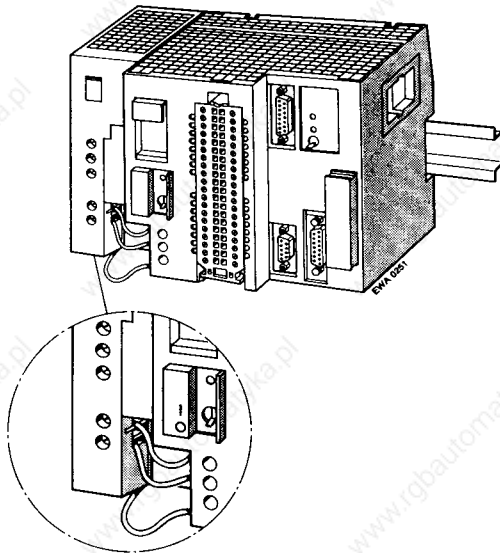

Screw-type terminals of the bus units:

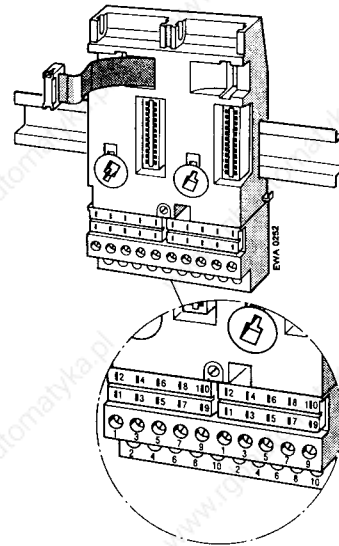

Terminal for two cables in a SIGUT screw-type connection:

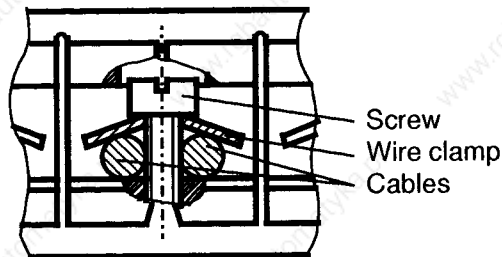

Figure 3-14. SIGUT Screw-Type Connection

You can wire two cables per terminal when using a SIGUT screw-type connection (see Figure 3-14). The cables may have different cross-sections. It is best to tighten the screws using a 5 mm screwdriver.

Permissible cable cross-sections:

- Stranded conductor with core end sleeve: 2 x 0.5 to 1.5 mm²
- Solid conductor: 2 x 0.5 to 2.5 mm²

Examples of Crimp-Snap-In Contacts:

- Crimp-snap-in contacts of the S5-95U front connector
- Crimp-snap-in contacts of the bus units

S5-95U front connector:

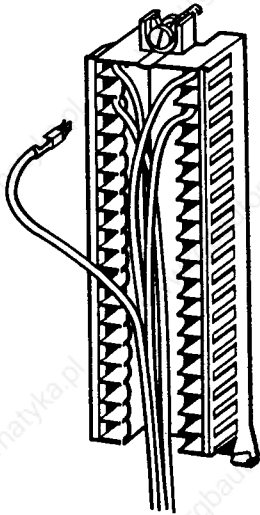

Crimp-snap-in contacts of the bus units:

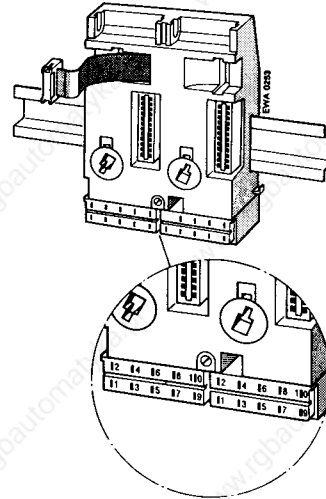

Figure 3-15. Crimp Snap-In Contacts

You can connect stranded conductors with a cross-section of 0.5 to 1.5 mm² to these terminals.

How to Connect the Contact to the Terminal Block (see Figure 3-16)

- ▶ Remove the module that is plugged into the bus unit.
- ▶ Use a screwdriver to press down on the terminal block (1).
- ▶ Swing the terminal block up. The rear side is now visible (2).
- ▶ Push the contact into the desired opening until the locating spring engages.
Caution: The spring must point into the slot!
- ▶ Pull lightly on the cable to make certain that the contact is properly engaged.
- ▶ Swing the terminal block back into its original position. Press up on the terminal block until it snaps into position.

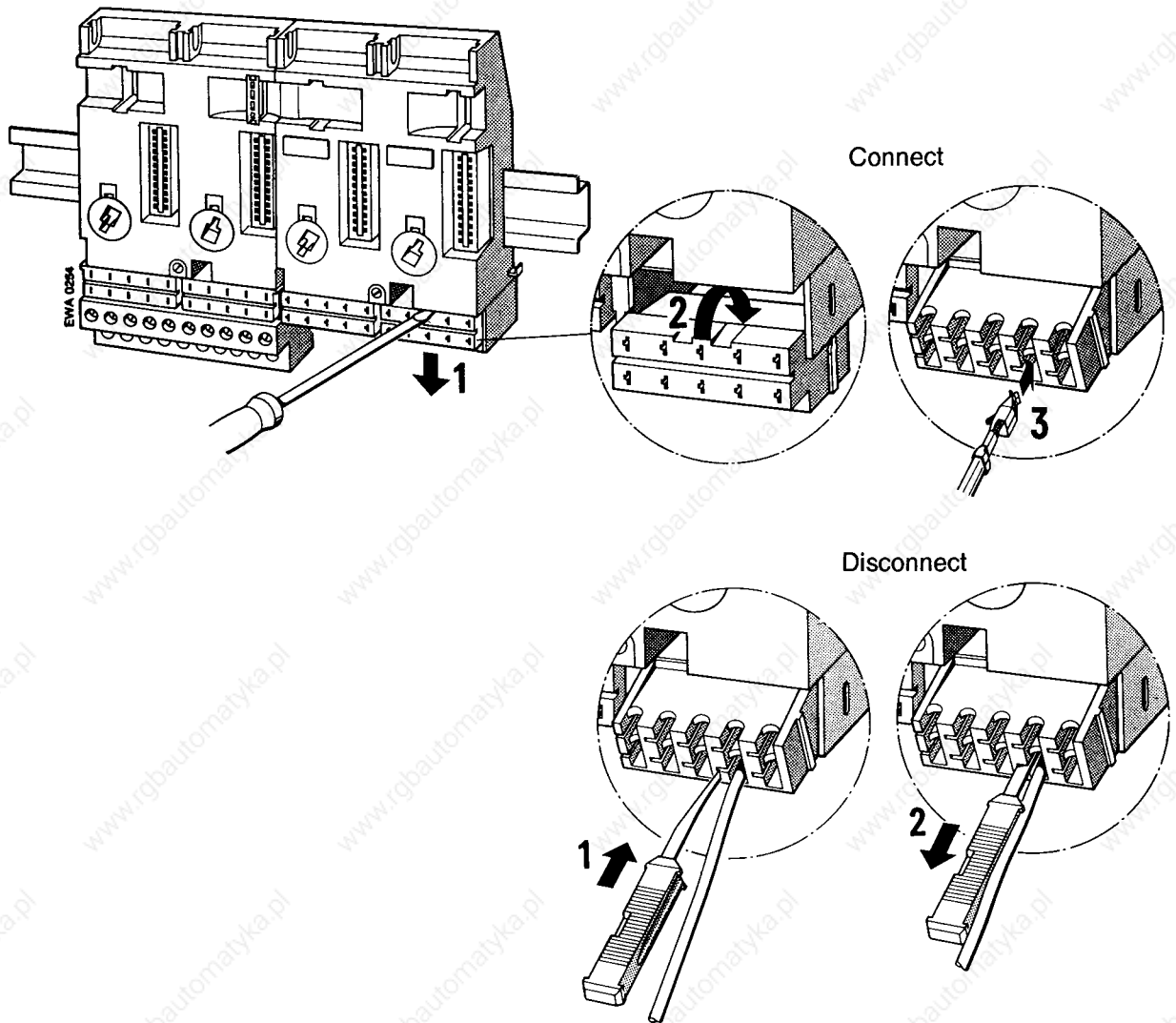

Figure 3-16. Connecting and Disconnecting Crimp Snap-In Contact

Disconnecting a Contact

- ▶ Position the terminal block as is shown in Figure 3-16.
- ▶ Insert the extraction tool into the slot beside the terminal so that you can compress the barb.
- ▶ Position the cable in the groove on the extraction tool and pull out both the tool and the cable.
- ▶ Realign the deformed barb so that you can use the terminal again.

Examples of Sub D Socket Connectors:

- Analog inputs of the S5-95U
- Interrupt and counter inputs of the S5-95U.

3.3.2 Connecting the Power Supply to the S5-90U

The S5-90U is directly connected to the 115 V or 230 V AC supply mains.

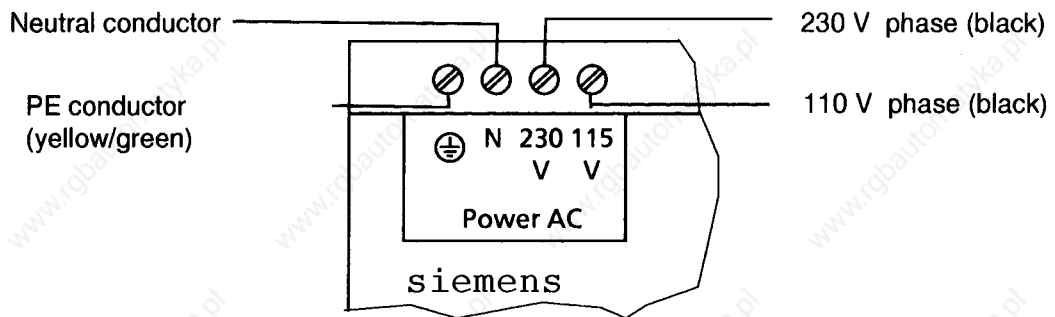

Figure 3-17. Connecting the S5-90U to the Supply Mains

3.3.3 Connecting the Power Supply to the S5-95U

Connecting the PS 931 Power Supply Modules to the Supply Mains (see Figure 3-18):

1. Set the voltage selector to the line voltage.
2. Swing up the protective cover.
3. Connect the supply cable to the L1, N and \perp terminals
4. Provide the supply cable with a cable grip.
5. Close the protective cover.

Connecting the S5-95U to the PS 931 (see Figure 3-18):

6. Connect the L+ and M terminals of the PS 931 power supply module to the corresponding terminals of the PLC.
Connect the PLC's terminal \perp to the standard mounting rail.

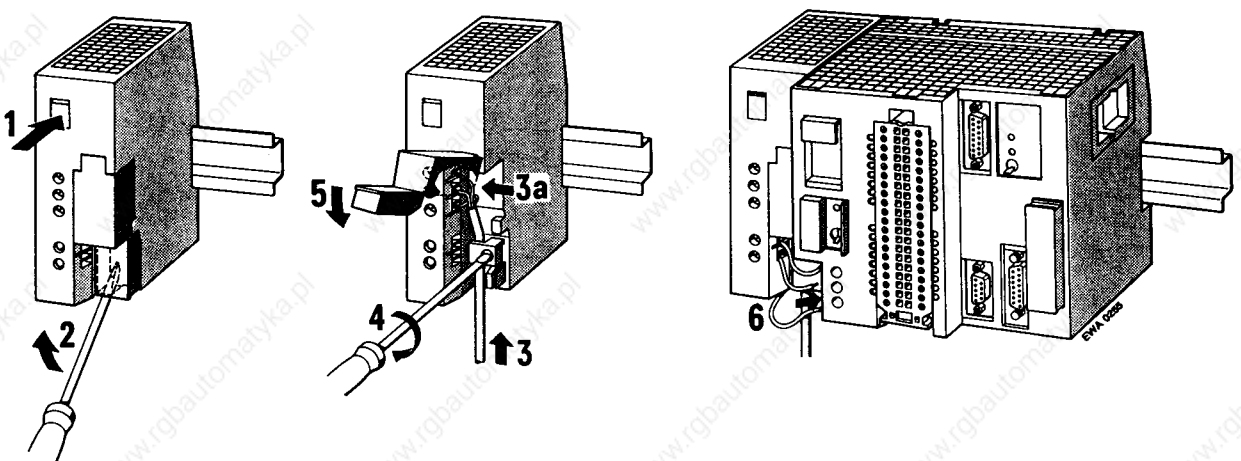

Figure 3-18. Connecting the S5-95U and the PS 931 Power Supply Module

3.3.4 Connecting the Onboard I/Os of the S5-90U

The signal cables for the onboard I/Os can be connected directly to the standard terminal on the PLC.

Connecting Digital Inputs

The digital inputs, located on the top of the PLC, are numbered with fixed bit addresses ranging from 32.0 to 33.1. The inputs are designed for 24 V DC. The PLC has a short-circuit-proof, isolated 24 V DC/100 mA voltage source that supplies the I/Os. The ground connections for the inputs are internally connected to the negative pole of the voltage source.

Example: Switch S1 is to be connected to input I 32.5

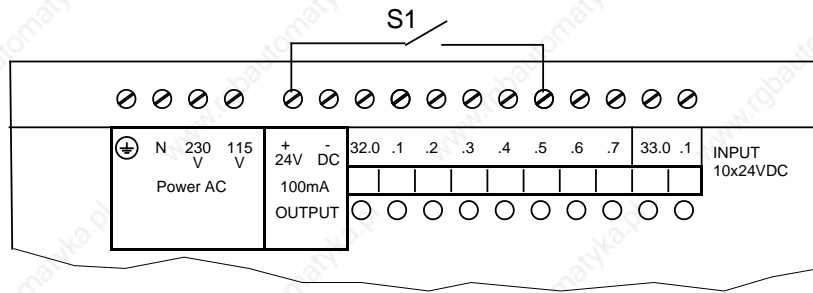

Figure 3-19. Example of How Digital Inputs Can Be Connected

Connecting Digital Outputs

The digital outputs are located on the lower front of the PLC. Their fixed bit addresses are numbered from 32.0 to 32.5.

Note

The sensor voltage for the S5-90U or the IM 90 is available when the first process image is read in.

Example: A signal lamp is connected to output Q 32.0.

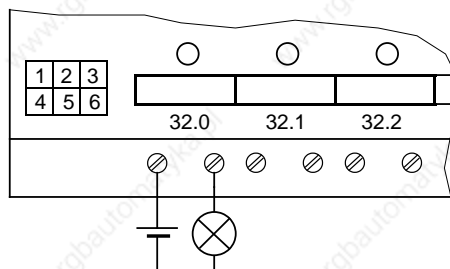

Figure 3-20. Example of How Digital Outputs Can Be Connected

Connecting the Interrupt and Counter Inputs

Terminal 33.0 can be used as interrupt input and terminal 33.1 as counter input. If you wish to use terminal 33.0 as interrupt input, set the parameters in DB 1 accordingly (see Chapter 10).

If you wish to use terminal 33.1 as counter input, set the parameters in DB 1 accordingly (see Chapter 11).

Due to the short input delay of inputs I 33.0 and I 33.1, the cables connected to these inputs must be shielded if longer than 50 m.

Example: Sensor S1 is to be connected to interrupt input 33.0.
 Sensor S2 is to be connected to counter input 33.1 (IW 36).

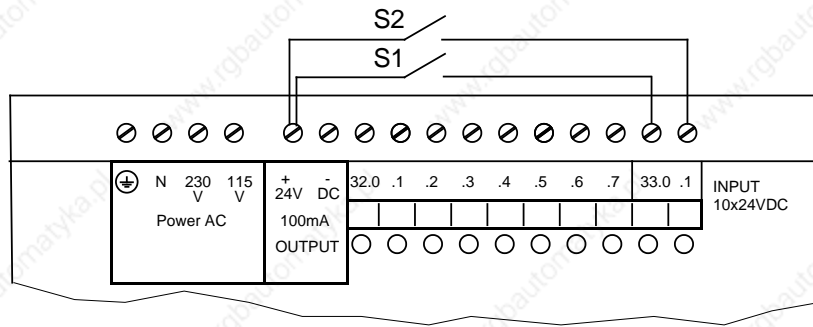

Figure 3-21. Connecting the Interrupt Input and the Counter Input

3.3.5 Connecting the Onboard I/Os of the S5-95U

Use the following parts to connect the onboard I/Os of the S5-95U.

- 40-pin front connector for digital inputs and outputs
- 15-pin sub D connector for analog inputs and outputs
- 9-pin sub D connector for interrupt and counter inputs

Connecting Digital Inputs and Outputs

The signal cables to the digital I/Os must be connected to a 40-pin front connector.

Two types of front connectors are available:

- Front connectors with standard screw-type terminals (see Section 3.3.1)
- Front connectors with crimp-snap-in terminals (see Section 3.3.1)

Every input and output (channel) has a terminal assigned to it on the front connector. The 16 inputs (IN) and the 16 outputs (OUT) are numbered from 32.0 to 33.7. Use a 24 V DC power supply for all digital inputs and digital outputs.

Example: A field device is connected to input I 32.4. A lamp is connected to output Q 33.3.

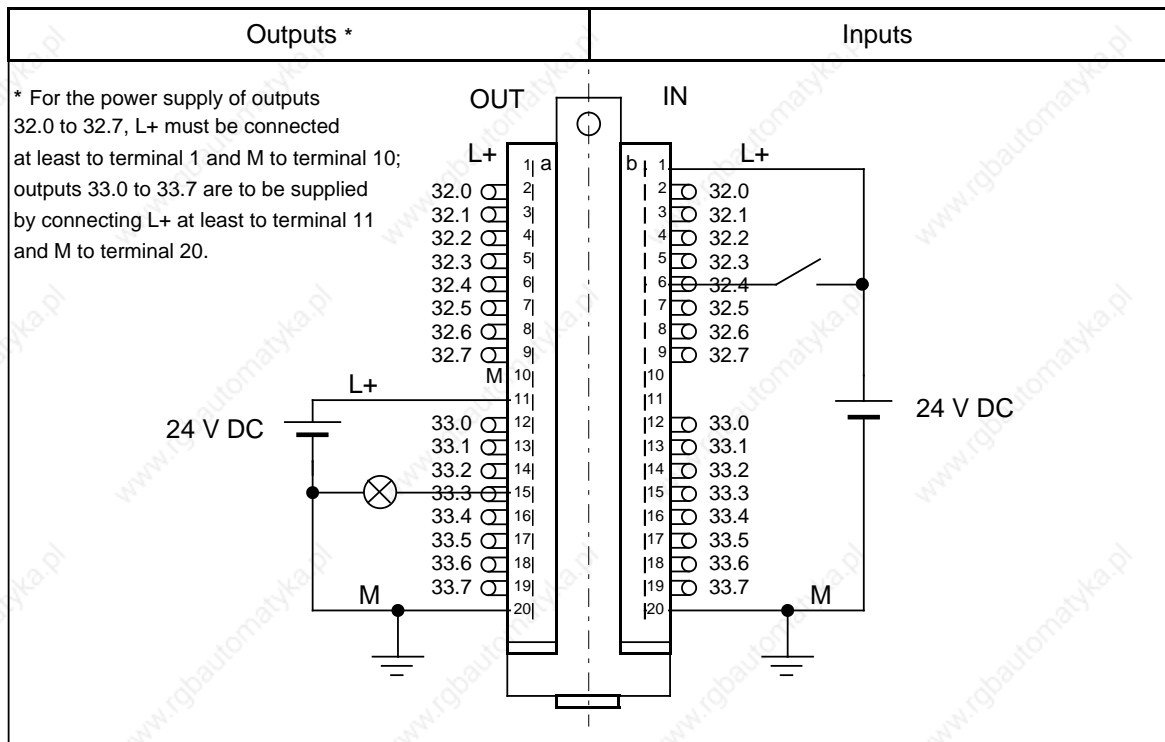

Figure 3-22. Wirings of the Front Connector for Digital Inputs and Outputs

Note

All digital inputs and outputs are connected to a common ground, i.e. they are non-floating.

Connecting Analog Inputs and Outputs

Attach the analog I/O signal cables to the PLC using a sub D connector. There are eight analog inputs and one analog output available. Depending on the terminal assignment, the analog output is either a "current" output or a "voltage" output.

Example: You are to connect a voltage sensor to channel 0 (input word IW 40) and a load resistor to the "voltage" analog output (output word QW 40).

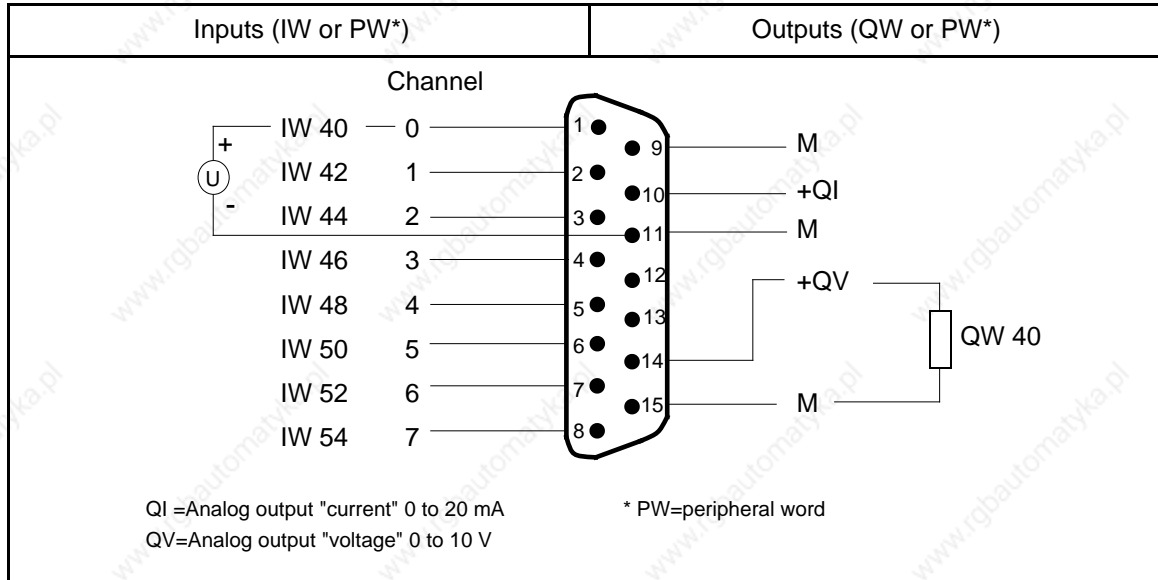

Figure 3-23. An Example of an Analog Input and an Analog Output Connection

Note

You may not assign terminals 12 and 13.

You must use shielded cables.

Note

Do not mount the cable shield to the PLC's sub D female connector. To provide high interference immunity, connect the shield at the other end of the cable to a ground reference.

Connecting Interrupt and Counter Inputs

There are four interrupt inputs and two counter inputs available in the S5-95U. The interrupt inputs and counter inputs have the same internal grounding point as the PLC. Use a 9-pin sub D connector to connect the signal cables for these inputs to the PLC.

Example: Sensor S1 is to be connected to interrupt input I 34.0.

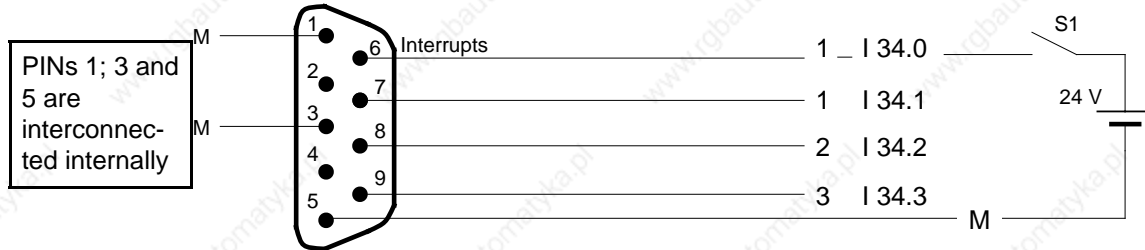

Figure 3-24. Connecting the Interrupt Inputs

All other interrupt inputs (I 34.1 to I 34.3) can be connected to the S5-95U in the same way as I 34.0.

Example: A pulse generator is to be connected to counter A (IW 36).

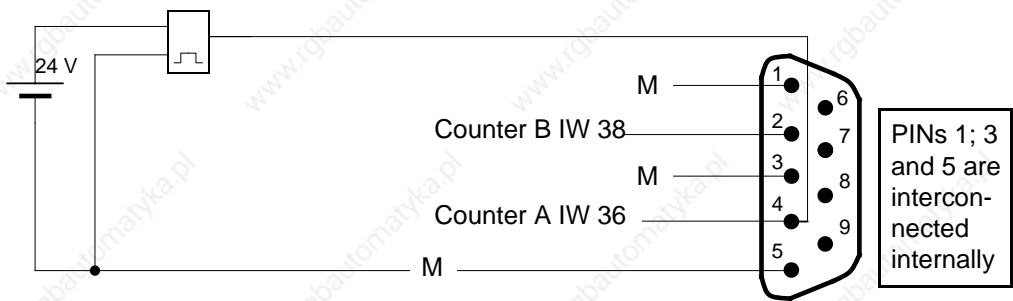

Figure 3-25. Connecting a Counter Input

Counter B (IW 38) can be connected analogously to counter A.

3.3.6 Connecting External I/Os

All I/O modules are plugged into bus units. Connect the I/O modules to the terminal blocks of the bus units.

Both SIGUT screw-type connections and crimp-snap-in connections can be used (see Section 3.3.1). In both cases, the terminal assignments are marked on the terminal blocks.

The I/O modules are described in Chapters 15 and 16. Connection diagrams are shown for all modules. The PIN number in the connection diagram is identical to the number stated on the terminal block of the bus unit or crimp-snap-in/screw-type connector.

3.4 Electrical Configuration with External I/Os

3.4.1 Electrical Configuration of the S5-90U with External I/Os

Figure 3-26 shows a possible configuration. Pay attention to the following points when you design your configuration.

- You must have a main switch **(1)** in accordance with VDE 0100 for your PLC, the sensors, and the actuators.
- You do not need an additional fuse **(2)** to connect your PLC and the load circuit to power if your radial lines are a maximum of 3 meters (9.84 feet) long and are inherently earth-fault-proof and short-circuit-proof.
- You should ground the load circuit at one end. Provide a removable connection **(3)** to the ground conductor on the load power supply (terminal M) or on the isolating transformer. You must provide earth-fault monitoring for any non-grounded load circuits.
- You must separately fuse **(4 and 5)** the load voltage for sensor circuits and for actuator circuits.
- Sensors and actuators can be supplied with 24 V DC/300 mA via the IM 90 **(8)**. Connect the ground of the IM 90 power supply with the standard mounting rail (PE) **(9)**.
- You must have a low-resistance connection between the standard mounting rail and the cabinet's chassis ground **(7)** for grounded configuration.
- You need a power fuse **(6)** to protect against a short-circuit occurring in the power supply.
- The IM 90 interface module has its own monitor for the supply voltage. When it reports a power failure to the S5-90U, the PLC goes into the "STOP" mode with the "NAU" error message (power failure). For this reason, it is recommended that you wire the S5-90U and the IM 90 interface module to the main power line in unison.

Grounded Configuration of an S5-90U

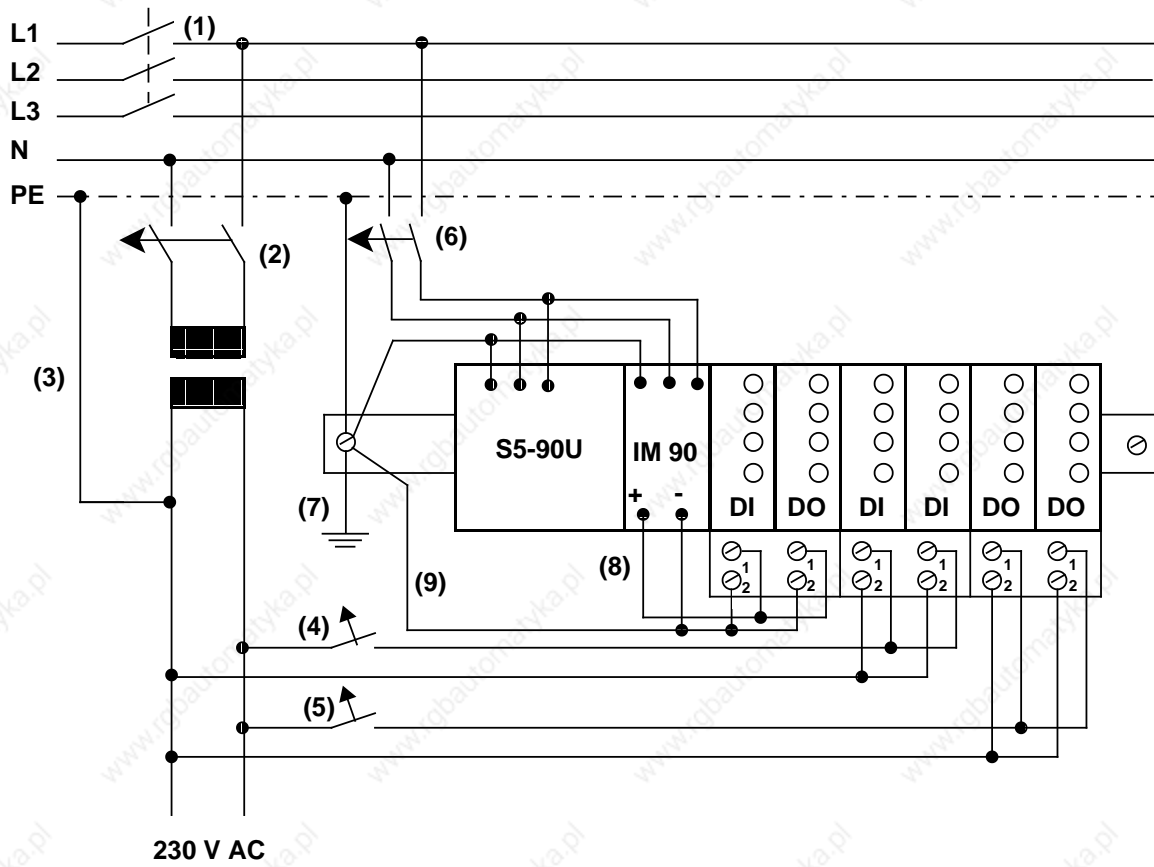

Figure 3-26. Configuration for the S5-90U with External I/Os and a 115/220V AC Power Supply

Ungrounded configurations are not possible for the S5-90U!

3.4.2 Electrical Configuration of the S5-95U with External I/Os

Figures 3-27 and 3-28 show different configuration possibilities. Pay attention to the following points when you design your configuration.

- You must have a main switch **(1)** in accordance with VDE 0100 for your PLC, the sensors, and the actuators.
- You do not need an additional fuse **(2)** to connect your PLC and the load circuit to power if your radial lines are a maximum of 3 meters (9.84 feet) long and are inherently earth-fault-proof and short-circuit-proof.
- You need a load power supply **(3)** for 24 V DC load circuits.
You need a back-up capacitor (rating: 200 μ F per 1 A of load current) if you have non-stabilized load power supplies.
- You should ground the load circuit at one end. Provide a removable connection **(4)** to the ground conductor on the load power supply (terminal M) or on the isolating transformer.
You must provide earth-fault monitoring for any non-grounded load circuits.
- You must separately fuse **(5 and 6)** the load voltage for sensor circuits and for actuator circuits.
- You must connect the standard mounting rail of the S5-95U to the ground conductor through a capacitor **(7)**, (to suppress high-frequency noise) for non-grounded configurations.
- You must have a low-resistance connection between the standard mounting rail and the cabinet's chassis ground **(9)** for grounded configurations.
- You need a power fuse **(8)** to protect against a short-circuit occurring in the power supply.

Grounded Configuration of an S5-95U

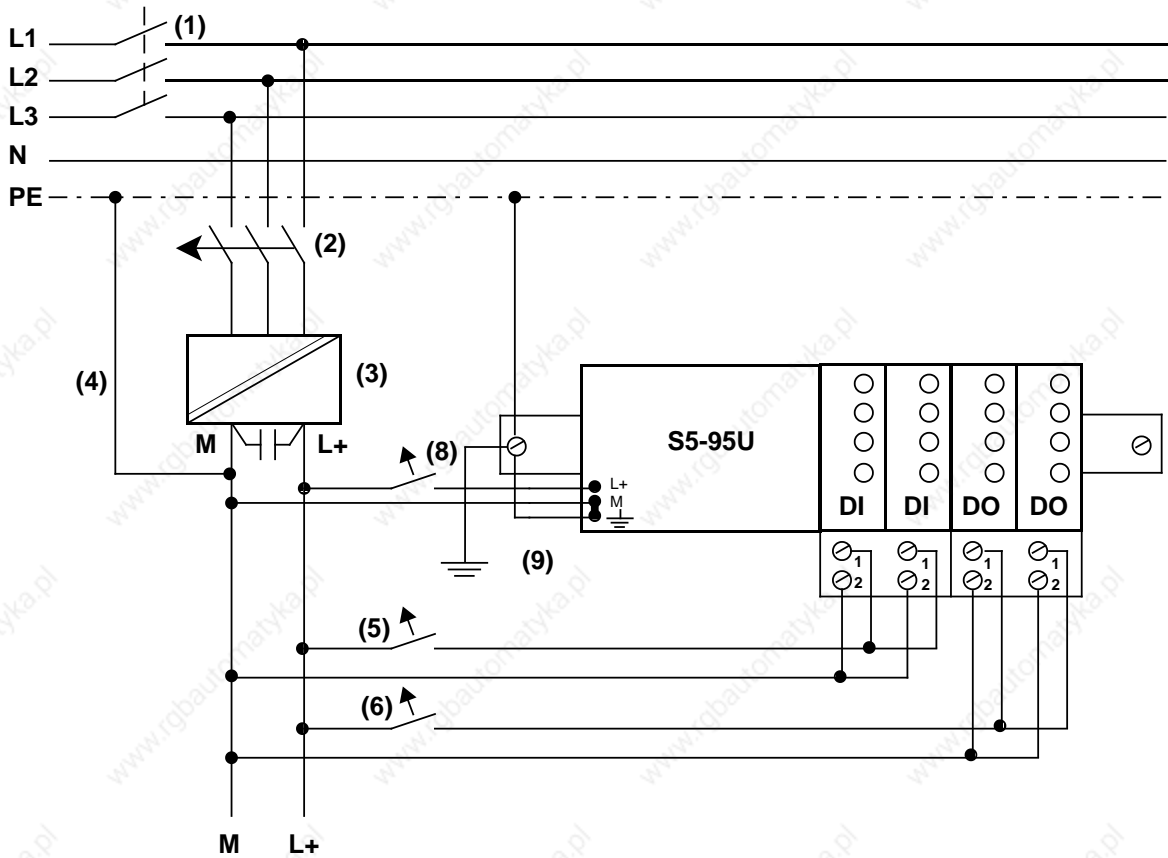

Figure 3-27. Grounded Configuration of the S5-95U with a 24 V DC Power Supply (with Safe Electrical Isolation in Accordance with DIN VDE 0160) for a Programmable Controller and Non-Floating, External I/Os

Ungrounded Configuration of an S5-95U

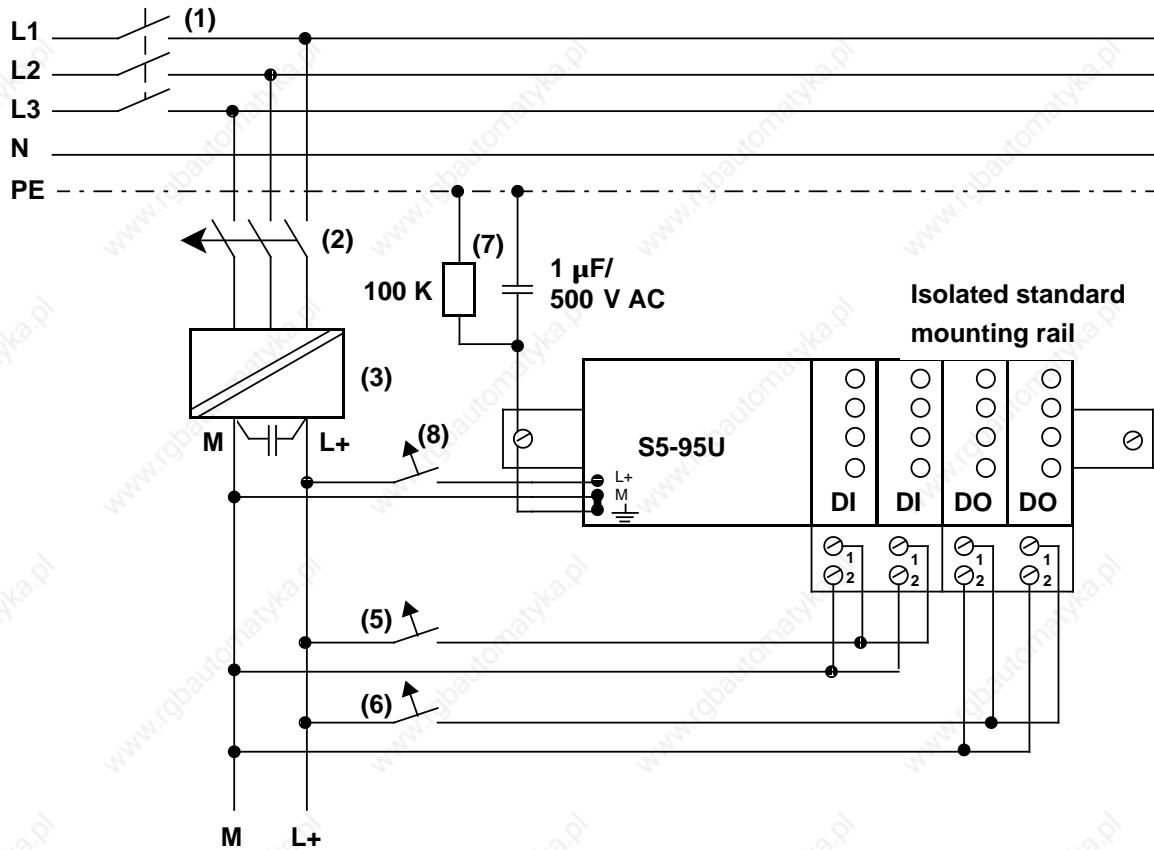

Figure 3-28. Ungrounded Configuration: 24 V DC Power Supply (with Safe Electrical Isolation According to VDE 0160) for Use with a Programmable Controller and External I/Os

Interference voltages are discharged to the ground conductor (PE) via a capacitor. You can prevent static charges by connecting a high-ohmic resistor (approx. 100 k / W) parallel to the capacitor.

3.4.3 Connecting Non-Floating and Floating Modules

The following sections show the special features involved in installations with nonfloating and floating modules.

Installation with Non-Floating Modules

In installations with non-floating modules, the reference potential of the control circuit (M_{internal}) and the load circuits (M_{external}) are not galvanically isolated.

The reference potential of the control circuit (M_{internal}) is at the PE terminal or \perp and must be connected to the reference potential of the load circuit via a line to be run externally.

Figure 3-29 shows a simplified representation of an installation with nonfloating modules. The installation is independent of the grounding concept. The connections for the grounding measures are therefore **not** shown:

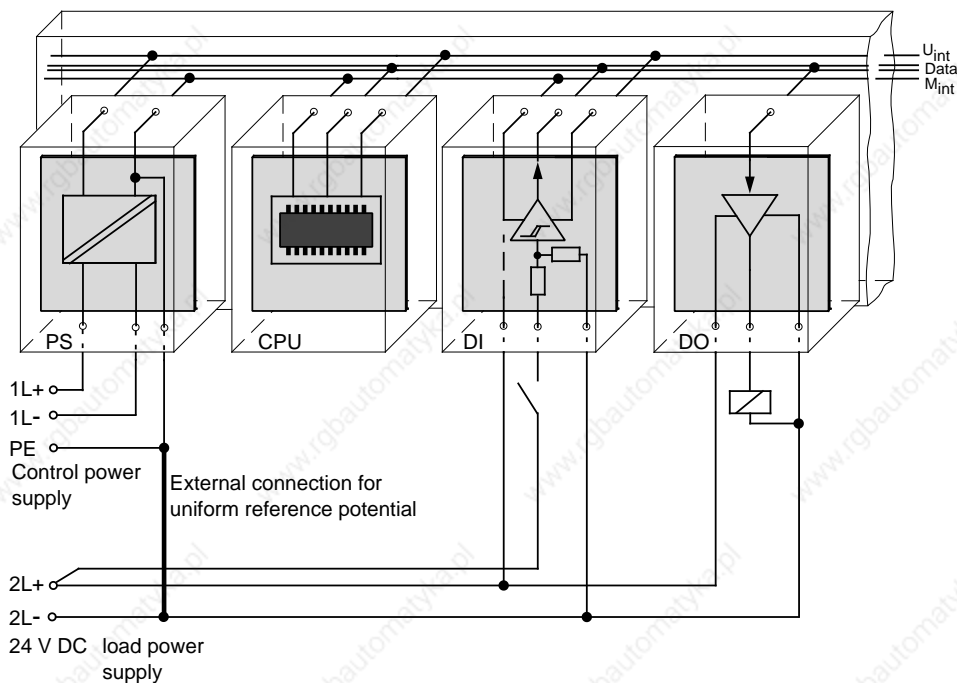

Figure 3-29. Simplified Representation of an Installation with Non-Floating Modules

Voltage drop on line must not exceed 1 V, otherwise the reference potentials will shift and result in failures of the module.

Note

It is imperative that you connect the reference potential of the load power supply unit with the L- terminal of the module in the case of 24 V DC digital output modules. If this connection is missing (e.g. wirebreak), a current of typically 15 mA can flow at the outputs. This output current can be sufficient to ensure that

- Energized contactors or relays do not drop out and
- High-resistance loads (e.g. miniature relays) can be driven.

Installation with Floating Modules

Control circuit and load circuit are galvanically isolated in the case of floating modules.

Installation with floating modules is necessary in the following cases:

- All AC load circuits and
- Non-connectable DC load circuits.

The reasons for this are, e.g. different reference potentials of the sensors or the grounding of the plus poles of a battery, ...

Figure 3-30 shows the simplified representation of an installation with floating modules. The installation is independent of the grounding concept. The connections for grounding measures are therefore **not** shown.

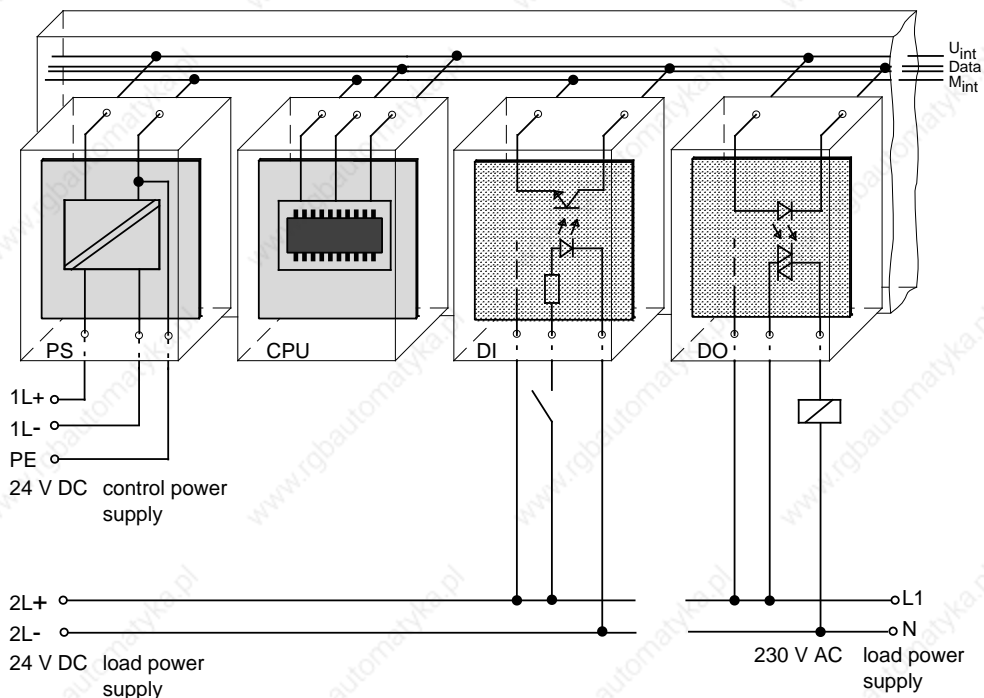

Figure 3-30. Simplified Representation for Installation with Floating Modules

Warning

If you use non-floating I/O modules, you must provide an external connection between the chassis ground of the non-floating I/O module and the chassis ground of the CPU.

Example of a Floating Configuration with Digital Modules

A floating configuration is required in the following situations.

- When you need to increase interference immunity in the load circuits
- When load circuits cannot be interconnected
- When you have AC load circuits

If you have a floating configuration, the PLC's control circuit and the load circuit must be galvanically isolated.

3.5 Wiring Arrangement, Shielding and Measures against Electromagnetic Interference

This section describes the wiring arrangements for bus cables, signal cables, and power supply cables that guarantee the electromagnetic compatibility (EMC) of your installation.

3.5.1 Running Cables Inside and Outside a Cabinet

Dividing the lines into the following groups and running the groups separately will help you to achieve electromagnetic compatibility (EMC).

- Group A: Shielded bus and data lines (for programmer, OP, printer, SINEC L1, PROFIBUS, Industrial Ethernet, etc.)
 Shielded analog lines
 Unshielded lines for DC voltage 60 V
 Unshielded lines for AC voltage 25 V
 Coaxial lines for monitors
- Group B: Unshielded lines for DC voltage > 60 V and 400 V
 Unshielded lines for AC voltage > 25 V and 400 V
- Group C: Unshielded lines for AC voltage > 400 V

You can use the following table to see the conditions which apply to the running of the various combinations of line groups.

Table 3-3. Rules for Common Running of Lines

	Group A	Group B	Group C
Group A			
Group B			
Group C			

Legend for table:

Lines can be run in common bundles or cable ducts

Lines must be run in separate bundles or cable ducts (without minimum distance)

Inside cabinets, lines must be run in separate bundles or cable ducts and outside cabinets but inside buildings, lines must be run on separate cable trays with a gap of a least of 10 cm between lines.

3.5.2 Running Cables Outside Buildings

Run lines outside buildings where possible in metal cable supports. Connect the abutting surfaces of the cable supports galvanically with each other and ground the cable supports.

When you run cables outdoors, you must observe the regulations governing lightning protection and grounding. Note the general guidelines:

Lightning Protection

If cables and lines for SIMATIC S5 devices are to be run outside buildings, you must take measures to ensure internal and external lightning protection.

Outside buildings run your cables either

- In metal conduits grounded at both ends
or
- In steel-reinforced concrete cable channels

Protect signal lines from overvoltage by using:

- Varistors
or
- Lightning arresters filled with inert gas

Install these protective elements at the point where the cable enters the building.

Note

Lightning protection measures always require an individual assessment of the entire system. If you have any questions, please consult your local Siemens office or any company specializing in lightning protection.

Grounding

Make certain that you have sufficient equipotential bonding between the devices.

3.5.3 Equipotential Bonding

Potential differences may occur between separate sections of the system if

- Programmable controllers and I/Os are connected via non-floating interface modules or
- Cables are shielded at both ends but grounded via different sections of the system.

Potential differences may be caused, for instance, by differences in the system input voltage. These differences must be reduced by means of equipotential bonding conductors to ensure proper functioning of the electronic components installed.

Note the following for equipotential bonding:

- A low impedance of the equipotential bonding conductor makes equipotential bonding more efficient.
- If any shielded signal cables connected to earth/protective earth at both ends are laid between the system sections concerned, the impedance of the additional equipotential bonding conductor must not exceed 10 % of the shield impedance.
- The cross-section of the equipotential bonding conductor must be matched to the maximum compensating currents. The following cross-sections are recommendable:
 - 16 mm² copper wire for equipotential bonding line up to 200 m (656.2 ft).
 - 25 mm² copper wire for equipotential bonding line over 200 m (656.2 ft).
- Use equipotential bonding conductors made of copper or zinc-plated steel. Equipotential bonding conductors are to be connected to earth/protective earth via a large contact area and to be protected against corrosion.
- The equipotential bonding conductor should be laid in such a way as to achieve a relatively small contact area between equipotential bonding conductor and signal cables (see Figure 3-31).

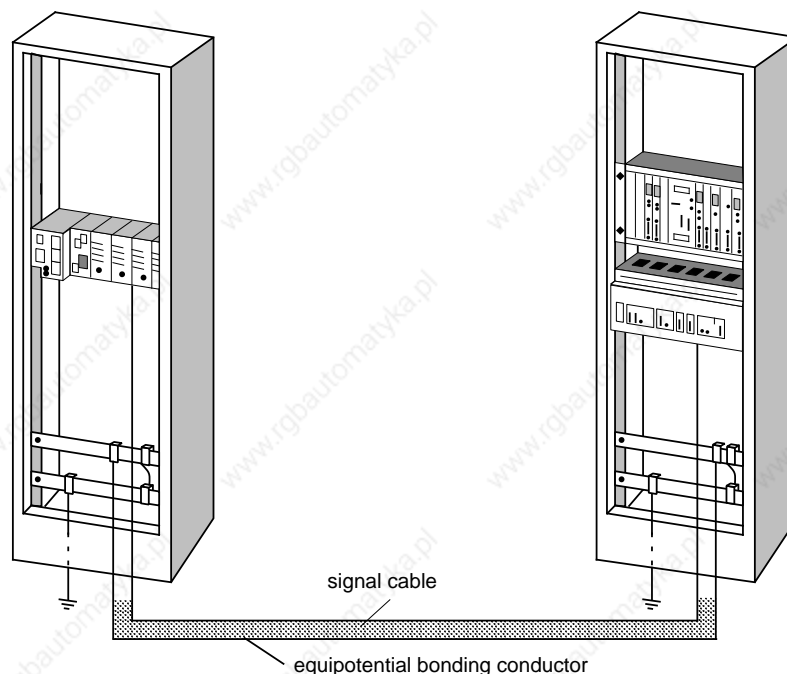

Figure 3-31. Laying Equipotential Bonding Conductor and Signal Cable

3.5.4 Shielding Cables

Shielding is a measure to weaken (attenuate) magnetic, electric or electromagnetic interference fields.

Interference currents on cable shields are discharged to ground over the shield bar which has a conductive connection to the housing. So that these interference currents do not become a source of noise in themselves, a low-resistance connection to the protective conductor is of special importance.

Use only cables with shield braiding if possible. The effectiveness of the shield should be more than 80%. Avoid cables with foil shielding since the foil can easily be damaged by tension and pressure; this leads to a reduction in the shielding effect.

As a rule, you should always shield cables at both ends. Only shielding at both ends provides good suppression in the high frequency range.

As an exception only, you can connect the shielding at one end. However, this attenuates only the lower frequencies. Shielding at one end can be of advantage in the following cases:

- If you cannot run an equipotential bonding conductor
- If you are transmitting analog signals (e.g. a few microvolts or microamps)
- If you are using foil shields (static shields).

Always use metallic or metalized connectors for data lines for serial connections. Secure the shield of the data line at the connector housing. Do **not** connect the shield to the PIN1 of the connector strip!

In the case of stationary operation, you are recommended to insulate the shielded cable without interrupt and to connect it to the shield/protective ground bar.

Note

If there are potential differences between the earthing points, a compensating current can flow over the shielding that is connected at both ends. For this reason, connect an additional equipotential bonding conductor.

Note the following when connecting the cable shield:

- Use metal cable clamps for fixing the braided shield. The clamps have to enclose the shield over a large area and make good contact (see Figure 3-32).
- Connect the shield to a shield bar immediately at the point where the cable enters the cabinet. Route the shield to the module; do **not** connect it to the module.

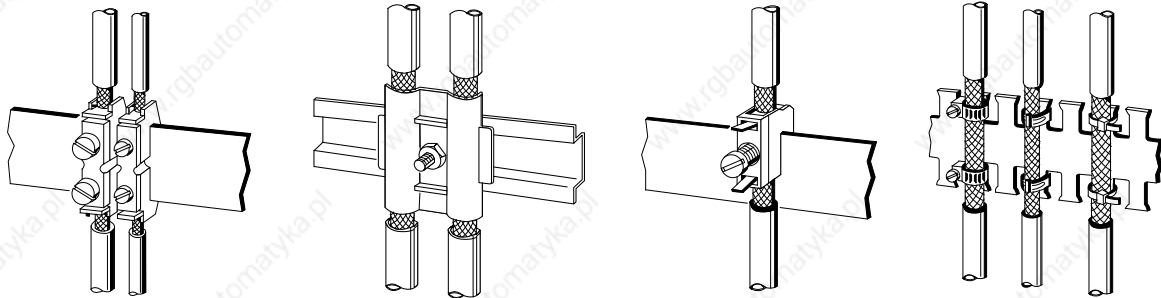

Figure 3-32. Fixing Shielded Cables with Various Types of Cable Clamps

3.5.5 Special Measures for Interference-Free Operation

Arc Suppression Elements For Inductive Circuits

Normally, inductive circuits (e.g. contactor or relay coils) energized by SIMATIC S5 do not require to be provided with external arc suppressing elements since the necessary suppressing elements are already integrated on the modules.

It only becomes necessary to provide arc suppressing elements for inductive circuits in the following cases:

- If SIMATIC S5 output circuits can be switched off by additionally inserted contactors (e.g. relay contactors for EMERGENCY OFF). In such a case, the integral suppressing elements on the modules become ineffective.
- If the inductive circuits are **not** energized by SIMATIC S5.

You can use free-wheeling diodes, varistors or RC elements for wiring inductive circuits.

Wiring coils activated by direct current

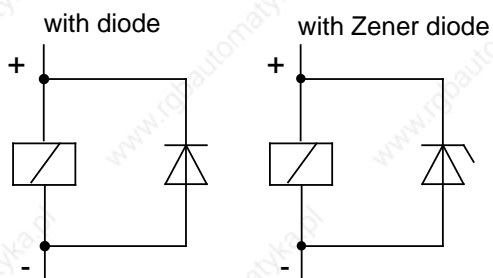

Wiring coils activated by alternating current

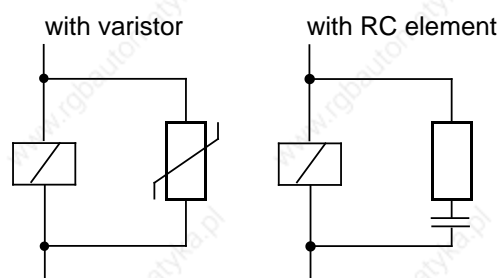

Figure 3-33. Wiring Coils

Mains Connection for Programmers

Provide a power connection for a programmer in each cabinet. The plug must be supplied from the distribution line to which the protective ground for the cabinet is connected.

Cabinet Lighting

Use, for example, LINESTRA® lamps for cabinet lighting. Avoid the use of fluorescent lamps since these generate interference fields. If you cannot do without fluorescent lamps, you must take the measures shown in Figure 3.34.

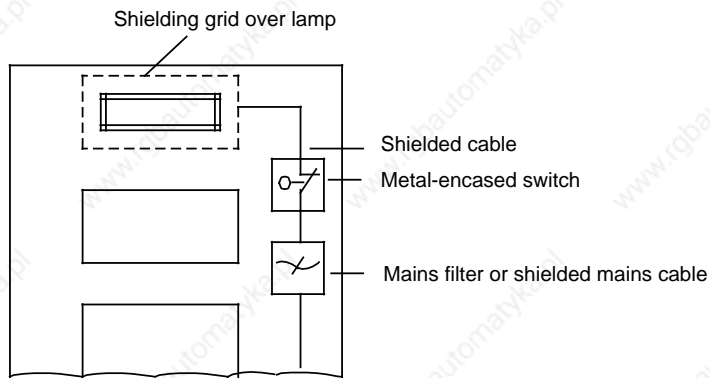

Figure 3-34. Measures for Suppressing Interference from Fluorescent Lamps in the Cabinet

4 Start-Up and Programmer Functions

4.1	Operating Instructions	4 - 1
4.1.1	Programmable Controller Operator Panel	4 - 1
4.1.2	Operating Modes	4 - 2
4.1.3	Performing an Overall Reset of the Programmable Controller	4 - 3
4.2	Starting Up a System	4 - 4
4.2.1	Suggestions for Configuring and Installing the Programmable Controller	4 - 4
4.2.2	Steps for Starting Up the Programmable Controller	4 - 5
4.3	Loading the Program into the PLC	4 - 8
4.3.1	Loading the Program Automatically	4 - 8
4.3.2	Loading the Program Manually	4 - 9
4.4	Saving a Program	4 - 10
4.4.1	Saving a Program to a Memory Submodule	4 - 10
4.4.2	Function of the Back-Up Battery	4 - 11
4.5	Programmer Functions	4 - 11
4.5.1	Overview of Programmer Functions	4 - 12
4.5.2	Peculiarities of the Programmer Functions for the S5-90U and S5-95U	4 - 13
4.5.3	Performance Characteristics When Using the Programmer Interface	4 - 13

Figures		
4-1	Operator Panel of the S5-90U	4 - 1
4-2	Operator Panel of the S5-95U	4 - 1
4-3	Procedure for Automatically Loading a Program	4 - 8
4-4	Procedure for Manually Loading a Program into the S5-95U	4 - 9
4-5	Procedure for Saving a Program on a Memory Submodule	4 - 10
Tables		
4-1	Starting Up the S5-90U and the S5-95U with and without External I/Os ...	4 - 5
4-2	Overview of Functions	4 - 12

4 Start-Up and Programmer Functions

4.1 Operating Instructions

4.1.1 Programmable Controller Operator Panel

S5-90U:

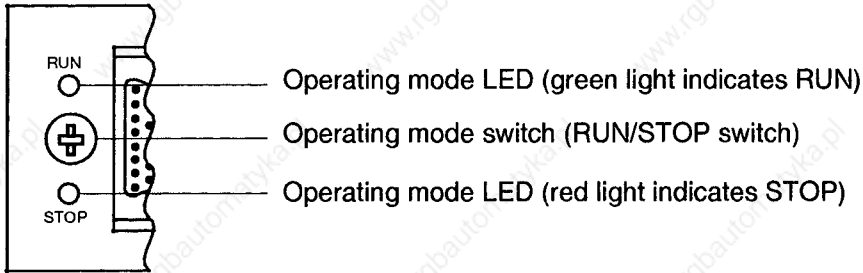

Figure 4-1. Operator Panel of the S5-90U

S5-95U:

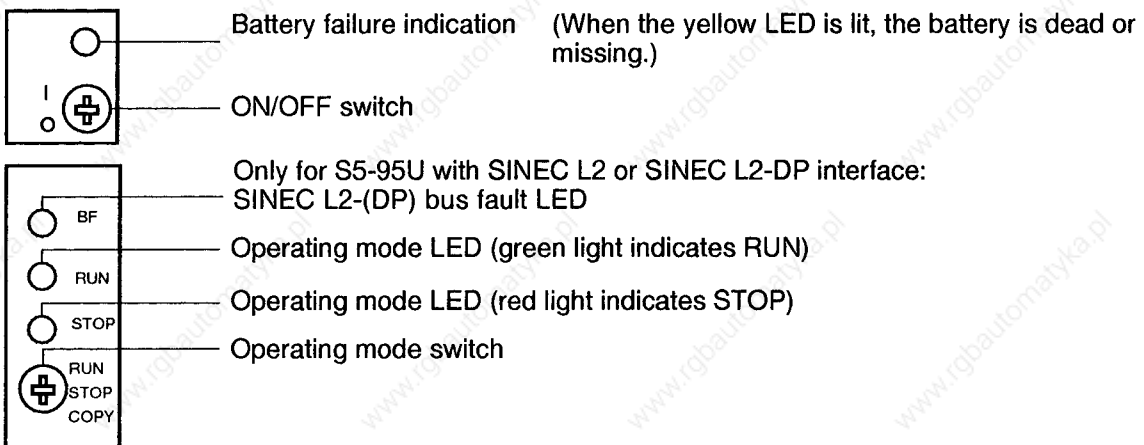

Figure 4-2. Operator Panel of the S5-95U

ON/OFF Switch (only for the S5-95U)

The ON/OFF switch turns on or shuts down the programmable controller. This switch does **NOT** separate the electronics from the L+/M terminals; i.e. in the event of an overvoltage, the PLC can even be destroyed when it is switched off.

Operating Mode Switch

Use the operating mode switch to select either the "RUN" or "STOP" operating mode. The programmable controller automatically goes into the "RESTART" mode during the transition from "STOP" to "RUN" (see Section 9.1.4).

Battery Low LED

The battery low LED may illuminate briefly upon POWER ON.

4.1.2 Operating Modes

"STOP" Operating Mode

- The program is not executed.
- The current values for timers, counters, flags, and process images are saved when the "STOP" operating mode begins.
- The onboard outputs and the output modules are disabled; i.e. the digital outputs have the "0" signal state and the analog outputs are de-energized.
- The onboard counters are not activated.
- The process images, timers, non-retentive flags and counters are set to "zero" during the transition from "STOP" to "RUN."

"RUN" Operating Mode

- The program is processed cyclically.
- Already started timers continue to run.
- Signal states for the onboard inputs and the input modules are read in.
- The onboard outputs and output modules are addressed.
- The "RUN" operating mode can also be set after an "OVERALL RESET", that is, when the program memory is empty.

"RESTART" Operating Mode

- The operating system processes DB1 and accepts the parameters (see Section 9.1).
- Restart organization block OB21 or OB22 is processed (see Section 7.4.1).
- The amount of time the restart requires is not limited since the scan time monitor is not activated.
- Neither time-controlled program processing nor interrupt-controlled program processing is possible.
- The onboard inputs and onboard outputs can be addressed by either the L PB/L PW operation or the T PB/T PW operation during start-up.
- The external input modules and output modules are disabled during start-up.

Changing Operating Modes

A change in operating mode can be caused by the following.

- Actuation of the operating mode switch.
- A programmer, if the operating mode switch on the programmable controller is set to "RUN".
- Malfunctions that cause the programmable controller to go into the "STOP" operating mode (see Chapter 5).

4.1.3 Performing an Overall Reset of the Programmable Controller

You should perform an overall reset before you input a new program. An overall reset achieves the following:

- All not integrated program and data blocks are erased.
- All integrated blocks that can be deleted by the user are again generated (e.g. the default DB1 is again available after an overall reset).
- All timers, counters, flags and the process image are set to "0".
- All system data are set to their default values.

Manual Reset

To perform an overall reset in the S5-90U, you must:

Set the operating mode switch to "STOP."

Remove the battery.

Disconnect the PLC from the power supply for about 15 seconds.

Re-establish the programmable controller's power supply.

Insert the battery.

To perform an overall reset in the S5-95U, you must:

Set the operating mode switch to "STOP".

Remove the battery.

Set the ON/OFF switch to "0".

Change the ON/OFF switch to "1".

Insert the battery.

Performing an Overall Reset with the Programmer

You can select the overall reset function from the programmer's menu line. Refer to the programmer manual.

4.2 Starting Up a System

The following section contains suggestions for configuring and starting up a system containing programmable controllers.

4.2.1 Suggestions for Configuring and Installing the Programmable Controller

A programmable controller is often used as a component in a larger system. The suggestions contained in the following warning are intended to help you safely install your programmable controller.



Warning

- Adhere to any safety and accident-prevention regulations applicable to your situation and system.
- If your system has a permanent power connection (stationary equipment) that is not equipped with an isolating switch and/or fuses that disconnect all poles, install either a suitable isolating switch or fuses in the building wiring system. Connect your system to a ground conductor.
- Before start-up, if you have units that operate using the main power supply, make sure that the voltage range setting on the equipment matches the local main power voltage.
- When using a 24-V supply, make sure to provide proper electric isolation between the main supply and the 24-V supply. Use only power supplies manufactured according to DIN VDE 0551/EN 60742 and DIN VDE 0160.
- Fluctuations or deviations of the supply voltage from the rated value may not exceed the tolerance limit specified in the technical data. If they do, functional failures or dangerous conditions can occur in the electronic modules or equipment.
- Take suitable measures to make sure that programs that are interrupted by a voltage dip or power failure resume proper operation when the power is restored. Make sure that dangerous operating conditions do not occur even momentarily. If necessary, force an EMERGENCY OFF.
- EMERGENCY OFF devices must be in accordance with EN 60204/IEC 204 (VDE 0113) and be effective in all operating modes of the equipment. Make certain to prevent any uncontrolled or undefined restart when the EMERGENCY OFF devices are released.
- Install power supply and signal cables so that inductive and capacitive interference can not affect the automation functions.
- Install your automation system and its operative components so as to prevent unintentional operation.
- Automation equipment can assume an undefined state in the case of a wire break in the signal lines. To prevent this, take the proper hardware and software safety measures when linking the inputs and outputs of the automation equipment.

4.2.2 Steps for Starting Up the Programmable Controller

Steps for Starting Up the S5-90U and the S5-95U with and without External I/Os

Table 4-1. Starting Up the S5-90U and the S5-95U with and without External I/Os

Procedures	Indications on S5-90U/S5-95U
Disconnect system and PLC from voltage source.	No LED lit.
Check mechanical configuration and wiring (see Chapter 3). Adhere to installation guidelines contained in VDE 0100 and VDE 0160.	
Remove battery from PLC.	
Set ON/OFF switch to "0" (S5-95U). Set operating mode switch to "STOP".	
Switch on power supply for the PLC (and IM 90). Set ON/OFF switch to "1" (S5-95U).	<ul style="list-style-type: none"> • PLC: Red operating mode LED lit; yellow battery failure LED lit (S5-95U). • External I/Os: Red fault LEDs lit. • IM 90 (S5-90U): Green LEDs lit.
Switch on sensor power supply. Switch on actuator power supply.	<ul style="list-style-type: none"> • PLC: Red operating mode LED lit; yellow battery failure LED lit (S5-95U); green signal status LEDs of the inputs lit. • External I/Os: Green signal status LEDs of the inputs lit. • IM 90 (S5-90U): Green LEDs lit.
Set operating mode switch to "RUN".	<ul style="list-style-type: none"> • PLC: Green operating mode LED lit; yellow battery failure LED lit (S5-95U); green signal status LEDs of the inputs lit. • External I/Os: green signal status LEDs of the inputs lit. • IM 90 (S5-90U): Green LEDs lit.

Table 4-1. Starting Up the S5-90U and S5-95U with and without External I/Os (Continued)

Procedures	Indications on S5-90U/S5-95U
Insert battery into PLC.	<ul style="list-style-type: none"> • PLC: Green operating mode LED lit; green signal status LEDs of the inputs lit. • External I/Os: Green signal status LEDs of the inputs lit. • IM 90 (S5-90U): Green LEDs lit.
<p>Use "STATUS VAR" programmer function to observe the sensor signals.</p> <p>Use "FORCE VAR" programmer function to observe the control states of the actuators.</p> <p>Use these programmer functions to check sensors and actuators and their assignment to the addresses in the process image.</p>	<ul style="list-style-type: none"> • PLC: Green operating mode LED lit; green signal status LEDs of the inputs/output lit. • External I/Os: green signal status LEDs of the inputs/output lit. • IM 90 (S5-90U): Green LED lit.
Set operating mode switch to "STOP".	<ul style="list-style-type: none"> • PLC: Red operating mode LE lit; Green signal status LEDs of the input lit. • External I/Os: Green signal status LEDs of the input lit. • IM 90 (S5-90U): Green LED lit.
Switch off power supply for actuators.	<ul style="list-style-type: none"> • PLC: Red operating mode LE lit; Green signal status LEDs of the input lit. • External I/Os: Red fault LEDs of output module lit; green signal status LEDs of the input lit. • IM 90 (S5-90U): Green LED lit.

Table 4-1. Starting Up the S5-90U and S5-95U with and without External I/Os (Continued)

Procedures	Indications on S5-90U/S5-95U
Load program from memory submodule into PLC if available (see Section 4.3). Otherwise, load program from programmer.	LEDs (see Section 4.3).
Set operating mode switch to "RUN".	<ul style="list-style-type: none"> • PLC: Green operating mode LED lit; green signal status LEDs of the inputs/outputs lit. • External I/Os: green signal status LEDs of the inputs/outputs lit. • IM 90 (S5-90U): Green LEDs lit.
Test and correct program.	
Set operating mode switch to "STOP".	<ul style="list-style-type: none"> • PLC: Red operating mode LED lit; green signal status LEDs of the inputs lit. • External I/Os: Red fault LEDs of the output modules lit; green signal status LEDs of the inputs lit. • IM 90 (S5-90U): Green LEDs.
Save program.	LEDs (see Section 4.4).
Switch on power supply for actuators.	<ul style="list-style-type: none"> • PLC: Red operating mode LED lit; green signal status LEDs of the inputs lit. • External I/Os: Green signal status LEDs of the inputs lit. • IM 90 (S5-90U): Green LEDs lit.
Set operating mode switch to "RUN".	<ul style="list-style-type: none"> • PLC: Green operating mode LED lit; green signal status LEDs of the inputs/outputs lit. • External I/Os: green signal status LEDs of the inputs/outputs lit. • IM 90 (S5-90U): Green LEDs lit.

4.3 Loading the Program into the PLC

The STEP 5 program is loaded into the RAM of the PLC. It includes all OBs, PBs, FBs, SBs and DBs, including DB1. The program can be loaded from a programmer connected to the PLC (on-line mode).

Please refer to your programmer's Manual for a detailed description. In the following, loading from a memory submodule will be described.



Warning

Memory submodules may be inserted or withdrawn only in the "POWER OFF" mode.

4.3.1 Loading the Program Automatically

You can use various memory submodules with the S5-90U and S5-95U . Appendix E contains a list of the submodules available.

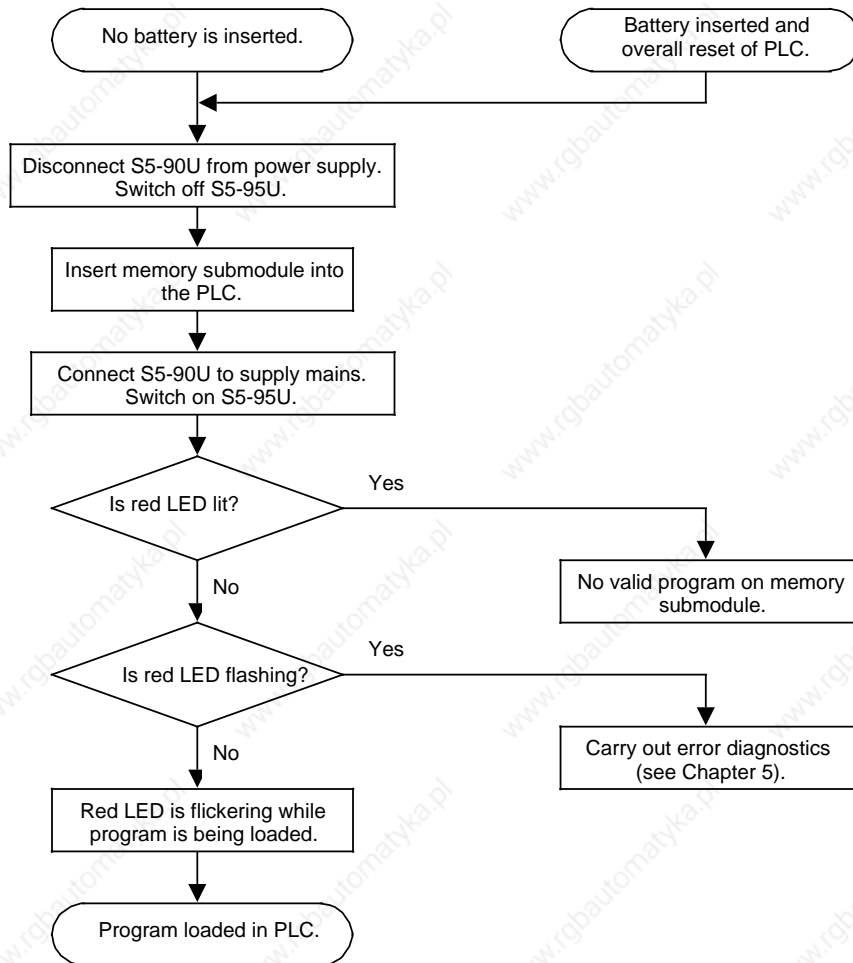
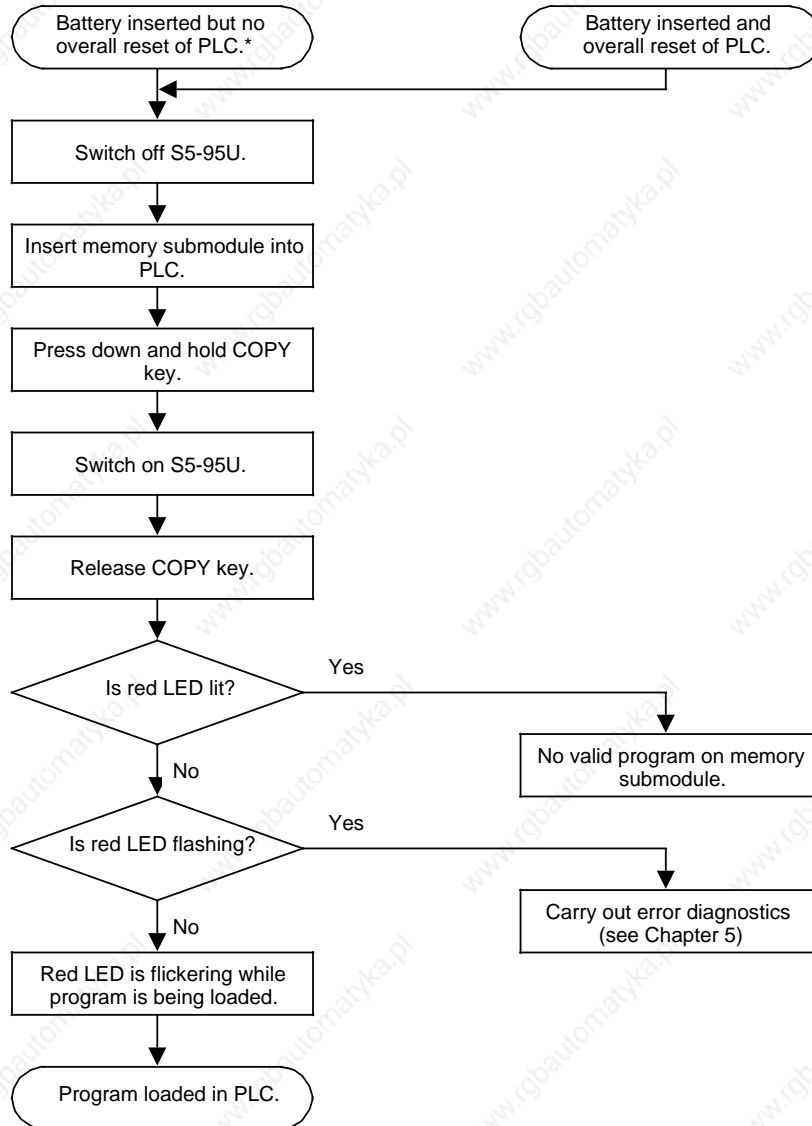

Figure 4-3. Procedure for Automatically Loading a Program

4.3.2 Loading the Program Manually (S5-95U)

Manual loading of the program is possible only in connection with the S5-95U. When you manually load a program, it is copied from the memory submodule into the PLC's program memory. If the back-up battery is installed, any program already in the memory is completely erased.



* This is not obligatory. If this condition is not fulfilled, however, the program is loaded automatically (see Section 4.3.1).

Figure 4-4. Procedure for Manually Loading a Program into the S5-95U

4.4 Saving a Program

You can save the STEP 5 program in the RAM of the PLC. The STEP 5 program includes all valid OBs, PBs, FBs, SBs and DBs, including DB1. The program can be saved in a program file or on a memory submodule using a programmer (on-line mode). Please refer to your programmer's Manual for a detailed description. In the following, the procedure for saving the program on a memory submodule inserted in the PLC will be described.

4.4.1 Saving a Program to a Memory Submodule

Only EEPROMs can be used for this saving procedure.

In the case of the S5-90U, a program can be saved on a memory submodule only if the "Compress" function is activated on the programmer connected to the PLC in on-line mode.

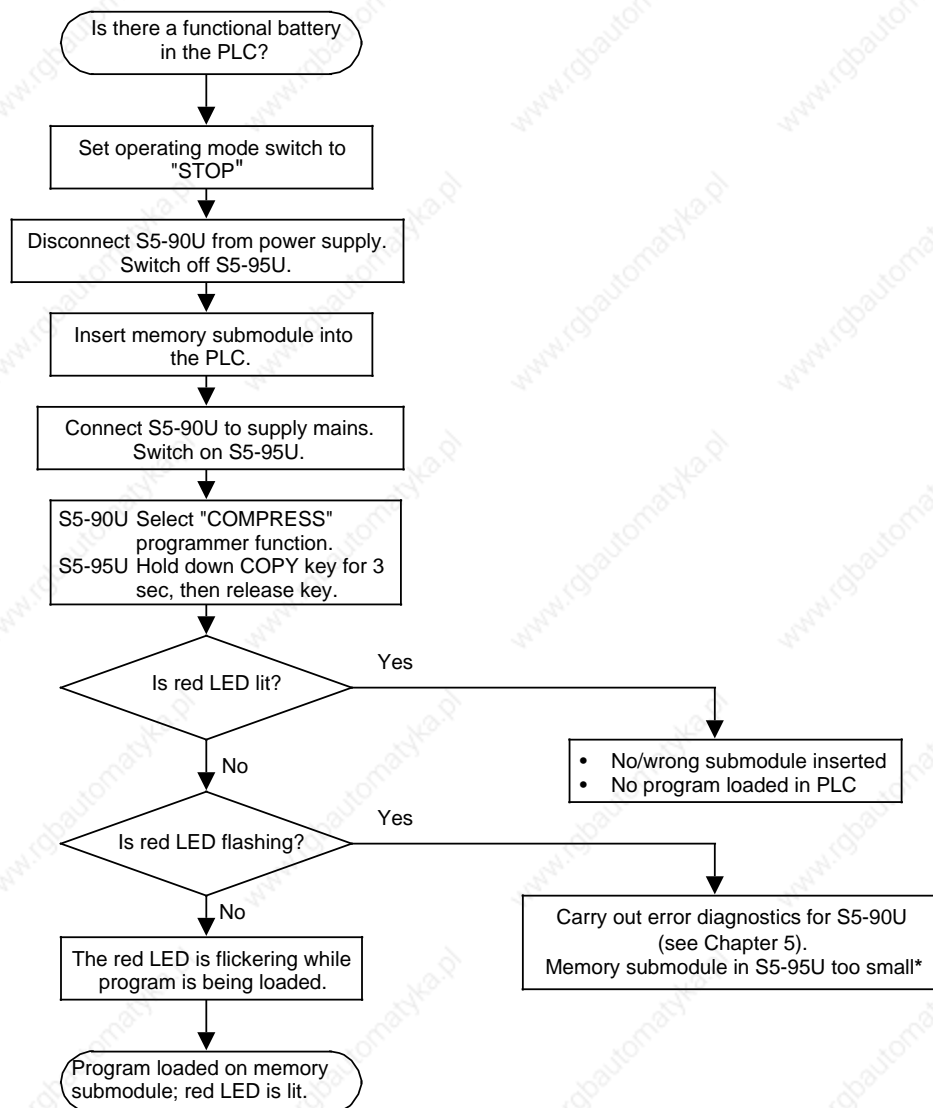

* The block headers of the integral FBs are stored in addition to the control program.

Figure 4-5. Procedure for Saving a Program on a Memory Submodule

4.4.2 Function of the Back-Up Battery

If the power fails or the programmable controller is switched off, the contents of the internal memory are stored (retentive) only if a back-up battery is connected. When the programmable controller is switched on, the following contents are available:

- Control program and data blocks (see Chapter 7)
- Retentive flags and counter values (see Chapter 2)
- ISTACK contents (see Chapter 5)
- System data (see Appendix B)

Note

- Only Insert or replace the battery while the PLC is switched on. Otherwise, an "OVERALL RESET" is required after POWER ON.
- The S5-90U has no battery low LED.
If the S5-90U is briefly (approx. 20 ms to 10 s) in the POWER OFF state and no battery back-up is provided, the PLC cannot recognize whether a backup battery is available during the next restart.
Program data might be falsified in this way. You can help avoid a failure of the battery back-up by **regularly replacing the battery every year**.
- A yellow LED on the operator panel of the S5-95U signals a failure of the back-up battery.



Warning

Do not recharge lithium batteries. Danger of explosion! Dispose of used batteries as classified waste.

4.5 Programmer functions

The serial interface (programmer interface) can be used for connecting

- Programmings or operator control and monitoring equipment,
- The PLC as a station on the SINEC L1 LAN (see Chapter 14).

4.5.1 Overview of Programmer Functions

The following table lists the complete scope of functions available at the programmer interface.

Table 4-2. Overview of Functions

Programmer Function Designation	Abbreviation	Possible for S5-90U	Possible for S5-95U
Input block	INPUT	Yes	Yes
Output block	OUTPUT	Yes	Yes
Test	TEST		
Program test	PROG TEST	No	No
END program test	END TEST	No	No
Signal status display	STATUS	Yes	Yes
PLC Functions	PC FCT		
PLC restart	START	Yes	Yes
PLC STOP	STOP	Yes	Yes
Compress	COMPRESS	Yes	Yes
STATUS variable	STAT VAR	Yes	Yes
Force	FORCE	No	No
FORCE variable	FORCE VAR	Yes	Yes
PLC information	PC INFO		
Output addresses	OUTP ADDR	Yes	Yes
Memory configuration	MEM CONF	Yes	Yes
System parameter	SYSPAR	Yes	Yes
Block stack	BSTACK	Yes	Yes
Interrupt stack	ISTACK	Yes	Yes
Auxiliary functions	AUX FCT		
Transfer	TRANSFER	Yes	Yes
Delete	DELETE	Yes	Yes
Directory	DIR	Yes	Yes
Function			
SINEC L1	MASTER	No	No
	SLAVE	Yes	Yes

The programmer functions are described in the Manual for your programmer. The following section will concentrate on describing the peculiarities of the programmer functions for the S5-90U/S5-95U.

4.5.2 Peculiarities of the Programmer Functions for the S5-90U and S5-95U

"Input block" Programmer Function for the S5-95U

If the PLC is switched to RUN and if you want to modify or transfer blocks, the scan time is automatically extended.

When transferring relatively long blocks, this function prevents the PLC from entering the STOP state and the output of "ZYK" in the ISTACK display (see Section 5.3).

"STATUS - Signal status display" Programmer Function for the S5-95U

The "STATUS" test function analyzes the status of operands involved in the execution of a block.

Consequence: If a STATUS request is given when the cyclic execution of a block starts, the execution time for this block and hence the scan time is extended.

If a "STATUS" request is present for several processing cycles of the block, the scan time is extended for each of these cycles.

If you diagnose a block that calls up a function block (see Section 7.3.4) by means of the "STATUS" function, the statuses of the actual parameters for the function block called are not displayed in the case of the **S5-95U**.

"Compress" Programmer Function for the S5-90U

The "Compress" function simultaneously initiates compressing of the program memory (see Section 7.5) and saving of the program on a memory submodules (see Section 4.4.1) if the S5-90U is switched to STOP and a memory submodule inserted.

"Compress" Programmer Function for the S5-95U

If you activate the "Compress" function while the PLC is switched to RUN, the scan time is extended automatically.

"ISTACK" Programmer Function for the S5-90U and S5-95U

The interrupt stack (ISTACK) is an internal memory of the PLC where the causes of faults are stored. Two types of faults exist for the S5-90U and the S5-95U which are displayed in different ways in the ISTACK. For detailed information see Section 5.4.

4.5.3 Performance Characteristics When Using the Programmer Interface

If you connect a programmer, operator panel or the PLC as SINEC L1 station via the programmer interface, the performance characteristics of the PLC change in the following respects:

- The scan time is extended depending on the function currently executing.
- The interrupt reaction times are extended (see Chapter 10).
- The maximum counter frequency of the onboard counters is reduced (see Chapter 11).

If your S5-95U programmable controller has a second serial interface, you should use the functions and interfacing capabilities of this interface. The second serial interface definitely imposes less load on the program cycle than the programmer interface.

www.rgbautomatyka.pl

5 Diagnostics and Trouble Shooting		
5.1	Diagnostic Byte	5 - 1
5.2	LED Error Display	5 - 3
5.3	Interrupt Analysis Using the Programmer	5 - 4
5.3.1	"ISTACK" Analysis Function	5 - 4
5.3.2	Meanings of the ISTACK Displays for Errors Occurring During Restart and Program Execution	5 - 7
5.3.3	Meanings of the ISTACK Displays in the Case of Errors During Copying the Program	5 - 8
5.4	Program Errors	5 - 9
5.4.1	Determining an Error Address	5 - 9
5.4.2	Program Tracing with the "BSTACK" Function	5 - 10
5.5	Faults in the External I/Os	5 - 12
5.6	System Parameters	5 - 13
5.7	The PLC does not Enter the "RUN" Mode	5 - 13

Figures		
5-1	Diagnostic Byte for the S5-90U	5 - 1
5-2	Diagnostic Byte for the S5-95U	5 - 2
5-3	Structured Program with Illegal Statement	5 - 9
5-4	Program Tracing with "BSTACK"	5 - 11
5-5	Analyzing the Cause of a Fault in the External I/Os	5 - 12
Tables		
5-1	Display and Analysis of Errors and Faults	5 - 3
5-2	Display of Control Bits	5 - 5
5-3	Display of the ISTACK	5 - 5
5-4	Abbreviations for Control Bits and Causes of Errors	5 - 6
5-5	Abbreviations of Other Relevant Status Data	5 - 6
5-6	Interrupt Analysis	5 - 7
5-7	Errors During Copying	5 - 8
5-8	BSTACK Display	5 - 11

5 Diagnostics and Trouble Shooting

5.1 Diagnostic Byte

The diagnostic byte offers you another means of controlling the process sequence.

The diagnostic byte displays the following:

- Whether a counter has reached the comparison value (counter overflow)
- Whether and where an interrupt was triggered
- Whether the power supply for the onboard I/Os has failed (only for the S5-95U)
- Whether a battery backup is available (only for the S5-95U)

The diagnostic byte for both programmable controllers is in input byte (IB) 35.

Diagnostic Byte Assignment for the S5-90U

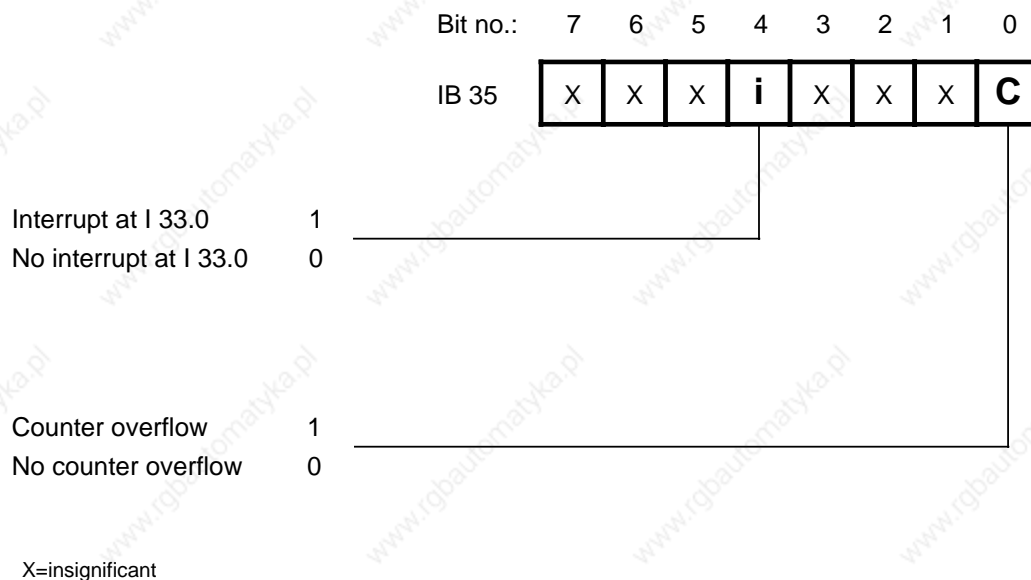

Figure 5-1. Diagnostic Byte for the S5-90U

Signal status "1" in one of the diagnostic bits signifies that:

- Since the last start-up, an interrupt has occurred. This does not mean that interrupt processing is taking place.

Signal status "0" in one of the diagnostic bits signifies one of the following conditions.

- Since the last start-up, no interrupt has occurred.
- The user erased the respective diagnostic bit after the interrupt. It does not signify that the corresponding interrupt processing is complete.

Diagnostic Byte Assignment for the S5-95U

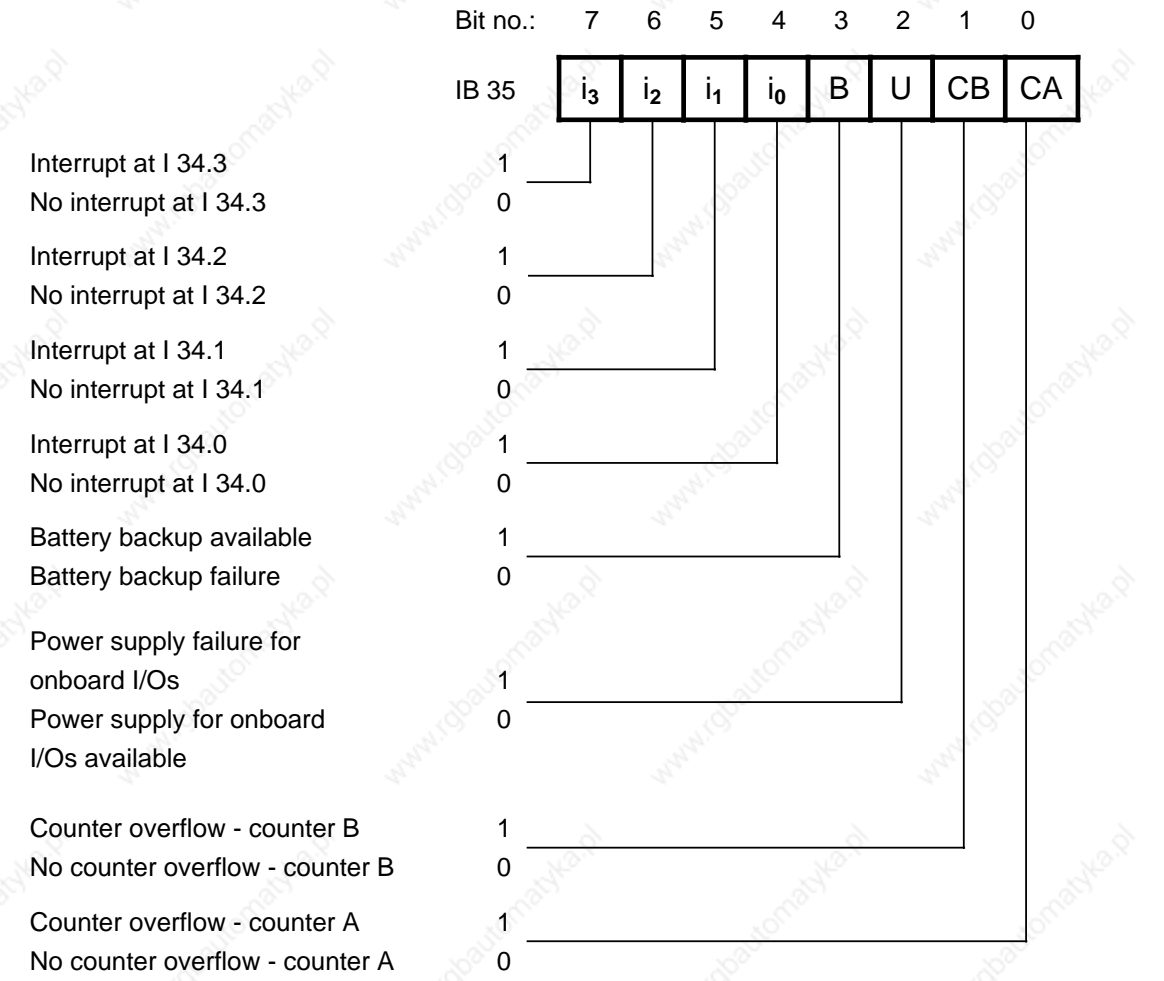

Figure 5-2. Diagnostic Byte for the S5-95U

Note

The "**Power supply failure for onboard I/Os**" bit is set only if **all** power supplies listed below have failed.

- Power supply for inputs 32.0 to 33.7 (PIN 1b Figure 3-22)
- Power supply for outputs 32.0 to 32.7 (PIN 1a Figure 3-22)
- Power supply for outputs 33.0 to 33.7 (PIN 11a Figure 3-22)

If at least one of the above mentioned supply voltages is present, the "**Power supply failure for onboard I/Os**" bit is "0".

Interrupts and counter overflow is flagged in the diagnostic byte only if the interrupt and counter inputs have been parameterized in DB1 (see Chapter 10 and 11).

Reading and Resetting the Diagnostic Byte

In the central program, you can read in and evaluate the data stored in the diagnostic byte using binary operations (e.g., A I 35.0) or load operations (e.g., L IB 35).

Example	STL	Explanation
The diagnostic byte is to be evaluated within the program.	<pre> . . A I 35.0 = Q 32.1 BE </pre>	If bit "0" is set to "1" in the diagnostic byte, then signal "1" is assigned to output 32.1.

Note

Reset the counter condition code bits and the interrupt condition code bits to "0" after the current program processing. Resetting in the program is possible using the bit operations R I 35.0 through 35.7. Note that this operation is executed only if RLO = "1". The next time there is a counter or interrupt call up, the respective bits will be reset (ORed).

5.2 LED Error Display

The programmable controller's operator panel will show you if there are any internal malfunctions (see Table 5-1).

Table 5-1. Display and Analysis of Errors and Faults

Display	Analysis
PLC in STOP Red LED is lit	PLC malfunction Use the programmer to execute an interrupt analysis (see Section 5.3)
PLC in STOP Red LED is flashing	Error when loading or saving the program Use the programmer to execute an interrupt analysis (see Section 5.3)
PLC in RUN Green LED is lit Faulty operation	Program error or I/O fault Execute a fault analysis (see Section 5.5)

If both LEDs are lit, your programmable controller is in the "RESTART" operating mode.

5.3 Interrupt Analysis Using the Programmer

The operating system sets various "analysis" bits in the case of any malfunction. These bits can be read by means of the ISTACK function of the programmer.

5.3.1 "ISTACK" Analysis Function

The interrupt stack is an internal programmable controller memory area where the causes of malfunctions are stored. If there is a malfunction, a bit in the respective byte of the memory area is set.

You can read out the contents of this memory area using the programmer.

ISTACK Call

The call is made through the programmer menu in the "STOP" operating mode. Refer to your programmer manual for the key sequence.

NOTE

In the RUN mode, only the control bits can be output in the ISTACK function.

Updating the ISTACK

The ISTACK is updated automatically in the following cases:

- When the PLC changes from "RUN" to "STOP"
- If the PLC remains in the "STOP" mode although you have switched the operating mode switch from "STOP" to "RUN".

If you now call up the ISTACK on the programmer, the current cause of the malfunction will be displayed.

The tables on the following pages inform you of the following:

- Which control bits are output in the ISTACK
- Which causes of malfunctions are output in the ISTACK;
- Descriptions of the abbreviations and error IDs used in the ISTACK display.

ISTACK Display on the 710/730/750 and 770 Programmers

The ISTACK display is divided up into two different programmer screen forms. The first screen form shows the control bits of the ISTACK, the second one basically lists the causes of errors. Table 5-2 shows the control bit screen form of the ISTACK. The relevant control bits for the S5-90U/S5-95U are shaded.

Table 5-2. Display of Control Bits

NB	PBSSCH	ESTSCH	SCHTAE	ADRBAU	SPABBR	NAUAS	QUITT
NB	NB	NB	REMAN	NB	NB	NB	NB
STOZUS	STOANZ	NEUSTA	NB	BATPUP*	NB	BARB	BARBEND
NB	UAFEHL	MAFEHL	EOVH	NB	AF	NB	NB
ASPNEP	ASP NRA	KOPFNI	PROEND	ASPNEEP	PADRFE	ASPLUE	RAMADFE
KEINAS	SYNFEH	NINEU	NB	NB	NB	SUMF	URLAD

* not relevant for S5-90U

Table 5-3 includes the ISTACK display for the causes of errors and other relevant data. The data pertaining to the S5-90U/S5-95U are shaded.

Table 5-3. Display of the ISTACK

INTERRUPT STACK							
BLOCK:	01						
INS-REG:	0000	SAC:	25CA	DB-ADD:	0000		
BLK-STP:	5E03	OB-No.:	1	DB-No.:			
		REL-SAC.:	0000				
ACCU1:	FFFF	ACCU2:	0000				
CONDITION CODE:		CC1	CC0	OVFL	CARRY	ODER	ERAB
							X
		STATUS	RLO				
			X				
CAUSE OF INTERR.:		STOPS	NB	SUP*	TRAP	NNN	STS
		X					
		STUEB	NAU	QVZ	ZYK	PEU	BAU
		ASPPA					

* not relevant for S5-90U

Tables 5-4 and 5-5 list the meanings for the abbreviations used in the ISTACK display on the programmer.

Table 5-4. Abbreviations for Control Bits and Causes of Errors

Abbreviations of Control Bits Relevant for S5-90U and S5-95U		Abbreviations of Error/Fault Causes Relevant for S5-90U and S5-95U (= Error IDs)	
BSTSCH	Block shift requested	STOPS	Operating mode switch set to STOP
SCHTAE	Block shift active (function: COMPRESS PC)	SUF	Substitution error (for S5-95U only)
ADRBAU	Construction of Address lists completed	TRAF	Transfer error for data block statement
STOZUS	STOP state (external request, e. g. via programmer)	NNN	Statement cannot be interpreted in the PLC
STOANZ	STOP display (internal request)	STS	STS statement has caused STOP
NEUSTA	Cold restart of PLC	STUEB	Block stack overflow (max. nesting depth exceeded)
BATPUF	Battery backup for RAM okay (for S5-95U only)	NAU	Power failure in central controller
AF	Interrupt enable	ZYK	Cycle time exceeded
KOPFNI	Block type could not be identified during address list construction	PEU	I/Os not ready (expansion unit not ready)
KEINAS	No user memory available	BAU	Battery failure
SYNFEH	Synchronization error or invalid code	ASPFA	Impermissible memory submodule
NINEU	Cold restart not possible		
URLAD	Bootstrapping required for user program		

Table 5-5. Abbreviations of Other Relevant Status Data

Abbreviations of Other Status Data Relevant for the S5-90U and S5-95U	
INS-REG:	Instruction register
SAC	STEP address counter
DB-ADD	Data block address
BLK-STP	Block stack pointer (points to last stack entry)
NO	Block number (OB, PB, FB, SB, DB)
REL-SAC	Relative STEP address counter
ACCU 1/2	Accumulator 1/2
CC1/CC0	Condition code 1/0
OVFL	Arithmetic overflow (value range exceeded)
ODER (OR)	AND before OR operation
ERAB	Statement last processed was first scan
STATUS	Logic state of the bit operation scanned
RLO	Result of logic operation (bit containing the result of the operation)

5.3.2 Meanings of the ISTACK Displays for Errors Occurring During Restart and Program Execution

You can use Table 5-6 to determine the cause of an interrupt in program processing. The PLC always enters the "STOP" mode.

Note

If DB1 is stated as the cause of the error in the ISTACK, refer to Section 9.4.5 for error elimination.

Table 5-6. Interrupt Analysis

ISTACK Display	Cause of Error	Error Elimination
BAU	When automatically loading the program - Battery is missing/is dead and there is no valid program available on the memory submodule	Replace the battery and recreate the program, or load the program again.
NAU	Interruption in the power supply voltage to the PLC or the IM 90 interface module (for S5-90U only)	
NINEU	The program in the PLC memory is defective. Cause: - A power failure has interrupted one of the following operations. <ul style="list-style-type: none"> • Compress • Block transfer from the PG to the PLC or memory submodule to the PLC • PLC overall reset - Battery has been replaced while the power was off.	Perform an overall reset and load the program again.
NINEU and SYNFEH	An error was detected during construction of the address list (wrong address in SD 100) Possible cause: - Error in LIR/TIR statement	Perform an overall reset and load modified program.
NNN	- Statement cannot be decoded - Nesting level too high - Too many parameters	Eliminate program errors.
PEU	- I/O bus malfunction/interruption - Maximum length of shift register exceeded - Module unknown - Module in wrong slot - I/O bus neither connected nor "PBUS J" parameterized in DB1 (for S5-95U only, see Section 6.5)	- Check the connections. - Check the module slots. - Replace defective modules/bus units. - Modify DB1 (for S5-95U only).
STOPS	Operating mode switch on STOP	Set to RUN.
STS	- Software stop by statement (STP) - STOP requested by programmer	
STUEB	Block stack overflow: the maximum block nesting depth (16) has been exceeded	Eliminate program errors.

Table 5-6. Interrupt Analysis (Continued)

ISTACK Display	Cause of Error	Error Elimination
SUF*	Substitution error: - Function block called with an incorrect actual parameter. - For interrupt- and time-driven processing: integral FB call while another FB is processed.	- Change actual parameter. - Disable interrupts.
TRAF	Transfer error: - Data block statement programmed with a data word number larger than the data block length. - Data block statement programmed without having previously opened a data block or DB not existing. - Memory space not sufficient for DB generation	- Eliminate program error (see your programmer's Manual).
ZYK	Scan time exceeded: The program processing time exceeds the set monitoring time. Causes: - Program too long - Interrupts too frequent - During STATUS function for very long blocks	- Check the program for continuous loops, shorten, if needed. - Use OB31 (for S5-95U) - Distribute program over several blocks

* Only possible for S5-95U

5.3.3 Meanings of ISTACK Displays in the Case of Errors During Copying the Program

Error display: after Switching the PLC to RUN, the red LED continues flashing.

Table 5-7. Errors During Copying

ISTACK Display	Cause of Error	Error Elimination
ASPFA	Loading the memory submodule into the PLC: - Program on the memory submodule too long for the PLC's program memory. - Program on the module contains an invalid block number.	Check the program on the memory submodule.
ASPFA	Saving from the PLC to the memory submodule: EEPROM memory submodule is defective or too small for the program in the PLC memory.	Replace the memory submodule, or use a larger EEPROM memory submodule.
ASPFA and KEIN AS and NNN and SAC=FFFF	Internal program memory overflow during compilation.	Shorten program, compress memory.

5.4 Program Errors

The ISTACK displays two types of program errors:

- Errors recognized by the compiler when compiling the program ("Compiler error", e.g. "NNN")
- Errors recognized during program execution (runtime errors, such as "SUF" and "TRAF")

5.4.1 Determining an Error Address

"Compiler Error"

A "compiler error" generates a complete ISTACK error display, i.e. the STEP address counter specifies the absolute memory address of the STEP 5 statement in the PLC that **follows** the statement which caused the PLC to enter the "STOP" state.

The relative STEP address counter (REL-SAC) specifies the relative address of the STEP 5 statement within a block that **follows** the statement which caused the PLC to enter the "STOP" state.

Example:

You have input a control program consisting of OB1, PB0 and PB7. An illegal statement was programmed in PB7.

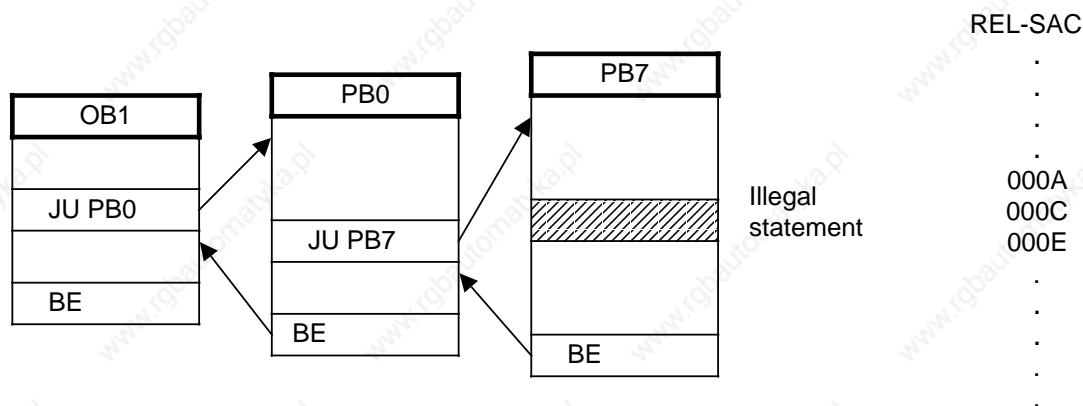

Figure 5-3. Structured Program with Illegal Statement

When the programmable controller reaches an illegal statement, it interrupts program processing and goes into the "STOP" mode with the "NNN" programmable controller error message.

The STEP address counter is at the absolute address of the next statement in the program memory that still has not been processed.

The REL-SAC contains the relative address of the next statement that has not yet been processed within PB7 (000E).

Runtime Errors

If a runtime error has occurred, the STEP address counter specifies the **initial address of the errored block**.

The relative STEP address counter (REL-SAC) has the value "0000".

In the case of the "SUF" and "TRAF" runtime errors, you can use a "trick" to determine the correct address of the error (for S5-95U only).

Proceed as follows:

Switch the operating mode switch of the PLC to "STOP".

Select the "STATUS" diagnostic function on the programmer to check the errored block.

Switch the PLC from "STOP" to "RUN".

Call up the ISTACK display on the programmer when the PLC has entered the "STOP" mode.

The STEP address counter shows the absolute memory address following the address at which the PLC entered the "STOP" state.

The REL-SAC specifies the relative address within a block following the address at which the PLC entered the "STOP" state.

5.4.2 Program Tracing with the "BSTACK" Function

During program processing, the following information about jump operations is entered in the block stack (BSTACK).

- The data block that was valid before program processing exited a block.
- The absolute block start address. It specifies the memory address of the block start in the program memory.

You can call up this information with the "BSTACK" programmer function in the "STOP" mode if a fault has caused the programmable controller to go into the "STOP" mode. "BSTACK" then reports the status of the block stack at the time the interruption occurred.

Example: Program scanning was interrupted at function block FB2. The programmable controller went into the "STOP" mode with the error message "TRAF" (because of incorrect DB access, e.g., DB5 is two words long, DB3 is ten words long). "BSTACK" lets you determine the path used to reach FB2 and which DB was open at the time of call up. "BSTACK" contains the three (marked) block start addresses.

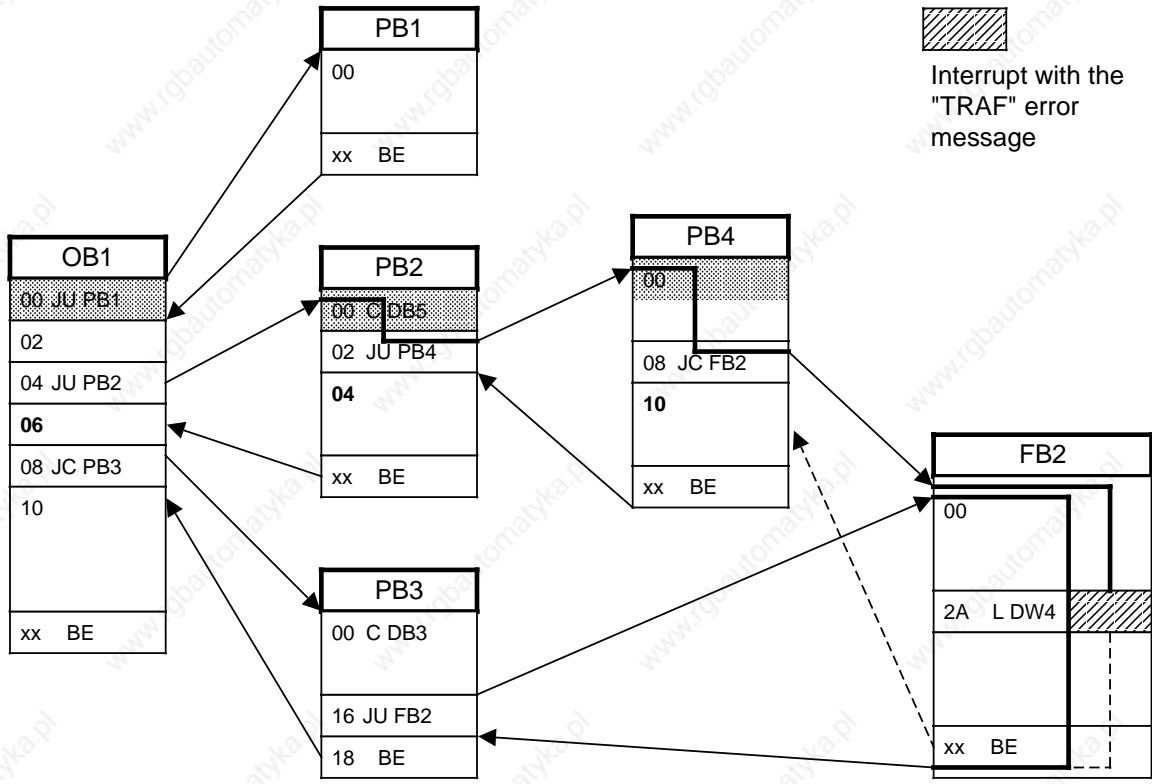

Figure 5-4. Program Tracing with "BSTACK"

Table 5-8. BSTACK Display

BLOCK STACK						
Block No.	Block Add.	Return Add.	Rel. Add.	DB No.	DB Add.	
PB 4	0174	0174	0000	DB 5	0164	
PB 2	011A	011A	0000	DB 5	0164	
OB 1	0152	0152	0000			

The above BSTACK display indicates a block was called up via the path of OB1 PB2 PB4. During processing of this block, the programmable controller went into the "STOP" mode. DB5 was valid when this block was called.

Refer to the ISTACK for the block that was being processed when the error occurred and for the cause of the error.

5.5 Faults in the External I/Os

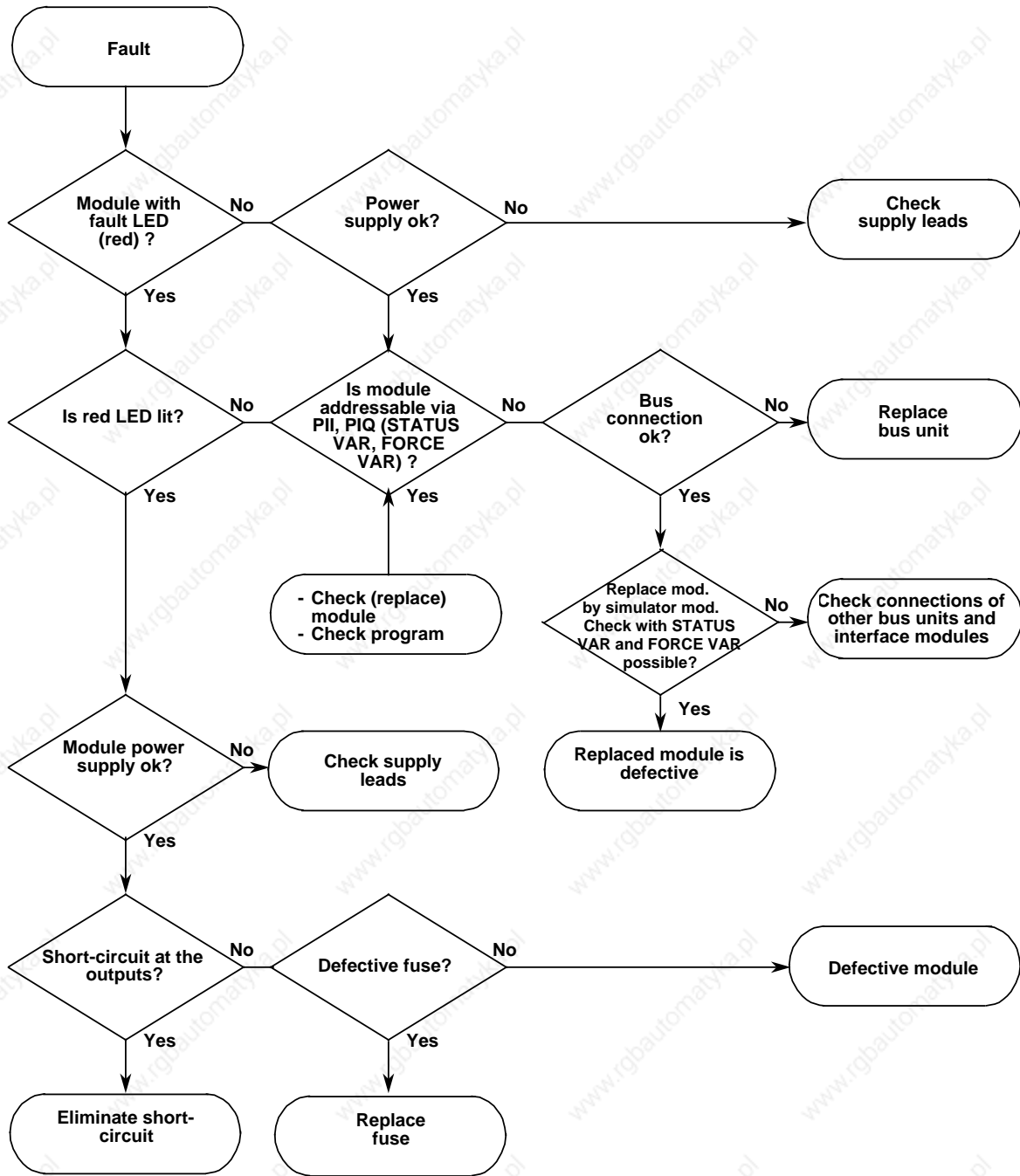

Figure 5-5. Analyzing the Cause of a Fault in the External I/Os

5.6 System Parameters

The "SYSPAR" programmer function can be used to read the system parameters (e.g. PLC software version) of the PLC (see Programmer Manual).

5.7 The PLC does not Enter the "RUN" Mode

Suppose the programmable controller cannot be brought into the "RUN" mode although all feasible causes of errors concerning parameterization (DB1) and the STEP 5 program can be excluded.

Possible cause: The battery has been installed or replaced when the programmable controller was switched off.

Remedy: Perform an overall reset (see Section 4.1.3) and load the program again.

www.rgbautomatyka.pl

6 Addressing and Access to I/Os		
6.1	Addressing the Onboard I/Os	6 - 1
6.2	Addressing the External I/Os	6 - 2
6.2.1	Slot Numbering	6 - 2
6.2.2	Digital Modules	6 - 5
6.2.3	Analog Modules	6 - 7
6.2.4	Function Modules	6 - 8
6.3	Process Image and Access to I/Os	6 - 9
6.3.1	Access to I/Os During Cyclic Program Execution	6 - 11
6.3.2	Access to I/Os During Time-Controlled Program Execution (for S5-95U only)	6 - 13
6.4	Calculating the Scan Time and Response Time	6 - 15
6.5	Start-Up with/without External I/Os and Parameterization of Internal Timers (S5-95U only)	6 - 23

Figures

6-1	Address Assignments for External I/Os	6 - 2
6-2	Consecutive Numbering of Slots in a Single-Tier Configuration	6 - 2
6-3	Slot Numbering in a Multi-Tier Configuration	6 - 3
6-4	Expanding from 14 to 18 Slots	6 - 4
6-5	Address Assignments for Digital Modules with 4 or 8 Channels	6 - 5
6-6	Structure of a Digital Address	6 - 5
6-7	Address Assignments for Digital Modules with more than 8 Channels	6 - 6
6-8	Structure of a Digital Address	6 - 6
6-9	Address Assignment for Analog Modules	6 - 7
6-10	Structure of an Analog Address	6 - 7
6-11	Procedure for Direct/Indirect I/O Access During Cyclic Program Execution ..	6 - 12
6-12	Procedure for Direct/Indirect I/O Access During Time-Controlled Program Execution	6 - 14
6-13	Entering the Address for "System Data Parameters"	6 - 24

Tables

6-1	Onboard Address of the S5-90U and S5-95U	6 - 1
6-2	S5-90U: Structure of the PII and PIQ	6 - 9
6-3	S5-95U: Structure of the PII and PIQ	6 - 10
6-4	Direct I/O Access During Cyclic Program Execution - STEP 5 Operations ..	6 - 11
6-5	Indirect I/O Access During Cyclic Program Execution - STEP 5 Operations ..	6 - 11
6-6	Indirect I/O Access During Time-Controlled Program Execution - STEP 5 Operations	6 - 13
6-7	Bits Assigned to the Various Modules in the PII/PIQ	6 - 19
6-8	Start-Up Characteristics of the PLC, Depending on the PBUS Setting and the External I/O Bus	6 - 23

6 Addressing and Access to I/Os

The S5-90U and the S5-95U have two types of inputs and outputs. The inputs and outputs located on the programmable controller itself are called onboard I/Os. The S5-100U modules that expand your programmable controller are called external I/Os.

The inputs and the outputs of both the external I/Os and the onboard I/Os have different assigned addresses so that you can access them specifically. The onboard I/O addresses cannot be changed. The external I/O addresses are the same as the slot addresses assigned to the S5-100U modules.

6.1 Addressing the Onboard I/Os

The following Table shows all the addresses of the onboard I/Os available to the S5-90U and S5-95U. The addresses of the onboard I/Os are fixed.

Table 6-1. Onboard Addresses of the S5-90U and S5-95U

Function	Addresses in the S5-90U	Addresses in the S5-95U
Digital onboard I/Os	Inputs: I 32.0 to 33.1 Outputs: Q 32.0 to 32.5	Inputs: I 32.0 to 33.7 Outputs: Q 32.0 to 33.7
Analog onboard I/Os	—————	Inputs: IW 40 to IW 54 Outputs: QW 40
Interrupts	Interrupt input: I 33.0	Interrupt inputs: I 34.0 to I 34.3
Counters	Counter input: I 33.1 Counter value: IW 36	Value of counter A : IW 36 Value of counter B: IW 38

6.2 Addressing the External I/Os

The addresses for the external I/Os are slot oriented.

This means that once a module is snapped onto its slot on the bus unit, it is assigned a slot number and thus a fixed address in one or both of the process images.

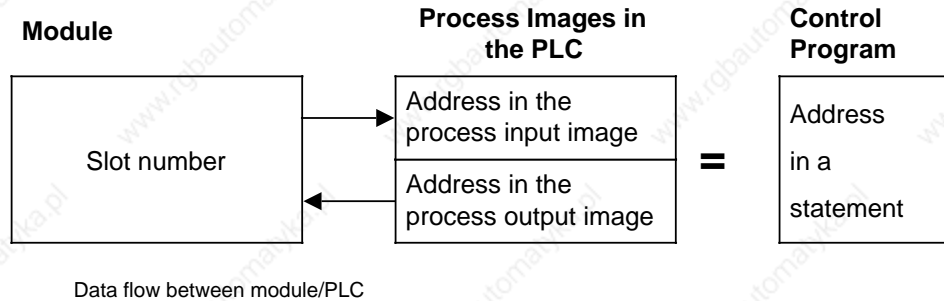

Figure 6-1. Address Assignments for External I/Os

6.2.1 Slot Numbering

The programmable controller can have a maximum of four tiers. The S5-90U has a maximum of three bus units (6 slots) and the S5-95U has a maximum of 16 bus units (32 slots).

The slots are numbered consecutively. Numbering begins with "0" at the slot beside the programmable controller. Whether a module is plugged in or not has no effect on the numbering.

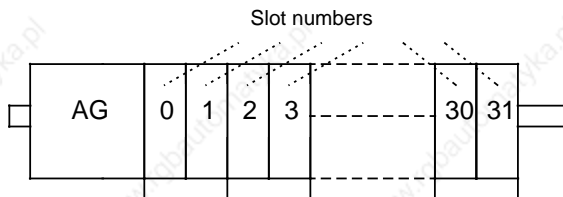

Figure 6-2. Consecutive Numbering of Slots in a Single-Tier Configuration

Note

Please note that the S5-90U (IM 90) provides a maximum current of 0.3 A and the S5-95U a maximum current of 1 A at the external I/O bus. These limits must not be exceeded. The maximum permissible number of slots can therefore not be used in some configurations. To by-pass this restriction, the PS 935 power supply module can additionally be used in the S5-95U.

If the programmable controller consists of more than one tier, numbering of the expansion tiers is continued at the slot on the extreme left.

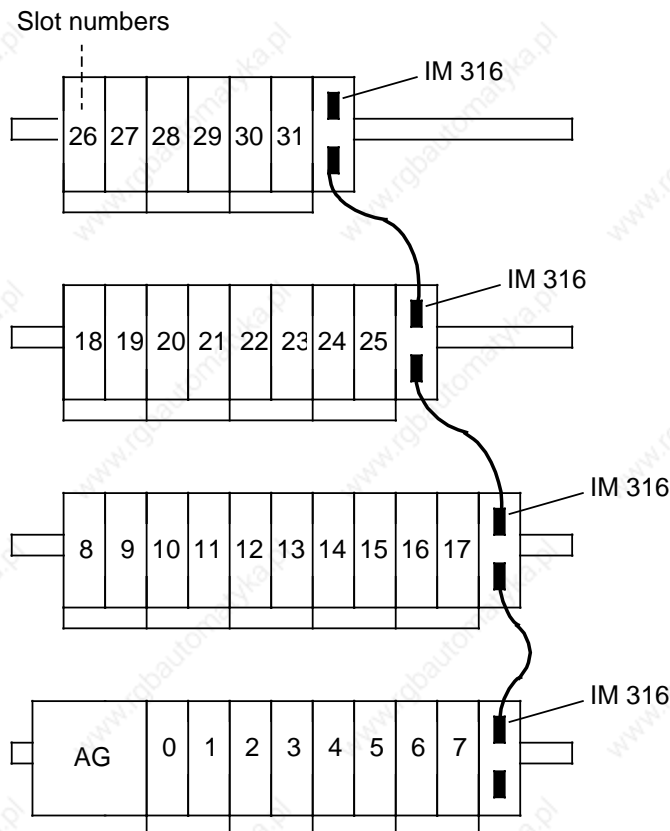

Figure 6-3. Slot Numbering in a Multi-Tier Configuration

When expanding your system, always add the new bus units to the topmost tier on the right. Otherwise, the slot numbers on the right of the new bus units will be changed, requiring address changes in your control program.

Use the IM 315 or IM 316 interface module for multi-tier configurations.

Note

After every expansion, to make certain that the addressing used in the control program corresponds to the actual configuration.

Example: Expanding from 14 to 18 Slots

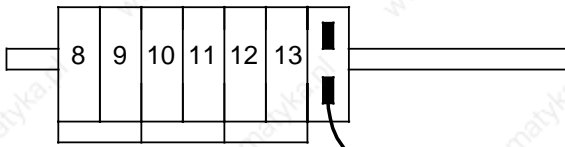

Existing configuration

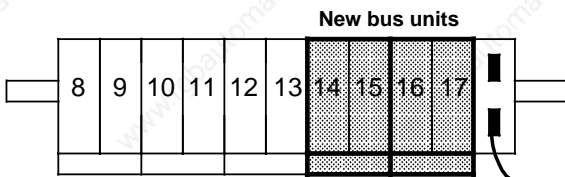
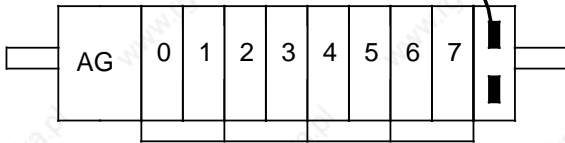

Correct expansion procedure

The new bus units are added at the right. The interface module is moved correspondingly to the right. The old slot numbers are retained. Continue numbering the new slots sequentially.

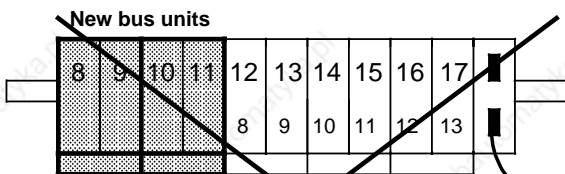
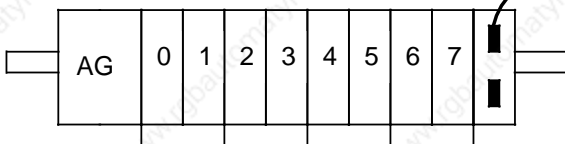

Incorrect expansion procedure

The slot numbers of the old bus units move to numbers 12 to 17. The new slots are given the numbers 8 to 11.

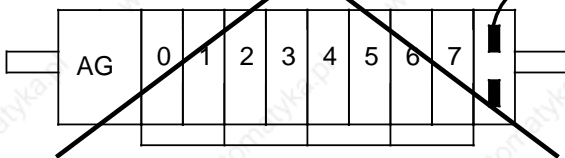

Figure 6-4. Expanding from 14 to 18 Slots

6.2.2 Digital Modules

Only two items of information ("0" or "1") per channel can be transferred either from or to a digital module. Digital modules are addressed channel by channel in the case of bit operations.

There are two types of digital modules with different address ranges:

- Digital modules with four or eight channels can be plugged into slots 0 to 31
- Digital modules with more than eight channels can be plugged into slots 0 to 7

Digital Modules with Four or Eight Channels



Figure 6-5. Address Assignments for Digital Modules with Four or Eight Channels

Each channel of a digital module is represented by a bit. This is the reason that every bit must be assigned its own number. Use the following form for a digital address:

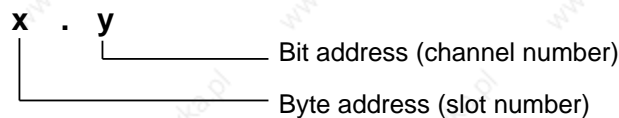

Figure 6-6. Structure of a Digital Address

The address "X.Y" is composed of the following:

Byte Address X (Slot Number X)

The byte address is the same as the number of the slot the module is plugged into.

Bit Address Y (Channel Number Y)

The bit address comes from the connection of the actuators or sensors to the terminals of the terminal block.

The assignment for the channel number and the terminal number is printed on the frontplate of the module.

Example: Address 3.1 - The module is plugged into slot 3, the channel number is 1.

Note

You can address 4-channel digital modules only with channel numbers 0 through 3. The channel numbers 4 through 7 printed on the frontplate are relevant only for the ET 100U system.

Digital Modules with more than Eight Channels

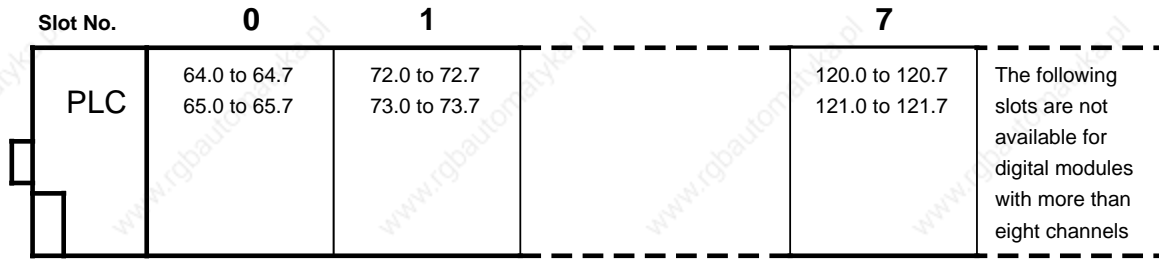

Figure 6-7. Address Assignments for Digital Modules with more than Eight Channels

Each channel of a digital module is represented by one bit. Each bit must therefore be assigned a separate number. A channel is thus addressed in the following manner:

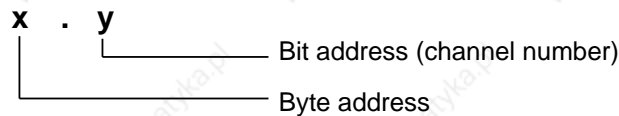

Figure 6-8. Structure of a Digital Address

The address "X.Y" is composed of the following:

Byte Address X

The byte address is derived from the number of the slot the module is plugged into and the connection of the actuators and sensors to the terminals of the module's front connector.

Bit Address Y (Channel Number Y)

The bit address is derived from the connection of the actuators and sensors to the terminals of the front connector.

The assignment of channel number to terminal number is printed on the module's front panel.

Example: A digital input module 6ES5 422-8MA11 is plugged into slot 1, a sensor is connected to terminal 13, i.e. the channel number is 1. The address is therefore 72.1. For assignments of front connector terminals to channel numbers refer to the illustration of the module in Section 15.5.1.

6.2.3 Analog Modules

Whereas either one "0" or "1" bit per channel can be transferred from one digital module to another, 65536 different items of information (16 bits) can be exchanged on each channel between two analog modules.

The modules are addressed word by word using load or transfer operations.

The channels of an analog module must be addressed in accordance with a certain data format (see Chapter 12, "Analog Value Processing").

Analog modules are addressed channel by channel using word operations.

The programmable controller takes this increased memory requirement into account when an analog module is plugged in.

- Eight bytes (=four words) are reserved per slot.
- The slot addressing area is changed.
- The permissible address space extends from byte 64 (slot 0, channel 0) to byte 127 (slot 7, channel 3).

Slot number	0	1	2	3	4	5	6	7
PLC	64+65 Channel 0	72 ...	80 ...	88 ...	96 ...	104 ...	112 ...	120 ...
	66+67 Channel 1							
	68+69 Channel 2							
	70+71 Channel 3	... 79	... 87	... 95	... 103	... 111	... 119	... 127

The following slots are not available for analog modules.

Figure 6-9. Address Assignment for Analog Modules

Each channel of an analog module is represented by one word. Each word must therefore be assigned a separate number. A channel is thus addressed in the following manner:



Figure 6-10. Structure of an Analog Address

Word Address z

The word address is derived from the number of the slot the module is plugged into and the connection of the actuators and sensors to the terminals of the terminal block.

Example: An analog module is plugged into slot 5, channel 1 is connected - hence, the word address is 106.

For assignments of the terminal block connections to the word addresses, refer to illustrations of the individual modules in Section 15.

Note

Any combination of analog and digital modules is possible in slots 0 through 7.

6.2.4 Function Modules

The address assignments vary for the individual function modules.

Some function modules are addressed like digital modules, some like analog modules.

For module addressing refer either to Chapter 16, "Function Modules", or to the Manual for a specific module.

One can distinguish between two module types according to the way they are addressed:

- Function modules that can be plugged into slots 0 to 5 (S5-90U) or 0 to 31 (S5-95U).
These modules are within the address range of the digital modules with four to eight channels, i. e. 0.0 to 5.7 (S5-90U) or 0.0 to 31.7 (S5-95U). These are the following modules:
 - Comparator module
 - Timer module
 - Simulator module
 - Diagnostic module
 - Counter module 2 x 0 to 500 Hz

- Function modules that can be plugged into slots 0 to 5 (S5-90U) or 0 to 7 (S5-95U) .
These modules are within the address range of the analog modules, i. e. 64.0 to 111.7 (S5-90U) or 64.0 to 127.7 (S5-95U). These are the following modules:
 - Counter module 25/500 kHz
 - IP 262 Closed-loop control module
 - IP 263 Positioning module
 - IP 264 Electronic cam controller module
 - IP 265 High Speed Sub Control
 - IP 266 Positioning module
 - IP 267 Stepper motor control module
 - CP 521 SI Communications processor
 - CP 521 BASIC Communications module

6.3 Process Image and Access to I/Os

The process input image (PII) includes information on inputs; information on outputs is written into the process output image (PIQ).

The PII and the PIQ occupy 128 bytes each in the RAM of the PLC.

I/O Areas and their Addresses in the Process Image of the S5-90U

Table 6-2. S5-90U: Structure of the PII and PIQ

Process Input Image (PII)		Process Output Image (PIQ)	
Address in PII	Assignment	Address in PIQ	Assignment
0.0 to 5.7	Digital inputs of the external I/Os	0.0 to 5.7	Digital outputs of the external I/Os
6.0 to 31.7	Unassigned	6.0 to 31.7	Unassigned
32.0 to 33.1	Digital inputs of the onboard I/Os	32.0 to 32.5	Digital outputs of the onboard I/Os
33.0	Interrupt input	from 32.6	Unassigned
33.1	Counter input		Unassigned
33.2 to 34.7	Unassigned		Unassigned
35.0 to 35.4	Diagnostic byte		Unassigned
36.0 to 37.7	Counter	up to 37.7	Unassigned
38.0 to 39.7	Internal assignment	38.0 to 39.7	Internal assignment
40.0 to 63.7	Unassigned	40.0 to 63.7	Unassigned
64.0 to 127.7	Analog inputs of the external I/Os	64.0 to 127.7	Analog outputs of the external I/Os

I/O Areas and their Addresses in the Process Image of the S5-95U

Table 6-3. S5-95U: Structure of the PII and PIQ

Process Input Image (PII)		Process Output Image (PIQ)	
Address in PII	Assignment	Address in PIQ	Assignment
0.0 to 31.7	Digital inputs of the external I/Os	0.0 to 31.7	Digital outputs of the external I/Os
32.0 to 33.7	Digital inputs of the onboard I/Os	32.0 to 33.7	Digital outputs of the onboard I/Os
34.0 to 34.3	Interrupt inputs	from 34.0	Unassigned
34.4 to 34.7	Unassigned		Unassigned
35.0 to 35.7	Diagnostic byte		Unassigned
36.0 to 37.7	Counter A		Unassigned
38.0 to 39.7	Counter B	up to 39.7	Unassigned
40.0 to 55.7	Analog inputs of the onboard I/Os	40.0 to 41.7	Analog outputs of the onboard I/Os
56.0 to 63.7	Unassigned	42.0 to 63.7	Unassigned
64.0 to 127.7	Analog inputs of the external I/Os	64.0 to 127.7	Analog outputs of the external I/Os

There are two possibilities of accessing the I/Os:

- Direct access
- Indirect access via the process image.

Both possibilities are explained in Section 6.3.1. Section 6.3.2 describes the two different access methods for the so-called interrupt process image.

Note

Reading from an empty slot always results in signal state "0".

6.3.1 Access to I/Os During Cyclic Program Execution

Direct I/O Access

Direct I/O access enables the exchange of information with the I/Os without previously writing this information either into the process input image or process output image. In this way, the values currently present at the inputs are processed by the program and the result immediately routed to the outputs.

Direct access is possible for all onboard I/Os of the S5-90U/S5-95U.

Sequence of a direct I/O access (see Figure 6-11):

1. The value currently available to the onboard I/Os is read directly into the cyclic program.
2. The result obtained by cyclic program execution is output directly to the onboard I/Os.
3. The result is also entered into the PIQ.

STEP 5 operations suitable for direct I/O access:

Table 6-4. Direct I/O Access During Cyclic Program Execution - STEP 5 Operations

Onboard I/Os		External I/Os	
Read inputs	Write outputs	Read inputs	Write outputs
L PY x	T PY x	Not possible	Not possible
L PW x	T PW x	Not possible	Not possible

x stands for any permissible address

Indirect I/O Access

Indirect I/O access involves the process input/output images for the exchange of information with the I/Os. If an address is read several times within a program cycle, it will always render the same value.

Indirect I/O access is possible for both onboard I/Os and external I/Os.

Sequence of an indirect I/O access (see Figure 6-11):

1. The value currently available to the I/Os is read into the PII and stored.
2. The value is then read from the PII into the cyclic program using STEP 5 operations.
3. The result obtained by cyclic program execution is written to the PIQ by means of STEP 5 operations.
4. The value stored in the PIQ is then transferred to the outputs, i.e. all output signal states are updated.

STEP 5 operations suitable for indirect I/O access:

Table 6-5. Indirect I/O Access During Cyclic Program Execution - STEP 5 Operations

Onboard I/Os		External I/Os	
Read inputs	Write outputs	Read inputs	Write outputs
A I x	= Q x	A I x	= Q x
L IB x	T QB x	L IB x	T QB x
L IW x	T QW x	L IW x	T QW x

x stands for any permissible address

The following Figure illustrates the procedures for direct and indirect I/O access.

PLC

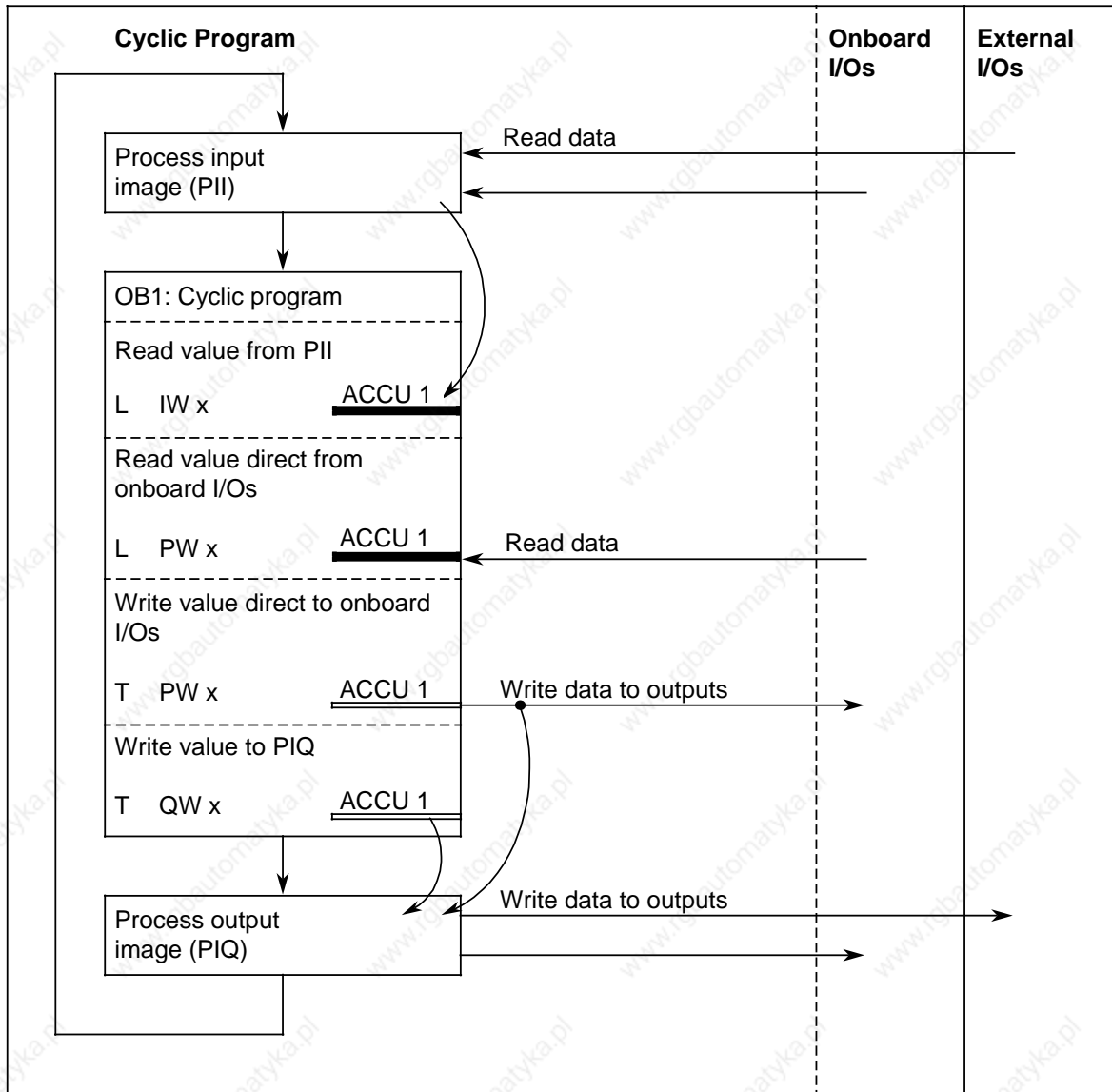

Figure 6-11. Procedure for Direct/Indirect I/O Access During Cyclic Program Execution

6.3.2 Access to I/Os During Time-Controlled Program Execution (for S5-95U only)

The S5-95U enables time-controlled program execution with the OB 13 (see Section 9.1.3).

There are two possibilities for accessing the I/Os during time-controlled program execution:

- Direct I/O access (analogous to cyclic program execution, see Section 6.3.1)
- Indirect I/O access via the interrupt process image.

Indirect I/O Access via the Interrupt Process Image

Information can be exchanged with the external I/Os only via the so-called interrupt process images. The interrupt process images are used exclusively for time-controlled program execution and are identical to the "normal" process images.

Procedure for indirect I/O access via the interrupt process image (see Figure 6-12):

1. At the beginning of time-controlled program processing, data is read from the inputs of the external I/Os into the interrupt PII. They are exclusively available to the time-controlled program.
2. The values in the interrupt PII are processed via the STEP 5 operations of the time-controlled program.
3. The values in the time-controlled program are written both into the "normal" PIQ and into the interrupt PIQ using STEP 5 operations.
4. The values in the interrupt PIQ are transferred to the outputs, i.e. all outputs signal states are updated.

STEP 5 operations suitable for indirect I/O access:

Table 6-6. Indirect I/O Access During Time-Controlled Program Execution - STEP 5 Operations

Onboard I/Os		External I/Os	
Read inputs	Write outputs	Read inputs	Write outputs
Not possible	Not possible	L PY x	T PY x
Not possible	Not possible	L PW x	T PW x

x stands for any permissible address

Note

For time-controlled program execution, the L PY x, L PW x, T PY x and T PW x operations can be used for

- Direct access to the onboard I/Os
- Indirect access to the external I/Os via the interrupt process image

depending on the address x.

The following Figure illustrates the procedures for direct and indirect I/O access.

PLC

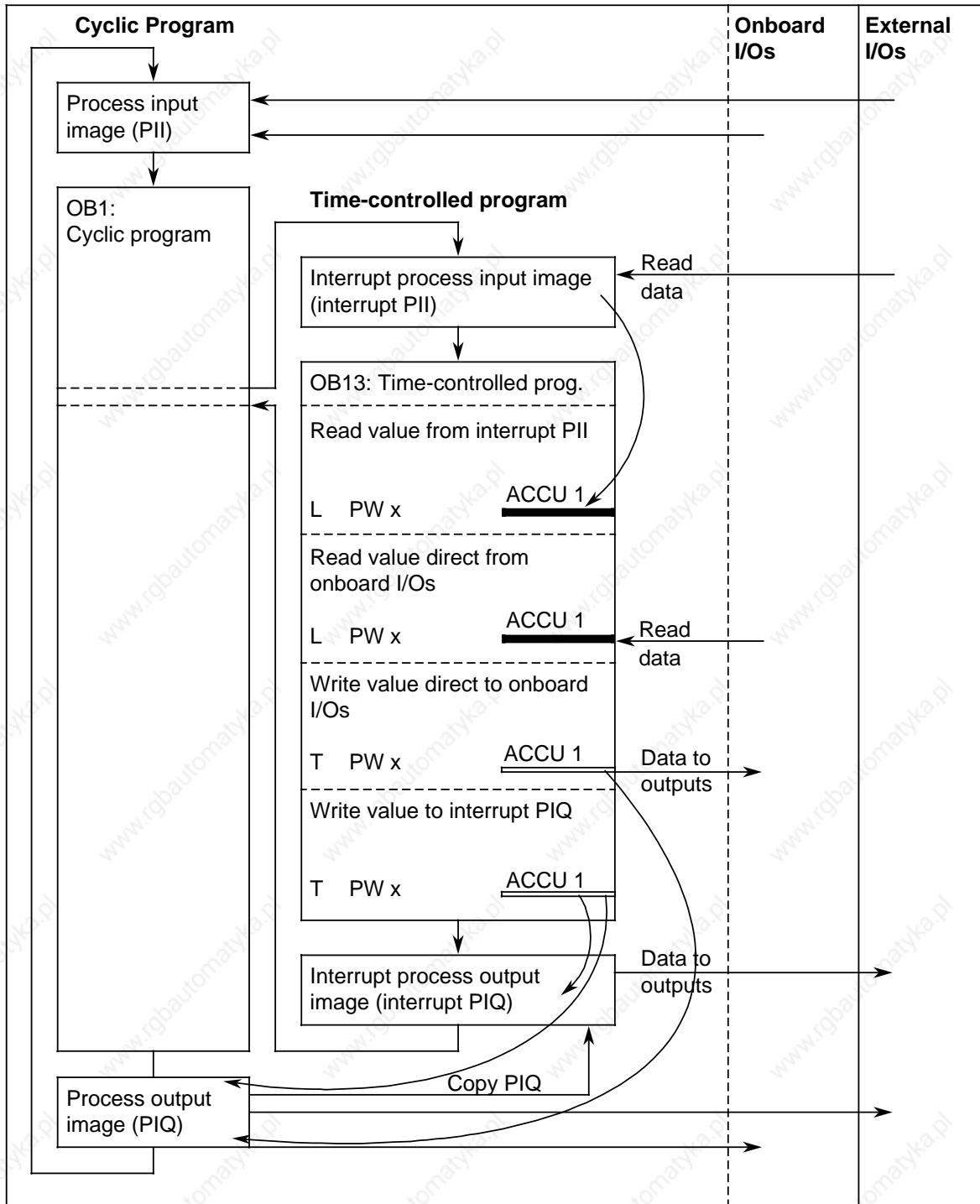

Figure 6-12. Procedure for Direct/Indirect I/O Access During Time-Controlled Program Execution

6.4 Calculating the Scan Time and Response Time

Scan Time

The scan time is the time required for one program cycle.

The scan time includes the following:

- Transfer time for the process image (PII and PIQ)
- Operating system runtime (cycle checkpoint)
- Program execution time
- Execution time for internal timers

The execution time for the internal timers is not shown in the diagram on the right since the internal timers are updated at regular intervals of 10 ms throughout the entire cycle.

(Please note that the units surrounded by a broken line represent sections that are not available for user program execution.)

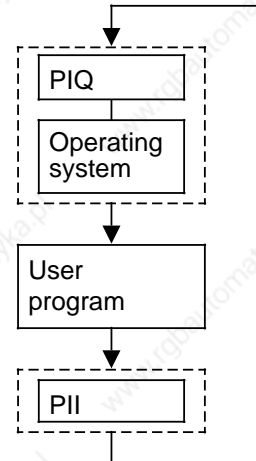

Response Time

The response time is the time that elapses between the recognition of an input signal change and the resulting output signal change.

The response time depends on the following factors:

- Process image transfer time
- Operating system runtime
- Program execution time
- Execution time for internal counters
- Delay of the inputs and outputs

Under normal operating conditions, the response times are between the shortest and longest possible response times. When configuring your system, you should always assume the longest possible response times.

In the following, the calculation of the shortest and longest possible response times will be described to illustrate the wide range within which response times can vary.

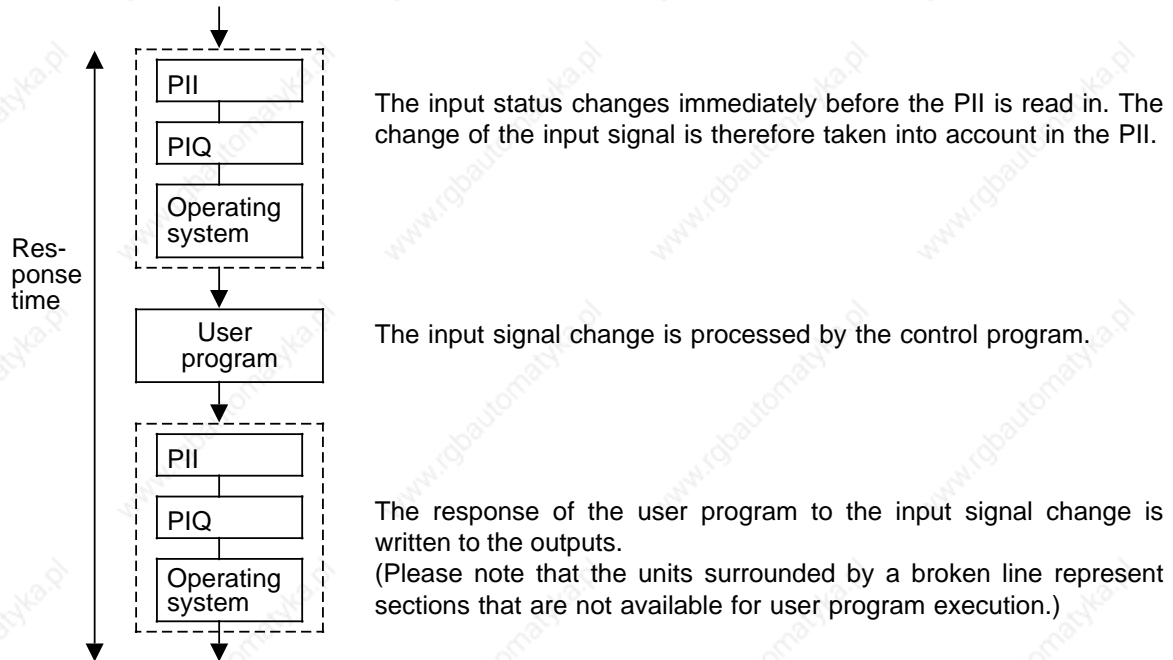
Shortest Possible Response Time:

The (shortest possible) response time is composed of the following:

- **2 x process image transfer time +**
- **2 x operating system runtime +**
- **1 x program execution time +**
- **Execution times for internal timers+**
(This time is not shown in the diagram since the internal timers are updated at regular intervals of 10 ms throughout the entire period under consideration.)
- **Delay of the inputs and outputs**
The input delay is also not marked in the diagram (see Appendix B, Technical Specifications - Onboard I/Os or Section 15, Technical Specifications for the individual modules).
The delays for electronic outputs are negligible. When using relay outputs, you should take into account the typical delay of 10 ms to 20 ms. The delay of the relay outputs depends, among others, on the temperature and voltage. In the case of analog outputs, the conversion time for the analog value must additionally be considered (see Appendix B or Section 15).

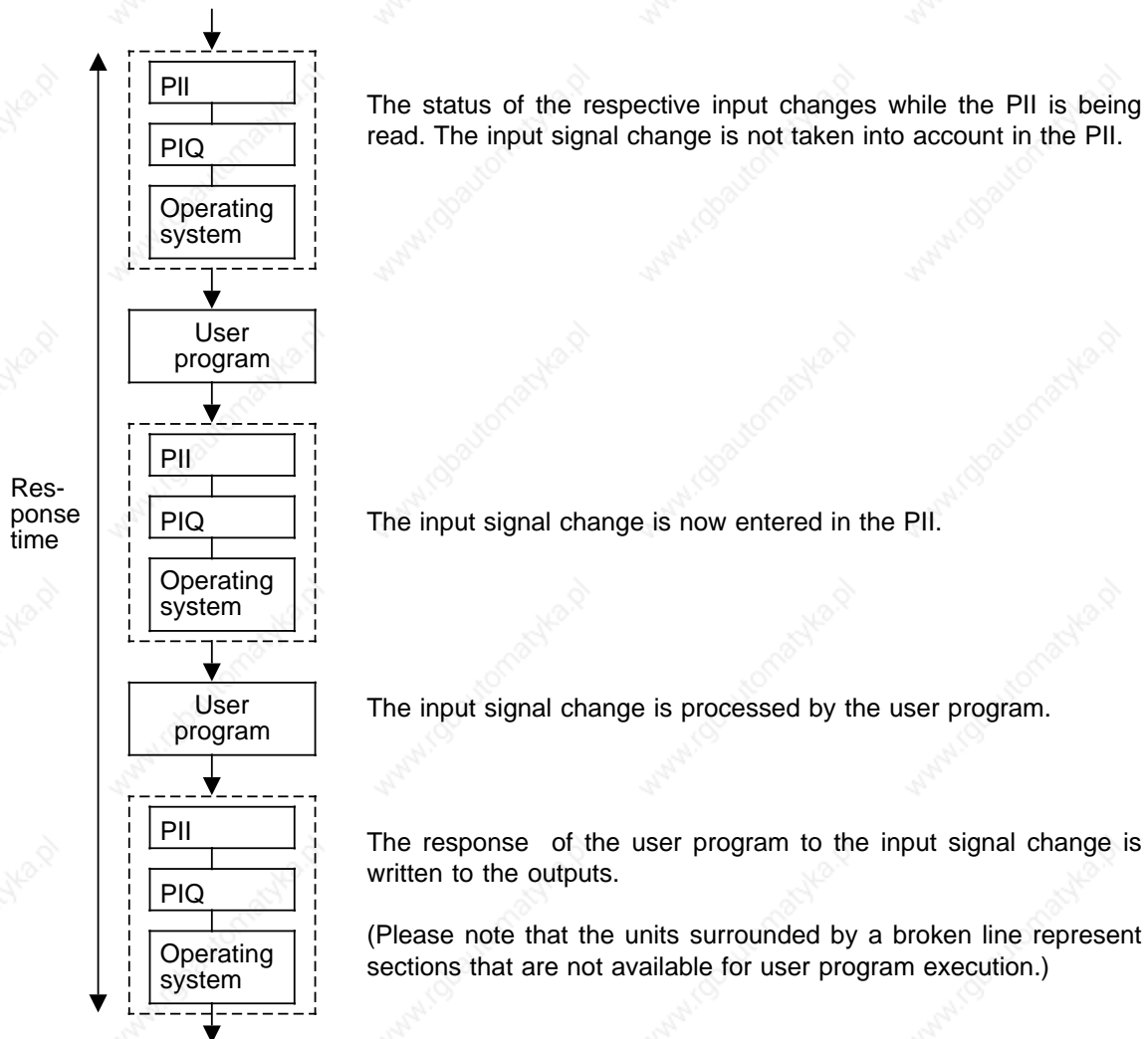
Longest Possible Response Time:

The (longest possible) response time is composed of the following:

- **3 x process image transfer time +**
- **3 x operating system runtime +**
- **2 x program execution time +**
- **Execution times for internal timers+**
(This time is not shown in the diagram since the internal timers are updated at regular intervals of 10 ms throughout the entire period under consideration.)
- **Delay of the inputs and outputs**
The input delay is also not marked in the diagram (see Appendix B, Technical Specifications - Onboard I/Os or Section 15, Technical Specifications for the individual modules).
The delays for electronic outputs are negligible. When using relay outputs, you should take into account the typical delay of 10 ms to 20 ms. The delay of the relay outputs depends, among others, on the temperature and voltage. In the case of analog outputs, the conversion time for the analog value must additionally be considered (see Appendix B or Section 15).

Note

Note the following points if you wish to **reduce the scan time and the response time**:

- DB1 enables you to parameterize the number of analog inputs to be read into the PII cyclically from the onboard I/Os of the S5-95U (see Chapter 12). It is recommendable to keep the number of analog inputs read cyclically to a minimum.
- DB1 enables you to parameterize the number of internal timers to be processed by the operating system (see Section 6.5).

In the default setting, all timers available (128) are executed by the operating system. Parameterize only those timers you are actually using in your program.

Please note that **the scan time and the response time are extended**

- Through the use of time-controlled program execution (OB13)/interrupt processing (OB3). In this case, you have to take into account the corresponding runtimes when calculating the scan time and the response time.
- Through the use of the programmer interface. In this case, the scan time and the response time mainly depend on the functions initiated via the programmer interface.

1. Process Image Transfer Time

The process image transfer time is the time required for reading the input signals into the PII and writing the output states into the PIQ.

The process image transfer time can be divided into the

- Process image transfer time for onboard I/Os and the
- Process image transfer time for external I/Os.

Process image transfer time for onboard I/Os:

The process image transfer time for the digital onboard I/Os is fixed and already included in the operating system runtime.

There is a linear relationship between the process image transfer time for the analog onboard I/Os (S5-95U) and the number of analog channels to be read into the PII. The transfer time can thus be calculated as follows:

PI transfer time for the analog onboard I/Os	=	Number of analog channels of the onboard I/Os read into the PII	· 80 μ s
--	---	---	--------------

A certain period for writing the analog output of the onboard I/Os is always required and therefore included in the operating system runtime of the S5-95U.

Process image transfer time for external I/Os:

The time required for this function is identical for the S5-90U and the S5-95U. There is a linear dependency between the time and the number and type of modules used. It can be calculated as follows:

PI transfer time for the external I/Os	=	Bits of the PII/PIQ used by all modules	· 34 μ s
--	---	---	--------------

Table 6-7. Bits Assigned to the Various Modules in the PII/PIQ

Module	Bits Assigned to Module in the PII/PIQ
<ul style="list-style-type: none"> • Digital modules with four channels • Diagnostic module • Comparator module • Timer module • 385A counter module • Unassigned slot 	4
<ul style="list-style-type: none"> • Digital modules with eight channels • Simulator module 	8
<ul style="list-style-type: none"> • Digital modules 6ES5 422-... and 6ES5 482-... • Analog modules 6ES5 464-... for each activated channel 	16
<ul style="list-style-type: none"> • Analog module 6ES5 466-8MC11 • 385B counter module • IP 267 	32
<ul style="list-style-type: none"> • CP 521 SI, CP 521 BASIC • IP 262, IP 263, IP 264, IP 265, IP 266 	64

2. Operating System Runtime

The operating system runtime is the time required by the operating system for executing the internal functions assigned to it.

The operating system runtime is a fixed value that cannot be modified.

- Operating system runtime of the S5-90U: 150 μ s
- Operating system runtime of the S5-95U: 500 μ s

3. Program Execution Time

The program execution time represents the sum of the execution times for all instructions from the call of OB1 to the block end (see Appendix A for execution time).

If any special OBs are called up, the program execution time is extended accordingly.

- Special OBs for S5-90U: OB3
- Special OBs for S5-95U: OB3, OB13, OB31, OB34, OB251.

4. Execution Time for Internal Timers

All internal timers parameterized (see 6.5) are updated by the operating system in intervals of 10 ms. The time required by the operating system for a single updating cycle of all timers parameterized is as follows:

$$\text{S5-95U: } t_T = (\text{number of timers parameterized}) \cdot 33 \mu\text{s}$$

For the S5-90U, the number of parameterized timers is fixed to 32.

$$\text{S5-90U: } t_T = 1056 \mu\text{s} \quad 1 \text{ ms}$$

For any interval t_X under consideration, the timers are updated

$$\left(1 + \frac{t_X}{10 \text{ ms}}\right) \text{ times during that interval.}$$

Total time requirement:

$$\text{Execution time for internal timers} = \left(1 + \frac{t_X}{10 \text{ ms}}\right) \cdot t_T$$

Calculating the Scan Time

The scan time includes the following:

- Process image transfer time
- Operating system runtime
- Program execution time
- Execution time for internal timers

Example: Your S5-95U configuration includes an IP 266 and an IP 267. All analog channels of the onboard I/Os are to be read into the PII. The program execution time for your control program is 4000 μs (=4 ms). You have parameterized 10 timers since your control program processes timers T0 to T9. How long is the scan time?

1. Process image transfer time:

PI transfer time of the onboard I/Os = $8 \cdot 80 \mu\text{s} = 640 \mu\text{s}$

PI transfer time of the external I/Os = $(64 + 32) \cdot 34 \mu\text{s} = 3264 \mu\text{s}$

The process image transfer time is thus $640 \mu\text{s} + 3264 \mu\text{s} = 3904 \mu\text{s}$ **3.9 ms**

2. Operating system runtime:

The operating system runtime is 500 μs = **0.5 ms**

3. Program execution time:

The program execution time is 4000 μs = **4 ms**.

4. Execution time for internal timers:

A single updating cycle for the 10 timers takes $t_T = 10 \cdot 33 \mu\text{s} = 330 \mu\text{s}$.

Add the operating system runtime, process image transfer time and program execution time, i. e. $t_x = 0.5 \text{ ms} + 3.9 \text{ ms} + 4 \text{ ms} = 8.4 \text{ ms}$, to obtain the interval. The execution time for the internal timers is to be added to this interval.

Hence:

$$\text{Execution time for internal timers} = \left(1 + \frac{8,4 \text{ ms}}{10 \text{ ms}}\right) \cdot 330 \mu\text{s} = 607.2 \mu\text{s} \text{ } \mathbf{0.6 \text{ ms}}$$

5. Scan time:

The scan time is the sum of all times calculated under 1 to 4.

Scan time = $0.5 \text{ ms} + 3.9 \text{ ms} + 4 \text{ ms} + 0.6 \text{ ms} = \mathbf{9 \text{ ms}}$

Calculating the Response time

The response time includes the following:

- 3 x process image transfer time+
- 3 x operating system runtime+
- 2 x program execution time+
- Execution time for internal timers+
- Input delays

Example: Your S5-95U configuration includes a 16-channel digital input module, an IP 266 and an IP 267. Four analog channels of the onboard I/Os are to be read into the PII. The time required for executing the control program is 5000 μs (=5 ms). You have parameterized 20 timers since your control program processes timers T0 to T19. Determine the (longest possible) response time.

1. Process image transfer time:

PI transfer time of the onboard I/Os = $4 \cdot 80 \mu\text{s} = 320 \mu\text{s}$

PI transfer time of the external I/Os = $(16+64+32) \cdot 34 \mu\text{s} = 3808 \mu\text{s}$

The process image transfer time is thus $320 \mu\text{s} + 3808 \mu\text{s} = 4128 \mu\text{s}$ **4.1 ms**

2. Operating system runtime:

The operating system runtime is $500 \mu\text{s} = 0.5 \text{ ms}$

3. Program execution time:

The program execution time is $5000 \mu\text{s} = 5 \text{ ms}$

4. Execution time for internal timers:

A single updating cycle for 20 timers takes $t_T = 20 \cdot 33 \mu\text{s} = 660 \mu\text{s}$.

Add 3 x process image transfer time, 3 x operating system runtime and 2 x program execution time, i.e. $t_X = 3 \cdot 4.1 \text{ ms} + 3 \cdot 0.5 \text{ ms} + 2 \cdot 5 \text{ ms} = 23.8 \text{ ms}$, to obtain the interval.

The execution time for the internal timers is to be added to this interval.

Hence:

$$\text{Execution time for internal timers} = \left(1 + \frac{23.8 \text{ ms}}{10 \text{ ms}}\right) \cdot 660 \mu\text{s} = 2230.8 \mu\text{s} \text{ } \mathbf{2.2 \text{ ms}}$$

5. Input Delays

The input delays for the S5-95U are typically 2.5 ms; the typical input delay for the 16-channel input module is 4 ms. The **4 ms** delay will be used for subsequent calculations.

6. Response time

The response time results from the addition of all times calculated under points 1 to 5.

Response time = $3 \cdot 4.1 \text{ ms} + 3 \cdot 0.5 \text{ ms} + 2 \cdot 5 \text{ ms} + 2.2 \text{ ms} + 4 \text{ ms} = \mathbf{30 \text{ ms}}$

6.5 Start-Up with/without External I/Os and Parameterization of Internal Timers (S5-95U only)

You can set some system characteristics in the "SDP:" (System-Dependent Parameters) parameter block of data block 1 (DB1). The syntax of DB1 and the procedure for parameterizing DB1 are described in Section 9.4. Please refer to this Section.

The following can be selected (parameterized):

- How many of the 128 internal timers are continuously executed by the processor (NT 128 parameter) and
- Whether the PLC is to take into account external I/O modules during restart (PBUS N parameter)

Before giving an example for assigning parameters for parameter block "SDP:", we will explain the meaning of the two system characteristics you can assign with the parameters.

The parameter for the internal timer "NT" is preset so that all 128 timers are constantly being processed. You can shorten the required processing time if you set only the internal timers that you really need.

The "PBUS" parameter is preset so that the programmable controller starts up without being connected via the external I/O bus (PBUS N).

If you want to be certain that the PLC starts up only if the I/O bus is connected, you have to change the parameter (PBUS J).

The following Table describes the start-up characteristics of the PLC depending on the setting of the DB1 parameter "PBUS" and the connection of the external I/O bus.

Table 6-8. Start-Up Characteristics of the PLC, Depending on the PBUS Setting and the External I/O Bus

Ext. I/O Bus Connected \ PBUS	PBUS N (Specified in DB 1)	PBUS J (Specified in DB1)
No	PLC starts up and enters the RUN mode	PLC recognizes PEU and enters the STOP mode
Yes	Has PLC recognized the external I/O bus during start-up? Yes: <ul style="list-style-type: none"> • PLC enters RUN mode, i.e. bus correctly configured, I/Os can be addressed; • PLC recognizes PEU and enters the STOP mode, i.e. incorrect bus configuration No: <ul style="list-style-type: none"> • PLC enters the RUN mode and I/Os are not addressed 	Has PLC recognized the external I/O bus during start-up? Yes: <ul style="list-style-type: none"> • PLC enters RUN mode, i.e. bus correctly configured, I/Os can be addressed; • PLC recognizes PEU and enters the STOP mode, i.e. incorrect bus configuration No: <ul style="list-style-type: none"> • PLC recognizes "PEU" and enters the STOP mode

Example: The program only requires 25 internal timers (T0 to T24) and you want to be certain that the programmable controller starts up only if the external I/O modules are ready.

How to proceed (see Section 9-4):

Display DB1 on the programmer.

Change the parameter block "SDP:" as described in Figure 6-13.

- Position the cursor below the parameter arguments

- Overwrite the arguments

Transfer the changed DB1 to the programmable controller.

Switch the programmable controller from STOP to RUN: the programmable controller accepts the changed parameters.

```

0:      KS  ='DB1 OBA: AI 0 ; OBI:      '
12:     KS  ='      ; OBC: CAP N      CBP '
24:     KS  ='N      ;#SL1: SLN 1 SF '
36:     KS  ='DB2 DW0 EF DB3 DW0 '
48:     KS  =' KBE MB100      KBS MBI'
60:     KS  ='01      PGN 1 ;# SDP: N
72:     KS  ='015 FBUS I      TFB: OB13'
84:     KS  =' 100      ; #CLP: STW MW10'
96:     KS  ='2      CLK DB5 DW0 '
108:    KS  =' SET 3 01.10.91 12:00:'
120:    KS  ='00      OHS 000000:00:00 '
132:    KS  =' TIS 3 01.10. 12:00:00 '
144:    KS  =' STP Y SAV Y CF 00 '
156:    KS  =' ; #END '

```

Figure 6-13. Entering the Address for "System Data Parameters"

Note

If you enclose the parameter block "SDP:" in comment characters (#), the PLC processes 128 timers (default).

7 Introduction to STEP 5		
7.1	Writing a Program	7 - 1
7.1.1	Methods of Representation	7 - 1
7.1.2	Operand Areas	7 - 2
7.2	Program Structure	7 - 3
7.2.1	Linear Programming	7 - 3
7.2.2	Structured Programming	7 - 4
7.3	Block Types	7 - 6
7.3.1	Organization Blocks (OBs)	7 - 8
7.3.2	Program Blocks (PBs)	7 - 10
7.3.3	Sequence Blocks (SBs; only for S5-95U)	7 - 10
7.3.4	Function Blocks (FBs)	7 - 10
7.3.5	Data Blocks (DBs)	7 - 15
7.4	Processing Blocks	7 - 17
7.4.1	Changing Programs	7 - 17
7.4.2	Changing Blocks	7 - 17
7.4.3	Compressing the Program Memory	7 - 17
7.5	Number Representation	7 - 18

Figures		
7-1	Nesting	7 - 5
7-2	Structure of a Block Header	7 - 7
7-3	Example of Organization Block Use	7 - 9
7-4	Programming a Function Block Parameter (only for S5-95U)	7 - 12
7-5	Programming a Function Block	7 - 15
7-6	Data Block Contents	7 - 16
7-7	Validity Areas of Data Blocks	7 - 16
7-8	Compressing the Program Memory	7 - 17
7-9	Bit Assignment of a 16-Bit Fixed-Point Binary Number	7 - 18
7-10	BCD and Decimal Formats	7 - 19
Tables		
7-1	Comparison of Operation Types	7 - 2
7-2	Comparison of Block Types	7 - 6
7-3	Block Parameter Types and Data Types with Permissible Actual Operands (only for S5-95U)	7 - 13
7-4	Comparison of Number Formats	7 - 19

7 Introduction to STEP 5

This chapter explains how to program the S5-90U/S5-95U. It describes how to write a program, how the program is structured, the types of blocks the program uses, and the number representation of the STEP 5 programming language.

7.1 Writing a Program

A control program specifies a series of operations that tell the programmable controller how it has to control a system. You must write the program in a very special language and according to specific rules so that the programmable controller can understand it. The standard programming language that has been developed for the SIMATIC S5 family is called STEP 5.

7.1.1 Methods of Representation

The following methods of representation are possible with the STEP 5 programming language.

- **Statement List (STL)**

STL represents the program as a sequence of operation mnemonics. A statement has the following format.

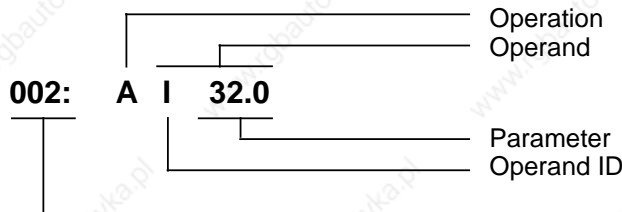

Relative address of the statement in a particular block

The operation tells the programmable controller what to do with the operand. The parameter indicates the operand address.

- **Control System Flowchart (CSF)**

CSF represents logic operations with graphics symbols.

- **Ladder Diagram (LAD)**

LAD graphically represents control functions with circuit diagram symbols.

- **GRAPH 5/GRAPH Mini**

GRAPH 5 describes the structure of sequence control systems. The restricted use of GRAPH 5 is possible only in the S5-95U.

You cannot use CSF, LAD, or GRAPH 5/GRAPH Mini with the PG 605 and PG 615 programmers.

The STEP 5 programming language has the following three operation types.

- Basic
- Supplementary
- System

Table 7-1 provides further information on these operations.

Table 7-1. Comparison of Operation Types

STEP 5 PROGRAMMING LANGUAGE			
	Basic Operations	Supplementary Operations	System Operations
Application	In all blocks	Only in function blocks	Only in function blocks
Methods of representation	STL, CSF, LAD	STL	STL
Special features			For users with good system knowledge

Refer to Chapter 8 for a description of all operations and programming examples.

7.1.2 Operand Areas

The STEP 5 programming language has the following operand areas.

I	(inputs)	Interfaces from the process to the programmable controller
Q	(outputs)	Interfaces from the programmable controller to the process
F	(flags)	Memory for intermediate results of binary operations
D	(data)	Memory for intermediate results of digital operations
T	(timers)	Memory for implementing timers
C	(counters)	Memory for implementing counters
P	(peripherals)	Interfaces from the process to the programmable controller
K	(constants)	Defined numeric values
OB, PB, SB,		
FB, DB	(blocks)	Program structuring aids

Refer to Appendix A for a listing of all operations and operands.

7.2 Program Structure

The programs of both PLCs can either be linear or structured. Sections 7.2.1. and 7.2.2 describe these program types.

7.2.1 Linear Programming

Programming individual operations in one section (block) is sufficient for handling simple automation jobs.

For the S5-90U and the S5-95U, this is organization block 1 (OB1) (see Section 7.3.1). The PLC scans this block cyclically (i.e., after it scans the last statement, it goes back to the first statement and begins scanning again).

Please note the following:

- Five words are assigned to the block header of OB1 in the program memory (see Section 7.3).
- Normally, a statement takes up one word in the program memory. Two-word statements also exist (e.g., with the operation "Load a constant"). Count these statements twice when calculating the program length.
- Like all blocks, OB1 must be terminated by a Block End statement (BE).

7.2.2 Structured Programming

To solve complex tasks, it is advisable to divide a program into individual, self-contained program parts (blocks).

This procedure has the following advantages:

- Simple and clear programming, even for large programs
- Capability to standardize program parts
- Easy alteration
- Simple program test
- Simple start-up
- Subroutine techniques (block call from different locations)
- Lower scan time extension through "STATUS" PLC function.

The STEP 5 programming language has the following five block types.

- **Organization Blocks (OBs)**
Organization blocks manage the control program.
- **Program Blocks (PBs)**
Program blocks arrange the control program according to functional or technical aspects.
- **Sequence Blocks (SBs)**
Sequence blocks are special blocks that program sequence controls. They are handled like program blocks. (They can be used only in the S5-95U).
- **Function Blocks (FBs)**
Function blocks are special blocks for programming frequently recurring or especially complex program parts (e.g., reporting and arithmetic functions). You can assign parameters to them (in the S5-95U). They have an extended set of operations (e.g., jump operations within a block).
- **Data Blocks (DBs)**
Data blocks store data needed to process a control program. Actual values, limiting values, and texts are examples of data.

The program uses block calls to exit one block and jump to another. You can therefore nest program, function, and sequence blocks randomly in up to 16 levels.

Note

When calculating the nesting depth, note that the operating system of the programmable controller can call an organization block under certain circumstances (e. g. OB3).

The total nesting depth is the sum of the nesting depths of cyclic (OB1), interrupt-controlled (OB3), and time-driven (OB13) program processing. If nesting goes beyond 16 levels, the PLC goes into the "STOP" mode with the error message "STUEB" (block stack overflow) (see Chapter 5). Figure 7-1 illustrates the nesting principle.

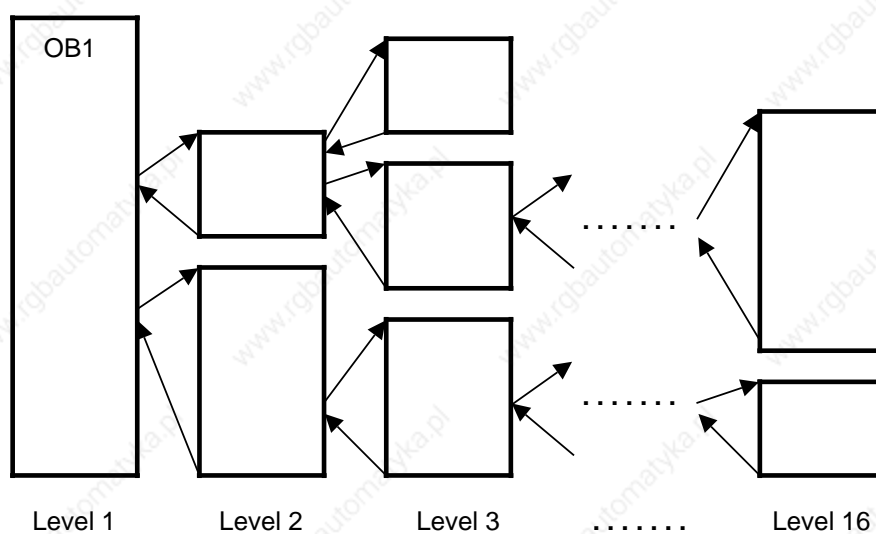

Figure 7-1. Nesting

7.3 Block Types

The following Table lists the most important characteristics of the individual block types.

Table 7-2. Comparison of Block Types

Block types \ Characteristics	OB	PB	SB	FB	DB
Number in S5-90U	4 OB1, 3, 21, 22	64 PB0 to PB63	—	64 FB0 to FB63	62 ² DB2 to DB63
Number in S5-95U	8 OB1, 3, 13, 21, 22, 31, 34, 251	256 PB0 to PB255	256 ³ SB0 to SB255	256 ¹ FB0 to FB255	254 ² DB2 to DB255
Length (max.) in S5-90U	4 KB	4 KB	—	4 KB	256 data words
Length (max.) in S5-95U	8 KB	8 KB	8 KB	8 KB	256 data words
Operations set (contents)	Basic operations	Basic operations	Basic operations	Basic, supplementary, system operations	Bit pattern Numbers texts
Representation methods	STL, CSF, LAD	STL, CSF, LAD	STL, CSF, LAD	STL	
Block header length	5 words	5 words	5 words	5 words +parameters	5 words

¹ Data blocks are already integrated into the operating system (see Chapter 9).

² Data blocks DB0 and DB1 are reserved.

³ SB2 is already integrated in the operating system (see Chapter 9).

Block Structure

Each block consists of the following parts.

- Block header specifying the block type, number, and length.
The programmer generates the block header when it transforms the block.
- Block body with the STEP 5 program or data.

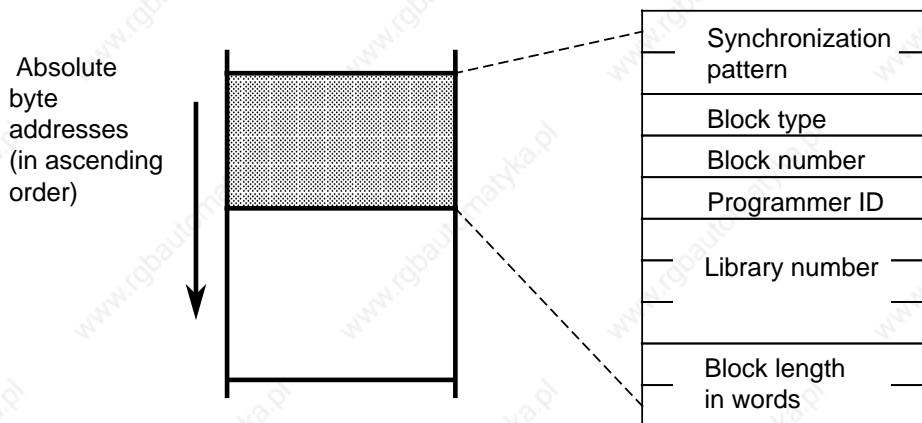

Figure 7-2. Structure of a Block Header

Programming

Program your blocks as follows (does not apply to data blocks).

1. Specify the block type (e.g., PB).
2. Specify the block number (e.g., 27).
3. Enter the control program statements.
4. Terminate the block with the "BE" statement.

7.3.1 Organization Blocks (OBs)

Organization blocks constitute the interface between the operating system and the control program, and coordinate the execution of the control program.

OBs can be grouped according to their tasks and called up as described below:

- OBs for restart processing
(event-driven operating system call)
- OBs for cyclic program execution
(cyclic call by operating system)
- OBs for time-controlled program execution
(operating system call at preset times (timed interrupts))
- OBs for interrupt-driven program execution
(event-driven operating system call)
- OBs performing functions similar to integral function blocks
(call by control program).

See Section 9.1 for a detailed description of the integrated OBs.

Figure 7-3 shows how to set up a structured control program. It also illustrates the significance of organization blocks.

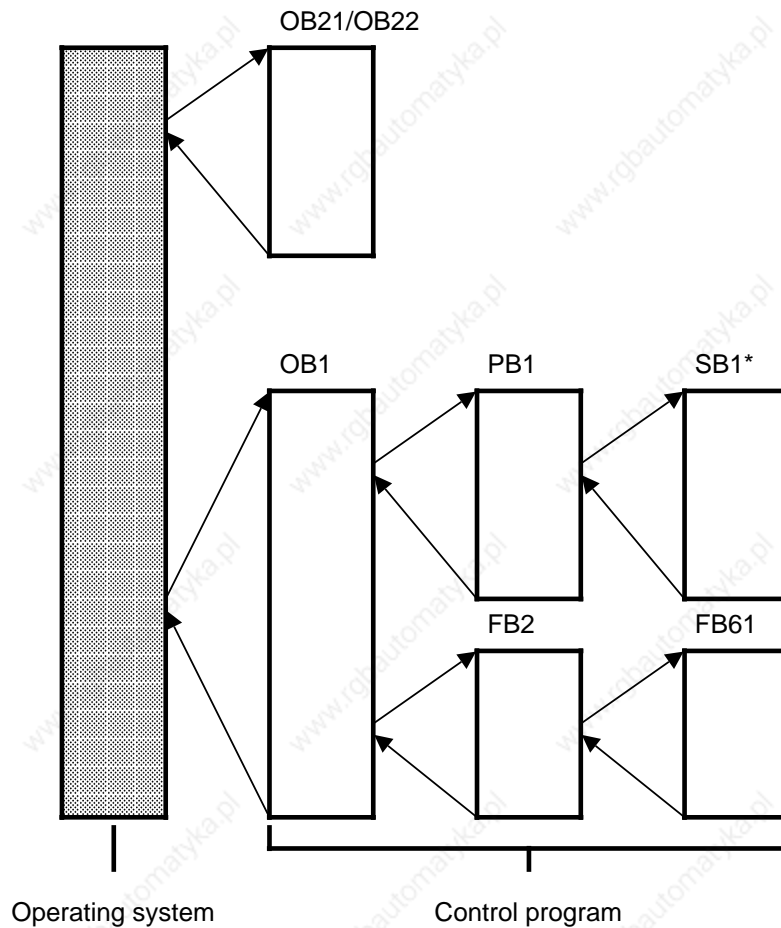

* Only for the S5-95U

Figure 7-3. Example of Organization Block Use

7.3.2 Program Blocks (PBs)

Self-contained program parts are programmed in program blocks.

Special feature: Control functions can be represented graphically in program blocks.

Call

Block calls JU and JC activate program blocks. You can program these operations in all block types except data blocks. Block call and block end cause the RLO to be reloaded. However, the RLO can be included in the "new" block and be evaluated there.

7.3.3 Sequence Blocks (SBs; only for S5-95U)

Sequence blocks are special program blocks that process sequence controls. They are treated like program blocks. SB2 is already integrated in the operating system.

7.3.4 Function Blocks (FBs)

Frequently recurring or complex control functions are programmed in function blocks.

Function blocks have the following special features.

- FBs can be assigned parameters (only for S5-95U).
Actual parameters can be assigned when the block is called (only for S5-95U).
- FBs have an extended set of operations not available to other blocks.
- The FB program can be written and documented in STL only.

The S5-95U has the following types of function blocks.

- FBs that you can program
- FBs that are integrated in the operating system (see Chapter 9)
- FBs that are available as software packages (standard function blocks, see Catalog ST 57)

Block Header

Besides the block header, function blocks have organizational forms that other blocks do not have.

A function block's memory requirements consist of the following.

- Block header as for other blocks (five words) (see Figure 7-2)
- Block name (five words)
- Block parameter for parameter assignment (three words per parameter).

Creating a Function Block (only for S5-95U)

In contrast to other blocks, parameters can be assigned to FBs.

To assign parameters, you must program the following block parameter information.

- **Block parameter name (formal operand)**
Each block parameter as a formal operand is given a designation (DES). Under this designation it is replaced by an actual operand when the function block is called.
The name can be up to four characters long and must begin with a letter of the alphabet. You can program up to 40 parameters per function block.
- **Block Parameter Type**
You can enter the following parameter types.
 - I input parameters
 - Q output parameters
 - D data
 - B blocks
 - T timers
 - C counters

In graphic representation, output parameters appear to the right of the function symbol. Other parameters appear to the left.

- **Block Parameter Data Type**
You can specify the following data types.
 - BI for operands with bit address
 - BY for operands with byte address
 - W for operands with word address
 - K for constants
 - D for operands with double word address (not possible for S5-90U/S5-95U)

When assigning parameters, enter all block parameter specifications.

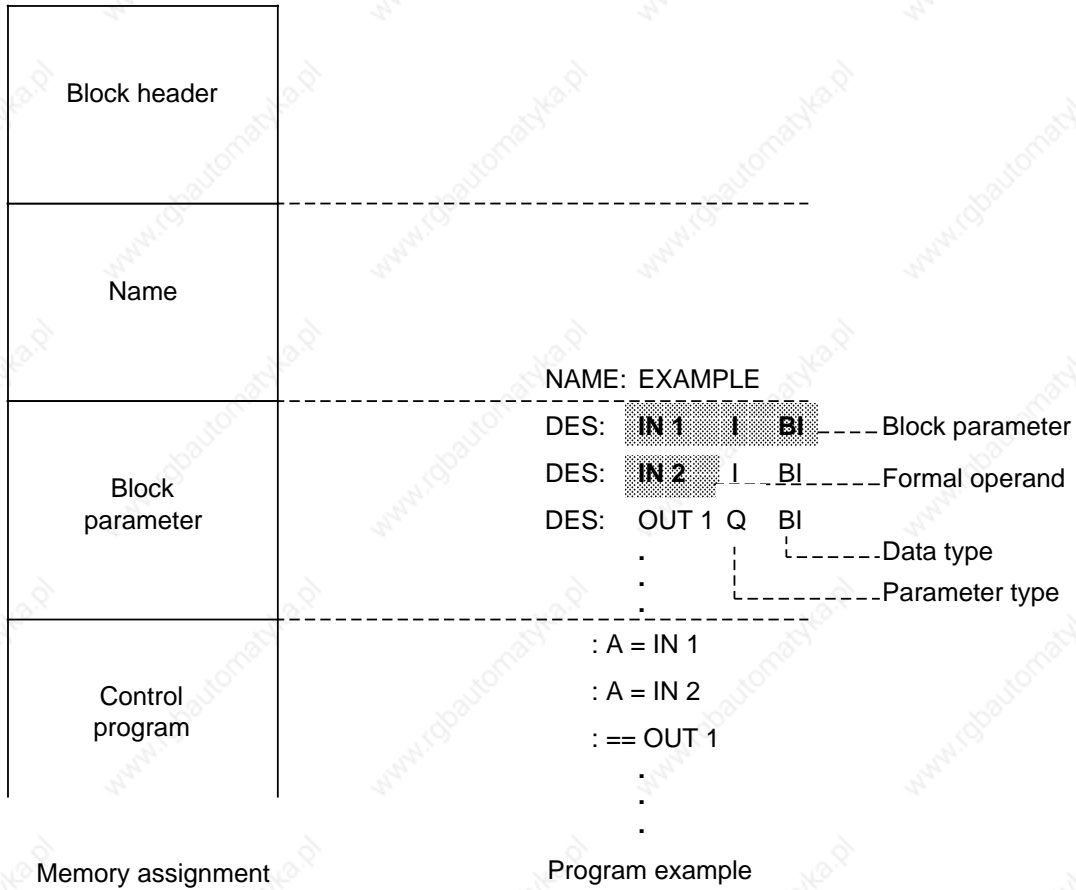

Figure 7-4. Programming a Function Block Parameter (only for S5-95U)

Table 7-3. Block Parameter Types and Data Types with Permissible Actual Operands (only for S5-95U)

Parameter Type	Data Type	Permissible Actual Operands
I, Q	BI for an operand with bit address BY for an operand with byte address W for an operand with word address	I x.y Inputs Q x.y Outputs F x.y Flags IB x Input bytes QB x Output bytes FY x Flag bytes DL x Data bytes left DR x Data bytes right PY x Peripheral bytes* IW x Input words QW x Output words FW x Flag words DW x Data words PW x Peripheral words*
D	KM for a binary pattern (16 digits) KY for two absolute numbers, one byte each, each in the range from 0 to 255 KH for a hexadecimal pattern (maximum 4 digits) KS for a character (maximum 2 alphanumeric characters) KT for a time (BCD-coded time) with time base 1.0 to 999.3 KC for a count (BCD-coded) 0 to 999 KF for a fixed-point number in the range from -32768 to +32767	Constants
B	Type designation not permitted	DBx Data blocks. The C DBx operation is executed. OBx Organization blocks are called unconditionally (JU ... x). FBx Function blocks (permissible without parameters only) are called unconditionally (JU..x). PBx Program blocks are called unconditionally (JU..x). SBx Sequence blocks are called unconditionally (JU..x).
T	Type designation not permitted	T Timer. The time should be assigned parameters as data or be programmed as a constant in the function block.
C	Type designation not permitted	C Counter. The count should be assigned parameters as data or be programmed as a constant in the function block.

* Not permitted for integral FBs

Calling a Function Block

Like other blocks, function blocks are stored under a specific number in the program memory (e.g., FB47). The numbers 240 to 255 are reserved for integrated function blocks (only for S5-95U).

You can program function block calls in all blocks except data blocks.

The call consists of the following parts.

- Call statement
 - JU FBx unconditional call (**J**ump **U**nconditional)
 - JC FBx call if RLO = 1 (**J**ump **C**onditional)
- Parameter list (only if block parameters were defined in the FB)

Function blocks can be called only if they have been programmed. When a function block call is being programmed, the programmer requests the parameter list for the FB automatically if block parameters have been defined in the FB.

Setting Parameters for a Function Block

The program in the function block specifies how the formal operands (parameters defined as "DES") are to be processed.

As soon as you have programmed a call statement (for example JU FB2), the programmer displays the **parameter list**. The parameter list consists of the names of the parameters. Each parameter name is followed by a colon (:). You must assign actual operands to the parameters. The actual operands replace the formal operands defined in the FB when the FB is called, so that the FB "in reality" operates with the actual operands.

A parameter list has a maximum of 40 parameters.

Example:

The name (DES) of a parameter is IN1, the parameter type is I (as in input), the data type is BI (as in bit). The formal operand for the FB has the following structure.

DES: IN1 I BI.

Specify in the parameter list of calling block which actual operand is to replace the formal operand in the FB call. In our example it is : I 1.0.

Enter in the parameter list:

IN1: I 1.0.

When the FB is called, it replaces the formal operand "IN1" with the actual operand "I 1.0".

Figure 7-5 provides you with a detailed example of how to set parameters for a function block.

The FB call takes up two words in the internal program memory. Each parameter takes up an additional memory word.

You can find the memory requirements for standard function blocks and the run times in the specifications of Catalog ST 57.

The designations (DES) of the function block inputs and outputs appearing during programming on the programmer, as well as the name of the function block, are stored in the function block itself. Therefore, you must transfer all necessary function blocks to the program diskette (for off-line programming) or directly into the program memory of the programmable controller before programming on the programmer.

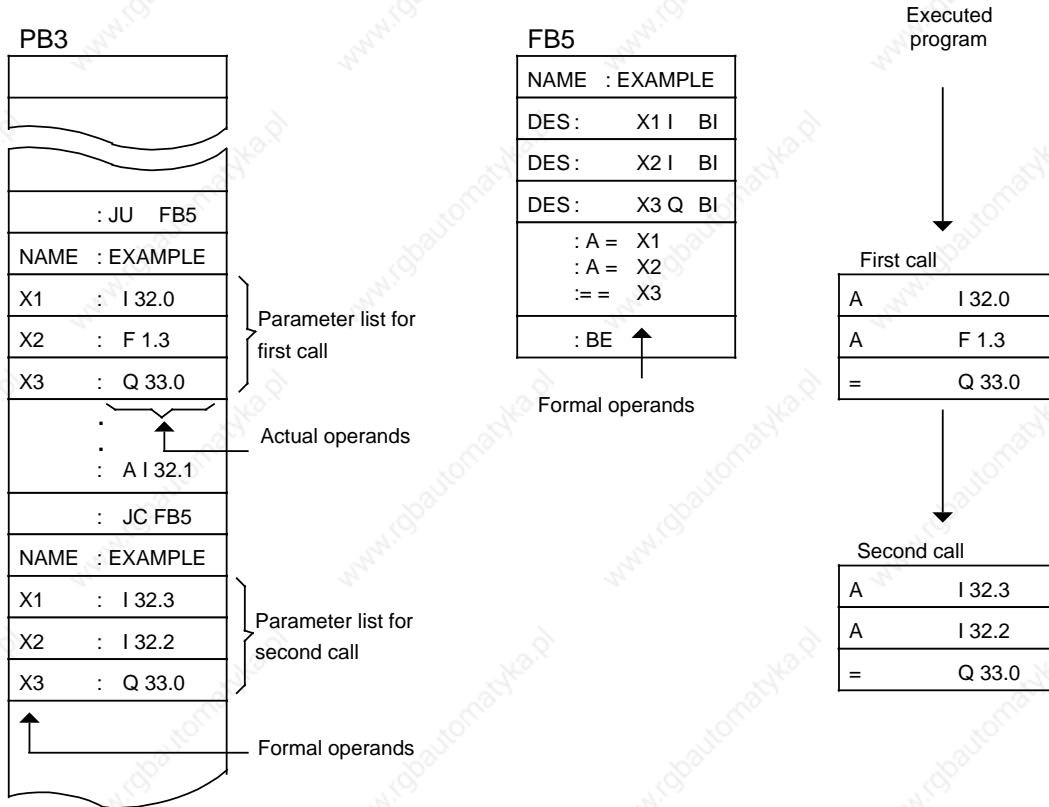

Figure 7-5. Programming a Function Block

7.3.5 Data Blocks (DBs)

Data blocks store data to be processed in a program.

The following data types are permissible.

- Bit pattern (representation of controlled system states)
- Hexadecimal, binary or decimal numbers (times, results of arithmetic operations)
- Alphanumeric characters (ASCII message texts)

Programming Data Blocks

Begin programming a data block by specifying a block number between 2 and 63 for the S5-90U, and between 2 and 255 for the S5-95U. DB0 is reserved for the operating system, DB1 for setting parameters for internal functions. Data is stored in this block in words. If the information takes up less than 16 bits, the high-order bits are padded with zeros. Data input begins at data word 0 and continues in ascending order. A data block can hold up to 256 data words. You can call up or change the data word contents with load or transfer operations.

Input			Stored Values		
0000	:	KH =	A13C	DW0	A13C
0001	:	KT =	100.2	DW1	2100
0003	:	KF =	+21874	DW2	5572

Figure 7-6. Data Block Contents

In the S5-95U, you can also create or delete data blocks in the control program (see Section 8.1.8).

Program Processing with Data Blocks:

- A data block must be called in the program with the C DBx operation (x = DB number).
- Within a block, a data block remains valid until another data block is called.
- When the program jumps back into the higher-level block, the data block that was valid before the block call is again valid.
- After OB1, 3, 13, 21, 22 have been called **by the operating system**, no DB is valid.

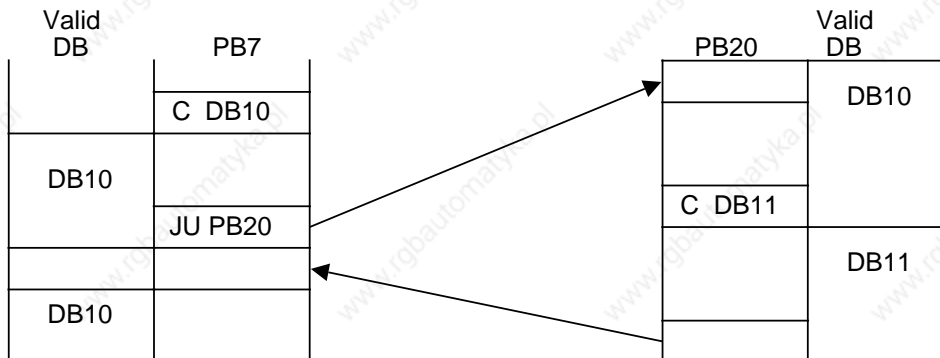

When PB20 is called, the valid data area is entered into a memory.
When the program jumps back, this area is reopened.

Figure 7-7. Validity Areas of Data Blocks

The Function of DB1

Both the S5-90U and the S5-95U use DB1 for special functions. DB1 is already integrated into both of them. DB1 contains default values that you can either accept or change (see Chapter 9). DB1 is evaluated during start-up after a transition from STOP to RUN.

7.4 Processing Blocks

Earlier sections in this chapter described how to use blocks. Chapter 8 introduces all of the operations required to work with blocks.

You can change any blocks that have already been programmed. The following sections will deal only briefly with the different ways you can change blocks. Refer to your STEP 5 manual for more detailed information on changing blocks.

7.4.1 Changing Programs

You can use the following programmer functions to make program changes with any block type.

- INPUT
- OUTPUT
- STATUS

These three programmer functions make it possible for you to make the following types of changes.

- Delete, insert, or overwrite statements.
- Insert or delete segments.

7.4.2 Changing Blocks

Program changes refer to changing the contents of a block. You can also delete or overwrite a complete block. When you delete a block, it is not deleted from the program memory but simply becomes invalid. You cannot enter new information in the memory location of an invalid block. This may cause a new block not to be accepted. If a new block is not accepted, then the PG transmits the "no space available" error message. You can delete this message by compressing the programmable controller memory.

7.4.3 Compressing the Program Memory

Figure 7-8 illustrates what takes place in the program memory during a COMPRESS operation. Internally, one block is shifted per cycle.

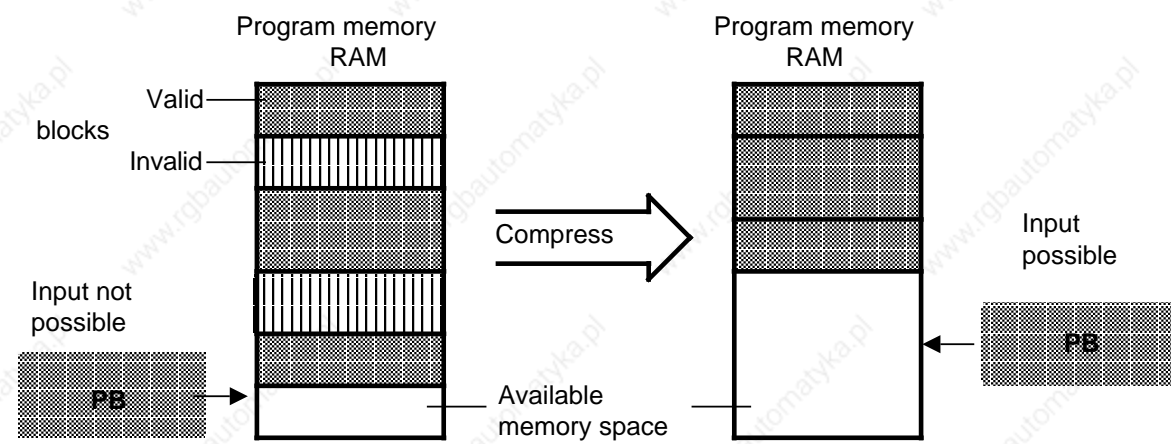

Figure 7-8. Compressing the Program Memory

You can use the COMPRESS programmer function to clean up program memory.

If there is a power failure during the compress operation when a block is being shifted and block shifting can not be completed, the programmable controller remains in the STOP mode. The "NINEU" error message appears and the "NINEU" bit is set in the ISTACK. Additionally, the "BSTSCH" and the "SCHTAE" bits are set.

Remedy: Overall reset.

7.5 Number Representation

With STEP 5 you can work with numbers in the following five representations.

- Decimal numbers from -32768 to +32767 (KF)
- Hexadecimal numbers from 0000 to FFFF (KH)
- BCD-coded numbers (4 tetrads) from 0000 to 9999
- Bit patterns (KM)
- Constant byte (two-byte representation) from 0 to 255 for each byte (KY)

Number Formats

The programmable controller is designed to process binary signal states ("0" and "1"). Therefore programmable controllers represent all numbers internally as 16-bit binary numbers or as bit patterns.

Four bits can be combined into a tetrad (BCD) to shorten the binary code representation. The value of these tetrads can be displayed in hexadecimal representation.

Example: 16-bit binary coded number and shortened hexadecimal representation

Word no.	n															
Byte no.	n (high byte)								n+ 1 (low byte)							
Bit no.	15	14	13	12	11	10	09	08	07	06	05	04	03	02	01	00
Binary code represent.	0	0	0	1	1	1	1	1	0	1	1	0	0	0	1	1
Meaning	2 ¹⁵	2 ¹⁴	2 ¹³	2 ¹²	2 ¹¹	2 ¹⁰	2 ⁹	2 ⁸	2 ⁷	2 ⁶	2 ⁵	2 ⁴	2 ³	2 ²	2 ¹	2 ⁰
Hexadecimal representation	1				F				6				3			

Figure 7-9. Bit Assignment of a 16-Bit Fixed-Point Binary Number

You can work with binary-coded decimals to program timers and counters in the decimal system.

BCD tetrads are defined in the range of 0 to 9.

Example: 12-bit timer or counter value in BCD and decimal formats

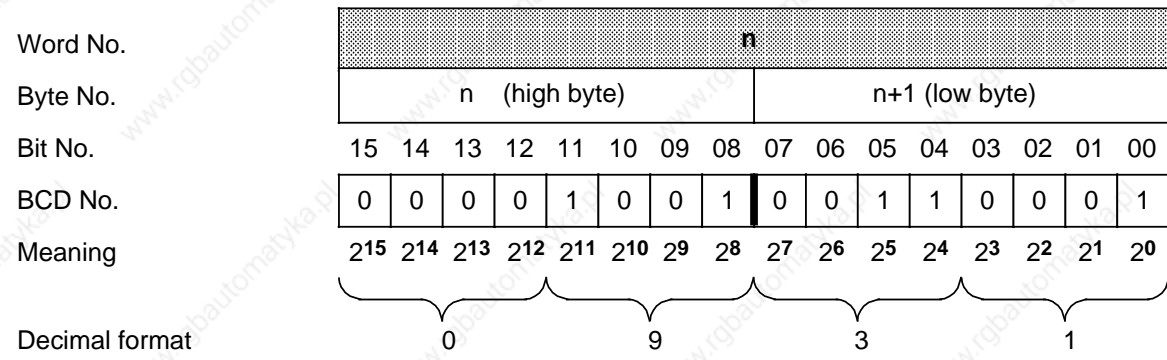

Figure 7-10. BCD and Decimal Formats

Table 7-4. Comparison of Number Formats

Binary	Decimal	BCD	Hexadecimal
0000	0	0000 0000	0
0001	1	0000 0001	1
0010	2	0000 0010	2
0011	3	0000 0011	3
0100	4	0000 0100	4
0101	5	0000 0101	5
0110	6	0000 0110	6
0111	7	0000 0111	7
1000	8	0000 1000	8
1001	9	0000 1001	9
1010	10	0001 0000	A
1011	11	0001 0001	B
1100	12	0001 0010	C
1101	13	0001 0011	D
1110	14	0001 0100	E
1111	15	0001 0101	F

You can use the "LD" operation to load a binary number as a BCD number for timer and counter values.

Example: Comparing a count in counter 1 with decimal number 499.
The comparison value must be stored in the accumulator by means of the load operation. In order not to have to convert the value 499 into other numerical systems (binary or hexadecimal) for input, use the "L KF +499" statement. The number 1F3_H is then stored in the accumulator.
The current count must also be loaded into the accumulator.

Incorrect method:

If you use the "LD C1" statement for this purpose, the current count will be loaded in BCD. The "I=F" comparison operation results in a not-equal-to condition since the comparison involves different formats.

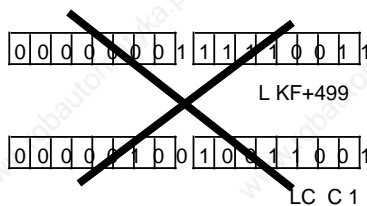

Correct method:

If the "L C1" statement is entered, the formats are identical.

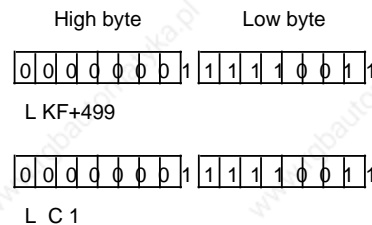

8 STEP 5 Operations

8.1	Basic Operations	8-1
8.1.1	Boolean Logic Operations	8-2
8.1.2	Set/Reset Operations	8-7
8.1.3	Load and Transfer Operations	8-10
8.1.4	Timer Operations	8-15
8.1.5	Counter Operations	8-25
8.1.6	Comparison Operations	8-30
8.1.7	Arithmetic Operations	8-31
8.1.8	Block Call Operations	8-33
8.1.9	Other Operations	8-38
8.2	Supplementary Operations	8-39
8.2.1	Load Operation (only for the S5-95U)	8-40
8.2.2	Enable Operation (only for the S5-95U)	8-41
8.2.3	Bit Test Operations (only for the S5-95U)	8-42
8.2.4	Digital Logic Operations	8-44
8.2.5	Shift Operations	8-48
8.2.6	Conversion Operations	8-50
8.2.7	Decrement/Increment (only for the S5-95U)	8-52
8.2.8	Disable/Enable Interrupt	8-53
8.2.9	DO Operation (only for the S5-95U)	8-54
8.2.10	Jump Operations	8-56
8.2.11	Substitution Operations (only for the S5-95U)	8-58
8.3	System Operations (only for the S5-95U)	8-64
8.3.1	Set Operations (only for the S5-95U)	8-64
8.3.2	Load and Transfer Operations	8-64
8.3.3	Arithmetic Operation (only for the S5-95U)	8-67
8.3.4	Other Operations (only for the S5-95U)	8-68
8.4	Condition Code Generation	8-69
8.5	Sample Programs	8-71
8.5.1	Momentary-Contact Relay (Edge Evaluation)	8-71
8.5.2	Binary Scaler (Binary Divider)	8-71
8.5.3	Clock (Clock-Pulse Generator)	8-73

Figures		
8-1	Accumulator Structure	8-10
8-2	Execution of the Load Operation	8-12
8-3	Transferring a Byte	8-12
8-4	Output of the Current Time (Example)	8-18
8-5	Outputting the Current Counter Status (Example)	8-27
8-6	Executing a DO Operation	8-55
Tables		
8-1	Overview of Boolean Logic Operations	8-2
8-2	Overview of the Set/Reset Operations	8-7
8-3	Overview of Load and Transfer Operations	8-11
8-4	Overview of Timer Operations	8-15
8-5	Overview of Counter Operations	8-25
8-6	Overview of Comparison Operations	8-30
8-7	Overview of Arithmetic Operations	8-31
8-8	Overview of Block Call Operations	8-33
8-9	Other Operations	8-38
8-10	Load Operation	8-40
8-11	Enable Operation	8-41
8-12	Overview of Bit Operations	8-42
8-13	Effect of "TB" and "TBN" on the RLO	8-42
8-14	Overview of Digital Logic Operations	8-44
8-15	Overview of Shift Operations	8-48
8-16	Overview of Conversion Operations	8-50
8-17	Decrement/Increment Operations	8-52
8-18	Disable/Enable Interrupt Operations	8-53
8-19	Overview of the DO Operation	8-54
8-20	Overview of Jump Operations	8-56
8-21	Overview of Binary Logic Operations	8-58
8-22	Overview of Set/Reset Operations	8-59
8-23	Overview of Load and Transfer Operations	8-60
8-24	Overview of Timer and Counter Operations	8-61
8-25	Processing Operation	8-63
8-26	Overview of Set Operations	8-64
8-27	Overview of Load and Transfer Operations	8-65
8-28	Overview of the "ADD" Operation	8-67
8-29	The "TAK" and "STS" Operations	8-68
8-30	Condition Code Settings for Comparison Operations	8-69
8-31	Condition Code Settings for Fixed-Point Arithmetic Operations	8-69
8-32	Condition Code Settings for Digital Logic Operations	8-70
8-33	Condition Code Settings for Shift Operations	8-70
8-34	Condition Code Settings for Conversion Operations	8-70

8 STEP 5 Operations

The STEP 5 programming language has the following three operation types.

- Basic Operations include functions that can be executed in organization, program, sequence, and function blocks. Except for the addition (+F), subtraction (-F), and organizational operations, the basic operations can be input and output in the statement list (STL), control system flowchart (CSF), or ladder diagram (LAD) methods of representation.
- Supplementary Operations include complex functions such as substitution statements, test functions, and shift and conversion operations. They can be input and output in STL form only.
- System Operations access the operating system directly. Only an experienced programmer should use them. System operations can be input and output in STL form only.

8.1 Basic Operations

Sections 8.1.1 through 8.1.9 use examples to describe the basic operations.

8.1.1 Boolean Logic Operations

Table 8-1 provides an overview of Boolean logic operations. Examples follow the table.

Table 8-1. Overview of Boolean Logic Operations

Operation	Operand	Meaning																		
O		Combine AND operations through logic OR Combine the result of the next AND logic operation (RLO) with the previous RLO through logic OR.																		
A(Combine expression enclosed in parentheses through logic AND Combine the RLO of the expression enclosed in parentheses with the previous RLO through logic AND.																		
O(Combine expression enclosed in parentheses through logic OR Combine the RLO of the expression enclosed in parentheses with the previous RLO through logic OR.																		
)		Close parenthesis Conclude the expression enclosed in parentheses.																		
A		Scan operand for "1" and combine with RLO through logic AND The result is "1" when the operand in question carries signal state "1". Otherwise the scan results in "0". Combine this result with the RLO in the processor through logic AND ¹ .																		
O		Scan operand for "1" and combine with RLO through logic OR The result is "1" when the operand in question has signal state "1". Otherwise the scan results in "0". Combine this result with the RLO in the processor through logic OR ¹ .																		
AN		Scan operand for "0" and combine with RLO through logic AND The result is "1" when the operand in question has signal state "0". Otherwise the scan results in "0". Combine this result with the RLO in the processor through logic AND ¹ .																		
ON		Scan operand for "0" and combine with RLO through logic OR The result is "1" when the operand in question has signal state "0". Otherwise the scan results in "0". Combine this result with the RLO in the processor through logic OR ¹ .																		
ID	↑ I Q F T C	<table border="1"> <thead> <tr> <th>Parameter</th> <th>S5-90U</th> <th>S5-95U</th> </tr> </thead> <tbody> <tr> <td></td> <td>0.0 to 127.7</td> <td>0.0 to 127.7</td> </tr> <tr> <td></td> <td>0.0 to 127.7</td> <td>0.0 to 127.7</td> </tr> <tr> <td></td> <td>0.0 to 127.7</td> <td>0.0 to 255.7</td> </tr> <tr> <td></td> <td>0 to 31</td> <td>0 to 127</td> </tr> <tr> <td></td> <td>0 to 31</td> <td>0 to 127</td> </tr> </tbody> </table>	Parameter	S5-90U	S5-95U		0.0 to 127.7	0.0 to 127.7		0.0 to 127.7	0.0 to 127.7		0.0 to 127.7	0.0 to 255.7		0 to 31	0 to 127		0 to 31	0 to 127
Parameter	S5-90U	S5-95U																		
	0.0 to 127.7	0.0 to 127.7																		
	0.0 to 127.7	0.0 to 127.7																		
	0.0 to 127.7	0.0 to 255.7																		
	0 to 31	0 to 127																		
	0 to 31	0 to 127																		

¹ If the scan follows an RLO limiting operation directly (first scan), the scan result is reloaded as a new RLO.

AND Operation

The AND operation scans to see if various conditions are satisfied simultaneously.

Example		Circuit Diagram	
<p>Output Q32.5 is "1" when all three inputs are "1". The output is "0" if at least one input is "0". The number of scans and the sequence of the logic statements are optional.</p>			
STL	CSF	LAD	
<pre>A I 32.0 A I 32.1 A I 32.2 = Q 32.5</pre>			

OR Operation

The OR operation scans to see if one of two (or more) conditions has been satisfied.

Example		Circuit Diagram	
<p>Output Q32.5 is "1" when at least one of the inputs is "1". Output Q32.5 is "0" when all inputs are "0" simultaneously. The number of scans and the sequence of their programming are optional.</p>			
STL	CSF	LAD	
<pre>O I 32.0 O I 32.1 O I 32.2 = Q 32.5</pre>			

AND before OR Operation

Example		Circuit Diagram	
<p>Output Q32.5 is "1" when at least one AND condition has been satisfied. Output Q32.5 is "0" when neither of the two AND conditions has been satisfied.</p>			
STL	CSF	LAD	
<pre> A I 32.0 A I 32.1 O A I 32.2 A I 32.3 = Q 32.5 </pre>			

OR before AND Operation

Example		Circuit Diagram	
<p>Output Q32.5 is "1" when one of the following conditions has been satisfied:</p> <ul style="list-style-type: none"> • Input I32.0 is "1". • Input I32.1 and either input I 32.2 or I 32.3 are "1". <p>Output Q32.5 is "0" when none of the AND conditions has been satisfied.</p>			
STL	CSF	LAD	
<pre> O I 32.0 O A I 32.1 A(O I 32.2 O I 32.3) = Q 32.5 </pre>			

OR before AND Operation

Example		Circuit Diagram	
<p>Output Q32.5 is "1" when both OR conditions have been satisfied. Output Q32.5 is "0" when at least one OR condition has not been satisfied.</p>			
STL	CSF	LAD	
<pre> A(O I 32.0 O I 32.1) A(O I 32.2 O I 32.3) = Q 32.5 </pre>			

8.1.2 Set/Reset Operations

Set/reset operations store the result of logic operation (RLO) formed in the processor. The stored RLO represents the signal state of the addressed operand. Storage can be dynamic (assignment) or static (set and reset). Table 8-2 provides an overview of the set/reset operations. Examples follow the table.

Table 8-2. Overview of the Set/Reset Operations

Operation	Operand	Meaning												
S		Set The first time the program is scanned with RLO = "1", signal state "1" is assigned to the addressed operand. An RLO change does not affect this status.												
R		Reset The first time the program is scanned with RLO = "1", signal state "0" is assigned to the addressed operand. An RLO change does not affect this status.												
=	↑	Assign Every time the program is scanned, the current RLO is assigned to the addressed operand.												
ID	↑ I Q F	<table border="1"> <thead> <tr> <th>Parameter</th> <th>S5-90U</th> <th>S5-95U</th> </tr> </thead> <tbody> <tr> <td></td> <td>0.0 to 127.7</td> <td>0.0 to 127.7</td> </tr> <tr> <td></td> <td>0.0 to 127.7</td> <td>0.0 to 127.7</td> </tr> <tr> <td></td> <td>0.0 to 127.7</td> <td>0.0 to 255.7</td> </tr> </tbody> </table>	Parameter	S5-90U	S5-95U		0.0 to 127.7	0.0 to 127.7		0.0 to 127.7	0.0 to 127.7		0.0 to 127.7	0.0 to 255.7
Parameter	S5-90U	S5-95U												
	0.0 to 127.7	0.0 to 127.7												
	0.0 to 127.7	0.0 to 127.7												
	0.0 to 127.7	0.0 to 255.7												

Flip-Flop for a Latching Signal Output

Example		Circuit Diagram
<p>A "1" at input I32.1 sets flip-flop Q32.5 (signal state "1"). If the signal state at input I32.5 changes to "0", the state of output Q32.5 is maintained, i.e., the signal is latched. A "1" at input I 32.0 resets the flip-flop (signal state "0"). When the "SET" signal (input I 32.1) and the "RESET" signal (input I32.0) are applied at the same time, the scanning operation that was programmed last (in this case A I 32.0) is in effect during processing of the rest of the program. In this example, resetting output Q32.5 has priority.</p>		
STL	CSF	LAD
<pre> A I 32.1 S Q 32.5 A I 32.0 R Q 32.5 NOP 0 * </pre>		

* **NOP 0** "NOP 0" is necessary if the program is to be represented in LAD or CSF form on programmers with a screen. During programming in LAD and CSF, such "NOP 0" operations are allotted automatically.

RS Flip-Flop with Flags

Example		Circuit Diagram	
<p>A "1" at input I32.1 sets flip-flop F 1.7 (signal state "1"). If the signal state at input I32.1 changes to "0", the state of flag F 1.7 is maintained, i.e., the signal is latched. A "1" at input I32.0 resets the flip-flop (signal state "0"). If the signal state at input I32.0 changes to "0", flag F 1.7 retains signal state "0". If both inputs have a "1" signal state, the flip-flop is reset. The signal state of the flag is scanned and transferred to output 32.5.</p>			
STL	CSF	LAD	
<p>A I 32.1 S F 1.7 A I 32.0 R F 1.7 A F 1.7 = Q 32.5</p>			

8.1.3 Load and Transfer Operations

Use load operations and transfer operations to do the following tasks.

- Exchange information between various operand areas
- Prepare time and count values for further processing
- Load constants for program processing

Information flows indirectly via accumulators (ACCU 1 and ACCU 2). The accumulators are special registers in the programmable controller that serve as temporary storage. They are each 16 bits long in both the S5-90U and S5-95U. The accumulators are structured as shown in Figure 8-1.

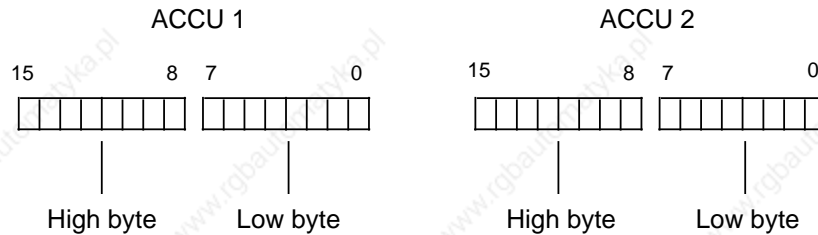

Figure 8-1. Accumulator Structure

You can load and transfer permissible operands in bytes or words. For exchange in bytes, information is stored right-justified, i.e., in the low byte.

The remaining bits are set to zero.

You can process the information in the two accumulators using various operations.

Load and transfer operations are executed independently of condition codes. Execution of these operations does not affect the condition codes.

You can program load and transfer operations graphically only in combination with timer or counter operations; otherwise you can represent them only in STL form.

Table 8-3 provides an overview of the load and transfer operations. Examples follow the table.

Table 8-3. Overview of Load and Transfer Operations

Operation		Operand		Meaning		
L				Load The operand contents are copied into ACCU 1 regardless of the RLO. The RLO is not affected.		
T		↑	↑	Transfer The contents of ACCU 1 are assigned to an operand regardless of the RLO. The RLO is not affected.		
ID			Parameter	S5-90U	S5-95U	
	IB			0 to 127	0 to 127	
	IW			0 to 126	0 to 126	
	QB			0 to 127	0 to 127	
	QW			0 to 126	0 to 126	
	FY			0 to 127	0 to 255	
	FW			0 to 126	0 to 254	
	DR			0 to 255	0 to 255	
	DL			0 to 255	0 to 255	
	DW			0 to 255	0 to 255	
	T ¹			0 to 31	0 to 127	
	C ¹			0 to 31	0 to 127	
	PY			32/33 36/37	0 to 127 (OB 13, OB 3)	
				---	32 to 55 (OB 1)	
	PW			32, 36	0 to 126	
	KM ¹			random bit pattern (16 bits)	random bit pattern (16 bits)	
	KH ¹			0 to FFFF	0 to FFFF	
	KF ¹			-32768 to +32767	-32768 to +32767	
	KY ¹			0 to 255 per byte	0 to 255 per byte	
	KB ¹			0 to 255	0 to 255	
	KS ¹			any 2 alphanumeric characters	any 2 alphanumeric characters	
	KT ¹			0.0 to 999.3	0.0 to 999.3	
	KC ¹			0 to 999	0 to 999	
LD				Load in BCD Binary times and counts are loaded into ACCU 1 in BCD code regardless of the RLO.		
ID			Parameter			
	T	↑		0 to 31	0 to 127	
	C	↑		0 to 31	0 to 127	

1 These operands cannot be used for transfer.

Load Operation:

During loading, information is copied from a memory area, e.g., from the PII, into ACCU 1. The previous contents of ACCU 1 are shifted to ACCU 2. The original contents of ACCU 2 are lost.

Example: Two consecutive bytes (IB 7 and IB 8) are loaded from the PII into the accumulator. Loading does not change the PII (see Figure 8-2).

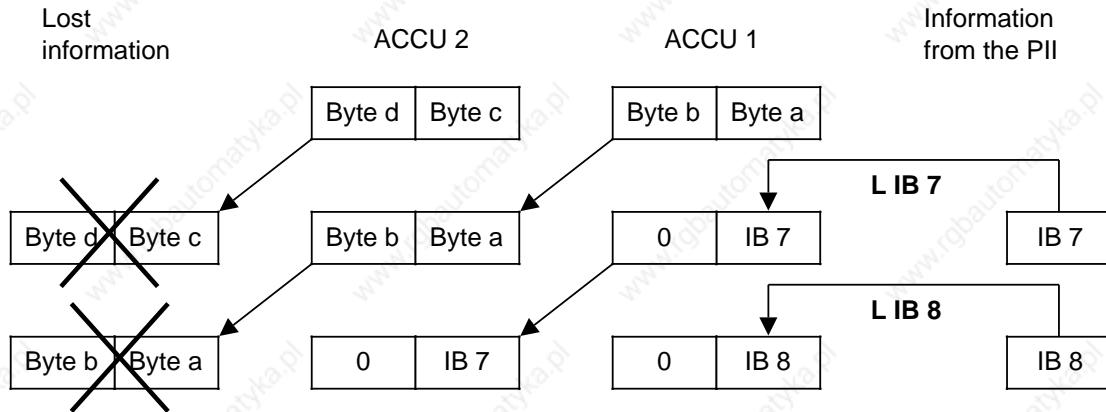

Figure 8-2. Execution of the Load Operation

Transfer Operation:

During transfer, information from ACCU 1 is copied into the addressed memory area, e.g., into the PIQ.

This transfer does not affect the contents of ACCU 1.

When transfer to the digital output area occurs, the byte or word in question in the PIQ is automatically updated.

Example: Figure 8-3 shows how byte a, the low byte in ACCU 1, is transferred to QB 5.

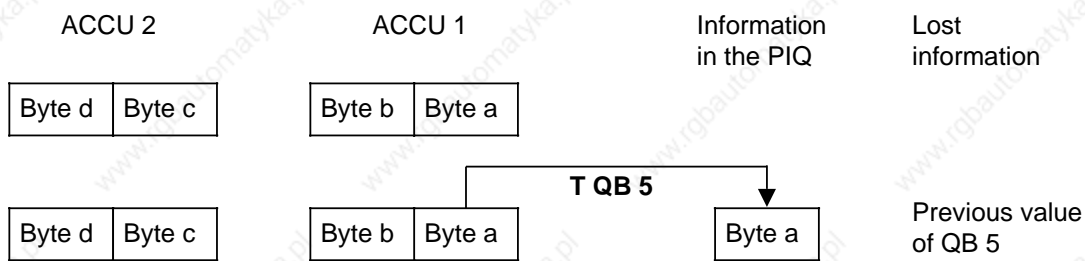

Figure 8-3. Transferring a Byte

Loading and Transferring a Time (See also Timer and Counter Operations)

Example		Representation	
<p>During graphic input, QW62 is assigned to output BI of a timer. The programmer automatically stores the corresponding load and transfer operation in the control program. Thus the contents of the memory location addressed with T 10 are loaded into ACCU 1. Afterwards, the contents of the accumulator are transferred to the process image addressed with QW62. In this example, you can see timer T 10 at QW62 in binary code.</p> <p>Outputs BI and DE are digital outputs. The time at output BI is in binary code. The time at output DE is in BCD code with time base.</p>			
STL	CSF	LAD	
<pre> A I 32.0 L IW 22 SP T 10 NOP 0 L T 10 T QW 62 NOP 0 NOP 0 </pre>			

Loading and Transferring a Timer (Coded)

Example		Representation	
<p>The contents of the memory location addressed with T 10 are loaded into the accumulator in BCD code. Then a transfer operation transfers the accumulator contents to the process image memory location addressed by QW 50. A coding operation is possible only indirectly for the graphic representation forms LAD and CSF by assigning an address to output DE of a timer or counter location. However, with STL, this operation can be entered with a separate statement.</p>			
STL	CSF	LAD	
<pre> A I 32.0 L IW 22 SP T 10 NOP 0 NOP 0 LD T 10 T QW 50 NOP 0 </pre>			

8.1.4 Timer Operations

The program uses timer operations to implement and monitor chronological sequences. Table 8-4 provides an overview of timer operations. Examples follow the table.

Table 8-4. Overview of Timer Operations

Operation	Operand	Meaning
SP		Pulse Timer The timer is started on the leading edge of the RLO. When the RLO is "0", the timer is set to "0". Scans result in signal state "1" as long as the timer is running.
SE		Extended Pulse Timer The timer is started on the leading edge of the RLO. When the RLO is "0", the timer is not affected. Scans result in signal state "1" as long as the timer is running.
SD		On-Delay Timer The timer is started on the leading edge of the RLO. When the RLO is "0", the timer is set to "0". Scans result in signal state "1" when the timer has run out and the RLO is still pending at the input.
SS		Stored On-Delay Timer The timer is started on the leading edge of the RLO. When the RLO is "0", the timer is not affected. Scans result in signal state "1" when the timer has run out. The signal state becomes "0" when the timer is reset with the "R" operation.
SF		Off-Delay Timer The timer is started on the trailing edge of the RLO. When the RLO is "1", the timer is set to its initial value. Scans result in signal state "1" as long as the RLO at the input is "1" or the timer is still running.
R	↑ ↑	Reset Timer The timer is reset to its initial value as long as the RLO is "1". When the RLO is "0", the timer is not affected. Scans result in signal state "0" as long as the timer is reset or has not been started yet.
ID	T	Parameter S5-90U 0 to 31 S5-95U 0 to 127

Note

To increase the performance of the S5-95U

- Use timers in ascending order,
- Assign only those timers you really need in DB1 (see Section 6.5).

Loading a Time

Timer operations call internal timers.

When a timer operation is started, the word in ACCU 1 is used as a time value. You must therefore first specify time values in the accumulator.

You can load a timer with any of the following data types.

KT	constant time value	} These data types must be in BCD code.
	or	
DW	data word	
IW	input word	
QW	output word	
FW	flag word	

Loading a Constant Time Value:

The following example shows how you can load a time value of 40 s.

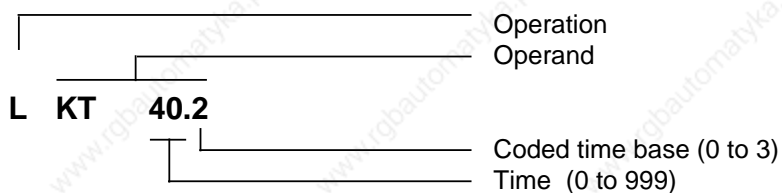

Key for Time Base:

Base	0	1	2	3
Factor	0.01 s	0.1 s	1 s	10 s

Example: KT 40.2 corresponds to 40 x 1 s.

Tolerance:

The time tolerance is equivalent to the time base.

Examples	Operand	Time Interval		
Possible settings for the time 40 s.	KT 400.1	400 x 0.1 s.	- 0.1 s.	39.9 s. to 40 s.
	KT 40.2	40 x 1 s.	- 1 s.	39 s. to 40 s.
	KT 4.3	4 x 10 s.	- 10 s.	30 s. to 40 s.

Note

Always use the smallest time base possible.

Loading a Time as an Input, Output, Flag, or Data Word

Load Statement: L DW 2

The time 638 s is stored in data word DW2 in BCD code.

Bits 14 and 15 are insignificant for the time value.

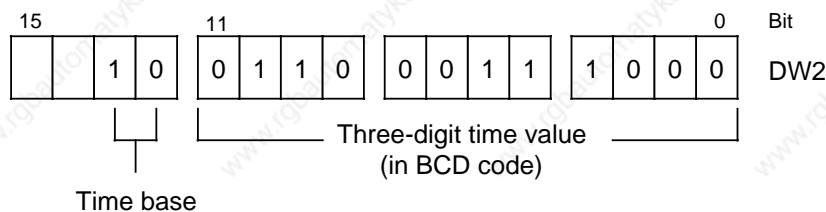

Key for Time Base:

Base	0 0	0 1	1 0	1 1
Factor	0.01 s	0.1 s	1 s	10 s

You can also use the control program to write to data word DW2.

Example: Store the value 270 x 100 ms. in data word DW2 of data block DB3.

C DB 3
 L KT 270.1
 T DW2

Output of the Current Time 1

You can use a load operation to put the current time into ACCU 1 and process it further from there (see Figure 8-4).

Use the "Load in BCD" operation for digital display output.

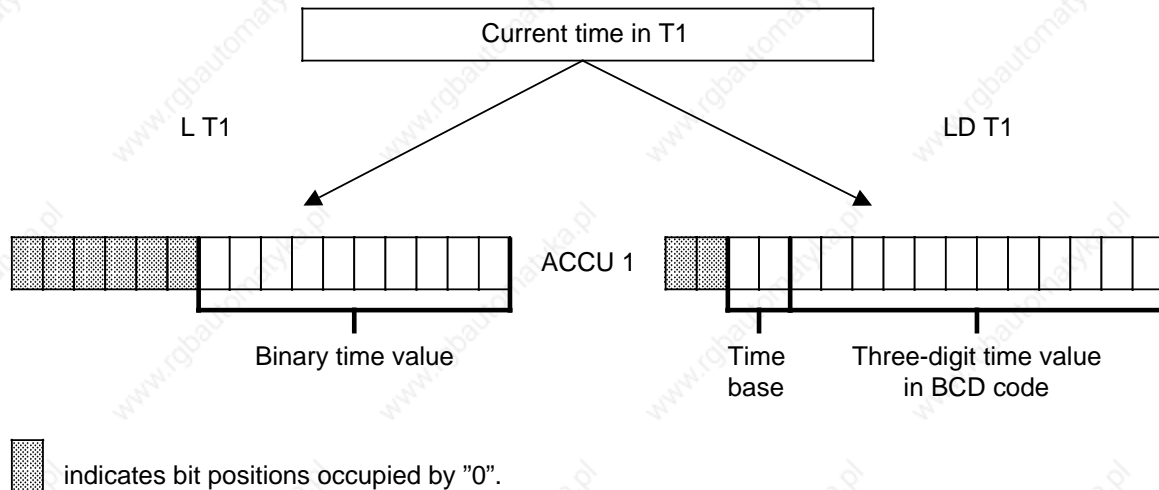

Figure 8-4. Output of the Current Time (Example)

¹ The current time is the time value in the addressed timer.

Starting a timer

In the programmable controller, timers run asynchronously to program scanning. The time that has been set can run out during a program scanning cycle. It is evaluated by the next time scan. In the worst case, an entire program scanning cycle can go by before this evaluation. Consequently, timers should not activate themselves.

Example:

Schematic Representation	Explanation
<p>n: number of program scanning cycles t_p: program scan time</p>	<p>The schematic shows the "nth + 1" processing cycle since timer T 17 * was started. Although the timer ran out shortly after the statement "= Q32.5", output Q32.5 remains set. The change is not considered until the next program scanning cycle.</p> <p>* KT 100.0 is equal to 1 s.</p>

Except for "Reset timer", all timer operations are started only on an edge of the RLO. (The RLO alternates between "0" and "1".)

After being started, the loaded time is decremented in units corresponding to the time base until it reaches zero.

If there is an edge change while the timer is running, the timer is reset to its initial value and restarted.

The signal state of a timer can be scanned with Boolean logic operations.

Pulse

Example:

Output Q32.5 is set when the signal state at input I32.0 changes from "0" to "1". However, the output should not remain set longer than 5 s.

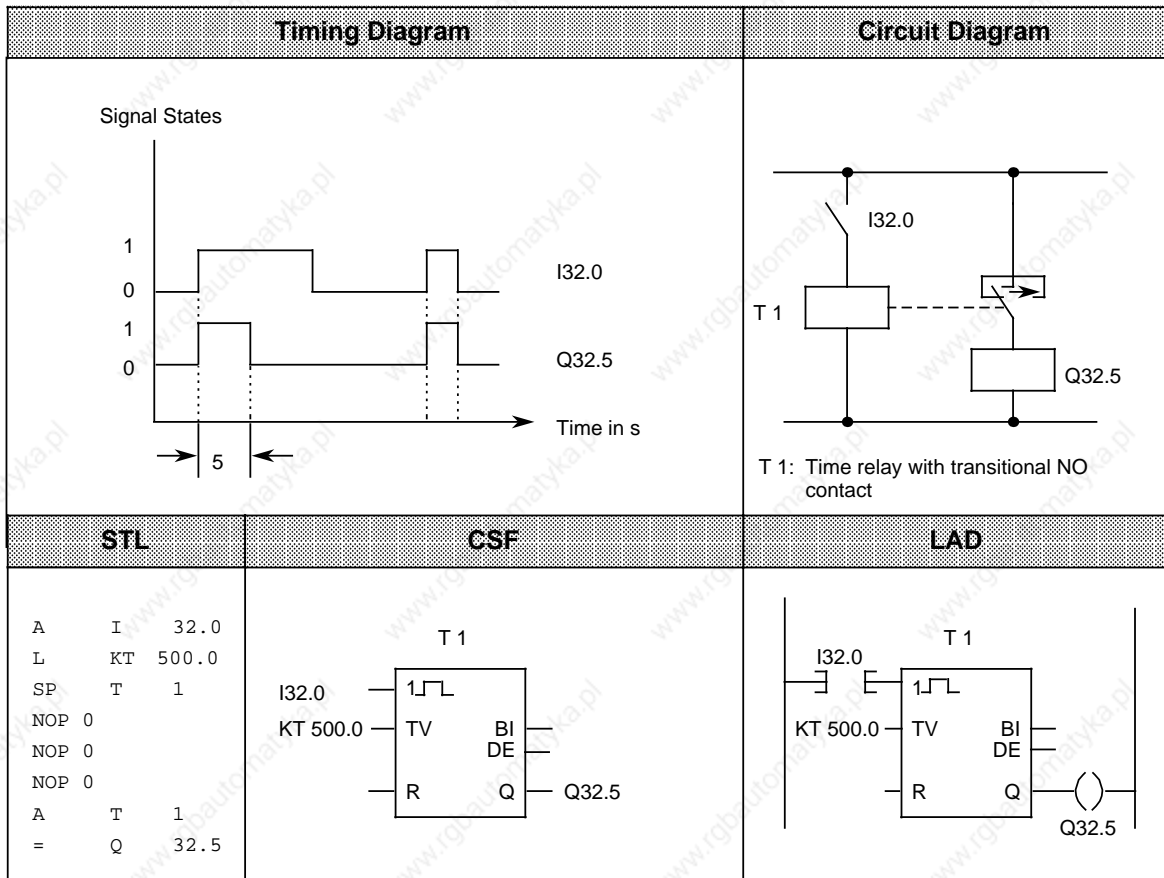

Note

The time tolerance is equivalent to the time base. Always use the smallest time base possible.

Extended pulse

Example:

Output Q32.5 is set for a specific time when the signal at input I32.0 changes to "1". The time is indicated in IW16.

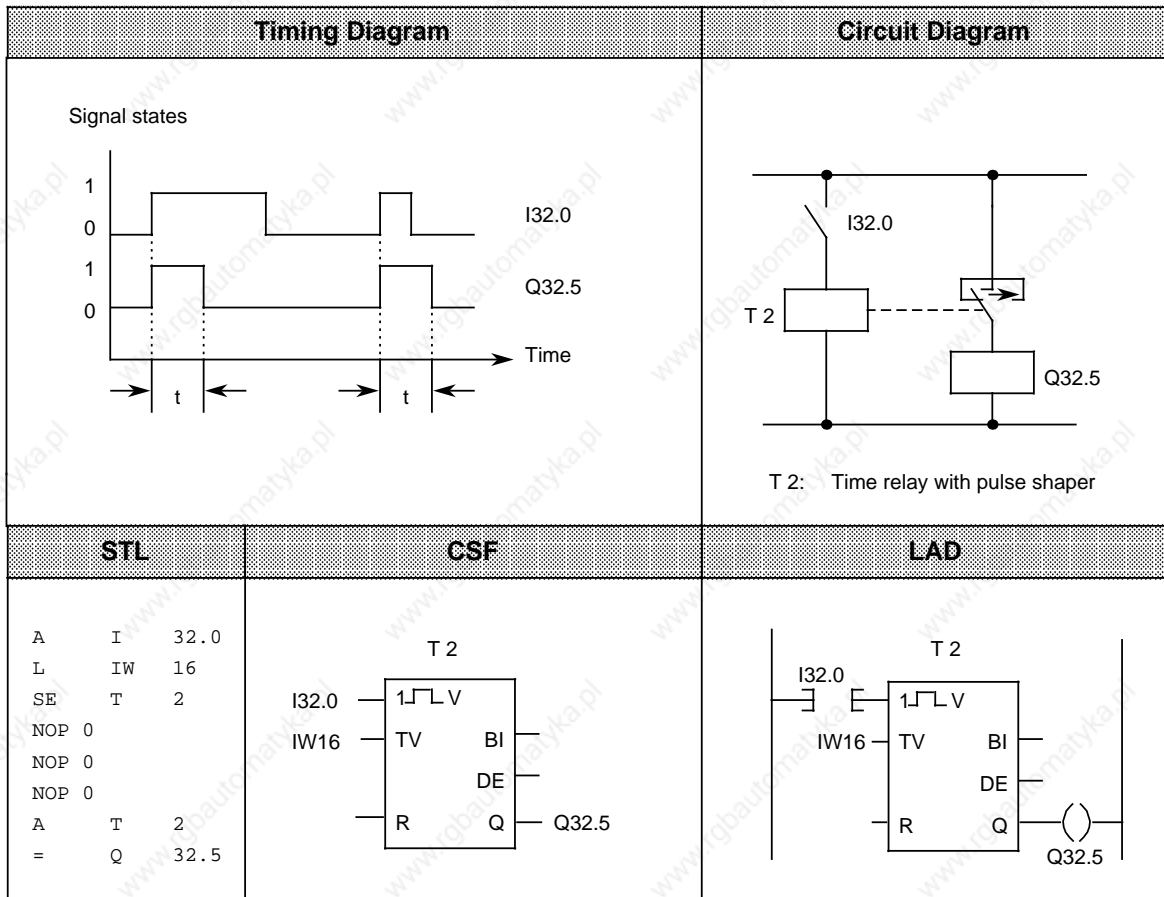

On-Delay

Example:

Output Q32.5 is set 9 s after input I32.0 and remains set as long as the input is "1".

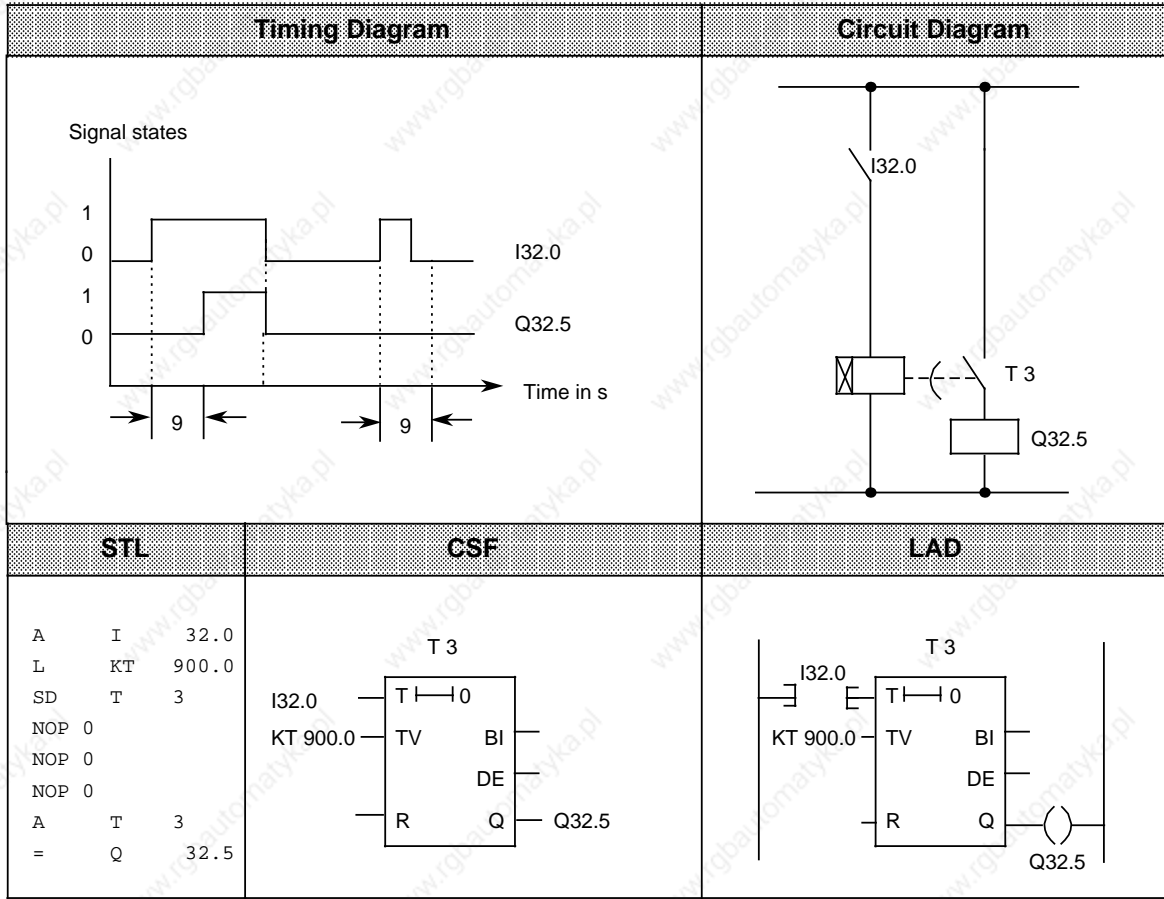

Stored On-Delay and Reset

Example:

Output Q32.5 is set 5 s after I32.0.

Further changes in the signal state at input I32.0 do not affect the output.

Input I32.1 resets timer T 4 to its initial value and sets output Q32.5 to zero.

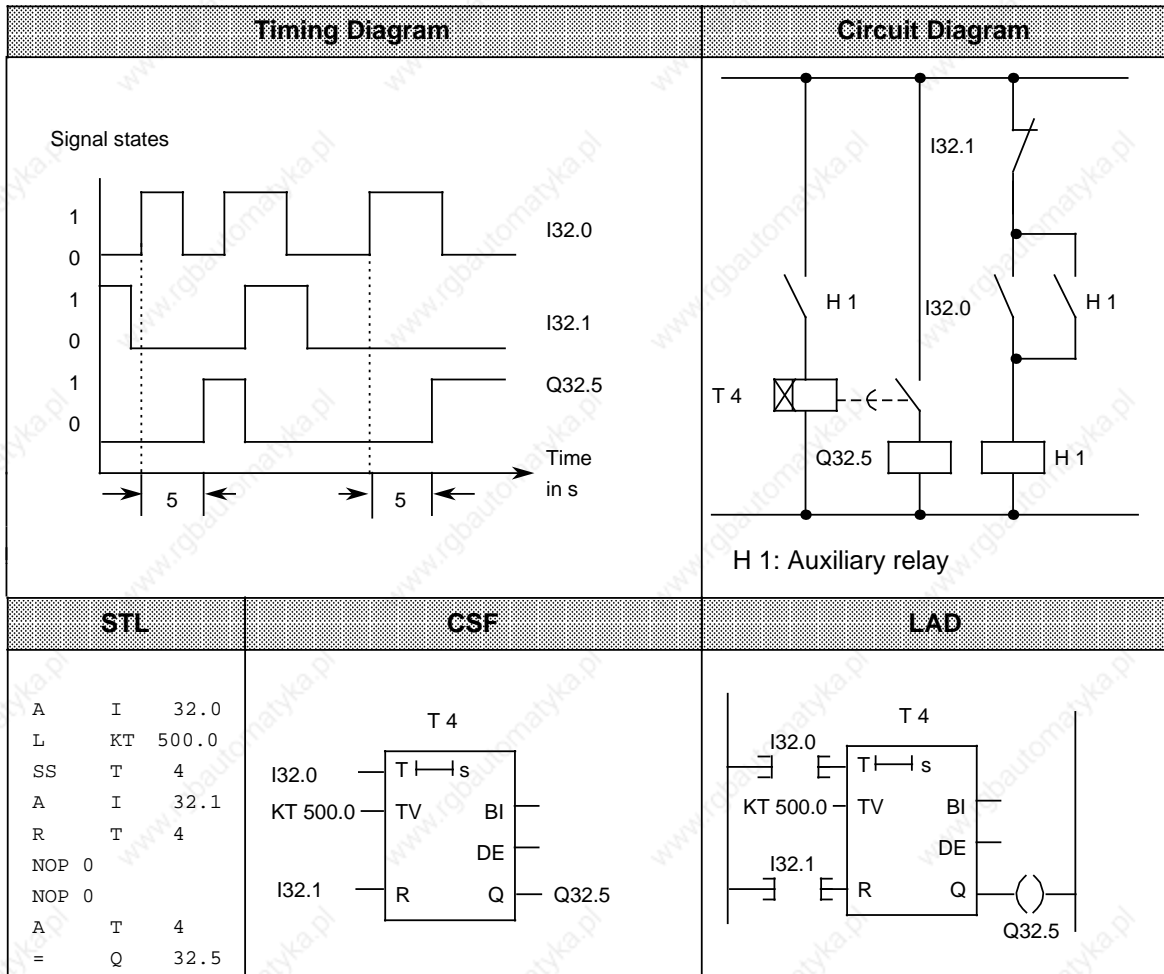

Note

The time tolerance is equivalent to the time base.

Off-Delay

Example:

When input I32.0 is reset, output Q32.5 is set to zero after a certain delay (t). The value in FW14 specifies the delay time.

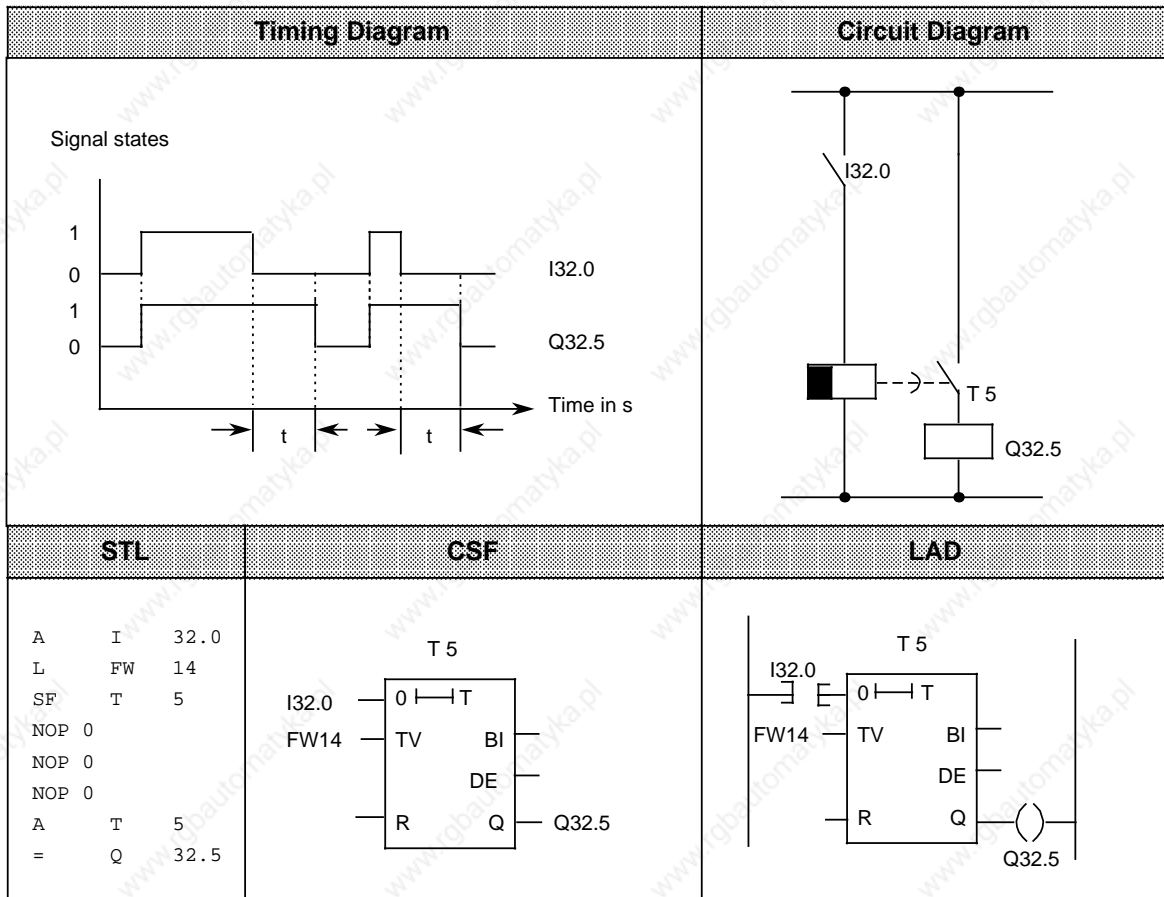

8.1.5 Counter Operations

The programmable controller uses counter operations to handle counting jobs directly. Counters can count up and down. The counting range is from 0 to 999 (three decades). Table 8-5 provides an overview of the counter operations. Examples follow the table.

Table 8-5. Overview of Counter Operations

Operation	Operand		Meaning
S			Set Counter The counter is set on the leading edge of the RLO.
R			Reset Counter The counter is set to zero as long as the RLO is "1".
CU			Count Up The count is incremented by 1 on the leading edge of the RLO. When the RLO is "0", the count is not affected.
CD			Count Down The count is decremented by 1 on the leading edge of the RLO. When the RLO is "0", the count is not affected.
ID	↑ C	↑ Parameter	S5-90U 0 to 31 S5-95U 0 to 127

Loading a Count

Counter operations call internal counters.

When a counter is set, the word in ACCU 1 is used as a count. You must therefore first store counts in the accumulator.

You can load a count with any of the following data types.

KC constant count
 or
DW data word
IW input word
QW output word
FW flag word

} The data for these words must
be in BCD code.

Loading a Constant Count

The following example shows how the count 38 is loaded.

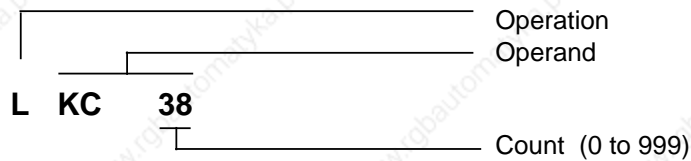

Loading a Count as Input, Output, Flag, or Data Word

Load statement: `L DW 3`

The count 410 is stored in data word DW3 in BCD code. Bits 12 to 15 are insignificant for the count.

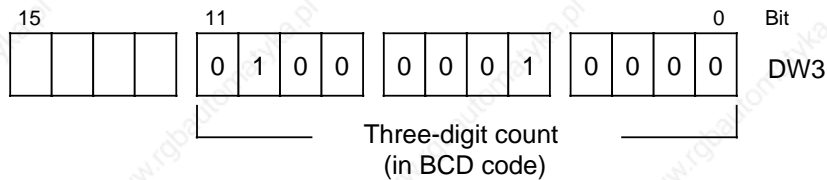

Scanning the Counter

Use Boolean logic operations to scan the counter status (e.g., A Cx). As long as the count is not zero, the scan result is signal state "1".

Outputting the Current Counter Status

You can use a load operation to put the current counter status into ACCU 1 and process it further from there. The "Load in BCD" operation outputs a digital display (see Figure 8-5).

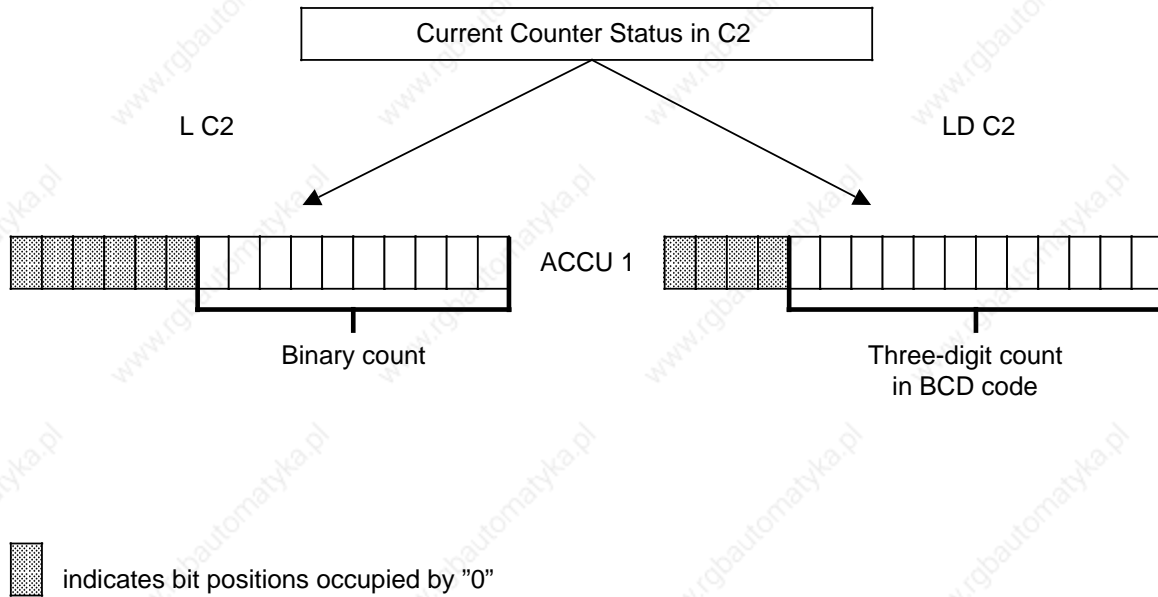

Figure 8-5. Outputting the Current Counter Status (Example)

Setting a Counter "S" and Counting Down "CD"

Example:

When input I32.1 is switched on (set), counter 1 is set to count 7. Output Q32.5 is now "1".

Every time input I32.0 is switched on (count down), the count is decremented by 1. The output is set to "0" when the count is "0".

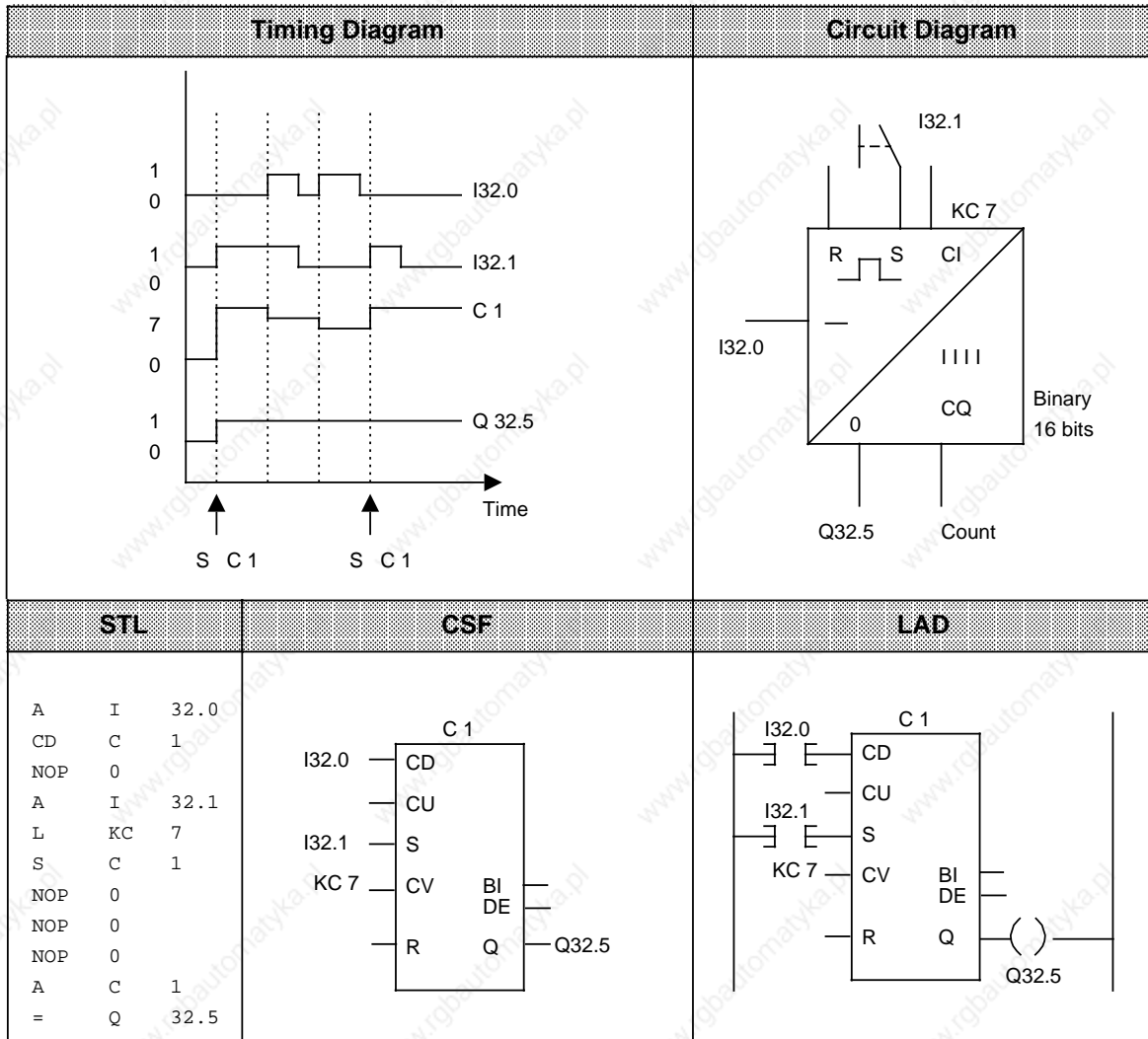

Resetting a Counter "R" and Counting Up "CU"

Example:

When input I32.0 is switched on, the count in counter 1 is incremented by 1. As long as a second input (I32.1) is "1", the count is reset to "0".

The A C1 operation results in signal state "1" at output Q32.5 as long as the count is not "0".

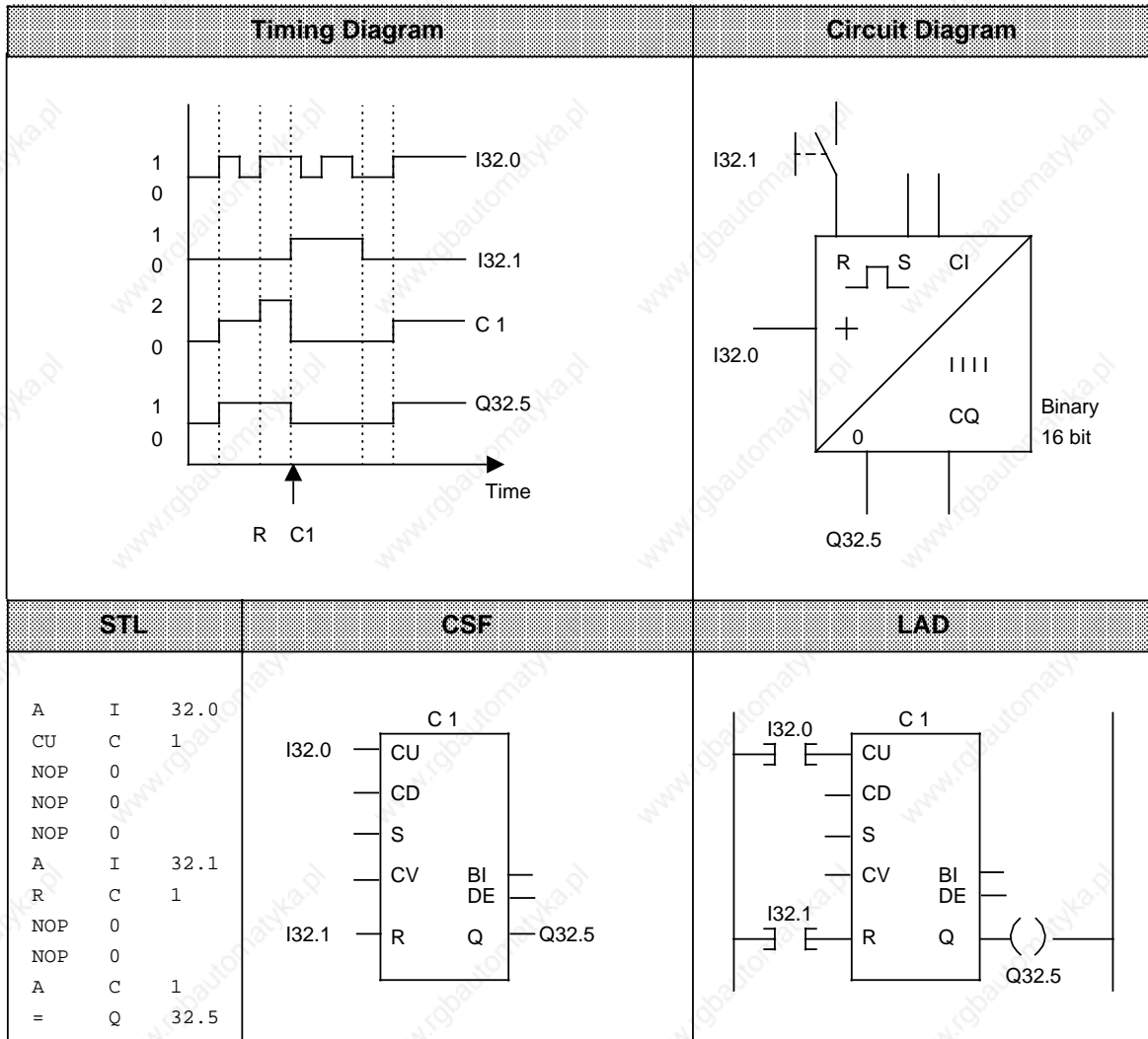

8.1.6 Comparison Operations

Comparison operations compare the contents of the two accumulators. The comparison does not change the accumulators' contents. Table 8-6 provides an overview of the comparison operations. An example follows the table.

Table 8-6. Overview of Comparison Operations

Operation	Operand	Meaning
! = F		Compare for "equal to" The contents of the two accumulators are interpreted as bit patterns and scanned to see if they are equal.
> < F		Compare for "not equal to" The contents of the two accumulators are interpreted as bit patterns and compared to see if they are not equal.
> F		Compare for "greater than" The contents of the two accumulators are interpreted as fixed-point numbers. They are compared to see if the operand in ACCU 2 is greater than the operand in ACCU 1.
> = F		Compare for "greater than or equal to" The contents of the two accumulators are interpreted as fixed-point numbers. They are compared to see if the operand in ACCU 2 is greater than or equal to the operand in ACCU 1.
< F		Compare for "less than" The contents of the two accumulators are interpreted as fixed-point numbers. They are compared to see if the operand in ACCU 2 is less than the operand in ACCU 1.
< = F		Compare for "less than or equal to" The contents of the two accumulators are interpreted as fixed-point numbers. They are compared to see if the operand in ACCU 2 is less than or equal to the operand in ACCU 1.

Processing Comparison Operations

To compare two operands, load them consecutively into the two accumulators. Execution of the operations is independent of the RLO.

The result is binary and is available as RLO for further program scanning. If the comparison is satisfied, the RLO is "1". Otherwise it is "0".

Executing the comparison operations sets the condition codes (see section 8.4).

Note

When using comparison operations, make sure the operands have the same number format.

Example: The values of input bytes IB 19 and IB 20 are compared. If they are equal, output Q32.5 is set.

Circuit Diagram	STL	CSF/LAD
	<pre> L IB 19 L IB 20 ! =F = Q 32.5 </pre>	

8.1.7 Arithmetic Operations

Arithmetic operations interpret the contents of the accumulators as fixed-point numbers and manipulate them. The result is stored in ACCU 1. Table 8-7 provides an overview of the arithmetic operations. An example follows the table.

Table 8-7. Overview of Arithmetic Operations

Operation	Operand	Meaning
+ F		Addition The contents of both accumulators are added.
- F		Subtraction The contents of ACCU 1 are subtracted from the contents of ACCU 2.

The S5-95U has integrated function blocks for multiplication and division (see Section 9.2).

Processing an Arithmetic Operation

Before an arithmetic operation is executed, both operands must be loaded into the accumulators.

Note

When using arithmetic operations, make sure the operands have the same number format.

Arithmetic operations are executed independently of the RLO. The result is available in ACCU 1 for further processing. The contents of ACCU 2 are not changed.

These operations do not affect the RLO. The condition codes are set according to the results.

STL	Explanation
L C 3	The value of counter 3 is loaded into ACCU 1.
L C 1	The value of counter 1 is loaded into ACCU 1. The previous contents of ACCU 1 are shifted to ACCU 2.
+ F	The contents of the two accumulators are interpreted as 16-bit fixed-point numbers and added.
T QW 12	The result, contents of ACCU 1, is transferred to output word QW12.

Numeric Example

876	15	0	ACCU 2
	0 0 0 0 0 0 1 1	0 1 1 0 1 1 0 0	
+		+ F	
668			ACCU 1
	0 0 0 0 0 0 1 0	1 0 0 1 1 1 0 0	
=			
1544			ACCU 1
	0 0 0 0 0 1 1 0	0 0 0 0 1 0 0 0	

8.1.8 Block Call Operations

Block call operations specify the sequence of a structured program. Table 8-8 provides an overview of the block call operations. Examples follow the table.

Table 8-8. Overview of Block Call Operations

Operation	Operand	Meaning															
JU		Jump unconditionally Program scanning continues in a different block regardless of the RLO. The RLO is not affected.															
JC		Jump conditionally Program scanning jumps to a different block when the RLO is "1". Otherwise program scanning continues in the previous block. The RLO is set to "1".															
ID	OB PB FB SB	<table border="1"> <thead> <tr> <th>Parameter</th> <th>S5-90U</th> <th>S5-95U</th> </tr> </thead> <tbody> <tr> <td>—</td> <td>—</td> <td>0 to 255 *</td> </tr> <tr> <td>—</td> <td>0 to 63</td> <td>0 to 255</td> </tr> <tr> <td>—</td> <td>0 to 63</td> <td>0 to 255</td> </tr> <tr> <td>—</td> <td>—</td> <td>0 to 255</td> </tr> </tbody> </table>	Parameter	S5-90U	S5-95U	—	—	0 to 255 *	—	0 to 63	0 to 255	—	0 to 63	0 to 255	—	—	0 to 255
Parameter	S5-90U	S5-95U															
—	—	0 to 255 *															
—	0 to 63	0 to 255															
—	0 to 63	0 to 255															
—	—	0 to 255															
C		Call a data block A data block is activated regardless of the RLO. Program scanning is not interrupted. The RLO is not affected.															
G		Generate and delete a data block (only for the S5-95U)** An area is set up in the RAM to store data regardless of the RLO.															
ID	DB	<table border="1"> <thead> <tr> <th>Parameter</th> <th>S5-90U (only C DBx is possible)</th> <th>A5-95U</th> </tr> </thead> <tbody> <tr> <td>—</td> <td>2 to 63***</td> <td>2 to 255 ***</td> </tr> </tbody> </table>	Parameter	S5-90U (only C DBx is possible)	A5-95U	—	2 to 63***	2 to 255 ***									
Parameter	S5-90U (only C DBx is possible)	A5-95U															
—	2 to 63***	2 to 255 ***															
BE		Block end The current block is terminated regardless of the RLO. Program scanning continues in the block in which the call originated. The RLO is "carried along" but not affected. BE is always the last statement in a block.															
BEU		Block end, unconditional The current block is terminated regardless of the RLO. Program scanning continues in the block in which the call originated. The RLO is "carried along" but not affected.															
BEC		Block end, conditional When the RLO is "1", the current block is terminated. Program scanning continues in the block in which the call originated. During the block change, the RLO remains "1". If the RLO is "0", the operation is not executed. The RLO is set to "1" and linear program scanning continues.															

* If using the PG 615, select "SYS. OPS. Y" in the presets menu. Also note that certain OBs are assigned by the operating system.

** The length of the DB must be loaded into ACCU 1 before execution. A length of 0 deletes the DB.

*** Data blocks DB0 and DB1 are reserved for special functions.

Call a Data Block "C DB"

Data blocks are always called unconditionally. All data processed following the call refers to the data block that has been called. This operation cannot generate new data blocks. Blocks that are called must be programmed before program scanning.

Example: Program block PB3 needs information that has been programmed as data word DW 1 in data block DB10. Other data, e.g., the result of an arithmetic operation, is stored as data word DW3 in data block DB20.

Program Sequence	STL	Explanation
	<pre> C DB 10 L DW 1 . . . C DB 20 T DW 3 </pre>	<p>The information from data word DW1 in data block DB10 is loaded into the accumulator. The contents of ACCU 1 are stored in data word DW3 of data block DB20.</p>

Generating and Deleting a Data Block (only for the S5-95U)

The "G DB x" statement does not call a data block. Instead, it generates a new block. If you want to use the data in this data block, call it with the "C DB" statement.

Before the "G DB" statement, indicate in ACCU 1 the number of data words the block is to have (see the example below).

If you specify zero as the data block length, the data block in question is deleted, i.e., it is removed from the address list. It is considered nonexistent.

Note

The block is stored in memory and not accessible. When the programmable controller memory is compressed, the old data block is deleted (see Section 7.4.3).

If you try to set up a data block that already exists, the "G DB x" statement is not executed.

A data block can be a maximum of 256 data words (DW0 to 255) in length.

Generating a Data Block

Example	STL	Explanation
Generate a data block with 128 data words without the aid of a programmer.	<pre>L KF + 127 G DB 5</pre>	The constant fixed-point number +127 is loaded into ACCU 1. At the same time, the old contents of ACCU 1 are shifted to ACCU 2. Data block 5 is generated with a length of 128 data words (0000) in the RAM of the PLC and entered in the block address list. The next time the "G DB5" operation is processed, it has no effect if the contents of ACCU 1 are not 0.

Deleting a Data Block

Example	STL	Explanation
Delete a data block that is no longer needed.	<pre>L KF + 0 G DB 5</pre>	The constant fixed-point number +0 is loaded into ACCU 1. At the same time, the old contents of ACCU 1 are shifted to ACCU 2. Data block 5, which is in the RAM of the PLC, is declared invalid and removed from the block address list.

Block End "BE"

The "BE" operation terminates a block. Data blocks do not need to be terminated. "BE" is always the last statement in a block.

In structured programming, program scanning jumps back to the block where the call for the current block was made.

Boolean logic operations cannot be continued in a higher-order block.

Example: Program block PB3 is terminated by the "BE" statement.

Program Sequence	STL	Explanation
	<p>·</p> <p>·</p> <p>·</p> <p>·</p> <p>·</p> <p>·</p> <p>BE</p>	<p>The "BE" statement terminates program block PB3 and causes program scanning to return to organization block OB1.</p>

Unconditional Block End "BEU"

The "BEU" operation causes a return within a block. However, jump operations can by-pass the "BEU" operation in function blocks (see sections 8.2.10 and 8.3.4).

Binary logic operations cannot be continued in a higher-order block.

Example: Scanning of function block FB21 is terminated regardless of the RLO.

Program Sequence	STL	Explanation
	<p>·</p> <p>·</p> <p>·</p> <p>·</p> <p>JC=</p> <p>BEU</p> <p>·</p> <p>·</p> <p>·</p> <p>BE</p>	<p>The "BEU" statement causes program scanning to leave function block FB21 and return to program block PB8.</p>

Conditional Block End "BEC"

The "BEC" operation causes a return within a block if the previous condition has been satisfied (RLO = 1).

Otherwise, linear program scanning is continued with RLO "1".

Example: Scanning of program block FB20 is terminated if the RLO = "1".

Program Sequence	STL	Explanation
	<pre> . . . A I 32.0 BEC . . . </pre>	<p>The "BEC" statement causes program scanning to return to program block PB 7 from function block FB20 if input I32.0 is "1".</p>

8.1.9 Other Operations

Table 8-9 lists other basic operations. Explanations follow the table.

Table 8-9. Other Operations

Operation	Operand	Meaning
STP		Stop at the end of program scanning (in OB1) Current program scanning is terminated. The PIQ is read out. Then the PLC goes into the "STOP" mode.
NOP 0		"No" Operation Sixteen bits in the RAM are set to "0".
NOP 1		"No" Operation Sixteen bits in the RAM are set to "1".
BLD	↑	Display Generation Operation "BLD" means a display generation operation for the programmer.
ID	↑	Parameter 130, 131, 132, 133, 255

Note

These operations can be programmed in STL form only.

STOP Operation

The "STP" operation puts the PLC into the "STOP" mode. This can be desirable for time-critical system circumstances or when a PLC error occurs.

After the statement is processed, the control program is scanned to the end, regardless of the RLO. Afterwards the PLC goes into the "STOP" mode with the error ID "STS". The PLC can be restarted with the mode selector (STOP to RUN) or with a programmer.

"NOP" (No Operations)

The "NOP" operations reserve or overwrite memory locations.

Display Generation Operations

"BLD" display generation operations divide program parts into segments within a block.

"NOP" operations and display generation operations are significant only for the programmer when representing the STEP 5 program.

The PLC does not execute any operations when these statements are processed.

8.2 Supplementary Operations

Supplementary operations extend the operations set. However, compared to basic operations, which can be programmed in all blocks, supplementary operations have the following limitations.

- They can be programmed in function blocks only.
- They can be represented in STL form only.

The following sections describe the supplementary operations.

8.2.1 Load Operation (only for the S5-95U)

As with the basic load operations, the supplementary load operation copies information into the accumulator. Table 8-10 explains the load operation. An example follows the table.

Table 8-10. Load Operation

Operation	Operand		Meaning
L			Load A word from the system data is loaded into ACCU 1 regardless of the RLO.
ID	↑ RS	↑ Parameter	0 to 255

Example	STL	Explanation
In order to set parameters for SINEC L1 bus operation via the system data, the programmer and slave numbers from SD57 should be input into ACCU 1.	<pre> ... L RS 57 ... </pre>	Load ACCU 1 with the programmer and slave numbers.

8.2.2 Enable Operation (only for the S5-95U)

Use the enable operation (FR) to execute the following operations even without edge change.

- Start a timer
- Set a counter
- Count up and down

Table 8-11 presents the enable operation. An example follows the table.

Table 8-11. Enable Operation

Operation	Operand		Meaning
FR			Enable a Timer/Counter Timers and counters are enabled on the leading edge of the RLO. This operation restarts a timer, sets a counter, or causes a counter to count up or down when the RLO "1" is pending at the "Start" operation.
ID	T C	Parameter	0 to 127 0 to 127

Example	STL	Explanation
Input I32.0 starts a timer T 2 as extended pulse (pulse width 50 s.). This timer sets output Q32.4 for the duration of the pulse.	<pre> A I 32.0 L KT 500.1 SE T 2 A T 2 = Q 32.4 </pre>	Start a timer T 2 as an extended pulse. Output Q32.4 is set for 50 s.
If output Q32.5 is reset repeatedly, the timer should also be restarted repeatedly.	<pre> A Q 32.5 FR T 2 BE </pre>	If output Q32.5 is set (positive edge change of the RLO) during the time in which input I32.0 is set, the timer T 2 is restarted. Output Q32.4 therefore remains set at the restarted time or is reset. If input I32.0 is not set during the edge change of output Q32.5, the timer is not restarted.

8.2.3 Bit Test Operations (only for the S5-95U)

Bit test operations scan digital operands bit by bit and affect them. Bit test operations must always be at the beginning of a logic operation. Table 8-12 provides an overview of these operations.

Table 8-12. Overview of Bit Operations

Operation	Operand	Meaning
TB		Test a bit for signal state "1" A single bit is scanned regardless of the RLO. The RLO is affected according to the bit's signal state (see Table 8-13).
TBN		Test a bit for signal state "0" A single bit is scanned regardless of the RLO. The RLO is affected according to the bit's signal state (see Table 8-13).
SU		Set a bit unconditionally The addressed bit is set to "1" regardless of the RLO. The RLO is not affected.
RU		Reset a bit unconditionally The addressed bit is set to "0" regardless of the RLO. The RLO is not affected.
ID	↑ T C D RS ¹	Parameter 0.0 to 127.15 0.0 to 127.15 0.0 to 255.15 0.0 to 255.15

¹ RS applies only to TB and TBN

Table 8-13 shows how the RLO is formed during the bit test operations "TB" and "TBN". An example for applying the bit operations follows the table.

Table 8-13. Effect of "TB" and "TBN" on the RLO

Operation	TB		TBN	
	0	1	0	1
Signal state of the bit in the operation indicated	0	1	0	1
Result of logic operation	0	1	1	0

Example	STL	Explanation
A photoelectric barrier that counts piece goods is installed at input I32.0. After every 100 pieces, the program is to jump to FB5 or FB6. After 800 pieces, counter 10 is to be reset automatically and start counting again.	<pre> C DB 10 A I 32.0 CU C 10 A I 32.1 L KC 0 S C 10 O I 32.2 O F 5.2 R C 10 LD C 10 T DW 12 TBN D 12.8 JC FB 5 TB D 12.8 JC FB 6 TB D 12.11 = F 5.2 </pre>	<p>Call data block 10.</p> <p>Input I32.1 loads the count of counter 10 with the constant 0. With each positive edge change at I32.0, the counter is incremented by 1. The counter is reset by either input I32.2 or flag F 5.2. The current count of the counter is stored in data word DW12 in BCD code.</p> <p>As long as bit 8 of data word DW12 is zero, program processing jumps to function block FB5. This is the case for the second, fourth, sixth etc. batch of 100 pieces.</p> <p>As long as bit 8 of data word DW12 is "1", program scanning jumps to function block FB 6. This is the case for the first, third, fifth etc. batch of 100 pieces.</p> <p>When data bit 11 of data word DW12 becomes "1" (the count is then 800), flag F 5.2 is set conditionally.</p>
A photoelectric barrier that counts piece goods is installed at input I32.3. After every 256 pieces, the counter is supposed to be reset and start counting again.	<pre> :A I 32.3 :CU C 20 :A I 32.4 :L KC 0 :S C 20 :TB C 20.8 :JC = FULL :BEU FULL:RU C 20.8 :BE </pre>	<p>Input I32.4 loads the count of counter 20 with the constant 0. The count is incremented by 1 with each positive edge change at input I32.3. If the count has reached 256 = 100_H (bit 8 is "1"), program scanning jumps to the label "FULL". Otherwise the block is terminated.</p> <p>Bit 8 of counter C 20 is set to "0" unconditionally. Then the count is again 000_H.</p>

Note

Times and counts are stored in the timer/counter word in hexadecimal notation in the 10 least significant bits (bits 0 to 9).

The time base is stored in bits 12 and 13 of the timer word.

8.2.4 Digital Logic Operations

Digital logic operations combine the contents of both accumulators logically bit by bit. Table 8-14 provides an overview of these digital logic operations. Examples follow the table.

Table 8-14. Overview of Digital Logic Operations

Operation	Operand	Meaning
AW		Combine bit by bit through logic AND.
OW		Combine bit by bit through logic OR
XOW		Combine bit by bit through logic EXCLUSIVE OR

Processing a Digital Logic Operation

A digital logic operation is executed regardless of the RLO. It also does not affect the RLO. However, it sets condition codes according to the result of the arithmetic operation (see section 8.4).

Note

Make sure both operands have the same number format. Then load them into the accumulators before executing the operation.

The result of the arithmetic operation is available in ACCU 1 for further processing. The contents of ACCU 2 are not affected.

STL		Explanation
L	IW 92	Load input word IW92 into ACCU 1.
L	KH 00FF	Load a constant into ACCU 1. The previous contents of ACCU 1 are shifted to ACCU 2.
AW		Combine the contents of both accumulators bit by bit through logic AND.
T	QW 82	Transfer the resulting contents from ACCU 1 to output word QW 82.
Numeric Example		
ACCU 2	<p>IW92</p> <p>15 0</p> <p>0 1 1 1 0 0 0 1 1 0 0 1 1 1 0 0</p>	<p>Set the 8 high-order bits in input word IW92 to "0".</p> <p>Compare both words bit by bit. If corresponding bits are both "1", the result bit is set to "1".</p>
ACCU 1	<p>KH 00FF</p> <p>0 0 0 0 0 0 0 0 1 1 1 1 1 1 1 1</p> <p>AND</p>	
ACCU 1	<p>Result</p> <p>0 0 0 0 0 0 0 0 1 0 0 1 1 1 0 0</p>	

STL		Explanation
L	IW 36	Load input word IW36 into ACCU 1.
L	KH 00FF	Load a constant into ACCU 1. The previous contents of ACCU 1 are shifted to ACCU 2.
OR		Combine the contents of both accumulators bit by bit through logic OR.
T	IW 36	Transfer the result (contents of ACCU 1) to input word IW36.

Numeric Example	
<p>ACCU 2</p> <p style="text-align: center;">15 IW36 0</p> <p>1 1 1 0 0 1 0 1 1 0 0 0 1 1 0</p>	<p>Set the 8 low-order bits in input word IW36 to "1". Compare both words bit by bit. If corresponding bits are both "1", a "1" is set in the result word.</p>
<p style="text-align: center;">KH 00FF</p> <p>ACCU 1</p> <p>0 0 0 0 0 0 0 0 1 1 1 1 1 1 1</p>	<p style="text-align: center;">OR</p>
<p style="text-align: center;">Result</p> <p>ACCU 1</p> <p>1 1 1 0 0 1 0 1 1 0 0 0 1 1 1</p>	

STL		Explanation
L	IW 70	Load input word IW70 into ACCU 1.
L	IW 6	Load input word IW6 into ACCU 1. The previous contents of ACCU 1 are shifted to ACCU 2.
XOR		Combine the contents of both accumulators bit by bit through logic EXCLUSIVE OR.
T	QW 86	Transfer the result (contents of ACCU 1) to output word QW 86.

Numeric Example		
ACCU 2	<p style="text-align: center;">IW70</p> <div style="display: flex; align-items: center;"> 15 <div style="border: 1px solid black; padding: 2px; display: flex; gap: 2px;"> 0001101101101100 </div> 0 </div>	<p>Check to see if input words IW70 and IW6 are equal. The result bit is set to "1" only if corresponding bits in ACCU 1 and ACCU 2 are unequal.</p>
	X-OR	
ACCU 1	<p style="text-align: center;">IW6</p> <div style="display: flex; align-items: center;"> <div style="border: 1px solid black; padding: 2px; display: flex; gap: 2px;"> 1001100111000110 </div> <div style="border: 1px solid black; padding: 2px; margin-left: 5px; display: flex; gap: 2px;"> 0011001100110010 </div> </div>	
ACCU 1	<p style="text-align: center;">Result</p> <div style="display: flex; align-items: center;"> <div style="border: 1px solid black; padding: 2px; display: flex; gap: 2px;"> 1000001010101010 </div> <div style="border: 1px solid black; padding: 2px; margin-left: 5px; display: flex; gap: 2px;"> 0011001100110010 </div> </div>	

8.2.5 Shift Operations

Shift operations shift a bit pattern in ACCU 1. The contents of ACCU 2 are not affected. Shifting multiplies or divides the contents of ACCU 1 by powers of two. Table 8-15 provides an overview of the shift operations. Examples follow the table.

Table 8-15. Overview of Shift Operations

Operation	Operand	Meaning
SLW		Shift to the left. The bit pattern in ACCU 1 is shifted to the left.
SRW		Shift to the right. The bit pattern in ACCU 1 is shifted to the right.
	↑ Parameter	0 to 15

Processing a Shift Operation

Execution of shift operations is unconditional. The RLO is not affected. However, shift operations set condition codes.

Consequently, the status of the last bit that is shifted out can be scanned with jump functions.

The shift statement parameter indicates the number of bit positions by which the contents of ACCU 1 are to be shifted to the left (SLW) or to the right (SRW). Bit positions vacated during shifting are assigned zeros.

The contents of the bits that are shifted out of ACCU 1 are lost. Following execution of the operation, the state of bit 2⁰ (SRW) or bit 2¹⁵ (SLW) has an influence on the CC1 bit, which can then be evaluated.

A shift operation with parameter "0" is handled like a "NOP" operation. The central processor processes the next STEP 5 statement with no further reaction.

Before executing a shift operation, load the operand to be processed into ACCU 1.

The altered operand is available there for further processing.

STL		Explanation
L	DW 2	Load the contents of data word DW2 into ACCU 1.
SLW	3	Shift the bit pattern in ACCU 1 three positions to the left.
T	DW 3	Transfer the result (contents of ACCU 1) to data word DW3.
Numeric Example		
ACCU 1	464_{10} (DW2) 15 0 0 0 0 0 0 0 1 1 1 0 1 0 0 0 0 0	The value 464_{10} is stored in data word DW2. Multiply this value by $2^3=8$. Do so by shifting the bit pattern of DW2 in ACCU 1 three positions to the left.
	← SLW 3	
ACCU 1	3712_{10} 15 0 0 0 0 0 1 1 1 0 1 0 0 0 0 0 0 0	

STL		Explanation
L	IW 124	Load the value of input word IW124 into ACCU 1.
SRW	4	Shift the bit pattern in ACCU 1 four positions to the right.
T	QW 126	Transfer the result (contents of ACCU 1) to output word QW126.
Numeric Example		
ACCU 1	352_{10} (IW124) 15 0 0 0 0 0 0 0 1 0 1 1 0 0 0 0 0 0	The value 352_{10} is stored in IW124. Shift the corresponding bit pattern in ACCU 1 four positions to the right to divide the value 352_{10} by $2^4 = 16$.
	SRW 4 →	
ACCU 1	22_{10} 15 0 0 0 0 0 0 0 0 0 0 0 1 0 1 1 0 0	

8.2.6 Conversion Operations

Conversion operations convert the values in ACCU 1. Table 8-16 provides an overview of the conversion operations. Examples follow the table.

Table 8-16. Overview of Conversion Operations

Operation	Operand	Meaning
CFW		One's complement The contents of ACCU 1 are inverted bit by bit.
CSW		Two's complement The contents of ACCU 1 are inverted bit by bit. Afterwards the word 0001 _H is added.

Processing Conversion Operations

Execution of these operations does not depend on the RLO nor does it affect the RLO. The "CSW" operation sets the condition codes (see section 8.4).

STL	Explanation
L DW 12	Load the contents of data word DW12 into ACCU 1.
CFW	Invert all bits in ACCU 1.
T QW 20	Transfer the new contents of ACCU 1 to output word QW 20.
Numeric Example	
ACCU 1 DW12 15 0 0 1 1 1 0 0 0 1 1 0 0 1 1 1 1 0	In a system, normally open contacts have been replaced by normally closed contacts. If the information in data word DW12 is to maintain its previous effect, DW12 must be inverted.
ACCU 1 CFW 15 0 1 0 0 0 1 1 1 0 0 1 1 0 0 0 1 1	

STL		Explanation																																
L	IW 12	Load the contents of input word IW12 into ACCU 1.																																
CSW		Invert all bits. Add a "1" at the least significant position.																																
T	DW 100	Transfer the altered word to data word DW100.																																
Numeric Example																																		
ACCU 1	<p style="text-align: center;">IW12</p> <p style="text-align: center;">15 0</p> <table border="1" style="margin-left: auto; margin-right: auto;"> <tr> <td>0</td><td>1</td><td>0</td><td>1</td><td>1</td><td>0</td><td>0</td><td>1</td><td>1</td><td>1</td><td>0</td><td>0</td><td>0</td><td>1</td><td>0</td><td>1</td> </tr> </table> <p style="text-align: center;">↓ ↓ ↓ ↓</p> <p style="text-align: center;">CSW +1</p> <p style="text-align: center;">15 0</p> <table border="1" style="margin-left: auto; margin-right: auto;"> <tr> <td>1</td><td>0</td><td>1</td><td>0</td><td>0</td><td>1</td><td>1</td><td>0</td><td>0</td><td>0</td><td>1</td><td>1</td><td>0</td><td>1</td><td>1</td><td>1</td> </tr> </table>	0	1	0	1	1	0	0	1	1	1	0	0	0	1	0	1	1	0	1	0	0	1	1	0	0	0	1	1	0	1	1	1	Form the negative value of the value in input word IW12.
0	1	0	1	1	0	0	1	1	1	0	0	0	1	0	1																			
1	0	1	0	0	1	1	0	0	0	1	1	0	1	1	1																			

8.2.7 Decrement/Increment (only for the S5-95U)

The decrement/increment operations change the data loaded into ACCU 1. Table 8-17 provides an overview of the decrement/increment operations. An example follows the table.

Table 8-17. Decrement/Increment Operations

Operation	Operand	Meaning
D		Decrement* Decrement the contents of the accumulator.
I		Increment* Increment the contents of the accumulator.
	↑ Parameter 0 to 255	

* The contents of ACCU 1 are either decremented or incremented by the number indicated in the parameter. Execution of the operation is unconditional and is limited to the right-hand byte (without carry).

Processing

Execution of the decrement and increment operations is independent of the RLO and does not affect the RLO or the condition codes.

The parameter indicates the value by which the contents of ACCU 1 are to be changed.

The operations refer to decimal values; however, the result is stored in ACCU 1 in binary form.

Changes relate only to the low byte in the accumulator.

Example	STL	Explanation
Increment the hexadecimal constant 1010 _H by 16 and store the result in data word DW8.	C DB 6 L KH 1010 I 16	Call data block DB6. Load hexadecimal constant 1010 _H into ACCU 1. Increment the low byte of ACCU 1 by 16. The result, 1020 _H , is located in ACCU 1.
In addition, decrement the incrementation result by 33 and store the new result in data word DW9.	T DW 8 D 33 T DW 9	Transfer the contents of ACCU 1 (1020 _H) to data word DW8. Since the incrementation result is still in ACCU 1, you can decrement by 33 directly. The result would be FFF _H . However, since the high byte of ACCU 1 is not decremented along with the low byte, the result in ACCU 1 is 10FF _H . The contents of ACCU 1 are transferred to DW9 (10FF _H).

8.2.8 Disable/Enable Interrupt

The disable/enable interrupt operations affect interrupt and time-driven program scanning. They prevent process or time interrupts from interfering with the processing of a sequence of statements or blocks. Table 8-18 lists the disable/enable interrupt operations. An example follows the table.

Table 8-18. Disable/Enable Interrupt Operations

Operation	Operand	Meaning
IA		Disable interrupt
RA		Enable interrupt

Processing

Execution of the disable/enable interrupt operations does not depend on the RLO. These operations do not affect the RLO or the condition codes. After the "IA" statement is processed, no more interrupts are executed. The "RA" statement cancels the effect of "IA".

Example	STL	Explanation
Disable interrupt processing in a specific program section and then enable it again.	<pre> = Q 32.5 IA A I 32.0 . . . JU FB 3 . . . RA . . . </pre>	<p>Disable interrupt.</p> <p>If an interrupt occurs, the program section between the operations IA and RA is scanned without interruption.</p> <p>Enable interrupt. Interrupts that occurred in the meantime are processed after the "RA" operation.</p>

8.2.9 DO Operation (only for the S5-95U)

The "B" operation makes it possible for you to process STEP 5 statements as indexed operations. This makes it possible for you to change the parameter of an operand during control program processing. Table 8.19 provides you with an overview and an example of the "B" operation.

Table 8-19. Overview of the DO Operation

Operation	Operand	Meaning
DO		Processing a flag word or data word
ID	↑ FW DW	↑ Parameter 0 to254 0 to254

DO Statements

"DO flag word or data word x" is a two-word statement that is unaffected by the RLO.

"DO" consists of two related statements that have to be processed successively:

- The first statement contains the DO operation and a flag word or data word.
- The second statement defines the operation and the operand identifier you want the control program to process. You must enter 0 or 0.0 as the parameter.

The control program works with the parameter that is stored in the flag word or data word. This parameter is the one called up in the first statement. If you want to index binary operations, inputs, outputs, or flags, you input the bit address in the high byte of this word, and you input the byte address in the low byte. In any other instance, the high byte must be "0."

You can combine the following operations with the DO statement:

Operations	Explanations
L FY, T FY, L FW, T FW, L IB, T IB, L QB, T QB, L IW, T IW, L QW, T QW, L DL, T DL, L DR, T DR, L DW, T DW	Load and transfer operations
CDB, JU OB, JU SB, JU FB, JU PB, JC OB, JC SB, JC FB, JC PB	Block call operations
A F, = F, A T, AN T	Boolean logic operations
S F, R F, R T	Set/reset operations
SS T, SE T	Timer operations
SLW, SRW	Shift operations

Figure 8-6 shows how the contents of a data word determine the parameter of the next statement.

DB6		FBx	Actual program
		:C DB 6	:C DB 6
		:	:
DW 12	KH = 0108	:B DW 12	:A F 8.1
DW 13	KH = 0001	:A F 0.0	:
		:B DW 13	:SS T 1
		:SS T 0	

Figure 8-6. Executing a DO Operation

The following example illustrates how new parameters are generated in every program scan.

Example	STL	Explanation
Set the contents of data words DW20 to DW100 to signal state "0." The index register for the parameter for the data words is DW1.	:C DB 202	Call data block DB 202.
	:L KB 20	Load constant number 20 in ACCU 1.
	:T DW 1	Transfer contents from ACCU 1 to data word DW1.
	F 1 :L KH 0	Load hex constant 0 in ACCU 1.
	:B DW 1	DO data word DW1.
	:T DW 0	Transfer the contents from ACCU 1 to the data word whose address is stored in data word DW1.
	:L DW 1	Load data word DW1 in ACCU 1.
	:L KB 1	Load constant number 1 in ACCU 1. Data word DW1 is shifted to ACCU 2.
	:+F	ACCU 2 und ACCU 1 are added, and the result is stored in ACCU 1 (data word address is higher).
	:T DW 1	Transfer contents of ACCU 1 to data word DW1 (new data word address).
	:L KB 100	The constant number 100 is loaded in ACCU 1 and the new data word address is shifted to ACCU 2.
	:<=F	Compare the ACCUs for less than: ACCU 2 \leq ACCU 1.
:JC = F 1	Jump conditionally to label F1, if ACCU 2 \leq ACCU 1.	

8.2.10 Jump Operations

Table 8.20 provides an overview of the jump operations. An example follows the table.

Table 8-20. Overview of Jump Operations

Operation	Operand	Meaning
JU =		Jump unconditionally The unconditional jump is executed independently of conditions.
JC=		Jump conditionally The conditional jump is executed if the RLO is "1". If the RLO is "0", the statement is not executed and the RLO is set to "1".
JZ =		Jump if the result is "zero" The jump is executed only if CC 1 = 0 and CC 0 = 0 The RLO is not changed.
JN =		Jump if the result is "not zero" The jump is executed only if CC 1 = 1 and CC 0 = 0 The RLO is not changed.
JP =		Jump if the result is positive The jump is executed only if CC 1 = 1 and CC 0 = 0 The RLO is not changed.
JM =		Jump if the result is negative The jump is executed only if CC 1 = 0 and CC 0 = 1 The RLO is not changed.
JO =		Jump on overflow The jump is executed if an overflow occurs. Otherwise the jump is not executed. The RLO is not changed.
ID Jump label (up to 4 characters)	↑	

Processing the Jump Operations

A symbolic jump destination (jump label) must always be entered next to a jump operation. This jump label can have up to four characters. The first character must be a letter of the alphabet.

When programming, please be aware of the following items.

- The absolute jump displacement cannot exceed +127 or - 128 words in the program memory. Some statements take up two words (e.g., "Load a constant"). For long jumps, insert an intermediate destination.
- Jumps can be executed only within a block.
- Jumping over segment boundaries ("BLD 255") is not permitted.
- Jump labels can be set only at the start of a series of scans.

Example	STL	Explanation
<p>If no bit of input word IW1 is set, program scanning jumps to the label "AN 1". If input word IW1 and output word QW3 do not agree, program processing jumps back to the label "AN 0". Otherwise input word IW 1 and data word DW12 are compared. If input word IW1 is greater than or less than data word DW12, program scanning jumps to the "Destination" label.</p>	<pre> AN0 :L IW 1 :L KH 0000 :+F :JZ= AN 1 :A I 32.0 AN1 :L IW 1 :L QW 3 :XOW :JN = AN 0 :L IW 1 :L DW12 :>< F :JC = DEST DEST :A I 32.1 . . </pre>	<p>Load input word IW1 into ACCU 1. If the contents of ACCU 1 equal zero¹, jump to the label "AN 1". Otherwise process the next statement (AI 32.0).</p> <p>Compare input word IW1 and output word QW3. If they are not equal, set individual bits in ACCU 1. If the contents of ACCU 1 are not zero, jump to the label "AN 0". Otherwise process the next statements.</p> <p>Compare input word IW1 and data word DW 12. If they are not equal, set RLO to "1". If the RLO = "1", jump to the "Destination" label. If the RLO = "0", process the next statement.</p>

¹ The "L..." statement does not affect the condition codes. An addition (+F) is executed with the constant 0000_H so that the "JZ" operation can evaluate the contents of the accumulator.

8.2.11 Substitution Operations (only for the S5-95U)

If you plan to process a program with various operands and without a lot of changes, it is advisable to assign parameters to individual operands (see section 7.3.4). If you have to change the operands, you only need to reassign the parameters in the function block call.

These parameters are processed in the program as "formal operands".

Special operations are necessary for this processing. However, these special operations are no different in their effect than operations without substitution. A brief description of these operations and examples follow.

Binary Logic Operations

Table 8-21 provides an overview of binary logic operations.

Table 8-21. Overview of Binary Logic Operations

Operation	Operand	Meaning		
A =		AND operation Scan a formal operand for "1".		
AN =		AND operation Scan a formal operand for "0".		
O =		OR operation Scan a formal operand for "1".		
ON =		OR operation Scan a formal operand for "0".		
Formal operand		Actual operands permitted	Parameter type	Data type
		Inputs, outputs, and flags addressed in binary form Timers and counters	I, Q, F T, C	BI

Set/Reset Operations

Table 8-22 provides an overview of the set/reset operations. An example follows the table.

Table 8-22. Overview of Set/Reset Operations

Operation	Operand	Meaning		
S =		Set a formal operand (binary).		
RB =		Reset a formal operand (binary).		
= =		Assign The RLO is assigned to a formal operand.		
Formal operand	↑	Actual operands permitted	Parameter type	Data type
		Inputs, outputs, and flags addressed in binary form	I, Q, F	BI

Example: FB 30 is assigned parameters in OB 1.

Call in OB1	Program in FB30	Executed Program
:JU FB 30	:A =ON 1	:A I 32.0
NAME :COMBINE	:AN =ON 2	:AN I 32.1
ON 1 : I 32.0	:O =ON 3	:O I 32.2
ON 2 : I 32.1	:S =MOT 5	:S Q 33.2
ON 3 : I 32.2	: = =OFF 1	: = Q 33.0
VAL1 : I 32.3	:A =VAL 1	:A I 32.3
OFF1 : Q 33.0	:A =ON 2	:A I 32.1
OFF2 : Q 33.1	:ON =ON 3	:ON I 32.2
MOT5 : Q 33.2	:RB =MOT 5	:R Q 33.2
: BE	: = =OFF 2	: = Q 33.1
	:BE	:BE

Load and Transfer Operations

Table 8-23 provides an overview of the load operations and transfer operations. An example follows the table.

Table 8-23. Overview of Load and Transfer Operations

Operation	Operand	Meaning		
L =		Load a formal operand.		
LD =		Load a formal operand in BCD code.		
LW =		Load the bit pattern of a formal operand.		
T =		Transfer to a formal operand.		
Formal operand		Actual operands permitted	Parameter type	Data type
For L =		Inputs, outputs, and flags addressed in binary form Timers and counters	I, Q, F PW*, PY* DW, DR, DL T, C	BY, W
For LD =		Timers and counters	T, C	
For LW =		Bit pattern	D	KF, KH, KM, KY, KS, KT, KC
For T =		Inputs, outputs, data (DW, DR, DL) and flags addressed in binary form	I, Q DW, DR, DL F, PW*, PY*	BY, W

* Not for integrated function blocks

Example: FB 34 is assigned parameters in PB 1.

Call in PB 1	Program in FB 34	Executed Program
	:A =I0	:A I 32.0
:JU FB 34	:L =L1	:L FW 10
NAME :LOAD/TRAN	:S C 6	:S C 6
I0 : I 32.0	:A =I 1	:A I 32.1
I1 : I 32.1	:LW =LW1	:L KC 140
L1 : FW 10	:S C 7	:S C 7
LW1 : KC 140	:A I 32.2	:A I 32.2
LC1 : C 7	:CU C 6	:CU C 6
T1 : QW 4	:CU C 7	:CU C 7
LW2 : KC 160	:LD =LC1	:LD C 7
:BE	:T =T1	:T QW 4
	:A I 32.3	:A I 32.3
	:R C 6	:R C6
	:R C 7	:R C7
	:LW =LW2	:L KC 160
	:LD =LC1	:LD C7
	:!=F	:!=F
	:R C 7	:R C7
	:BE	:BE

Timer and Counter Operations

Table 8-24 provides an overview of timer operations and counter operations. Examples follow the table.

Table 8-24. Overview of Timer and Counter Operations

Operation	Operand	Meaning		
FR =		Enable a formal operand for cold restart. (For a description, see "FT" or "FC", according to the formal operand).		
RD =		Reset a formal operand (digital).		
SP =		Start a pulse timer specified as a formal operand using the value stored in the accumulator.		
SD =		Start an on-delay timer specified as a formal operand using the value stored in the accumulator.		
SEC =		Start an extended pulse timer specified as a formal operand using the value stored in the accumulator or set a counter specified as a formal operand using the count specified in the accumulator.		
SSU =		Start a stored on-delay timer specified as a formal operand using the value stored in the accumulator or start the count up of a counter specified as a formal operand.		
SFD =		Start an off-delay timer specified as a formal operand using the value stored in the accumulator or start the count down of a counter specified as a formal operand.		
	↑			
Formal operand		Actual operands permitted	Parameter type	Data type
		Timers and counters ¹	T, C ¹	

¹ "SP" and "SD" do not apply to counters

Specifying Times and Counts

As with the basic operations, you can specify a time or count as a formal operand. In this case, you must distinguish as follows whether the value is located in an operand word or is specified as a constant.

- Operand words can be of parameter type "I" or "Q" and of data type "W". Use the "L=" operation to load them into the accumulator.
- Constants can be of parameter type "D" and of data type "KT" or "KC". Use "LW=" to load these formal operands into the accumulator.

The following examples show how to work with timer and counter operations.

Example 1:

Function Block Call	Program in Function Block (FB32)	Executed Program
<pre> :JU FB 32 NAME :TIME I5 : I 32.0 I6 : I 32.1 TIM5 : T 5 TIM6 : T 6 OFF6 : Q 32.5 :BE </pre>	<pre> :AN =I 5 :A =I 6 :L KT 005.2 :SFD =TIM5 :A =I 5 :AN =I 6 :L KT 005.2 :SSU =TIM6 :A =TIM5 :O =TIM6 := =OFFS6 :A I 032.2 :RD =TIM5 :RD =TIM6 :BE </pre>	<pre> :AN I 32.0 :A I 32.1 :L KT 5.2 :SF T 5 :A I 32.0 :AN I 32.1 :L KT 5.2 :SS T 6 :A T 5 :O T 6 := Q 32.5 :A I 32.2 :R T 5 :R T 6 :BE </pre>

Example 2:

Function Block Call	Program in Function Block (FB33)	Executed Program
<pre> STL :JU FB 33 NAME :COUNT I2 : I 32.0 I3 : I 32.1 I4 : I 32.2 CNT5 : C 5 OFF3 : Q 32.5 :BE </pre>	<pre> :A =I2 :L KC 017 :SEC =CNT5 :A =I 3 :SSU =CNT5 :A =I 4 :SFD =CNT5 :A =CNT5 := =OFF3 :A I 32.3 :RD =CNT5 :BE </pre>	<pre> :A I 32.0 :L KC 17 :S C 5 :A I 32.1 :CU C 5 :A I 32.2 :CD C 5 :A C 5 := Q 32.5 :A I 32.3 :R C 5 :BE </pre>

DO Operation

Table 8-25 and the example that follows explain the processing operation.

Table 8-25. Processing Operation

Operation	Operand	Meaning		
DO =	↑	Process formal operand The substituted blocks are called unconditionally.		
Formal operands	Actual operands permitted	Parameter type	Data type	
	DB, PB, SB, FB ¹	B		

¹ As actual operands, function blocks cannot have block parameters.

Note

This command always limits the RLO regardless of the command actually executed.

Example:

Function Block Call	Program in Function Block FB35	Executed Program
STL		
:JU FB 35	:DO =D5	:C DB 5
NAME :DO	:L =DW2	:L DW 2
D5 : DB 5	:DO =D6	:C DB 6
DW2 : DW 2	:T =DW1	:T DW 1
D6 : DB 6	:T =Q4	:T QW 4
DW1 : DW 1	:DO =MOT5	:JU FB 36
Q4 : QW 4	:BE	:BE
MOT5 : FB 36		
:BE		

8.3 System Operations (only for the S5-95U)

System operations and supplementary operations have the following limitations.

- You can program them only in function blocks.
- You can program them only in the STL method of representation.

Since system operations access system data, only users with system knowledge should use them. If you want to program system operations, you must select "SYS: OPS. Y" in the programmer presets menu.

8.3.1 Set Operations (only for the S5-95U)

Like the supplementary bit operations, these set operations can change individual bits. Table 8-26 provides an overview of the set operations.

Table 8-26. Overview of Set Operations

Operation	Operand		Meaning
SU			Set bit unconditionally A specific bit is set to "1" in the system data area.
RU			Reset bit unconditionally A specific bit is set to "0" in the system data area.
ID	↑ RS	↑ Parameter	0.0 to 255.15

Processing Set Operations

Execution of set operations does not depend on the RLO.

8.3.2 Load and Transfer Operations

Use these load operations and transfer operations to address the entire program memory of the programmable controller. They are used mainly for data exchange between the accumulator and memory locations that cannot be addressed by operands. Table 8-27 provides an overview of the load and transfer operations.

Table 8-27. Overview of Load and Transfer Operations

Operation	Operand	Meaning
LIR*		Load the register indirectly The contents of a memory word are loaded into the specified register (ACCU 1, 2). The address is in ACCU 1.
TIR*		Transfer the register indirectly The contents of the indicated register are transferred to a memory location. The address is in ACCU 1.
	↑ Parameter 0 (for ACCU 1), 2 (for ACCU 2)	
TNB		Transfer a data field (byte by byte) A memory area is transferred in the program memory as a field. End address destination area: ACCU 1 End address source area: ACCU 2
T*	↑	Transfer A word is transferred to the system data area.
ID	↑ RS	Parameter 0 to 255

* only for the S5-95U

Loading and Transferring Register Contents

Both accumulators can be addressed as registers. Each register is 16 bits wide. Since the "LIR" and "TIR" operations transmit data by words, the S5-95U registers are addressed in pairs.

Loading and transferring register contents are independent of the RLO. The processor goes to ACCU 1 to get the address of the memory location referenced during data exchange.

Consequently, make sure that the desired address is stored in ACCU 1 before this system operation is processed.

STL	Explanation
L KH 6100	Load the address 6100 _H into ACCU 1.
LIR 0	Load the information from the memory location with the address 6100 _H into ACCU 1.

Processing a Field Transfer

A field transfer is processed independently of the RLO. The parameter indicates the length of the data field (in bytes) that is to be transferred. The field can be up to 255 bytes long.

The address of the source field is in ACCU 2. The address of the destination field is in ACCU 1. The highest address of each field must be specified. The bytes in the destination field are overwritten during the transfer.

Example	Representation
Transfer a 12-byte data field from address 61FF to address 613F.	<p>The diagram illustrates the memory layout for a field transfer. On the left, a vertical stack of memory addresses is shown: 6134, 613F, a vertical ellipsis, 61F4, and 61FF. To the right of these addresses, corresponding field addresses are listed: FY 52, Destination, FY 63, a vertical ellipsis, FY 244, Source, and FY 255. Two curved arrows indicate the transfer of data from the source field (between FY 244 and FY 255) to the destination field (between FY 52 and Destination). To the right of the diagram, the parameter TNB is shown.</p>
STL	Explanation
<pre>:L KH 61FF</pre>	Load the end address of the source field into ACCU 1
<pre>:L KH 613F</pre>	Load the end address of the destination field into ACCU 1. The source address is shifted to ACCU 2.
<pre>:TNB 12</pre>	Transfer the data field to the destination field.

Note

Please note that the contents of ACCU 1 and ACCU 2 are undefined after execution of the TNB statement.

The TNB operation can be interrupted by OB3 and OB13. Make sure the data is consistent.

Enter the "IA", "TNB" and "RA" operations in succession to ensure data consistency.

Transferring to the System Data Area

Example: Set the scan monitoring time for the OB13 calls to 1 s after each mode change from "STOP" to "RUN". The following function block can be called from OB21, for example.

STL	Explanation
FB 11	Block number and type
L KF +100	Load ACCU 1 with the factor 100.
T RS 97	Transfer this value to system data word 97.
BE	



Caution

The TIR, TRS and TNB operations are memory changing operations with which you can access the user memory and the system data area. These accesses are not monitored by the operating system. Improper use of the operations can lead to changes in the program and to a programmable controller crash.

8.3.3 Arithmetic Operation (only for the S5-95U)

An arithmetic operation changes the contents of ACCU 1 by a specified value. The parameter represents this value as a positive or negative number. Table 8-28 shows the essential features of the "ADD" operation. An example follows the table.

Table 8-28. Overview of the "ADD" Operation

Operation	Operand	Meaning
ADD		Add a constant Add byte or word constants.
ID	↑ BF KF	Parameter -128 to +127 -32768 to +32767

Processing

An arithmetic operation is executed independently of the RLO. It does not affect the RLO or the condition codes.

You can subtract by entering a negative parameter.

Even if the result cannot be represented by 16 bits, no carry is made to ACCU 2, i.e., the contents of ACCU 2 are not changed.

Example	STL	Explanation
Decrement the constant 1020 _H by 33 and store the result in flag word FW 28. Afterwards add the constant 256 to the result and store the sum in flag word FW30.	L KH 1020	The constant 1020 _H is loaded into ACCU 1.
	ADD BF -33	The constant -33 ₁₀ is added to the ACCU contents.
	T FW 28	The new ACCU contents (0FFF _H) are stored in flag word FW28.
	ADD KF 256	The constant 256 ₁₀ is added to the last result.
	T FW 30	The new ACCU contents (10FF _H) are stored in flag word FW30.

8.3.4 Other Operations (only for the S5-95U)

Table 8-29 provides an overview of the remaining system operations.

Table 8-29. The "TAK" and "STS" Operations

Operation	Operand	Meaning
TAK		Swap accumulator contents Swap the contents of ACCU 1 and ACCU 2 regardless of the RLO. The RLO and the condition codes are not affected.
STS		Stop immediately The PLC goes into the "STOP" mode regardless of the RLO.

Processing the "STS" Operation

When the "STS" operation is executed, the programmable controller goes into the "STOP" mode immediately. Program scanning is terminated at this point. The "STOP" state can only be cancelled manually (with the mode selector) or with the programmer function "PC START".

8.4 Condition Code Generation

The processor of the programmable controller has the following three condition codes.

- CC 0
- CC 1
- OV (overflow)

The following operations affect the condition codes.

- Comparison operations
- Arithmetic operations
- Shift operations
- Some conversion operations

The state of the condition codes represents a condition for the various jump operations.

Condition Code Generation for Comparison Operations

Execution of comparison operations sets condition codes CC 0 and CC 1 (see Table 8-30). The overflow condition code is not affected. However, comparison operations affect the RLO. When a comparison is satisfied, the RLO is 1. Consequently, the conditional jump operation "JC" can also be used after a comparison operation.

Table 8-30. Condition Code Settings for Comparison Operations

Contents of ACCU 2 as Compared to Contents of ACCU 1	Condition Codes			Possible Jump operations
	CC 1	CC 0	OV	
Equal to	0	0		JZ
Less than	0	1		JN, JM
Greater than	1	0		JN, JP

Condition Code Generation for Arithmetic Operations

Execution of arithmetic operations sets all condition codes according to the result of the arithmetic operation (see Table 8-31).

Table 8-31. Condition Code Settings for Fixed-Point Arithmetic Operations

Result after Arithmetic Operation is Executed	Condition Codes			Possible Jump Operations
	CC 1	CC 0	OV	
< - 32768	1	0	1	JN, JP, JO
- 32768 to - 1	0	1	0	JN, JM
0	0	0	0	JZ
+1 to +32767	1	0	0	JN, JP
> +32767	0	1	1	JN, JM, JO
(-) 65536 *	0	0	1	JZ, JO

* This number is the result of the calculation -32768 - 32768

Condition Code Generation for Digital Logic Operations

Digital logic operations set CC 0 and CC 1. They do not affect the overflow condition code (see Table 8-32). The setting depends on the contents of the ACCU after the operation has been processed.

Table 8-32. Condition Code Settings for Digital Logic Operations

Contents of the ACCU	Condition Codes			Possible Jump Operations
	CC 1	CC 0	OV	
Zero (KH = 0000)	0	0		JZ
Not zero	1	0		JN, JP

Condition Code Generation for Shift Operations

Execution of shift operations sets CC 0 and CC 1. It does not affect the overflow condition code (see Table 8-33).

Code setting depends on the state of the last bit shifted out.

Table 8-33. Condition Code Settings for Shift Operations

Value of the Last Bit Shifted Out	Condition Codes			Possible Jump Operations
	CC 1	CC 0	OV	
"0"	0	0		JZ
"1"	1	0		JN, JP

Condition Code Generation for Conversion Operations

The formation of the two's complement (CSW) sets all condition codes (see Table 8-34). The state of the condition codes is based on the result of the conversion function.

Table 8-34. Condition Code Settings for Conversion Operations

Result after Arithmetic Operation is Executed	Condition Codes			Possible Jump Operations
	CC 1	CC 0	OV	
- 32768 *	0	1	1	JN, JM, JO
- 32767 to - 1	0	1	0	JN, JM
0	0	0	0	JZ
+1 to +32767	1	0	0	JN, JP

* This number is the result of the conversion of KH = 8000.

8.5 Sample Programs

Sections 8.5.1 through 8.5.3 provide a few sample programs that you can enter and test in all three methods of representation on a programmer.

8.5.1 Momentary-Contact Relay (Edge Evaluation)

Example		Circuit Diagram	
<p>On each leading edge of the signal at input I 32.0, the AND condition "A I32.0 and AN F 64.0" is satisfied; the RLO is "1". This sets flags 64.0 and 2.0 ("edge flags").</p> <p>In the next processing cycle, the AND condition "A I32.0 and AN F 64.0" is not satisfied since flag 64.0 has already been set.</p> <p>Flag 2.0 is reset.</p> <p>Therefore, flag 2.0 is "1" for only one program run.</p> <p>When input 32.0 is switched off, flag 64.0 is reset.</p> <p>This resetting prepares the way for evaluation of the next leading edge of the signal at input 32.0.</p>			
STL	CSF	LAD	
<pre> A I 32.0 AN F 64.0 = F 2.0 S F 64.0 AN I 32.0 R F 64.0 NOP 0 </pre>			

8.5.2 Binary Scaler (Binary Divider)

This section describes how to program a binary scaler.

Example: The binary scaler (output Q32.5) changes its state each time I32.0 changes its signal state from "0" to "1" (leading edge). Therefore, half the input frequency appears at the output of the flip-flop.

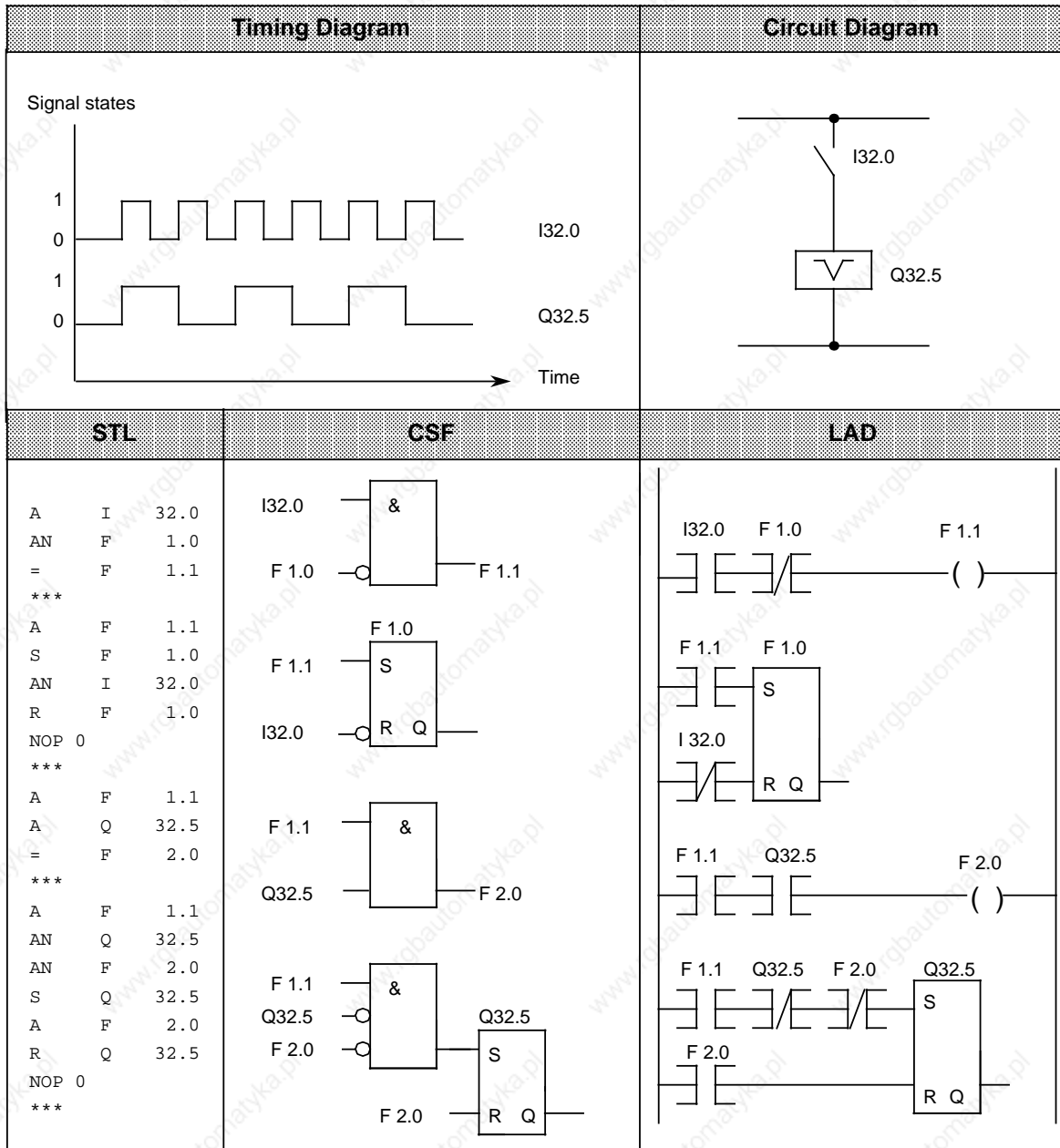

Note

Output in CSF or LAD is possible only if you enter the segment boundaries "****" when programming in STL.

8.5.3 Clock (Clock-Pulse Generator)

This subsection describes how to program a clock-pulse generator.

Example: A clock-pulse generator can be implemented using a self-clocking timer that is followed in the circuit by a binary scaler. Flag F 2.0 restarts timer T 7 each time it runs down, i.e., flag F 2.0 is "1" for one cycle each time the timer runs down. The pulses of flag F 2.0 applied to the binary scaler result in a pulse train with pulse duty factor 1:1 at output Q32.5. The period of this pulse train is twice as long as the time value of the self-clocking timer.

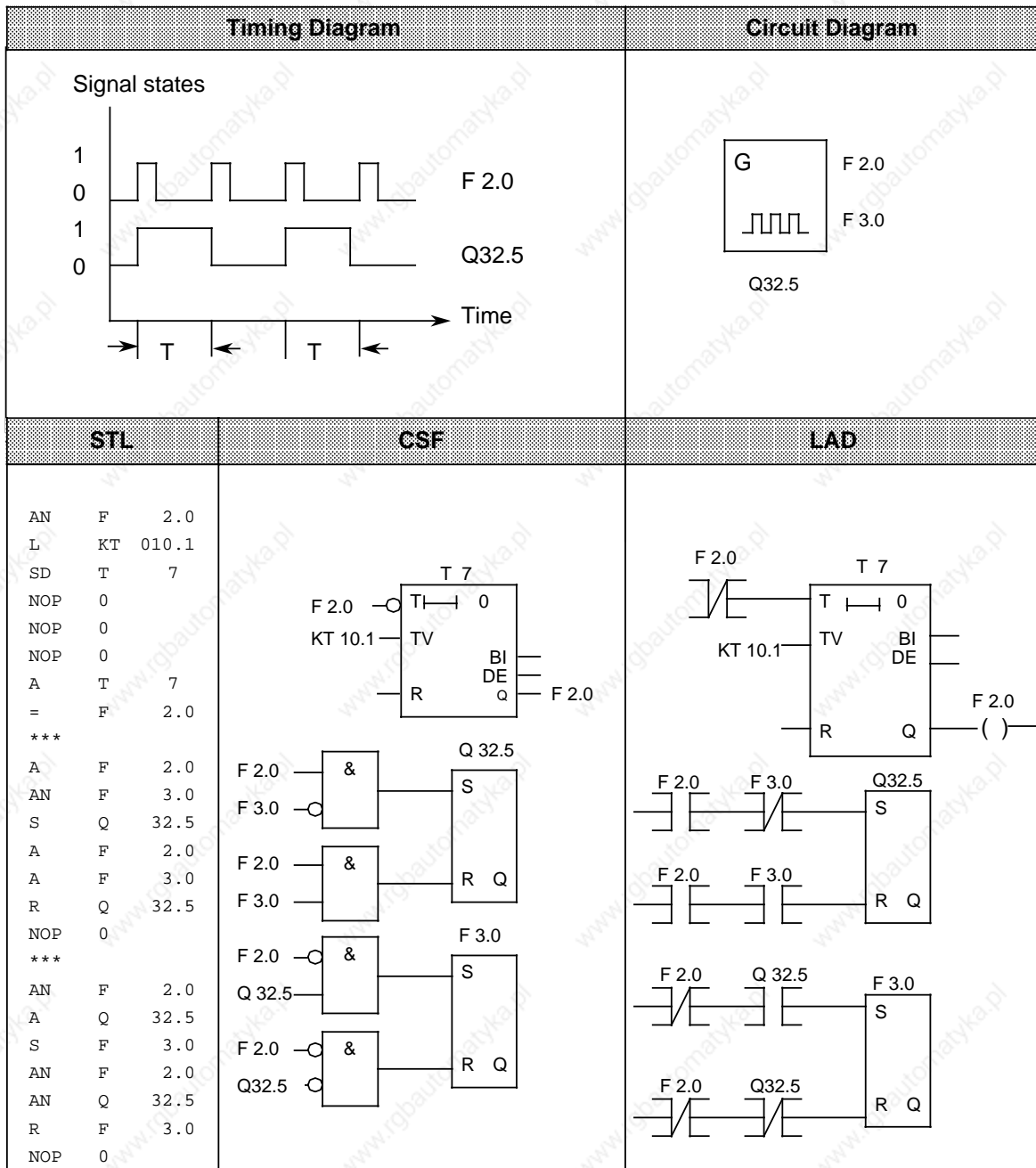

www.rgbautomatyka.pl

9 Integrated Blocks and Their Functions		
9.1	Integrated Organization Blocks (OBs)	9 - 1
9.1.1	Cyclic Program Execution (OB1)	9 - 2
9.1.2	Interrupt-Driven Program Execution (OB3)	9 - 3
9.1.3	Time-Controlled Program Execution (OB13; for S5-95U only)	9 - 3
9.1.4	Restart Processing (OB21, OB22)	9 - 5
9.1.5	Retriggering the Scan Time (OB31; for S5-95U only)	9 - 6
9.1.6	Procedure after Battery Failure (OB34; for S5-95U only)	9 - 7
9.1.7	OB251 PID Algorithm (for S5-95U only)	9 - 8
9.2	Integrated Function Blocks (FBs)	9 - 20
9.2.1	Code Converter : B4 - FB240 -	9 - 20
9.2.2	Code Converter : 16 - FB 241-	9 - 21
9.2.3	Multiplier : 16 - FB242 -	9 - 22
9.2.4	Divider : 16 - FB243 -	9 - 23
9.2.5	Reading of Analog Values (FB250)	9 - 24
9.2.6	Output of Analog Values (FB251)	9 - 24
9.3	Integrated Sequence Block 2 (SB2)	9 - 24
9.4	Integrated Data Block 1 (DB1)	9 - 25
9.4.1	Parameter Blocks	9 - 26
9.4.2	Rules to Observe When Generating DB1	9 - 27
9.4.3	Transferring DB1 Parameters to the Programmable Controller	9 - 30
9.4.4	Procedure for Parameterizing the PLC	9 - 30
9.4.5	How to Recognize and Correct Parameter Errors	9 - 31

Figures		
9-1	Time-Controlled Program Execution - Possible Interrupts	9 - 4
9-2	Restart Procedure	9 - 5
9-3	Calling Up the OB251 PID Algorithm	9 - 8
9-4	Block Diagram of the PID Controller	9 - 9
9-5	Principle of Interval Sampling	9 - 14
9-6	Process Schematic	9 - 15
9-7	Default DB1	9 - 25
9-8	Structure of DB1	9 - 27
9-9	Parameter Error Codes and Their Meaning	9 - 33
9-10	Erroneous Parameter Assignment in DB1	9 - 34
Tables		
9-1	Overview of Integrated Organization Blocks	9 - 1
9-2	Legend for the Block Diagram of the PID Controller (Figure 9.4)	9 - 9
9-3	Description of the Control Bits in Control Word "STEU"	9 - 10
9-4	Format of the Controller DB	9 - 12
9-5	Overview of Integrated Function Blocks	9 - 20
9-6	Call and Parameter Assignments of FB240	9 - 20
9-7	Call of FB240	9 - 21
9-8	Parameter Assignments of FB241	9 - 21
9-9	Call of FB241	9 - 21
9-10	Parameter Assignments of FB242	9 - 22
9-11	Call of FB242	9 - 22
9-12	Parameter Assignments of FB243	9 - 23
9-13	Call of FB243	9 - 23
9-14	Parameter Blocks in DB1	9 - 26
9-15	Inputting the Address for the Parameter Error Code	9 - 32

9 Integrated Blocks and Their Functions

The following Sections describe all blocks integrated in the operating system of the PLC.

Users can make use of the functions implemented in these blocks depending on their specific requirements.

The description of the blocks is structured according to block types and block numbers in ascending order.

9.1 Integrated Organization Blocks (OBs)

Organization blocks constitute the interface between the operating system and the control program and coordinate the execution of the control program. In principle, organization blocks can be divided into two groups:

- OBs that must be programmed by the user. They are called automatically by the operating system.
- OBs that are already programmed. They have to be called by your control program.

The following Table lists the organization blocks integrated in the PLC.

Table 9-1. Overview of Integrated Organization Blocks

OB No.	Function	Integrated in S5-90U	Integrated in S5-95U	Described in Section
OB must be programmed by the user; called up by operating system				
OB1	Cyclic program execution	Yes	Yes	9.1.1
OB3	Interrupt-driven program execution	Yes	Yes	9.1.2
OB13	Time-controlled program execution	No	Yes	9.1.3
OB21	Restart procedure after manual POWER ON (STOP RUN)	Yes	Yes	9.1.4
OB22	Restart procedure after power recovery	Yes	Yes	9.1.4
OB34	Procedure after battery failure	No	Yes	9.1.6
OB is already programmed; OB must be called up by user program				
OB31	Scan time trigger	No	Yes	9.1.5
OB251	PID algorithm	No	Yes	9.1.7

Valid at the start of OB1, OB3, OB13, OB21 or OB22: Result of logic operation (RLO)=1.

9.1.1 Cyclic Program Execution (OB1)

Function of OB1

OB1 can be used for both linear and structured program execution.

For structured programming, only block calls should be written into OB1. The blocks called (PBs, FBs and SBs) should form self-contained functional units to obtain a clear overall program structure.

A time monitor (scan time trigger) is activated each time cyclic program execution starts. If the scan time trigger is not activated again within the monitoring time, the PLC enters the "STOP" mode.

The monitoring time is preset to 300 ms.

If the scan time for your control program is greater than 300 ms, OB31 can be used in the S5-95U (see Section 9.1.5) to retrigger the scan time monitor in the control program.

If the maximum scan time is exceeded for a program with a scan time < 300 ms, the program may have entered a continuous loop or a fault may have occurred in the PLC.

Calling OB1

OB1 is called cyclically by the operating system.

Prerequisites for OB1 Execution

Cyclic program execution using OB1 is possible only if the following requirements are met:

- OB1 is programmed.
- The PLC is in the "POWER ON" state and switched to "RUN".

Interrupting OB1 Execution

The cyclic processing of OB1 can be interrupted after any STEP 5 operation:

- During interrupt-driven program execution (branching to OB3; if OB3 is not programmed, cyclic program execution will be resumed)
- During time-controlled program execution (branching to OB13; if OB13 is not programmed, cyclic program execution is resumed).

After processing the interrupt, cyclic program execution is continued starting at the point of interruption.

OB1 cannot interrupt other program sections on its own.

9.1.2 Interrupt-Driven Program Execution (OB3)

Function of OB3

OB3 includes the control program section for the response to a process interrupt or a completed count procedure.

Calling OB3

OB3 can be called due to a certain process interrupt or when a comparison value of the onboard counter is reached.

Prerequisites for OB3 Execution

Interrupt-driven program execution using OB3 is possible only if the following requirements are met:

- The interrupt input(s) is/are enabled (parameterized) in DB1.
- The counter input(s) is/are enabled (parameterized) in DB1.
- OB3 is programmed.
- Interrupt processing is not disabled by STEP 5 operation IA (see Section 8.2.8).
- The PLC is in the "POWER ON" state and switched to "RUN".

Interrupting OB3 Execution

The interrupt-driven execution of OB3 cannot be interrupted. However, OB3 is able to interrupt a cyclic or time-controlled program.

Note

Even for interrupt-driven program execution, the maximum of 16 nesting levels must not be exceeded.

9.1.3 Time-Controlled Program Execution (OB13; for S5-95U only)

Function of OB13

OB13 includes a control program section that must be processed periodically. The call interval can be parameterized in DB1. Times from 10 ms to 655350 ms (in steps of 10 ms) can be set. The default for the call interval is 100 ms.

Calling OB13

OB13 is called automatically by the operating system after a certain time has elapsed.

Prerequisites for OB13 Execution

Time-controlled program execution using OB13 is possible only if the following requirements are met:

- OB13 is programmed.
- The OB13 call interval set in DB1 10.
- Interrupt processing is not disabled by the STEP 5 operation "IA" (see Section 8.2.8).
- The PLC is in the "POWER ON" state and switched to "RUN".

Interrupting OB13 Execution

Time-controlled program execution of OB13 can be suspended by the interrupt-driven program execution programmed in OB3 after processing the current STEP 5 operation.

After completing interrupt-driven program execution, time-controlled processing is resumed at the point of interruption.

OB13 is first processed to the end before it can be initiated again.

OB13 can interrupt cyclic program execution in OB1 after any STEP 5 operation.

Note

Even for time-controlled program execution, the maximum of 16 nesting levels must not be exceeded in general.

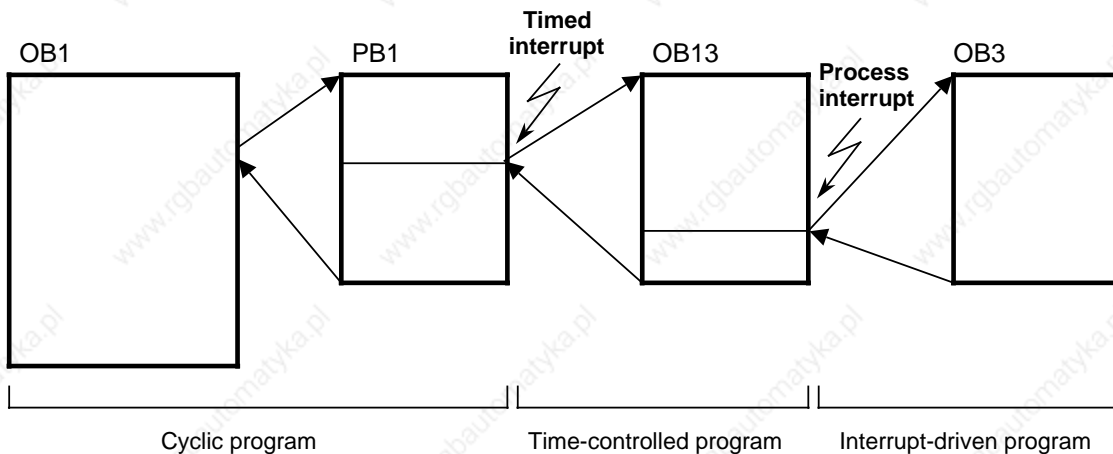

Figure 9-1. Time-Controlled Program Execution - Possible Interrupts

9.1.4 Restart Processing (OB21, OB22)

Functions of the OBs

OB21 and OB22 are available for restart processing.

The restart OBs can be used for the (single) execution of program sections to be processed prior to the first-time cyclic program execution with OB1. They are therefore suitable, for instance, for presetting flags and data.

If the corresponding restart OB is not programmed, the PLC immediately enters the "RUN" mode.

The restart OBs have the following characteristics:

- Both the green and the red operating mode LED are lit during restart processing.
- The timers are processed.
- Scan time monitoring is not activated.
- Interrupts are not processed.
- The counter inputs are disabled.
- The onboard I/Os can be accessed directly via load and transfer operations.

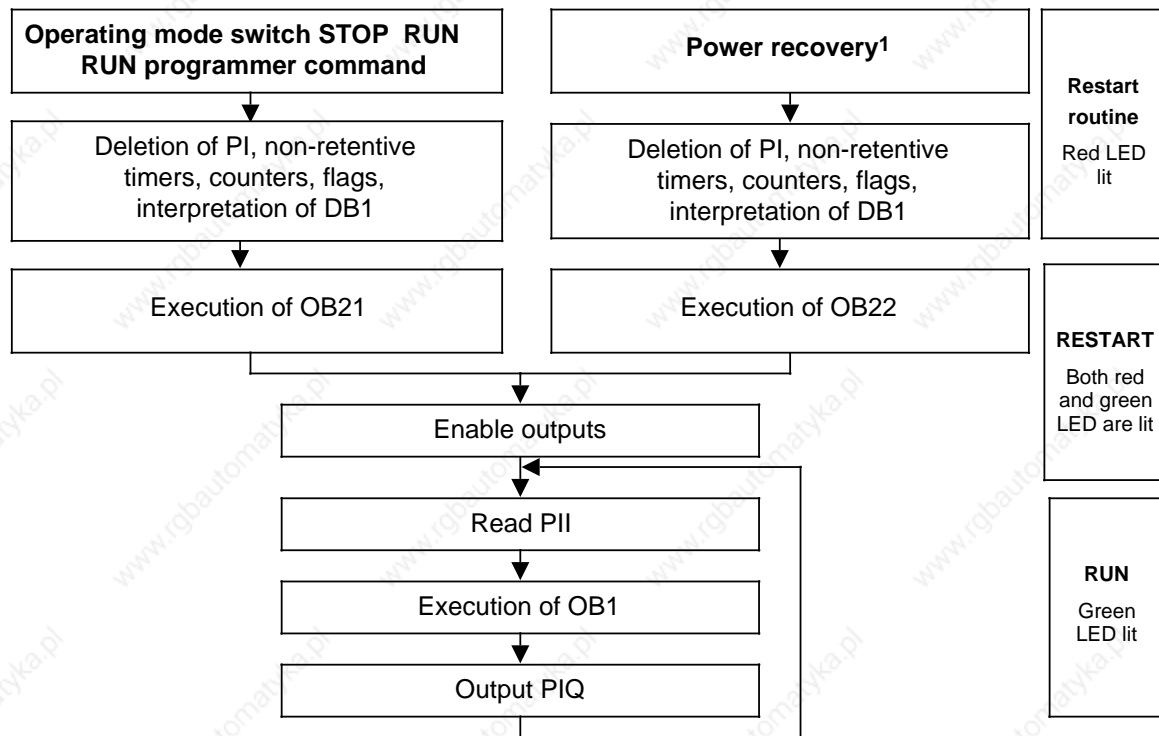

1 If PLC was switched to RUN at POWER OFF; if operating mode switch was set to RUN at power recovery and battery backup was provided. Without battery backup, a memory submodule containing valid blocks must have been inserted.

Figure 9-2. Restart Procedure

Calling the OBs

The operating system automatically calls OB21 at every manual cold restart, i.e. when the operating mode switch is set from STOP to RUN.

OB22 is automatically called up by the operating system in the case of an automatic cold restart after power recovery.

Prerequisites for OB21/OB22 Execution

Restart processing using the OB21 is possible only if the following requirements are met:

- OB21 is programmed.
- The PLC is in the "POWER ON" state.

Restart processing using the OB22 is possible only if the following requirements are met:

- OB22 is programmed.
- The PLC is in the "POWER ON" state.
- The PLC was in the "RUN" mode prior to "POWER OFF".
- The operating mode switch is set to RUN after power recovery and battery backup is provided.

Interrupting Execution of the OBs

The restart OBs cannot be interrupted and cannot interrupt any other program sections on their part.

9.1.5 Retriggering the Scan Time (OB31; for S5-95U only)

Function of OB31

By calling OB31, the scan time monitor can be retriggered (re-initiated) at any point of control program execution.

This may become necessary when the actual scan time exceeds the monitoring time of approx. 300 ms, e.g. due to a loop in program execution.

The OB31 used in the S5-95U is already programmed. It cannot be programmed by the user.

The runtime for the OB31 in the S5-95U is approx. 45 μ s.

Calling OB31

The call of OB31 must be explicitly programmed in your control program.

Prerequisites for OB31 Execution

Retriggering of the scan time using OB31 is possible only if the following requirements are met:

- OB31 is called in your control program.
- The PLC is in the "POWER ON" state and switched to "RUN".

Interrupting OB31 Execution

OB31 cannot be interrupted.

9.1.6 Procedure after Battery Failure (OB34; for S5-95U only)

Function of OB34

The response to a failure of the backup battery, for example an indication on the operator panel (OP) can be programmed in OB34.

Calling OB34

The operating system automatically calls up OB34 prior to each program cycle if it recognizes a battery failure (BAU) at the cycle checkpoint.

Call sequence

For "STOP-RUN" transition: OB21/OB34/OB1

For "POWER OFF/ON": OB22/OB1/OB34

Prerequisites for OB34 Execution

The procedure described above is possible only if the following requirements are met:

- OB34 is programmed.
- The PLC is in the "POWER ON" state and switched to "RUN".

Interrupting OB34 Execution

The OB34 procedure after a battery failure can be suspended by interrupt-driven program execution involving OB3.

9.1.7 OB251 PID Algorithm (for S5-95U only)

A PID algorithm is integrated in the operating system of the S5-95U. OB251 helps you use this algorithm to meet your needs.

Before calling up OB251, you must first open a data block called the controller DB. It contains the controller parameters and other controller specific data. The PID algorithm must be invoked periodically and generates the manipulated variable. The more closely the scan time is maintained, the more accurately the controller fulfills its task. The control parameters specified in the controller DB must be adapted to the scan time.

You should always call OB251 from the time OB (OB13). You can set time OBs at a call up interval ranging between 10 ms and 655350 ms. The PID algorithm requires no more than 1.7 ms to process.

OB251 can be interrupted by OB3 or OB13.

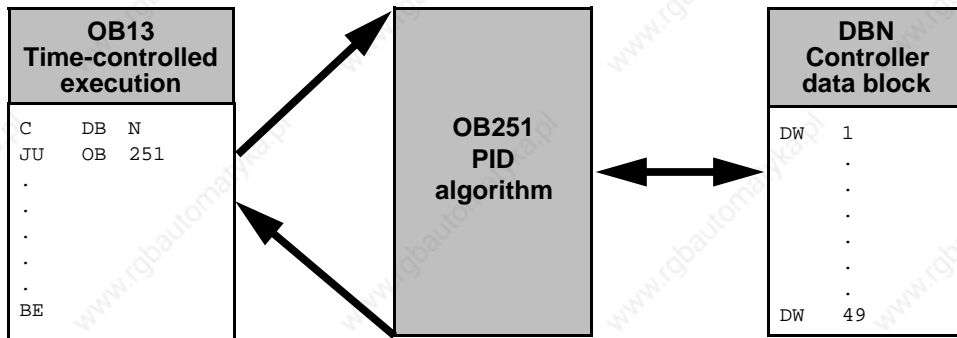

Figure 9-3. Calling Up the OB251 PID Algorithm

The continuous-action controller is designed for controlled systems such as those present in process engineering for controlling pressure, temperature, or flow rate.

The "R" variable sets the proportional component of the PID controller. If proportional action is required, most controller designs use the value $R = 1$.

The individual Proportional action, Integral action, and Derivative action components can be deactivated via their parameters (R, TI, and TD) by presetting the pertinent data words to zero. This enables you to implement all required controller structures without difficulty, e.g., PI, PD, or PID controllers.

You can forward the system deviation XW or, using the XZ input, any disturbance variable or the inverted actual value X to the derivative action element. Specify a negative K value for a reverse acting controller.

When the correction information (dY or Y) is at a limit, the integral action component is automatically deactivated in order not to impair the dynamic response of the controller.

The switch settings in the block diagram are implemented by setting the respective bits in control word "STEU".

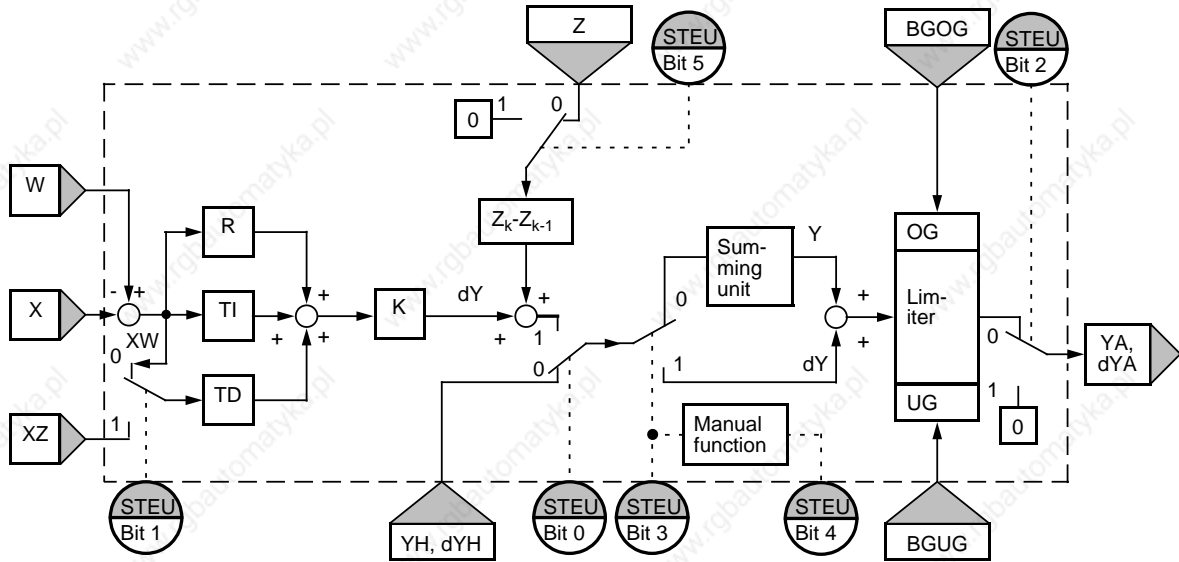

Figure 9-4. Block Diagram of the PID Controller

Table 9-2. Legend for the Block Diagram of the PID Controller (Figure 9.4)

Designation	Explanation
K	Proportional coefficient: K>0 direct acting K<0 reverse acting
R	R parameter (usually 1000)
TA	Scan time
TN	Integral-action time
TV	Derivative-action time
TI	Constant TI TI=Scan time TA/Integral-action time TN
TD	Constant TD TD=Derivative-action time TV/Scan time TA
W	Setpoint
STEU	Control word
YH, dYH	Output value: YH Control Word Bit 3=0 dYH Control Word Bit 3=1
Z	Disturbance variable
XW	System error
X	Actual value
XZ	Substitute value for system error
Y, dY	Manipulated variable, manipulated increments
OG/UG	Upper limit/lower limit
BGOG	Upper limit of the manipulated variable
BGUG	Lower limit of the manipulated variable
YA, dYA	Output value: YA Control Word Bit 3=1 dYA Control Word Bit 3=0

Table 9-3. Description of the Control Bits in Control Word "STEU"

Control Bit	Name	Signal State	Description
0	AUTO	0	Manual mode The following variables are updated in Manual mode: 1) X_k , XW_{k-1} and PW_{k-1} 2) XZ_k , XZ_{k-1} and PZ_{k-1} , when STEU bit 1=1 3) Z_k and Z_{k-1} , when STEU bit 5=0 Variable dD_{k-1} is set to 0: The algorithm is not computed.
		1	Automatic mode
1	XZ EIN	0	XW_k is forwarded to the differentiator. The XZ input is ignored.
		1	A variable other than XW_k is forwarded to the differentiator via the XZ input.
2	REG AUS	0	Normal controller processing
		1	When the controller is invoked (OB251), all variables (DW 18 to DW 48) with the exception of K, R, TI, TD, BGOG, BGUG, YH_k and W_k are reset in the controller DB. The controller is deactivated.
3	GESCHW	0	Positioning algorithm
		1	Correction rate algorithm
4	HANDART	0	When GESCHW=0: Following the transfer to Manual mode, the specified manipulated variable value YA is adjusted exponentially to the manual value in four sampling steps. Additional manual values are then forwarded immediately to the controller output. When GESCHW=1: The manual values are forwarded immediately to the controller output. The limiting values are in force in Manual mode.
		1	When GESCHW=0: The manipulated variable last output is retained. When GESCHW=1: Correction increment dY_k is set to zero.
5	NO Z	0	With feedforward control
		1	No feedforward control
6 and 7	-		These bits are not assigned.
8 to 15	-		The PID algorithm uses these bits as auxiliary flags.

The control program can be supplied with fixed values or parameters. Parameters are input via the assigned data words. The controller is based on a PID algorithm. Its output signal can be either a manipulated variable (positioning algorithm) or a manipulated variable modification (correction rate algorithm).

Correction Rate Algorithm

The relevant correction increment dY_k is computed at instant $t = k \cdot TA$ according to the following formula:

- Without feedforward control (D11.5=1); XW is forwarded to the differentiator (D11.1=0)

$$\begin{aligned} dY_k &= K[(XW_k - XW_{k-1}) R + TI \cdot XW_k + (TD (XW_k - 2XW_{k-1} + XW_{k-2}) + dD_{k-1})] \\ &= K (dPW_k R + dl_k + dD_k) \end{aligned}$$

- With feedforward control (D11.5=0); XW is forwarded to the differentiator (D11.1=0)

$$\begin{aligned} dY_k &= K[(XW_k - XW_{k-1}) R + TI \cdot XW_k + (TD (XW_k - 2XW_{k-1} + XW_{k-2}) + dD_{k-1})] + (Z_k - Z_{k-1}) \\ &= K (dPW_k R + dl_k + dD_k) + dZ_k \end{aligned}$$

- Without feedforward control (D11.5=1); XZ is forwarded to the differentiator (D11.1=1)

$$\begin{aligned} dY_k &= K[(XW_k - XW_{k-1}) R + TI \cdot XW_k + (TD (XZ_k - 2XZ_{k-1} + XZ_{k-2}) + dD_{k-1})] \\ &= K (dPW_k R + dl_k + dD_k) \end{aligned}$$

- With feedforward control (D11.5=0); XZ is forwarded to the differentiator (D11.1=1)

$$\begin{aligned} dY_k &= K[(XW_k - XW_{k-1}) R + TI \cdot XW_k + (TD (XZ_k - 2XZ_{k-1} + XZ_{k-2}) + dD_{k-1})] + (Z_k - Z_{k-1}) \\ &= K (dPW_k R + dl_k + dD_k) + dZ_k \end{aligned}$$

P component I component D component Z component k: kth sample

When XW_k is applied:

$$\begin{aligned} XW_k &= W_k - X_k \\ PW_k &= XW_k - XW_{k-1} \\ QW_k &= PW_k - PW_{k-1} \\ &= XW_k - 2XW_{k-1} + XW_{k-2} \end{aligned}$$

When XZ is applied:

$$\begin{aligned} PZ_k &= XZ_k - XZ_{k-1} \\ QZ_k &= PZ_k - PZ_{k-1} \\ &= XZ_k - 2XZ_{k-1} + XZ_{k-2} \end{aligned}$$

The result is:

$$\begin{aligned} dPW_k &= (XW_k - XW_{k-1})R \\ dl_k &= TI \cdot XW_k \\ dD_k &= (TD \cdot QW_k + dD_{k-1}) \text{ when } XW \text{ is applied} \\ &= (TD \cdot QZ_k + dD_{k-1}) \text{ when } XZ \text{ is applied} \\ dZ_k &= Z_k - Z_{k-1} \end{aligned}$$

Positioning Algorithm

The formula used to compute the correction rate algorithm is also used to compute the positioning algorithm.

In contrast to the correction rate algorithm, however, the sum of all correction increments computed (in DW 48), rather than the correction increment dY_k is output at sampling instant t_k .

At instant t_k , manipulated variable Y_k is computed as follows:

$$Y_k = \sum_{m=0}^{m=k} dY_m$$

Initializing the PID Algorithm

OB251's interface to its environment is the controller DB. All data needed to compute the next manipulated variable value is stored in this DB. Each controller must have its own controller data block.

The controller-specific data are initialized in a data block that must comprise at least 49 data words. The CPU goes to STOP with a transfer error (TRAF) if no DB has been opened or if the DB is too short.



Caution

Make sure that the right controller DB has been opened before calling control algorithm OB251.

Table 9-4. Format of the Controller DB

Data Word	Name	Comments
1	K	Proportional gain (-32 768 to + 32 767) for controllers without a differential comp. Proportional gain (- 1500 to +1500) for controllers with a diff. comp. ¹ K is greater than zero when the control is direct acting, and less than zero when the control is reverse acting; the specified value is multiplied by a factor of 0.001.
3	R	R parameter (- 32 768 to+32 767) for controllers w/o a diff. component R parameter (- 1500 to+1500) for controllers with a diff. component ¹ Normally 1 for controllers with P component; the specified value is multiplied by the approximate factor of 0.001
5	TI	Constant TI (0 to 9999) $TI = \frac{\text{Sampling interval } TA}{\text{Integral-action time } TN}$ The specified value is multiplied by the approximate factor of 0.001.
7	TD	Constant TD (0 to 999) $TD = \frac{\text{Derivative-action time } TV}{\text{Sampling interval } TA}$
9	W	Setpoint (- 2047 to+2047)

¹ It is possible to have larger gains, if sudden incremental changes to the system deviation are small enough. This is the reason you have to divide larger deviations into smaller ones such as adding the setpoint via a ramp function.

Table 9-4. Format of the Controller DB (Continued)

Data Word	Name	Comments
11	STEU	Control word (bit pattern)
12	YH	Value for manual operation (- 2047 to +2047)
14	BGOG	Upper limit value (- 2047 to +2047)
16	BGUG	Lower limit value (- 2047 to +2047)
22	X	Actual value (- 2047 to +2047)
24	Z	Disturbance variable (- 2047 to +2047)
29	XZ	Derivative time (- 2047 to +2047)
48	YA	Output variable (- 2047 to +2047)

All parameters (with the exception of the control word STEU) must be specified as 16-bit fixed point numbers.



Caution

The PID algorithm uses the data words that are not listed in Table 9-4 as auxiliary flags.

Initialization and Call Up of the PID Controller in a STEP 5 Program

Several different PID controllers can be implemented by calling up OB251 repeatedly. A data block must be initialized prior to each OB251 call up.

Note

Important controller data are stored in the high-order byte of control word DW11 (DL11). Therefore make sure that only T DR 11/SU D11.0 to D11.7 or RU D 11.0 to D11.7 operations are used to modify user-specific bits in the control word.

Selecting the Sampling Interval

In order to be able to use the known analog method of consideration for digital control loops too, do not select a sampling interval that is too large.

Experience has shown that a T_A sampling interval of approximately 1/10 of the time constant $T_{RK, dom}$ produces a control result comparable to the equivalent analog result. Dominant system time constant $T_{RK, dom}$ determines the step response of the closed control loop.

$$T_A = 1/10 \cdot T_{RK, dom}$$

In order to ensure the constancy of the sampling interval, OB251 must always be called up in the service routine for time interrupts (OB13).

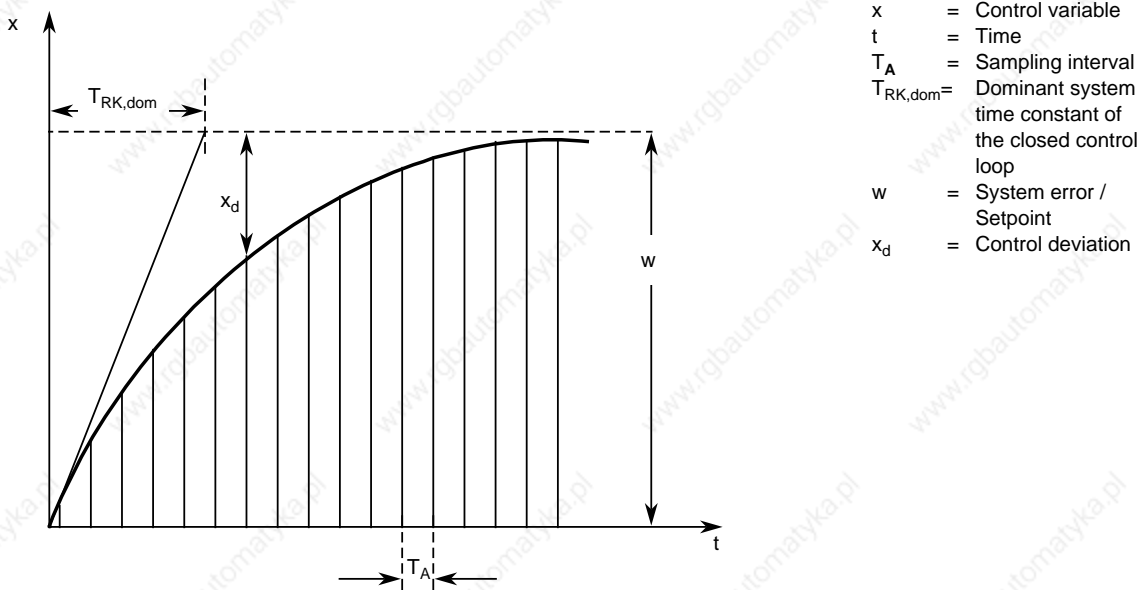

Figure 9-5. Principle of Interval Sampling

Example for the Use of the PID Controller Algorithm:

A PID controller is supposed to keep an annealing furnace at a constant temperature. The temperature setpoint is entered via a potentiometer.

The setpoints and actual values are acquired via analog channels 0 (IW 40) and 1 (IW 42) and forwarded to the controller. The computed manipulated variable is then output via the analog output channel (QW10).

The controller mode is set in input byte 32 (see control word DW 11 in the controller DB). You must use the well-known controller design procedure to determine how to tune the controller for each controlled system.

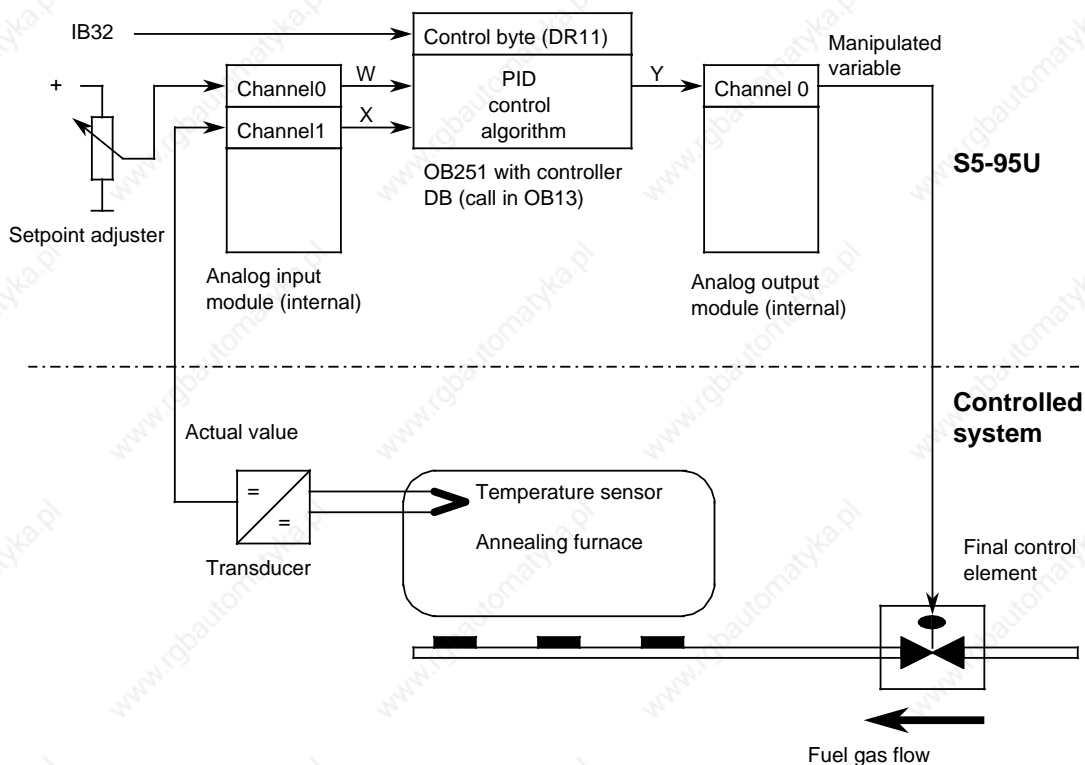

Figure 9-6. Process Schematic

The analog signals of the setpoint and actual values are converted into corresponding digital values in each sampling interval (set in OB13). OB251 uses these values to compute the new digital manipulated variable, from which, in turn, the analog output module generates a corresponding analog signal. This signal is then forwarded to the controlled system.

Calling the Controller in the Program:

OB13	STL	Description
	<pre> : : JU FB 10 NAME : CONTROLLER 1 : : : : : BE </pre>	<p>Process controller</p> <p>The controller's sampling interval depends on the time base used to call OB13 (set in DB1; see also Section "Selecting the Sampling Interval").</p>

FB10	STL	Description
NAME	:CONTROLLER 1	
:	:	
:	:C DB 30	Select controller's DB
:	:	
:	:	*****
:	:	Read controller's control bits
:	:	*****
:	:	
:	:L PY 32	Read controller's
:	:T MB 10	control bits
:	:T DR 11	and store in DR11
:	:	Note carefully:
:	:	DR11 contains important control
:	:	data for OB251, the control bits must
:	:	therefore be transferred with
:	:	T DR11 to prevent
:	:	corrupting DL11
:	:	
:	:	*****
:	:	Read actual value and setpoint
:	:	*****
:	:	
:	:A F 12.0	Flag 0 (for unused functions
:	:R F 12.0	in FB250)
:	:AN F 12.1	Flag 1
:	:S F 12.1	
:	:	
:	:JU FB 250	Read actual value
NAME	:RLG: AI	
BG	: KF +8	Module address
KNKT	: KY 0,4	Channel no. 0, fixed-point bipolar
OGR	: KF +2047	Upper limit for actual value
UGR	: KF - 2047	Lower limit for actual value
EINZ	: F 12.0	No selective sampling
XA	: DW 22	Store scaled actual value in controller DB
FB	: F 12.2	Error bit
BU	: F 12.3	Range violation
:	:	

FB10 (Continued) STL	Explanation
<pre> : :JU FB 250 NAME :RLG: AI BG : KF +8 KNKT : KY 1,6 OGR : KF +2047 UGR : KF - 2047 EINZ : F 12.0 XA : DW 9 FB : F 13.1 BU : F 13.2 : :A F 10.0 :JC =WEIT :L DW 22 :T DW 9 : : : WEIT : : : : : :JU FB 251 NAME :RLG:AQ XE : DW 48 BG : KF +8 KNKT : KY 0,0 OGR : KF +2047 UGR : KF - 2047 FEH : F 13.5 BU : F 13.6 :BE </pre>	<pre> Read setpoint Module address Channel no. 1, fixed-point bipolar Upper limit for setpoint Lower limit for setpoint No selective sampling Store scaled setpoint in controller DB Error bit Range violation In manual mode, the setpoint is set to the actual value to force the controller to react to a system deviation, if any, with a P step on transfer to Automatic mode. ***** Call controller ***** ***** Output value of manipulated variable Y ***** Module address Channel 0, fixed-point bipolar Upper limit for actuating signal Lower limit for actuating signal Error bit when limiting value defined Manipulated variable Y to analog output Range violation </pre>

DB30	STL	Explanation
0:	KH = 0000;	
1:	KF = +01000;	K parameter (here=1), factor 0.001
2:	KH = 0000;	(value range: - 32768 to 32767)
3:	KF = +01000;	R parameter (here=1), factor 0.001
4:	KH = 0000;	(value range: - 32768 to 32767)
5:	KF = +00010;	TI=TA/TN (here=0.01), factor 0.001
6:	KH = 0000;	(value range: 0 to 9999)
7:	KF = +00010;	TD=TV/TA (here=10), factor 1
8:	KH = 0000;	(value range: 0 to 999)
9:	KF = +00000;	Setpoint w, factor 1
10:	KH = 0000;	(value range: - 2047 to 2047)
11:	KM = 00000000 00100000;	Control word
12:	KF = +00500;	Manual value YH, factor 1
13:	KH = 0000;	(value range: - 2047 to 2047)
14:	KF = +02000;	Upper controller limit BGOG, factor 1
15:	KH = 0000;	(value range: - 2047 to 2047)
16:	KF = -02000;	Lower controller limit BGUG, factor 1
17:	KH = 0000;	(value range: - 2047 to 2047)
18:	KH = 0000;	
19:	KH = 0000;	
20:	KH = 0000;	
21:	KH = 0000;	
22:	KF = +00000;	Actual value X, factor 1
23:	KH = 0000;	(value range: - 2047 to 2047)
24:	KF = +00000;	Disturbance variable Z, factor 1
25:	KH = 0000;	(value range: - 2047 to 2047)
26:	KH = 0000;	
27:	KH = 0000;	
28:	KH = 0000;	
29:	KF = +00000;	Feedforward XZ for difference,
30:	KH = 0000;	factor 1, (- 2047 to 2047)
31:	KH = 0000;	
32:	KH = 0000;	
33:	KH = 0000;	
34:	KH = 0000;	
35:	KH = 0000;	
36:	KH = 0000;	
37:	KH = 0000;	
38:	KH = 0000;	
39:	KH = 0000;	
40:	KH = 0000;	
41:	KH = 0000;	
42:	KH = 0000;	
43:	KH = 0000;	
44:	KH = 0000;	
45:	KH = 0000;	
46:	KH = 0000;	
47:	KH = 0000;	
48:	KF = +00000;	Controller output Y, factor 1
49:	KH = 0000;	(value range: - 2047 to 2047)
50:		

9.2 Integrated Function Blocks (FBs)

The function blocks listed in Table 9.5 are integrated in the PLC. They can be called up from the control program using the "JU FB x" or "JC FB x" instruction (x stands for the block number). The integrated FBs cannot be deleted.

Table 9-5. Overview of Integrated Function Blocks

FB No.	Function	Runtime in ms	Call Length in Words	Integrated in S5-90U	Integrated in S5-95U	Described in Section
FB240	Code converter BCD Fixed-point	< 0.6	5	No	Yes	9.2.1
FB241	Code converter Fixed-point BCD	< 1.0	6	No	Yes	9.2.2
FB242	Multiplication of two fixed-point numbers	< 0.9	7	No	Yes	9.2.3
FB243	Division of two fixed-point nos.	< 2.1	10	No	Yes	9.2.4
FB250	Read analog value	2.4	10	No	Yes	9.2.5
FB251	Output analog value	4.8	9	No	Yes	9.2.6

Note

If OB3 or OB13 interrupts an integrated FB and an **integrated** FB is called up in the interrupt-driven program included in OB3/OB13, the PLC enters the "STOP" mode and enters the "SUF" error ID in the ISTACK. To avoid this, write the following in the interruptable program:

- Insert the "IA" operation before the call of the integrated FB;
- Insert the "RA" operation after the call of the integrated FB.

9.2.1 Code Converter : B4 - FB240 -

Use function block FB240 to convert a number in BCD (4 tetrads) with sign to a fixed-point binary number (16 bits).

You must change a two-tetrad number to a four-tetrad number before you convert it.

- If a tetrad is not in the BCD defined range, then FB240 displays the value "0". An error bit message does not follow.

Table 9-6. Parameter Assignments of FB240

Parameter	Meaning	Type	Assignment
BCD	BCD number	I W	0 to 9999
SBCD	Sign of the BCD number	I BI	"1" for "-" "0" for "+"
DUAL	Fixed-point number (KF)	Q W	16 bits "0" or "1"

Table 9-7. Call of FB240

STL	CSF
<pre> : JU FB 240 NAME : COD:B4 BCD : SBCD : DUAL :</pre>	

9.2.2 Code Converter : 16 - FB 241-

Use function block FB 241 to convert a fixed-point binary number (16 bits) to a number in BCD code with additional consideration of the sign.

An eight-bit binary number must be transferred to a 16-bit word before conversion.

Table 9-8. Parameter Assignments of FB241

Parameter	Meaning	Type	Assignment
DUAL	Binary Number	I W	- 32768 to+32767
SBCD	Sign of the BCD Number	Q BI	"1" for "-" "0" for "+"
BCD2	BCD no. 4th and 5th tetrads	Q BY	2 tetrads
BCD1	BCD number tetrads 0 to 3	Q W	4 tetrads

Table 9-9. Call of FB241

STL	CSF
<pre> : JU FB 241 NAME : COD:16 DUAL : SBCD : BCD2 : BCD1 :</pre>	

9.2.3 Multiplier : 16 - FB242 -

Use function block FB 242 to multiply one fixed-point binary number (16 bits) by another. The product is represented by a fixed-point binary number (32 bits). The result is also scanned for zero. An eight-bit number must be transferred to a 16-bit word prior to multiplication.

Table 9-10. Parameter Assignments of FB242

Parameter	Meaning	Type	Assignment
Z1	Multiplier	I W	- 32768 to+32767
Z2	Multiplicand	I W	- 32768 to+32767
Z3=0	Scan for zero	Q BI	"1" if the product is zero
Z32	Product high-word	Q W	16 bits
Z31	Product low-word	Q W	16 bits

Table 9-11. Call of FB242

STL	CSF
<pre> : JU FB 242 NAME : MUL:16 Z1 : Z2 : Z3=0 : Z32 : Z31 :</pre>	

9.2.4 Divider : 16 - FB243 -

Use function block FB 243 to divide one fixed-point binary number (16 bits) by another. The result (quotient and remainder) is represented by two fixed-point binary numbers (16 bits each).

The divisor and the result are also scanned for zero. An eight-bit number must be transferred to a 16-bit word prior to division.

Table 9-12. Parameter Assignments of FB243

Parameter	Meaning	Type	Assignment
Z1	Dividend	I W	- 32768 to+32767
Z2	Divisor	I W	- 32768 to+32767
OV	Overflow bit	Q BI	"1" if overflow
FEH		Q BI	"1" for division by zero
Z3=0	Scan for zero	Q BI	"1": quotient is zero
Z4=0	Scan for zero	Q BI	"1": remainder is zero
Z3	Quotient	Q W	16 bits
Z4	Remainder	Q W	16 bits

Table 9-13. Call of FB243

STL	CSF
<pre> : JU FB 243 NAME : DIV:16 Z1 : Z2 : OV : FEH : Z3=0 : Z4=0 : Z3 : Z4 :</pre>	

9.2.5 Reading of Analog Values (FB250)

FB250 reads an analog value from an analog input or an analog input module and outputs the value XA in a range defined (scaled) by the user.

Chapter 12 includes detailed information on how to call and parameterize FB250. Chapter 12 additionally describes an example of analog value processing with FB250 and FB251.

9.2.6 Output of Analog Values (FB251)

FB251 can be used to output analog values to analog output modules. Values of the range between the parameterized "UGR" (lower limit) and "OGR" (upper limit) are converted to the nominal range of the respective module.

Chapter 12 contains detailed information on how to call and parameterize FB251. Chapter 12 additionally describes an example of analog value processing with FB250 and FB251.

9.3 Integrated Sequence Block 2 (SB2)

The S5-95U, Order No. 6ES5 095-8MA.., features the SB2. SB2 can be programmed in the GRAPH 5 method of representation only.

You can delete the integrated SB2, generate a "new" SB2 and load it into the PLC.

With which GRAPH 5 Version can Sequence Block SB2 be Used?

The integrated sequence block SB2 is suitable for:

- Order No. 6ES5 845-8DA01
GRAPH 5 function and sequence blocks for S5-95U, S5-100U and S5-115U under S5-DOS/ST.
Executable in the S5-95U: FB72/SB2 (integrated), FB73/SB3, FB74.
- Order No. 6ES5 848-7DA01
GRAPH 5 function and sequence blocks for S5-95U, S5-100U and S5-115U under S5-DOS/ST.
Executable in the S5-95U: FB72/SB2 (integrated), FB73/SB3, FB74.

Please note that the integrated sequence block SB2 is not suitable for GRAPH5/II. For operating GRAPH5/II on the S5-95U, the integrated sequence block SB2 must be overwritten with the GRAPH5/II sequence block SB2.

- Order No. 6ES5 848-7DAx2 (German: x = 1; English: x = 2; French: x = 3)
GRAPH 5/II function and sequence blocks for S5-95U, S5-100U and S5-115U under S5-DOS/ST.
Executable in the S5-95U: FB72/SB2, FB73/SB3, FB74 and SB5.

9.4.1 Parameter Blocks

The following Table shows the functions that can be parameterized in DB1.

Table 9-14. Parameter Blocks in DB1

Parameter Blocks and Their Default Settings in Default DB1	Block ID	S5-90U	S5-95U	Described in Section
Onboard Analog inputs Parameter block for analog Onboard I/Os <i>Default:</i> No analog input is cyclically read into the PII.	OBA: _	No	Yes	12
Onboard Interrupt Parameter block for interrupt inputs <i>Default:</i> No interrupt input enabled.	OBI: _	Yes	Yes	10
Onboard Counter Parameter block for onboard counters <i>Default:</i> No counter enabled.	OBC: _	Yes	Yes	11
SINEC L1 Parameter block for SINEC L1 parameters <i>Default:</i> No SINEC L1 parameter initialized.	SL1: _	Yes	Yes	14
System-Dependent Parameters Parameter block for system characteristics <i>Default:</i> All timers are processed and PLC starts up without external I/Os.	SDP: _	No	Yes	6
Timer Function Block Parameter block for time-controlled program execution <i>Default:</i> OB13 is called at intervals of 100 ms.	TFB: _	No	Yes	9
Clock Parameters Parameter block for the integral clock <i>Default:</i> Integral clock is not activated.	CLP: _	No	Yes	13
Error Return Parameter block with address for DB1 parameterization error code <i>Default:</i> No address specified.	ERT: _	Yes	Yes	9

_ stands for one or more fillers. Fillers can either be blanks or commas.

Additional parameter blocks are available for the variants of the S5-95U with a second interface. These parameter blocks are described in connection with the respective interface in the Manual.

Tables listing all permissible DB1 parameters for the above-mentioned functions of S5-90U and S5-95U are included in Appendix B.

9.4.2 Rules to Observe When Generating DB1

When generating DB1, certain rules (syntax) must be observed to make sure that it can be interpreted by the PLC.

General structure of DB1

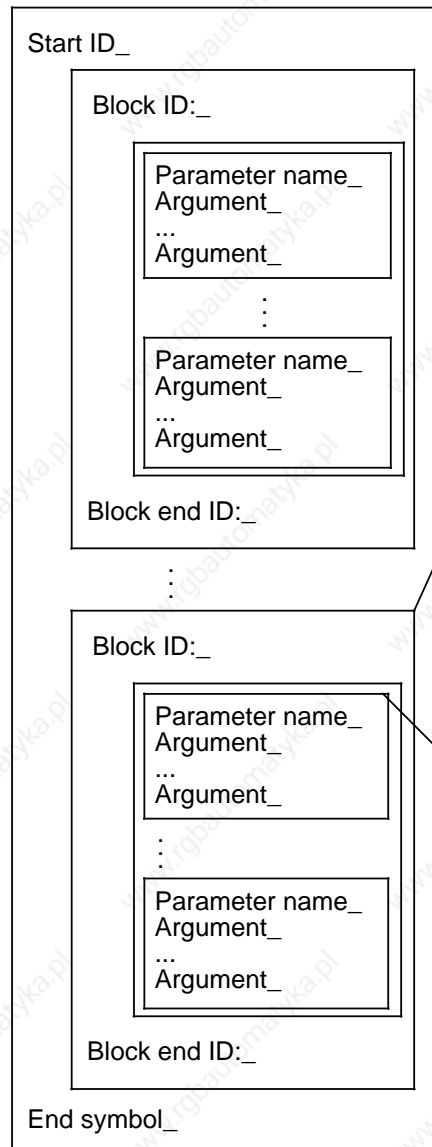

Example:

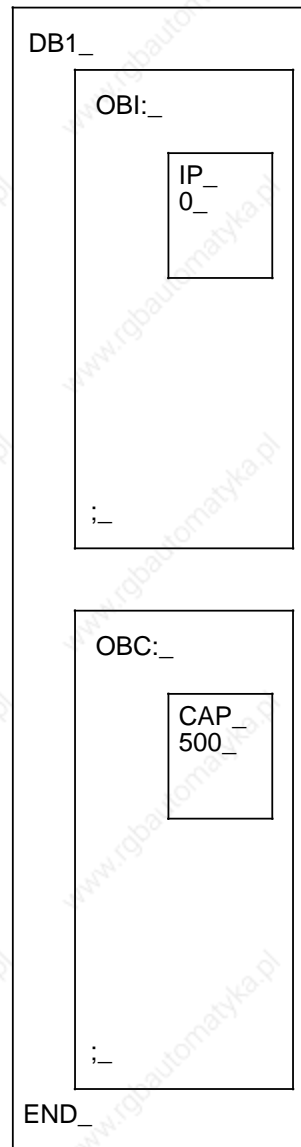

Parameter block

A parameter block combines all parameters pertaining to a function, e.g. parameters for counters.

The parameter blocks can be arranged in any order in DB1.

Parameters

Each parameter defines functional characteristics and is composed of the parameter name and at least one argument, e.g. counting edge and comparison value. The parameters can be entered in any sequence in the parameter block.

_ stands for one or more fillers. Fillers can either be blanks or commas.

Figure 9-8. Structure of DB1

If you write the above DB1 continuously, i.e. without carriage return after each start ID, block ID, parameter name, argument, block end ID or end symbol, DB1 has the following form:

```
0:      KS='DB1_OBI:_IP_0_;_OBC:_CAP_
12:     KS='_500_;_END_';
```

Rules that Should Always be Observed when Generating a DB1:

Start ID, block ID, parameter names, arguments, block end IDs and end symbols always consist of a sequence of characters terminated by at least one filler. Fillers can be blanks or commas. Fillers are impermissible within a character sequence.

Options Available for the User-Friendly Generation of DB1:

- **Comments**
Comments can be inserted at any location where a filler is permitted. Comments are marked by the "#" character. It must be used to demarcate the beginning and the end of a comment, i.e. a comment starts with the first "#" of DB1, any further comment starts with the third "#" and ends with the fourth "#", etc.
- **Capitalization**
Both lower-case and upper-case letters can be used in DB1.
- **Completing parameter names**
To make parameter names easily comprehensible, any number of characters can be added to the parameter name, separated by an underscore. Example: SF would then read SF_SEND MAILBOX. The supplemented parameter name must be followed by at least one filler.

You can use the following flowchart to check your DB1 with regard to syntax conventions. In a correct DB1 syntax, start ID, block IDs, parameter names, arguments, block end IDs and end symbols appear in the sequence and form described in the flowchart.

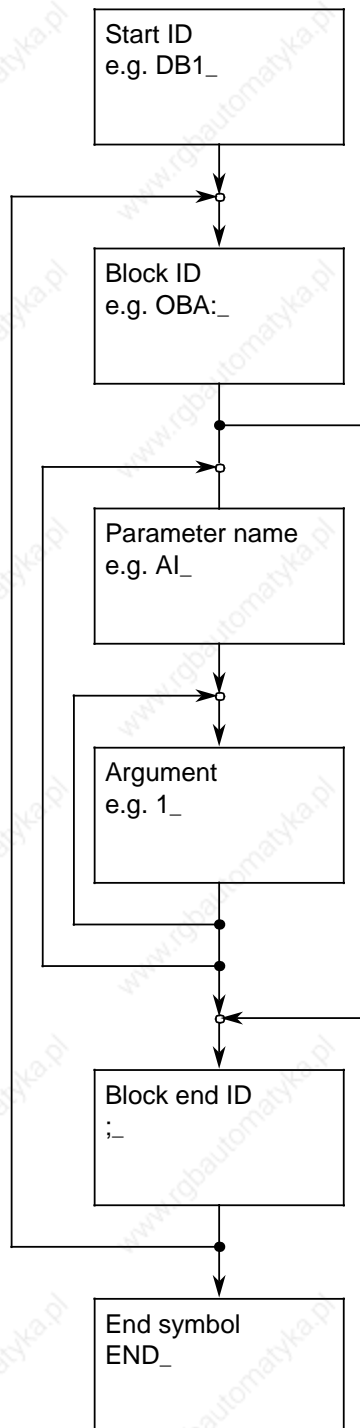

Start ID:

- DB1 must always start with the start ID.
- The start ID is always "DB1_".
- Please note that the start ID must be terminated by at least one filler (blank or comma).

Block ID:

- A block ID is always preceded by the start ID or a block end ID.
- The block IDs for the individual parameter blocks are listed in Table 9-14.
- Please note that the block ID must be terminated by ":" and at least one filler.

Parameter name:

- A parameter name is always preceded by a block ID or another parameter (parameter name and arguments).
- For specific parameter names refer to the Tables in Appendix B.2.
- Please note that a parameter name is always terminated by at least one filler.

Argument:

- An argument is always preceded by a parameter name or another argument.
- For value ranges of arguments refer to the Tables in Appendix B.2.
- If a parameter name requires several arguments, the prescribed order is also stated in the Tables in Appendix B.2.
- Please note that an argument is always terminated by at least one filler.

Block end ID:

- A block end ID is always preceded by an argument or a block ID.
- The block end ID is always ";_".
- Please note that the block end ID is always terminated by at least one filler.

End symbol:

- The end symbol is always preceded by a block end ID.
- The block end ID is always "END_".
- Please note that the block end ID is always terminated by at least one filler.

_ stands for one or more fillers. Fillers can either be blanks or commas.

9.4.3 Transferring DB1 Parameters to the Programmable Controller

Unlike all the other data blocks, DB1 is processed (only) during the PLC's transition to "RUN".

If DB1 is free of errors, i.e. if it can be fully interpreted by the PLC, the PLC transfers its parameters into the system data area. The PLC operates in accordance with the parameter assignments in DB1.

The parameter assignments remain valid until

- They are overwritten by other parameters and the PLC is switched to the "RUN" mode or
- An overall reset of the PLC is performed. After the overall reset, the settings of the default DB1 are valid.

Modifications of DB1 assignments thus become effective only after the PLC has been switched to "RUN".

Note

The programmable controller remains in the "STOP" mode if a parameter assignment error is found during restart. The red LED on the operator panel lights up and DB1 is displayed as the cause of the error in the ISTACK (see Section 9.4.5).

9.4.4 Procedure for Parameterizing the PLC

Parameterization of a PLC needs little effort if you follow the suggestion below.

Use the settings of the default DB1 (see Figure 9-7) as a guideline for your specific parameter assignments:

- Perform an overall reset of the PLC.
- Display the default DB1 on your programmer.

You now have to modify the default DB1 to suit your requirements. To facilitate the entry and modification of parameters, the default DB1 includes considerably more fillers (blanks) than required.

- Use these blanks when entering your parameters but stick to the syntax prescribed for DB1 (see Section 9.4.3).
- Transfer the modified default DB1 to the PLC.
- Switch PLC from STOP to RUN.

If you have made an error and the PLC therefore remains in the STOP mode, refer to Section 9.4.5.

9.4.5 How to Recognize and Correct Parameter Errors

If the PLC detects a parameter error in DB1, it will enter the STOP mode even after a transition from STOP to RUN, i.e. the red LED lights up.

There are two ways of analyzing parameter errors:

- By means of a parameter error code
oder
- By means of the "ISTACK" analysis function.

Both possibilities are described below.

Interrogating the Parameter Error Code

In order to facilitate the detection and elimination of parameter errors, the PLC offers the possibility of displaying error messages in coded form. The PLC need only be "told" where it is to store the error code. This must be specified in the parameter block "ERT:" of DB1.

The error code can be written into

- Flag words, flag bytes
or
- Data words of a data block.

The complete error code takes up 20 flag bytes or 10 data words. Only the start address for the error code must be specified in parameter block "ERT:".

If you have specified a start ID for the parameter error code in parameter block "ERT:" of DB1, you can refer to this address for interrogating the cause and location of the error.

Correct entry of the parameter block "ERT:" considerably facilitates the elimination of parameter errors. It is therefore recommended that this block of DB1 be completed before modifying or adding any other parameters.

Since this parameter block is only important in the start-up phase, it should be deleted before starting "normal" operation in order to save memory space.

If you do not specify any parameter block "ERT:" in DB1, you can locate the error in the ISTACK in the event of a parameterization error but you get no information on the type of error. The same applies if you have made an error when making the settings in parameter block "ERT:".

How to Proceed:

- Perform an overall reset on the programmable controller.
- Display the default DB1 on the programmer.
- Position the cursor on the E of the "END" ID at the end of the default DB1.
- Enter the characters, including the blanks, that are highlighted in Figure 9-15.

Table 9-15. Inputting the Address for the Parameter Error Code

DB1	Explanation
<pre> 0: KS ='DB1 OBA: AI 0 ; OBI: ' 12: KS =' ; OBC: CAP N CBP ' 24: KS ='N ;#SL1: SLN 1 SF ' 36: KS ='DB2 DW0 EF DB3 DW0 ' 48: KS =' KBE MB100 KBS MB1' 60: KS ='01 PGN 1 ;# SDP: N' 72: KS ='T 128 PBUS N ; TFB: OB13' 84: KS =' 100 ; #CLP: STW MW10' 96: KS ='2 CLK DB5 DW0 ' 108: KS =' SET 3 01.10.91 12:00:' 120: KS ='00 OHS 000000:00:00 ' 132: KS =' TIS 3 01.10. 12:00:00 ' 144: KS =' STP Y SAV Y CF 00 ' 156: KS =' ; #ERT: ERR MW2 ; END ; </pre>	<p>The parameter error code is stored in flag word MW2 after start-up.</p>

- Use the following check list to make sure your entries are correct.
- Transfer the changed DB1 to the programmable controller.
- Now you can switch the programmable controller from STOP to RUN.

If you have proceeded as described above, the PLC will carry out the following steps automatically:

1. The PLC parameterizes DB1 when changing from STOP to RUN mode.
2. If DB1 does not contain any errors, the PLC transfers the parameters of DB1 into the system data area. In this case, the "ERT:" parameter block is meaningless. Flag words 2 to 20 are assigned "0".

If DB1 is errored, the PLC remains in the STOP mode and writes the cause and location of the error into the flag word appearing behind the parameter name "ERR_". In the example, cause and location of the error will be entered in MW2.

If your DB1 contains several errors, they are stored in the subsequent flag words. Up to ten errors are stored, i.e. you have make provisions for 10 flag words. In the example, MW2 up to and including MW20 are used.

Coding the Cause and Location of the Error

The following screen display shows a complete list of the parameter error codes.

MW2	KH=	0 6 0 3
MW4	KH=	0 0 0 0
MW6	KH=	0 0 0 0
MW8	KH=	0 0 0 0
MW10	KH=	0 0 0 0
MW12	KH=	0 0 0 0
MW14	KH=	0 0 0 0
MW16	KH=	0 0 0 0
MW18	KH=	0 0 0 0
MW20	KH=	0 0 0 0

Screen display with parameter error codes

Cause of the error (which error occurred?)	High byte (Hex.)	Low byte (Hex.)	Location of error (in which parameter block did the error occur?)
No error	00	00	OBI: Onboard interrupt
Start or end ID is missing	01	01	OBC: Onboard counter
Comment not closed off correctly before END; semicolon missing in front of END	02	02	OBA: Onboard analog connections
Syntax error - block ID	03	03	SL1: SINEC L1
Syntax error - parameter	04	06	CLP: Clock parameter
Syntax error - argument	05	09	TFB: Timer function block
Range violated	06	11	SDP: System data parameter
in an argument		99	ERT: Error return
Parameter combination is not allowed	07	F0	} Error can not be assigned to any block
Not defined	08	:	
Not defined	09	:	
DB is not present	10	FF	
Not enough space in DB	11		
Error when entering day of the week	12		
Error in the date	13		
Error when entering time	14		
Irregular time format in parameter blocks (24h/12h mode)	15		

Figure 9-9. Parameter Error Codes and Their Meaning

In the S5-95U with second serial interface (Order No. 6ES5 095-8MC..) and the S5-95U with SINEC L2 interface (Order No. 6ES5 095-8MB..), interface-specific parameter errors can additionally be entered in coded form in DB1. Please refer to the Section "DB1 Parameter Errors" for the relevant interface in the Manual if you need a detailed description.

Locating Parameter Errors in the "ISTACK"

If the programmable controller recognizes an error in DB1, then the programmable controller remains in the "STOP" mode and stores a message in "ISTACK" describing where the error happened. The "ISTACK" contains the absolute error address as well as the relative error address. The STEP Address Counter (SAC) in the ISTACK points either

- to the address that contains the incorrect input or
- in front of the address that contains the incorrect input.

These are byte addresses.

Example: Your inputs into DB1 are as follows. The position shaded contains an error.

```

0:   KS  ='DB1 OBA: AI 0 ; OBI:  '
12:  KS  ='  ; OBC: CAP N      CBP '
24:  KS  ='N      ; SL1: SLN 40 SF '
36:  KS  ='DB2 DW0  EF DB3 DW0 '
48:  KS  =' KBE MB100      KBS MB1 '
60:  KS  ='01      PGN 1  ; SDP: N'
72:  KS  ='T 128 PBUS N ; TFB: OB13'
84:  KS  =' 100      ; #CLP: STW MW10'
96:  KS  ='2        CLK DB5 DW0  '
108: KS  =' SET 3  01.10.91 12:00:'
120: KS  ='00      OHS 000000:00:00 '
132: KS  =' TIS 3  01.10. 12:00:00 '
144: KS  =' STP Y SAV Y  CF 00  '
156: KS  =' ; #END  '
    
```

The decimal numbers in front of each input line represent the word address for the first character that can be entered for that respective line. Each word consists of two characters (2 bytes).

Figure 9-10. Erroneous Parameter Assignment in DB1

The error causes the ISTACK to display the following addresses.

- The absolute (error) address: 014C_H (absolute SAC)
- The relative (error) address: 0042_H (relative SAC)

So that you can locate the error in DB1 exactly, you must convert the relative byte address that is displayed in hexadecimal format into a decimal word address. Decimal format is required because the programmer displays a DB in words.

0042 _H	=	66 _D	66 _D	:	2 _D	=	33 _D
Hexadecimal byte address		Decimal byte address					Decimal word address

The information displayed in the chart above shows that the error occurred after address 24 and before address 36. In Figure 9-10, argument 40 occupies address 33; the "40" is an incorrect entry. The error is due to a range violation.

10	Onboard Interrupt Inputs	
10.1	Setting Parameters for Interrupt Inputs in DB1	10- 1
10.2	Interrogating the Cause for an Interrupt in the Diagnostic Byte	10- 2
10.3	Interrupt Priority	10- 4
10.4	Calculating Interrupt Reaction Times	10- 7

Figures		
10-1	Sequence of Interrupts Requiring Entries to be Made in the Queue	10- 5
10-2	Example of Acquisition of Interrupt Causes in the Diagnostic Byte	10- 6
Tables		
10-1	Parameters for the Interrupt Inputs (S5-90U)	10- 1
10-2	Parameter for the Interrupt Inputs (S5-95U)	10- 1
10-3	Setting Parameters for Interrupt Inputs	10- 2
10-4	Program Example Including OB3	10- 3
10-5	Transfer Operations to the Onboard Outputs	10- 3
10-6	Additional Reaction Times	10- 7

10 Onboard Interrupt Inputs

The S5-90U has one interrupt input (I 33.0). The S5-95U is provided with four separate interrupt inputs (I 34.0 to I 34.3).

Please refer to Sections 3.3.4 and 3.3.5 for the interrupt input assignments of the S5-90U and the S5-95U.

In the default DB1, all interrupt inputs are disabled. The interrupt function is not available unless you parameterize, i.e. enable the interrupt inputs in DB1. The procedure will be described in the following Section.

If you have programmed OB3, the PLC automatically branches to OB3 if an interrupt is called up. If you have not programmed OB3, program execution will not be interrupted.

OB3 is described in Section 9.1.2.

10.1 Setting Parameters for Interrupt Inputs in DB1

To set interrupt parameters, enter the following items in DB1:

- Which interrupt input should trigger interrupt-driven program processing (S5-95U)
- Whether the interrupt input should react to the positive, the negative, or to both edges of a pulse (S5-95U); in the S5-90U, the interrupt input I 33.0 reacts only to the positive edge of a pulse.

Possible DB1 Parameters (S5-90U)

Table 10-1. Parameters for the Interrupt Inputs (S5-90U)

Parameter	Argument	Meaning
Block ID:	OBI:	Onboard Interrupt
IP	0	Alarm, positive edge, I 33.0

Possible DB1 Parameters (S5-95U)

Table 10-2. Parameters for the Interrupt Inputs (S5-95U)

Parameter	Argument	Meaning
Block ID:	OBI:	Onboard Interrupt
IP	p	Interrupt, positive edge, channel p
IN	p	Interrupt, negative edge, channel p
IPN or INP	p	Interrupt, positive and negative edge, channel p
p=0 to 3		

You will find the procedures for setting, modifying and transferring the parameters in DB1 in Chapter 9.

Example: All four interrupt inputs (S5-95U) are enabled.

Table 10-3. Setting Parameters for Interrupt Inputs

Setting Parameters for Interrupt Inputs	Explanation
0: KS='DB1 OBA: AI 0 ; OBI: '	Interrupt after positive edge at I 34.0;
12: KS='IP 0 IN 1 IPN 2 INP 3 ; '	Interrupt after negative edge at I 34.1;
24: KS=' ; OBC: CAP N CBP '	Interrupt after positive as well as negative edge at I 34.2;
:	Interrupt after negative as well as positive edge at I 34.3

Note

If the necessary shielding is provided, interrupt input I 33.0 of the S5-90U or interrupt inputs I 34.0 to I 34.3 of the S5-95U can also be used as "normal" digital inputs (with a short delay).

If you want to use an interrupt input as digital input, do **not** parameterize this interrupt input in DB1.

If no parameter assignment has been made in DB1, a signal edge does not trigger an interrupt (OB3) at this input.

10.2 Interrogating the Cause for an Interrupt in the Diagnostic Byte

In the S5-90U:

A positive edge at interrupt input I 33.0 triggers an interrupt.

Reaction:

- OB3 is called up if it is programmed;
- Bit 35.4 in diagnostic byte IB 35 is set to "1" even if OB3 is not programmed.

In the S5-95U:

Positive and/or negative edges trigger interrupts at one or more interrupt inputs.

Reaction:

- OB3 is called up if it is programmed;
- The appropriate bit in the diagnostic byte (IB 35) is set to "1" after an OR operation even if OB3 is not programmed as follows
 - Bit 35.4 for I 34.0
 - Bit 35.5 for I 34.1
 - Bit 35.6 for I 34.2
 - Bit 35.7 for I 34.3

Example: An electronic transducer is connected to interrupt input I 34.0. When the transducer initiates an interrupt, the program branches to FB3.

Table 10-4. Program Example Including OB3

STL	Explanation
OB3	
A I 35.4	There was an interrupt at I 34.0.
R I 35.4	Bit 4 in the diagnostic byte is reset to "0".
JC FB3	The interrupt reaction program in FB3 is
:	executed.
:	
BE	



Caution

Be sure to save the flags of the cyclic program (into a data block for example) if these flags are overwritten during interrupt processing and are needed in the cycle again.

Please note the following:

- After interrupt processing, the interrupt bits in the diagnostic byte must be reset to "0" by the program (see Table 10-4).
- The operating system always updates the diagnostic byte prior to calling OB3.
- Any causes of interrupt occurring during OB3 processing are not entered in the diagnostic byte. The operating system enters them in the diagnostic byte prior to the next OB3 call.
- The internal timers are **not** updated during interrupt processing.
- During interrupt processing with the OB3, data can **only** be transferred to the onboard I/Os. The data is transferred directly to the relevant onboard outputs by means of the T PY/PW operation. The "normal" PIQ is updated. Neither an interrupt PII nor an interrupt PIQ are used.

Table 10-5. Transfer Operations to the Onboard Outputs

STEP 5 Operations for		Explanation
S5-95U	S5-90U	
T PY 32/33 T PW 32/40	T PY 32/33 T PW 32	The contents of ACCU1 are written directly to the onboard outputs and into the normal PIQ.

10.3 Interrupt Priority

In the S5-90U:

You cannot stop interrupt processing once it has started. If an interrupt and a counter overflow occur simultaneously, interrupt processing has priority.

Only one new cause for an interrupt can be stored while interrupt processing is running. If more causes for interrupts are present than can be stored, then they are ignored.

In the S5-95U:

Interrupt-driven program execution (OB3) cannot be interrupted by another interrupt. The relevant program steps are processed sequentially instead.

Up to eight new OB3 calls can be stored while interrupt processing is running. They are processed in the order of their occurrence ("queue").

For each interrupt that occurs, a separate diagnostic byte with the relevant interrupt information (on the channel triggering the interrupt) is available.

If several interrupts occur simultaneously or if interrupt processing is disabled by additionally used PLC functions (see Table 10.6), the corresponding number of entries is made in the diagnostic byte (several interrupt-triggering channels are specified). However, OB3 is called only once for these interrupts.

If interrupts and a counter overflow occur at the same time, the following priorities are adhered to during execution:

1. OB3 call: Counter B (I 35.1=1)
2. OB3 call: Interrupt inputs (I 35.4 to 35.7=1)
3. OB3 call: Counter A (I 35.0=1)

The diagnostics information (IB 35) for the interrupts and counter A are stored in the queue while counter B is being processed.

Reaction of the PLC to "Interrupt Disable" through STEP 5 Operation "IA":

The PLC recognizes interrupts and stores the relevant diagnostics information in the queue (same procedure as if OB3 execution already running) while interrupt processing is disabled by the "IA" operation (see Section 8.2.8).

Reaction of the PLC to "Interrupt Enable" through STEP 5 Operation "RA":

The queue is processed in the case of an interrupt enable through the "RA" operation (see Section 8.2.8); for each diagnostics entry in the queue, an OB3 will be started and the cause of the interrupt flagged in IB 35.

Example of Interrupt Priorities: The cyclic program (OB1) is being processed in the S5-95U. An interrupt (signal edges) occurs at each of the inputs I 34.0 to 34.3. The sequence of the interrupts is shown in Figure 10-1.

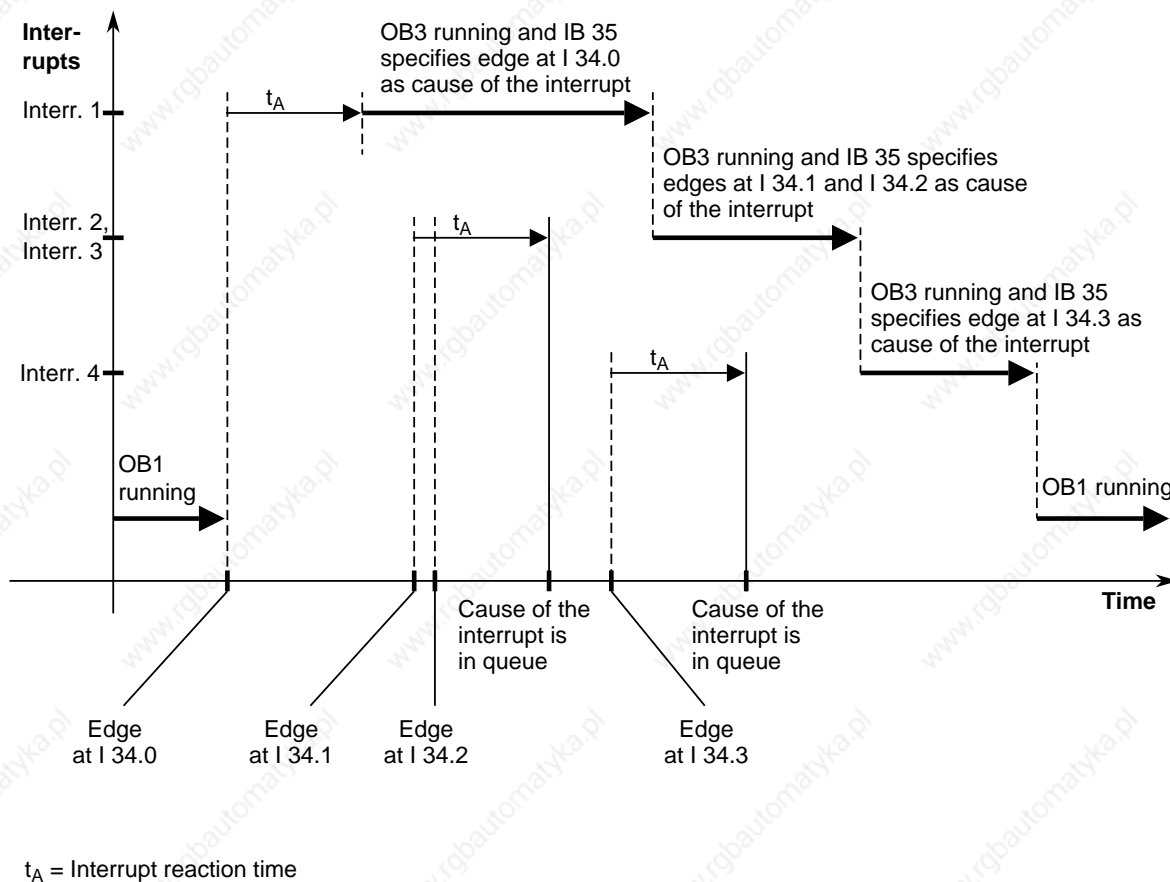

Figure 10-1. Sequence of Interrupts Requiring Entries to be Made in the Queue

Please note that an edge occurs at I 34.2 while the interrupt reaction time t_A for the edge at I 34.1 is running.

Consequently, only one interrupt is entered in the queue and OB3 called only once. However, both interrupt causes (edges at I 34.1 and I 34.2) are entered in the diagnostic byte.

More than eight Causes of Interrupts are Signalled to the S5-95U:

If more causes of interrupts are present than can be stored in the "queue" (> eight interrupts), the corresponding number of additional entries is made in the diagnostic byte for the eighth interrupt (specification of several channels triggering interrupts).

If several interrupts in succession are triggered on one channel, the PLC is not able to differentiate between them (since associated bit is already set).

Example: During interrupt processing, a total of nine additional causes of interrupts are present. The eighth cause of interrupt is present at I 34.3. The ninth cause of interrupt is present at I 34.2. Both causes are combined and entered in diagnostic byte IB 35. The associated diagnostic byte is as follows:

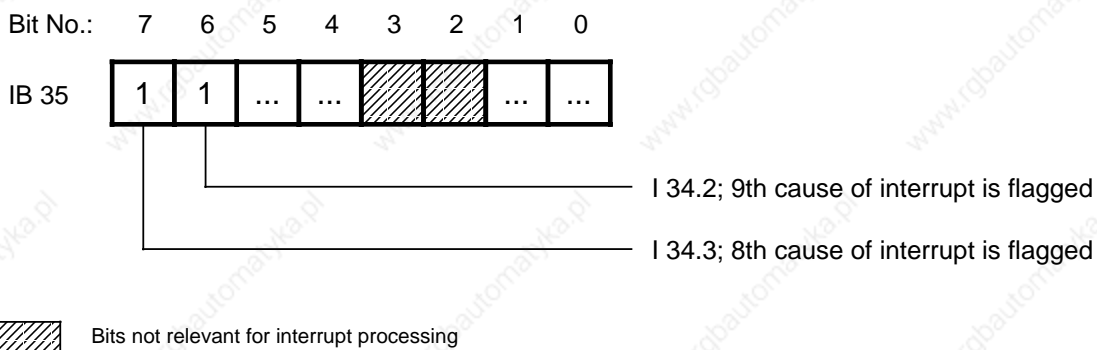

Figure 10-2. Example of Acquisition of Interrupt Causes in the Diagnostic Byte

If the 9th cause of interrupt was also present at I 34.3, this interrupt would not be noticed.

10.4 Calculating Interrupt Reaction Times

The interrupt reaction times is the amount of time that passes from the first occurrence of an interrupt until the first statement in OB3 is called up. The interrupt reaction time is dependent upon the delay time of the interrupt input and upon the corresponding operating system run time.

If several interrupt or counter inputs are used, the time elapsing until OB3 is called up increases in accordance with the interrupt priorities (see Section 10.3).

In order to make sure that all interrupts are recognized in the S5-95U, the interrupt-triggering signals need to have a minimum pulse duration, i.e. minimum pulse duration interrupt reaction time.

Calculate the Programmable Controller's Interrupt Reaction Times as Follows:

Programmable controller's interrupt reaction time = Basic reaction time + Additional reaction times

The basic reaction time is 0.6 ms and is valid if the following conditions exist.

- No integrated FBs were used
- The parameters for the integral clock are not set
- There are no programmer/OP functions present and
- No SINEC L1 is connected.

The additional reaction times are variable. They are listed in Table 10-6.

Table 10-6. Additional Reaction Times

Additional Functions of the Programmable Controller	Variable Reaction Times
Integrated FBs (S5-95U only)	0.5 ms
Parameters set for clock (S5-95U only)	0.2 ms
SINEC L1 connected to the programmer interface	8.0 ms
OP Functions	0.4 ms
Programmer functions: Block status/transfer Output address Compress block via programmer - If no blocks are moved - If blocks are moved	0.5 ms 18 ms per KB - Depending on the number of blocks present (after overall reset 31 ms) - 600 ms per 1K statements in the block to be moved
Second interface (for S5-95U variants with a second interface)	See relevant Section in the Manual

www.rgbautomatyka.pl

11 Onboard Counter Inputs		
11.1	Setting Parameters for Counter Inputs in DB1	11- 3
11.2	Programming the Reaction to Interrupts in OB3	11- 4
11.3	Scanning the Actual Counter Status	11- 5
11.4	Entering the Comparison Value and Resetting the Counter	11- 5
11.5	Cascading Counters (with the S5-95U only)	11- 7
11.6	Calculating the Counter Frequency Limit	11- 9

Figures		
11-1	Principle of Operation of the Onboard Counter Inputs	11- 2
Tables		
11-1	Characteristics of the Onboard Counter Inputs	11- 1
11-2	Parameters for Counter Inputs of the S5-90U	11- 3
11-3	Parameters for Counter Inputs of the S5-95U	11- 3
11-4	Setting Parameters for Counter Inputs	11- 4
11-5	Program Example for OB3	11- 4
11-6	Scanning the Actual Counter Status	11- 5
11-7	Resetting Counter and Entering the Comparison Value	11- 5
11-8	Setting Parameters for Counter Cascade	11- 7

11 Onboard Counter Inputs

The S5-90U is provided with a counter input which can optionally be used as digital input. The S5-95U has two counter inputs which, however, cannot be used as digital inputs. Table 11-1 gives an overview of the data of the counter and counter inputs.

Table 11-1. Characteristics of the Onboard Counter Inputs

Characteristics of the Counter Inputs	S5-90U	S5-95U
Number of counters	1	2
Counter frequency limit	1 kHz*	2 kHz, 5 kHz*
Actual-value representation	16-bit, fixed-point, without sign	16-bit, fixed-point, without sign
Counter type	Up	Up
Input voltage for counter inputs	24 V DC	24 V DC

* Programmer interface unassigned

Please refer to Sections 3.3.4 and 3.3.5 for counter input assignments.

Note

- The counters are active only when the PLC is in the RUN mode.
- The actual status of the counter is set to "0" at each transition from STOP to RUN.
- The actual status of the counter is not retentive. Each time the PLC switched on, the actual status is set to "0".
- When connecting the supply voltage (load supply voltage) for the onboard outputs and in the case of some I/O modules (451-8MA11, 482-8MA13 and 265-8MA01), a pulse with a duration of approx. 100 μ s is generated at the outputs. If these outputs are used for controlling counter inputs, the count is thus incremented by "1". This phenomenon is relevant only when the S5-90U or S5-95U are in the RUN mode. The pulse has no effect on "standard inputs" which generally have longer input delays.

Principle of Operation

- The counter input is routed to a (hardware) counter which operates independently of the CPU.
- The counter counts the signal edges present at the counter input. The onboard counter of the S5-90U counts positive edges only. In the S5-95U, the user can parameterize whether positive or negative edges are to be counted.
- The counter always needs a comparison value. When the actual counter status has reached the comparison value, it is immediately reset to "0". After resetting, the counter immediately resumes the counting of signal edges.
- Reaching of the comparison value triggers an interrupt, i.e. OB3 (see Section 9.1.2) is called up. In order to enable you to determine the cause of the interrupt in OB3, the cause is flagged in diagnostic byte IB 35 (see Chapter 5) when the program branches to OB3.

The principle of operation of the counter will be explained with an example on the following page.

Example:

- Counter counts positive edges
- The comparison value is 3

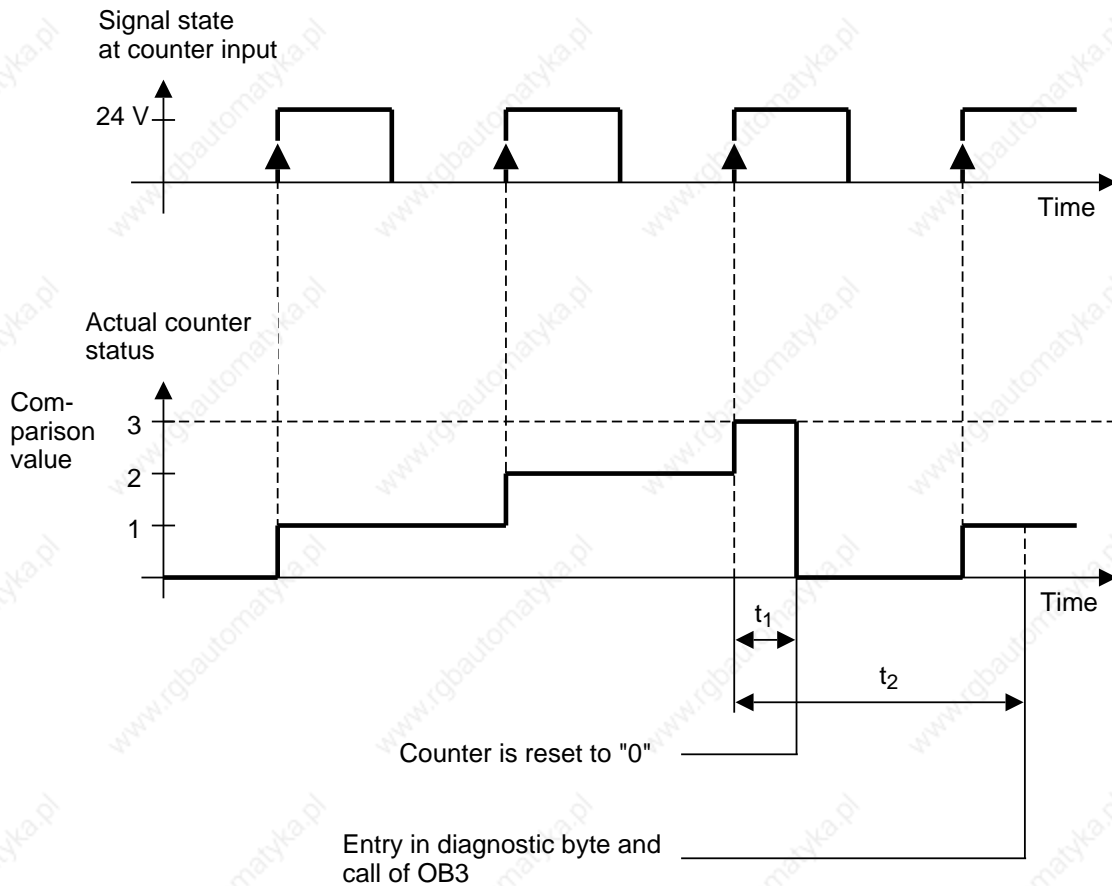

Figure 11-1. Principle of Operation of the Onboard Counter Inputs

Explanation of Figure 11-1:

- When reaching the comparison value, the counter is immediately reset to "0". After the reset, the counter can immediately resume the counting of edges. It can thus not miss any edges.
- The counter is reset during time interval t_1 whereas t_1 interrupt reaction time. t_1 corresponds to the reciprocal value of the counter frequency limit (see Section 11.6).
- The cause of the interrupt is entered in the diagnostic byte when t_2 has elapsed. OB3 is then called up. t_2 interrupt reaction time.
- In the example, t_2 is that long that another edge is present before OB3 is called up. This may be the case if an OB3 is just being processed when the comparison value is reached (see Section 10.3).

11.1 Setting Parameters for Counter Inputs in DB1

The counter function is not available unless you parameterize it in DB1. The counters are disabled in the default DB1.

The procedure for entering, modifying and transferring DB1 is explained in Chapter 9.

Possible DB1 Parameters in the S5-90U

Table 11-2. Parameters for Counter Inputs of the S5-90U

Parameter	Argument	Meaning
Block ID:	OBC:	Onboard Counter
CAP	p/N	Counter counts positive edge, comparison value p
p=0 to 65,535		N/n=not activated

Possible DB1 Parameters in the S5-95U

Table 11-3. Parameters for Counter Inputs of the S5-95U

Parameter	Argument	Meaning
Block ID:	OBC:	Onboard Counter
CAP	p/N	Counter A, positive edge, comparison value p
CBP	p/N	Counter B, positive edge, comparison value p
CAN	p/N	Counter A, negative edge, comparison value p
CBN	p/N	Counter B, negative edge, comparison value p
CCP	q/N	Cascaded counter, positive edge, comparison value q (Counter A is counter input)
CCN	q/N	Cascaded counter, negative edge, comparison value q (Counter A is counter input)
p=0 to 65535		q=0 to 4,294,967,295 N/n=not activated

How to read the Table:

- The counter frequency limit of counter A is 5 kHz; the counter input is assigned to PIN 4 of the sub D socket (see Section 3.3.5).
- The counter frequency limit of counter B is 2 kHz; the counter input is assigned to PIN 2 of the sub D socket (see Section 3.3.5).
- Counter A and counter B can be combined (cascaded) to form one counter with 32-bit fixed-point actual value representation without sign (see Section 11.5).

Example: Setting Parameters for Counter A and Counter B (S5-95U)

Table 11-4. Setting Parameters for Counter Inputs

Setting Parameters for Counter Inputs	Explanation
12: KS = ' OBC: CAP 500 CBN 999 ;	Counter A counts positive edges; compar. value 500
24: KS = ' '	Counter B counts negative edges; compar. value 999

Counter A and counter B count independently of each other.

If the counters reach the comparison value (counter overflow), the following takes place.

- The actual counter status is reset to "0",
- Bit I 35.0 of the diagnostic byte is set (counter A),
- Bit I 35.1 of the diagnostic byte is set (counter B),
- OB3 is called if it has been programmed.

11.2 Programming the Reaction to Interrupts in OB3

S5-90U

Bit I 35.0 of the diagnostic byte is set in OB3 if the interrupt was caused by "Counter has reached comparison value".

You must reset bit I 35.0 in the interrupt program.

S5-95U

Bit I 35.0 of the diagnostic byte is set in OB3 if the interrupt was caused by "Counter A has reached comparison value".

Bit I 35.1 of the diagnostic byte is set in OB3 if the interrupt was caused by "Counter B has reached comparison value".

You must reset bit I 35.0 and/or I 35.1 in the interrupt program.

Example: Counter A has counted up to the comparison value; an interrupt was triggered. Program execution is to jump from OB3 to FB3 if the interrupt was caused by "Counter A has reached comparison value".

Table 11-5. Program Example for OB3

STL	Explanation
OB3	
A I 35.0	An interrupt has been triggered.
R I 35.0	Bit 0 in the diagnostic byte is reset to "0".
JC FB3	The counter reaction program in FB3 will be processed.
:	
:	
BE	

11.3 Scanning the Actual Counter Status

Table 11-6 shows how to scan the actual status of the counter.

Table 11-6. Scanning the Actual Counter Status

Access Possibilities:	PLCs:	S5-90U	S5-95U
Location of the counters		IB 36 ... 37	Counter A: IB 36 to 37 Counter B: IB 38 to 39
Scanning counter status by reading in the PII (The value read in corresponds to the last actual value read into the PII.)		L IW 36	L IW 36 L IW 38
by direct access to I/Os (The value read in corresponds to the current actual value.)		L PW 36	L PW 36 L PW 38

11.4 Entering the Comparison Value and Resetting the Counter

The counter starts with the comparison value specified in DB1. Table 11-7 shows how to input a new comparison value in the RUN mode.

Table 11-7. Resetting Counter and Entering the Comparison Value

Access Possibilities:	PLCs:	S5-90U	S5-95U
Reset counter to "0" and input a new comparison value. X is the new comparison value.		L KH x T PW 36	L KH x T PW 36 T PW 38

Please note that entry of a new comparison value always involves resetting of the counter's actual value to "0".

After the reset, the counter is immediately ready for counting further edges.

The entry of a new comparison value does not affect the comparison value specified in DB1.

Example: When the comparison value is reached, a new comparison value is to be entered for counter A (S5-95U).

STL	Explanation
OB3	Counter A counted until it reached the comparison value. An interrupt was triggered. Bit 35.0 in the diagnostic byte is reset. The program branches to FB10.
A I 35.0	
R I 35.0	
JC FB 10	
BE	

STL	Explanation
FB10	Control program responds to "Comparison value reached". The new comparison value x is loaded into ACCU 1 and counter A is set.
L KH x	
T PW 36	
BE	

11.5 Cascading Counters (with the S5-95U only)

Instead of using counter A and counter B individually and independently of each other, you can combine them (cascading).

Use cascading of counters if you want to count amounts larger than 65,535 (up to 4,294,967,295). The registers of both counters work together like a larger counter with more digits. The maximum counting frequency for the counter cascade is 5 kHz if no programmers, operator panels or SINEC L1/L2 are connected.

If you cascade counters, counter input B is automatically disabled; therefore, you must connect the incoming pulses to counter input A. Section 3.3.5 describes how to connect a pulse generator to counter input A.

• Parameterizing the Counter Cascade in DB1

You specify in DB1

- Whether the counter cascade is to count the positive pulse edges or
- The negative pulse edges, and
- The value (comparison value) up to which the counter cascade is to count.

Example: Setting parameters for counter cascade

Table 11-8. Setting Parameters for Counter Cascade

Set Parameters for Cascading Counter	Explanation
12: KS = ' ; OBC: CCN 90000 ; '	Counter cascade counts negative edges, comparison value 90,000

Both counter registers work together as **one** counter. If the cascading counter exceeds the comparison value, then:

- An interrupt is triggered and OB3 is called up, if it has been programmed.
- Bit 35.0 and bit 35.1 are set to "1" at the same time in the diagnostic byte (IB 35) independent of the presence of OB3.
- The counter is reset to "0".

The "set" bits in the diagnostic byte that flag a counter overflow or reaching of the comparison value can be reset by using bit operations R I 35.0 and R I 35.1 (see Section 11.2).

Note

You have to reset the counter overflow bits 35.0 and 35.1 in the diagnostic byte to "0" when the program has completed interrupt processing.

The operating system generally updates the diagnostic byte before calling OB3. Any new causes of interrupts signalled during OB3 execution are not immediately flagged in the diagnostic byte. The operating system enters them in the diagnostic byte before OB3 is called again.

• **Scanning the Actual Counter Status**

The counter status can be scanned and reset to "0". The same STEP 5 operations as for individual counters can be used (see Section 11.3).

In the following, you will find a program example for the input of a new comparison value for the counter cascade.

Example: When the comparison value is reached, the new comparison value 1,280,520 for the counter cascade is specified.

Set the parameters for the counter cascade in DB1 (see Table 11-8).
Calculate the hexadecimal value of 1, 280, 520.

Counter Register - Counter Cascade

	IW 38																16	IW 36																0
bin.:	0	0	0	0	0	0	0	1	0	0	1	1	1	0	0	0	1	0	1	0	0	0	0	1	0	0	0	0	1	0	0	0		
hex.:	0				1				3				8				A				0				8									

Load the following program into the PLC.

STL	Explanation
OB3	The counter cascade counted until it reached a comparison value. An interrupt was triggered.
A I 35.0	
R I 35.0	Bits 35.0 and 35.1 in the diagnostic byte are reset.
A I 35.1	
R I 35.1	
JC FB 11	The program branches to FB11.
BE	

STL	Explanation
FB11	User program responds to "Comparison value reached".
L KH 0013	The new comparison value is loaded into the ACCUs.
L KH 8A08	
T PW 36*	The counter cascade is set.
BE	

* If the S5-95U counter is cascaded, the operation "T PW 36" transfers ACCU 1 and ACCU 2.

11.6 Calculating the Counter Frequency Limit

The maximum counting frequency (frequency limit) - without connecting programmers, OPs, SINEC L1/L2 is as follows:

S5-90U: 1 kHz

S5-95U: 5 kHz for counter A, 2 kHz for counter B,
5 kHz for counter cascade.

If you want to use the PLC interfaces (e.g. connect an OP to the programmer interface), you can calculate the maximum counting frequency (frequency limit) of the counters by means of simple formulae:

S5-90U

For counter: Frequency limit 1 kHz.

$$\text{Frequency limit} = \frac{1}{1 \text{ ms} + \text{additional interrupt reaction time}^*}$$

* See Section 10.4, Table 10-6 for additional reaction times

S5-95U

For counter A or counter cascade: Frequency limit 5 kHz.

$$\text{Frequency limit} = \text{Currently valid comparison value of counter A} \cdot \frac{1}{(0.5 \text{ ms} + \text{additional interr. reaction time}^*)}$$

* See Section 10.4, Table 10-6 for additional reaction times

For counter B: Frequency limit 2 kHz.

$$\text{Frequency limit} = \frac{1}{0.5 \text{ ms} + \text{additional interrupt reaction time}^*}$$

* See Section 10.4, Table 10-6 for additional reaction times

Example: An OP is connected to the programmer interface of the S5-95U. The currently valid comparison value is 3 for counter A. The frequency limits for counters A and B are to be calculated.

According to Table 10-6 in Section 10.4, the additional interrupt reaction time for the OP function is 0.4 ms.

Counter A:

$$\text{Frequency limit} = 3 \cdot \frac{1}{(0.5 \text{ ms} + 0.4 \text{ ms})} = 3.33 \text{ kHz}$$

In the example, the frequency limit for counter A is **3.3 kHz**.

Counter B:

$$\text{Frequency limit} = \frac{1}{(0.5 \text{ ms} + 0.4)} = 1.111 \text{ kHz}$$

In the example, the frequency limit for counter B is **1.1 kHz**.

www.rgbautomatyka.pl

12 Analog Value Processing		
12.1	Reading in Analog Values	12- 2
12.1.1	General Representation of Analog Input Values	12- 3
12.1.2	Reading in and Scaling an Analog Value -FB250-	12- 5
12.1.3	Time Required for Reading and Accuracy of the Analog Value Read in	12- 7
12.1.4	Using Analog Inputs of the S5-95U as Additional Digital Inputs	12- 8
12.2	Output of Analog Values	12- 9
12.2.1	General Representation of Analog Output Values	12- 9
12.2.2	Outputting Analog Values -FB251-	12- 10
12.2.3	Time Required for Output and Accuracy of the Analog Value Output	12- 12
12.3	Example: Analog Value Processing with FB250 and FB251	12- 14

Figures		
12-1	Scaling Schematic for FB250	12- 6
12-2	Transforming the Nominal Range to a Specified Range	12- 15
12-3	Transforming the Specified Range into the Nominal Range	12- 16
Tables		
12-1	Onboard Analog Inputs	12 - 1
12-2	Onboard Analog Outputs	12- 1
12-3	Reading in Analog Values	12- 2
12-4	Parameters for Analog Inputs	12- 2
12-5	Analog Inputs	12 - 3
12-6	General Representation of the Analog Input Value as Bit Pattern	12 - 3
12-7	Analog Value Representation of Inputs (0 to 10 V; Onboard I/Os)	12 - 4
12-8	Calling FB250	12 - 5
12-9	Call and Parameter Assignments of FB250	12 - 6
12-10	Maximum Duration for Reading in an Analog Value	12 - 7
12-11	Possibilities for the Output of Analog Values	12 - 9
12-12	General Representation of the Analog Output Value as Bit Pattern	12 - 9
12-13	Analog Value Representation of Outputs (Onboard I/Os)	12 - 10
12-14	Call of FB251	12 - 10
12-15	Parameter Assignment of FB251	12 - 11
12-16	Maximum Duration for Outputting an Analog Value	12 - 12
12-17	Setting Parameters in FB250	12 - 15
12-18	Parameters for FB250	12 - 15
12-19	Entering Parameters for FB251	12 - 16
12-20	Parameters for FB251	12 - 17

12 Analog Value Processing

This Chapter deals with the analog value processing functions of the onboard I/Os. It also includes general information on reading in and output of analog values by means of analog input and analog output modules.

For information on analog value processing by means of analog modules (external I/Os) please refer to

- Section 6.2 (Addressing analog modules)
- Section 15 (Specific information on individual modules)

Onboard Analog Inputs in the S5-90U and the S5-95U:

Table 12-1. Onboard Analog Inputs

PLC	Number of Inputs	Electrical isolation	Input Range	Resolution	Features
S5-90U	0	-	-	-	Can be expanded by analog input modules
S5-95U	8	No	0 to 10 V	10 bits	Can be expanded by analog input modules; onboard analog inputs can also be used as digital inputs

Address assignments of onboard analog inputs of the S5-95U:

- Analog input channel 0: Address IW 40
- Analog input channel 1: Address IW 42
- ⋮
- Analog input channel 7: Address IW 54

Onboard Analog Outputs in the S5-90U and the S5-95U:

Table 12-2. Onboard Analog Outputs

PLC	Number of Outputs	Electrical isolation	Output Range	Resolution	Features
S5-90U	0	-	-	-	Can be expanded by analog output modules
S5-95U	1	No	0 to 10 V or 0 to 20 mA	10 bits	Can be expanded by analog output modules

Address assignments of onboard analog outputs of the S5-95U:

- Analog output channel: Address QW 40

Please refer to Section 3.3.5 for assignments of the onboard analog inputs/outputs in the S5-95U.

12.1 Reading in Analog Values

The following Table shows the various possibilities for reading in analog values both via onboard I/Os and external I/Os.

Table 12.3 Reading in Analog Values

Possibilities for Reading in Analog Values	Onboard I/Os	External I/Os (Analog Input Modules)
Reading in analog values from the process image	After parameterizing DB1 accordingly: <ul style="list-style-type: none"> Using the L IW ... operation or Using FB250 	<ul style="list-style-type: none"> Using the L IW ... operation or Using FB250
Reading in analog values with direct I/O access	<ul style="list-style-type: none"> Using the L PW ... operation or Using FB250 	Not possible

When the PLCs and modules are supplied, their default settings permit only direct I/O access.

Parameterizing Analog Inputs in DB1

Specify in DB1 which analog inputs are to be read into the PII cyclically.

Possible DB1 Parameters

Table 12-4. Parameters for Analog Inputs

Parameter	Argument	Meaning
Block ID: OBA:		Onboard Analog Inputs
AI	p	Number of analog inputs cyclically read via process image transfer
p=0 to 8		0= No analog input is read

Chapter 9 describes the procedure for entry, modification and transfer of DB1.

Example: Parameterizing analog inputs 1 to 4.

Table 12-5. Analog Inputs

Parameterizing Analog Input	Explanation
0: KS = 'DB1 OBA: AI 4 ; OBI: '	Analog inputs 1 to 4 (channels 0 to 3) are cyclically read into the PII.

Information on Example:

Analog inputs 1 to 4 can be read in from the PII using operations L IW 40 to L IW 46.

Note

It is recommended that the analog inputs be connected in ascending order and not more analog input than required be parameterized.

12.1.1 General Representation of Analog Input Values

Every analog process signal must first be converted into a digital format before it can be stored in the process input image (PII). The analog signals are transformed into a binary number represented by two bytes.

The following Table shows the locations of the powers of two within the bit pattern.

Table 12-6. General Representation of the Analog Input Value as Bit Pattern

	High-Order Byte								Low-Order Byte							
Bit number	7	6	5	4	3	2	1	0	7	6	5	4	3	2	1	0
Analog value represent.	S	2 ¹¹	2 ¹⁰	2 ⁹	2 ⁸	2 ⁷	2 ⁶	2 ⁵	2 ⁴	2 ³	2 ²	2 ¹	2 ⁰	X	E	OV

Legend:

S	Sign bit	0="+", 1="-"
X	Irrelevant bits	
E	Error bit	0 = No wire break; 1 = Wire break (bit is irrelevant for onboard I/Os)
OV	Overflow bit	0 = Measured value amounts to max. 4095 units 1 = Measured value is greater or equal to 4096 units

Representation of Analog Value Input via Onboard I/Os

The following peculiarities should be noted when representing an analog value of the onboard I/Os (see Table 12-7):

- The sign bit (S) is always "0".
- The error bit (E) is irrelevant.
- Bit 3 is always "0".
- The highest measured value amounts to 2046 units.
- The analog value has a 10-bit resolution but is represented by 12 bits.

The assignment of units (in IW 40 to IW 54) to the measured value read in is as follows:

Table 12-7. Analog Value Representation of Inputs (0 to 10 V; Onboard I/Os)

Units	Measured Value in V	High-Order Byte	Low-Order Byte	Range
2048	10	0 1 0 0 0 0 0 0	0 0 0 0 0 0 0 1	Overflow
2046	9.9902	0 0 1 1 1 1 1 1	1 1 1 1 0 0 0 0	Nominal range
1024	5	0 0 1 0 0 0 0 0	0 0 0 0 0 0 0 0	
2	0.0098	0 0 0 0 0 0 0 0	0 0 0 1 0 0 0 0	
0	0.0	0 0 0 0 0 0 0 0	0 0 0 0 0 0 0 0	

You obtain the analog value representation shown in Table 12-7 when using the "L IW ..." or "L PW" operations for reading the analog values.

Disadvantages:

- The analog value has not yet been separated from the status information.
- The analog value is not yet scaled for the desired range.

You can bypass these disadvantages by using FB250 for reading in analog values. Channel type Y = 4 "Unipolar representation" must be set in FB250 for this purpose.

The following Section describes how to call and parameterize FB250.

Representation of the Analog Value Input via External I/Os

The representation of the analog value and the assignment of units to the measured values read in will be described in connection with the relevant modules in Chapter 15.

12.1.2 Reading in and Scaling an Analog Value -FB250-

Function block FB250 reads in an analog value from an analog input module and outputs a value XA in the scale range specified by the user.

The FB250 can be used in the S5-95U.

Execution time of the FB 250 2.4 ms.

Specify the type of analog value representation for the module (channel type) in the KNKT parameter (see Table 12-8).

Define the desired range using the "upper limit" (OGR) and "lower limit" (UGR) parameters.

Calling FB250

Table 12-8. Calling FB250

STL	CSF
<pre> : JU FB 250 NAME : RLG.AE BG : KNKT : OGR : UGR : EINZ : XA : FB : BU :</pre>	<pre> FB 250 RLG.AE BG XA KNKT FB OGR BU UGR TBIT EINZ</pre>

Table 12-9. Call and Parameter Assignments of FB250

Parameter	Explanation	Type	Assignment	
			External I/Os	Onboard I/Os
BG	Slot number	D KF	0 to 7	8
KNKT	Channel number Channel type	D KY	KY=x,y x=0 to 3 y=3 to 6 3: Absolute value repres. (4 to 20 mA) 4: Unipolar representation 5: Bipolar absolute value 6: Bipolar fixed-point no.	KY=x,y x=0 to 7 y=4 Unipolar representation
OGR	Upper limit of the output value	D KF	- 32767 to +32767	
UGR	Lower limit of the output value	D KF	- 32767 to +32767	
EINZ	Single scan	I BI	Not relevant	Single scan is triggered with signal status "1" This bit determines the foll.: 0: Read from process image 1: Direct I/O access
XA	Output value	Q W	Scaled analog value is "0" on wirebreak	Scaled analog value
FB	Error bit	Q BI	"1" in case of wirebreak, illegal channel or slot number or illegal channel type	"1" on illegal channel or slot number or illegal channel type
BU	Range violation	Q BI	1" when nominal range is exceeded	

Scaling Schematic

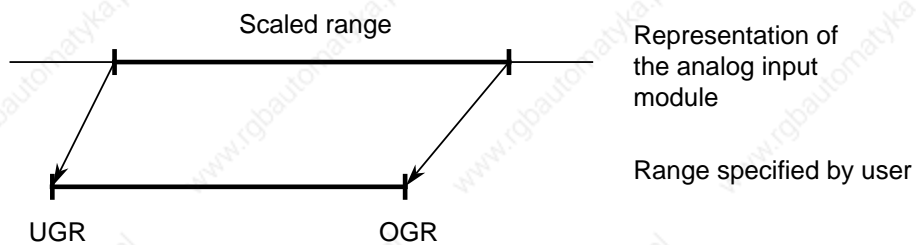

Figure 12-1. Scaling Schematic for FB250

Note

The cyclically read onboard analog inputs of the S5-95U (must be parameterized in DB1) can be read in directly by means of the integrated FB250 (Reading in analog value).

If you still wish to use the integrated FB250 for reading in analog values although the analog inputs are not read cyclically, you have to set the bit "Single scan" for FB250.

12.1.3 Time Required for Reading and Accuracy of the Analog Value Read in

The Table below shows the various possibilities for calculating the time that elapses between the point of reading in the analog value and the access of the user program to the converted value. In order to determine how old an analog value is, you need to know how long it takes to read in an analog value.

Table 12-10. Maximum Duration for Reading in an Analog Value

Possibilities for Reading in Analog Values	Maximum Duration of Input from Onboard I/Os	Maximum Duration of Input from External I/Os
Read analog values from the process image	<ul style="list-style-type: none"> Using the L IW ... operation: Scan time up to and including the L IW operation. Using FB250: Scan time up to and including FB250 	<ul style="list-style-type: none"> Using the L IW ... operation: No. of channels on module x Coding time per input + Scan time up to and including the L IW operation + Operating system runtime + PI transfer time Using FB 250: No. of channels on module x Coding time per input + Scan time including runtime of FB250 + Operating system runtime + PI transfer time
Read analog values via direct I/O access	<ul style="list-style-type: none"> Using L PW ...: Execution time for this operation Using FB250: Exec. time for FB250 	Not possible

The time values for the runtimes specified in Table 12-10 are given in the Operations List (see Appendix A) and Chapter 6.

Accuracy of the Analog Value Read

In order to establish the accuracy of an analog value (actual analog value), you have to calculate the absolute error of the analog value.

Use the formula below to determine the absolute error of the analog value read in:

$$\text{Absolute error} = \text{Nominal analog input value} \cdot \frac{\text{Operational limit in \%}}{100\%}$$

Please refer to the Technical Specifications for the PLC (see Appendix B) or the respective analog input module (see Chapter 15) for nominal value and operational limit of the analog input.

The actual analog value is within the following range:

$$\begin{array}{ccccccc} \text{Value} & & \text{Absolute} & & \text{Actual} & & \text{Value} \\ \text{read} & - & \text{error} & & \text{value} & + & \text{read} \\ & & & & & & \text{error} \end{array}$$

$$\text{Actual value} = \text{Value read} \pm \text{Absolute error}$$

Example: The analog value of 9.7 V was read in at a 4 x ± 10 V analog input module. The nominal value for the analog input is ± 10 V. The operational limit for this module is ± 0.45 %. Determine the accuracy of the analog value.

$$\text{Absolute error} = 10 \text{ V} \cdot \frac{0.45\%}{100\%} = \underline{0.045 \text{ V}}$$

$$\begin{array}{ccc} 9.7 \text{ V} - 0.045 \text{ V} & \text{Actual} & 9.7 \text{ V} + 0.045 \text{ V} \\ & \text{value} & \end{array}$$

$$\text{Actual analog value} = \underline{9.7 \text{ V} \pm 0.045 \text{ V}}$$

The accuracy of the analog value varies within the range of ± 0.045 V.

12.1.4 Using Analog Inputs of the S5-95U as Additional Digital Inputs

By performing the following simple trick, you can also use the analog inputs of the onboard I/Os as digital inputs:

Connect sensors with signal voltages > 10 V to analog inputs of the onboard I/Os (assign channels in ascending order!).

Even when using the analog inputs as digital inputs, you still have to adhere to the installation guidelines for the analog signal leads (e.g. use shielded cables).

Parameterize the analog inputs in DB1 (precondition for cyclic reading).

Program a scan of bit 0 of the input word assigned to the respective analog input in your control program (overflow (OV) bit):

OV bit = 1 Signal state "1"

OV bit = 0 Signal state "0"

In this way, you have eight additional digital inputs at your disposal!

Nota

If you used analog inputs as digital inputs and then use the digital inputs as analog inputs again, accuracy can no longer be guaranteed.

12.2 Output of Analog Values

The bit pattern output by the PLC is converted into analog output voltages or currents at the outputs.

The following Table shows the various possibilities for the output of analog values via onboard I/Os and external I/Os.

Table 12-11. Possibilities for the Output of Analog Values

Possibilities for the Output of Analog Values	Onboard I/Os	External I/Os (Analog Output Module)
Writing analog values into the process image	<ul style="list-style-type: none"> Using the T QW 40 operation or Using FB251 	<ul style="list-style-type: none"> Using the T QW ... operation or Using FB251
Writing analog values to the outputs via direct I/O access	<ul style="list-style-type: none"> Using the T PW 40 operation 	Not possible

12.2.1 General Representation of Analog Output Values

The analog output values are written into two bytes as can be seen in the following Table.

Table 12-12. General Representation of the Analog Output Value as Bit Pattern

	High-Order Byte								Low-Order Byte							
Bit number	7	6	5	4	3	2	1	0	7	6	5	4	3	2	1	0
Analog value represent.	S	2 ¹⁰	2 ⁹	2 ⁸	2 ⁷	2 ⁶	2 ⁵	2 ⁴	2 ³	2 ²	2 ¹	2 ⁰	X	X	X	X

Legend: X Irrelevant bits

Representation of Analog Value Output via Onboard I/Os

The voltages and currents output depending on the units (in QW 40) are listed in Table 12-13. If the value in QW 40 exceeds 1024 units, 10 V (or 20 mA) are automatically output. If the sign bit (bit 7 in the high-order byte) is set (negative value), 0 V (0 mA) will be automatically output.

Table 12-13. Analog Value Representation of Outputs (Onboard I/Os)

Units	Output value		High-Order Byte	Low-Order Byte	Range
	in V	in mA			
1024	10	20	0 1 0 0 0 0 0 0	0 0 0 0 0 0 0 0	Nominal range
512	5.0	10	0 0 1 0 0 0 0 0	0 0 0 0 0 0 0 0	
1	0.0098	0.0195	0 0 0 0 0 0 0 0	0 0 0 1 0 0 0 0	
0	0.0	0.0	0 0 0 0 0 0 0 0	0 0 0 0 0 0 0 0	

Voltage output 0 to 10 V
 Current output 0 to 20 mA

The analog value representation shown in Table 12-13 is necessary for output of the analog value by means of the T QW or T PW operation.

Disadvantages:

- The analog value is not yet scaled for the desired range.
- The method of representation has not yet been fixed for the analog value.

You can bypass these disadvantages by using FB251 for the output of analog values. The following Section describes how to call and parameterize FB251.

Representation of the Analog Value Output via External I/Os

The representation of the analog value and the assignment of units to the voltages and currents output will be described in connection with the relevant modules in Chapter 15.

12.2.2 Outputting Analog Values -FB251-

FB251 allows analog values to be output to analog output modules/onboard analog outputs. In doing so, values from the range between the "UGR" (lower limit) parameter and the "OGR" (upper limit) parameter are converted to the nominal range of the respective module.

FB251 can be used in the S5-95U.
 Execution time of FB251 4.8 ms.

Call of FB251

Table 12-14. Call of FB251

STL	CSF
<pre> : JU FB 251 NAME : RLG.AA XE : BG : KNKT : OGR : UGR : FEH : BU :</pre>	

Table 12-15. Parameter Assignment of FB251

Parameter	Meaning	Type	Assignment	
			External I/Os	Onboard I/Os
XE	Analog value to be output	I W	Input value (two's complement) in the range UGR to OGR	
BG	Slot address	D KF	0 to 7	8
KNKT	Channel number Channel type	D KY	KY=x,y x=0;1 y=0;1 0: Unipolar representation 1: Bipolar fixed-point	KY=x,y x=0 y=0 Unipolar representation
OGR	Upper limit of the output value	D KF	- 32767 to +32767	
UGR	Lower limit of the output value	D KF	- 32767 to +32767	
FEH	Error in limit value setting	Q BI	"1" if UGR = OGR, invalid channel or slot number, or invalid channel type	
BU	Input value exceeds UGR or OGR	Q BI	"1" if XE lies outside limits (UGR; OGR). XE assumes the limit value	

12.2.3 Time Required for Output and Accuracy of the Analog Value Output

The Table below shows the various possibilities for calculating the time required for the output of an analog value.

Table 12-16. Maximum Duration for Outputting an Analog Value

Possibilities for Outputting Analog Values	Maximum Duration of Output to Onboard I/Os	Maximum Duration of Output to External I/Os
Write analog values into the process image	<ul style="list-style-type: none"> Using the T QW operation: Cycle time from the T QW ... operation to the end of the cycle + operating system runtime Using FB251: Cycle time starting from the call of FB251 + execution time of FB251 	<ul style="list-style-type: none"> Using the T QW ... operation: No. of channels on module x Conversion time per output + Cycle time from T QW ... operation to end of cycle + Operating system runtime + PI transfer time Using FB251: No. of channels on module x Conversion time per output + Cycle time from T QW ... operation to end of cycle + Exec. time of FB251 + Oper. system runtime + PI transfer time
Write analog values to the outputs via direct I/O access	<ul style="list-style-type: none"> Using the T PW 40 operation: Execution time of operation + conversion time 	Not possible

The time values for the runtimes specified in Table 12-16 are given in the Operations List (see Appendix A), in the Technical Specifications for the S5-95U (see Appendix B) and Chapter 6.

Accuracy of the Analog Value Output

In order to establish the accuracy of an analog output value (actual analog value), you have to calculate the absolute error of the analog value.

Use the formula below to determine the absolute error of the analog value output:

$$\text{Absolute error} = \frac{\text{Nominal analog output value}}{100\%} \cdot \text{Operational limit in \%}$$

Please refer to the Technical Specifications for the PLC (see Appendix B) or the respective analog output module (see Chapter 15) for nominal value and operational limit of the analog output.

The actual analog value is within the following range:

$$\begin{array}{rcccl} \text{Output} & & \text{Absolute} & & \text{Actual} & & \text{Output} & & \text{Absolute} \\ \text{value} & - & \text{error} & & \text{value} & & \text{value} & + & \text{error} \end{array}$$

$$\text{Actual value} = \text{Output value} \pm \text{Absolute error}$$

Example: The analog value of 6.4 V was output at a $2 \times \pm 10$ V analog output module. The nominal value for the analog output is ± 10 V. The operational limit for this module is $\pm 0.6\%$. Determine the accuracy of the analog value.

$$\text{Absolute error} = 10 \text{ V} \cdot \frac{0.6\%}{100\%} = \underline{0.06 \text{ V}}$$

$$\begin{array}{rcc} 6.4 \text{ V} - 0.06 & \text{Actual} & 6.4 \text{ V} + 0.06 \text{ V} \\ & \text{value} & \end{array}$$

$$\text{Actual analog value} = \underline{6.4 \text{ V} \pm 0.06 \text{ V}}$$

The accuracy of the analog value varies within the range of $\pm 0.06 \text{ V}$.

12.3 Example: Analog Value Processing with FB250 and FB251

There are eight analog inputs and one analog output on the S5-95U. The inputs are preset at the factory so that if no parameters are entered, the inputs can only be read in via a direct I/O access (L PW). If you want to read in the inputs cyclically into the PII, you must first enter parameters in DB1 (see Section 12.1).

Example: You can use a fan to help regulate the temperature in a room. The temperature should fluctuate between 20 and 28 degrees Celsius (68 degrees Fahrenheit and 82 degrees Fahrenheit). The fan speed depends on the room temperature. You can input the room temperature into FB250. You can output the setpoint value for the fan speed in FB251.

Prerequisites:

- You have wired the analog connections (see Section 3).
- You have parameterized an analog input in the default DB1 ("AI1"; see Section 12.1), transferred DB1 to the PLC and switched the PLC from STOP to RUN.

Reading in Analog Values (FB250)

In order to read in the analog value, call up FB250 on the programmer and enter its parameters as they are shown in the example (see Table 12-17). Figure 12-2 shows you how the function block operates. There is an explanation of the individual parameters in Table 12-18.

FB 250 reads in the analog values of analog input channel 0 cyclically and transfers an XA value to the output in the range specified (scaled) by the user (see Figure 12-2).

Table 12-17. Setting Parameters in FB250

STL	Explanation
: JU FB 250 NAME : RLG:AE BG : KF=+8 KNKT KY=0,4 OGR : KF=+280 UGR : KF=+200 EINZ : F 50.0 XA : FW 130 FB : F 120.0 BU : F 121.0	In the temperature range from 20 to 28 degrees Celsius, the analog input (channel number 0) delivers a nominal value from 0 to 10 V (channel type 4). If you assign the value KF = +200 to parameter UGR (lower limit) and the value KF = +280 to the OGR (upper limit), the function block gives the temperature value in 1/10 degrees at the XA output. The value is stored as a fixed-point number in FW 130.

FB250 transforms the range 0 to 10 V into the range 20 to 28° C.

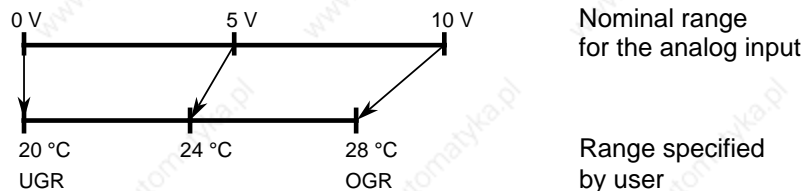

Figure 12-2. Transforming the Nominal Range to a Specified Range

Table 12-18. Parameters for FB250

Parameter	Meaning	Type	Assignment
BG	Slot number	D KF	8 (Onboard I/Os)
KNKT	Channel number Channel type	D KY	KY=x,y x=0 to 7 y=4 Unipolar representation
OGR	Upper limit of the output value	D KF	- 32767 to +32767
UGR	Lower limit of the output value	D KF	- 32767 to +32767
EINZ	Single scan	I BI	Single scan is triggered with signal state "1"
XA	Output value	Q W	Scaled analog value
FB	Error bit	Q BI	"1" if illegal channel number or slot number, or illegal channel type
BU	Range violation	Q BI	"1" if nominal range is exceeded

Outputting an Analog Value (FB251)

In order to output the analog value, call up FB251 on the programmer and assign it parameters as shown in the example (see Table 12-19). Flag word 130 contains the fixed-point number that FB250 calculated. This number is now converted into the RPM setpoint in FB251.

Figure 12-3 shows you how the FB functions. There is an explanation of the individual parameters in Table 12-20.

When FB251 is called it outputs the analog values calculated from the digital values at the analog output channel.

Table 12.19 Entering Parameters for FB251

STL	Explanation
: JU FB 251 NAME : RLG:AQ XE : FW130 BG : KF=8 KNKT : KY=0,0 OGR : KF=1500 UGR : KF=120 FEH : F 120.1 BU : F 121.1	In the range of 120 to 1500 RPM a speed setpoint is to be displayed (corresponding to the nominal range of the analog output). If the parameter UGR is set with the value KF = + 120 and OGR is set with the value KF = + 1500, you can enter the speed setpoint into parameter XE in RPMs. Function Block 251 writes the corresponding value (0 V to 10 V) to the analog output.

FB251 transforms the range + 120 to 1500 RPM into the range 0 to 10 V (nominal range of the analog output)

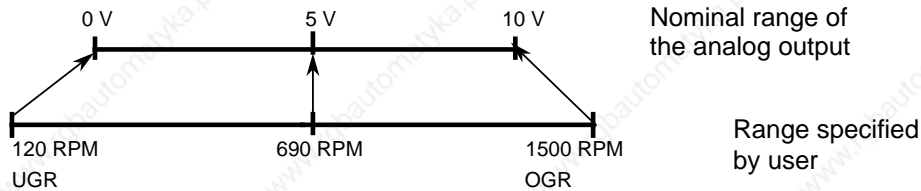

Figure 12-3. Transforming the Specified Range into the Nominal Range

Table 12-20. Parameters for FB251

Parameter	Meaning	Type	Assignment
XE	Analog value to be output	I W	Input value (2's complement) in the UGR to OGR range
BG	Slot number	D KF	8 (for onboard I/Os)
KNKT	Channel number Channel type	D KY	KY=x,y x=0 (for onboard I/Os) y=0 unipolar representation
OGR	Upper limit of the output value	D KF	- 32767 to +32767
UGR	Lower limit of the output value	D KF	- 32767 to +32767
FEH	Error in the limit value setting	Q BI	"1" if UGR = OGR, for invalid channel or slot number, or invalid channel type
BU	Input value exceeds UGR or OGR	Q BI	"1" if XE is outside the range (UGR; OGR). XE accepts the limit value

Duration of Input and Output of the Analog Value

Reading the analog value from the PII by means of FB250 takes max. 5.9 ms (cf. Table 12-10).
Output of the analog value to the PIQ by means of FB251 takes max. 5 ms (cf. Table 12-16).

Accuracy of the Analog Value

1. Input Value:

Value read = 5 V

Nominal analog input value = 10 V

Operational limit = 1.68 V

$$\text{Absolute error} = 10 \text{ V} \cdot \frac{1.68\%}{100\%} = \underline{0.168 \text{ V}}$$

$$5 \text{ V} - 0.168 \quad \text{Actual value} \quad 5 \text{ V} + 0.168 \text{ V}$$

$$\text{Actual value} = \underline{5 \text{ V} \pm 0.168 \text{ V}}$$

The accuracy of the analog value read in varies within the range of + 0.168 V corresponding to $\pm 0.8^\circ\text{C}$.

2. Output Value:

Analog value output = 5 V

Nominal analog output value = 10 V

Operational limit = 1.0%

$$\text{Absolute error} = 10 \text{ V} \cdot \frac{1.0\%}{100\%} = \underline{0.1 \text{ V}}$$

$$5 \text{ V} - 0.1 \quad \text{Actual value} \quad 5 \text{ V} + 0.1 \text{ V}$$

$$\text{Actual value} = \underline{5 \text{ V} \pm 0.1 \text{ V}}$$

The accuracy of the analog value output varies within the range of $\pm 0.1 \text{ V}$ corresponding to **$\pm 13.8 \text{ RPM}$** .

13 Integral Real-Time Clock (only in the S5-95U)		
13.1	Function	13- 1
13.2	Structure of the Clock Data Area	13- 2
13.3	Structure of the Status Word and How to Scan it	13- 5
13.4	Backup of the Hardware Clock	13- 7
13.5	Setting Parameters in DB1	13- 8
13.5.1	Setting the Clock in DB1	13- 10
13.5.2	Setting the Prompt Time in DB1	13- 10
13.5.3	Setting the Operating Hours Counter in DB1	13- 11
13.5.4	Entering the Clock Time Correction Factor in DB1	13- 11
13.6	Programming the Integral Real-Time Clock in the User Program ...	13- 12
13.6.1	Reading and Setting the Clock	13- 12
13.6.2	Programming the Prompt Function	13- 16
13.6.3	Programming the Operating Hours Counter	13- 21
13.6.4	Entering the Clock Time Correction Factor	13- 26

Figures		
13-1	How DB1 or the Control Program and the Clock Access the Clock Data Area	13- 2
13-2	DB1 with Default Parameters for the Integral Real-Time Clock of the S5-95U Basic Unit	13- 8
13-3	Example - Setting the Clock in DB1	13- 10
13-4	Example - Setting the Prompt Time in DB1	13- 10
13-5	Example - Setting the Operating Hours Counter in DB1	13- 11
13-6	Example - Entering a Correction Factor in DB1	13- 11
13-7	Flowchart - Transferring a New Prompt Time	13- 17
13-8	Flowchart - Transferring Settings to the Operating Hours Counter	13- 22
Tables		
13-1	Clock Data in the Clock Data Area	13- 3
13-2	Range Definitions for Clock Data	13- 4
13-3	Significance of the Bits of the Status Word	13- 5
13-4	Reading the Current Clock Time and Current Date	13- 9
13-5	DB1 Parameters for the Integral Real-Time Clock	13- 9

13 Integral Real-Time Clock (only in the S5-95U)

13.1 Function

The integral real-time clock (hardware clock) offers the following possibilities of controlling the process sequence.

- Clock and calendar function
used to configure clock-time dependent control, for example.
- Prompt and alarm function
used to monitor the duration of a process, for example.
- Operating hours counter
used to monitor inspection intervals, for example.

In order to be able to use the integral clock, you must assign the corresponding parameters in DB1 or program it in the control program.

Programming of the clock in the control program should be reserved to users with an extensive system knowledge (see Section 13.6). All other users are recommended to assign the relevant parameters of the clock in DB 1 (see Section 13.5).

The integral hardware clock requires a clock data area and a status word in order to function. The following information must be stored in DB 1 or, when programming the clock in the control program, in the system data 8 to 10 (see Appendix B):

- Location of the clock data area
- Location of the status word

Operating Principle

Data exchange between the integral real-time clock and the control program always goes through the clock data area. The clock stores current values for time, date, and operating hours counter in the clock data area. You can transfer into the clock data area the values for the time, date, prompt time, and operating hours counter that you want the clock to use.

You can scan the status word to identify setting errors, for example. Or you can change certain status word bits to deliberately disable or enable transfer or read operations.

The clock data area and the status word can have the following locations:

- Data block
- Flag area
- Input area
- Output area

Refer to Sections 13.2 and 13.3 for additional information about the clock data area and the status word.

13.2 Structure of the Clock Data Area

You need only to change the default values in DB1 to program the clock in DB1. See section 13.5. During start-up, the DB1 interpreter writes all information into the system data area (for system data assignment through integral clock see Appendix B).

Data exchange between DB1 and the integral real-time clock is always through the clock data area. On the one hand, the integral real-time clock stores current time, date, and operating hours counter values in the clock data area (flag area, data block, input area, or output area). On the other hand, DB1 stores the settings for prompt times and operating hours counters in the same data area.

The control program can read or write only the clock data area. The control program can never access the clock directly. Figure 13-1 illustrates the relationship between DB1 or the control program, the clock data area, and the integral real-time clock.

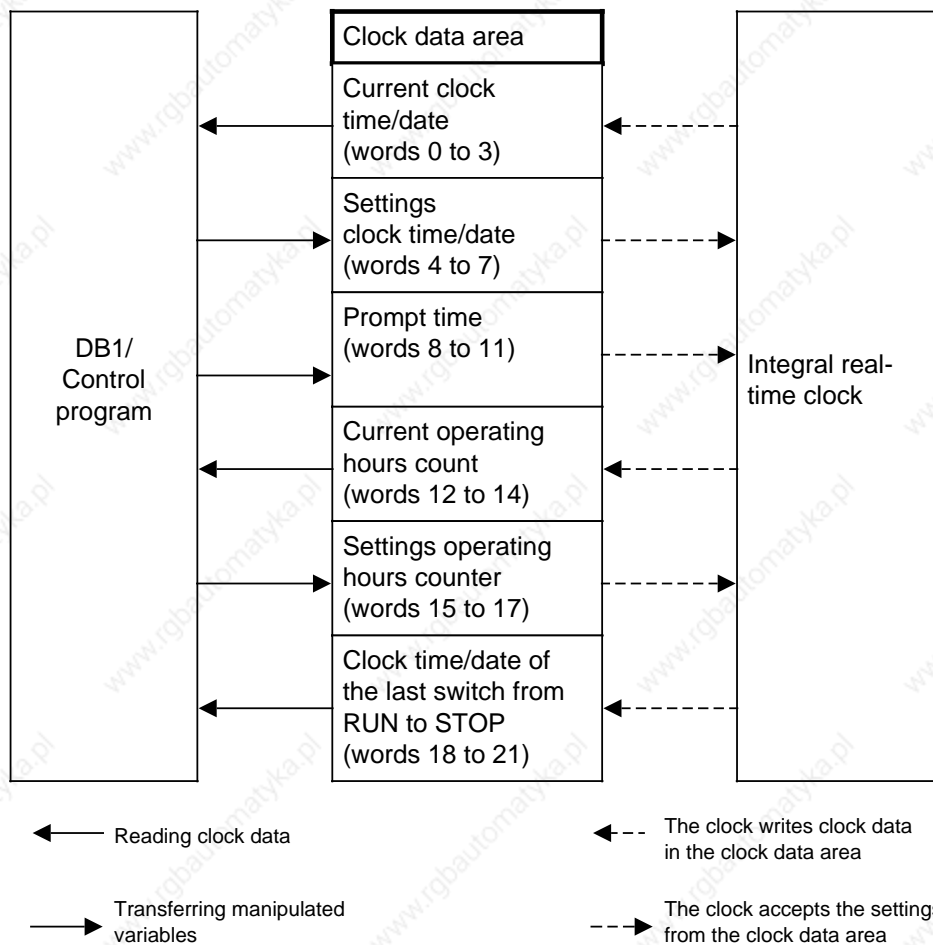

Figure 13-1. How DB1 or the Control Program and the Clock Access the Clock Data Area

Note

The time in the clock data area is updated each time after 1 s at the beginning of the next program cycle (at the cycle checkpoint). Reading clock data in OB 22 leads to faulty values.

Table 13-1 provides you with information about where specific clock data is located within the clock data area.

If the clock data area is located

- in a data block, then the word numbers in the table apply,
- in the flag, input or outputs areas, then the byte numbers apply.

The explanations on the entries in the clock data area follow Table 13-1.

Table 13-1. Clock Data in the Clock Data Area

Clock Data Area		Meaning	Left Word or Low Byte	Right Word or High Byte
Word No.	Byte No.			
0	0; 1	Current clock time/ Current date *	---	Weekday
1	2; 3		Day	Month
2	4; 5		Year	AM/PM (Bit 7), Hour
3	6; 7		Minute	Second
4	8; 9	Settings for clock time/date	---	Weekday
5	10;11		Day	Month
6	12;13		Year	AM/PM (Bit 7) **, Hour
7	14;15		Minute	Second
8	16;17	Time prompt	---	Weekday
9	18;19		Day	Month
10	20; 21		---	AM/PM (Bit 7) **, Hour
11	22; 23		Minute	Second
12	24; 25	Current operating hours	---	Seconds
13	26; 27		Minutes	Hours
14	28; 29		Hours · 100	Hours · 10,000
15	30; 31	Settings for operating hours counter	---	Seconds
16	32; 33		Minutes	Hours
17	34; 35		Hours · 100	Hours · 10,000
18	36; 37	Clock time/date after a switch from RUN to STOP or Power OFF (only if bit 5 in the status word 5=1)	---	Weekday
19	38; 39		Day	Month
20	40; 41		Year	AM/PM (Bit 7), Hour
21	42; 43		Minute	Second

* Leap years are taken into account; there is no automatic changeover between summer and winter time.

** Significant only in the 12-hour mode Bit 7=1 means PM; Bit 7=0 means AM

Make certain you are aware of the following information when you make inputs into the clock data area:

- Entries into the clock data area must be in BCD code.
- The clock runs either in the 12-hour mode or the 24-hour mode depending on how you set bit 1 in the status word. See Section 13.3 for additional information.
- The AM/PM flag (0 = AM, 1 = PM) is significant only for the 12-hour mode of the hardware clock. Bit 7 corresponds to the following words: word 2, word 6 word 10, word 20. In the 12-hour mode, you have to set the hours and the AM/PM flag the same way for the clock and prompt functions. In the 24-hour mode, if you set an AM/PM flag when you enter the values for the clock and prompting time, then the program sets the relevant error bit.
- The clock settings you enter must be within the range defined in Table 13-2.

Table 13-2. Range Definitions for Clock Data

Variable	Permissible Parameters	Variable	Permissible Parameters
Seconds	0 to 59	Day	1 to 31
Minutes	0 to 59	Month	1 to 12
Hours	in the 24-hour mode: 0 to 23 in the 12-hour mode: for AM 1 to 12 (12=12 o'clock noon) for PM 1 to 12 (12=1 o'clock PM) 0 to 999999 when entering the operating hours	Year	0 to 99
		Weekday	1 to 7 1=Sunday 2=Monday 3=Tuesday 4=Wednesday 5=Thursday 6=Friday 7=Saturday

If your inputs differ from the ones described, the operating system outputs error messages that are displayed in the status word. The operating system resets error messages displayed in the status word the next time you set the clock, prompt time, or the operating hours counter, if the new settings are within the definition range. See Section 13.3.

- When you set the clock, you need to enter only the data which is required for the implementation of the individual function. If you wish, for example, to change only the clock function, you need not input the data for the prompt function or for the operating hours counter.
- If the clock data area is located at the end of other areas (flags, data blocks, inputs, and outputs), the amount of clock data transferred is only as much as will fit in the area available. Settings are not accepted if they lie outside of the available range.
- If clock data is located in the non-retentive flag area, then all the settings are lost after Power OFF, and the time the last switch from RUN to STOP occurred is lost.
- Remember that you can determine where the clock data area is located. The word numbers and byte numbers listed in Table 13-1 are relative.

If your clock data area is located in a data block and does not begin with DW0 but DWX, then you must add the value X to the word number shown in Table 13-1. The same applies for the flag, input and output areas.

Example: Your clock data area begins with DW124. The data for the time and date is then stored in DW124 to DW127.

13.3 Structure of the Status Word and How to Scan it

You can scan the status word to identify errors in the entered settings. You can deliberately change certain bits in the status word to enable or disable transfer or read operations.

- The status word can be located in the flag area, input area or output area or in a data block. You must define the location of the status word in DB1. See Section 13.5.
- There are four types of bits in the status word:
 - Clock flags
 - Operation system flags
 - Operating hours counter flags
 - Prompt time flags

Table 13-3 provides you with information about the significance of the signal states of the respective flags. Explanations about resetting of certain bits in the status word follow Table 13-3.

Table 13-3. Significance of the Bits of the Status Word

Flags	Bit No.	Read/Overwrite Bit ?	Signal State	Meaning
Clock flags	0	Read	1	Error in setting entry
			0	No error in setting entry
	1	Read and overwrite	1	12-hour clock mode
			0	24-hour clock mode
	2	Read and overwrite	1	Transfer settings
			0	Do not transfer settings
3	-	irrelev.	Occupied by the operating system of the PLC	
Operating system flags	4	Read and overwrite	1	PLC in RUN mode The clock continually updates the clock data area (words 0 to 17).
				PLC in STOP mode The clock updates only words 0 to 3 in the clock data area (current time/current date). You can set the clock by using the FORCE VAR programmer function.
			0	PLC in RUN mode The clock updates the clock data area (words 0 to 17).
				PLC in STOP mode The clock does not update the clock data area. Words 0 to 3 contain the time at which the last switch from RUN to STOP occurred.

Table 13-3. Significance of the Bits of the Status Word (Continued)

Flags	Bit No.	Read/Overwrite Bit?	Signal State	Meaning
Operating system flags	5	Read and overwrite	1	Words 0 to 3 are saved in words 18 to 21 when a switchover from RUN to STOP or a POWER OFF occurs.
			0	Words 18 to 21 are not used
	6	-	irrelev.	Occupied by the operating system of the PLC
	7	-	irrelev.	Occupied by the operating system of the PLC
Operating hours counter flags	8	Read	1	Error in setting entry
			0	No error in setting entry
	9	Read and overwrite	1	Enable operating hours counter
			0	Disable operating hours counter
	10	Read and overwrite	1	Transfer settings
			0	Do not transfer settings
	11	-	irrelev.	Occupied by the operating system of the PLC
Prompting time flags	12	Read	1	Error in setting entry
			0	No error in setting entry
	13	Read	1	Set prompting time is reached
			0	Set prompting time is not reached
	14	Read and overwrite	1	Transfer settings
			0	Do not transfer settings
	15	-	irrelev.	Occupied by the operating system of the PLC

- The operating system resets the "transfer settings" bits (bits 2, 10, and 14 in the status word) under the following conditions.
 - The settings have been transferred.
 - The settings have not been transferred because they were outside of the permissible range. The corresponding error bit (bits 0, 8, and 12 in the status word) is set.
- The operating system does **not** reset the "transfer settings" bits (bits 2, 10, and 14 in the status word) under the following conditions.
 - The system data for the clock is either incorrect or not available.
 - The clock data area is too small.
 - The clock is defective (hardware error).

Scanning the Status Word

In a data block, you can use the "P <data word number> <bit number>" operation to scan the individual bits of a data word. In the flag area, you can scan the individual bits if you enter the <byte address> and the <bit number>.

Example: The status word is stored in DW13. You are checking to see if the set prompting time has been reached.
The "P D 13.13" instruction triggers a scan.
If the status word is stored in FW12, then the same scan would be "A F 12.5".

13.4 Backup of the Hardware Clock

If there is a backup battery, the clock continues to run even after Power OFF. If the programmable controller does not have a backup battery, the clock values will be set at "October 1, 1991, 12.00.00 o'clock, weekday: 3" when the clock is initialized after a Power ON. The default is the 24-hour time mode. You should install a battery only during Power ON; otherwise, you would lose the clock data.

13.5 Setting Parameters in DB1

You must set the clock parameters in DB1 to be able to use the clock functions. Follow the same rules you used in setting parameters for other functions in DB 1 (see Section 9.4).

After having performed an overall reset, output default DB1 to the programmer.

The real-time clock has the following parameter block:

```

84:    KC  =' 100    ; #CLP: STW MW10';
96:    KC  =' 2      CLK DB5 DW0    ';
108:   KC  =' SET 3  01.10.91 12:00:00';
120:   KC  =' 00    OHS 000000:00:00  ';
132:   KC  =' TIS 3  01.10. 12:00:00  ';
144:   KC  =' STP Y SAV Y CF 00    ';
156:   KC  =' ; #END  ':

```

Fig. 13-2. DB1 with the Default Parameters for the Integral Real-Time Clock of the S5-95U Basic Unit

Use the cursor to jump into the parameter block "CLP:".
Delete the two comment characters (#) in front of "CLP" and "END".
Change the clock parameters.

After the CLP block ID for the integral real-time clock, the STW parameter specifies the location of the status word (in flag word MW102, for example). The CLK parameter defines the location of the clock data (in DB5 beginning with DW0, for example).

You must specify both parameters if you want to read the clock. The following section describes the procedures you must follow to read the clock.

Transfer the changed DB 1 to the programmable controller.

If you have stored the status word or the clock data area in a data block, then generate the DB with a sufficient length and transfer it to the programmable controller.

Switch the programmable controller from STOP to RUN.

Every time there is a change from STOP to RUN, the programmable controller accepts the new clock data.

Note

The programmable controller accepts the clock data on a STOP to RUN switchover only if one of the DB 1 parameters "SET", "OHS" or "TIS" has been changed.
This mechanism ensures, that the clock setting cannot be changed unintentionally by a STOP to RUN switchover

In order to see how and with which values the clock runs, you can monitor the clock data area with the programmer function "STATUS VAR".

You receive, for example:

Table 13-4. Reading the Current Clock Time and Current Date

Operand	Signal States	Explanation
DB 5		
DW 0	KH = 0003	Tuesday
DW 1	KH = 0110	October 1
DW 2	KH = 9112	1991, 12:00
DW 3	KH = 0000	(00 min; 00 s)

DB1 Parameters Used for the Integral Real-Time Clock

Table 13-5. DB1 Parameters for the Integral Real-Time Clock

Parameter	Argument	Meaning
Block ID: CLP:		Clock Parameters
STW	DBxDWy, MYz,EWV or AWV	Location of the status word (STatus Word)
CLK	DBxDWy, MWz,EWV or AWV	Location of the clock data (CLocK Data)
SET	wd dd.mm.yy hh:mn:ss ¹ AM/PM ²	Setting the clock time and date
OHS	hhhhhh:mn:ss ¹	Setting the operating hours counter (Operating Hours counter Set)
OHE	J/Y/N	Enabling the operating hours counter (Operating Hours counter Enable)
TIS	wd dd.mm. hh:mn:ss ¹ AM/PM ²	Setting the prompt time (Timer Set)
STP	J/Y/N	Updating the clock during STOP (SToP) ³
SAV	J/Y/N	Saving the clock time after the last change from RUN to STOP or Power OFF (SAVe)
CF	p	Entering the correction factor (Correc-tion Factor)
wd	=1 ... 7 (weekday = So ...Sa)	p= - 400 ... 400
dd	=01 ... 31 (day)	v=0 ... 126
mm	=01 ...12 (month)	x = 2 ... 255
yy	=0 ... 99 (year)	y=0 ... 255
hh	=00 ... 23 (hours)	z=0 ... 254
mn	=00 ... 59 (minutes)	j/J=yes
ss	=00 ... 59 (seconds)	y/Y=yes
hhhhhh	=0 ... 999999 (hours)	n/N=no

¹ If an argument such as seconds, for example, is not to be entered or changed, enter XX. The clock continues to run with the current data. In the "TIS" parameter block, the clock does not acknowledge the argument entered by "XX" (is not available).

² If you enter AM or PM after the clock time, the clock runs in the 12-hour mode. If you omit this argument, the clock runs in the 24-hour mode. You must use the same time mode in the SET and TIS parameter blocks.

³ If the program is monitored with an operator panel, such as OP 20, it is advantageous that the programmable controller updates the clock data area also in the STOP mode.

The following sections contain examples for programming the clock. Adhere to the rules described in Section 9.4 for setting parameters when you enter these examples into the programmable controller.

Note

If the programmable controller recognizes a parameter setting error in DB1, the programmable controller remains in the STOP mode even after it has been switched from STOP to RUN. The red LED is lit.

13.5.1 Setting the Clock in DB1

Setting the Clock		Explanation
84:	KS = ' 100 ; CLP: STW MW10 ' ;	The status word is located in flag word MW102. The clock data is stored in data block 5 beginning with data word DW0. After the SET parameter, enter the weekday, the date, and the clock time you want the clock to use when it begins running. Be certain to include the blank spaces. The clock runs in the 24-hour time mode since you do not enter either AM or PM.
96:	KS = ' 2 CLK DB5 DW0 ' ;	
108:	KS = ' SET 6 08.11.91 15:30 ' ;	
120:	KS = ' 00 OHS 000000:00:00 ' ;	
144:	KS = ' STP Y SAV Y CF 00 ' ;	The clock is updated when the programmable controller is in STOP. The clock time of the last RUN to STOP switchover is saved in the clock data area. See Table 13-1.

Figure 13-3. Example - Setting the Clock in DB1

13.5.2 Setting the Prompt Time in DB1

Setting the Prompt Time		Explanation
84:	KS = ' 100 ; CLP: STW MW10 ' ;	The status word is in flag word MW102. The clock data is stored in data block DB5 beginning with data word DW0.
96:	KS = ' 2 CLK DB5 DW0 ' ;	
132:	KS = ' TIS 3 07.01 09:00:00 ' ;	After the TIS parameter, enter the weekday, the data, and the clock time to initiate the prompt time. You can enter the parameter for the clock mode. The clock in the example runs in the 12-hour mode.
144:	KS = ' AM STP Y SAV Y CF 00 ' ;	The clock data area is updated when the programmable controller is in STOP. The clock time of the last RUN to STOP switchover is saved in the clock data area. Refer to Table 13-1.

Figure 13-4. Example - Setting the Prompt Time in DB1

13.5.3 Setting the Operating Hours Counter in DB1

The programmable controller has been replaced. You set the start value for the operating hours counter at 1600 hours.

Setting the Operating Hours Counter		Explanation
84:	KS = ' 100 ; CLP: STW MW10 ' ;	The status word is located in flag word MW102.
96:	KS = ' 2 ; CLK DB5 DW0 ' ;	The clock data is stored in data block DB5 beginning with data word DW0.
.	.	
120:	KS = ' 00 OHS 1600:00:00 ' ;	After the OHS parameter, enter the start value for the operating hours counter.
.	.	
144:	KS = ' STP Y SAV Y CF 00 ' ;	The clock data area is updated when the programmable controller is in STOP. The time of the last RUN to STOP switchover is saved in the clock data area. Refer to Table 13-1. The operating hours counter is enabled.
156:	KS = ' OHE Y ; END ' ;	OHE is not a default parameter; that is, you must enter it completely.

Figure 13-5. Example - Setting the Operating Hours Counter in DB1

13.5.4 Entering the Clock Time Correction Factor in DB1

The exactness of the clock is temperature-dependent. You can configure a correction value to increase the clock's exactness. The correction value is output in s/month. You must measure how many seconds per month the clock runs fast or slow. A month is defined as 30 days.

Example: Your measurements indicate the clock is 12 s too slow in four days. That would be 90 s too slow in 30 days. The correction value is +90 s/month.

In addition to the changed clock parameters, enter the example into DB1 as follows:

Enter the Clock Time Correction Factor		Explanation
156:	KS = ' STP Y SAV Y CF +90 ' ;	The correction value of +90 s is loaded into the clock.

Figure 13-6. Example - Entering a Correction Factor in DB1

13.6 Programming the Integral Real-Time Clock in the User Program

The programming of the clock in the user program should be performed only by users with extensive knowledge of the system. For all other users, use of DB1 is recommended (see Sections 13.5 and 13.6). The following section provides you with information on how to access the clock through the user program.

13.6.1 Reading and Setting the Clock

Example: Program for setting the time and date

Transfer of the settings for the time and date is triggered by input I 32.0. Before you set input I 32.0 (see OB1), you must transfer these settings to flag bytes FY120 to FY127. Values that you do not want to change must be preset with "FF_H". You can define the clock mode with input I 33.0 (1 = 12-hour mode). Input I 32.1 is the AM/PM bit that you use for setting the 12-hour mode.

The clock data area is located in DB2 beginning with DW0, and the status word is FW10.

OB1 STL	Explanation
:	=====
:	SETTING THE TIME AND DATE
:	=====
:	FIRST TRANSFER TIME AND DATE VALUES
:	INTO FB120 TO FB127.
:U E 32.0	CLOCK SETTING TRIGGERED
:S M 20.0	BY SETTING F 20.0 (RESET IN FB10)
:	
:SPA FB 10	
NAME :UHR-STEL	
WDAY : MB 121	WEEKDAY
DAY : MB 122	DAY
MON : MB 123	MONTH
YEAR : MB 124	YEAR
HOUR : MB 125	HOUR
AMPM : E 32.1	AMPM-BIT (ONLY IMPORTANT IN 12-HOUR MODE)
MIN : MB 126	MINUTES
SEC : MB 127	SECONDS
ERR : M 12.1	ERROR BIT
MODE : E 33.0	12 HOUR-MODE: I 33.0 = 1
:BE	

FB10 STL	Explanation
NAME :UHR-STEL	SETTING THE CLOCK
DES :WDAY I/Q/D/B/T/C: I BI/BY/W/D: BY	
DES :DAY I/Q/D/B/T/C: I BI/BY/W/D: BY	
DES :MON I/Q/D/B/T/C: I BI/BY/W/D: BY	
DES :YEAR I/Q/D/B/T/C: I BI/BY/W/D: BY	
DES :HOUR I/Q/D/B/T/C: I BI/BY/W/D: BY	
DES :AMPM I/Q/D/B/T/C: I BI/BY/W/D: BI	
DES :MIN I/Q/D/B/T/C: I BI/BY/W/D: BY	
DES :SEC I/Q/D/B/T/C: I BI/BY/W/D: BY	
DES :ERR I/Q/D/B/T/C: Q BI/BY/W/D: BI	
DES :MODE I/Q/D/B/T/C: I BI/BY/W/D: BI	
:A =MODE	24HR-MODE = 0, 12HR-MODE = 1
: = F 11.1	(CLOCK MODE STATUS WORD BIT 1)
:AN F 20.0	FLAG IS RESET IF SETTINGS ALREADY
:JC =M001	READ INTO CLOCK DATA AREA
:R F 20.0	
:	
:C DB 2	CLOCK DATA AREA
:L =WDAY	STORE VALUE FOR WEEKDAY
:T DR 4	
:L =DAY	STORE VALUE FOR DAY
:T DR 5	
:L =MON	STORE VALUE FOR MONTH
:T DR 5	
:L = YEAR	STORE VALUE FOR YEAR
:T DL 6	
:L =HOUR	STORE VALUE FOR HOUR
:ON =AMPM	IF 12-HOUR MODE IS SET, AND
:ON =MODE	AM/PM BIT = 1 (AFTERNOON), THE
:JC =MORN	RELEVANT BIT IN THE CLOCK AREA
:L KH 0080	IS SET
:OW	
MORN :T DR 6	
:L =MIN	STORE VALUE FOR MINUTES
:T DL 7	
:L =SEC	STORE VALUE FOR SECONDS
:T DR 7	
:AN F 11.2	TRANSFER SETTINGS
:S F 11.2	(STATUS WORD IS FW10)
:L KT 020.1	START MONITORING TIME
:SE T 10	
M001 :A T 10	BEC, IF MONITORING TIME
:BEC	NOT YET ELAPSED

FB10 STL (continued)	Explanation
<pre> :AN F 11.2 :JC =M002 :S =ERR :BEU M002 :AN F 11.0 :R =ERR :BEC :S =ERR :BE </pre>	<pre> HAVE SETTINGS BEEN TRANSFERRED? IF YES, JUMP TO M002 SET ERROR BIT IF THERE ARE ERRORS WERE THERE ERRORS WHILE ENTERING SETTINGS? IF NO, RESET ERROR BIT IF NO ERROR, THEN BEC IF AN ERROR, SET ERROR BIT </pre>

Example: Program for reading the current time and the current date

The time is stored in flag bytes FY30 to FY36, depending on an external event, simulated here by a positive edge at input I 32.5. Flag F 13.1 indicates which mode the clock is operating in. Flag F 13.0 is the AM/PM bit in the 12-hour mode.

The clock data area is located in DB2 beginning with DW0, and the status word is FW10.

OB1 STL	Explanation
<pre> : : : :A I 32.5 :AN F 0.1 := F 0.0 :A I 32.5 := F 0.1 : :A F 0.0 :JC FB 13 NAME :UHR-LES WDAY : FY 30 DAY : FY 31 MON : FY 32 YEAR : FY 33 HOUR : FY 34 AMPM : F 13.0 MIN : FY 35 SEC : FY 36 MODE : F 13.1 :BE </pre>	<pre> ===== READING TIME AND DATE ===== TIME AND DATE ARE STORED IN FY30 TO FY36 IN CASE OF A POSITIVE EDGE AT I 32.5. (EXTERNAL EVENT) EDGE TRIGGER FLAG (READING TIME AND DATE) WEEKDAY DAY MONTH YEAR HOUR F 13.0 = 1, AFTERNOON IN 12H-MODE MINUTES SECONDS F 13.1 = 1, IN 12-HOUR MODE </pre>

FB13 STL	Explanation
NAME :UHR-LES	READING THE CLOCK
DES :WDAY I/Q/D/B/T/C: Q BI/BY/W/D/:BY	
DES :DAY I/Q/D/B/T/C: Q BI/BY/W/D/:BY	
DES :MON I/Q/D/B/T/C: Q BI/BY/W/D/:BY	
DES :YEAR I/Q/D/B/T/C: Q BI/BY/W/D/:BY	
DES :HOUR I/Q/D/B/T/C: Q BI/BY/W/D/:BY	
DES :AMPM I/Q/D/B/T/C: Q BI/BY/W/D/:BI	
DES :MIN I/Q/D/B/T/C: Q BI/BY/W/D/:BY	
DES :SEC I/Q/D/B/T/C: Q BI/BY/W/D/:BY	
DES :MODE I/Q/D/B/T/C: Q BI/BY/W/D/:BI	
:C DB 2	
:L DR 0	WEEKDAY
:T =WDAY	
:L DL 1	DAY
:T =DAY	
:L DR 1	MONTH
:T =MON	
:L DL 2	YEAR
:T =YEAR	
:L DR 2	HOUR
:L KH 007F	ERASE AM/PM BIT
:AW	(ONLY RELEVANT IN 12-HOUR MODE)
:T =HOUR	
:TB D 2.7	DISPLAY AM/PM BIT
: = =AMPM	(ONLY RELEVANT IN 12-HOUR MODE)
:L DL 3	MINUTE
:T =MIN	
:L DR 3	SECOND
:T =SEC	
:A F 11.1	DISPLAY CLOCK MODE
: = =MODE	MODE = 1, IN 12-HOUR MODE
:BE	

Storing the Updated Time/Date after a RUN to STOP Switch

Note

This clock data area is only written to if the following requirements are met.

- Bit 5 in the status word is set to "1".
- A RUN to STOP switch or a Power OFF has taken place.
- The necessary memory space is available in the operand area.

This enables you to detect a RUN to STOP switch or a Power OFF even if the programmable controller has since gone back to RUN mode. The time and date of the last RUN to STOP switch or Power OFF are in words 18 to 21 (see Table 13-1)

If several RUN to STOP switches have occurred before you read out this clock data area, you will only be able to determine the time of the last switch.

If you do not have sufficient memory for this clock data area, you either cannot use this area or use only part of it. This has no impact on anything else.

13.6.2 Programming the Prompt Function

Transferring Settings to the Clock

- You can store the settings in the clock data area by using transfer operations (see Table 13-1).
- The AM/PM flag (bit number 7) is only significant in 12-hour mode.
Bit 7=1 means PM
Bit 7=0 means AM
- You must transfer the clock data in BCD code.
The "KC" data format loads a BCD constant into ACCU 1 and is therefore especially suitable.
- If you enter the value "255_D" or "FF_H" in a byte as the prompt time, this byte will be ignored when evaluating "Prompt time reached". This makes it easy to program, for example, an alarm that is repeated daily by entering the value in the "255_D" or "FF_H" in the "Weekday", "Date" and "Month" settings.
- You can transfer the prompt time settings to the clock by initiating bit 14 in the status word.
- The settings are transferred 1 second after the start of the next cycle.
- Bit 12 in the status word displays incorrect settings.

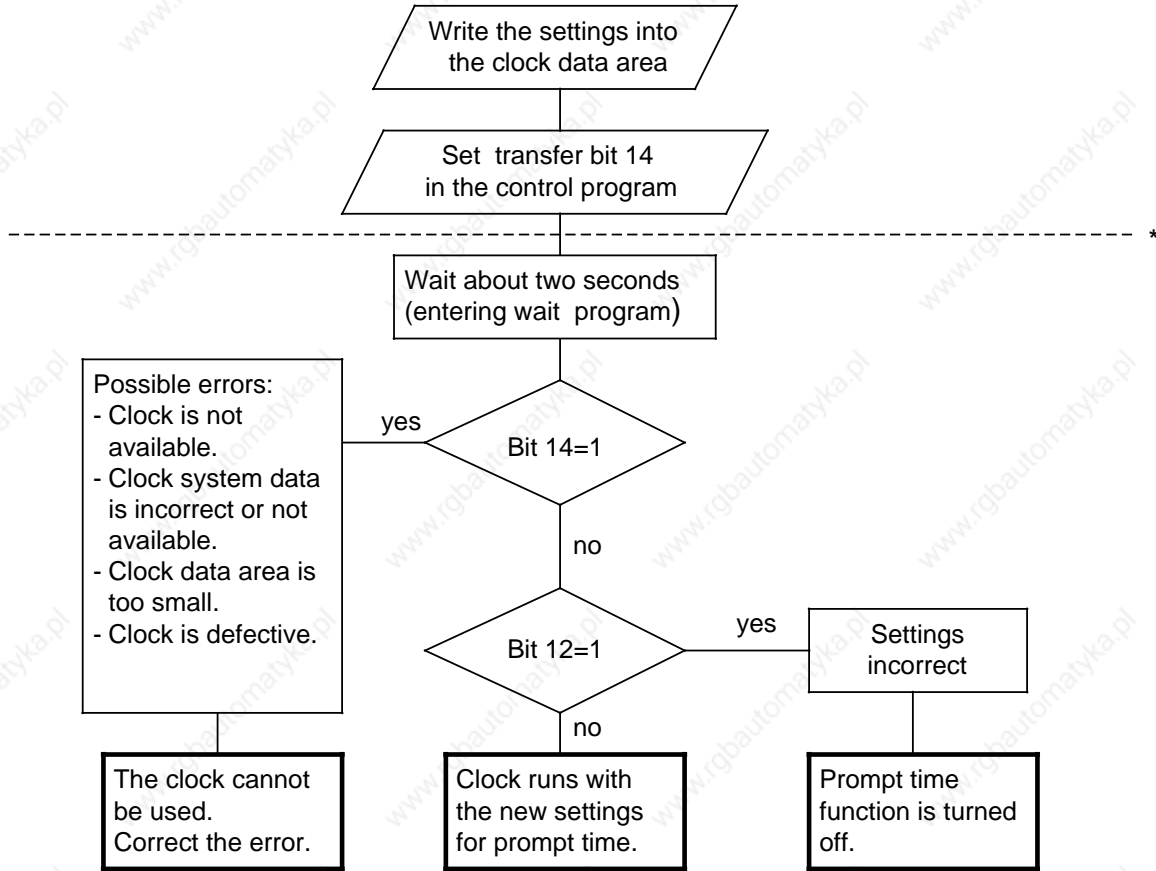

* The lower part of the flow chart has only a diagnostic function. There is nothing you must perform.

Figure 13-7. Flowchart - Transferring a New Prompt Time

Prompt Time Sequence

- Bit 13 in the status word is set after the prompt time has elapsed.
- Bit 13 remains set until you reset it in the control program.
- The prompt time can be read at any time.



Caution

If the prompt time is reached in the STOP mode or during Power OFF, the prompt time cannot be evaluated. It is always deleted on restart.

Example: Setting and evaluating the prompt time

In the example program, the status of input I 32.6 determines whether the settings for the prompt time are transferred. Before setting input I 32.6, you must transfer the settings to flag bytes FY130 and FY135. Enter values that you do not wish to be evaluated as FF_H.

You set the clock mode with input I 33.0. Use input I 32.1 to specify the the AM/PM bit for 12-hour mode.

If the preset prompt time has been reached, set flag F 13.2. Any errors made while entering the prompt time are displayed in flag F 12.2.

The clock data is stored in DB2 beginning with data word DW0, and the status word is flag word FW10.

OB1 STL	Explanation
:	=====
:	SETTING AND EVALUATING THE PROMPT TIME
:	=====
:	LOAD VALUES INTO FY130 TO FY135
:	FIRST.
:A I 32.6	TRIGGER SETTING OF PROMPT TIME
:S F 20.1	BY SETTING F 20.1 (RESET IN FB11)
:JU FB 11	
NAME :WECKZ-ST	(SET AND EVALUATING PROMPT TIME)
WDAY : FY 130	WEEKDAY
DAY : FY 131	DAY
MON : FY 132	MONTH
HOUR : FY 133	HOUR
AMPM : I 32.1	AMPM-BIT (ONLY IMPORTANT IN 12-HOUR MODE)
MIN : FY 134	MINUTES
SEC : FY 135	SECONDS
ERR : F 12.2	ERROR BIT
ALRM : F 13.2	DISPLAYS THAT PROMPT TIME IS REACHED.
MODE : I 33.0	12-HOUR MODE: I 33.0 = 1
:BE	

FB11 STL	Explanation
NAME :WECKZ-ST	SETTING THE PROMPT TIME
DES :WDAY I/Q/D/B/T/C: I BI/BY/W/D: BY	
DES :DATE I/Q/D/B/T/C: I BI/BY/W/D: BY	
DES :MON I/Q/D/B/T/C: I BI/BY/W/D: BY	
DES :HOUR I/Q/D/B/T/C: I BI/BY/W/D: BY	
DES :AMPM I/Q/D/B/T/C: I BI/BY/W/D: BI	
DES :MIN I/Q/D/B/T/C: I BI/BY/W/D: BY	
DES :SEC I/Q/D/B/T/C: I BI/BY/W/D: BY	
DES :ERR I/Q/D/B/T/C: Q BI/BY/W/D: BI	
DES :ALRM I/Q/D/B/T/C: Q BI/BY/W/D: BI	
DES :MODE I/Q/D/B/T/C: I BI/BY/W/D: BI	
:A =MODE	24 HOUR MODE = 0, 12 HOUR = 1
:= F 11.1	(SET CLOCK MODE)
:A F 10.5	DISPLAY PROMPT TIME REACHED
:S =ALRM	(BIT 13 IN STATUS WORD)
:R F 10.5	RESET BIT AFTER EVALUATION
:	
:AN F 20.1	FLAG IS RESET IF SETTINGS HAVE ALREADY
:JC =M001	BEEN READ INTO THE CLOCK DATA AREA
:R F 20.1	
:	
:C DB 2	CLOCK DATA AREA
:L =WDAY	STORE VALUE FOR WEEKDAY
:T DR 8	
:L =DAY	STORE VALUE FOR DATE
:T DL 9	
:L =MON	STORE VALUE FOR MONTH
:T DR 9	

FB11 STL (continued)	Explanation
:L =HOUR :ON =AMPM :ON =MODE :JC =MORN :L KH 0080 :OW MORN :T DR 10	STORE VALUE FOR HOURS IF AM/PM = 1 (AFTERNOON) AND 12-HOUR MODE IS SET, THE CORRESPONDING BIT IN THE CLOCK DATA AREA IS SET
:L =MIN :T DL 11 :L =SEC :T DR 11	STORE VALUE FOR MINUTES STORE VALUE FOR SECONDS
:AN F 10.6 :S F 10.6 :L KT 020.1 :SE T 11 M001 :A T 11 :BEC	TRANSFER SETTINGS (BIT 14 IN STATUS WORD FW10) START MONITORING TIME BEC, IF MONITORING TIME NOT YET ELAPSED
:AN F 10.6 :JC =M002 :S =ERR :BEU M002 :AN F 10.4 :RB =ERR :BEC	HAVE SETTINGS BEEN TRANSFERRED? IF YES, JUMP TO M002 IF ERROR, SET ERROR BIT ERROR WHEN ENTERING SETTINGS? IF NO, RESET ERROR BIT BEC, IF NO ERROR
:S =ERR :BE	IF ERROR, SET ERROR BIT

13.6.3 Programming the Operating Hours Counter

You can enable the operating hours counter with bit 9 of the status word. This allows you to establish, for example, the number of hours a motor has been in operation. The operating hours counter is active only in the RUN mode.

Transferring Settings to the Operating Hours Counter

You can preset the operating hours counter with a certain start value.

- The clock data must be transferred in BCD code. The "KC" data format loads a BCD constant into ACCU 1 and is therefore especially suitable for entering the settings.
- If you do not want a value (for example minutes) to be transferred, entering the relevant byte as "255_D" or "FF_H". The current value for this variable is then retained.
- After you have transferred the settings to the clock data area, you must set bit 10 in the status word for the clock to accept the clock data.
- Bit 8 in the status word displays incorrect settings.

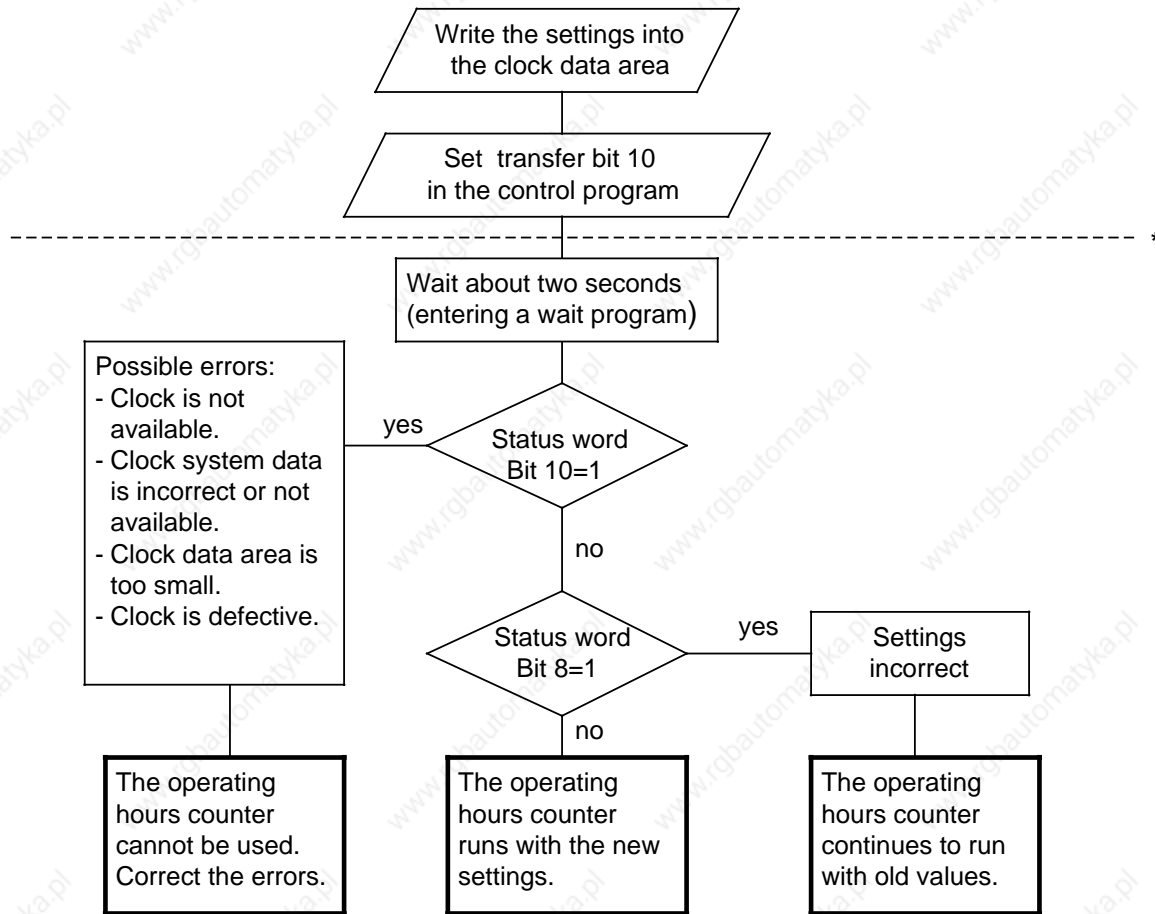

* The lower part of the flow chart has only a diagnostic function. There is nothing you must perform.

Figure 13-8. Flowchart - Transferring Settings to the Operating Hours Counter

Example: Setting the operating hours counter

The status of I 32.7 determines whether the operating hours counter values are transferred. You must transfer these values to flag bytes FY136 to FY140 before setting input I 32.7 (not implemented in the example program). Values that are not to be changed should be preset with FF_H.

Errors are displayed in flag F 12.3. The clock data area is in DB2 beginning with data word DW 0, and the status word is flag word FW 10.

OB1 STL	Explanation
:	=====
:	SETTING THE OPERATING HOURS COUNTER
:	=====
:	LOAD VALUES INTO FY136 TO FY140
:	
:A I 32.7	TRIGGER TRANSFER OF SETTINGS FOR
:S F 20.2	OPERATING HOURS COUNTER BY SETTING
:	F 20.2
:JU FB 12	
NAME :BETRST-S	(SETTING THE OPERATING HOURS COUNTER)
SEC : FY 136	SECONDS
MIN : FY 137	MINUTES
HOUR0: FY 138	HOURS
HOUR2: FY 139	HOURS X 100
HOUR4: FY 140	ERRORS X 10000
ERR : F 12.3	ERROR BIT
:BE	

FB12 STL	Explanation
NAME :BETRST-S	SETTING THE OPERATING HOURS COUNTER
DES :SEC I/Q/D/B/T/C: I BI/BY/W/D: BY	
DES :MIN I/Q/D/B/T/C: I BI/BY/W/D: BY	
DES :HOUR0 I/Q/D/B/T/C: I BI/BY/W/D: BY	
DES :HOUR2 I/Q/D/B/T/C: I BI/BY/W/D: BY	
DES :HOUR4 I/Q/D/B/T/C: I BI/BY/W/D: BY	
DES :ERR I/Q/D/B/T/C: Q BI/BY/W/D: BI	
:AN F 20.2	FLAG IS RESET IF SETTINGS
:JC =M001	ALREADY READ INTO THE
:R F 20.2	CLOCK DATA AREA
:	
:C DB 2	CLOCK DATA AREA
:L =SEC	STORE VALUE FOR SECONDS
:T DR 15	
:L =MIN	STORE VALUE FOR MINUTES
:T DL 16	
:L =HOUR0	STORE VALUE FOR HOURS
:T DR 16	
:L =HOUR2	STORE VALUE FOR HOURS X 100
:T DL 17	
:L =HOUR4	STORE VALUE FOR HOURS X 1000
:T DR 17	
:AN F 10.2	TRANSFER SETTINGS
:S F 10.2	(BIT 10 IN STATUS WORD FW10)
:S F 10.1	ENABLE OPERATING HOURS COUNTER
:	IF NOT ALREADY ENABLED
:L KT 020.1	START MONITORING TIME
:SE T 12	
M001 :A T 12	BEC IF MONITORING TIME NOT YET
:BEC	ELAPSED
:AN F 10.2	HAVE SETTINGS BEEN TRANSFERRED?
:JC =M002	IF YES, JUMP TO M002
:S =ERR	IF ERROR, SET ERROR BIT
:BEU	
M002 :AN F 10.0	ERROR WHEN ENTERING SETTINGS?
:RB =ERR	IF NO, RESET ERROR BIT
:BEC	BEC IF NO ERROR
:S =ERR	IF ERROR, SET ERROR BIT
:BE	

Reading the Current Operating Hours Counter

The current data is stored in words 12 to 14 of the clock data area. You can use load operations to read out the data.

Example: Reading the operating hours counter

You need to switch off a machine for inspection after every 300 hours of operation. Flag F 12.4 is set when the machine is switched off. After 300 hours of operation, a jump is made to PB5 to switch the machine off (not programmed in the example).

The clock data area is in DB2 beginning with flag word FW0, and the status word is flag word FW10.

OB1 STL	Explanation
<pre> :JU PB 14 NAME :BETR-LES : :BE </pre>	EVALUATE OPERATING HOURS COUNTER

FB14 STL	Explanation
<pre> NAME :BETR-LES :C DB 2 :A F 12.4 :BEC : :L DL 14 : :L KC 003 :><F :BEC : :S F 12.4 :JU PB 5 : :BE </pre>	<p>READING THE OPERATING HOURS COUNTER</p> <p>DB IN WHICH THE CLOCK DATA IS LOCATED.</p> <p>IF AUXILIARY FLAG 12.4 IS SET, OFF.</p> <p>THE MACHINE IS ALREADY</p> <p>BLOCK END</p> <p>LOAD HOUR VALUE X 100 IN ACCU 1</p> <p>COMPARE TO 3 (=300 HOURS)</p> <p>END IF 300 HOURS NOT YET</p> <p>REACHED</p> <p>SET AUXILIARY FLAG</p> <p>JUMP TO PB5 WHEN 300 OPERATING</p> <p>HOURS REACHED</p>

13.6.4 Entering the Clock Time Correction Factor

You can configure a correction value that increases the exactness of the integral real-time clock. The correction value is displayed in seconds/month. The month is defined as 30 days.

Absolute Address RAM Memory	Range	System Data Word
5D 18	- 400 _D to + 400 _D seconds/month	12

Example: You determined that the clock runs 12 seconds slow in a four day period. That would be 90 seconds in 30 days. The correction value is + 90 seconds/month.

Note

Use the data KF format to enter the correction value. You then do not have to convert the value to other numbering systems.

STL	Explanation
FB10 L KF + 90 T RS 12 BE	LOAD THE + 90 SECONDS CORRECTION VALUE INTO ACCU 1 AND STORE IT IN SYSTEM DATA WORD 12.

Note

The correction value you have entered is read in after the next minute change. If an error occurs when a setting is entered, bit 15 in system data word 11 is set.

14 Communication via SINEC L1 LAN

14.1	Connection of the Programmable Controllers to the L1 Bus Cable .	14- 1
14.2	Basic Principle of Data Interchange	14- 2
14.3	Parameterization of the PLC for Data Interchange in DB1	14- 3
14.4	Sending Data	14- 5
14.5	Receiving Data	14- 7
14.6	Program Example	14- 9

Figures		
14-1	Structure of a SINEC L1 LAN	14- 1
14-2	Connection of the Bus Cable	14- 2
14-3	Principle of Data Interchange	14- 3
14-4	DB1 with Default Parameters	14- 4
14-5	Structure of the Send Mailbox	14- 5
14-6	Structure of the Coordination Byte Send (KBS)	14- 6
14-7	Structure of the Receive Mailbox	14- 7
14-8	Structure of the Coordination Byte Receive (KBE)	14- 8
14-9	Program Structure SINEC L1 Slave	14- 9
Tables		
14-1	DB1 Parameters for SINEC L1	14- 4
14-2	Entering Parameters for SINEC L1	14- 5

14 Communication via SINEC L1 LAN

SINEC L1 is a local area network that enables SIMATIC S5 programmable controllers to communicate with each other. It operates on the master-slave principle.

One single programmable controller, called master, is responsible for the entire communication and monitoring of the data exchange in the local area network, as well as for enabling and monitoring of programming functions via the LAN. All other programmable controllers connected are slaves.

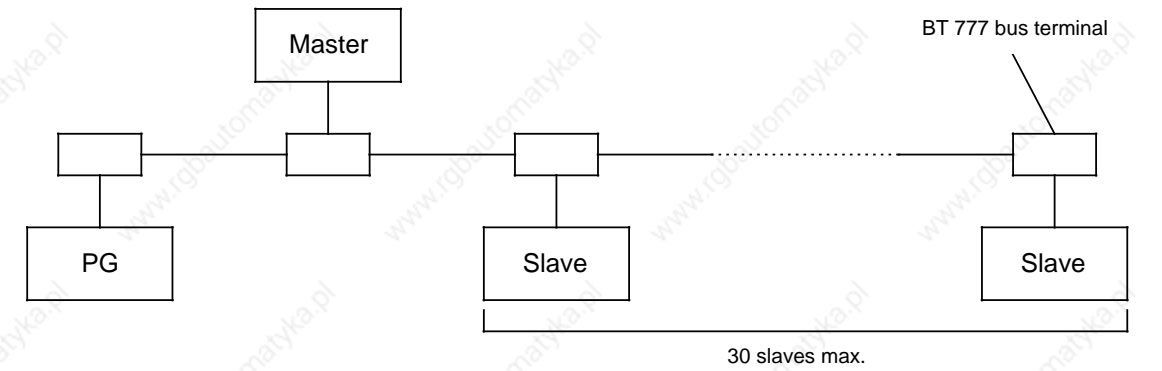

Figure 14-1. Structure of a SINEC L1 LAN

You will find more exact information on the SINEC L1 in the "SINEC L1" manual (Order No. 6ES5 998-7LA21). You need to understand the SINEC L1 operating system before continuing with this chapter.

The S5-90U/S5-95U can be connected directly to the SINEC L1 as a slave. The information you need to perform this operation is explained in this chapter.

14.1 Connection of the Programmable Controllers to the L1 Bus Cable

Bus terminal BT 777 is the signal level converter that connects the programmable controller to the L1 bus cable. The procedure is as follows:

Connect the L1 bus cable to bus terminal BT 777, as shown in the figure below.

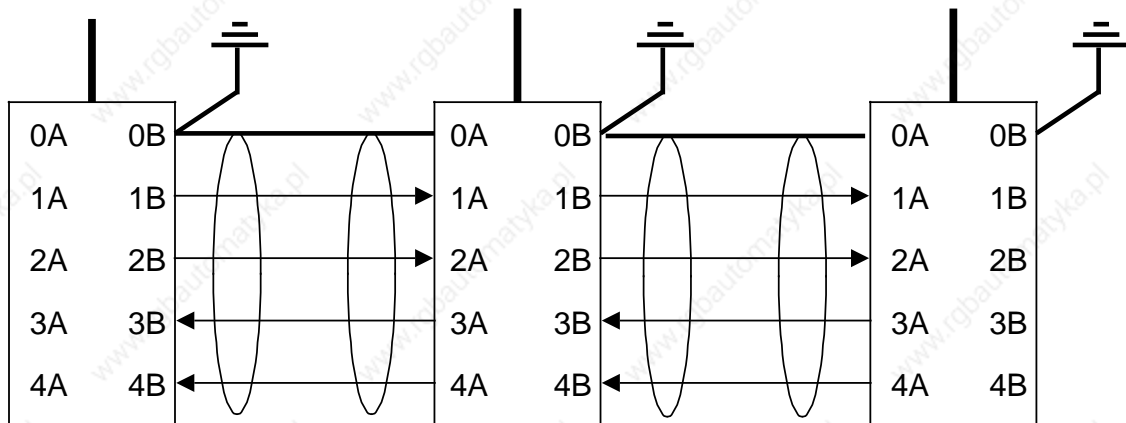

Figure 14-2. Connection of the Bus Cable

Connection of the S5-90U:

The current required for bus terminals BT 777-0BB01 or BT 777-0BC01 is supplied by the S5-90U. External supply of the bus terminal is not required.

All other BT 777 bus terminals must be supplied with 5 V DC (terminal C=+5 V; 5.0 to 5.3 V; 0.3 A; terminal D=ground). The following note applies to bus terminals with an external supply:

Note

Refer to the section "Bus Terminals for non-Siemens Nodes" in the SINEC L1 manual, beginning with Version 5, Section 1.3.4. If there is a power failure with the S5-90U, the 5-V supply to the bus terminals must be turned off, otherwise no other bus functions are possible.

Plug the connector of the bus terminal cable onto the programmer port of the programmable controller.

Connection of the S5-95U:

On the S5-95U the bus terminal is supplied by the programmer port. An external supply for the bus terminal is not required.

Plug connector of the bus terminal cable onto the programmer port of the programmable controller.

14.2 Basic Principle of Data Interchange

Data interchange requires the following mailboxes and bytes to be defined once:

- A Send Mailbox (SF), containing the data to be sent (max. 64 bytes).
- A Coordination Byte Send (KBS), which is used for coordination between the control program and SINEC L1.
- A Receive Mailbox (EF), containing the received data (max. 64 bytes).
- A Coordination Byte Receive (KBE), which is used for coordination between the control program and SINEC L1.

The coordination bytes are located in the flag area and the send and receive mailboxes are usually stored in a data block. Figure 14-3 shows the interchange of data between two slaves. Seen from the slave, the exchange of data between the master and the slave functions in the same way. Data exchange seen from the master is described in detail in the "SINEC L1" manual.

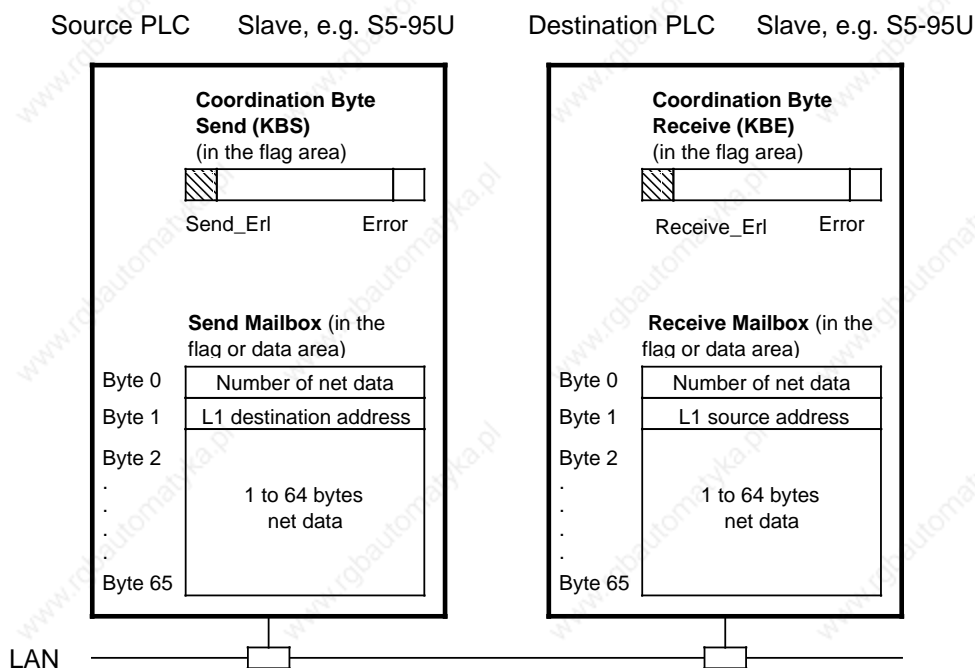

Figure 14-3. Principle of Data Interchange

Explanation of Figure 14-3:

To send a message, fill in the Send Mailbox. This enables you to specify how much data is to be sent (number of net data), to address the receiver (L1 destination address) and to store the message (net data). You then enable sending in the Coordination Byte Send (by setting bit "Send_Erl").

The S5-95U then sends the message via the local area network to the addressed receiver. After the sending process, the bit "Send_Erl" is reset by the operating system.

When the message has arrived at the receiver, the bit "Empf_Erl" (receiving enabled) in the Coordination Byte Receive is reset. The data received is available for evaluation in the Receive Mailbox.

In order to restore the readiness to receive, you set the bit "Empf_Erl" in the Coordination Byte Receive after having read the data from the Receive Mailbox.

14.3 Parameterization of the PLC for Data Interchange in DB1

The following parameters are set in DB1:

- Slave number of the programmable controller (SLN)
- Location of the Send Mailbox (SF)
- Location of the Receive Mailbox (EF)
- Location of the Coordination Byte Receive (KBE)
- Location of the Coordination Byte Send (KBS)
- Programmer bus number (PGN); necessary for programmer functions via the SINEC L1 LAN.

Figure 14-4 shows the default parameters in DB1. The SINEC L1 parameter block is shaded. Entering, modifying and transmission of the DB1 is described in detail in Chapter 9.

S5-95U		S5-90U	
0:	KS = 'DB1 OBA: AI 0 ; OBI: '	0:	KS = 'DB1 OBI: ; OBC: ';
12:	KS = ' ; OBC: CAP N CBP '	12:	KS = 'CAP N ; #SL1: SLN 1 ';
24:	KS = 'N ; #SL1: SLN 1 SF '	24:	KS = 'SF DB2 DW0 EF DB3 ';
36:	KS = 'DB2 DW0 EF DB3 DW0 '	36:	KS = 'DW0 KBE MB100 ';
48:	KS = 'KBE MB100 KBS MB1 '	48:	KS = 'KBS MB101 PGN 1 # ';
60:	KS = '01 PGN 1 ; # SDP: N'	60:	KS = ' END ';
72:	KS = 'T 128 PBUS N ; TFB: OB13'		
84:	KS = ' 100 ; #CLP: STW MW10'		
96:	KS = '2 CLK DB5 DW0 '		
108:	KS = ' SET 3 01.10.91 12:00:00'		
120:	KS = '00 OHS 000000:00:00 '		
132:	KS = ' TIS 3 01.10. 12:00:00 '		
144:	KS = ' STP Y SAV Y CF 00 '		
156:	KS = ' ; #END ';		

Figure 14-4. DB1 with Default Parameters

DB1 Parameters for SINEC L1

Table 14-1. DB1 Parameters for SINEC L1

Parameter	Argument	Meaning	
Block ID: SL1:		SINEC L1	
SLN	p	Slave number	
SF	DBxDWy	Location of the Send Mailbox	
EF		Location of the Receive Mailbox	
KBE	MBz	Location of the Coordination Byte Send	
KBS		Location of the Coordination Byte Receive	
PGN	p	Programmer bus number	
S5-90U:			
p=1 to 30	x=2 to 63	y=0 to 255	z=0 to 127
S5-95U:			
p=1 to 30	x=2 to 255	y=0 to 255	z=0 to 255

Example: The S5-95U is to be connected to the SINEC L1 local area network as a slave with slave number 2.

Table 14-2. Entering Parameters for SINEC L1

DB1	Explanation
<pre> . . . 24: KS='N ; SL1: SLN 2 SF ' 36: KS='DB2 DW0 EF DB2 DW10 ' 48: KS=' KBE MB2 KBS MB0 ' 60: KS=' PGN 1 ; SDP: N' . . . </pre>	<p>The PLC has slave number 2; Send Mailbox in DB2 beginning with data word DW0; Receive Mailbox in DB2 beginning with data word DW10; Coordination Byte Receive is flag byte FY2; Coordination Byte Send is flag byte FY0; the programmer bus number is 1</p>

The following section describes in detail how sending and receiving of data have to be executed.

14.4 Sending Data

The prerequisites for sending data are as follows:

- The parameters are set in DB1 for the location of the Send Mailbox and the location of the Coordination Byte Send (KBS) (see Section 14.3).
- The data to be sent, additional information (length of the send data "net data"), and destination slave number have been transferred to the Send Mailbox.

Send Mailbox

Figure 14-5 shows which information has to be stored in what part of the Send Mailbox.

Example:

Send Mailbox in the **flag area**
(beginning with flag byte 0)

Example:

Send Mailbox in a **data block**
(beginning with DW 0)

		DL	DR
Flag byte 0	Length of the "net data" (0 to 64 bytes)	DW 0	Length of the "net data" (1 to 64 bytes)
Flag byte 1	Numb. of the dest. slave*	DW 1	1st data byte
Flag byte 2	1st data byte		2nd data byte
Flag byte 65	64th data byte	DW 32	63th data byte
			64th data byte

* Number of the receiver; 0=Master
1 to 30=Slave
31=Broadcast

Figure 14-5. Structure of the Send Mailbox

Structure of the Coordination Byte Send (KBS)

Figure 14-6 shows the structure of the Coordination Byte Send (KBS).

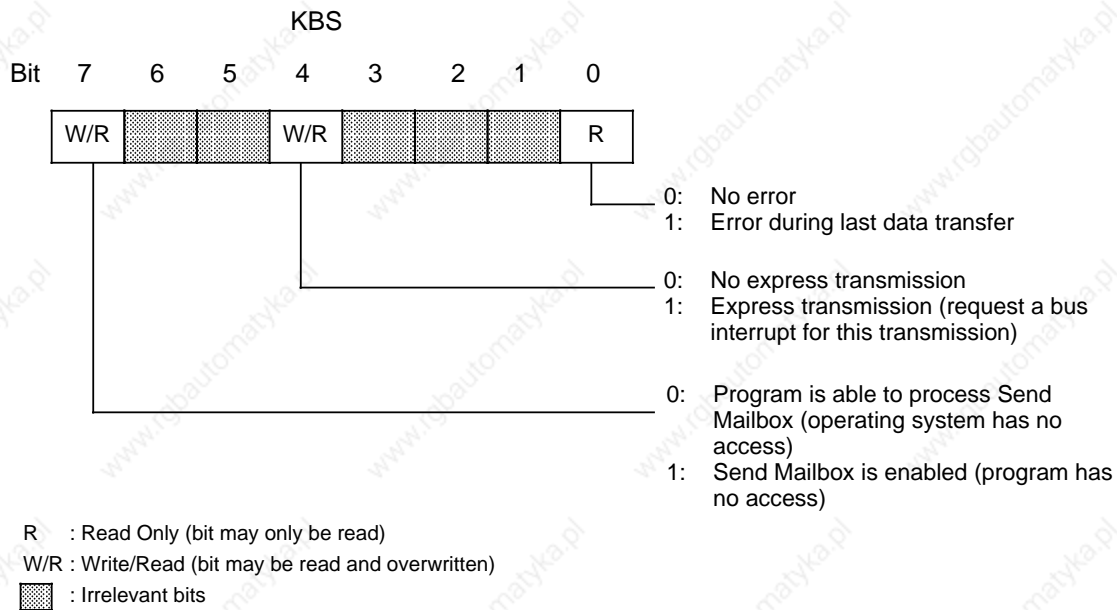

Figure 14-6. Structure of the Coordination Byte Send (KBS)

The control program for sending data should be structured as follows:

- Check bit 7 in the KBS to see if data is currently being sent. (If the programmable controller is sending data, bit 7 is set. During this phase, the Send Mailbox can not be modified and no transmission can be started.)
- When bit 7 in the KBS has been reset, you can start the transmission by setting bit 7.
- When bit 7 has been reset by the operating system after data has been sent, you can evaluate possible errors.

You achieve the following by setting bit 4 in the KBS (express transmission).

- The sending programmable controller treats this message preferentially
- The receiver treats the message as an express transmission.

In case of an error, the operating system sets bit 0 of the KBS. The error message is not valid until bit 7 has been reset in the KBS.

14.5 Receiving Data

The prerequisites for receiving data are as follows:

The parameters for the location of the Receive Mailbox and the Coordination Byte Receive (KBE) have been set in DB1 (see Section 14.3).

Receive Mailbox

Figure 14-7 shows you which information has to be stored in what part of the Receive Mailbox.

Example:
Receive Mailbox in the **flag area**
(beginning with flag byte 0)

FY 0	Length of "net data" (in bytes (1 to 64 bytes))
FY 1	Source slave number*
FY 2	1st data byte
FY 65	64th data byte

Example:
Receive Mailbox in a **data block**
(beginning with data word 0)

	DL	DR
DW 0	Length of the "net data"	Source slave number*
DW 1	1st data byte	4th data byte
DW 2	3rd data byte	4th data byte
DW 32	63rd data byte	64th data byte

* Number of the sender; 0=Master
 1 to 30=Slave

Figure 14-7. Structure of the Receive Mailbox

Structure of the Coordination Byte Receive (KBE)

Figure 14-8 shows the structure of the Coordination Byte Receive (KBE).

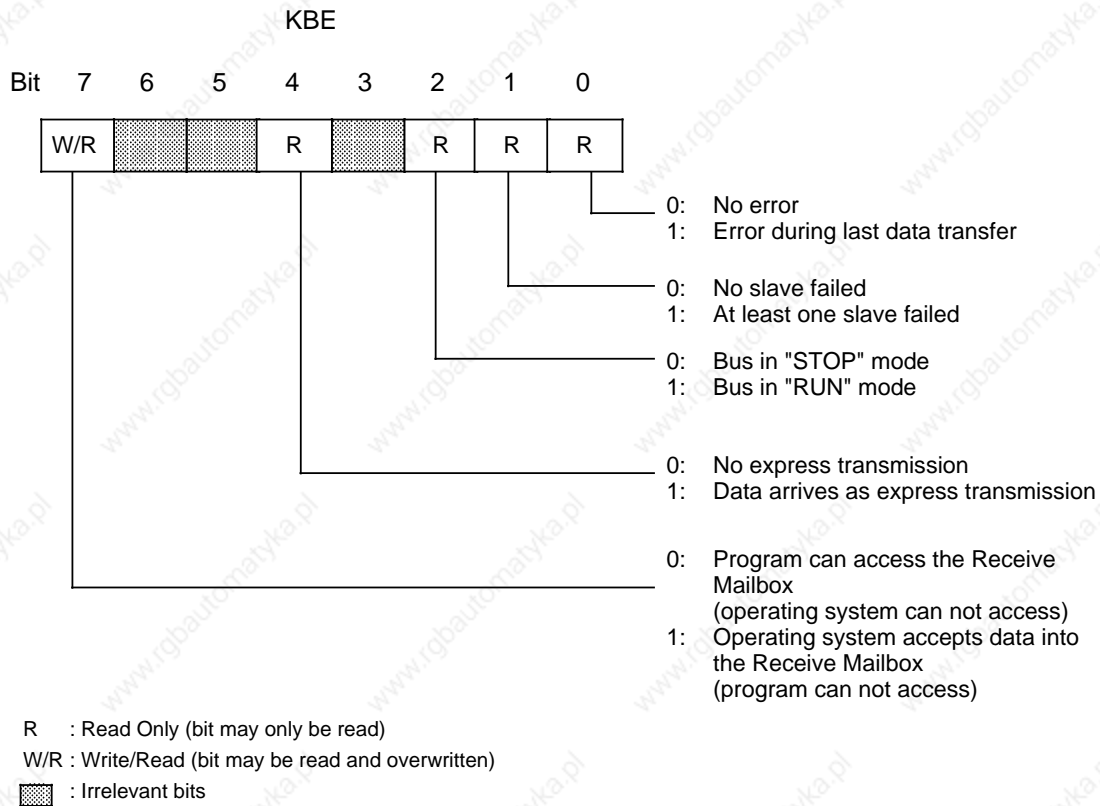

Figure 14-8. Structure of the Coordination Byte Receive (KBE)

The control program for receiving data should be structured as follows:

- Check bit 7 of the KBE to see if it is possible to read the data from the Receive Mailbox. Bit 7 must be set to "0" so that the Receive Mailbox can be read. In order to restore the readiness to receive, set bit 7 "Empf-Erl" in the KBE after having read out the Receive Mailbox.

In addition, you can scan through the KBE for the following errors and operating conditions:

- At least one slave has failed.
- The bus is in "RUN" ("STOP") mode.
- The received data pack comes as an express transmission.

Special Features

If you have reserved too little memory for the Receive Mailbox, the available memory area is filled up completely. The remaining receive data cannot be stored. In this case, the programmable controller does not generate an overflow message.

The following section describes a sample program for sending and receiving data with an S5-95U as a SINEC L1 slave. Further sample programs for sending and receiving data are described in the SINEC L1 manual (in the chapter on "Programming").

14.6 Program Example

In this section, the structure of a control program for an S5-95U as a slave to the SINEC L1 LAN is explained in detail.

Example:

An S5-95U is to be used as a slave in the SINEC L1 local area network. The S5-95U has a slave number 4 and is to communicate with slave number 2. For this purpose, specify slave number 4 in DB1 and destination address 2 in FB100. The S5-95U is to receive data from the communication partner and send data to the communication partner.

Proceed as follows:

- Establish the ready state at the communication partner (parameterized as slave 2).
- Switch the S5-95U on and carry out "PLC overall reset" (PLC mode: STOP).
- Parameterize the SINEC L1 parameter block in DB 1 of the S5-95U as described below.
- Program the individual blocks as described below.
- Transfer DB 1 and the control program to the S5-95U.
- Switch the mode and selector of the PLC to RUN.

For the program structure of the program example please refer to the following diagram.

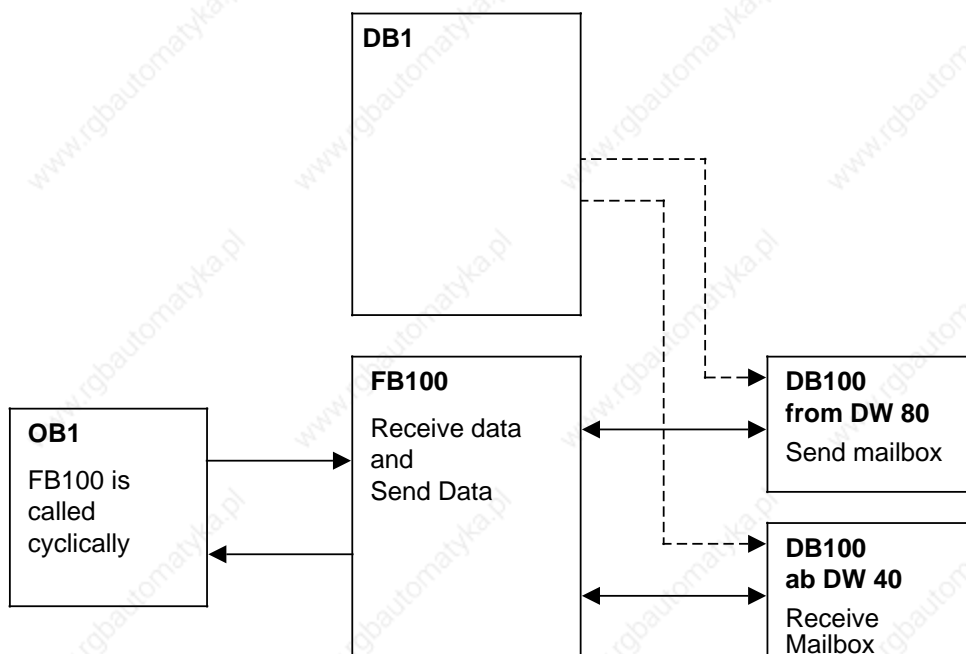

Figure 14-9. Program Structure SINEC L1 Slave

DB1 STL	Explanation
<pre> : 24: KS = 'N ; SL1: SLN 4 SF ' ; 36: KS = 'DB100DW80 EF DB100DW40 ' ; 48: KS = ' KBE MB61 KBS MB6' ; 60: KS = '2 PGN 1 ; SDP: N' ; 72: </pre>	<pre> Slave number: 4 ; Send Mailbox: DB100 from DW 80; Receive Mailbox: DB100 from DW 40; "Receive" coordination byte: FY 61; "Send" coordination byte : FY 62; PG bus number: 1 </pre>

OB1 STL	Explanation
<pre> :AN I 0.0 :R F 99.0 :A I 0.0 :AN F 99.0 :S F 99.0 :S F 1.0 : :JU FB 100 NAME :SINEC : :BE </pre>	<pre> Pulse edge evaluation I 0.0 Positive-going edge at I 0.0 sets send initialization bit Send and receive via SINEC L1 LAN </pre>

FB100 STL	Explanation
<pre> NAME :SINEC :C DB 100 : :O F 61.7 :L DL 40 :JC =M001 : :L DL 40 :T MB 40 :L DR 40 :T MB 41 : :L KF +1 :T FW 254 :L KF +41 :T FW 252 : M003 :B FW 252 :L DW 0 :B FW 254 :T DW 0 </pre>	<pre> Open send and receive mailbox KBE bit 7=1 "No new data received" Jump to "Send data" Receive data ===== Evaluate frame length and source if necessary Default settings of index scratch flags for copying the frame from the receive mailbox into the user area In the example all 32 data words (DW 41 to DW 72) are copied into the user area DB100. DW 1 to DW 32 </pre>

FB100 STL (continued)	Explanation
<pre> :L KF +72 :L FW 252 :!=F :JC =M002 :L FW 252 :ADD KF +1 :T FW 252 :L FW 254 :ADD KF +1 :T FW 254 :JU =M003 : M002 :AN F 61.7 :S F 61.7 : M001 : :AN F 1.0 :BEC : :O F 1.1 :O F 62.7 :JC =M004 : :AN F 1.1 :S F 1.1 :L KY 64.2 :T DW 80 : : :AN F 62.7 :S F 62.7 :R F 1.2 M004 : :AN F 62.7 :AN F 1.2 := F 1.3 :A F 1.3 :S F 1.2 : :A F 1.3 :AN F 62.0 :R F 1.0 :R F 1.1 : :A F 1.3 :A F 62.0 :R F 1.1 :BE </pre>	<p>Scan to determine whether all 32 DW have already been copied</p> <p>then jump to receive mailbox enable otherwise, data word numbers are incremented by 1</p> <p>and next data word is copied</p> <p>Enable receive mailbox again for new frame</p> <p>Send data =====</p> <p>if no request to send, end</p> <p>if transmitting disabled or if send request active then jump to pulse edge evaluation "Send ready"</p> <p>Disable transmission since the send mailbox must not be changed during transmission Enter frame length (here = 64 bytes) and destination address (here = 2 for slave 2) in 1st DW of the send mailbox Net data must be entered in DW 81 to DW 112 at this point.</p> <p>Enable transmitting in the KBS and reset edge auxiliary flag</p> <p>Pulse edge evaluation "Transmission terminated" if KBS bit 7 changes from 1 to 0 and edge auxiliary flag is not set. Edge "Transmission terminated" in the case of negative edge, set auxiliary flag again</p> <p>If transmission terminated and no errors have occurred during transmission, reset send initiation bit, reenable transmission</p> <p>If transmission terminated and errors have occurred during transmission, enable transmission for repeat</p>

www.rgbautomatyka.pl

15 Module Spectrum		
15.1	General Technical Specifications	15- 3
15.2	Power Supply Modules	15- 4
15.3	Bus Units	15- 6
15.4	Interface Modules	15- 8
15.5	Digital Modules	15- 11
15.5.1	Digital Input Modules	15- 13
15.5.2	Digital Output Modules	15- 23
15.5.3	Digital Input/Output Modules	15- 34
15.6	Analog Modules	15- 36
15.6.1	Analog Input Modules	15- 37
15.6.2	Analog Output Modules	15- 92

Figures

15-1	Thermocouple	15- 40
15-2	Connecting Thermocouples of the Same Type Directly to the Module	15- 42
15-3	Remote Connection of Thermocouples of the Same Type to the Module ..	15- 42
15-4	Direct or Remote Connection of Thermocouples of Different Type to the Module	15- 43
15-5	Connecting Thermocouples of the Same Type with Linearization and Internal Compensation Directly to the Module	15- 49
15-6	Remote Connection of Thermocouples of the Same Type with Linearization and Internal Compensation to the Module	15- 49
15-7	Connecting Thermocouples of the Same Type without Linearization and External Compensation Directly to the Module	15- 50
15-8	Remote Connection of Thermocouples of the Same Type without Linearization and External Compensation to the Module	15- 50
15-9	Direct and Remote Connection of Thermocouples of Different Type without Linearization and External Compensation to the Module	15- 51
15-10	Connection of only Four-Wire Transducers (6ES5 464-8MD11)	15- 68
15-11	Connection of only Two-Wire Transducers (6ES5 464-8MD11)	15- 68
15-12	Connection of Two-Wire and Four-Wire Transducers (6ES5 464-8MD11) ..	15- 69
15-13	Connection of only Two-Wire Transducers (6ES5 464-8ME11)	15- 74
15-14	Connection of only Four-Wire Transducers (6ES5 464-8ME11)	15- 74
15-15	Connection of Two-Wire and Four-Wire Transducers (6ES5 464-8ME11) ..	15- 75
15-16	Wiring Method for PT 100 (6ES5 464-8MF11)	15- 80
15-17	Wiring Possibilities for ± 500 mV Voltage Measurement for the Input Module (6ES5 464-8MF11)	15- 80
15-18	Wiring Method for PT 100 (6ES5 464-8MF21)	15- 85
15-19	Load Connection via a Four-Wire Circuit (6ES5 470-8MA12)	15- 94
15-20	Connection via a Two-Wire Circuit (6ES5 470-8MB12)	15- 96
15-21	Connection via a Two-Wire Circuit (6ES5 470-8MC12)	15- 98
15-22	Load Connection via a Four-Wire Circuit (6ES5 470-8MD12)	15-100

Tables

15-1	Overview of Digital Input Modules	15- 11
15-2	Overview of Digital Output Modules	15- 11
15-3	Overview of Digital Input/Output Modules	15- 12
15-4	Error Messages of Output Modules with Error Diagnostics	15- 23
15-5	Overview of Analog Input Modules	15- 36
15-6	Overview of Analog Output Modules	15- 36
15-7	Representation of an Analog Input Value as Bit Pattern	15- 37
15-8	Options for Connecting Thermocouples with Compensating Box	15- 41
15-9	Settings for the Operating Mode Switch for Analog Input Module 464-8MA11	15- 44
15-10	Analog Input Module 464-8MA11 (Bipolar Fixed-Point Number)	15- 45
15-11	Options for Connecting Thermocouples	15- 48
15-12	Settings for the Operating Mode Switch for Analog Input Module 464-8MA21	15- 53
15-13	Analog Input Module 464-8MA21, $4 \times \pm 50$ mV, without Linearization and without Temperature Compensation (Internal) (Bipolar Fixed-Point Number)	15 - 54
15-14	Analog Input Module 464-8MA21, $4x \pm 50$ mV with Linearization and with Temperature Compensation (Internal); Thermoelement Type K (Nickel-Chromium/Nickel-Aluminium, according to IEC 584)	15- 55
15-15	Analog Input Module 464-8MA21, $4x \pm 50$ mV with Linearization and with Temperature Compensation (Internal); Thermoelement Type J (Iron/Copper-Nickel (Konstantan), according to IEC 584)	15- 56
15-16	Analog Input Module 464-8MA21, $4x \pm 50$ mV with Linearization and with Temperature Compensation (Internal); Thermoelement Type L (Iron/Copper-Nickel (Konstantan), according to DIN 43710)	15- 57
15-17	Settings for the Operating Mode Switch for Analog Input Module 464-8MB11	15- 61
15-18	Analog Input Module 464-8MB11 (Bipolar Fixed-Point Number)	15- 61
15-19	Settings for the Operating Mode Switch for Analog Input Module 464-8MC11	15- 64
15-20	Analog Input Module 464-8MA11 (Bipolar Fixed-Point Number)	15- 65
15-21	Settings for the Operating Mode Switch for Analog Input Module 464-8MD11	15- 70
15-22	Analog Input Module 464-8MD11 (Bipolar Fixed-Point Number)	15- 71
15-23	Settings of the Operating Mode Switch for Analog Input Module 464-8ME11	15- 76
15-24	Analog Input Module 464-8ME11, 4×4 to 20 mA (Absolute Value)	15- 77
15-25	Settings for the Operating Mode Switch for Analog Input Module 464-8MF11	15- 81
15-26	Analog Input Module 464-8MF11, $2 \times PT 100$ (Unipolar)	15- 82
15-27	Analog Input Module 464-8MF11, ± 500 mV (Bipolar Fixed-Point Number) .	15- 82
15-28	Settings for the Operating Mode Switch for Analog Input Module 464-8MA21	15- 86
15-29	Analog Input module 464-8MF21, $2 \times PT 100$ "with Linearization", to IEC 751	15- 87

Tables

15-30 Analog Input Module 464-8MF21, 2xPT 100 "without Linearization" (Unipolar)	15- 87
15-31 Analog Input Module 464-8MF21, ±500 mV (Bipolar Fixed-Point Number)	15- 88
15-32 Analog Input Module 466-8MC11, 4x0 to 10 V	15- 91
15-33 Representation of an Analog Output Value as Bit Pattern	15- 92
15-34 Analog Output Module 470-8MA12 (Bipolar Fixed-Point Number)	15- 94
15-35 Analog Output Module 470-8MA12 (Bipolar Fixed-Point Number)	15- 96
15-36 Analog Output Module 470-8MC12 (Unipolar)	15- 98
15-37 Analog Output Module 470-8MD12 (Unipolar)	15-100

15 Module Spectrum

The following section describes the standards and test values the S5-90U/95U meets and fulfills and the test criteria with which the S5-90U/95U has been tested.

UL/CSA approvals

The following approvals exist for the S5-90U/95U:

UL Recognition Mark

Underwriters Laboratories (UL) in accordance with Standard UL 508, File E 116536

CSA Certification Mark

Canadian Standard Association (CSA) in accordance with Standard C 22.2 No. 142, File LR 48323

CE marking

Our products meet the requirements and protection objectives of the following EC Directives and comply with the harmonized European standards (EN) published in the Official Gazettes of the European Communities with regard to programmable controllers:

- 89/336/EC "Electromagnetic Compatibility" (EMC Directive)
- 73/23/EC "Electrical Equipment Designed for Use between Certain Voltage Limits" (Low-Voltage Directive)



The EC declarations of conformity are held at the disposal of the competent authorities at the address below:

Siemens Aktiengesellschaft
 Bereich Automatisierungstechnik
 A&D AS E 4
 Postfach 1963
 D-92209 Amberg
 Federal Republic of Germany

Area of Application

SIMATIC products have been designed for use in industrial environments.

With individual approval, SIMATIC products can also be used in residential environments (residential, commercial and light industry).

You must acquire the individual approval from the respective national authority or testing board.

Area of Application	Requirements in respect of	
	Emitted interference	Immunity
Industry	EN 50081-2 : 1993	EN 50082-2 : 1995
Residential	Individual approval	EN 50082-1 : 1992

Installing the units

PLCs in the SIMATIC S5-90U, S5-95U and S5-100U series must be installed in electrical equipment rooms or in enclosed housing (e.g. control boxes made of metal or plastic).

Observing the Installation Guidelines

S5 modules meet the requirements, if installed and operated in accordance with the Installation Guidelines (see chapter 3).

Notes for the machine manufacturer

The SIMATIC automation system is not a machine in the sense of the EC Directives Machines. Therefore a declaration of conformity with regard to the EC Directive Machines 89/392/EC does not exist for SIMATIC.

The EC Directive Machines 89/392/EC regulates the requirements on a machine. A machine in this sense is a group of interconnected parts or devices (see also EN 292-1, para. 3.1).

The SIMATIC is part of the electrical equipment of a machine and must therefore be included in the declaration of conformity procedure by the machine manufacturer.

The standard EN 60204-1 (safety of machines, general requirements for the electrical equipment of machines) applies for the electrical equipment of machines.

The following table is intended to help you with the declaration of conformity and shows which criteria apply to SIMATIC in accordance with EN 60204-1 (June 1993).

EN 60204-1	Topic/criterion	Remarks
Para. 4	General requirements	Requirements are fulfilled if the devices are assembled/installed in accordance with the Installation Guidelines. Please also observe the section on CE marking.
Para. 11.2	Digital input/output interfaces	Requirements are fulfilled
Para. 12.3	Programmable equipment	Requirements are fulfilled if the devices are installed in lockable cabinets to protect them from memory modifications through unauthorized persons.
Para. 20.4	Voltage tests	Requirements are fulfilled

15.2 Power Supply Modules

Power Supply Module PS 931 115/230 V AC; 24 V DC/2A

(6ES5 931-8MD11)

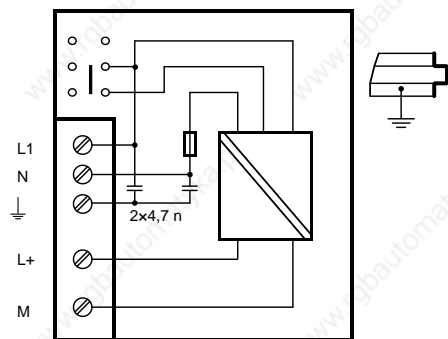
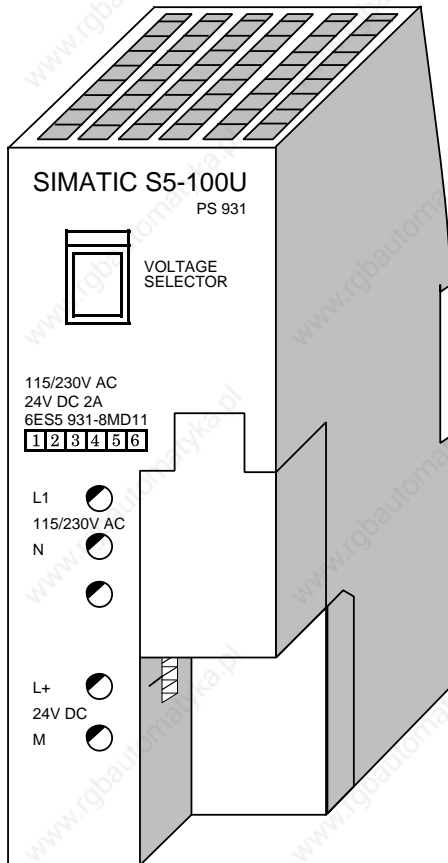

Technical specifications

Input voltage		
- rated value		115/230 V AC
- permiss. range		86 to 127 V/ 187 to 253 V
Line frequency		
- rated value		50/60 Hz
- permiss. range		47 to 63 Hz
Input current at 115/230 V		
- rated value		0.9/0.6 A
Efficiency	approx.	85%
Power consumption	approx.	58 W
Output voltage		
- rated value		24 V DC
- permiss. range		22.8 to 25.2 V
- open-circuit voltage		yes
Output current		
- rated value		2 A
Buffering of line voltage dips		
- duration of voltage dips		20 ms at 187 V/2 A
- repetition rate		1 s
Short-circuit protection		power limiting, electronic cutoff, non-latching
Fault LED		no
Protection class		1
Galvanic isolation		yes
Conductor cross-sectional area		
- stranded*		2x0.5 to 1.5 mm ²
- solid		2x0.5 to 2.5 mm ²
Insulation rating		VDE 0160 and VDE 0805 (transformer)
Rated insulation voltage (+24 V to L1)		250 V AC
- insulation group		2xB
- tested with		230 V AC
Dimensions WxHxD in mm		45.4x135x120
Power loss of the module	typ.	10 W
Weight	approx.	500 g (1.1 lbs.)
* with core end sleeves		
When interference-susceptible loads are connected, the use of a mains filter on the 24 V side is recommended (e.g. No. B84114-D-B20 from Siemens).		

Power Supply Module PS 935

(6ES5 935-8ME11)

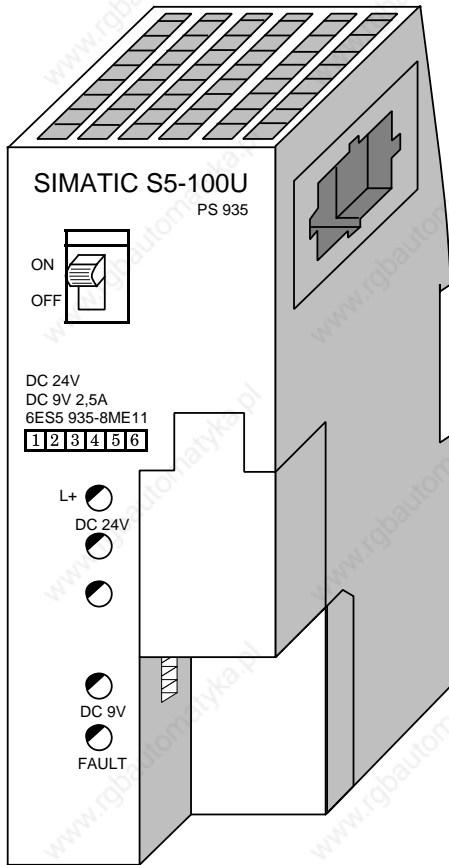

Technical Specifications

Number of inputs (only internal)	2x4 bits
Input voltage	24 V DC
- rated value	dyn. 18.5 to 30.2 V DC
- permissible range	stat. 20.4 to 28.8 V DC
- Polarity reversal protection	yes
Radio interference level	A to VDE 0871
Input current at 24 V DC	1.25 A
- rated value	15 times rated current
- inrush current limitation	approx. 75%
Power input	approx. 30 W
Output voltage	9 V DC
- rated value	8.55 to 9.45 V
- permissible range	yes
- open-circuit voltage	
Output current	2.5 A
- rated value	0.0 to 2.5 A
- permissible range	2.5 to 2.7 A
- overload recognition	
Buffering during mains voltage dips	
- duration of voltage dips	20 ms at 20.4 V/2.5 A
- repeat rate	1 s
Short-circuit protection (output side)	yes electronic switch-off, non-retentive
Diagnostics	yes (24 V DC input voltage, 9 V output voltage)
Fault indication	yes
Class of protection	Class 1
Galvanic isolation	no
Conductor cross-section	
- stranded*	2x0.5 to 1.5 mm ²
- solid	2x0.5 to 2.5 mm ²
Dimensions	
WxHxD (mm)	45.4x135x120
Power loss of the module	typ. 7.5 W
Weight	approx. 500 g (1.1 lbs)

* with core end sleeve

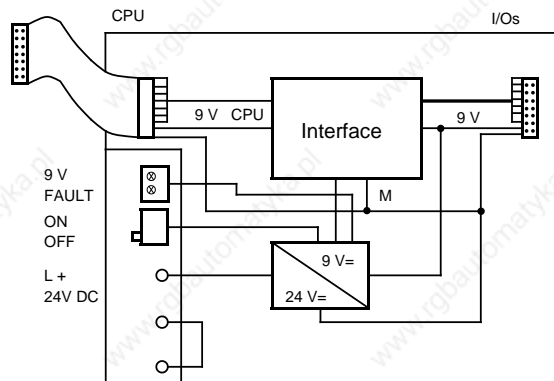

15.3 Bus Units

Bus Unit (SIGUT)

(6ES5 700-8MA11)

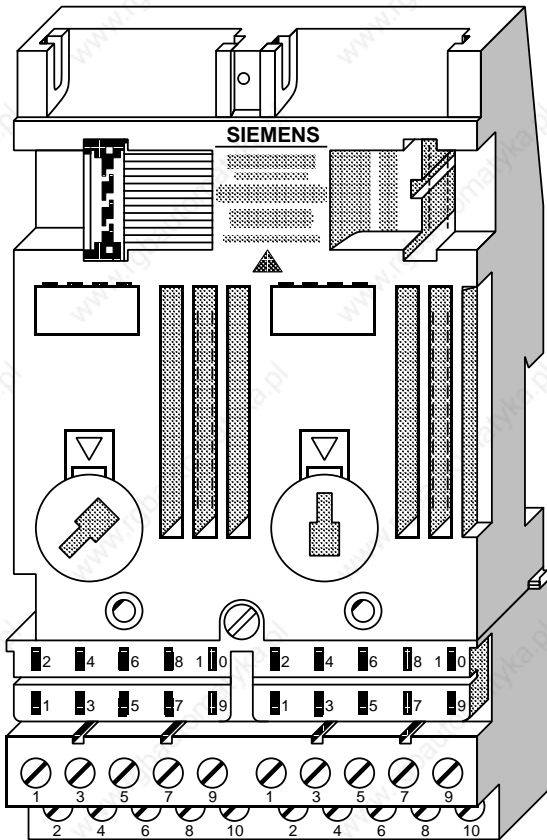

Technical specifications

Type of connection		SIGUT screw-type terminals
Number of plug-in modules		2
Number of bus units per programmable controller	max.	16
Connection between two bus units		flat ribbon
Number of terminals		10 per slot
Rated insulation voltage (+9 V to \perp)		12 V AC
- insulation group		1xB
- tested with		500 V AC
Conductor cross sectional area		
- stranded*		2x0.5 to 1.5 mm ²
- solid		2x0.5 to 2.5 mm ²
Current consumption - from +9 V (CPU)	typ.	1 mA
Dimensions WxHxD (in mm)		91.5x162x39
Weight	approx.	300 g (10.6 oz.)
* with core end sleeves		

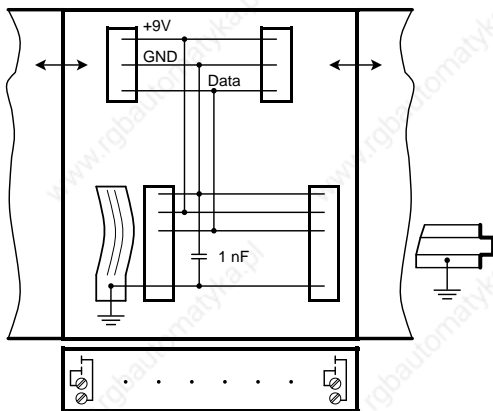

Bus Unit (Crimp-Snap-In Connections)

(6ES5 700-8MA22)

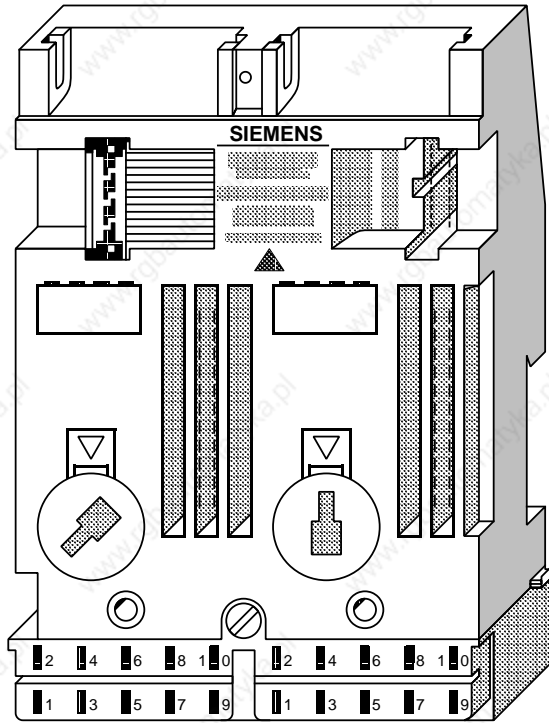

Technical specifications

Type of connection	Crimp snap-in
Number of plug-in modules	2
Number of bus units per programmable controller	max. 16
Connection between two bus units	flat ribbon
Number of terminals	10 per slot
Conductor cross sectional area - stranded	0.5 to 1.5 mm ²
Rated insulation voltage (+9 V to \perp)	12 V AC
- insulation group	1xB
- tested with	500 V AC
Current consumption - from +9 V (CPU)	typ. 1 mA
Dimensions WxHxD (in mm)	91.5x135x39
Weight	approx. 250 g (8.8 oz.)

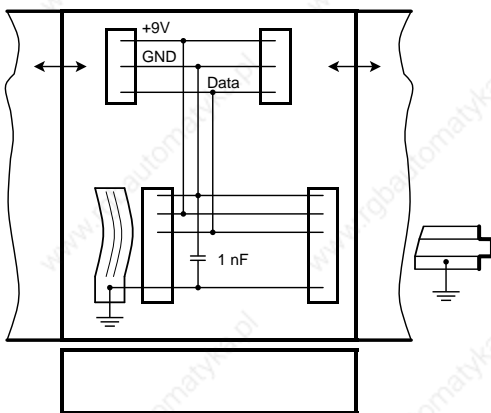

15.4 Interface Modules

IM 315 Interface Module

(6ES5 315-8MA11)

The diagram illustrates the IM 315 Interface Module. At the top, two perspective views show the module's physical form: one labeled 'OUT' with a connector on the front and a cable, and another labeled 'IN' with a connector on the back. Below these are two detailed connection diagrams. The top diagram shows the 'input' connection with a 1 nF capacitor connected to the Data line. The bottom diagram shows the 'output' connection with a 1 nF capacitor connected to the Data line. Both diagrams show the +9V and GND lines connected to the module's terminals.

SIEMENS
SIMATIC S5
INTERFACE MODULE
6ES5 315-8MA11
1 2 3 4 5 6
MADE IN GERMANY

Technical specifications

Current supply to the expansion unit	max.	2.5 A
Number of interface modules per S5-100U	max.	1
Permissible potential difference between (IM 315) and central ground point (CPU)		±1 V
Rated insulation voltage (+9 V to \perp)		12 V AC
- insulation group		1xB
- tested with		500 V AC
Dimensions WxHxD in mm		2x(45.4x135x39)
Current consumption - from +9 V (CPU)	typ.	1 mA
Weight	approx.	280 g (9.8 oz.)

IM 316 Interface Module

(6ES5 316-8MA12)

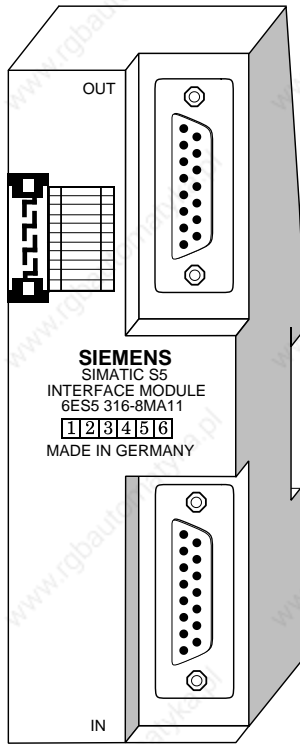

Technical specifications

Current supply to the expansion unit	max.	2.5 A
Number of interface modules per PLC	max.	4
Cable connectors for the IM 316		
- Cable connector (0.5 m/1.6 ft.)		6ES5 712-8AF00
- Cable connector (2.5 m/8.2 ft.)		6ES5 712-8BC50
- Cable connector (5.0 m/16.4 ft.)		6ES5 712-8BF00
- Cable connector (10 m/33 ft.)		6ES5 712-8CB00
Cable insulation in ducts		permissible
Permissible potential difference between \perp (IM 316) and central ground point (CPU)		± 1 V
Rated insulation voltage (+9 V to \perp)		12 V AC
- insulation group		1xB
Dimensions WxHxD in mm		45.4x135x39
Current consumption - from +9 V (CPU)	typ.	27 mA
Weight	approx.	120 g (4.2 oz.)

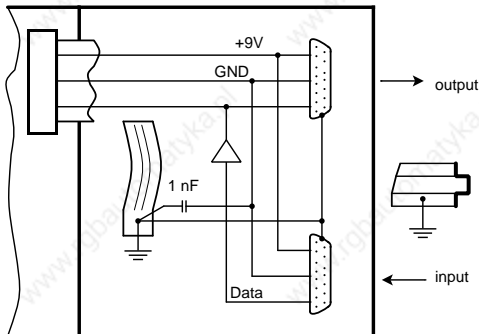

IM 90 Interface Module

(6ES5 090-8ME11)

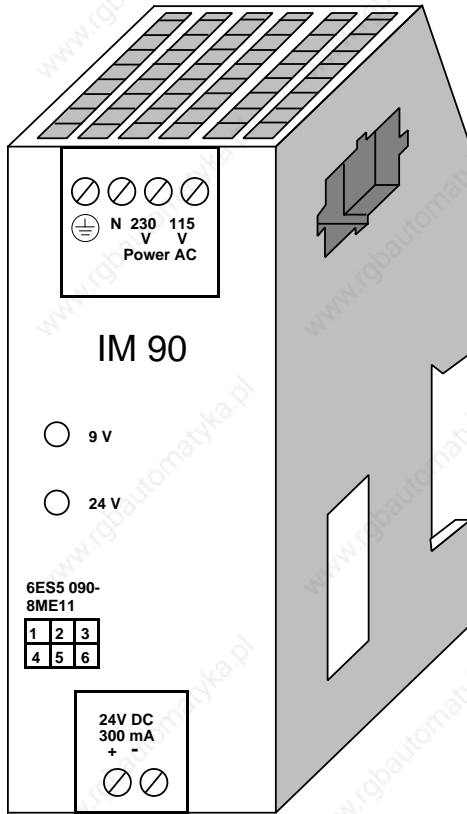

Technical Specifications

Current supply (internal)	
Input voltage	115 V/230 V AC
- rated value	93 to 127 V/
- permissible range	187 to 253 V
Line frequency	50 to 63 Hz
- permissible range	
Current consumption from 115 V (IM 90)	190 mA
Current consumption from 230 V (IM 90)	95 mA
Inrush current at 115 V/230 V	2 A/1.2 A
Output voltage	
- V1 (for sensor)	+24 V
- V2 (for I/Os)	+9 V
Output current	
- from V1	300 mA
- from V2	300 mA
Short-circuit protection	electronic
Galvanic isolation V1	yes
Galvanic isolation V2	no
Radio interference level	A to VDE 0871
Conductor cross-section	
- stranded*	2x0.5 to 1.5 mm ²
- solid	2x0.5 to 2.5 mm ²
Power loss of the module	typ. 11 W
Dimensions in mm WxHxD (mm)	58.5x135x120
Weight	approx. 820 g (1.8 lbs)
* with core end sleeve	

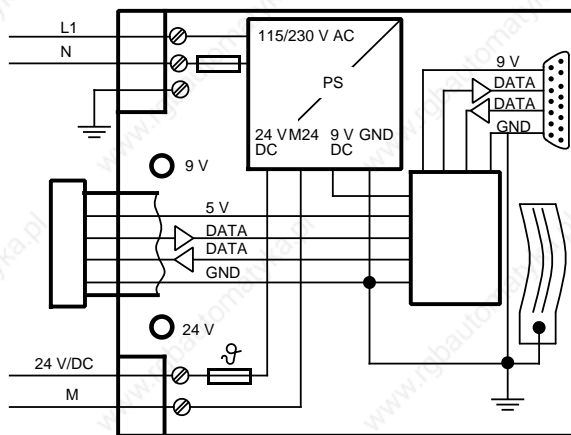

15.5 Digital Modules

Digital Input Modules

Table 15-1. Overview of Digital Input Modules

Order No.	Number of Inputs	Galvanic Isolation	Input Voltage Rated Value	Special Features
6ES5 420-8MA11	4	no	24 V DC	Fault indication: "no L+ supply"
6ES5 421-8MA12	8	no	24 V DC	Fault indication: "no L+/M supply"
6ES5 422-8MA11	16	no	24 V DC	Fault indication on L+/M interruption
6ES5 430-8MB11	4	yes (optocoupler)	24 to 60 V DC	Fault indication: "no L+ supply"
6ES5 430-8MC11	4	yes (optocoupler)	115 V AC/DC	
6ES5 430-8MD11	4	yes (optocoupler)	230 V AC/DC	
6ES5 431-8MA11	8	yes (optocoupler)	24 V DC	
6ES5 431-8MC11	8	yes (optocoupler)	115 V AC/DC	
6ES5 431-8MD11	8	yes (optocoupler)	230 V AC/DC	
6ES5 433-8MA11	8	yes (optocoupler)	5 to 24 V DC	Optional sink/source output
6ES5 437-8EA12	4	yes (optocoupler)	NAMUR 8.2 V DC	For sensors in an Ex environment see "Ex I/O: S5-100U" manual

Digital Output Modules

Table 15-2. Overview of Digital Output Modules

Order No.	Number of Outputs	Galvanic Isolation	Load Voltage Rated Value	Outp. Curr. with "1" Signal Rated Val.	Special Features
6ES5 440-8MA12	4	no	24 V DC	0.5 A	Fault indication: "Short circuit/no L+ supply"; fault diagnostics possible
6ES5 440-8MA22	4	no	24 V DC	2 A	Fault indication: "Short circuit/no L+ supply"; fault diagnostics possible
6ES5 441-8MA11	8	no	24 V DC	0.5 A	Capacitor C remains loaded after switch off of L+
6ES5 450-8MB11	4	yes (optocoupler)	24 to 60 V DC	0.5 A	Fault indication: "Short circuit/no L+ supply"; fault diagnostics possible
6ES5 450-8MD11	4	yes	115 to 230 V AC	1 A	Signal status display with load connected
6ES5 451-8MA11	8	yes (optocoupler)	24 V DC	1 A	Fault indication with short circuit
6ES5 451-8MD11	8	yes (optocoupler)	115 V to 230 V AC	0.5 A	Signal status display with load connected
6ES5 453-8MA11	8	yes	5 to 24 V DC	100 mA	Sink output
6ES5 451-8MR12	8 relay outputs	yes	30 V DC/230 V AC		Relay output module
6ES5 452-8MR11	4 relay outputs	yes (optocoupler)	30 V DC/230 V AC		Relay output module
6ES5 457-8EA12	4	yes (optocoupler)	7 V DC	2 mA	For actuators in an Ex environment see "Ex I/O:S5-100U" manual

Digital Input/Output Modules

Table 15-3. Overview of Digital Input/Output Modules

Order No.	Number of		Galvanic Isolation		Input Voltage Rated Value	Load Voltage Rated Value	Output Current at "1" Signal	Special Feature
	Inputs	Out-puts	Inputs	Out-puts				
6ES5 482-8MA13	16	16	no	no	24 V DC	24 V DC	500 mA	is assigned the same address space as an analog module

15.5.1 Digital Input Modules

Digital Input Module 4x24 V DC

(6ES5 420-8MA11)

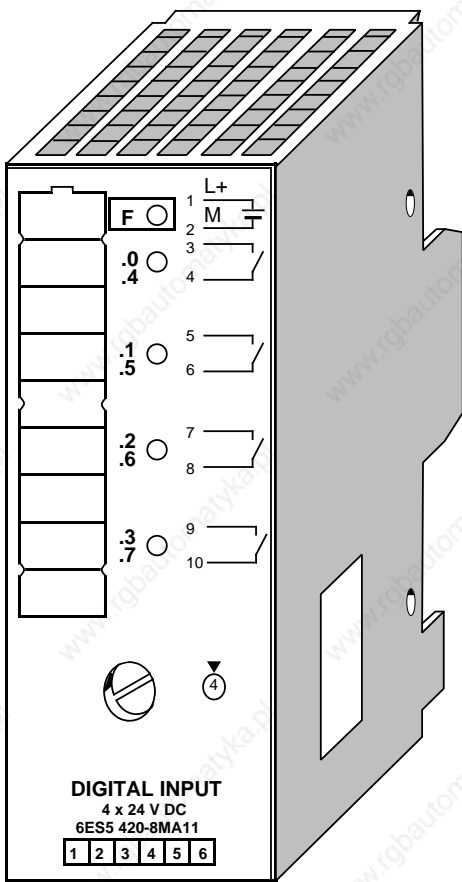

Technical specifications

Number of inputs	4
Galvanic isolation	no
- in groups of	4
Input voltage L+	
- rated value	24 V DC
- "0" signal	0 to 5 V
- "1" signal	13 to 33 V
Input current at "1" signal	typ. 7 mA (at 24 V)
Inherent delay	
- from "0" to "1"	typ. 2.5 ms*
- from "1" to "0"	typ. 5 ms*
Length of cable	
- unshielded	max. 100 m (330 ft.)
Rated insulation voltage**	
(+9 V to \perp)	12 V AC
- insulation group	1xB
Fault LED (red)	no input voltage L+
Connection of 2-wire BERO proximity switches	possible
- residual current	1.5 mA
Current consumption	
- from +9 V (CPU)	typ. 16 mA
Power loss of the module	typ. 0.8 W
Weight	approx. 205 g (7.2 oz.)

* Times depend on voltage

** Relevant only for isolated assembly in the ET 100U/200 U

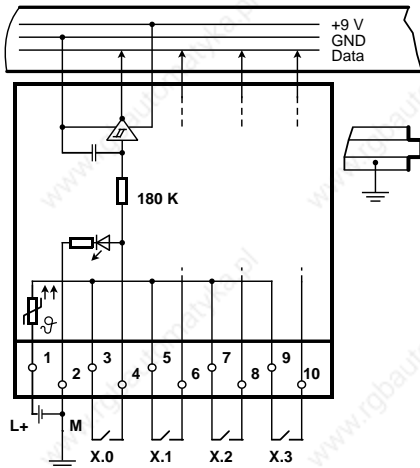

Digital Input Module 8x24 V DC

(6ES5 421-8MA12)

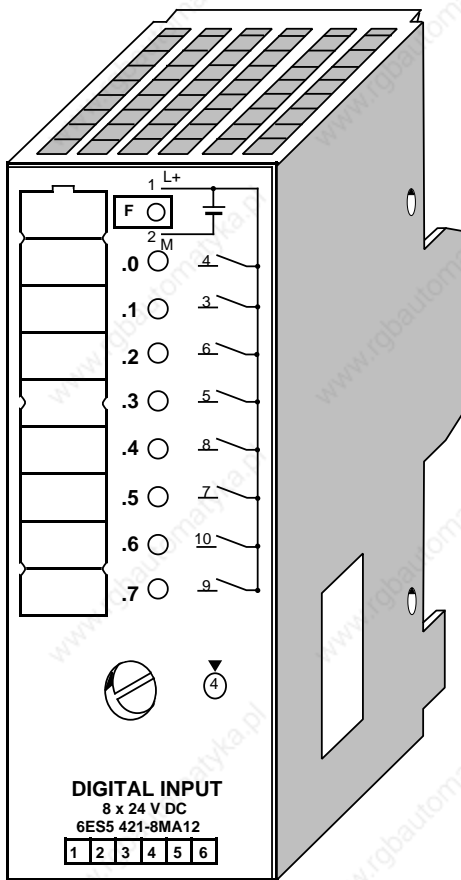

Technical specifications

Number of inputs	8
Galvanic isolation	no
- in groups of	8
Input voltage L+	
- rated value	24 V DC
- "0" signal	0 to 5 V
- "1" signal	13 to 33 V
Input current at "1" signal	typ. 7 mA at 24 V
Inherent delay	
- from "0" to "1"	typ. 2.3 ms*
- from "1" to "0"	typ. 3.5 ms*
Length of cable	
- unshielded	max. 100 m (330 ft.)
Rated insulation voltage**	
(+9 V to ⊥)	12 V AC
- insulation group	1xB
Fault LED (red)	no input voltage L+/M
Connection of 2-wire BERO proximity switches	possible
- residual current	1.5 mA
Current consumption from +9 V (CPU)	typ. 34 mA
Power loss of the module	typ. 1.6 W
Weight	approx. 190 g (6.7 oz.)

* Times depend on voltage
 ** Relevant only for isolated assembly in the ET 100U/200U

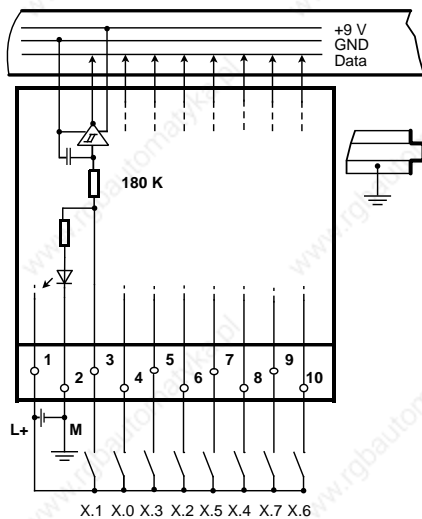

Digital Input Module 16x24 V DC

**(6ES5 422-8MA11)
(6ES5 490-8MA12)
(6ES5 490-8MB11)**

Technical specifications

Number of inputs	16
Galvanic isolation	no
Input voltage L+	24 V DC
- rated value	0 to 5 V
- "0" signal	13 to 30 V
- "1" signal	
Input protection	
- against polarity reversal	no, fuse trips
- against overvoltage	up to 33 V
Input current at "1" signal	typ. 4.5 mA
Inherent delay	
- from "0" to "1"	typ. 4 ms
- from "1" to "0"	typ. 3 ms
Length of cable - unshielded	100 m
Rated insulation voltage (+9 V to \perp)	12 V AC
- insulation group	1xB
EMC/noise immunity to VDE 801-4, severity level 3	2 kV
Fault LED (red)	on L+/M interruption
Connection of 2-wire BERO proximity switches - residual current	possible 1.5 mA
Current consumption - from +9 V (CPU)	typ. 50 mA
Power loss of the module	typ. 4.5 W
Weight	ca. 190 g (6.7 oz.)

Digital Input Module 4 × 24 to 60 V DC

(6ES5 430-8MB11)

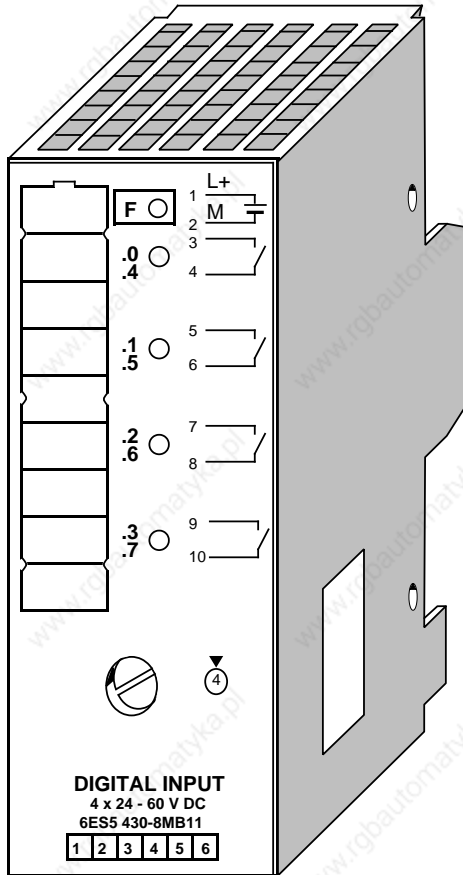

Technical specifications

Number of inputs	4
Galvanic isolation	yes (optocoupler)
- in groups of	4
Input voltage L+	
- rated value	24 to 60 V DC
- "0" signal	- 33 to 8 V
- "1" signal	13 to 72 V
Input current at "1" signal	typ. 4.5 to 7.5 mA
Inherent delay	
- from "0" to "1"	typ. 3 ms (1.4 to 5 ms)
- from "1" to "0"	typ. 3 ms (1.4 to 5 ms)
Length of cable	
- unshielded	max. 100 m (330 ft.)
Rated insulation voltage (+9 V to $\bar{\text{M}}$)	12 V AC
- insulation group	1xB
- tested with	500 V AC
Rated insulation voltage (+9 V to L+)	60 V AC
- insulation group	2xB
- tested with	1250 V AC
Fault LED (red)	no input voltage L+
Connection of 2-wire BERO proximity switches	possible
- residual current	1.5 mA
Current consumption	
- from +9 V (CPU)	max. 5 mA
- from L+	max. 35 mA
Power loss of the module	max. 2 W
Weight	approx. 200 g (7 oz.)

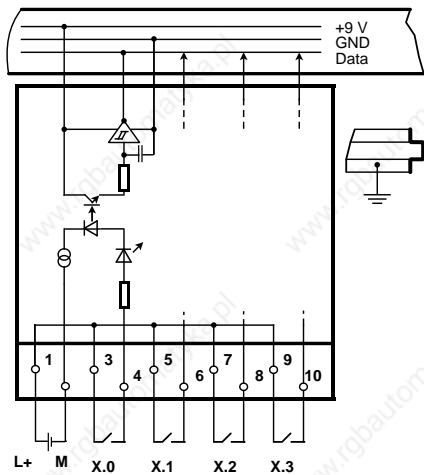

Digital Input Module 4x115 V AC

(6ES5 430-8MC11)

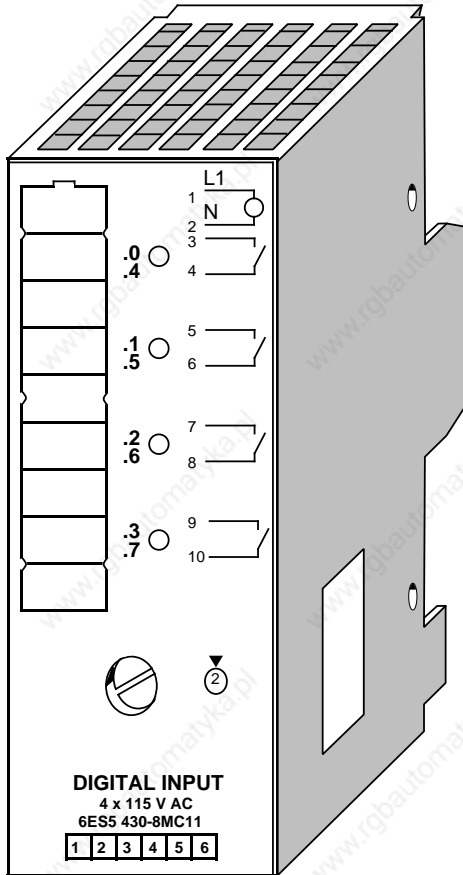

Technical specifications

Number of inputs	4
Galvanic isolation	yes (optocoupler)
- in groups of	4
Input voltage L1	
- rated value	115 V AC/DC
- "0" signal	0 to 40 V
- "1" signal	85 to 135 V
- frequency	47 to 63 Hz
Input current at "1" signal	
typ.	14 mA at 115 V AC
typ.	6 mA at 115 V DC
Inherent delay	
- from "0" to "1"	typ. 10 ms
- from "1" to "0"	typ. 20 ms
Length of cable	
- unshielded	max. 100 m (330 ft.)
Rated insulation voltage (+9 V to L1)	125 V AC
- insulation group	2xB
- tested with	1250 V AC
Rated insulation voltage (+9 V to \perp)	12 V AC
- insulation group	1xB
- tested with	500 V AC
Connection of 2-wire BERO proximity switches	possible
- residual current	5 mA
Current consumption	
- from +9 V (CPU)	typ. 16 mA
Power loss of the module	typ. 2.8 W
Weight	approx. 210 g (7.4 oz.)

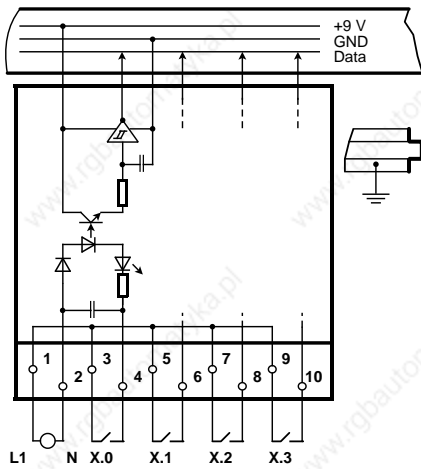

Digital Input Module 4x230 V AC

(6ES5 430-8MD11)

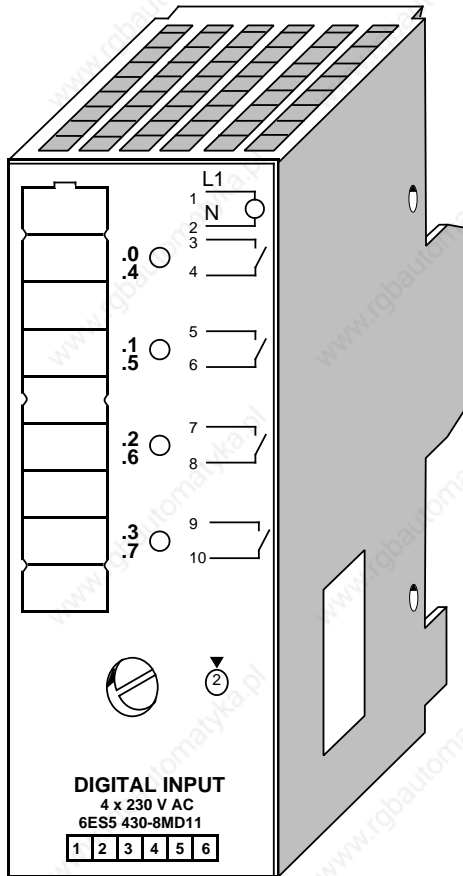

Technical specifications

Number of inputs	4
Galvanic isolation	yes (optocoupler)
- in groups of	4
Input voltage L1	
- rated value	230 V AC/DC
- "0" signal	0 to 70 V
- "1" signal	170 to 264 V
- frequency	47 to 63 Hz
Input current at "1" signal	typ. 16 mA at 230 V AC typ. 2.5 mA at 230 V DC
Inherent delay	
- from "0" to "1"	typ. 10 ms
- from "1" to "0"	typ. 20 ms
Length of cable	
- unshielded	max. 100 m (330 ft.)
Rated insulation voltage (+9 V to L1)	250 V AC
- insulation group	2xB
- tested with	1500 V AC
Rated insulation voltage (+9 V to \downarrow)	12 V AC
- insulation group	1xB
- tested with	500 V AC
Connection of 2-wire BERO proximity switches	possible
- residual current	5 mA
Current consumption	
- from +9 V (CPU)	typ. 16 mA
Power loss of the module	typ. 2.5 W
Weight	approx. 210 g (7.4 oz.)

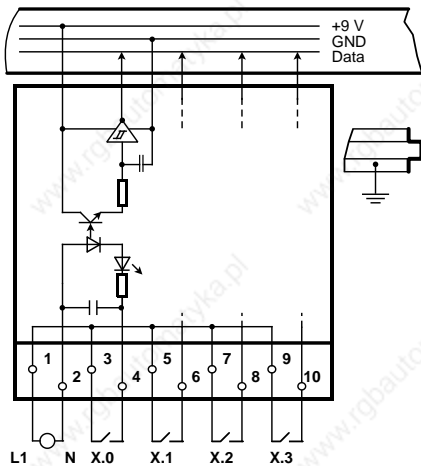

Digital Input Module 8 x 24 V DC

(6ES5 431-8MA11)

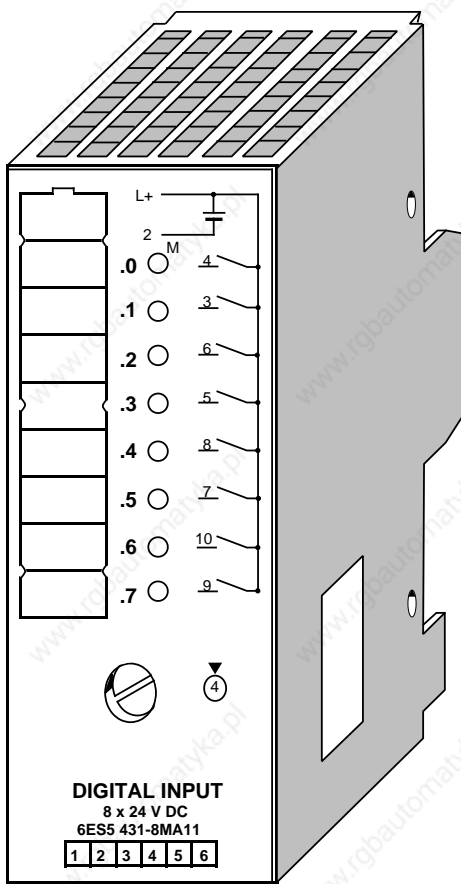

Technical Specifications

Number of inputs	8
Galvanic isolation	yes (optocoupler)
- in groups of	8
Input voltage L+	24 V DC
- rated value	0 to 5 V
- "0" signal	13 to 33 V
- "1" signal	
Input current at "1" signal	typ. 8.7 mA (at 24 V)
Inherent delay	typ. 5.5 ms
- from "0" to "1"	typ. 4.5 ms
- from "1" to "0"	
Length of cable	max. 100 m (330 ft.)
- unshielded	
Rated insulation voltage	12 V AC
(+ 9 V to ±)	2 x B
- insulation group	500 V AC
- tested with	
Rated insulation voltage	30 V AC
(+ 9 V to L+)	2 x B
- insulation group	500 V AC
- tested with	
Connection of 2-wire BERO proximity switches	possible
- residual current	1.5 mA
Current consumption	typ. 32 mA
- from + 9 V (CPU)	
Power loss of the module	typ. 2 W
Weight	approx. 190 g (6.7 oz.)

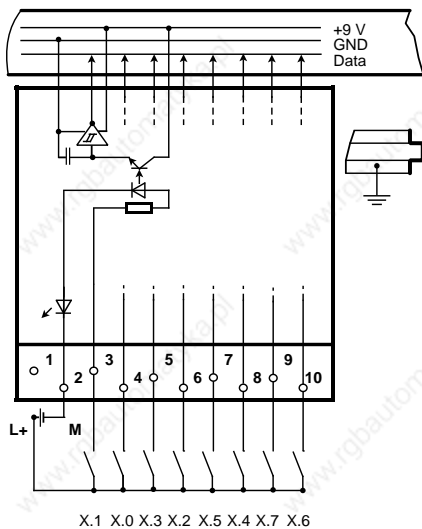

Digital Input Module 8x115 V AC

(6ES5 431-8MC11)

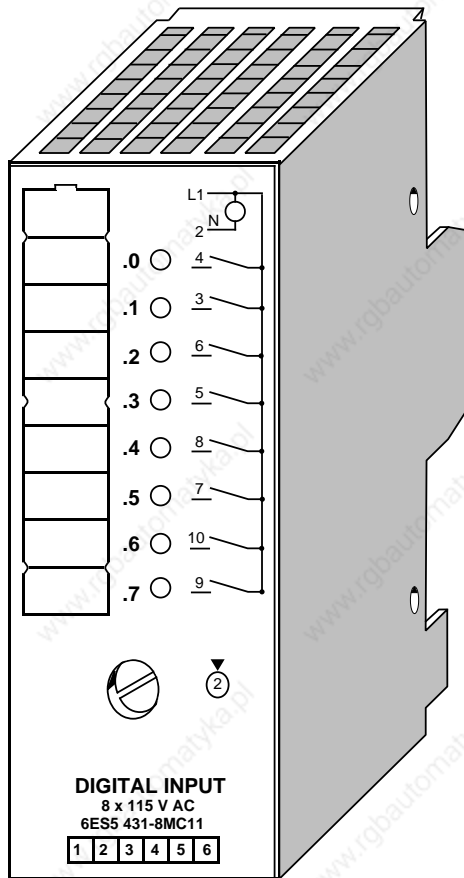

Technical specifications

Number of inputs	8
Galvanic isolation	yes (optocoupler)
- in groups of	8
Input voltage L1	
- rated value	115 V AC/DC
- "0" signal	0 to 40 V
- "1" signal	85 to 135 V
- frequency	47 to 63 Hz
Input current at "1" signal	typ. 12 mA at 115 V AC typ. 2.5 mA at 115 V DC
Inherent delay	
- from "0" to "1"	typ. 10 ms
- from "1" to "0"	typ. 20 ms
Length of cable	
- unshielded	max. 100 m (330 ft.)
Rated insulation voltage (+9 V to L1)	125 V AC
- insulation group	2xB
- tested with	1250 V AC
Rated insulation voltage (+9 V to ⚡)	12 V AC
- insulation group	1xB
- tested with	500 V AC
Connection of 2-wire BERO proximity switches	possible
- residual current	4 mA
Current consumption	
- from +9 V (CPU)	typ. 32 mA
Power loss of the module	typ. 2.5 W
Weight	approx. 260 g (9 oz.)

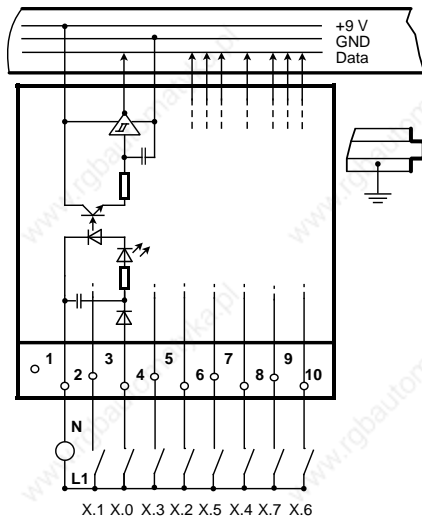

Digital Input Module 8 x 230 V AC

(6ES5 431-8MD11)

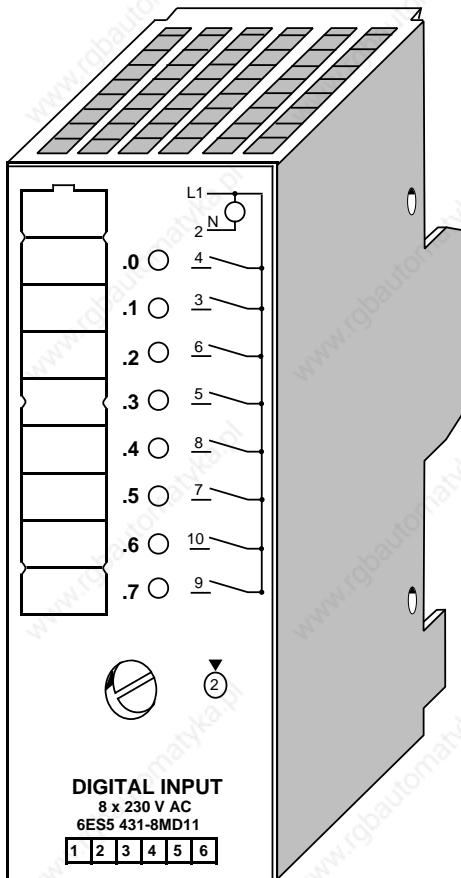

Technical specifications

Number of inputs	8
Galvanic isolation	yes (optocoupler)
- in groups of	8
Input voltage L1	
- rated value	230 V AC/DC
- "0" signal	0 to 95 V
- "1" signal	195 to 253 V
- frequency	47 to 63 Hz
Input current at "1" signal	typ. 16 mA at 230 V AC typ. 1.8 mA at 230 V DC
Inherent delay	
- from "0" to "1"	typ. 10 ms
- from "1" to "0"	typ. 20 ms
Length of cable	
- unshielded	max. 100 m (330 ft.)
Rated insulation voltage	
(+9 V to L1)	250 V AC
- insulation group	2xB
- tested with	1500 V AC
Rated insulation voltage	
(+9 V to GND)	12 V AC
- insulation group	1xB
- tested with	500 V AC
Connection of 2-wire BERO proximity switches	possible
- residual current	5 mA
Current consumption	
- from +9 V (CPU)	typ. 32 mA
Power loss of the module	typ. 3.6 W
Weight	approx. 260 g (9 oz.)

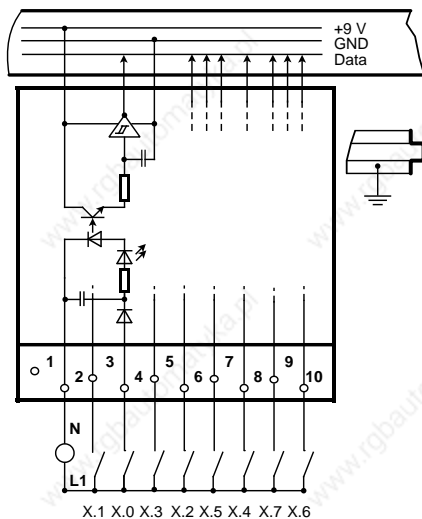

Digital Input Module 8 x 5 to 24 V DC

(6ES5 433-8MA11)

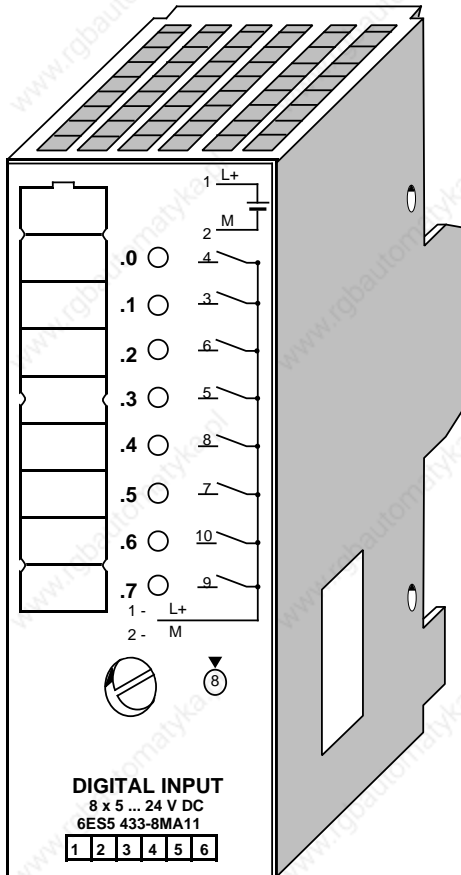

Technical Specifications

Number of inputs	8
Galvanic isolation	yes (optocoupler)
- in groups of	8
Input voltage L+	
- rated value	5 to 24 V DC
- "0" signal	V _{in} approx. 25% L+
- "1" signal	V _{in} approx. 45% L+
Permissible range	4.5 to 30 V
Input resistance	4.7 k Ω to L+ or M; reversible on the back of the module*
The LED displays the evaluated signal	
Inherent delay	approx. 1 ms or 10 ms; reversible on the back of the module*
Length of cable	
- unshielded	max. 100 m (330 ft.)
Rated insulation voltage (+ 9 V to L+)	
- insulation group	30 V AC
- tested with	2 x B 500 V AC
Rated insulation voltage (+ 9 V to ↓)	
- insulation group	12 V AC
- tested with	2 x B 500 V AC
Current consumption	
- from + 9 V (CPU)	typ. 6 mA
- from L+	typ. 60 mA
Power loss of the module	typ. 2.4 W
Weight	approx. 225 g (8 oz.)

* reversible in groups of 8

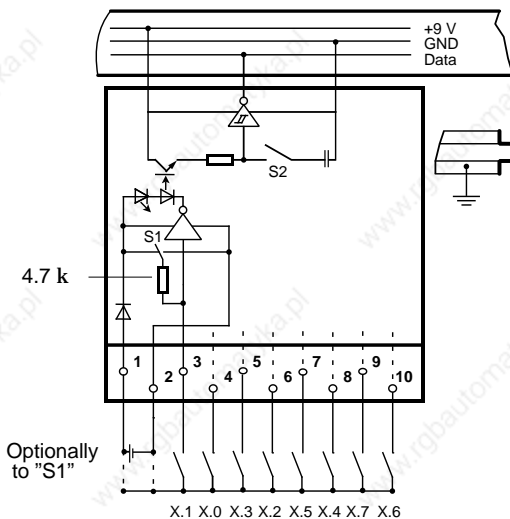

15.5.2 Digital Output Modules

Output Modules with Error Diagnostics

The output modules	4 x 24 V DC/0.5 A	(6ES5 440-8MA12)
	4 x 24 V DC/2.0 A	(6ES5 440-8MA22)
	4 x 24 to 60 V DC/0.5 A	(6ES5 450-8MB11)

can signal errors to the CPU in addition to indicating of faults (red LED).

The error messages can be scanned at input channels I X.0 and I X.1.

The following error messages are possible:

Table 15-4. Error Messages of Output Modules with Error Diagnostics

Address	Type of Error
I X.0	Short-circuit at output channel/fuse tripped or no load voltage
I X.1	Module defective (output transistor failed)

X is the byte address of the output module

A pending error is indicated by signal status "1". In the case of output modules without error diagnostics, the PII is set to "0".

Digital Output Module 4x24 V DC/0.5 A

(6ES5 440-8MA12)

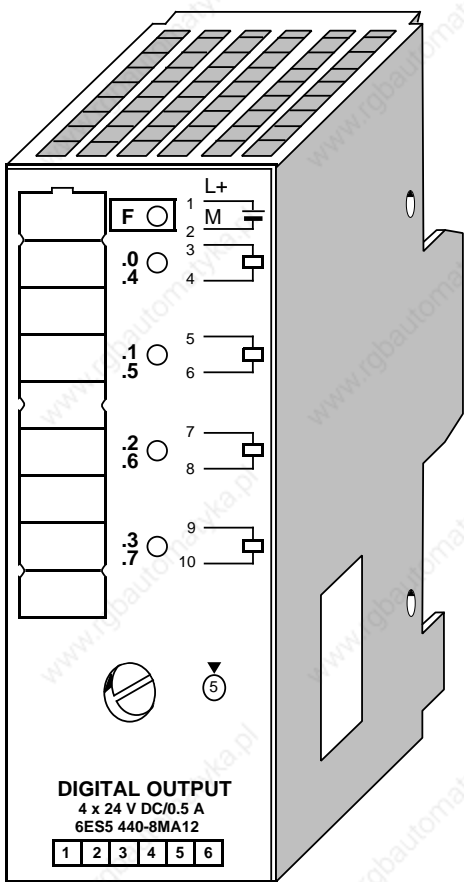

Technical specifications

Number of outputs	4
Galvanic isolation	no
- in groups of	4
Load voltage L+	
- rated value	24 V DC
- permissible range (including ripple)	20 to 30 V
- value at t<0.5 s	35 V
Output current for "1" signal	
- rated value	0.5 A
- permissible range	5 to 500 mA
- lamp load	max. 5 W
Residual current at "0" signal	max. 0.5 mA
Output voltage - "1" signal	max. L+ (- 0.6 V)
Short-circuit protection	short-circuit protected output with autom. switch on when the short-circuit does not exist any more
Fault LED (red)	short-circuit/no load voltage L+
Error diagnostics	possible
Voltage induced on circuit interruption (internal) limited to	- 15 V
Switching frequency	
- resistive load	max. 100 Hz
- inductive load	max. 2 Hz
Total permissible current of outputs	2 A
Driving of digital input	possible
Paralleling of outputs	possible
- maximum current	0.8 A
Length of cable - unshielded	max. 100 m (330 ft.)
Rated insulation voltage* (+9 V to ⚡)	12 V AC
- insulation group	1xB
Current consumption	
- from +9 V (CPU)	typ. 15 mA
- from L+(without load)	typ. 25 mA
Power loss of the module	typ. 1.5 W
Weight	approx. 200 g (7 oz.)

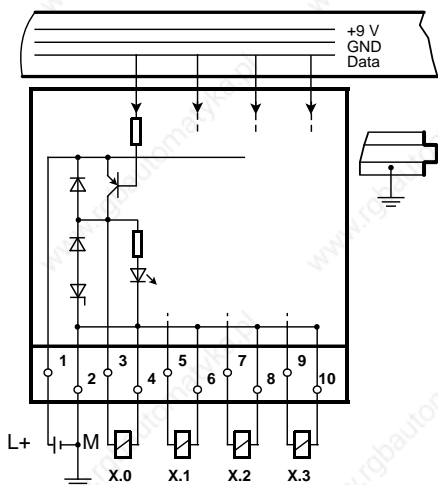

* Relevant only for isolated assembly in the ET 100U/200U

Digital Output Module 4 x 24 V DC/2 A

(6ES5 440-8MA22)

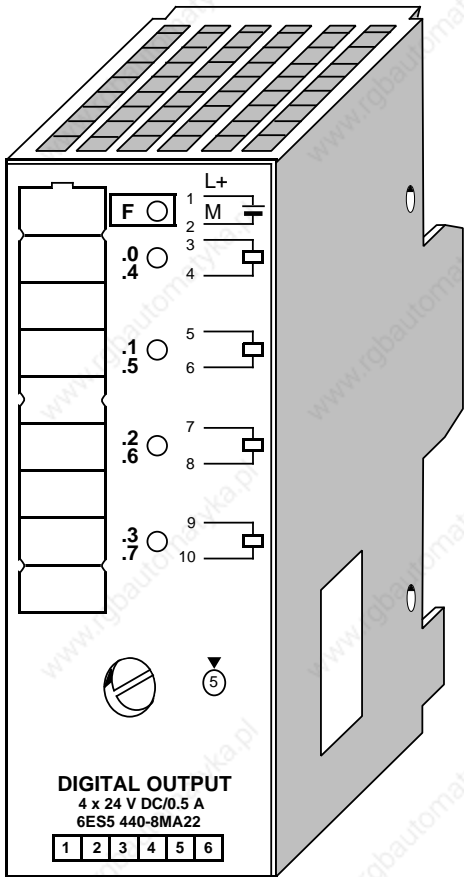

Technical specifications

Number of outputs	4
Galvanic isolation	no
- in groups of	4
Load voltage L+	
- rated value	24 V DC
- permissible range (including ripple)	20 to 30 V
- value at $t < 0.5$ s	35 V
Output current for "1" signal	
- rated value	2 A
- permissible range	5 mA to 2 A
- lamp load	max. 10 W
Residual current at "0" signal	max. 1 mA
Output voltage - "1" signal	max. L+ (- 0.8 V)
Short-circuit protection	short-circuit protected output with autom. switch on when the short-circuit does not exist any more
Fault LED (red)	short-circuit/no load voltage L+ possible
Error diagnostics	possible
Voltage induced on circuit interruption (internal) limited to	- 15 V
Switching frequency	
- resistive load	max. 100 Hz
- inductive load	max. 2 Hz
Total permissible current of outputs	4 A
Driving of digital input	possible
Paralleling of outputs	possible
- maximum current	3.2 A
Length of cable	
- unshielded	max. 100 m (330 ft.)
Rated insulation voltage* (+9 V to \rightarrow)	12 V AC
- insulation group	1xB
Current consumption	
- from +9 V (CPU)	typ. 15 mA
- from L+ (without load)	typ. 25 mA
Power loss of the module	typ. 3 W
Weight	approx. 200 g (7 oz.)

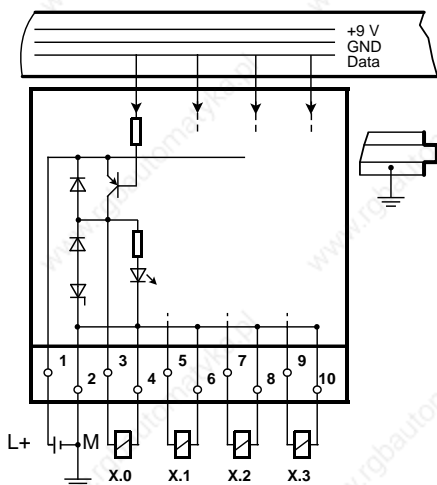

* Relevant only for isolated assembly in the ET 100U/200U

Digital Output Module 8x24 V DC/0.5 A

(6ES5 441-8MA11)

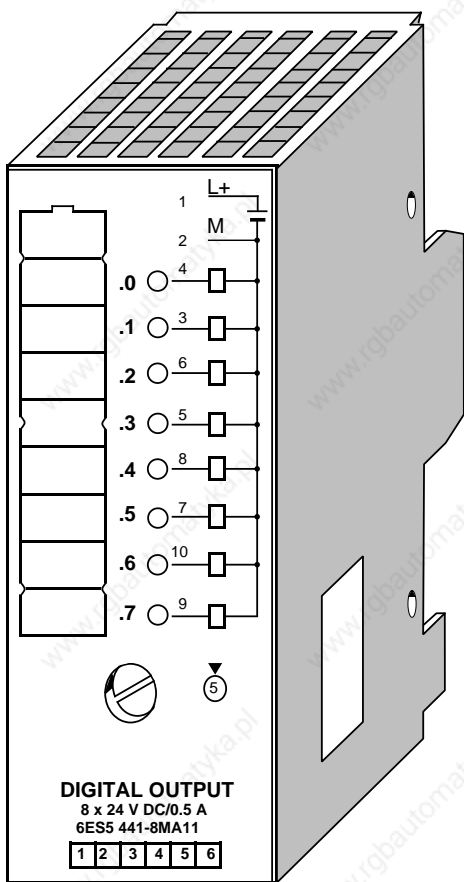

Technical specifications

Number of outputs	8
Galvanic isolation	no
- in groups of	8
Load voltage L+	
- rated value	24 V DC
- permissible range (including ripple)	20 to 30 V
- value at t<0.5 s	35 V



Warning

Capacitor remains loaded after switch off of L+

Output current for "1" signal		
- rated value		0.5 A at 60 °C (140 °F)/ 1 A at 30 °C (86 °F)
- permissible range		5 mA to 1 A
- lamp load	max.	5 W
Residual current at "0" signal	max.	1.0 mA
Output voltage		
- "1" signal	max.	L+ (- 0.5 V)
Short-circuit protection		no
Voltage induced on circuit interruption (internal) limited to		- 15 V
Switching frequency		
- resistive load	max.	100 Hz
- inductive load	max.	2 Hz
Total permissible current of outputs		4 A
Driving of digital input		possible
Paralleling of 2 outputs		possible
- maximum current		0.8 A

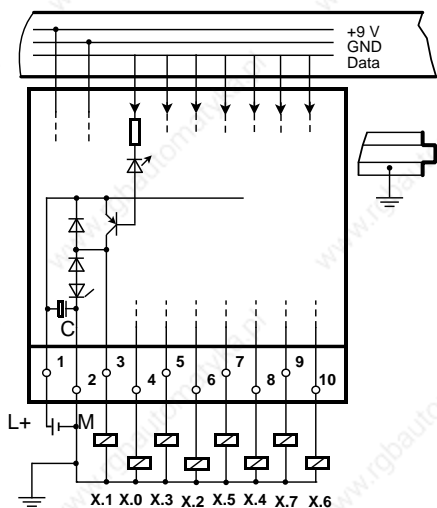

Length of cable		
- unshielded	max.	100 m (330 ft.)
Rated insulation voltage* (+9 V to ⚡)		12 V AC
- insulation group		1xB
Current consumption		
- from +9 V (CPU)	typ.	14 mA
- from L+(without load)	typ.	15 mA
Power loss of the module	typ.	2 W
Weight	approx.	220 g (7.7 oz.)

* Relevant only for isolated assembly in the ET 100U/200 U

Digital Output Module 4x24 to 60 V DC/0.5 A

(6ES5 450-8MB11)

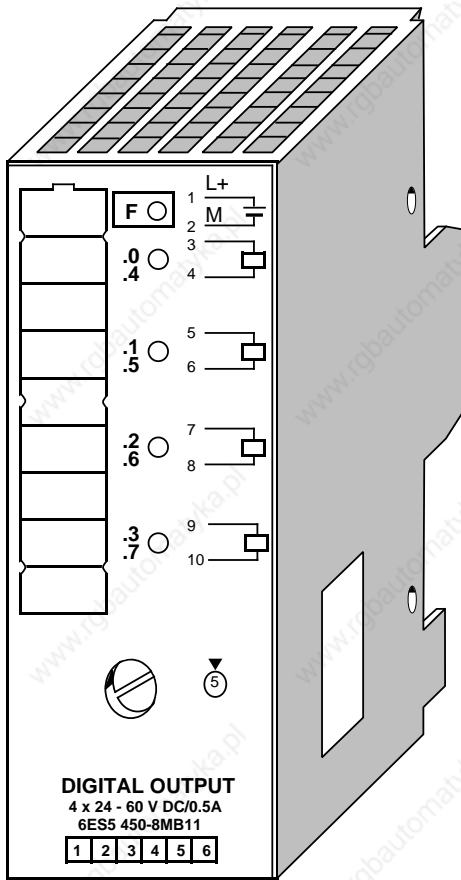

Technical specifications

Number of outputs	4
Galvanic isolation	yes (optocoupler)
- in groups of	4
Load voltage L+	
- rated value	24 to 60 V DC
- permissible range	20 to 72 V
Output current for "1" signal	
- rated value	0.5 A
- permissible range	5 mA to 0.5 A
- lamp load	max. 5 to 12 W
Residual current at "0" signal	max. 1 mA
Short-circuit protection	short-circuit protected output with autom. switch on when the short-circuit does not exist any more
Fault LED (red)	short circuit/ no load voltage L+
Error diagnostics	possible
Voltage induced on circuit interruption (internal) limited to	- 30 V
Switching frequency	
- resistive load	max. 100 Hz
- inductive load	max. 2 Hz
Total permissible current of outputs	2 A
Driving of digital input	possible
Paralleling of 2 outputs	possible
- maximum current	2x0.4 A
Length of cable	
- unshielded	max. 100 m (330 ft.)
Rated insulation voltage	
- (+9V to L+)	60 V AC
- insulation group	2xB
- tested with	500 V AC
Rated insulation voltage (+9 V to \perp)	12 V AC
- insulation group	1xB
- tested with	500 V AC
Current consumption	
- from +9 V (CPU)	typ. 15 mA
- from L+ (without load)	typ. 30 mA (at 60 V)
Power loss of the module	typ. 5 W
Weight	approx. 200 g (7 oz.)

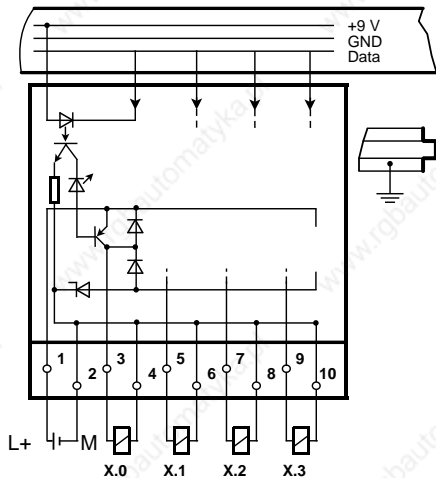

Digital Output Module 4x115 to 230 V AC/1 A

(6ES5 450-8MD11)

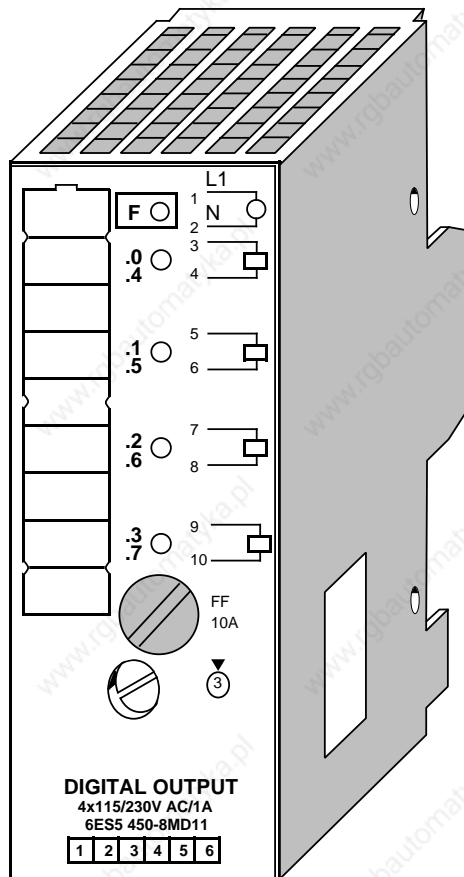

Technical specifications

Number of outputs	4
Galvanic isolation	yes
- in groups of	4
Load voltage L1	
- rated value	115 to 230 V AC
- frequency	max. 47 to 63 Hz
- permissible range	85 to 264 V
Output current for "1" signal	
- rated value	1 A
- permissible range	max. 50 mA to 1 A
- lamp load	25/50 W
Contact current closing rating:	determined by the size of the fuse
Residual current at "0" signal	max. 3/5 mA
Output voltage - "1" signal	max. L1 (- 7 V)
Signal status display (green LEDs)	only with load connected
Short-circuit protection	fuse (10 A extra fast) (Wickmann No. 19231, or 6ES5 980-3BC41)
Fault LED (red)	fuse blown*
Switching frequency	max. 10 Hz
Permissible current of all outputs	4 A
Driving of digital input	possible
Paralleling of outputs	not possible
Length of cable - unshielded	max. 100 m (330 ft.)
Rated insulation voltage (+9 V to L1)	250 V AC
- insulation group	2xB
- tested with	1500 V AC
Rated insulation voltage (+9 V to ⚡)	12 V AC
- insulation group	1xB
- tested with	500 V AC
Current consumption - from +9 V (CPU)	typ. 14 mA
Power loss of the module	typ. 3.5 W
Weight	approx. 315 g (11 oz.)

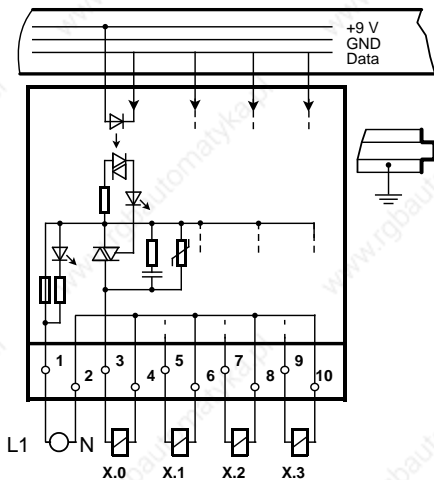

* Indication only given if load voltage is applied and at least one load is connected

Digital Output Module 8 x 24 V DC/1 A

(6ES5 451-8MA11)

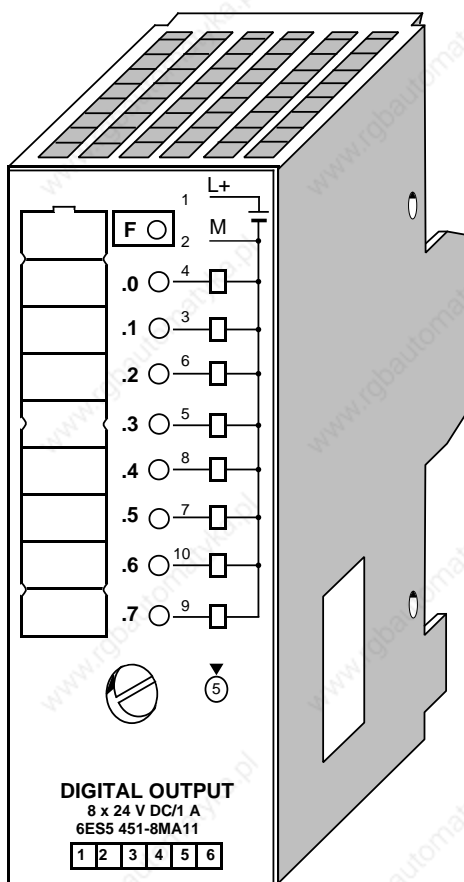

Technical specifications

Number of outputs	8
Galvanic isolation	yes (optocoupler)
- in groups of	8
Load voltage L+	
- rated value	24 V DC
- permissible range (including ripple)	20 to 30 V
- value at $t < 0.5$ s	35 V
Output current for "1" signal	
- rated value	1 A
- permissible range	5 mA to 1A
- lamp load	max. 10 W
Residual current at "0" signal	max. 0.5 mA
Output voltage	
- at "1" signal	max. L+ (- 0.6 V)
Short-circuit protection	short-circuit protected output with autom. switch on when the short-circuit does not exist any more
	short-circuit
Fault LED (red)	
Voltage induced on circuit interruption (internal) limited to	-15 V
Switching frequency	
- resistive load	max. 100 Hz
- inductive load	max. 2 Hz
Permissible current of all outputs	6 A
Driving of digital input	possible
Paralleling of 2 outputs	possible in pairs
- maximum current	1.8 A
Length of cable	
- unshielded	max. 100 m (330 ft.)
Rated insulation voltage (+ 9 V to L+)	24 V AC
- insulation group	2 x B
- tested with	500 V AC
Rated insulation voltage (+ 9 V to \perp)	12 V AC
- insulation group	1 x B
- tested with	500 V AC
Current consumption	
- from +9 V (CPU)	typ. 35 mA
- from L+ (without load)	typ. 50 mA
Power loss of the module	typ. 3 W
Weight	approx. 230g (8 oz.)

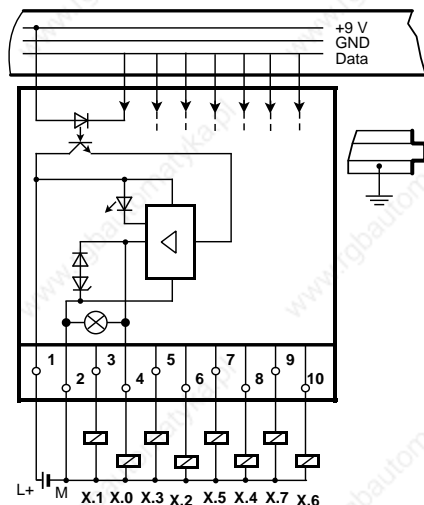

Digital Output Module 8x115 to 230 V AC/0.5 A

(6ES5 451-8MD11)

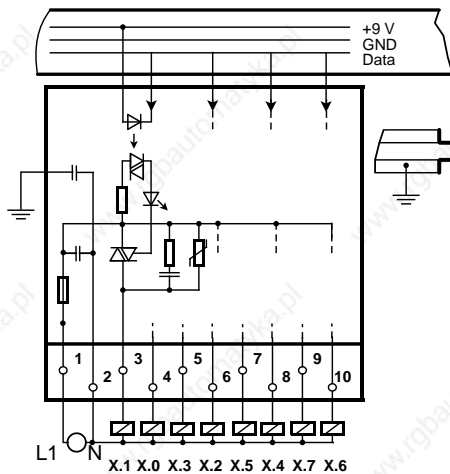
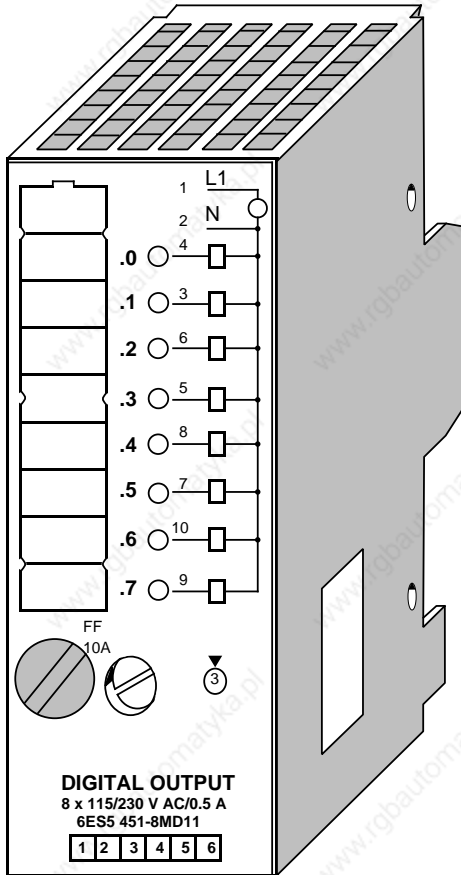

Technical specifications

Number of outputs	8
Galvanic isolation	yes (optocoupler)
- in groups of	8
Load voltage L1	
- rated value	115 to 230 V AC
- frequency	max. 47 to 63 Hz
- permissible range	85 to 264 V
Output current for "1" signal	
- rated value	0.5 A
- permissible range	max. 50 mA to 0.5 A
- lamp load	25/50 W
Contact current closing rating:	determined by the size of the fuse
Residual current at "0" signal	max. 3/5 mA
Output voltage - at "1" signal	max. L1 (-7 V)
Signal Status Display (green LEDs)	only with load connected
Short-circuit protection	fuse (10 A extra fast) (Wickmann No. 19231, or 6ES5 980-3BC41)
Switching frequency	max. 10 Hz
Permissible current of all outputs	4 A
Driving of digital input	possible
Paralleling of outputs	not possible
Length of cable - unshielded	max. 100 m (330 ft.)
Rated insulation voltage (+9 V to L1)	250 V AC
- insulation group	2xB
- tested with	1500 V AC
Rated insulation voltage (+9 V to \perp)	12 V AC
- insulation group	1xB
- tested with	500 V AC
Current consumption - from +9 V (CPU)	typ. 25 mA
Power loss of the module	typ. 3.5 W
Weight	approx. 270 g (9 oz.)

Digital Output Module 8x5 to 24 V DC/0.1 A

(6ES5 453-8MA11)

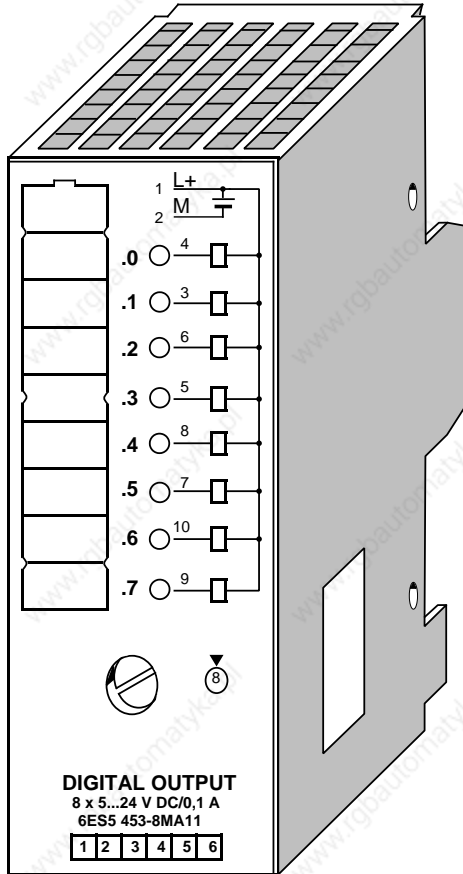

Technical specifications

Number of outputs	8
Galvanic isolation	yes
- in groups of	8
Load voltage L+	
- rated value	5 to 24 V DC
- permissible range (including ripple)	4.75 to 30 V
- value at t<0.5 s	35 V
Output current for "1" signal	
- rated value	100 mA
Output voltage	TTL-compatible*
Short-circuit protection	no
Voltage induced on circuit interruption (internal) limited to	- 19 V (at 24 V)
Switching frequency	
- resistive load	max. 100 Hz
- inductive load	max. 2 Hz
Paralleling of outputs	possible
- maximum current	(0.8 x I _{rated})
Length of cable	
- unshielded	max. 100 m (330 ft.)
Rated insulation voltage (+9 V to ⚡)	12 V AC
- insulation group	1xB
- tested with	500 V AC
Current consumption	
- from +9 V (CPU)	typ. 20 mA
- from L+ (without load)	typ. 28 mA
Power loss of the module	typ. 1 W
Weight	approx. 220 g (8 oz.)

* transistor with open collector, switching to M potential

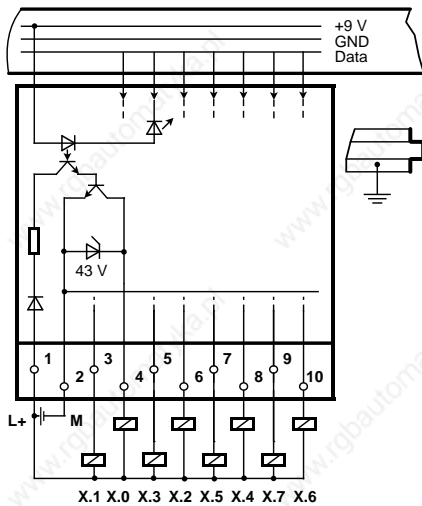

Relay Output Module 8 x 30 V DC/230 V AC
Crimp Snap-in Connector, 40-pin
Screw Plug Connector, 20-pin
Screw Plug Connector, 40-pin

(6ES5 451-8MR12)
(6ES5 490-8MA13/8MA03)
(6ES5 490-8MB21)
(6ES5 490-8MB11)

The technical drawing includes three main parts: a perspective view of the module, a side view of the terminal block, and a detailed circuit diagram. The perspective view shows the module with a label 'RELAY OUTPUT 8x30 V DC' and a status indicator 'F'. The side view shows 20 screw terminals numbered 1 to 20. The circuit diagram shows two relay channels, A and B, each with four relays. Channel A has terminals 1, 3, 5, 7, 9, 11, 13, 15, 17, 19. Channel B has terminals 1, 3, 5, 7, 9, 11, 13, 15, 17, 19. The diagram also shows a +9V supply, GND, and Data lines at the top, and a +24V supply and M terminal at the bottom.

Technical specifications

Outputs	8 relay outputs, contact switching varistor SIOV-S07-K275
Galvanic isolation - in groups of	yes 2 with signal status display
Continuous current I_{th}	3 A
Relay type	Dold OW 5699
Switching capacity of the contacts - resistive load	max. 3 A at 250 V AC 1.5 A at 30 V DC
- inductive load	max. 0.5 A at 250 V AC 0.5 A at 30 V DC
Operating cycles of the contacts according to VDE 0660, part 200	- AC - 11 1 x 10 ⁶ - DC - 11 0.5 x 10 ⁶
Switching frequency	max. 10 Hz
Fault LED (red)	no input voltage
Permissible ambient temperature of module - horizontal arrangement	0 to 60 °C (32 to 140 °F)
- vertical arrangement	0 to 40 °C (32 to 104 °F)
Length of cable - unshielded	max. 100 m (330 ft.)
Insulation rating	VDE 0160
Rated insulation voltage (+ 9 V to L 1)	250 V AC
- insulation group	2 x B
- tested with	1500 V AC
Rated insulation voltage (+ 9 V to \perp)	12 V AC
- insulation group	1 x B
- tested with	500 V AC
Rated insulation voltage (between contacts)	250 V AC
- insulation group	2 x B
- tested with	1500 V AC
Supply voltage L+ (for the relay)	- rated value 24 V DC
- ripple V_{pp}	max. 3.6 V
- permissible range (ripple included)	20 to 30 V
- value to $t < 0.5$ s	35 V
Current consumption - from + 9 V (CPU)	typ. 30 mA
- from L+	typ. 70 mA
Power loss of the module	typ. 1.6 W
Weight	approx. 300 g (11 oz.)

Relay Output Module 4 x 30 V DC/ 230 V AC

(6ES5 452-8MR11)

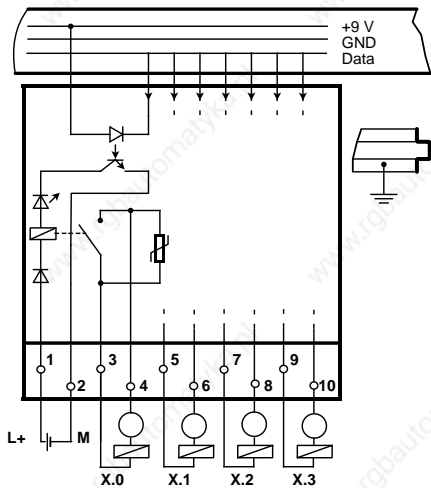
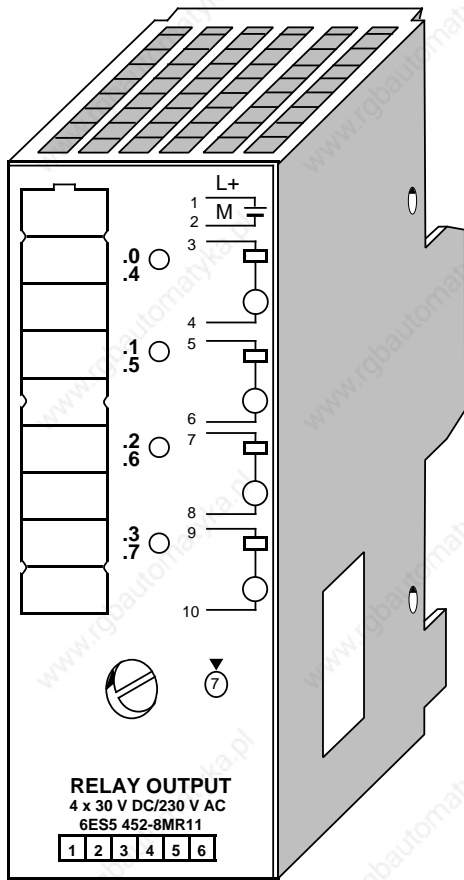

Technical specifications

Outputs		4 relay outputs, contact switching varistor SIOV-S07-K275
Galvanic isolation - in groups of		yes (optocoupler) 1
Continuous current I_{th}		5 A
Relay type		Siemens V 23127-D 0006-A402
Switching capacity of the contacts - resistive load	max.	5 A at 250 V AC 2.5 A at 30 V DC
- inductive load	max.	1.5 A at 250 V AC 0.5 A at 30 V DC
Operating cycle of the contacts according to VDE 0660, part 200 - AC-11		1.5×10^6
- DC-11		0.5×10^6
Switching frequency	max.	10 Hz
Permissible ambient temperature of module - horizontal arrangement		0 to 60 °C (32 to 140 °F)
- vertical arrangement		0 to 40 °C (32 to 104 °F)
Length of cable - unshielded	max.	100 m (330 ft.)
Insulation rating		VDE 0160
Rated insulation voltage (+ 9 V to L1)		250 V AC
- insulation group - tested with		2 x B 1500 V AC
Rated insulation voltage (+ 9 V to \perp)		12 V AC
- insulation group - tested with		1 x B 500 V AC
Rated insulation voltage (between contacts)		250 V AC
- insulation group - tested with		2 x B 1500 V AC
Supply voltage L+ (for the relay) - rated value		24 V DC
- ripple V_{pp}	max.	3.6 V
- permissible range (ripple included) - value at $t < 0.5$ s		20 to 30 V 35 V
Current consumption - from + 9 V (CPU)	typ.	14 mA
- from L+	typ.	100 mA
Power loss of the module	typ.	2 W
Weight	approx.	240 g (8 oz.)

15.5.3 Digital Input/Output Modules

Digital Input/Output Module with LED Display
 Crimp Snap-in Connector, 40-pin
 Screw Plug Connector, 40-pin

(6ES5 482-8MA13)
 (6ES5 490-8MA13/8MA03)
 (6ES5 490-8MB11)

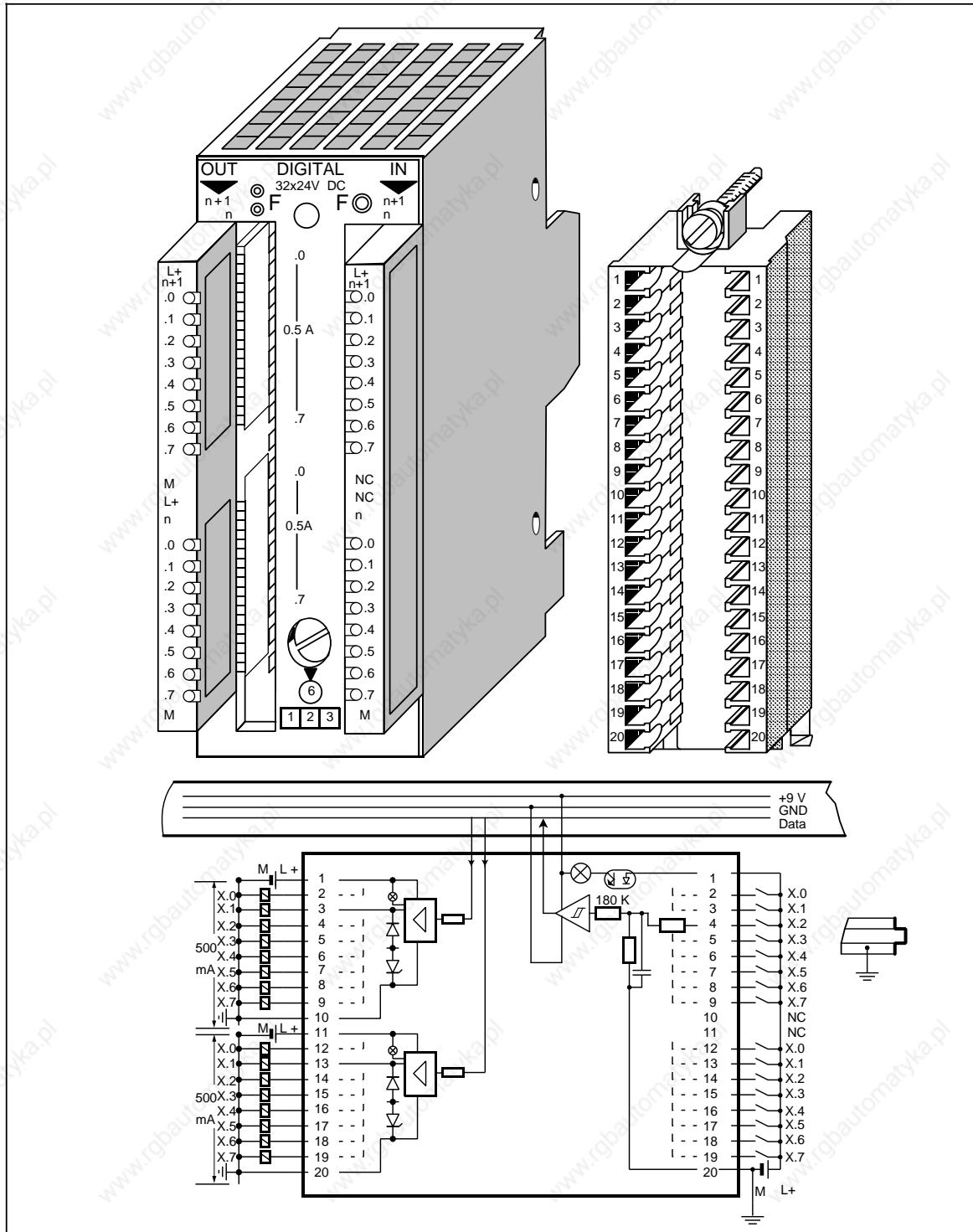

Digital Input/Output Module with LED Display (continued)

(6ES5 482-8MA13)

Technical specifications		Output side	
Cable length - unshielded	100 m (330 ft.)	Number of outputs	16
Rated insulation voltage (+9 V to → - insulation group	12 V AC 1 x B	Galvanic isolation - in groups of	no 8
Power loss of the module	typ. 4.5 W	Load voltage L+ - rated value - permissible range (ripple included) - value at t<0.5 s	24 V DC 20 to 30 V 35 V
Weight	approx. 190 g (7 oz.)	Output current I _N for "1" signal - rated value - permissible range	500 mA 5 to 500 mA
Input side		Residual current for "0" signal	max. 0.5 mA
Number of inputs	16	Short-circuit protection	yes
Galvanic isolation - in groups of	no 16	Short-circuit indication	red LED
Input voltage L+ - rated value - for "0" signal - for "1" signal	24 V DC 0 to 5 V 13 to 30 V	Output voltage for "1" signal	L+(- 0.6 V)
Input current for "1" signal	typ. 4.5 mA	Voltage induced on circuit interruption (internal) limited to	- 15 V
Inherent delay - from "0" to "1" - from "1" to "0"	typ. 4 ms typ. 3 ms	Switching frequency with - resistive load - inductive load	100 Hz 2 Hz
Fault LED (red)	indicates interruption of L+/M supply	Permissible total current of the outputs	6 A
Connection of two-wire BERO proximity switches - residual current	possible 1.5 mA	Driving of a digital input	possible
Current consumption - from +9 V (CPU)	typ. 50 mA	Paralleling of outputs - maximum current	possible in pairs (0.8×I _N)
		Current consumption - from +9 V (CPU) - from L+ (without load)	typ. 10 mA typ. 100 mA
		Lamp load	max. 5 W

15.6 Analog Modules

Analog Input Modules

Table 15-5. Overview of Analog Input Modules

Order No.	Number of Inputs	Galvanic Isolation	Input Range	Resolution	Special Features
6ES5 464-8MA11	4	yes	±50 mV	12 bits + sign	for thermocouples
6ES5 464-8MA21	4	yes	±50 mV	12 bits+ sign	for thermocouples with linearization and internal temperature compensation with types J, K, L
6ES5 464-8MB11	4	yes	±1 V	12 bits+ sign	
6ES5 464-8MC11	4	yes	±10 V	12 bits+ sign	
6ES5 464-8MD11	4	yes	±20 mA	12 bits+ sign	
6ES5 464-8ME11	4	yes	4 to 20 mA	12 bits	
6ES5 464-8MF11	2	yes	±500 mV	12 bits + sign	with current source for PT 100
6ES5 464-8MF21	2	yes	±500 mV	12 bits+ sign	with current source for PT 100 and linearization for PT 100
6ES5 466-8MC11	4	no	0 to 10 V	8 bits	
6ES5 467-8ME11	2	yes	4 to 20 mA	12 bits	for sensors in an Ex environment see "Ex I/O: S5-100U" manual

Analog Output Modules

Table 15-6. Overview of Analog Output Modules

Order No.	Number of Outputs	Galvanic Isolation	Output Range	Resolution	Special Features
6ES5 470-8MA12	2	yes	±10 V	11 bits + sign	
6ES5 470-8MB12	2	yes	±20 mA	11 bits + sign	
6ES5 470-8MC12	2	yes	4 to 20 mA	11 bits	
6ES5 470-8MD12	2	yes	1 to 5 V	11 bits	
6ES5 477-8EC11	2	yes	4 to 20 mA	11 bits	for actuators in an Ex environment see "Ex I/O: S5-100U" manual

15.6.1 Analog Input Modules

Analog Input Modules - Connecting Current and Voltage Sensors to Analog Input Modules

Analog input modules convert analog process signals to digital values that the CPU can process (via the process input image PII).

Observe the following rules to connect current and voltage sensors to analog input modules.

- When you have multi-channel operations, assign the channels in ascending order. This shortens the data cycle.
- Use terminals 1 and 2
 - for the connection of a compensating box (464-8MA11)
 - or
 - for the supply of two-wire transducers (464-8ME11).
 Terminals 1 and 2 cannot be used with the remaining analog input modules.
- Short-circuit the terminals of unused inputs (except for 464-8ME11).
- The permissible potential difference between the common references of the inputs must not exceed 1 V. To prevent this, set the reference potentials of the sensors to a common reference potential.
- If insulated sensors are used, either the sensor or the module must be earthed.

Analog Value Representation of Analog Input Modules

Each analog process signal has to be converted into a digital format, to be stored in the process input image (PII). The analog signals are converted into a binary digit that is written in one of the following ways.

- in one byte (466-8MC11)
- or
- in two bytes (the remaining analog input modules).

Each position has a fixed value in powers of two.

Analog values are represented in two's complement.

The following table shows the analog value representation of the different analog inputs in 2-byte format. The specific analog value representations are given in the description of the individual modules.

Tabelle 15-7. Representation of an Analog Input Value as Bit Pattern

Bit Number	High Byte								Low Byte							
	7	6	5	4	3	2	1	0	7	6	5	4	3	2	1	0
Analog Value Represent.	S	2 ¹¹	2 ¹⁰	2 ⁹	2 ⁸	2 ⁷	2 ⁶	2 ⁵	2 ⁴	2 ³	2 ²	2 ¹	2 ⁰	X	E	OV

Key	S	Sign bit	0="+", 1="-"
	X	Irrelevant bits	
	E	Error bit	0=no wire break; 1 = wire break
	OV	Overflow bit	0=Measured value 4095 units at the most 1=Measured value greater than or equal to 4096 units

Analog Input Module 4 x±50 mV

(6ES5 464-8MA11)

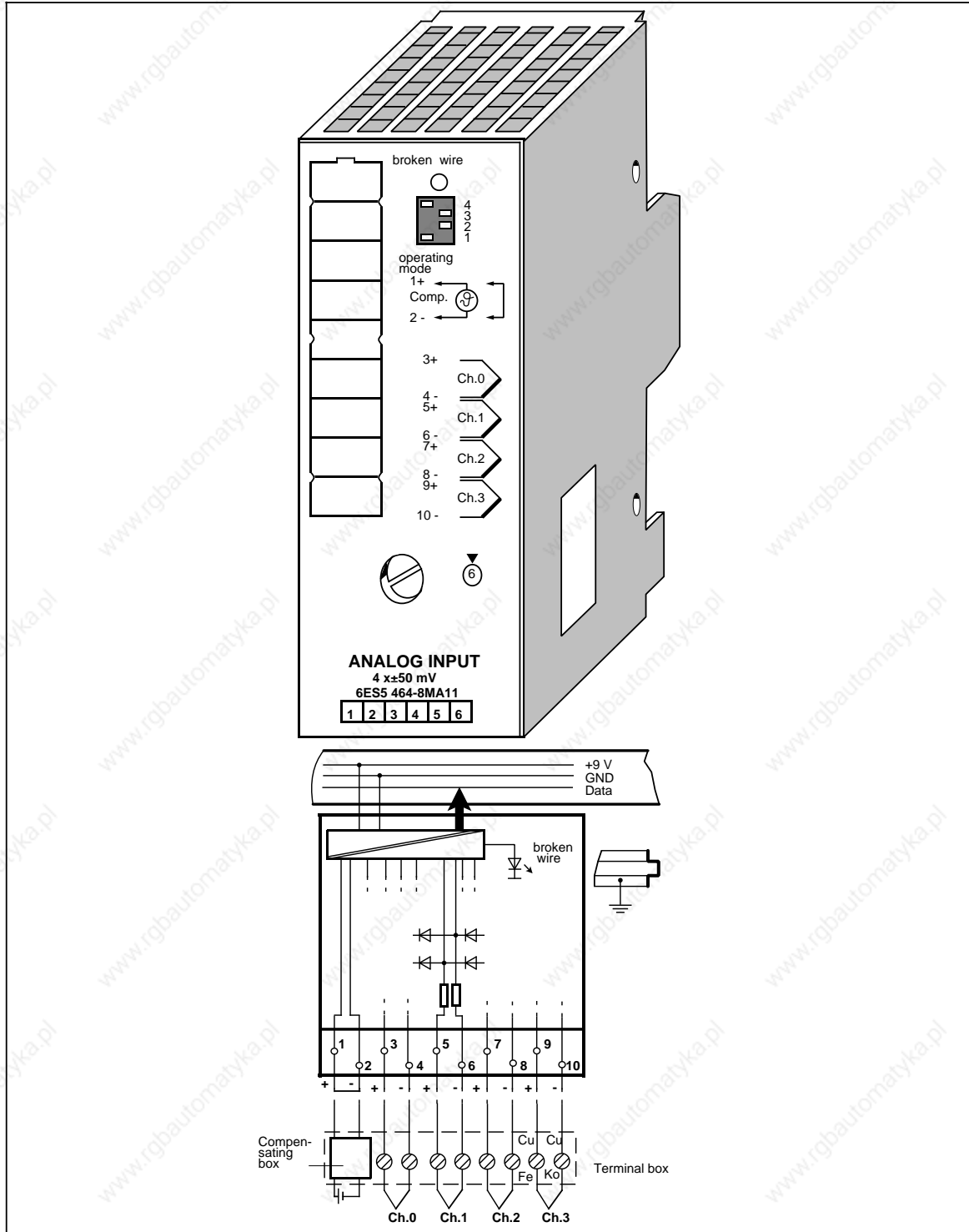

Analog Input Module 4 ± 50 mV (continued)

(6ES5 464-8MA11)

Technical specifications				
Input ranges (rated values)	± 50 mV	Noise suppression for $f=nx$ (50/60 Hz $\pm 1\%$); $n=1, 2, \dots$		
Number of inputs	1, 2 or 4 (selectable)	- common-mode rejection ($V_{pp}=1$ V)	min.	86 dB
Galvanic isolation	yes (inputs to grounding point; not between inputs)	- series-mode rejection (peak value of noise < rated value of input range)	min.	40 dB
Input resistance	10 M	Basic error limits (=operational error limits at 25°C, referred to input ranges of the module)		± 0.15 %
Connection method of sensors	two-wire connection	Operational error limits (0 to 60 °C) (32 to 140 °F) (referred to input ranges of the module)		± 0.4 %
Digital representation of input signal	12 bits+sign (2048 units = rated value)	Length of cable - shielded	max.	50 m (164 ft.)
Measured value representation	two's complement (left-justified)	Supply voltage L+		none
Measuring principle	integrating	Connection of compensating box		possible
Conversion principle	voltage-time conversion (dual slope)	Rated insulation voltage (+9 V to \rightarrow) - insulation group - tested with		12 V AC 1xB 500 V AC
Integration time (adjustable for optimum noise suppression)	20 ms at 50 Hz 16.6 ms at 60 Hz	Rated insulation voltage (inputs to+9 V) - insulation group - tested with		60 V AC 1xB 500 V AC
Encoding time per input - for 2048 units	max. 60 ms at 50 Hz max. 50 ms at 60 Hz	Current consumption - from+9 V (CPU)	typ.	100 mA
- for 4095 units	max. 80 ms at 50 Hz max. 66.6 ms at 60 Hz	Power loss of the module	typ.	0.9 W
Permissible voltage difference - between inputs	max. ± 5 V	Weight	approx.	230 g (8 oz.)
- between inputs and central ground point	max. 75 V DC/60 V AC			
Permissible input voltage (destruction limit)	max. 24 V DC			
Fault indication for - range exceeded	yes (more than 4095 units)			
- sensor wire break	yes (selectable), via test pulse			
- general indication of wire break	red LED			

Function

The module 6ES5 464-8MA11 is suitable for connection of thermocouples and for voltage measurement.

Design and Mode of Operation of Thermocouples

A thermocouple consists of

- the thermocouple wires (sensors) and
- the necessary installation and connection components.

The thermocouple consists of two wires of different metals or alloys, the ends of which are soldered or welded to each other. Since it is possible to have different combinations of materials, there are various types of thermocouples, e.g. types K, J and L. The measuring principle is the same for all types.

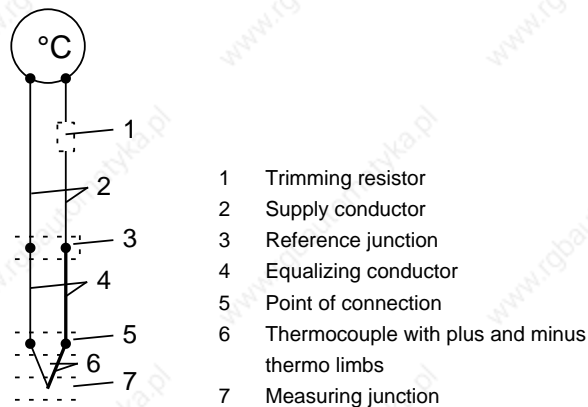

Figure 15-1. Thermocouple

If the measuring junction is subject to a different temperature than the free ends of the thermocouple, a thermal emf is generated between the free ends.

The value of the thermal emf depends on the difference between the temperature of the measuring junction and the temperature at the free ends, as well as on the material combination of the thermocouple. Since one temperature difference is always sensed with one thermocouple, the free ends must be kept at a known temperature at a reference junction in order to determine the temperature of the measuring junction.

From their point of connection, the thermocouples can be extended via **equalizing conductors** up to a point with, as far as possible, constant temperature (reference junction).

The equalizing conductors are of the same materials as the wires of the thermocouple. Make sure that the equalizing conductors are connected with the right polarity, as polarity reversal can cause considerable measuring errors.

The influence of temperature fluctuations at the reference junction can be compensated by an **equalizing circuit**, e.g. by a **compensating box**.

Connection of Thermocouples with a Compensating Box

The influence of temperature on the reference junction of a thermocouple (e.g. terminal box) can be compensated with a compensating box.

The compensating box contains a bridge circuit adjusted for a specific reference junction temperature (compensation temperature). The terminals for the ends of the equalizing conductor of the thermocouple form the reference junction.

If the actual reference temperature deviates from the compensation temperature, the temperature-dependent bridge resistance changes. A positive or negative compensation voltage is generated, which is added to the thermal emf.

Compensating boxes with a reference junction temperature of 0 °C must be used for compensation at the analog input modules 6ES5 464-8MA11/21.

The following should be noted:

- The compensating box must have a floating supply.
- The power supply must have a grounded shielding winding.

Furthermore, it is possible to use the analog input module 6ES5 464-8MA21 with internal temperature compensation.

Possible Connections to 6ES5 464-8MA11

The following possibilities exist for connecting thermocouples with compensating box to the analog input module 464-8MA11:

Table 15-8. Options for Connecting Thermocouples with Compensating Box

	Direct Connection of Thermocouple to Module	Remote Connection of Thermocouple to Module
All thermocouples of the same type	possible	possible
Thermocouples of different types	possible	possible

The individual options are shown below in the following connection diagrams:

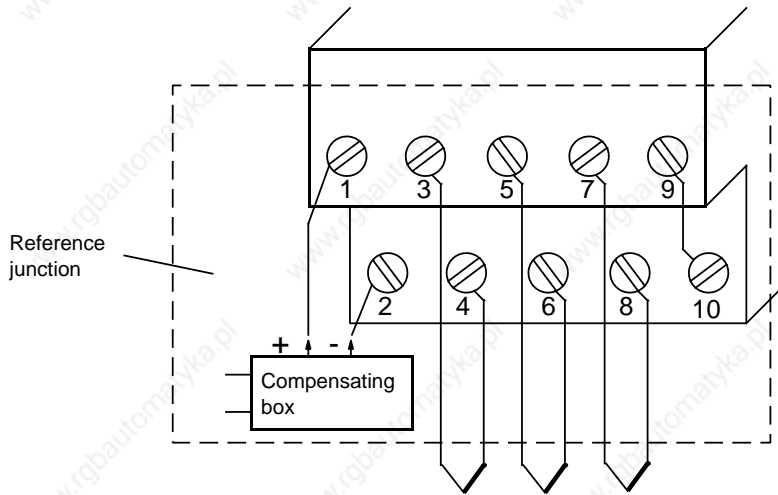

Figure 15-2. Connecting Thermocouples of the Same Type Directly to the Module

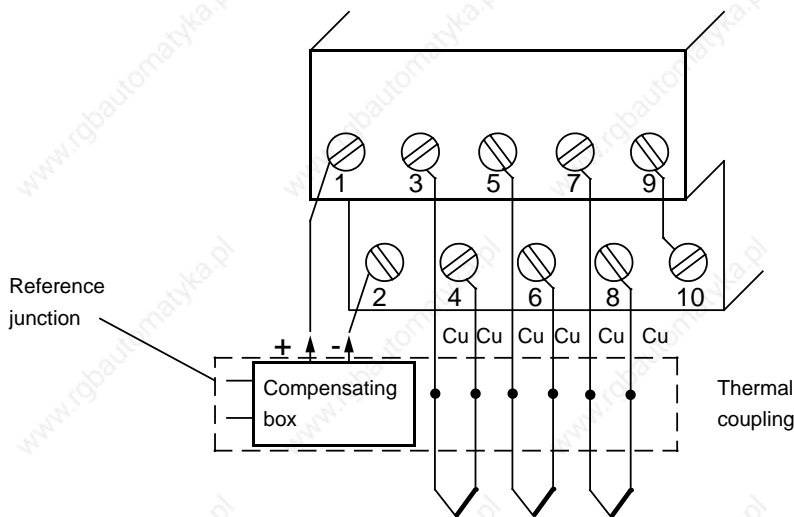

Figure 15-3. Remote Connection of Thermocouples of the Same Type to the Module

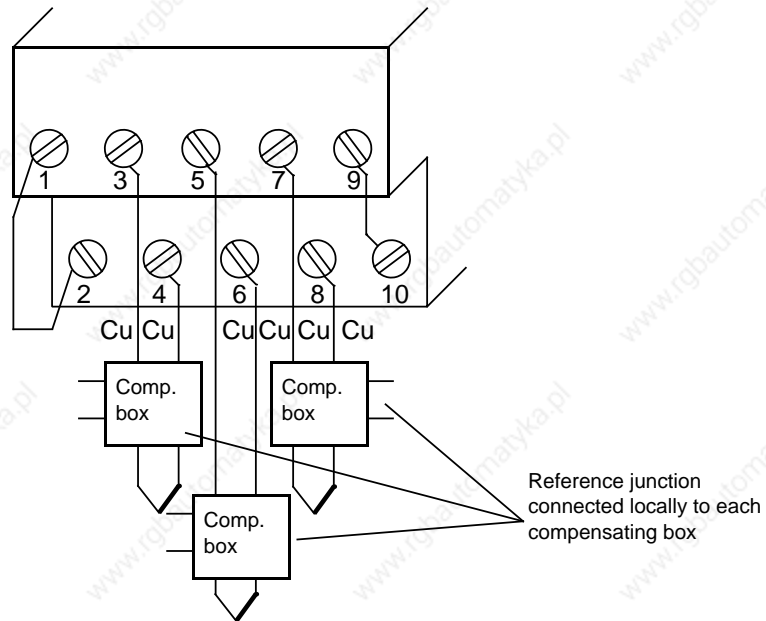

Figure 15-4. Direct or Remote Connection of Thermocouples of Different Type to the Module

Start-Up of Module

Set the intended operating mode using the operating mode switch of analog input module 464-8MA11. The switch is located on the right side at the top of the front panel of the module.







Power supply frequency: Set the switch to the available power supply frequency. This selects the integration time of the A/D converters for optimal interference voltage suppression.
 Power frequency 50 Hz: Integration time 20 ms
 Power frequency 60 Hz: Integration time 16.66 ms

Operation: Set the number of channels you wish to assign on the input module. If there are fewer than four channels, the measured values will be updated faster.

Broken wire: Once the broken wire signal has been activated, a break on one of the lines to the sensor (thermocouple) or of the sensor itself causes the red LED above the function selection switch to light up. At the same time, the broken wire error bit F (bit 1, byte 1) for the faulty channel is set.

The module "recognizes" a wire break by applying a conventional tripping current to the input terminals and by comparing the resulting voltage to a limit value. If there is a wire break in the sensor or the lines, the voltage exceeds the limit value and a "wire break" signal is sent. When the signal at the input is measured with a digital voltmeter, the tripping current pulses cause apparent fluctuations of the signal. Deactivation of the wire break signal does **not** turn off the tripping current.

Table 15-9. Settings for the Operating Mode Switch for Analog Input Module 464-8MA11

Function	Settings for Operating Mode Switch			
	50 Hz		60 Hz	
Power supply frequency	 4 3 2 1		 4 3 2 1	
Operation	1 channel (channel 0)  4 3 2 1	2 channels (channel 0 and channel 1)  4 3 2 1	4 channels (channel 0 - channel 3)  4 3 2 1	
Wire break	With wire break signal  4 3 2 1		No wire break signal  4 3 2 1	

Analog Value Representation

The following table shows the analog value representation of the analog input module 6ES5 464-8MA11.

Table 15-10. Analog Input Module 464-8MA11 (Bipolar Fixed-Point Number)

Units	Meas. value in mV	High Byte	Low Byte	Range
>4095	100.0	0 1 1 1 1 1 1 1	1 1 1 1 1 0 0 1	Overflow
4095	99.976	0 1 1 1 1 1 1 1	1 1 1 1 1 0 0 0	Overrange
2049	50.024	0 1 0 0 0 0 0 0	0 0 0 0 1 0 0 0	
2048	50.0	0 1 0 0 0 0 0 0	0 0 0 0 0 0 0 0	Nominal range
1024	25.0	0 0 1 0 0 0 0 0	0 0 0 0 0 0 0 0	
1	0.024	0 0 0 0 0 0 0 0	0 0 0 0 1 0 0 0	
0	0.0	0 0 0 0 0 0 0 0	0 0 0 0 0 0 0 0	
- 1	- 0.024	1 1 1 1 1 1 1 1	1 1 1 1 1 0 0 0	
- 1024	- 25.0	1 1 1 0 0 0 0 0	0 0 0 0 0 0 0 0	
- 2048	- 50.0	1 1 0 0 0 0 0 0	0 0 0 0 0 0 0 0	Overrange
- 2049	- 50.024	1 0 1 1 1 1 1 1	1 1 1 1 1 0 0 0	
- 4095	- 99.976	1 0 0 0 0 0 0 0	0 0 0 0 1 0 0 0	Overflow
<- 4095	- 100.0	1 0 0 0 0 0 0 0	0 0 0 0 1 0 0 1	

Standard function blocks FB 250 (read in analog value) and FB "polygon function" can be used to normalize and linearize the analog value. Set type of channel y = 6 "bipolar fixed-point number" in function block FB250. The non-linear temperature/voltage characteristic of the thermocouples can be linearized via interpolation points using function block FB "polygon function". For the interpolation points please see the standard characteristic of the individual type of the thermocouple in IEC 584 or DIN 43710.

Analog Input Module 4 x ± 50 mV

(6ES5 464-8MA21)

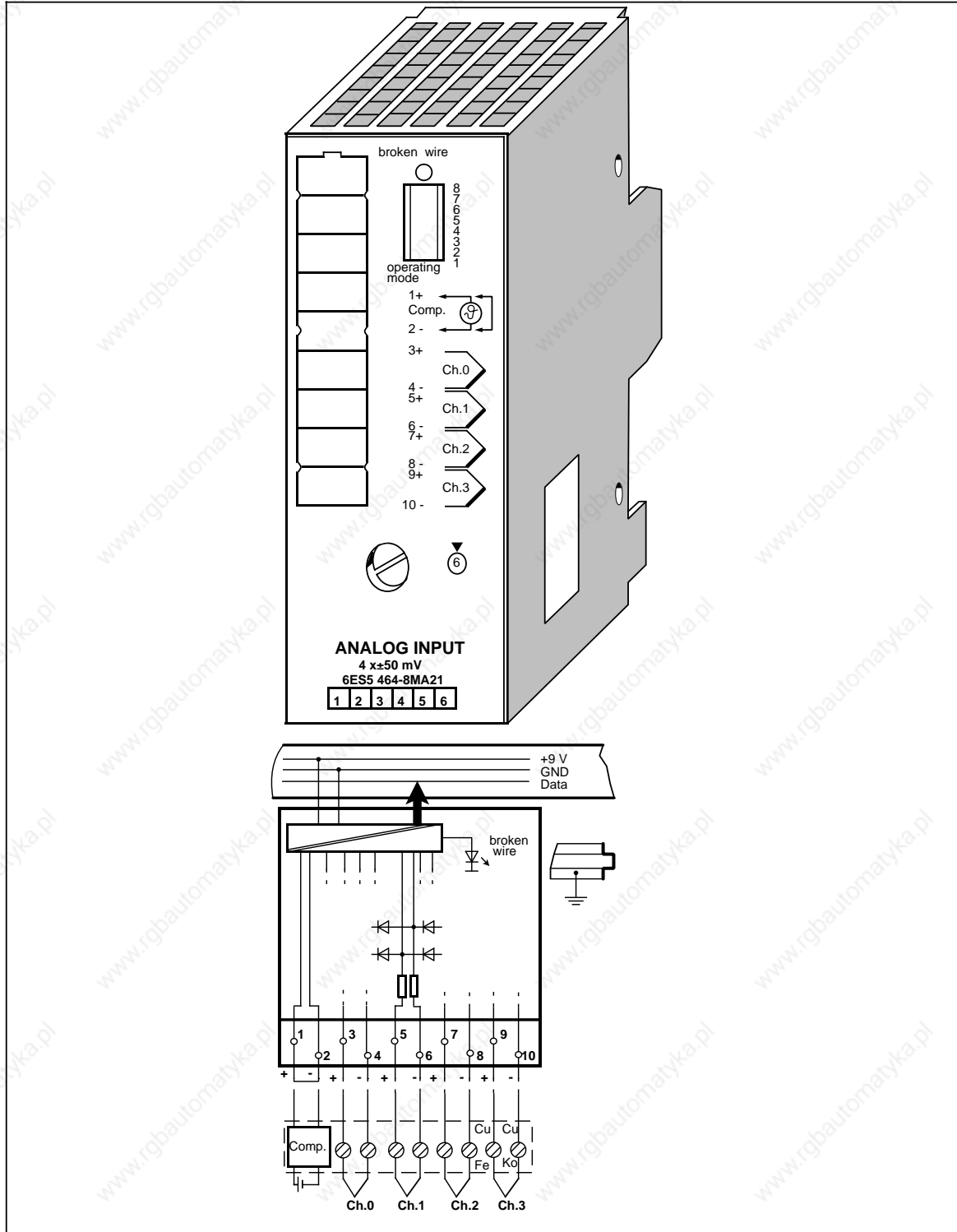

Analog Input Module 4 x±50 mV (continued)

(6ES5 464-8MA21)

Technical specifications			
Input ranges (rated values)	± 50 mV	Noise suppression for $f = nx$ (50/60 Hz±1%) $n = 1, 2, \dots$	
Number of inputs (selectable)	1, 2 or 4	- common mode rejection ($V_{pp} = 1\text{ V}$)	min. 86 dB
Galvanic isolation	yes (inputs to grounding point; not between inputs)	- series mode rejection (peak value of noise < rated value of input range)	min. 40 dB
Input resistance	10 M	Basic error limits (operating error limits at 25°C, referred to input ranges of module)	±0.15%
Connection method of sensors	two-wire connection	Operating error limits (0 to 60 °C, referred to input range of module (32 to 140 °F))	±0.4%
Digital representation of input signal	12 bits + sign (2048 units = rated value)	Linearization exactness for rated range (for types J,K,L)	±1 °C (1.8 °F)
Measured value representation	two's complement (left-justified)	Characteristic linearization for the following thermoelements - Nickel-Chromium/ Nickel-Aluminium (Type K) - Iron/Copper-Nickel (Type J) - Iron/Copper-Nickel (Type L)	IEC 584 IEC 584 DIN 43710
Measuring principle	integrating	Length of cable - shielded	max. 50 m (164 ft.)
Conversion principle	voltage-time conversion (dual slope)	Supply voltage L+	none
Integration time (adjustable for optimum noise suppression)	20 ms at 50 Hz 16.6 ms at 60 Hz	Internal temperature compensation	possible
Encoding time per input		Connection of compensating box	possible
- for 2048 units	max. 60 ms at 50 Hz	Rated insulation voltage (+9 V to \pm)	12 V AC 1 x B 500 V DC
- for 4095 units	max. 50 ms at 60 Hz max. 80 ms at 50 Hz max. 66.6 ms at 60 Hz	Rated insulation voltage (inputs to + 9 V) - insulation group - tested with	60 V AC 1 x B 500 V AC
Permissible voltage difference		Current consumption - from + 9 V (CPU)	typ. 120 mA
- between inputs	max. ± 5 V	Power loss of the module	typ. 1 W
- between inputs and central ground point	max. 75 V DC/60 V AC	Weight	approx. 230 g (8 oz.)
Permissible input voltage (destruction limit)	max. 24 V DC		
Fault indication for - range exceeded	yes (more than 4095 units)		
- sensor wire break	yes (selectable), via test pulse		
- general indication of wire break	red LED		

Function

The module 6ES5 464-8MA21 is suitable for connection of thermocouples and for voltage measurement. It features both interruptible internal "temperature compensation" and "linearization".

Information on the "Design and Mode of Operation of Thermocouples" and "Connection of Thermocouples with a Compensating Box" can be found under module 6ES5 464-8MA11.

Connection Options to 6ES5 464-8MA21

There are various options for connecting thermocouples to the analog input module 6ES5 464-8MA21. They are obtained by combining the following criteria accordingly:

- Operation with internal/external compensation
- Operation with/without linearization
- Connection of thermocouples of the same/different type
- Direct/remote connection of the thermocouple to the module.

The table below shows the various options:

Table 15-11. Options for Connecting Thermocouples

Thermocouple Characteristics		without Linearization		with Linearization	
		Direct connection to module	Remote connection to module	Direct connection to module	Remote connection to module
Internal Compensation	All thermocouples of the same type	not possible	not possible	possible	possible
	Thermocouples of different type	not possible	not possible	not possible	not possible
External Compensation	All thermocouples of the same type	possible	possible	not possible	not possible
	Thermocouples of different type	possible	possible	not possible	not possible

The individual options are shown below in the following connection diagrams:

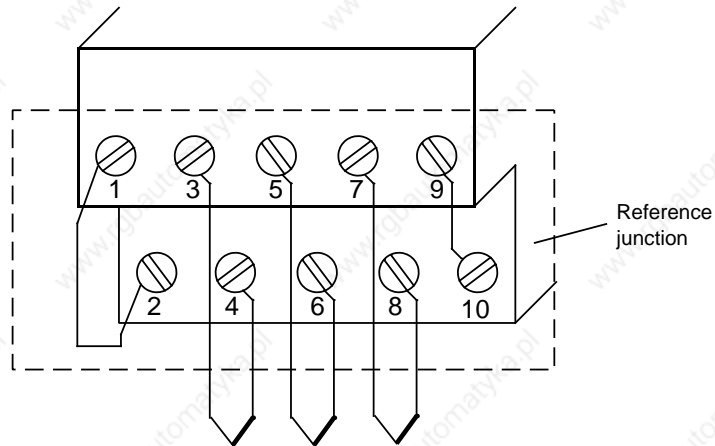

Figure 15-5. Connecting Thermocouples of the Same Type with Linearization and Internal Compensation Directly to the Module

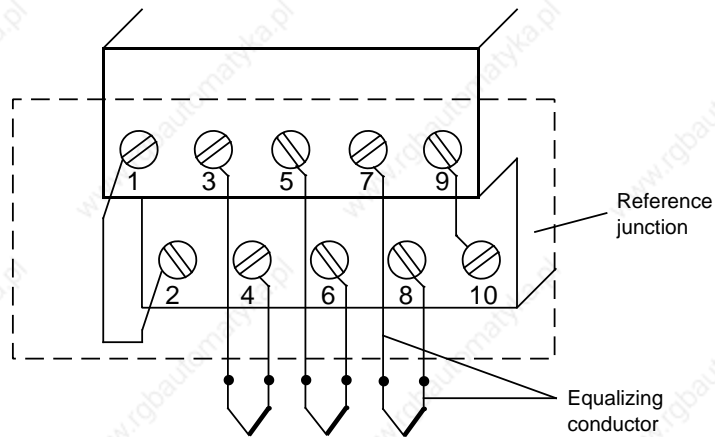

Figure 15-6. Remote Connection of Thermocouples of the Same Type with Linearization and Internal Compensation to the Module

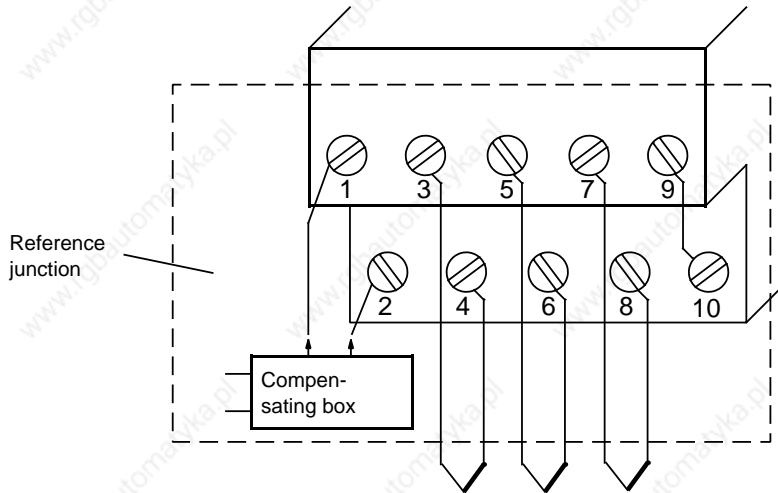

Figure 15-7. Connecting Thermocouples of the Same Type without Linearization and External Compensation Directly to the Module

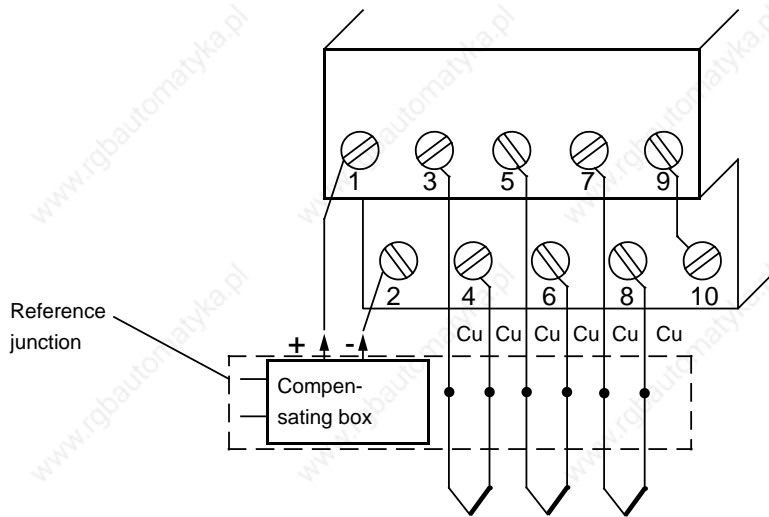

Figure 15-8. Remote Connection of Thermocouples of the Same Type without Linearization and External Compensation to the Module

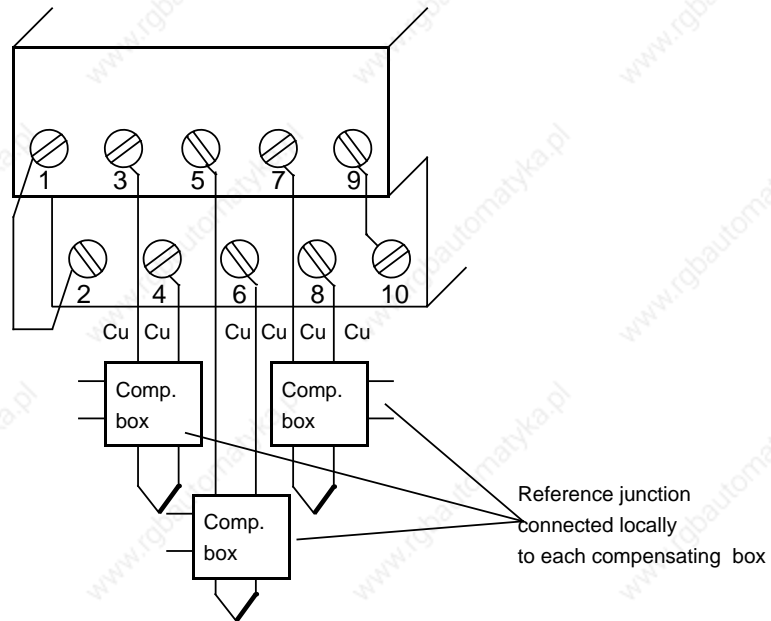

Figure 15-9. Direct and Remote Connection of Thermocouples of Different Type without Linearization and External Compensation to the Module

Start-Up of the Module

Set the intended operating mode using the switch on the front panel of analog input module 464-8MA21. This switch is located on the right side at the top of the front panel of the module.

Power supply frequency: Set the switch to the available power supply frequency. This selects the integration time of the A/D converters for optimal interference voltage suppression.

Power frequency 50 Hz:	Integration time 20 ms
Power frequency 60 Hz:	Integration time 16.66 ms

Operation: Set the number of channels you wish to assign on the analog input module. If there are fewer than four channels, the measured values will be updated faster.

Broken wire: Once the broken wire signal has been activated, a break on one of the lines to the sensor (thermocouple) or of the sensor itself causes the red LED above the function selection switch to light up. At the same time, the broken wire error bit F (bit 1, byte 1) for the faulty channel is set.

The module "recognizes" a wire break by applying a conventional tripping current to the input terminals and by comparing the resulting voltage to a limit value. If there is a wire break in the sensor or the lines, the voltage exceeds the limit value and a "wire break" signal is sent. When the signal at the input is measured with a digital voltmeter, the tripping current pulses cause apparent fluctuations of the signal. Deactivation of the wire break signal does **not** turn off the tripping current.

Linearization: With this function, you can obtain a characteristic linearization of the thermocouples of type J, K, and L.
With module 464-8MA21, the linearization must always be activated together with the corresponding compensation of the reference point temperature.



Thermocouples:

Type J: - 200° C (-328° F) to	+1200° C (1392° F)	
Type K: - 200° C (-328° F) to	+1369° C (2497° F)	
Type L: - 199° C (-326° F) to	+900° C (1652° F)	(in steps each of 1° C (1.8° F)).

Temperature compensation: For the thermocouples of type J, K, and L, you can compensate, on the one hand, the temperature of the reference point using an external compensating box.

On the other hand, it is possible to move the reference point to the front of the module by activating the "temperature compensation" function. When thermocouples are directly connected, an internal circuit on the module causes the digital value "0" to be displayed independently of the temperature of the terminal when the temperature at the measuring junction is 0° C (32° F). In order to accomplish this, the terminals of the sensors have to be connected directly or via an equalizing conductor to the module, i.e., without a copper extension cable (see Figures 15-5, 15-6).

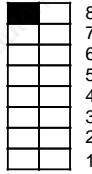
Table 15-12. Settings for the Operating Mode Switch for Analog Input Module 464-8MA21

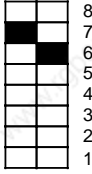
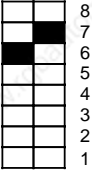
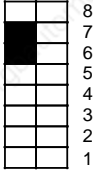
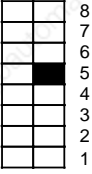
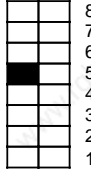
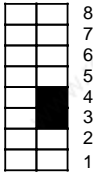
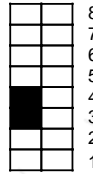
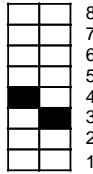
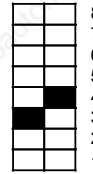
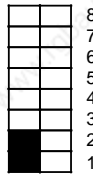
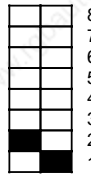
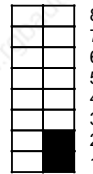
Function	Settings for Operating Mode Switch			
Power supply frequency	50 Hz 		60 Hz 	
Operation	1 channel (ch. 0) 	2 channels (ch.0 u. ch1) 	4 channels (ch. 0 to 3) 	
Wire break	With wire break signal 		No wire break signal 	
Characteristic linearization of the thermocouples	No linearization 	Linearization type K 	Linearization type J 	Linearization type L 
Temperature compensation	No temperature compensation 	Temperature compensation for type K 	Temperature compensation for types J and L 	

If you have set "Characteristic linearization" and "Temperature compensation" with the operating mode switches on module **464-8MA21** for the thermocouple used, then the reference temperature is 0° C (32° F). This means that with 0° C (32° F) at the measuring junction, the value "0" is displayed.

If you equip several channels with thermocouples, use the same type of thermocouple. If you select mixed thermocouples, or if you use thermocouples other than type J, K, or L, then you must choose the following settings.

- "No linearization"
- "No temperature compensation"

When you set the switches to "no linearization" and "no temperature compensation", then module 464-8MA21 functions just like module 464-8MA11.

Analog Value Representation

The following tables show the analog value representation of the analog input module 6ES5 464-8MA21, depending on the switch position or the operating mode of the module:

Table 15-13. Analog Input Module 464-8MA21, 4 x ± 50 mV, without Linearization and without Temperature Compensation (Internal) (Bipolar Fixed-Point Number)

Units	Meas. Val. in mV	High Byte	Low Byte	Range
>4095	100.0	0 1 1 1 1 1 1 1	1 1 1 1 1 0 0 1	Overflow
4095	99.976	0 1 1 1 1 1 1 1	1 1 1 1 1 0 0 0	Overrange
2049	50.024	0 1 0 0 0 0 0 0	0 0 0 0 1 0 0 0	
2048	50.0	0 1 0 0 0 0 0 0	0 0 0 0 0 0 0 0	Nominal range
1024	25.0	0 0 1 0 0 0 0 0	0 0 0 0 0 0 0 0	
1	0.024	0 0 0 0 0 0 0 0	0 0 0 0 1 0 0 0	
0	0.0	0 0 0 0 0 0 0 0	0 0 0 0 0 0 0 0	
- 1	- 0.024	1 1 1 1 1 1 1 1	1 1 1 1 1 0 0 0	
- 1024	- 25.0	1 1 1 0 0 0 0 0	0 0 0 0 0 0 0 0	
- 2048	- 50.0	1 1 0 0 0 0 0 0	0 0 0 0 0 0 0 0	
- 2049	- 50.024	1 0 1 1 1 1 1 1	1 1 1 1 1 0 0 0	Overrange
- 4095	- 99.976	1 0 0 0 0 0 0 0	0 0 0 0 1 0 0 0	
<- 4095	- 100.0	1 0 0 0 0 0 0 0	0 0 0 0 1 0 0 1	Overflow

Standard function blocks FB 250 (read in analog value) and FB "polygon function" can be used to normalize and linearize the analog value. Set type of channel y=6 "bipolar fixed-point number" in function block FB 250.

The non-linear temperature/voltage characteristic of the thermocouples can be linearized via interpolation points using function block FB "polygon function".

For the interpolation points please see the standard characteristic of the individual type of thermocouple in IEC 584 or DIN 43710.

Table 15-14. Analog Input Module 464-8MA21, $4x \pm 50$ mV with Linearization and with Temperature Compensation (Internal); Thermoelement Type K (Nickel-Chromium/Nickel-Aluminium, according to IEC 584)

Units	Thermal Voltage in mV	Temperature in °C	High Byte	Low Byte	Range
>2359			0 1 0 0 1 0 0 1	1 0 1 1 1 0 0 1	Overflow
1370		1370	0 0 1 0 1 0 1 0	1 1 0 1 0 0 0 1	Overrange**
1369	54.773	1369	0 0 1 0 1 0 1 0	1 1 0 0 1 0 0 0	Nominal range
1000	41.269	1000	0 0 0 1 1 1 1 1	0 1 0 0 0 0 0 0	
500	20.640	500	0 0 0 0 1 1 1 1	1 0 1 0 0 0 0 0	
150	6.137	150	0 0 0 0 0 1 0 0	1 0 1 1 0 0 0 0	
100	4.095	100	0 0 0 0 0 0 1 1	0 0 1 0 0 0 0 0	
1	0.039	1	0 0 0 0 0 0 0 0	0 0 0 0 1 0 0 0	
0	0	0	0 0 0 0 0 0 0 0	0 0 0 0 0 0 0 0	
-1	-0.039	-1	1 1 1 1 1 1 1 1	1 1 1 1 1 0 0 0	Accuracy 2 K
-100	-3.553	-100	1 1 1 1 1 1 0 0	1 1 1 0 0 0 0 0	
-101	-3.584	-101	1 1 1 1 1 1 0 0	1 1 0 1 1 0 0 0	
-150	-4.912	-150	1 1 1 1 1 0 1 1	0 1 0 1 0 0 0 0	
-200	-5.891	-200	1 1 1 1 1 0 0 1	1 1 0 0 0 0 0 0	
-201		-201	1 1 1 1 1 0 0 1	1 0 1 1 1 0 0 1	Overrange**
-273			1 1 1 1 0 0 0 0	1 0 0 1 0 0 0 1	Overflow
X		X	X X X X X X X X	X X X X X 0 1 0	Wire break

* For a reference temperature of 0° C (32° F)

** In the overrange, the current slope of the characteristic curve is maintained when leaving the linearized nominal range.

Function block FB "polygon function" cannot be used, since linearization is executed by the module.

Table 15-15. Analog Input Module 464-8MA21, $4x\pm 50$ mV with Linearization and with Temperature Compensation (Internal); Thermoelement Type J (Iron/Copper-Nickel (Konstantan), according to IEC 584)

Units	Thermal Voltage in mV	Temperature in °C	High Byte	Low Byte	Range
1485			0 0 1 0 1 1 1 0	0 1 1 0 1 0 0 1	Overflow
1201		1201	0 0 1 0 0 1 0 1	1 0 0 0 1 0 0 1	Overrange**
1200	69.536	1200	0 0 1 0 0 1 0 1	1 0 0 0 0 0 0 0	Nominal range
1000	57.942	1000	0 0 0 1 1 1 1 1	0 1 0 0 0 0 0 0	
500	27.388	500	0 0 0 0 1 1 1 1	1 0 1 0 0 0 0 0	
100	5.268	100	0 0 0 0 0 0 1 1	0 0 1 0 0 0 0 0	
1	0.05	1	0 0 0 0 0 0 0 0	0 0 0 0 1 0 0 0	
0	0	0	0 0 0 0 0 0 0 0	0 0 0 0 0 0 0 0	
- 1	- 0.05	- 1	1 1 1 1 1 1 1 1	1 1 1 1 1 0 0 0	
- 100	- 4.632	- 100	1 1 1 1 1 1 0 0	1 1 1 0 0 0 0 0	
- 150	- 6.499	- 150	1 1 1 1 1 0 1 1	0 1 0 1 0 0 0 0	
- 199	- 7.868	- 199	1 1 1 1 1 0 0 1	1 1 0 0 1 0 0 0	
- 200	- 7.890	- 200	1 1 1 1 1 0 0 1	1 1 0 0 0 0 0 0	
- 201		- 201	1 1 1 1 1 0 0 1	1 0 1 1 1 0 0 1	Overrange**
- 273			1 1 1 1 0 1 1 1	0 1 1 1 1 0 0 1	Overflow
X		X	X X X X X X X X	X X X X X 0 F 0	Wire break

* For a reference temperature of 0° C (32° F)

** In the overrange, area the current slope of the characteristic curves is maintained when leaving the linearized nominal range.

Function block FB "polygon function" cannot be used, since linearization is executed by the module.

Table 15-16. Analog Input Module 464-8MA21, $4x\pm 50$ mV with Linearization and with Temperature Compensation (Internal); Thermoelement Type L (Iron/Copper-Nickel (Konstantan), according to DIN 43710)

Units	Thermal Voltage in mV*	Temperature in °C	High Byte	Low Byte	Range
1361			0 0 1 0 1 0 1 0	1 0 0 0 1 0 0 1	Overflow
901		901	0 0 0 1 1 1 0 0	0 0 1 0 1 0 0 1	Overrange**
900	53.14	900	0 0 0 1 1 1 0 0	0 0 1 0 0 0 0 0	Nominal range
500	27.85	500	0 0 0 0 1 1 1 1	1 0 1 0 0 0 0 0	
250	13.75	250	0 0 0 0 0 1 1 1	1 1 0 1 0 0 0 0	
100	+5.37	100	0 0 0 0 0 0 1 1	0 0 1 0 0 0 0 0	
1	0.05	1	0 0 0 0 0 0 0 0	0 0 0 0 1 0 0 0	
0	0	0	0 0 0 0 0 0 0 0	0 0 0 0 0 0 0 0	
- 1	- 0.05	- 1	1 1 1 1 1 1 1 1	1 1 1 1 1 0 0 0	
- 100	- 4.75	- 100	1 1 1 1 1 1 0 0	1 1 1 0 0 0 0 0	
- 150	- 6.60	- 150	1 1 1 1 1 0 1 1	0 1 0 1 0 0 0 0	
- 190	- 7.86	- 190	1 1 1 1 1 0 1 0	0 0 0 1 0 0 0 0	
- 199	- 8.12	- 199	1 1 1 1 1 0 0 1	1 1 0 0 1 0 0 0	
- 200		- 200	1 1 1 1 1 0 0 1	1 1 0 0 0 0 0 1	Overrange**
- 273			1 1 1 1 0 1 1 1	0 1 1 1 1 0 0 1	Overflow
X		X	X X X X X X X X	X X X X X 0 1 0	Wire break

* For a reference temperature of 0° C (32° F)

** In the overrange, the current slope of the characteristic curve is maintained when leaving the linearized nominal range.

Function block FB "polygon function" cannot be used, since linearization is executed by the module.

Analog Input Module 4 x ± 1 V

(6ES5 464-8MB11)

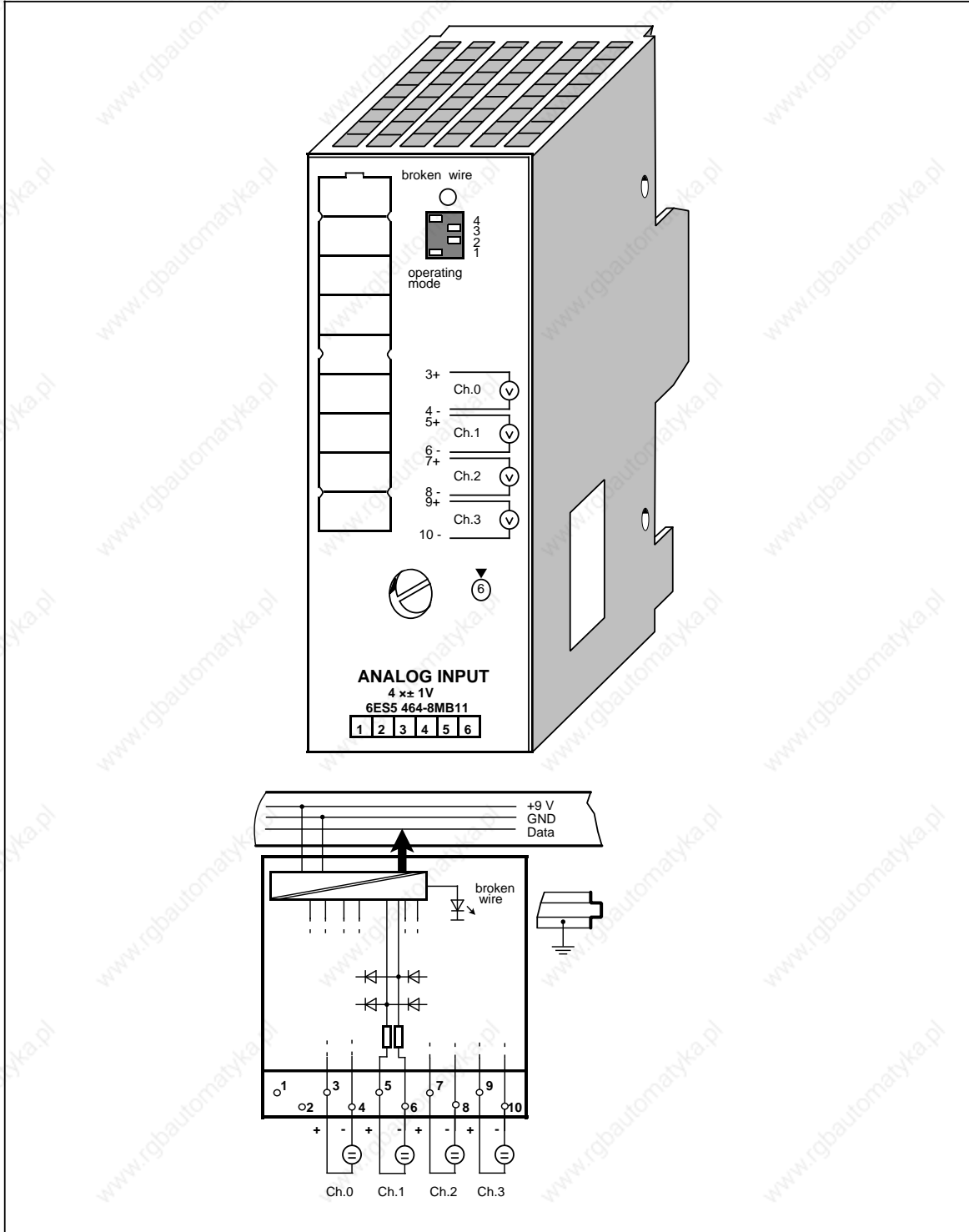

Analog Input Module 4 x ± 1 V (continued)

(6ES5 464-8MB11)

Technical specifications				
Input ranges (rated values)		± 1 V		Noise suppression for $f=nx$ (50/60 Hz $\pm 1\%$); $n=1, 2, \dots$
Number of inputs		1, 2 or 4 (selectable)		- common-mode rejection ($V_{pp}=1$ V) min. 86 dB
Galvanic isolation		yes (inputs to grounding point; not between inputs)		- series-mode rejection (peak value of noise < rated value of input range) min. 40 dB
Input resistance		10 M		Basic error limits (operational error limits at 25°C, referred to input ranges of the module) $\pm 0.1\%$
Connection method of sensors		two-wire connection		Operational error limits (0 to 60 °C, referred to input range of the module) (32 to 140 °F) $\pm 0.35\%$
Digital representation of input signal		12 bits+sign (2048 units = rated value)		Length of cable - shielded max. 200 m (660 ft.)
Measured value representation		two's complement (left-justified)		Supply voltage L+ none
Measuring principle		integrating		Rated insulation voltage (+9 V to \rightarrow) - insulation group 1xB - tested with 500 V AC
Conversion principle		voltage-time conversion (dual slope)		Rated insulation voltage (inputs to +9 V) - insulation group 1xB - tested with 500 V AC
Integration time (adjustable for optimum noise suppression)		20 ms at 50 Hz 16.6 ms at 60 Hz		Current consumption - from +9 V (CPU) typ. 100 mA
Encoding time per input				Power loss of the module typ. 0.9 W
- for 2048 units	max.	60 ms at 50 Hz		Weight approx. 230 g (8 oz.)
- for 4095 units	max.	50 ms at 60 Hz		
	max.	80 ms at 50 Hz		
	max.	66.6 ms at 60 Hz		
Permissible voltage difference				
- between inputs	max.	± 5 V		
- between inputs and central ground point	max.	75 V DC/60 V AC		
Permissible input voltage (destruction limit)	max.	24 V DC		
Fault indication for - range exceeded		yes (more than 4095 units)		
- sensor wire break		yes (selectable), via test pulse		
- general indication of wire break		red LED		

Function

The module 6ES5 464-8MB11 is suitable for connection of voltage sensors.

Wiring of the module (two-wire connection) is shown in the block diagram (on the first page of the module description).

Start-Up of Module

Set the intended operating mode using the switch on the front panel of analog input module 464-8MB11. The switch is located on the right side at the top of the front panel of the module.

Power supply frequency: Set the switch to the available power supply frequency. This selects the integration time of the A/D converters for optimal interference voltage suppression.

Power frequency 50 Hz: Integration time 20 ms

Power frequency 60 Hz: Integration time 16.66 ms

Operation: Set the number of channels you wish to assign on the input module. If there are fewer than four channels, the measured values will be updated faster.

Broken wire: Once the broken wire signal has been activated, a break on one of the lines to the sensor or of the sensor itself causes the red LED above the function selection switch to light up. At the same time, the broken wire error bit F (bit 1, byte 1) for the faulty channel is set.

The module "recognizes" a wire break by applying a conventional tripping current to the input terminals and by comparing the resulting voltage to a limit value. If there is a wire break in the sensor or the lines, the voltage exceeds the limit value and a "wire break" signal is sent. When the signal at the input is measured with a digital voltmeter, the tripping current pulses cause apparent fluctuations of the signal. Deactivation of the wire break signal does **not** turn off the tripping current.

Table 15-17. Settings for the Operating Mode Switch for Analog Input Module 464-8MB11

Function	Settings for Operating Mode Switch		
Power supply frequency	50 Hz		60 Hz
Operation	1 channel (ch.0)	2 chan. (ch.0 + ch1)	4 channels (ch. 0 to 3)
Wire break	With wire break signal		No wire break signal

Analog Value Representation

Table 15-18. Analog Input Module 464-8MB11 (Bipolar Fixed-Point Number)

Units	Meas. Val. in mV	High Byte	Low Byte	Range
>4095	2000.0	0 1 1 1 1 1 1 1	1 1 1 1 1 0 0 1	Overflow
4095	1999.5	0 1 1 1 1 1 1 1	1 1 1 1 1 0 0 0	Overrange
2049	1000.48	0 1 0 0 0 0 0 0	0 0 0 0 1 0 0 0	
2048	1000.0	0 1 0 0 0 0 0 0	0 0 0 0 0 0 0 0	Nominal range
1024	500.0	0 0 1 0 0 0 0 0	0 0 0 0 0 0 0 0	
1	0.48	0 0 0 0 0 0 0 0	0 0 0 0 1 0 0 0	
0	0.0	0 0 0 0 0 0 0 0	0 0 0 0 0 0 0 0	
- 1	- 0.48	1 1 1 1 1 1 1 1	1 1 1 1 1 0 0 0	
- 1024	- 500.0	1 1 1 0 0 0 0 0	0 0 0 0 0 0 0 0	
- 2048	- 1000.0	1 1 0 0 0 0 0 0	0 0 0 0 0 0 0 0	Overrange
- 2049	- 1000.48	1 0 1 1 1 1 1 1	1 1 1 1 1 0 0 0	
- 4095	- 1999.5	1 0 0 0 0 0 0 0	0 0 0 0 1 0 0 0	
<- 4095	- 2000.0	1 0 0 0 0 0 0 0	0 0 0 0 1 0 0 1	Overflow

Standard function block FB250 (read in analog value) can be used to normalize the analog value. Set type of channel y=6 "bipolar fixed-point-number" in function block FB250.

Analog Input Module 4 x ± 10 V

(6ES5 464-8MC11)

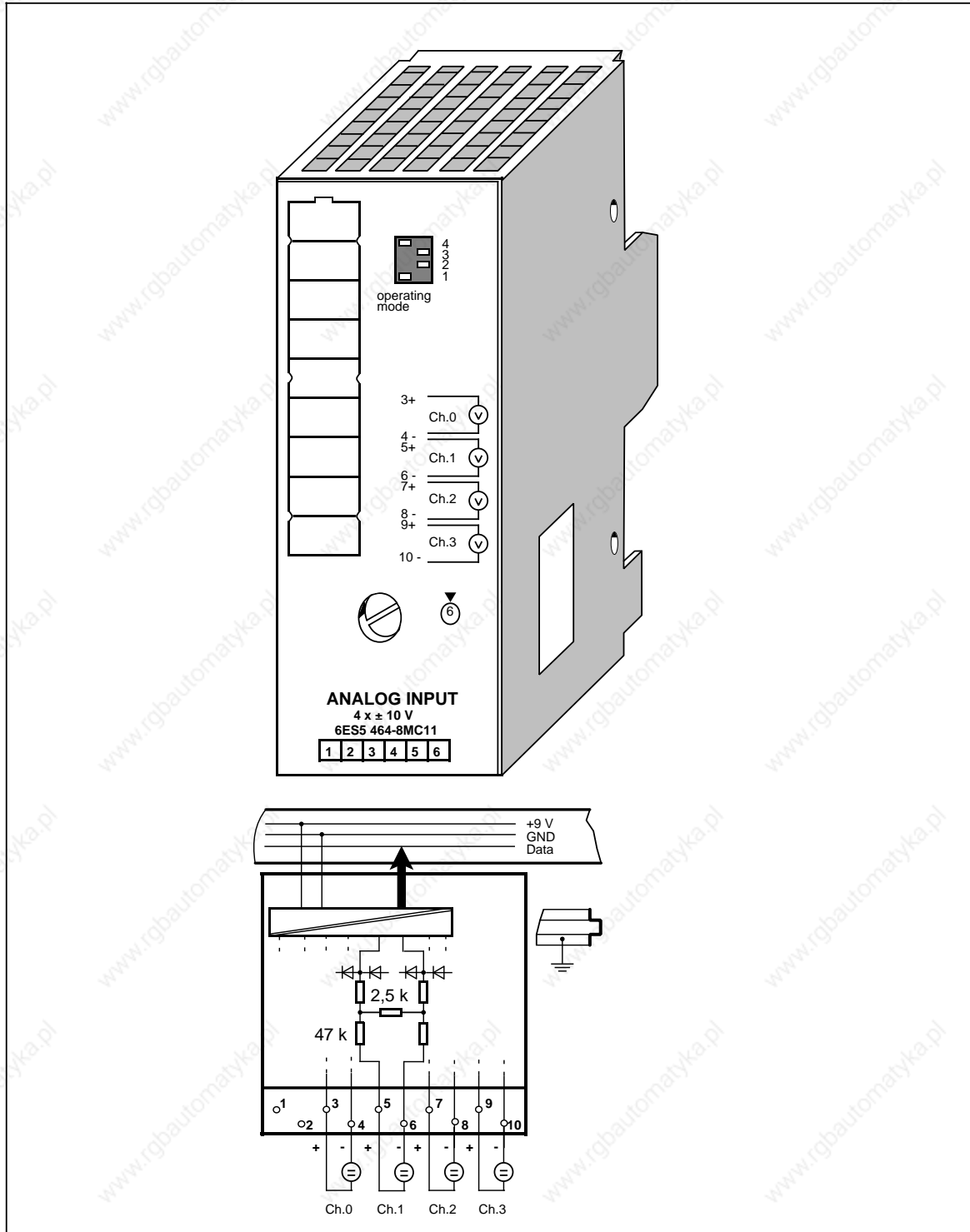

Analog Input Module 4 x±10 V (continued)

(6ES5 464-8MC11)

Technical specifications			
Input ranges (rated values)	±10 V	Noise suppression for f=nx (50/60 Hz±1%); n=1,2, ...	
Number of inputs	1, 2 or 4 (selectable)	- common-mode rejection ($V_{pp}=1$ V)	min. 86 dB
Galvanic isolation	yes (inputs to grounding point; not between inputs)	- series-mode rejection (peak value of noise < rated value of input range)	min. 40 dB
Input resistance	50 k	Basic error limits (operational error limits at 25°C, referred to the input ranges of the module)	±0.2 %
Connection method of sensors	two-wire connection	Operational error limits (0 to 60 °C, referred to the input ranges of the module) (32 to 140 °F)	±0.45 %
Digital representation of input signal	12 bits+sign (2048 units =rated value)	Length of cable - shielded	max. 200 m (660 ft.)
Measured value representation	two's complement (left-justified)	Supply voltage L+	none
Measuring principle	integrating	Rated insulation voltage (+9 V to $\underline{\underline{0}}$)	12 V AC 1xB 500 V AC
Conversion principle	voltage-time conversion (dual slope)	- insulation group - tested with	
Integration time (adjustable for optimum noise suppression)	20 ms at 50 Hz 16.6 ms at 60 Hz	Rated insulation voltage (inputs to +9 V) - insulation group - tested with	60 V AC 1xB 500 V AC
Encoding time per input		Current consumption - from +9 V (CPU)	typ. 100 mA
- for 2048 units	max. 60 ms at 50 Hz	Power loss of the module	typ. 0.9 W
- for 4095 units	max. 50 ms at 60 Hz max. 80 ms at 50 Hz max. 66.6 ms at 60 Hz	Weight	approx. 230 g (8 oz.)
Permissible voltage difference			
- between inputs	max. ± 5 V		
- between inputs and central ground point	max. 75 V DC/60 V AC		
Permissible input voltage (destruction limit)	max. 50 V DC		
Fault indication for - range exceeded	yes (more than 4095 units)		
- sensor wire break	no		
- general indication of wire break	no		

Function

The module 6ES5 464-8MC11 is suitable for connection of voltage sensors.

Wiring of the module (two-wire connection) is shown in the block diagram (on the first page of the module description).

Start-Up of Module







Set the intended operating mode using the switch on the front panel of analog input modules 464-8MC11. The switch is located on the right side at the top of the front panel of the module.

Power supply frequency: Set the switch to the available power supply frequency. This selects the integration time of the A/D converters for optimal interference voltage suppression.
 Power frequency 50 Hz: Integration time 20 ms
 Power frequency 60 Hz: Integration time 16.66 ms

Operation: Set the number of channels you wish to assign on the input module. If there are fewer than four channels, the measured values will be updated faster.

Broken wire: Broken wire signalling not possible.

Table 15-19. Settings for the Operating Mode Switch for Analog Input Module 464-8MC11

Function	Settings for Operating Mode Switch			
	50 Hz		60 Hz	
Power supply frequency	 4 3 2 1		 4 3 2 1	
Operation	1 channel (ch.0)  4 3 2 1	2 chan. (ch.0 + ch1)  4 3 2 1	4 chan. (ch.0 to 3)  4 3 2 1	
No function	 4 3 2 1		 4 3 2 1	

Analog Value Representation

Table 15-20. Analog Input Module 464-8MC11 (Bipolar Fixed-Point Number)

Units	Meas. Val. in V	High Byte	Low Byte	Range
>4095	20.000	0 1 1 1 1 1 1 1	1 1 1 1 1 0 0 1	Overflow
4095	19.995	0 1 1 1 1 1 1 1	1 1 1 1 1 0 0 0	Overrange
2049	10.0048	0 1 0 0 0 0 0 0	0 0 0 0 1 0 0 0	
2048	10.000	0 1 0 0 0 0 0 0	0 0 0 0 0 0 0 0	Nominal range
1024	5.000	0 0 1 0 0 0 0 0	0 0 0 0 0 0 0 0	
1	0.0048	0 0 0 0 0 0 0 0	0 0 0 0 1 0 0 0	
0	0.0	0 0 0 0 0 0 0 0	0 0 0 0 0 0 0 0	
- 1	- 0.0048	1 1 1 1 1 1 1 1	1 1 1 1 1 0 0 0	
- 1024	- 5.000	1 1 1 0 0 0 0 0	0 0 0 0 0 0 0 0	
- 2048	- 10.000	1 1 0 0 0 0 0 0	0 0 0 0 0 0 0 0	Overrange
- 2049	- 10.0048	1 0 1 1 1 1 1 1	1 1 1 1 1 0 0 0	
- 4095	- 19.995	1 0 0 0 0 0 0 0	0 0 0 0 1 0 0 0	Overflow
<- 4095	- 20.000	1 0 0 0 0 0 0 0	0 0 0 0 1 0 0 1	

Standard function block FB 250 (read in analog value) can be used to normalize the analog value. Set type of channel y = 6 "bipolar fixed-point number" in function block FB250.

Analog Input Module 4 x±20 mA

(6ES5 464-8MD11)

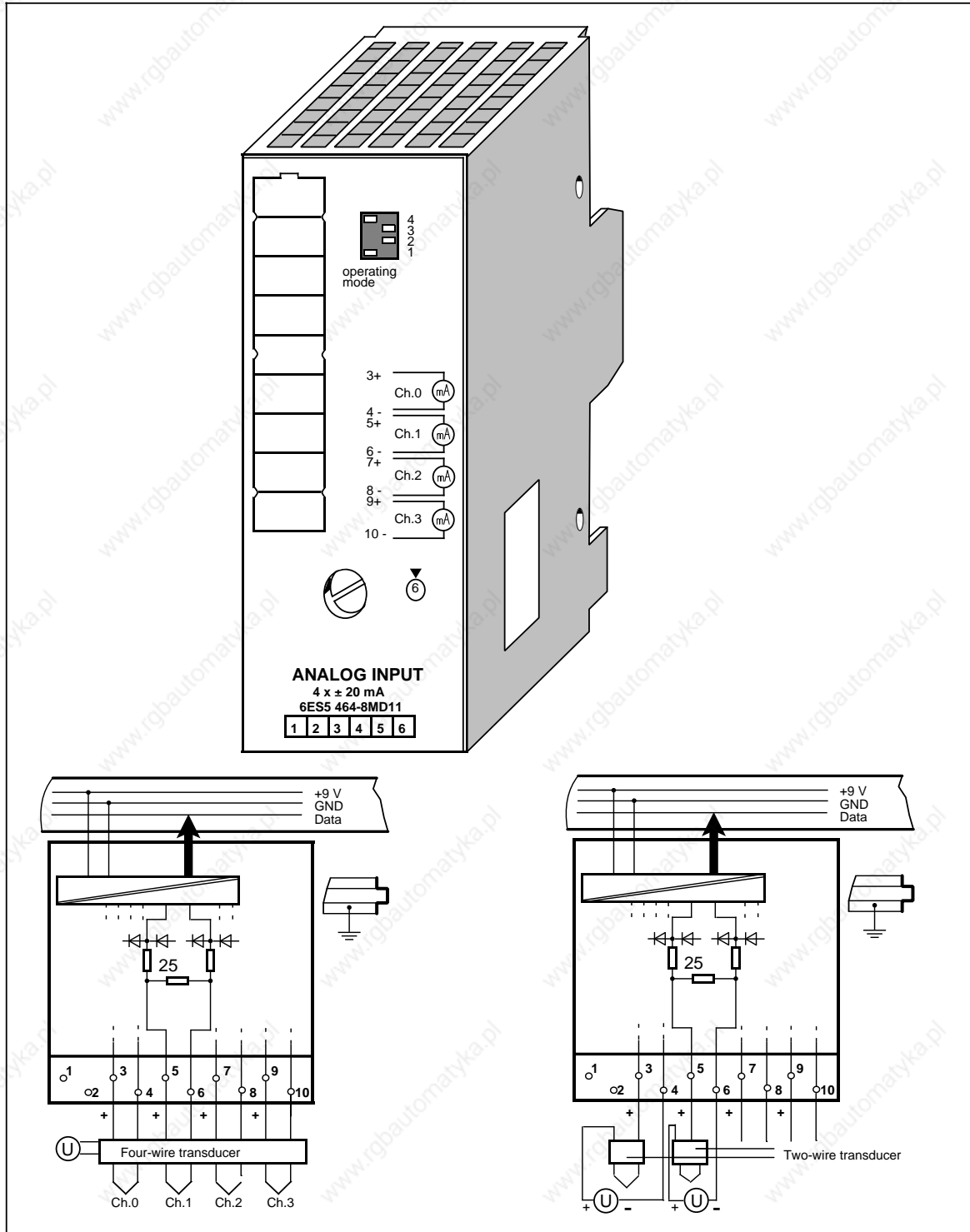

Analog Input Module 4 x ± 20 mA (continued)

(6ES5 464-8MD11)

Technical specifications			
Input ranges (rated values)		± 20 V	Noise suppression for $f=nx$ (50/60 Hz $\pm 1\%$); $n=1,2, \dots$
Number of inputs		1, 2 or 4 (selectable)	- common-mode rejection ($V_{pp}=1$ V) min. 86 dB
Galvanic isolation		yes (inputs to grounding point; not between inputs)	- series-mode rejection min. 40 dB (peak value of noise < rated value of input range)
Input resistance		25 k	Basic error limits (operational error limits at 25°C, referred to the input ranges of the module) ± 0.2 %
Connection method of sensors		two-wire connection	Operational error limits (0 to 60 °C, referred to the input ranges of the module) ± 0.45 %
Digital representation of input signal		12 bits+sign (2048 units =rated value)	Length of cable - shielded max. 200 m (660 ft.)
Measured value representation		two's complement (left-justified)	Supply voltage L+ none
Measuring principle		integrating	Rated insulation voltage (+9 V to \pm) 12 V AC - insulation group 1xB - tested with 500 V AC
Conversion principle		voltage-time conversion (dual slope)	Rated insulation voltage (inputs to +9 V) - insulation group 1xB - tested with 500 V AC
Integration time (adjustable for optimum noise suppression)		20 ms at 50 Hz 16.6 ms at 60 Hz	Current consumption - from +9 V (CPU) typ. 100 mA
Encoding time per input			Power loss of the module typ. 0.9 W
- for 2048 units	max.	60 ms at 50 Hz	Weight approx. 230 g (8 oz.)
- for 4095 units	max.	50 ms at 60 Hz	
	max.	80 ms at 50 Hz	
	max.	66.6 ms at 60 Hz	
Permissible voltage difference			
- between inputs	max.	± 5 V	
- between inputs and central ground point	max.	75 V DC/60 V AC	
Permissible input voltage (destruction limit)	max.	80 mA	
Fault indication for - range exceeded		yes (more than 4095 units)	
- sensor wire break		no	
- general indication of wire break		no	

Function

The module 6ES5 464-8MD11 is suitable for two-wire connection of current sensors.

Wiring:

If you use four-wire transducers, these must be connected as follows:

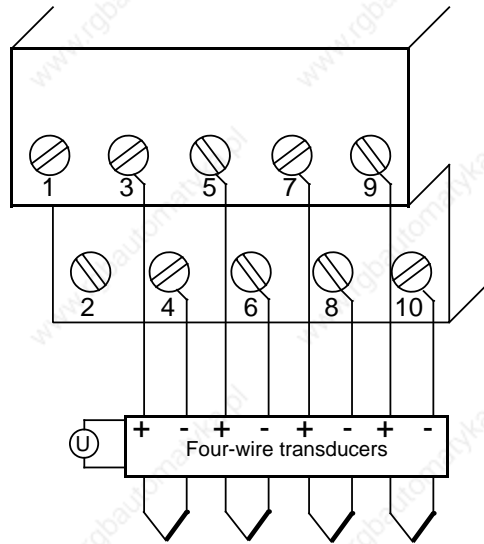

Figure 15-10. Connection of only Four-Wire Transducers (6ES5 464-8MD11)

If you use two-wire transducers, these must be connected as follows:

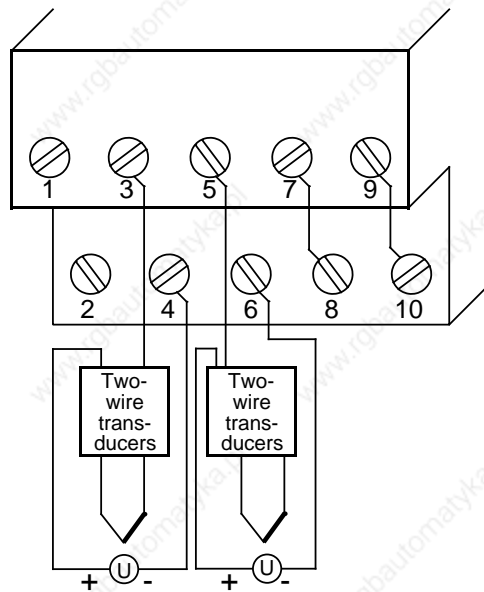

Figure 15-11. Connection of only Two-Wire Transducers (6ES5 464-8MD11)

If you use two-wire and four-wire transducers, these must be connected as follows:

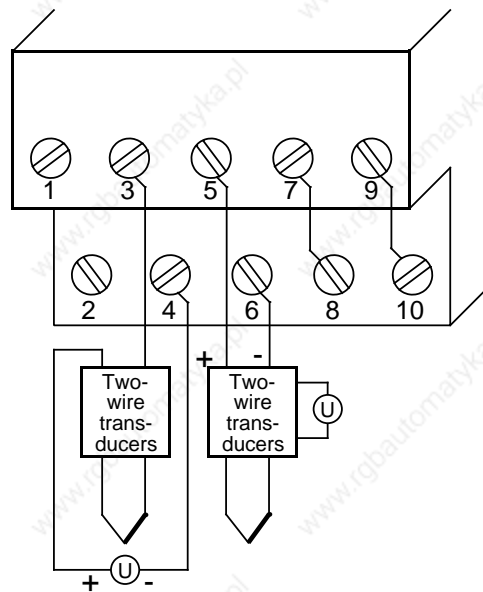

Figure 15-12. Connection of Two-Wire and Four-Wire Transducers (6ES5 464-8MD11)

Start-Up of Module







Set the intended operating mode using the switch on the front panel of analog input module 464-8MD11. This switch is located on the right side at the top of the front panel of the module.

Power supply frequency: Set the switch to the available power supply frequency. This selects the integration time of the A/D converters for optimal interference voltage suppression.
 Power frequency 50 Hz: Integration time 20 ms
 Power frequency 60 Hz: Integration time 16.66 ms

Operation: Set the number of channels you wish to assign on the input module. If there are fewer than four channels, less address space will be assigned and measured values will be updated faster.

Broken wire: Broken wire signalling not possible

Table 15-21. Settings for the Operating Mode Switch for Analog Input Module 464-8MD11

Function	Settings for Operating Mode Switch		
Power supply frequency	50 Hz  4 3 2 1		60 Hz  4 3 2 1
Operation	1 channel (ch.0)  4 3 2 1	2 chan. (ch.0 + ch.1)  4 3 2 1	4 chan. (ch.0 to 3)  4 3 2 1
No function	 4 3 2 1		 4 3 2 1

Analog Value Representation

Table 15-22. Analog Input Module 464-8MD11 (Bipolar Fixed-Point Number)

Units	Meas. Val. in mA	High Byte	Low Byte	Range
>4095	40.0	0 1 1 1 1 1 1 1	1 1 1 1 1 0 0 1	Overflow
4095	39.9902	0 1 1 1 1 1 1 1	1 1 1 1 1 0 0 0	Overrange
2049	20.0098	0 1 0 0 0 0 0 0	0 0 0 0 1 0 0 0	
2048	20.0	0 1 0 0 0 0 0 0	0 0 0 0 0 0 0 0	Nominal range
1024	10.0	0 0 1 0 0 0 0 0	0 0 0 0 0 0 0 0	
1	0.0098	0 0 0 0 0 0 0 0	0 0 0 0 1 0 0 0	
0	0.0	0 0 0 0 0 0 0 0	0 0 0 0 0 0 0 0	
- 1	- 0.0098	1 1 1 1 1 1 1 1	1 1 1 1 1 0 0 0	
- 1024	- 10.0	1 1 1 0 0 0 0 0	0 0 0 0 0 0 0 0	
- 2048	- 20.0	1 1 0 0 0 0 0 0	0 0 0 0 0 0 0 0	Overrange
- 2049	- 20.0098	1 0 1 1 1 1 1 1	1 1 1 1 1 0 0 0	
- 4095	- 39.9902	1 0 0 0 0 0 0 0	0 0 0 0 1 0 0 0	Overflow
<- 4095	- 40.0	1 0 0 0 0 0 0 0	0 0 0 0 1 0 0 1	

Standard function block FB 250 (read in analog value) can be used to normalize the analog value. Set type fo channel Y = 6 "bipolar fixed-point number" in function block FB 250.

Analog Input Module 4 x 4 to 20 mA

(6ES5 464-8ME11)

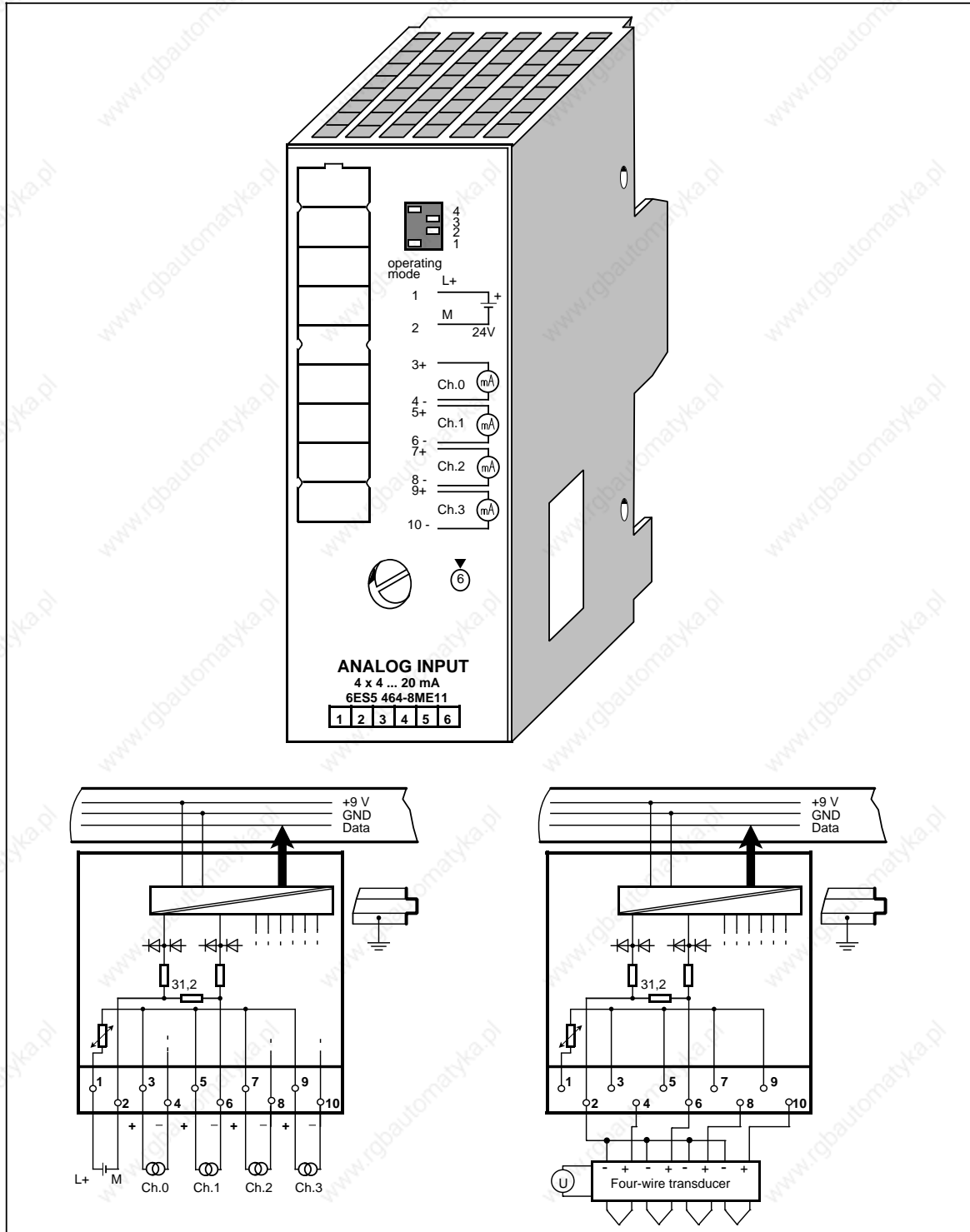

Analog Input Module 4 x ± 4 to 20 mA (continued)

(6ES5 464-8ME11)

Technical specifications			
Input ranges (rated values)	4 to 20 mA	Noise suppression for $f=nx$ (50/60 Hz \pm 1%); $n=1, 2, \dots$	
Number of inputs	1, 2 or 4 (selectable)	- common-mode rejection ($V_{pp}=1$ V)	min. 86 dB
Galvanic isolation	yes (inputs to grounding point; not between inputs)	- series-mode rejection (peak value of noise < rated value of input range)	min. 40 dB
Input resistance	31.25 k	Basic error limits (operational error limits at 25°C, referred to input ranges of the module)	± 0.15 %
Connection method of sensors	two-wire connection for 2/4 wire transducers	Operational error limits (0 to 60 °C, referred to the input ranges of the module) (32 to 140 °F)	± 0.4 %
Digital representation of input signal	12 bits+sign (2048 units =rated value)	Length of cable - shielded	max. 200 m (660 ft.)
Measured value representation	two's complement (left-justified)	Supply voltage L+ for 2-wire transducers	
Measuring principle	integrating	- rated value	24 V DC
Conversion principle	voltage-time conversion (dual slope)	- ripple V_{pp}	3.6 V
Integration time (adjustable for optimum noise suppression)	20 ms at 50 Hz 16.6 ms at 60 Hz	- permissible range	20 to 30 V
Encoding time per input		Rated insulation voltage (+9 V to \rightarrow)	12 V AC
- for 2048 units	max. 60 ms at 50 Hz	- insulation group	1xB
- for 4095 units	max. 80 ms at 50 Hz max. 66.6 ms at 60 Hz	- tested with	500 V AC
Permissible voltage difference		Rated insulation voltage (inputs to +9 V)	60 V AC
- between inputs	max. ± 5 V	- insulation group	1xB
- between inputs and central ground point	max. 75 V DC/60 V AC	- tested with	500 V AC
Permissible input voltage (destruction limit)	max. 80 mA	Current consumption	
Fault indication for - range exceeded	yes (more than 4095 units)	- from +9 V (CPU)	typ. 100 mA
- sensor wire break	no	- from L+	typ. 80 mA
- general indication of wire break	no	Power loss of the module	
		- for 2-wire transducers	typ. 1.2 W
		- for 4-wire transducers	typ. 0.9 W
		Weight	approx. 230 g (8 oz.)

Function

You can use module 6ES5 464-8ME11 for the connection of two-wire and four-wire transducers.

Use the 24 V inputs 1 and 2 to supply the two-wire transducers. The two-wire transducer converts the voltage supplied to a current of 4 to 20 mA.

Wiring:

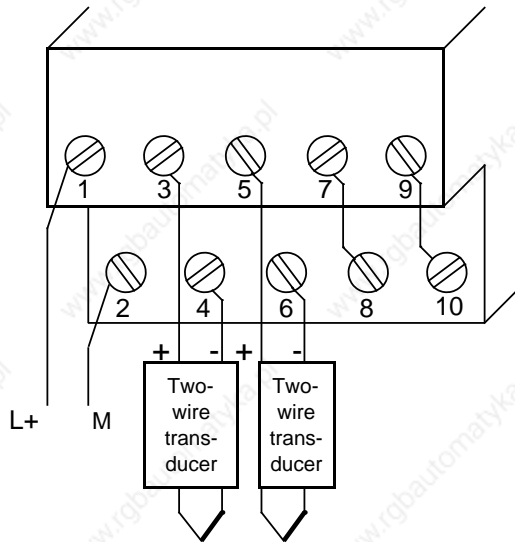

Figure 15-13. Connection of only Two-Wire Transducers (6ES5 464-8ME11)

If you use a four-wire transducer connect it as shown in Figure 15-14:

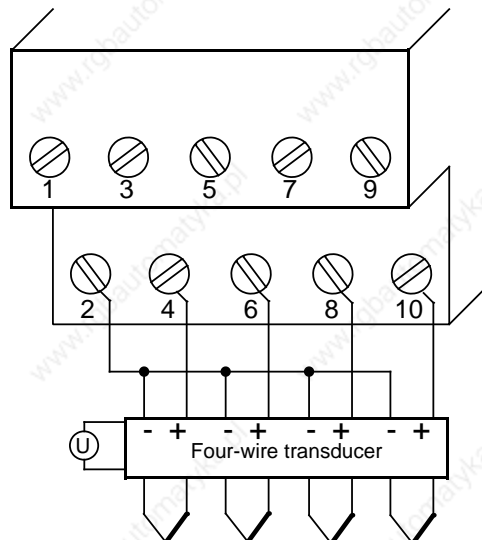

Figure 15-14. Connection of only Four-Wire Transducers (6ES5 464-8ME11)

Please note that four-wire transducers require their own voltage supply and that the "+" pole of the four-wire transducer must be connected to the corresponding "-" pole of the terminal block (opposite connection technique to the two-wire transducer).

All "-" terminals of the four-wire transducer must be connected to terminal 2 of the terminal block.

The following must be observed when connecting four-wire transducers with more than two "-" terminals:

- Connect the "-" terminals to the same potential (terminal strip or terminal block) and
- Connect the terminal strip with terminal 2 of the terminal block.

Reason for this measure: Only 2 conductors may be connected at each terminal of the terminal block.

If you use two-wire and four-wire transducers simultaneously, these must be connected as follows. Please note that the four-wire transducers must be galvanically isolated from the module via isolating transformers.

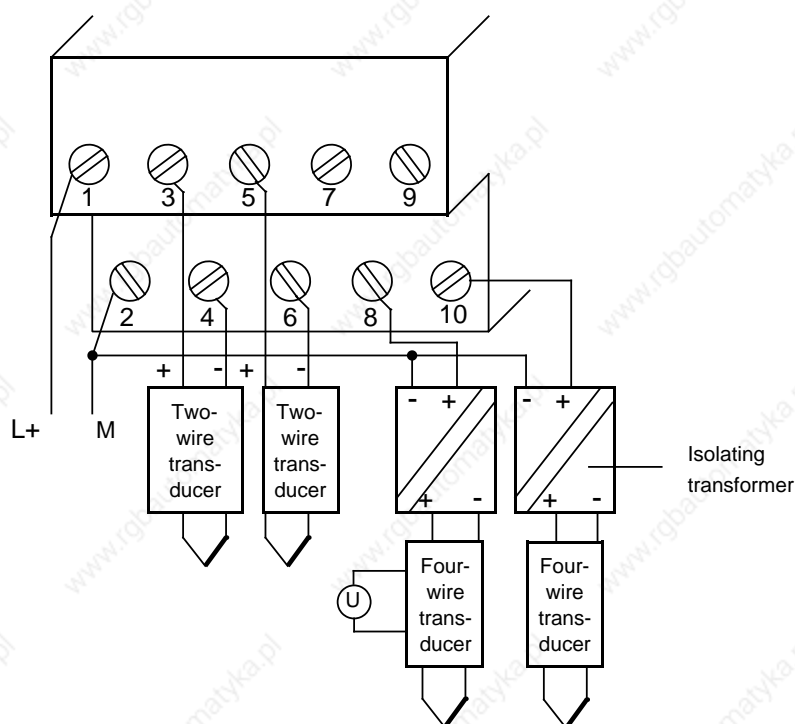

Figure 15-15. Connection of Two-Wire and Four-Wire Transducers (6ES5 464-8ME11)

Start-Up of Module







Set the intended operating mode using the switch on the front panel of analog input module 464-8ME11. This switch is located on the right side at the top of the front panel of the module.

Power supply frequency: Set the switch to the available power supply frequency. This selects the integration time of the A/D converters for optimal interference voltage suppression.
 Power frequency 50 Hz: Integration time 20 ms
 Power frequency 60 Hz: Integration time 16.66 ms

Operation: Set the number of channels you wish to assign on the input module. If there are fewer than four channels, the measured values will be updated faster.

Broken wire: Inputs 4, 6, 8 and 10 are connected internally via shunt resistors. Because of the internal shunt resistors, broken wire signalling is not possible.

Table 15-23. Settings of the Operating Mode Switch for Analog Input Module 464-8ME11

Function	Settings for Operating Mode Switch			
Power supply frequency	50 Hz  4 3 2 1		60 Hz  4 3 2 1	
Operation	1 channel (ch.0)  4 3 2 1	2 chan. (ch.0 + ch1)  4 3 2 1	4 chan. (ch.0 to 3)  4 3 2 1	
No function	 4 3 2 1		 4 3 2 1	

Analog Value Representation

Table 15-24. Analog Input Module 464-8ME11, 4 x 4 to 20 mA (Absolute Value)

Units	Meas- Val. in mA	High Byte	Low Byte	Range
>4095	>32.769	0 1 1 1 1 1 1 1	1 1 1 1 1 0 0 1	Overflow
4095	31.992	0 1 1 1 1 1 1 1	1 1 1 1 1 0 0 0	Overrange
2561	20.008	0 1 0 1 0 0 0 0	0 0 0 0 1 0 0 0	
2560	20.0	0 1 0 1 0 0 0 0	0 0 0 0 0 0 0 0	Nominal range
2048	16.0	0 1 0 0 0 0 0 0	0 0 0 0 0 0 0 0	
512	4.0	0 0 0 1 0 0 0 0	0 0 0 0 0 0 0 0	
511	3.992	0 0 0 0 1 1 1 1	1 1 1 1 1 0 0 0	Transducer failure
384	3.0	0 0 0 0 1 1 0 0	0 0 0 0 0 0 0 0	
0	0.0*	0 0 0 0 0 0 0 0	0 0 0 0 0 0 0 0	
- 1	- 0.008	1 1 1 1 1 1 1 1	1 1 1 1 1 0 0 0	
<- 4095	<- 32.769	1 0 0 0 0 0 0 0	0 0 0 0 1 0 0 1	

* Because of tolerances of components used in the module, the converted value can also be negative (e.g. FFF8_H Unit: - 1).

Standard function block FB 250 (read in analog value) can be used to normalize the analog value. Set type of channel y = 3 "absolute value" in function block FB250.

Analog Input Module 2 x PT 100/± 500 mV

(6ES5 464-8MF11)

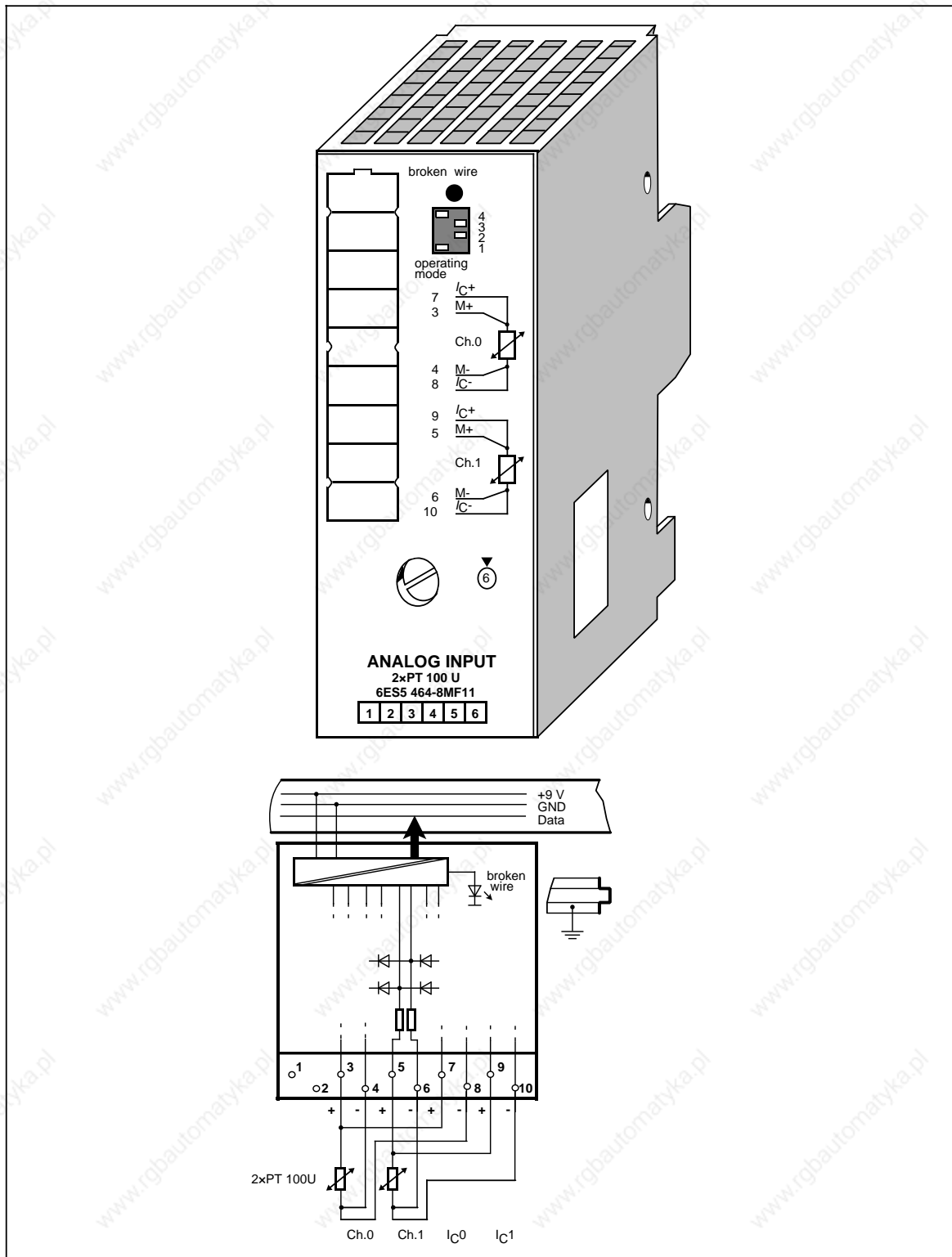

Analog Input Module 2 x PT 100/±500 mV (continued)

(6ES5 464-8MF11)

Technical Specifications			
Input ranges (rated values)			Noise suppression for $f = nx$ (50/60 Hz±1%) $n = 1, 2, \dots$
- Resistance encoder (PT 100)	0 to 200 (max. 400)		- common mode rejection ($V_{pp} = 1 V$)
- Voltage sources	±500 mV		min. 86 dB
Number of inputs	1 or 2 (selectable)		- series mode rejection (peak value of noise < rated value of input range)
Galvanic isolation	yes (inputs to grounding point; not between inputs)		min. 40 dB
Input resistance	10 M		Basic error limits (operating error limits at 25°C, referred to input range ±500 mV)
Connection method of sensors	two-wire connection		±0.15%
Digital representation of input signal	12 bits + sign (2048 units = rated value)		Operating error limits (0 to 60 °C, referred to input range ±500 mV (32 to 140 °F)
Measured value representation	two's complement (left-justified)		±0.4%
Measuring principle	integrating		Length of cable - shielded
Conversion principle	voltage-time conversion (dual slope)		max. 200 m (660 ft.)
Integration time (adjustable for optimum noise suppression)	20 ms at 50 Hz 16.6 ms at 60 Hz		Supply voltage L+
Encoding time per input			none
- for 2048 units	max. 60 ms at 50 Hz		Auxiliary current for PT 100
- for 4095 units	max. 50 ms at 60 Hz max. 80 ms at 50 Hz max. 66.6 ms at 60 Hz		2.5 mA
Permissible voltage difference			Auxiliary current single error
- between inputs	max. ± 5 V		- tolerance
- between inputs and central ground point	max. 75 V DC/60 V AC		- temperature error
Permissible input voltage (destruction limit)	max. 24 V DC		- influence of load variation
Fault indication for			Internal temperature compensation
- range exceeded	yes (more than 4095 units)		possible
- sensor wire break	yes (selectable), via test pulse		Connection of compensating box
- general indication of wire break	red LED		possible
			Rated insulation voltage (+9 V to $\frac{1}{2}$)
			- insulation group
			- tested with
			12 V AC
			1 x B
			500 V AC
			Rated insulation voltage (inputs to + 9 V)
			- insulation group
			- tested with
			60 V AC
			1 x B
			500 V AC
			Current consumption
			- from + 9 V (CPU)
		typ.	100 mA
			Power loss of the module
		typ.	0.9 W
			Weight
		approx.	230 g (8 oz.)

Function

Analog input module 464-8MF11 is suited for the connection of resistance thermometers (e.g., PT 100).

The resistance of the PT 100 is measured in a four-wire circuit. A constant current is supplied to the resistance thermometer via terminals 7 and 8 as well as via terminals 9 and 10. The voltage at the resistance thermometer is measured via terminals 3/4 and 5/6. In this way, highly accurate measuring results are obtained.

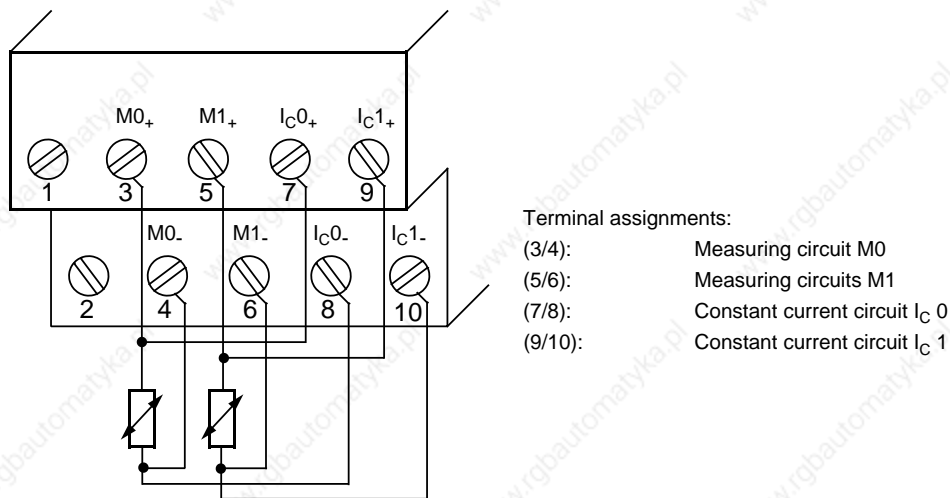

Figure 15-16. Wiring Method for PT 100 (6ES5 464-8MF11)

If you use only one channel for PT 100 measurement (e.g., channel 0), then you can use the other channel for voltage measurement (± 500 mV). In this case, use terminals M+/M- for the signal connection and short circuit the terminals I_{C+} and I_{C-}.

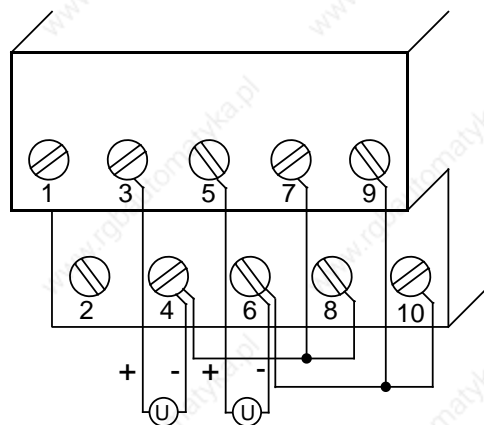

Figure 15-17. Wiring Possibilities for ± 500 mV Voltage Measurement for the Input Module (6ES5 464-8MF11)

Start-Up of Module

Set the intended operating mode using the switch on the front panel of analog input module 464-8MF11. This switch is located on the right side at the top of the front panel of the module.

Power supply frequency: Set the switch to the available power supply frequency. This selects the integration time of the A/D converters for optimal interference voltage suppression.

Power frequency 50 Hz: Integration time 20 ms







Power frequency 60 Hz: Integration time 16.66 ms

Operation: Set the number of channels you wish to assign on the input module. If there are fewer than four channels, the measured values will be updated faster.

Broken wire: Once the broken wire signal has been activated, a break on one of the lines to the sensor (PT 100) or of the sensor itself causes the red LED above the function selection switch to light up. At the same time, the broken wire error bit F (bit 1, byte 1) for the faulty channel is set.

The module "recognizes" a wire break by applying a conventional tripping current to the input terminals and by comparing the resulting voltage to a limit value. If there is a wire break in the sensor or the lines, the voltage exceeds the limit value and a "wire break" signal is sent. When the signal at the input is measured with a digital voltmeter, the tripping current pulses cause apparent fluctuations of the signal. Deactivation of the wire break signal does **not** turn off the tripping current.

Table 15-25. Settings for the Operating Mode Switch for Analog Input Module 464-8MF11

Function	Settings for Operating Mode Switch		
Power supply frequency	50 Hz		60 Hz
	 4 3 2 1		 4 3 2 1
Operation	1 channel (ch. 0)	2 ch. (ch. 0 + ch. 1)	4 chan. (ch. 0 - ch. 3)
	 4 3 2 1	 4 3 2 1	 4 3 2 1
Wire break	With wire break signal		No wire break signal
	 4 3 2 1		 4 3 2 1

Analog Value Representation

Table 15-26. Analog Input Module 464-8MF11, 2xPT 100 (Unipolar)

Units	Resistance in	High Byte	Low Byte	Range
>4095	400.0	0 1 1 1 1 1 1 1	1 1 1 1 1 0 0 1	Overflow
4095	399.90	0 1 1 1 1 1 1 1	1 1 1 1 1 0 0 0	Overrange
2049	200.098	0 1 0 0 0 0 0 0	0 0 0 0 1 0 0 0	
2048	200.0	0 1 0 0 0 0 0 0	0 0 0 0 0 0 0 0	Nominal range
1024	100.0	0 0 1 0 0 0 0 0	0 0 0 0 0 0 0 0	
1	0.098	0 0 0 0 0 0 0 0	0 0 0 0 1 0 0 0	
0	0.0	0 0 0 0 0 0 0 0	0 0 0 0 0 0 0 0	

* Because of tolerances of components used in the module, the converted value can also be negative (e.g. FFF8_H Unit: -1).

Standard function blocks FB250 (read in analog value) and FB "polygon function" can be used to normalize and linearize the analog value when measuring with PT 100. Set type of channel y =4 "unipolar" in function block FB 250.

The non-linear temperature/resistance characteristic of PT 100 can be linearized via interpolation points using function block FB "polygon function". For the interpolation points please see the standard characteristic of the PT 100 in IEC 751.

Table 15-27. Analog Input Module 464-8MF11, ± 500 mV (Bipolar Fixed-Point Number)

Units	Meas. Val. in mV	High Byte	Low Byte	Range
>4095	1000.0	0 1 1 1 1 1 1 1	1 1 1 1 1 0 0 1	Overflow
4095	999.75	0 1 1 1 1 1 1 1	1 1 1 1 1 0 0 0	Overrange
2049	500.24	0 1 0 0 0 0 0 0	0 0 0 0 1 0 0 0	
2048	500.0	0 1 0 0 0 0 0 0	0 0 0 0 0 0 0 0	Nominal range
1024	250.0	0 0 1 0 0 0 0 0	0 0 0 0 0 0 0 0	
1	0.24	0 0 0 0 0 0 0 0	0 0 0 0 1 0 0 0	
0	0.0	0 0 0 0 0 0 0 0	0 0 0 0 0 0 0 0	
- 1	- 0.24	1 1 1 1 1 1 1 1	1 1 1 1 1 0 0 0	
- 1024	- 250.0	1 1 1 0 0 0 0 0	0 0 0 0 0 0 0 0	
- 2048	- 500.0	1 1 0 0 0 0 0 0	0 0 0 0 0 0 0 0	Overrange
- 2049	- 500.24	1 0 1 1 1 1 1 1	1 1 1 1 1 0 0 0	
- 4095	- 999.75	1 0 0 0 0 0 0 0	0 0 0 0 1 0 0 0	
<- 4095	- 1000.0	1 0 0 0 0 0 0 0	0 0 0 0 1 0 0 1	Overflow

Analog Input Module 2 x PT 100/±500 mV

(6ES5 464-8MF21)

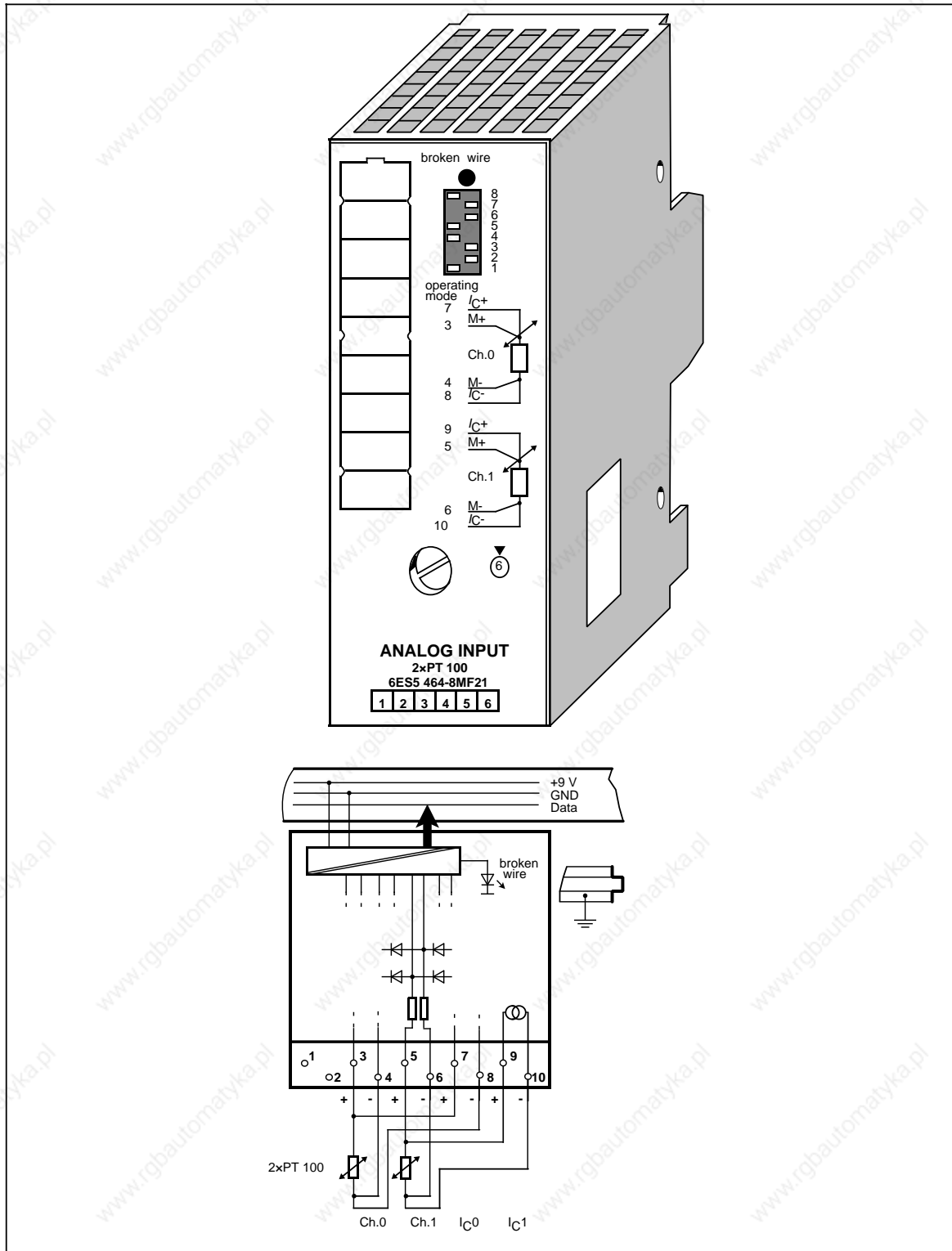

Analog Input Module 2×PT 100/± 500 mV (continued)

(6ES5 464-8MF21)

Technical specifications			
Input range (rated values)			Noise suppression for $f=nx$ (50/60 Hz±1%); $n=1, 2, \dots$
- resistance sensor (PT 100)	0 to 200 (max. 400/± 500)		- common-mode rejection ($V_{pp}=1$ V) min. 86 dB
- voltage source			- series-mode rejection (peak value of noise <rated value of input range) min. 40 dB
Number of inputs	1 or 2 (selectable)		
Galvanic isolation	yes (inputs to grounding point; not between inputs)		Basic error limits (operational error limits at 25°C, referred to input range ±500 mV) ±0.15 %
Input resistance	10 M		
Connection method of sensors	two-or four-wire connection		Operational error limits (0 to 60 °C, referred to input range ±500 mV) (32 to 140 °F) ±0.4 %
Digital representation of input signal	12 bits + sign (2048 units = rated value)		Linearization exactness in rated range Characteristic linearization of PT 100-characteristic curve ±0.5 °C (0.9 °F) DIN IEC 751
Measured value representation	two's complement (left-justified)		
Measuring principle	integrating		Length of cable - shielded max. 200 m (660 ft.)
Conversion principle	voltage-time conversion (dual slope)		Supply voltage L+ Auxiliary current for PT 100 none 2.5 mA
Integration time (adjustable for optimum noise suppression)	20 ms at 50 Hz 16.6 ms at 60 Hz		Auxiliary current single error - tolerance ± 0.05% - temperature error ±0.006%/K - influence of load variation ±0.02%/100
Encoding time per input			
- for 2048 units	max. 60 ms at 50 Hz max. 50 ms at 60 Hz		Rated insulation voltage (+9 V to \downarrow) 12 V AC - insulation group 1xB - tested with 500 V AC
- for 4095 units	max. 80 ms at 50 Hz max. 66.6 ms at 60 Hz		
Permissible voltage difference			Rated insulation voltage (inputs to +9 V) 60 V AC - insulation group 1xB - tested with 500 V AC
- between inputs	max. ± 5 V		
- between inputs and central ground point	max. 75 V DC/60 V AC		
Permissible input voltage (destruction limit)	max. 24 V DC		Current consumption - from +9 V (CPU) typ. 120 mA
Fault indication for - range exceeded	yes (more than 4095 units)		Power loss of the module typ. 1 W
- sensor wire break	yes (selectable), via test pulse		Weight approx. 230 g (8 oz.)
- general indication of wire break	red LED		

Function

Analog input module 464-8MF21 is suited for the connection of resistance thermometers (e.g. PT 100) and is provided with an interruptible internal linearization.

The resistance of the PT 100 is measured in a four-wire circuit. A constant current is supplied to the resistance thermometer via terminals 7 and 8 as well as via terminals 9 and 10. The voltage at the resistance thermometer is measured via terminals 3/4 and 5/6. In this way, highly accurate measuring results are obtained.

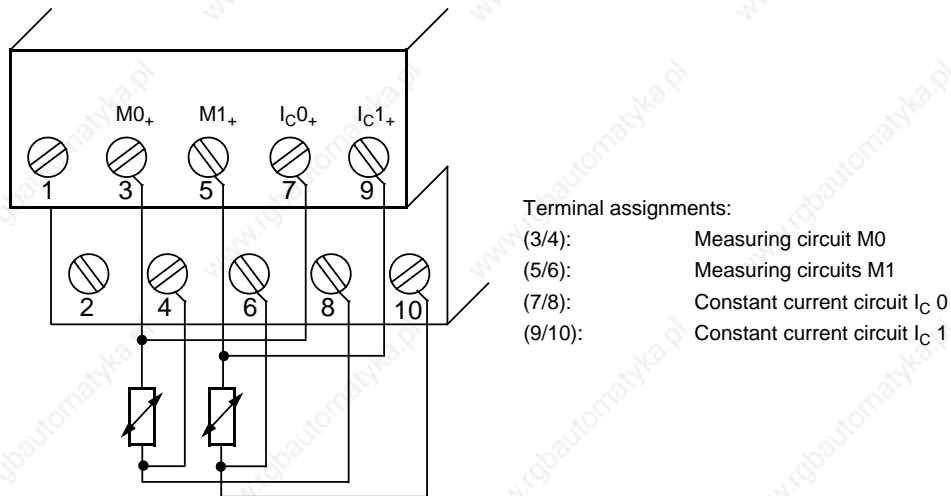

Figure 15-18. Wiring Method for PT 100 (6ES5 464-8MF21)

Start-Up of Module

Set the intended operating mode using the switch on the front panel of analog input module 464-8MF21. This switch is located on the right side at the top of the front panel of the module.

Power supply frequency: Set the switch to the available power supply frequency. This selects the integration time of the A/D converters for optimal interference voltage suppression.

Power frequency 50 Hz:	Integration time 20 ms
Power frequency 60 Hz:	Integration time 16.66 ms

Operation: Set the number of channels you wish to assign on the input module.





Broken wire: Once the broken wire signal has been activated, a break on one of the lines to the sensor or of the sensor itself causes the red LED above the function selection switch to light up. At the same time, the broken wire error bit F (bit 1, byte 1) for the faulty channel is set.

The module "recognizes" a wire break by applying a conventional tripping current to the input terminals and by comparing the resulting voltage to a limit value. If there is a wire break in the sensor or the lines, the voltage exceeds the limit value and a "wire break" signal is sent. When the signal at the input is measured with a digital voltmeter, the tripping current pulses cause apparent fluctuations of the signal. Deactivation of the wire break signal does **not** turn off the tripping current.

Linearization: With this function, you can obtain a characteristic linearization of the resistance thermometer.

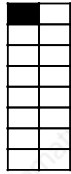
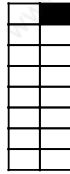
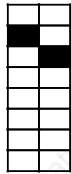
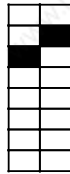
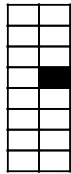
The analog input module 464-8MF21 allows the following settings for the operating mode switch:

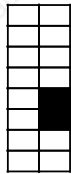
Table 15-28. Settings for the Operating Mode Switch for Analog Input Module 464-8MF21

Function	Settings for Operating Mode Switch	
Power supply frequency	50 Hz 	60 Hz 
Operation	1 channel (ch. 0) 	2 channel (ch. 0 + ch. 1) 
Wire break	With wire break signal 	No wire break signal 
Characteristic linearization for the PT 100	No linearization 	Linearization for type L 

Positions 1 and 2 on the operating mode switch have no function.

If you set the switch to "no linearization", module 464-8MF21 functions just like module 464-8MF11.

The characteristic linearization is possible for the following temperature ranges:

PT 100: -200° C (-328° F) to +850° C (1562° F) (in steps of 0.5° C (0.9° F))

Analog Value Representation

Table 15-29. Analog Input Module 464-8MF21, 2xPT 100 "with Linearization", to IEC 751

Units	Resistance in	Temperature in °C	High Byte	Low Byte	Range
>1766	>400	>883	0 0 1 1 0 1 1 1	0 0 1 1 0 0 0 1	Overflow
1766		883	0 0 1 1 0 1 1 1	0 0 1 1 0 0 0 1	Overrange*
1702		851	0 0 1 1 0 1 0 1	0 0 1 1 0 0 0 1	
1700	390.26	850	0 0 1 1 0 1 0 1	0 0 1 0 0 0 0 0	Nominal range
1400	345.13	700	0 0 1 0 1 0 1 1	1 1 0 0 0 0 0 0	
1000	280.90	500	0 0 0 1 1 1 1 1	0 1 0 0 0 0 0 0	
600	212.02	300	0 0 0 1 0 0 1 0	1 1 0 0 0 0 0 0	
300	157.31	150	0 0 0 0 1 0 0 1	0 1 1 0 0 0 0 0	
200	138.50	100	0 0 0 0 0 1 1 0	0 1 0 0 0 0 0 0	
2	100.39	1	0 0 0 0 0 0 0 0	0 0 0 1 0 0 0 0	
0	100.00	0	0 0 0 0 0 0 0 0	0 0 0 0 0 0 0 0	
- 40	92.16	- 20	1 1 1 1 1 1 1 0	1 1 0 0 0 0 0 0	
- 80	84.27	- 40	1 1 1 1 1 1 0 1	1 0 0 0 0 0 0 0	
- 200	60.25	- 100	1 1 1 1 1 0 0 1	1 1 0 0 0 0 0 0	
- 202		- 101	1 1 1 1 1 0 0 1	1 0 1 1 0 0 0 1	Overrange*
- 494		- 247	1 1 1 1 0 0 0 0	1 0 0 1 0 0 0 1	
<- 494		<- 247	1 1 1 1 0 0 0 0	1 0 0 1 0 0 0 1	Overflow

* In the overrange the current slope of the characteristic curve is maintained when leaving the linearized nominal range.

Table 15-30. Analog Input Module 464-8MF21, 2 x PT 100 "without Linearization" (Unipolar)

Units	Resistance in	High Byte	Low Byte	Range
>4095	400,0	0 1 1 1 1 1 1 1	1 1 1 1 1 0 0 1	Overflow
4095	399,90	0 1 1 1 1 1 1 1	1 1 1 1 1 0 0 0	Overrange
2049	200,098	0 1 0 0 0 0 0 0	0 0 0 0 1 0 0 0	
2048	200,0	0 1 0 0 0 0 0 0	0 0 0 0 0 0 0 0	Nominal range
1024	100,0	0 0 1 0 0 0 0 0	0 0 0 0 0 0 0 0	
1	0,098	0 0 0 0 0 0 0 0	0 0 0 0 1 0 0 0	
0	0,0*	0 0 0 0 0 0 0 0	0 0 0 0 0 0 0 0	

* Because of tolerances of components used in the module, the converted value can also be negative (e.g. FFF8_H Unit: -1).

Standard function blocks FB250 (read in analog value) and FB "polygon function" can be used to normalize and linearize the analog value when measuring with PT 100. Set type of channel y =4 "unipolar" in function block FB 250.

The non-linear temperature/resistance characteristic of PT 100 can be linearized via interpolation points using function block FB "polygon function". For the interpolation points please see the standard characteristic of the PT 100 in IEC 751.

Table 15-31. Analog Input Module 464-8MF21, ± 500 mV (Bipolar Fixed-Point Number)

Units	Meas. Val. in mV	High Byte	Low Byte	Range
>4095	1000.0	0 1 1 1 1 1 1 1	1 1 1 1 1 0 0 1	Overflow
4095	999.75	0 1 1 1 1 1 1 1	1 1 1 1 1 0 0 0	Overrange
2049	500.24	0 1 0 0 0 0 0 0	0 0 0 0 1 0 0 0	
2048	500.0	0 1 0 0 0 0 0 0	0 0 0 0 0 0 0 0	Nominal range
1024	250.0	0 0 1 0 0 0 0 0	0 0 0 0 0 0 0 0	
1	0.24	0 0 0 0 0 0 0 0	0 0 0 0 1 0 0 0	
0	0.0	0 0 0 0 0 0 0 0	0 0 0 0 0 0 0 0	
- 1	- 0.24	1 1 1 1 1 1 1 1	1 1 1 1 1 0 0 0	
- 1024	- 250.0	1 1 1 0 0 0 0 0	0 0 0 0 0 0 0 0	
- 2048	- 500.0	1 1 0 0 0 0 0 0	0 0 0 0 0 0 0 0	
- 2049	- 500.24	1 0 1 1 1 1 1 1	1 1 1 1 1 0 0 0	Overrange
- 4095	- 999.75	1 0 0 0 0 0 0 0	0 0 0 0 1 0 0 0	Overrange
<- 4095	- 1000.0	1 0 0 0 0 0 0 0	0 0 0 0 1 0 0 1	

Analog Input Module 4x+0 to 10 V

(6ES5 466-8MC11)

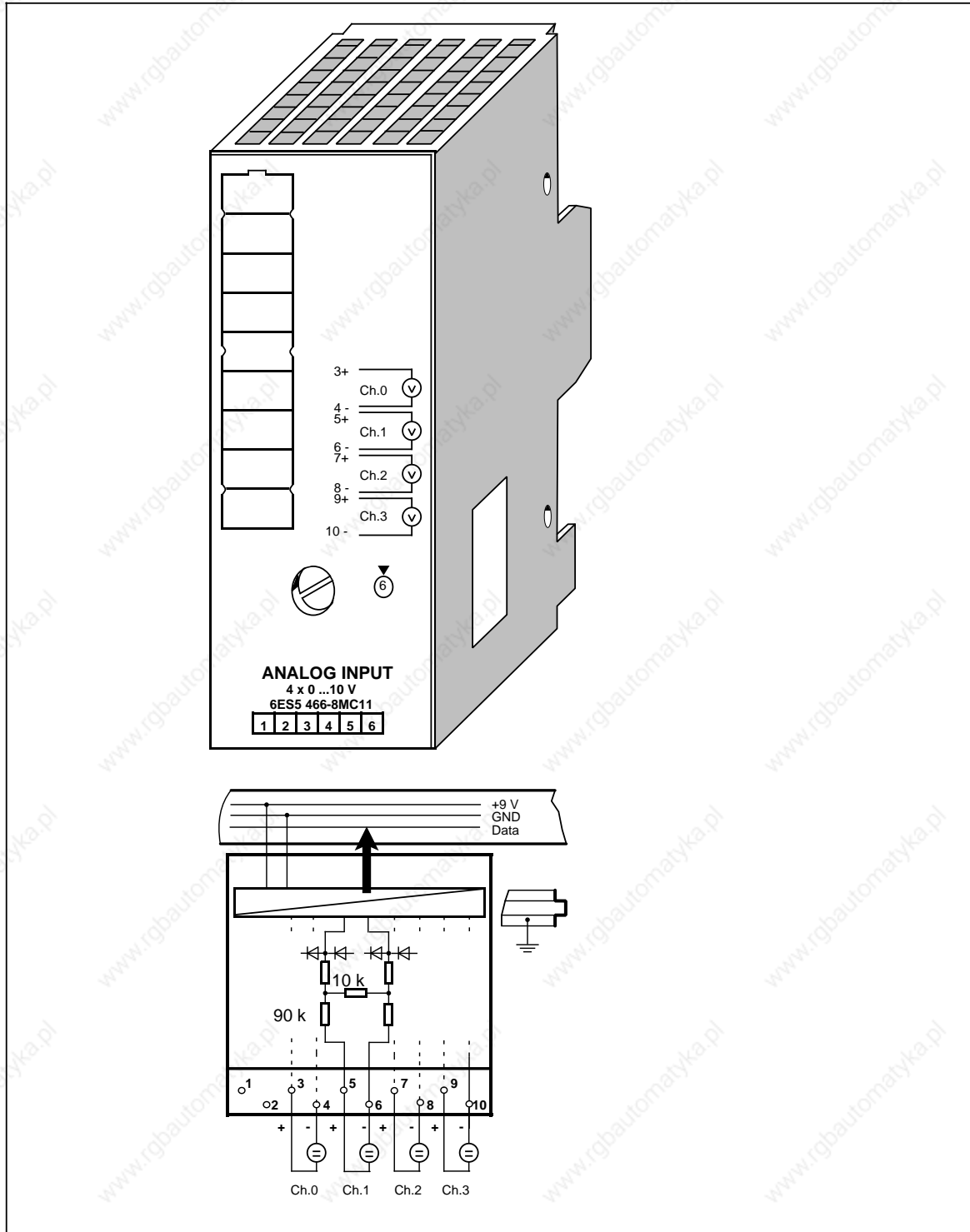

Analog Input Module 4x+0 to 10 V (continued)

(6ES5 466-8MC11)

Technical specifications			
Input range (rated values)	+0 to 10 V	Noise suppression - common mode interference ($V_{PP}=1$ V) min.	86 dB
Number of inputs	4	Basic error limits (operational error limits at 25°C, referred to input ranges of the module)	±0.4 %
Galvanic isolation	no	Operational error limits (0 to 60 °C, referred to the input ranges of the module) (32 to 140 °F)	±0.6 %
Input resistance	100 M	Length of cable - shielded	max. 200 m (660 ft.)
Connection method of sensors	two-wire connection	Supply voltage L+	none
Digital representation of input signal	8 bits + sign (256 units = rated value)	Current consumption - from +9 V (CPU)	typ. 100 mA
Representation of the measured value	binary	Power loss of the module	typ. 0.9 W
Measuring principle	successive approximation	Weight	approx. 230 g (8 oz.)
Conversion time	100µs		
Encoding time per input	5 ms		
Permissible voltage difference - between inputs	max. ±1 V		
Permissible input voltage (destruction limit)	max. 60 V DC		
Fault indication for - range exceeded	no		
- sensor wire break	no		
- general indication of wirebreak	no		

Function

The module 6ES5 466-8MC11 is suitable for connection of voltage sensors.

For wiring of the module (two-wire connection) see block diagram (on the first page of the module description).

Analog Value Representation

The analog input module stores the analog values in one byte each; it thus differs from other analog input modules, which store the analog values in a word.

Table 15-32. Analog Input Module 466-8MC11, 4 x 0 to 10 V

Units	Input voltage in V	Bit							
		7 27	6 26	5 25	4 24	3 23	2 22	1 21	0 20
255	9.961	1	1	1	1	1	1	1	1
254	9.922	1	1	1	1	1	1	1	0
192	7.500	1	1	0	0	0	0	0	0
191	7.461	1	0	1	1	1	1	1	1
128	5.000	1	0	0	0	0	0	0	0
127	4.961	0	1	1	1	1	1	1	1
64	2.500	0	1	0	0	0	0	0	0
63	2.461	0	0	1	1	1	1	1	1
1	0.039	0	0	0	0	0	0	0	1
0	0.000	0	0	0	0	0	0	0	0

If you want to read in the analog value with function block FB250 (analog value reading), you have to pre-process the analog value before calling up FB250.

Example

Analog input module 466-8MC11 is inserted in slot 1, which means that the module's start address is 72.

The analog values are stored in four consecutive bytes:

1st analog value (channel 0) in IB72

2nd analog value (channel 1) in IB73

3rd analog value (channel 2) in IB74

4th analog value (channel 3) in IB75

The function block shown reads in the analog values and pre-processes them for the FB250 (read in analog value) OR (analog value reading).

FB	Explanation
0005 :	
0006 :L IB 75	SLOT 1, CHANNEL 3
0007 :SLW 6	PRE-PROCESS ANALOG VALUE AND
0008 :T IW 78	WRITE BACK TO PII SO THAT
0009 :JU FB 250	FB 250 CAN ACCESS IT
000A :	

15.6.2 Analog Output Modules

Connection of Loads to Analog Output Modules

Analog output modules convert the bit patterns that are output by the CPU into analog output voltages or currents.

No adjustments are necessary if you want to connect loads to the analog outputs.

Check the following items before connecting loads.

- The load voltage 24 V DC must be connected to terminals 1 and 2.
- The maximum permissible potential difference between the outputs is 60 V AC (for this purpose it might be necessary to earth the actuator or the module).
- Unused outputs must be left open-circuited.

Analog Value Representation of the Analog Output Modules

The following table shows how the analog value to be output is stored in the PIQ. The special analog value representations are included in the descriptions of the individual modules.

Table 15-33. Representation of an Analog Output Value as Bit Pattern

Bit Number	High Byte								Low Byte							
	7	6	5	4	3	2	1	0	7	6	5	4	3	2	1	0
Rep. of Analog Value	VZ	2 ¹⁰	2 ⁹	2 ⁸	2 ⁷	2 ⁶	2 ⁵	2 ⁴	2 ³	2 ²	2 ¹	2 ⁰	X	X	X	X

Key: X irrelevant bits

Standard function block FB 251 (output analog value) can be used for all analog output modules 470-8M...12 to support the analog value output.

Analog Output Module 2 x±10 V

(6ES5 470-8MA12)

ANALOG OUTPUT
2 x ± 10 V
6ES5 470-8MA12

Terminal block labels: 1 L+, 2 M, 3 QV 24 V, 4 S+, 5 S-, 6 M_A, 7 S+, 8 QV, 9 S-, 10 M_A. Resistor R 3.3k is shown between terminals 4 and 5, and between 8 and 9.

Technical specifications

Output range (rated values)		±10 V
Number of outputs		2
Galvanic isolation		yes (outputs to grounding point and between outputs)
Input resistance	min.	3.3 k
Capacitive load incl. cable capacitance		<100 nF
Connection method		two- or four-wire connection
Digital representation of output signal		11 bits + sign (1024 units = rated value)
Measured value representation		two's complement (left-justified)
Conversion time (0 to 100%)	max.	0.15 ms
Permissible overload		25%
Short-circuit protection		yes
Short-circuit current		±30 mA
Permissible voltage difference to ground and between outputs	max.	75 V DC/60 V AC
Basic error limits (operational error limits at 25°C, referred to output range of the module)		±0.3%
Operational error limits (0 to 60 °C, referred to output range) (32 to 140 °F)		±0.6%
Length of cable - shielded	max.	200 m (660 ft.)
Supply voltage L+ (peripheral)		24 V DC
- rated value		3.6 V
- ripple V _{pp}		20 to 30 V
- permissible range (ripple included)		
Rated insulation voltage (+9 V to ±)		12 V AC
- insulation group		1 x B
- tested with		500 V AC
Rated insulation voltage (Output to L+, between outputs, output to +9V)		60 V AC
- insulation group		1 x B
- tested with		500 V AC
Current consumption		
- from +9 V (CPU)	typ.	120 mA
- from L+	typ.	100 mA
Power loss of the module	typ.	3.1 W
Weight	approx.	220 g (10 oz.)

Legend:
QV: Analog output "voltage"

Connection of the Module

Figure 15-19 shows how to connect loads to the voltage outputs of the modules.

The sensor lines (S+ and S-) must be directly connected to the load, so that the voltage is measured and regulated directly at the load. In this manner, voltage drops of up to 3 V per line can be compensated for.

The sensor lines can be left out if the resistances of the QV and M lines are negligible compared to the load resistance. In such a case, connect terminal S + to terminal QV, and terminal S to M_{ANA}.

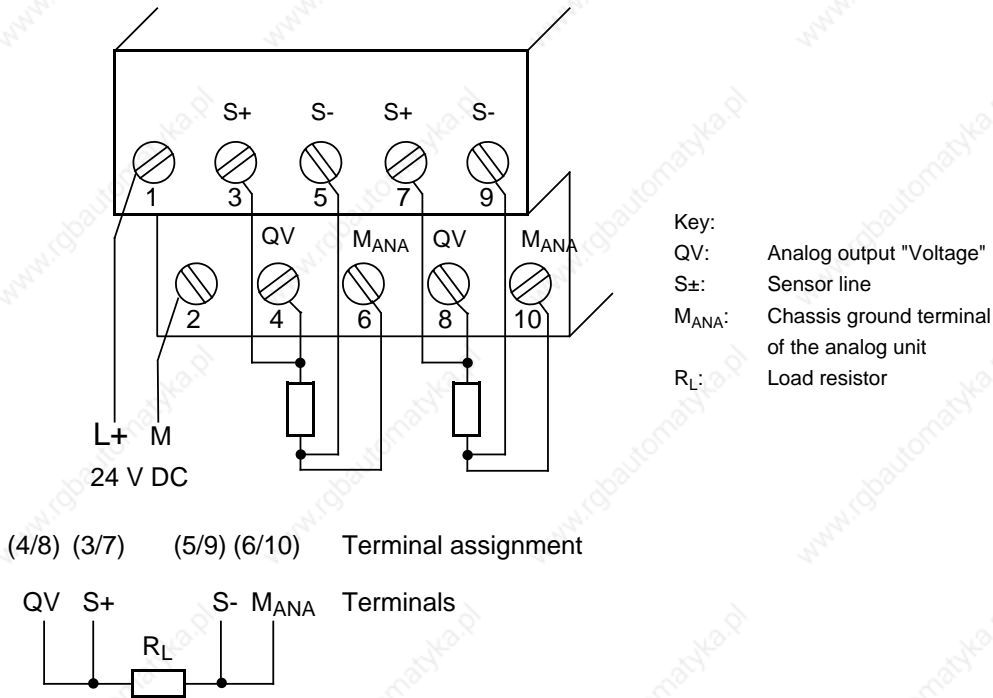

Figure 15-19. Load Connection via a Four-Wire Circuit (6ES5 470-8MA12)

Analog Value Representation

Table 15-34. Analog Output Module 470-8MA12 (Bipolar Fixed-Point Number)

Units	Output Values in V	High Byte	Low Byte	Range
1280	12.5	0 1 0 1 0 0 0 0	0 0 0 0 x x x x	Overrange
1025	10.0098	0 1 0 0 0 0 0 0	0 0 0 0 x x x x	
1024	10.0	0 1 0 0 0 0 0 0	0 0 0 0 x x x x	Nominal range
512	5.0	0 0 1 0 0 0 0 0	0 0 0 0 x x x x	
1	0.0098	0 0 0 0 0 0 0 0	0 0 0 0 x x x x	
0	0	0 0 0 0 0 0 0 0	0 0 0 0 x x x x	
- 1	- 0.0098	1 1 1 1 1 1 1 1	1 1 1 1 x x x x	
- 512	- 5.0	1 1 1 0 0 0 0 0	0 0 0 0 x x x x	
- 1024	- 10.0	1 1 0 0 0 0 0 0	0 0 0 0 x x x x	Overrange
- 1025	- 10.0098	1 0 1 1 1 1 1 1	1 1 1 1 x x x x	
- 1280	- 12.5	1 0 1 1 0 0 0 0	0 0 0 0 x x x x	

Analog Output Module 2 x±20 mA

(6ES5 470-8MB12)

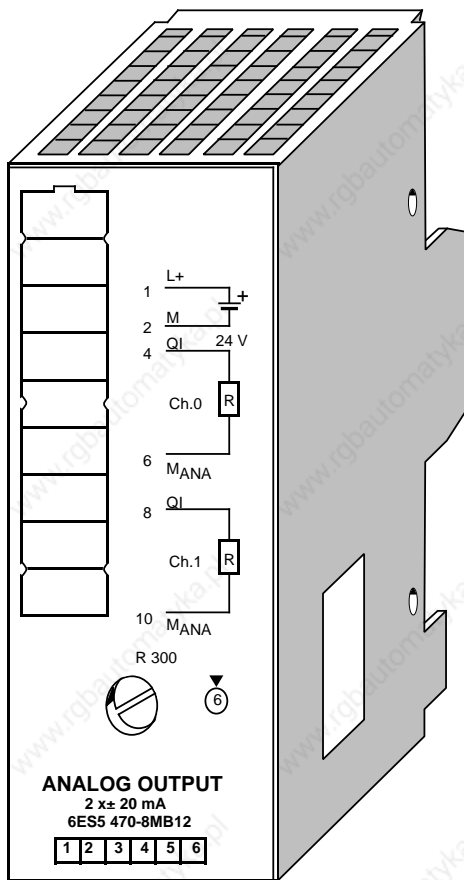

Technical specifications

Output range (rated values)		±20 mA
Number of outputs		2
Galvanic isolation		yes (outputs to grounding point and between outputs)
Load resistance		300 k
Connection method		two-wire connection
Digital representation of output signal		11 bits + sign (1024 units = rated value)
Measured value representation		two's complement (left-justified)
Conversion time (0 to 100%)	max.	0.15 ms
Permissible overload		25%
Open-circuit voltage		±12 V
Permissible voltage difference to ground and between outputs	max.	75 V DC/60 V AC
Basic error limits (operational error limits at 25°C, referred to output range)		±0.3%
Operational error limits (0 to 60 °C, referred to output range) (32 to 140 °F)		±0.6%
Length of cable - shielded	max.	200 m (660 ft.)
Supply voltage L+ - rated value		24 V DC
- ripple V _{PP}		3.6 V
- permissible range (ripple included)		20 to 30 V
Rated insulation voltage (+9 V to \rightarrow)		12 V AC
- insulation group		1 x B
- tested with		500 V AC
Rated insulation voltage (Output to L +, between outputs, output to +9V)		60 V AC
- insulation group		1 x B
- tested with		500 V AC
Current consumption - from +9 V (CPU)	typ.	120 mA
- from L +	typ.	130 mA
Power loss of the module	typ.	3.8 W
Weight	approx.	220 g (10 oz.)

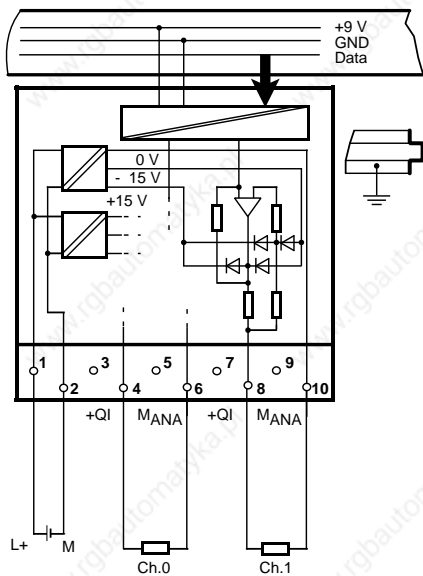

Legend:
QI: Analog output "current"

Connection of the Module

Figure 15-20 shows how to connect loads to the current outputs of the module.

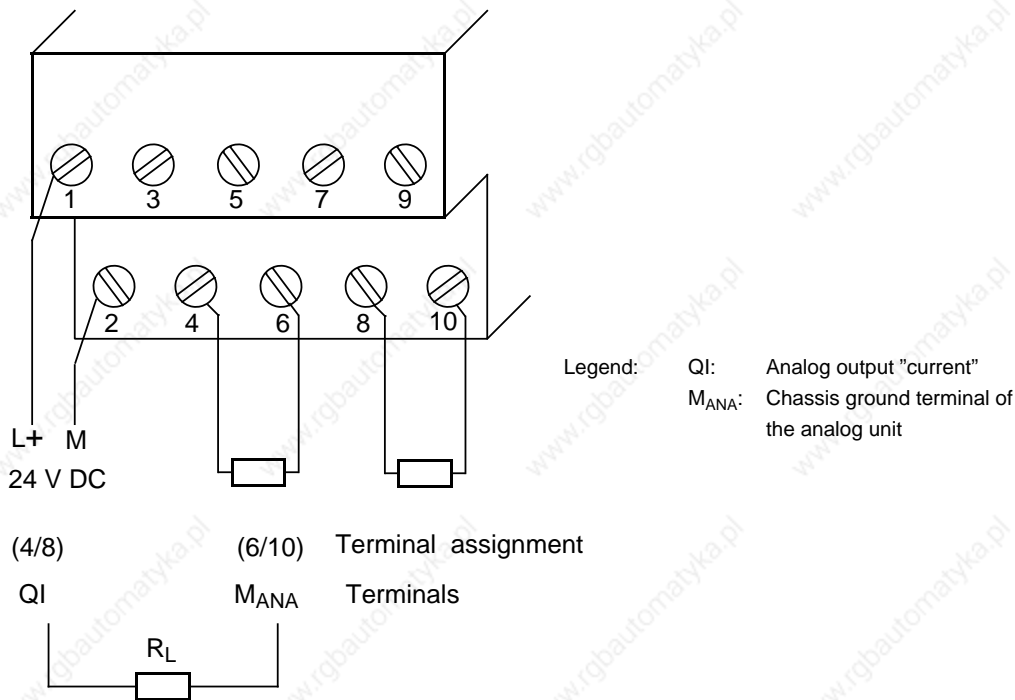

Fig. 15-20 Connection via a Two-Wire Circuit (6ES5 470-8MB12)

Analog Value Representation

Tabelle 15-35. Analog Output Module 470-8MB12 (Bipolar Fixed-Point Number)

Units	Output Values in mA	High Byte	Low Byte	Range
1280	25.0	0 1 0 1 0 0 0 0	0 0 0 0 x x x x	Overrange
1025	20.0195	0 1 0 0 0 0 0 0	0 0 0 0 x x x x	
1024	20.0	0 1 0 0 0 0 0 0	0 0 0 0 x x x x	Nominal range
512	10.0	0 0 1 0 0 0 0 0	0 0 0 0 x x x x	
1	0.0195	0 0 0 0 0 0 0 0	0 0 0 0 x x x x	
0	0	0 0 0 0 0 0 0 0	0 0 0 0 x x x x	
- 1	- 0.0195	1 1 1 1 1 1 1 1	1 1 1 1 x x x x	
- 512	- 10.0	1 1 1 0 0 0 0 0	0 0 0 0 x x x x	
- 1024	- 20.0	1 1 0 0 0 0 0 0	0 0 0 0 x x x x	Overrange
- 1025	- 20.0195	1 0 1 1 1 1 1 1	1 1 1 1 x x x x	
- 1280	- 25.0	1 0 1 1 0 0 0 0	0 0 0 0 x x x x	

Analog Output Module 2 x 4 to 20 mA

(6ES5 470-8MC12)

ANALOG OUTPUT
2 x 4 ... 20 mA
6ES5 470-8MC12

1	2	3	4	5	6
---	---	---	---	---	---

Technical specifications

Output range (rated value)	4 to 20 mA
Number of outputs	2
Galvanic isolation	yes (outputs to grounding point and between outputs)
Load resistance	300
Capacitive load incl. cable capacitance	< 100 nF
Connection method	two-wire connection
Digital representation of output signal	11 bits + sign (1024 units = rated value)
Measured value representation	two's complement (left-justified)
Conversion time (0 to 100%)	max. 0.15 ms
Permissible overload	25%
Open-circuit voltage	± 12 V
Permissible voltage difference to central ground point and between outputs	max. 75 V DC/60 V AC
Basic error limits (operational error limits at 25°C, referred to output range)	±0.2%
Operating error limits (0 to 60 °C, referred to output range) (32 to 140 °F)	±0.6%
Length of cable - shielded	max. 200 m (660 ft.)
Supply voltage L+ - rated value	24 V DC
- ripple V _{PP}	3.6 V
- permissible range (ripple included)	20 to 30 V
Rated insulation voltage (+9 V to ⚬)	12 V AC
- insulation group	1 x B
- tested with	500 V AC
Rated insulation voltage (outputs to L+, between outputs, output to + 9 V)	60 V AC
- insulation group	1 x B
- tested with	500 V AC
Current consumption - from + 9 V (CPU)	typ. 120 mA
- from L+	typ. 130 mA
Power loss of the module	typ. 3.8 W
Weight	approx. 220 g (10 oz.)

Legend:
QI: Analog output "current"

Connection of the Module

Figure 15-21 shows how to connect loads to the current outputs of the module.

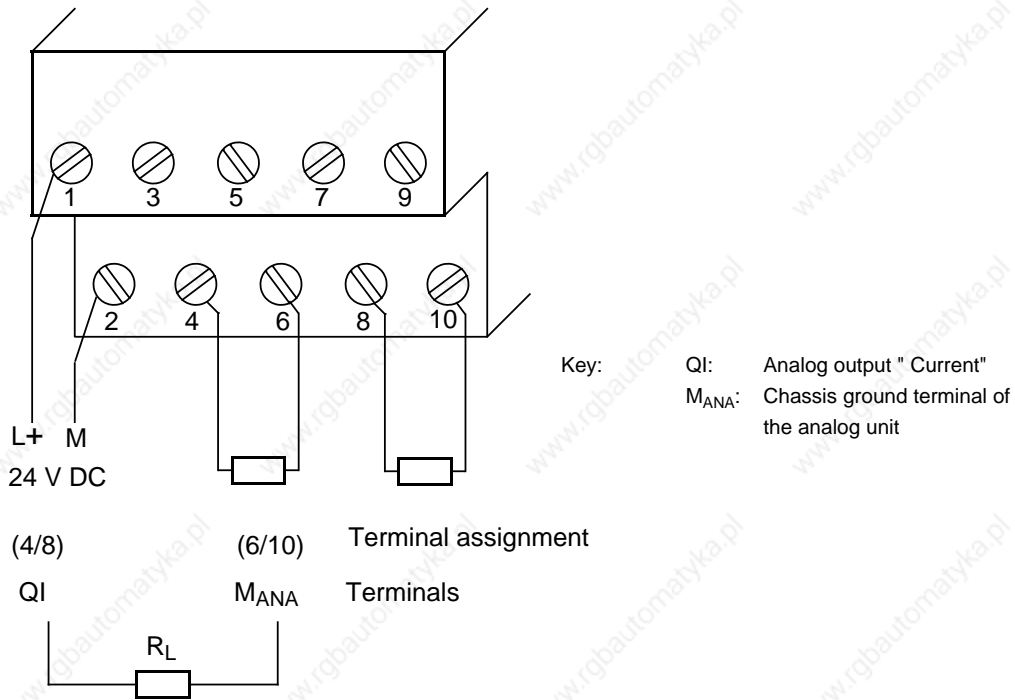

Figure 15-21. Connection via a Two-Wire Circuit (6ES5 470-8MC12)

Analog Value Representation

Table 15-36. Analog Output Module 470-8MC12 (Unipolar)

Units	Output Values in mA	High Byte	Low Byte	Range
1280	24.0	0 1 0 1 0 0 0 0	0 0 0 0 x x x x	Overrange
1025	20.016	0 1 0 0 0 0 0 0	0 0 0 1 x x x x	
1024	20.0	0 1 0 0 0 0 0 0	0 0 0 0 x x x x	Nominal range
512	12.0	0 0 1 0 0 0 0 0	0 0 0 0 x x x x	
1	4.016	0 0 0 0 0 0 0 0	0 0 0 1 x x x x	
0	4.0	0 0 0 0 0 0 0 0	0 0 0 0 x x x x	
- 1	3.984	1 1 1 1 1 1 1 1	1 1 1 1 x x x x	Overrange
- 256	0.0	1 1 1 1 0 0 0 0	0 0 0 0 x x x x	
- 512	- 4.0	1 1 0 0 0 0 0 0	0 0 0 0 x x x x	
- 1024	- 12.0	1 1 0 0 0 0 0 0	0 0 0 0 x x x x	
- 1280	- 16.0	1 0 1 1 0 0 0 0	0 0 0 0 x x x x	

Analog Output Module 2 x 1 to 5 V

(6ES5 470-8MD12)

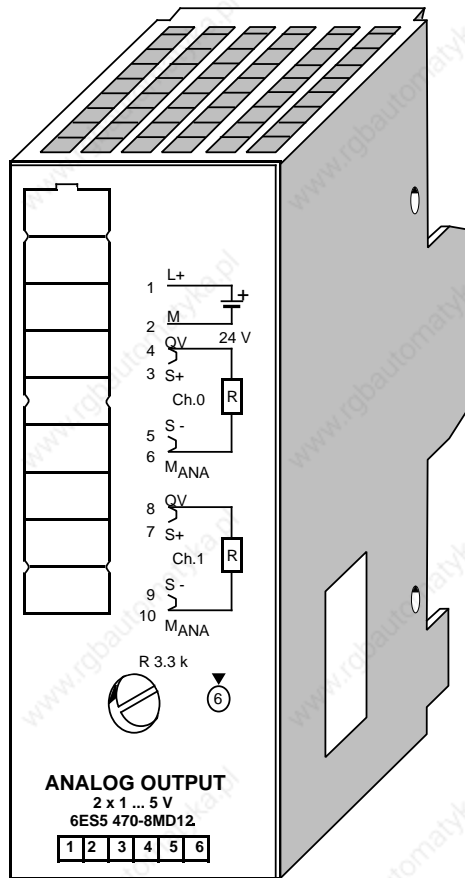

Technical specifications

Output range (rated value)	1 to 5 V
Number of outputs	2
Galvanic isolation	yes (outputs to grounding point and between outputs)
Load resistance	min. 3.3 k
Connection method	two- or four-wire connection
Digital representation of output signal	11 bits + sign (1024 units=rated value)
Measured value representation	two's complement (left-justified)
Conversion time (0 to 100%)	max. 0.15 ms
Permissible overload	25%
Short-circuit protection	yes
Short-circuit current	±30 mA
Permissible voltage difference to central ground point and between outputs	max. 75 V DC/60 V AC
Basic error limits (operational error limits at 25°C, referred to output range)	±0.2%
Operating error limits (0 to 60 °C, referred to output range) (32 to 140 °F)	±0.6%
Length of cable - shielded	max. 200 m (660 ft.)
Supply voltage L+ - rated value	24 V DC
- ripple V_{PP}	3.6 V
- permissible range (ripple included)	20 to 30 V
Insulation rating	VDE 0160
Rated insulation voltage (+9 V to \rightarrow)	12 V AC
- insulation group	1 x B
- tested with	500 V AC
Rated insulation voltage (outputs to L+, between outputs, output to +9 V)	60 V AC
- insulation group	1 x B
- tested with	500 V AC
Current consumption - from +9 V (CPU)	typ. 120 mA
- from L+	typ. 100 mA
Power loss of the module	typ. 3.1 W
Weight	approx. 220 g (10 oz.)

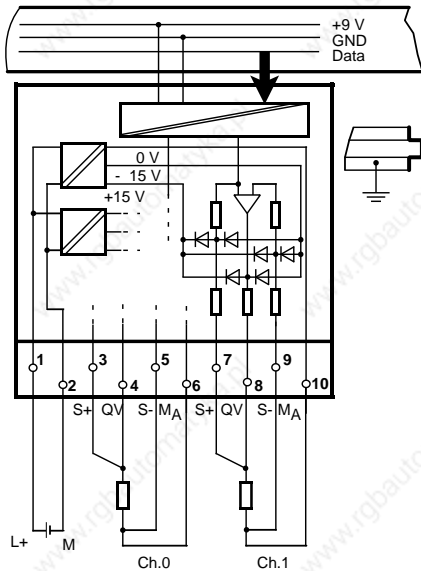

Connection of the Module

Figure 15-22 shows how to connect loads to the voltage outputs of the module.

The sensor lines (S+ and S-) must be directly connected to the load, so that the voltage is measured and regulated directly at the load. In this manner, voltage drops of up to 3 V per line can be compensated for.

The sensor lines can be left out if the resistances of the QV and M lines are negligible compared to the load resistance. In such a case, connect terminal S + to terminal QV, and terminal S to M_{ANA}.

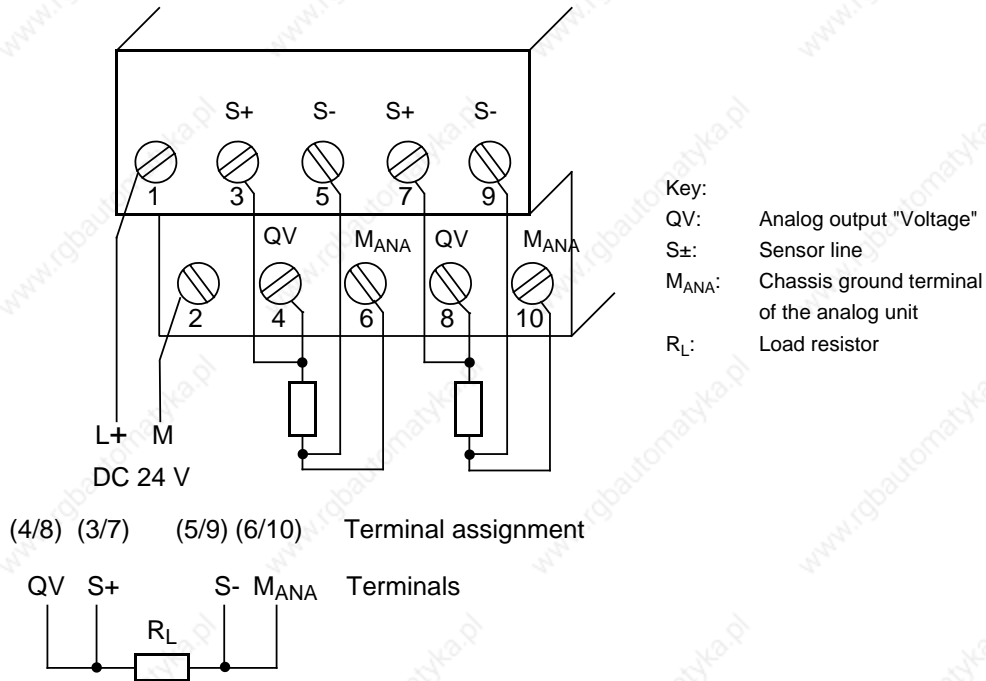

Figure 15-22. Load Connection via a Four-Wire Circuit (6ES5 470-8MD12)

Analog Value Representation

Table 15-37. Analog Output Module 470-8MD12 (Unipolar)

Units	Output Values in V	High Byte	Low Byte	Range
1280	6.0	0 1 0 1 0 0 0 0	0 0 0 0 x x x x	Overrange
1025	5.004	0 1 0 0 0 0 0 0	0 0 0 1 x x x x	
1024	5.0	0 1 0 0 0 0 0 0	0 0 0 0 x x x x	Nominal range
512	3.0	0 0 1 0 0 0 0 0	0 0 0 0 x x x x	
1	1.004	0 0 0 0 0 0 0 0	0 0 0 1 x x x x	
0	1.0	0 0 0 0 0 0 0 0	0 0 0 0 x x x x	Overrange
- 1	- 0.996	1 1 1 1 1 1 1 1	1 1 1 1 x x x x	
- 256	0.0	1 1 1 1 0 0 0 0	0 0 0 0 x x x x	
- 512	- 1.0	1 1 0 0 0 0 0 0	0 0 0 0 x x x x	
- 1024	- 3.0	1 1 0 0 0 0 0 0	0 0 0 0 x x x x	
- 1280	- 4.0	1 0 1 1 0 0 0 0	0 0 0 0 x x x x	

16 Function Modules		
16.1	Comparator Module	16-1
16.2	Timer Module	16-4
16.3	Simulator and Simulator Module	16-7
16.3.1	Simulator only for the S5-90U	16-7
16.3.2	Simulator Module	16-8
16.4	Diagnostic Module	16-10
16.5	Counter Module 2x0 to 500 Hz	16-13
16.6	Counter Module 25/500 kHz	16-18
16.6.1	Installation Guidelines	16-21
16.6.2	Data Transfer	16-26
16.6.3	Functional Description of the Counter Mode	16-28
16.6.4	Functional Description of the Position Decoder	16-30
16.6.5	Entering New Setpoints for the Counter and Position Decoder	16-39
16.6.6	Addressing	16-40
16.7	IP 262 Closed-Loop Control Module	16-42
16.8	IP 263 Positioning Module	16-46
16.9	IP 264 Electronic Cam Controller Module	16-50
16.10	IP 265 High Speed Sub Control	16-53
16.11	IP 266 Positioning Module	16-53
16.12	IP 267 Stepper Motor Control Module	16-56
16.13	CP 521 SI Communications Processor	16-63
16.14	CP 521 BASIC Communications Module	16-66

Figures

16-1	Scanning the Comparator Module	16-2
16-2	Scanning the Timer Module	16-5
16-3	Installing and Removing a Simulator on a Programmable Controller	16-7
16-4	Scanning the Simulator Module as a Digital Input	16-9
16-5	Setting the Input Voltage Range on the Counter Module (500 Hz)	16-15
16-6	Scanning the Counter Module (500 Hz)	16-16
16-7	Timing Diagram: Setting and Resetting an Output of the Counter Module (500 Hz)	16-16
16-8	Switch Positions on the Operating Mode Switch	16-20
16-9	Pin Assignment of the 15-Pin Sub-D Female Connector	16-21
16-10	Connecting a Counting Pulse Sensor for 5-V Differential Signal to RS 422 ..	16-22
16-11	Connecting a Counting Pulse Sensor for 24 V DC	16-22
16-12	Connecting a 5-V Position Sensor to RS 422	16-23
16-13	Connecting a 24 V DC Position Sensor	16-23
16-14	Signal Sequence for Up-Counting	16-24
16-15	Assignment Diagram for the Terminal Block	16-25
16-16	Diagnostic Byte	16-27
16-17	Switching the Outputs Dependent on the Status of the Counter and the Enable Input	16-29
16-18	Position of the Reference Point (SYNC Bit = 1) within the Reference Signal Range	16-33
16-19	Position of the Reference Point (SYNC Bit = 1) after the Reference Signal	16-33
16-20	Position of the Reference Point (SYNC = 1) during a Reversal of Direction before Reaching the Reference Pulse in a Positive Direction	16-34
16-21	Schematic of a Reference Point Approach Operation	16-34
16-22	Enabling the Outputs - Reaching the Setpoints - Resetting the Outputs ..	16-35
16-23	Approaching a Setpoint in Up-Count Direction	16-36
16-24	Approaching a Setpoint in Down-Count Direction	16-37
16-25	Approaching a Setpoint in Up-Count Direction and Consecutive Reversal of Direction	16-37
16-26	Requirement for New Setpoints	16-39
16-27	Positioning with the IP 263	16-49
16-28	Processed Units of Measurement for Circular Axis and Linear Axis	16-57
16-29	Course of a Following Error during a Positioning Operation	16-58
16-30	Velocity Profile of the IP 267	16-61

Tables

16-1	Sending Data from the Programmable Controller to the Counter Module ...	16-26
16-2	Sending Data from the Counter Module to the Programmable Controller ..	16-26
16-3	Pulse Evaluation	16-31
16-4	Example for a Traversing Range	16-32
16-5	Reaction of the Counter Module during Transfer of the Setpoints	16-39
16-6	Slot Addressing	16-40
16-7	Meaning of the Address Bytes of a Slot Address (Example: Slot 1)	16-40
16-8	Designation of the Operating Modes	16-59

16 Function Modules

16.1 Comparator Module 2x0.5 to 20 mA/0.5 to 10 V (6ES5 461-8MA11)

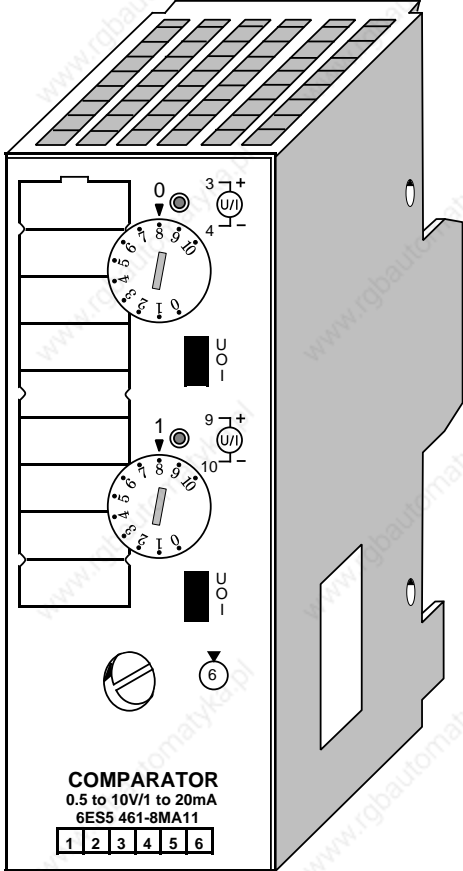

COMPARATOR
0.5 to 10V/1 to 20mA
6ES5 461-8MA11

1 2 3 4 5 6

Technical Specifications

Channels	2
Galvanic isolation	yes
Current or voltage measurement	switch-selectable
Switch position "0"	no measuring
Display	green LED for actual value setpoint
Setpoint adjustment	with potentiometer
Setting error	±10 %
Reproducibility	±2 %
Hysteresis	10 %
"V" measuring range	0.5 to 10 V DC
Input resistance	47 k
Inherent delay	typ. 5 ms
Input voltage	max. 100 V DC (0.5 s)
"I" measuring range	0.5 to 20 mA
Input resistance	500
Overload capability	100 %
Rated insulation voltage (+9 V to measuring circuit and between measuring circuits)	30 V AC
- insulation	2xB
- tested with	500 V AC
Rated insulation voltage (+9 V to GND)	12 V AC
- insulation group	1xB
- tested with	500 V AC
Length of cable - shielded	200 m (660 ft.)
- unshielded	100 m (330 ft.)
Current consumption - from +9 V (CPU)	typ. 35 mA
Power losses of the module	typ. 0.3 W
Weight	approx. 200 g (7oz.)

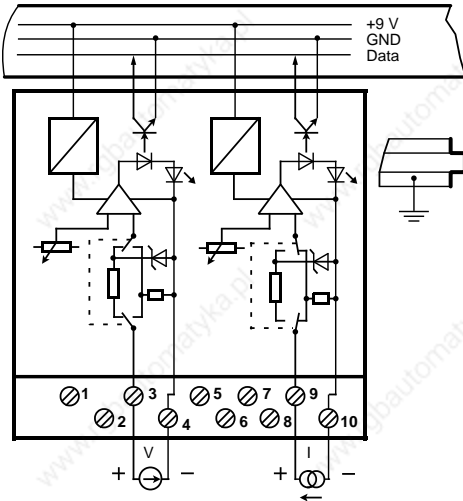

+9 V
GND
Data

Function

The module has two isolated comparators for voltage or current measurement (selector switch with positions U/I). When the preset value is reached, the LED of the respective channel lights up and sends a "1" signal to the programmable controller.

The module must be removed or the measuring circuit disconnected before you select the function.

In switch position "0", the comparator is switched off; if scanned, a "0" signal results.

The response threshold of the comparator is set by a selector on the front panel. The selector has scale divisions to simplify adjustment.

Installation

The comparator module is mounted on a bus unit like any other input or output module (see Chapter 3).

Wiring

See schematic diagram. Unused inputs can be left open.

Addressing

The comparator module is addressed like as a 2-channel digital input module (channel "0" or "1").

Scan	A	I	x . 0	Channel "0"
(examples)	O	I	x . 1	Channel "1"
			Channel number	
			Slot address	

Figure 16-1. Scanning the Comparator Module

Typical Application

A comparator module is mounted at slot 4. The current source is connected to channel 1. If the Schmitt trigger 1 detects that the current has exceeded the preset value, a switch (output 5.1) is to be operated.

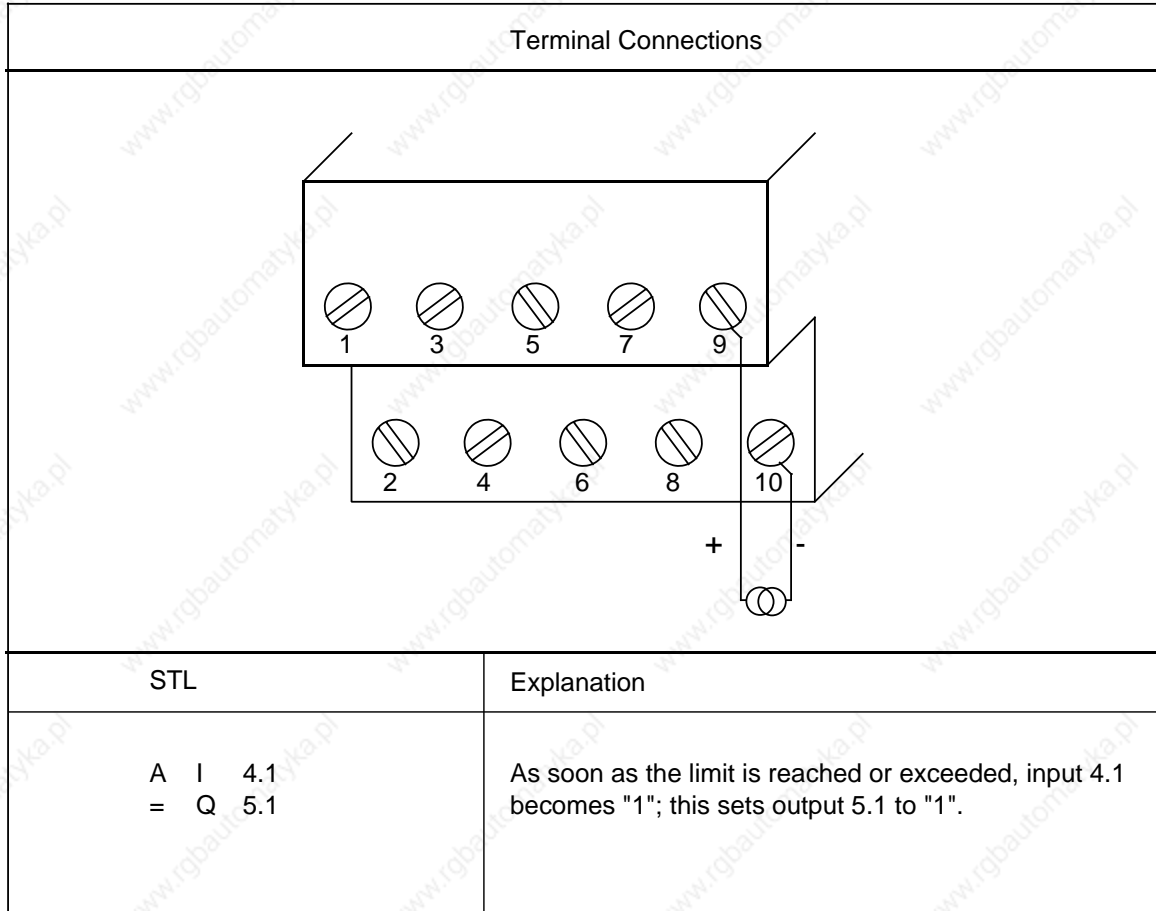

16.2 Timer Module 2x0.3 to 300 s

(6ES5 380-8MA11)

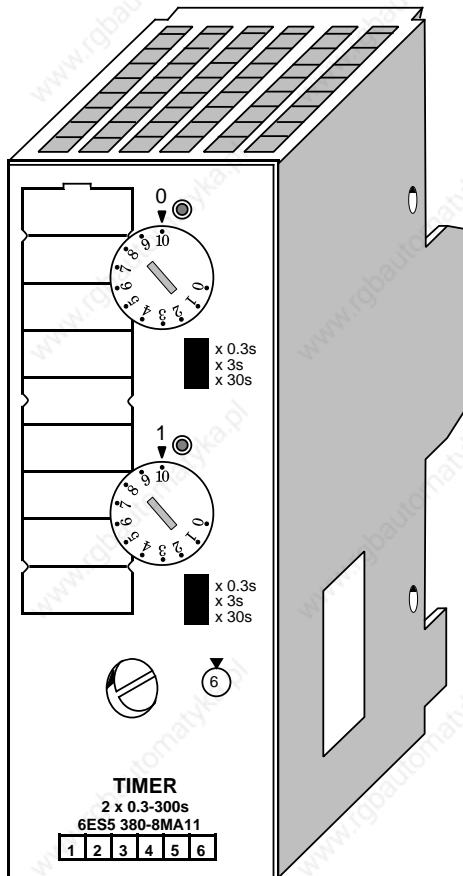

Technical Specifications

Number of timers	2
Time setting	0.3 to 3 s
Range extension factor	x10, x100
Function display	green LED
Setting error	±10 %
Reproducibility	±3%
Temperature influence	+1 %/10° C (50° F) from set time
Rated insulation voltage (+ 9V to →)	12 V AC
- insulation group	1xB
- tested with	500 V AC
Current consumption - from +9 V (CPU)	typ. 10 mA
Weight	approx. 200 g (7 oz.)

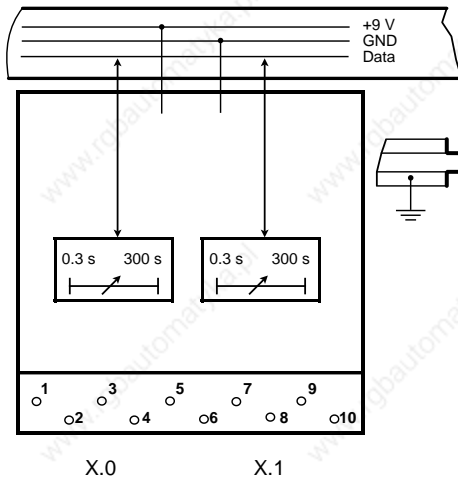

Function

The module contains two pulse timers. As long as the timer is running, the LED of the respective channel is lit; a "1" is reported to the CPU.

The pulse duration is preselected with the time range selector "x 0.3s / x 3s / x 30s" in a definite range and then set to the exact value by means of a potentiometer on the front panel. This selector has scale divisions to simplify setting.
(time value=time range x scale value)

Example: Time range: x 3s
 Scale value: 7
 Set time: 7 x 3s=21s

Installation

The counter is inserted into a bus unit like any other input or output module (see Chapter 3.2.1).

Wiring

No wiring is required.

Addressing

A timer module is addressed like a two-channel digital module (channel "0" or "1").

The timer module is addressed like a digital output module for starting, resetting, or interrupting the pulse. The signal status is scanned like a digital input module.

Starting the pulse	S	Q	x . 0	Channel "0"
	S	Q	x . 1	Channel "1"
Interrupt/ Reset	R	Q	x . 0	
	R	Q	x . 1	
Scan "1" = timer running	A	I	x . 0	
	A	I	x . 1	
				Channel number
				Slot address

Figure 16-2. Scanning the Timer Module

Typical Application as "On-Delay Timer"

A timer module is mounted at slot 5. A time of 270 s is set on channel "0" of this module by means of the time-range selector and the potentiometer. The timer is started when input 0.0 is "1". A lamp lights up (output 4.0) when the timer has run down.

Terminal Connections	
<p>No process peripherals are connected to this module. Unlike the internal timers, times can be set or modified using a timer module without making any program modifications.</p>	
STL	Explanation
A I 0.0 AN I 5.0 A F 65.0 S Q 4.0 A I 5.0 = F 65.0 AN I 0.0 R Q 4.0 A I 0.0 = Q 5.0	<p>The timer must not be scanned in the program scan cycle in which it was enabled since the CPU would not receive the acknowledgement that the timer had started until one program scan later.</p> <p>If flag 65.0 is "1" and the timer has run down (AN I 5.0), output 4.0 is set to "1".</p> <p>If the "Timer started" message has been sent to the CPU, the flag is set.</p> <p>If I 0.0 is "0", the lamp is switched off.</p> <p>The timer is started if I 0.0 is "1".</p>

16.3 Simulator and Simulator Module

16.3.1 Simulator only for the S5-90U

(6ES5 788-8MK11)

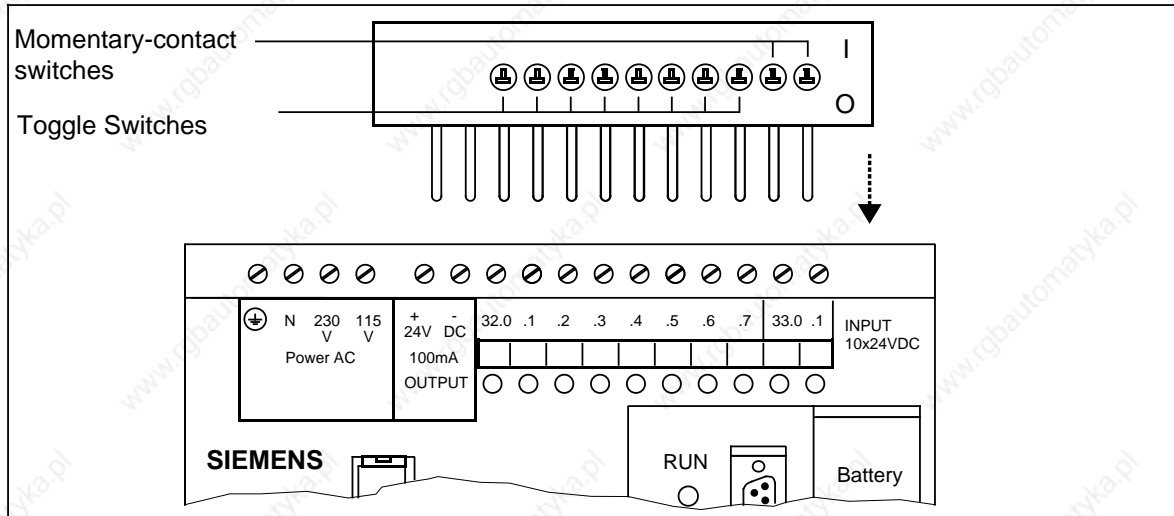

Figure 16-3. Installing and Removing a Simulator on a Programmable Controller

Function

To simulate input signals on the 10 digital inputs, insert a simulator (see Appendix C).

There are eight toggle switches for digital inputs 32.0 to 32.7 and two momentary-contact switches for interrupt input 33.0 and counter input 33.1.

Installation



Warning

Disconnect the power supply before you install or remove a module!

Unplug the power supply: the programmable controller is de-energized.

Plug the simulator into the programmable controller as illustrated in Figure 14-3.

Screw the simulator contacts to the connection terminals of the programmable controller.

Turn a switch to ON to input a "1" signal. The respective LED lights up.

16.3.2 Simulator Module

(6ES5 788-8MA11)

Technical Specifications

Function selection - simulation of 8 input signals - display of 8 output signals	selected by switch on rear of module
Function display "0"/"1" input signals	yellow LED switch-selectable
Rated insulation voltage (+9 V to → - insulation group - tested with	12 V AC 1xB 500 V AC
Signal status display for input/output	green LEDs
Current consumption - from +9 V (CPU)	30 mA
Power loss of the module	typ. 0.3 W
Weight	190 g (6.7 oz.)

Function

Simulator modules are 8-channel modules that can simulate digital input signals and display output signals.

The type of module to be simulated (input or output) is selected by means of a switch on the rear of the module and displayed by two LEDs on the front panel.

The module cannot simulate interrupt inputs.

Installation

The simulator module is inserted into a bus unit like any other input or output module (see Chapter 3). The module does not have a coding key and can therefore replace any digital module. The coding element on the bus unit does not have to be readjusted.

Wiring

There is no electrical connection between the module and the terminal block. It can therefore be inserted into slots that have already been wired and connected to the power supply.

Addressing

A simulator module is addressed like a 8-channel digital module (channels 0 to 7).

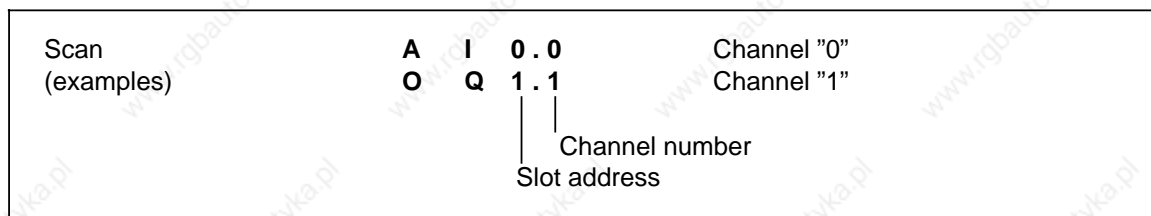

Figure 16-4. Scanning the Simulator Module as a Digital Input

Typical Application

The CPU is in the "RUN" mode, the green LED is lit but the PLC is malfunctioning. You have also discovered that the fault must be in a particular I/O module. If the module has no fault indicator, check to see if:

- the power supply is connected
- the bus connections and interface modules are plugged in correctly

Then, try to access the module via the process image ("STATUS" or "STATUS VAR"). If this procedure is not successful, replace the module with the simulator module. Perform a second check with the "STATUS" or "STATUS VAR" function. If the simulator performs, the input/output module you replaced is defective.

16.4 Diagnostic Module

(6ES5 330-8MA11)

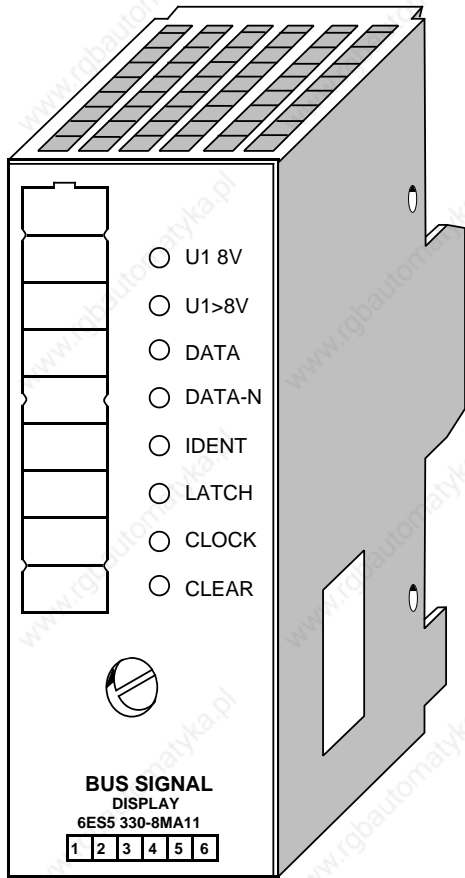

Technical Specifications

Rated insulation voltage (+9 V to \rightarrow)	12 V AC
- insulation group	1xB
- tested with	500 V AC
Voltage monitor	
- undervoltage	red LED
- voltage ok	green LED
Signal status display for control signals	yellow LEDs
Current consumption	
- from +9 V (CPU)	25 mA
Power loss of the module	typ. 0.3 W
Weight	approx. 175 g (6.1 oz.)

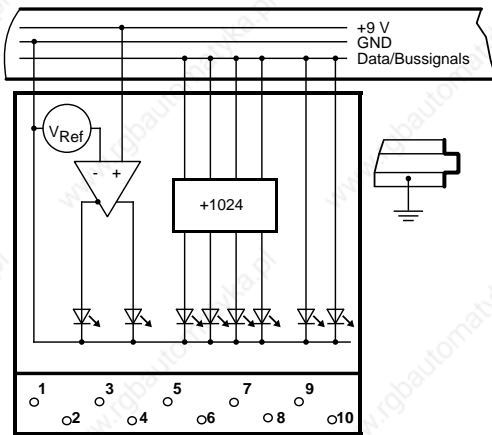

Function

The diagnostic module is used for monitoring the S5-100U I/O bus. LEDs on the front panel display the signal states of the control lines and the supply voltage for the I/O bus.

- **IDENT**
The programmable controller executes an IDENT run after each change from "STOP" to "RUN" mode and after any changes in the configuration in order to determine the current configuration of the programmable controller. The "IDENT" LED lights up briefly. If the LED lights up in the "RUN" mode, this indicates that a faulty I/O module has been plugged in.
- **CLEAR**
The CLEAR signal line is only "1" in the "STOP" mode in normal operation.
The outputs of the output modules are disabled.
If CLEAR is "1" in the "RUN" mode, the control line itself may be defective (no contact).
- **LATCH/CLOCK**
These two control lines control data interchange between the CPU, the I/O bus, and the I/O modules.
During normal operation, both LEDs must flash (programmable controller in "RUN" mode).
The flashing frequency provides information on the speed of the serial bus.
If both LEDs show a steady light in the "RUN" mode, the bus unit that the diagnostic module is plugged into is defective.
- **DATA/DATA-N**
The alternate lighting up of the "DATA" and "DATA-N" LEDs indicates data flow on the I/O bus.
If these two LEDs show a steady light (as in the case of the "LATCH" and "CLOCK" LEDs), this indicates that the bus unit that the diagnostic module is plugged into is defective.
- **U1 8V**
If the supply voltage of a slot remains at a value U1 8V, proper functioning of the I/O modules is no longer guaranteed. The low supply voltage can be explained by an excessively high bus load (> 1 A).
If this LED flickers, noise pulses are superimposed on the supply voltage U1 (e.g., by the coupling of noise pulses).
The LED lights up briefly if the programmable controller is switched on or off.
- **U1 > 8V**
The supply voltage of the I/O bus is O.K.

Installation

The diagnostic module is plugged into a bus unit like any other input or output module (see Chapter 3). The module has no mechanical coding and the coding element on the bus unit does not have to be reset.

Note

The module can be plugged in and removed regardless of the operating status of the programmable controller.

Wiring

No wiring is required. Existing wiring does not have to be removed.

Addressing

There is no addressing since the module cannot be addressed by the programmable controller.

16.5 Counter Module 2x0 to 500 Hz

(6ES5 385-8MA11)

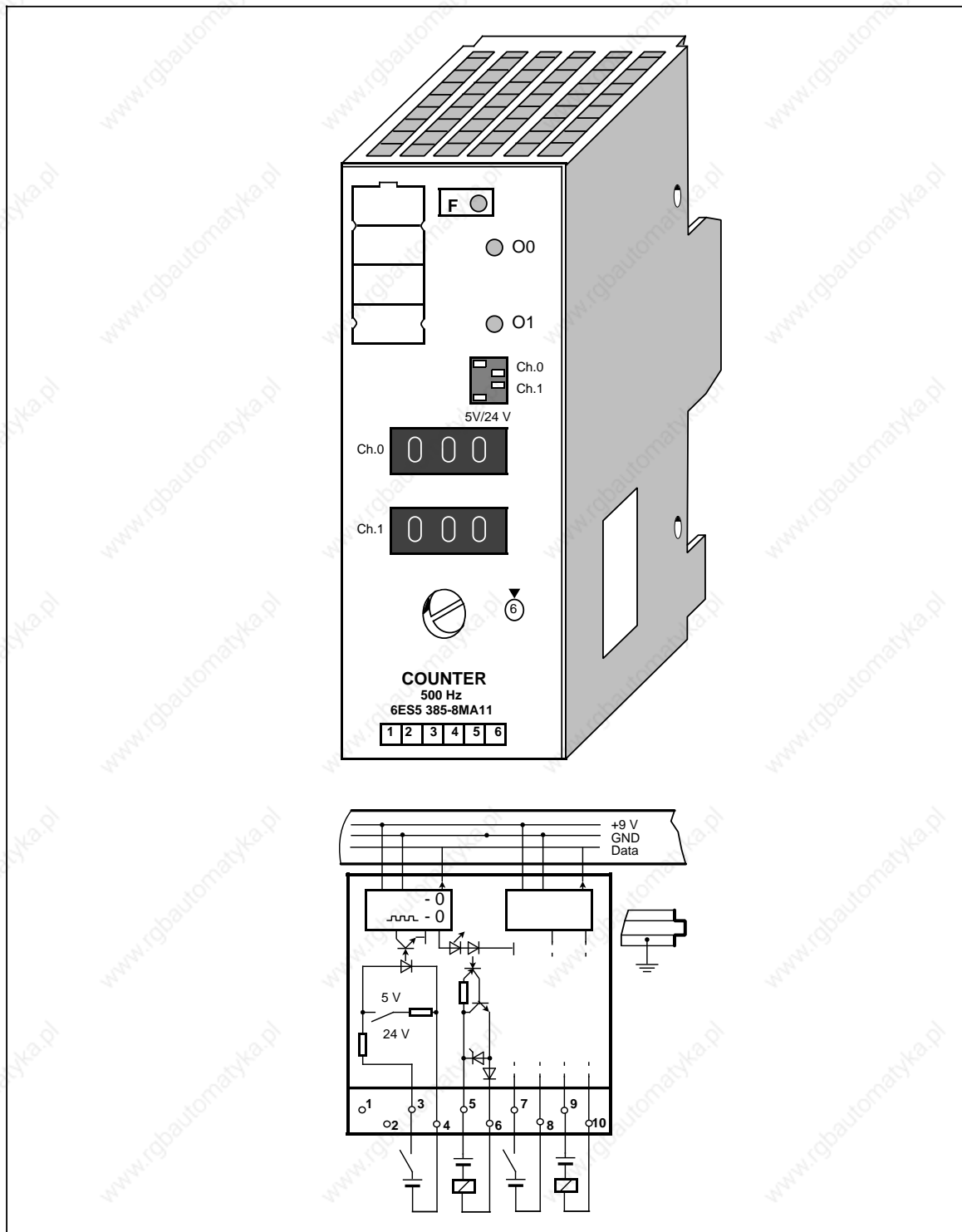

Technical Specifications			
Number of Inputs	2	Total permissible current of outputs	1 A
Galvanic isolation	yes	Driving a digital input	possible
Input voltage		Paralleling of outputs	possible
- rated value	5 V/24 V DC	- max. current	0.5 A
- for "0" signal	0 to 0.8/-33 to 5 V	Length of cable	
- for "1" signal	3 to 5 V/13 to 33 V	- unshielded	max. 100 m (330 ft.)
Input current for "1" signal	typ. 1.5/8.5 mA	Rated insulation voltage (inputs and outputs to each other and to \pm ; input to +9 V)	60 V AC
Inherent delay	typ. 180 μ s	- insulation group	1xB
Input frequency	max. 500 Hz	- tested with	1250 V AC
Connection of 2-wire BERO proximity switches (24 V DC)	possible	Current consumption - from +9 V (CPU)	typ. 20 mA
- quiescent current	1.5 mA	Power loss of the module	typ. 2.5 W
Length of cable - unshielded	max. 30/50 m (99ft./165 ft.)	Weight	approx. 200 g (7 oz.)
Number of Outputs	2		
Galvanic isolation	yes		
Supply voltage L+ (for load)			
- rated value	24 V DC		
- permissible range (including ripple)	20 to 30 V		
Output current for "1" signal			
- rated value	0.5 A		
- permissible range	0.5 to 500 mA		
- lamp load	max. 5 W		
Residual current at "0" signal	max. 1 mA		
Output voltage - for "0" signal	max. 3 V		
- for "1" signal	max. L+-2.5 V		
Short-circuit protection	electronic		
Fault indication (red LED)	short-circuit		
Voltage induced on circuit interruption (internal) limited to	L+-47 V		
Switching frequency - resistive load	max. 100 Hz		
- inductive load	max. 2 Hz		

Function

The module consists of two independent down counters with isolated inputs and outputs. It counts input signals up to a frequency of 500 Hz from a set value down to the value "0". When zero is reached, the 24-V DC output of the module is energized.

At the same time, a green LED on the module lights up and the input signal (I x.0 or I x.1) is set to "1".

The setpoint (0 to 999) can be entered via the three-digit thumbwheel switches on the front panel of the module.

The input voltage ranges can be set for 5 V DC or 24 V DC on rocker switches on the front panel.

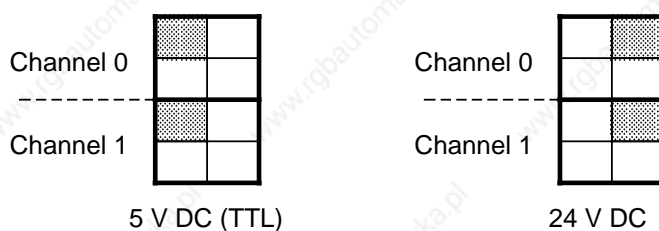

Figure 16-5. Setting the Input Voltage Range on the Counter Module (500 Hz)

Installation

The counter module is plugged into a bus unit like any other module (see Chapter 3).

Wiring

See schematic diagram.

Addressing

A counter module can be addressed like a two-channel digital module (channel "0" or "1"). For enabling and resetting the counter, you address the module like a digital output module. The counter reading is scanned in the same way as a digital input module.

Counter enable	S	Q	x . 0	Channel "0"
(Set to start value)	S	Q	x . 1	Channel "1"
Counter reset	R	Q	x . 0	
	R	Q	x . 1	
Scan	A	I	x . 0	
"1" = Counter at zero	A	I	x . 1	
				Channel number
				Slot address

Figure 16-6. Scanning the Counter Module (500 Hz)

Timing Diagram

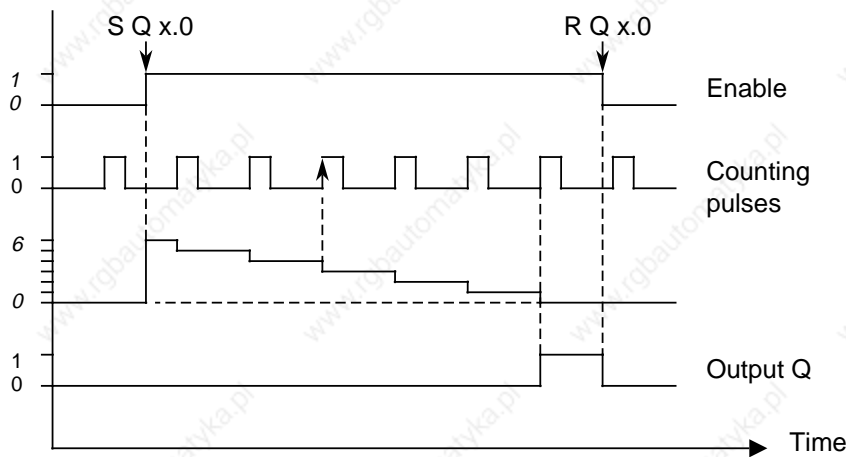
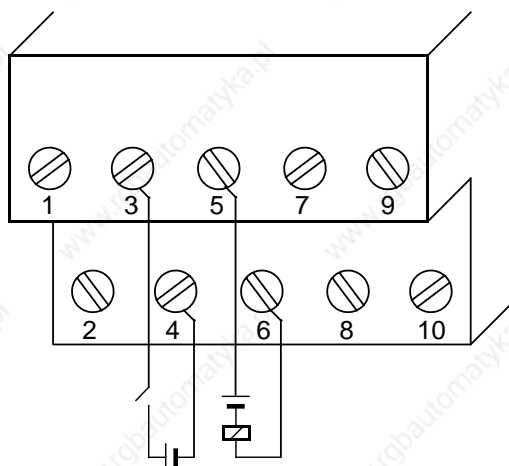
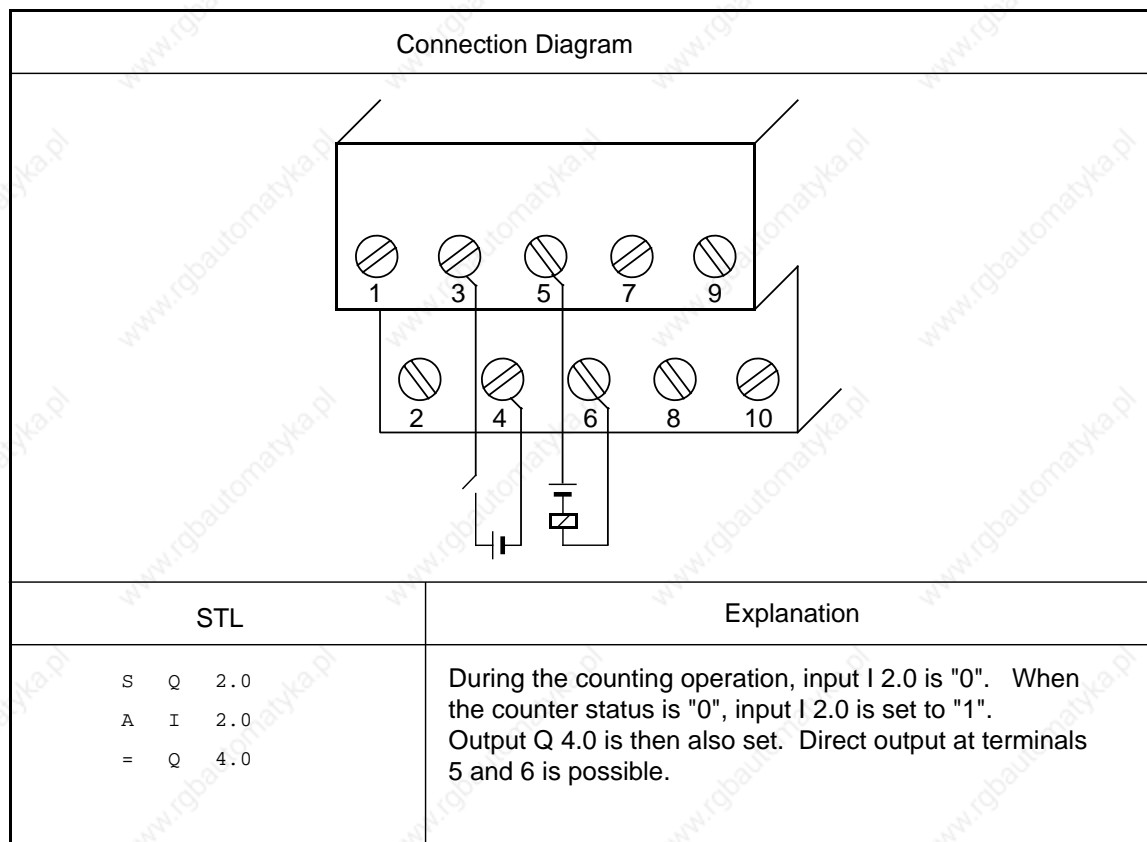

Figure 16-7. Timing Diagram: Setting and Resetting an Output of the Counter Module (500 Hz)

Typical Application

A counter module is plugged into slot 2. A value of 100 is set on channel "0" of this module via the three-digit thumbwheel switches. The incoming pulses are counted once the counter has been enabled by the control program. As soon as 100 pulses have been counted, a signal (output 4.0) is released.



16.6 Counter Module 25/500 kHz

(6ES5 385-8MB11)

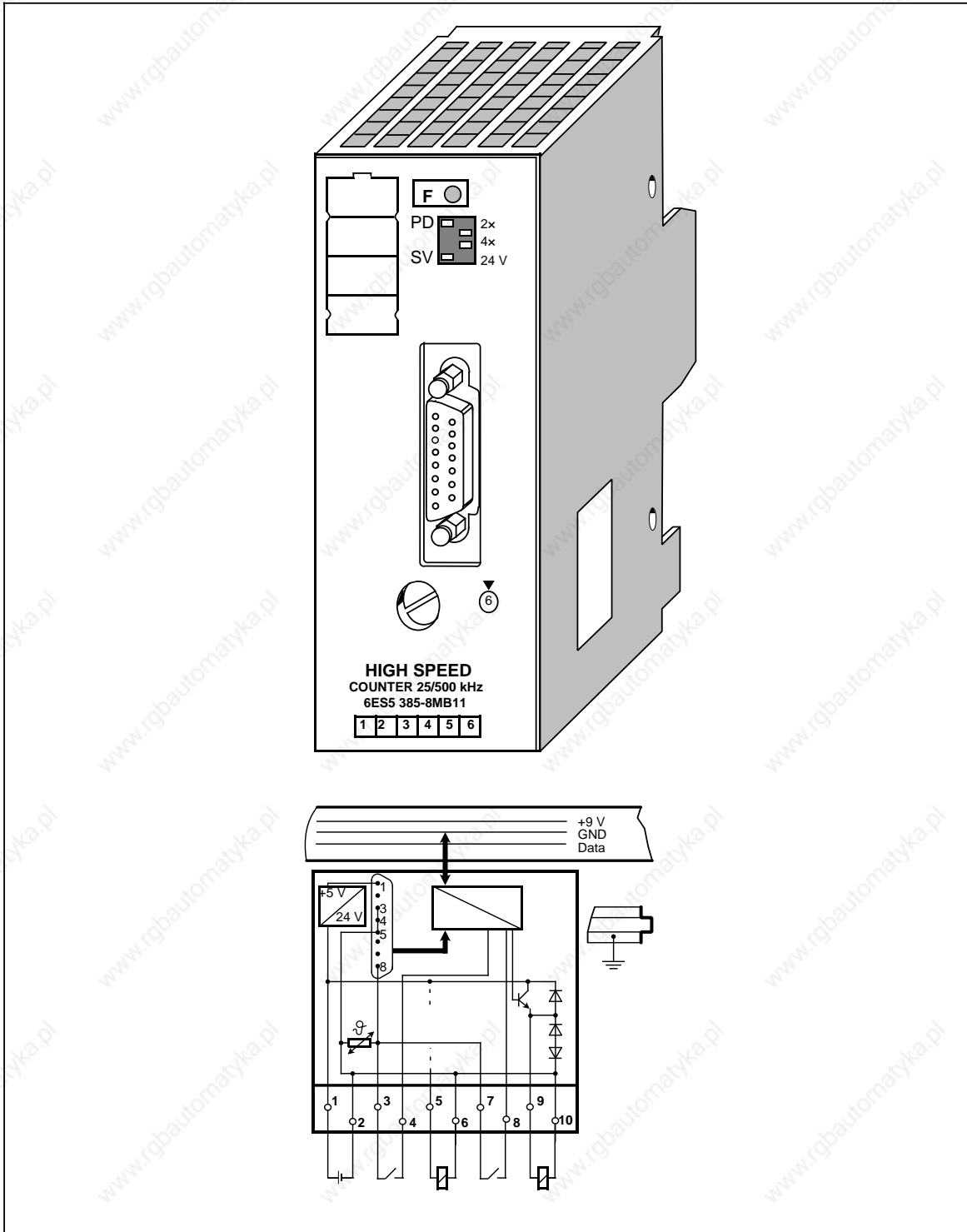

Technical Specifications			
Operating mode (switch-selectable)		Power supply for decoder	24 V from L+ (PTC thermistor)
- position decoder	PD	Output current	max. 300 mA, short-circuit-proof
- counter	C		
Decoder inputs	1 decoder 5 V (differential input) or 1 decoder 24 V DC	Digital Inputs	reference and enabling
Digital inputs	2; reference and enabling	Rated input voltage	24 V DC
Digital outputs	2; setpoints reached 1 and 2	Input voltage	
Galvanic isolation	no	- "0" signal	- 33 to +5 V DC
Counting range		- "1" signal	+13 to 33 V DC
Operating mode - position decoder	two's complement (KF) - 32768 to +32767	Rated input current for "1" signal and at 24 V	typ. 8.5 mA
- counter	unipolar representation (KH) 0 to 65535	Input frequency	max. 100 Hz
Counting mode - position decoder	forwards/backwards up	Inherent delay	typ. 3 ms (1.4 to 5 ms)
- counter	via program	Cable length (unshielded)	max. 100 m (330 ft.)
Setpoint input		Short-circuit protection (cable impedance up to 15)	
5-V Decoder Input	15-pin Cannon sub-miniature D connector	Digital Outputs	setpoints 1 and 2
Input signals	differential signals to RS 422	Output current (resistive, inductive load)	5 mA to 0.5 A
- position decoder	A A-N, B B-N, R R-N	Residual current for "0" signal	max. 0.5 mA
- counter	A A-N	Switching current for lamps	0.22 A (5 W)
Counting frequency	max. 500 kHz	Limitation of inductive interrupting voltage	to -15 V
Cable length (shielded)	max. 50 m (165 ft.)	Output voltage	
Power supply for decoder	5 V from L+ via voltage transformer	- "1" signal	min. L+ - 2.2 V
Output current	max. 300 mA, short-circuit-proof	- "0" signal	max. 3 V
24-V Decoder Input	15-pin Cannon sub-miniature D connector	Cable length (unshielded)	max. 100 m (330 ft.)
Rated input voltage	24 V DC	Short-circuit protection (cable impedance up to 15)	electronic
Input signals - position decoder	A, B, R	Short-circuit indication (short-circuit to M)	red LED
- counter	A	Supply voltage L+	
Input voltage		- rated value	max. 24 V DC
- "0" signal	- 33 to 5 V DC	- ripple V_{pp}	3.6 V
- "1" signal	+13 to 33 V DC	- permissible range (including ripple)	20 to 30 V DC
Rated input current for "1" signal	typ. 8.5 mA	Fuse (internal)	T 5 A
Counting frequency	max. 25 kHz	Current consumption	
Cable length (shielded)	max. 100 m (330 ft.)	- from L+ without decoder supply	30 mA
		- without load	
		- internal (+9 V)	70 mA
		Power consumption of the module	typ. 1.9 W+total output current (I_A)×1.1 V
		Weight	approx. 250 g (9 oz.)

Function

The counter module can be used as an up-counter or as an up/down counter for a position decoder. The counting pulses are supplied by a sensor that you can connect to the 15-pin subminiature D female connector of the module. You can choose from two types of sensors that fulfill the following requirements.

- 5-V error voltages according to RS 422 (up to 500 kHz)
- 24-V signals (up to 25 kHz)

As additional inputs, the module has an enable input and a reference input connected to terminals on the 10-terminal strip that is on the bottom of the bus unit.

By using the STEP 5 program, you can assign two setpoints via the I/O bus. These setpoints are output to channels 0 and 1 in the I/O slot for the module. Once the counter status reaches one of these values, the respective output completes the circuit at terminal block (Q0 or Q1). The status of the outputs is displayed in the diagnostic byte in status bits S1 and S2.

You can also read the following values by using the STEP 5 program.

- The updated count (load IW channel 1 and 2)
- The diagnostic byte (load IW channel 0 high byte)

You can preselect the following items on the operating mode switch.

- Function mode (counter/position decoder)
- Position resolution (X1, X2, or X4)
- Input voltage range of the sensor (5 V DC or 24 V DC)

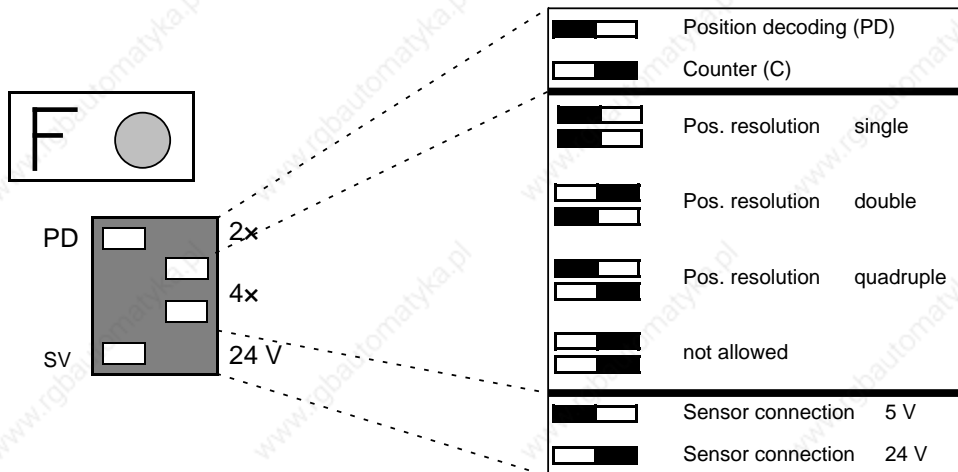

Figure 16-8. Switch Positions on the Operating Mode Switch

16.6.1 Installation Guidelines

Installing and Removing the Module

The counter module is plugged into a bus unit like other I/Os.
The counter module can only be plugged into slots 0 through 7.
Set the coding key to number 6 on the bus unit.

Installing or Removing the Sensor

Disconnect the 24-V DC power supply (terminals 1 and 2 of the terminal block) before connecting or disconnecting the transducer cables.



Warning

Connecting or disconnecting the 5-V transducer cable while the module is energized can cause damage to the sensor.

Connection of Pulse and Position Sensors

Connect pulse and position sensors on the front plate by means of a 15-pin sub-D female connector. The correct cable connectors are listed in Appendix D. The module can supply the sensors (5 V DC or 24 V DC).

Basically, all sensors can be connected if they fulfill the requirements of the system signals and supply voltage. Sensors with OPEN-COLLECTOR outputs cannot be connected to the module.

The cable shield of the sensor cable must extend up to the module, the shielding may not be connected to the connector.

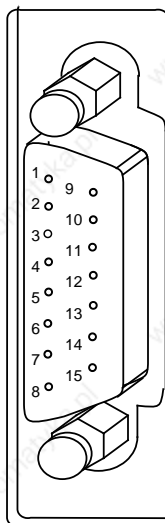

Pin	Assignment
1	5 V Supply voltage
2	5 V Sensor line
3	} Ground
4	
5	
6	Rectang.-wave signal A-N (5 V)
7	Rectang.-wave signal A (5 V)
8	Supply voltage (24 V)
9	Rectang.-wave signal B (5 V)
10	Rectang.-wave signal B-N (5 V)
11	Reference pulse R (5 V)
12	Reference pulse R-N (5 V)
13	Rectang.-wave signal A (24 V)
14	Rectang.-wave signal B (24 V)
15	Reference pulse R (24 V)

Figure 16-9. Pin Assignment of the 15-Pin Sub-D Female Connector

- **Connecting Counting Pulse Sensors for 5-V Differential Signal to RS 422**

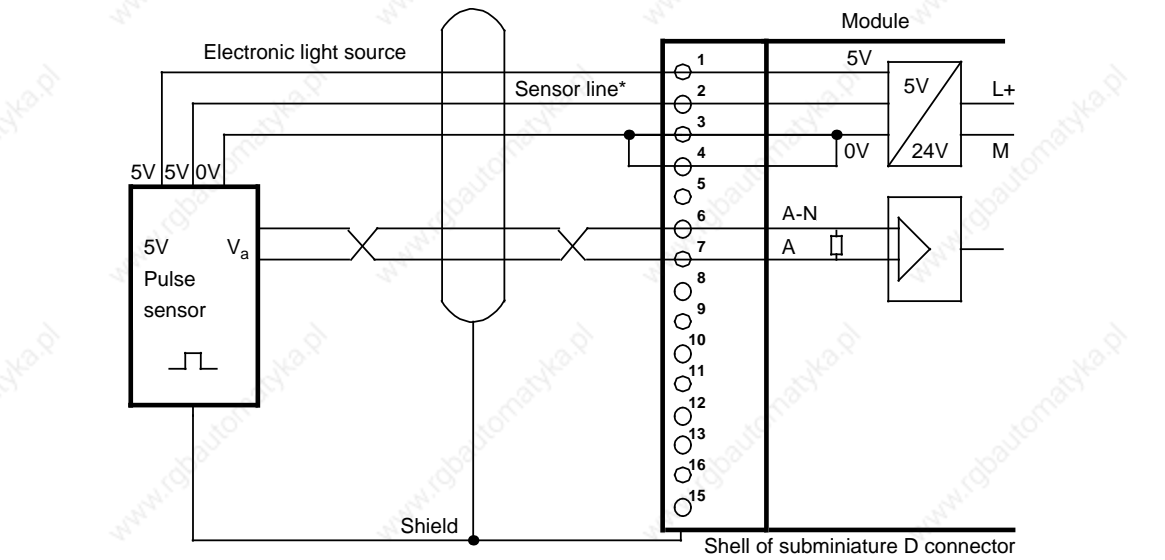

* If there is no sensor line between the sensor and the counter module, pins 1 and 2 of the module must be bridged.

Figure 16-10. Connecting a Counting Pulse Sensor for 5-V Differential Signal to RS 422

- **Connecting a Counting Pulse Sensor for 24 V DC**

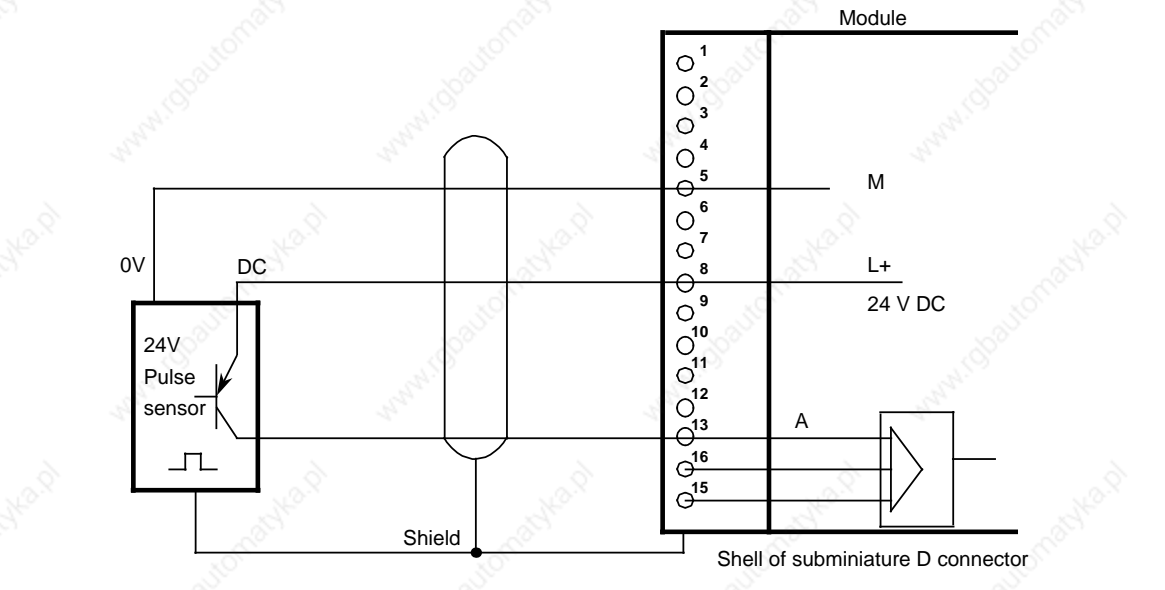
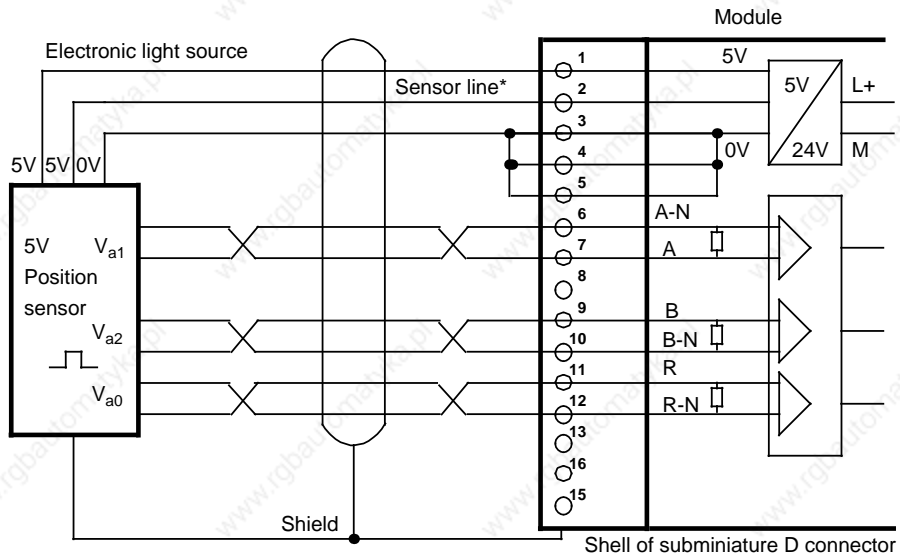

Figure 16-11. Connecting a Counting Pulse Sensor for 24 V DC

- **Connecting a 5-V Position Sensor to RS 422**



* If there is no sensor line between the sensor and the counter module, pins 1 and 2 of the module must be bridged.

Figure 16-12. Connecting a 5-V Position Sensor to RS 422

- **Connecting a 24-V DC Position Sensor**

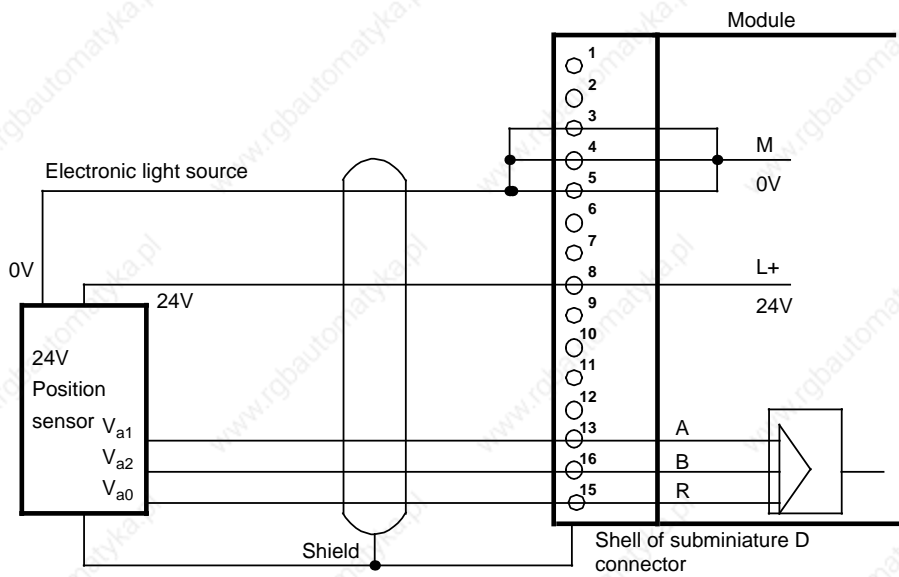

Figure 16-13. Connecting a 24 V-DC Position Sensor

Sensor Requirements

The following requirements must be satisfied by the sensor signals to the module inputs.

- Signal sequence for up-counting

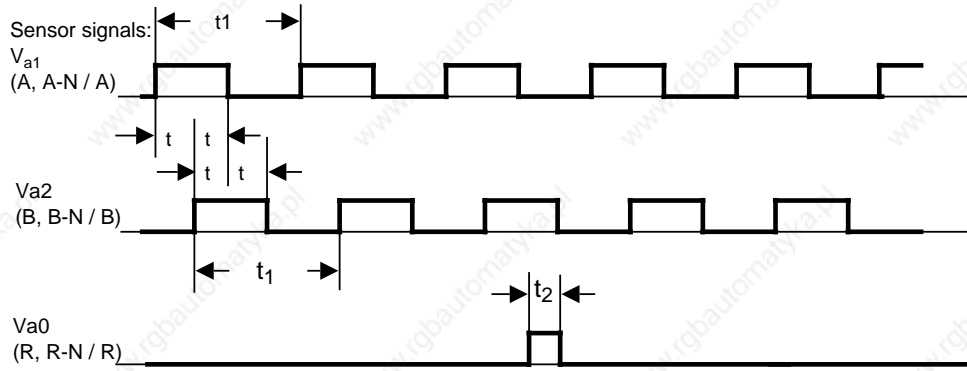

Figure 16-14. Signal Sequence for Up-Counting

- Pulse time of the sensors

	5 V Sensors	24 V Sensors	Pulses
t	500 ns	10 μs	U _{a1} =Position decoder count pulses (A)
t ₁	2 μs	40 μs	U _{a2} =Position decoder count pulses (B)
t ₂	500 ns	10 μs	U _{a0} =Position decoder ref. pulse (R)

- Minimum edge steepness

5 V - differential signals according to RS 422A (A, A-N, B, B-N, R, R-N):	5 v/μs
24 V - count pulses and reference signal (A, B, R):	0.3 v/μs
24 V - enable and reference signal:	0.3 mV/μs

Terminal Block

Proximity switches can be connected (contacts, two-wire BERO proximity limit switches) to the inputs on the terminal block.

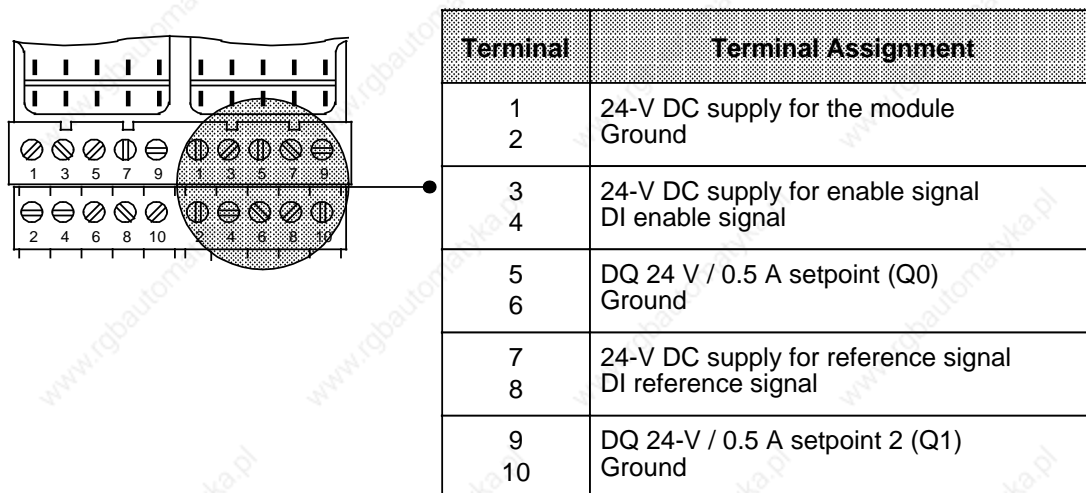

Figure 16-15. Assignment Diagram for the Terminal Block

- Assignment of Inputs on the Terminal Block**
 Two-wire BERO proximity limit switches can be connected to the reference input. The enable input can also be driven by a 24-V DC digital output module.
- Outputs on the Terminal Block**
 There are two short-circuit protected 24-V DC digital outputs on the terminal block.
- Short-Circuit Indication**
 A shorted output is indicated by the red LED on the front panel.

16.6.2 Data Transfer

The data is transmitted via the I/O bus. Four bytes are used. Examples of data transfer are shown in Section 16.6.6.

Transfer from the Programmable Controller to the Counter Module (PIQ)

The control program transfers two setpoints to the counter module by means of transfer operations.

Table 16-1. Sending Data from the Programmable Controller to the Counter Module

Byte 0	Byte 1	Byte 2	Byte 3
Setpoint 1		Setpoint 2	
High byte	Low byte	High byte	Low byte

Transfer from the Counter Module (PII) to the Programmable Controller

The counter module transfers the diagnostic byte and the current counter status. In the control program, this data can be read in by means of load operations and then evaluated.

Table 16-2. Sending Data from the Counter Module to the Programmable Controller

Byte 0	Byte 1	Byte 2	Byte 3
Irrelevant	Diagnostic byte	Actual value	
		High byte	Low byte

- **Diagnostic Byte (Byte1)**

The diagnostic byte is byte 1 of the first input word. Byte 0 has no significance. The diagnostic byte provides information on the following items.

- Preset position resolution
- Preset mode
- The reaching of setpoints
- Signal status of the sync bit for position decoding

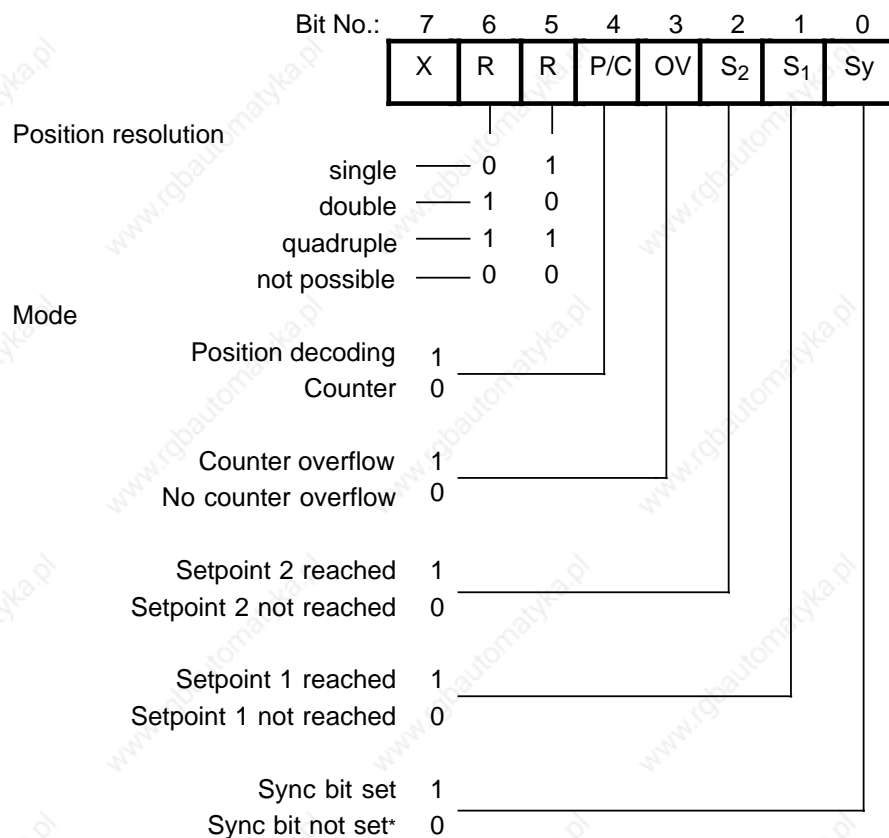

X = irrelevant

* If the sync bit is not set, a reference point approach must be implemented before operation can continue in the "Position decoding" mode.

Figure 16-16. Diagnostic Byte

16.6.3 Functional Description of the Counter Mode

In the operation mode "Counter", the module works as a "port-controlled" up-counter and counts the positive edges of the counting pulses while the enable input is high. If the counter reaches a preselected setpoint, the respective output is then enabled.

Initial Settings

On the operating mode switch, make the following selections.

- "Counter" (C)
- Counting pulse signal level (5 V or 24 V)

The position of the switches for the position resolution is irrelevant.

For this operation, you need a counting pulse sensor (e.g., BERO). The pulses can be applied as 5-V differential signals according to RS 422A (up to 500 kHz) or as 24-V signals (up to 25 kHz). The sensor is connected to the sub-D interface of the module.

Loading Setpoints

The control program can transfer two setpoints to the module. These setpoints must be in the range of 0 to 65,535. The transfer of the setpoints via the module depends on whether the "setpoint 1 (setpoint 2) reached" bit is set in the diagnostic byte (S1 and S2).

If the bit is not set, which means the existing setpoint has not been reached or has not been exceeded, the new setpoint is transferred immediately and is immediately valid.

If the bit is set, which means the existing setpoint has been reached or exceeded, the new setpoint is valid only after a positive edge occurs at the enabled input.

If you do not specify a setpoint, a setpoint of "0" applies.

Enabling the Counter

The signal state of the enable input (terminal 3 on the terminal block) determines the function of the counter.

A **positive edge** at the enable input:

- Sets the counter to 0
- Resets the diagnostic bits for "setpoint reached"
- Resets the outputs
- Enables the counter

Note

The enable input should be set to "1" only after the setpoint has been transferred. Otherwise, the outputs are enabled automatically when the first positive edge occurs.

Disabling the Counter

A **negative edge** at the enable input disables the counter. The outputs, diagnostic bits, and the counter are not reset. You can continue reading the current count. A positive edge at the enable input resets the outputs and the diagnostic bytes.

Reaching the Setpoints - Setting the Outputs - Resetting the Outputs

If setpoints have been preselected and the counter is enabled, the module counts the positive edges at the counter input. The count is incremented by "1" with every leading edge.

After setpoint 1 has been reached, output Q 0 is enabled. At the same time, status bit S1 is set. After setpoint 2 has been reached, output Q 1 is enabled. At the same time, status bit S2 is set.

As long as the enable input is active, the counter counts the pulses. After the enable command has been cancelled, the counter is disabled. The actual value remains constant. You can read the current count in the STEP 5 program. The actual value is displayed as an unsigned whole number and must lie in the range of 0 to 65,535.

Note

If no setpoint is preselected, the respective value "0" is assigned. The corresponding output is enabled with the positive edge of the enabled input.

Example: Setpoints S1=2 and S2=4 are entered into the counter

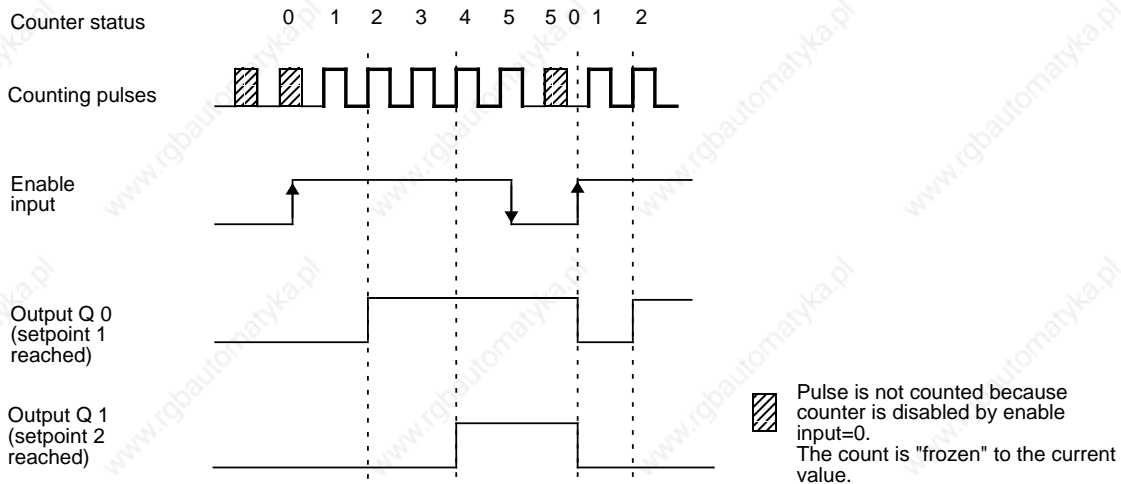

Figure 16-17. Switching the Outputs Dependent on the Status of the Counter and the Enable Input

When the programmable controller goes from RUN to STOP, outputs Q 0 and Q 1 are reset.

Performance during Overflow

If the enabled counter exceeds the counter range limit 65,535 the following actions occur.

- Bit 3 (overflow) in the diagnostic byte is set to "1" and
- The outputs and diagnostic bits for "setpoint reached" are disabled, but they remain unchanged

The counting function continues. Thus the actual value is constantly updated.

You can continue to read all data from the module in the STEP 5 program.

- The updated count
- The status of the outputs at the time of the overflow (This status remains unchanged until the overflow bit is reset.)
- The set overflow bit

After an overflow, the counter can be reset by one of the following actions.

- A positive edge at the enable input
- An overall reset of the programmable controller (STOP to RUN mode)

Note

After a cold restart of the programmable controller, the outputs are disabled. These outputs can be enabled via a positive edge to the enable input.

16.6.4 Functional Description of the Position Decoder

In the operation mode "position decoder" the module works as an up-counter/down-counter and counts the pulses of the connected position encoder. Because of the phase offset of the two decoder signals A and B, the counter determines the counting direction. If the counter reaches a preselected setpoint, the respective output is then turned on.

Settings

Set the following items on the operating mode switch.

- "Position decoding" (PD) function
- The desired position resolution (single, double, or quadruple)
- The signal level of the counting pulses (5 V or 24 V)

Connect the sub-D interface female connector to an incremental position encoder that has to deliver the following signals.

- Two counting pulses offset by 90 degrees
- A reference pulse

The pulses can be supplied as 5-V differential signals according to RS 422 (up to 500 kHz) or as 24-V DC signals (up to 25 kHz).

Connect a switch to the enable input. This switch must deliver a 24-V signal. In the same way, the reference pulse has to deliver a 24-V signal to the reference input.

Position Resolution

- Counter capacity
The 16-bit up-down counter permits a resolution of 65,536 units between -32768 and +32767. The traversing range depends on the resolution of the position encoders.
- Pulse evaluation
The counting pulses, which are offset by 90 degrees, can be subjected to single, double, or quadruple evaluation. The necessary setting is made on the operating mode switch (see Section 16.6).

The accuracy of the traversing path increases accordingly if double or quadruple pulse evaluation is used. However, the traversing range then available is reduced by the factor 2 or 4.

Table 16-3. Pulse Evaluation

	Single Evaluation	Double Evaluation	Quadruple Evaluation
Counting pulse A			
Counting pulse B			
Count	0 1	0 1 2	0 1 2 3 4

Example:

A rotary incremental position encoder produces 1000 pulses per revolution.

The spindle has a pitch of 50 mm/revolution. The position encoder therefore produces 1000 pulses for a traversing path of 50mm (1 revolution).

The resolution of the encoder is therefore 50 mm/1000 pulses.

The counter can handle up to 65536 pulses. With the above resolution, the following traversing ranges are obtained:

Table 16-4. Example for a Traversing Range

Pulse evaluation	Single	Double	Quadruple
Traversing range	3.25 m (10.7 ft.)	1.625 m (5.3 ft.)	0.81 m (2.7 ft.)
Distance travelled/ pulse	50 μ m	50 μ m	50 μ m

Loading Setpoints

In the STEP 5 program, two setpoints can be transferred to the module. These setpoints must lie between -32768 and +32767.

The acceptance of the setpoints by the module depends on whether the "setpoint 1 (setpoint 2) reached" bit has been set in the diagnostic byte.

If the bit is not set, which means the existing setpoint is not reached or not exceeded, the new setpoint is immediately accepted and is immediately valid.

If the bit is set, which means the existing setpoint is reached or exceeded, the new setpoint is not valid until a positive edge occurs at the enable input.

If you do not specify a setpoint, a setpoint of "0" applies.

Synchronization of the Actual Value Detection (Reference Point Approach)

The synchronization of the actual value detection is necessary after "power-up" and after a counter overflow.

Synchronization performs the following functions.

- The count (actual value) is set to "0" and
- The **SYNC bit** (bit 0 in the diagnostic bit) is **set** after "power-up"
- or
- The **overflow bit** (bit 3 in the diagnostic byte) is **reset** after an overflow

Prerequisites for a Synchronization

- The reference signal
The sensor for the reference signal is connected to terminals 7 and 8 of the terminal block. Synchronization is enabled with the **leading edge** (0 to 1) at terminal 8. If the signal was already on "1" when the module was switched on, then the reference signal must be turned off to restart the synchronization.
If the reference signal lies in the normal traversing range, the actual value will be constantly resynchronized by the reference signal. To prevent the unwanted resynchronizing, you have to mask out the reference signal after the first reference point approach.
- Traversing path after a positive edge of the reference signal
After the reference signal has been reached, the module has to recognize a **positive traversing path** (up-counting) while the reference signal is still active (1). This means, you have to input the reference signal with increasing actual value to synchronize the module.
- Reference pulse
The reference pulse is generated by the position encoder at least once per revolution.
 - The first reference pulse that the module recognizes after a leading edge of the reference signal synchronizes the module (see figures 16.18 and 16.20a).
 - If the reference signal changes from "1" to "0" before the reference pulse is reached, the module is only synchronized if a positive traversing path is recognized after the falling edge of the reference signal (see figure 16.19).
The module is not synchronized, if a negative traversing path is recognized after the falling edge of the reference signal (see figure 16.20b).

The figures 16.18, 16.19 and 16.20a illustrate different possibilities for a reference traversing path. Figure 16.20b illustrates a reference traversing path, which is terminated without synchronization:

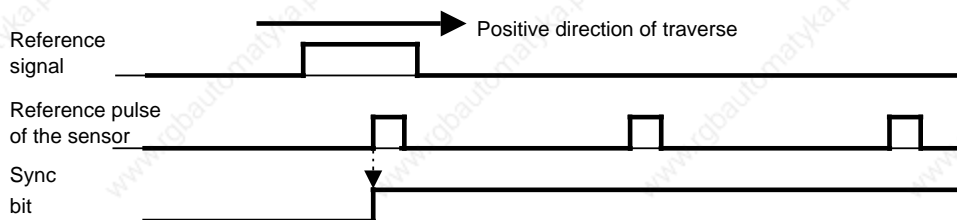

Figure 16-18. Position of the Reference Point (SYNC Bit=1) within the Reference Signal Range

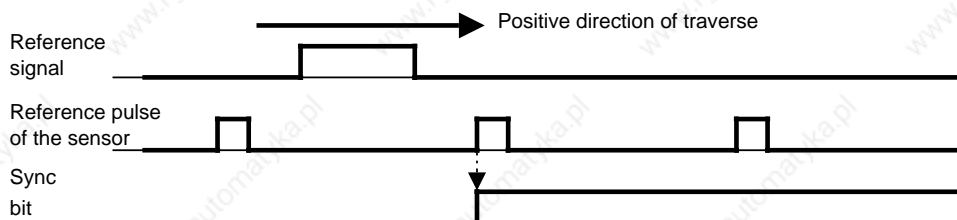

Figure 16-19. Position of the Reference Point (SYNC Bit=1) after the Reference Signal

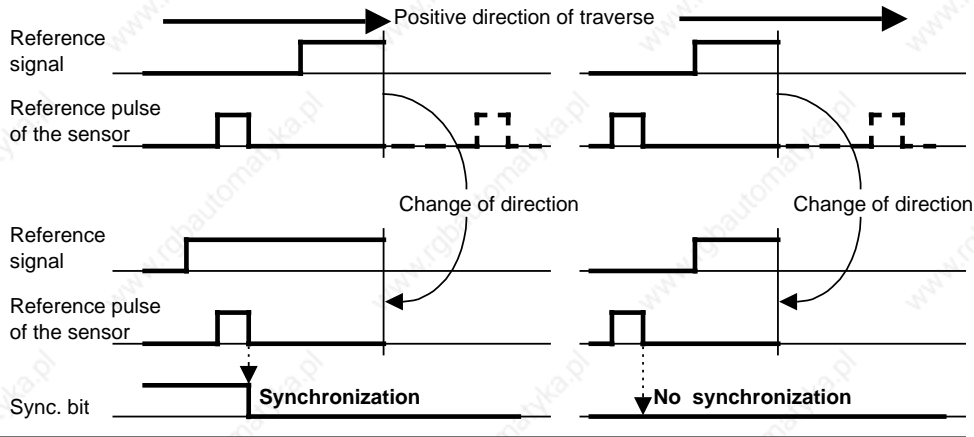

Figure 16-20a. Synchronization (SYNC Bit 0 =1) 16-20b. No Synchronization during a Reversal of Direction before Reaching the Reference Pulse in a Positive Direction

Example:

Transporting objects from point A to point B on a conveyor belt. A rotary position encoder is used, together with a BERO proximity switch as reference transmitter. The conveyor belt is marked at a definite point. As soon as this mark comes within the range of the BERO, the BERO produces a reference signal.

Following the reference point approach, the enable input is set via a digital output module.

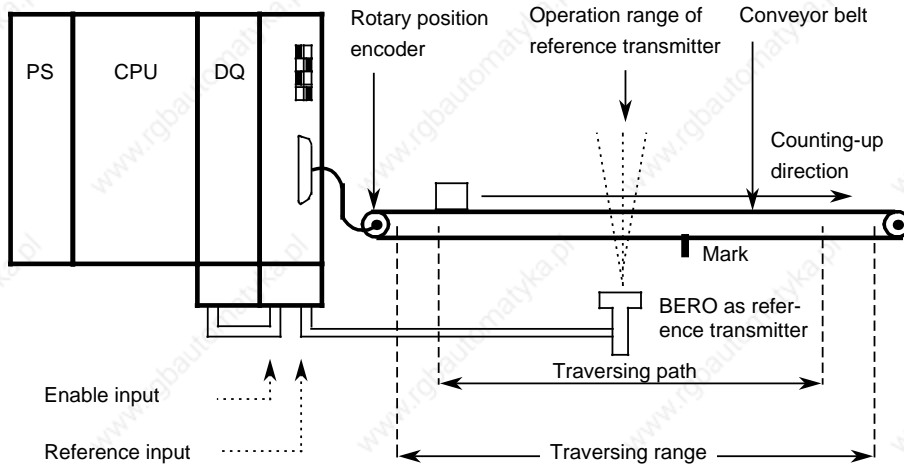

Figure 16-21. Schematic of a Reference Point Approach Operation

Starting the Counter

The counter is reset and started by setting the SYNC bit in the diagnostic byte during the reference point approach operation. The active pulses are counted according to the rotation direction of the position encoder. The count value is incremented during a positive count direction, and decremented during a negative count direction.

Enabling the Outputs - Reaching the Setpoints - Resetting the Outputs

The two outputs are enabled for switching by a positive pulse edge at the enable input.

An output and the associated diagnostic bit "setpoint reached" are set if all of the following statements are true.

- The position decoder was synchronized (SYNC bit=1 and overflow bit=0).
- The enable signal (terminal 3 on the terminal block) is set to "1" signal.
- The actual value corresponds to the selected setpoint.

The setpoint can be reached in the up-count or down-count direction.

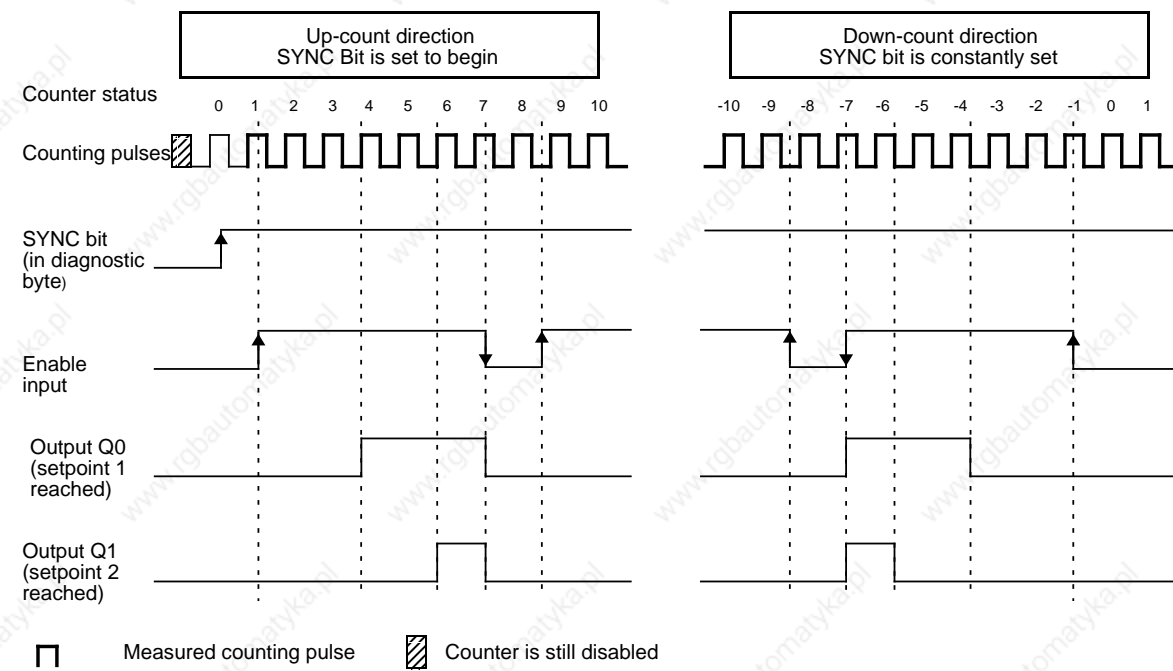

Figure 16-22. Enabling the Outputs - Reaching the Setpoints - Resetting the Outputs

After reaching setpoint 1, the output Q 0 is energized and the status bit S 1 is set. After reaching setpoint 2, the output Q 1 is energized and status bit S 2 is set.

As long as the enable input is active, the outputs are switchable through the module. If the enable command is cancelled, the outputs are switched off and the diagnostic bits are reset. The current actual value is still being measured and incremented or decremented depending on the direction of rotation.

You can read the current count in the STEP 5 program. The actual value is displayed as a signed whole number in two's complement and lies in the range - 32768 to +32767.

Note

Before you enable the outputs to be switched on by setting the enable input to "1", make sure the following conditions exist.

1. Both setpoints were transferred.
2. The overflow bit=0.
3. The SYNC bit=1.

If you ignore these prerequisites, the outputs are switched on directly when the actual value=0.

The diagnostic bit and the output are reset with the "0" signal at the enable input. Outputs Q 0 and Q 1 are also reset when the programmable controller goes from RUN to STOP.

The following examples show the switching on of the output at the selected setpoint. Following are the three possibilities.

- Reaching the setpoint in the direction of a rising actual value
- Reaching the setpoint in the direction of a falling actual value
- Reaching the setpoint in the direction of a rising actual value, then a reversal of direction and a reapproaching of the setpoint in the opposite direction

Example 1: Approaching a Setpoint in Up-Count Direction

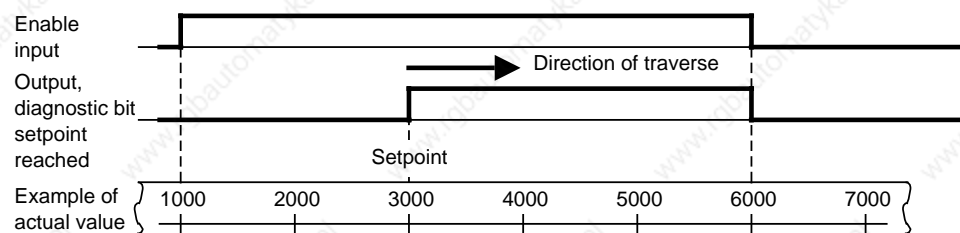
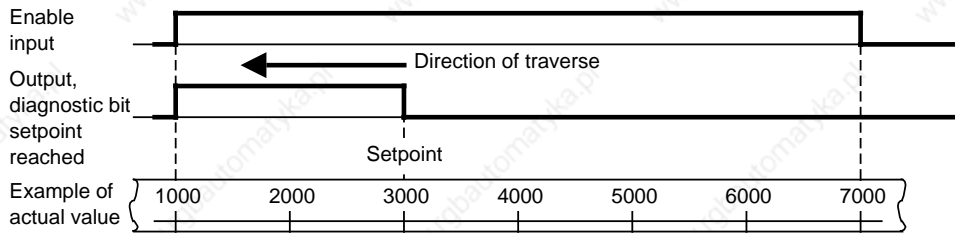
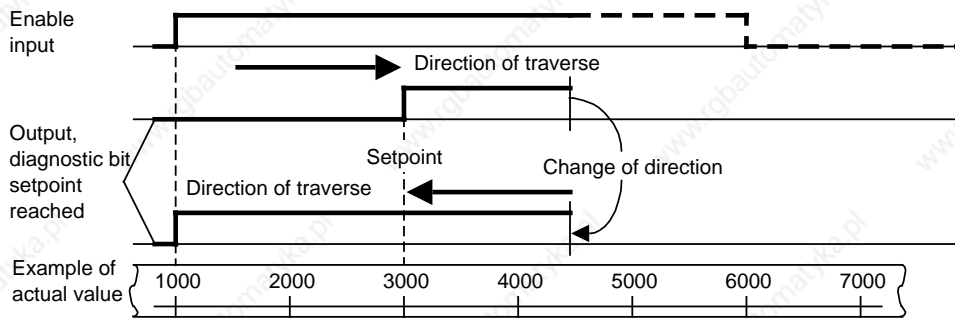

Figure 16-23. Approaching a Setpoint in Up-Count Direction

- With actual value=1000, the enable input is set to "1".
- With actual value=3000, the setpoint is reached, output and diagnostic bit "setpoint reached" are set.
- With actual value=6000, the enable input is set to "0", output and diagnostic bit are reset.

Example 2: Approaching a Setpoint in Down-Count Direction**Figure 16-24. Approaching a Setpoint in Down-Count Direction**

- With actual value = 7000, the enable input is set to "1".
- With actual value = 3000, the setpoint is reached, the output and the diagnostic bit "setpoint reached" are set.
- With actual value = 1000, the enable input is set to "0", the output and the diagnostic bit are reset.

Example 3: Reversal of Direction after Approaching a Setpoint**Figure 16-25. Approaching a Setpoint in Up-Count Direction and Consecutive Reversal of Direction**

- With actual value=1000, the enable input is set to "1".
- With actual value=3000, the setpoint is reached, the output and the diagnostic bit "setpoint reached" are set.
- With actual value=4500, the traversing path is reversed.
- With actual value=1000, the enable input is set to "0", the output and the diagnostic bit are reset.

Note

Set outputs can be reset only via a "0" signal to the enable input.

Performance during Overflow

If the counter leaves the counting range of -32768 to + 32767, then the following occur.

- Bit 3 (overflow) in the diagnostic byte is set to "1".
- The outputs of the counter module are disabled.

The enable input (terminal 4 of the terminal block) must be set to "0", in order to switch off active outputs.

After an overflow, a new reference point approach operation has to be executed for synchronization of the actual value detection. After reaching the synchronization, bit 3 in the diagnostic byte is again set to "0", and the outputs along with the active enable input can be turned on.

Note

During an overflow, active outputs are not switched off, and the SYNC bit (bit 0 in the diagnostic byte) is not reset.

16.6.5 Entering New Setpoints for the Counter and Position Decoder

Entering new setpoints is always possible via the PIQ. However, a setpoint is only valid if the respective output is not switched on. The status of the outputs is displayed with diagnostic bits S 1 and S 2.

Diagnostic bit S 1 (bit 1 in the diagnostic byte)=1: setpoint 1 is reached and output 1 is switched on.

Diagnostic bit S 2 (bit 2 in the diagnostic byte)=1: setpoint 2 is reached and output 2 is switched on.

Table 16-5. Reaction of the Counter Module during Transfer of the Setpoints

Diag. Bit	Response
S 1 = 0 S 2 = 0	New setpoint 1 is transferred and is valid immediately. New setpoint 2 is transferred and is valid immediately.
S 1 = 1 S 2 = 1	New setpoint 1 only becomes active if a positive edge has appeared at the enable input. New setpoint 2 only becomes active if a positive edge has appeared at the enable input.

Example for the Position Decoder:

You want to control a drive by using the outputs of the counter module. After a run of positioning, both setpoints are reached and both outputs are turned on. You can enter the new setpoints by using the following sequence.

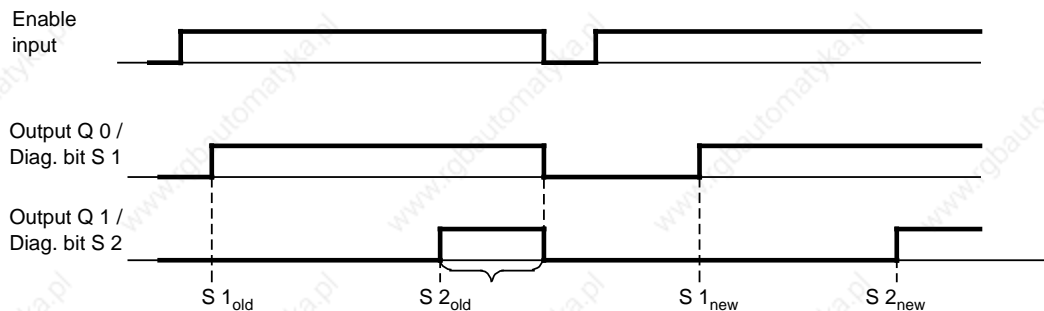

Figure 16-26. Requirement for New Setpoints

Transfer the new setpoints to the module. Since both diagnostic bits S 1 and S 2 are set to "1", the actual values are **not yet accepted**.

Switch the signal now at the enable input to "0". With the falling edge, the outputs are switched off and the diagnostic bits are reset.

Switch the signal at the enable input again to "1". The new **setpoints are accepted and are now active**.

After reaching the new setpoints, the respective output is turned on again.

16.6.6 Addressing

The counter module is addressed like an analog module (see Chapter 6).

- The module may only be plugged into slots 0 to 7 (slots 0 to 5 for S5-90U).
- The address space extends from byte 64 to byte 127.
- In both process images, eight bytes are reserved per slot and of these eight bytes only the first four are used.

Slot Addressing

Table 16-6. Slot Addressing

Slot	0	1	2	3	4	5	6	7
Address	64-	72-	80-	88-	96-	104-	112-	120-
PII/PIQ	71	79	87	95	103	111	119	127

Meaning of the Bytes of a Slot Address (Example: Slot 1)

Table 16-7. Meaning of the Address Bytes of a Slot Address

Byte Number	Byte Address	Meaning in PII	Meaning in PIQ
0	72	Irrelevant	High byte
1	73	Diagnostic byte	Low byte
2	74	High byte	High byte
3	75	Low byte	Low byte
4-7	76-79	Irrelevant	

Examples for Data Exchange between the Programmable Controller and the Counter Module

- 1) The counter module is plugged into slot 4. If you now wish to check whether your system for position decoding has been synchronized by a reference point approach, you must scan the sync bit in the diagnostic byte (bit 0). If this bit is set, a branch is to be made to FB20. The position decoding operation is started in FB20.

STL	Description
<pre> ... A I 97.0 JC FB20 ... </pre>	<p>Read in bit 0 of the diagnostic byte (sync bit). If this bit is set, a branch is made to FB20. If the bit is not set, program scanning is continued with the statement following the block call.</p>

- 2) Transferring the setpoints stored in flag words 0 and 2 to the counter module inserted into slot 4. The module has only to accept the setpoints when the old setpoints have been reached or exceeded.

STL	Description
<pre> ... AN I 97.1 JC= L001 L FW 0 T QW 96 L001 AN I 97.2 JC= L002 L FW 2 T QW 98 L002 BE ... </pre>	<p>If setpoint 1 has not yet been reached (bit 1=0), a branch is made to label 1. Read in setpoint 1 and transfer it to the counter module. If setpoint 2 has not yet been reached (bit 2=0), a branch is made to label 2. Read in setpoint 2 and transfer it to the counter module. Block end</p>

16.7 IP 262 Closed-Loop Control Module

(6ES5 262-8MA12)

(6ES5 262-8MB12)

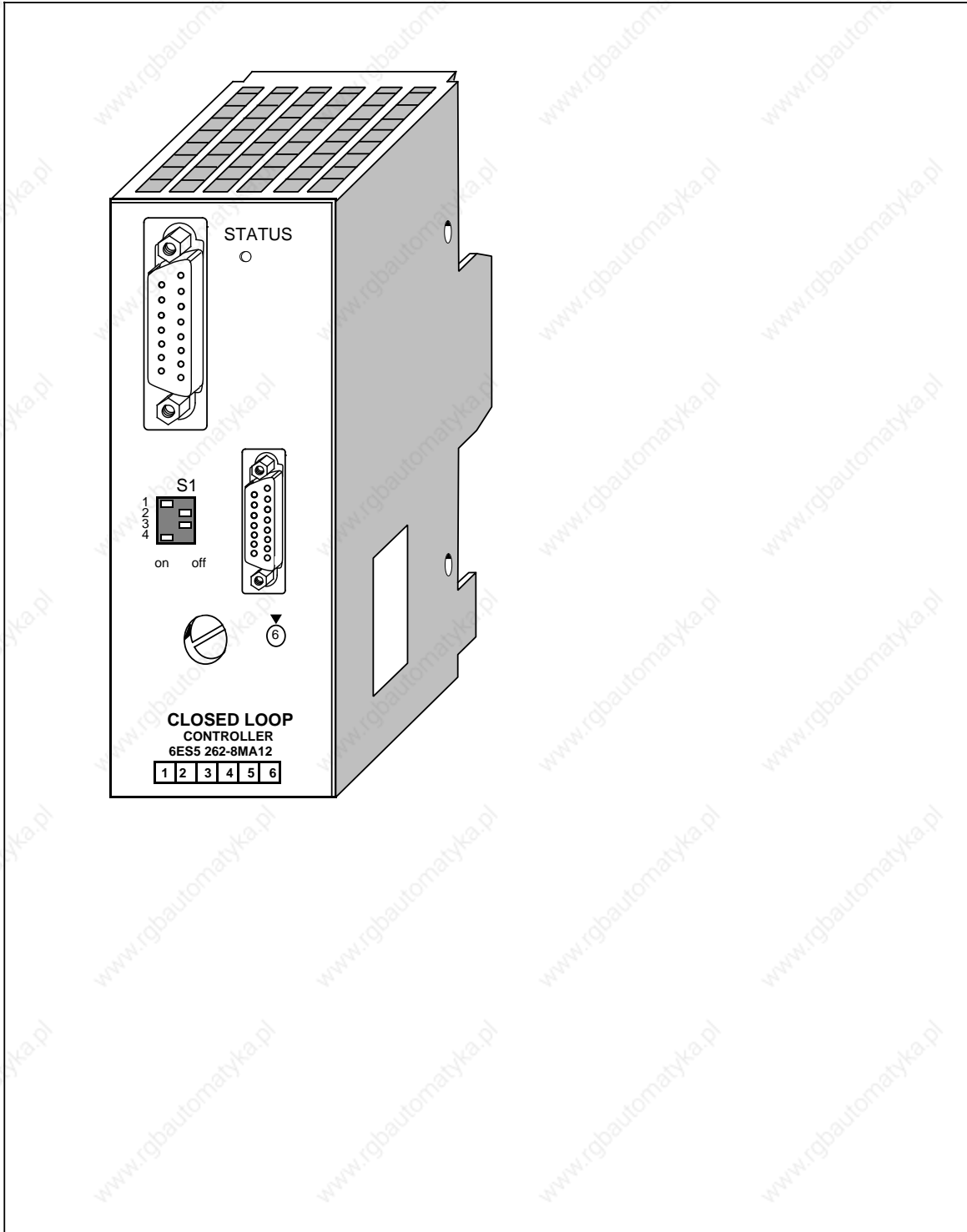

Technical Specifications			
Controller		Analog Outputs of Continuous-Action Controller (6ES5 262-8MA12)	
Total cycle time (equals scan time)	100 to 200 ms	Number of outputs	3
Resolution of the open-loop controller	5 ms at 50 Hz 4.2 ms at 60 Hz	Galvanic isolation	no
Analog Inputs		Output signal range	0 to 20 mA or 4 to 20 mA
Number of inputs	4 (suited for current, thermo-couple, or resistance thermometer) Voltage with external switching	Maximum permissible load	600
Additional input for reference temperature	1 (resistance thermometer)	No load voltage	(L+) - 2 V
Galvanic isolation	no	Binary Outputs of Step-Action Controller (6ES5 262-8MB12)	
Permissible voltage difference Between inputs	- 1 V to +1 V	Number of outputs	8
Between inputs and central ground point	- 1 V to +1 V	Galvanic isolation	no
Digital representation of the input signal	11 bits+sign	Signal state "0"	<1.5 V
Current input		Signal state "1"	(L+) - 3.8 V
Input signal range	0 to 20 mA or 4 to 20 mA	Maximum load current	100 mA short-circuit proof
Input resistance	24.3 ±0.1%	Wiring method	
mV Input (for thermocouple)		Programmer (PG)	front side via
Input signal range	0 to 50 mV or - 8.9 to 41.1 mV (type J, K, L, S)	Operator panel (OP)	15-pin subminiature
Cable impedance	30 per wire	SINEC-L1 network connection	D connector
Resistance thermometer		Connectable are	PG 605, PG 710, PG 730, PG 750, PG 770, OP 393, OP 395
Start	18.49	Analog and binary inputs	front side via 25-pin subminiature D connector
End	219.12	Analog and binary outputs	via terminal block of the bus unit
Permissible cable impedance	30 per wire	General data	
Binary Inputs		Input voltage	
Number of inputs	4	Rated value	24 V DC
Galvanic isolation	no	Permissible range	18 to 34 V DC
Signals state "0"	- 30 to +4.5 V or open	Permissible range with the PG 605/OP 393	18 to 27 V DC
Signal state "1"	+13 to +30 V (signal state invertible)	Current consumption	
Input resistance	approx. 4 k	Internal (from the CPU; 9 V)	approx. 20 mA
		External (for 24 V; without load)	approx. 180 mA
		External (for 24 V; without load; with PG 605 / OP 393)	approx. 340 mA
		Ambient temperature	0° to 55°C (32 to 131°F)

Function

SIMATIC S5-90U and SIMATIC S5-95U offer different solutions for individual closed-loop control (PID) tasks. First there is a software solution via function blocks (only for the S5-95U) and second, a control module (for example, a module that can solve PID control tasks simply and in a time saving manner). The basis, in both cases, is a PID-control algorithm.

The IP 262 closed-loop control module can be used with any of the S5-90U, S5-95U, and S5-100U programmable controllers. It can be used without COM software.

The module relieves the programmable controller from closed-loop control tasks. The IP 262 also works with its own power supply in a stand-alone operation. The module can function independently without a programmable controller and can handle up to four closed-loop control circuits.

Two interfaces are located on the front panel of the module.

- An interface for the connection of a programmer (PG) or an operator panel (OP) or the SINEC L1 Network (under development)
- An interface for the connection of analog and binary inputs

In addition, the following items are available.

- A selector switch for each channel for current and voltage (thermocouples or PT 100)
- A status LED for RUN (a continuously lit green light), transducer malfunction (blinking light), and module malfunction (off)

Additionally, the module offers the following inputs.

- 4 analog inputs for direct feed of setpoint and actual values
- 4 binary inputs for control variables

The module is well-suited to take over control-loop tasks in the area of industrial processing technology, for example, temperature control, pressure and flow control, continuous injection functions, and non-time-critical closed-loop speed controls.

Modules

There are two IP 262 modules.

- ... - 8MA 12 with 3 analog outputs for continuous controllers with analog output signals
- ... - 8MB12 with 8 binary outputs for continuous controllers with pulse time interval signals for step-action controllers

Installation

- The closed-loop control module is plugged into a bus unit like any other input or output module (see Chapter 3).
- With the S5-90U, a maximum of 4 closed-loop control modules can be plugged into slots 0 through 5.
- With the S5-95U, a maximum of 8 closed-loop control modules can be plugged into slots 0 through 7.
- The connections for power supply and the analog and binary output signals are located on the terminal block of the bus unit.
- The analog and binary inputs are connected to the module with a 25-pin sub-D female connector.

Addressing

The module is addressed like a four-channel analog module.

Operating Modes

Since transducers and sensors are directly wired to the module, the module can work independently from a programmable controller in stand-alone operation, provided that the setpoints and the 24-V power supply voltage are fed directly to the IP 262. This means that the module executes the control and the output of the control value and can work alone or be controlled via the SINEC L1 by a master unit.

Besides this, the IP 262 has its own back-up, which means that the module can continue to work alone in the event the master CPU (e.g., S5-135U with R64) fails. It uses the last setpoint received from the CPU or the predefined back-up setpoint. Two operating modes are possible.

- **DDC-Operation (Direct Digital Control):**
The control is executed entirely from the CPU and the IP only outputs the manipulated variable. If the CPU fails, the module can continue to control independently with a predefined back-up setpoint.
- **SPC-Operation (Setpoint Control):**
The module receives only the setpoint from the CPU; the control is carried out independently of the CPU. If the CPU fails, the IP continues to control using the last setpoint received from the CPU. It is also possible to use a predefined back-up setpoint here.

16.8 IP 263 Positioning Module

(6ES5 263-8MA13)

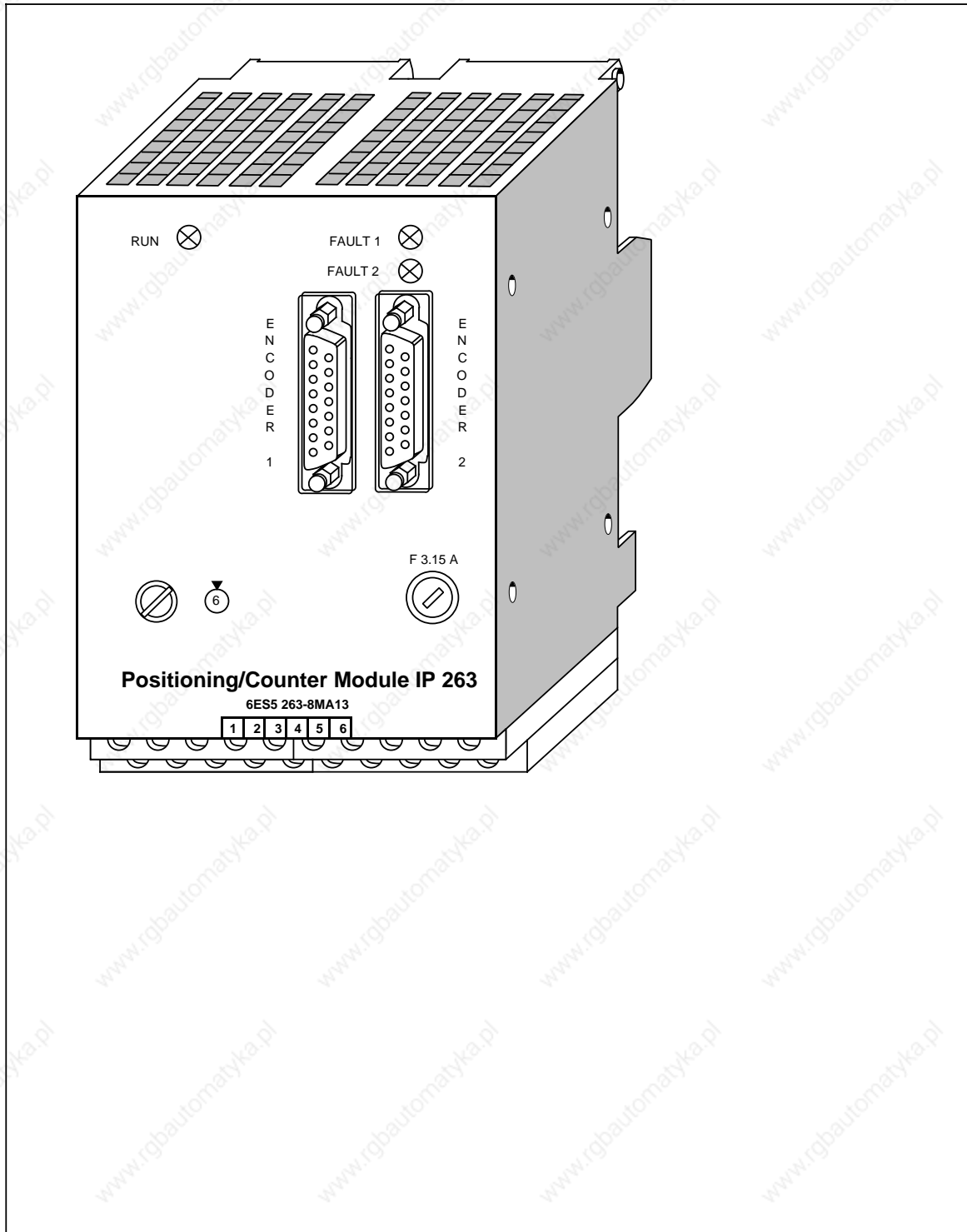

Technical Specifications**Encoders**

Position decoder	incremental, absolute (SSI interface)
Maximum traversing range - with incremental encoders - with absolute encoders	2 ²⁴ increments 8192 increments per revolution x2048 revolutions
Signal voltages - Differential inputs - Asymmetrical inputs	5 V to RS 422 24 V (only incremental encoders)
Supply voltage for encoders (short-circuit-proof, no overload)	5 V/300 mA 24 V/300 mA
Input frequency and cable length Symmetrical encoders (5 V signals): - with 5 V encoder supply - with 24 V encoder supply	max. 200 kHz for 32 m (105 ft.) cable, shielded max. 200 kHz for 100 m (328 ft.) cable, shielded max. 100 kHz for 25 m (82 ft.) cable, shielded max. 25 kHz for 100 m (328 ft.) cable, shielded
Asymmetrical encoders (24 V signals):	
Data transmission rate and cable length with absolute encoders	62.5 kHz (selectable in steps) 125 kHz (160 m/ 525 ft. shielded) 250 kHz 500 kHz 1 MHz (32 m/ 105 ft. shielded)
Input signals - Incremental - 24 V initiator (BERO) - SSI	2 pulse trains displaced by 90° 1 zero pulse 1 pulse train Absolute value
Input currents - 5 V - 24 V	to RS 422 typ. 5 mA

Digital Inputs

Input voltage range	- 3 V to + 30 V
Galvanic isolation	no
0 signal	- 3 V to +5 V
1 signal	+13 V to+30 V
Permissible zero-signal current at 0 signal	1.1 mA
Input current at 24 V	typ. 5 mA

Other: If the digital inputs are used, they must always be connected to a defined potential (0 V, 24 V) and must not be kept open.

Digital Outputs

Output voltage range	+20 V to+30 V
Galvanic isolation	no
Output current at 1 signal	max. 500 mA
Short-circuit protection	Short-circuit-proof output
Cable length, shielded	max. 100 m (328 ft.)

Supply Voltage

Logic voltage from 24 V supply produced with switched- mode power supply	4.9 V to 5.1 V
Current consumption from 24 V without outputs and encoder	typ. 120 mA
Undervoltage monitoring	$V_{\text{internal}} < 4.65 \text{ V}$

Power Loss

typ. 4 W

A separate manual is available for the IP 263 positioning module. It can be ordered under the order number 6ES5 998-5SK21.

The IP 263 is suitable for positioning of two independent axes.

Assignments of Outputs

The IP 263 is a two-channel module: 4 digital outputs are assigned to each channel for the control of drives;

- Rapid traverse
- Creep speed
- Anti-clockwise rotation
- Clockwise rotation

Both incremental and absolute encoders (SSI - synchronous serial interface) can be connected for actual position encoding.

They transmit the machine data, such as

- Software limit switches
- Resolution
- Cutoff difference
- Switchover difference
- Zero-speed control

The syntax for the data block which has to be created for this purpose is simple and is described in the manual.

Positioning

The only thing that remains to be done is to specify the desired target and then the module is ready for the positioning procedure.

The IP 263 then carries out positioning automatically. When the target has been reached, it sends a message to the IM 318-B interface module and thus to the CPU.

Figure 16-27 shows the positioning procedure with the IP 263: After the start, a rapid traverse towards the target takes place first. When the switchover/cutoff point has been reached, a switchover to creep speed or cutoff takes place. Afterwards, the IP 263 monitors approach of the target. When the axis has reached the target range, a signal is sent to the IM 318-B interface module.

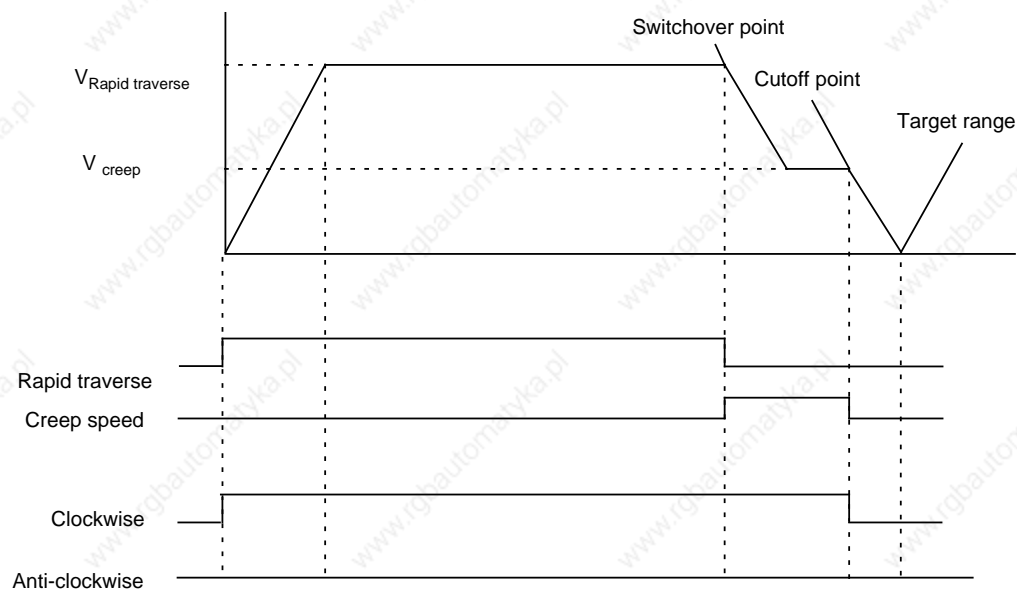

Fig. 16-27. Positioning with the IP 263

During reference point travel, the digital input of the module senses the speed reducing cam (reference point switch).

In the "Length measurement" operating mode, the module senses encoder pulses as long as this input has a "1" signal.

Installation

As other I/O modules, the IP 263 is mounted on the bus unit (see Chapter 3).

- With the S5-90U, a maximum of 3 positioning modules can be plugged in only at slots 0 through 5.
- With the S5-95U, a maximum of 4 positioning modules can be plugged in only at slots 0 through 7.

Addressing

The IP 263 is addressed like a 4-channel analog module.

16.9 IP 264 Electronic Cam Controller Module

6ES5 264-8MA12

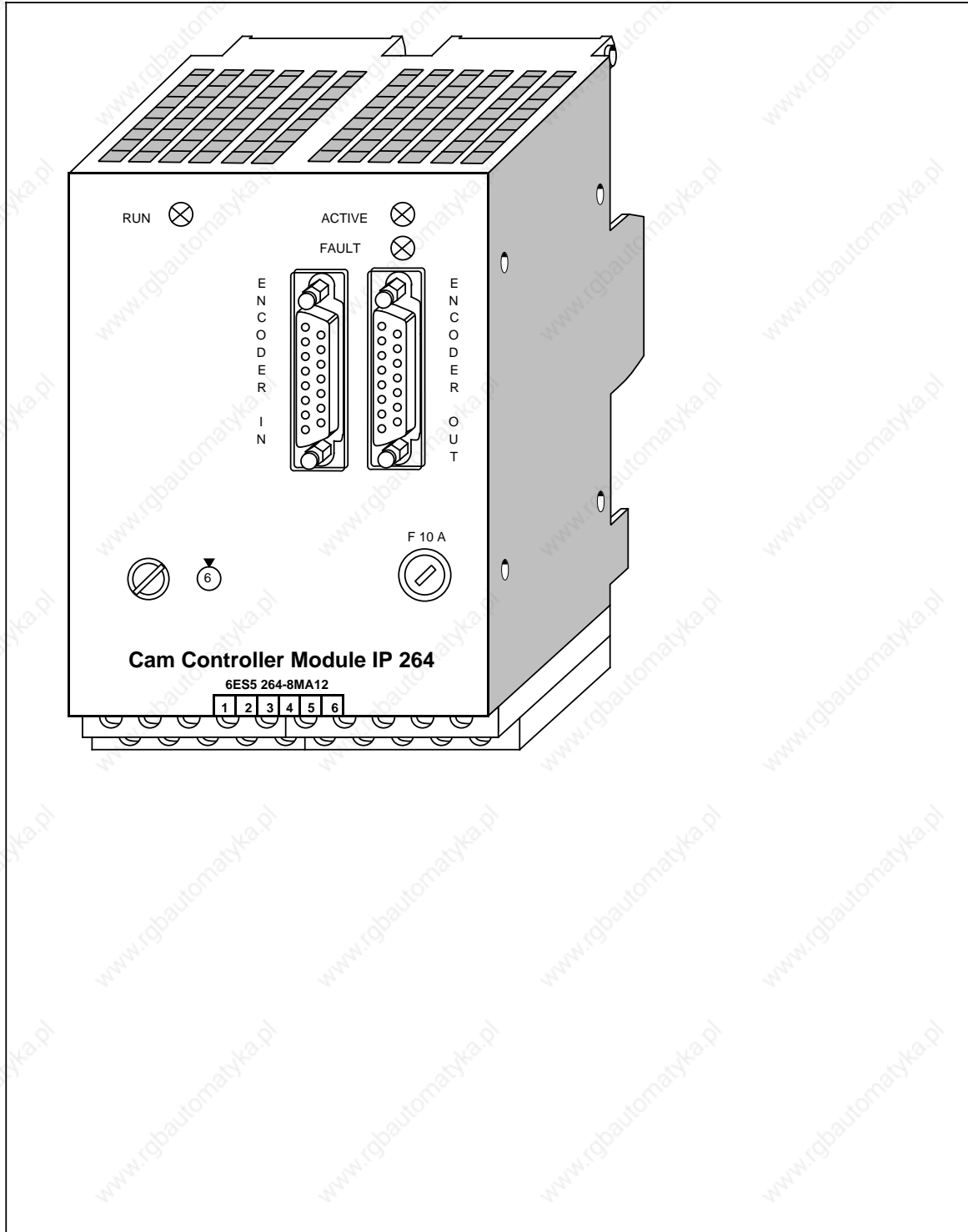

Technical Specifications		Digital Inputs	
Encoders		Input voltage range	-3 V to +30 V
Actual value sensing	incremental, absolute (SSI interface)	Galvanic isolation	no
Maximum traversing range		0 signal	-3 V to +5 V
- with incremental encoders	2 ¹⁶ increments	1 signal	+13 V to +30 V
- with absolute encoders	2 ¹⁶ encoders	Permissible zero-signal current at 0 signal	1.1 mA
Signal voltages		Input current at 24 V	typ. 5 mA
- Differential inputs	5 V to RS 422		
- Asymmetrical inputs	24 V (only incremental encoders)	Other: If the digital inputs are used, they must always be connected to a defined potential (0 V, 24 V) and must not be kept open.	
Supply voltage for encoders (short-circuit-proof, no overload)	5 V/300 mA 24 V/300 mA	Digital Outputs	
Input frequency and cable length		Output voltage range	+20 V to +30 V
Symmetrical encoders (5 V signals):		Galvanic isolation	no
- with 5 V encoder supply	max. 200 kHz for 32 m (105 ft.) cable, shielded	Output current at 1 signal	max. 300 mA
- with 24 V encoder supply	max. 200 kHz for 100 m (328 ft.) cable, shielded	Short-circuit protection	Short-circuit-proof output
Asymmetrical encoders (24 V signal):	max. 100 kHz for 25 m (82 ft.) cable, shielded	Cable length, shielded	max. 100 m (328 ft.)
	max. 25 kHz for 100 m (328 ft.) cable, shielded	Supply Voltage	
Data transmission rate and cable length with absolute encoders (selectable in steps)	125 kHz (160 m/525 ft. shielded) 250 kHz 500 kHz 1 MHz (32 m/105 ft. shielded)	Logic voltage from 24 V supply produced with switched-mode power supply	4.9 V to 5.1 V
Input signals		Current consumption from 24 V without outputs and sensors	typ. 120 mA
- Incremental	2 pulse trains displaced by 90° 1 zero pulse	Undervoltage monitoring	V _{internal} < 4.65 V
- 24 V initiator (BERO)	1 pulse train	Power Loss	typ. 4 W
- SSI	Absolute value	Module Cycle Time (incl. dead-time compensation)	
Input currents	to RS 422	Separate cam programs with max. 32 cams each for forwards and backwards	
- 5 V	typ. 5 mA	(incl. dead-time compensation)	57.6 μs
- 24 V		"Common" cam program with max. 32/64 cams for forwards and backwards	57.6/115.2 μs

A separate manual is available for the electronic cam controller. It can be ordered under the order number 6ES5 998-5SL21.

The IP 264 can be used both for rotary and linear axes.

The IP 264 electronic cam controller makes electronic processing of cams economical even for applications in the lower performance range.

32 cams which can be allocated as desired to 16 tracks have a switching accuracy of better than 1 degree at 2400 revolutions per minute. This corresponds to a response time of less than 60 μ s. For applications with low precision requirements it is even possible to program 64 cams.

It is also possible to integrate 32 cams each into a cam program for "forwards" and a cam program for "backwards". Switchover between these two programs is carried out by automatic direction sensing of the IP 264 or it is controlled by the SIMATIC S5.

All cams can be defined either as path-path cams or as path-time cams.

Dead Time Compensation

Through the speed-dependent, dynamic shift, each individual cam compensates the dead time of the actuator connected (e.g. pneumatic valve) at a scanning rate of 60 μ s. This enables the utmost accuracies to be achieved even at changing drive speeds.

Direct Process Connection

In order to be able to pass on the short response time of the IP 264 directly to the process, a digital output (24 V, 0.3 A) is available on the module for each track. Generally, the units to be controlled can be connected directly. Auxiliary contactors are required only for actuators with a higher current consumption.

The sensors to be connected can be incremental encoders, absolute SSI encoders (SSI= synchronous serial interface) or simple 24 V signal sensors (e.g. BEROs). The sensor data can be looped through to further modules via the additional sensor output, without separating the sensor cables mechanically or using additional fan-out units.

Installation

As other I/O modules, the IP 263 is mounted on the bus unit (see Chapter 3).

- With the S5-90U, a maximum of 3 positioning modules can be plugged in only at slots 0 through 5.
- With the S5-95U, a maximum of 4 positioning modules can be plugged in only at slots 0 through 7.

Addressing

The IP 264 is addressed like a 4-channel analog module.

16.10 IP 265 High Speed Sub Control

(6ES5 265-8MA01)

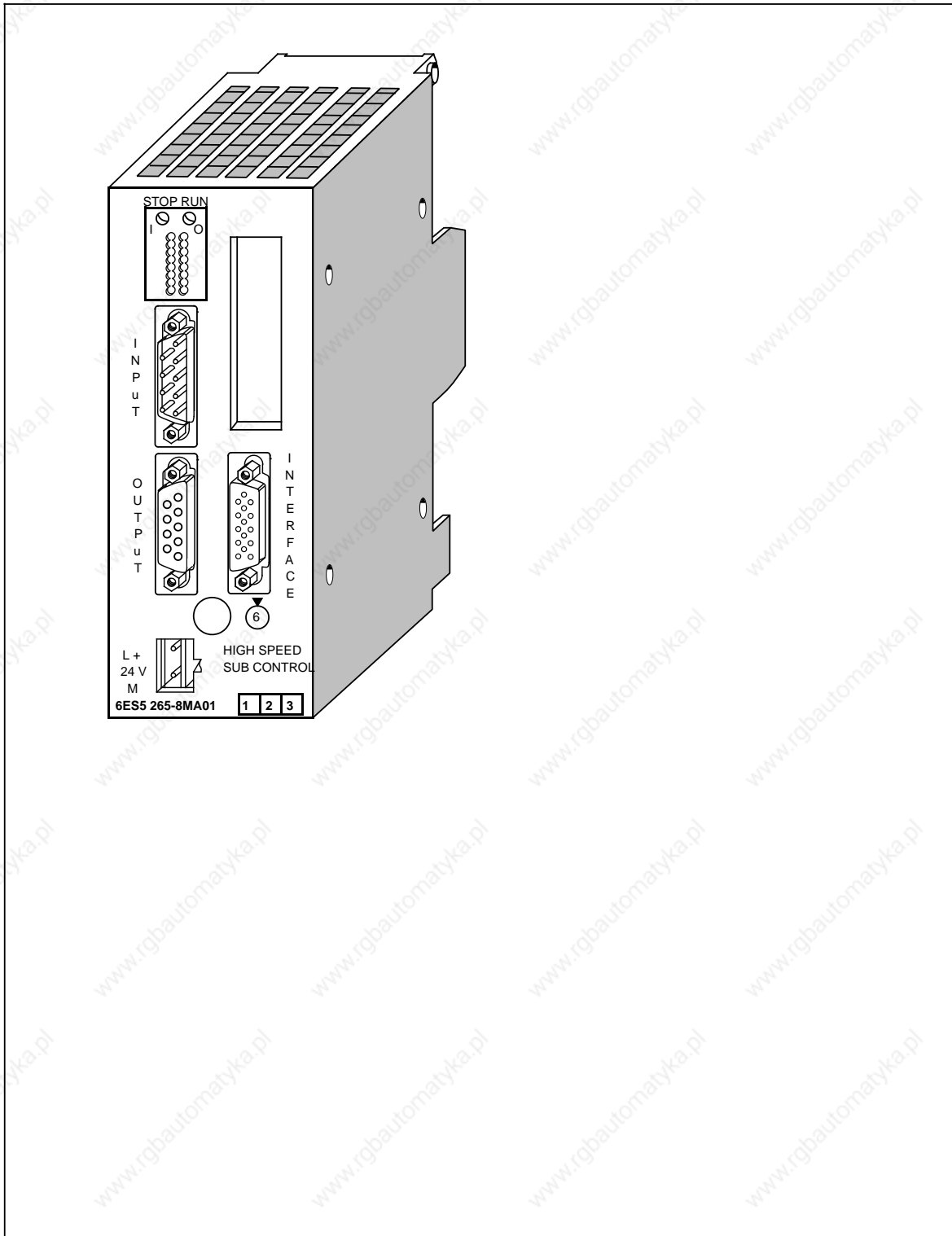

Technical Specifications		Digital 24 V outputs (9-pin sub D socket connector)	
Current consumption from +9 V (CPU)	<175 mA	Number of outputs	8
Signal status display	only for 24 V inputs and 24 V outputs (green LEDs)	Galvanic isolation	no
Operating status display	STOP (red LED) RUN (green LED)	Status display	Yes, on 5 V side
Memory submodule	EPROM/EEPROM	Short-circuit protection	Yes, electronic clock cycle
Power loss	typ. 2.3 W	Load voltage L+ - Rated value - Permissible range	24 V DC 20 to 30 V
Weight	approx. 300 g	Output current at "1" signal	0.5 A at 60 °C
Digital 24 V Inputs (9-pin sub D connector)		Permissible total current of output	2 A at 60 °C
Number of inputs	8	Connection of outputs in parallel	possible in pairs ($I_{\text{outp}}=0.8 \times I_{\text{rated}}$)
Galvanic isolation	no	Output frequency at ohmic load	max. 1 kHz at 15 mA load* max. 2 kHz at 50 mA load* max. 4 kHz at 500 mA load*
Status display	Yes, on 5 V side	Cable length	max. 100 m (330 ft.)
Input voltage L+ - Rated value - for "0" signal - for "1" signal	24 V DC 0 to 5 V 11 to 30 V (IEC 65A)	Lamp load	max. 2 W
Input current at "1" signal	typ. 6.5 mA (IEC 65 A)	Residual current at "0" signal	max. 1 mA
Connection of 2-wire BERO	possible (zero signal current 1.5 mA)	Voltage drop at "1" signal	max. 1 V
Input frequency	max. 10 kHz	Limitation of inductive cut-off voltage	-15 V
Cable length (shielded)	max. 100 m (330 ft.)	Delay time of output circuit - Rising edge - Falling edge, depending on ohmic load:	typ. 10 µs typ. 150 µs at 15 mA load* typ. 90 µs at 50 mA load* typ. 70 µs at 500 mA load*
Delay time of input circuit - Rising edge - Falling edge	typ. 15 µs typ. 10 µs	Expansion input and outputs (15-pin D sub HD socket connector)	
5 V differential inputs (15-pin D sub HD socket connector)		Number of inputs and outputs	8 (any desired mixture of I/Os can be configured)
Number and type of input signals	3 differential signals RS 422	Connector for 24 V load voltage (2-pin)	
Input frequency	max. 58 kHz	Permissible cross-sections of cables - Flexible cable H07V-K with end sleeve - Solid cable H07V-U	0.5 to 1.5 mm ² 0.5 to 2.5 mm ²
Pulse length - "Low" level - "High" level	min. 8.6 µs min. 8.6 µs		
Cable length (shielded)	max. 32 m (105 ft)		

* Peak value (no effective value specified)

The IP 265 High Speed Sub Control is a powerful, user-programmable I/O module which relieves the CPU's of the SIMATIC S5-100 systems of automation tasks which place great demand on speed and reproducibility.

A separate manual is available for the IP 265. It can be ordered under the order number 6ES5 998-5SH21.

Function

The IP 265 High Speed Sub Control is available with a COM software package which is required to determine the function of the module.

The use of the IP 265 in an S5 system enables rapid I/O processing in the millisecond range. By implementation of an FPGA (Field Programmable Gate Array) in the IP 265 it is possible to process process signals in parallel and very fast.

The IP 265 user program consists of elementary basic functions such as logic operations, counters, timers or comparators. The structure of the IP 265 user program is based on the CSF5 type of representation.

The following can be used:

- Either a user-programmed user program
or
- a fixed-programmed standard program from SIEMENS.

The COM 265 is available for user-programming of the IP 265. Besides it being programmable, the IP 265 can also be used to implement the special "counter" function with a fixed-program standard program. For this purpose, SIEMENS AG offers a memory submodule for the IP 265 with the standard "counter" function.

The IP 265 user program is automatically processed by the IP 265. It conditions process input signals to process output signals. The IP 265 can read 11 process inputs (8 x 24 V inputs, 3 x 5 differential inputs) and set 8 process outputs (24 V outputs).

The program capacity of the FPGA and the number of process inputs/outputs of **one** IP 265 are limited. The IP 265 is therefore used for rapid sub controls. By adding one IP 265 to another, complex sub-processes can be controlled with this module.

Installation

As other I/O modules, the IP 265 High Speed Sub Control is mounted on a bus unit.

- With the S5-90U, a maximum of 1 IP 265 module (limited by current consumption) can be plugged in only at slots 0 to 5 steckbar.
- With the S5-95U, a maximum of 5 IP 265 modules (limited by current consumption) can be plugged in only at slots 0 to 7.

Addressing

The module is addressed like a 4-channel analog module.

16.11 IP 266 Positioning Module

(6ES5 266-8MA11)

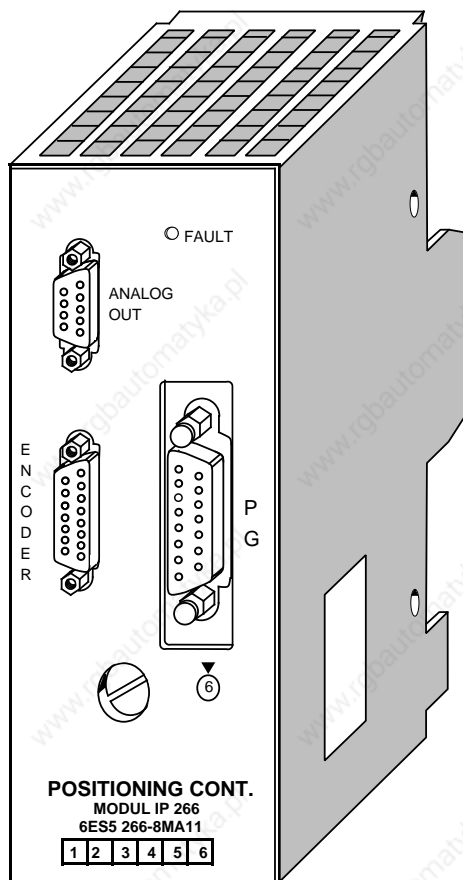
**Technical Specifications****Analog Output**

Output signal range	±10 V
Digital signal representation	13 bits plus sign
Short-circuit proof	Yes
Reference potential of the analog output signal	analog ground of the power section
Cable length shielded	max. 32 m (105 ft)

Pulse Input

Position decoder	incremental
Traverse range	±32767.999 mm/ 0.1 inch/grd
Input voltage for the tracks	
- differential inputs	5 V/RS 422
- asymmetrical inputs	24 V/typ. 7.3 mA
Supply voltage for the sensor (short-circuit proof)	5 V/350 mA 24 V/350 mA

Input Frequency and Cable Length

Symmetrical sensors (5 V)	max. 500 kHz, 30 m (98 ft) shielded cable length
Asymmetrical sensors (24 V)	max. 100 kHz at 25 m cable length shielded
	max. 25 kHz at 100 m cable length shielded

Input Signals

	2 pulse series 90 degrees out of phase, 1 zero pulse
--	--

Digital Inputs

Input voltage range	±30 V
Galvanic isolation	no
"0" signal	- 30 V to +5 V
"0" signal	13 V to 30 V
Permissible zero signal current at "0" signal 24 V	1.5 mA 7.3 mA

Digital Outputs

Output voltage range	20 V to 30 V
Galvanic isolation	no
Max. output current at "1" signal	100 mA
Short-circuit protector	short-circuit proof output
Cable length shielded	max. 100 m (330 ft.)

Supply voltage

Logic voltage from 24 V ext. supply produced with switched-mode power supply	4.7 V to 5.5 V
Current consumption from 24 V supply without outputs and 24 V sensor	typ. 180 mA

Because of its performance capability and the complexity of its description, the IP 266 has its own manual. The order number is: 6ES5 998-5SC21. The positioning control module IP 266 expands the field of application for "positioning operations" of the S5-90/95U.

As an "intelligent I/O module", it allows you to use open-loop as well as closed-loop control positioning.

The positioning operations are processed independently of the execution times of the user programs in the programmable controller. Thus the CPU is not burdened with positioning jobs constantly being processed.

Operation Principle of the IP 266

The IP 266 enables you to control the positioning operation of your drive exactly. The module delivers a voltage setpoint in the range of ± 10 V via an analog output for the control of a power section for servo motors.

The IP 266 needs exact data about your drive system in order to calculate speed, acceleration, or traverse residual distances. This data can be stored in an EEPROM that is permanently installed in the programmable controller. By using its own start-up routine, this data can be accessed immediately after you switch on the programmable controller and can be processed directly.

The IP 266 allows you to select between a linear axis and a circular axis. You can also select the unit of measurement for processing the data: either [mm], [in.] or [deg].

Linear Axis	Circular Axis
 <p style="text-align: center;">Table</p>	 <p style="text-align: center;">Beginning/end of traversing range</p> <p style="text-align: center;">Rotary table</p> <p style="text-align: center;">Continuous belt</p>
Can be initialized in [mm], [in.]	Can be initialized in [deg], [mm], [in.]

Figure 16-28. Processed Units of Measurement for Circular Axis and Linear Axis

Besides purely traversing movements, other operating modes allow offset generation of axis coordinates or drift compensation in the system. In addition, the IP 266 offers operating modes to read data such as positioning actual value or residual traversing distances.

In order to use the IP 266 in an automatic manufacturing process, it is possible to combine individual traversing applications, positioning corrections, offsets or dwell times in a "traversing program". These traversing programs can be called up via two special operating modes and processed automatically or semi-automatically.

Such a traversing program can be created by using the "learning capable" "Teach-in-mode" for positioning applications. The information from single positioning applications can be stored at the end of an operation in a traversing program.

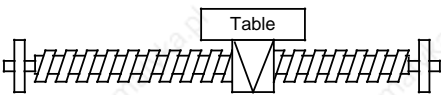
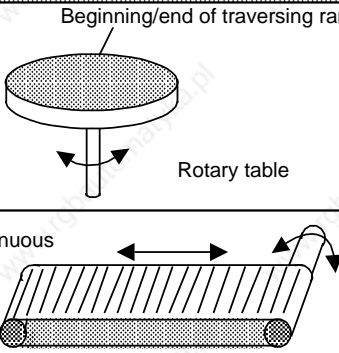
Positioning

For the positioning operation, the IP 266 calculates the setpoint from the selected end data and velocity data in conjunction with the programmed machine data. The actual value follows the selection. The deviation (following error) which occurs reaches a constant value after the short start-up phase and must reach zero at the end of the positioning operation.

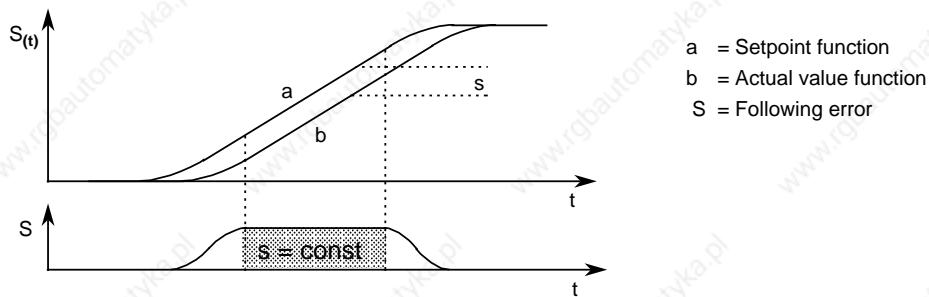

Figure 16-29. Course of a Following Error during a Positioning Operation

Overview of the Operation Modes

Table 16-8. Designation of the Operating Modes

Description		
JOG 1	AUTOMATIC SINGLE BLOCK	ACKNOWLEDGE ERROR
JOG 2	TEACH-IN ON	DRIFT COMPENSATION ON
CONTROLLED JOG	TEACH-IN OFF	DRIFT COMPENSATION OFF
FOLLOW-UP MODE	ZERO OFFSET ABSOLUTE	RAM EEPROM
REFERENCE POINT	ZERO OFFSET RELATIVE	READ ACTUAL POSITION
INCREMENTAL ABSOLUTE	CLEAR ZERO OFFSET	READ FOLLOWING ERROR
INCREMENTAL RELATIVE	TOOL OFFSET ON	READ DISTANCE TO GO
AUTOMATIC	TOOL OFFSET OFF	SYNCHRONIZE IP

The COM 266 software package offers user friendly operation and parameter settings. The IP 266 exchanges all data with the programmable controller via a serial interface. All tasks written in 8-byte messages are sent to the IP 266 during the program cycle via the process output image (PIQ). The IP 266 transmits feedback messages cyclically via the process image input (PII). These messages can be about the actual value position, remaining traversing distance, or following error as well as a status byte, error byte, the current operation mode, and special data from the traversing program.

Installation

- Plug the IP 266 into a bus unit like any other I/O module.
- With the S5-90U, a maximum of 4 positioning modules (limited by addressing range) can be plugged in only at slots 0 to 5.
- With the S5-95U, a maximum of 8 positioning modules (limited by addressing range) can be plugged in only at slots 0 to 7.
- Connect the external switches to the digital inputs of the IP 266 via the terminal block. These switches are used to limit the traversing range. They also allow you to intervene at any time into the processing of the module.
- The IP 266 can bypass the CPU of the programmable controller, via three digital outputs, and send signals directly to external I/Os. The controller must, however, be enabled (function signal enable controller, FUM) and must be connected to the power section of the drive.
- Connect the servo motor's power section to the 9-pin subminiature D female connector.
- Connect the incremental encoder to the left 15-pin subminiature D female connector "ENCODER".
- You can connect a programmer with screen to the 15-pin subminiature connector on the right side to operate the IP 266 via the COM software.

16.12 IP 267 Stepper Motor Control Module

(6ES5 267-8MA11)

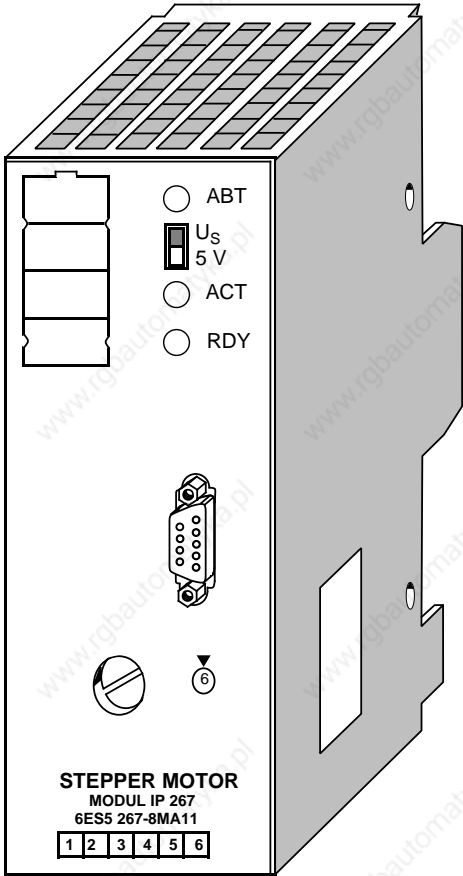

Technical Specifications

Supply voltage (PLC BUS)	9 V
Current consumption	approx. 150 mA
Special voltage V_S	5 V to 30 V

Digital Inputs

Rated input voltage	24 V
Galvanic isolation	no
Input voltage:	
"0" signal	- 33 V to 5 V
"1" signal	13 V to 33 V
Input current	typ. 8.5 mA
Supply voltage for two-wire BEROs	22 V to 30 V

9-pin Subminiature D Interface

Output voltage with 5-V supply	
"0" signal	max. 0.4 V
"1" signal	min. 4.5 V
With special supply voltage V_S (5 V to 30 V)	
"0" signal	max. 0.4 V
"1" signal	min. $V_S - 0.4 V$
Output current	20 mA (short-circuit proof)
Output frequency	max. 204 kHz
Increment number of steps	max. $2^{20} - 1$ pulses/job
Permissible cable length	max. 50 m (165 ft.) at 50 kHz (twisted pair cable)

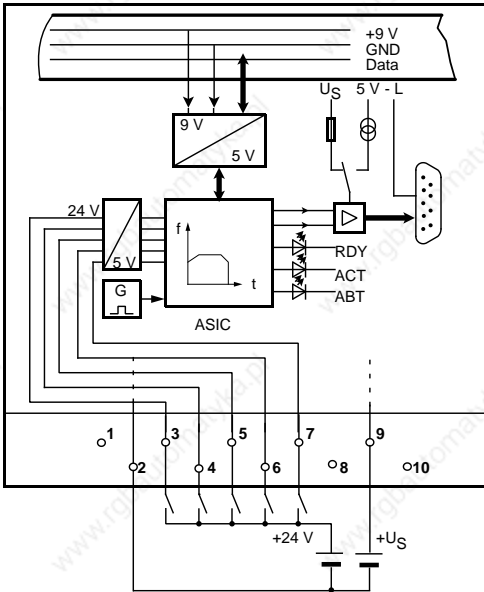

Because of its performance capability and the complexity of its description, the IP 267 has its own manual. The order number is: 6ES5 998-5SD21. The IP 267 Stepper Motor Control Module expands the field of application as an intelligent I/O module (IP) of the S5-100U and S5-95U programmable controllers for "closed-loop control positioning". The IP 267 controls positioning processes independently of the run time of user programs in the programmable controller. The CPU is not loaded with processing positioning job operations.

Principle of Operation

The IP 267 generates pulses for the stepper motor power section. The number of output pulses determines the length of the traversing path and the pulse frequency is a measure of the velocity. Each pulse causes the stepper motor shaft to turn through a certain angle. In the case of high-speed pulse trains, this step movement becomes a constant rotational movement. Stepper motors can reproduce all movement sequences only as long as no steps are lost. Step losses can be caused when load variations occur or when the programmed pulse trains exceed motor-specific values.

To enable the IP 267 to generate these pulse trains, the user must enter the following data.

- Configuration data: This data describes the individual stepper motors and the technical characteristics of the drive system.
- Positioning data: This data describes the individual traverse jobs and indicates the velocities, directions, and lengths of the configured paths.

The IP exchanges data with the programmable controller via the serial interface. During the program scans, all necessary information is sent from the process image output table (PIQ) to the IP 267 in 4-byte messages. The IP 267 cyclically transmits feedback signals on the remaining distance to go and various status bits to the process image input table (PII).

Using the configuration and positioning data settings, the IP 267 generates a symmetrical traverse profile consisting of an acceleration ramp, a constant velocity range and a deceleration ramp.

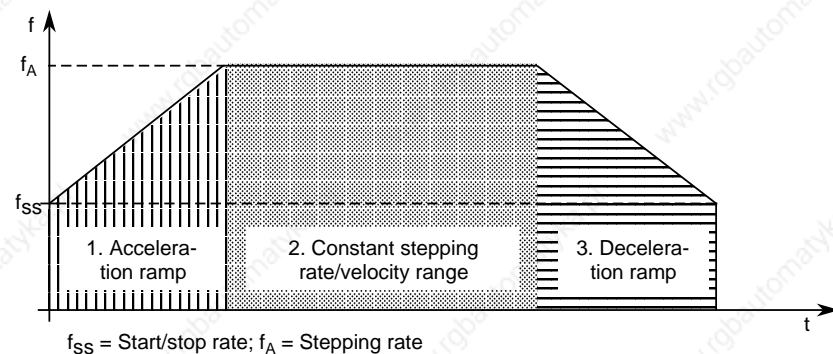

Figure 16-30. Velocity Profile of the IP 267

Using a limit switch on the digital inputs, IP 267 can monitor the limits of a traversing range and stop the traversing movement when the permissible range limit is exceeded.

The activated input "external stop" causes a calculated decelerating of the traversing movement. An emergency limit switch can be installed at input "IS" (pulse inhibit). When this switch responds, the pulse output is interrupted immediately.

For a reference point approach operation, an additional switch can be connected at input REF that lies within the traversing zone. The reference point approach operation is also possible without this switch.

Status LEDs provide you with the following information.

The IP 267 is configured	RDY
Pulse outputs during a positioning operation	ACT
Interruption of the positioning operation	ABT

There are four operating modes:

STOP
START FORWARDS
START BACKWARDS
NEUTRAL

Installation

- Plug the IP 267 into a bus unit like any other I/O module.
- With the S5-90U, a maximum of 2 IP 267 modules (limited by current consumption) can be plugged in at slots 0 to 5.
- With the S5-95U, a maximum of 6 IP 267 modules (limited by current consumption) can be plugged in at slots 0 to 7.
- Connect the external switches to the DIs of the IP 267 via the terminal block.
- Connect the stepper motor's power section to the 9-pin subminiature D female connector.

Addressing

The IP 267 is addressed like an analog module.

16.13 CP 521 SI Communications Processor

(6ES5 521-8MA22)

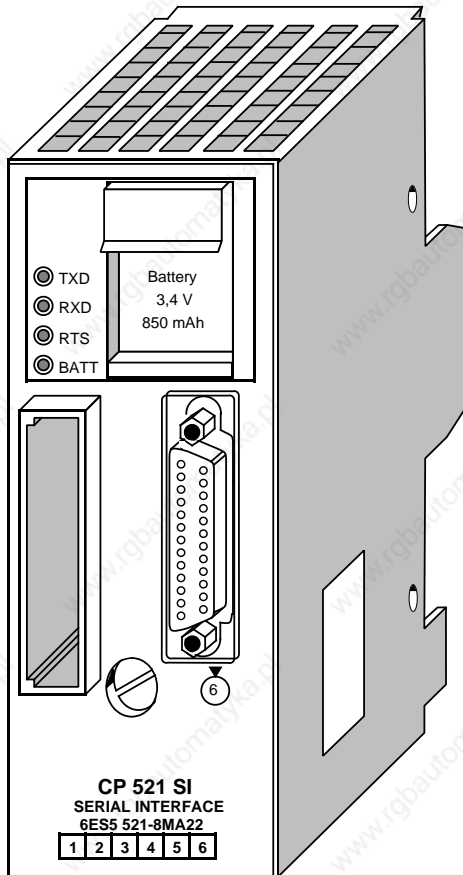

Technical Specifications

Galvanic isolation	TTY signals are isolated
Memory submodule	EPROM/EEPROM
Serial interface	V.24/TTY passive (active)
Transmission	Asynchronous 10-bit character frame/11-bit character frame
Transmission rate	110 to 9600 baud
Permissible cable length	15 m (49.2 ft.)
- V.24	Results from: (Voltage drop on cable)+ (Receiver-typ. voltage drop 1.5 V) or (transmitter-typ. voltage drop 0.9 V)
- TTY	max. 1000 m (3281 ft.)
LED displays	Transmitting Receiving Ready to send Battery failure
- TxD (green)	
- RxD (green)	
- RTS (green)	
- BATT (yellow)	
Back-up battery	3.6 V/850 mAh
Lithium 1/2 AA	
Current consumption from +9 V	typ. 140 mA
Power loss of module	typ. 1.2 W
Weight	approx. 500 g (1.1 lb.)

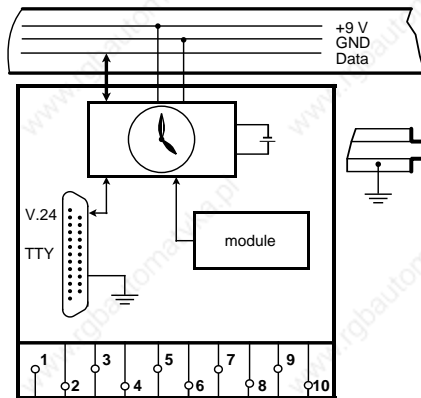

The CP 521 SI (Serial Interface) communications module is a powerful I/O module with its own central processor.

A separate manual is available for this module. It can be ordered under the order number 6ES5 998-1UD21.

The following is an overview of the module's mode of operation.

Function

The CP 521 SI can be used for unidirectional and bidirectional data exchange.

Unidirectional Data Exchange

For unidirectional data traffic, the CP 521 is provided with a printer driver. If the printer driver is used, the following must be connected to the serial interface of the CP 521 SI:

- A printer with TTY interface (active) or
- A printer with V.24 (RS 232C) interface.

This enables you to log process states and process disturbances. The output of messages on the printer does not extend the response time of the programmable controller.

The following messages and texts can be output:

- Message texts, which you have configured on a memory submodule in data blocks DB 2 to 63.
- Time of day and date, which are provided by the module's own clock
- Values for variables which are transmitted to the CP 521 SI via the I/O bus.

The message texts are stored on an EPROM or EEPROM memory submodule (up to 8/16 Kbytes).

Bidirectional Data Exchange

The following drivers are implemented for the bidirectional data exchange:

- ASCII driver, transparent
- ASCII driver, interpreting mode I and interpreting mode II
- "3964(R)" driver
- SINEC L1 driver, master (point-to-point)
- SINEC L1 driver, slave
- Terminal driver

The use of these drivers enables the transmission of data frames between the CPU and an I/O device connected to the CP 521 SI.

The maximum data flow rate is 6 bytes of user data per 2 program cycles; i.e. at a program cycle time of, for example, 50 ms a maximum of 60 bytes per second can be transmitted.

The following terminals and communications devices can be used as I/O devices:

- Keyboard
- Terminal
- Another CP 521 SI
- CP 523
- S5-95U with second serial interface
- CP 524/CP 525-2 (in connection with special driver 6ES5 897-2AB11)
- CPU 944 (with ASCII driver, 3964(R) driver)
- Other I/O devices with serial interface, e.g. bar code readers

Which of the I/O devices and transmission modes are used depends on the intended application of data transmission. In the bidirectional data exchange mode of the module you are, for example, able to network programmable controllers (point-to-point link).

I/O devices and CP 521 SI are connected with each other via a serial interface. Either a passive TTY interface or a 24 V voltage interface are available (programmable).

Parameterizing (matching) of the I/O interface and configuring of the message texts are supported by the DB editor of programmers. The parameters of the I/O interface are stored either on a memory submodule in DB1 or are directly transmitted in the user program. The CP 521 SI can be programmed and operated without the COM software.

Integrated Real-Time Clock

The CP 521 SI has its own real-time clock which is battery-backed when the module is in the de-energized state. Independent of the type of function selected for the CP 521 SI, the clock data can be read from the CPU and can be used in the user program for date and time-dependent tasks.

Installation

As other I/O modules, the CP 521 SI is mounted on the bus unit.

- With the S5-90U, a maximum of 2 CP 521 SI modules (limited by current consumption) can be plugged in only at slots 0 to 5.
- With the S5-95U, a maximum of 7 CP 521 SI modules (limited by current consumption) can be plugged in only at slots 0 to 7.
- The module has no connection to the terminal block.

Addressing

The CP 521 SI is addressed like a 4-channel analog module.

16.14 CP 521 BASIC Communications Module

(6ES5 521-8MB12)

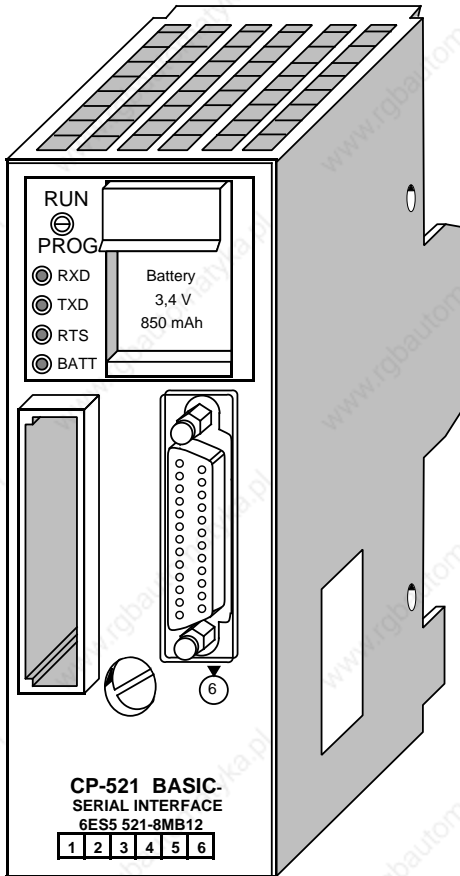

Technical Specifications

Galvanic isolation	TTY signals are isolated
Serial interface	V.24 (RS-232-C)/TTY, passive (active)
Memory submodule	EPROM/EEPROM/ RAM
Real-time clock	± 1 s/day at 25 °C (77 °F)
- accuracy tg	
- variation due to temperature change ΔT	-10 to +70 °C
- (ambient temperature TV in °C)	1 s to -11 s according to data sheet
Transmission mode	asynchronous 10-bit character frame /11-bit character frame
Baud rate	110 to 9600 Baud
LED displays:	
-TXD	Send data
- RXD	Receive data
- RTS	Ready to send
- BATT	Battery low signal (yellow LED)
Permissible cable lengths	
-TTY, dependent on voltage drop on the + line:	
- typical for receiver	1.5 V +
- typical for sender	0.9 V
- V.24	15 m (50 feet)
Back-up battery	Battery failure display, yes
Lithium 1/2 AA	3.4 V/850 mAh
Life expectancy	1 year minimum
Degree of protection	IP 20
Current consumption from + 9 V (CPU)	typ. 180 mA
Power loss of the module	typ. 1.6 W
Weight	approx. 500 g (1 lb 5 oz.)

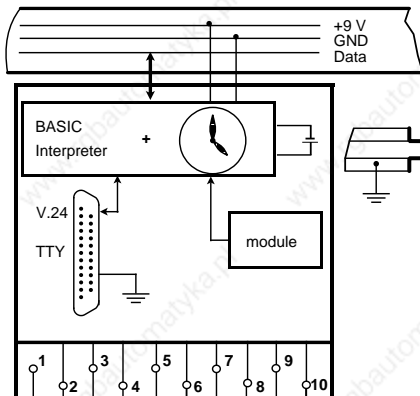

The CP 521 BASIC is a powerful peripheral module that can be used with the SIMATIC systems S5-90U, S5-95U and the S5-100U. It has its own central processor (cannot be used with the CPU 100, 6ES5 100-8MA01).

A separate manual for this module is available. The order number is 6ES5 998-0UW21.

A brief overview of the functions of this module follows.

Function

This module comes with a special COM software package that is required for generating and storing BASIC programs (on a floppy disk or an EPROM submodule).

Since the CP 521 includes a basic interpreter, you can create and run BASIC programs that exchange data with a CPU and a connected peripheral device. Use a programmer or a PC terminal and the COM software to program the BASIC interpreter.

You can store the BASIC programs in the module's own battery backed-up RAM or on a memory submodule that can be plugged in.

Connect programmers or PC terminals to the CP 521 via a serial interface. You can choose (by setting parameters) between a passive TTY current-loop interface or a RS-232 C V.24 interface to connect a programmer or terminal. Connect a printer to the unidirectional V.24 interface of the module to print listings or messages.

Change parameter settings for the peripheral interface by using a BASIC command or by using the BASIC program.

The CP 521 has an integral real-time clock that can be backed up by a battery. You can use the clock data in unidirectional data traffic to log process statuses or process malfunctions.

Installation

- Install the CP 521 BASIC communications module on the bus module like any other I/O module (see section 3)
- With the S5-90U, a maximum of 1 communications module (limited by current consumption) can be plugged in only at slots 0 to 5.
- With the S5-95U, a maximum of 5 communications modules (limited by current consumption) can be plugged in only at slots 0 to 7.
- The module has no connection to the terminal block.
- Connect the printer to the module via a 25-pin sub-D female connector.

Addressing

The module is addressed like a 4-channel analog module.

www.rgbautomatyka.pl

Appendices

Appendix A	Operations List, Machine Code and List of Abbreviations
Appendix B	Technical Specifications, DB1 Parameters, RAM Address Assignment
Appendix C	Dimension Drawings
Appendix D	Active and Passive Faults in Automation Equipment/Guidelines for Handling Electrostatic Sensitive Devices (ESD)
Appendix E	Information for Ordering Accessories
Appendix F	Reference Materials

www.rgbautomatyka.pl

A Operations List, Machine Code and List of Abbreviations		
A.1	Operations List	A - 1
A.1.1	Basic Operations	A - 1
A.1.2	Supplementary Operations	A - 8
A.1.3	System Operations	A - 13
A.1.4	Evaluation of CC 1 and CC 0	A - 14
A.2	Machine Code Listing	A - 15
A.3	List of Abbreviations	A - 18

www.rgbautomatyka.pl

A Operations List

A.1 Operations List

A.1.1 Basic Operations

- for organization blocks (OB) for function blocks (FB)
 for program blocks (PB) for sequence blocks (SB)

Operation (STL)	Permissible Operands	RLO*			S5-90U Execution Time in μ s		S5-95U Execution Time in μ s		Function
		1	2	3	Onboard	Ext. I/O	Onboard	Ext. I/O	
Boolean Logic Operations									
A	I, Q	N	Y	N	1 to 2	3 to 5	1 to 2	3 to 5	Scan operand for "1" and combine with RLO through logic AND.
	F	N	Y	N	3 to 5		3 to 5		
	T	N	Y	N	6 to 10		6 to 10		
	C	N	Y	N	3 to 6		3 to 6		
AN	I, Q	N	Y	N	2	3 to 5	2	3 to 5	Scan operand for "0" and combine with RLO through logic AND.
	F	N	Y	N	3 to 5		3 to 5		
	T	N	Y	N	6 to 10		6 to 10		
	C	N	Y	N	3 to 6		3 to 6		
O	I, Q	N	Y	N	1 to 2	3 to 5	1 to 2	3 to 5	Scan operand for "1" and combine with RLO through logic OR.
	F	N	Y	N	3 to 5		3 to 5		
	T	N	Y	N	6 to 10		6 to 10		
	C	N	Y	N	3 to 6		3 to 6		
ON	I, Q	N	Y	N	2	3 to 5	2	3 to 5	Scan operand for "0" and combine with RLO through logic OR.
	F	N	Y	N	3 to 5		3 to 5		
	T	N	Y	N	6 to 10		6 to 10		
	C	N	Y	N	3 to 6		3 to 6		
O		N	Y	Y	2 to 5		2 to 5		Combine AND operations through logic OR.
A(N	Y	Y	4 to 8		4 to 8		Combine expressions enclosed in parentheses through logic AND (6 nesting levels).
O(N	Y	Y	4 to 8		4 to 8		Combine expressions enclosed in parentheses through logic OR (6 nesting levels).
)		N	Y	Y	4 to 10		4 to 10		Close parentheses (conclusion of a parenthetical expression).
Set / Reset Operations									
S	I, Q	Y	N	Y	2	5 to 8	2	5 to 8	Set operand to "1".
	F	Y	N	Y	5 to 8		5 to 8		

* 1 RLO dependent ? 2 RLO affected ? 3 RLO reloaded ?

Operation (STL)	Permissible Operands	RLO*			S5-90U Execution Time in µs		S5-95U Execution Time in µs		Function
		1	2	3	Onboard	Ext. I/O	Onboard	Ext. I/O	
Set / Reset Operations (cont.)									
R	I, Q	Y	N	Y	2	5 to 8	2	5 to 8	Reset operand to "0".
	F	Y	N	Y	5 to 8		5 to 8		
=	I, Q	N	N	Y	2	4 to 7	2	4 to 7	Assign value of RLO to operand.
	F	N	N	Y	4 to 7		4 to 7		
Load Operations									
L	IB	N	N	N	5	11	5	11	Load an input byte from the PII into ACCU 1.
L	QB	N	N	N	5	11	5	11	Load an output byte from the PIQ into ACCU 1.
L	IW	N	N	N	5	15	5	15	Load an input word from the PII into ACCU 1: byte n ACCU 1 (bits 8-15); byte n+1 ACCU 1 (bits 0-7)
L	QW	N	N	N	5	15	5	15	Load an output word from the PIQ into ACCU 1: byte n ACCU 1 (bits 8-15); byte n+1 ACCU 1 (bits 0-7)
L	PY0 to 31 PY64 to 127	N N	N N	N N	—		39		Permissible only in OB13. Load an input byte of the digital/analog inputs from the interrupt PII into ACCU 1.
	PY32/33 PY34/35 PY36 to 39 PY40 to 55	N N N N	N N N N	N N N N	8/11 — — —		40 to 48 40 to 48 45 to 60 105		Load an input word of the digital/analog inputs into ACCU 1.
	PW0 to 30 PW64 to 126	N N	N N	N N	—		42		Permissible only in OB13. Load an input word of the digital/analog inputs from the interrupt PII into ACCU 1.
	PW32 PW33 to 35 PW36 to 39 PW40 to 45	N N N N	N N N N	N N N N	17 — — —		50 to 67 50 to 67 55 to 80 104		Load an input word of the digital/analog inputs into ACCU 1.
L	FY	N	N	N	11		11		Load a flag byte into ACCU 1.
L	FW	N	N	N	15		15		Load a flag word into ACCU 1: byte n ACCU 1 (bits 8-15); byte n+1 ACCU 1 (bits 0-7).
L	DL	N	N	N	33		33		Load a data word (left-hand byte) of the current data block into ACCU 1.

* 1 RLO dependent ? 2 RLO affected ? 3 RLO reloaded ?

Operation (STL)	Permissible Operands	RLO*			S5-90U Execution Time in μ s		S5-95U Execution Time in μ s		Function
		1	2	3	Onboard	Ext. I/O	Onboard	Ext. I/O	
Load Operations (cont.)									
L	DR	N	N	N	35		35		Load a data word (right-hand byte) of the current data block into ACCU 1.
L	DW	N	N	N	35		35		Load a data word of the current data block into ACCU 1: byte n ACCU 1 (bits 8-15); byte n+1 ACCU 1 (bits 0-7).
L	KB	N	N	N	5		5		Load a constant (1-byte number) into ACCU 1.
L	KS	N	N	N	5		5		Load a constant (2 characters in ASCII format) into ACCU 1.
L	KF	N	N	N	5		5		Load a constant (fixed-point number) into ACCU 1.
L	KH	N	N	N	5		5		Load a constant (hexadecimal code) into ACCU 1.
L	KM	N	N	N	5		5		Load a constant (bit pattern) into ACCU 1.
L	KY	N	N	N	5		5		Load a constant (2-byte number) into ACCU 1.
L	KT	N	N	N	5		5		Load a constant (time in BCD) into ACCU 1.
L	KC	N	N	N	5		5		Load a constant (count in BCD) into ACCU 1.
L	T, C	N	N	N	14		14		Load a time or count (in binary code) into ACCU 1.
LD	T	N	N	N	58		58		Load times or counts (in BCD) into ACCU 1.
	C	N	N	N	59		59		
Transfer Operations									
T	IB	N	N	N	2	5	2	5	Transfer the contents of ACCU 1 to an input byte (into the PIJ).
T	QB	N	N	N	2	5	2	5	Transfer the contents of ACCU 1 to an output byte (into the PIQ).
T	IW	N	N	N	4	12	4	12	Transfer the contents of ACCU 1 to an input word (into the PII): ACCU 1 (bits 8-15) byte n; ACCU 1 (bits 0-7) byte n+1.

* 1 RLO dependent ? 2 RLO affected ? 3 RLO reloaded ?

Operation (STL)	Permissible Operands	RLO*			S5-90U Execution Time in µs		S5-95U Execution Time in µs		Function
		1	2	3	Onboard	Ext. I/O	Onboard	Ext. I/O	
Transfer Operations (cont.)									
T	QW	N	N	N	4	12	4	12	Transfer the contents of ACCU 1 to an output word (into the PIQ): ACCU 1 (bits 8-15) byte n; ACCU 1 (bits 0-7) byte n+1.
T	PY0 to 31 PY64 to 127	N N	N N	N N	—		41		Permissible only in OB13. Transfer the contents of ACCU 1 to the interrupt PIQ with updating of the PIQ.
	PY32/33	N	N	N	5/2		38		Transfer the contents of ACCU 1 to the output with updating of the PIQ.
T	PW0 to 30 PW64 to 126	N N	N N	N N	—		45		Permissible only in OB13. Transfer the contents of ACCU 1 to the interrupt PIQ with updating of the PIQ.
	PW32 PW40	N N	N N	N N	10 —		49 113		Transfer the contents of ACCU 1 to the output with updating of the PIQ.
	PW36/38	N	N	N	—		49 to 75		Reset counter to "0". Transfer comparison value.
T	FY	N	N	N	5		5		Transfer the contents of ACCU 1 to a flag byte.
T	FW	N	N	N	12		12		Transfer the contents of ACCU 1 to a flag word (into the PIQ): ACCU 1 (bits 8-15) byte n; ACCU 1 (bits 0-7) byte n+1.
T	DL	N	N	N	25		25		Transfer the contents of ACCU 1 to a data word (left-hand byte).
T	DR	N	N	N	26		26		Transfer the contents of ACCU 1 to a data word (right-hand byte).
T	DW	N	N	N	34		34		Transfer the contents of ACCU 1 to a data word.
Timer Operations									
SP	T	Y	N	Y	64		64		Start a timer (stored in ACCU 1) as a signal-contracting pulse on the leading edge of the RLO.

* 1 RLO dependent ? 2 RLO affected ? 3 RLO reloaded ?

Operation (STL)	Permissible Operands	RLO*			S5-90U Execution Time in μ s		S5-95U Execution Time in μ s		Function
		1	2	3	Onboard	Ext. I/O	Onboard	Ext. I/O	
Timer Operations (cont.)									
SE	T	Y	N	Y	64		64		Start a timer (stored in ACCU 1) as extended pulse (signal contracting and stretching) on the leading edge of the RLO.
SD	T	Y	N	Y	65		65		Start an on-delay timer (stored in ACCU 1) on the leading edge of the RLO.
SS	T	Y	N	Y	65		65		Start a stored on-delay timer (stored in ACCU 1) on the leading edge of the RLO.
SF	T	Y	N	Y	64		64		Start an off-delay timer (stored in ACCU 1) on the trailing edge of the RLO.
R	T	Y	N	Y	21		21		Reset a timer.
Counter Operations									
CU	C	Y	N	Y	35		35		Counter counts up 1 on the leading edge of the RLO.
CD	C	Y	N	Y	40		40		Counter counts down 1 on leading edge of the RLO.
S	C	Y	N	Y	62		62		Set counter if RLO="1".
R	C	Y	N	Y	17		17		Reset counter if RLO="1".
Arithmetic Operations									
+F		N	N	N	19		19		Add two fixed-point numbers: ACCU 1+ACCU 2. CC 1 / CC 0 / OV are affected.
-F		N	N	N	22		22		Subtract one fixed-point number from another: ACCU 2 - ACCU 1. CC 1 / CC 0 / OV are affected.
Comparison Operations									
!=F		N	Y	N	20		21		Compare two fixed-point numbers for "equal to": If ACCU 2=ACCU 1, the RLO is "1". CC 1 / CC 0 are affected.
><F		N	Y	N	22		22		Compare two fixed-point numbers for "not equal to": If ACCU 2 ACCU 1, the RLO is "1". CC 1 / CC 0 are affected.

* 1 RLO dependent ? 2 RLO affected ? 3 RLO reloaded?

Operation (STL)	Permissible Operands	RLO*			S5-90U Execution Time in μ s		S5-95U Execution Time in μ s		Function
		1	2	3	Onboard	Ext. I/O	Onboard	Ext. I/O	
Comparison Operations (cont.)									
>F		N	Y	N	22		22		Compare two fixed-point numbers for "greater than": If ACCU 2 > ACCU 1, the RLO is "1". CC 1 / CC 0 are affected.
>=F		N	Y	N	22		22		Compare two fixed-point numbers for "greater than or equal to": If ACCU 2 ACCU 1, the RLO is "1". CC 1 / CC 0 are affected.
<F		N	Y	N	22		22		Compare two fixed-point numbers for "less than": If ACCU 2 < ACCU 1, the RLO is "1". CC 1 / CC 0 are affected.
<=F		N	Y	N	22		22		Compare two fixed-point numbers for "less than or equal to": If ACCU 2 ACCU 1, the RLO is "1". CC 1 / CC 0 are affected.
Block Call Operations									
JU	PB	N	N	Y	63		66		Jump unconditionally to a program block.
JU	FB	N	N	Y	65		68		Jump unconditionally to a function block.
JU	SB	N	N	Y	—		66		Jump unconditionally to a sequence block.
JC	PB	Y	Y ¹⁾	Y	64		68		Jump conditionally to a program block.
JC	FB	Y	Y ¹⁾	Y	67		70		Jump conditionally to a function block.
JC	SB	Y	Y ¹⁾	Y	—		68		Jump conditionally to a sequence block.
C	DB	N	N	N	30		30		Call a data block.
G	DB	N	N	Y	—		109		Generate or delete a data block.
Return Operations									
BE		N	N	Y	37		42		Block end (termination of a block)
BEC		Y	Y ¹⁾	Y	38		43		Block end, conditional

* 1 RLO dependent ? 2 RLO affected ? 3 RLO reloaded ?

1) RLO is set to "1".

Operation (STL)	Permissible Operands	RLO*			S5-90U Execution Time in μ s		S5-95U Execution Time in μ s		Function
		1	2	3	Onboard	Ext. I/O	Onboard	Ext. I/O	
Return Operations (cont.)									
BEU		N	N	Y	37		42		Block end, unconditional (BEU cannot be used in organization blocks.)
"No" Operations									
NOP 0		N	N	N	0		0		No operation (all bits reset)
NOP 1		N	N	N	0		0		No operation (all bits set)
Stop Operation									
STP		N	N	N	1		1		Stop: scanning is still completed before a stop. Error ID "STS" is set in the ISTACK.
Display Generation Operations									
BLD 130		N	N	N	0		0		Display generation operation for the programmer: carriage return generates blank line.
BLD 131		N	N	N	0		0		Display generation operation for the programmer: switch to statement list (STL).
BLD 132		N	N	N	0		0		Display generation operation for the programmer: switch to control system flowchart (CSF).
BLD 133		N	N	N	0		0		Display generation operation for the programmer: switch to ladder diagram (LAD).
BLD 255		N	N	N	0		0		Display generation operation for the programmer: terminate a segment.

* 1 RLO dependent ? 2 RLO affected ? 3 RLO reloaded ?

A.1.2 Supplementary Operations and System Operations

- for organization blocks (OB) for function blocks (FB)
 for program blocks (PB) for sequence blocks (SB)

Operation (STL)	Permissible Operands	RLO*			S5-90U Execution Time in μ s		S5-95U Execution Time in μ s		Function
		1	2	3	Onboard	Ext. I/O	Onboard	Ext. I/O	
Boolean Logic Operations									
A=	Formal operand I, Q, F, T, C	N	Y	N	—	—	56 to 77	—	AND operation: scan formal operand for "1". (Data type: BI)
AN=	Formal operand I, Q, F, T, C	N	Y	N	—	—	57 to 78	—	AND operation: scan formal operand for "0". (Data type: BI)
O=	Formal operand I, Q, F, T, C	N	Y	N	—	—	56 to 77	—	OR operation: scan formal operand for "1". (Data type: BI)
ON=	Formal operand I, Q, F, T, C	N	Y	N	—	—	57 to 78	—	OR operation: scan formal operand for "0". (Data type: BI)
AW		N	N	N	16	—	16	—	Combine contents of ACCU 2 and ACCU 1 through logic AND (word operation). Result is stored in ACCU 1. CC 1 / CC 0 are affected.
OW		N	N	N	16	—	16	—	Combine contents of ACCU 2 and ACCU 1 through logic OR (word operation). Result is stored in ACCU 1. CC 1 / CC 0 are affected.
XOW		N	N	N	16	—	16	—	Combine contents of ACCU 2 and ACCU 1 through logic EXCLUSIVE OR (word operation). Result is stored in ACCU 1. CC 1 / CC 0 are affected.
Bit Operations									
TB	T, C	N	Y	N	—	—	5	—	Test a bit of a timer or counter word for "1".
TB	D	N	Y	N	—	—	32	—	Test a bit of a data word for "1".
TB	RS	N	Y	N	—	—	5	—	Test a bit of a data word in the system data area for "1".
TBN	T, C	N	Y	N	—	—	5	—	Test a bit of a timer or counter word for "0".

* 1 RLO dependent ? 2 RLO affected ? 3 RLO reloaded ?

Operation (STL)	Permissible Operands	RLO*			S5-90U Execution Time in μ s		S5-95U Execution Time in μ s		Function
		1	2	3	Onboard	Ext. I/O	Onboard	Ext. I/O	
Bit Operations (cont.)									
TBN	D	N	Y	N	—	—	33	—	Test a bit of a data word for "0".
TBN	RS	N	Y	N	—	—	5	—	Test a bit of a data word in the system data area for "0".
SU	T, C	N	N	Y	—	—	6	—	Set a bit of a timer or counter word unconditionally.
SU	D	N	N	Y	—	—	34	—	Set a bit of a data word unconditionally.
RU	T, C	N	N	Y	—	—	6	—	Reset a bit of a timer or counter word unconditionally.
RU	D	N	N	Y	—	—	34	—	Reset a bit of a data word unconditionally.
Set / Reset Operations									
S=	Formal operand I, Q, F	Y	N	Y	—	—	82 to 92	—	Set a formal operand (when RLO=1). (Data type: BI)
RB=	Formal operand I, Q, F	Y	N	Y	—	—	83 to 94	—	Reset a formal operand (when RLO=1). (Data type: BI)
RD=	Formal operand T, C	Y	N	Y	—	—	69 to 73	—	Reset a formal operand (digital) (when RLO=1).
==	Formal operand I, Q, F	Y	N	Y	—	—	80 to 91	—	Assign the value of the RLO to the status of the formal operand. (Data type: BI)
Timer and Counter Operations									
FR	T	Y	N	Y	—	—	20	—	Enable a timer/counter for cold restart. If RLO="1", - "FR T" restarts the timer - "FR C" sets, decrements, or increments the counter.
	C	Y	N	Y	—	—	16	—	
FR=	Formal op. T	Y	N	Y	—	—	70	—	Enable formal operand (timer/counter) for cold restart (for detailed description, see "FR" operation).
	Formal op. C	Y	N	Y	—	—	66	—	
SP=	Formal op. T	Y	N	Y	—	—	114	—	Start a timer (formal operand) as pulse with the value stored in ACCU 1.

* 1 RLO dependent ? 2 RLO affected ? 3 RLO reloaded ?

Operation (STL)	Permissible Operands	RLO*			S5-90U Execution Time in µs		S5-95U Execution Time in µs		Function
		1	2	3	Onboard	Ext. I/O	Onboard	Ext. I/O	
Timer and Counter Operations (cont.)									
SD=	Formal op. T	Y	N	Y	—	—	116	—	Start an on-delay timer (formal operand) with the value stored in ACCU 1.
SEC =	Formal op. T	Y	N	Y	—	—	114	—	Start a timer (formal operand) as an extended pulse with the value stored in ACCU 1, or set a counter (formal operand) with the next count value indicated.
	Formal op. C	Y	N	Y	—	—	112	—	
SSU =	Formal op. T	Y	N	Y	—	—	116	—	Start a stored on-delay timer (formal operand) with the value stored in ACCU 1, or increment a counter (formal operand).
	Formal op. C	Y	N	Y	—	—	86	—	
SFD =	Formal op. T	Y	N	Y	—	—	114	—	Start an off-delay timer (formal operand) with the value stored in ACCU 1, or decrement a counter (formal operand).
	Formal op. C	Y	N	Y	—	—	89	—	
Load and Transfer Operations									
L=	Formal operand I, Q, F, T, C	N	N	N	—	—	53 to 79	—	Load the value of the formal operand into ACCU 1. Data type: BY, W Additional actual operands: DL, DR, DW
L	RS	N	N	N	—	—	15	—	Load a word from the system data area into ACCU 1.
LD=	Formal operand T, C	N	N	N	—	—	99	—	Load the value of the formal operand in BCD code into ACCU 1.
LW=	Formal operand	N	N	N	—	—	47	—	Load a formal operand bit pattern into ACCU 1. Data type: D Parameter type: KC, KF, KH, KM, KS, KT, KY
T=	Formal operand I, Q, F	N	N	N	—	—	47 to 77	—	Transfer the contents of ACCU 1 to the formal operand. Data type: BY, W Additional actual operands: DR, DL, DW

* 1 RLO dependent ? 2 RLO affected ? 3 RLO reloaded ?

Operation (STL)	Permissible Operands	RLO*			S5-90U Execution Time in μ s		S5-95U Execution Time in μ s		Function
		1	2	3	Onboard	Ext. I/O	Onboard	Ext. I/O	
Conversion Operations									
CFW		N	N	N	4		4		Form the one's complement of ACCU 1.
CSW		N	N	N	19		19		Form the two's complement of ACCU 1. CC 1 / CC 0 and OV are affected.
Shift Operations									
SLW	Parameter n=0 to 15	N	N	N	$12+n \cdot 8$		$12+n \cdot 8$		Shift the contents of ACCU 1 to the left by the value specified in the parameter. Unassigned positions are padded with zeros. CC 1 / CC 0 are affected.
SRW	Parameter n=0 to 15	N	N	N	$12+n \cdot 8$		$12+n \cdot 8$		Shift the contents of ACCU 1 to the right by the value specified in the parameter. Unassigned positions are padded with zeros. CC 1 / CC 0 are affected.
Jump Operations									
JU=	Symbolic address max. 4 characters	N	N	N	5		5		Jump unconditionally to the symbolic address.
JC=	Symbolic address max. 4 characters	Y	Y ¹⁾	Y	7		7		Jump conditionally to the symbolic address. (If the RLO is "0", it is set to "1".)
JZ=	Symbolic address max. 4 characters	N	N	N	9		9		Jump if the result is zero. The jump is made only if CC 1=0 and CC 0=0. The RLO is not changed.
JN=	Symbolic address max. 4 characters	N	N	N	12		12		Jump if the result is not zero. The jump is made only if CC 1 CC 0. The RLO is not changed.
JP=	Symbolic address max. 4 characters	N	N	N	9		9		Jump if the result is greater than 0. The jump is made only if CC 1=1 and CC 0=0. The RLO is not changed.
JM=	Symbolic address max. 4 characters	N	N	N	9		9		Jump if the result is less than 0. The jump is made only if CC 1=0 and CC 0=1. The RLO is not changed.
JO=	Symbolic address max. 4 characters	N	N	N	7		7		Jump on overflow. The jump is made only if the OVERFLOW bit is set. The RLO is not changed.

* 1 RLO dependent ? 2 RLO affected ? 3 RLO reloaded ?

1) RLO is set to "1".

Operation (STL)	Permissible Operands	RLO*			S5-90U Execution Time in µs		S5-95U Execution Time in µs		Function
		1	2	3	Onboard	Ext. I/O	Onboard	Ext. I/O	
Other Operations									
IA		N	N	N	1		1		Disable interrupt. Input / output interrupt or timer OB processing** is disabled.
RA		N	N	N	19		26		Enable interrupt. This operation cancels the effect of IA.
D		N	N	N	—		4		Decrement the low byte (bits 0 to 7) of ACCU 1 by the value n (n=0 to 255).
I		N	N	N	—		3		Increment the low byte (bits 0 to 7) of ACCU 1 by the value n (n=0 to 255).
DO=	Formal operand	N	N	Y	—		108		Process a block. (Only C DB, JU OB, J U PB, JU FB, JU SB can be substituted.) Actual operands: C DB, JU OB, JU PB, JU FB, JU SB
DO	DW***	N	N	N	—		181 to 216		Process data word. The next operation is combined with the parameter specified in the data word (OR operation) and then carried out.***
DO	FW***	N	N	N	—		139 to 174		Process flag word. The next operation is combined with the parameter specified in the flag word (OR operation) and then carried out.***

* 1 RLO dependent ? 2 RLO affected ? 3 RLO reloaded ?

** Timer OB processing applies to the S5-95U only

*** Permissible operations:

L FY, T FY, L FW, T FW, L IB, T IB, L QB, T QB, L IW, T IW, L QW, T QW, L DL, T DL, L DR, T DR, L DW, T DW, JU OB/SB/FB/PB, JC OB/SB/FB/PB/ C DB	A F, S F, R F, = F, SS T, SE T, R T, A T, AN T, SLW, SRW
---	--

A 1.3 System Operations

Operation (STL)	Permissible Operands	RLO*			S5-90U Execution Time in μ s		S5-95U Execution Time in μ s		Function
		1	2	3	Onboard	Ext. I/O	Onboard	Ext. I/O	
Set Operations									
SU	RS	N	N	Y	—	—	6	—	Set bit in system data area unconditionally.
RU	RS	N	N	Y	—	—	6	—	Reset bit in system data area unconditionally.
Load and Transfer Operations									
LIR		N	N	N	—	—	50	—	Load the contents of a memory word (addressed by ACCU 1) indirectly into the register (0: ACCU 1; 2: ACCU 2).
TIR		N	N	N	—	—	50	—	Transfer the register contents (0: ACCU 1; 2: ACCU 2) indirectly into the memory word (addressed by ACCU 1).
TNB	Parameter n=0 to 255	N	N	N	52+n · 16	—	52+n · 16	—	Transfer a field byte by byte (number of bytes 0 to 255) .
T	RS	N	N	N	—	—	12	—	Transfer a word to the system data area.

* 1 RLO dependent ? 2 RLO affected ? 3 RLO reloaded ?

Operation (STL)	Permissible Operands	RLO*			S5-90U Execution Time in μ s		S5-95U Execution Time in μ s		Function
		1	2	3	Onboard	Ext. I/O	Onboard	Ext. I/O	
Block Call Operations and Return Operations									
JU	OB	N	N	Y	—		66		Call an organization block unconditionally.
JC	OB	Y	Y ¹⁾	Y	—		68		Call an organization block conditionally.
Arithmetic Operations									
ADD	BN	N	N	N	—		10		Add byte constant (fixed point) to ACCU 1.
ADD	KF	N	N	N	—		10		Add fixed-point constant (word) to ACCU 1.
Other Operations									
STS		N	N	N	—		2		Stop operation. Program processing is interrupted immediately after this operation.
TAK		N	N	N	—		10		Swap the contents of ACCU 1 and ACCU 2.

* 1 RLO dependent ? 2 RLO affected ? 3 RLO reloaded ?
 1) RLO is set to "1"

A.1.4 Evaluation of CC 1 and CC 0

CC 1	CC 0	Arithmetic Operations	Digital Logic Operations	Comparison Operations	Shift Operations	Conversion Operations
0	0	Result = 0	Result = 0	ACCU 2 = ACCU 1	shifted bit = 0	—
0	1	Result < 0	—	ACCU 2 < ACCU 1	—	Result < 0
1	0	Result > 0	Result 0	ACCU 2 > ACCU 1	shifted bit = 1	Result > 0

A.2 Machine Code Listing

Machine Code								Operation	Oper- and
B0		B1		B2		B3			
L	R	L	R	L	R	L	R		
0	0	0	0					NOP 0	
0	1	0	0					CFW	
0	2	0 _d	0 _d					L	T
0	3	0 _i	0 _i					TNB	
0	4	0 _d	0 _d					FR	T
0	5	0	0					BEC	
0	6	0 _c	0 _c					FR=	
0	7	0 _c	0 _c					A=	
0	8	0	0					IA	
0	8	8	0					RA	
0	9	0	0					CSW	
0	A	0 _a	0 _a					L	FB
0	B	0 _a	0 _a					T	FB
0	C	0 _d	0 _d					LC	T
0	D	0 _i	0 _i					JO=	
0	E	0 _c	0 _c					LC=	
0	F	0 _c	0 _c					0	
1	0	8	2					BLD	130
1	0	8	3					BLD	131
1	0	8	4					BLD	132
1	0	8	5					BLD	133
1	0	F	F					BLD	255
1	1	0 _n	0 _n					I	
1	2	0 _a	0 _a					L	FW
1	3	0 _a	0 _a					T	FW
1	4	0 _d	0 _d					SF	T
1	5	0 _i	0 _i					JP=	
1	6	0 _c	0 _c					SFD=	
1	7	0 _c	0 _c					S=	
1	9	0 _n	0 _n					D	
1	C	0 _d	0 _d					SE	T
1	D	0 _f	0 _f					JC	FB

Machine Code								Operation	Oper- and
B0		B1		B2		B3			
L	R	L	R	L	R	L	R		
1	E	0 _c	0 _c					SEC=	
1	F	0 _c	0 _c					==	
2	0	0 _f	0 _f					C	DB
2	1	2	0					>F	
2	1	4	0					<F	
2	1	6	0					><F	
2	1	8	0					!=F	
2	1	A	0					>=F	
2	1	C	0					<=F	
2	2	0 _g	0 _g					L	DL
2	3	0 _g	0 _g					T	DL
2	4	0 _d	0 _d					SR	T
2	5	0 _i	0 _i					JM=	
2	6	0 _c	0 _c					SR=	
2	7	0 _c	0 _c					AN=	
2	8	0 _e	0 _e					L	KB
2	A	0 _g	0 _g					L	DR
2	B	0 _g	0 _g					T	DR
2	C	0 _d	0 _d					SS	T
2	D	0 _i	0 _i					JU=	
2	E	0 _c	0 _c					SSU=	
2	F	0 _c	0 _c					ON=	
3	0	0	1	0 _e	0 _e	0 _e	0 _e	L	KC
3	0	0	2	0 _e	0 _e	0 _e	0 _e	L	KT
3	0	0	4	0 _e	0 _e	0 _e	0 _e	L	KF
3	0	1	0	0 _e	0 _e	0 _e	0 _e	L	KS
3	0	2	0	0 _e	0 _e	0 _e	0 _e	L	KY
3	0	4	0	0 _e	0 _e	0 _e	0 _e	L	KH
3	0	8	0	0 _e	0 _e	0 _e	0 _e	L	KM
3	2	0 _g	0 _g					L	DW
3	3	0 _g	0 _g					T	DW
3	4	0 _d	0 _d					SP	T

Machine Code								Operation	Oper- and
B0		B1		B2		B3			
L	R	L	R	L	R	L	R		
3	5	0 _i	0 _i					JN=	
3	6	0 _c	0 _c					SI=	
3	7	0 _c	0 _c					RB=	
3	C	0 _d	0 _d					R	T
3	D	0 _f	0 _f					JU	FB
3	E	0 _c	0 _c					RD=	
3	F	0 _c	0 _c					LW=	
4	0	0	0 _k					LIR	
4	1	0	0					AW	
4	2	0 _o	0 _o					L	C
4	4	0 _o	0 _o					FR	C
4	5	0 _i	0 _i					JZ=	
4	6	0 _c	0 _c					L=	
4	8	0	0 _k					TIR	
4	9	0	0					OW	
4	A	0 _a	0 _a					L	IB
4	A	8 _a	0 _a					L	QB
4	B	0 _a	0 _a					T	IB
4	B	8 _a	0 _a					T	QB
4	C	0 _o	0 _o					LC	C
4	D	0 _f	0 _f					JC	OB
4	E	0 _g	0 _g					B	FW
5	0	0 _e	0 _e					ADD	BN
5	1	0	0					XOW	
5	2	0 _a	0 _a					L	IW
5	2	8 _a	0 _a					L	QW
5	3	0 _a	0 _a					T	IW
5	3	8 _a	0 _a					T	QW
5	4	0 _o	0 _o					LD	C
5	5	0 _f	0 _f	0 _e	0 _e	0 _e	0 _e	JC	PB
5	8	0	0					ADD	KF
5	9	0	0					-F	

Machine Code								Operation	Oper- and
B0		B1		B2		B3			
L	R	L	R	L	R	L	R		
5	C	0 _o	0 _o					S	C
5	D	0 _f	0 _f					JC	SB
6	1	0 _h	0 _h					SLW	
6	2	0 _g	0 _g					L	RS
6	3	0 _g	0 _g					T	RS
6	5	0	0					BE	
6	5	0	1					BEU	
6	6	0 _c	0 _c					T=	
6	9	0 _h	0 _h					SRW	
6	C	0 _o	0 _o					CU	C
6	D	0 _f	0 _f					JU	OB
6	E	0 _g	0 _g					B	DW
7	0	0	0					STS	
7	0	0	2					TAK	
7	0	0	3	C	0	0 _o	0 _o	STP	
7	0	1	5	8	0	0 _o	0 _o	TB	C
7	0	1	5	4	0	0 _o	0 _o	TBN	C
7	0	1	5	0	0	0 _o	0 _o	SU	C
7	0	1	5	C	0	0 _d	0 _d	RU	C
7	0	2	5	8	0	0 _d	0 _d	TB	T
7	0	2	5	4	0	0 _d	0 _d	TBN	T
7	0	2	5	0	0	0 _d	0 _d	SU	T
7	0	2	5	C	0 _b	0 _g	0 _g	RU	T
7	0	4	6	8	0 _b	0 _g	0 _g	TB	D
7	0	4	6	4	0 _b	0 _g	0 _g	TBN	D
7	0	4	6	0	0 _b	0 _g	0 _g	SU	D
7	0	4	6	C	0 _b	0 _g	0 _g	RU	D
7	0	5	7	8	0 _b	0 _g	0 _g	TB	RS
7	0	5	7	4	0 _b	0 _g	0 _g	TBN	RS
7	0	5	7	0	0 _b	0 _g	0 _g	SU	RS
7	0	5	7					RU	RS

Machine Code								Operation	Oper- and
B0		B1		B2		B3			
L	R	L	R	L	R	L	R		
7	2	0 _a	0 _a					L	PB/PY*
7	3	0 _a	0 _a					T	PB/PY*
7	5	0 _f	0 _f					JU	PB
7	6	0 _c	0 _c					DO=	
7	8	0	5	0	0	0 _f	0 _f	G	DB
7	9	0	0					+F	
7	A	0 _a	0 _a					L	PW
7	B	0 _a	0 _a					T	PW
7	C	0 _o	0 _o					R	C
7	D	0 _f	0 _f					JU	SB
8	0 _b	0 _a	0 _a					A	F
8	8 _b	0 _a	0 _a					O	F
9	0 _b	0 _a	0 _a					S	F
9	8 _b	0 _a	0 _a					=	F
A	0 _b	0 _a	0 _a					AN	F
A	8 _b	0 _a	0 _a					ON	F
B	0 _b	0 _a	0 _a					R	F
B	8	0 _o	0 _o					A	C
B	9	0 _o	0 _o					O	C
B	A	0	0					A(
B	B	0	0					O(
B	C	0 _o	0 _o					AN	C
B	D	0 _o	0 _o					ON	C

Machine Code								Operation	Oper- and
B0		B1		B2		B3			
L	R	L	R	L	R	L	R		
B	F	0	0)	
C	0 _b	0 _a	0 _a					A	I
C	0 _b	8 _a	0 _a					A	Q
C	8 _b	0 _a	0 _a					O	I
C	8 _b	8 _a	0 _a					O	Q
D	0 _b	0 _a	0 _a					S	I
D	0 _b	8 _a	0 _a					S	Q
D	8 _b	0 _a	0 _a					=	I
D	8 _b	8 _a	0 _a					=	Q
E	0 _b	0 _a	0 _a					AN	I
E	0 _b	8 _a	0 _a					AN	Q
E	8 _b	0 _a	0 _a					ON	I
E	8 _b	8 _a	0 _a					ON	Q
F	0 _b	0 _a	0 _a					R	I
F	0 _b	8 _a	0 _a					R	Q
F	8	0 _d	0 _d					A	T
F	9	0 _d	0 _d					O	T
F	A	0 _i	0 _i					JC=	
F	B	0	0					O	
F	C	0 _d	0 _d					AN	T
F	D	0 _d	0 _d					ON	T
F	F	F	F					NOP 1	

* depending on the type of programmer used

Explanation of the Indices

a + byte address
b + bit address
c + parameter address
d + timer number
e + constant
f + block number
g + word address

h + number of shifts
i + relative jump address
k + register address
l + block length in bytes
m + jump displacement (16 bits)
n + value
o + counter number

A.3 List of Abbreviations

Abbreviation	Explanation	Permissible Operand Value Range for	
		S5-90U	S5-95U
ACCU 1	Accumulator 1 (When accumulator 1 is loaded, any existing contents are shifted into accumulator 2.)		
ACCU 2	Accumulator 2		
AI	DB1 parameter: number of analog inputs that are read in cyclically		
BN	Byte constant (fixed-point number)		(- 127 to +127)
C	Counter - retentive - non-retentive - for the "Bit Test" and "Set" supplementary operations	(0 to 7) (8 to 31)	(0 to 7) (8 to 127) (0 to 127) (0.0 to 127.15)
CAN	DB1 parameter: counter A counts with negative and positive edge		
CAP	DB1 parameter: counter A counts with positive edge		
CBN	DB1 parameter: counter B counts with negative and positive edge		
CBP	DB1 parameter: counter B counts with positive edge		
CC 0 / CC 1	Condition code 0 / Condition code 1		
CCN	DB1 parameter: cascaded counter counts with negative edge		
CCP	DB1 parameter: cascaded counter counts with positive edge		
CF	DB1 parameter: input correction factor (integral real-time clock)		
CLK	DB1 parameter: clock data location		
CPU	Central processing unit of programmable controller		
CSF	STEP 5 control system flowchart method of representation		
D	Data (1 bit)		(0.0 to 255.15)
DB	Data block	(2 to 63)	(2 to 255)
DL	Data word (left-hand byte)	(0 to 255)	(0 to 255)
DR	Data word (right-hand byte)	(0 to 255)	(0 to 255)
DW	Data word	(0 to 255)	(0 to 255)
EF	DB1 parameter: SINEC L1, position of receive mailbox		
F	Flag - retentive - non-retentive	(0.0 to 63.7) (64.0 to 127.7)	(0.0 to 63.7) (64.0 to 255.7)
FB	Function block	(0 to 63)	(0 to 255)

Abbreviation	Explanation	Permissible Operand Value Range for	
		S5-90U	S5-95U
FB/FY	Flag byte - retentive - non-retentive	(0 to 63) (64 to 127)	(0 to 63) (64 to 255)
Formal operand	Expression with a maximum of 4 characters. The first character must be a letter of the alphabet.		
FW	Flag word - retentive - non-retentive	(0 to 62) (64 to 126)	(0 to 62) (64 to 254)
I	Input	(0.0 to 127.7)	(0.0 to 127.7)
IB	Input byte	(0 to 127)	(0 to 127)
IN	DB1 parameter: activate interrupt on negative edge		
INP	DB1 parameter: activate interrupt on negative and positive edge		
IP	DB1 parameter: activate interrupt on positive edge		
IPN	DB1 parameter: activate interrupt on positive and negative edge		
IW	Input word	(0 to 126)	(0 to 126)
KB	Constant (1 byte)	(0 to 255)	(0 to 255)
KBE	DB1 parameter: SINEC L1, position of the "Receive" coordination byte		
KBS	DB1 parameter: SINEC L1, position of the "Send" coordination byte		
KC	Constant (count)	(0 to 999)	(0 to 999)
KF	Constant (fixed-point number)	(- 32768 to +32767)	(- 32768 to +32767)
KH	Constant (hexadecimal code)	(0 to FFFF)	(0 to FFFF)
KM	Constant (2-byte bit pattern)	arbitrary bit pattern: (16 bit)	arbitrary bit pattern: (16 bit)
KS	Constant (2 characters)	(any two alphanumeric characters)	(any two alphanumeric characters)
KT	Constant (time)	(0.0 to 999.3)	(0.0 to 999.3)
KY	Constant (2 bytes)	(0 to 255 per byte)	(0 to 255 per byte)
LAD	STEP 5 ladder diagram method of representation		
NT	DB1 parameter: number of timers being processed		
OB	Organization block for special applications: 1, 3, 13, 21, 22, 31, 34, 251	1, 3, 21, 22	(0 to 255)
OB13	DB1 parameter: interval (ms) within which OB13 is called and processed		
OBA	DB1 block ID for onboard analog inputs		
OBC	DB1 block ID for onboard counters		
OBI	DB1 block ID for onboard interrupt		
OHE	DB1 parameter: enable operating hours counter		

Abbreviation	Explanation	Permissible Operand Value Range for	
		S5-90U	S5-95U
OHS	DB1 parameter: set operating hours counter		
OP	Operator panel		
OV	Overflow. This condition code bit is set if, e.g., a numerical range is exceeded during arithmetic operations.		
PB	Program block (with block call and return operations)	(0 to 63)	(0 to 255)
PB or PY (depending on type of program- mer used)	Peripheral byte	(32, 33)	(0 to 127)
PBUS	DB1 parameter: startup only via connected bus units		
PG	Programmer		
PGN	DB1 parameter: SINEC L1, programmer bus number		
PII	Process image input table		
PIQ	Process image output table		
PW	Peripheral word	(32)	(0 to 126)
Q	Output	(0.0 to 127.7)	(0.0 to 127.7)
QB	Output Byte	(0 to 127)	(0 to 127)
QW	Output word	(0 to 126)	(0 to 126)
RLO	Result of logic operation		
RLO affected? Y/N	The RLO is affected/not affected by the operation.		
RLO dependent? Y Y/Y N	Y The statement is executed only if the RLO is "1". Y/Y The statement is executed only on positive/negative edge change of the RLO. N The statement is always executed.		
RLO reloaded? Y/N	When the next binary operation takes place, the RLO is reloaded/not reloaded (e.g. A I 0.0).		
RS	System data area - for load operations (supplementary operations) and transfer operations (system operations) - for bit test and set operations (system operations)		(0 to 255) (0.0 to 255.15)
SAC	STEP address counter		
SB	Sequence block		(0 to 255)
SDP	DB1 block ID for system data parameters		
SF	DB1 parameter: SINEC L1, position of send mailbox		
SL1	DB1 block ID for SINEC L1		
SLN	DB1 parameter: SINEC L1, slave number		
STL	STEP 5 statement list method of representation		

Abbreviation	Explanation	Permissible Operand Value Range for	
		S5-90U	S5-95U
STP	DB1 parameter: update the clock while in the STOP state.		
STW	DB1 parameter: status word location (integral real-time clock)		
T	Timer - for the "Bit Test" and "Set" supplementary operations	(0 to 31)	(0 to 127) (0.0 to 127.15)
TFB	DB1 block ID for timer function block		
TIS	DB1 parameter: set prompt time		

www.rgbautomatyka.pl

B Technical Specifications, DB1 Parameters, RAM Address Assignment		
B.1	Technical Specifications	B - 1
B.1.1	General Technical Specifications S5-90U and S5-95U	B - 1
B.1.2	Technical Specifications S5-90U	B - 2
B.1.3	Technical Specifications S5-95U	B - 3
B.2	DB1 Parameters	B - 5
B.2.1	DB1 Parameters of S5-90U	B - 5
B.2.2	DB1 Parameters of S5-95U	B - 6
B.3	RAM Address Assignment	B - 8
B.3.1	RAM Address Assignment in the S5-90U	B - 8
B.3.2	RAM Address Assignment in the S5-95U	B - 10

www.rgbautomatyka.pl

B.1.2 Technical Specifications S5-90U

Dimensions and Weight		Specific Onboard I/O Specifications	
Dimensions WxHxD	(mm)145x135x91 (in). 5.7x5.3x5.7	For digital inputs:	
Weight-S5-90U	approx. 1.0 kg / 2.2 lbs.	Floating	yes*(optocoupler)
Weight-memory subm.	approx. 0.02 kg / 0.7 oz.	- Isolated in groups of	10
Internal Technical Specifications		Input voltage L+	
Memory capacity		- Rated value	24 V DC
- Internal RAM for	2 K statements	- At "0" signal	0 to 5 V DC
STEP 5 program		- At "1" signal	13 to 30 V DC
Execution time		Input current	
- Per binary operation	approx. 2 μ s	- At "1" signal	typ. 8.5 mA (at 24 V DC)
Scan time monitoring	approx. 300 ms	Response time	
Flags	1024 (512 retentive)	- From "0" to "1"	typ. 2.8 ms
Timers: number/range	32 / 0.01 to 9990 s	- From "1" to "0"	typ. 3.6 ms
Counters: number/range	32(8 retentive) / 0 to 999	Connection of 2-wire	
Inputs/outputs (onboard):		BERO proximity switches	possible
Digital inputs	8	Residual current for "0" signal	1.5 mA
Interrupt input*	1	Cable length unshielded	max. 100 m (330 ft.)
Counter input*	1	For interrupt input:	
Digital outputs	6	Floating	yes**
Inputs/outputs (external I/O):		Input voltage and current as	
Digital inputs/outputs - total	max. 192	for digital inputs (see Specific	
Analog inputs/outputs - total	max. 16	Onboard I/O Data)	
Permissible blocks:		Response time	
Organization blocks	1, 3, 21, 22	- From "0" to "1"	typ. 40 μ s
Program blocks	0 to 63	- From "1" to "0"	typ. 180 μ s
Function blocks	0 to 63	Pulse duration for signal	
Data blocks	2 to 63	"0" or "1"	500 μ s
Operation set	119	Cable length unshielded	50 m (164.05 ft.)
Power Supply (Internal)		Counter input:	
Input voltage		Floating	yes**
- Rated value	115 V/230 V AC	Input voltage and current as	
- Permissible range	93 to 127 V / 187 to 253 V	for digital inputs (see Specific	
System frequency		Onboard I/O Specifications)	
- Permissible range	47 to 63 Hz	Response time	
Current consumption from 230 V		- From "0" to "1"	typ. 40 μ s
for the S5-90U	40 mA	- From "1" to "0"	typ. 180 μ s
Inrush current		Counter frequency	max. 1 kHz
- for 230 V	1 A	Pulse duration for signal	
- for 115 V	2 A	"0" or "1"	500 μ s
Output voltage		Cable length (unshielded)	50 m (165 ft.)
- V 1 (for sensor)	+24 V	For digital outputs:	
- V 2 (for programmer)	+5.2 V	Outputs	Relay outputs, contact wiring, Varistor SIOV-S10-K275
Output current		Floating	yes
- From V 1	100 mA	- Isolated in groups of	1
- From V 2	100 mA	Continuous current I_{th}	3 A
Short-circuit protection	electronic	Switching capacity of the contacts	
Class of protection	Class I	- Resistive load	max. 3 A at 250 V AC max. 1.5 A at 30 V DC
Floating V 1	yes	- Inductive load	max. 0.5 A at 250 V AC max. 0.5 A at 30 V DC
Floating V 2	no	Operating cycles of the contacts according to VDE 0660, Section 200	
Back-up battery	Lithium battery (3.4 V/ 850 mAh)	- AC-11	1x10 ⁶
- Life expectancy	min. 1 year	- DC-11	0.5x10 ⁶
- Service life (at 25° C/77° F)	approx. 5 years	Switching frequency	max. 10 Hz
Power losses of the module	typ. 10.5 W	Cable length unshielded	max. 100 m (330 ft)
Mains buffering	20 ms		
(for maximum degree of expansion)			

* You can also use this input as a digital input.

** All inputs are nonfloating in relation to one another.

B.1.3 Technical Specifications S5-95U

Dimensions and Weight		Internal Technical Specifications (continued)	
Dimensions WxHxD	(mm) 145x135x146 (in.) 5.7x5.3x5.7	Mains buffering	10 ms
Weight-S5-95U	approx. 1.5 kg / 3.3 lbs	(for maximum degree of expansion)	
Weight-memory submodule	approx. 0.1 kg / 3.5 oz.		
Internal Technical Specifications		Specific Onboard I/O Specifications	
Memory capacity - internal RAM for STEP 5 program 8K statements Execution time - per binary operation approx. 2 μ s Scan time monitoring approx. 300 ms Flags 2048 (512 retentive) Timers: number/range 128/0.01 to 9990 s Counters: number/range 128/(8 retentive) 0 to 999		For digital inputs: Floating yes (optocoupler) - isolated in groups of 16 Input voltage - rated value 24 V - at "0" signal -30 V to +5 V DC - at "1" signal +13 V to +30 V DC Input current - at "0" signal <1.5 mA - at "1" signal <6.5 mA (at 30 V) Response time - at "0" to "1" typ. 2.5 ms - at "1" to "0" typ. 2.0 ms Cable length unshielded max. 100 m (330 ft.)	
Inputs/outputs (onboard): Digital inputs 16 Digital outputs 16 Interrupt inputs, can also be used as digital inputs 4 Counter inputs 2 Analog output (0 to 10V), can also be used as DI 8 Analog output (0 to 10V; 0 to 20mA) 1 Inputs/outputs (external I/O): Digital inputs/outputs - total max. 448 Analog inputs/outputs - total max. 32 Permissible blocks: Organization blocks 1, 3, 13, 21, 22, 31, 34, 251 Program blocks 0 to 255 Function blocks - programmable 0 to 255 - integrated 240 to 243, 250, 251 Sequence blocks* 0 to 255 Data blocks 2 to 255 Operation set approx. 140 Back-up battery Lithium battery (3.4 V/ 850 mAh) - life expectancy min. 1 year - service life (at 25° C/77° F) approx. 5 years Power loss of the module typ. 12 W		For digital outputs: Floating yes - isolated in groups of 16 Load voltage L+ - rated value 24 V DC - permissible range (including ripple) 20 to 30 V DC Output current for "1" signal max. 0.5 A at 60°C (140°F) Lamp load max. 5 W Residual current for "0" signal 400 μ A Output voltage - for "0" signal max. 2.4 V (at 6k load resistance) - for "1" signal max. L+ -0.6 V (at 0.5 A) Short-circuit protection yes, electronic Limitation of the voltage induced on circuit interruption (internal) -16 V Switching frequency - resistive load max. 100 Hz - inductive load max. 2 Hz Total current 6 A 8 A (50° C/ 122° F) Setting a digital output possible Parallel switching of output yes, 0.5 A each Cable length, unshielded max. 100 m/330 ft	

* Sequence block 2 is integrated only in the S5-95U basic unit (Order No. 6ES5 095-8MA...). It can be overwritten by the user.

Specific Onboard I/O Specifications (continued)	Specific Onboard I/O Specifications (continued)
<p>For analog outputs:</p> <p>Floating no</p> <p>Input range (rated value) 0 to +10 V</p> <p>Permissible input voltage -10 to +30 V</p> <p>Input resistance 20 k</p> <p>Digital representation of the signal 12 bits</p> <p>Resolution 10 bits</p> <p>Measuring principle Instantaneous value coding (successive approx.)</p> <p>Conversion time 40 μs</p> <p>Internal settling time* max. 3.5 ms</p> <p>Error indication for overranging yes</p> <p>Total error limit (0 to 60° C) 1.68 %</p> <p>Cable length (shielded) max. 100 m/330 ft</p> <p>for R_{sensor} < 100</p> <p>For analog outputs:</p> <p>Floating no</p> <p>Digital representation of the signal 11 bits</p> <p>Resolution 10 bits</p> <p>Voltage output</p> <p>- Output range (rated value) 0 to 10 V</p> <p>- Load resistance 2.5 k</p> <p>- Conversion time typ. 20 μs (including settling time**)</p> <p>- Short-circuit protection yes</p> <p>- Short-circuit current typ. 30 mA</p> <p>- Total error limit (0 to 60° C) 1 %</p> <p>- Cable length (shielded) max. 100 m/ 330 ft</p> <p>Current output</p> <p>- Output range (rated value) 0 to 20 mA</p> <p>- Load resistance 300</p> <p>- Conversion time typ. 20 μs (including settling time **)</p> <p>- Total error limit (0 to 60° C/140° F) 1.1 %</p> <p>- Cable length (shielded) 100 m/330 ft.</p>	<p>For interrupt inputs:</p> <p>Floating no</p> <p>Input voltages and currents as for digital inputs (see Specific Onboard I/O Specifications)</p> <p>Response time</p> <p>- from "0" to "1" typ. 75 μs</p> <p>- from "1" to "0" typ. 140 μs</p> <p>Pulse duration 500 μs**</p> <p>Cable length (shielded) 100 m/330 ft.</p> <p>Counter inputs:</p> <p>Floating no</p> <p>Input voltages and currents as for digital inputs (see Specific Onboard I/O Specifications)</p> <p>Response time</p> <p>- from "0" to "1" typ. 10 μs</p> <p>- from "1" to "0" typ. 15 μs</p> <p>Counter frequency** counter A: 5 kHz counter B: 2 kHz</p> <p>Pulse duration 100 μs</p> <p>Cable length (shielded) 100 m/330 ft.</p> <p>* The setting time is a measure for the maximum frequency, which can be measured with the analog input (maximum frequency = 1: setting time). If the voltage jump from 0 to 10 V is applied to the analog input, the actual (rated value) is read in aagter the setting time. (Values read in after the voltage jump and before the end of the setting time are incorrect).</p> <p>** The settling time of the analog output increases with the capacitive load on the cable connected.</p> <p>*** without connection of a programmer, operator panel or SINEC L1</p>

Memory Capacity	Power Supply (Internal; Continued)
<p>Internal RAM: 16 KB (memory can be subdivided for statements and data blocks as necessary)</p> <p>Memory submodule: EPROM/EEPROM</p>	<p>Current consumption from 24 V</p> <p>- for the PLC typ. 160 mA</p> <p>- for full external I/O configuration typ. 1 A</p> <p>Output voltage</p> <p>- U 1 (for external I/O) +9 V</p> <p>- U 2 (for programmer) +5.2 V</p> <p>Output current</p> <p>- from U 1 1 A</p> <p>- from U 2 0.61 A</p> <p>Short-circuit protection Electronic</p> <p>Galvanic isolation no</p> <p>Class of protection Class I</p>
<p>Power Supply (Internal)</p> <p>Input voltage</p> <p>- Rated value 24 V DC</p> <p>- Permissible range 20 to 30 V</p>	

B.2 DB1 Parameters

B.2.1 DB1 Parameters of S5-90U

Parameter	Argument	Explanation	
Block ID: OBI:		Onboard Interrupt	
IP	0	Interrupt, positive edge I 33.0	
Block ID: OBC:		Onboard Counter	
CAP	p/N	Counter, positive edge, comparison value p	
p = 0 to 65536		N/n=not activated	
Block ID: SL1:		SINEC L1	
SLN		Slave number	
SF		Location of Send Mailbox	
EF		Location of Receive Mailbox	
KBE		Location of Coordination byte "Receive"	
KBS		Location of Coordination byte "Send"	
PGN		Programmer bus number	
p = 1 to 30	x = 2 to 63	y = 0 to 255	z = 0 to 127
Block ID: ERT:		Error Return	
ERR	DBwDWx, MBy or MWz	Position of the error code	
w = 2 to 63	x = 0 to 255	y = 0 to 127	z = 0 to 126

B.2.2 DB1 Parameters of S5-95U

Parameter	Argument	Explanation
Block ID: OBA:		Onboard Analog Inputs
AI	p	Number of analog inputs read in cyclically
p = 0 to 8		0 = no analog channel read in
Block ID: OBI:		Onboard Interrupt
IP	p	Interrupt, positive edge, channel p
IN	p	Interrupt, negative edge, channel p
IPN	p	Interrupt, positive and negative edge, channel p
INP	p	Interrupt, negative and positive edge, channel p
p = 0 to 3		
Block ID: OBC:		Onboard Counter
CAP	p/N	Counter A, positive edge, comparison value p
CBP	p/N	Counter B, positive edge, comparison value p
CAN	p/N	Counter A, negative edge, comparison value p
CBN	p/N	Counter B, negative edge, comparison value p
CCP	q/N	Cascaded counter, positive edge, comparison value q
CCN	q/N	Cascaded counter, negative edge, comparison value q
p = 0 to 65536		q = 0 to 4 294 967 296 N/n = not activated
Block ID: SL1:		SINEC L1
SLN	} DBx DWy or MBy	Slave number
SF		Location of Send Mailbox
EF		Location of Receive Mailbox
KBE		Location of Coordination Byte "Receive"
KBS		Location of Coordination Byte "Send"
PGN		p
p = 1 to 30		x = 2 to 255 y = 0 to 255
Block ID: SDP:		System Dependent Parameter
NT	p	Number of timers being processed
PBUS	J/Y/N	Start-up only via connected bus units
p = 0 to 128		j/J/y/Y = yes n/N = no
Block ID: TFB:		Timer Function Block
OB13	p	Intervals (ms) at which OB 13 is called up and is processed
p = 0 to 655350 (in 10 ms steps; p=0 means: time-controlled program execution not possible)		

Parameter	Argument	Meaning
Block ID: CLP:		Clock Parameters
STW	DBxDWy, MWz,EWv or AWv	Location of the status word (STatus Word)
CLK	DBxDWy, MWz,EWv or AWv	Location of the clock data (CLocK Data)
SET	wd dd.mm.yy ¹ hh:mn:ss ¹ AM/PM ²	Setting the clock time and date
OHS	hhhhh:mn:ss ¹	Setting the operating hours counter (Operating Hours counter Set)
OHE	J/Y/N	Enabling the operating hours counter (Operating Hours counter Enable)
TIS	wd dd.mm. ¹ hh:mn:ss ¹ AM/PM ²	Setting the prompting time (Timer Interrupt Set)
STP	J/Y/N	Updating the clock during "STOP" (SToP) ³
SAV	J/Y/N	Saving the clock time after the last change from "RUN" to "STOP" or "POWER OFF" (SAVe)
CF	p	Inputting the correction factor (Correction Factor)
wd	=1 to 7 (weekday = Sun to Sat)	p=- 400 to 400
dd	=01 to 31 (day)	v=0 to 126
mm	=01 to 12 (month)	x=2 to 255
yy	=0 to 99 (year)	y=0 to 255
hh	=00 to 23 (hours)	z=0 to 254
mn	=00 to 59 (minutes)	j/J=yes
ss	=00 to 59 (seconds)	y/Y=yes
hhhhh	=0 to 999999 (hours)	n/N=no
Block ID: ERT:		Error Return
ERR	DBxDWy, MBz or MWz	Position of the error code
x = 2 to 255		y = 0 to 255
		z = 0 to 236

- 1 If an argument such as seconds, for example, is not to be entered or changed, input XX. The clock continues to run with the existing argument. In the TIS parameter block, the argument entered with "XX" is not acknowledged by the clock (is not existing).
- 2 If you input AM or PM after the clock time, the clock runs in the 12-hour mode. If you omit this argument, the clock runs in the 24-hour mode. You must use the same time mode in the SET and TIS parameter blocks.
- 3 If you monitor the program with an operator panel (e.g. OP 20), it is advantageous that the PLC updates the clock data area also in the STOP mode.

B.3 RAM Address Assignment

B.3.1 RAM Address Assignment in the S5-90U

Address	RAM in the S5-90U
0000 _H : CFFF _H	Internal data
D000 _H : DFFF _H	Program memory
E000 _H : E9FF _H	Internal data
EA00 _H : EBFF _H	System data*
EC00 _H : EC3F _H	T0 Timers T T31
EC40 _H : ECFF _H	Internal data
ED00 _H : ED0F _H	C0 Counters C (retentive) C7
ED10 _H : ED3F _H	C8 Counters C (non-retentive) C31
ED40 _H : EDFF _H	Internal data
EE00 _H : EE3F _H	FY0 Flags F (retentive) FY63
EE40 _H : EE7F _H	FY64 Flags F (non-retentive) FY127
EE80 _H : EEFF _H	Internal data

* For detailed list see following table

Address	RAM in the S5-90U
EF00 _H : EF1F _H	IB0 Digital PII (external I/Os) IB31
EF20 _H : EF25 _H	IB32 Digital PII (onboard I/Os) IB37
EF26 _H : EF3F _H	Internal data
EF40 _H : EF7F _H	IB64 Digital PII (external I/Os) IB127
EF80 _H : EF9F _H	QB0 Digital PIQ (external I/Os) QB31
EFA0 _H : EFA1 _H	QB32 Digital PIQ (onboard I/Os) QB33
EFA2 _H : EFBF _H	Internal data
EFC0 _H : EFFF _H	QB64 Analog PIQ (external I/Os) QB127
F000 _H : FC7F _H	Internal data

Address	RAM in the S5-90U
FC80 _H : FCFF _H	OB
FD00 _H : FEFF _H	FB
FF00 _H : FF7F _H	PB
FF80 _H : FFFF _H	DB

} Block address list

System Data Area of the S5-90U

Address (hex.)	System Data Word RS	Meaning
EA0A : EA0F	5 to 7	Error messages
EA42 EA43	33	Indicator for how full the internal program memory is
EA46 EA47	35	Start address for the internal RAM
EA4A EA4B	37	End address for the internal RAM
EA50 EA5F	40 to 47	CPU version / software version
EA72 : EA7F	57 to 63	SINEC L1 parameter field
EA80 : EA83	64 and 65	Interrupt control word Counter comparison value
EB00 EB95	128 to 202	Block stack
EB96 EBAC	203 to 214	Interrupt stack

B.3.2 RAM Address Assignment in the S5-95U

Address	RAM in the S5-95U
0000 _H : 00FF _H	Internal data
0100 _H : 40FF _H	Program memory
4100 _H : 5CFF _H	Internal data
5D00 _H : 5EFF _H	RS0 System data* RS255
5F00 _H : 5FFF _H	T0 Timers T T127
6000 _H : 600F _H	C0 Counters C (retentive) C7
6010 _H : 60FF _H	C8 Counters C (non-retentive) C127
6100 _H : 613F _H	FY0 Flags F (retentive) FY63
6140 _H : 61FF _H	FY64 Flags F (non-retentive) FY255

Address	RAM in the S5-95U
6200 _H : 621F _H	PY0 Digital interrupt PII (external I/Os) PY31
6220 _H : 623F _H	Internal data
6240 _H : 627F _H	PY64 Analog interrupt PII (external I/Os) PY127
6280 _H : 629F _H	PY0 Digital interrupt PIQ (external I/Os) PY31
62A0 _H : 62BF _H	Internal data
62C0 _H : 62FF _H	PY64 Analog interrupt PIQ (external I/Os) PY127

* For detailed list see following table

Address	RAM in the S5-95U
6300 _H . . 631F _H	IB0 Digital PII (external I/Os) IB31
6320 _H . . 6321 _H	IB32 Digital PII (onboard I/Os) IB33
6322 _H	PII interrupt inputs (onboard)
6323 _H	PII diagnostic byte (onboard)
6324 _H . . 6327 _H	PII counters A and B (onboard)
6328 _H . . 6337 _H	IB40 Analog PII (external I/Os) IB55
6338 _H . . 633F _H	Internal data
6340 _H . . 637F _H	IB64 Analog PII (external I/Os) IB127
6380 _H . . 639F _H	QB0 Digital PIQ (external I/Os) QB31
63A0 _H . . 63A1 _H	QB32 Digital PIQ (onboard I/Os) QB33
63A2 _H . . 63A7 _H	Internal data

Address	RAM in the S5-95U (continued)
63A8 _H . . 63A9 _H	QB40 Analog PIQ (onboard I/Os) QB41
63AA _H . . 63BF _H	Internal data
63C0 _H . . 63FF _H	QB64 Analog interrupt PIQ (external I/Os) QB127
6400 _H . . 75FF _H	Internal data

Address	Block Address List
7600 _H . . 77FF _H	OB
7800 _H . . 79FF _H	FB
7A00 _H . . 7BFF _H	PB
7C00 _H . . 7DFF _H	SB
7E00 _H . . 7FFF _H	DB

Note

Accessing of addresses greater than "7FFF_H" both in the read and write mode is not permitted and may lead to undefined results.

System Data Area of the S5-95U

Address (hex.)	System Data Word (RS)	Meaning
5D10 : 5D19	8 to 12	Integral clock: clock data area, status word, error messages, correction value*
5D1A	13	Number of times processed
5D40 5D41	32	Length of STEP 5 code
5D42 5D43	33	Indicator for how full the internal program memory is
5D44 5D46	34 35	Indicator for how full the assembler area is
5D48 5D49	36	Start address for the internal RAM
5D4A 5D4B	37	End address for the internal RAM
5D50 5D5F	40 to 45	CPU version / software version
5D72 : 5D7F	57 to 63	SINEC L1 parameter field
5DC2 5DC3	97	Time interval for OB 13 (multiple of 10 ms)
5ECC 5ECD	100	Memory address recognized as faulty during address list generation; displayed in ISTACK: SYNFEH and NINEU
5E00 5E3F	128 to 159	Block stack
5E96 5EDD	203 to 214	Interrupt stack

* For detailed list see following table

Clock Data Area of the S5-95U

Table 13-9. System Data Area for the Integral Real-Time Clock

Address (hex.)	System Data Word (RS)	Meaning	Permissible Parameters
5D10	8	Operand area for the clock data	ASCII characters I, Q, F, D
5D11		Start address for the clock data Operand area D Operand areas I, Q, F	DB number DB2 to DBFF _H Byte address
5D12	9	Start address for the clock data Relevant only for operand area D	DB word number DW0 to DWFF _H
5D13		Operand area for the status word	ASCII characters I, Q, F, D
5D14	10	Start address for the status word Operand area D Operand areas I, Q, F	DB word number DB2 to DBFF _H Byte address
5D15		Start address for the status word Relevant only for operand area D	DB word number DW 0 ... DW FF _H
5D16	11	Status for hardware ¹ (only bits 0 and 1 are relevant) <ul style="list-style-type: none"> If either bit 0 or bit 1 is set, the clock chip is defective If no bit is set, the clock chip is running 	"0", "1"
5D17		Incorrect correction value? (only bit 15 is relevant) <ul style="list-style-type: none"> If bit 15 is set, the correction value is incorrect (>+400 or <- 400) If bit 15 is not set, the correction value is correct 	"0", "1"
5D18	12	Correction value ²	- 400 to 400
5D19			

1 You can scan SD11 during start-up. You must call up an FB in OB21 or OB22 by using "L RS 11" to read out and then continue processing SD11.

2 Always use the "L KF X" instruction to load the correction value in ACCU 1 since negative values can also be specified.

Figures

C-1	Cross Sections of Standard Mounting Rails	C-1
C-2	Dimension Drawing of the 483-mm (19-in.) Standard Mounting Rail	C-1
C-3	Dimension Drawing of the 530-mm (20.9-in.) Standard Mounting Rail	C-2
C-4	Dimension Drawing of the 830-mm (32.7-in.) Standard Mounting Rail	C-2
C-5	Dimension Drawing of the 2-m (6.6-ft.) Standard Mounting Rail	C-2
C-6	Dimension Drawing of the S5-90U	C-3
C-7	Dimension Drawing of the S5-95U	C-4
C-8	Dimension Drawing of the Bus Unit (Crimp Snap-in Connections) with I/O Module	C-5
C-9	Dimension Drawing of the Bus Unit (SIGUT Screw-type Terminals) with I/O Module	C-6
C-10	Dimension Drawing of the IM 90 Interface Module	C-7
C-11	Dimension Drawing of the IM 315 Interface Module	C-8
C-12	Dimension Drawing of the IM 316 Interface Module	C-9
C-13	Dimension Drawing of the PS 931 and PS 935 Power Supply Modules ...	C-10

C Dimension Drawings

Dimensions are indicated in millimeters. The approximate equivalent in inches is indicated in parentheses. (1 mm=0.039 in. rounded off to the nearest tenth or hundredth of an inch)

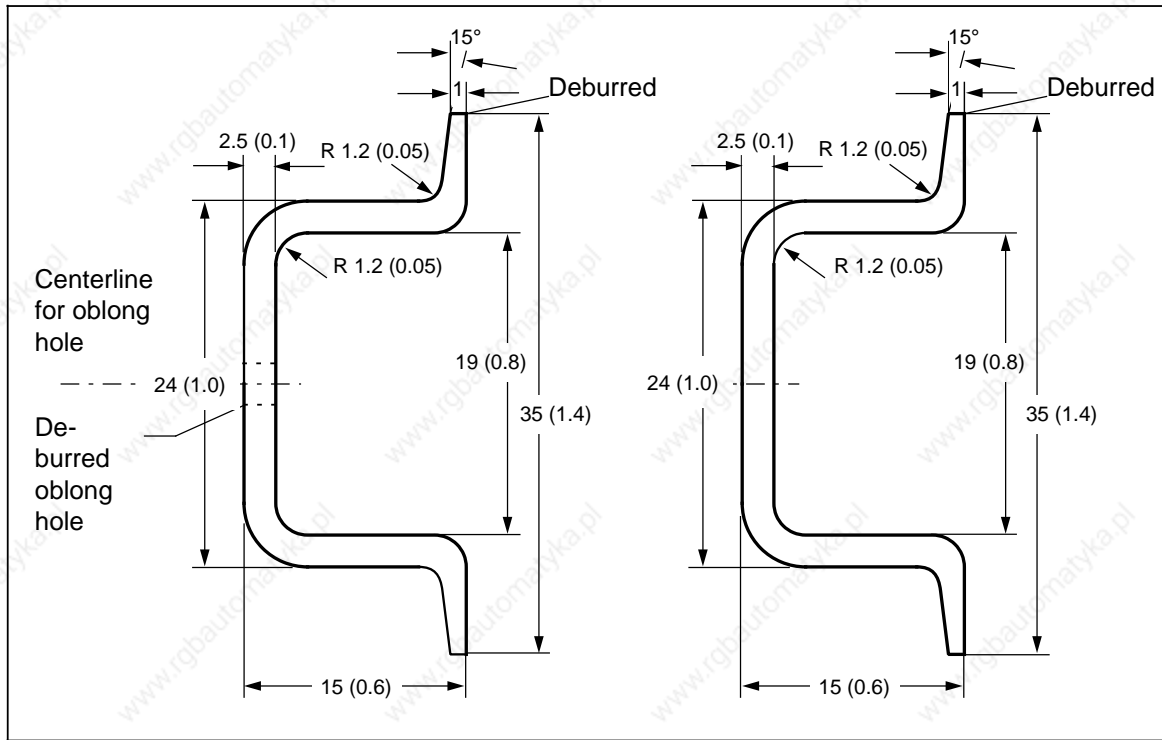

Figure C-1. Cross Sections of Standard Mounting Rails

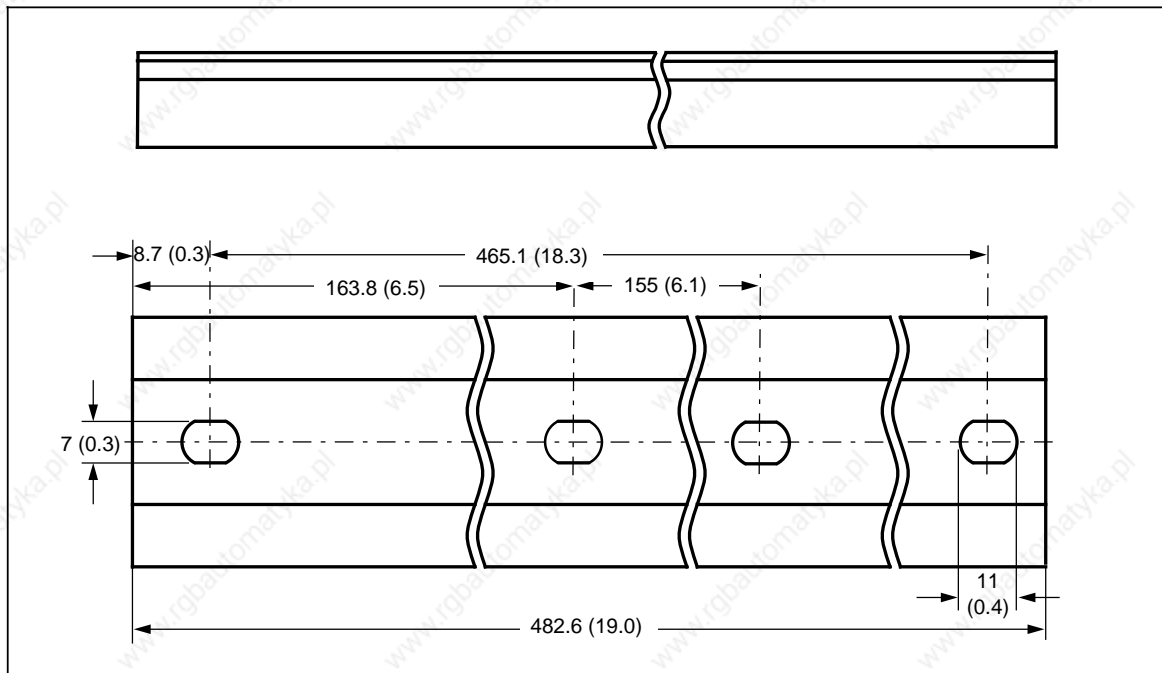

Figure C-2. Dimension Drawing of the 483-mm (19-in.) Standard Mounting Rail

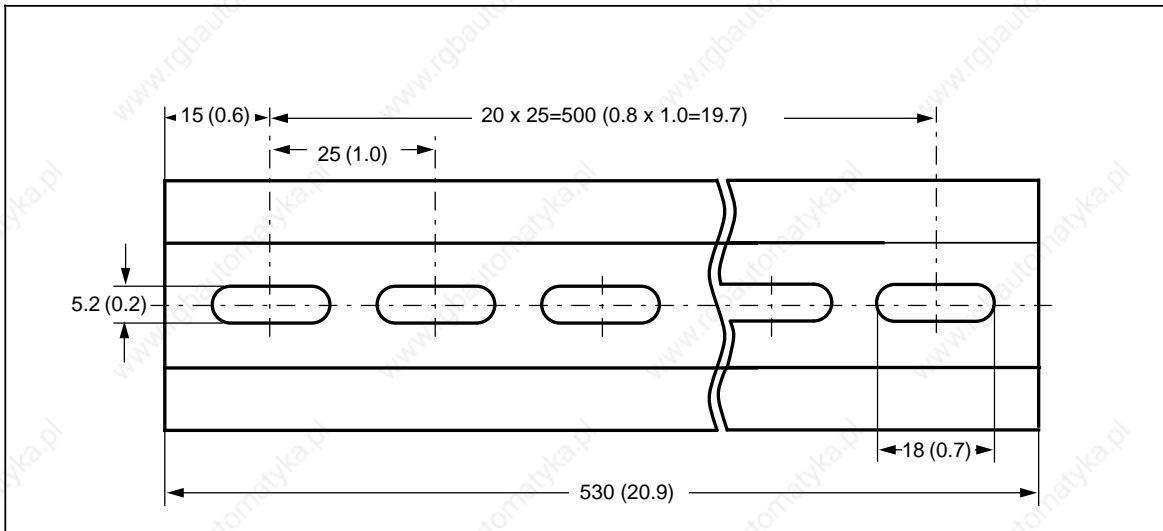

Figure C-3. Dimension Drawing of the 530-mm (20.9-in.) Standard Mounting Rail

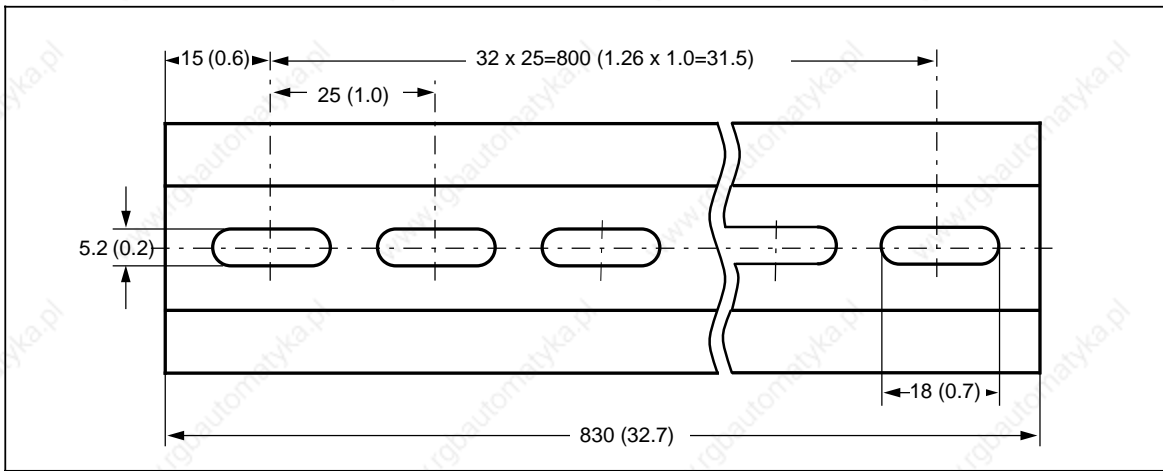

Figure C-4. Dimension Drawing of the 830-mm (32.7-in.) Standard Mounting Rail

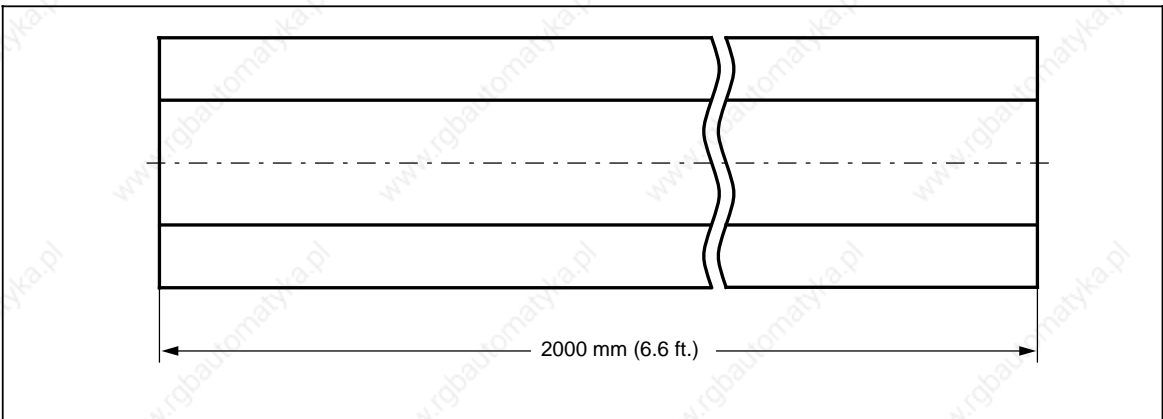

Figure C-5. Dimension Drawing of the 2-m (6.6-ft.) Standard Mounting Rail

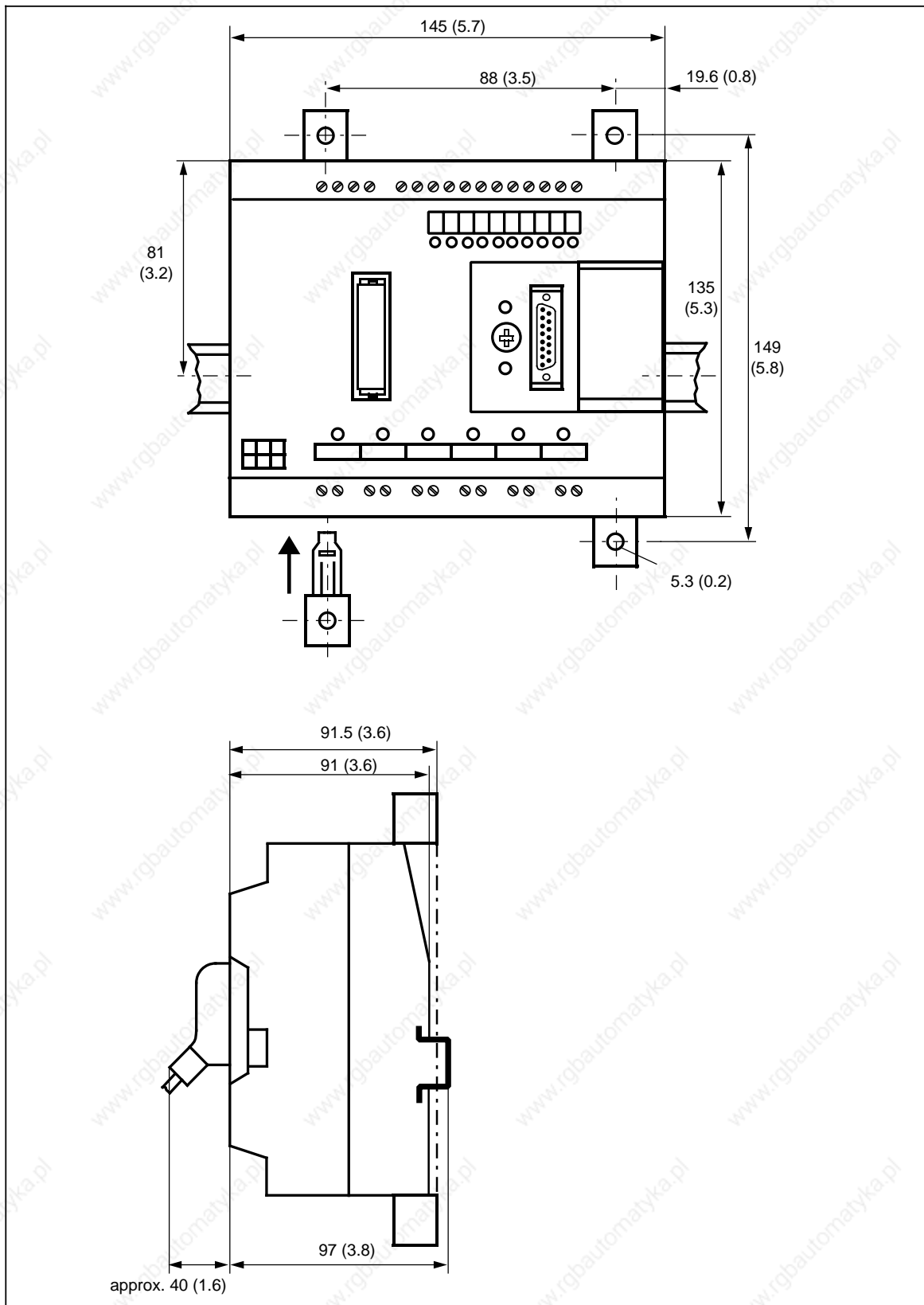

Figure C-6. Dimension Drawing of the S5-90U

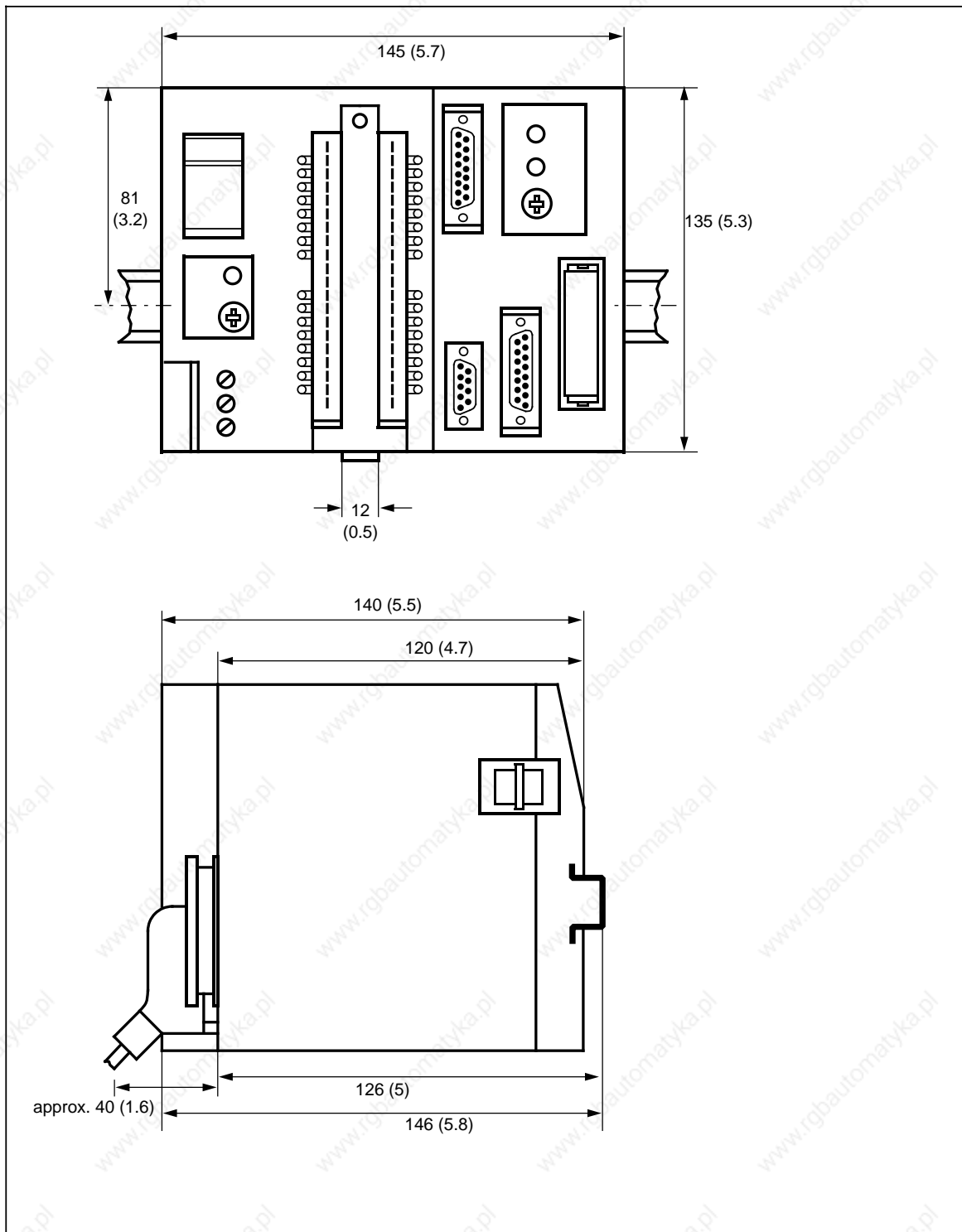

Figure C-7. Dimension Drawing of the S5-95U

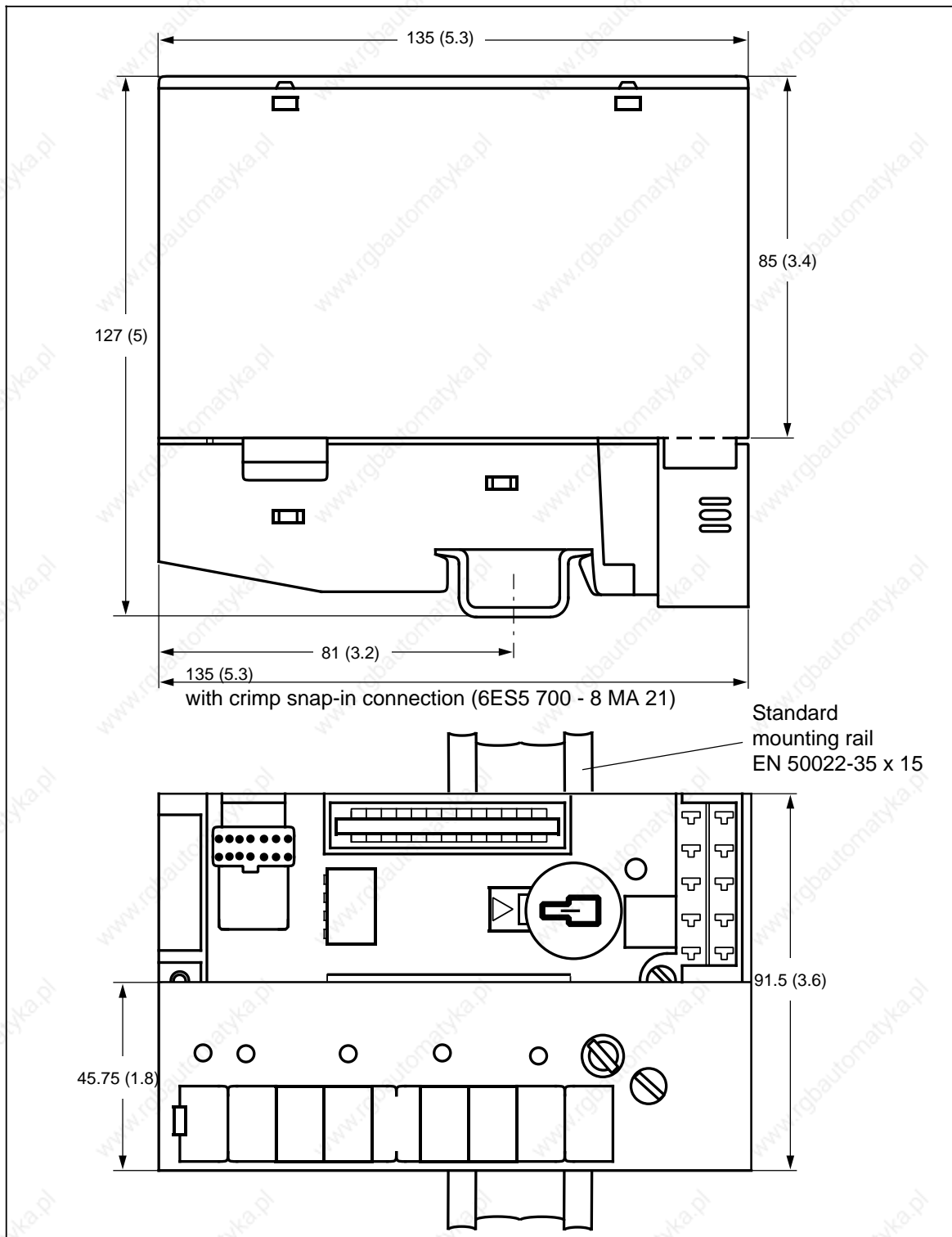

Figure C-8. Dimension Drawing of the Bus Unit (Crimp Snap-in Connections) with I/O Module

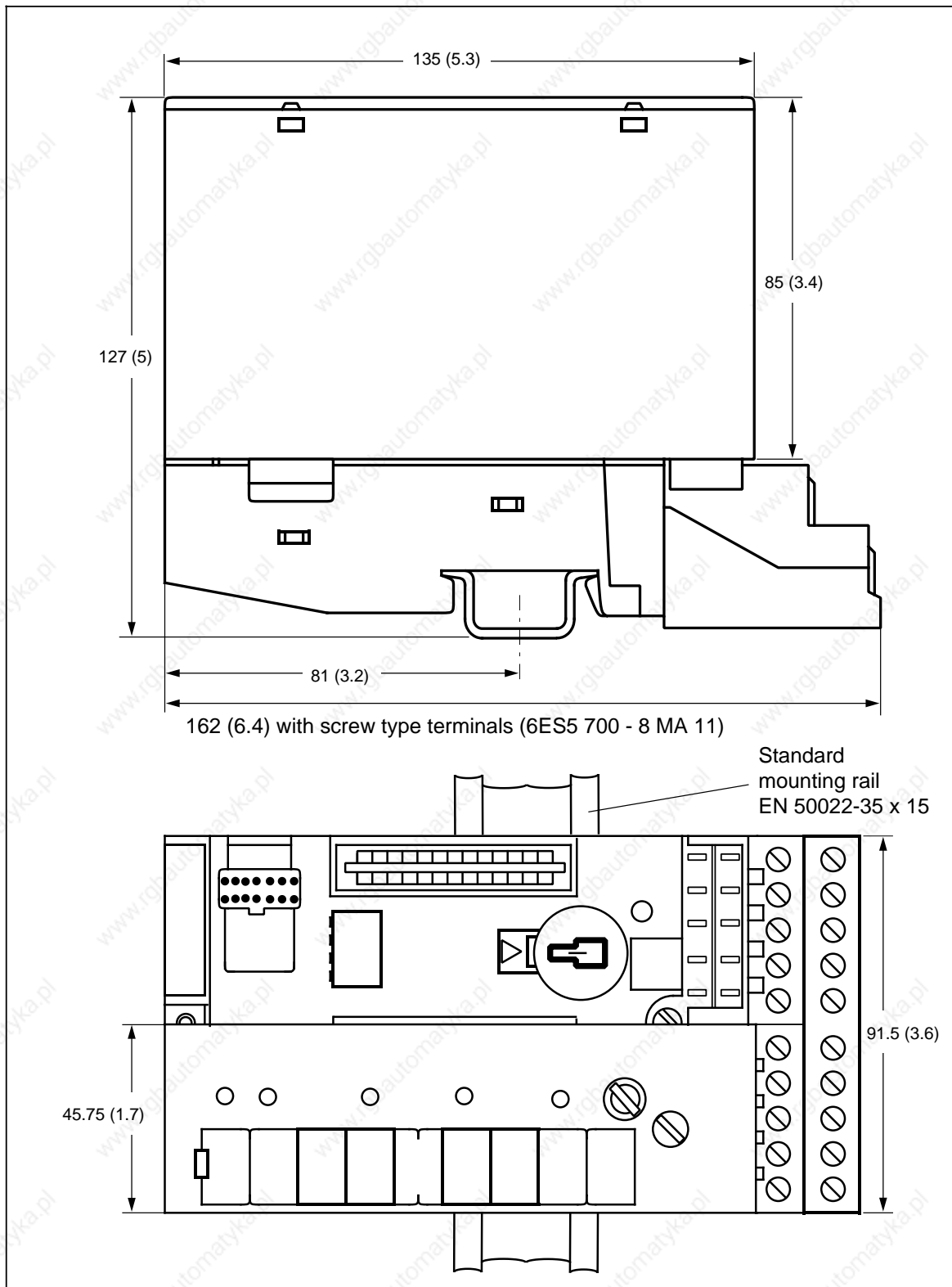

Figure C-9. Dimension Drawing of the Bus Unit (SIGUT Screw-type Terminals) with I/O Module

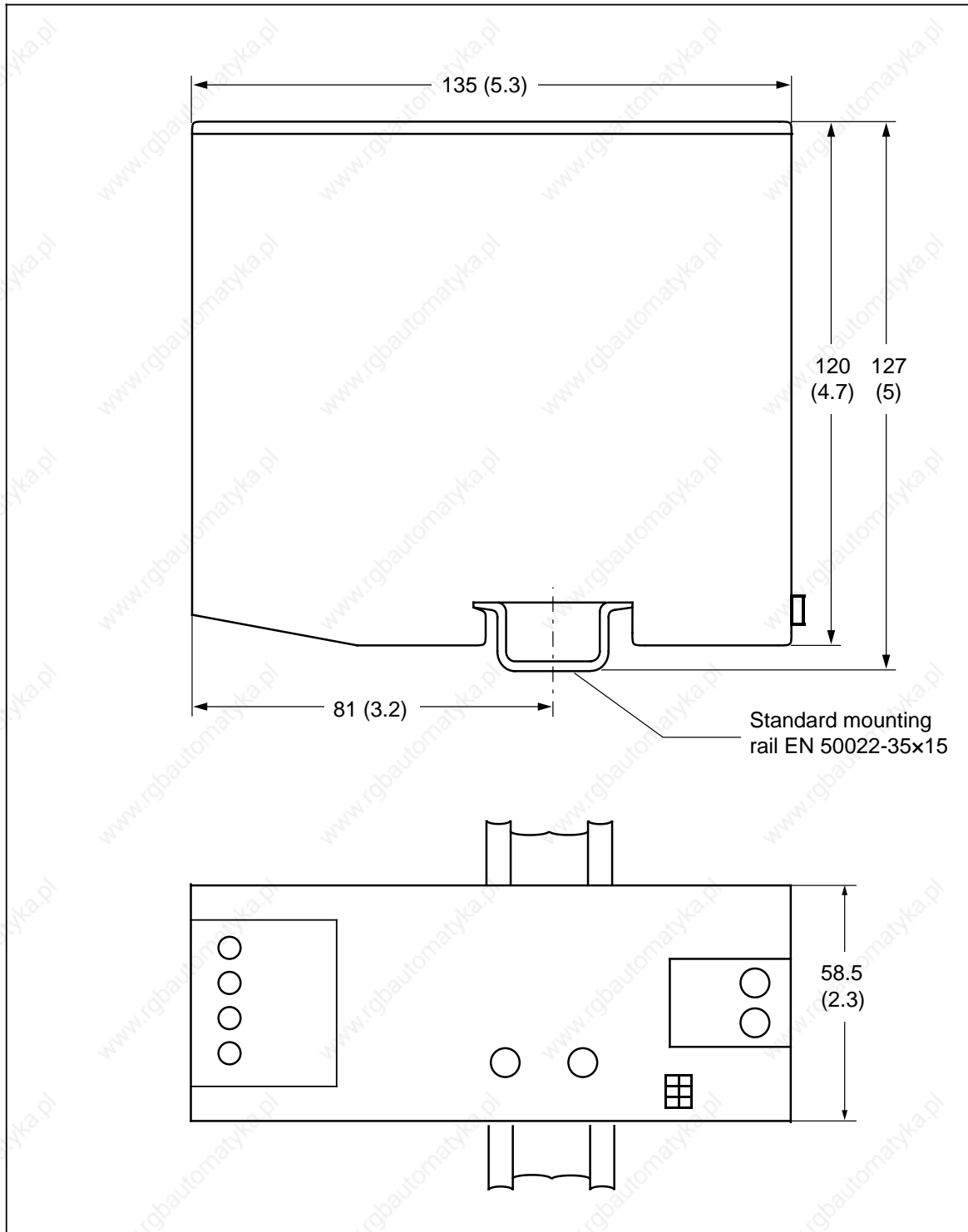

Figure C-10. Dimension Drawing of the IM 90 Interface Module

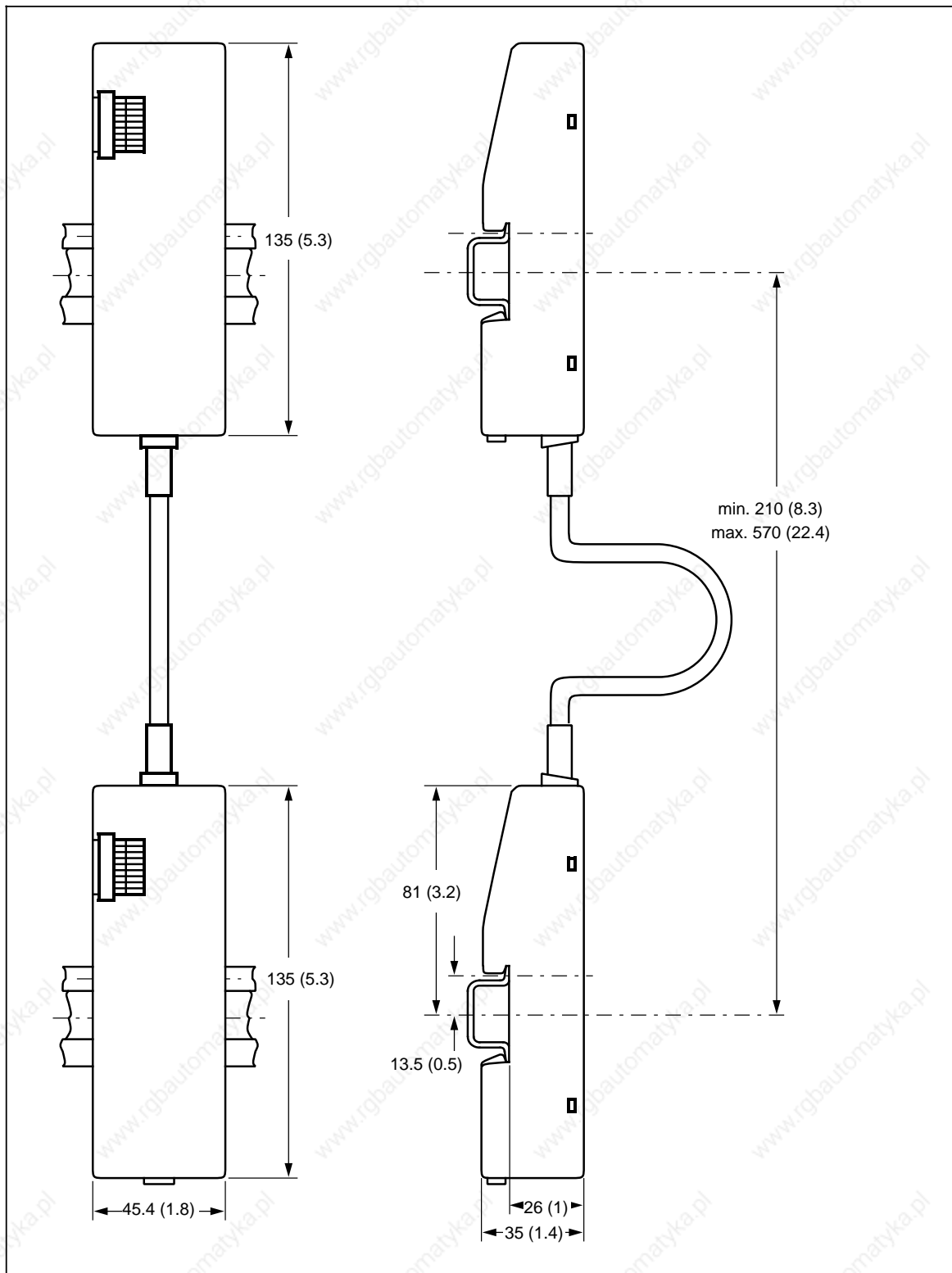

Figure C-11. Dimension Drawing of the IM 315 Interface Module

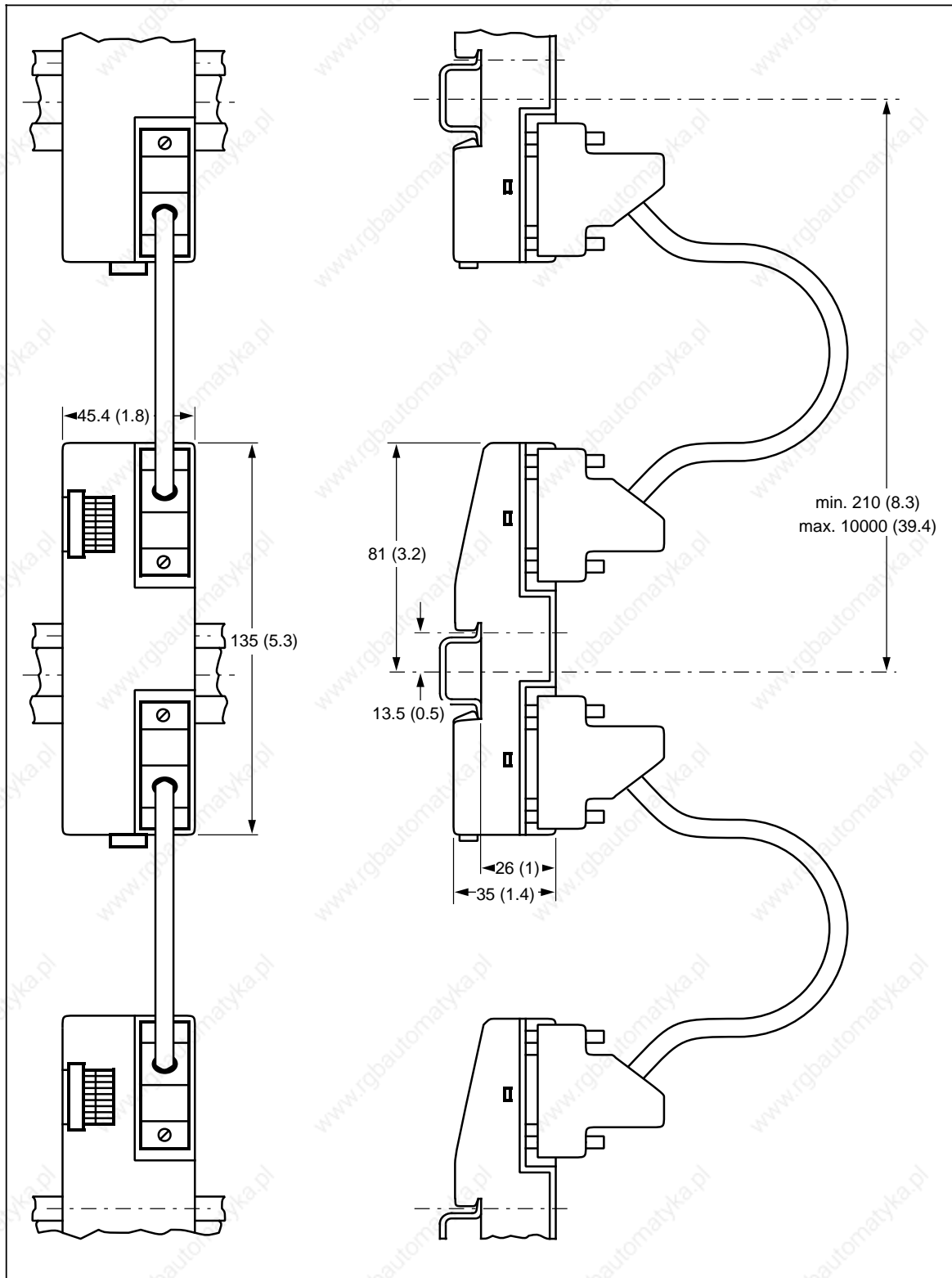

Figure C-12. Dimension Drawing of the IM 316 Interface Module

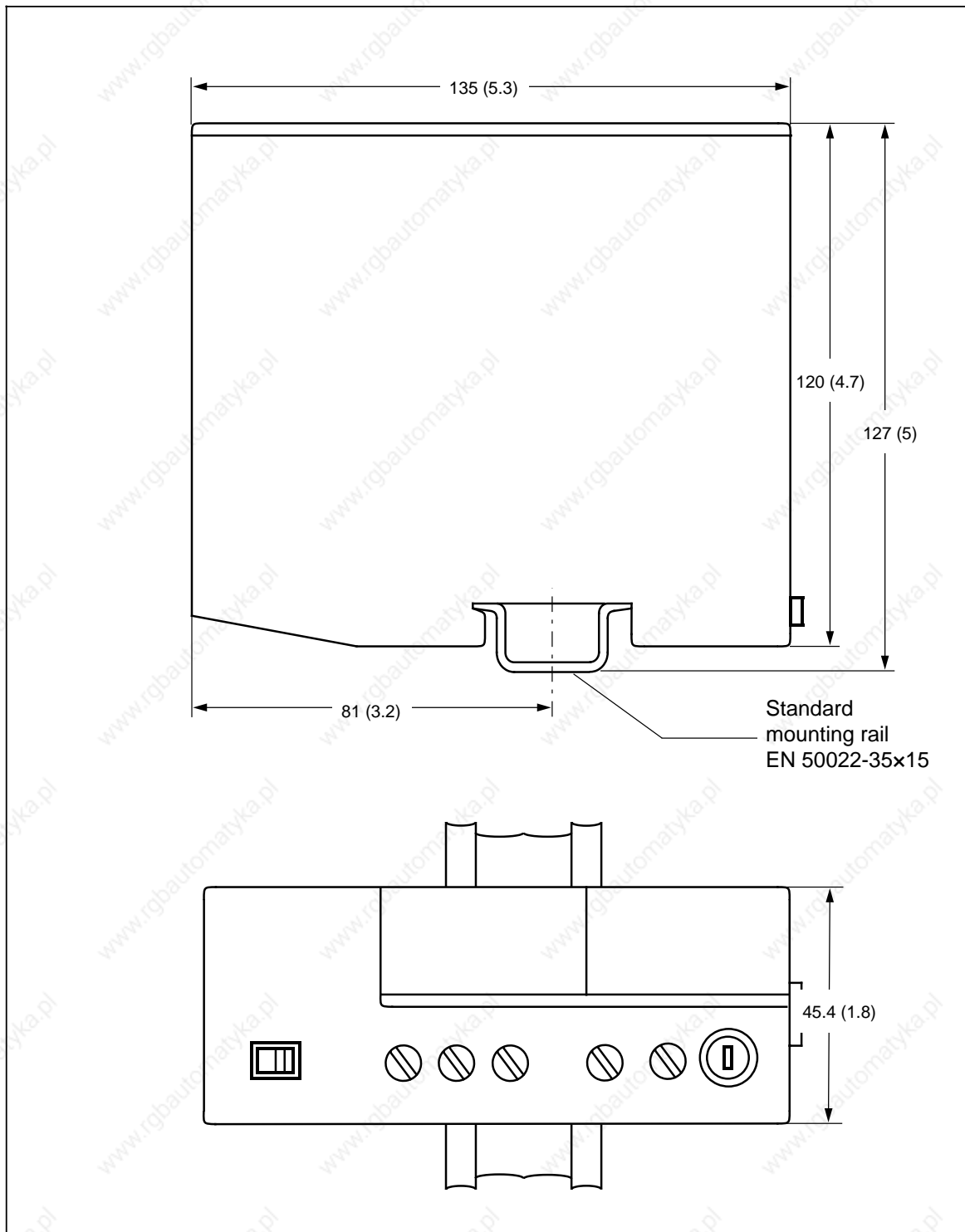

Figure C-13. Dimension Drawing of the PS 931 and PS 935 Power Supply Modules

**D Active and Passive Faults in Automation Equipment/
Guidelines for Handling Electrostatic Sensitive Devices (ESD)**

www.rgbautomatyka.pl

D Active and Passive Faults in Automation Equipment / Guidelines for Handling Electrostatic Sensitive Devices

Active and Passive Faults in Automation Equipment

- Depending on the particular task for which the electronic automation equipment is used, both **active** as well as **passive** faults can result in a **dangerous** situation. For example, in drive control, an active fault is generally dangerous because it can result in an unauthorized startup of the drive. On the other hand, a passive fault in a signalling function can result in a dangerous operating state not being reported to the operator.
- The differentiation of the possible faults and their classification into dangerous and non-dangerous faults, depending on the particular task, is important for all safety considerations in respect to the product supplied.



Warning

In all cases where a fault in automation equipment can result in severe personal injury or substantial property damage, i.e., where a dangerous fault can occur, additional external measures, additional external measures must be taken or equipment provided to ensure or force safe operating conditions even in the event of a fault (e.g., by means of independent limit monitors, mechanical interlocks, etc.).

Procedures for Maintenance and Repair

If you are carrying out measurement or testing work on an active unit, you must adhere to the rules and regulations contained in the "VGB 4.0 Accident Prevention Regulations" of the German employers liability assurance association ("Berufsgenossenschaften"). Pay particular attention to paragraph 8, "Permissible exceptions when working on live parts."

Do not open the S5-90U or S5-95U.

Do not attempt to repair an item of automation equipment. Such repairs may only be carried out by **Siemens service personnel or repair shops Siemens has authorized to carry out such repairs.**

The information in this manual is checked regularly for updating and correctness and may be modified without prior notice. The information contained in this manual is protected by copyright. Photocopying and translation into other languages is not permitted without express permission from Siemens.

Guidelines for Handling Electrostatic Sensitive Devices (ESD)

What is ESD?

All electronic modules are equipped with large-scale integrated ICs or components. Due to their design, these electronic elements are very sensitive to overvoltages and thus to any electrostatic discharge.

These **Electrostatic Sensitive Devices** are commonly referred to by the abbreviation **ESD**.

Electrostatic sensitive devices are labelled with the following symbol:

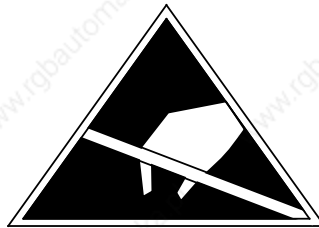

Caution

Electrostatic sensitive devices are subject to voltages that are far below the voltage values that can still be perceived by human beings. These voltages are present if you touch a component module without previously being electrostatically discharged. In most cases, the damage caused by an overvoltage is not immediately noticeable and results in total damage only after a prolonged period of operation.

Electrostatic charging of objects and persons

Every object with no conductive connection to the electrical potential of its surroundings can be charged electrostatically. In this way, voltages up to 15000 V can build up whereas minor charges, i.e. up to 100 V, are not relevant.

Examples:

- | | |
|---|---------------|
| • Plastic covers | up to 5000 V |
| • Plastic cups | up to 5000 V |
| • Plastic-bound books and notebooks | up to 8000 V |
| • Desoldering device with plastic parts | up to 8000 V |
| • Walking on plastic flooring | up to 12000 V |
| • Sitting on a padded chair | up to 15000 V |
| • Walking on a carpet (synthetic) | up to 15000 V |

Limits for perceiving electrostatic discharges

An electrostatic discharge is

- perceptible from 3500 V
- audible from 4500 V
- visible from 5000 V

A fraction of those voltages is capable of destroying or damaging electronic devices.

Carefully note and apply the protective measures described below to protect and prolong the life of your modules and components.

General protective measures against electrostatic discharge damage

- Keep plastics away from sensitive devices. Most plastic materials have a tendency to build up electrostatic charges easily.
- Make sure that the personnel, working surfaces and packaging are sufficiently grounded when handling electrostatic sensitive devices.
- If possible, avoid any contact with electrostatic sensitive devices. Hold modules without touching the pins of components or printed conductors. In this way, the discharged energy cannot affect the sensitive devices.

Additional precautions for modules without housings

Note the following measures that have to be taken for modules that are not protected against accidental contact:

- Touch electrostatic sensitive devices only
 - if you wear a wristband complying with ESD specifications or
 - if you use special ESD footwear or ground straps when walking on an ESD floor.
- Persons working on electronic devices should first discharge their bodies by touching grounded metallic parts (e.g. bare metal parts of switchgear cabinets, water pipes, etc.)
- Protect the modules against contact with chargeable and highly insulating materials, such as plastic foils, insulating table tops or clothes made of plastic fibres.
- Place electrostatic sensitive devices only on conductive surfaces:
 - Tables with ESD surfaces
 - Conductive ESD foam plastic (ESD foam plastic is mostly coloured black)
 - ESD bags
- Avoid direct contact of electrostatic sensitive devices with visual display units, monitors or TV sets (minimum distance to screen > 10 cm).

The following Figures once again illustrates the precautions for handling electrostatically sensitive devices.

- a Conductive flooring material
- b Table with conductive, grounded surface
- c ESD footwear
- d ESD smock
- e Grounded ESD wristband
- f Grounded connection of switchgear cabinet
- g Grounded chair

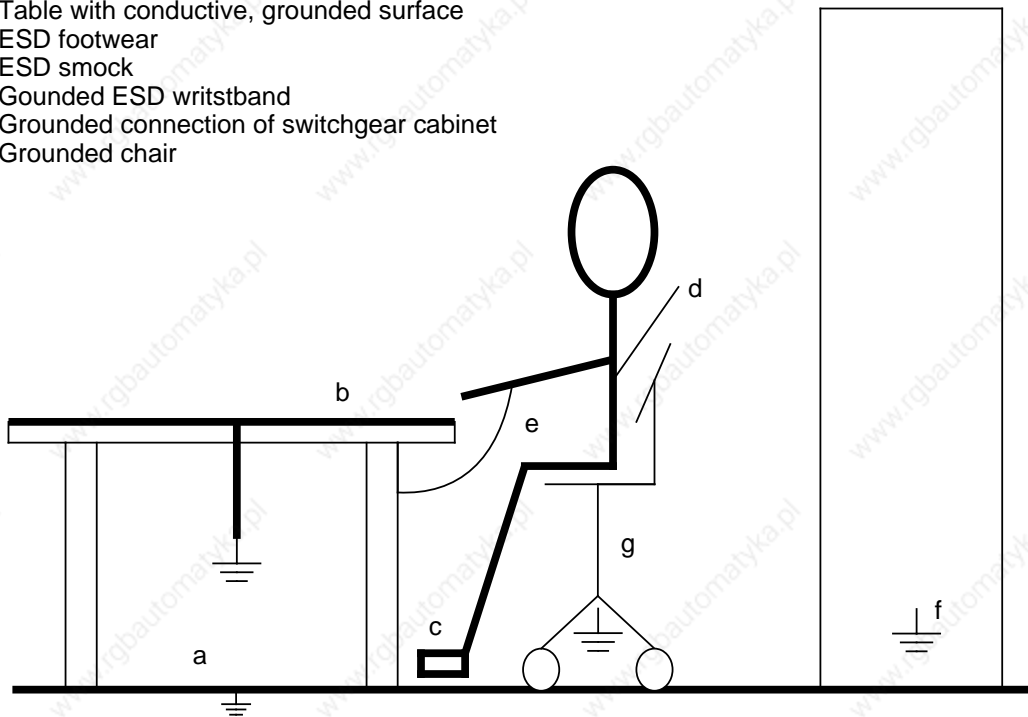

Figure D-1. ESD Measures

Taking measurements and working on ESD modules

Measurements may be taken on electrostatic sensitive devices only if

- the measuring device is grounded (e.g. via protective conductor) or
- the tip of the isolated measuring tool has previously been discharged (e.g. by briefly touching grounded metal parts).

www.rgbautomatyka.pl

E Information for Ordering Accessories

www.rgbautomatyka.pl

E Information for Ordering Accessories

Order Numbers

Standard 35 mm Mounting Rail

for 19-in. cabinets, length 483 mm
 for 600 mm cabinets, length 530 mm
 for 900 mm cabinets, length 830 mm
 Length 2000 mm, without holes

6ES5 710-8MA11
 6ES5 710-8MA21
 6ES5 710-8MA31
 6ES5 710-8MA41

Power Supply Modules

Power supply module PS 931
 115 /230 V AC; 24 V DC; 2 A
 (with electronic protection)
 Power supply module PS 935
 Load power supply 6EW1
 115/230 V AC; 24 V DC; 4 A
 115/230 V AC; 24 V DC; 8 A

6ES5 931-8MD11

 6ES5 935-8ME11

 6EW1 380-1AB
 6EW1 380-4AA

Bus Units

Bus unit with SIGUT screw-type terminals
 Bus unit with crimp snap-in connections

6ES5 700-8MA11
 6ES5 700-8MA22

Accessories

Extracting tool
 for crimp snap-in connections
 Crimp snap-in contacts, 250 pieces
 Crimping tool
 for attaching the crimp contacts

6ES5 497-8MA11
 6XX3070

 6XX3071

Interface Modules

IM 315 interface module
 IM 316 interface module
 - Cable connectors (0.5 m/1.6 ft.)
 - Cable connectors (2.5 m/8.2 ft.)
 - Cable connectors (5.0 m/16.5 ft.)
 - Cable connectors (10 m/33 ft.)

6ES5 315-8MA11
 6ES5 316-8MA12
 6ES5 712-8AF00
 6ES5 712-8BC50
 6ES5 712-8BF00
 6ES5 712-8CB00

Programmable Controller (S5-90U)

6ES5 090-8MA01

S5-90U Accessories

IM 90 interface module
 Memory submodule (EPROM) 8 Kbytes
 Memory submodule (EEPROM) 2 Kbytes

 Memory submodule (EEPROM) 4 Kbytes

 Backup battery (lithium battery)
 Simulator (digital input signals)
 Wall brackets, one set (4 pieces)

6ES5 090-8ME11
 6ES5 375-8LA11
 6ES5 375-8LC11
 (Prog. number 202)
 6ES5 375-8LC21
 (Prog. number 211)
 6ES5 980-8MB11
 6ES5 788-8MK11
 6ES5 981-8MB11

	Order Numbers
Programmable Controller S5-95U, Basic Unit	6ES5 095-8MA04
Programmable Controller S5-95U with SINEC L2 Interface	6ES5 095-8MB03
Programmable Controller S5-95U with Second Serial Interface	6ES5 095-8MC02
Programmable Controller S5-95U with SINEC L2 DP Interface	6ES5 095-8MD02
S5-95U Accessories	
Memory submodule (EPROM) 8 Kbytes	6ES5 375-1LA15
Memory submodule (EPROM) 16 Kbytes	6ES5 375-1LA21
Memory submodule (EPROM) 32 Kbytes	6ES5 375-1LA41
Memory submodule (EEPROM) 2 Kbytes	6ES5 375-0LC11
Memory submodule (EEPROM) 4 Kbytes	6ES5 375-0LC21
Memory submodule (EEPROM) 8 Kbytes	6ES5 375-0LC31
Memory submodule (EEPROM) 16 Kbytes	6ES5 375-0LC41
Back-up battery (lithium battery)	6ES5 980-0MA11
Front connectors:	
Crimp connectors, 40-pin with crimp contacts	6ES5 490-8MA12
Crimp connectors, 40-pin without crimp contacts	6ES5 490-8MA02
Screw-type connectors, 40 pin	6ES5 490-8MB11
Sub D plug connector, 9 pin*,	6ES5 750-2AA11
Sub D plug connector, 15 pin*,	6ES5 750-2AA21

* You can use any standard sub D plug connector of this type.

		Order Numbers
System Manual S5-90U/S5-95U		
	German	6ES5 998-8MA12
	English	6ES5 998-8MA22
	French	6ES5 998-8MA32
	Spanish	6ES5 998-8MA42
	Italian	6ES5 998-8MA52
Manual SINEC L2 Interface of the S5-95U Programmable Controller		
	German	6ES5 998-8MB12
	English	6ES5 998-8MB22
	French	6ES5 998-8MB32
	Spanish	6ES5 998-8MB42
	Italian	6ES5 998-8MB52
Manual Second Serial Interface of the S5-95U Programmable Controller		
	German	6ES5 998-8MC11
	English	6ES5 998-8MC21
	French	6ES5 998-8MC31
	Spanish	6ES5 998-8MC41
	Italian	6ES5 998-8MC51
Manual SINEC L2 DP Interface of the S5-95U Programmable Controller		
	German	6ES5 998-8MD11
	English	6ES5 998-8MD21
	French	6ES5 998-8MD31
	Spanish	6ES5 998-8MD41
	Italian	6ES5 998-8MD51
Accessories for the S5-90U and the S5-95U		
PC cable with TTY / V.24 conversion		6ES5 734-1BD20
PC software package "STEP 5 LAD 90" for S5-90U	English	6ES5 866-0MA23
UV eraser for 230 V AC / 50 Hz		6ES5 985-1AA11
for 115 V AC / 60 Hz		6ES5 985-1BA21
Programming pad (STL 50 sheets)		E80850-C254-XA1
Digital Input Modules		
4 x 24 V DC		6ES5 420-8MA11
8 x 24 V DC		6ES5 421-8MA12
16 x 24 V DC		6ES5 422-8MA11
4 x 24 ... 60 V DC	isolated	6ES5 430-8MB11
4 x 115 V AC	isolated	6ES5 430-8MC11
4 x 230 V AC	isolated	6ES5 430-8MD11
8 x 24 V DC	isolated	6ES5 431-8MA11
8 x 115 V AC	isolated	6ES5 431-8MC11
8 x 230 V AC	isolated	6ES5 431-8MD11
8 x 5 ... 24 V DC	isolated	6ES5 433-8MA11

Order Numbers

Digital Output Modules

4 x 24 V DC / 2 A		6ES5 440-8MA22
4 x 24 V DC / 0.5 A		6ES5 440-8MA12
8 x 24 V DC / 0.5 A		6ES5 441-8MA11
4 x 24...60 V DC / 0.5A	isolated	6ES5 450-8MB11
4 x 115...230 V AC / 1A	isolated*	6ES5 450-8MD11
8 x 24 V DC / 1 A	isolated	6ES5 451-8MA11
8 x 115...230 V AC / 0.5A	isolated*	6ES5 451-8MD11
8 relays x 30 V DC / 230 V AC		6ES5 451-8MR12
4 relays x 30 V DC / 230 V AC		6ES5 452-8MR11
8 x 5 ... 24 V DC/0.1A	isolated	6ES5 453-8MA11

* Replacement fuse (10 A extra-fast)

6ES5 980-3BC11

** Front connector

Digital Input/Output Module

24 V DC 16 inputs/16 outputs		6ES5 482-8MA13
Crimp connector, 40 pin, with crimp contacts		6ES5 490-8MA13
Crimp connector, 40 pin, without crimp contacts		6ES5 490-8MA03
Screw-type connector, 40 pin		6ES5 490-8MB11
Screw-type connector, 20 pin		6ES5 490-8MB21

Analog Input Modules

4 x ± 50 mV	isolated	6ES5 464-8MA11
4 x ± 50 mV	isolated	6ES5 464-8MA21
4 x ± 1 V	isolated	6ES5 464-8MB11
4 x ± 10 V	isolated	6ES5 464-8MC11
4 x ± 20 mA	isolated	6ES5 464-8MD11
4 x + 4...20 mA	isolated	6ES5 464-8ME11
2 x PT 100 / ± 500 mV	isolated	6ES5 464-8MF11
2 x PT 100 / ± 500 mV	isolated	6ES5 466-8MF21
4 x + 0...10 V	isolated	6ES5 466-8MC11

Analog Output Modules

2 x ± 10 V	isolated	6ES5 470-8MA12
2 x ± 20 mA	isolated	6ES5 470-8MB12
2 x + 4...20 mA	isolated	6ES5 470-8MC12
2 x + 1...5 V	isolated	6ES5 470-8MD12

Function Modules

IP 262 Closed-loop control module with 3 analog outputs		6ES5 262-8MA12
with 8 binary outputs		6ES5 262-8MB12
IP 263 Positioning module		6ES5 263-8MA13
IP 264 Electronic cam controller module		6ES5 264-8MA12
IP 265 High Speed Sub Control		6ES5 265-8MA01
IP 266 Positioning module		6ES5 266-8MA11
IP 267 Stepper motor control module		6ES5 267-8MA11
Diagnostic module 330		6ES5 330-8MA11
Timer module 380 2 x 0.3...300 s		6ES5 380-8MA11
Counter module 2 x 0...500 Hz		6ES5 385-8MA11
Counter module 385B 1 x 25 / 500 KHz		6ES5 385-8MB11

Further Function Modules

Comparator module 461 2 x 1...20 mA / 0.5...10 V
 CP 521 SI communications processor
 CP 521 BASIC communications module
 Simulator 788 (digital input/output signals)

Order Numbers

6ES5 461-8MA11
 6ES5 521-8MA22
 6ES5 521-8MB12
 6ES5 788-8MA11

Programmiers

PG 605 Programmer
 PG 720 Programmer
 PG 720C Programmer
 PG 740 Programmer
 PG 760 Programmer
 (catalog ST 59)

6ES5 605-0UA12
 6ES7 720-0AB00-0YA0
 6ES7 720-1AB00-0YB0
 6ES7 740-0AA00-0YA0
 6ES7 760-1AA00-0YA0

Program Packages**Basic Functions Program Package**

description in German, English, and French
 for the S5-DOS operating system
 for the MS-DOS, S5-DOS/MT operating system

6ES5 848-8AA01
 6ES5 848-7AA01

Floating Point Arithmetic Program Package

description in German, English, and French
 for the S5-DOS operating system
 for the MS-DOS, S5-DOS/MT operating system

6ES5 845-8GP01
 6ES5 845-7GP01

GRAPH 5 Program Package

description in German, English, and French

6ES5 886-1FA01

GRAPH Mini Program Package

German
 English
 French
 Spanish
 Italian

6ES5 886-1SE11
 6ES5 886-1SE21
 6ES5 886-1SE31
 6ES5 886-1SE41
 6ES5 886-1SE51

S5-100U Program Package

description in

German
 English
 Italian

6ES5 840-4BC11
 6ES5 840-4BC21
 6ES5 840-4BC51

STEP 5 Package for Mini PLCs for PC

documentation for STEP 5 package in German

6ES5 866-0MA02
 6ES5 896-0MY11

www.rgbautomatyka.pl

F Reference Materials

www.rgbautomatyka.pl

F Reference Materials

The following reference material can be ordered from your local Siemens Company or your local bookshop:

- **Automating with the SIMATIC® S5-115U**
Programmable Controllers
Hans Berger
Siemens AG, Berlin and Munich, 1989 (2nd Edition)
(Order No.: ISBN 3-8009-1530-8)
- **Programmable Controllers**
Basic Concepts
Siemens AG, 1992 (Order No.: A19100-L531-F914-X-7600)
- **Programming Primer for the SIMATIC® S5-90/95U**
Practical Exercises with the PG 710 Programmer
Siemens AG, Berlin and Munich, 1992
Order No.: A19100-L531-F550-X-7600

www.rgbautomatyka.pl

Index

www.rgbautomatyka.pl

Index

=	8-7	Analog value	
= =	8-59	- output	9-24, 12-9 , 12-10, 12-16
A		- read in	12-2 , 12-5, 12-14
A	8-2	Arc suppressing element	3-37
A =	8-58	Argument	9-27, 9-29
ACCU 1	8-10	Arithmetic operations	8-31 , 8-67 , 8-69, A-5, A-14
ACCU 2	8-10	Arithmetic unit	2-9
Accumulator	2-9, 8-10	ASPFA	5-8
Actual operand	7-11, 7-13	Assembly	
Actual value	9-13	- of a tier	3-5, 3-7
ADD	8-67	- multi-tier	3-11
Address	6-1	Atmospheric pressure	B-1, 15-3
Address assignment in the S5-90U	B-8	AW	8-44
AM/PM	13-4	B	
AN	8-2	Back-up	16-45
AN =	8-58	Back-up battery	4-11, B-2-B-3
Analog input	1-4, 12-1	Backup of the hardware clock	13-7
- as digital input	12-8	Basic operations	7-2
- connect	3-23	BASIC programs	16-67
- accuracy	12-8, 12-13	Battery failure	9-7
- time required for output	12-12	BAU	5-7
- time required for reading in	12-7	BCD number	7-19 , 9-20, 9-21
Analog input module		BE	8-33
- 2xPT 100/±500 mV	15-78, 15-83	BEC	8-33
- 4x+0 to 10 V	15-89	BEU	8-33
- 4x±1 V	15-58	Bidirectional data exchange	16-64
- 4x±10 V	15-62	Binary logic operation	8-58
- 4x±20 mA	15-66	Binary number	7-18
- 4x±4 to 20 mA	15-72	Binary scaler	8-71
- 4x±50 mV	15-38, 15-46	Bit	
Analog input modules	3-23, 12-1	- address	6-5
- analog value representation	15-37	- operations	A-8, A-9
- connecting current and voltage sensors	15-37	- pattern	12-3 , 15-37
- multi-channel operation	15-37	- test operation	8-42
- potential difference	15-37	BLD	8-38
Analog module	6-7	Block	7-2, 7-7, 8-37
Analog output	3-23, 12-1	- body	7-7
Analog output module		- call	7-5
- 2x1 to 5 V	15-99	- call operations	8-33, A-6
- 2x4 to 20 mA	15-97	- end	8-37
- 2x±10 V	15-93	- end ID	9-27, 9-29
- 2x±20 mA	15-95	- header	7-7
Analog output modules	15-92	- ID	9-25, 9-29
- connecting of loads	15-92	- parameters	7-11 , 7-12
Analog value representation	15-92, 15-37		

Block		Coding	
- programming	7-7	- element	3-9
- permissible	B-2, B-3	- key	3-9
- start address	5-10	Cold restart	9-5
- structure	7-7	Comments	9-28
- transfer	8-66	Communications	
- types	7-6	- capabilities	1-2
Block call operations and return operations	A-14	- processor	1-6
Boolean logic operations	8-2, A-1, A-8	Comparator module 2x0.5 to 20 mA/0.5 to 10 V	16-1
Broadcast	14-5	Comparison	
BSTACK	5-10	- operation	8-30, 8-69, A-5-A-6
Bus terminal BT 777	14-2	- value	11-3-11-5
Bus unit	1-2, 3-6, 3-11	Compensating box	15-40
- crimp-snap-in connections	15-7	Compiler	2-10
- SIGUT	15-6	"Compiler error"	5-9
Byte address	6-5	"Compress"	4-13
C		COMPRESS	7-17
C	8-33	Condition code	2-9
Cascaded counter	11-3	- generation	8-69
Cause of an interrupt	5-7	Configuration	
Causes of errors	5-5	- floating	2-5
CC 0	A-14	- grounded	3-25
CC 1	A-14	- non-floating	2-6
CD	8-25	- non-grounded	3-27
CFW	8-50	Connecting	16-22
Change in operating mode	4-2	- a 5-V position sensor	16-23
Channel	3-23	Connection of	
- number	6-5	- loads	15-92
Characteristic linearization	15-86	- only four-wire transducers	15-74
Class of protection	B-4	- only two-wire transducers	15-74
Clock		- pulse and position sensors	16-23
- acceptance	13-8	- resistance thermometers	15-80, 15-85
- backup	13-7	- thermocouples	15-48
- data	13-4	- thermocouples with a compensating box	15-41
- data area	13-1, 13-2	- of voltage sensors	15-60, 15-64, 15-91
- data area of the S5-95U	B-13	Constants	7-2
- data in the clock data area	13-3	Control	
- flags	13-5	- bit	5-5
- integral	13-1	- deviation	9-14
- reading and setting	13-12	- system flowchart (CSF)	7-1
- settings	13-4	- variable	9-14
- setting parameters in DB1	13-8, 13-10	Controller	
Clock-pulse generator	8-73	- continuous-action	9-8
Clock time correction factor		- DB	9-12
- setting in DB1	13-11	Conversion operation	8-50, 8-70, A-11
- entering	13-26	Coordination byte	
Closed-loop control positioning	16-61	- receive (KBE)	14-3, 14-8
Code converter: B4	9-20	- send (KBS)	14-3
Code converter: 16	9-21		

Counter		Design of the PLC	2-1
- comparison value	11-3	Diagnostic byte	10-2 , 11-4, 11-7
- frequency limit	11-1	- read/reset	5-3
- input	11-1, 1-4, 3-21, 3-24	Diagnostic byte assignment	
- module	1-4	- S5-90U	5-1
- module 25/500 kHz	16-18	- S5-95U	5-2
- module 2x0 to 500 Hz	16-13	Diagnostic module	16-10
- operation	8-25, 8-61, A-5	Digital input	1-4, 3-20, 3-22
- overflow	11-4	Digital input module	
- register	11-8	- 4x115 V AC	15-17
- resetting	8-29, 11-2	- 4x230 V AC	15-18
- retentive	2-8	- 4x24 to 60 V DC	15-16
- setting	8-28	- 4x 24 V DC	15-13
- status	8-27	- 8x155 V AC	15-20
Counter input		- 8x230 V AC	15-21
- counting frequency	1-4	- 8x24 V DC	15-14, 15-19
Counting		- 8x5 to 24 V DC	15-22
- down	8-28	- 16x24 V DC	15-15
- frequency	11-7, 11-9	- with LED display	15-34
- pulse sensor	16-22	Digital input and output modules	15-34
- up	8-29	with LED display	
CP Communications processor		Digital logic operation	8-44, 8-70
CP 521 BASIC communications module	16-66	Digital module	6-5
Crimp snap-in connector		Digital output	3-20, 3-22
- 40-pin	15-32	Digital output module	
Crimp-snap-in contact	3-17	- 4x115 to 230 V AC/1 A	15-28
CSW	8-50	- 4x24 to 60 V DC/0.5 A	15-27
CU	8-25	- 4x24 V DC/0.5 A	15-24
Current		- 4x24 V DC/2 A	15-25
- consumption	B-2, B-4	- 8x115 to 230 V AC; 0.5 A	15-30
- time	8-18	- 8x24 V DC/0.5 A	15-26
		- 8x24 V DC/1 A	15-29
		- 8x5 to 24 V DC/0.1 A	15-31
D		Digital output modules	15-23
D	8-52	Dimensions	1-3, B-3
Data	7-2	Dimensions and weight	B-2
Data block (DB)	7-4	Direct I/O access	6-11
- call, delete, generate	8-35	Disable interrupt	8-53
- integrated	9-25	Display generation operation	8-39, A-7
DB1	7-16, 9-25-9-27, 9-29, 9-31	Disturbance variable	9-13
- parameters	B-5-B-6	Divider : 16	9-23
DDC operation	16-45	DO	8-54
Dead time compensation	16-52	DO=	8-63
Decimal number	7-19	DO operation	8-54, 8-63
Decrement	8-52	Dominant system time constant	9-14
Default DB1	9-25	Down counters	16-15
Degree of protection	B-1, 15-1		
Delay			
- of inputs/outputs	6-16		
Derivative-action time	9-12		

E			
Edge	10-1, 10-5, 11-1, 11-7	Fixed-point number	9-20 , 9-21, 9-22, 9-23
Electrostatic discharge test	B-1	Flags	1-5, 2-8, 7-2, B-2-B-3
Emitted interference	B-1	Flat ribbon cable	3-9
Enable interrupt	8-53	Flip-flop	8-8, 8-71
Enable operation	8-41	"FORCE VAR"	4-6
End operation	9-27	Formal operand	7-11
End symbol	9-27, 9-29	FPGA	16-55
Equalizing circuit	15-40	FR	8-41
Equipotential bonding conductor	3-35	FR =	8-61
Error bit	12-3	Free fall	15-3, B-1
ESD	D-2	Frequency limit	11-9
Evaluation of edges	8-71	Front connector	3-22
Execution time	1-5, B-2-B-3	Function block (FB)	7-4
Execution time for internal timers	6-20	- standard	1-6
Expansion	3-11		
Express transmission	14-6	G	
External I/Os	6-1 , B-2, B-3	Galvanic isolation	B-4
External I/O bus	2-9, 6-23	Galvanically isolated	3-32
		Generating of BASIC programs	16-67
F		GRAPH 5	9-24
! =F	8-30	GRAPH 5/GRAPH Mini	7-1
+ F	8-31	GRAPH Mini	7-1
- F	8-31	Ground	3-22
< =F	8-30		
<F	8-30	H	
> <F	8-30	Hardware counter	11-1
> =F	8-30	Hardware clock	13-1
>F	8-30	Hexadecimal number	7-18
Fast transient burst	B-1, 15-3	12-hour mode	13-4
Faults in automation equipment	D-1	24-hour mode	13-4
FB117	15-80		
FB240	9-20	I	
FB241	9-21	I	8-52
FB242	9-22	I/O access	6-11
FB243	9-23	I/O areas	6-9
FB250	9-24, 12-2, 12-4, 12-5 , 12-7, 12-14, 15-45, 15-54, 15-61, 15-65, 15-71, 15-77, 15-82	I/O bus	6-23, 16-11
FB251	9-24, 12-10 , 12-16, 15-92	I/O modules	1-2
		I/Os	
Field test	15-3	- external	6-1
Field transfer	8-66	- onboard	2-8, 6-1
Filler	9-27	IA	10-4, 8-53
Fixed-point binary number	9-21 - 9-23	IM 90 interface module	2-7, 3-6 , 15-10
		IM 315 interface module	3-11 , 15-8
		IM 316 interface Module	3-11 , 6-3, 15-9
		Increment	8-52
		Indirect I/O access	6-11
		Inductive circuits	3-37

Input voltage	B-2, B-4	L	
Inputs	6-16, 7-2	L	8-11, 8-40
- delay	6-16	L =	8-60
Inputs/outputs	B-2-B-3	L1 bus cable	14-2
Inrush current	B-2	Ladder diagram (LAD)	7-1
Installation	3-1, 3-30-3-31	LD =	8-60
Insulation rating	B-1, 15-3	Lightning protection	3-34
Integral clock clock		Line groups	3-33
Integral real-time clock (hardware clock)	13-1	LIR	8-65
Intelligent I/O module	1-6	Load	8-12, 8-16
Interface	2-9	- circuit	3-25, 3-27
- module	3-11	- operation	8-10, 8-40, 8-60,
Interrupt	1-5, 10-2, 11-1	- register contents	8-64, A-2
- input	3-21, 3-24, 10-1	- voltage	8-65
- priority	10-4	Load and transfer operations	A-10, A-13
- process image	2-8, 6-13	Loading	8-65
- reaction time	10-7 , 11-2	Logic AND	8-2
- stack	4-13	Logic OR	8-2
Interrupt-driven program execution	9-3	LW =	8-60
IP Intelligent I/O module		M	
IP 262 closed-loop control module	16-42	Machine code listing	A-15
IP 263 positioning module	16-46	Maintenance	D-1
IP 264 electronic cam controller mod.	16-50	Master	14-1, 14-5
IP 265 high speed sub control	16-53	Memory capacity	B-2-B-4
IP 266 positioning module	16-56	Memory submodule	2-9, 4-8, 4-10
IP 267 stepper motor control mod.	16-60	Minimum pulse duration	10-7
ISTACK	5-4, 9-34	Mode of operation	15-40
- call	5-3	Momentary-contact relay	8-71
- output	5-5	Monitor for the supply voltage	3-25
- updating	5-4	Monitoring	16-11
J		- time	9-6
JC	8-33	Mounting	1-3
JC =	8-56	Multi-channel operations	15-37
JM =	8-56	Multi-tier configuration	6-3
JN =	8-56	Multiplier : 16	9-22
JO =	8-56	N	
JP =	8-56	NAU	5-7
JU	8-33	Nesting	
JU =	8-56	- depth	7-5
Jump		- levels	9-4
- displacement	8-57	Net data	14-5
- label	8-57	NINEU	5-7
- operation	8-56, A-11	NNN	5-7
JZ =	8-56	No operations	8-39
K		NOP 0	8-8, 8-38
KEIN AS	5-8	NOP 1	8-38
		Number format	7-18

O

O	8-2
O =	8-58
OB1	9-2
OB3	9-3 , 10-2, 10-3, 11-4
OB13	9-3
OB21	9-5
OB22	9-5
OB31	9-6
OB34	9-7
OB251	9-8
Off-delay	8-24
ON	8-2
ON =	8-58
On-delay	8-22
- timer	16-6
On-line mode	4-8
ON/OFF switch	4-1
Onboard I/O	2-8, 6-1
- specifications	B-2, B-3
OP Operator panel	
Operating hours counter	
- flags	13-6
- reading	13-25
Operating hours counter	
- setting in DB1	13-11
- programming	13-21
- transferring settings	13-21
Operating mode switch	4-1
Operating system flags	13-5 , 13-6
Operating system runtime	
- S5-90U	6-19
- S5-95U	6-19
Operator panel	1-6
Organization block (OB)	7-4, 9-1
Other operations	8-38, 8-68, A-12, A-14
Output	7-2
- current	B-2, B-4
- delay	6-16
- variable	9-13
- voltage	B-2, B-4
Overall reset	4-3
Overflow bit	12-3
OW	8-44

P

Parameter	9-27
- block	9-27
- error	9-31, 9-33, 9-34
- name	9-29
Peripherals	7-2
Permissible blocks	B-2, B-3
PEU	5-7
PG	1-9
PID	
- algorithm	9-8
- controller	1-6
PII	6-9, 6-19, 11-5
- bits assigned to various modules	6-16
PIQ	6-9 , 6-19
- bits assigned to various modules	6-16
Point-to-point connection	1-7
Pollutants	B-1, 15-1
Position	
- decoder	16-20, 16-30
- resolution	16-27, 16-31
Positioning	16-48, 16-57- 16-58
- algorithm	9-11
Potential difference	3-35-3-36, 15-37
Power recovery	9-5
Power supply	1-3
- failure	5-2
- module	3-8,
Power supply	
- module PS 931	15-4
- module PS 935	15-5
Process image	2-8, 6-9
- addresses	6-9
- transfer time	6-18
Process interrupt	1-5, 9-3
Processor	2-9
Program processing	9-5, 6-13
- restart	9-5
Program blocks (PBs)	7-4
Program execution	9-3
- time	6-19
- time-controlled	6-13
Programmer	1-9
- bus number (PGN)	14-4
- function	4-12
- interface	2-2, 2-4, 2-9, 4-12

Programming	1-5	ROM	2-8
- language	7-1	RU	8-42, 8-64
- structured	1-5	Runtime error	5-10
- time-controlled	1-5		
Prompt function		S	
- programming	13-6	S	8-7, 8-25
Prompt time		S =	8-59
- setting in DB1	13-10	S5-90U	B-5, B-9
- sequence	13-18	S5-95U	B-6
Prompting time flags	13-6	Sampling interval	9-12, 9-14
Proportional gain	9-12	SB2	9-24
PS 935	6-2	Scan time	6-15, 6-21
PT 100	15-80, 15-85	- monitor	9-6
Pulse	8-20 - 8-21	Scanning the status word	13-7
		Scope	
Q		- of the system manual	xvii
Queue	10-4 - 10-5	Screw plug connector	
		- 20-pin	15-32
R		- 40-pin	15-32
R	8-7, 8-15, 8-25	Screw-type terminal	3-15 - 3-16
RA	8-53, 10-4	SD	8-15
Radiated electromagnetic	15-3	SD =	8-61
- to IEC 801-3 field test	B-1	SE	8-15
RAM	2-8 , 2-10, B-8	SEC =	8-61
- address assignment in the S5-90U	B-8	Second serial interface	2-9
- address assignment in the S5-95U	B-10	Send mailbox (SF)	14-3, 14-5
RB =	8-59	Sensor line	15-94, 15-100
RD =	8-61	Sequence	
Receive Mailbox (EF)	14-3	- block SB	7-4, B-3
Reference		- block 2	9-24
- point approach	16-32	Set/reset operations	8-7, 8-59, A-1- A-2, A-9
- potential	3-30	Set operations	8-64, A-13
- pulse	16-33	Set the clock	13-4
- signal	16-33	Set the clock parameters in DB1	13-8
REL-SAC	5-10	Setpoint	9-12 , 9-14
Relative humidity	15-3, B1	SF	8-15
Relay output module		SFD =	8-61
- 4x30 V DC/230 V AC	15-33	Shift operation	8-48, 8-70, A-11
- 8x30 V DC/230 V AC	15-32	Shock	15-3, B-1
Removal	3-1, 3-4	Sign bit	12-3
Repair	D-1	Signal cable	3-35
Resistance thermometers	15-80, 15-85	SIGUT screw-type terminal	3-16
Response time	6-15, 6-22	Simulator	
Restart processing	9-5	- for the S5-90U	16-7
Restart operations	A-6 - A-7	Simulator module	16-8
RLO	8-33, 8-42		

SINEC L1	14-1	System data area	
SINEC L1 LAN	1-7	- S5-90U	B-9
SINEC L2 LAN	1-7	- S5-95U	B-12
SINEC L2 bus fault LED	4-1	System deviation	9-12
SINEC L2 interface	2-9	System error	9-14
Single scan	12-6	System operation	7-2, 8-64
Single-tier configuration	6-2		
Slave	14-1 , 14-5, 14-9	T	
- number	14-4	T	8-11, 8-65
Slot	6-2	T =	8-60
- number	6-5	TAK	8-68
SLW	8-48	TB	8-42
Software	1-6	TBN	8-42
SP	8-15	TD Text display	
SP =	8-61	Temperature	15-3, B-1
SPC-operation	16-45	Text display	1-6
SRW	8-48	Thermocouples	15-48
SS	8-15	Time	
SSU	8-61	- base	8-16-8-17
Stand-alone operation	16-44	- for execution of internal timers	6-20
Standard		- monitor	9-2
- function block	1-6	- operating system runtime	6-19
- mounting rail	3-3	- updating	13-2
- screw-type terminal	3-15	Time-controlled program execution	9-4
Start ID	9-29	Timer	1-5, 2-8,
Statement list (STL)	7-1	- internal	7-2, B-2 - B-3
Static electricity	15-3	- module 2x0.3 to 300 s	6-23
"STATUS"	4-13	- operation	16-4
"STATUS VAR"	4-6	- start	8-61, A-4-A-5
Status word	13-1, 13-5	Timer and counter operations	8-19
STEP 5	1-8 , 1-9	TIR	A-9-A-10
- methods of representation	1-8	TNB	8-65
STEP address counter	5-10	TRAF	8-65
Stepper motor	16-61	Transfer	5-8
"STOP" operating mode	4-2	Transfer operation	8-11
STOP operation	8-39 , A-7	Transfer to system data area	8-10, 8-60, 8-64 ,
STOPS	5-7	Transferring	A-3, A-4
STP	8-38	Transferring	8-65, 8-67
Structure of the Coordination	14-6	Two-wire connection	15-91
Byte Send (KBS)		- of current sensors	15-68
STS	5-7, 8-68		
STUEB	5-7		
SU	8-42, 8-64		
Sub D connector	3-23-3-24		
Substitution operation	8-58		
SUF	5-8		
Supplementary operation	7-2, 8-39		
Supply voltage	5-2		
SYNFEH	5-7		
System characteristics	6-23		
System data	2-8		

U

Unidirectional data exchange 16-64
User memory 1-5

V

Vibration 15-3, B-1
Voltage measurement 15-48
Voltage sensors 9-2

V

Vibration 15-3, B-1
Voltage measurement 15-48
Voltage sensors 9-2

W

Wall bracket 3-1
Weight **B-3**
Wire break 12-3
With error diagnostics 15-23
Word address 6-7

X

XOW 8-44

Z

ZYK 5-8

www.rgbautomatyka.pl

Siemens AG
A&D AS E 48
Postfach 1963

D-92209 Amberg
Federal Republic of Germany

From:

Your Name: _____

Your Title: _____

Company Name: _____

Street: _____

City, Zip Code: _____

Country: _____

Phone: _____

Please check any industry that applies to you:

Automotive

Chemical

Electrical Machinery

Food

Instrument and Control

Nonelectrical Machinery

Petrochemical

Pharmaceutical

Plastic

Pulp and Paper

Textiles

Transportation

Other _____

Remarks Form

Your comments and recommendations will help us to improve the quality and usefulness of our publications. Please take the first available opportunity to fill out this questionnaire and return it to Siemens.

Title of Your Manual:

Order No. of Your Manual:

Edition:

Please give each of the following questions your own personal mark within the range from 1 (very good) to 5 (poor).

- 1. Do the contents meet your requirements?
- 2. Is the information you need easy to find?
- 3. Is the text easy to understand?
- 4. Does the level of technical detail meet your requirements?
- 5. Please rate the quality of the graphics/tables:

Additional comments:

.....

.....

.....

.....

.....

.....

.....

.....

.....

.....