

DDS 2.1 and MDD Digital Intelligent AC Servo Drives with ANALOG interface

Application Manual

DOK-DIAX02-DDS02.1*ANA-ANW1-EN-P

About this documentation	Section
<hr/>	
Contents	
<hr/>	
The digital intelligent AC servo drive	1
<hr/>	
The digital intelligent AC servo drive with ANALOG interface	2
<hr/>	
Fundamental safety notes	3
<hr/>	
Commissioning equipment	4
<hr/>	
Operating the drive controller during commissioning and diagnostics	5
<hr/>	
Commissioning procedure up to initial start-up of the AC servo drive	6
<hr/>	
Commissioning the functions of the digital AC servo drive with ANALOG interface	7
<hr/>	
Final commissioning work	8
<hr/>	
Diagnostics and fault clearance	9
<hr/>	
Overview of parameters	10
<hr/>	
Appendix	11
<hr/>	
Glossary	12
<hr/>	
List of keywords	13
<hr/>	

Titel DDS 2.1 and MDD
Digital intelligent AC servo drives with ANALOG interface

Type of documentation: Applications Manual

Documenttype DOK-DIAX02-DDS02.1*ANA-ANW1-EN-E1,44

Internal file reference

- Mappe 11b
- DDS*A-AN.pdf
- 209-0069-4315-03

Reference This electronic document is based on the hardcopy document with document desig.: 209-0069-4315-03 EN/12.93

This documentation is used:

- as a practical instruction manual for commissioning the digital AC servo drive with ANALOG interface and is intended for trained personnel.
- to explain the safety considerations when handling the digital AC servo drive.
- to explain the drive controller functions and their application to the machine.
- to parametrize the drive controller during commissioning.
- to ensure security of the parameters entered on completion of commissioning.
- for fault diagnostics and fault clearance on the digital AC servo drive.

Änderungsverlauf

Designation of documentation up to present edition	Release-date	Comments
209-0069-4315-03 EN/12.93	Dez./93	First Edition
DOK-DIAX02-DDS02.1*ANA-ANW1-EN-E1,44	Dez./96	Introduction of document type

Copyright © INDRAMAT GmbH, 1993
Copying of this document, and giving it to others and the use or communication of the contents thereof, are forbidden without express authority. Offenders are liable to the payment of damages. All rights are reserved in the event of the grant of a patent or the registration of a utility model or design. (DIN 34-1)
The electronic documentation (E-doc) may be copied as often as needed if such are to be used by the consumer for the purpose intended.

Publisher INDRAMAT GmbH • Bgm.-Dr.-Nebel-Straße 2 • D-97816 Lohr
Telefon 0 93 52 / 40-0 • Tx 689421 • Fax 0 93 52 / 40-48 85
Dept ENA (VS, FS)

Validity All rights reserved with respect to the content of this documentation and the availability of the products.

Documentation Overview "Digital intelligent AC servo drives"

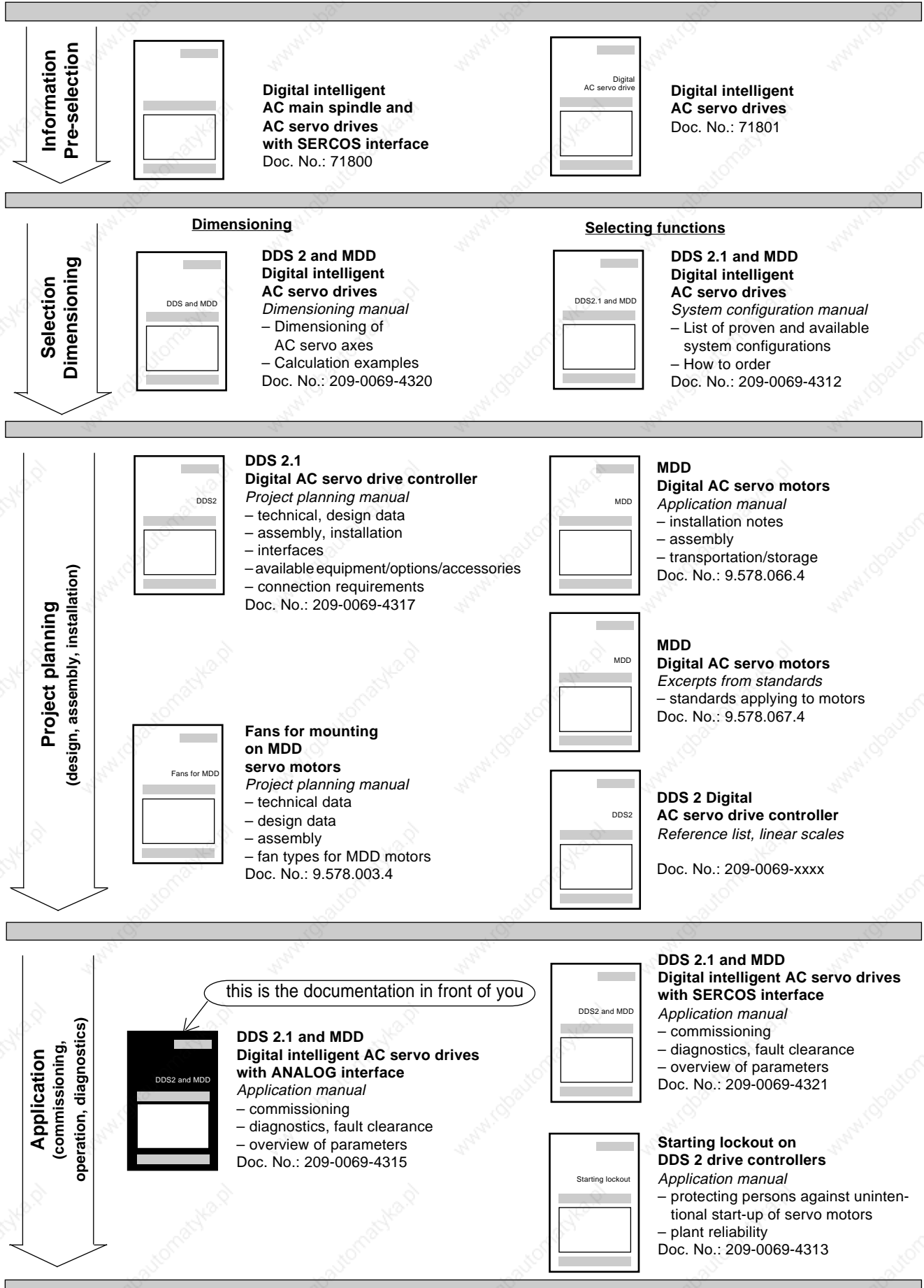


Fig. 1: Documentation overview

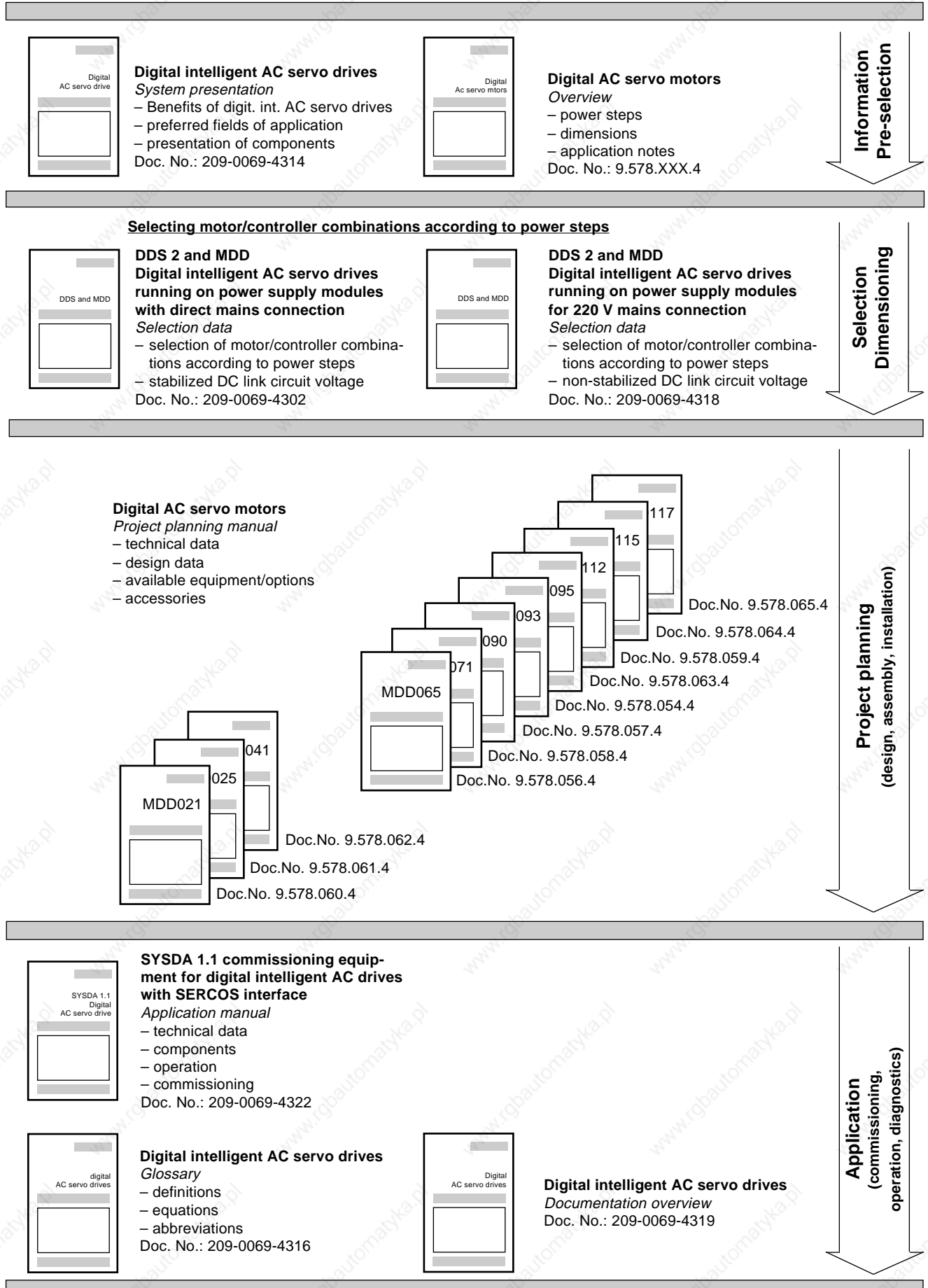


Table of Contents	Page
1. The digital intelligent AC servo drive	11
2. The digital intelligent AC servo drive with ANALOG interface	14
2.1. Components of the digital AC servo drive	15
2.2. Function schematic of the digital AC servo drive	16
2.3. System configuration of the digital AC servo drive	17
2.4. System configuration components	22
3. Fundamental safety notes	31
3.1. Warning notes and symbols	31
3.2. Use as prescribed	31
3.3. Safety notes for commissioning	32
3.4. Notes on protection of personnel	32
3.5. Notes on protection of equipment	34
3.6. Notes on protection of machinery	34
4. Commissioning equipment	35
4.1. Measuring instruments	35
4.2. Battery power source	36
4.3. Service cable IN 391	37
4.4. Personal computer (PC)	37
4.5. VT 100 Terminal	38
5. Operating the drive controller during commissioning and diagnostics	39
5.1. How to handle the parametrizing and diagnostics program	39
5.2. Saving data	51
6. Commissioning procedure up to initial start-up of the AC servo drive	52
6.1. Checks to be run with power disconnected	52
6.2. Checks to be run with control voltage applied	55
6.3. Entering parameters for initial start-up	55
6.4. Powering up	56
6.5. Checks to be run after switching on power	56
6.6. Initial start-up of the drive with a battery power source	57
7. Commissioning the functions of the AC servo drive with ANALOG interface	58
7.1. Error reaction	58
7.2. Safety lockout (drive interlock open)	61
7.3. Holding brake function	64
7.4. Operational status (Ready)	67
7.5. Temperature monitoring	68
7.6. Velocity command matching	70
7.7. Command value smoothing	72

7.8. Actual-position sensing by indirect relative position measuring system	72
7.9. Actual-position sensing by indirect absolute position measuring system	76
7.10. Master/slave mode	80
7.11. Torque reduction	82
7.12. Drift-free positioning of a servo axis.	85
7.13. Velocity Loop	86
7.14. What to do in the event of a power failure or emergency shutdown	88
7.15. Setting the short-time operation torque "M _{KB} "	89
8. Final commissioning work	90
8.1. Preparations for running the axis with an NC control system ..	90
8.2. Compensating the servo axis drift	91
8.3. Checking the servo drive	92
8.4. Saving data	94
9. Diagnostics and fault clearance	95
9.1. Diagnosing the operating status of the controller using its status display	95
9.2. Status indications during drive initialization	96
9.3. Fault diagnostics and clearance using the drive controller status display	97
9.4. Input errors and faults due to errors while saving	104
9.5. Selecting signals for diagnostics outputs	105
9.6. Notes on component replacement	107
10. Overview of parameters	108
11. Appendix	109
11.1. Repair Card	109
11.2. Specific axis data list, to be completed by hand	110
11.3. Example of a parameter file printout	112
11.4. DDS 2.1 drive controller connection diagram for motors with resolver feedback	114
11.5. DDS 2.1 drive controller connection diagram for motors with digital servo feedback	115
11.6. Pin allocations/abbreviations on drive controller	116
11.7. Overview of INDRAMAT companies, subsidiaries and agencies	120
12. Glossary,	124
13. List of keywords	128

1. The digital intelligent AC servo drive

Digital intelligent AC servo drives are microprocessor-controlled brushless three-phase AC drives with outstanding servo control characteristics in terms of dynamic response and precision.

Excellent performance data, flexible operating modes and applications-orientated functions offer the ideal pre-requisites for:

- CNC machine tool axes
- Electronic transmissions, e.g. for gear milling machines
- Grinding machines
- Robots
- Handling systems
- Assembly equipment
- Woodworking machines
- Packaging machines
- Textile machines
- Printing machines

All drive control, monitoring, parametrizing and diagnostics functions are digital - employing a signal processor - with an extremely high-resolution measurement of the rotor position over the entire speed range.

INDRAMAT digital intelligent AC servo drives can be supplied with either of two interfaces:

- SERCOS interface
- ANALOG interface

SERCOS interface

The SERCOS interface is a serial real-time communication system between NC controls and drives which has been proposed for standardization in a draft standard (DIN IEC/TC 44) drawn up by a joint workgroup made up of representatives from the Verein Deutscher Werkzeugfabriken e.V. (VDW) [Association of German Machine Tool Factories] and from the trade association for Electrical Drives of the Zentralverband Elektrotechnik und Elektroindustrie e.V.(ZVEI) [Central Association of Electrical Engineering and the Electrical Industry].

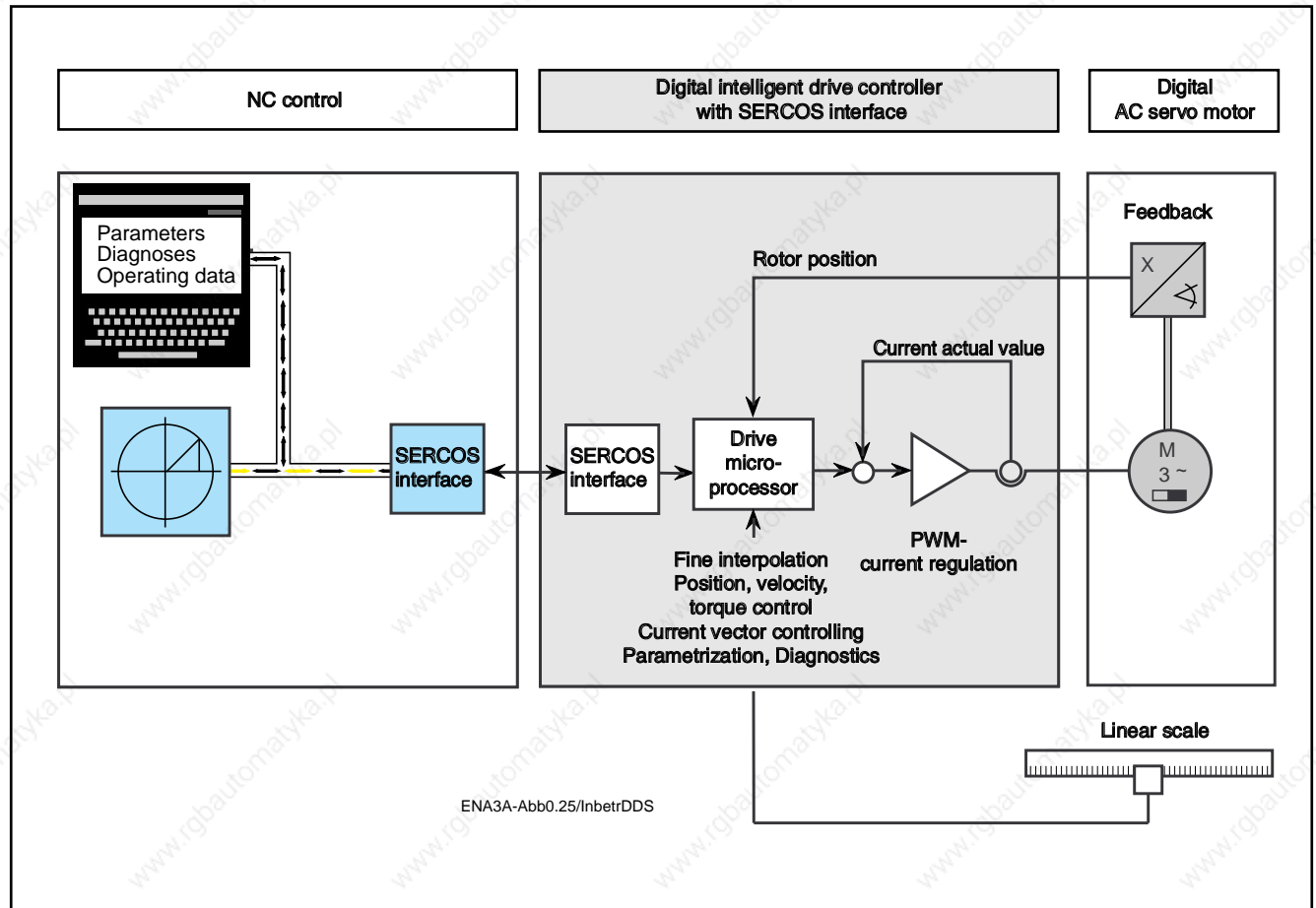


Fig. 2: CNC axis with digital three-phase AC servo drive and SERCOS interface

The full range of possibilities and benefits of digital intelligent drives can only be exploited through the SERCOS interface.

These include:

- Display and entry of all internal drive data, parameters and diagnoses via the SERCOS terminal of compatible NC controls.
- Exploitation of the high speed resolution of 0.0001 rpm up to maximum speed.
- Exploitation of the drive's internal fine interpolation and position control loop (cycle time 0.250 ms, resolution 0.00001 mm to 180 m/min with linear scales with a graticule constant of 20 μm free of following error) for positioning, contouring and C-axis mode including the high-velocity range.
- Normalization of position, velocity, acceleration and load data as well as adaptation of machine parameters, such as gearbox, spindle pitch, etc.
- Reducing the complexity of NC controls, wiring and position encoders.

ANALOG interface

DDS 2.1 Series drive controllers with ANALOG interface allow digital intelligent AC servo drives to be operated by conventional NC controls with a $\pm 10V$ analog interface.

The possible operating modes are:

- velocity control loop
- torque control loop (for master/slave mode, see Section 7.10)

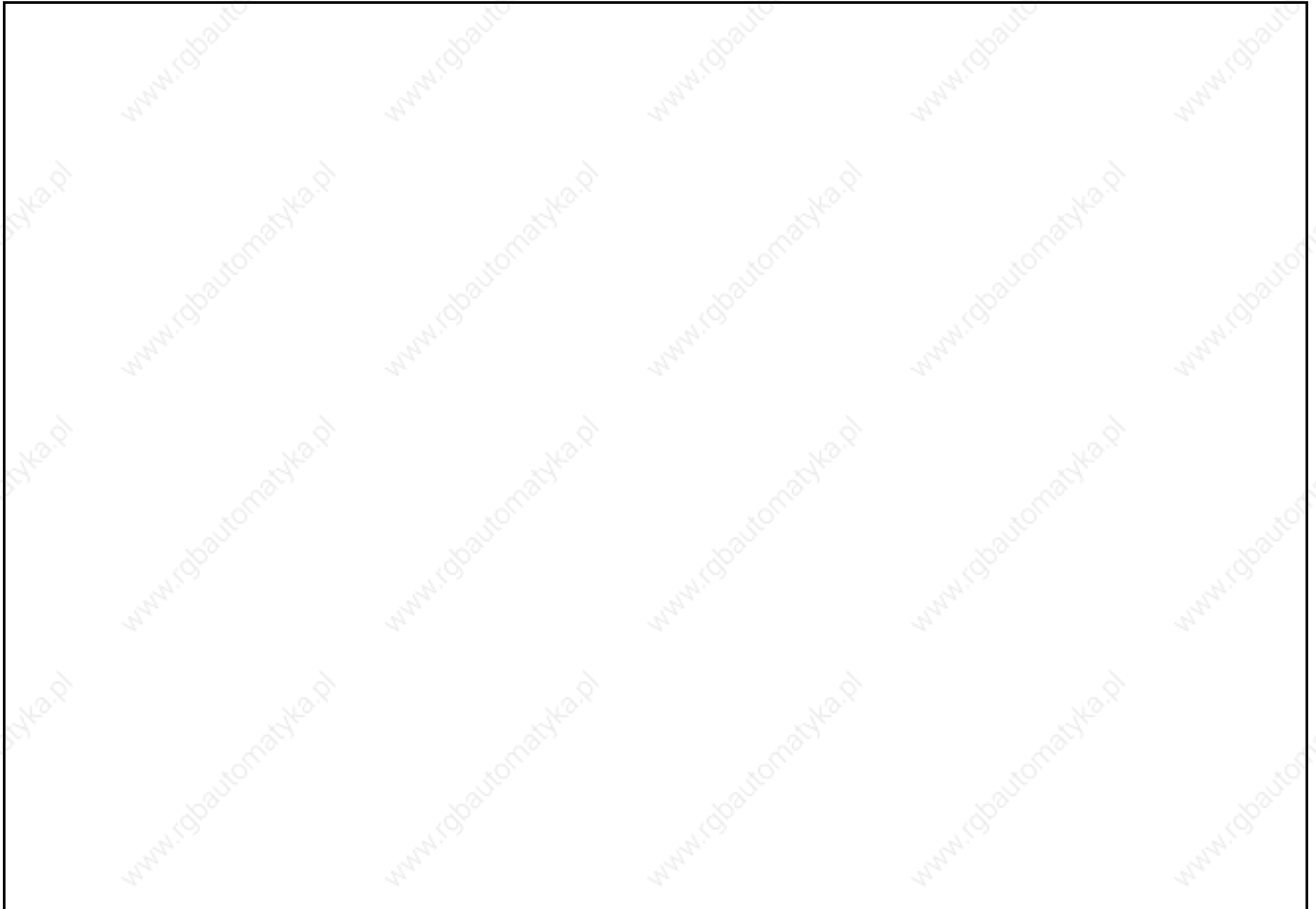


Fig. 3: CNC axis with digital three-phase AC servo drive and $\pm 10V$ ANALOG interface

Digital servo drives with ANALOG interface differ from analog drives by the following functional features:

- Output of the rotor position either as an incremental encoder signal or an absolute position encoder signal for use as a position actual value in the NC control, thus providing benefits such as:
 - elimination of an additional measuring system with wiring.
 - shortening the overall dimensions of the motor.
- Effortless matching of the resolution of the position encoder signal to different machine and NC control configurations due to parametrization.
- Drift-free positioning after stopping of the digital AC servo drive via a switching input. The stopping position is maintained by the drive's internal velocity loop as long as the drive controller is active.
- Control and monitoring of the holding brake through the drive controller.

2. The digital intelligent AC servo drive with ANALOG interface

Digital intelligent AC servo drives are of modular construction.

The modular principle allows flexible combination of AC servo drives and AC main spindle drives of different power ratings to form compact drive packages with one common power supply module.

The available power supply modules for AC servo drives may be connected up directly to international three-phase power mains of 3 x AC (380 to 460) V, (50-60) Hz.

A digital intelligent AC servo drive consists in each case of a carefully matched combination of AC servo motor MDD and a DDS 2.1 drive controller.

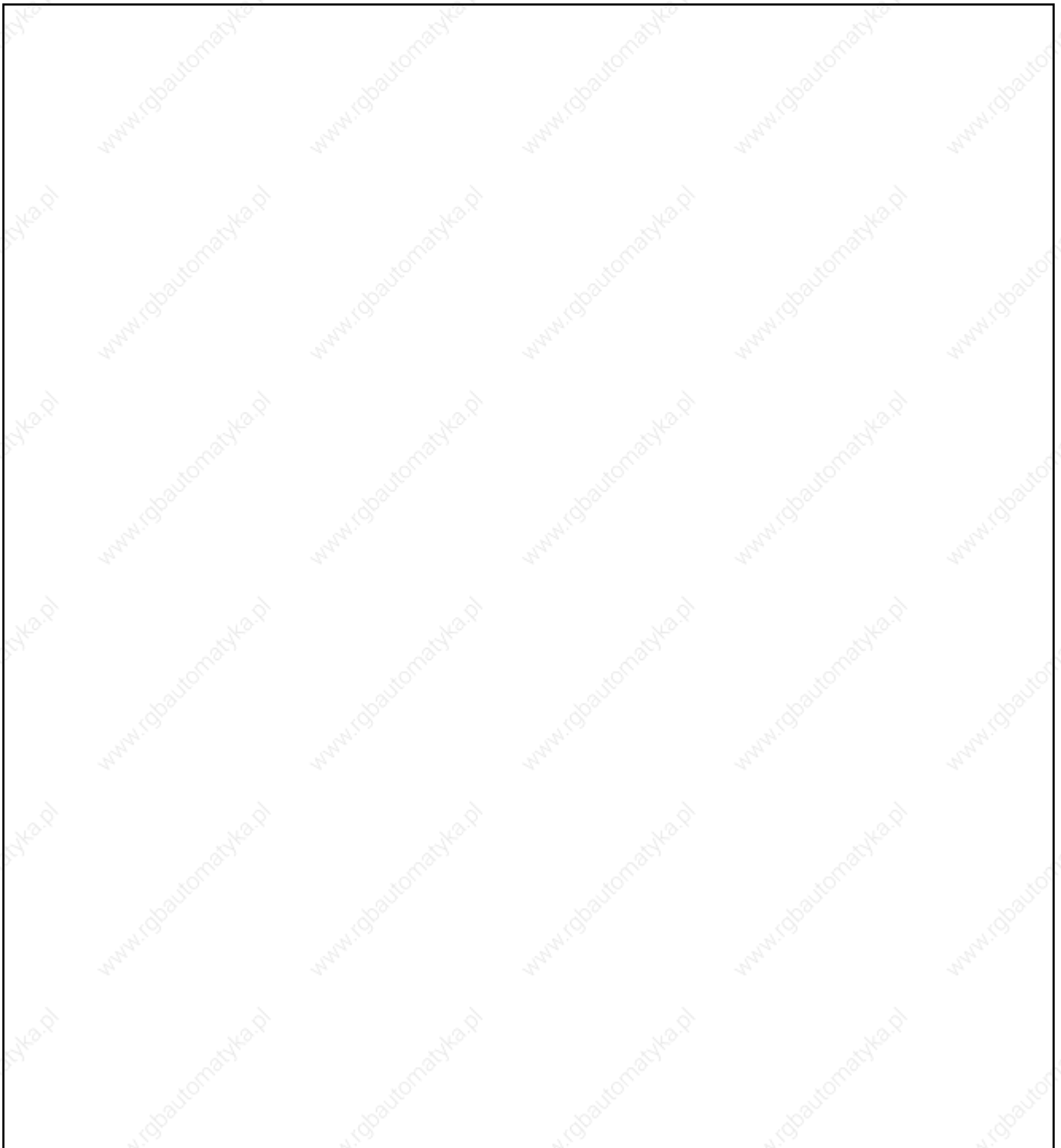


Fig. 4: Digital AC servo drives combined to form a modular drive package

2.1. Components of the digital AC servo drive

Figure 5 shows the designations of the various components making up a digital AC servo drive with a DDS 2.1 drive controller and an MDD digital AC servo motor.

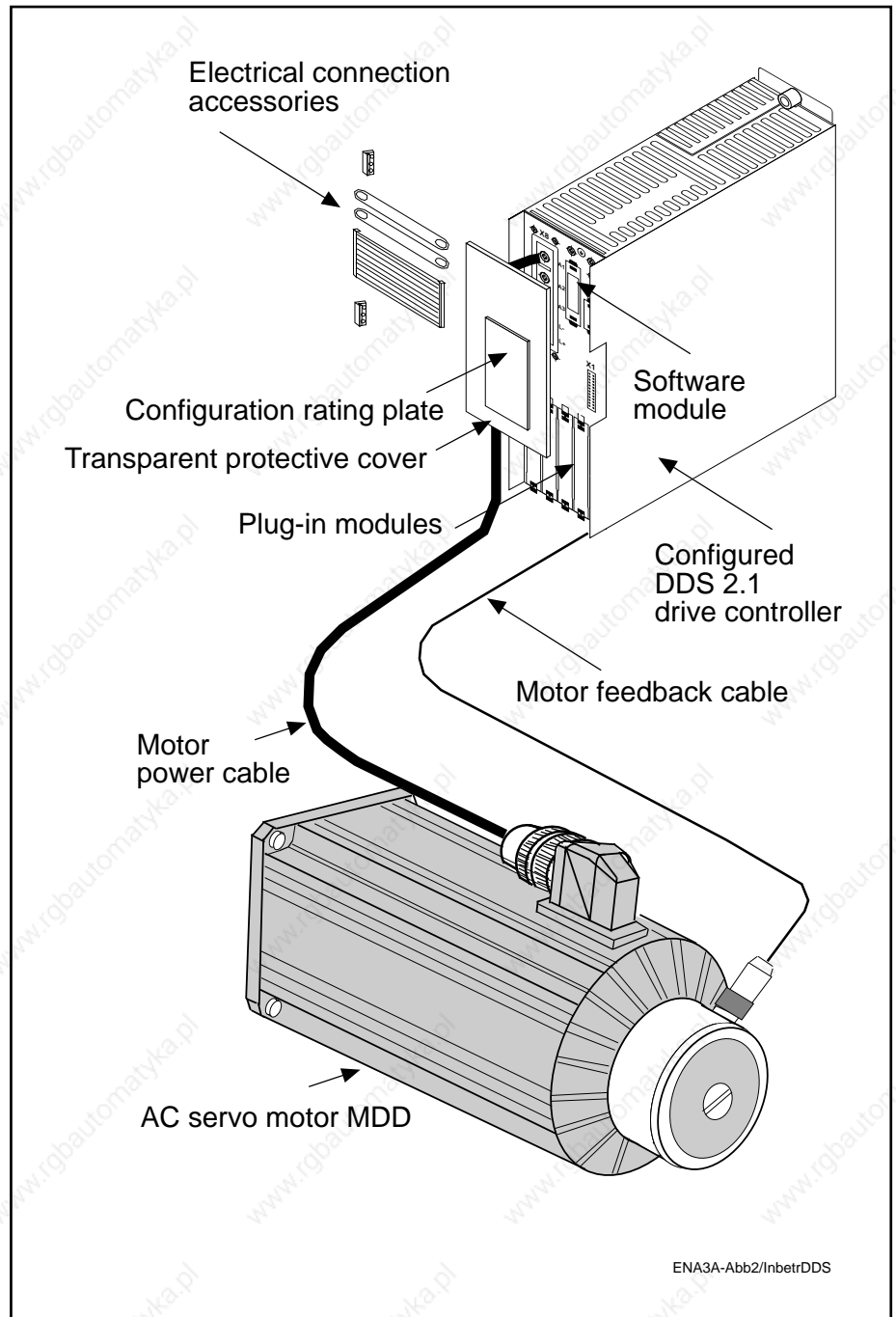


Fig. 5: Individual components of a digital AC servo drive with their designations

2.2. Function schematic of the digital AC servo drive

The interaction of an NC control with an analog command output and the digital AC servo drive with ANALOG interface is illustrated in Figure 6.

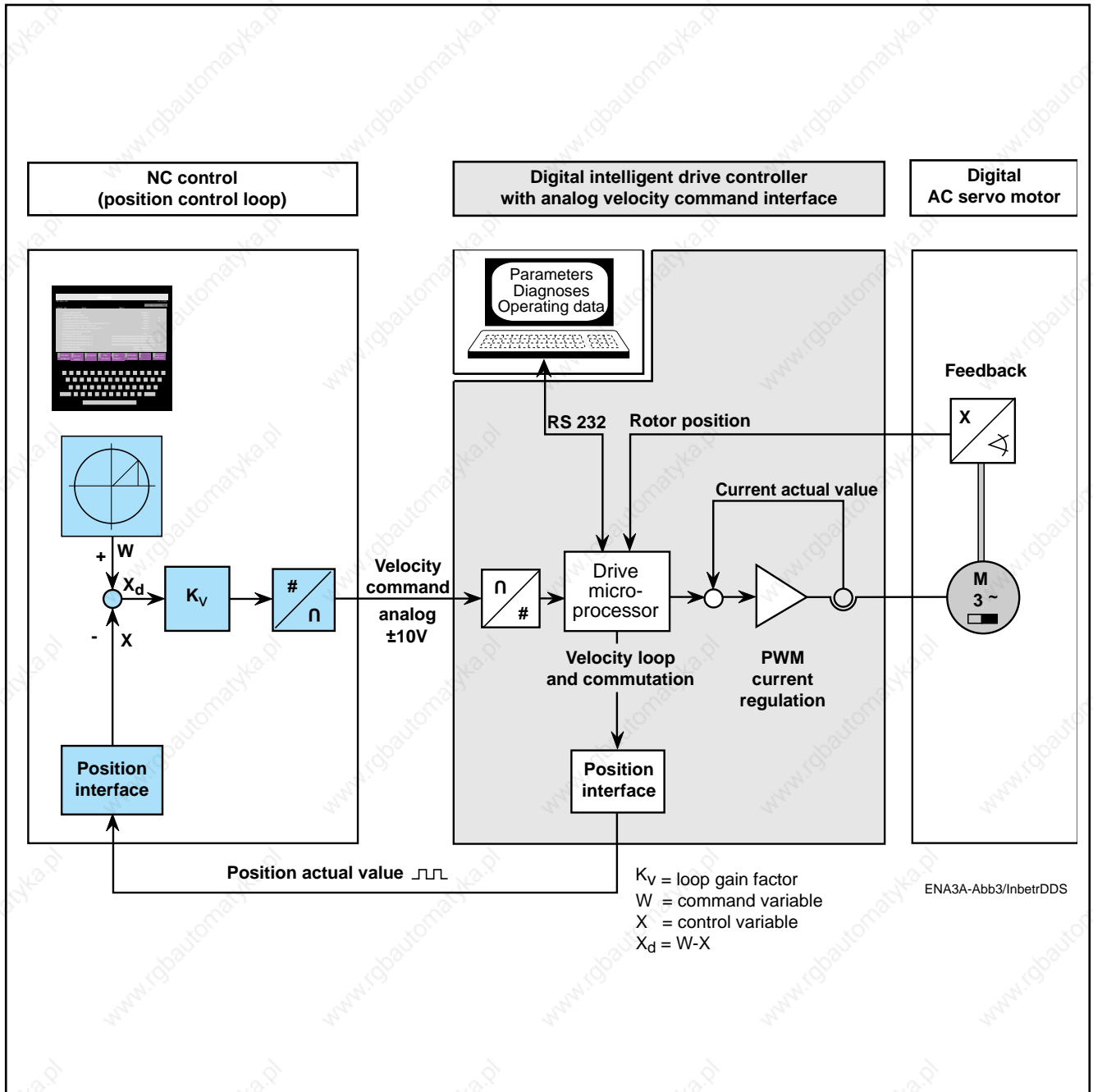


Fig. 6: Interaction of NC control, digital drive controller and digital servo motor

2.3. System configuration of the digital AC servo drive

To fulfil a given task, the drive controller, basic unit and individual components are combined together to form a configured drive controller. This configured controller and the digital AC servo motor MDD are then combined into proven and readily available system configurations. (Fig. 11 to 14).

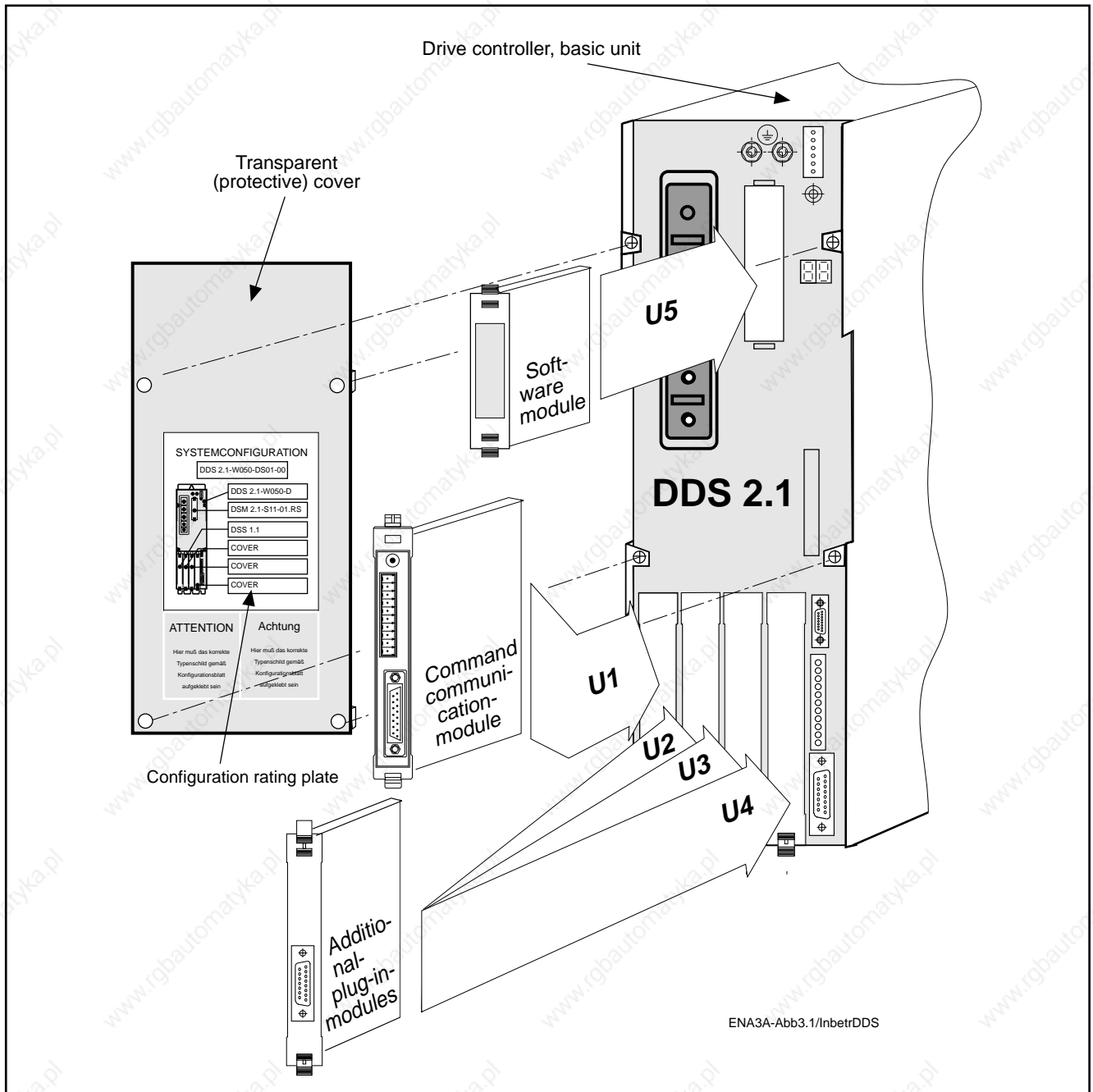


Fig. 7: Components of a configured drive controller

The constituent parts of a configured drive controller are:

- Drive controller (basic unit)
- Software module
- Command communication module
- Additional plug-in module
- Transparent (protective) cover
- Configuration rating plate

Distinguishing criteria of the digital AC servo drive

The digital AC servo drive with ANALOG interface is distinguished according to:

1. Type of position actual-value evaluation
 - incremental
 - absolute
2. Motor feedback version

The distinguishing features are combined in system configurations, each of which is documented and identified by an alphanumeric code (e.g. RA01).

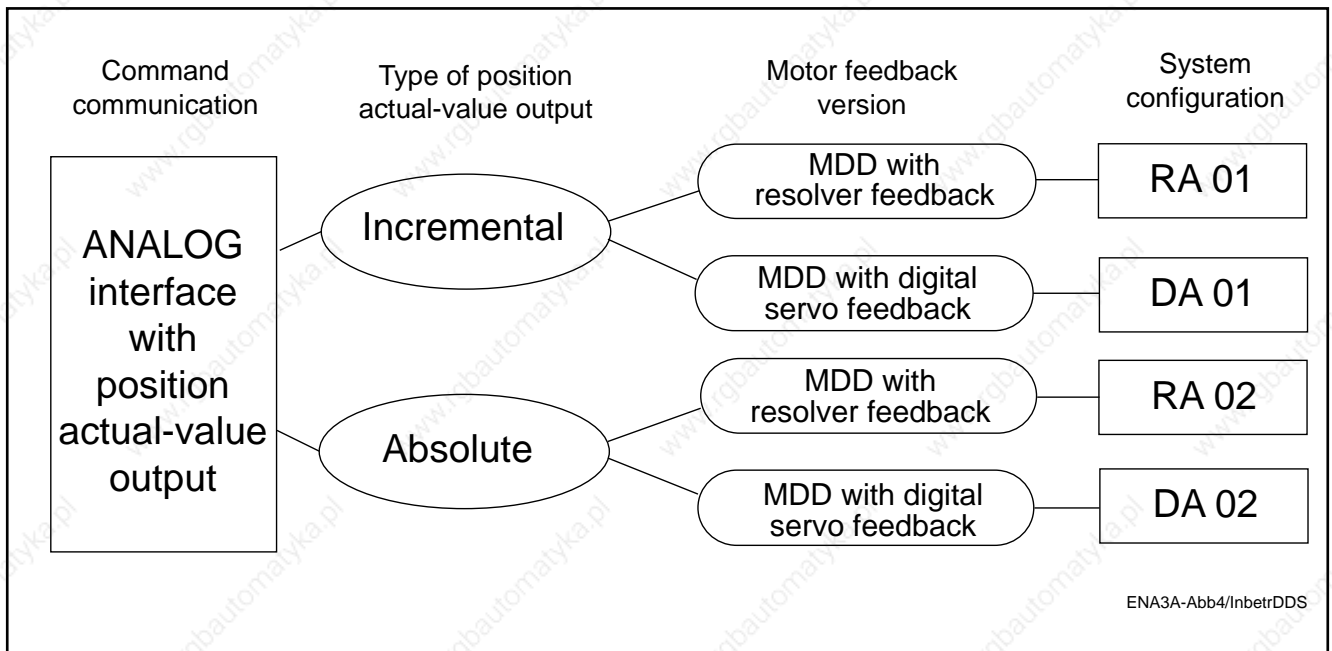


Fig. 8: Distinguishing criteria for selection of the system configuration

The system configurations are shown in the Figures 11, 12, 13 and 14.

The system configuration of a drive controller and the type designation of the plug-in modules it contains are given on the configuration rating plate (see Fig. 9 and 10).

Configuration rating plate

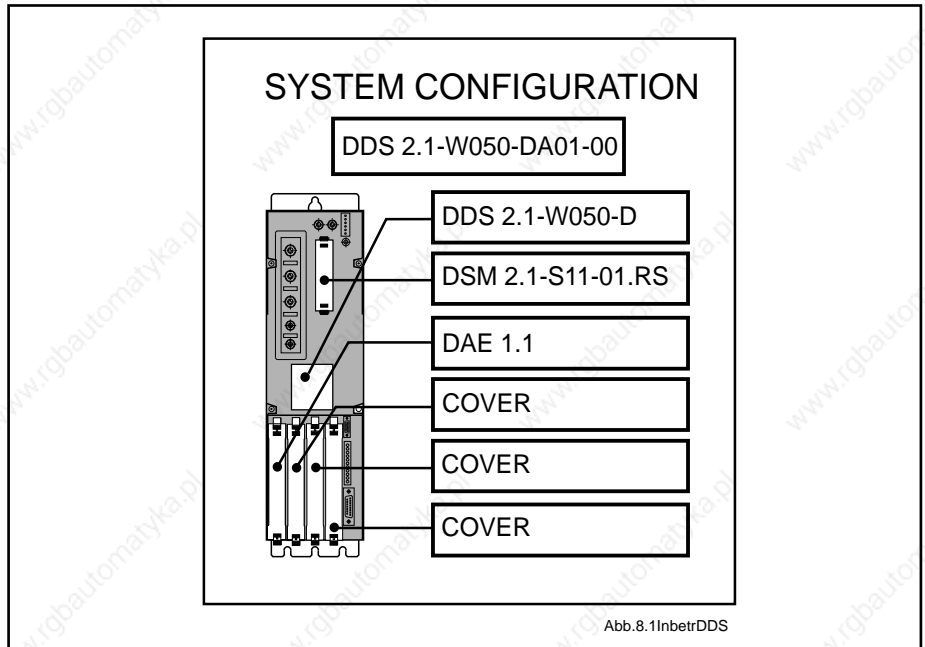


Fig. 9: Rating place of the configured drive controller

Type code of the configuration rating plate

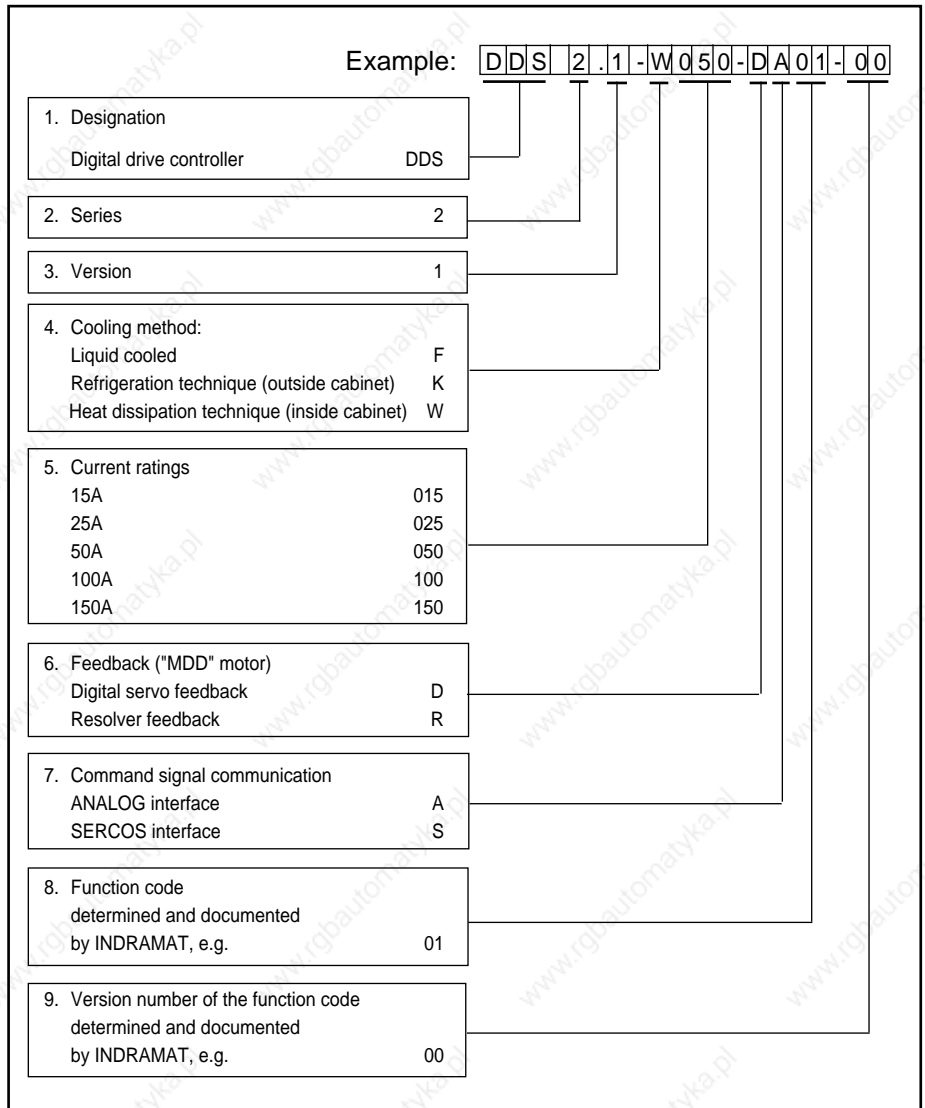


Fig. 10: Type code explaining a configured drive controller

System configuration
RA 01

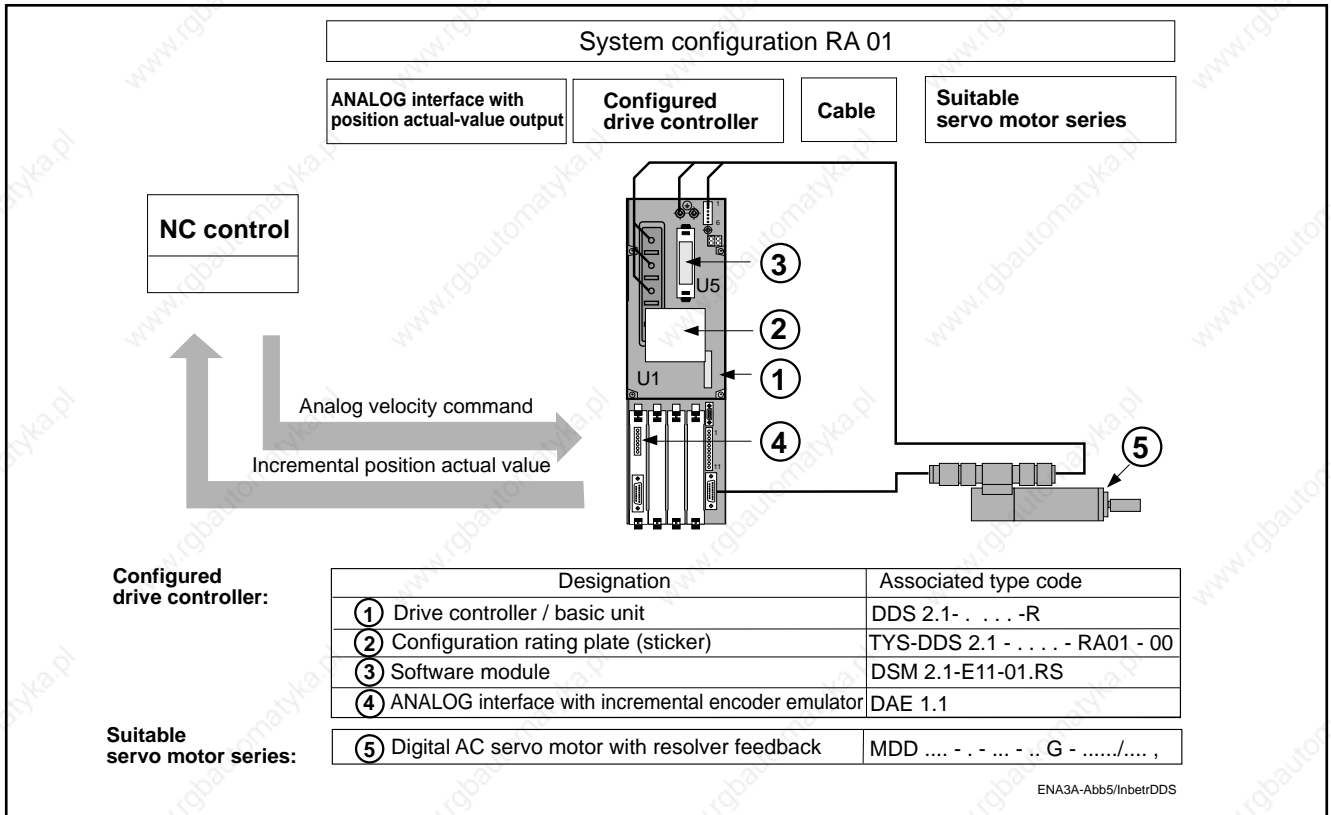


Fig. 11: ANALOG interface with incremental position actual-value output for motor series with resolver feedback

System configuration
DA 01

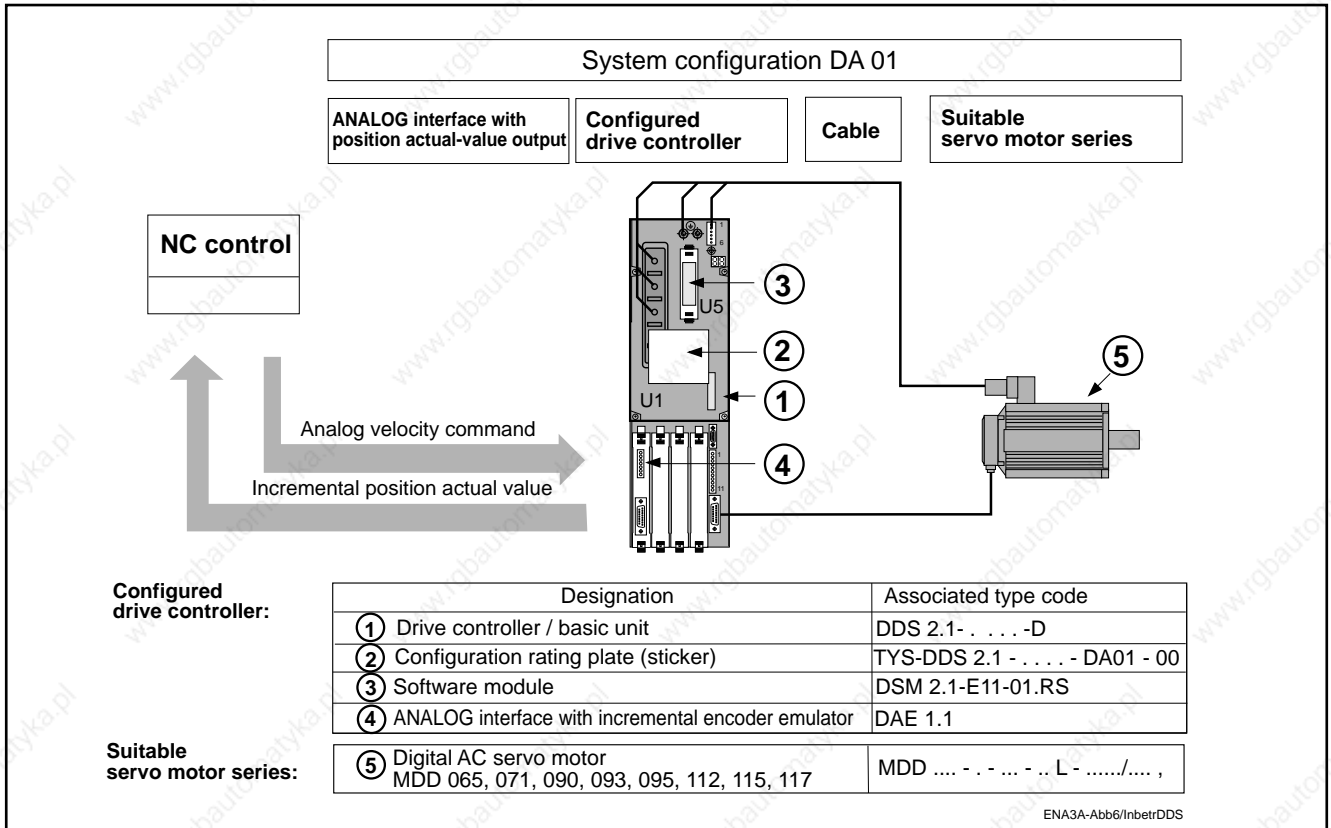


Fig. 11: ANALOG interface with incremental position actual-value output for motor series with digital servo feedback

System configuration
RA 02

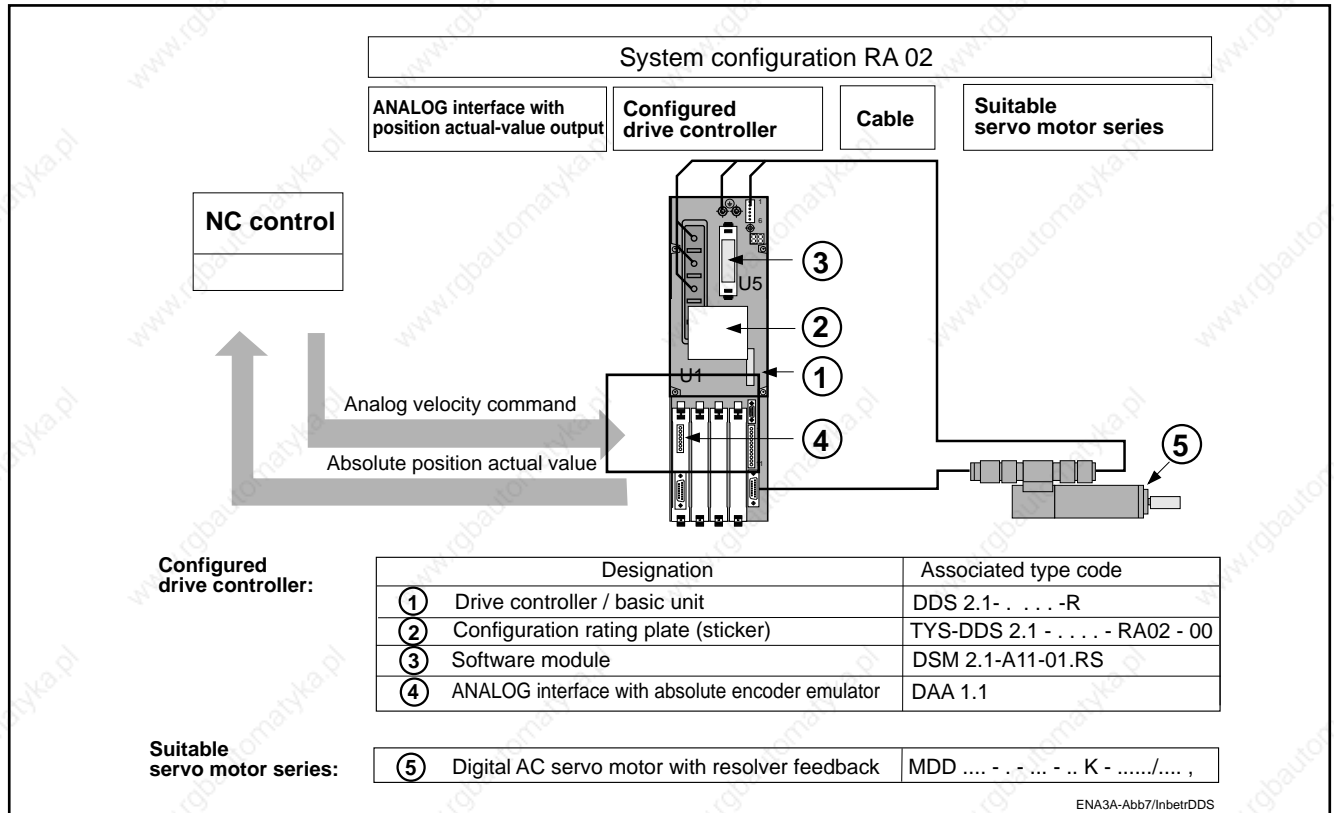


Fig. 11: ANALOG interface with incremental position actual-value output for motor series with resolver feedback

System configuration
DA 02

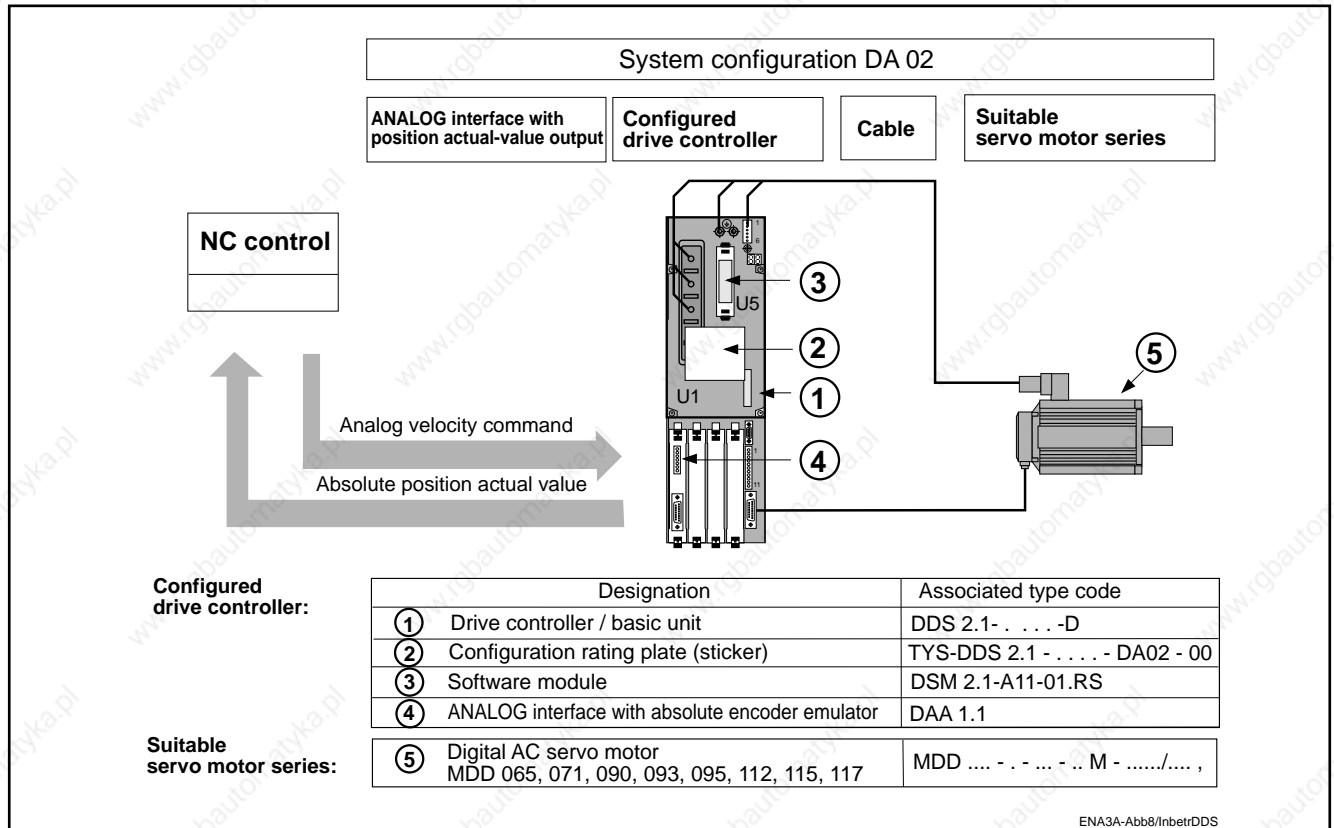


Fig. 11: ANALOG interface with absolute position actual-value output for motor series with digital servo feedback

2.4. System configuration components

Drive controller, basic unit

A system configuration consists of a "configured drive controller" and an "MDD servo motor".

The basic unit is equipped with different modules to make up a configured drive controller.

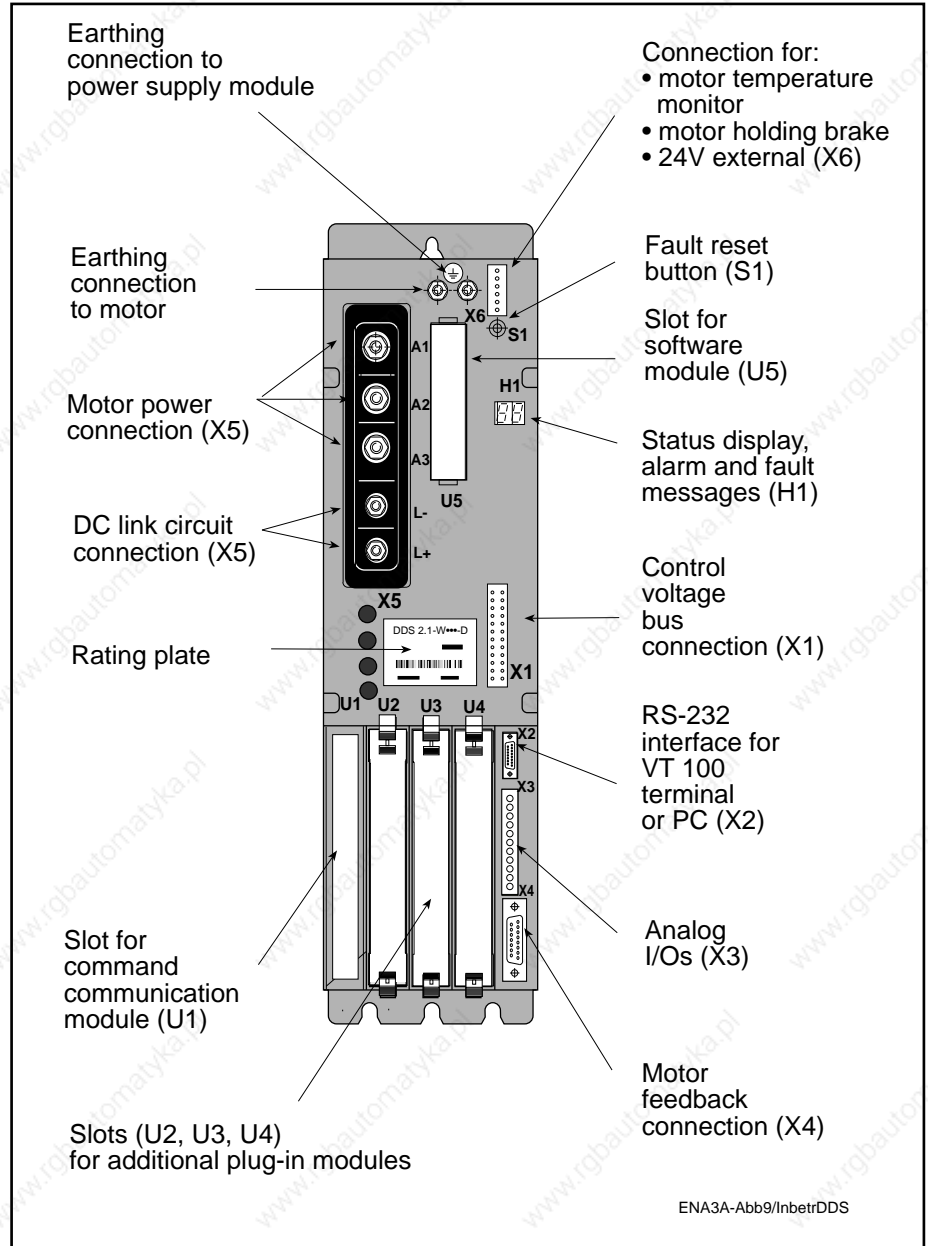


Fig. 15: Designations of DDS2.1 basic unit features

Rating plate
Drive controller
Basic unit

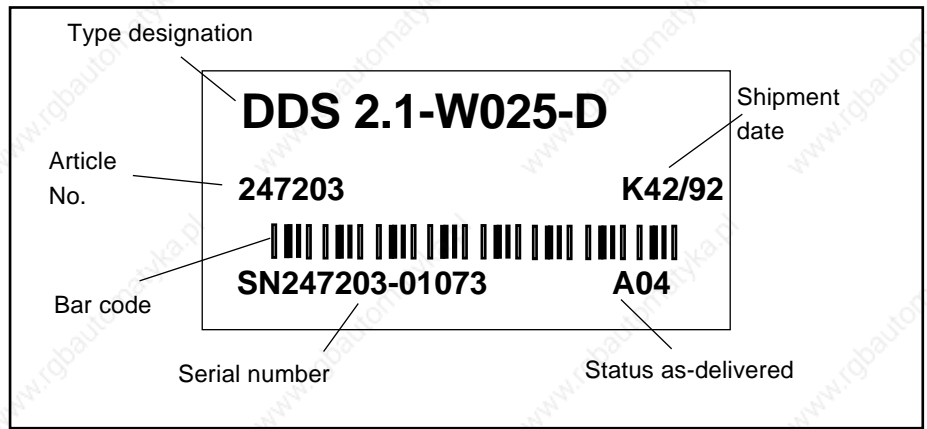


Fig. 16: Rating plate of a drive controller, basic unit

The rating plate is located on the front panel of the basic unit (Fig. 15).

Type code
Drive controller
Basic unit

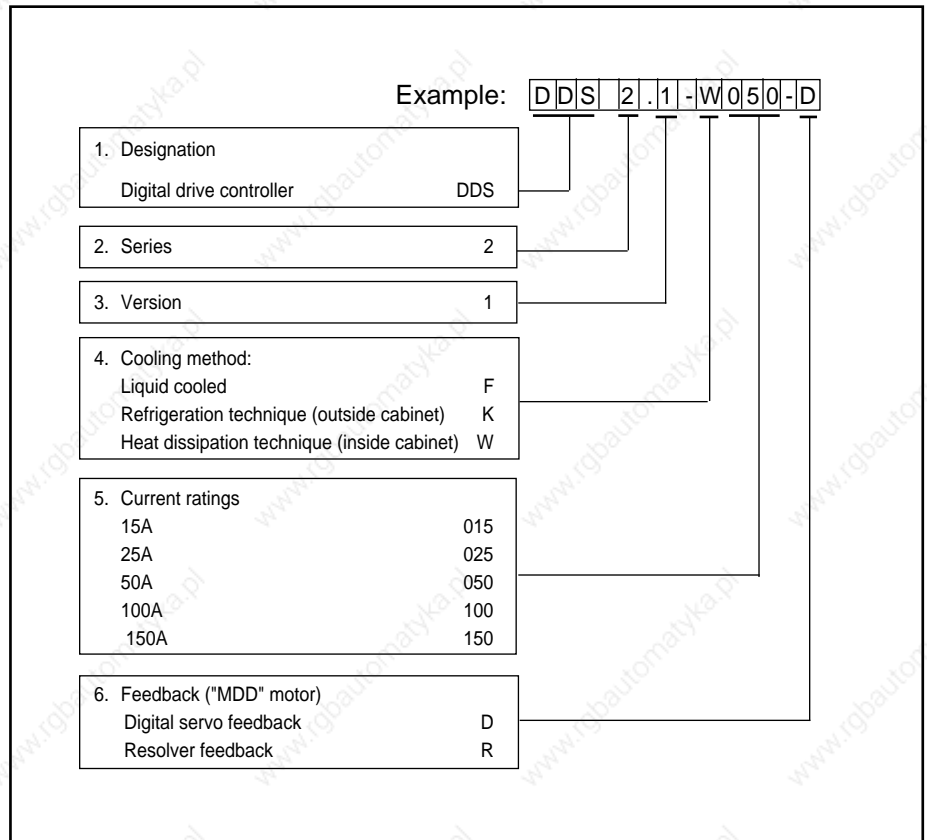


Fig. 17: Type code explaining the drive controller basic unit.

Command communication module with position actual-value output

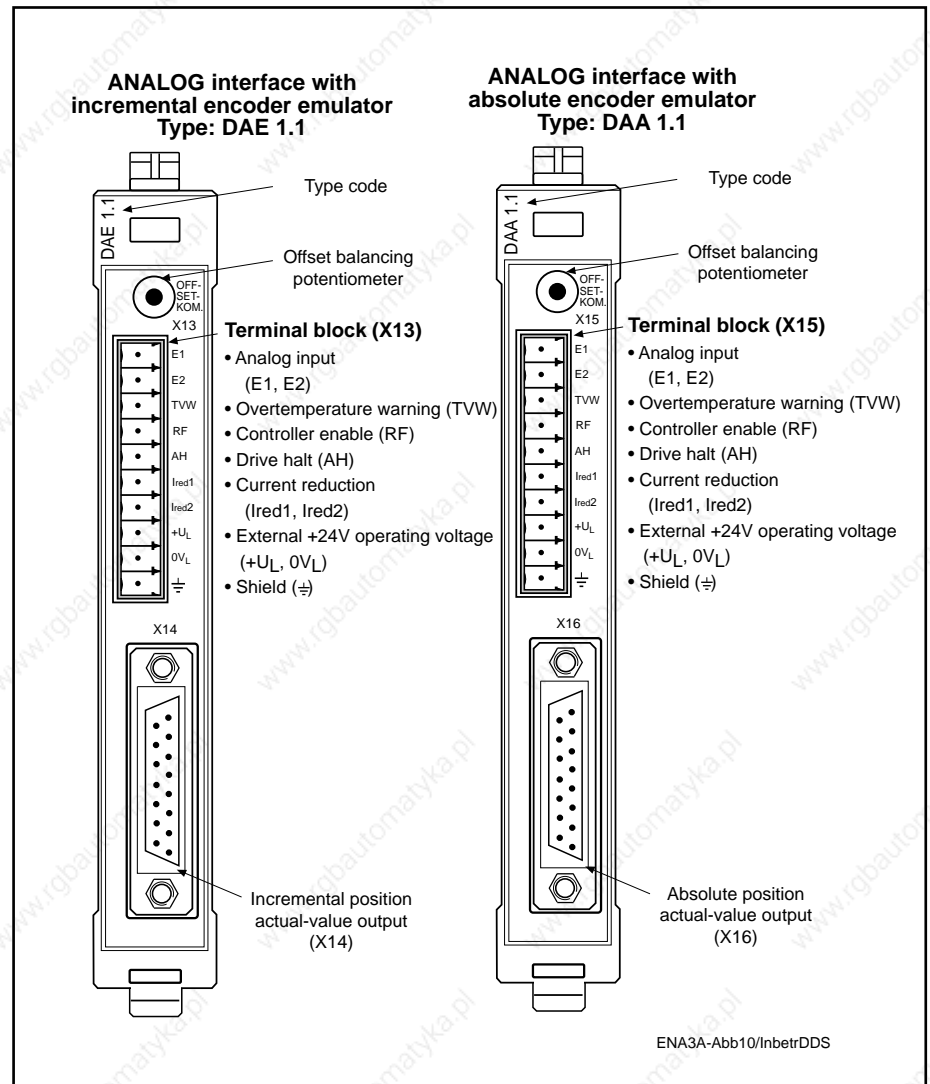


Fig. 18: Designations of ANALOG interface module features

The ANALOG interface of the DDS 2.1 drive controller serves to communicate with an NC control equipped with a $\pm 10V$ analog interface. The ANALOG interface has therefore been provided with various control inputs and signal outputs (see Fig. 18).

The ANALOG interface comes in two versions:

- ANALOG interface with incremental encoder emulator
- ANALOG interface with absolute encoder emulator

ANALOG interface with incremental encoder emulator

The incremental encoder emulation enables the output of internal drive information on position or angle. This information is passed to the connected NC control as an input signal for actual-value sensing.

Output signals: incremental encoder compatible square-wave signals (voltage signals)

ANALOG interface with absolute encoder emulator

The absolute encoder emulation enables the output of internal drive information on position or angle via the SSI (synchronous serial interface) usual in absolute encoders, thus providing a position actual value for external use.

2. The digital intelligent AC servo drive with ANALOG interface

Type code
Command communication
module

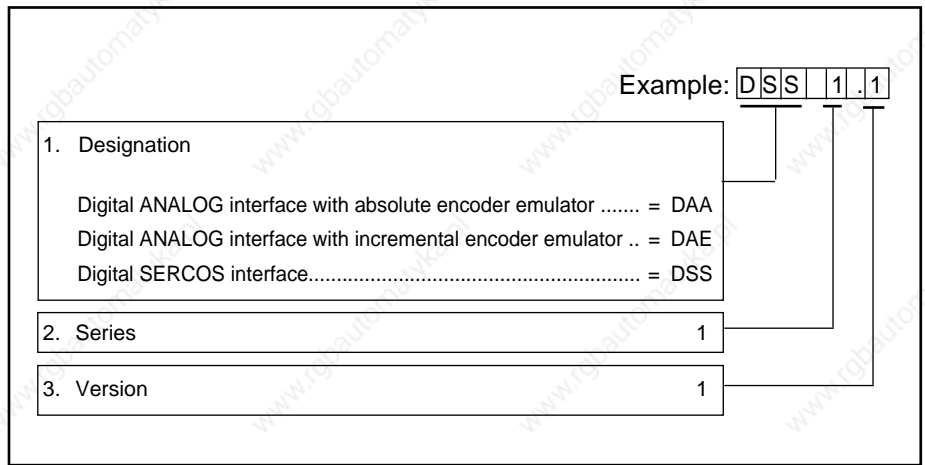


Fig. 19: Type code explaining the command communication module

Type code
Additional plug-in module
as provided at present
for the SERCOS interface

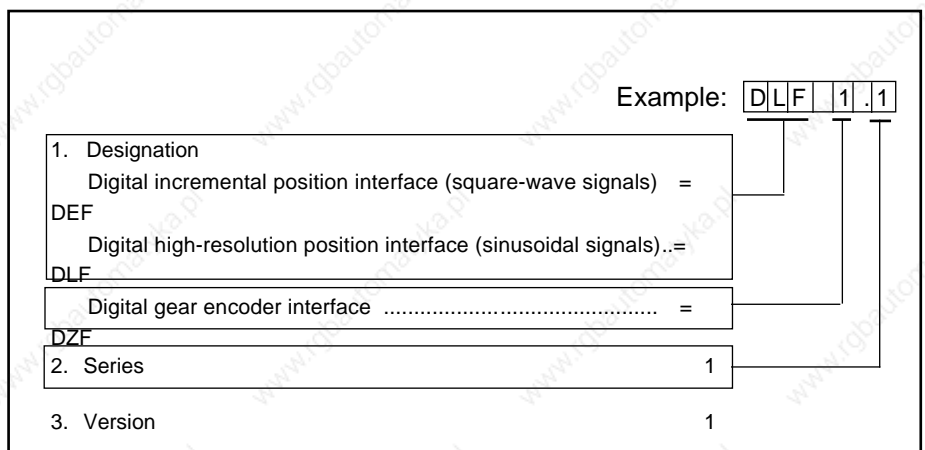


Fig. 20: Type code explaining the additional plug-in modules

Software module

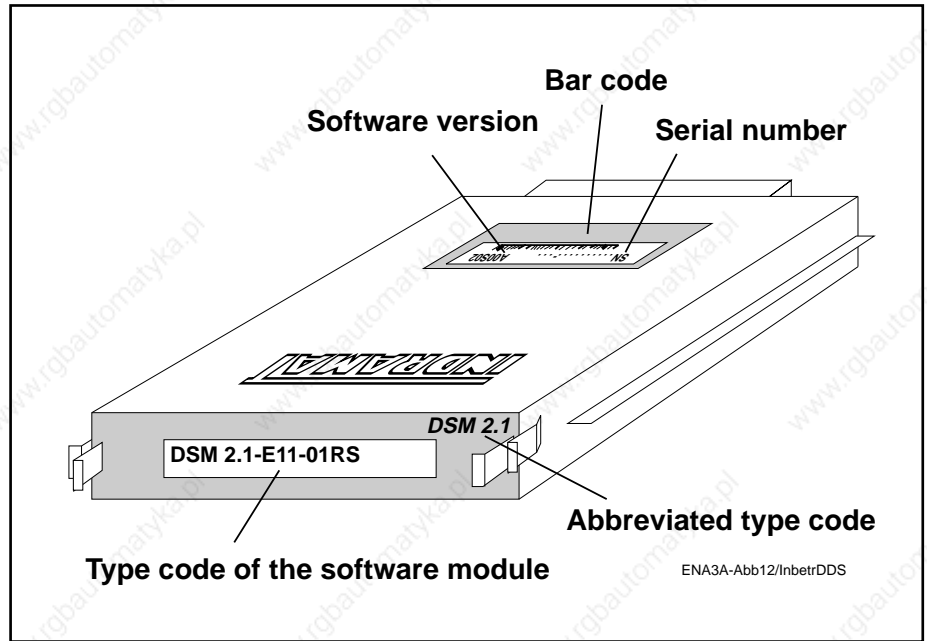


Fig. 21: Designations of software module features

Matching of the drive controller to the motor and of the AC servo drive to the machine mechanics is done by means of parameters stored in the software module.

Benefit in the event of unit replacement

The software module stores the operating software and the parameters. If a unit has to be replaced, the new drive controller does not require to be matched to the motor or the machine. This is done automatically by plugging in the old software module into the new drive controller.

Duplication

Software modules can be duplicated for use on other identical machines or for security purposes. Duplication is done using the serial interface.

Standard software modul

The **drive-related parameter values** calculated by INDRAMAT are stored in the motor feedback and are activated on request during commissioning.

Application-related parameters are set on site to machine-dependent values.



The documentation and management of application-related parameters is the responsibility of the customer.

Compatibility of software modules

The latest state of the art (software module update) for operation of the drive is supplied without any change being made to the ordering code (type designation) of the software module. Updated software modules are compatible with software modules already in the field.

Rating plate
Software module

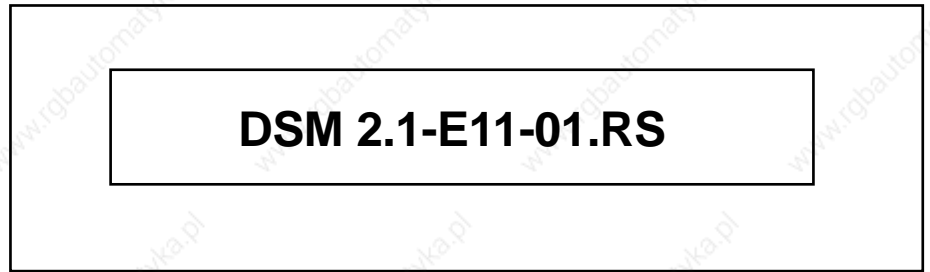


Fig. 22: Rating plate, software module

Type code
Software module

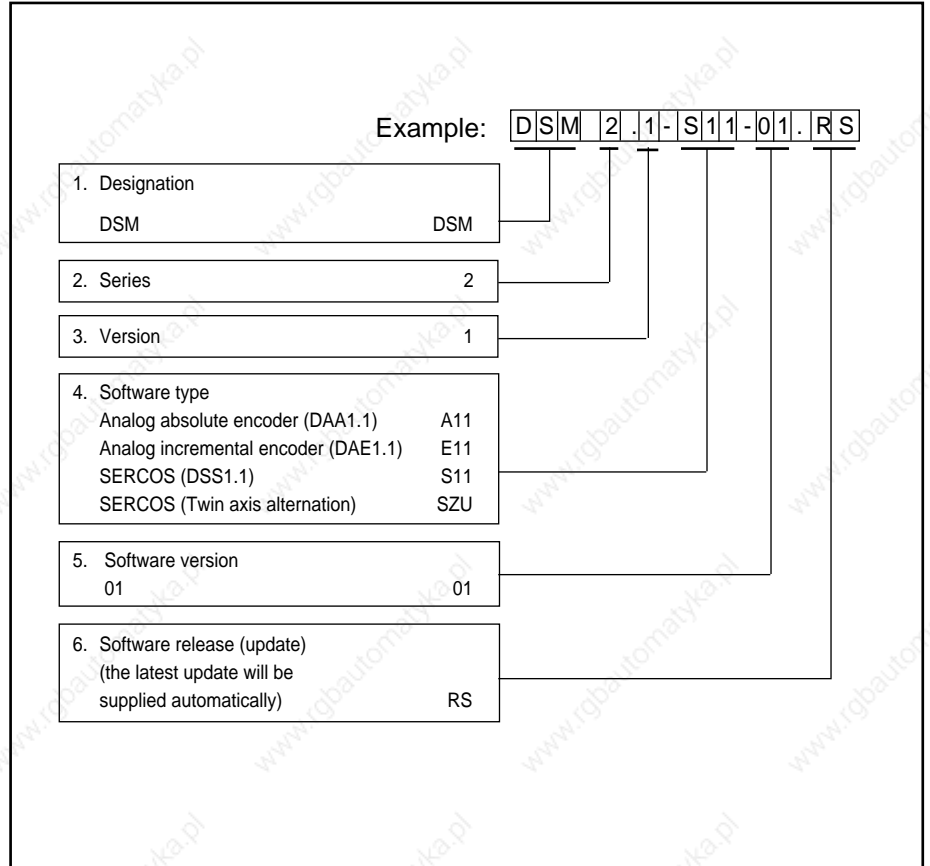


Fig. 23: Type code explaining the software module

Digital AC servo motors

MDD... digital AC servo motors are supplied in the following feedback versions.

- Motors with "digital servo feedback" (DSF)
- Motors with "digital servo feedback and multi-turn encoder" (DSF + MTG)
- Motors with "resolver feedback" (RSF)
- Motors with "resolver feedback and multi-turn encoder" (RSF + MTG)

Motors are used for different applications in accordance with their properties:

Properties

	Digital servo feedback	Resolver feedback
Sensor principle	Optical scanning of a code disk	Three-phase transformer with angle-dependent coupling ratio
Maximum position resolution	$256 \times 2^{13} = 2\,097\,152$ increments/revolution	$3 \times 2^{13} = 24\,576$ increments/revolution
System accuracy	$\pm 0,5$ angular minutes	± 7 angular minutes
Multi-turn version, sensing range	4096 rotor revolutions	4096 rotor revolutions
Available on motor series:	MDD 065 to MDD 117	MDD 021 to MDD 117
Suitable for applications with:	High demands on dynamic control response, synchronism, absolute accuracy	– Low demands on synchronism, absolute accuracy; – Extreme impact and vibration stresses
Range of applications:	Servo applications in: – machine tool axes – robot applications – handling systems – assembly equipment – wood-working machines – packaging machines – textile machines – printing machines	Handling applications, feed axes, low-cost applications etc.

Fig. 24: Properties of available feedback versions

2. The digital intelligent AC servo drive with ANALOG interface

Type code
AC servo motors

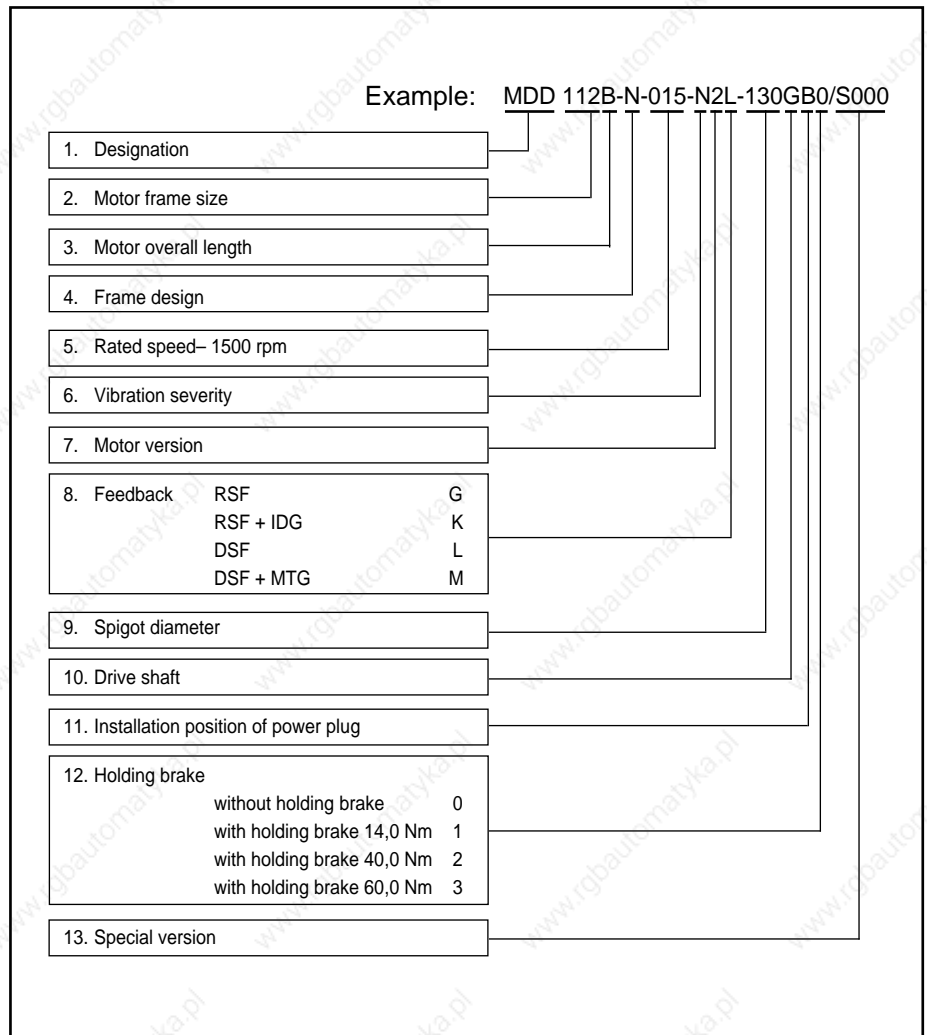


Fig. 25: Type code explaining MDD servo motors in terms of feedback and holding brake version


For further details please refer to the relevant motor documentation.

Rating plate
MDD servo motors

①		Build Date ②	
③			
S.No. ④		Com.No. ⑤	Part No. ⑥
⑦			
natural convection ⑧		surface cooled ⑪	I.Cl. ⑭ IP ⑮
Tcont Nm ⑨		Nm ⑫	n min ⁻¹ ⑯
IdN A ⑩		A ⑬	Km Nm/A ⑰
		m	kg ⑱
Brake ⑲ Nm		24 V +- 10 % A	
Made in Germany			

- ① **INDRAMAT-Logo**
- ② **Build date** Week and year of manufacture
- ③ **Motor type**
- ④ **S.No.** Serial number
- ⑤ **Com.No.** Job number
- ⑥ **Part.No.** Part number
- ⑦ **Bar code**
- ⑧ **natural convection** Cooling method: natural convection
- ⑨ **MdN** Continuous zero-speed torque for natural convection in Nm
- ⑩ **IdN** Continuous zero-speed current for natural convection in A
- ⑪ **surface cooled or liquid cooled** Cooling method: surface cooled or liquid cooled
- ⑫ **Continuous zero-speed torque for surface cooling or liquid cooling in Nm**
- ⑬ **Concinnuous zero-speed current for surface cooling or liquid cooling in A**
- ⑭ **I.Cl.** Insulation class
- ⑮ **Protection class**
- ⑯ **n** Motor rated speed in rpm
- ⑰ **Km** Torque constant in Nm/A
- ⑱ **m** Mass in Kg
- ⑲ **Brake** Holding brake
Holding torque in Nm,
Rated voltage in V, (with indication of tolerance range)
Rated current in A
- ⑳ / ㉑ **Internal index numbers**

Example of a completed rating plate

Build Date 44 / 92	
MDD090C-N-020-N2L-110GB0/S016	
S.No. 123456	Com.No. 234567 Part No. 345678
	
natural convection	surface cooled I.Cl. F IP 65
Tcont 10.4 Nm	16.0 Nm n 2000 min ⁻¹
IdN 9.5 A	14.6 A Km 1.10 Nm/A
	m 50 kg
Brake 14.0 Nm	24 V +- 10 % 0,75 A
Made in Germany	

ENA3A-Abb14.2/InbetrDDS

Fig. 26: Example of an MDD servo motor rating plate

3. Fundamental safety notes

3.1. Warning notes and symbols

This Application Manual contains the following warning notes and symbols:



Symbol	Meaning	Explanation
	Danger:	Instructions or DOs and DON'Ts for the prevention of accidents and damage to equipment.
	Note:	Text passages marked with this symbol contain special notes or DOs and DON'Ts relating to accident prevention.

Fig. 27: Meaning of warning notes and symbols

Digital intelligent AC servo drives are built to the state of the art and to recognized regulations. Nevertheless, their use may still involve risks to life and limb of the user or third parties or of damage to the machine and other equipment.

3.2. Use as prescribed

Digital AC servo drives are installed in machinery and plant. It is imperative that they be used as prescribed.

Use as prescribed can only be guaranteed when:

- the machine/plant is in flawless technical condition and used as prescribed with due attention to safety and risk considerations and according to the relevant technical instructions for use.
- any necessary work on the drives is done exclusively by trained personnel.
- any necessary work on the electrical installation or the machine/plant is done exclusively by a trained electrician or trained personnel under the supervision of a trained electrician and according to technical regulations.
- the instructions for handling the drives as contained in the technical documentation and in this Application Manual in particular are known and adhered to.
- the drives are operated exclusively in secondary position control loops.

3.3. Safety notes for commissioning

When commissioning a servo drive problems may arise that increase the risk of accidents and damage to the drive and machine. These are:

- errors in wiring up the motor, drive controller and feedback
- errors in the NC control
- errors putting monitoring equipment out of action



To reduce the accident risk commissioning must always be carried out by trained and qualified personnel only.

3.4. Notes on protection of personnel

INDRAMAT drives operate as components in machinery and plant. They cannot, in themselves, ensure the safety of personnel for each machine/plant in which they are installed.

INDRAMAT drives must always be included in the global safety concept for each application.

The drives provide certain functions which may be incorporated into the safety concept. This Application Manual indicates such possibilities.

Risks due to axis motions

Risks to human safety may occur through:

- unintentional start-up of servo axes due to faults and errors in the machine or drive.
- operation of servo axes in unsecured working areas of a machine.

Unintentional start-up can be prevented by:

- disconnecting the power contactor (E-STOP)
- disconnecting the master switch when operation is interrupted for any length of time. Appropriate measures must be taken to protect the master switch against accidental reconnection, e.g. by hanging up a suitable warning notice or removing the key from lockable master command equipment. For activation of the starting lockout (drive interlock open) see Section 7.2.

Risks through contact with electrical parts

The following connections may carry dangerous voltage levels:

- **on the drive controller: motor power connection X5** (see Fig. 15), terminals
 - L+, L- DC link circuit voltage
After power has been switched off wait for the link circuit to discharge (approx. 5 min.) and check that the voltage level is under 50 V before beginning to work. If in doubt, short-circuit.
 - A1, A2, A3 motor voltage;
Even after power has been disconnected, dangerous voltage levels may appear on the terminals when the motors rotate (runout). Check that the drives are at a complete standstill.
- **on the power supply module**
 - L1, L2, L3 mains power connection.

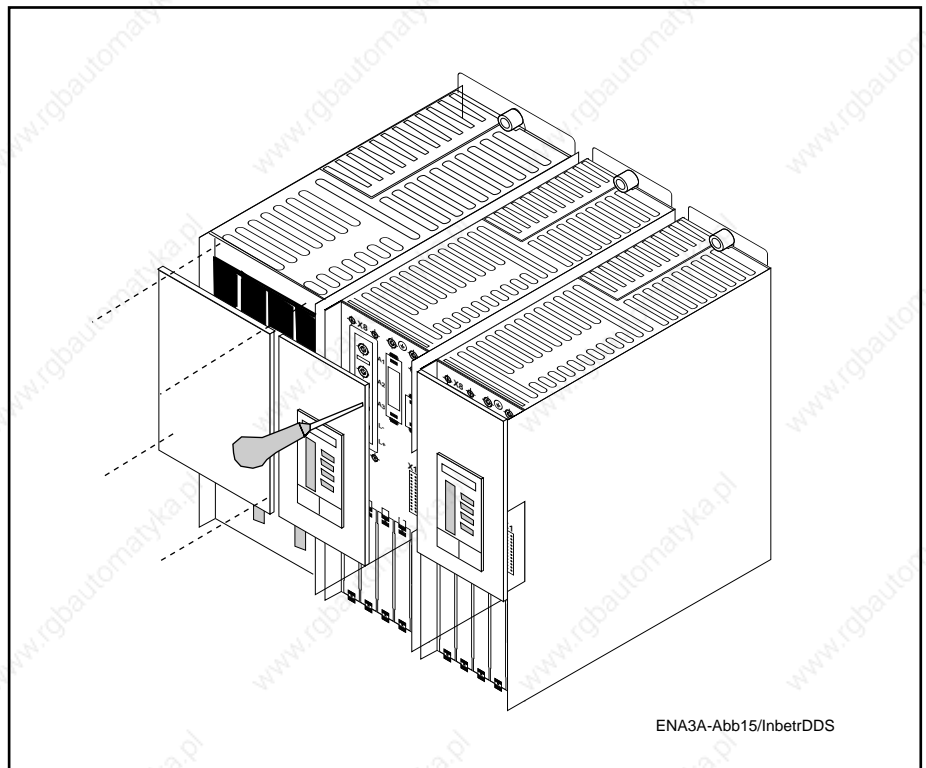


Fig. 28: Power supply module and DDS 2.1 drive controller with screwed-down transparent protective plates.



Accident risk through lethal voltage levels!

Never operate drive controllers without the transparent protective plate in place (see. Fig. 28). All connections on terminal block X5 carry lethal voltage levels when power is switched on. The same applies to the power and DC link circuit terminals of the power supply module.

Protection against indirect contact with power-conducting parts: Earth linkage circuit-breaker systems cannot be used on INDRAMAT equipment. The mains protection for indirect contact must be achieved by other means, e.g. by overcurrent protective devices with multiple earthing.

3.5. Notes on protection of equipment

Risk of damage through wrong connection

INDRAMAT electronic drive components are provided with comprehensive protective circuitry and protected against overloading.

Nevertheless, the following precautions must still be taken:

- Voltage levels applied to inputs must always be in accordance with prescribed data.
- Do not connect outputs to external power sources.
- Do not connect mains power, DC link circuit and motor conductors to the low-voltage ± 15 V and +24 V supplies. These conductors must also be provided with adequate insulation against each other.

Risk of damage through external or high-voltage power sources

INDRAMAT drive components are 100% h.v. tested according to VDE standard 0160.

If an h.v. or separate-source voltage-withstand test is to be carried out on a machine's electrical equipment, all component connections must be disconnected in order not to damage the components' electronic modules (permissible acc. to VDE 0113).

Our Sales Department will provide additional information on request.

Risk of damage through electrostatic charges

Electrostatic charges represent a danger to electronic equipment. Bodies liable to come into contact with components and circuit cards must be discharged by earthing:

- discharge your own body by touching a conductive, earthed object.
- when carrying out soldering work, first discharge the soldering iron.
- discharge parts and tools by laying them on a conductive substrate.

Parts at risk, such as software modules, must always be stored or shipped in conductive packaging.

3.6. Notes on protection of machinery

If the position control loop of the NC control is opened during commissioning and the drives are operated in a velocity loop, the machine will be at risk due to the limited stroke lengths of linear axes.

To avoid damage to the machine, please ensure the following:

- Enabling of the drives and injection of a velocity command must always be carried out by properly qualified personnel.
- Make sure the emergency stop function will be triggered by limit switch or E-STOP button.

4. Commissioning equipment

The following equipment is needed for commissioning:

- measuring instruments
- battery power source
- service cable IN 391
- personal computer with a program emulating a VT 100 terminal or a VT 100 terminal itself
- Selection Data Doc. No. 209-0069-4302

4.1. Measuring instruments

The following measuring instruments are required:

- multimeter for voltage measurement
- oscilloscope or plotter
required only to produce test records for prototype commissioning and as an aid in fault locating.

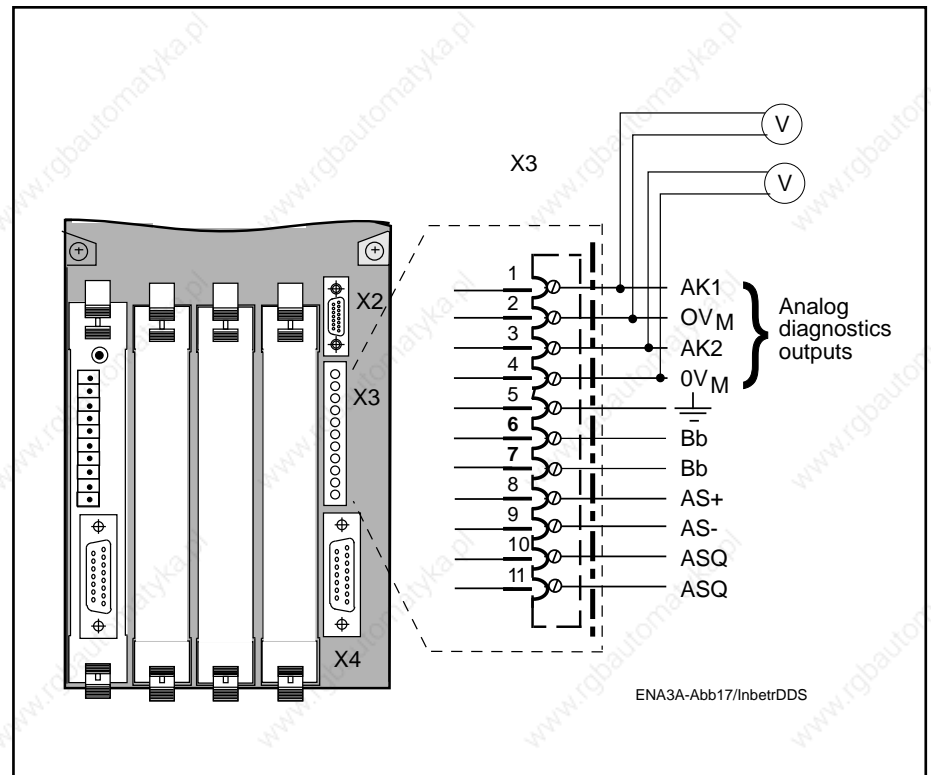


Fig. 29: Connection of voltage measuring instruments to the analog diagnostics outputs on the drive controller

4.2. Battery power source

Digital AC servo drives are intended for use in secondary control loops. With the digital AC servo drive with ANALOG interface, this is achieved by forward feeding an analog voltage signal through an associated NC control.



Risk of personal injury and machine damage through uncontrolled drive motions. Operating an AC servo drive in anything other than a secondary control loop runs counter to the prescribed use for this equipment. Should this still be desired, special safety precautions must be taken. These are explained in Section 6.6.

If a Digital AC servo drive is to be operated without an NC control, this is possible in velocity loop mode using a battery power source to be connected up as illustrated in Fig. 30. The procedure for operating a servo axis is described in Section 6.6.

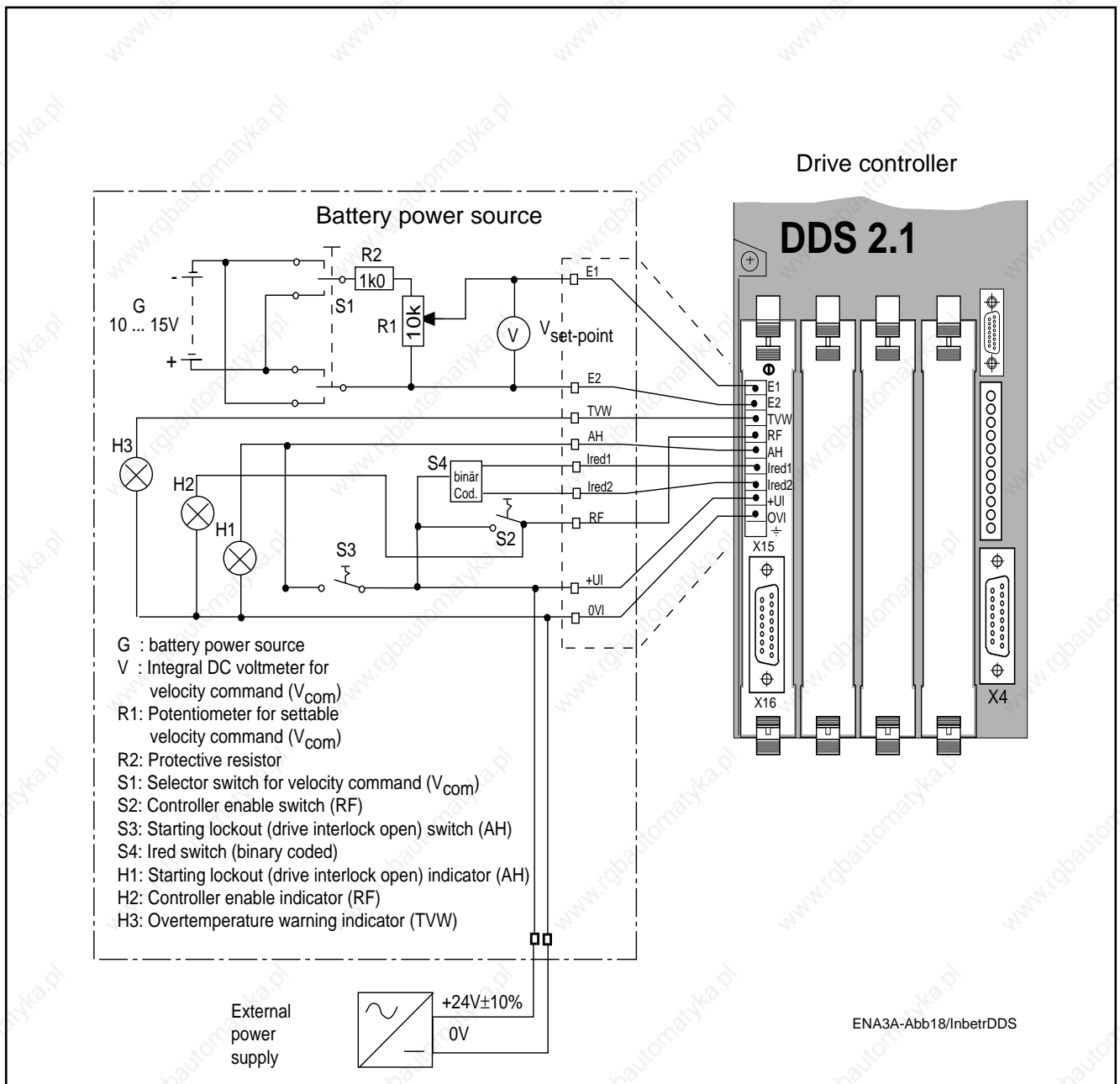


Fig. 30: Proposed circuitry for connecting up a battery power source to the DDS 2.1 with ANALOG interface

4.3. Service cable IN 391

Before connecting a PC or VT 100 terminal to the drive controller switch off the power. INDRAMAT supplies special, pre-assembled cables, type IN 391 to make the connection between the computer and the controller. These are available in four different lengths. For more details, refer to Fig. 31.

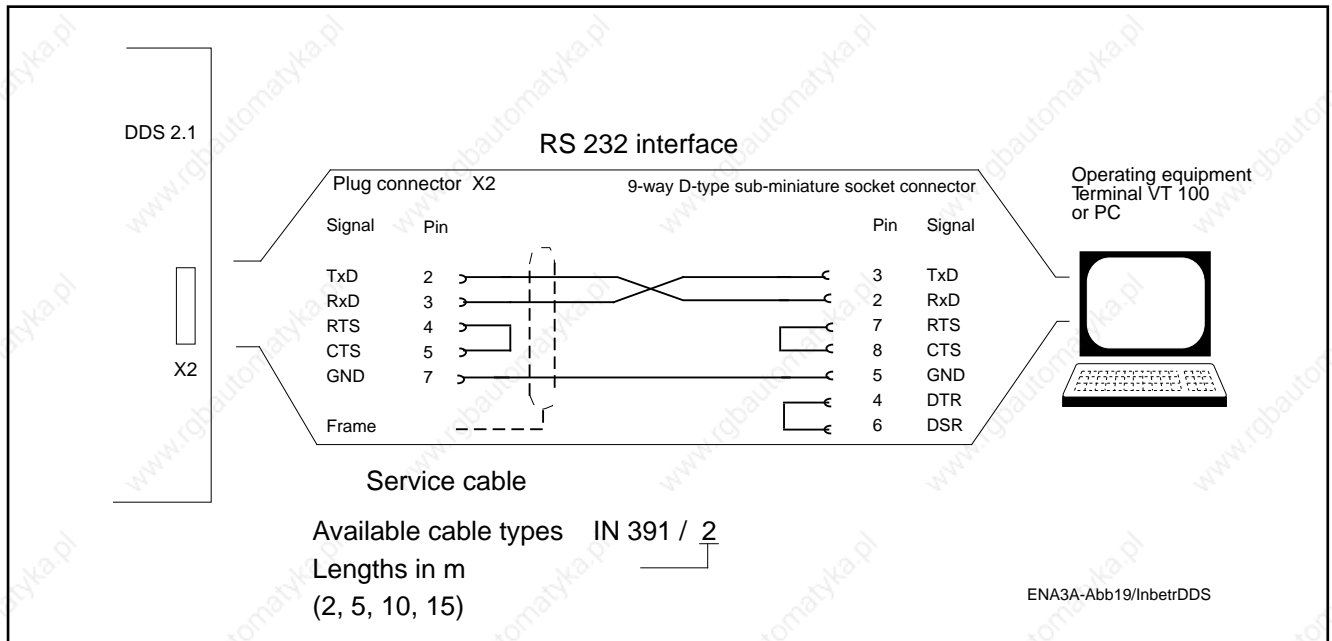


Fig. 31: Connecting up a personal computer via RS 232 interface to a DDS 2.1 with ANALOG interface

4.4. Personal computer (PC)

The PC must fulfil the following conditions:

- IBM compatible
- MS-DOS operating system
- RS 232 interface installed
- Floppy disk drive or hard disk for storage of parameters
- VT 100 terminal emulation software installed

The VT 100 terminal emulation software (available from INDRAMAT) allows you to display the user interface stored in the drive controller on the PC's monitor. To set parameters, follow the operating instructions for the terminal emulation software.

4.5. VT 100 Terminal

The VT 100 terminal is the minimum hardware requirement for visualization and operation of the user interface stored in the DDS 2.1.

The VT 100 terminal cannot be used for electronic storage of data outside the DDS 2.1 as it has no memory capacity.

Terminal settings:

Parameters	Settings
Terminal type	VT 100
Columns	80
Lines	24
Line feed	off (only CR after ENTER)
Automatic line wrap	off
Backspace key	active
Control characters	invisible
Parity	data bits 8
Stop bit	1
Transmission rate ¹⁾	9600 Baud

¹⁾ Communication between the DDS 2.1 and the data entry equipment is not possible at any other transmission rate.

For instructions on how to handle your VT 100 terminal, please refer to the associated user manual.

5. Operating the drive controller during commissioning and diagnostics

5.1. How to handle the parametrizing and diagnostics program

Main menu

Pre-conditions:

- DDS 2.1 drive controller installed, electrical connections made and tested (see Section 6).
- AC servo motor power and feedback cables connected up to the drive controller.
- Personal computer or VT 100 terminal connected up to the drive controller via the service cable IN 391.
- VT 100 terminal emulation program called up (applies to PCs only).

Once all the pre-conditions are fulfilled , proceed as follows:

1. Switch on the power at the power supply module (see Application Manual for the power supply module).

The parametrization and diagnostics program stored in the DDS 2.1 will respond with the following message:

"To start Parametrization and Diagnostic Program, press ENTER"

Press <ENTER> to start.

The MAIN MENU will appear.

The MAIN MENU offers you a choice of sub-programs that can be accessed by hitting the appropriate key:

- 1** - "DRIVE STATUS"
- 2** - "PARAMETERS"
- 3** - "LANGUAGE SELECTION"

Use the ESC key to quit the programs. This will take you to the next highest menu level and finally exit the main program itself.

Drive status

The "DRIVE STATUS" menu supplies instantaneous information on:

– the signal status of control inputs and signal outputs used on the installed ANALOG interface module, as given below:

- TVW - Overtemperature warning
- RF - Controller enable
- AH - Drive enable
- Ired1 - Torque reduction
- Ired2 - Torque reduction
- Nullimp. - Zero pulse (marker pulse)

– The type designations of the installed motor/drive controller combination

– The current operating mode

– Velocity, current and motor torque values

– Rotor position

Parameters menu

The "PARAMETERS" menu gives you the choice of 8 submenus (accessed by pressing keys 1 to 8) for entry of parameters. The parameters contain the settings necessary to operate the drive controller.

Language selection

The "LANGUAGE SELECTION/SPRACHAUSWAHL" menu allows you to choose between the English and the German languages.

The following illustrations show the different function levels of the user interface.

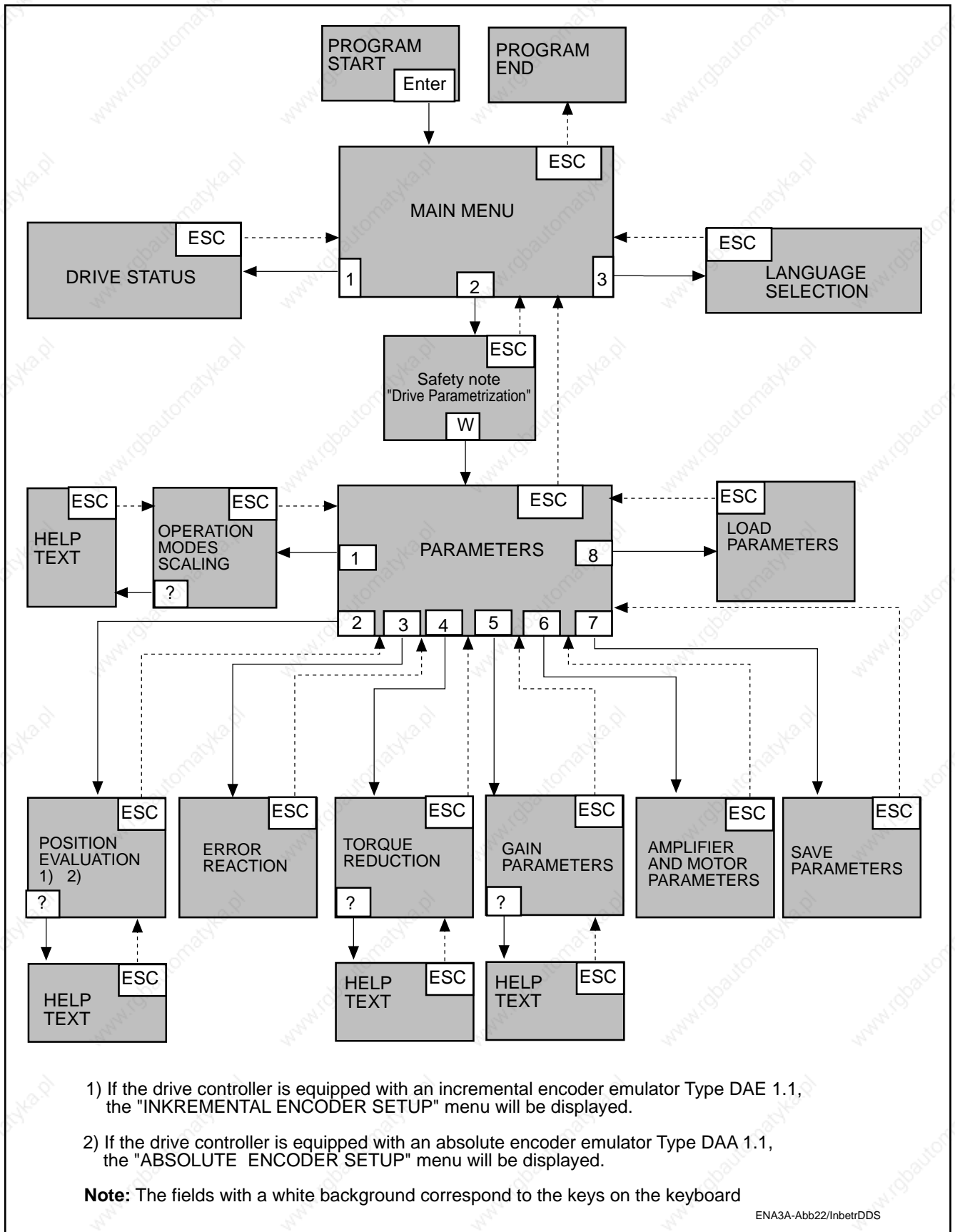


Fig. 32: Function levels of the user interface.

Absolute encoder error

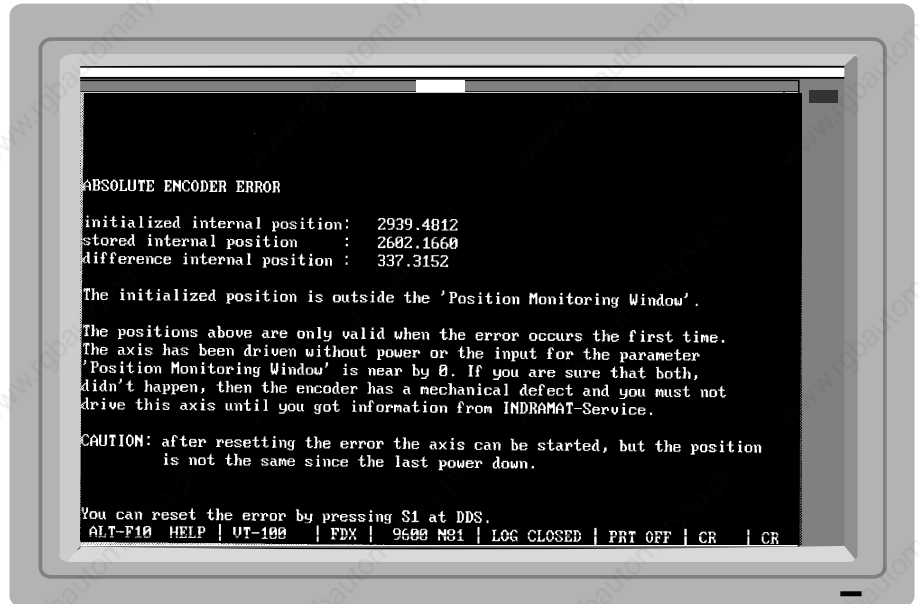


Fig. 33: Absolute encoder error

Program start
(screen message)

Fig. 34: Program start (screen message)

Main menu

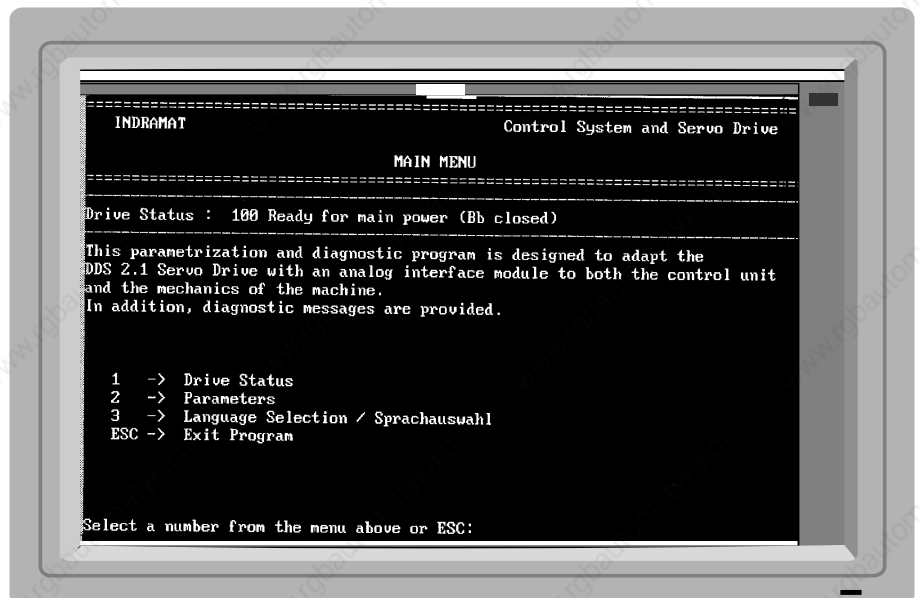


Fig. 35: Main menu

Drive status

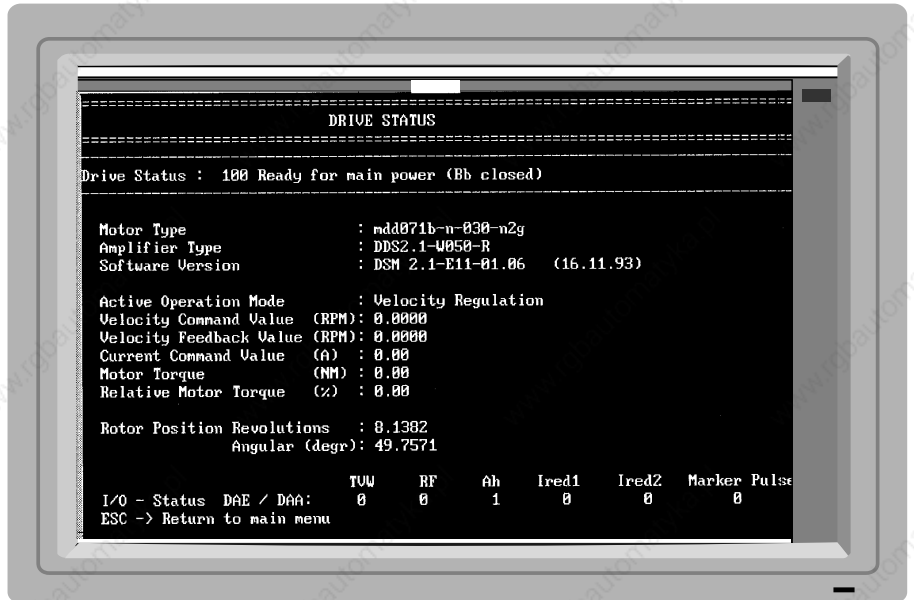


Fig. 36: "DRIVE STATUS" menu

Language selection

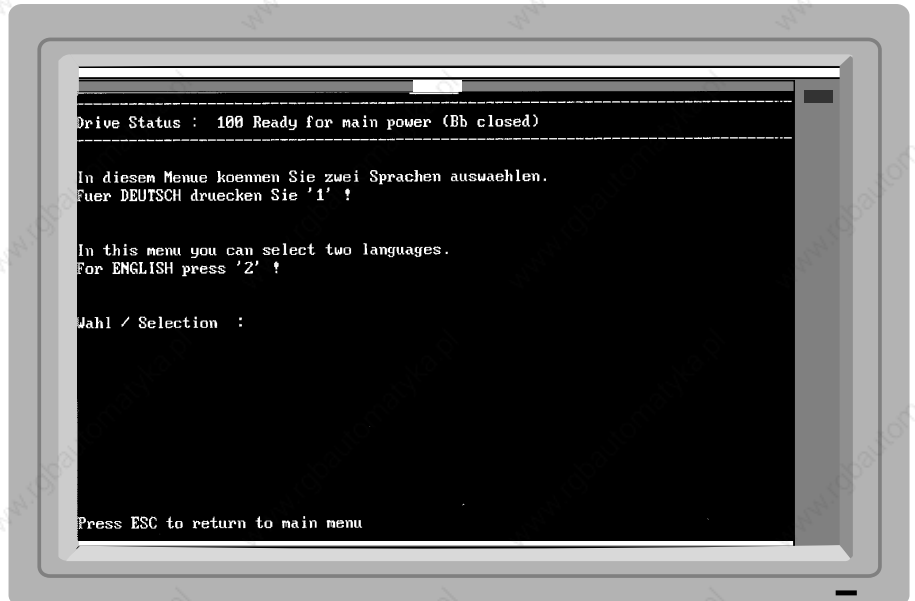


Fig. 37: "LANGUAGE SELECTION" menu

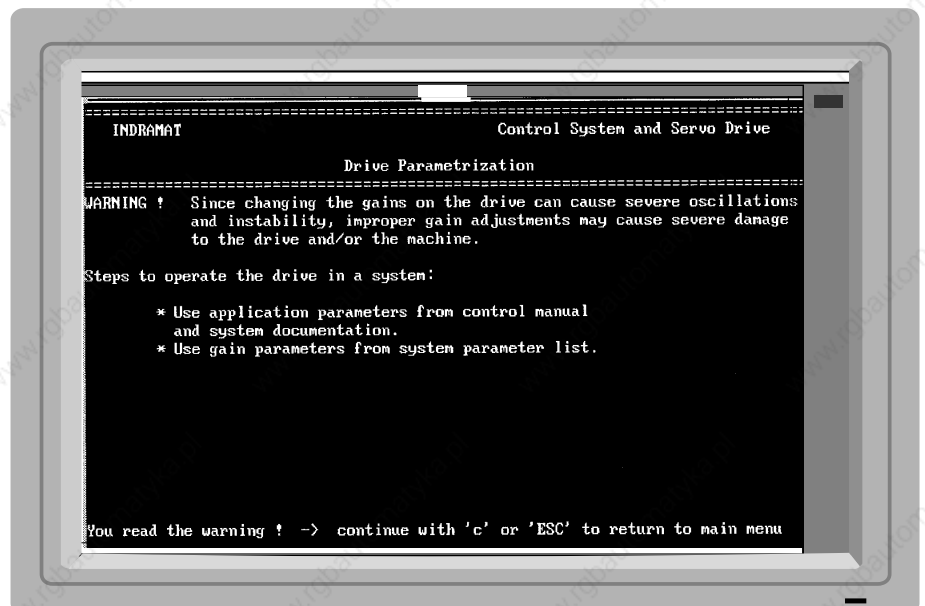
Safety note
"Drive Parametrization"

Fig. 38: Safety note to "PARAMETERS" menu

Parameter menu



Fig. 39: "PARAMETER" menu of parametrization and diagnostic program

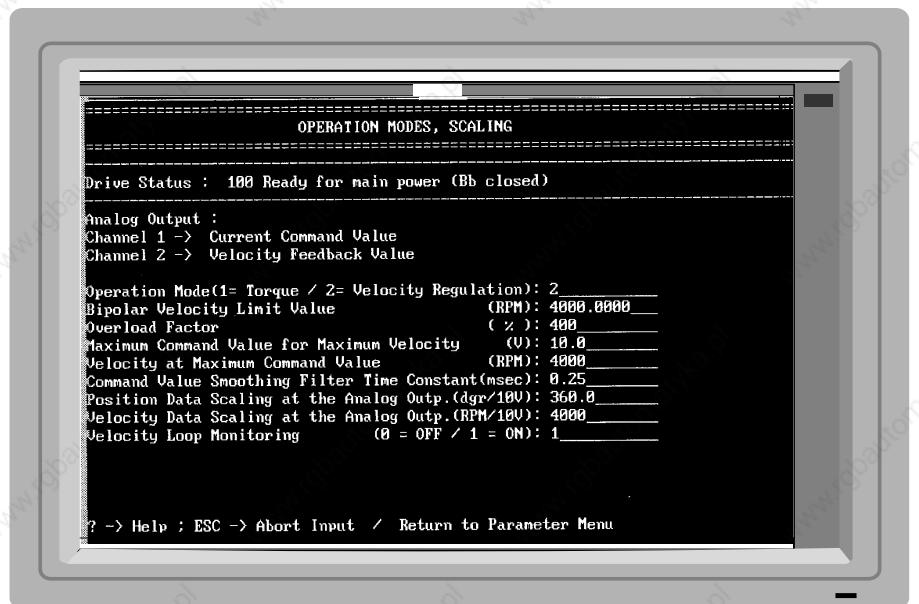
Operating modes, scaling
Feedback versions
with DSF or RSF

Fig. 40: "OPERATING MODES, SCALING" menu

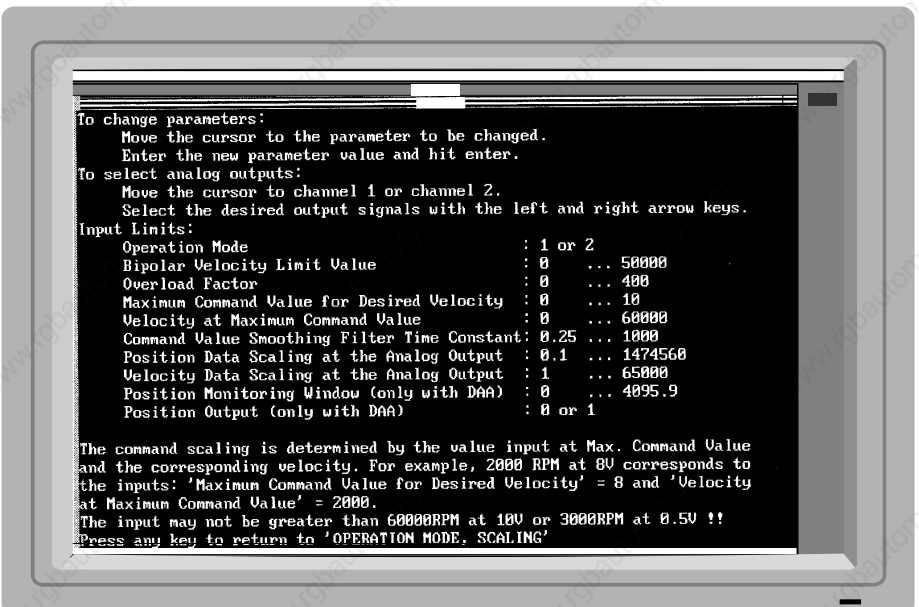
Operating modes, scaling
Feedback versions
with DSF or RSF
Help text

Fig. 41: Help text to "OPERATING MODES, SCALING" menu

Operating modes, scaling
Feedback versions with
absolute encoder options
(DSF + MTG or
RSF + IDG)

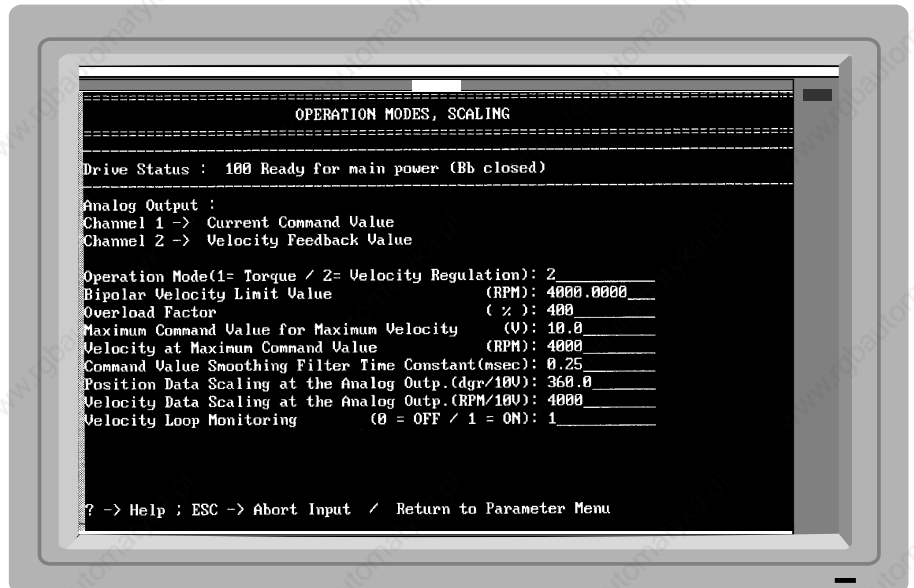


Fig. 42: "OPERATING MODES, SCALING" menu for motors with absolute encoders

Operating modes, scaling
Feedback versions with
absolute encoder options
(DSF + MTG or
RSF + IDG)
Help text

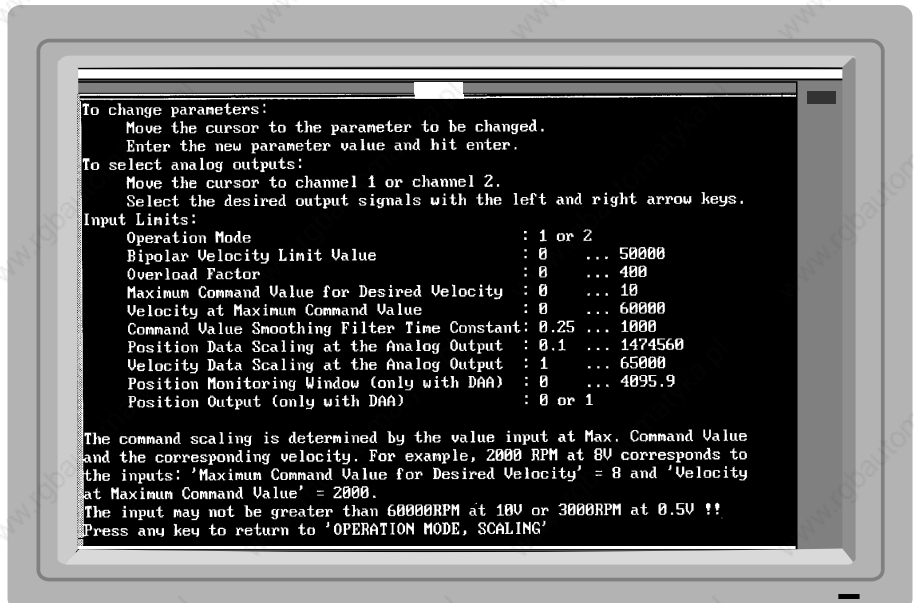


Fig. 43: "OPERATING MODES, SCALING"; help text for feedback versions with absolute encoder options

Incremental encoder
setup

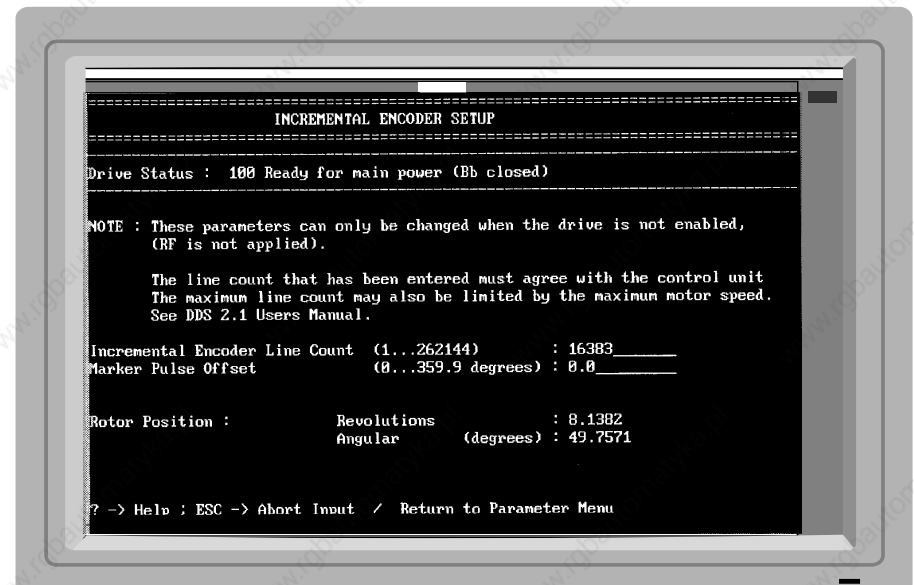


Fig. 44: "INCREMENTAL ENCODER SETUP" menu

Incremental encoder setup
Help text

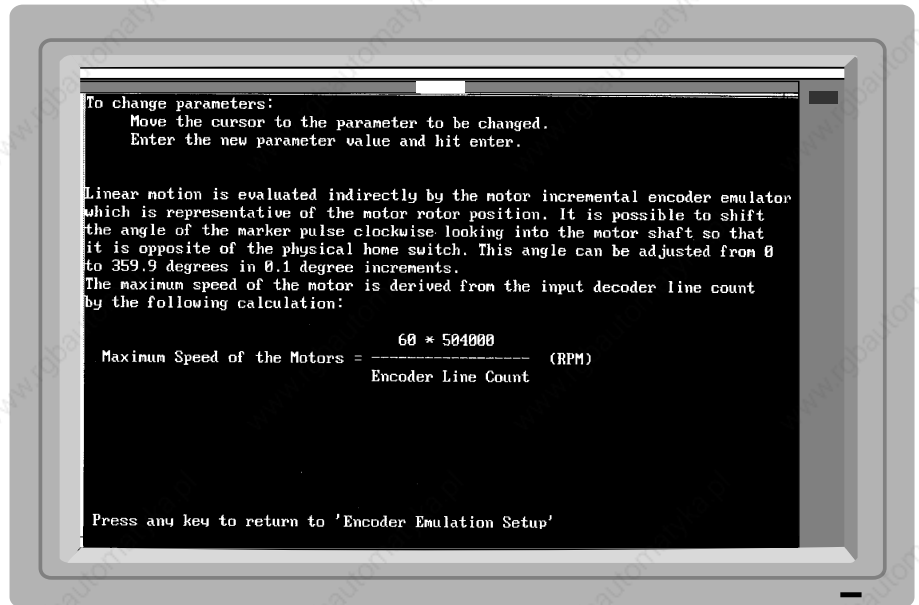


Fig. 45: Help text to "INCREMENTAL ENCODER SETUP" menu

Absolute encoder setup

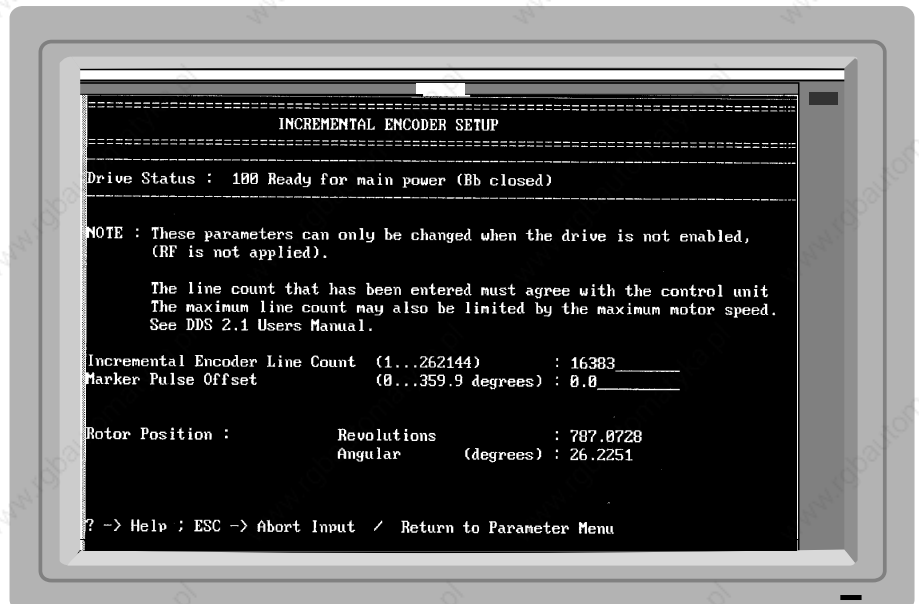


Fig. 46: "ABSOLUTE ENCODER SETUP" menu

Absolute encoder setup
Help text

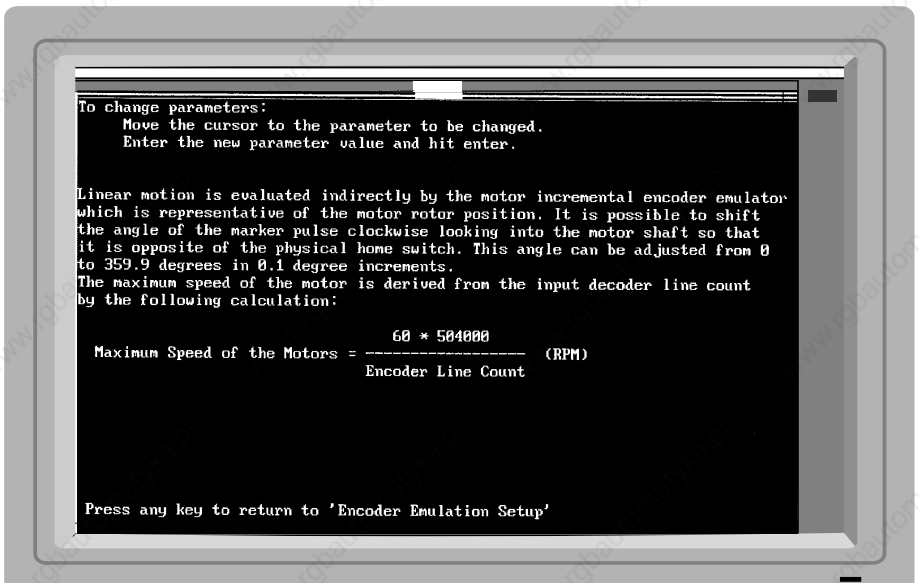


Fig. 47: Help text to "ABSOLUTE ENCODER SETUP" menu

Modulo parameters



Fig. 48: "MODULO PARAMETERS" menu

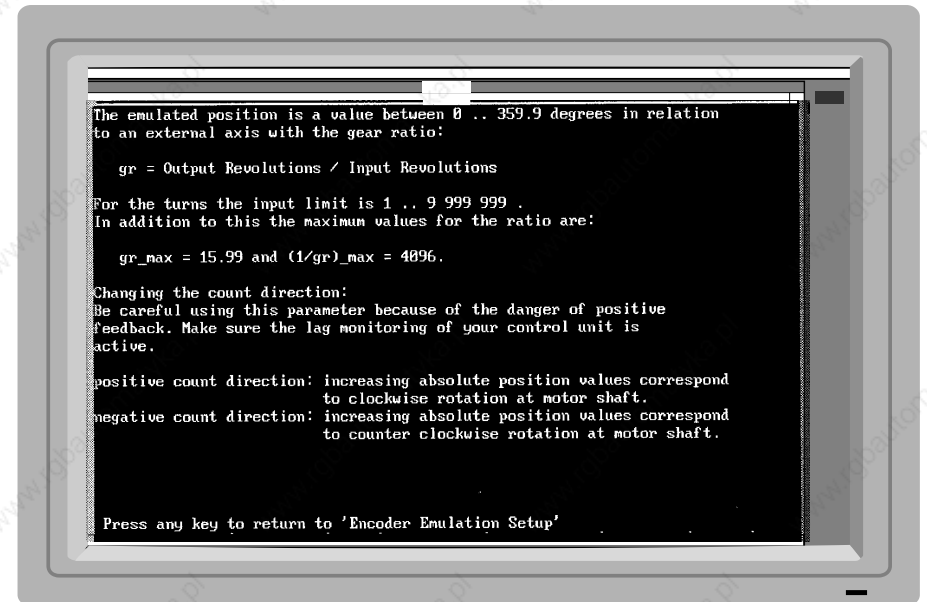
Modulo parameters
Help text

Fig. 49: Help text to "MODULO PARAMETERS" menu

Error reaction

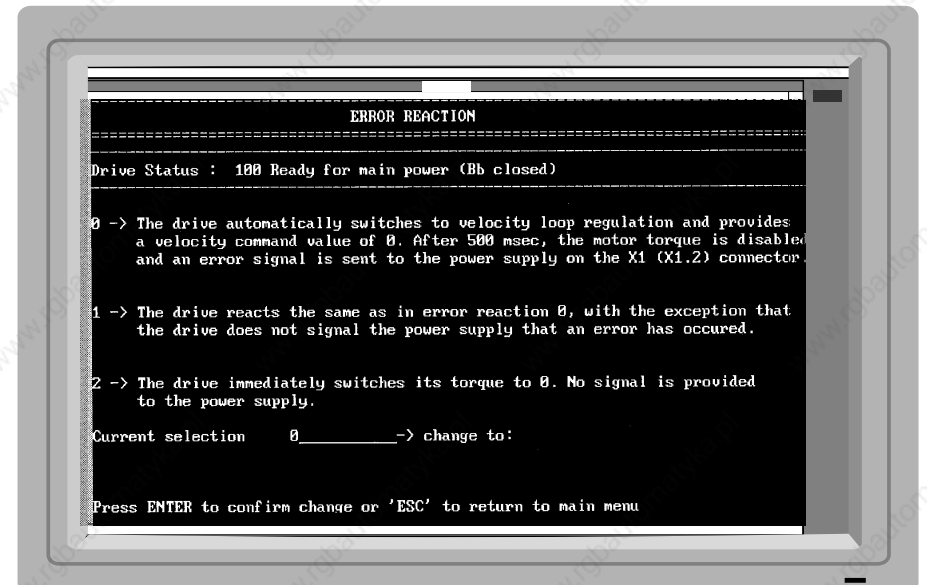


Fig. 50: "ERROR REACTION" menu

Torque/current limits

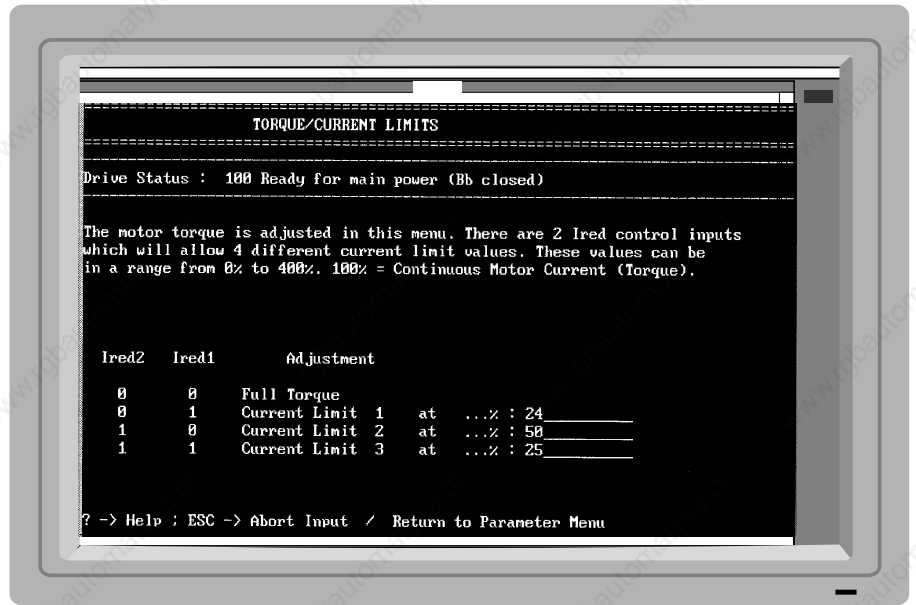


Fig. 51: "TORQUE / CURRENT LIMITS" menu

Torque/current limits
Help text



Fig. 52: Help text to "TORQUE/CURRENT LIMITS" menu

Gain parameters



Fig. 53: "GAIN PARAMETERS" menu

Gain parameters
Help text



Fig. 54: Help text to "GAIN PARAMETERS" menu

Amplifier/motor
parameters

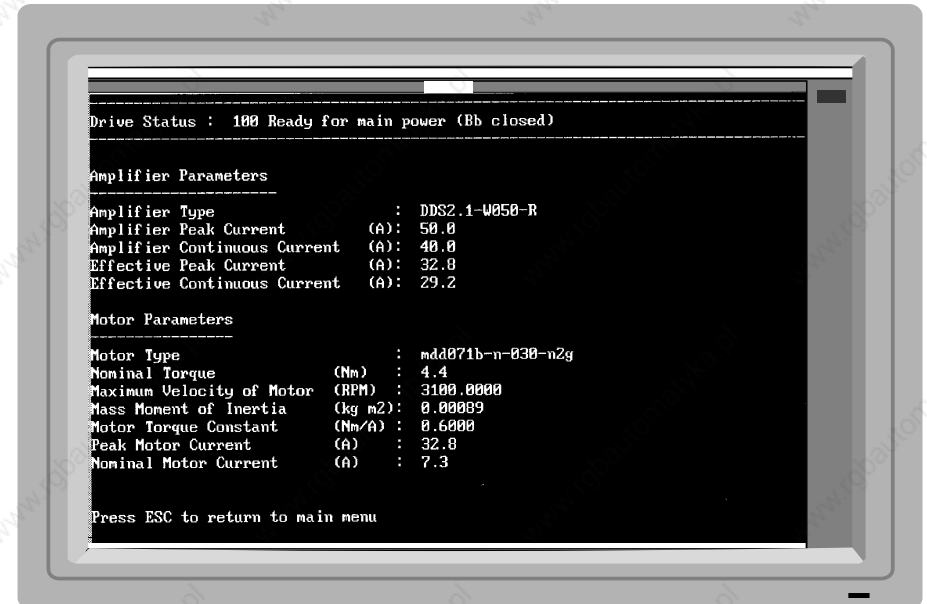


Fig. 55: "AMPLIFIER /MOTOR PARAMETERS" menu

Save parameters



Fig. 56: "SAVE PARAMETERS" menu

Load parameters

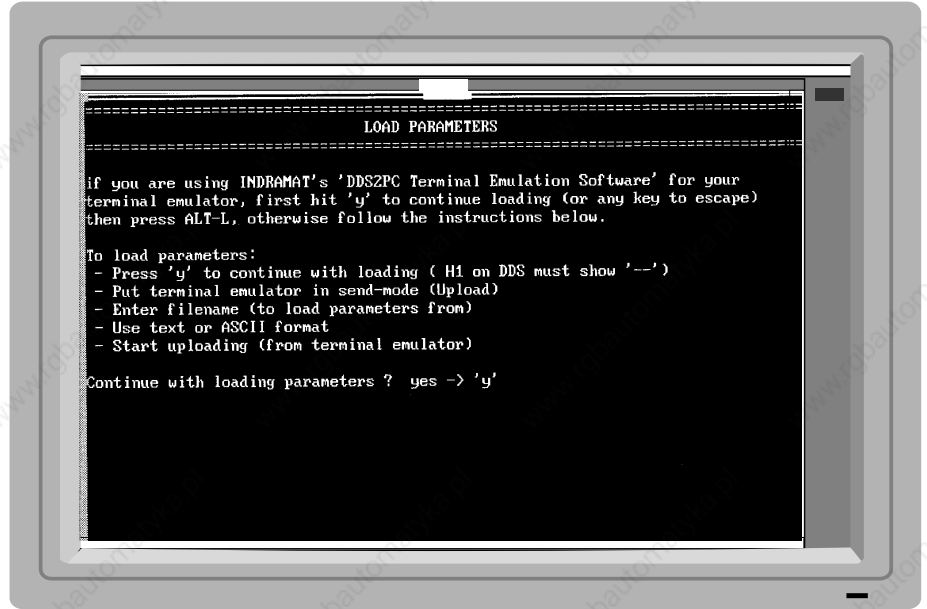


Fig. 57: "LOAD PARAMETERS" menu

5.2. Saving data

Saving data using the personal computer



The file format is: text (ASCII).

Procedure:

1. In the "PARAMETERS" menu call up the submenu "SAVE PARAMETERS".
2. Enter data to identify the machine (see Fig. 56).
 - You may enter up to a maximum of 55 alphanumeric characters per field.
 - To complete an entry hit <ENTER>.
3. Set the emulation program to the receive mode (download).
4. Enter a file name for the parameters to be saved.
5. Press button S1 on the DDS 2.1. This starts data transfer.
6. Complete the data transfer after the last "\$" character (see the user manual for the emulation program).
7. Hit any key to return to the user interface.



To edit the parameter file, use only a clear text editor, e.g. DOS Editor, Norton Editor. These editors do not add control characters.

The saved file can be changed as follows using the editor:

- **Make any changes you like before the ":" control character.**
- **For the parameter values, you may change the figures after the ":".**
- **The "\$" character is an end-of-file character and must neither be removed nor changed.**

An example of a parameter file printout is shown in the Appendix, Section 11.5.

Loading parameters to the drive

For axes with identical parameters it is possible to load a previously saved parameter file into the drive.

Procedure:

1. In the "PARAMETERS" menu call up the submenu "LOAD PARAMETERS".
2. Switch the emulation program to transmit mode (upload).
3. Select a parameter file.
4. Start transmission.
5. When transmission is completed the program will display a message telling you to hit any key to continue.

6. Commissioning procedure up to initial start-up of the AC servo drive

6.1. Checks to be run with power disconnected

Mains power requirements

Before starting any commissioning work check that the mains power supply is suitable for the installed power supply module (see power supply module documentation).

Drive components

The installed drive components must be suitable for the connection voltages used (see Project Planning Doc. No. 209-0069-4317-00).



Check the configuration of the drive controller (See Fig. 58): The data on the configuration rating plate must correspond to the components installed in the drive controller. If this is not the case, the AC servo drive and the machine mechanics may be destroyed or damaged!

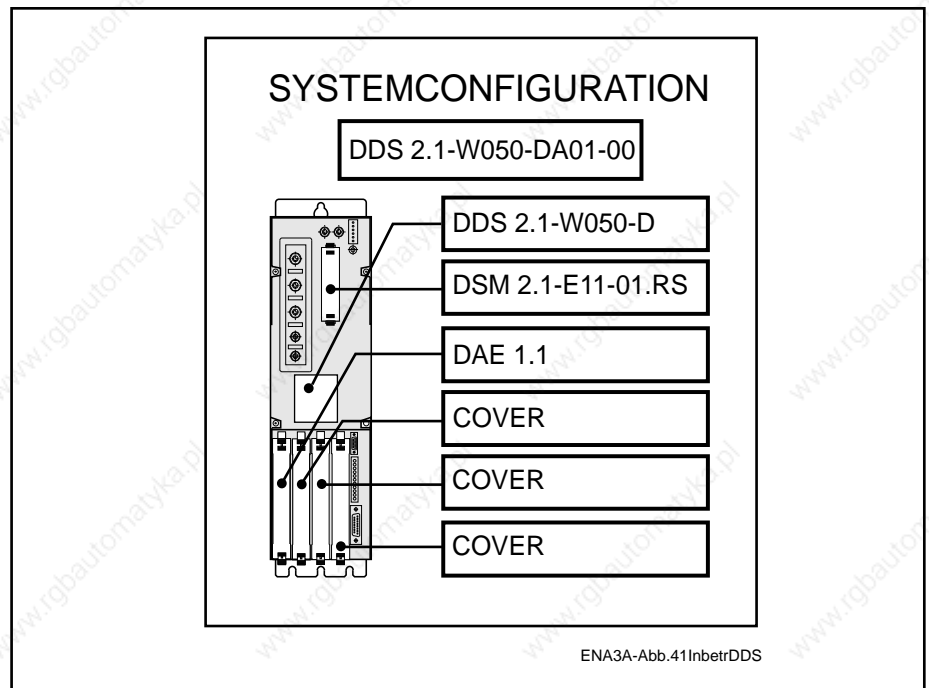


Fig. 58: Configuration rating plate

Wiring

Check all wiring for short circuits, interruptions, reverse polarity and conductor cross-sections.

Earth connections

- Earth the components exactly as prescribed in the specific INDRAMAT connection diagrams.
- Observe the valid safety precautions for the machine.
- Earth each motor to its drive module.
- Earth each drive module separately to the power supply module.



The earthable point of the power supply module is the common reference point for all drive components.

- Connect up the common reference point of the power supply module to the source earth.



Danger
The earth connections described above are operational earths and have a protective function. Do not disconnect them!

- Make an electrically conductive connection between the frames of the drive controllers and the rear wall of the cabinet (electromagnetic compatibility)).

Power cables

- Twist the power cables leading from the drive controllers to the motor or lay a four-core cable (3x phase, 1x earth).
- Check the conductor cross-sections for compliance with VDO 0113.

Power connections to additional modules

Power conductors leading to additional modules or other buffers should be twisted and kept short.

Power connections between servo drive modules

Normally, the units are installed adjacent to each other and the power connection is made using two conductor rails. If this is not possible, use two 16 mm² twisted conductors with a maximum length of 1 m.

Terminals and plug connectors

- Check that:
- proper contact has been made
 - terminals are firmly connected
 - sub-miniature connectors are tightly screwed down.

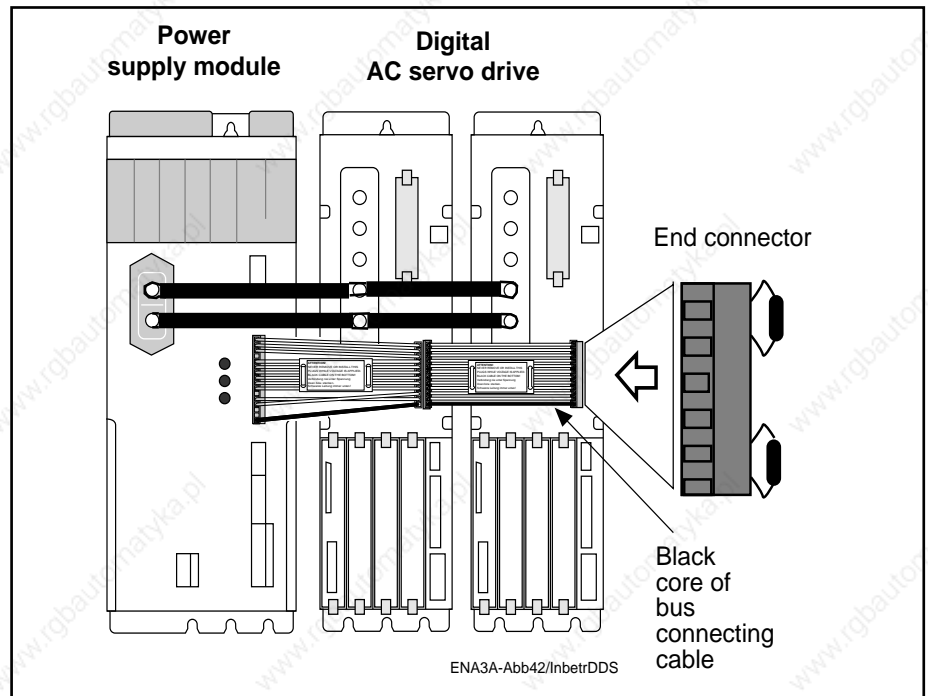


Fig. 59.: Arrangement of bus connecting cable and end connector

Bus connecting cable, end connector

A bus connecting cable is used for control voltage supply and the coordination of monitoring devices.

- Connect up the bus connecting cable with the black core at the bottom.
- For control voltage monitoring, plug in the end connector to the drive controller furthest away from the power supply module.



The end connector is an integral part of the accessories supplied along with the power supply module.

Screening

Shields for the motor feedback cable and the conductors to the thermistor must be connected up to the frame earth terminal of the drive controller.

Connection of a power transformer

If a power transformer is to be installed, check that the transformer output voltage and the connection voltage on the power supply module match.

E-STOP

If the plant is shut down by an E-STOP command, malfunction of the servo drive cannot be totally excluded and the circuit must therefore be broken (see documentation on the installed power supply module). Until the servo drive has come to a halt, uncontrolled drive motions will have to be reckoned with. The extent of these will depend on the type of fault and the operating status of the servo drive at the time the fault occurred. All precautions must therefore be taken at the higher plant level to exclude any risks of injury to persons.

Machine axes requiring immobilization of the axis after the servo drive has been stopped must be equipped with a holding brake. MDD servo motors can be supplied with an optional holding brake.

6.2. Checks to be run with control voltage applied

Before running the following checks, switch on the signal conditioning voltage supply at the power supply module.

The power supply module provides the voltage for signal conditioning in the drive controller.



DO NOT switch on the main contactor K1 for powering up.

"H1" status indicator messages

The drive controller is in working order when the status indicator H1 displays "Bb", i.e. "Ready" for powering up. If the indicator shows any other message, see Section 9, "Diagnostics and fault clearance".

Power circuit ON/OFF switching sequence

The correct switching sequence is guaranteed when the "Ready" contact in the power supply module has been installed according to INDRAMAT diagrams. Do not power up until the power supply module's "Ready" contact is closed (see documentation on the installed power supply module).

6.3. Entering parameters for initial start-up

Pre-conditions:

- The auxiliary equipment for operating the drive controller has been connected up (see Section 4).
- The person commissioning the equipment must be familiar with the Parametrization and Diagnostic Program (see Section 5).

Activate the "velocity loop" operating mode

Procedure:

1. Call up the "OPERATING MODES, SCALING" menu (refer to Fig. 40).
2. Activate the "velocity loop" operating mode.



Danger!
If you activate the "torque loop" mode by accident, the drive will accelerate uncontrollably even at the smallest command signal.

Limit the maximum velocity

Procedure:

1. Call up the "OPERATING MODES, SCALING" menu
2. Set the "bipolar velocity limit value" to c. 10% of the maximum NC working motor speed.

Limit the maximum torque

Limit the maximum motor torque to 100% (see Section 7.11)

Set command value parameters

Procedure:

1. Set the "maximum command value for maximum velocity" to the maximum output voltage of the battery power source (e.g. 10V).
2. Set the "velocity at maximum command value" to the same value as "bipolar velocity limit value".
3. Set the "command value smoothing filter time constant" to 0.250 (this makes the parameter ineffective).

Select error reactions

Procedure:

1. Call up the "ERROR REACTION" menu
2. Activate the error reaction "0".

Set gain parameters

1. Call up the "GAIN PARAMETERS" menu
2. Activate the line "reset to standard parameters". (The standard values stored in the motor feedback for controller parametrization will be loaded into the software module.)

Set short-time operation torque

Procedure:

1. Consult the selection list (Doc. No. 209-0069-4302-00 IDE) to find the overload factor of the installed motor/drive controller combination.
2. Enter this value in the "OPERATING MODES, SCALING" menu under the "overload factor".

6.4. Powering up

Check safety devices



Danger!
Be prepared for uncontrolled drive motion!

- **Make sure the E-STOP button is within easy reach.**
- **Check that the safety limit switches are far enough away from the fixed stops on the machine.**
- **Check that the E-STOP signal chain is functioning.**

Switch on power

The drive controller will respond by displaying "Bb" (ready) on the status indicator. The drive is ready to be powered up.

Switch on the power via the power supply module.

Observe the diagnostics display

The status indicator changes to "Ab". The drive's control and power circuits are ready. If this does not happen, proceed according to Section 9.

6.5. Checks to be run after switching on power

Check the holding brake function

The servo drive module will apply the signal for release of the holding brake at the same time as the controller enable signal. Check that the axis locking function is cancelled once the signal has been emitted.

6.6. Initial start-up of the drive with a battery power source

The servo axis can be operated independently of an NC control using a battery power source (see Section 4.2).

This may be useful in the following cases:

- the control system is not yet installed,
- the control system has failed,
- optimization work is being carried out on the axis to match up the machine mechanics and the servo drive.



Risk of injury to persons and damage to machines through uncontrolled drive motions.

Operating an AC servo drive in anything other than a secondary control loop is beyond its prescribed use. If this is still required, special safety precautions must be taken.

These are:

- 1. Persons must never stand within the range of servo axis motions.**
- 2. Set the maximum operating velocity such that the operator can always safely bring the servo axis to a halt by cancelling the "RF" signal (controller enable).**
- 3. Set an adequate safety distance between the E-STOP limit switch and the mechanical machine stop.**

Procedure:

- Connect up the batter power source terminals according to Section 4.2, Fig. 30.
- Apply the controller enable signal.
- De-activate the "drive halt" function (see Section 7.12).
- Apply a small command signal.
A positive voltage signal at the differential input E1 against E2 will cause the motor to rotate clockwise (looking at the motor shaft).
A negative voltage signal at the differential input E1 against E2 will cause the motor to rotate counter clockwise.
- The drive velocity must follow the command signal. This can be checked in the "DRIVE STATUS" menu under the items Velocity Command Value and the Velocity Feedback Value. If this is not the case, check for faults according to Section 9.



DO NOT attempt to change the direction of rotation of the servo motor by switching two cores in the motor power cable, as this may destroy the motor.

- Cancel the torque limitation and velocity limitation if these have been activated during commissioning.

The commissioning procedure up to initial start-up is now completed.

7. Commissioning the functions of the AC servo drive with ANALOG interface

7.1. Error reaction

Digital intelligent AC servo drives offer the possibility of preselecting different error reactions for each drive in a drive package. Error reactions 1 and 2 make it possible to complete machining operations on workpieces even in the event of errors occurring in other drive package axes not involved in the machining process (e.g. loading axes).

INDRAMAT classifies errors according to:

- Errors causing an error reaction in the entire drive package.
- Errors causing individual drive-specific error reactions.

Errors causing an error reaction in the entire drive package

Errors causing an error reaction in all drives connected up to one power supply module are:

- 22 "Motor encoder error"
- 24 "Overcurrent"
- 60 "Bridge fuse"
- 61 "Earth-fault fuse"
- 67" "Faulty hardware synchronization"
- 69 "± 15 Volt error"
- 70 "± 24 Volt error"
- 71 "± 10 Volt error"
- 72 "+ 8 Volt error"
- 73 "Voltage supply driver stage"

(For more details on errors, see Section 9)



Danger through involuntary drive movements!
The errors stated above prevent the drive being stopped under controlled conditions.

Error reaction of the drive package

1. The drive affected by the error sends an error signal to the power supply module.
2. The power supply module cuts the power.
3. The error signal "undervoltage" sent by the power supply module to the drives is ignored by the unaffected drives. These can then be brought to a standstill in under normal process conditions via the NC control. However, stopping under normal process conditions will depend on the residual energy available in the DC link circuit.
4. The deceleration path can be shortened via the power supply module by activating the "plug braking" function (see documentation on the installed power supply module).



Activating the "plug braking" function affects all AC servo drives in one drive package, irrespective of their preset error reactions.

Errors causing drive-specific error reactions

With all other types of errors it is possible to select any desired error reaction for each servo axis. Unaffected axes in the drive package will remain operative.

Setting error reactions

The "ERROR REACTION" menu offers the following selection options:

Error reaction	Drive reaction in the presence of an error
0	<ul style="list-style-type: none"> - Automatic switch to velocity loop mode - Braking at maximum acceleration - Torque disable signal for the drive after 500 ms - Opening of the "bb" Ready contact X3-6/7 on the drive controller (see Section 7.4) - Error signal to the power supply module <ul style="list-style-type: none"> • The power supply module cuts the power.
1	<ul style="list-style-type: none"> - The drive reacts the same as in error reaction 0 - No error signal to the power supply module - Other unaffected drives connected up to the same power supply module remain operative.
2	<div data-bbox="820 1061 938 1122" style="float: left; margin-right: 10px;"> </div> <div data-bbox="948 1070 1485 1234" style="border: 1px solid black; padding: 5px; margin-bottom: 10px;"> <p>Error reaction "2" is not to be recommended for motors equipped with a holding brake. Upwards of 20,000 revolutions against a closed holding brake will wear the brake out.</p> </div> <ul style="list-style-type: none"> - Undelayed torque disable signal (axis slows to a halt) - Undelayed braking through motor holding brake (if fitted) - No error signal to power supply module - Unaffected drives connected up to the same power supply module remain operative - "Ready" contact Bb X3-6/7 on drive controller open (Section 7.4)

Fig. 60: Setting error reactions on the DDS 2.1



Irrespective of the selected error reaction, the corresponding error can be evaluated immediately by means of the lag detection feature on an NC control as well as by observing the Bb contact (X3 pin 6/7) on the drive controller (see Section 7.4). This allows rapid shutdown of the drives at any time by an NC control command overriding the selected error reaction.

Error reaction and holding brake control

The reaction of the holding brake under different preset error reactions is shown in Fig. 61.

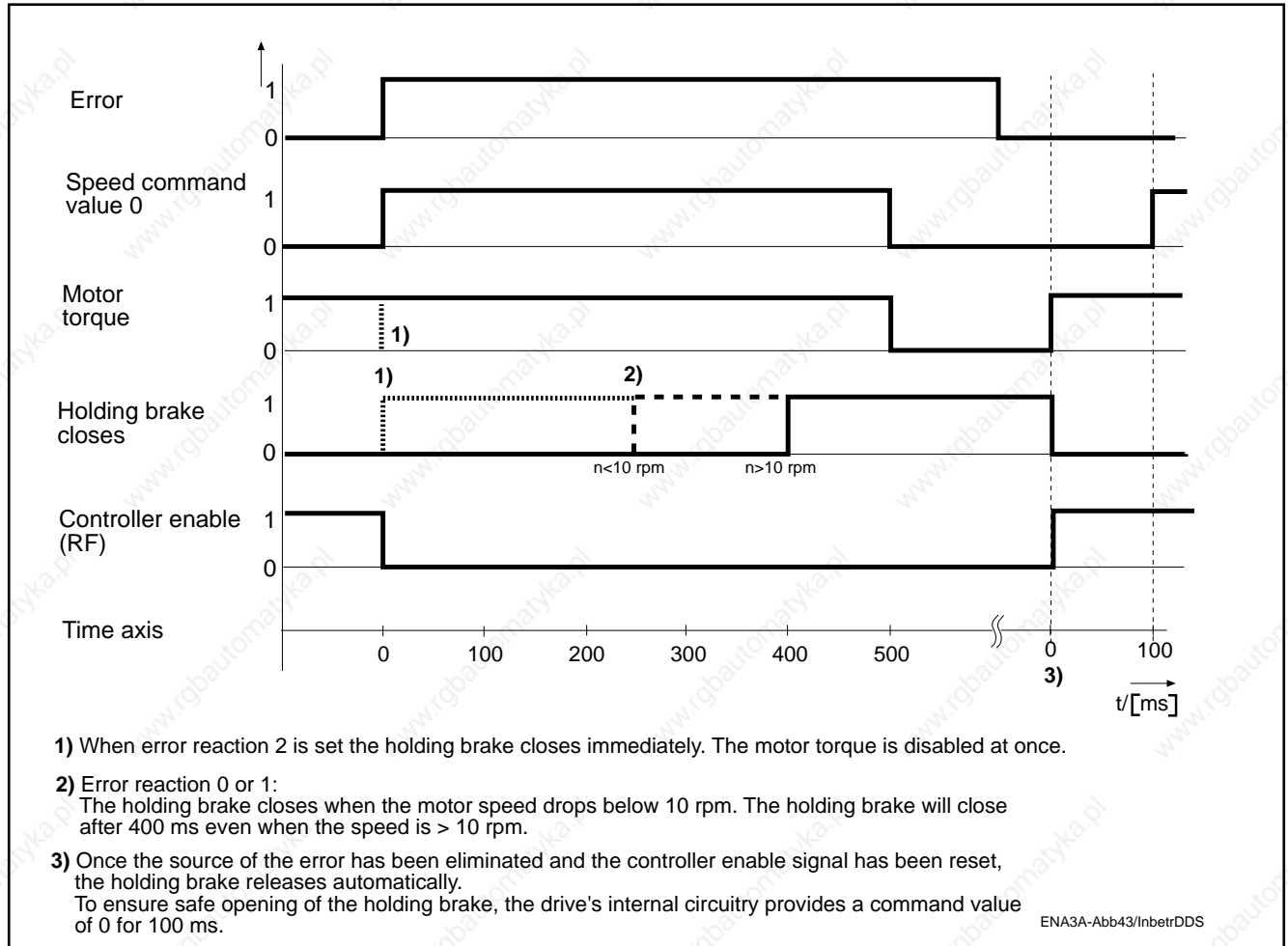


Fig. 61: Reaction of the holding brake under different error reactions.

7.2. Safety lockout (drive interlock open)

Production facilities, transfer lines and machine tools often consist of physically separate operational units such as machining stations, transport, handling and storage systems.

Personnel often have to perform work in a danger zone on one of these units while the other units on the machine are still running. If a person has to enter the working area of an axis, this must first be stopped and secured against involuntary start-up.

The safety lockout is such a feature intended to prevent an installed motor starting up again in the presence of an error. It provides safe shutdown of separate working areas in a machine or a plant.

Series DDS 2.1 drive controllers are equipped with a safety lockout to stop a servo axis starting up accidentally. When this lockout is activated, the control electronics for the power output stage are disconnected from the latter by means of a relay contact.



Risk of injury or damage due to uncontrolled axis movements!

The safety lockout is NOT intended to stop a moving axis.

When the lockout is active, the drives can no longer be operated via the NC control or the drive controller. The motor torque signal is immediately disabled and the axis can no longer be brought to a halt under controlled conditions.

Vertical axes must always be immobilized using a mechanical brake before the safety lockout is activated.

For motors with holding brakes, this function is executed by cancelling the controller enable signal. Only then may the safety lockout be switched on.

Activating the safety lockout

Activate the safety lockout by applying a + 24 V signal to the pins AS+; AS- on connector X3. Switching of the safety lockout relay in the drive controller is signalled to the NC control when the potential-free feedback contacts (output ASQ - ASQ) close (Fig. 62).

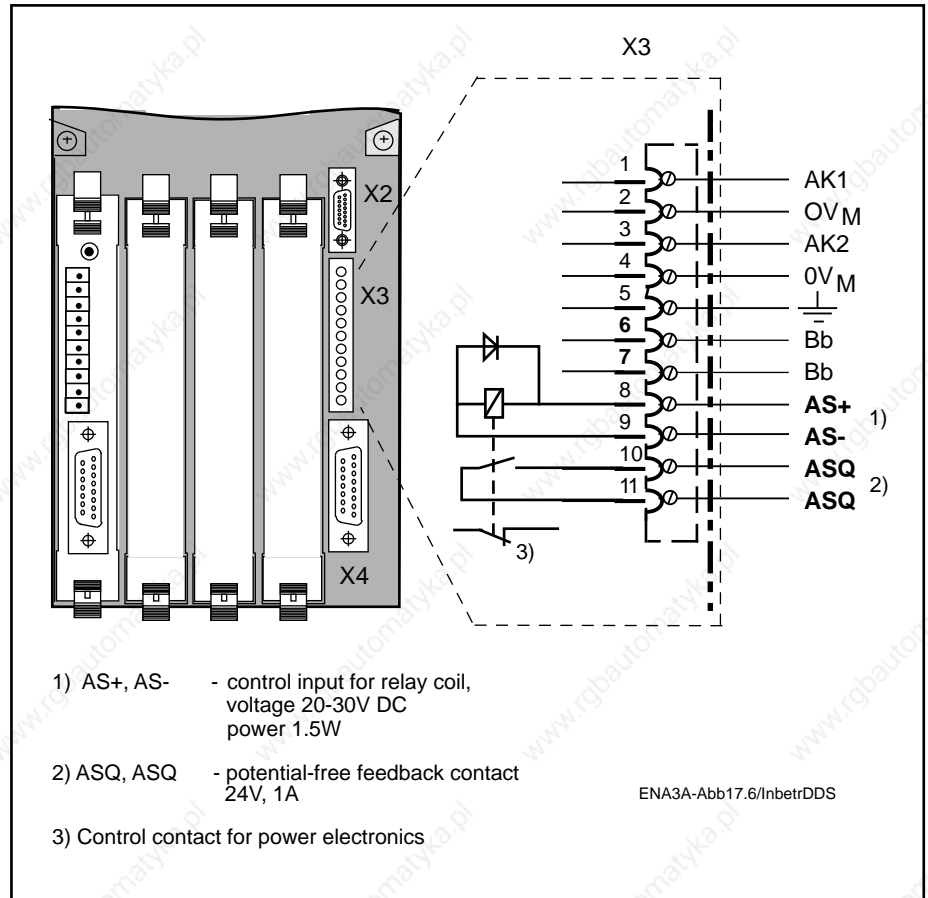


Fig. 62: Control inputs and signal outputs of the safety lockout on a DDS 2.1 drive controller

Status diagnosis



When the safety lockout has been activated, the status indicator H1 on the drive controller will display the message "AS".

Additional information

Application examples explaining how to use the safety lockout are contained in the documentation "Safety lockout for DDS 2 drive controllers" (Doc. No. 209-0069-4313).

Time sequence for safety lockout activation

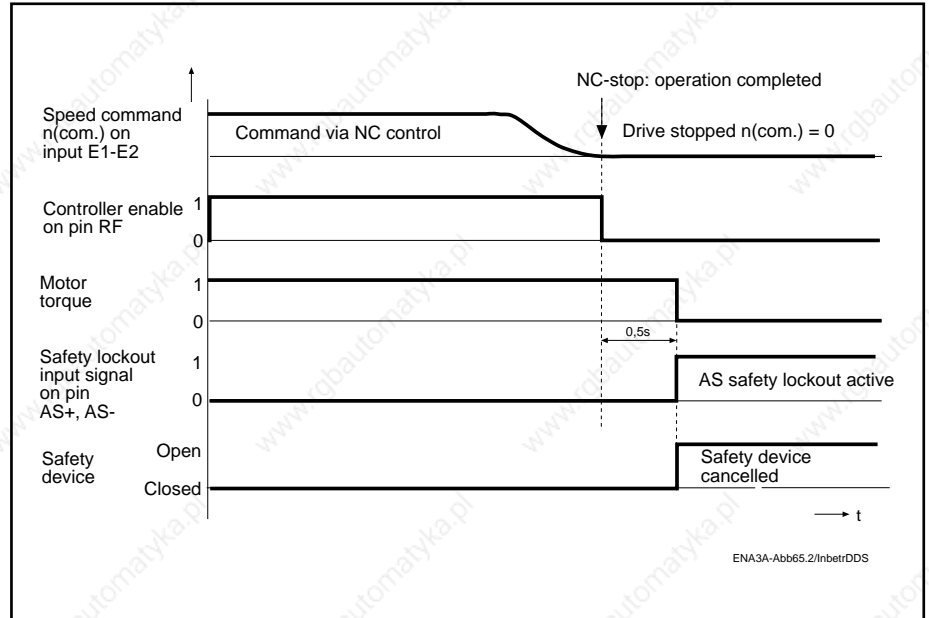


Fig. 63: Time sequence for safety lockout activation

7.3. Holding brake function

When stopped, servo axes must be secured against involuntary start-up if such a movement could cause injury to personnel or damage to machinery. INDRAMAT provides protection of this type in the form of an optional holding brake.



The holding brake for MDD motors is not designed as a service brake. If applied with the motor running, it will wear out after approx. 20,000 motor revolutions.

When the holding brake is de-energized a force acts on the braking/armature disc of the servo motor, thus safely immobilizing the axis. The holding brake is activated by the drive controller according to the status of the controller enable signal (see Fig. 65) and the preset error reaction (see Fig. 66). To power up the holding brake, apply an DC voltage from an external source to the terminal block X6 on the drive controller (see Fig. 64).

Electrical connections for the holding brake

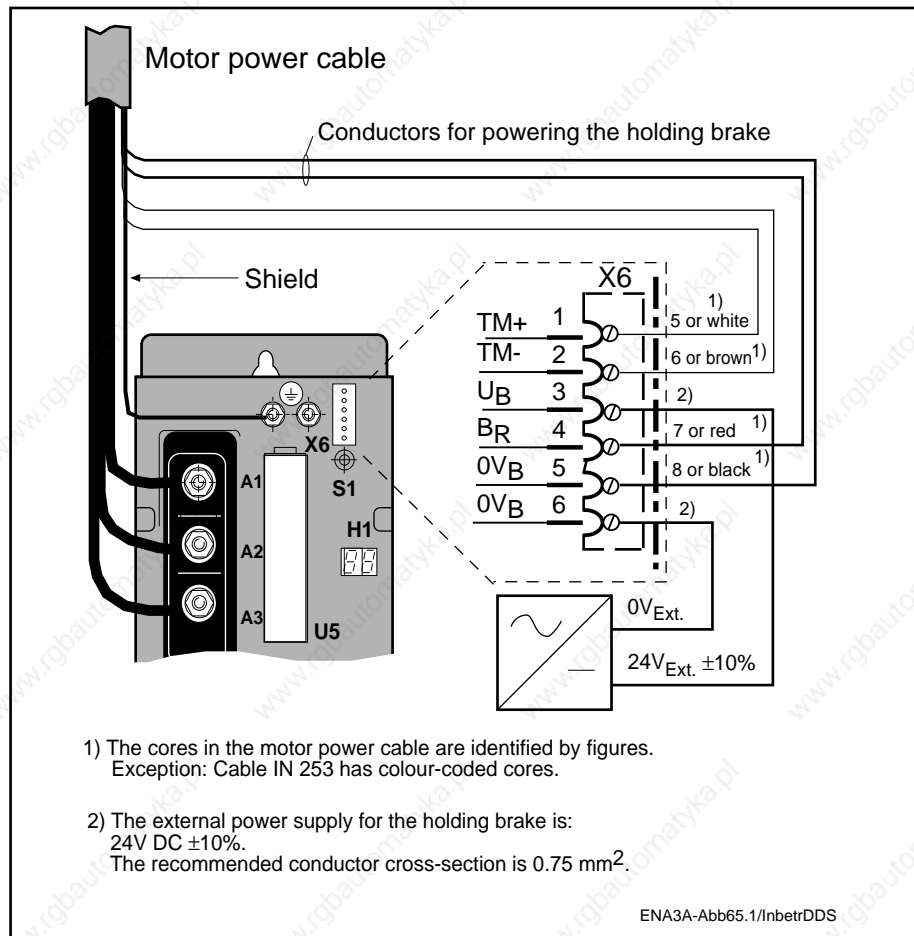


Fig. 64: Connecting up the holding brake to terminal block X6

7. Commissioning the functions of the digital AC servo drive

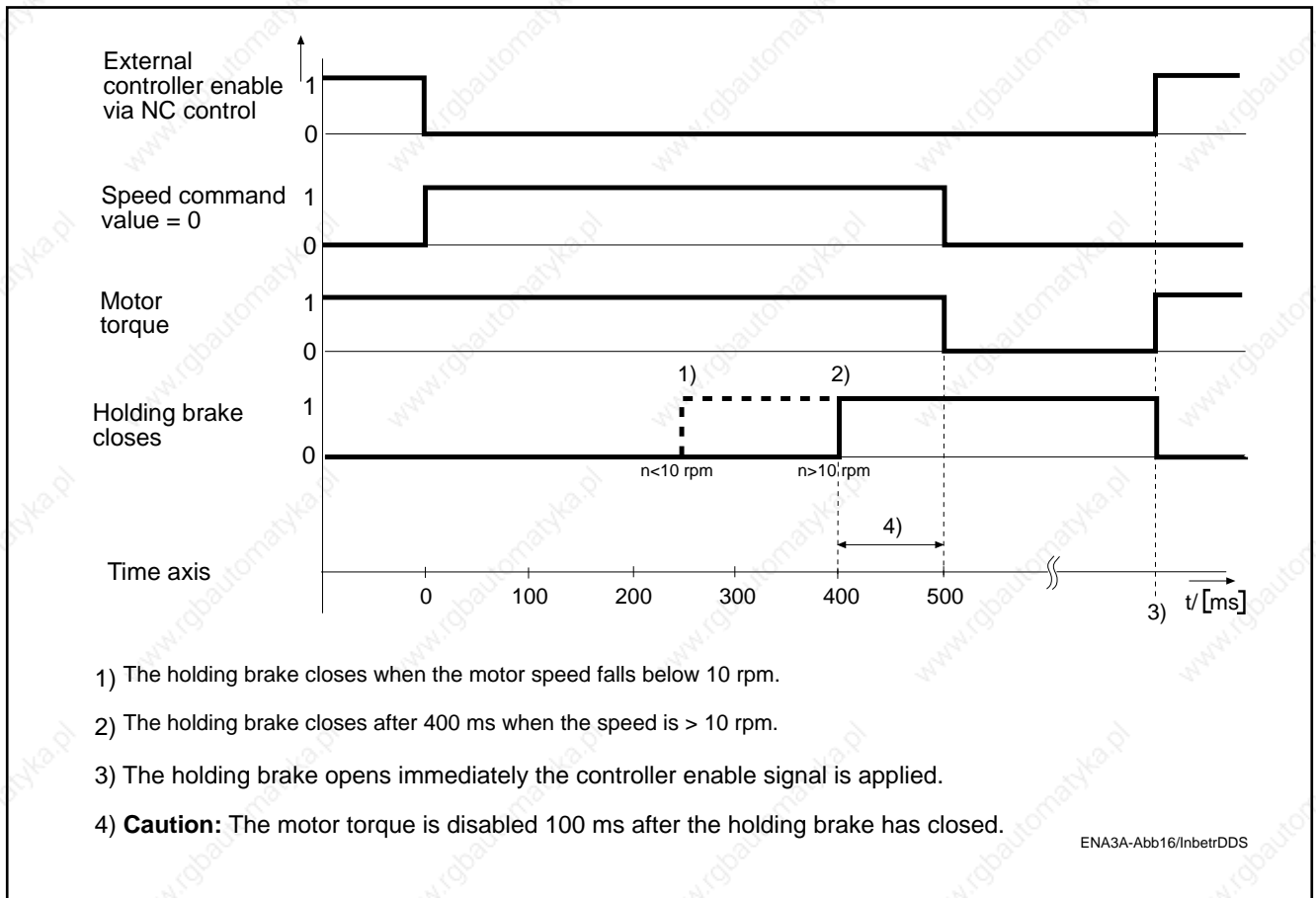


Fig. 65: Time sequence of holding brake status corresponding to controller enable status

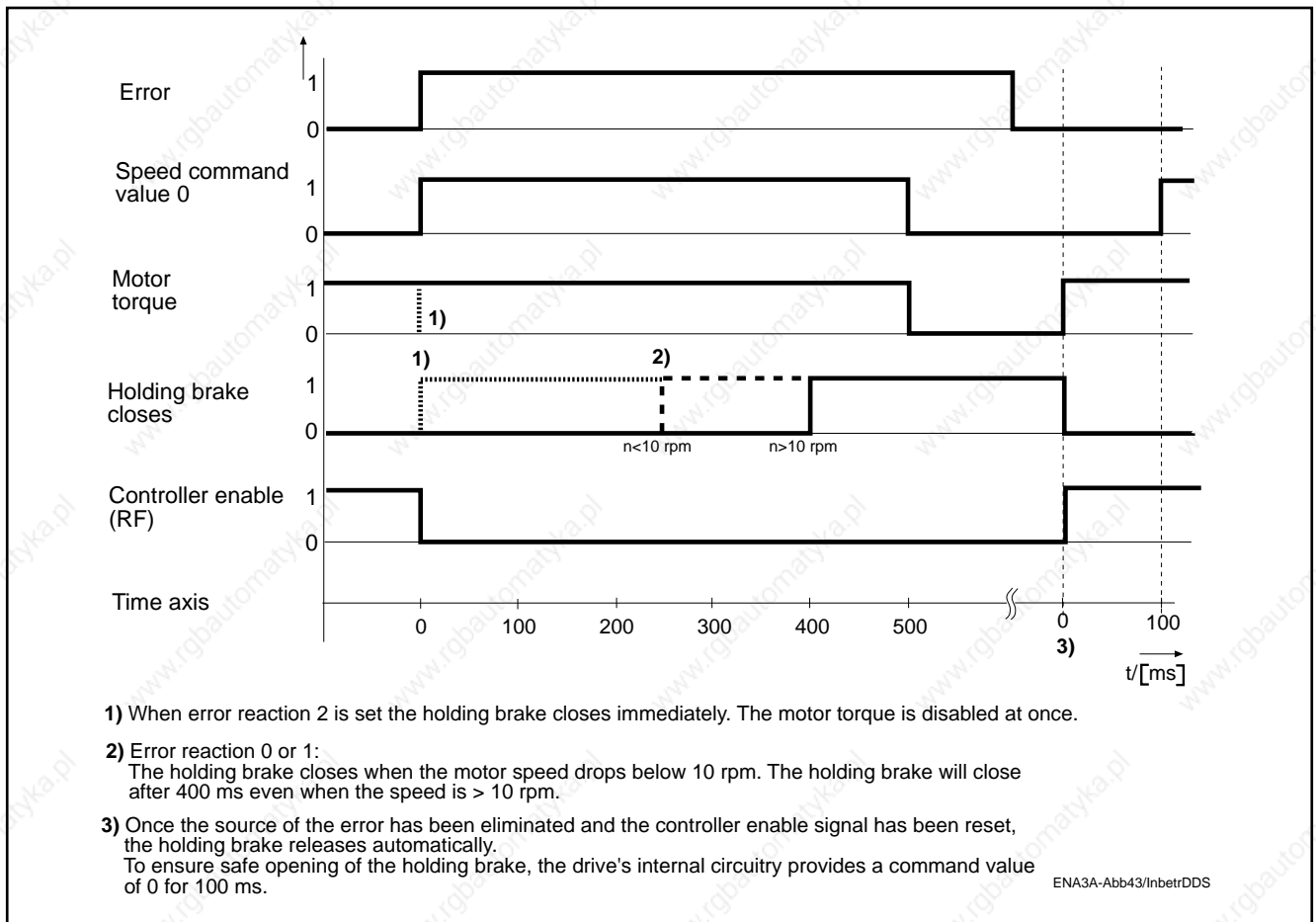


Fig. 66: Reaction of the holding brake under different error reactions.

Holding brake,
manual release

In cases where the controller enable signal cannot be set and it is necessary to move the servo axis by hand, the holding brake can be released as described below.



**Danger of injury to persons and damage to machinery.
Secure vertical axes against accidental movement!**

Procedure: (see Fig. 64)

1. Disconnect the conductors that power the holding brake (X6/4 and X6/5).
2. Apply an external +24V DC signal to the core marked "7" or coloured red.
3. Apply a 0 V signal to the core marked "8" or coloured black.
4. The brake will open.
5. Move the axis to the desired position.
6. Disconnect the external DC power supply.
7. Reconnect the cores to X6 as shown in Fig. 64.

Verifying the brake
has opened

When the holding brake opens, this produces an audible sound in the servo motor. Activate the holding brake briefly several times and listen for a synchronous knocking sound in the motor!

Check that the holding
brake is correctly dimen-
sioned

During commissioning, measure the mass moment of inertia of the axis acting on the motor (see Section 8.3)

The figure given in the motor specification sheet for the brake's holding moment must be greater than the mass moment of inertia of the axis. Vibrations liable to occur when the machine is in operation require an oversizing factor of 30% on account of dynamic moment combinations.

Error
diagnosis



Error in the holding brake and its control signals (see Section 9.3)

7.4. Operational status (Ready)

In order to avoid unnecessary down time, machinery and plant require continuous monitoring. The DDS 2.1 drive controller caters to this need with a signal contact.

The potential-free signal contact "Bb" (Ready) on connector X3 pin 6/7 makes it possible to pinpoint the affected machine in the event of a drive error in the associated NC control or signalling device (see Fig. 67).

The signal issued by the drive controller can be indicated through an NC control or a signalling device.

Switching status

The Bb contact opens whenever:

- there is an interruption in the control voltage
- the control voltage is applied, but there is an error in the AC servo drive

The Bb contact remains closed when:

- the control voltage is continuously applied
- the servo drive is free of errors

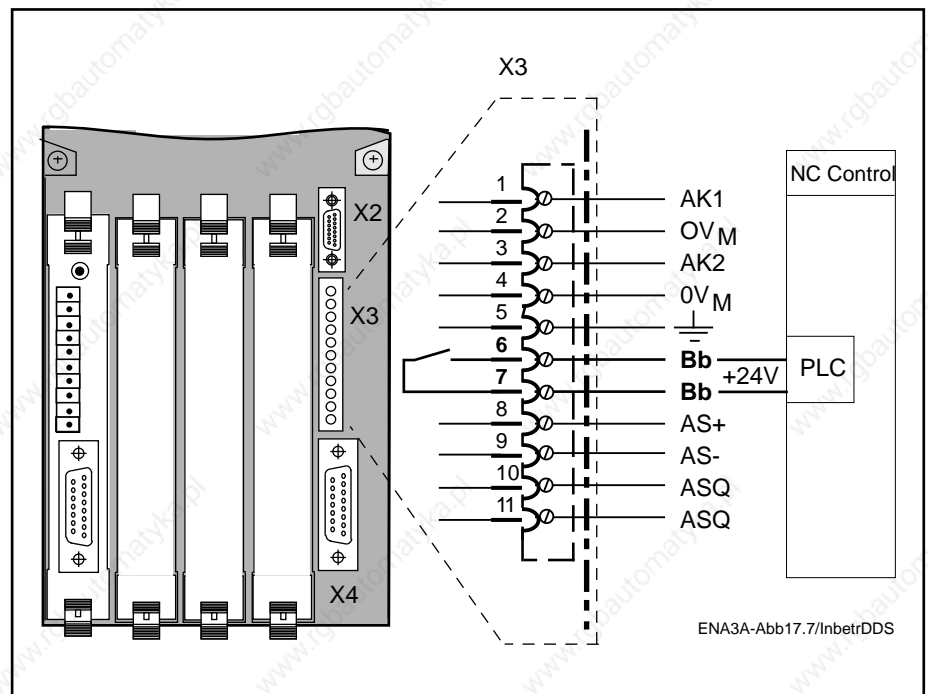


Fig. 67: "Ready" signal contact for external evaluation

Status diagnoses

Status diagnoses are signals referring to the operational readiness of the drive. They are displayed on the status indicator H1.

"Ready"
drive ready
for powering up

When the control voltage has been applied and the drive is free of errors, the status indicator "H1" will display the message "bb".

"Drive ready"
for power output

Once the mains power has been switched on the status indicator "H1" will switch to "Ab" (drive ready)

"Drive enable"
the drive will follow
the command value

Application of the controller enable signal will enable the internal control circuits.

7.5. Temperature monitoring

To avoid unnecessary production stoppages, the digital AC servo drive is equipped with a temperature monitoring feature for both the drive controller and the AC servo motor.

The causes of overheating may be:

- Contamination of heat transfer points
- Overloading due to the machine's work cycle
- Failure of the cooling system in the drive controller
- Failure of the cooling system on the AC servo motor

Working principle

The temperature of both the drive controller and the servo motor are monitored continuously and separately. When the temperature rises above the permissible limit an overtemperature warning signal is emitted for 30 s.

The following temperature warnings are emitted as flashing messages:

Warning displayed
on the status
indicator "H1"

"Warning: amplifier overtemperature"

"Warning: motor overtemperature"

Warning signal emitted through the output "TVW"

The signal output "TVW" on the ANALOG interface provides a 24V signal for evaluation by an NC control.

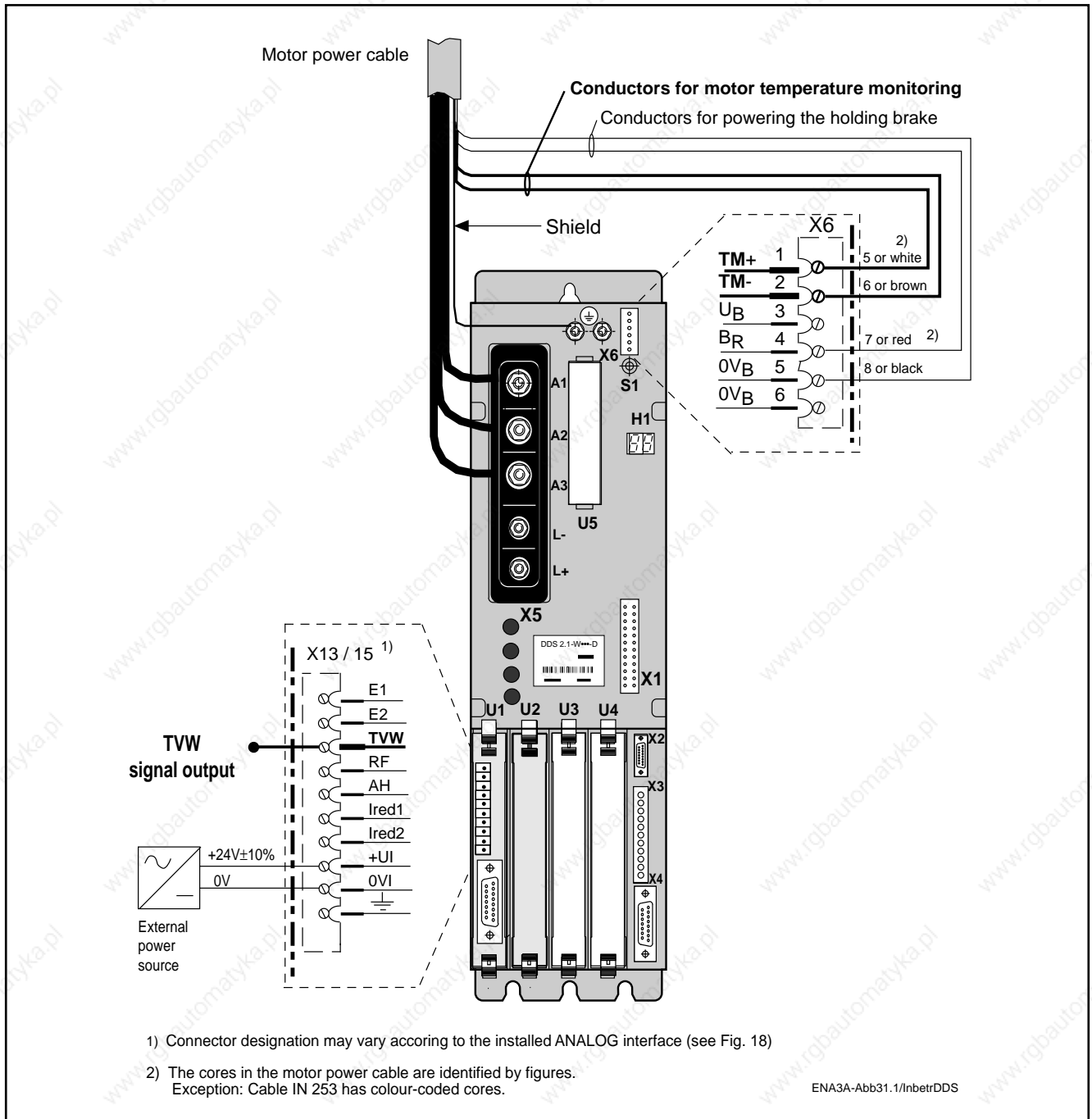


Fig. 68: Drive controller inputs and outputs for temperature monitoring

Drive's internal error reaction

Within the following 30 s, the drive may be shut down under controlled conditions by the NC control. After this time the digital drive will react according to the preset error reaction.

Error message

The status indicator "H1" will display the following messages:



"Amplifier overtemperature - shutdown"



"Motor overtemperature - shutdown"
(refer also to Section 9.3)

7.6. Velocity command matching

Different makes of NC controls are provided with different output voltage levels for rapid traverse velocities. INDRAMAT AC servo drives therefore offer the option of adapting the level of the velocity command value.

The actual motor speed and direction of rotation depends on the plant design.

To match the velocity command value, the "OPERATING MODES, SCALING" menu offers two different parameters:

- Maximum command value for desired velocity
- Velocity at maximum command value

Matching the signal to the NC control's output voltage

Use the parameter "Maximum command value for desired velocity" to set the maximum voltage at analog inputs E1, E2 for the desired velocity.

Matching the signal to the rapid traverse velocity

The signal "Velocity at maximum command value" serves to set the desired speed of the servo motor. This speed is achieved at the previously set command value. See parameter "Maximum command value for desired velocity".

Example:

The entries for maximum command value and for the corresponding velocity represent the command value scaling factor. For 2000 [rpm] at 8 [V] the entry is:

"Maximum command value for desired velocity":

Entry: 8 [V]

"Velocity at maximum command value":

Entry: 2000 [rpm]

Upper and lower limits for entry:

- "Maximum command value for desired velocity" \tilde{O} 0 to 10 [V]
- "Velocity at maximum command value" \tilde{O} 0 to 65000 [rpm]



If the ratio of "maximum command value for desired velocity" to "velocity at maximum command value" exceeds 6500 rpm per 1V, the error message "parameters outside range" will be signalled.

Preselecting the servo motor's direction of rotation

A positive voltage at the differential input E1 against E2 will cause the motor to rotate clockwise (looking at the motor shaft)

A negative voltage at the differential input E1 against E2 will cause the motor to rotate counter clockwise.



DO NOT attempt to change the direction of rotation of the motor by switching two cores in the motor power cable. This may destroy the motor.

Permissible input signals at the velocity command interface

	Designation	Unit	Min.	Max.	
ANALOG interface	Input voltage	E1	V	-10	+10
		E2	V	-10	+10
		ΔU	V		10
Input current	E1 _{POSIN}	mA	-0,25	+0,25	
	E2 _{NEGIN}	mA	-0,5	+0,5	

ENA3A-Abb65.8/InbetrDDS

Fig. 69: Input signals at the ANALOG interface

Connecting up the velocity command interface to an NC control

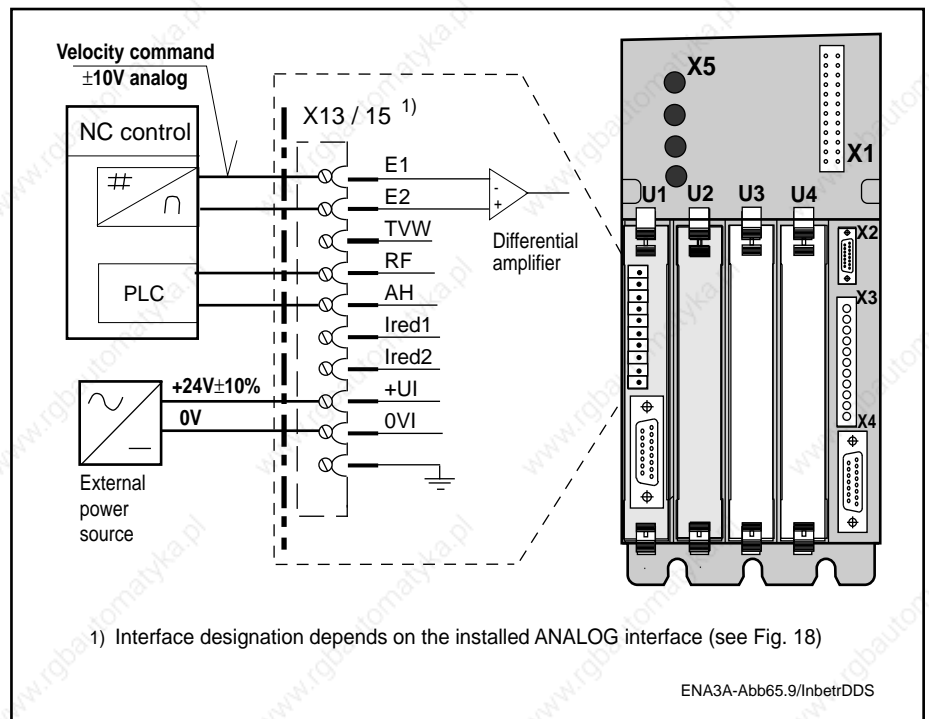


Fig. 70: ANALOG interface on the DDS 2.1 drive controller

7.7. Command value smoothing

When the servo drive is controlled in closed loop by the NC control, stepped command value signals - due to the control's cycle time - will result in torque fluctuations.

The effects of such a stepped command signal are:

- noise generation during acceleration and braking.
- vibration of the machine during interpolation.

This causes:

- increased mechanical stress in the machine.
- increased motor power dissipation.

The command signal emitted by the NC control can be smoothed using the parameter "Command value smoothing filter time constant". The recommended smoothing filter time constant is 1/3 the control cycle time.



- If the smoothing filter time constant is too high, this will cause signal delays in the control loop and result in contouring errors.
- If the step response is desired, cancel the smoothing filter time constant function by entering 0.25 msec.

7.8. Actual-position sensing by indirect relative position measuring system

An NC control requires position measuring systems to sense the position of machine axes. These position measuring systems can either be mounted directly on the machine's mechanical construction (direct position measuring system) or on the motor (indirect position measuring system).

For indirect sensing of the axis position INDRAMAT supplies an interface as standard on digital drives with ANALOG interface. This interface comes in two versions:

- indirect relative position sensing with incremental encoder compatible signals
- indirect absolute position sensing. Refer to Section 7.9 for more details.

Indirect relative position sensing

The motor feedback senses the position of the rotor in the servo motor, the process being cyclically absolute. The signal thus obtained undergoes high resolution conditioning in the drive controller.

The output connector of the ANALOG interface with incremental encoder emulator (DAE1.1) provides incremental encoder compatible square-wave signals for evaluation through an external control system.

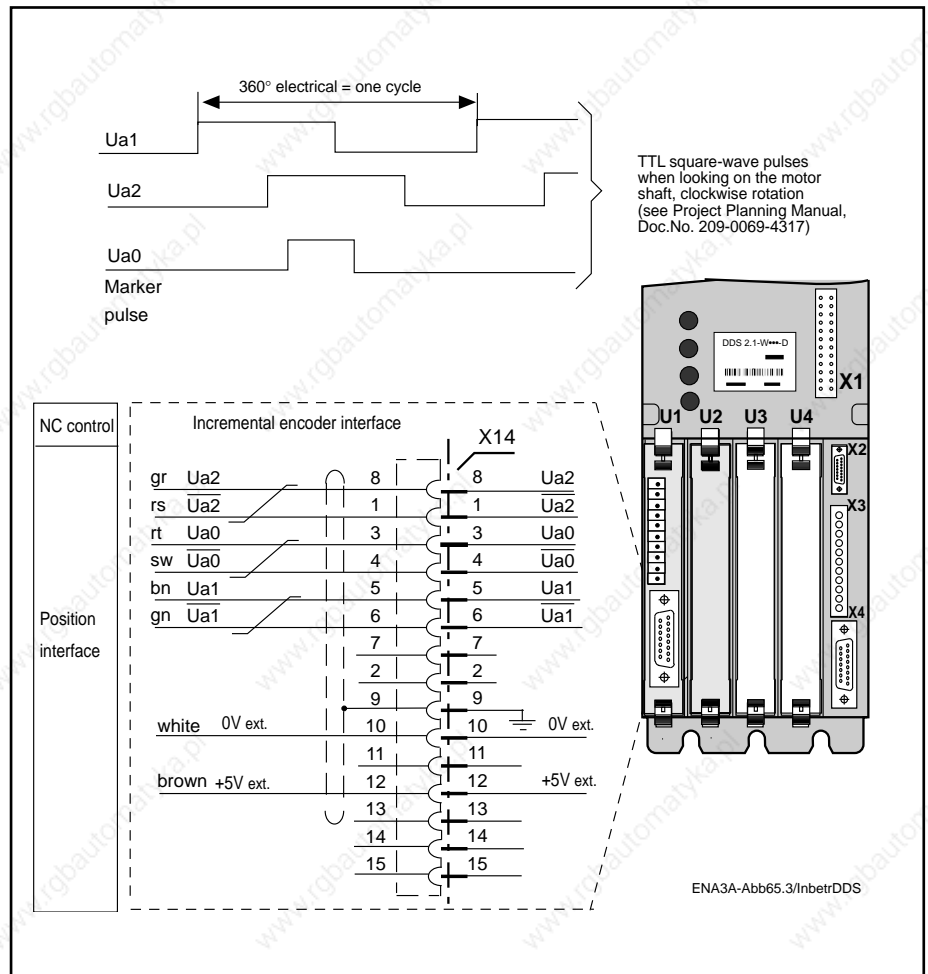


Fig. 71: Output signals of the incremental encoder version of the ANALOG interface, Type DAE 1.1

Settable incremental encoder resolution

The incremental encoder emulation offers the possibility of varying the resolution of the position sensing feature.

The "INCREMENTAL ENCODER SETUP" menu allows you to enter the desired line count for the incremental encoder emulation and the marker pulse offset.

Upper and lower limits:

- Line count (at the incremental encoder emulation output) 1 to 252 144 lines/revolution
- Marker pulse offset Increment 0 to 359.9 [deg.]
Clockwise looking on the motor shaft 0.1 [deg.]
- Max output frequency 504 [kHz]
Refer also to Fig. 72.

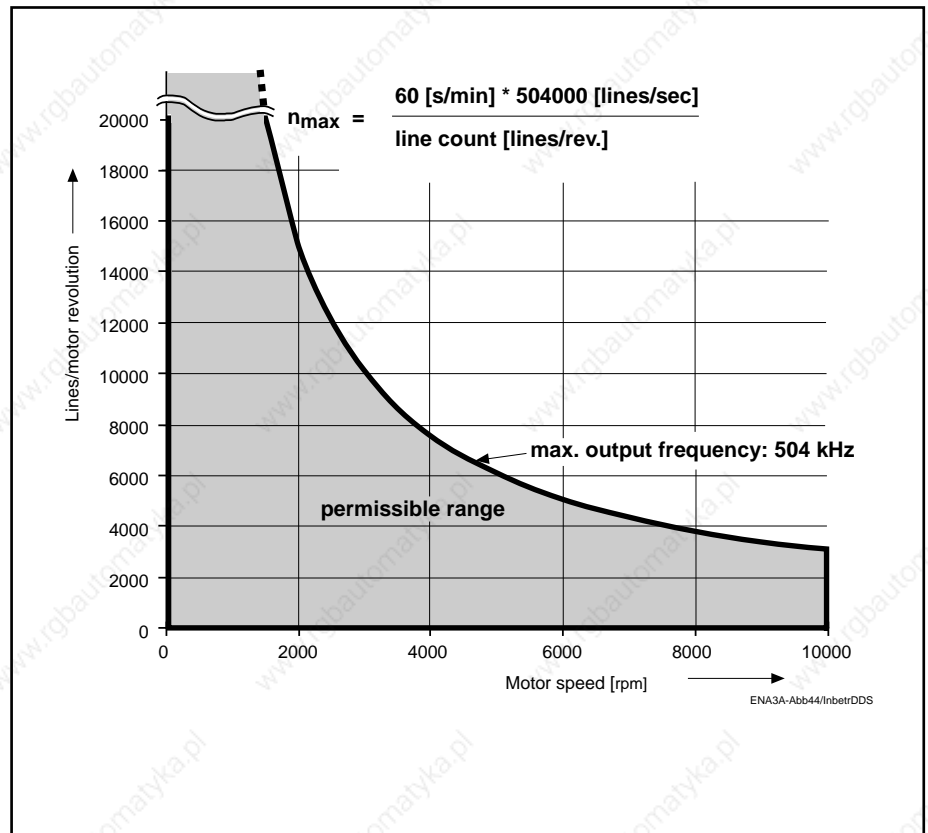


Fig. 72: Maximum motor speed in relation to the settable encoder line count per motor revolution

Setting the market pulse offset

Accurate homing requires exact sensing of the marker pulse and this is not guaranteed when the switching edge of the physical home switch coincides with the encoder's marker pulse. The homing cycle cannot be completed.

To avoid this, the following procedure is recommended:

1. Traverse the servo axis until it reaches the switching edge of the home switch.
2. Jot down the rotor position indicated in degrees in the "Drive Status" menu.
3. Continue in the same direction towards the reference cam until the "marker pulse" display in the "Drive Status" menu switches from "0" to "1". The marker pulse is now active.
4. Stop the axis.
5. Read off the new rotor position in degrees. The difference between the old and the new rotor position should be 90° . If this is not the case, the amount needed to make up 90° should be entered as "marker pulse offset" in the "incremental encoder setup" menu.

Checking the marker pulse offset

To check the entry you have just made, execute a homing cycle at approx. 10% the rapid traverse velocity.

If the homing cycle finishes without errors, increase the homing cycle velocity step by step. If an error occurs, repeat the setting procedure.

Motors with keyways

Motors with keyways have a normalized position of the keyway in relation to the marker pulse. (see Fig. 73).

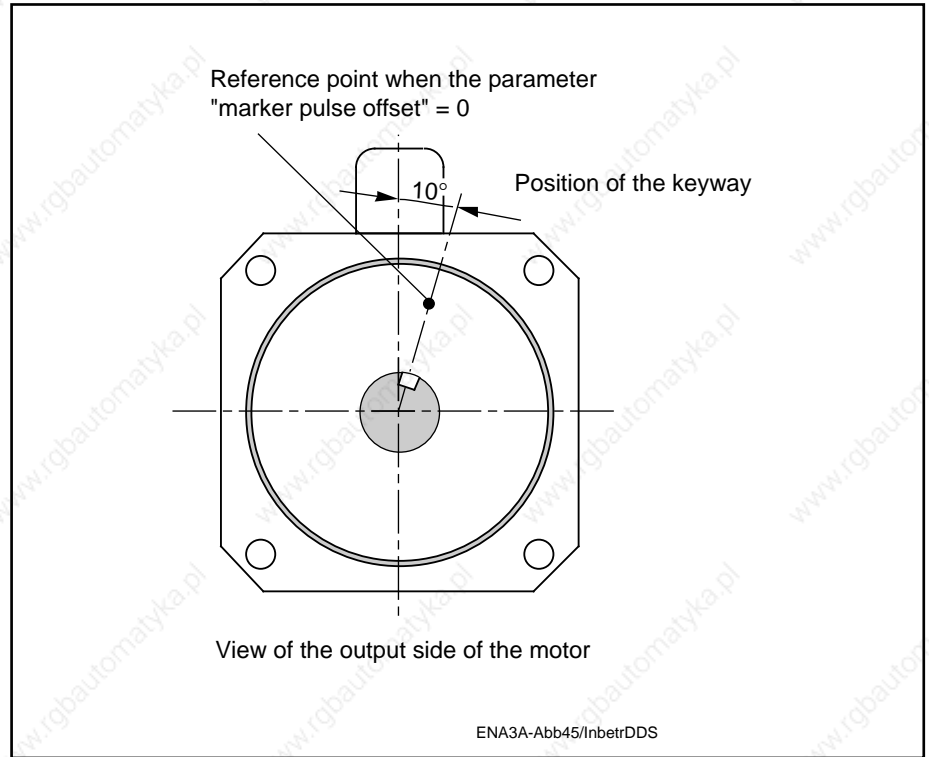


Fig. 73: Normalized position of the drive shaft with keyway on MDD motors for "marker pulse offset" = 0 degrees.

7.9. Actual-position sensing by indirect absolute position measuring system

An NC control requires position measuring systems to sense the axis position on machine axes. These position measuring systems can either be mounted directly on the machine's mechanical construction (direct position measuring system) or on the motor (indirect position measuring system).

For indirect sensing of the axis position INDRAMAT supplies an interface as standard on digital drives with ANALOG interface. This interface comes in two versions:

- indirect relative position sensing (refer to Section 7.8).
- indirect absolute position sensing.

Benefits of absolute position sensing:

- no new homing cycle necessary when position information is lost by a shutdown of the NC control (saves time).
- no risk of damaging the machine or workpiece during homing cycles after losing instantaneous position information.
- elimination of reference cams along with switches and wiring.

Indirect absolute position sensing

The motor feedback senses the position of the rotor in the servo motor, the process being cyclically absolute. The signal thus obtained undergoes high resolution conditioning in the drive controller.

Motors whose feedback circuitry includes an additional absolute encoder option can achieve absolute resolution of up to 4096 motor revolutions.

The precondition for this is:

The axis has been equipped according to system configurations RA 02 or DA 02 (see Section 2.3).

The output connector of the ANALOG interface with absolute encoder emulator (DAA1.1) is provided with absolute encoder signals in Gray code. These are transferred to an external control system by an SSI interface (synchronous serial interface).

Absolute encoder monitoring

When a DDS with absolute encoder motor (multiturn) is shut down, the instantaneous actual position is stored. When the unit is started up again, the position calculated by the absolute encoder evaluation is compared with the stored value. If the deviation is greater than the amount given in the absolute encoder position monitoring window in the "Operating modes, scaling" menu, the error message "76" "absolute encoder error" will be generated.

Remedy:



Danger!

The axis has been moved while it was shut down and is now outside the limits parametrized for the "absolute encoder monitoring window".

Check whether a new start command will cause damage.

- Reset the error using the reset key (S1) (see Fig. 15).
- If error 76 cannot be reset, there is a fault in the feedback circuit. In this case, replace the motor.

Absolute position output

The absolute position is output through the ANALOG interface with absolute encoder emulator DAA 1.1 via connector X16 and in SSI data format (refer to Digital intelligent AC servo drives, Project Planning Manual, Doc. No. 209-0069-4317-0019:

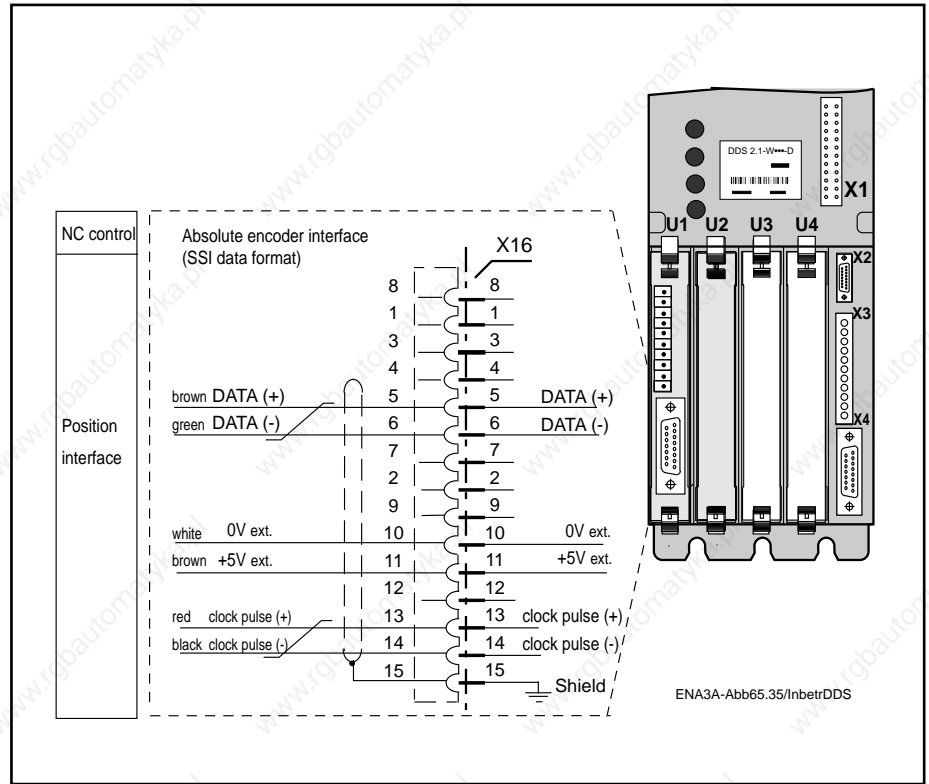


Fig. 74: Output connector pin allocation for drive controller with absolute encoder interface

Setting the reference position

The reference position is set using the parameter "absolute encoder parameter" in the „POSITION EVALUATION“ menu.

Example (see Fig. 75):

- The desired reference position is in the middle of the operating stroke

Procedure:

1. Manoeuvre the axis to the manually measured reference position.
2. Enter the desired absolute position actual value in the parameter "reference position" (according to the example, this will be 2048).

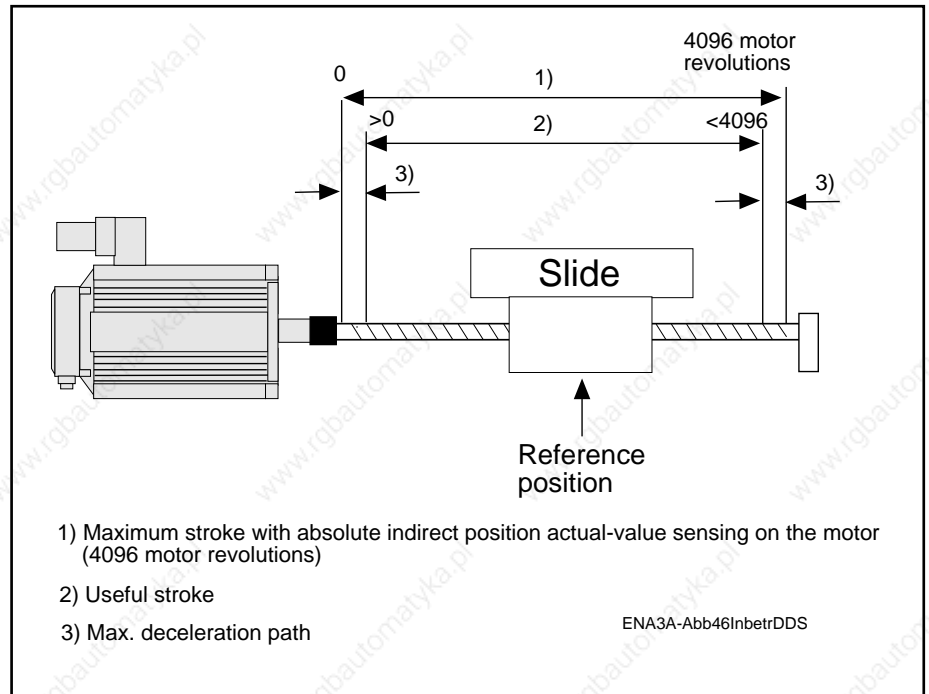


Fig. 75: Example: setting the reference position using the "absolute encoder parameter".



Traversing commands outside the permissible stroke will result in a high accident risk for both operators and machines.

If the maximum stroke is exceeded, the absolute position actual value will be lost.

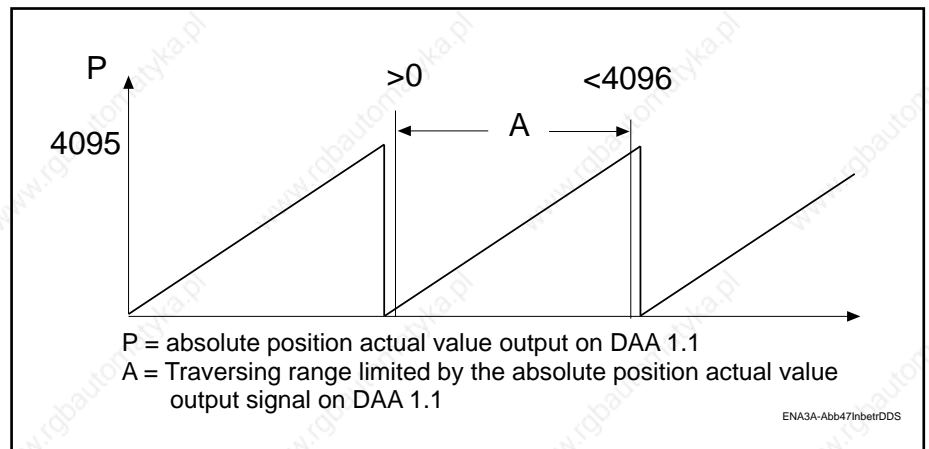


Fig. 76: Absolute position actual value signal of the DAA 1.1

Counting direction of the position actual value output

To match the servo axis traversing direction to the counting direction in the machine's coordinates system, the counting direction of the position actual value output can be fixed by means of parameters.





Counting direction of the position actual value output	Motor's direction of rotation, locking at the drive side	"Counting direction" parameter
Positive (rising)		0
Negative (falling)		1
Positive (rising)		1
Negative (falling)		0

Fig. 77: Counting direction of the position actual value output referred to the motor's direction of rotation.



Risk of personal injury or machine damage!
Be careful using this parameter because of the danger of positive feedback in the position control loop. This will lead to uncontrolled axis motion at maximum speed.

Diagnosis

When you select this parameter, the following warning is generated:

Caution:

Changing this parameter will change the counting direction of the absolute encoder. Danger of positive feedback!! Make sure the lag monitoring of your control unit is active.

7.10. Master/slave mode

Machine axes that cannot achieve the required torque with one servo drive alone are equipped with two drives working according to the master/slave principle.

The master drive controls the velocity for both the positively locked drives.

The slave drive receives its torque command as an analog voltage signal from the master, working as a torque arm.



Danger!

NEVER operate the slave drive on its own. Even the smallest torque command signal will cause the slave drive to rev up uncontrollably. To avoid this, make sure the two drives are positively locked.

Procedure for setting up a master/slave drive

1. Set the operating mode "velocity loop" on the master drive controller.
2. Call up the "OPERATING MODES, SCALING" menu on the master controller.
3. Analog output: channel 2 \Rightarrow : Call up the current command value by hitting the \Rightarrow or \Leftarrow arrow keys.
4. Connect up the analog output of the master AK2 connector X3.3 with the analog input E1 of the slave drive controller.
5. Connect up the master's OV_M (test) (connector X3.4) to the analog input E2 of the slave.
6. Make sure the master and slave drives are force locked and positively locked.
7. Set the "torque loop" mode on the slave controller.
8. Continue parametrizing the slave drive in the same way as the master.

Wiring

The circuit diagram for connecting up drive controllers for master/slave operation (same direction of rotation for master and slave) is shown in Fig. 78.

Reversing the direction of rotation

Depending on the method used to positively lock the drives, the direction of rotation of master and slave may be the same or opposite.

Same direction of rotation for master and slave

- Connect up master AK2 to slave E1
- Connect up master OV_M to slave E2

Opposite direction of rotation for master and slave

- Connect up master AK2 to slave E2
- Connect up master OV_M to slave E1

7. Commissioning the functions of the digital AC servo drive

Checking the master slave drive

1. Call up the "OPERATING MODES, SCALING" menu (see Section 5).
2. Set the current command value output to channel 2 (see Section 9.5)
3. Record the current command value of master and slave at the terminals AK2 on connector X3.3 and X3.4 respectively.
4. Check that both current values are the same.
Maximum permissible deviation < 10%

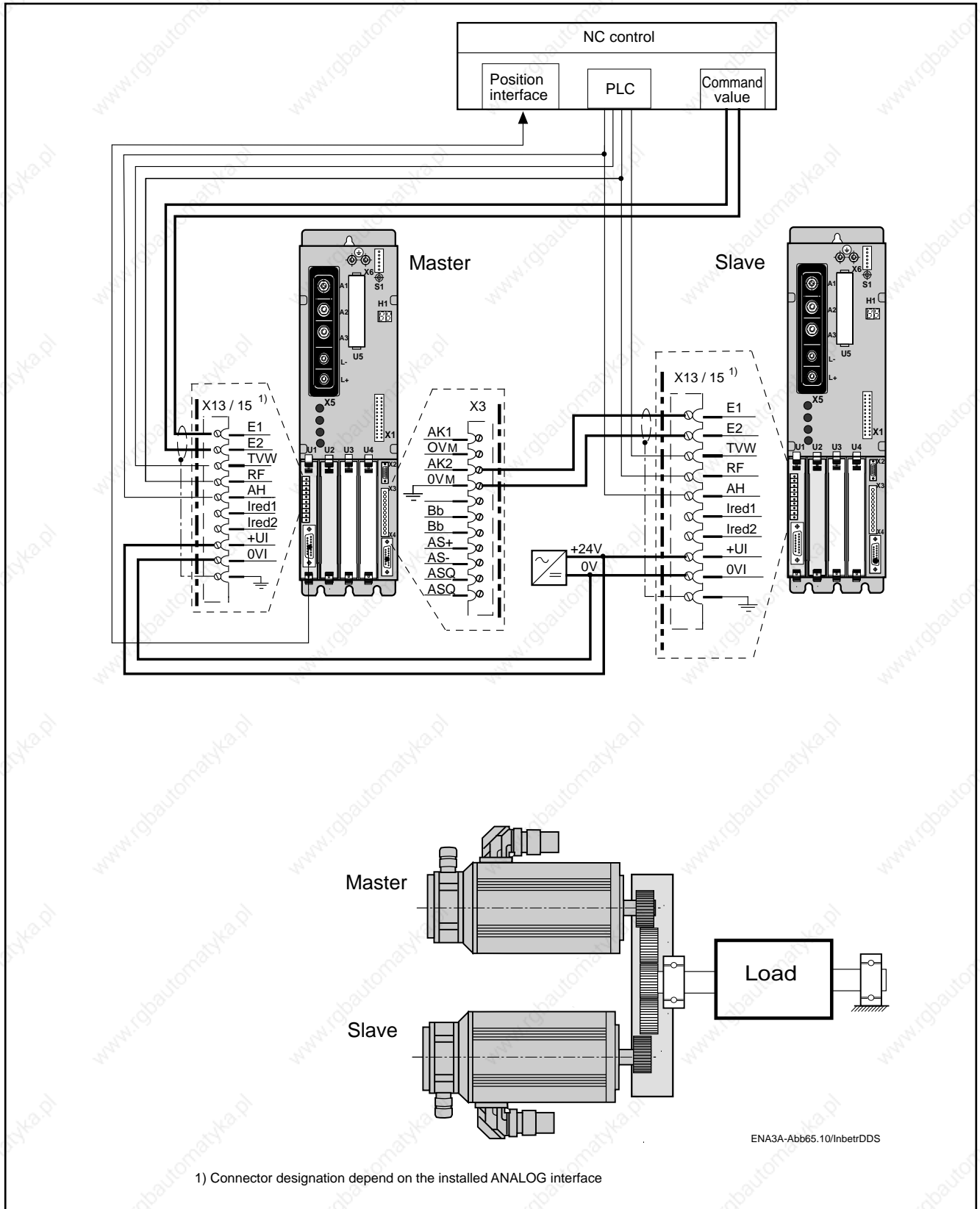


Fig. 78: Connection diagram for a master/slave application (same direction of rotation for master and slave)

7.11. Torque reduction

Entering a reduced torque level

Depending on the type of machine and its design, certain operating conditions may call for torque reduction of the drive.

The DDS 2.1 drive controller allows you to set three different torque reductions. These are selected and activated by binary coded signals through the control inputs Ired1 and Ired2.

Enter the desired torque reduction in %. Entering the figure 100 will produce a torque identical to the continuous zero-speed torque M_{dN} of the uncooled motor. See "nominal torque" in the "AMPLIFIER/MOTOR PARAMETERS" menu.

Upper and lower limits for entries : 0 to 400.

Procedure:

1. Call up the "TORQUE/CURRENT LIMITS" menu.
2. Select the desired torque reduction.
3. Enter the desired torque.

Ired2	Ired1	Setting	Torque value in % of nominal torque M_{dN}
0	0	Full torque	
0	1	Current limit 1 to	e.g.: 80
1	0	Current limit 2 to	e.g.: 150
1	1	Current limit 3 to	e.g.: 50

1 : Input activated (+12-32V)
 0 : Input deactivated (0-3V)

ENA3A-Abb48/InbetrDC

Fig. 79: Overview of setting options for external torque reduction

Calculating the value to enter for torque reduction

$$\text{Reduced torque [\%]} = \frac{100 \cdot M_{\text{max. desired}}}{M_{dN}}$$

$M_{\text{max. desired}}$ = desired torque in [Nm]
 M_{dN} = Nominal torque (zero-speed) in [Nm]

Example of a torque reduction calculation

The desired torque reduction is $M_{\text{max desired}} = 20 \text{ Nm}$

The installed motor/drive controller combination is:

MDD112B.-N-030
 DDS 2.1-050
 Mains power supply with stabilized DC link circuit.

Procedure:

1. For the above motor/controller combination, the following figures can be found in the selection data list:

- Nominal torque $M_{\text{dN}} = 17.5 \text{ Nm}$ (uncooled motor)
- Full torque $M_{\text{max}} = 35.2 \text{ Nm}$

2. Putting these figures into the equation, we obtain:

$$\frac{100 \cdot 20 \text{ [Nm]}}{17.5 \text{ [Nm]}} = \frac{100 \cdot M_{\text{max. desired}}}{M_{\text{dN}}} = \underline{\underline{114 \text{ [%]}}}$$

3. Enter the value in the parameter, e.g. "current limit 1": 114

Torque/speed characteristic for a torque reduction to 20 Nm

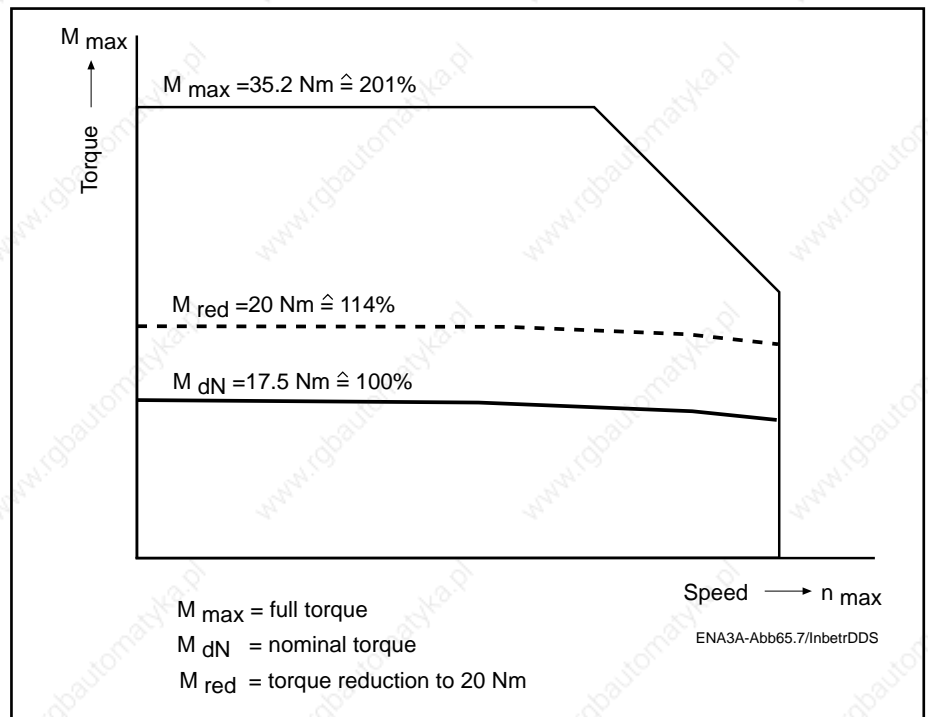


Fig. 80: Setting the torque reduction/current limit to 20 Nm



The full torque for this motor/controller combination is $M_{\text{max.}} = 35.2 \text{ [Nm]}$. Referred to the nominal torque, this corresponds to (M_{dN}) 201%. Entering a higher value than 201 in the parameter torque reduction would limit the drive controller to the full torque $M_{\text{max.}}$ of the motor.

Activating the torque reduction

Selecting and activating the torque/current limit 1 is done by applying +24 V DC from an external source to inputs Ired1 and Ired2 (Fig. 81).

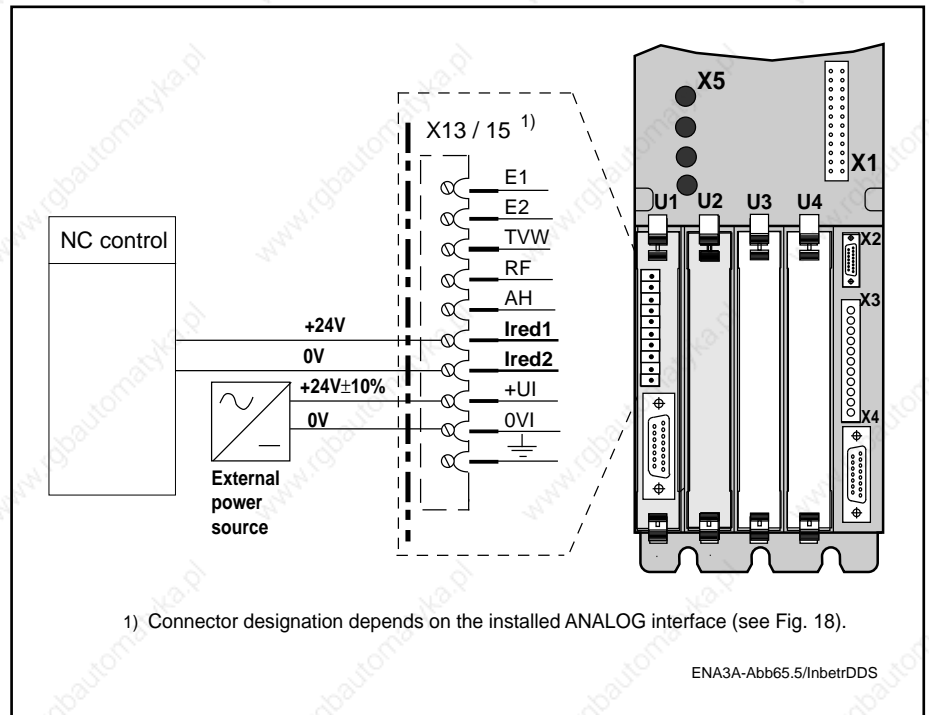


Fig. 81: Activating torque/current limit 1



Before recording the step response, deactivate the torque limit.

Assessing the speed control circuit while the torque limit is active will lead to wrong evaluation.

7.12. Drift-free positioning of a servo axis.

Drive halt
„AH“

With conventional analog servo drives operating in a velocity loop, the axis may drift when a command value of 0V (to stop the servo axis) is applied on account of temperature drifts of the components in the velocity controller or due to incorrect zero-speed balancing.

The DDS 2.1 with ANALOG interface as a command communication module allows drift-free positioning of the axis in the "velocity loop" mode after the axis has been stopped.

This function can be called up with the signal "AH" \bar{O} (drive halt) on the ANALOG interface by applying 0 V DC or by leaving the input open.

When the "drive halt" function is activated at the ANALOG interface, the drive will come to a halt under consideration of any set torque limit (see Section 7.11).

The status indicator "H1" on the drive controller will display the message "AH".



Danger!

If the "drive halt" function is deactivated (by applying a 24 V signal) when the controller enable signal is still active, the drive will immediately follow the applied command value.

As long as "drive halt" is active, the velocity command values will not be evaluated.

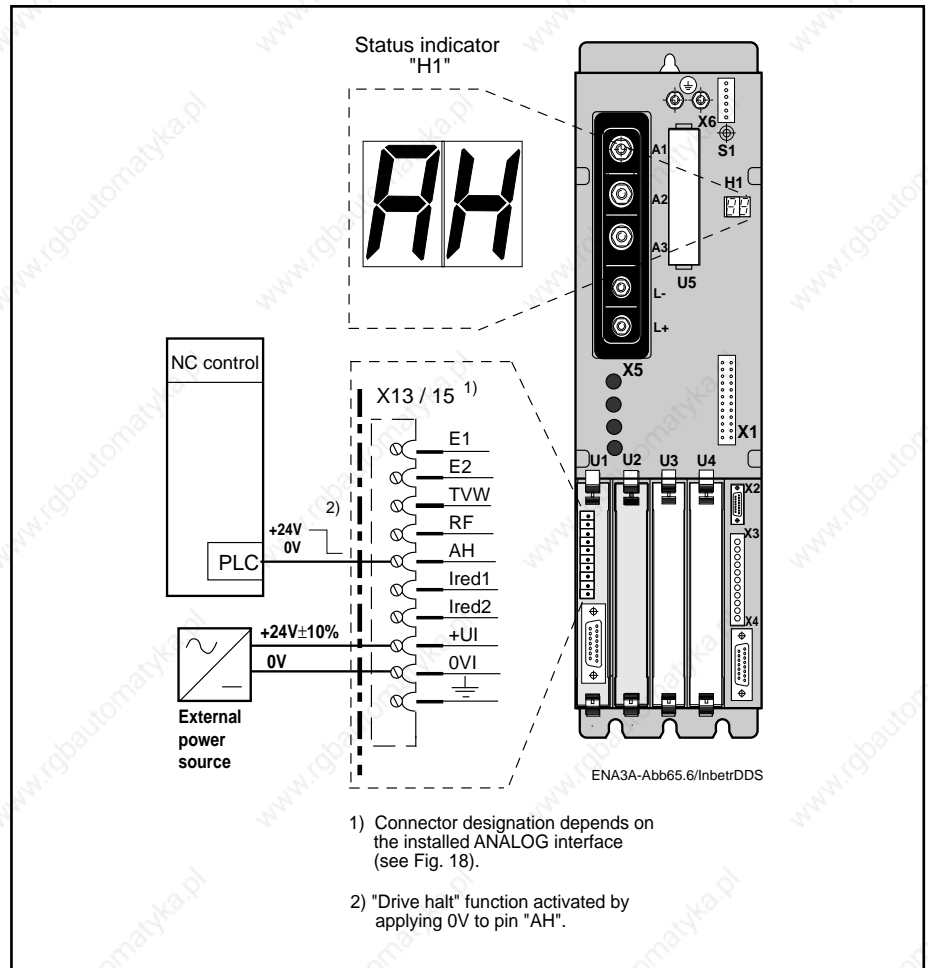


Fig. 82: Circuitry and diagnosis display of the drive controller for drift-free positioning.

7.13. Velocity Loop

Matching of the digital servo drive to the machine mechanics is done by activating the velocity loop parameters stored in the motor feedback (see Section 6.3 "Setting the gain parameters". These are the standard parameters for the servo drive. If the machine axis tends to become unstable during operation even after the standard values have been activated, this may be due to the following:

- backlash between the motor shaft and the machine
- the machine construction is not rigid enough.
- unfavourable matching of mass moments of inertia (the ideal case is a 1 : 1 ratio for rotor mass moment of inertia to the external mass moment of inertia).

These factors can cause:

- poor surface quality of the workpieces
 - increased wear on the machine mechanics
- and must therefore be avoided.

In cases where these symptoms cannot or can only partly be eliminated, the digital intelligent INDRAMAT AC servo drive offers the possibility of adjusting the gain parameters. The functions of the gain parameters are illustrated in Fig. 83.



Changing the standard settings of the velocity loop should not be undertaken by anyone other than personnel with sound knowledge of control engineering.

If changes to the standard settings do not achieve the desired result, consult the INDRAMAT Service Department.

Functions of the speed controller parameters

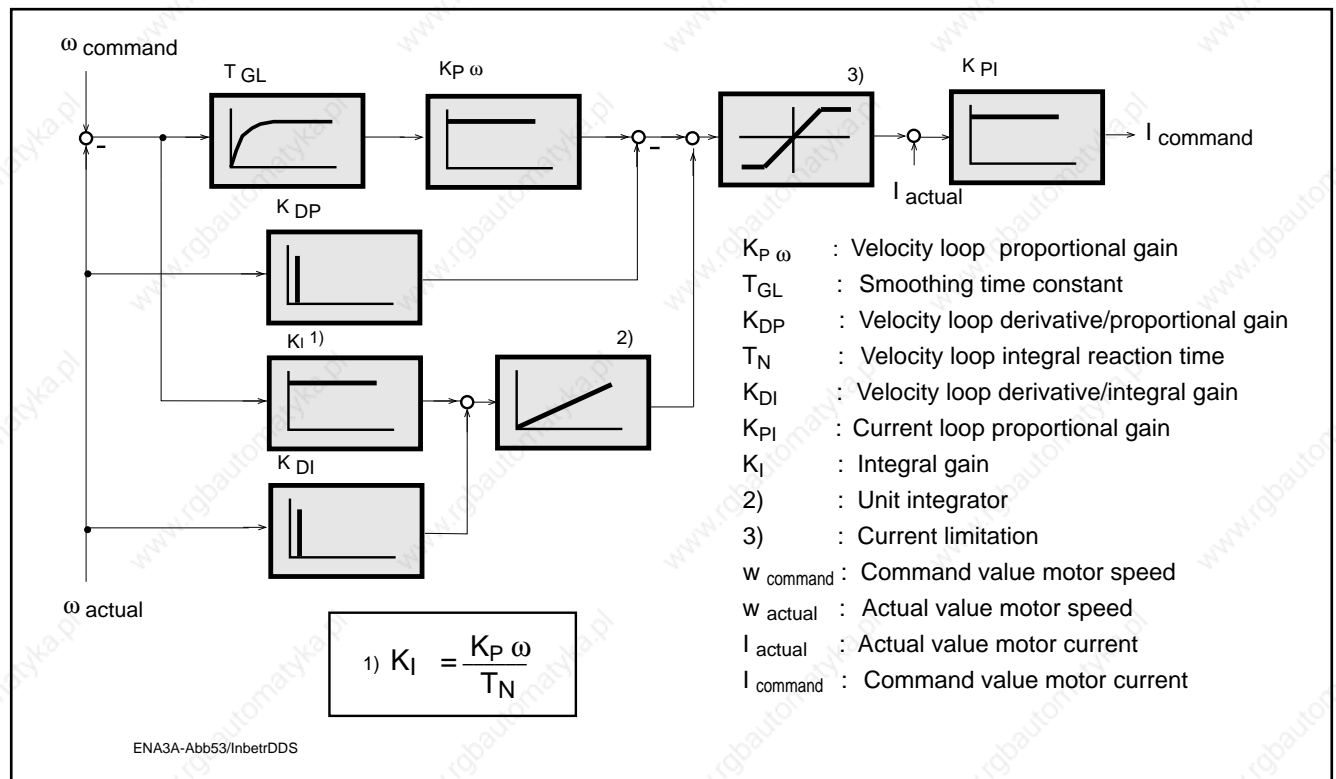


Fig. 83: Block diagram of the velocity loop

Velocity loop
proportional gain
"K_{PW}"

This parameter sets the proportional gain of the velocity loop.

Velocity loop derivative/
proportional gain "K_{DP}"

This parameter sets the derivative/differential gain of the velocity loop.

Velocity loop
integral reaction time

For the definition of the velocity loop integral reaction time, refer to Fig. 84.

This representation of the transition function of the PI controller assumes a step change of the input signal "U_e" to a constant value and shows the characteristic of the output signal U_a.

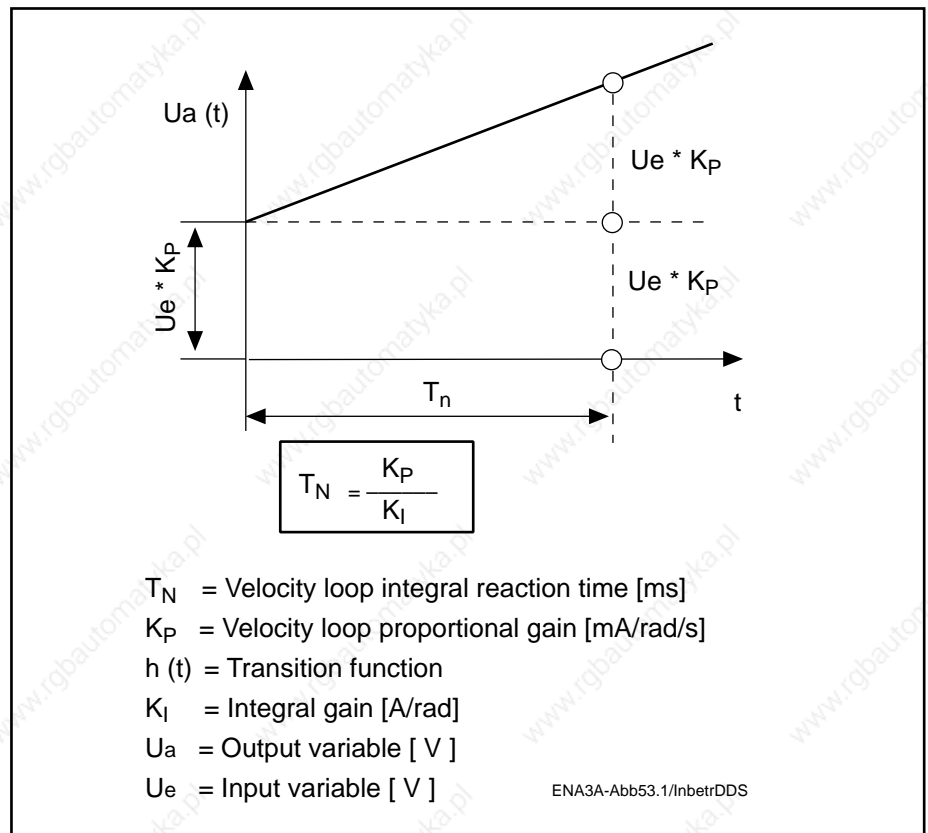


Fig. 84: Transition function of the PI controller

Velocity loop
derivative/integral gain "K_{DI}"

This parameter allows an acceleration dependent component to act on the integral gain of the velocity control loop.

Smoothing time
constant "T_{GL}"

A time constant can be activated in the proportional component of the velocity control loop to suppress the quantization effect and to limit the band width of the velocity control loop.

If the smallest possible value of 250 μs is entered here, the filter is rendered inactive.

Current loop
proportional gain



This parameter defines the proportional gain of the current loop

This value is motor-specific, set by INDRAMAT and may not be changed.

7.14. What to do in the event of a power failure or emergency shutdown

In the event of a power failure or an emergency shutdown, machines and workpieces risk being damaged by uncontrolled deceleration of servo axes. INDRAMAT power supply units are equipped with monitoring and signalling devices permitting safe return movements in the presence of faults (the exceptions are TVM and KDV). For more details see the application manual for the installed power supply module.

7.15. Setting the short-time operation torque " M_{KB} "

The short-time operation torque M_{KB} is entered in the parameter "overload factor". Consult the selection data list Doc. No. 209.0069.4302-00 IDE for the value corresponding to the installed motor/controller combination.

If a value other than that given in the selection data list for the relevant motor/controller combination is required, this can be changed in the parameter "overload factor".

For the overload factor in the "OPERATING MODES, SCALING" menu the following applies:

Overload factor

$$\text{Overload factor}^1) = \frac{M_{KB}}{M_{dN}} \times 100 [\%]$$

M_{KB} = Short-time operation torque [Nm]

M_{dN} = Nominal torque [Nm]

¹⁾ Settable range = 0 to 400 [%]

The short-time operating torque for intermittent operation can be selected according to the "duty cycle" column of the selection data list (Doc. No. 209-0069-4302-00) (load condition S6 to DIN 57530/VDE0530). The maximum cycle time depends on the size of the motor and is indicated in the operating characteristics of the relevant motor documentation. For lower short-time torque levels, the duty cycle can be calculated as follows:

$$ED = \frac{(M_{dN})^2}{(M_{KB})^2} \times 100 [\%]$$

ED = duty cycle [%]

M_{dN} = nominal torque [Nm]

M_{KB} = short-time operation torque [Nm]

When in continuous operation, the AC servo motor can sustain the nominal torque M_{dN} as follows:

- up to 25% of n_{max} (max. NC useful velocity)
- up to an ambient temperature of 45°C.

An overtemperature of 60 K will develop on the motor frame corresponding to the thermal time constant. The nominal torque for higher speeds can be found in the relevant motor documentation.

8. Final commissioning work

8.1. Preparations for running the axis with an NC control system

Figure 85 illustrates the interaction of an NC control, servo drive, position measurement and the machine's mechanical construction in a position and velocity loop for a machine axis with a direct measuring system.

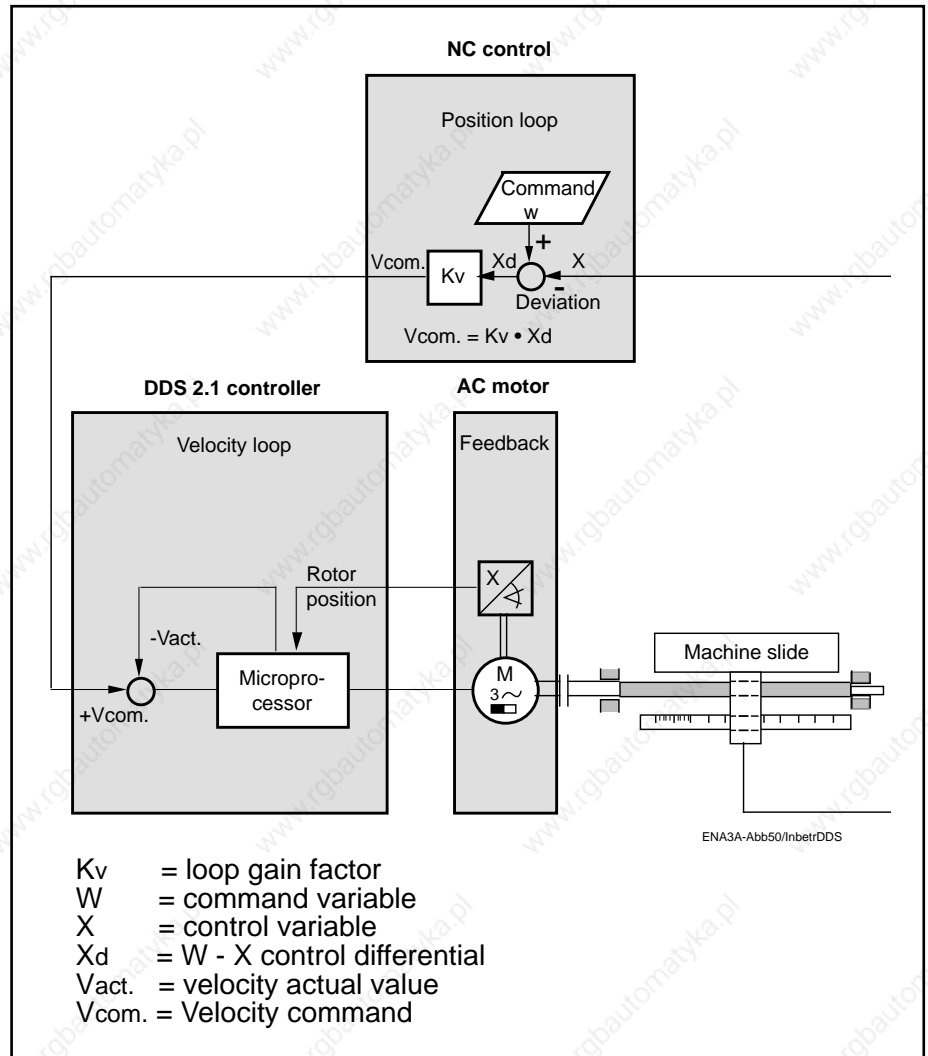


Fig. 85: Velocity loop and position loop with direct measuring system as illustrated by a machine axis.

Checking the position loop

Check whether the position loop corrects a position deviation.

Procedure:

1. Open the position loop between the NC control and the drive controller by disconnecting the command conductor E1/E2.
2. Use a battery power source to inject a positive velocity command voltage signal at the command input E1/E2 of the ANALOG interface module to move the axis.
3. The NC control should emit a negative command voltage signal for the traversed axis. If this is not the case, reverse the polarity of the position actual value.

When this check has been run the position loop can be closed again.

Procedure:

1. Switch the power off.
2. Disconnect the battery power source.
3. Connect up the command conductor and controller enable from the NC control to the servo drive module.
4. Set the velocity command evaluation on the DDS 2.1.
(see Section 7.6, Velocity command)

8.2. Compensating the servo axis drift

The zero drift of the servo axis can be compensated using the potentiometer (offset voltage compensation) on the ANALOG interface (see Fig. 86).

Procedure:

1. Apply 24V DC to pins "AH" (drive halt) and "RF" (controller enable).
2. Activate the axis via the NC control.
3. Call up the lag display of the NC control.
4. Turn the potentiometer until the lag oscillates around zero.

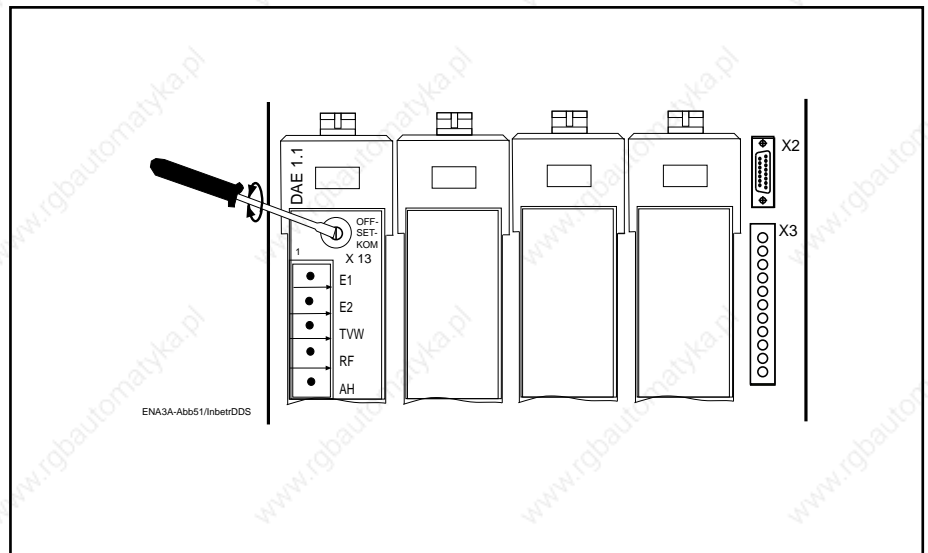


Fig. 86: Drift compensation on the ANALOG interface (detail of Fig. 18.)

8.3. Checking the servo drive

Setting the safety limit switch

Set the safety limit switch of the axis at an adequate distance from the fixed stop:

Procedure:

1. Check that the cams are of sufficient length.
2. Traverse the axis at maximum velocity until it passes the safety limit switch.
3. Measure the braking path.
4. For vertical axes, carry out this measurement in both traversing directions.
5. Set the measured braking path as the minimum distance between the machine's fixed stop and the safety limit switch.

Determining the load torque

Record the load torque for maximum weight loading in both directions of rotation.

Option 1:

The "DRIVE STATUS" menu shows the instantaneous motor torque in [Nm] and in [%] of the nominal torque of the uncooled motor.

Option 2:

Record the current command value by measuring the DC voltage at pins X3.3 and X3.4 → 0VM (see Fig. 29) of the servo drive module. Remember that 10V corresponds to the rated current of the controller.

Procedure:

1. Call up the "OPERATING MODES, SCALING" menu of the parametrization and diagnostic program (see Section 4 and 5).
2. Call up analog output: channel 2 →: current command value by hitting the right "→" or left "←" arrow key.
3. Connect up a multimeter or an oscilloscope.
4. Record the current command value (measured DC voltage) as the measure for the load torque in the feed range (base torque) and the rapid traverse range.

The current command value can be converted into the load torque using the following equation.

$$M_{\text{load}} = \frac{U \times I_{\text{controller}}}{10} \times K_m$$

U = Level of the DC voltage [V] signal measured at pin X 3.3 and X 3.4

$I_{\text{controller}}$ = Rated current [A] of the drive controller

K_m = Torque constant [Nm/A] of the motor at 20°C

See "AMPLIFIER/MOTOR PARAMETERS" menu, parameter "torque constant K_m [Nm/A]" or the rating plate of the servo motor "T Const. [Nm/A]".

Torque
in the feed range
(base torque)

Measure the torque at minimum and maximum feed velocity. It should not exceed 60% of the nominal torque.

Causes of excessively high base torque:

- axis lock not released
- insufficient lubrication
- excessive static friction on the slide guide rails
- incorrectly set weight compensation
- mechanical jamming of the drive axis
- unreleased holding brake
- incorrect dimensioning of the drive equipment

Torque in the
rapid traverse range

This should not exceed 75% of the nominal torque.

Causes of excessively high torque:

- incorrect hydraulic weight compensation (pressure change dependent on velocity)
- fluid congestion in the tothing of an oil-flooded gear
- overtensioned toothed belt
- break in the lubrication film
- ball screw spindle not running smoothly
- incorrect dimensioning of the drive equipment

Setting the
weight compensation

Set the weight compensation so that the motor current consumption is at the same minimum value for upward and downward movements of the machine axis. Carry out this check both in the feed range and in the rapid traverse range.

Monitoring the
recovered energy

Peak energy recovery:

Operate all axes simultaneously in rapid traverse mode via the NC control and brake them using the E-STOP function. This must happen without the power supply module cutting out with error message "bleeder overload" or the DDS 2.1 with error message 25 "overvoltage".

Continuous energy recovery:

Run the axes of the drive package to be checked for at least 15 minutes in the load cycle for which the highest energy recovery (braking energy) is to be expected. The test phase must run without the supply module cutting out with error message "bleeder overload".

If the system does cut out in either of the above cases, the power supply setup must be corrected (see manual for power supply setup). It may be necessary to change the power supply module or install an extension module (TBM or TCM).

8.4. Saving data

Saving data using the "specific axis data list"

The "specific axis data list" is intended as an additional data saving option for axis-related parameter contents and should be stored in the machine file. This list is to be completed by commissioning personnel on initial start-up.

If necessary, the blank "specific axis data list" can be photocopied for documenting the parameter contents of other axes. The form is included in the appendix to this documentation.

Saving data on a personal computer

The procedure for saving axis-related parameter contents with a personal computer is described in Section 5.2.

9. Diagnostics and fault clearance

Errors detected by the drive as well as warnings and operating status messages are displayed by the two-digit, seven-segment "Status indicator H1" (see Fig. 15).

If errors are detected during the initialization phase of the microprocessor in the drive controller, the 7-segment display of the DDS 2.1 with ANALOG interface will indicate the most recent error. The user program will output a list of all initializing errors which have occurred. Initializing errors carry the error codes: 83, 84, 87, 88, 89, 91 (see Section 9.3).

Warnings issued by the controller and command errors are indicated by a flashing display. The operating status and the error messages can be called up at the same time via the diagnostics text in the "drive status" message line of the operator interface for the "Drive Status" menu of the DDS 2.1 (see Section 5.1, Fig. 36).

9.1. Diagnosing the operating status of the controller using its status display

The different types of operating status of the drive are indicated by a two-letter code.

"Ready"

Meaning:
The drive is ready for powering up.

Diagnosis text:
Ready for main power (Bb closed)

"Drive ready"

Meaning:
The control and power section of the drive is ready.

Diagnosis text:
Control and power section ready (drive ready)

"Drive enable"

Meaning:
The drive enable signal has been emitted and activates the drive which then follows a command signal.

Diagnosis text:
Drive enable

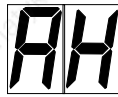
"Safety lockout"

Meaning:
The power output stage has been locked. This signal ensures safe torque disabling of the drive independently of the current operating status of the drive package.

Diagnosis text:
Drive interlock open



When the power output stage has been enabled by deactivating the safety lockout, the controller enable signal (RF) must be applied once more.



"Drive halt"

Meaning:

The drive has been stopped at the torque chosen in the menu "TORQUE/ CURRENT LIMIT" and remains in velocity loop mode.

Diagnosis text:

Drive halt



Danger !

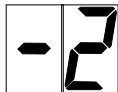
If the "drive halt" function is deactivated (by applying 24 V) while the controller enable signal is still applied, the drive will immediately follow the applied command signal.

If the drive controller stalls in one of the status displays during the initialization phase, the controller requires to be changed.

9.2. Status indications during drive initialization



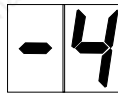
"Data RAM error"



"Waiting for PLL to stabilize"



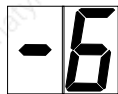
"Initializing hardware"



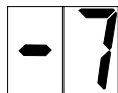
"Reading user parameters from software module"



"Reading parameters from amplifier"



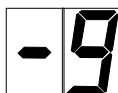
"Reading parameters from motor feedback"



"Reading configuration, selecting language"



"Calculating runtime parameters"



"Initializing position"

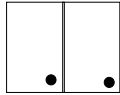
9.3. Fault diagnostics and clearance using the drive controller status display

The prerequisites for fault diagnosis using the DDS 2.1 drive controller are:

- Mains power is switched on.

The fault message must be reset once the associated fault has been cleared. To reset fault messages, press the reset button S1 (see Fig. 15).

The controller will only be ready again when the error message has been reset.



"Watchdog"

The drive controller's processor is inoperative.

Cause:

1. Software module not installed or defective.
2. Processor defective.

Remedy:

1. Install or change the software module.
2. Replace the drive controller



"Amplifier overtemperature shutdown"

Overtemperature was detected in the power output stage of the DDS 2.1 drive controller. The controller then emitted a 30 second warning: 50 "Amplifier overtemperature warning", and shut itself down according to the selected error reaction, while signalling the above error message.

Cause:

1. Failure of the unit's internal cooling system.
2. Failure of the cabinet air conditioning.
3. Incorrectly dimensioned heat dissipation of the cabinet air conditioning

Remedy:

1. If the cooling system is defective, change the controller.
2. Restore the cabinet air conditioning function.
3. Check the cabinet dimensioning.



"Motor overtemperature shutdown"

The motor temperature has risen above the permissible level. The drive controller then emitted a 30-second warning: 51 "Motor overtemperature warning". This is done by outputting 24 V DC via the "TVW" output. The drive then shuts down according to the selected error reaction and signals the above error message (see selection options for error reactions, Section 7.1 "Error reaction").

Cause:

1. The motor has been overloaded. The effective torque demanded from the motor was above the permissible nominal torque for too long.
2. Earthing or short-circuit in the conductor for motor temperature monitoring.

Remedy:

1. Check the motor dimensioning. For plants which have been in operation for some time, check whether the drive conditions have changed (e.g. contamination, friction, moved masses, etc.).
2. Check the motor temperature monitoring conductor for earth leakage or short-circuit.

**"Motor encoder error"**

The signals emitted by the motor encoder are monitored. If the signals lie outside the tolerance window, this message will be signalled and the main power cut out.

Cause:

- Defective or disconnected encoder cable
- Defective motor feedback.

Remedy:

Check the feedback cable. If no error can be found, replace the motor (feedback defective).

**Danger !**

For drives with absolute encoder functions, make sure to set the right absolute reference point when changing the motor (refer to Section 7.9. "Absolute encoder parameters").

**"Overcurrent"****Cause:**

One of the three phase currents has risen to a level higher than 1.5 times the unit's rated current.

Remedy:

1. Check the current loop parameters. Consult INDRAMAT Service Department.
2. Check the motor cable.

**"Overvoltage"**

The DC link circuit voltage has risen above the permissible level. ($U_d > 475$ V). The drive torque has been disabled in order not to risk damaging the power output stage of the controller.

Cause:

The energy of a braking main spindle motor could not be converted quickly enough by the installed bleeder resistors.

Remedy:

Flatten the gradient of the braking ramp for the main spindle or increase the bleeder resistance by installing an additional bleeder.



See Section 8.3, Monitoring the recovered energy.

**"Undervoltage error"**

The DC link circuit voltage is monitored in the supply module. It signals to the controller via the control voltage bus whether the link circuit voltage is above the minimum permissible level of +200 V. If the voltage falls below this level, the drive will be shut down according to the selected error reaction.

Cause:

1. Mains power shutdown without first deactivating the drive by cancelling the controller enable (RF) signal.
2. Malfunction of the supply unit.

Remedy:

1. Check the NC control logics for activating the drive.
2. Remedy the malfunction in the power supply unit.



"External power supply voltage error"

Different optional plug-in modules have DC-decoupled inputs and outputs. An external power supply must be applied for proper operation of these inputs and outputs. If this voltage lies above the permissible level, the above error message will be signalled.

Remedy:

Check the external power supply. Refer to the relevant connection diagram and project planning documentation for the voltage range and tolerance (see project planning documentation, Doc. No.: 209-0069-4317-00).



"Amplifier overtemperature warning"

The temperature of the heatsink in the drive controller has reached the maximum permissible level. The drive will follow the given command value for 30 seconds. This permits the axis to be brought to a halt by the NC control without endangering the process (e.g. completing a machining operation, retreating from an area where collisions might occur, etc.)

After 30 seconds, the drive will react according to the parameter "error reaction" (P-0-0007), see Section 7.1.

Cause:

1. Failure of the unit's internal cooling system
2. Failure of the cabinet air conditioning system
3. Insufficiently dimensioned cabinet air conditioning.

Remedy:

1. If the cooling system is defective, change the controller.
2. Restore the cabinet air conditioning function.
3. Check the cabinet dimensioning.



"Motor overtemperature warning"

The motor has risen above the permissible temperature. The drive will follow the given command value for 30 seconds. This permits the axis to be brought to a halt by the NC control without endangering the process (e.g. completing a machining operation, retreating from an area where collisions might occur, etc.)

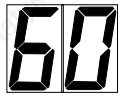
After 30 seconds, the drive will react according to the parameter "error reaction", see Section 7.1.

Cause:

The motor was overloaded. The effective torque demanded from the motor was above the permissible nominal torque for too long.

Remedy:

Check the motor dimensioning. For plants which have been in operation for some time, check whether the drive conditions have changed (e.g. contamination, friction, moved masses, etc.)

**"Bridge fuse"**

The current in the power transistor bridge has risen to more than twice the unit's rated current. The drive torque function is immediately disabled.

Cause:

1. Short-circuit in the motor cable
2. Power section of the drive controller defective.

Remedy:

1. Check the motor cable for short-circuits
2. If necessary, replace the drive controller.

**"Earth connection"**

The sum of the phase currents is monitored. During normal operation, the sum = 0. The earth connection fuse will react when the sum of the currents rises above $0.5 \times I_N$.

Cause:

1. Defective motor cable
2. Earth connection in the motor.

Remedy:

- 1./2. Check motor cable and motor for earth connection and replace if necessary.

**"Faulty hardware synchronization"**

Cause:

1. The pulse width modulator of the drive controller is synchronized by a phase control loop. The synchronization is monitored and the above error message signalled when a fault is detected.

Remedy:

1. Replace the unit and send in for inspection.

**"Brake fault"**

For MDD motors with integral brakes, the drive controller pilots the brake. The brake current is monitored. If it lies outside the permissible range, the above error message will be signalled.

Cause:

1. The supply voltage for the holding brake has not been properly connected or lies outside the tolerance window (24 V +/- 10%).
2. The motor cable is incomplete or wrongly connected (reverse polarity).
3. Defective holding brake
4. Defective drive controller.

Remedy:

1. Check the supply voltage.
2. Check the motor cable.
3. Replace the motor.
4. Replace the controller.



"± 15 V fault"

The controller has detected a fault in the ± 15 V supply.

Cause:

1. Defective control voltage bus cable
2. Defective supply module

Remedy:

1. Check and, if necessary, replace the control voltage bus cable or plug connector.
2. Check the power supply module (see application manual for supply module).



" + 24 V fault"

The controller has detected a fault in the +24 V supply.

Cause:

1. Defective control voltage bus cable
2. Defective supply module.

Remedy:

1. Check and, if necessary, replace the control voltage bus cable or plug connector.
2. Check the power supply module (see application manual for supply module).



" + 10 V fault"

The supply voltage to the current sensors is faulty.

Cause:

Defect in the drive controller

Remedy:

Replace the drive controller



" + 8 V fault"

The supply voltage to the encoder systems is faulty.

Cause:

Short-circuit in the motor encoder cable or in the cable for external encoders.

Remedy:

Check cables and replace if necessary.



"Driver voltage fault"

The voltage supply of the driver stages is faulty.

Cause:

Defect in the drive controller

Remedy:

Replace drive controller.

76**"Absolute encoder error"** (Position outside the monitoring window)

When a DDS with absolute encoder motor (multiturn) is switched off the instantaneous actual position is stored. When the unit is powered up again, this position is compared with the position detected by the absolute encoder evaluation. If the deviation is outside the absolute encoder monitoring window parametrized in the "Operating Modes, Scaling" menu, message no. "76", "Position outside the position monitoring window" is signalled.

Remedy:

**Danger!**

The axis has been moved while shut down and is outside the parametrized "absolute encoder position window". Check whether a start-up command will cause any damage.

- Reset the error using button S1 (see Fig. 15).
- If error 76 cannot be reset, there is a feedback error and the motor needs to be replaced.

81**"Program RAM error"**

The memory modules in the drive controller are checked during initialization. If an error is detected during this check, the above message will be signalled.

Cause:

Hardware error in the controller.

Remedy:

Replace the controller.

82**"Data RAM error"**

The memory modules in the drive controller are checked during initialization. If an error is detected during this check, the above message will be signalled.

Cause:

Hardware error in the controller.

Remedy:

Replace the controller.

83**"Error reading drive data"**

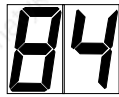
The operating software reads data from an EEPROM in the drive controller during initialization. If this is not successful, the above message is signalled.

Cause:

Hardware error in the controller.

Remedy:

Replace the controller.



"Drive data invalid"

Cause:
EEPROM not written or contains invalid data.

Remedy:
Rewrite the EEPROM. Consult INDRAMAT Service Department.



"Parameter data invalid"

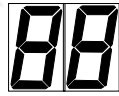
During the controller initialization phase, one or more parameters in the software module were found to be invalid.

Cause:

1. The software module was not initialized before.
2. The operating software EEPROMs in the software module have been changed.
3. Hardware fault in the software module.

Remedy:

- 1./2. Start the operator interface (see Section 5.1) and call up each of the submenus in the "PARAMETERS" menu. Invalid parameters are indicated by "****". Enter new parameters for these items.
3. Replace the software module.



"Error reading motor data"

All motor data are stored in a data memory in the motor feedback. An error has occurred while reading these data.

Cause:

1. Defective motor feedback cable
2. Defective motor feedback

Remedy:

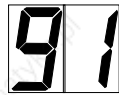
1. Check motor feedback cable
2. Replace motor



"Motor data invalid"

Cause:
EEPROM not written or contains invalid data.

Remedy:
Rewrite EEPROM. Consult INDRAMAT Service Department



"Configuration error"

Cause:

1. Software and hardware configurations do not match.
2. Plug-in module defective, not installed or not properly inserted.

Remedy:

1. Check drive controller configuration rating plate and if necessary replace the software or hardware.
2. Check the plug-in modules.

**"Absolute encoder not calibrated"**

(Reading error: reference position/counting direction)

The parameter "reference position" and or "counting direction" in the menu ABSOLUTE ENCODER SETUP could not be read.

Cause:

1. These parameters have not yet been entered.
2. DSF feedback defective.

Remedy:

1. Enter or confirm parameters.
2. Replace motor.

9.4. Input errors and faults due to errors while saving

Faults of this type can only occur in the DDS 2.1 when working with a PC or a VT 100 terminal, and they are indicated by messages on the operator interface.

"Parameters outside the input limits"

Cause:

Parameters are outside the upper and lower input limits.

Remedy:

Enter the figures within the permissible range.

"Error at saving the parameter"

Cause:

An error was detected while attempting to write the parameter to the software module.

Remedy:

Repeat the entry. If the error message appears once more, replace the software module.

Procedure:

1. Save the parameters from the old software module.
2. Replace the software module.
3. Enter the parameters in the new software module (see Section 4).

"Parameter only to change when RF not applied"

Cause:

An attempt was made to change a parameter in one of the menus

- "INCREMENTAL ENCODER EMULATOR"
- "OPERATING MODES, SCALING"
- "ABSOLUTE ENCODER EMULATOR"

while the controller enable (RF) signal was applied.

Remedy:

Cancel the RF signal and enter the parameter once more.

"Commutation adjustment not possible: Drive is not disabled."

Cause:

The commutation offset adjustment was started while the RF signal was still applied.

Remedy:

Cancel the RF signal and try again.

"Commutation adjustment not possible:
Turn power on"

Cause:
The commutation offset adjustment was started while power was down.
Remedy:
Turn power on and try again.

"Commutation adjustment not possible:
drive interlock open"

Cause:
The commutation offset adjustment was started while the safety lockout was active.
Remedy:
Switch off the input for the safety lockout, X3 pin 8/9, and start again. (see Section 7.2)

9.5. Selecting signals for diagnostics outputs

The DDS 2.1 is equipped with two analog diagnostics outputs. These may be used to emit internal drive variables for test purposes.

Analog signal output

The DDS 2.1 with ANALOG interface offers the possibility of selecting two signals for analog output via the diagnostics output AK1 on pin X3.1 and X3.2 or AK2 on pin X3.3 and X3.4 (for the purpose of these signals, see Fig. 87). This can be done using the menus "OPERATING MODES, SCALING" or "GAIN PARAMETERS" on the operator interface.

The "velocity data scaling at the analog output [rpm/10V]" allows you to scale the velocity data at the analog output channel 1 or 2. The unit is [rpm/10V].

The "position data scaling at the analog output [dgr/10V]" allows you to scale the position data at the analog output channel 1 or 2. The unit is [dgr/10V], but it must be remembered that the total voltage range is 20 V ($\pm 10V$).

The following signals can be set for output using the "→" and "←" arrow keys to change the entries in the input fields:

"Analog output: Channel 1 →:"

"Analog output: Channel 2 →:"

- Velocity command
- Velocity actual value
- Position actual value
- Current actual value
- Motor encoder sine signal
- Motor encoder cosine signal.

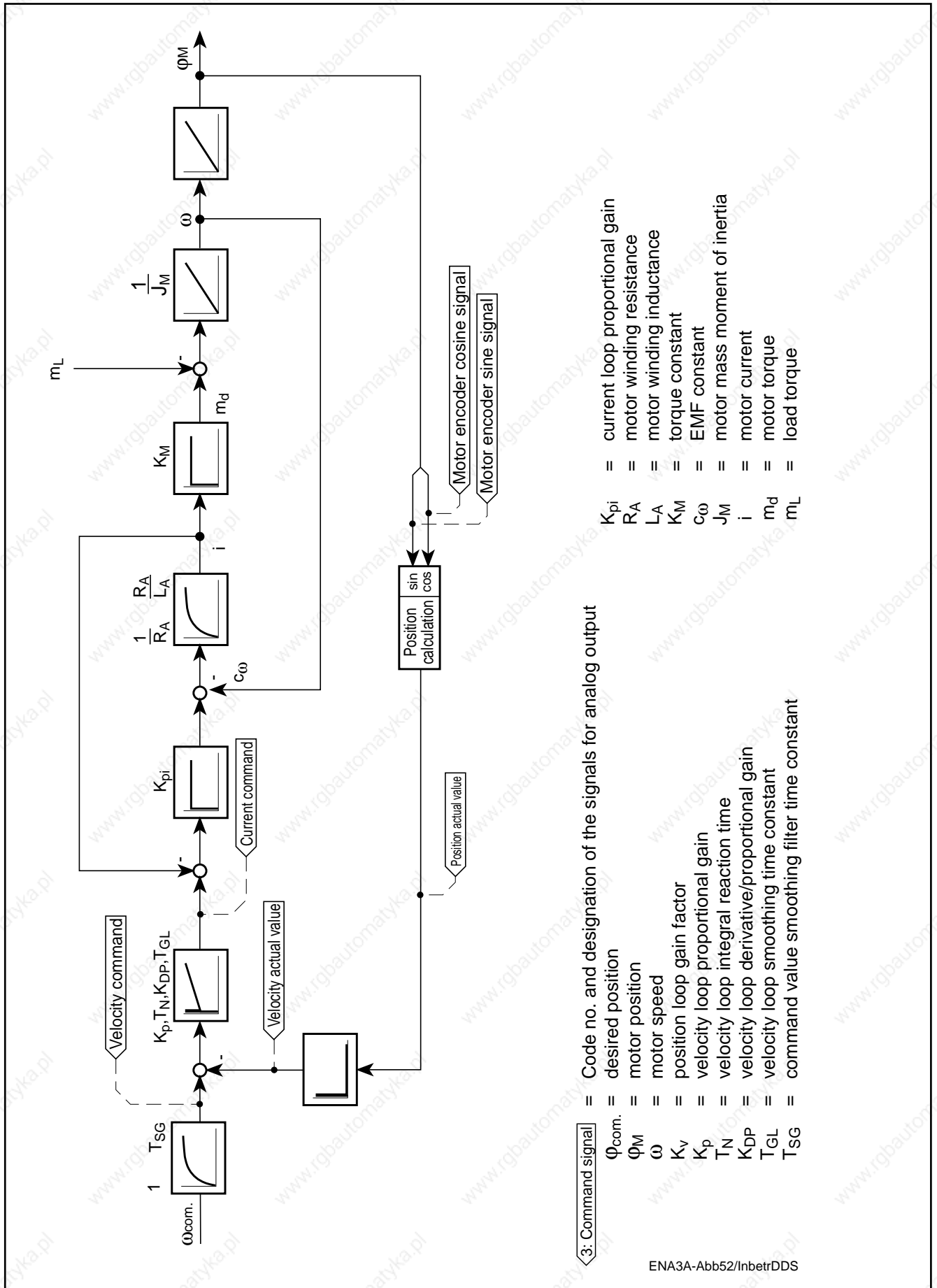


Fig. 87: Analog output signals on the DDS 2.1

9.6. Notes on component replacement

Lengthy fault locating on several different units and repairing the units on the machine should be avoided due to the associated loss of production time.

The diagnostics display and the message signals on the DDS 2.1 drive controller enable methodical and effective fault location.

Simple replacement of defective drive components guarantees the fastest possible clearance of the fault and resumption of operation without any lengthy assembly and readjustment work.

The software module DSM 2.1 allows you to replace the drive controller without needing to reset the drive. The new drive controller is immediately ready for action when the existing software module has been plugged in.

When replacing components, please remember the following points:

- The new unit, motor or cable must have exactly the same type designation as the part you removed. The configuration rating plate on the transparent protective plate of the defective drive controller carries all the information necessary to order a replacement unit from INDRAMAT or to build a replacement unit from existing single parts.
- If a drive controller does develop a fault, remove the software module DSM (which is usually intact) from the defective module and plug it into the newly installed drive module.
- When returning a defective unit to INDRAMAT Service Department, please send the completed "Repair Card", as illustrated in Fig. 88, Section 11.1, along with it. If no repair card is to hand, make a photocopy of the specimen in the appendix to this documentation and enter the relevant data for the defective component. In any event, you should always include a short report of the type of errors or faults which have occurred while the unit was in operation. This will ensure that repairs are carried out promptly and correctly. Extra copies of the Repair Card may be obtained from INDRAMAT.

10. Overview of parameters

Application parameters

Description	Unit
Operating mode 1= torque / 2 = velocity loop	
Bipolar velocity limit value	[rpm]
Overload factor	[%]
Maximum command value for maximum velocity	[V]
Velocity at maximum command value	[rpm]
Command value smoothing filter time constant	[ms]
Position data scaling at the analog output	[dgr/10V]
Velocity data scaling at the analog output	[rpm/10V]
Line count of the incremental encoder	
Marker pulse offset	
Torque/current limit 1 to	%
Torque/current limit 2 to	%
Torque/current limit 3 to	%
Selected error reaction	[current code]

Drive parameters

Current loop proportional gain-1	[V/A]
Velocity loop proportional gain	[mAs/rad]
Velocity loop integral reaction time	[ms]
Velocity loop derivative/integral gain	[mAs/rad]
Velocity loop derivative/proportional gain	[uAs ² /rad]
Smoothing time constant	[usec]
Reset to standard parameters	[Enter]

Amplifier and motor parameters

Amplifier parameters

Amplifier parameters are automatically set.

Motor parameters for Series MDD motors \geq 065

Motor parameters will be automatically set for Series MDD motors \geq 065.

Motor type	
Nominal torque	[Nm]
Maximum speed of motor	[rpm]
Mass moment of inertia	[Kgm ²]
Motor torque constant Km	[Nm/A]
Peak motor current	[A]
Nominal motor current	[A]

11. Appendix

11.1. Repair Card

Repair Card for INDRAMAT equipment and components			
Completed by: _____		Company/Town: _____	
Date: _____			
When replacing single components, enter component designation		SN: _____	Supply job no.: _____
		SN: _____	Shipment date: _____
Machine manufacturer/Company: _____	Type: _____	Machine no.: _____	if necessary - commissioning date
Fault in axis no. _____	<input type="checkbox"/> horizontal <input type="checkbox"/> vertical <input type="checkbox"/> vertical	Operating hours: _____	Date fault occurred: _____
Fault status: Fault _____ _____ <input type="checkbox"/> always present <input type="checkbox"/> occurs sporadically <input type="checkbox"/> occurs after _____ hrs <input type="checkbox"/> occurs on impact/vibration <input type="checkbox"/> is temperature-dependent <input type="checkbox"/> other * _____ * _____ * _____	Additional information: (e.g. LED diagnosis messages in display) _____ _____ _____ _____ _____ _____	Cause of fault: <input type="checkbox"/> not known <input type="checkbox"/> faulty connection <input type="checkbox"/> ext. short-circuit <input type="checkbox"/> mech. damage <input type="checkbox"/> loose cable connections <input type="checkbox"/> other * _____ * _____ * _____	
Supplementary information			
General details: <input type="checkbox"/> no function <input type="checkbox"/> drive running irregularly <input type="checkbox"/> uncontrolled drive motion <input type="checkbox"/> fault in one direction only <input type="checkbox"/> burnt-out fuse on supply <input type="checkbox"/> other	Related incidents: <input type="checkbox"/> mechanical problems <input type="checkbox"/> failure of power supply <input type="checkbox"/> failure of controller <input type="checkbox"/> motor failure <input type="checkbox"/> cable break <input type="checkbox"/> other	Controller, supply unit, amplifier, mains power: <input type="checkbox"/> faulty control voltage <input type="checkbox"/> mains power fuse burnt out <input type="checkbox"/> defective fan <input type="checkbox"/> defective bleeder resistor <input type="checkbox"/> faulty power supply voltage <input type="checkbox"/> connection bolt sheared off <input type="checkbox"/> other	
Control system: <input type="checkbox"/> no function <input type="checkbox"/> faulty display <input type="checkbox"/> no command value output <input type="checkbox"/> diagnosis <input type="checkbox"/> dimensional shift in direction <input type="checkbox"/> E-STOP circuit interrupted <input type="checkbox"/> pos. control loop does not close <input type="checkbox"/> programme sequence fault <input type="checkbox"/> faulty internal auxiliary function (outputs) <input type="checkbox"/> acknowledgements not accepted (inputs) <input type="checkbox"/> other _____ _____ _____	Motor: <input type="checkbox"/> defective thermocouple <input type="checkbox"/> defective brake <input type="checkbox"/> defective fan <input type="checkbox"/> defective feedback <input type="checkbox"/> defective speed encoder signal <input type="checkbox"/> defective BLC signal <input type="checkbox"/> earthing short-circuit <input type="checkbox"/> overheating <input type="checkbox"/> other _____ _____ _____ _____	Remarks: _____ _____ _____ _____ _____ _____	

Fig. 88: Repair card

**11.2. Specific axis data list,
to be completed by hand**

Specific Axis Data List

This list is intended as an additional safety record of the parameter contents.
Include this list in the machine file.

Machine manufacturer :

Plant No. :

Machine Type :

Axis designation :

Axis equipment

Drive controller : DDS 2.1.....

Software module : DSM 2.1-.....

MDD servo motor : MDD

Supply module :

Date :

Completed by : **Approved by** :

Company :

ENA3A-Abb55/InbetrDDS

Fig. 89: Specific axis data list

1. Application parameters

Description	Recorded value	Unit
Operating mode (1=torque loop/2=velocity loop)		÷
Bipolar velocity limit value		[rpm]
Overload factor		[%]
Maximum command value for maximum velocity		[V]
Velocity at maximum command value		[rpm]
Command value smoothing filter time constant		[ms]
Line count of the incremental encoder		÷
Marker pulse offset		[dgr]
Torque/current limit 1		[%]
Torque/current limit 2		[%]
Torque/current limit 3		[%]
Selected error reaction		[current code]

2. Drive parameters

Description	Recorded value	Unit
Current loop proportional gain-1		[V/A]
Velocity loop proportional gain		[mAs/rad]
Velocity loop integral reaction time		[ms]
Velocity loop derivative/proportional gain		[μ As ² /rad]
Velocity loop derivative/integral gain		[mAs/rad]
Smoothing time constant		[μ sec]
Nominal torque		[Nm]
Maximum speed of motor (nmax)		[rpm]
Mass moment of inertia		[kgm ²]
Motor torque constant		[Nm/A]
Peak motor current		[A]
Nominal motor current		[A]

ENA3A-Abb56/InbetrDDS

Fig. 90: Specific axis data list

11.3. Example of a parameter file printout

Specific axis data list		
Machine manufacturer	:	XY-AG
Plant No.	:	1234
Machine Type	:	Machining center
Axis designation	:	X axis
Drive controller	:	DDS 2.1-W025-D
MDD servo motor	:	MDD065A-N-040
Software module	:	DSM 2.21-E11-01.03 (16.10.92)
OPERATING MODES, SCALING		
S-0-0032	Operating mode	: 2 ---
S-0-0091	Bipolar velocity limit value	: 2500.0000 rpm
P-0-0006	Overload factor	: 100 %
P-7-0000	Maximum command value for maximum velocity	: 10.0 V
P-7-0001	Velocity at maximum command value	: 1500 rpm
P-7-0004	Command value smoothing filter time constant	: 20.00 ms
P-0-0042	Position data scaling at analog output	: 90.0 dgr/10V
P-0-0040	Velocity data scaling at analog output	: 1500 rpm/10V
ABSOLUTE ENCODER SETUP		
P-7-0015	Reference position	: 0.5000 rpm
ERROR REACTION		
P-0-0007	Error reaction	: 0 ---
TORQUE/CURRENT LIMIT		
P-7-0005	Torque/current limit 1	: 100 %
P-7-0006	Torque/current limit 2	: 50 %
P-7-0007	Torque/current limit 3	: 25 %
GAIN PARAMETERS		
S-0-0106	Current loop proportional gain-1	: 9.60 V/a
S-0-0100	Velocity loop proportional gain	: 1500 mAs/ rad
S-0-0101	Velocity loop integral reaction time	: 50.0 ms
P-0-0002	Velocity loop derivative/integral gain	: 0 mAs / rad
P-0-0003	Velocity loop derivative/proportional gain	: 0 μ As ² / rad
P-0-0004	Smoothing time constant	: 1000 μ s
Date: completed by: Fr. 13.11.1992 Mr. A.N. Other		
ENA3A-Abb71/InbetrDDS		

Fig. 91: Specimen of a printed parameter file.

11.4. DDS 2.1
drive controller connection diagram for motors with resolver feedback

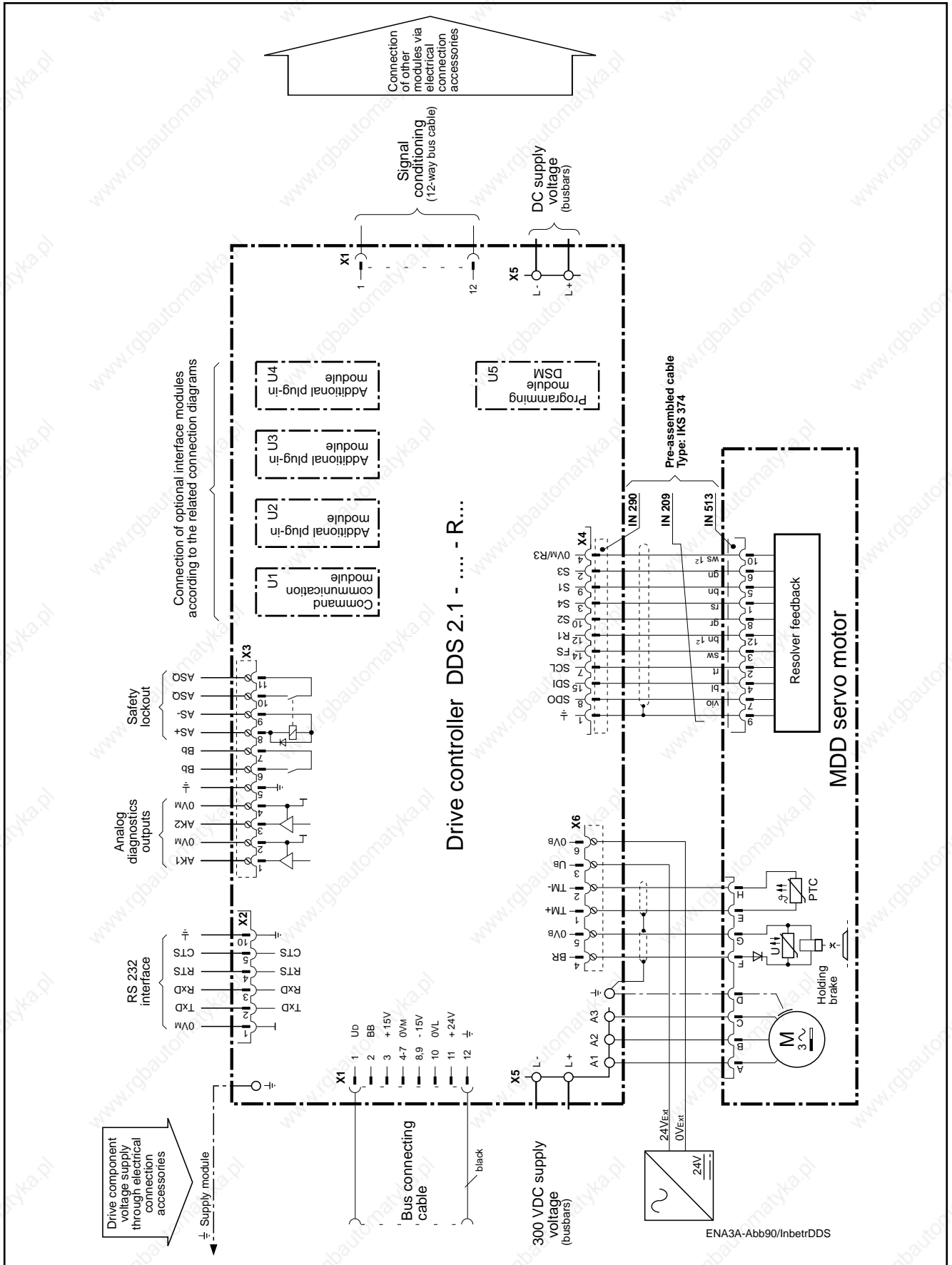


Fig. 92: Connection diagram for DDS 2.1-...-R— drive controller for motors with resolver feedback.

11.5. DDS 2.1
drive controller connection
diagram for motors
with digital servo feedback

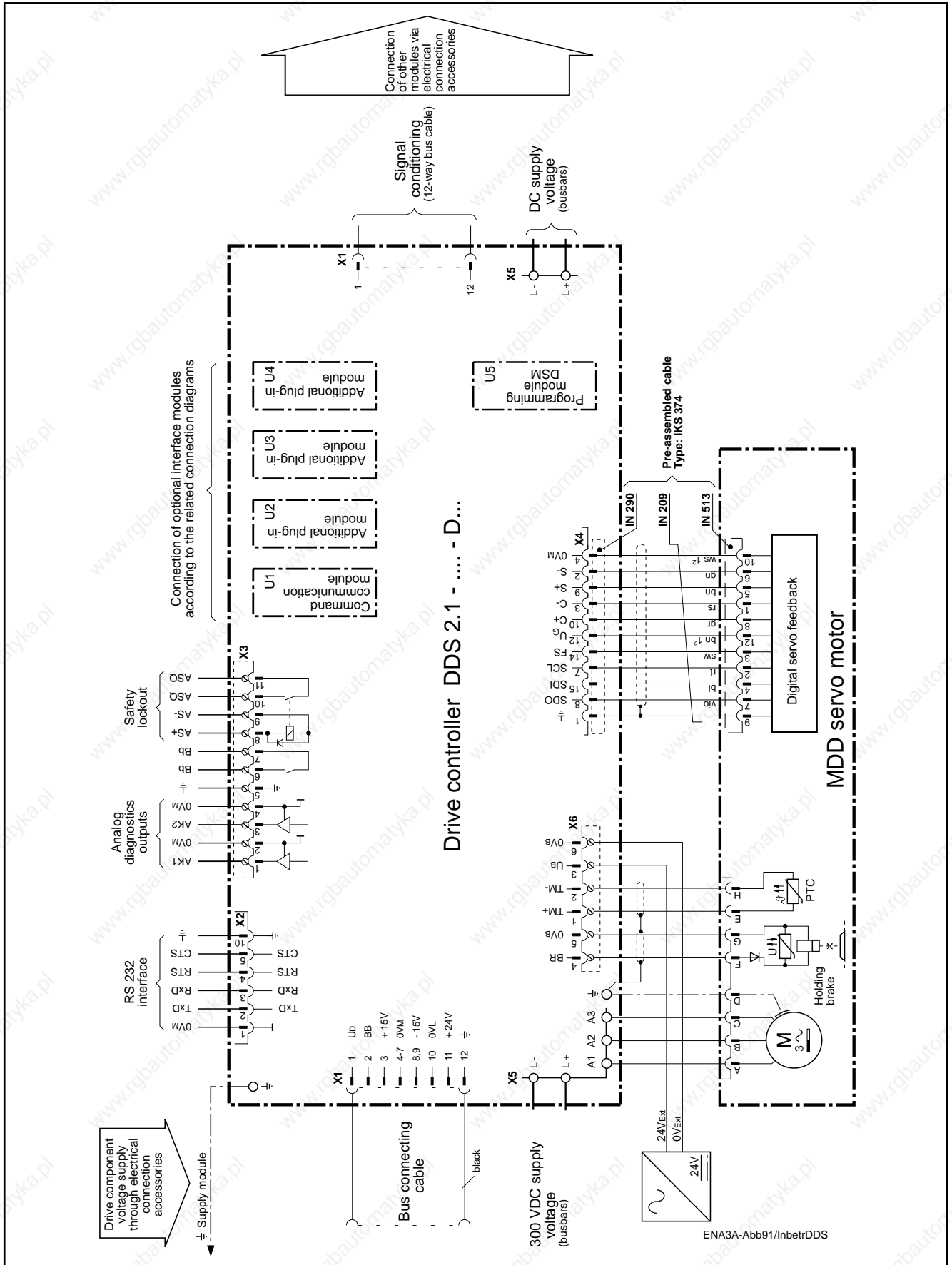


Fig. 93: Connection diagram for DDS 2.1-...-R— drive controller for motors with digital feedback.

11.6. Pin allocations/ abbreviations on drive controller

Plug-in terminal strip X1

Pin	Signal	Meaning
X1/1	UD	Error message from supply module
X1/2	BB	Ready message from drive controller to supply module
X1/3	+15V	15 V supply voltage
X1/4 to X1/7	0VM	0 Volt test voltage
X1/8 to X1/9	-15V	-15V supply voltage
X1/10	0VL	0V load voltage
X1/11	+24V	+24V supply voltage
X1/12	⏏	Earth

Fig. 94: Control voltage bus on the DDS 2.1

Plug-in terminal strip X2

Pin	Signal	Meaning
X2/1	0VM	0V test voltage
X2/2	TXD	Transmit data
X2/3	RXD	Receive data
X2/4	RTS	Request to send
X2/5	CTS	Clear to send
X2/10	⏏	Earth

Fig. 95: RS 232 interface on the DDS 2.1

Plug-in terminal strip X3

Pin	Signal	Meaning
X3/1	AK1	Analog output channel 1
X3/2	0VM	0V test voltage
X3/3	AK2	Analog output channel 2
X3/4	0VM	0 V test voltage
X3/5	⏏	Earth
X3/6, X3/7	Bb	Potential-free signal contact "Ready"
X3/8	AS+	Safety lockout
X3/9	AS-	Safety lockout
X3/10	ASQ	Accept safety lockout
X3/11	ASQ	Accept safety lockout

Fig. 96: Analog inputs and outputs on the DDS 2.1

Plug-in terminal strip X4
Digital feedback

Pin	Signal	Meaning
X4/1	⏏	Earth
X4/2	S-	Signal conductor
X4/3	C-	Signal conductor
X4/4	0VM	0V test voltage
X4/7	SCL	Signal conductor
X4/8	SDO	Signal conductor
X4/9	S+	Signal conductor
X4/10	C+	Signal conductor
X4/12	UG	Signal conductor
X4/14	FS	Signal conductor
X4/15	SDI	Signal conductor

Fig. 97: Connections of the digital servo feedback on the DDS 2.1

Plug-in terminal strip X4
Resolver feedback

Pin	Signal	Meaning
X4/1	⊥	Earth
X4/2	S3	Signal conductor
X4/3	S4	Signal conductor
X4/4	0VM/R3	0V test voltage
X4/5	not used	
X4/6	not used	
X4/7	SCL	
X4/8	not used	
X4/9	S1	Signal conductor
X4/10	S2	Signal conductor
X4/11	not used	
X4/12	R1	Signal conductor
X4/13	not used	
X4/14	FS	
X4/15	not used	

Fig. 98: Connections of the resolver feedback on the DDS 2.1

Plug-in terminal strip X5

Pin	Signal	Meaning
X5/1	A1	Phase 1 motor connection
X5/2	A2	Phase 2 motor connection
X5/3	A3	Phase 3 motor connection
X5/4	L-	Negative DC link circuit voltage
X5/5	L+	Positive DC link circuit voltage

Fig. 99: Mains power connections on the DDS 2.1

Plug-in terminal strip X6

Pin	Signal	Meaning
X6/1	TM+	Positive temperature sensing conductor
X6/2	TM-	Negative temperature sensing conductor
X6/3	UB	External +24V operating voltage
X6/4	BR	+24V connection for brake
X6/5	0VB	0V connection for brake
X6/6	0VB	External 0V operating voltage

Fig. 100: Connections for motor temperature monitoring, holding brake on the DDS 2.1

Plug-in terminal X13, X14

Pin	Signal	Meaning
X13/1	E1 NEGIN	Analog input 1 (-10V)
X13/2	E2 POSIN	Analog input 2 (+10V)
X13/3	TVW	Overtemperature warning
X13/4	RF	Controller enable
X13/5	AH	Drive halt
X13/6	Ired1	Current reduction 1 (torque reduction 1)
X13/7	Ired2	Current reduction 2 (torque reduction 2)
X13/8	+UI, ext	External +24V operating voltage
X13/9	0VI, ext	
X13/10	shield	Shield
X14/1	Ua2	(Negated square-wave pulse)
X14/2	not used	
X14/3	Ua0	(Square-wave pulse) Marker pulse
X14/4	Ua0	(Negated square-wave pulse) Marker pulse
X14/5	Ua1	(Square-wave pulse)
X14/6	Ua1	(Negated square-wave pulse)
X14/7	not used	
X14/8	Ua2	
X14/9	shield	Shield
X14/10	0Vext	Supply voltage +0V
X14/11	not used	
X14/12	+5Vext	Supply voltage +5V
X14/13	not used	
X14/14	not used	
X14/15	not used	

Fig. 101: Command communication module DAE 1.1

Plug-in terminal X13, X14

Pin	Signal	Meaning
X15/1	E1 NEGIN	Analog input 1 (-10V)
X15/2	E2 POSIN	Analog input 2 (+10V)
X15/3	TVW	Overtemperature warning
X15/4	RF	Controller enable
X15/5	AH	Drive halt
X15/6	Ired1	Current reduction 1 (Torque reduction 1)
X15/7	Ired2	(Torque reduction 2)
X15/8	+UI, ext	External +24V operating voltage
X15/9	0VI, ext	
X15/10	shield	Shield
X16/1	not used	
X16/2	not used	
X16/3	not used	
X16/4	not used	
X16/5	DATA(+)	
X16/6	DATA(-)	
X16/7	not used	
X16/8	not used	
X16/9	not used	
X16/10	0Vext	Supply voltage
X16/11	+Uext	Supply voltage +24V
X16/12	not used	
X16/13	clock pulse (+)	Clock line
X16/14	clock pulse (-)	Clock line
X16/15	shield	Shield

Fig. 102: Command communication module DAA 1.1

11.7. Overview of INDRAMAT companies, subsidiaries and agencies

GERMANY

Lohr:

Indramat GmbH
Bgm.-Dr.-Nebel-Str. 2
D - 8770 Lohr am Main
☎ 0 93 52/40-0
Telex 6 89 421
Telefax 0 93 52/40-4885

Chemnitz:

Indramat GmbH
c/o Rexroth Vertriebsund Service-
gesellschaft mbH
Beckerstraße 31
O - 9048 Chemnitz
☎ 03 71/355-0
Telefax 03 71/355-225

Düsseldorf:

Indramat GmbH
Technisches Büro Ratingen
Harkortstraße 25
Postfach 32 02
D - 4030 Ratingen 1
☎ 0 21 02/44 20 48 /-49
Telefax 0 21 02/41 315

München:

Indramat GmbH
c/o Mannesmann Rexroth GmbH
Technisches Büro
Institutstraße 14
D - 8000 München 60
☎ 089/82 91 55 30
Telefax 089/82 91 55 10

Stuttgart:

Indramat GmbH
Technisches Büro
Liststraße 1/2
D - 7250 Leonberg 1
☎ 0 71 52/25 076/-77
Telefax 0 71 52/25 034

AUSTRIA

G.L. Rexroth GmbH
Geschäftsbereich Indramat
Weimarer Straße 104
A - 1190 Wien
☎ 02 22/31 308-26
Telex 115 006
Telefax 02 22/31 308-93

G.L. Rexroth GmbH
Geschäftsbereich Indramat
Randlstraße 14
A - 4061 Pasching
☎ 07 229/44 01-72
Telefax 07 229/44 01-80

BELGIUM

G.L. Rexroth N.V./S.A.
Geschäftsbereich Indramat
Industrielaan, 8
B - 17 40 Ternat
☎ 02/582 318-0
Telex 222 10
Telefax 02/5 82 43 10

REPUBLIC OF CROATIA

Mannesmann Rexroth
Technisches Büro Indramat
Medveščak 82
YU - 41 000 Zagreb
☎ 041/43 52 27 u. 27 28 26
Telefax 041/43 56 76

CZECHOSLOVAKIA

Rexroth Spol.s.r.o
Videnska 125
CSFR - 639 00 Brno
☎ 5/32 46 32
Telex 62 332
Telefax 5/32 42 30

DENMARK

BEC Elektronik AS
Zinkvej 6
DK - 8900 Randers
☎ 086/44 78 66
Telefax 086/44 71 60

ENGLAND

G.L. Rexroth Ltd.
 Indramat Division
 4 Esland Place, Love Lane
 Cirencester, Glos GL 7 1 YG
 ☎ 02 85/65 86 71
 Telex 43 565
 Telefax 02 85/65 49 91

FINLAND

Rexroth OY
 Riihimiehentie 3
 SF - 0 17 20 Vantaa
 ☎ 0/84 85 11
 Telefax 0/84 63 87

FRANCE

Rexroth - Sigma
 Division Indramat
 Parc des Barbanniers
 4, Place du Village
 F - 92 632 Gennevilliers Cedex
 ☎ 1/47 98 44 66
 Telex 616 581
 Telefax 1/47 94 69 41

Rexroth - Sigma
 Division Indramat
 91, Bd I. Joliot Curie
 F - 69 634 Venissieux - Cx
 ☎ 78 75 81 55
 Telex 380 852
 Telefax 78 01 58 31

Indramat Bureau de Toulouse
 Immeuble Sud America
 20, Bd de Thibaud
 F - 31 084 Toulouse
 ☎ 61 76 03 22
 Telex 521 321
 Telefax 61 41 62 29

ITALY

Rexroth S.p.A.
 Divisione Indramat
 Via G. Di Vittorio, 1
 I - 20 063 Cernusco S/N. MI
 ☎ 02/9 23 65 - 270
 Telex 331 695
 Telefax 02/92 10 80 69

Rexroth S.p.A.
 Divisione Indramat
 Via Borgomanero, 11
 I - 10 145 Torino
 ☎ 011/7 71 22 30
 Telefax 011/7 71 01 90

Rexroth S.p.A.
 Divisione Indramat
 Via Vallescura, 15
 I - 40 136 Bologna
 ☎ 051/33 20 68
 Telefax 051/58 13 45

NETHERLANDS

Hydraudyne Hydrauliek B.V.
 Kruisbroeksestraat 1a
 P.O.Box 32
 NL - 5280 AA Boxtel
 ☎ 04 116/51 951
 Telefax 04 116/51 483

SPAIN

Rexroth S.A.
 Centro Industrial Santiga
 Obradors s/n
 Santa Perpetua de Mogoda
 (Barcelona)
 ☎ 03/7 18 68 51
 Telex 59 181
 Telefax 03/718 98 62

Goimendi S.A.
 División Indramat
 Jolastokieta (Herrera)
 Apartado 11 37
 San Sebastian, 20 017
 ☎ 043/40 01 63
 Telex 36 172
 Telefax 043/39 93 95

SWEDEN

Zander & Ingeström
 Indramat Division
 Box 120 88
 S - 102 23 Stockholm
 ☎ 08/80 90 00
 Telefax 08/80 65 67

SWITZERLAND

Rexroth SA
 Département Indramat
 Chemin de l'Ecole 6
 CH - 10 36 Sullens
 ☎ 021/731 43 77 (Indramat)
 Telefax 021/7314678 (Indramat)
 ☎ 021/635 19 91 (Rexroth)

Rexroth AG
 Geschäftsbereich Indramat
 Gewerbestraße 3
 CH - 8500 Frauenfeld
 ☎ 054/720 21 00
 Telefax 054/720 21 11

REPUBLIC OF SLOVENIA

ISKRA Elektromotorji
 Otoki 21
 YU - 64 228 Zelezniki (Slowenien)
 ☎ 064/66 441
 Telex 34 578
 Telefax 064/ 67 150

TURKEY

Orsel Ltd.
 Altiyol, KUSDILI Cad. 43
 Toraman Han Kat 3
 TR - 813 10 Kadiköy - Istanbul
 ☎ 1-347 83 95 /-96
 Telefax 1-347 83 93

**F.R. OF YUGOSLAVIA
(SERBIA - MONTENEGRO)**

Mannesmann Rexroth
 Technisches Büro Indramat
 Gospodar Jevremova BR 1
 YU - 11 000 Beograd (Serbien)
 ☎ 011/630 047 u. 636 414
 Telefax 011/636 351

CIS

AITI - INDRAMAT
 Service - Büro
 Ul. Pjatznikaja 46
 10 90 17 Moskau (Rußland)
 ☎ 7 - 095/ 238 - 25 - 43
 233 - 58 - 79
 233 - 09 - 89
 Telex 911 617 Lidia
 Telefax 7 - 095/230 - 22 - 95

CANADA

Basic Technologies Corporation
 Burlington Division
 3426 Mainway Drive
 Burlington, Ontario
 Canada L7M 1A8
 ☎ 416/335 - 55 11
 Telex 06 18 396
 Telefax 416/335-41 84

MEXICO

Motorizacion y Diseño de
 Controles
 Av. Dr. Gustavo Baz No. 288
 Col. Parque Industrial la loma
 Apartado Postal No. 318
 54 060 Tlalnepantla
 Estado de Mexico
 ☎ 5/39 78 64 4
 Telefax 5/39 89 88 8

USA

Rexroth Corporation
 Indramat Division
 255 Mittel Drive
 Wood Dale, Illinois 60 191
 ☎ 708/8 60 - 10 10
 Telex 206 582
 Telefax 708/5 30 - 46 31

Rexroth Corporation
 Indramat Division
 2110 Austin Avenue
 Rochester Hills, Michigan 48 309
 ☎ 313/853 - 82 90
 Telefax 313/853 - 82 98

ARGENTINA

Mannesmann Rexroth S.A.I.C
 Division Indramat
 Acassusso 48 41/7
 1605 Munro (Buenos Aires)
 Argentina
 ☎ 01/7 56 01 40
 01/7 56 02 40
 01/7 56 03 40
 01/7 56 04 40
 Telex 26 266 rexro ar
 Telefax 01/7 56 01 36

BRAZIL

Rexroth Hidráulica Ltda.
 Divisão Indramat
 Rua Heinrich Passold,130
 CP 156
 BR - 89. 107 000 Pomerode SC
 ☎ 04 73/87 03 21
 Telex 47 32 88 REXR BR
 Telefax 04 73/87 02 51

Rexroth Hidráulica Ltda.
 Centro de Serviços
 Rua Georg Rexroth, 182
 Vila Padre Anchieta
 BR - 09951-270 Diadema - SP
 Caixa Postal 377
 BR - 09901-970 Diadema - SP

☎ 011/745-36 22
 Telex 11 44 351 REXR BR
 Telefax 011/ 745-3277
 745-4929

CHINA

G.L. Rexroth Ltd.
 Shanghai Office
 Room 25 05
 Shanghai Intern. Trade Centre
 2200 Yan An Road West
 Shanghai 20 03 35
 P.R. China
 ☎ 2755-666; 2755-333

HONGKONG

G.L. Rexroth Ltd.
 19 Cheung Shun Street
 1st Floor, Cheung Sha Wan,
 Kowloon, Hongkong
 ☎ 74 11 351/-54 und 74 11 430
 Telex 34 617 GL REX HX
 Telefax 78 64 019 und
 78 60 733

INDIA

Kirloskar Electric Co. Ltd.
 International Agency
 Division (Indramat)
 Post Box No. 55 55
 Malleswaram West
 Bangalore - 560 055
 ☎ 08 12/32 21 11
 Telex 08 45/22 30 und 27 90
 Telefax 08 12/32 24 69

JAPAN

Mannesmann Rexroth GmbH
 Japan Representative Office
 6F, Shiba Daimon Seiyoken
 Building
 1-15-7 Shiba Daimon
 Minato-ku, Tokyo 105 / Japan
 ☎ 03/54 73-70 15
 Telefax 03/54 73-70 17

KOREA

Seo Chang Corporation Ltd.
 44 - 35 Yeouido-Dong
 Yeongdeungpo-Ku
 Seoul, Korea
 ☎ 02/780 - 82 08 ~9
 Telex K 22 686 SCCLTD
 Telefax 02/784 - 54 08

TAIWAN

Minteke Supply Co., Ltd.
 23, Lane 457, Lung Chiang Road
 Taipei, Taiwan, 10 482, R.O.C.
 ☎ 02/503 43 75
 Telefax 02/505 01 08

THAILAND

N. R. Automation Co., Ltd.
49/23-24 Srinakarin Road,
Bangna, Prakanong
Bangkok 102 60 / Thailand
☎ 399 09 20-1; 399 09 56-8
Telefax 662-399 03 06

AUSTRALIA

Australasian Machine Tool
Co. Pty. Ltd.
9 Webber Parade,
East Keilor (Melbourne)
Victoria, 30 33, Australia
☎ 03/336 78 22
Telefax 03/336 17 52

NEW ZEALAND

Engineering Computer
Services Ltd.
23 Bandon St, Hamilton
New Zealand
☎ 07/847 90 93
Telefax 07/847 26 05

12. Glossary, Explanations

Absolute encoder	<p><i>Absolute value encoder, multiturn encoder, absolute position encoder</i></p> <p>Position encoders which supply a position signal referred to a reference point set at initial start-up as soon as the power supply is switched on. No reference run necessary during operation.</p>
Absolute encoder emulator	<p>The absolute encoder emulation is an integral part of ANALOG interfaces with absolute encoder emulator DAA 1.1. It allows the output of the drive's internal absolute position or angle information via the SSI (synchronous serial interface) common to all absolute encoders for the purposes of external use as a position actual value.</p>
Drive controller	<p><i>Servo control amplifier, servo drive module</i></p> <p>Unit required to operate an AC servo motor.</p>
Application-related parameters	<p>Application-related parameters are used to match the AC servo drive to the mechanical structure of the machine. They are listed in Section 10, "Over-view of Parameters".</p>
Drive-related parameters	<p>Drive-related parameters are used to parametrize the drive controller and the AC servo motor. They are listed in Section 10 "Overview of Parameters".</p>
Bleeder	<p><i>Load resistor, bleeder resistor, chopper resistor</i></p> <p>Electronically controlled braking resistor which dissipates as heat the excess energy generated when a motor is braked.</p>
Digital servo feedback	<p><i>DSF</i></p> <p>Position encoder in AC servo motors for digital intelligent drives for high-resolution measurement of the rotor position (resolution 1/2 000 000 revolutions). The measurement is absolute within one revolution.</p>
Torque control loop	<p><i>Force control loop, torque loop</i></p> <p>Operating mode in which the drive sets the torque according to the applied torque command value. This mode is only recommended for master/slave applications. The slave servo motor is then run in a torque control loop.</p>
Emulator	<p>Hardware extensions or programs allowing emulation of the characteristics of another system.</p>

Velocity control loop	<p><i>Speed control loop</i></p> <p>Drive operating mode with SERCOS and ANALOG interfaces in which the drive sets the motor speed or the velocity of the moved machine part with a high dynamic response as a function of the applied velocity command.</p>
Base torque	<p><i>Idling torque, friction torque</i></p> <p>The torque required to move the drive and the attached mechanical construction at constant velocity (machine-related).</p>
Holding brake closed-circuit current	<p>An electromagnetic brake built into the servo motor as an option. It serves to protect the AC servo motor (servo axis) against involuntary movement when shut down. The brake is closed when de-energized. It is not intended as a brake in the event of an E-STOP!</p>
High-resolution position interface	<p><i>DLF</i></p> <p>Sinusoidal position encoder signals are conditioned in the drive controller at high resolution (multiplication factor 2048).</p>
Pulse wire absolute encoder	<p><i>IDG</i></p> <p>An optional feature for resolver feedback on AC servo motors for digital intelligent drives for absolute measurement of the rotor position over 4096 revolutions.</p>
Incremental encoder	<p><i>Position encoder, relative position encoder</i></p> <p>Incremental encoders supply a defined number of measuring cycles per revolution or stroke. Position measurement referred to a reference point is achieved by traversing to the reference point after switching on the supply voltage with continuous direction-biased counting of the measurement cycles in the NC control or the drive.</p>
Incremental encoder emulator	<p><i>DAE</i></p> <p>The incremental encoder emulation is an integral part of "ANALOG interfaces with incremental encoder emulator DAE 1.1". It allows the output of the drive's internal position or angle information. This information is used by the related NC control as a position actual value signal.</p>
Interface	<p><i>Plug-in card</i></p> <p>The transition point for signal interchange between drives, control systems, encoders, etc. In digital intelligent drive controller units the basic interfaces are permanently installed. Over and above this, optional, variable application-related interfaces may be plugged into the controller units.</p>
Kv faktor	<p><i>Loop gain factor</i></p> <p>In a position control with a lag error the Kv factor indicates the velocity (m/min) at which a lag error of 1 mm occurs.</p>

Position control loop	Loop to control a system's position.
Multiturn encoder	<i>Multiturn absolute encoder, MTG</i> Absolute position measurement over several revolutions. Digital AC servo motors may optionally be fitted with multiturn encoders (absolute measurement of the rotor position over 4092 revolutions).
Surface cooling	<i>Fan unit</i> Forced cooling with an external fan (optional)
Position interface	Interface for exchange of position data.
Radial surface cooling	<i>Radial cooling</i> Forced cooling of the motor frame by means of a fan (optional) installed radially to the motor axis to increase the nominal torque.
Reference point run	<i>Referencing</i> Travelling to a reference point which helps to create an absolute reference in an incremental measuring system.
Controller enable	<i>Analog interface RF</i> Signal to activate the drive when power has been switched on.
Resolver	<i>Angle measuring unit</i> Inductive angle measuring unit that generates alternating voltages with angle-dependent amplitude. Absolute measurement referred to 360° (cyclically absolute).
Resolver feedback	<i>RSF</i> Position encoder for cyclical absolute measurement of the rotor position on digital intelligent drives (resolver principle).
Continuous power rating at energy recovery	Continuous power dissipated by AC servo motors over one cycle through a bleeder or, in the case of supply units with an energy recovery capability, back into the mains when the motor is braking or in "generative mode".
Lag error	<i>Lag error</i> The lag error in CNC machines with a position control loop is the difference between the position command and the position actual value.
Vibration severity grade	Factor enabling the assessment of how smoothly a machine runs (effective value of vibration speed (r.m.s. value of vibration velocity)).

Servo feedback	Special measuring device on servo motors to detect the rotor position and measure the rotor speed (cyclically absolute position sensing).
Signal conditioner	<i>Microprocessor</i> A microprocessor that achieves a high signal processing speed due to parallel signal conditioning.
Singleturn encoder	<i>Singleturn absolute encoder</i> Position encoder that supplies an absolute position information signal within one revolution.
Software module (DSM)	Module in the drive controller containing the operating software and the drive parameters.
Peak current, drive controller	Peak current that the drive controller can supply in 300 ms overload operation mode.
Gear encoder interface	Interface for high-resolution position measurement using a gear encoder or a high-resolution main spindle position encoder.
Status indicator	<i>Status display</i> Two-character indicator on the drive controller displaying the instantaneous operating status and error messages.

13. Index

A

Absolute encoder emulation 24
Additional plug-in module 17
ANALOG interface 13, 24

B

Bus connecting cable 54

C

Command communication module 17, 24
Configuration rating plate 52, 17
Control voltage bus connection 22
Current loop proportional gain 88

D

DC link circuit connection (X5) 22
Direction of rotation, servo motor 71

E

Earthing 53
Electrostatic charges 36
Emulation software 39
Error reaction 58

I

Incremental encoder emulation 73, 24
Incremental encoder resolution 73
Initializing phase 95

K

KI 86

L

Load torque 92

M

Motor power connection (X5) 22

O

Operating mode "velocity loop" 55
Overload factor 89

P

Parameter file 51
Parametrization and diagnostic program 41

R

Rapid traverse velocity 70
Rating plate of configured drive controller 19
Rating plate, drive controller, basic unit 23
Rating plate, MDD servo motors 29
Rating plate, software module 27
RS 232 interface 22

S

Safety limit switch 92
Separate-source voltage-withstand test 36
SERCOS interface 12
Smoothing time constant 87
Software module 17, 26
SSI interface 24
Status indicator (H1) 22
System configuration 18

T

Terminal setup 40
Torque arm 80
Torque fluctuations 72
Torque reduction 82
Type code, additional plug-in modules 25
Type code, command communication module 25
Type code, configured drive controller 19
Type code, drive controller, basic unit 23
Type code, MDD servo motors 30
Type code, software module 27

V

Velocity limitation 55
Velocity loop derivative/integral gain 87
Velocity loop derivative/proportional gain 87
Velocity loop integral reaction time 87
Velocity loop proportional gain 87

W

Weight compensation 93
Wiring 53

