

SKM 75GD123D



SEMITRANS® 6

IGBT Modules

SKM 75GD123DL

SKM 75GD123D

SKM 75GDL123D

Features

- MOS input (voltage controlled)
- N channel, homogeneous Si
- Low inductance case
- Very low tail current with low temperature dependence
- High short circuit capability, self limiting to $6 \times I_{Cnom}$
- Latch-up free
- Fast & soft inverse Cal diodes
- Isolated copper baseplate using DCB Direct Bonding Technology
- Large clearance (9 mm) and creepage distance (13 mm)

Typical Applications*

- Switched mode power supplies
- DC servo and robot drives
- Three phase inverters for AC motor speed control
- Switching (not for linear use)

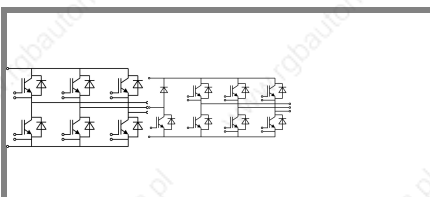

GD GD

Absolute Maximum Ratings		$T_c = 25^\circ\text{C}$, unless otherwise specified			
Symbol	Conditions	Values			Units
IGBT					
V_{CES}	$T_j = 25^\circ\text{C}$	1200			V
I_C	$T_j = 150^\circ\text{C}$	$T_{case} = 25^\circ\text{C}$	75		A
		$T_{case} = 80^\circ\text{C}$	50		A
I_{CRM}	$I_{CRM} = 2 \times I_{Cnom}$	100			A
V_{GES}		± 20			V
t_{psc}	$V_{CC} = 600\text{ V}; V_{GE} \leq 20\text{ V}; T_j = 125^\circ\text{C}$ $V_{CES} < 1200\text{ V}$	10			μs
Inverse Diode					
I_F	$T_j = 150^\circ\text{C}$	$T_{case} = 25^\circ\text{C}$	75		A
		$T_{case} = 80^\circ\text{C}$	50		A
I_{FRM}	$I_{FRM} = 2 \times I_{Fnom}$	100			A
I_{FSM}	$t_p = 10\text{ ms}; \sin.$	$T_j = 150^\circ\text{C}$	550		A
Module					
$I_{t(RMS)}$		100			A
T_{vj}		- 40 ... + 150			$^\circ\text{C}$
T_{stg}		- 40 ... + 125			$^\circ\text{C}$
V_{isol}	AC, 1 min.	2500			V

Characteristics		$T_c = 25^\circ\text{C}$, unless otherwise specified					
Symbol	Conditions	min.	typ.	max.	Units		
IGBT							
$V_{GE(th)}$	$V_{GE} = V_{CE}, I_C = 2\text{ mA}$	4,5	5,5	6,5	V		
I_{CES}	$V_{GE} = 0\text{ V}, V_{CE} = V_{CES}$	$T_j = 25^\circ\text{C}$		0,4	1,2	mA	
V_{CE0}		$T_j = 25^\circ\text{C}$		1,4	1,6	V	
		$T_j = 125^\circ\text{C}$		1,6	1,8	V	
r_{CE}	$V_{GE} = 15\text{ V}$	$T_j = 25^\circ\text{C}$		22	28	$\text{m}\Omega$	
		$T_j = 125^\circ\text{C}$		30	38	$\text{m}\Omega$	
$V_{CE(sat)}$	$I_{Cnom} = 50\text{ A}, V_{GE} = 15\text{ V}$	$T_j = T_{chiplever.}$		2,5	3	V	
C_{ies}	$V_{CE} = 25, V_{GE} = 0\text{ V}$	$f = 1\text{ MHz}$		3,3	4,3	nF	
C_{oes}				0,5	0,6	nF	
C_{res}				0,22	0,3	nF	
$t_{d(on)}$	$R_{Gon} = 22\ \Omega$	$V_{CC} = 600\text{ V}$ $I_C = 50\text{ A}$			44	100	ns
t_r					56	100	ns
E_{on}					8	mJ	
$t_{d(off)}$	$R_{Goff} = 22\ \Omega$	$T_j = 125^\circ\text{C}$		380	500	ns	
t_f		$V_{GE} = \pm 15\text{ V}$		70	100	ns	
E_{off}				5		mJ	
$R_{th(j-c)}$	per IGBT				0,32	K/W	

SKM 75GD123D



SEMITRANS® 6

IGBT Modules

SKM 75GD123DL

SKM 75GD123D

SKM 75GDL123D

Features

- MOS input (voltage controlled)
- N channel, homogeneous Si
- Low inductance case
- Very low tail current with low temperature dependence
- High short circuit capability, self limiting to $6 \times I_{cnom}$
- Latch-up free
- Fast & soft inverse Cal diodes
- Isolated copper baseplate using DCB Direct Bonding Technology
- Large clearance (9 mm) and creepage distance (13 mm)

Typical Applications*

- Switched mode power supplies
- DC servo and robot drives
- Three phase inverters for AC motor speed control
- Switching (not for linear use)

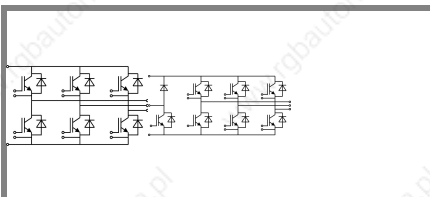

GD GD

Characteristics

Symbol	Conditions	min.	typ.	max.	Units
Inverse Diode					
$V_F = V_{EC}$	$I_{Fnom} = 50 \text{ A}; V_{GE} = 0 \text{ V}$	$T_j = 25 \text{ }^\circ\text{C}_{chiplev.}$	2	2,5	V
		$T_j = 125 \text{ }^\circ\text{C}_{chiplev.}$	1,8		V
V_{F0}		$T_j = 25 \text{ }^\circ\text{C}$	1,1	1,2	V
		$T_j = 125 \text{ }^\circ\text{C}$			V
r_F		$T_j = 25 \text{ }^\circ\text{C}$	18	26	mΩ
		$T_j = 125 \text{ }^\circ\text{C}$			mΩ
I_{RRM}	$I_F = 50 \text{ A}$	$T_j = 125 \text{ }^\circ\text{C}$	35		A
Q_{rr}	$di/dt = 800 \text{ A}/\mu\text{s}$		7		μC
E_{rr}	$V_{GE} = 0 \text{ V}; V_{CC} = 600 \text{ V}$		2,2		mJ
$R_{th(j-c)D}$	per diode			0,6	K/W
Module					
L_{CE}				60	nH
$R_{th(c-s)}$	per module			0,05	K/W
M_s	to heat sink M5				Nm
M_t	to terminals	4		5	Nm
w				175	g

This is an electrostatic discharge sensitive device (ESDS), international standard IEC 60747-1, Chapter IX.

* The specifications of our components may not be considered as an assurance of component characteristics. Components have to be tested for the respective application. Adjustments may be necessary. The use of SEMIKRON products in life support appliances and systems is subject to prior specification and written approval by SEMIKRON. We therefore strongly recommend prior consultation of our personal.

SKM 75GD123D



SEMITRANS[®] 6

IGBT Modules

SKM 75GD123DL

SKM 75GD123D

SKM 75GDL123D

Features

- MOS input (voltage controlled)
- N channel, homogeneous Si
- Low inductance case
- Very low tail current with low temperature dependence
- High short circuit capability, self limiting to $6 \times I_{cnom}$
- Latch-up free
- Fast & soft inverse Cal diodes
- Isolated copper baseplate using DCB Direct Bonding Technology
- Large clearance (9 mm) and creepage distance (13 mm)

Typical Applications*

- Switched mode power supplies
- DC servo and robot drives
- Three phase inverters for AC motor speed control
- Switching (not for linear use)

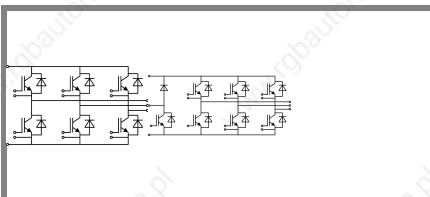

GD

GDL

Z_{th} Symbol	Conditions	Values	Units
$Z_{th(j-c)}$			
$R_{\theta j-c}$	$i = 1$	240	mk/W
$R_{\theta j-c}$	$i = 2$	68	mk/W
$R_{\theta j-c}$	$i = 3$	9,2	mk/W
$R_{\theta j-c}$	$i = 4$	2,8	mk/W
$\tau_{\theta j-c}$	$i = 1$	0,06	s
$\tau_{\theta j-c}$	$i = 2$	0,0228	s
$\tau_{\theta j-c}$	$i = 3$	0,0013	s
$\tau_{\theta j-c}$	$i = 4$	0,0002	s
$Z_{th(j-c)D}$			
$R_{\theta j-cD}$	$i = 1$	400	mk/W
$R_{\theta j-cD}$	$i = 2$	168	mk/W
$R_{\theta j-cD}$	$i = 3$	28	mk/W
$R_{\theta j-cD}$	$i = 4$	4	mk/W
$\tau_{\theta j-cD}$	$i = 1$	0,0831	s
$\tau_{\theta j-cD}$	$i = 2$	0,0112	s
$\tau_{\theta j-cD}$	$i = 3$	0,0013	s
$\tau_{\theta j-cD}$	$i = 4$	0,08	s

SKM 75GD123D

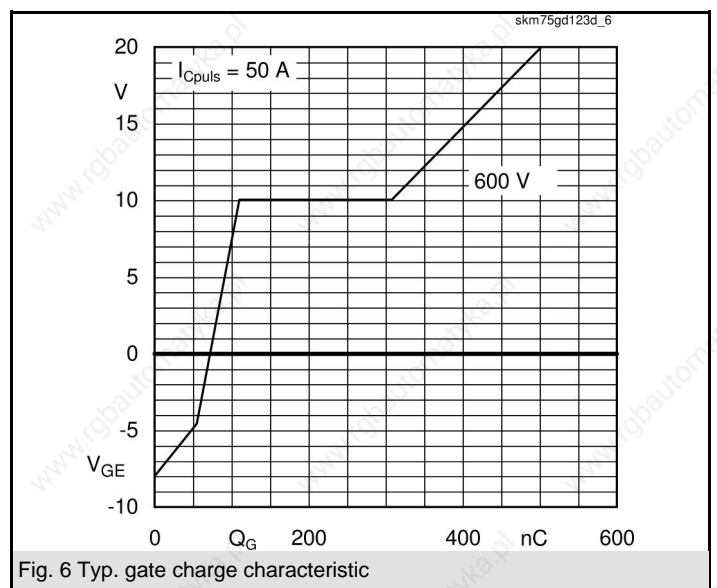
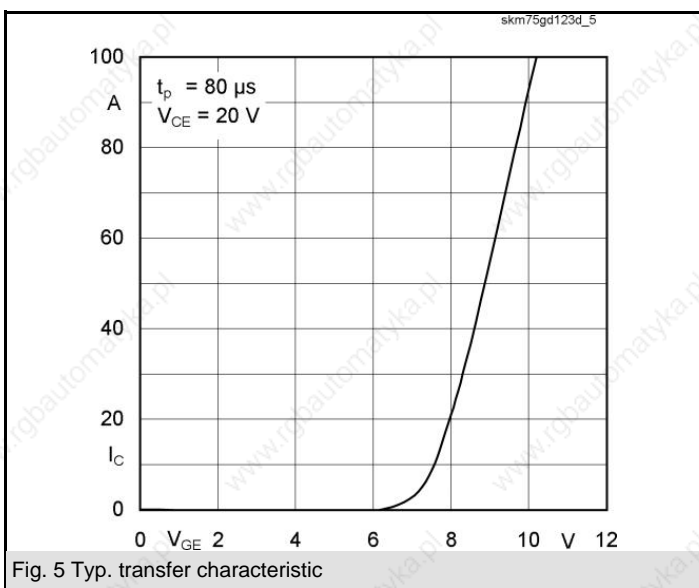
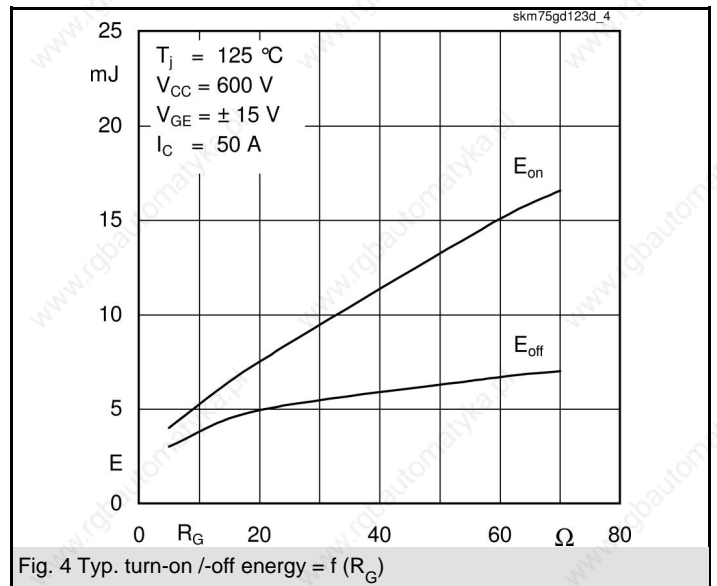
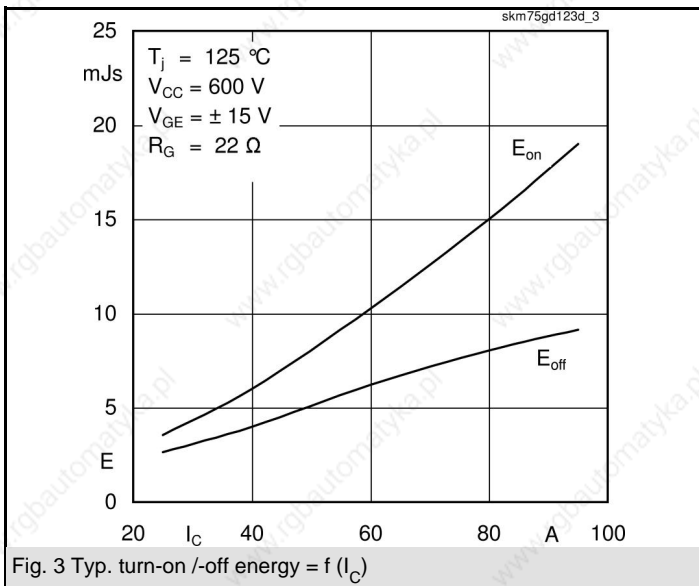
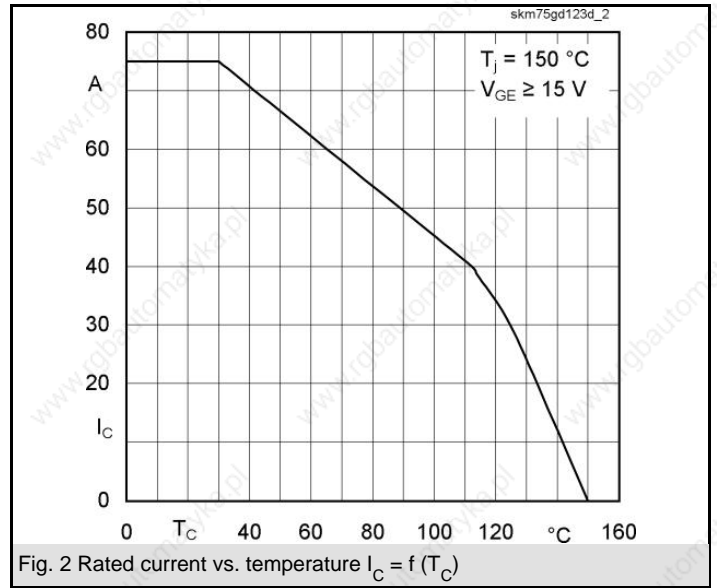
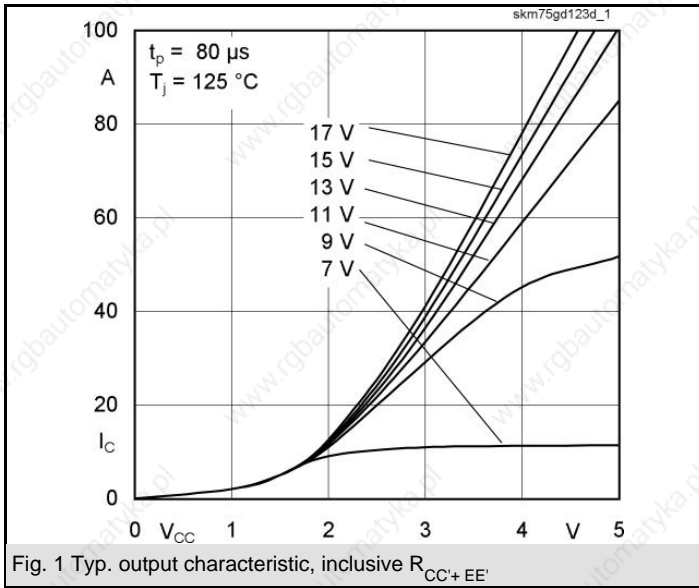

SKM 75GD123D

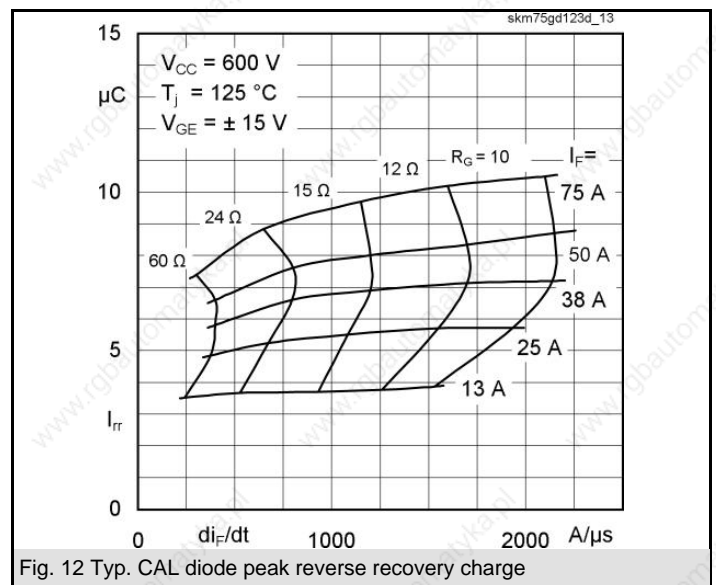
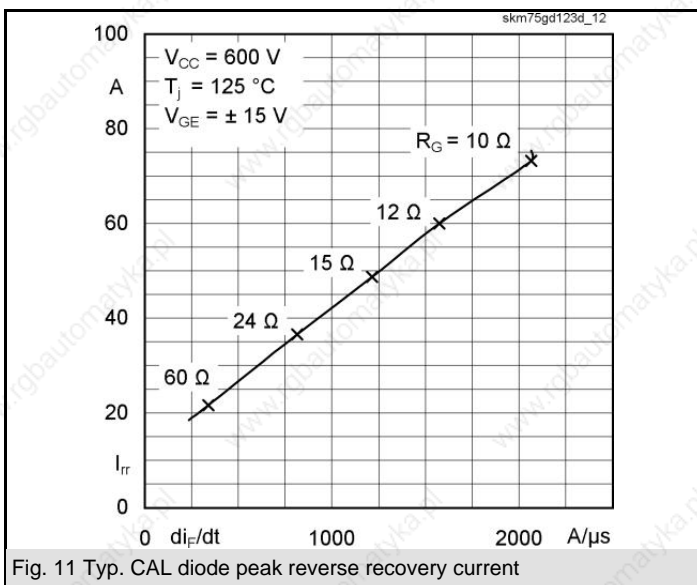
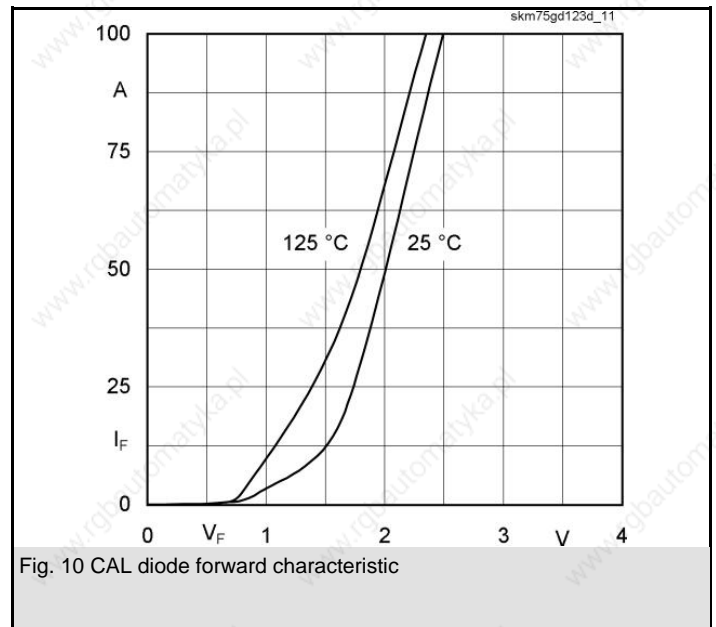
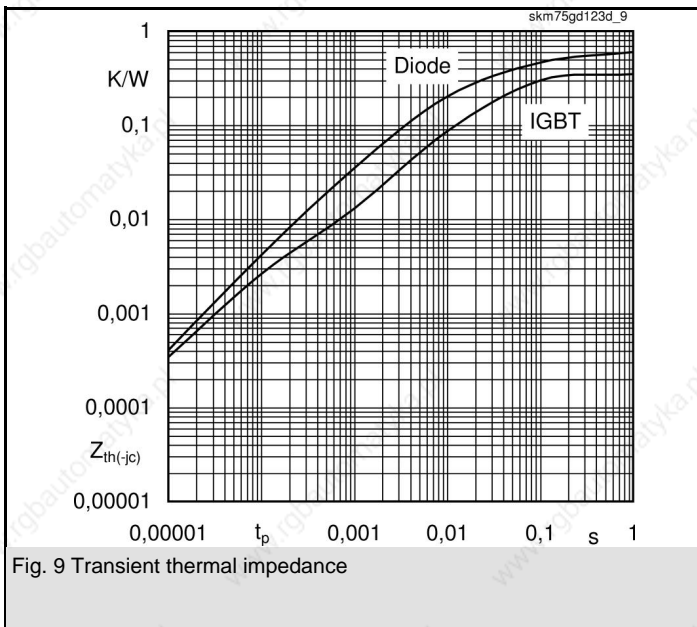
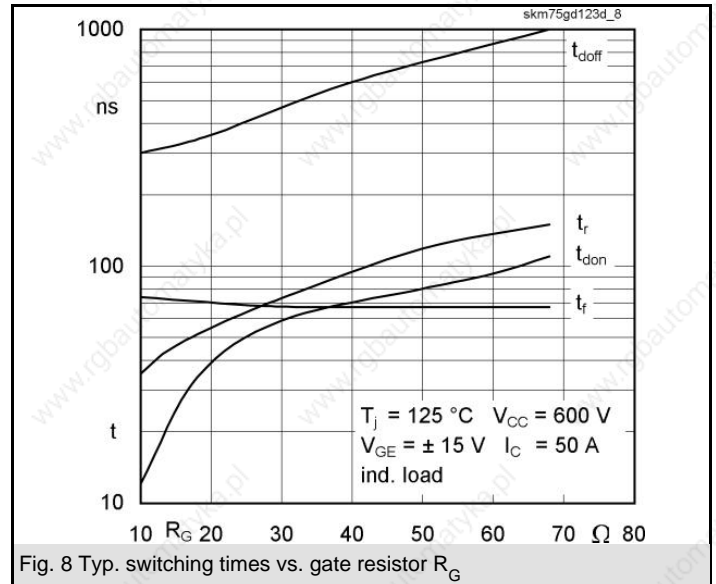
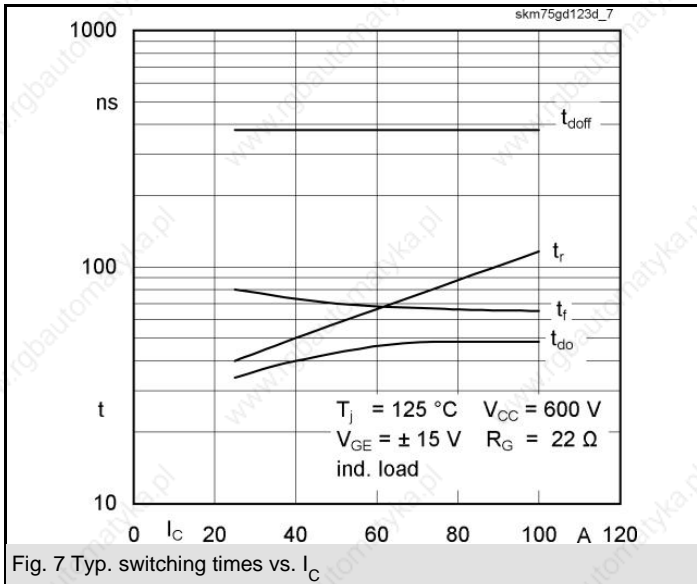

SKM 75GD123D

UL Recognized

File 63 532

CASED68

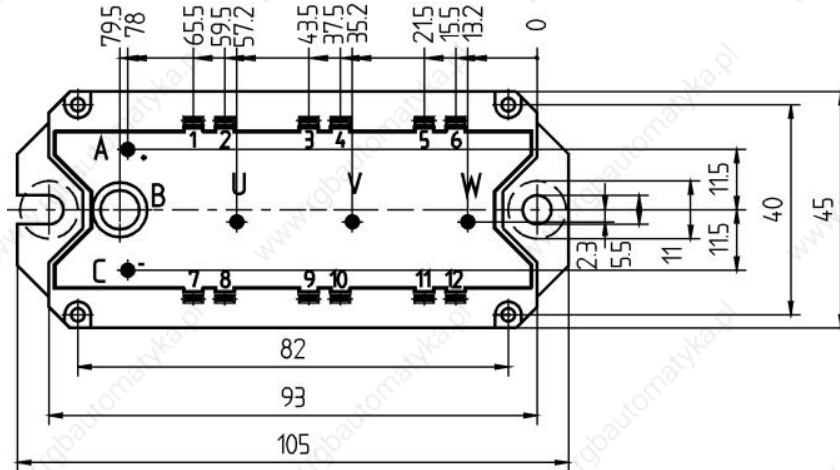
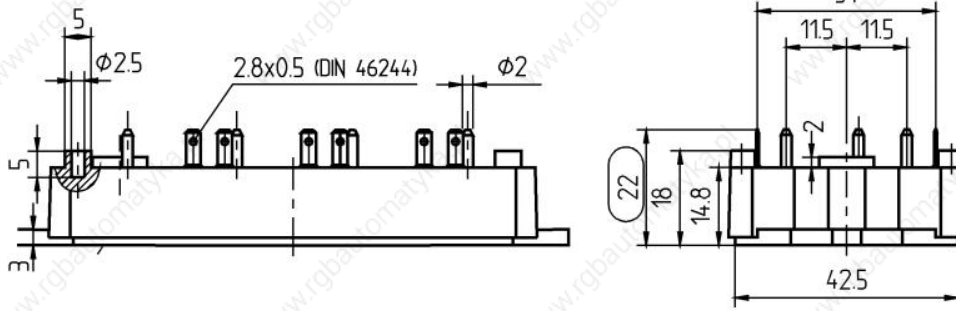

Case D 56a

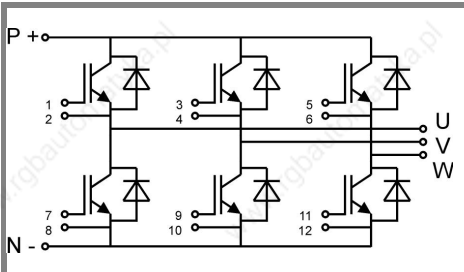

Case D 67

GD

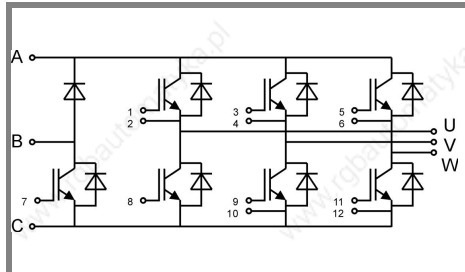

Case D 73

GDL