

EDK82EV113  
13239113

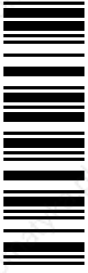

Information for the operator of the machine

## 8200 vector 0.25 ... 11 kW

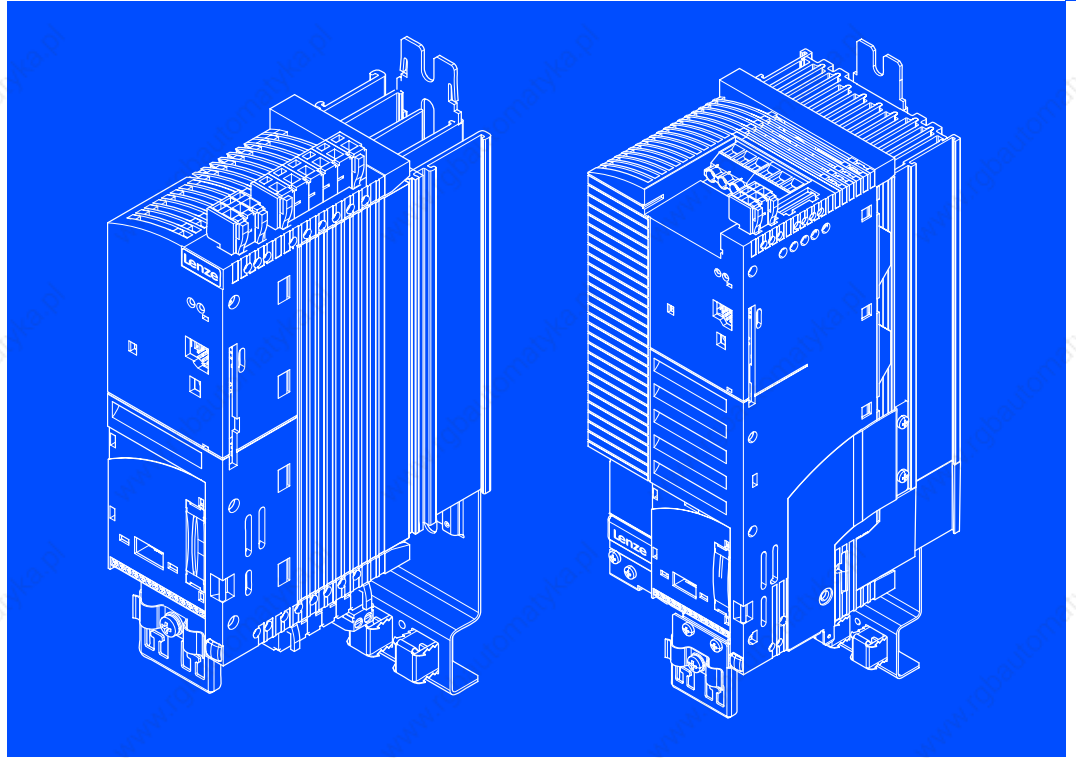

E82xV251Kxxxxx ... E82xV113Kxxxxx

Frequency inverter

[LenzePartsOnline.com](http://LenzePartsOnline.com)

**Lenze**

# This documentation is valid for ...

... 8200 vector frequency inverters as of nameplate data:

	①	②	③	Nameplate							
	E82	x	V	xxx	K	x	C	xxx	3x	3x	
<b>Product series</b>	8200 vector										
<b>Type</b>	E = built-in unit C = built-in unit in "cold plate" technique D = built-in unit in push-through technique										
<b>Design</b>	V = vector-controlled frequency inverter										
<b>Rated power [W]</b>	e. g. 152 = $15 \times 10^2 \text{ W} = 1.5 \text{ kW}$ 113 = $11 \times 10^3 \text{ W} = 11 \text{ kW}$ ...										
<b>Voltage class</b>	2 = 230 V 4 = 400 V / 500 V										
<b>Drive generation</b>	<b>Type</b> 0xx = EMC filter integrated 2xx = without EMC filter x0x = without "safe standstill" function x4x = with "safe standstill" function xx0 = not coated xx1 = coated										
<b>Hardware version</b>											
<b>Software version</b>											

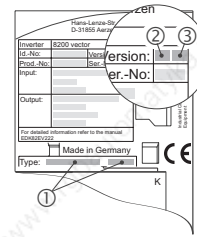



### Note!

This documentation contains all the information required by the machine operator to run the drive controllers of the 8200 vector series installed in your machine/system. You may make further use of the information contained in this documentation without asking Lenze for permission if you do not change the contents.



### Tip!

Current documentation and software updates concerning Lenze products can be found on the Internet in the "Services & Downloads" area under <http://www.Lenze.com>

**LenzePartsOnline.com**

© 2008 Lenze Drive Systems GmbH, Hans-Lenze-Straße 1, D-31855 Aerzen

We have compiled all information in this documentation with great care and have checked it with regard to compliance with the hardware and software described. Nevertheless, we cannot entirely exclude deviations. We do not accept legal responsibility or liability for damage possibly resulting therefrom. We will include necessary amendments in the subsequent editions.

# Basic units in the power range 0.25 ... 2.2 kW

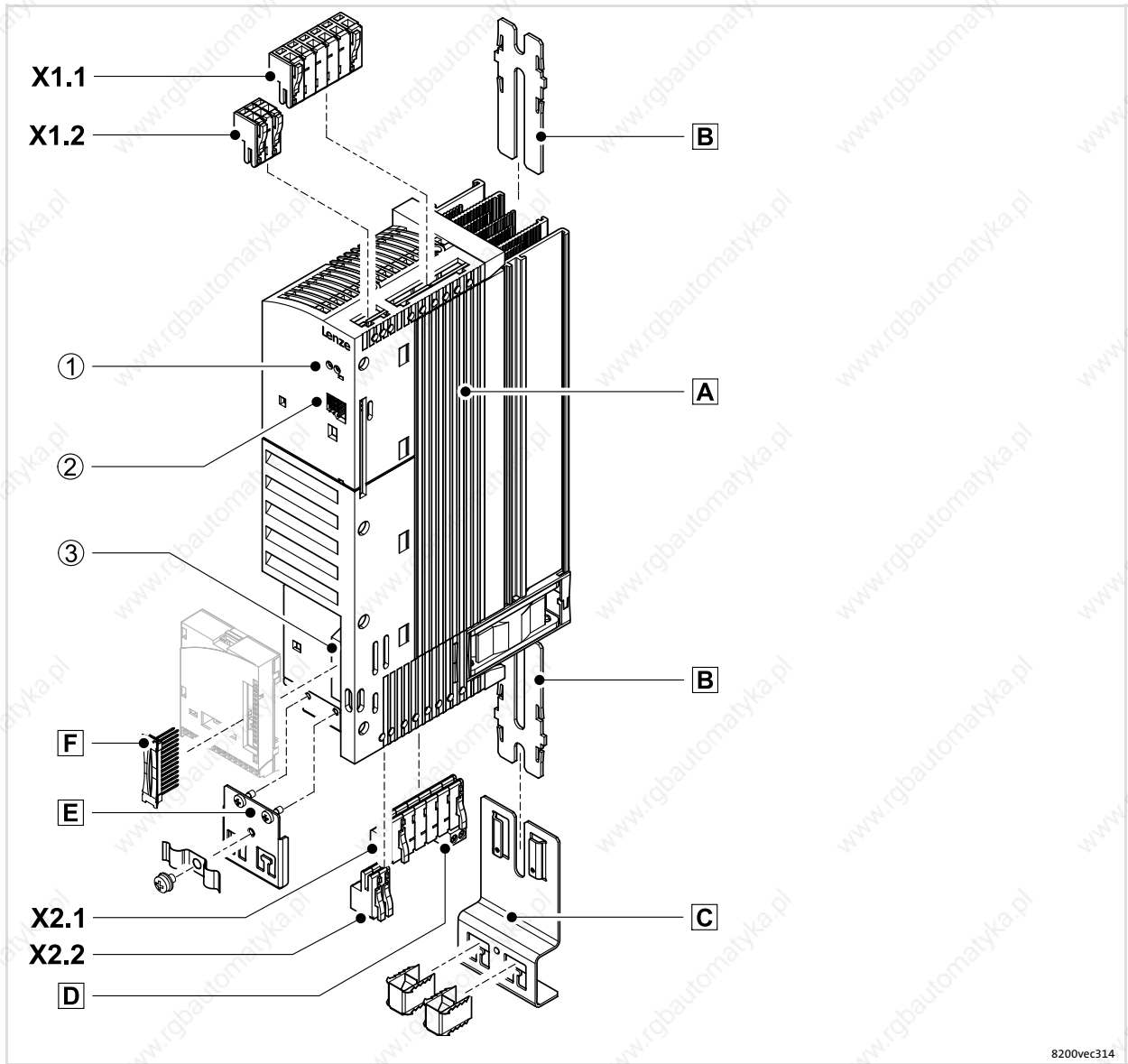

8200vec314

[LenzePartsOnline.com](http://LenzePartsOnline.com)

# Basic units in the power range 3 ... 11 kW

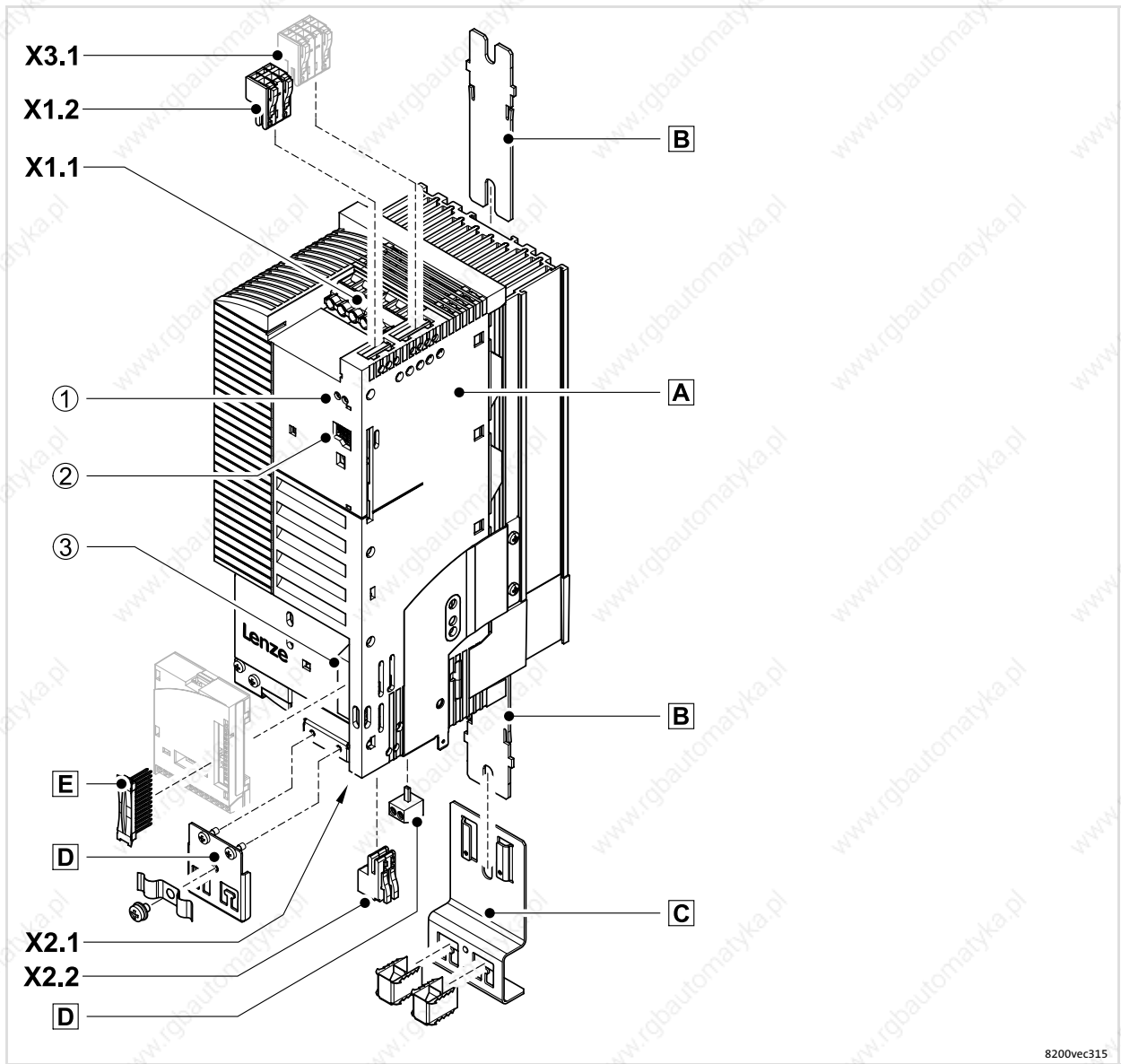

8200vec315

[LenzePartsOnline.com](http://LenzePartsOnline.com)

## Key for overview

Position	Description
A	8200 vector frequency inverter
B	Support for standard fixing
C	EMC shield sheet with shield clips for the motor cable and for the motor temperature monitoring feed cable
D	2-pole terminal strip for motor PE and motor shield at X2.1
E	EMC shield sheet with fixing screws and shield clamp for shielded control cables
F	Plug connector 2 × 13-pole for function modules on FIF interface
X1.1	Mains connection and DC supply (integrated terminal strip)
X1.2	Terminal strip for relay output
X2.1	Motor connection, connection brake resistor (option) (integrated terminal strip)
X2.2	Terminal strip for PTC connection or thermal contact (NC contact) of the motor
X3.1	Special design: terminal strip for feedback contact - only for "safe standstill" E82EVxxxKxCx4x variant

## Interfaces and displays

Position	Description	Function
①	2 light-emitting diodes (red, green)	Status display
②	AIF interface (automation interface)	Slot for communication module keypad E82ZBC, keypad XT EMZ9371BC field bus modules type 21XX, e. g. INTERBUS 2111, PROFIBUS-DP 2133, ...
③	FIF interface (function interface)	With cover for the operation without function module or slot for function module standard I/O E82ZAFSC application I/O E82ZAFAC fieldbus function modules type E82ZAFXC, e. g. INTERBUS E82ZAFIC, PROFIBUS-DP E82ZAFPC, ...

<b>1</b>	<b>Safety instructions</b> .....	<b>8</b>
1.1	General safety and application notes for Lenze controllers .....	8
1.2	Residual hazards .....	11
1.3	Definition of notes used .....	13
<b>2</b>	<b>Parameter setting</b> .....	<b>14</b>
2.1	Parameter setting with E82ZBC keypad .....	14
2.1.1	Installation and commissioning .....	14
2.1.2	Display elements and function keys .....	15
2.1.3	Changing and saving parameters .....	17
2.1.4	Menu structure .....	18
<b>3</b>	<b>Troubleshooting and fault elimination</b> .....	<b>20</b>
3.1	Malfunction of the drive .....	20
3.2	Troubleshooting .....	21
3.3	Fault messages on the keypad or in the parameter setting program Global Drive Control .....	22

**LenzePartsOnline.com**

# 1 Safety instructions

General safety and application notes for Lenze controllers

## 1 Safety instructions

### 1.1 General safety and application notes for Lenze controllers

(in accordance with Low-Voltage Directive 2006/95/EC)

#### For your personal safety

Depending on their degree of protection, some parts of the Lenze controllers (frequency inverters, servo inverters, DC speed controllers) and their accessory components can be live, moving and rotating during operation. Surfaces can be hot.

Non-authorized removal of the required cover, inappropriate use, incorrect installation or operation, creates the risk of severe injury to persons or damage to material assets.

For more information, please see the documentation.

High amounts of energy are produced in the controller. Therefore it is required to wear personal protective equipment (body protection, headgear, eye protection, ear protection, hand guard).

All operations concerning transport, installation, and commissioning as well as maintenance must be carried out by qualified, skilled personnel (IEC 364 or CENELEC HD 384 or DIN VDE 0100 and IEC report 664 or DIN VDE 0110 and national regulations for the prevention of accidents must be observed).

According to this basic safety information, qualified, skilled personnel are persons who are familiar with the assembly, installation, commissioning, and operation of the product and who have the qualifications necessary for their occupation.

#### Application as directed

Controllers are components which are designed for installation in electrical systems or machines. They are not to be used as domestic appliances, but only for industrial purposes according to EN 61000-3-2.

When controllers are installed into machines, commissioning (i.e. starting of the operation as directed) is prohibited until it is proven that the machine complies with the regulations of the EC Directive 98/37/EC (Machinery Directive); EN 60204 must be observed.

Commissioning (i.e. starting of the operation as directed) is only allowed when there is compliance with the EMC Directive (2004/108/EC).

The controllers meet the requirements of the Low-Voltage Directive 2006/95/EC. The harmonised standard EN 61800-5-1 applies to the controllers.

The technical data and supply conditions can be obtained from the nameplate and the documentation. They must be strictly observed.

**Warning:** Controllers are products which can be installed in drive systems of category C2 according to EN 61800-3. These products can cause radio interferences in residential areas. In this case, special measures can be necessary.

#### Transport, storage

Please observe the notes on transport, storage, and appropriate handling. Observe the climatic conditions according to the technical data.

**LenzePartsonline.com**



## Installation

The controllers must be installed and cooled according to the instructions given in the corresponding documentation.

Ensure proper handling and avoid excessive mechanical stress. Do not bend any components and do not change any insulation distances during transport or handling. Do not touch any electronic components and contacts.

Controllers contain electrostatic sensitive devices which can easily be damaged by inappropriate handling. Do not damage or destroy any electrical components since this might endanger your health!

## Electrical connection

When working on live controllers, observe the applicable national regulations for the prevention of accidents (e.g. VBG 4).

The electrical installation must be carried out according to the appropriate regulations (e.g. cable cross-sections, fuses, PE connection). Additional information can be obtained from the documentation.

This documentation contains information on installation in compliance with EMC (shielding, earthing, filter, and cables). These notes must also be observed for CE-marked controllers. The manufacturer of the system is responsible for compliance with the limit values demanded by EMC legislation. The controllers must be installed in housings (e.g. control cabinets) to meet the limit values for radio interferences valid at the site of installation. The housings must enable an EMC-compliant installation. Observe in particular that e.g. the control cabinet doors have a circumferential metal connection to the housing. Reduce housing openings and cutouts to a minimum.

Lenze controllers can cause a direct current in the protective conductor. If a residual current device (RCD) is used as a protective means in case of direct or indirect contact, only a residual current device (RCD) of type B may be used on the current supply side of the controller. Otherwise, another protective measure such as separation from the environment through double or reinforced insulation or disconnection from the mains by means of a transformer must be applied.

## Operation

If necessary, systems including controllers must be equipped with additional monitoring and protection devices according to the valid safety regulations (e.g. law on technical equipment, regulations for the prevention of accidents). The controllers can be adapted to your application. Please observe the corresponding information given in the documentation.

After the controller has been disconnected from the supply voltage, all live components and power connections must not be touched immediately because capacitors can still be charged. Please observe the corresponding stickers on the controller.

All protection covers and doors must be shut during operation.

**Notes for UL-approved systems with integrated controllers:** UL warnings are notes that only apply to UL systems. The documentation contains special UL notes.

## Safety functions

Special controller variants support safety functions (e.g. "safe torque off", formerly "safe standstill") according to the requirements of appendix I No. 1.2.7 of the EC Directive "Machinery" 98/37/EC, EN 954-1 category 3 and EN 1037. Strictly observe the notes on the safety functions given in the documentation on the respective variants.

## Safety instructions

General safety and application notes for Lenze controllers

### Maintenance and servicing

The controllers do not require any maintenance if the prescribed operating conditions are observed.

If the ambient air is polluted, the cooling surfaces of the controller may become dirty or the air vents may be obstructed. Therefore, clean the cooling surfaces and air vents periodically under these operating conditions. Do not use sharp or pointed tools for this purpose!

### Disposal

Recycle metal and plastic materials. Ensure professional disposal of assembled PCBs.

**The product-specific safety and application notes given in these instructions must be observed!**

[LenzePartsOnline.com](http://LenzePartsOnline.com)

**1.2**

**Residual hazards**

**Protection of persons**

- ▶ Before working on the drive controller, check whether all power terminals, the relay output, and the pins of the FIF interface are dead, because
  - the power terminals U, V, W, +UG, -UG, BR1 and BR2 still carry dangerous voltage for at least 3 minutes.
  - the power terminals L1, L2, L3; U, V, W, +UG, -UG, BR1 and BR2 carry dangerous voltage when the motor is stopped.
  - the relay outputs K11, K12, K14 can carry dangerous voltage when the drive controller is disconnected from the mains.
- ▶ If you don't use the fail-safe function "selection of direction of rotation" via the digital signal DCTRL1-CW/CCW, (C0007 = 0 ... 13, C0410/3 ≠ 255):
  - In case of open circuit or failure of the control voltage, the drive may change the direction of rotation.
- ▶ If you use the function "flying restart circuit" (C0142 = 2, 3) for machines with a low moment of inertia and low friction:
  - After controller enable has been effected in the standstill status, the motor may temporarily start up, or change direction of rotation.
- ▶ The operating temperature of the heatsink on the drive controller is > 80 °C:
  - Skin contact with the heatsink causes burns.

**Device protection**

- ▶ All pluggable terminals can only be plugged in or unplugged when the controller is disconnected from the power supply!
- ▶ Frequent mains switching (e.g. inching mode via mains contactor) can overload and destroy the input current limitation of the controller:
  - Therefore at least 3 minutes must pass between two switch-on operations.

**Motor protection**

- ▶ Certain drive controller settings can overheat the connected motor:
  - E. g. long-time operation of the DC injection brake.
  - Long-time operation of self-ventilated motors at low speeds.



**Protection of the machine/system**

- ▶ Drives can reach dangerous overspeeds (e. g. setting of high output frequencies in connection with motors and machines not suitable for this purpose):
  - The drive controllers do not provide protection against such operating conditions. For this purpose, use additional components.

**Warnings!**

- ▶ The device has no overspeed protection.
- ▶ Must be provided with external or remote overload protection.
- ▶ Suitable for use on a circuit capable of delivering not more than 5000 rms symmetrical amperes, 240 V maximum (240 V devices) or 500 V maximum (400/500 V devices) resp.
- ▶ Use 60/75 °C or 75 °C copper wire only.
- ▶ Shall be installed in a pollution degree 2 macro-environment.

**LenzePartsOnline.com**

### 1.3 Definition of notes used

The following pictographs and signal words are used in this documentation to indicate dangers and important information:

#### Safety instructions

Structure of safety instructions:



#### Danger!

(characterises the type and severity of danger)

#### Note

(describes the danger and gives information about how to prevent dangerous situations)

Pictograph and signal word	Meaning
<b>Danger!</b>	<b>Danger of personal injury through dangerous electrical voltage.</b> Reference to an imminent danger that may result in death or serious personal injury if the corresponding measures are not taken.
<b>Danger!</b>	<b>Danger of personal injury through a general source of danger.</b> Reference to an imminent danger that may result in death or serious personal injury if the corresponding measures are not taken.
<b>Stop!</b>	<b>Danger of property damage.</b> Reference to a possible danger that may result in property damage if the corresponding measures are not taken.

#### Application notes

Pictograph and signal word	Meaning
<b>Note!</b>	Important note to ensure troublefree operation
<b>Tip!</b>	Useful tip for simple handling
<b>Reference to another documentation</b>	Reference to another documentation



## 2 Parameter setting

Parameter setting with E82ZBC keypad  
Installation and commissioning

## 2 Parameter setting

### 2.1 Parameter setting with E82ZBC keypad

#### Description

The keypad is available as an accessory. A full description of the keypad can be obtained from the Instructions included in the keypad delivery.

#### Plugging in the keypad

It is possible to plug the keypad into the AIF interface or remove it during operation.

As soon as the keypad is supplied with voltage, it carries out a self-test. The keypad is ready for operation if it is in display mode.

#### 2.1.1 Installation and commissioning

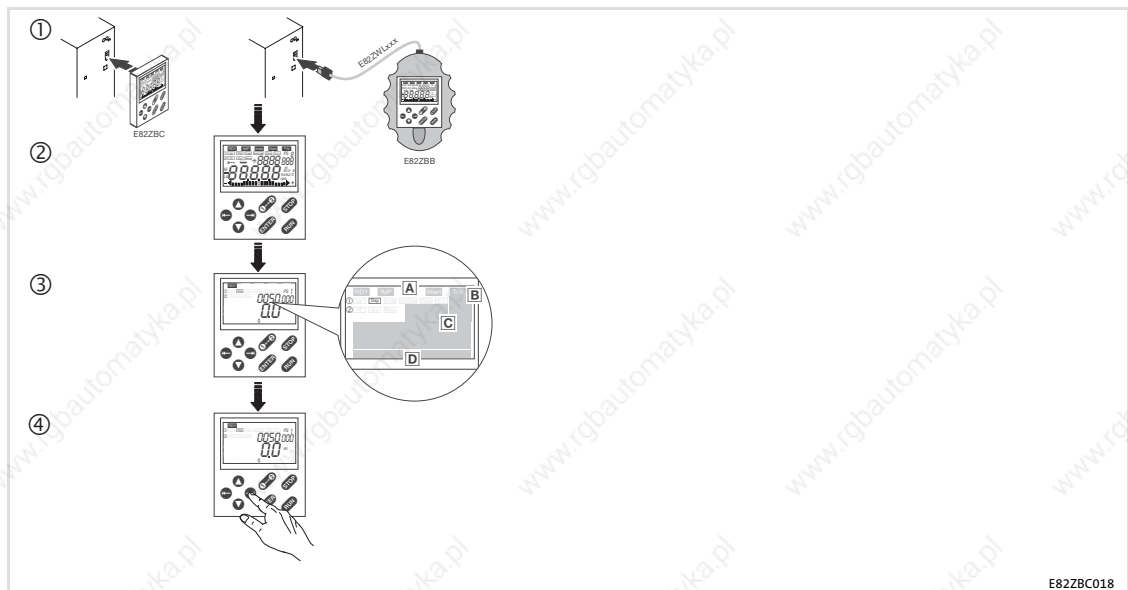

- ① Connect keypad to the AIF interface on the front of the standard device.  
It is possible to connect the keypad and remove it during operation.
- ② As soon as the keypad is supplied with voltage, it carries out a short self-test.
- ③ The keypad is ready for operation, if it displays the "Disp" mode:
  - A Current state of the standard device
  - B Parameter set activated via terminal
  - C Memory location 1 of the user menu (C0517):  
Code number, subcode number, and current value
  - D Current value in % of the status display defined in C0004
- ④ Press **Disp** to leave the "Disp" mode

**LenzePartsOnline.com**

2.1.2 Display elements and function keys

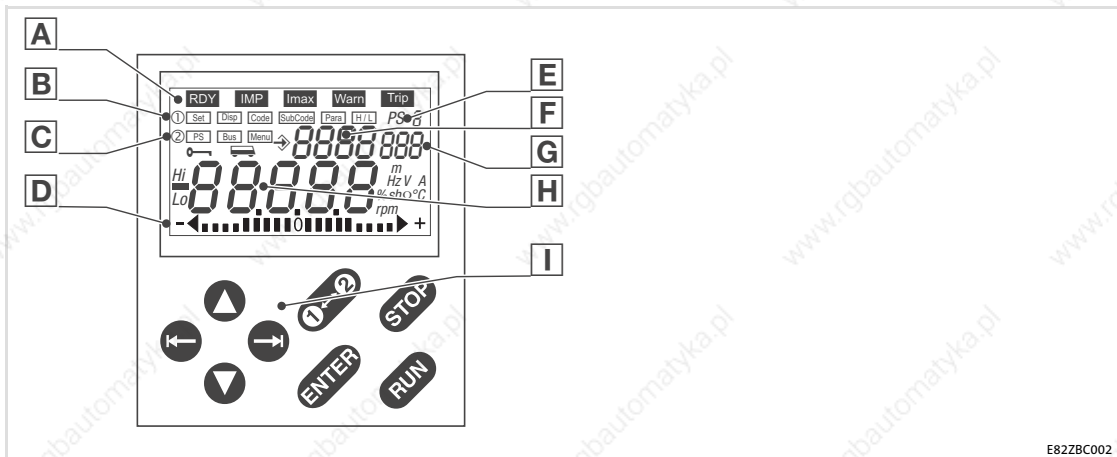

Displays







Display	Meaning	Explanation
<b>A</b>	<b>Status displays</b>	
<b>RDY</b>	Ready for operation	
<b>IMP</b>	Pulse inhibit active	Power outputs are inhibited
<b>Imax</b>	Set current limit exceeded in motor or generator mode	C0022 (in motor mode) or C0023 (in generator mode)
<b>Warn</b>	Warning active	
<b>Trip</b>	Fault active	
<b>B</b>	<b>Function bar 1</b>	
<b>Set</b>	Setpoint selection via	Not possible if password protection is active (display = "LDC")
<b>Disp</b>	Display function: • Display user menu, memory location 1 (C0517/1) • Display active parameter set	Active after every mains connection
<b>Code</b>	Select codes	Four-digit display of the active code <b>F</b>
<b>SubCode</b>	Select subcodes	Three-digit display of the active subcode <b>G</b>
<b>Para</b>	Change parameter value of a code/subcode	Five-digit display of the actual value <b>H</b>
<b>H/L</b>	Display values which have more than 5 digits H: higher-order digits L: lower-order digits	Display of "Hi" Display of "Lo"
<b>C</b>	<b>Function bar 2</b>	
<b>PS</b>	Select parameter set 1 ... 4 for changing	<ul style="list-style-type: none"> <li>• Display of e.g. PS 2 (<b>E</b>)</li> <li>• The parameter sets can only be activated via digital signals (configuration with C0410)</li> </ul>
<b>Bus</b>	Select node of the system bus (CAN)	The selected node can be parameterised from the current drive = Function is active
<b>Menu</b>	Select menu The user menu is active after every mains switching	<ul style="list-style-type: none"> <li><b>uSer</b> List of the codes in the user menu (C0517)</li> <li><b>ALL</b> List of all codes</li> <li><b>Func</b> Only specific codes for bus function modules, e.g. INTERBUS, PROFIBUS-DP, LECOM-B, ...</li> </ul>

## Parameter setting

Parameter setting with E82ZBC keypad  
Display elements and function keys

Display	Meaning	Explanation
<b>D</b>	<b>Bar graph display</b>	
	Value set in C0004 in % (Lenze setting: Device utilisation C0056)	Display range: - 180 % ... + 180 % (1 mark = 20 %)
<b>E</b>	<b>Parameter set display</b>	
	In the <b>[Disp]</b> mode: Display of the parameter set activated via digital signal	
	Otherwise: Display of the parameter set active for changing	Select the individual parameter sets in the <b>[PS]</b> mode in the function bar 2
<b>F</b>	<b>Code number display</b>	
<b>G</b>	<b>Subcode number display</b>	
<b>H</b>	<b>Display of parameter value or fault message</b>	

### Function keys

Pos.	Key	Function	Explanation
<b>I</b>		<b>Function keys</b>	
		Enable controller	For operation with a function module, the X3/28 terminal must be set to HIGH level.
		Inhibit controller (CINH) or quick stop (QSP)	Configuration in C0469; inactive if the standard device is running in manual mode (C0410/17)
		Change between function bar 1 ↔ function bar 2	
		To the right/left in the active function bar	The active function is framed.
		Increase/decrease value Quick change: Keep the key pressed	Only blinking values can be changed.
		Store parameters if  is blinking Confirmation by <i>STOP-E</i> in the display	

**LenzePartsOnline.com**



2.1.3 Changing and saving parameters



**Note!**

- ▶ The *USER* menu is active after mains switching. Change to the *ALL* menu to address all codes.
- ▶ With the keypad you can only change parameter values in the parameter sets.
- ▶ A parameter set can only be activated for operation by means of digital signals (configuration via C0410)!
- ▶ In the Disp function, the keypad shows the parameter set which is currently active during operation.

Step	Key sequence	Result	Action
1.	Connect keypad	<span style="border: 1px solid black; padding: 0 2px;">Disp</span> XX.XX Hz	The <span style="border: 1px solid black; padding: 0 2px;">Disp</span> function is active. The first code in the user menu is displayed (C0517/1, Lenze setting: C0050 = output frequency).
2.	If required, change to the "ALL" menu		Change to function bar 2
3.		<span style="border: 1px solid black; padding: 0 2px;">Menu</span>	
4.			Select "ALL" menu (list of all codes)
5.			Confirm selection and change to function bar 1
6.	Select parameter set for change		Change to function bar 2
7.		<span style="border: 1px solid black; padding: 0 2px;">PS</span>	
8.		1 ... 4	Select parameter set to be changed
9.			Confirm selection and change to function bar 1
10.	Inhibit controller	<span style="border: 1px solid black; padding: 0 2px;">STOP</span> <span style="border: 1px solid black; padding: 0 2px;">RDY</span> <span style="border: 1px solid black; padding: 0 2px;">IMP</span>	Only necessary if you change C0002, C0148, C0174, and/or C0469
11.	Set parameters	<span style="border: 1px solid black; padding: 0 2px;">Code</span>	
12.		XXXX	Select code
13.		<span style="border: 1px solid black; padding: 0 2px;">SubCode</span> 00i	For codes without subcodes: automatic skip to <span style="border: 1px solid black; padding: 0 2px;">Para</span>
14.		XXX	Select subcode
15.		<span style="border: 1px solid black; padding: 0 2px;">Para</span>	
16.		XXXXX	Set parameter
17.		<span style="border: 1px solid black; padding: 0 2px;">ENTER</span> <i>STOP-E</i>	Confirm entry if  is blinking
			Confirm entry if  is not blinking; <span style="border: 1px solid black; padding: 0 2px;">ENTER</span> is inactive
18.			Restart "loop" at 11. or 6. to set further parameters



**2.1.4****Menu structure**

For easy operation, the codes are grouped into two menus:

- ▶ The *uSEr* menu
  - is active after every mains switching or after connection of the keypad during operation.
  - contains all codes for a standard application with linear V/f characteristic control (Lenze setting).
  - can be modified as required under C0517.
- ▶ The *ALL* menu
  - contains all codes.
  - shows a list of all codes in numerically ascending order.

**The *uSEr* menu - the 10 most important drive parameters at a glance**

After every mains switching, or after connection of the keypad during operation, the 10 codes that have been defined in code C0517 are immediately available.

In the Lenze setting, the *uSEr* menu contains all codes required for starting up a standard application with linear V/f characteristic control:

**LenzePartsOnline.com**



### 3 Troubleshooting and fault elimination

#### Malfuction of the drive

### 3 Troubleshooting and fault elimination

#### 3.1 Malfuction of the drive

Malfuction	Cause	Remedy
<b>Motor does not rotate</b>	DC-bus voltage too low (red LED is blinking every 0.4 s; keypad displays: <i>LU</i> )	Check mains voltage
	Controller inhibited (green LED is blinking, keypad displays: <i>IMP</i> )	Deactivate controller inhibit, controller inhibit can be set via several sources
	Automatic start inhibited (C0142 = 0 or 2)	LOW-HIGH edge at X3/28 If necessary, correct starting condition (C0142)
	DC-injection braking (DCB) active	Deactivate DC injection brake
	Mechanical motor brake is not released	Manual or electrical release of mechanical motor brake
	Quick stop (QSP) active (keypad displays: <i>IMP</i> )	Deactivate quick stop
	Setpoint = 0	Select setpoint
	JOG setpoint activated and JOG frequency = 0	Select JOG setpoint (C0037 ... C0039)
	Active fault	Eliminate fault
	Incorrect parameter set active	Change to correct parameter set via terminal
	Operating mode C0014 = -4-, -5- set, but no motor parameter identification	Identify motor parameters (C0148)
	Assignment of several functions excluding each other to one signal source in C0410	Correct configuration in C0410
	Use of internal voltage source X3/20 for the function modules Standard I/O, INTERBUS, PROFIBUS-DP, or LECOM-B (RS485): No jumper between X3/7 and X3/39	Jumper terminals
<b>Motor does not rotate smoothly</b>	Motor cable defective	Check motor cable
	Maximum current set too low (C0022, C0023)	Adjust settings to the application
	Motor is under- or overexcited	Check parameter setting (C0015, C0016, C0014)
	C0084, C0087, C0088, C0089, C0090, C0091 and/or C0092 not adjusted to the motor data	Adjust codes manually or identify motor parameters (C0148); optimise vector control
<b>Current consumption of motor too high</b>	Setting of C0016 too high	Correct setting
	Setting of C0015 too low	Correct setting
	C0084, C0087, C0088, C0089, C0090, C0091 and/or C0092 not adjusted to the motor data	Adjust codes manually or identify motor parameters (C0148); optimise vector control
<b>Motor rotates, setpoints are "0"</b>	With the <input type="checkbox"/> <i>Set</i> function of the keypad a setpoint has been selected	Set setpoint to "0" with C0140 = 0
<b>Motor parameter identification stops with error LP1</b>	Motor is too small in relation to the rated power of the drive	
	DC injection brake (DCB) active via terminal	
<b>Unacceptable drive response with vector control</b>	Various	Optimise vector control
<b>Torque dip in the field weakening range</b>	Various	Contact Lenze
<b>Stalling of the motor when operating in the field weakening range</b>		

3.2 Troubleshooting

LED red ①	LED green ②	Operating status	
Off	On	Drive controller enabled	
On	On	Mains switched on and automatic start inhibited	
Off	Blinking slowly	Drive controller inhibited	
Off	Blinking quickly	Motor parameter identification	
Blinking quickly	Off	Undervoltage or overvoltage	
Blinking slowly	Off	Fault active, check in C0161	

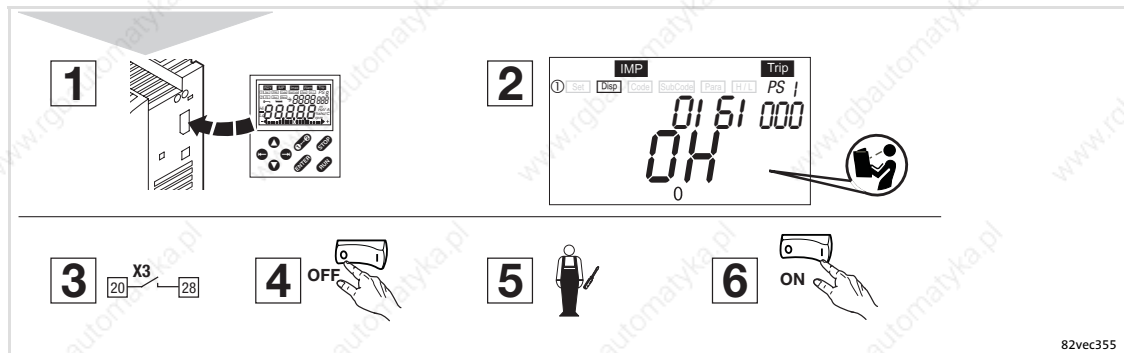

Reset the drive controller in this way if a fault occurs (TRIP reset):

1. Plug the keypad onto the AIF interface during operation.
2. Read and take down fault message on the keypad display.
3. Inhibit controller.
4. Disconnect controller from the mains.
5. Carry out a fault analysis and eliminate the faults.
6. Restart the controller.

**LenzePartsOnline.com**

#### 3.3 Fault messages on the keypad or in the parameter setting program Global Drive Control

Keypad	PC 1)	Fault	Cause	Remedy
nDEr	0	No fault	-	-
CCr Trip	71	System failure	Strong interference injections on the control cables Earth loops in the wiring	Shield control cable
CE0 Trip	61	Communication error on AIF (configurable in C0126)	Faulty transmission of control commands via AIF	Insert the communication module properly into the diagnosis terminal
CE1 Trip	62	Communication error on CAN-IN1 with sync control	CAN-IN1 object receives faulty data or communication is interrupted	<ul style="list-style-type: none"> <li>Check plug connection of bus module ↔ FIF</li> <li>Check sender</li> <li>Increase monitoring time in C0357/1, if necessary</li> </ul>
CE2 Trip	63	Communication error on CAN-IN2	CAN-IN2 object receives faulty data or communication is interrupted	<ul style="list-style-type: none"> <li>Check plug connection of bus module ↔ FIF</li> <li>Check sender</li> <li>Increase monitoring time in C0357/2, if necessary</li> </ul>
CE3 Trip	64	Communication error on CAN-IN1 with event or time control	CAN-IN1 object receives faulty data or communication is interrupted	<ul style="list-style-type: none"> <li>Check plug connection of bus module ↔ FIF</li> <li>Check sender</li> <li>Increase monitoring time in C0357/3, if necessary</li> </ul>
CE4 Trip	65	BUS-OFF (many communication errors occurred)	Controller has received too many faulty telegrams via the system bus and has been disconnected from the bus	<ul style="list-style-type: none"> <li>Check whether bus termination is available</li> <li>Check shield connection of the cables</li> <li>Check PE connection</li> <li>Check bus load, reduce the baud rate, if necessary</li> </ul>
CE5 Trip	66	CAN time-out (configurable in C0126)	In case of remote parameterisation via the system bus (C0370): Slave does not respond. Communication monitoring time has been exceeded	<ul style="list-style-type: none"> <li>Check wiring of the system bus</li> <li>Check system bus configuration</li> </ul>
			When operating with Application I/O: Parameter set change-over has been parameterised incorrectly	In all parameter sets, the "change parameter set" signal (C0410/13, C0410/14) must be connected with the same source
			When operating with module on FIF: Internal error	Contact Lenze
CE6 Trip	67	System bus (CAN) function module on FIF has the "Warning" or "BUS-OFF" status (configurable in C0126)	CAN controller signals "Warning" or "BUS-OFF" status	<ul style="list-style-type: none"> <li>Check whether bus termination is available</li> <li>Check shield connection of the cables</li> <li>Check PE connection</li> <li>Check bus load, reduce the baud rate, if necessary</li> </ul>
CE7 Trip	68	Communication error in case of remote parameterisation via the system bus (C0370) (configurable in C0126)	Node does not respond or is not available	<ul style="list-style-type: none"> <li>Check whether bus termination is available</li> <li>Check shield connection of the cables</li> <li>Check PE connection</li> <li>Check bus load, reduce the baud rate, if necessary</li> </ul>
			When operating with Application I/O: Parameter set change-over has been parameterised incorrectly	In all parameter sets, the "change parameter set" signal (C0410/13, C0410/14) must be connected with the same source
EEr Trip	91	External fault (TRIP-SET)	A digital signal assigned to the TRIP-SET function is activated	Check external encoder

## Fault messages on the keypad or in the parameter setting program Global Drive Control

Keypad	PC <sup>1)</sup>	Fault	Cause	Remedy
<i>ErPO</i> ... <i>ErPI9</i> <b>Trip</b>	-	Communication interruption between keypad and standard device	Various	Contact Lenze
<i>FRnI</i> <b>Trip</b>	95	Fan failure (only 8200 motec 3 ... 7.5 kW)	Fan is defective	Replace fan
<i>FRnI</i>	-	TRIP or warning configurable in C0608	Fan is not connected	Connect fan Check wiring
<i>H05</i> <b>Trip</b>	105	Internal fault		Contact Lenze
<i>IdI</i> <b>Trip</b>	140	Faulty parameter identification	Motor is not connected	Connect motor
<i>LPI</i> <b>Trip</b>	32	Error in motor phase (Display when C0597 = 1)	<ul style="list-style-type: none"> <li>● Failure of one/several motor phase(s)</li> <li>● Motor current too low</li> </ul>	<ul style="list-style-type: none"> <li>● Check motor supply cables</li> <li>● Check <math>V_{min}</math> boost,</li> <li>● Connect motor with a corresponding power or adapt motor with C0599</li> </ul>
<i>LPI</i>	182	Error in motor phase (Display when C0597 = 2)		
<i>LU</i> <b>IMP</b>	-	DC bus undervoltage	Mains voltage too low	Check mains voltage
			Voltage in DC-bus connection too low	Check power supply module
			400 V controller is connected to 240 V mains	Connect controller to correct mains voltage
<i>DCI</i> <b>Trip</b>	11	Short circuit	Short circuit	<ul style="list-style-type: none"> <li>● Search for cause of short circuit; check motor cable</li> <li>● Check brake resistor and cable to brake resistor</li> </ul>
			Capacitive charging current of the motor cable too high	Use shorter/low-capacitance motor cable
<i>DC2</i> <b>Trip</b>	12	Earth fault	Earthed motor phase	Check motor; check motor cable
			Capacitive charging current of the motor cable too high	Use shorter/low-capacitance motor cable
				Deactivate earth-fault detection for test purposes
<i>DC3</i> <b>Trip</b>	13	Controller overload during acceleration or short circuit	Acceleration time set is too short (C0012)	<ul style="list-style-type: none"> <li>● Increase acceleration time</li> <li>● Check drive dimensioning</li> </ul>
			Defective motor cable	Check wiring
			Interturn fault in the motor	Check motor
<i>DC4</i> <b>Trip</b>	14	Controller overload during deceleration	Deceleration time set is too short (C0013)	<ul style="list-style-type: none"> <li>● Increase deceleration time</li> <li>● Check dimensioning of the external brake resistor</li> </ul>
<i>DC5</i> <b>Trip</b>	15	Controller overload during steady-state operation	Frequent and too long overload	Check drive dimensioning
<i>DC6</i> <b>Trip</b>	16	Motor overload ( $I^2 \times t$ overload)	Motor is thermally overloaded by e.g. <ul style="list-style-type: none"> <li>● impermissible continuous current</li> <li>● frequent or too long acceleration processes</li> </ul>	<ul style="list-style-type: none"> <li>● Check drive dimensioning</li> <li>● Check setting of C0120</li> </ul>
<i>DH</i> <b>Trip</b>	50	Heatsink temperature > +85 °C	Ambient temperature is too high	Allow controller to cool and provide better ventilation
<i>DH</i> <b>Warn</b>	-	Heatsink temperature > +80 °C	Heatsink is very dirty	Clean heatsink
			Impermissibly high currents or frequent and too long acceleration processes	<ul style="list-style-type: none"> <li>● Check drive dimensioning</li> <li>● Check load, exchange tight, defective bearings if necessary</li> </ul>

### 3

## Troubleshooting and fault elimination

Fault messages on the keypad or in the parameter setting program Global Drive Control

Keypad	PC <sup>1)</sup>	Fault	Cause	Remedy
DH3 Trip	53	PTC monitoring (TRIP) (Display when C0119 = 1 or 4)	Motor too hot due to impermissibly high currents or frequent and too long acceleration processes	Check drive dimensioning
			No PTC connected	Connect PTC or switch off monitoring
DH4 Trip	54	Controller overtemperature	Controller too hot inside	<ul style="list-style-type: none"> <li>• Reduce controller load</li> <li>• Improve cooling</li> <li>• Check fan in the controller</li> </ul>
DHS1	203	PTC monitoring (Display when C0119 = 2 or 5)	Motor too hot due to impermissibly high currents or frequent and too long acceleration processes	Check drive dimensioning
			No PTC connected	Connect PTC or switch off monitoring
DU IMP	-	DC bus overvoltage (Message or TRIP configurable in C0310)	Mains voltage too high	Check supply voltage
QUE Trip	22		Braking operation	<ul style="list-style-type: none"> <li>• Increase deceleration times</li> <li>• When operating with an external brake resistor:                             <ul style="list-style-type: none"> <li>– Check dimensioning, connection and supply cable of the brake resistor</li> <li>– Increase deceleration times</li> </ul> </li> </ul>
			Earth leakage on the motor side	Check motor supply cable and motor for earth fault (disconnect motor from the inverter)
Pr Trip	75	Faulty parameter transfer with the keypad	All parameter sets are defective	Before enabling the controller, repeat the data transfer or load the Lenze setting
Pr-1 Trip	72	Faulty PAR1 transfer with keypad	Parameter set 1 is defective	
Pr-2 Trip	73	Faulty PAR2 transfer with keypad	Parameter set 2 is defective	
Pr-3 Trip	77	Faulty PAR3 transfer with keypad	Parameter set 3 is defective	
Pr-4 Trip	78	Faulty PAR4 transfer with keypad	Parameter set 4 is defective	
Pr-5 Trip	79	Internal fault	EEPROM is defective	Contact Lenze
PT5 Trip	81	Time error during parameter set transfer	Data flow from keypad or PC interrupted, e.g. because keypad was disconnected during transfer	Before enabling the controller, repeat the data transfer or load the Lenze setting.
r-5T Trip	76	Error during auto TRIP reset	More than 8 error messages within 10 minutes	Depends on the error message
Sd5 Trip	85	Open circuit - analog input 1	Current at analog input < 4 mA at setpoint range 4 ... 20 mA	Close circuit at analog input
Sd7 Trip	87	Open circuit - analog input 2		

1) LECOM error number, display in Global Drive Control (GDC) parameter setting program

**LenzePartsOnline.com**



Lenze Drive Systems GmbH  
Hans-Lenze-Straße 1  
D-31855 Aenzen  
Germany



+49 (0) 51 54 82-0

Service

00 80 00 24 4 68 77 (24 h helpline)

Service

+49 (0) 51 54 82-1112

E-Mail

Lenze@Lenze.de

Internet

www.Lenze.com

EDK82EV113 4.0 02/2008  
© 2008  
TD23



LenzePartsOnline.com

10 9 8 7 6 5 4 3 2 1