



OFFICIAL DISTRIBUTOR

RGB ELEKTRONIKA AGACIAK CIACIEK SP.J.
ul. Jana Długosza 2-6
51-162 Wrocław

+48 71 325 15 05
biuro@rgbelektronika.pl

ENCODER ROD 700 18000 ROD70018000 SIN/COS 18000 PPR +5V REPLACEMENT
ID23627



PRECIZIKA
METROLOGY



A170

PHOTOELECTRIC ANGLE ENCODER

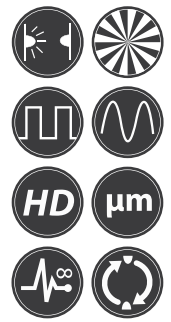

Precision photoelectric angle encoder A170 is used for precise angular displacement measurement of rotary tables, dividers, comparators, antennas and other high precision equipment. It provides information about the value and direction of motion. The encoder is used in automatic control, on-line gauging, process monitoring systems, etc.

The stainless steel case of the encoder is mounted using screws. The angle encoder is connected to the motor shaft or spindle via coupling, available optionally.

Three versions of output signals are available:

- A170-A - sinusoidal signals, with amplitude approx. 11 μ App;
- A170-AV - sinusoidal signals, with amplitude approx. 1 Vpp;
- A170-F - square-wave signals (TTL) with integrated subdividing electronics for interpolation x1, x2, x5, x10, x20, x25, x50 and x100.

The modification with distance-coded reference marks is available

MECHANICAL DATA

Line number on disc (Z)	18000, 36000
Number of output pulses per revolution for A170-F	Z x k, where k = 1, 2, 3, 4, 5, 8, 10, 20, 25, 50, 100
Reference signal:	
- standard (S)	One per shaft revolution
- distance-coded (K) for z = 18000	36 per shaft revolution
- distance-coded (K) for z = 36000	72 per shaft revolution
Permissible mech. speed	≤ 1000 rpm
Max. operating speed (depends on number of output pulses)	300 to 500 rpm
Accuracy	$\pm 2.5; \pm 5.0$ arc. sec

Permissible shaft load:	
- axial	≤ 30 N
- radial	≤ 30 N
Starting torque at 20°C	≤ 0.012 Nm
Rotor moment of inertia	$< 3.7 \times 10^{-4}$ kgm ²
Protection (IEC 529)	IP64
Maximum weight without cable	3.5 kg
Operating temperature	0...+70 °C
Storage temperature	-30...+85°C
Maximum humidity (non condensing)	98 %
Permissible vibration	≤ 100 m/s ²
Permissible shock (6 ms)	≤ 300 m/s ²

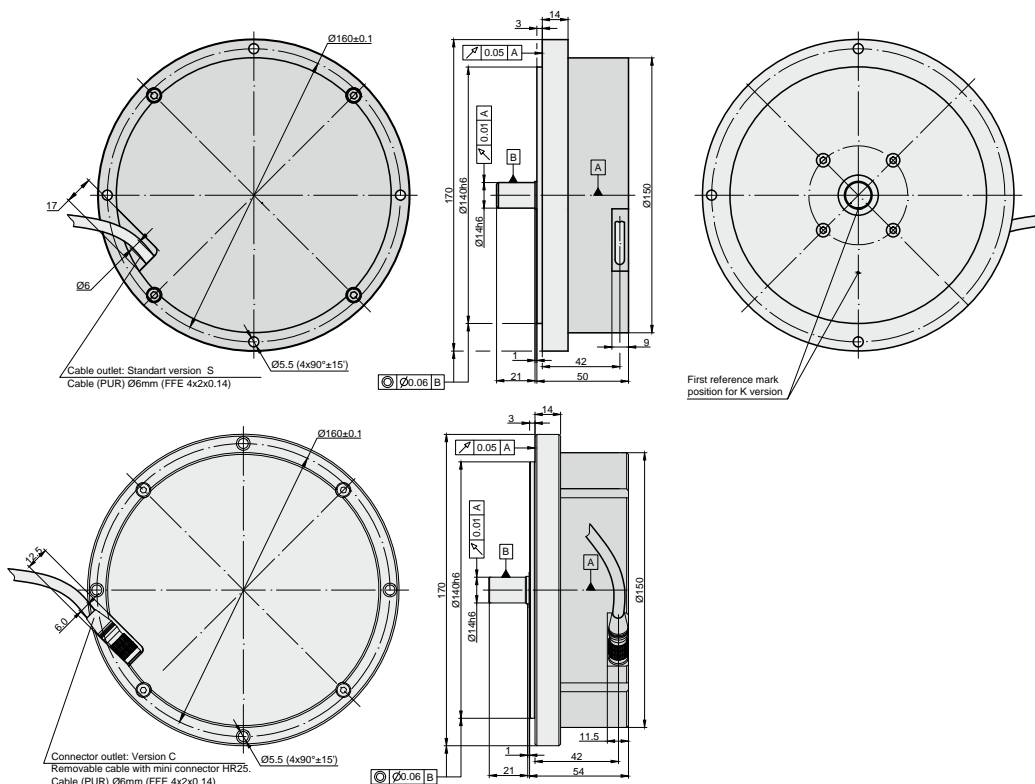

ELECTRICAL DATA

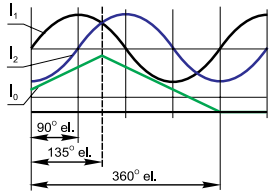
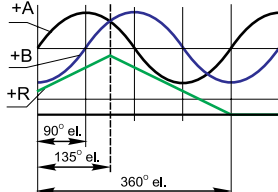
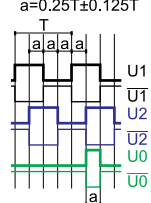
VERSION	A170-A \sim 11 μ App	A170-AV \sim 1 Vpp	A170-F \square TTL
Supply voltage (U_p)	+5 V \pm 5% 100 mA max.	+5 V \pm 5% 120 mA max.	+5 V \pm 5%; 150 mA max.
Light source	LED	LED	LED
Incremental signals	Two sinusoidal I_1 and I_2 Amplitude at 1 k Ω load: - $I_1 = 7 \dots 16 \mu$ A - $I_2 = 7 \dots 16 \mu$ A	Differential sine +A/-A and +B/-B Amplitude at 120 Ω load: - A = 0.6...1.2 V - B = 0.6...1.2 V	Differential square-wave $U1/\overline{U1}$ and $U2/\overline{U2}$. Signal levels at 20 mA load current: - low (logic "0") \leq 0.5 V - high (logic "1") \geq 2.4 V
Reference signal	One quasi-triangular I_0 peak per revolution. Signal magnitude at 1 k Ω load: - $I_0 = 2 \dots 8 \mu$ A (usable component)	One quasi-triangular +R and its complementary -R per revolution. Signals magnitude at 120 Ω load - R = 2...8 V (usable component)	One differential square-wave $U0/\overline{U0}$ per revolution. Signal levels at 20 mA load current: - low (logic "0") < 0.5 V - high (logic "1") > 2.4 V
Maximum operating frequency	(-3 dB cutoff) \geq 160 kHz	(-3 dB cutoff) \geq 180 kHz	(160-2500 kHz (depends on interpolation factor)
Direction of signals	I_2 lags I_1 for clockwise rotation (viewed from encoder mounting side)	+B lags +A for clockwise rotation (viewed from encoder mounting side)	$U2$ lags $U1$ with clockwise rotation (viewed from encoder mounting side)
Maximum rise and fall time	-	-	< 0.5 μ s
Standard cable length	1 m, without connector	1 m, without connector	1 m, without connector
Maximum cable length	5 m	25 m	25 m
Output signals			

Note:

- Maximum working rotation speed (with proper encoder counting) is limited by maximum operating frequency and maximum mechanical rotation speed.
- If cable extension is used, power supply conductor cross-section should not be smaller than 0.5 mm².

ACCESSORIES

CONNECTORS FOR CABLE	B12 12-pin round connector	C9 9-pin round connector	C12 12-pin round connector	D9 9-pin flat connector	D15 15-pin flat connector	RS10 10-pin round connector	ONC 10-pin round connector	HR25 8-pins round mini connector
DIGITAL READOUT DEVICES	CS3000				CS5000			
COUPLING	SC98-1				SC98-2			
EXTERNAL INTERPOLATOR	NK							

ORDER FORM

A170 - X - XXXXXX/XXXXX - X - XX - X - XX/X - X								
OUTPUT SIGNAL VERSION:	PULSE NUMBER PER REVOLUTION:	OPTIONAL LINE NUMBER ON DISC (Z):	REFERENCE SIGNAL:	ACCURACY GRADE:	CABLE OR CONNECTOR OUTLET:	CABLE LENGTH:	CONNECTOR TYPE:	COUPLING:
A AV F	1...18000 ... 1...3600000	18000 36000 *only for A170-F	S - one per revolution, K - distance-coded	25 \pm 2.5 arc.sec. 50 \pm 5.0 arc.sec.	S - version S (cable outlet) C-version C (connector outlet)	AR01 - 1m AR02 - 2m AR03 - 3m ...	W - without connector B12 - round, 12 pins C9 - round, 9 pins C12 - round, 12 pins D9 - flat, 9 pins D15 - flat, 15 pins RS10 - round, 10 pins ONC - round, 10 pins	0 - without coupling 1 - SC98-1
ORDER EXAMPLES:			1) A170-F-360000/36000-K-25-C-AR01/C12-1 2) A170-F-360000-K-25-S-AR01/C12-1					