

Pegasus

Contact blocks

Spring loaded Terminals



AUTOMATION TECHNOLOGIES

SPRING LOADED TERMINALS

		CONTACT BLOCKS			
	DESIGNATION	FUNCTIONS	CODE	DIMENSIONS	
			PCW01		

LAMPHOLDER BA9s

	DESIGNATION	POWER SUPPLY	CODE	DIMENSIONS
		BA9s lamp socket 250V 2,4 w max bulb not included	PCWAD	

LAMPHOLDER WITH BUILT-IN LED

	DESIGNATION	POWER SUPPLY	CODE	DIMENSIONS
		AC/DC 12V	PCW5L12	
		AC/DC 24V	PCW5L24	
		AC/DC 48V	PCW5L48	
		AC/DC 110V	PCW5L110	
		AC 220V	PCW5L220	

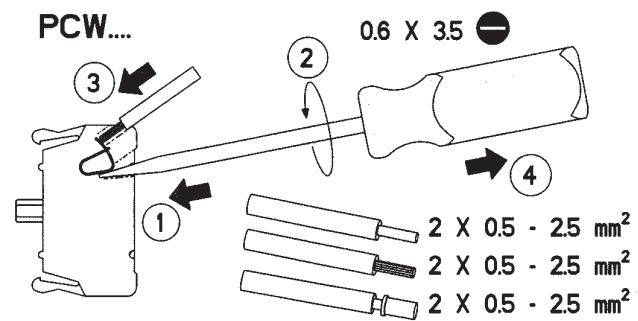
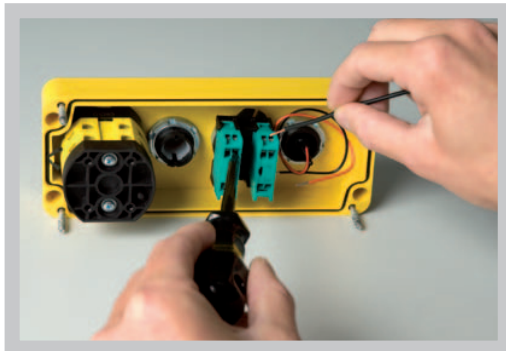





Pegasus

Contact blocks

Welding terminals

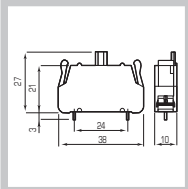
CONTACT BLOCKS

CONTACT BLOCKS				
DESIGNATION	FUNCTIONS	CODE	DIMENSIONS	
 <p>NC 1 — 2</p>	<p>0 1,5 6 mm</p> 	PSC01		
<p>NO 3 — 4</p>	<p>0 3,5 6 mm</p> 	PSC10		

LAMPHOLDER BA9s

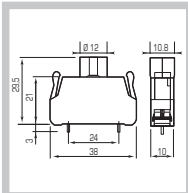
DESIGNATION	POWER SUPPLY	CODE	DIMENSIONS
 <p>X1 — X2</p>	<p>BA9s lamp socket 250V 2,4 w max bulb not included</p>	PSCAD	

LAMPHOLDER WITH BUILT-IN LED

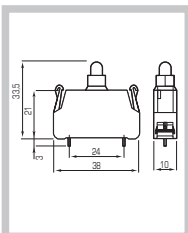
DESIGNATION	POWER SUPPLY	CODE	DIMENSIONS
 <p>X1 — X2</p>	AC/DC 12V	PSC5L12	
	AC/DC 24V	PSC5L24	
	AC/DC 48V	PSC5L48	
	AC/DC 110V	PSC5L110	
	AC 220V	PSC5L220	

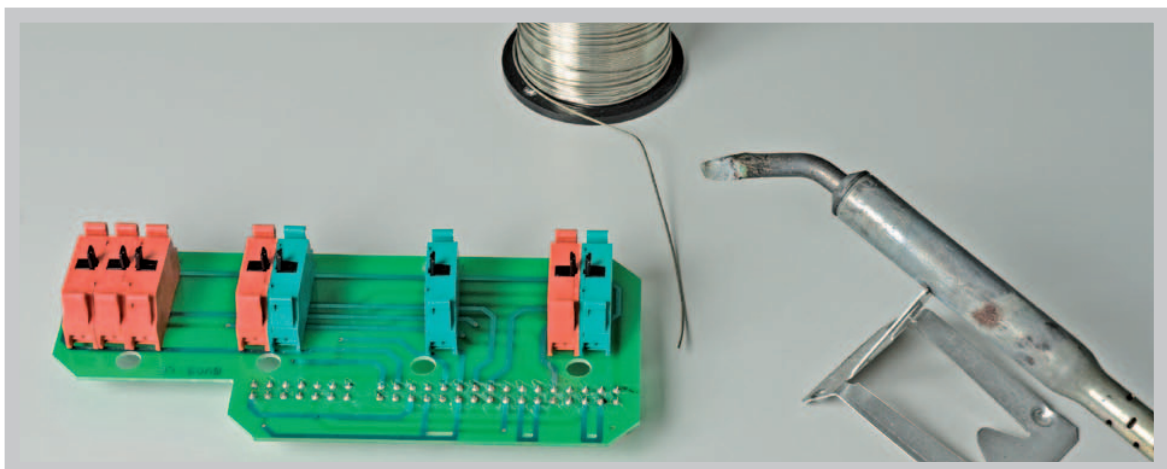

Pegasus



Contact blocks

Screw terminals



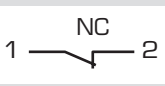

AUTOMATION TECHNOLOGIES

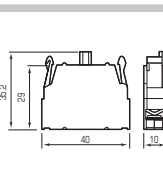
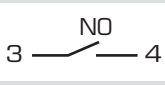
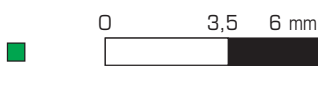
CONTACT BLOCKS

		CONTACT BLOCKS				
DESIGNATION	FUNCTIONS	CODE	DIMENSIONS			
	NC 		PL004001			
	NO 		PL004002			

LAMPHOLDER BA9s

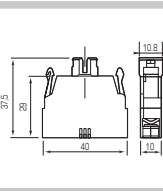
DESIGNATION	POWER SUPPLY	CODE	DIMENSIONS	
	 <p>BA9s lamp socket 250V 2,4 w max bulb not included</p>	PL004007		



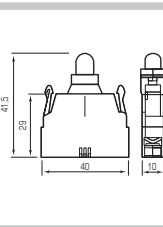



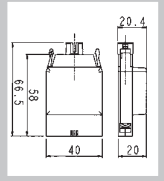

LAMPHOLDER WITH BUILT-IN LED

DESIGNATION	POWER SUPPLY	CODE	DIMENSIONS	
	AC/DC 12V	PL0045L12		
	AC/DC 24V	PL0045L24		
	AC/DC 48V	PL0045L48		
	AC/DC 110V	PL0045L110		
	AC 220V	PL0045L220		

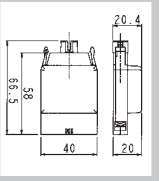
POWER SUPPLY WITH DIODE AND RESISTORS

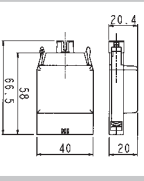
POWER SUPPLY WITH TRANSFORMER

POWER SUPPLY WITH FLASHING LIGHT

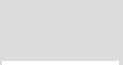
					
1 BA9s 110/130V Lamp 4B/60V 2W max CODE: PL004RD1	1 BA9s Input 110/130V Output 24V CODE: PL004TR1	1 BA9s 24V Lamp 24V-2,6 max CODE: PL004LA1			
 220/240V Lamp 110/130V 2W max CODE: PL004RD2	 Input 220/240V Output 24V CODE: PL004TR2	 110/130V 110/130V-2,6 max CODE: PL004LA2			
 Input 380/440V Output 24V CODE: PL004TR3					

1 Lamp supply separately