

NANO B and C

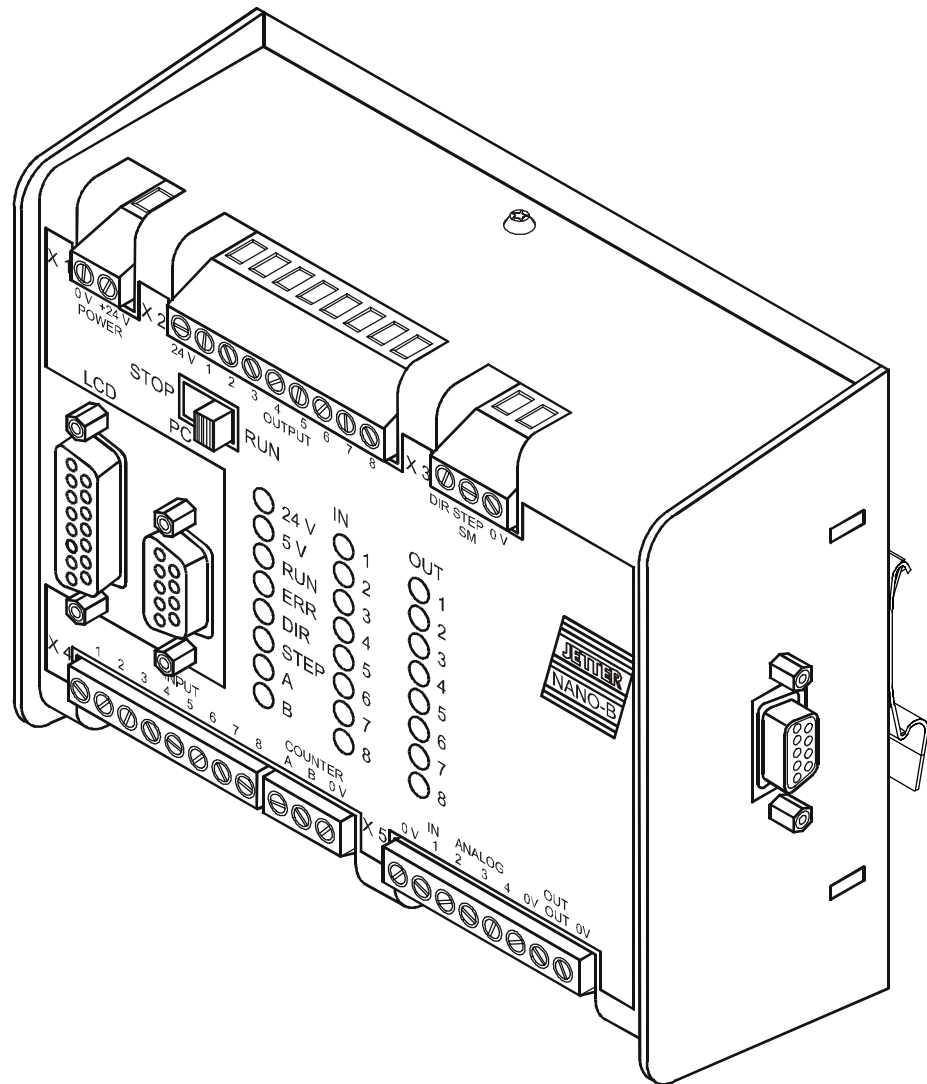

PROCESS-PLC

Operator's Manual



Edition 3.5

Jetter AG reserves the right to make alterations to its products in the interest of technical progress. These alterations need not be documented in every single case.

This manual and the information contained herein have been compiled with due diligence. However, Jetter AG assumes no liability for printing or other errors or damages arising from such errors.

The brand names and product names used in this manual are trade marks or registered trade marks of the respective title owner.

How to Contact us:

Jetter AG
Gräterstrasse 2
D-71642 Ludwigsburg
Germany

Phone - Switchboard: ++49 7141/2550-0
Phone - Sales: ++49 7141/2550-530
Phone - Technical Hotline: ++49 7141/2550-444

Telefax: ++49 7141/2550-425
E-Mail - Sales: sales@jetter.de
E-Mail - Technical Hotline: hotline@jetter.de
Internet Address: http://www.jetter.de

This Manual is an Integral Part of the PROCESS-PLC Systems NANO-B and NANO-C:

Model: _____
Serial No: _____
Year of Manufacture: _____
Order No: _____



To be entered by the customer:

Inventory No: _____
Place of operation: _____

© Copyright 2002 by Jetter AG. All rights reserved.

Significance of this Operator's Manual

This manual is an integral part of the PROCESS-PLC NANO-B

- and must be kept in a way that it is always at hand until the PROCESS-PLC NANO-B will be disposed.
- If the PROCESS-PLC NANO-B is sold, transferred or lent, this manual must be handed over.

In any case you encounter difficulties to clearly understand the manual, please contact the manufacturer.

We would appreciate any kind of suggestion and contributions on your part and would ask you to inform or write us. This will help us to produce manuals that are more user-friendly and to address your wishes and requirements.

From this PROCESS-PLC NANO-B may result unavoidable residual risks to persons and property. For this reason, any person who has to deal with the operation, transport, installation, maintenance and repair of the PROCESS-PLC NANO-B must have been familiarised with it and must be aware of these dangers.

Therefore, this person must carefully read, understand and observe this manual, and especially the safety instructions.

Missing or inadequate knowledge of the manual results in the loss of any claim of liability on part of Jetter AG. Therefore, the operating company is recommended to have the instruction of the persons concerned confirmed in writing.

Table of Contents

1	Safety Instructions	11
2	Installing the NANO-B Controller	16
2.1	Mechanical Connection	16
2.2	Electrical Connection	18
2.2.1	Power Supply	18
2.2.2	Interfaces	19
2.2.3	Digital Inputs	31
2.2.4	Digital Outputs	32
2.2.5	Single- and Dual-Channel Counter	33
2.2.6	Analog Inputs	34
2.2.7	Analog Output	35
2.2.8	Stepper Motor Control	36
2.3	Description of LEDs	39
2.4	Description of the STOP/RUN Switch	40
3	Basic Unit	41
3.1	Physical Dimensions	41
3.2	Technical Data	41
4	Operating Conditions	44
5	Software Programming	48
5.1	Addressing Digital Inputs/Outputs	48
5.1.1	Basic Controller	48
5.1.2	Expansion Modules	48
5.2	Access to Flags	50
5.2.1	User Flags	50
5.2.2	Special Flags	52
5.3	Register Description	55
5.3.1	User Registers	55
5.3.2	Programming with the Aid of Registers	55
5.3.3	Calculating with the Aid of Registers	58
5.3.4	Special Registers	61
6	User Interfaces, Operator Guidance	74
6.1	Technical Data	74
6.2	Description of Connections	76
6.3	Multi-Display Mode	76
6.4	Programming the User Interfaces	78
6.4.1	Display of Texts	78
6.4.2	Text Output Parameters	78

6.4.3	Control Characters for Text Output	80
6.4.4	Displaying Register Contents	81
6.4.5	Query of Register Values	82
6.5	Fixed-point Numbers	83
6.5.1	Display of Fixed-point Numbers	83
6.5.2	Input of Fixed-point Numbers	84
6.5.3	USER_INPUT: Suggested Value	86
6.6	Registers for User Interfaces	87
6.7	User Interface-related Flags	100
6.8	Controlling the Keys and LEDs of the User Interface	101
7	Network Operation	107
7.1	JETWay-H: JETTER Data Highway	107
7.2	JETWay-R: Process Level	108
7.3	N-SEND Registers and N-GET Registers	109
7.3.1	N-SEND REGISTER	109
7.3.2	N-GET REGISTER	110
7.3.3	Access to slave inputs, slave outputs and slave flags	110
7.4	Registers for Network Operation	112
8	Single-/Dual-Channel Counter	117
8.1	Description of Connections	117
8.2	Register Description	117
9	Analog I/Os	120
9.1	Description of Connections	120
9.2	Register Description	120
10	Stepper Motor Control	123
10.1	Overview and Technical Data	123
10.2	Firmware of Stepper Motor Control	124
10.2.1	Register Assignment	126
10.2.2	Register Description	127
10.3	Sample Programs	137
11	User-Programmable Interface	140
11.1	Description of Connections, Activation	140
11.2	Register Description	143
11.3	Programming	145
11.3.1	Program Listing	145
11.3.2	Symbol Listing	147
12	Real-Time Clock	148

13	Expansion Modules	150
13.1	Topology of the JETTER System Bus	150
13.1.1	Centralised Arrangement on the JETTER System Bus	151
13.1.2	Decentralised Arrangement on the JETTER System Bus	151
13.1.3	Direct Connection of FESTO CP Modules to the JETTER System Bus	152
13.2	N-ID 8 Module, 8 Digital Inputs	153
13.2.1	Physical Dimensions	153
13.2.2	Overview and Technical Data	154
13.2.3	Description of Connections	157
13.2.4	Description of LEDs	157
13.3	N-OD 4.2 Module, 4 Digital Outputs	158
13.3.1	Physical Dimensions	158
13.3.2	Overview and Technical Data	159
13.3.3	Description of Connections	162
13.3.4	Description of LEDs	162
13.4	N-OD 8 Module, 8 Digital Outputs	163
13.4.1	Physical Dimensions	163
13.4.2	Overview and Technical Data	164
13.4.3	Description of Connections	167
13.4.4	Description of LEDs	167
13.5	N-IO 16 Module - Digital Inputs and Outputs	168
13.5.1	Physical Dimensions of the N-IO 16 Module	168
13.5.2	Overview and Technical Data	169
13.5.3	Description of Connections	172
13.6	N-IA 4 Module - Analog Inputs	176
13.6.1	Physical Dimensions of the N-IA 4 Module	176
13.6.2	Overview and Technical Data	177
13.6.3	Description of Connections	181
13.6.4	Register Description - N-IA 4 Module	185
13.7	N-OA 2 and N-OA 4 Modules - Analog Outputs	187
13.7.1	Physical Dimensions of the N-OA 2, and N-OA 4 Modules	187
13.7.2	Overview and Technical Data	189
13.7.3	Description of Connections	192
13.7.4	Register Description - N-OA 2, and N-OA 4 Modules	195
13.8	N-CNT 1 Module - Single and Dual-Channel Counter	197
13.8.1	Physical Dimensions of the N-CNT 1 Module	197
13.8.2	Overview and Technical Data	198
13.8.3	Description of Connections	201
13.8.4	Register Description - N-CNT 1 Module	207
13.9	Serial Interface Module N-SER 1	212
13.9.1	Physical Dimensions of the N-SER 1 Module	212
13.9.2	Overview and Technical Data	213
13.9.3	Description of Connections	216
13.9.4	Register Description - N-SER 1 Module	219

13.9.5	Hardware and Software Flow Control of the N-SER 1 Module	223
13.9.6	Sample Program	224
13.10	Parallel Interface Module N-PRN 1	227
13.10.1	Physical Dimensions of the N-PRN 1 Module	227
13.10.2	Overview and Technical Data	228
13.10.3	Description of Connections	231
13.10.4	Register Description - N-PRN 1 Module	233
13.10.5	Sample Program	235
13.11	N-PS1 Module - Power Supply Unit for Remote Modules	237
13.11.1	Physical Dimensions of the N-PS 1, and N-PS 1CP Modules	237
13.11.2	Technical Data	239
13.11.3	Description of Connections of the N-PS 1 Module	242
13.11.4	Description of Connections of the N-PS 1CP Module	243
14	NANO Network Topology and FESTO CP Modules	244
14.1	FESTO CP Modules, FESTO Tee Connector	244
14.2	Networking of NANO and FESTO CP Modules	245
14.3	FESTO CP Modules Attached to a NANO-B Controller	246
14.3.1	Commissioning a PROCESS-PLC NANO-B/C equipped with FESTO CP Modules	248
14.3.2	Comparing Set/Actual Configuration	249
14.4	Register Description of the FESTO CP Module	251
14.5	Example: Register Assignment of FESTO CP Modules	255
15	Error Handling	258
15.1	Hardware Errors	258
15.2	Application Program Errors	259
15.3	OS Error Messages	262
16	NANO-C: Differences from NANO-B	264

List of Appendices

Appendix A:	Downloading the Operating System	268
Appendix B:	Multitasking Operating System	269
Appendix C:	Glossary	273
Appendix D:	List of Abbreviations	278
Appendix E:	List of Illustrations	281
Appendix F:	Index	283

1 Safety Instructions

The PROCESS-PLCs NANO-B or NANO-C are in line with the current state of the art. The PROCESS-PLCs NANO-B or NANO-C fulfil the valid safety regulations and standards. Special emphasis was given to the safety of the users. In the following text, the term NANO-B is used for both PROCESS-PLCs NANO-B or NANO-C. Differences between these controllers are described explicitly.

Of course, the following regulations apply to the user:

- relevant accident prevention regulations;
- accepted safety rules;
- EC guidelines and other country-specific regulations.

Usage as Agreed Upon

Usage as agreed upon includes operation in accordance with the operating instructions

The PROCESS-PLC NANO-B is used to control machinery, such as conveyors, production machines, and handling machines.

Power supply of the PROCESS-PLC NANO-B must be made through the SELV module exclusively.

The use of other power supply modules is not admissible.

Usage Other Than Agreed Upon

The PROCESS-PLC NANO-B must not be used in technical systems which to a high degree have to be fail-safe, e.g. ropeways and aeroplanes.

If the PROCESS-PLC NANO-B is to be run under surrounding conditions, which differ from the conditions mentioned in chapter 4: "Operating Conditions, page 44, , the manufacturer is to be contacted beforehand.

Who is permitted to operate the PROCESS-PLC NANO-B?

Only instructed, trained and authorised persons are permitted to operate the PROCESS-PLC NANO-B.

Mounting and backfitting may only be carried out by specially trained personnel, as specific know-how in the field of electrical engineering will be required.

Maintenance of the PROCESS-PLC NANO-B

The PROCESS-PLC NANO-B is maintenance-free. Therefore, for the operation of the module no inspection or maintenance are required.

Shutting down and disposing of the PROCESS-PLC NANO-B

The environmental regulations for the respective country apply to shutting down and disposing of the PROCESS-PLC NANO-B on the operating company's premises.

Descriptions of Symbols



Danger

This sign is to indicate a possible impending danger of serious physical damage or death.



Caution

This sign is to indicate a possible impending danger of light physical damage. This sign is also to warn you of material damage.



Important!

This sign is to indicate a possible impending situation which might bring damage to the product or to its surroundings.



Note!

You will be informed of various possible applications, e.g. with regard to installation, and will receive further useful suggestions.

• / -

Enumerations are marked by full stops, strokes or scores.



Operating instructions are marked by this arrow.



Automatically running processes or results to be achieved are marked by this arrow.

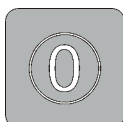

Illustration of PC and user interface keys.

Ensure Your Own Safety

Disconnect the PROCESS-PLC NANO-B from the electricity mains to carry out maintenance work. By doing so, you will prevent accidents resulting from electric voltage and moving parts.

Instructions on EMI

The noise immunity of a system corresponds to the weakest component of the system. For this reason, correct wiring and shielding of the cables is important.



Important!

Measures for increasing immunity to interference:

- Shielding must be done on both ends of the applicable cables.
- The entire shield must be drawn behind the isolation, and then be clamped under a strain relief with the greatest possible surface area.
- When the signal is connected to terminal screws: The strain relief must directly and with the greatest possible surface area be connected with a grounded surface.
- When male connectors are used: Only use metallised connectors, e.g. SUB-D with metallised housing. Please take care of direct connection here as well.
- On principle, physical separation should be maintained between signal and voltage lines.

Male/female SUB-D connectors (9, 15 or 25 pins) with metallised housing.

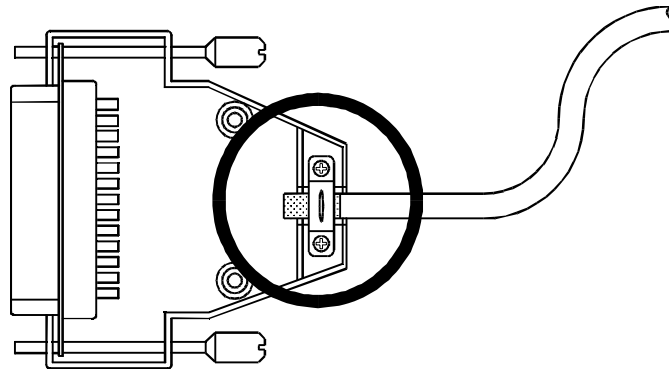

Fig. 1: Shielding in conformity with the EMC standards



Important!

To avoid malfunctions the following must be ensured:

- The shielding must be clamped under a strain relief with the greatest possible surface area.
- The connection between the housing and the shielding must be electrically conducting.
- The distance between unshielded conductor ends must be as short as possible.

Modifications and Alterations to the Module

For safety reasons, no modifications and changes to the PROCESS-PLC NANO-B and its functions are permitted. Any modifications to the PROCESS-PLC NANO-B not expressly authorised by the manufacturer will result in a loss of any liability claims to Jetter AG.

The original parts are specially designed for the PROCESS-PLC NANO-B. Parts and equipment of other manufacturers are not tested on our part, and are, therefore, not released by us. The installation of such parts may impair the safety and the proper functioning of the PROCESS-PLC NANO-B.

For any damages resulting from the use of non original parts and equipment any claims with respect to liability of Jetter AG are excluded.

Malfunctions

Malfunctions or other damages are to be reported to an authorised person immediately. The PROCESS-PLC NANO-B must be protected from improper or inadvertent use. Only qualified experts are allowed to carry out repairs.

Safety and protective devices, e.g. the barrier and cover of the terminal box, must never be shunted or by-passed.

Dismantled protective equipment must be reattached prior to commissioning and checked for proper functioning.

Information Signs and Labels

Writings, information signs, and labels always have to be observed and kept readable.

Damaged or unreadable information signs and labels are to be exchanged.

Residual Dangers

Danger resulting from electric shock!



If the PROCESS-PLC NANO-B is not isolated from the mains, for example during maintenance and repair works, you can suffer from an electric shock. Please, observe the following precautions in order to avoid injuries such as muscle cramps, burns, unconsciousness, respiratory standstill:

- Isolate the PROCESS-PLC NANO-B from the mains (pull out the mains plug) when working on the control system.
- Have works on the electric and electronic system performed by qualified personnel only.

2 Installing the NANO-B Controller

2.1 Mechanical Connection

Scope of Supply

- PROCESS-PLC NANO-B
- Operator's Manual

Installation Sequence

- Check the shipment for completeness.
- Choose the place of the DIN rail for mounting the PROCESS-PLC NANO-B and, if necessary, the expansion modules in your electric cabinet in accordance with chapter 13 "Expansion Modules", page 150.
- Mount the NANO-B module and any expansion modules to the DIN rail according to chapter 13 "Expansion Modules", page 150.
- Connect a user interface to your controller (LCD port) using the interface cable DK-422.
- Connect the NANO-B controller to your computer using the programming cable EM-PK.
- Switch the controller on and download a SYMPAS program from your computer to your user interface.
- Check the controller for proper functioning.

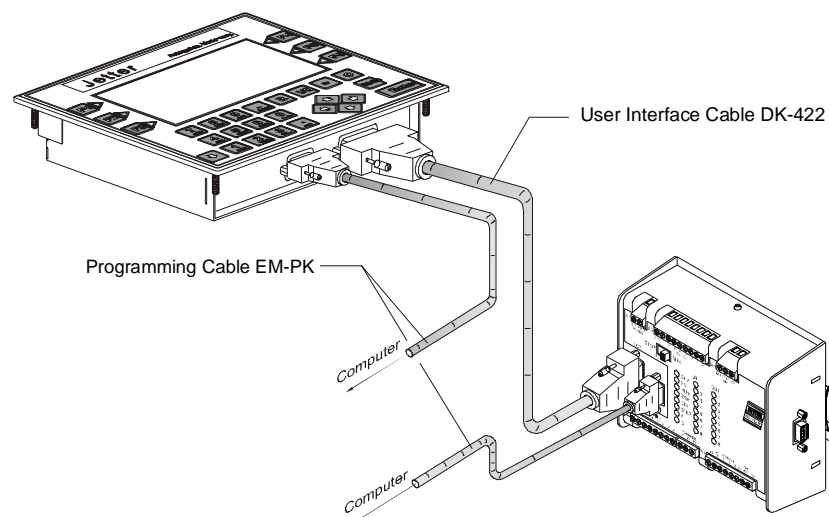

Fig. 2: Example: Connecting a LCD display to the PROCESS-PLC NANO-B

Installation Accessories (not included in the scope of delivery)

- DIN rail with mounting screws
- Programming cable EM-PK; 0.5 m, 2.5 m, or 5 m long
- User interface cable DK-422; 2.5 m or 5 m long
- Expansion modules according to chapter 13 "Expansion Modules", page 150
- Computer

Notes on safety as regards the installation

Caution: Electric Shock!



If the PROCESS-PLC NANO-B and any expansion modules according to chapter 13 "Expansion Modules", page 150 are not isolated from the mains, for example during installation, maintenance, and repair, you can get an electric shock. Please, observe the following precautions in order to avoid injuries such as muscle cramps, burns, unconsciousness, etc.



Have works on the electric and electronic system performed by qualified personnel only.



Isolate the PROCESS-PLC NANO-B and associated peripheral devices from the mains when working on the control system.



Prior to putting the PROCESS-PLC NANO-B into operation:

- reattach dismantled protective equipment and check it for proper functioning;
- secure the PROCESS-PLC NANO-B against accidental contact with conductive parts and components;
- connect only devices or electrical components to the signal lines of the PROCESS-PLC NANO-B that have been sufficiently separated from the connected electric circuits;
- a durable connection to the PROCESS-PLC and the expansion modules must be provided.

2.2 Electrical Connection

2.2.1 Power Supply

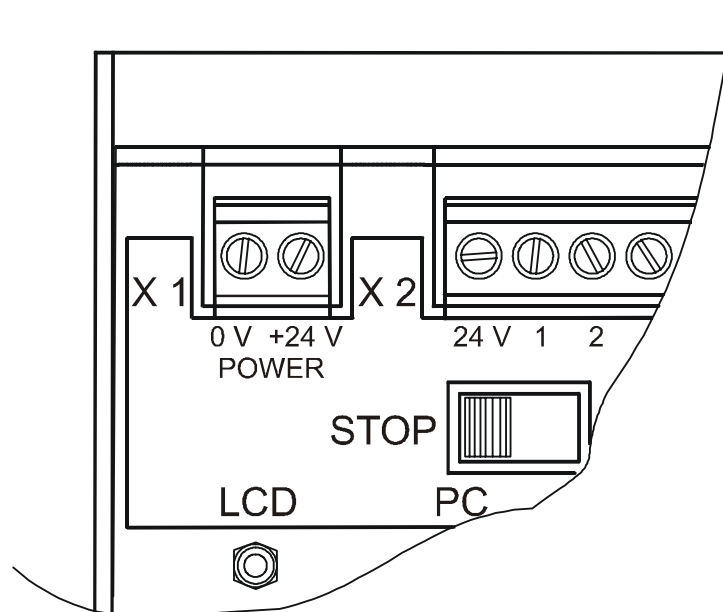

Fig. 3: Power Supply Terminals

Power supply is to be made through a 24 V DC power supply unit with SELV output. The power supply must meet the following requirements:

Voltage range:	DC 20 30 V
Filtration:	Residual ripple 5 %
Rating:	approx. 100 W (fully equipped)



Important!

If the NANO CPU is not supplied with sufficient power (under-voltage), malfunctions may occur.

In case of centralised arrangement, the digital expansion modules are also supplied through the basic controller. In case of decentralised arrangement, the digital expansion modules are supplied through the power supply unit N-PS1, see chapter 13 "Expansion Modules", page 150. The intelligent expansion modules have got their own connection for the 24 V power supply.

2.2.2 Interfaces

On the basic controller there are three female connectors for various interfaces; see fig. 17, page 41.

Assignment of these interfaces is shown in the following illustration:

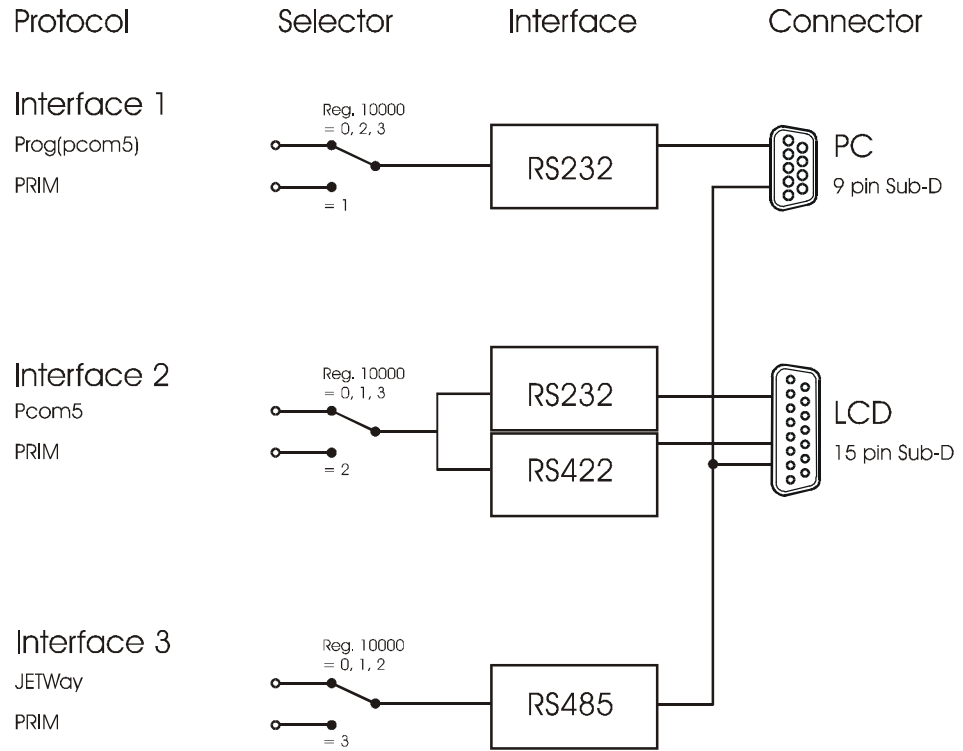

Fig. 4: Block Diagram of NANO-B Interfaces

Interface	Function	Specification
9 pin SUB-D port (front panel)	<ul style="list-style-type: none"> • Programming • Visualising • JETWay-H, -R 	<ul style="list-style-type: none"> - RS232 - RS232 - RS485
15 pin SUB-D port (front panel)	<ul style="list-style-type: none"> • Programming • User Interfaces • Visualising • JETWay-R, -H 	<ul style="list-style-type: none"> - RS232 - RS422 - RS232 - RS485
9 pin SUB-D port	<ul style="list-style-type: none"> • Expansion by modules connected to system bus 	

**Note!**

Please note that simultaneous use of all interfaces is not possible. For more information, please refer to the following table:

	RS232 9-pin	RS232 15-pin	RS485^{*)} 9-/15-pin	RS 422 15-pin
RS 232 9-pin	—	yes	yes	yes
RS232 15-pin	yes	—	yes	no
RS485 ^{*)} 9-/15-pin	yes	yes	—	yes
RS 422 15-pin	yes	no	yes	—

^{*)} RS485 short-circuited on both plug connectors

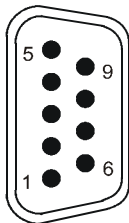

Pin Assignment - 9 pin male SUB-D connector		
PIN	Signal	Interface
1	—	—
2	TXD	Programming interface or VIADUKT: RS 232
3	RXD	
4	24 V	—
5	—	—
6	—	—
7	GND	Ground
8	Data +	JETWay H, or JETWay R
9	Data -	

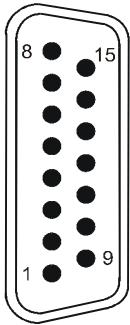

Pin Assignment - 15 pin male SUB-D connector		
PIN	Signal	Interface
1	—	—
2	TXD	Programming interface or VIADUKT: RS 232
3	RXD	
4	24 V	—
5	—	—
6	—	—
7	GND	Ground
8	Data +	JETWay H, or JETWay R
9	Data -	
10	SDB	LCD: RS 422
11	SDA	
12	RDB	
13	RDA	
14	—	—
15	—	—



Important!

Power consumption through pin 4 of the 9 pin SUB-D connector, or pin 4 of the 15-pin SUB-D connector is limited to a maximum of 750 mA.
 In case both connectors are used simultaneously, power consumption of the 9-pin and 15-pin SUB-D connectors is limited to a maximum of 750 mA.

Programming Interface RS232 to PC

Please refer to "Programming Interface JETWay-H/PC" on page 24.

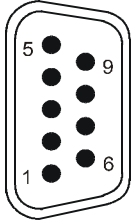
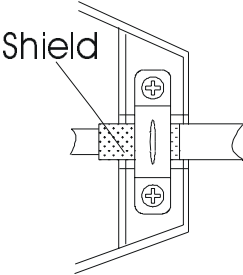
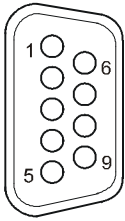
Programming Cable EM-PK			
PROCESS-PLC	Shield		PC
 9 pin male SUB-D connector	 Connect shield with the greatest possible surface area! Use metallised housing only!		 9-pin female SUB-D connector
PIN	Signal		PIN
2	TXD	RXD	2
3	RXD	TXD	3
7	Gnd		5
For hardware-handshake, pins 7 and 8, as well as pins 1, 4 and 6 have to be short-circuited on the PC side (COM1).			



Important!

- The connection cable EM-PK can be obtained from JETTER AG.
- In case you prefer to fabricate your own cable, the following minimum requirements, also with a view to EMC, must be met:
 1. Number of cores: 3
 2. Core cross-sectional area: 0.25 mm²
 3. Connector (male): SUB-D, metallised
 4. Maximum cable length: 15 m
 5. Shield: complete shielding, no paired shielding
- The shield must be connected to the metallised connector housings on both ends of the cable with the greatest possible surface area.

Interface for LCD Displays

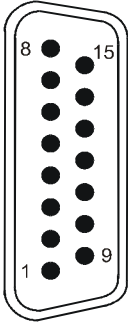
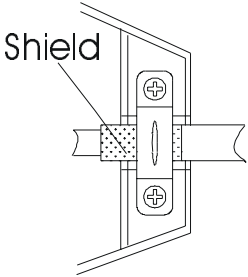
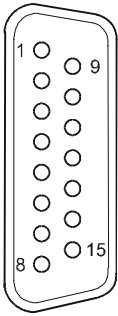
EM-DK Cable for LCD 9, LCD 10 and LCD 12			
PROCESS-PLC	Shield	LCD Display	
 <p>15 pin male SUB-D connector</p>	 <p>Connect shield with the greatest possible surface area! Use metallised housing only!</p>	 <p>15 pin female SUB-D connector</p>	
PIN	Signal		PIN
4	DC 24 V		15
7	Gnd		12
10	TXD	RXD	9
12	RXD	TXD	11



Important!

- The connection cable EM-DK can be obtained from JETTER AG.
- In case you prefer to fabricate your own cable, the following minimum requirements, also with a view to EMC, must be met:
 1. Number of cores: 4
 2. Core cross-sectional area: 0.25 mm²
 3. Connector (male): SUB-D, metallised
 4. Maximum cable length: 30 m
 5. Shield: complete shielding, no paired shielding
- The shield must be connected to the metallised connector housings on both ends of the cable with the greatest possible surface area.

Programming Interface JETWay-H/PC Use of the JETWay-H interface demonstrates the following advantages over the RS232 interface:

- 99 PROCESS-PLCs can be addressed from a SYMPAS workstation.
- Transfer rates of up to 115 Kbaud can be realised.

JETWay-H Cable		
PROCESS-PLC	Shield	Specification
9 pin male SUB-D connector or 15 pin male SUB-D connector	<p>Connect shield with the greatest possible surface area! Use metallised housing only!</p>	RS485
PIN	Signal	JETWay card
7	Gnd	7
8	Data +	8
9	Data -	9



Important!

- Also with a view to EMC, the following minimum requirements apply to the JETWay-H cable fabrication:
 1. Number of cores: 3
 2. Core cross-sectional area: 0.25 mm²
 3. Connector (male): SUB-D, metallised
 4. Maximum cable length: 400 m
 5. Shield: complete shielding, no paired shielding
- The shield must be connected to the metallised connector housings on both ends of the cable with the greatest possible surface area.

JETWay-H board for PCs Connection between the SYMPAS program and up to 99 Process PLC control systems via JETWay-H is realised with the help of the PC board shown below.

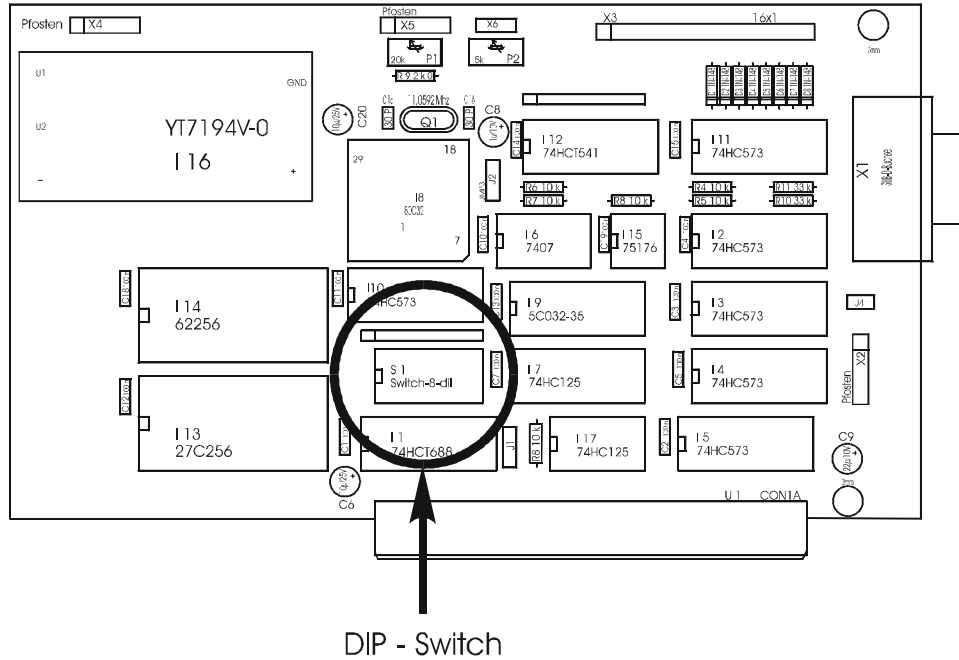

Fig. 5: JETWay-H PC Board

The DIP-switch is used to define the port address. The default address "340h" must be inserted into the **AUTEXEC.BAT** as follows:

```
SET JETWAY_PORT = 340h
```

Note!



If it is intended to use the SYMPAS program together with the operating system Windows NT and the JETWay port, the program "SETUP JETWAY BOARD" must be installed.

DIP Switch A different port address can be selected using the DIP-switch on the JETWay-H board as shown above, cf. fig. 5, page 25.

DIP-switch (S) on the JETWay-H board							
Port X	S 7	S 6	S 5	S 4	S 3	S 2	S 1
300h	OFF	OFF	ON	ON	ON	ON	ON
310h	OFF	OFF	ON	ON	ON	OFF	ON
320h	OFF	OFF	ON	ON	OFF	ON	ON
330h	OFF	OFF	ON	ON	OFF	OFF	ON
340h ^{*)}	OFF	OFF	ON	OFF	ON	ON	ON
350h	OFF	OFF	ON	OFF	ON	OFF	ON
360h	OFF	OFF	ON	OFF	OFF	ON	ON

^{*)} Default setting

The **AUTEXEC.BAT** entry must be changed in accordance with the table as shown above:

```
SET JETWAY_PORT = X
```

During system configuration selection is made between programming interface RS232 and JETWay-H in the SYMPAS menu [menu item: Special -> Interface].

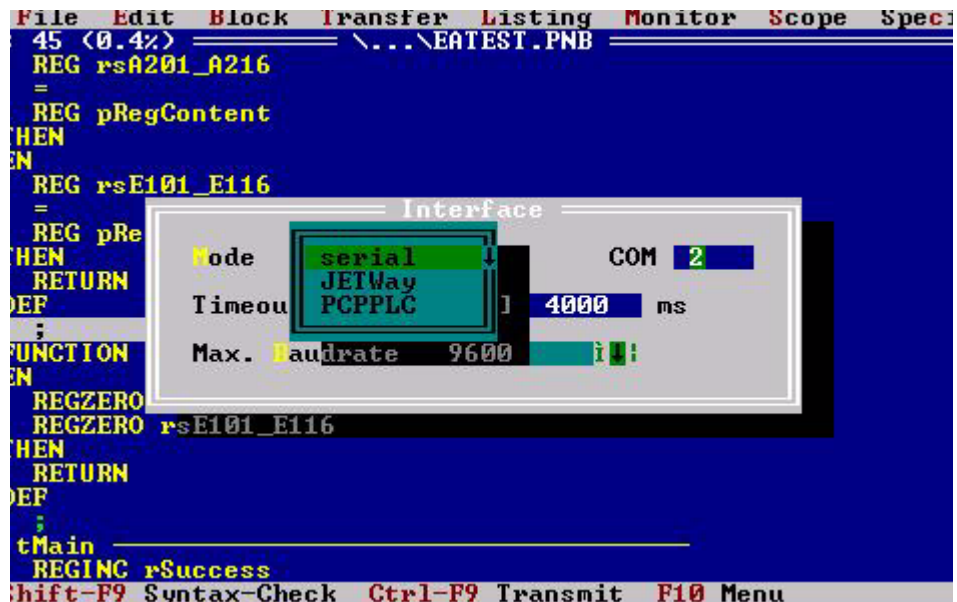
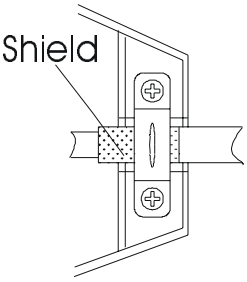

Fig. 6: SYMPAS Menu [Special -> Interface]

Network Interface JETWay-R The network interface JETWay-R serves for networking PROCESS-PLC's and/or networking of devices, such as remote I/Os, valve terminals etc.; cf. chapter 7 "Network Operation", page 107.

JETWay-R Cable		
PROCESS-PLC	Shield	Specification
9 pin male SUB-D connector (PC) or 15 pin male SUB-D connector (LCD)	 <p>Shield</p> <p>Connect shield with the greatest possible surface area! Use metallised housing only!</p>	RS485
PIN	Signal	Comment
7	Gnd	-
8	Data +	-
9	Data -	-



Important!

- Also with a view to EMC, the following minimum requirements apply to the JETWay-R cable fabrication:
 1. Number of cores: 3
 2. Core cross-sectional area: 0.25 mm²
 3. Connector (male): SUB-D, metallised
 4. Maximum cable length: 400 m
 5. Shield: complete shielding, no paired shielding
- The shield must be connected to the metallised connector housings on both ends of the cable with the greatest possible surface area.

User Interface Port

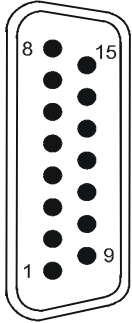
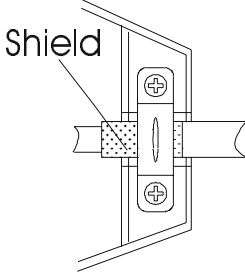
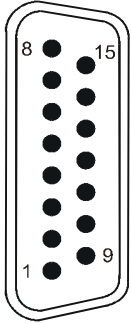
User Interface Cable DK-422			
PROCESS-PLC	Shield	User Interface	
 <p>15 pin male SUB-D connector</p>	 <p>Connect shield with the greatest possible surface area! Use metallised housing only!</p>	 <p>15 pin male SUB-D connector</p>	
PIN	Signal		PIN
4	DC 24 V		15
7	Gnd		12
10	SDB	RDB	6
11	SDA	RDA	7
12	RDB	SDB	4
13	RDA	SDA	5



Important!

- The connection cable DK-422 can be obtained from JETTER AG.
- In case you prefer to fabricate your own cable the following minimum requirements, also with a view to EMC, must be met:
 1. Number of cores: 6
 2. Core cross-sectional area: 0.25 mm²
 3. Connector (male): SUB-D, metallised
 4. Maximum cable length: 400 m
 5. Shield: complete shielding, no paired shielding
- The shield must be connected to the metallised connector housings on both ends of the cable with the greatest possible surface area.



Important!

When the DK-422 cable is used, care must be taken that the end marked with "CPU" is connected to the basic controller NANO-B. The other end of the cable must be connected to the user interface. If the cable is connected the other way round, the port of the user interface will be destroyed.



Important!

If you prefer to manufacture the cables yourself, be sure to unambiguously mark the cable ends with "CPU" and "LCD" to prevent incorrect connection. If the cable is connected the other way round, the port of the user interface will possibly be destroyed.

Visualisation Interface

The process visualisation system VIADUKT can optionally be connected to the PROCESS-PLC by two different types of connectors. Connector selection depends on the slot available and free to use on the NANO-B. For cable specification see "Programming Interface RS232 to PC" on page 22.

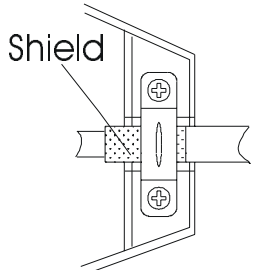
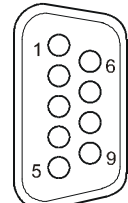
VIADUKT Cable			
PROCESS-PLC	Shield		VIADUKT
9-pin male SUB-D connector or 15-pin male SUB-D connector	 <p>Connect shield with the greatest possible surface area! Use metallised housing only!</p>		RS232 
PIN	Signal		PIN
2	TXD	RXD	2
3	RXD	TXD	3
7	Gnd		5
For hardware-handshake, pins 7 and 8, as well as pins 1, 4 and 6 have to be short-circuited on the PC side (COM1).			

CAN-BUS

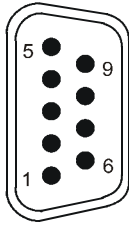

9-pin male or female SUB-D connector

System Bus Cable for NANO Expansion Modules		
Signal	Contact # (pin)	Contact # (socket)
CMODE0	1	1
CL	2	2
GND	3	3
CMODE1	4	4
TERM	5	5
unused	6	6
CH	7	7
unused	8	8
Do not connect	9	9

A detailed description of the CAN bus and of the expansion modules will be given in chapter 13.1 "Topology of the JETTER System Bus", page 150.



Important!

Also with a view to EMC, the following minimum requirements apply to the system bus (CAN-BUS) cable fabrication:

1. Number of cores: 5
2. Core cross-sectional area: 0.25 mm²
3. Connector (male): SUB-D, metallised
4. Shield: complete shielding, no paired shielding
5. Cable capacitance: maximum 60 $\frac{pF}{m}$
6. Resistivity: maximum 70 $\frac{\Omega}{km}$
7. Cable length: a maximum of 30 m for a maximum transfer rate of 1MBit/s
8. The shield must be connected to the connector housings on both ends of the cable with the greatest possible surface area.

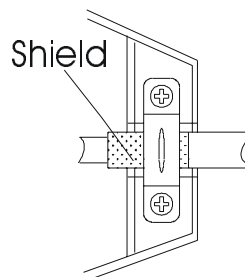

2.2.3 Digital Inputs

On the basic controller, 8 terminals have been provided for digital inputs (24 V signals). The 0 V signal is to be connected to the 0 V terminal of the electric cabinet.

Technical Data of Digital Inputs	
Amount of inputs	8
Rated input voltage	DC 24 V
Voltage range	20 .. 30 V
Input current	approx. 8mA
Input resistance	3.0 kΩ
Input delay time	approx. 3 ms
Signal voltage ON	min. 15 V
Signal voltage OFF	max. 10 V
Electrical isolation	None

Numbering System of Basic Controller Inputs ^{*)}	
Input	Number
Input # 1	101
...	...
Input # 8	108

^{*)} cf. chapter 5.1 "Addressing Digital Inputs/Outputs", page 48.

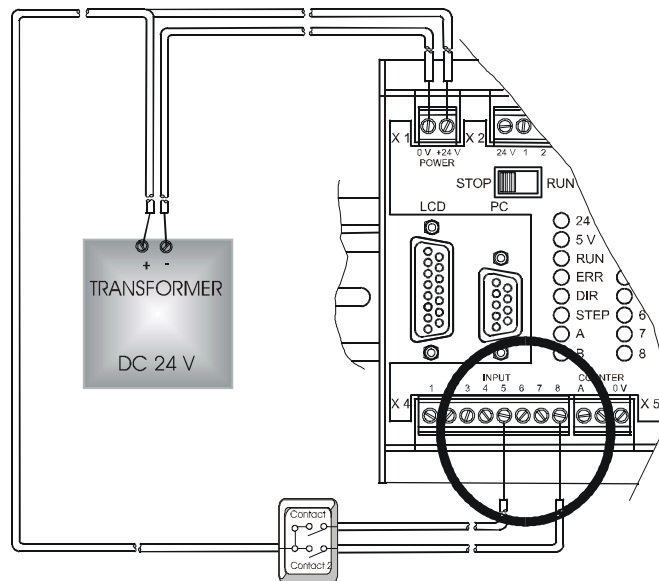

Fig. 7: Connection Details for Digital Inputs

2.2.4 Digital Outputs

On the basic controller, 8 terminals have been provided for digital outputs (24 V signals). The 0 V signal is to be connected to the 0 V terminal of the electric cabinet.

Technical Data of Digital Outputs	
Amount of outputs	8
Type of outputs	Transistor, pnp
Rated voltage	DC 24 V
Voltage range	20 .. 30 V
Load current	Max. 0.5 A per output
Electrical isolation	None
Protective circuit	Short-circuit, overload, overvoltage, overtemperature protection
Protection against inductive loads	Yes
Signal voltage ON	Typ. $V_{Supply} - 1.5 V$

Numbering system of Basic Controller Outputs ^{*)}	
Output	Number
Output # 1	101
...	...
Output # 8	108

^{*)} cf. chapter 5.1 "Addressing Digital Inputs/Outputs", page 48.

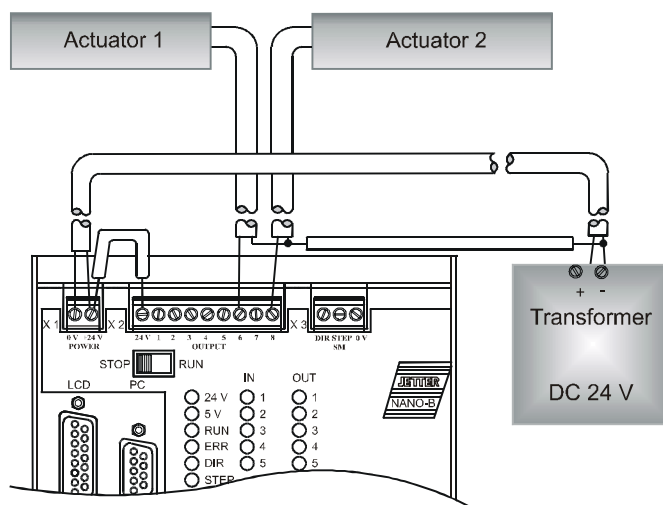

Fig. 8: Connecting Digital Outputs

2.2.5 Single- and Dual-Channel Counter

- In register 2900 the counter can be set to single- or dual-channel operation.
- The count value is stored to register 2901. It is possible to count events with a pulse frequency of up to 10 kHz.
- With dual-channel operation, in register 2901 four-fold evaluation with a counting frequency of 40 kHz is carried out.
- When using the single-channel counter with channel A, the rising as well as the falling edge will be counted. With single-channel operation, the counting frequency in register 2901 is 20 kHz.

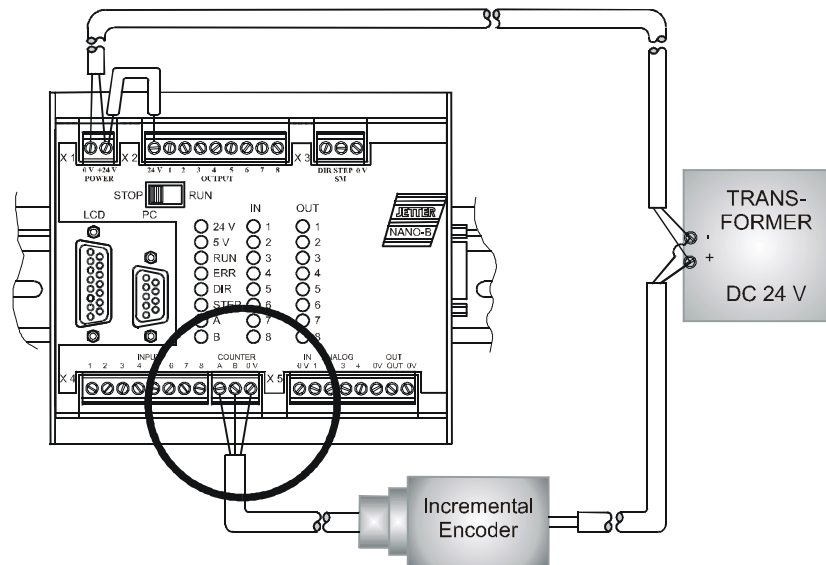
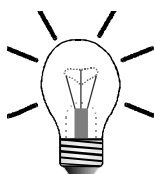

Fig. 9: Connection Details for Single-/Dual-Channel Counter

Technical Data - Single-/Dual-Channel Counter (X4)	
Signal Voltage	DC 24 V
Operating Point:	<ul style="list-style-type: none"> • Low level up to 2.0 V • High level 20 ... 30 V
Pulse Frequency	10 kHz
Connection of Counter (X4)	
COUNTER A	Channel # 1
COUNTER B	Channel # 2
0 V	Ground



Note!

As a rule, use only 24 V sensors, since 5 V sensors cannot be evaluated.

2.2.6 Analog Inputs

On the basic controller, four terminals for voltage signals and one 0 V terminal have been provided for analog inputs (X5).

Technical Data of Analog Inputs	
Amount of Analog Inputs	4 (IN 1 through IN 4)
Ground	0 V (IN 0 V)
Voltage Range	0 .. 10 V
Input Resistance	20 kΩ
Resolution	10 Bit
Accuracy	1%
Delay Time	< 10 ms ^{*)}

^{*)} cf. register 2920 in chapter 5.3.4 "Special Registers", page 61.

Note!



Bit 0 of register 2900 is set to 1 using the SYMPAS program or following a reset. This way, analog inputs are enabled.

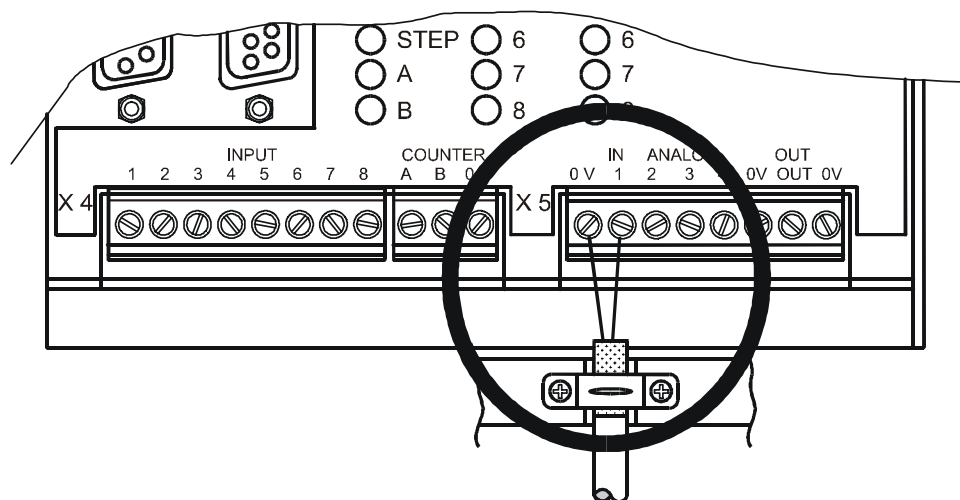

Fig. 10: Connection Details for Analog Inputs

2.2.7 Analog Output

On the basic controller, one terminal for voltage signals and one 0 V terminal have been provided for analog outputs (X5).

Technical Data of Analog Outputs	
Number of Analog Outputs	1 (OUT)
Ground	0 V (OUT 0 V)
Voltage Range	0 .. 10 V
Frequency	0.5 Hz
Ripple	±10 mV
Resolution	8 Bit
Delay Time	< 120 ms
Load Current Carrying Capability	10 mA

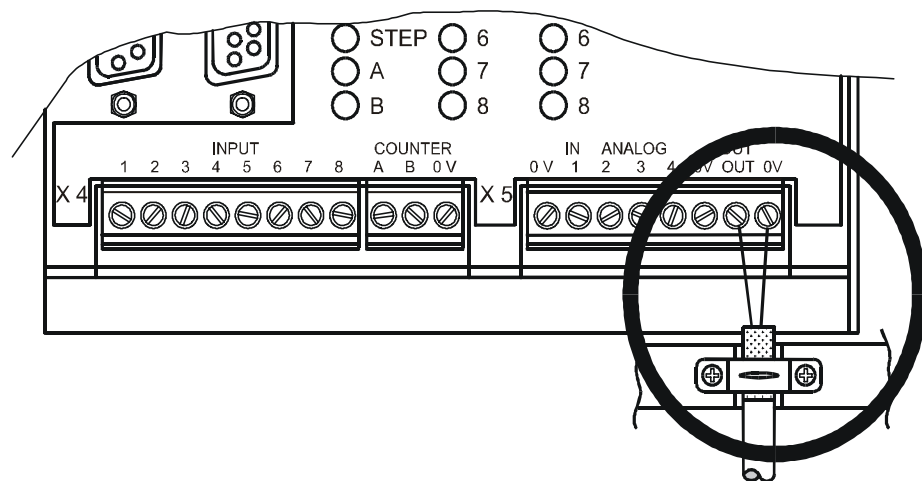

Fig. 11: Connection Details for Analog Output

2.2.8 Stepper Motor Control

For stepper motor control, 2 terminals for the DIR and STEP signal and one 0 V terminal have been provided on the basic controller (X3).

Technical Data - Stepper Motor Control	
Positioning Range	-8388608 .. +8388607
Positioning Speed	Max. 5 kHz
Acceleration/Deceleration Ramp	Linear, rate programmable
Acceleration/Deceleration Frequency	Programmable
Frequency Setting Accuracy	1 Hz resolution, crystal-calibrated
Interface (outputs) to Power Amplifier	Open collector: <ul style="list-style-type: none"> • DIR - direction • STEP - stepping pulse
Load Current Carrying Capability of Outputs	$I_{max.} = 300 \text{ mA}$
Inputs	Limit switch LH side/RH side (24 V, NC or NO) Reference switch (24 V, NC or NO)



Note!

The stepper motor control functions without any feedback, e.g. from an incremental encoder. Consequently, the operator must ensure that the axis is smoothly moving and that settings for acceleration and deceleration ramps are not too steep, otherwise the motor will skip steps.

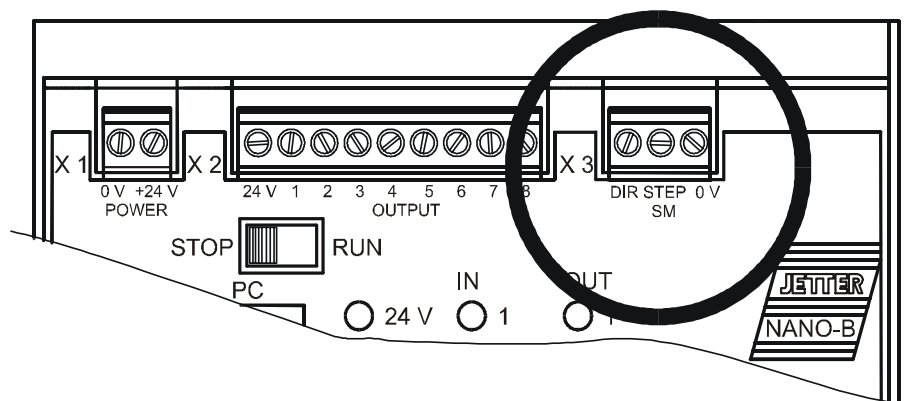

Fig. 12: Connection Details for Stepper Motor Control

Stepper Motor Control Connection (X3, X4)	
DIR (X3) (open collector)	Directional signal
STEP (X3) (open collector)	Stepping signal
0 V (X3)	Ground
IN 2 (X4)	Reference switch
IN 3 (X4)	Negative limit switch
IN 4 (X4)	Positive limit switch

**Note!**

The limit and reference switches are physically identical with the digital inputs 102 (IN 2), 103 (IN 3), and 104 (IN 4) located on the basic control unit. Definition of their function is made in register 11104.

**Note!**

If, in spite of correct wiring, the axis cannot be positioned, polarity reversal of limit switches can be a possible cause. If the limit switches have been defined as NC's and if no signal is present, the stepper motor will interpret this as if the axis had actuated the limit switch. In this case, positioning in direction of the limit switch is not possible.

**Important!**

Usually, the power amplifier includes pull-up resistors for STEP and DIR signals. In case **there are no pull-up resistors**, an **external circuitry with pull-up resistors** must be set up. When doing so, the maximum current is limited to 300 mA, or else the transistors of the controller will be destroyed.

For this purpose, it is **mandatory** to read the **description of connections** given in the operator's manual of the relevant **stepper motor** and **power amplifier** manufacturer. Malfunctions during operation of your plant can only be avoided if the connection is correct.

Connection according to fig. 13, page 38 is only one option for connecting a specific stepper motor controller, and is not universally applicable.

STEP and DIR Signals STEP and DIR outputs are open collector outputs. The 0 V potential is applied to the terminals through these outputs. The voltage is determined by the power circuitry of the stepper motor drive. As a rule, switching voltage is supplied by the power unit via pull-up resistors, thus enabling direct connection of motors.

Stepper Motor Driving Circuit

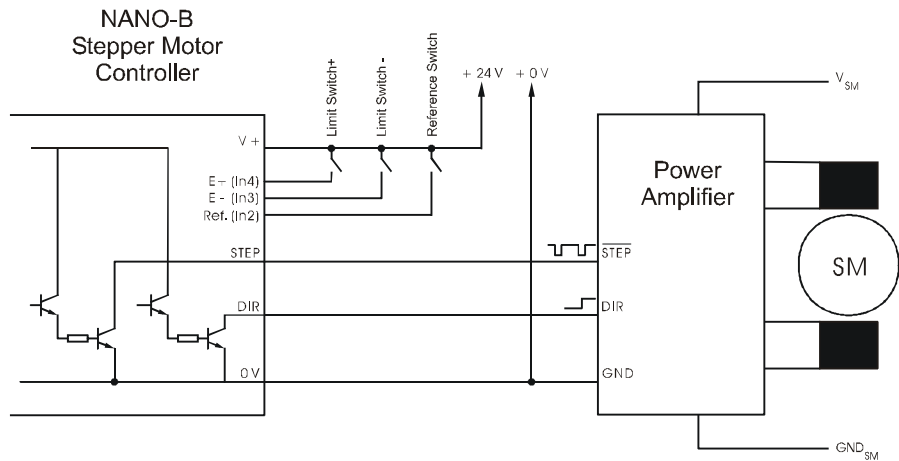

Fig. 13: NANO-B Stepper Motor Driving Circuit

Possible Internal Circuitry DIR and STEP

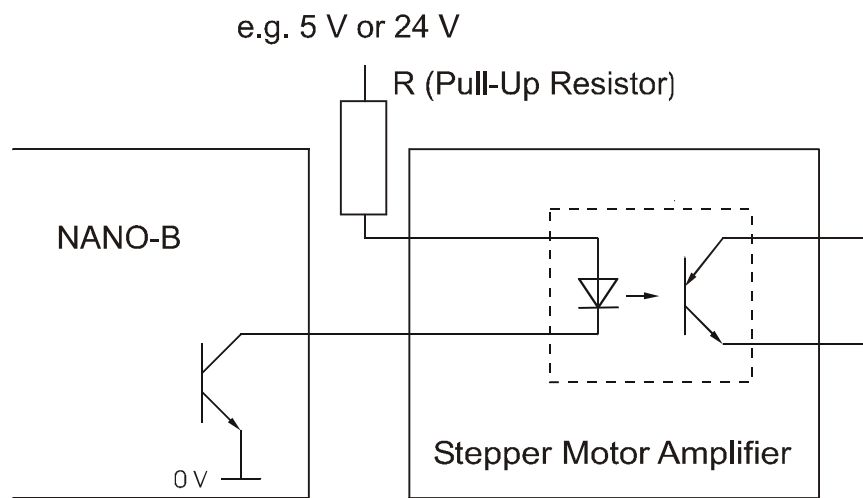

Fig. 14: Exemple: Internal Circuitry of a DIR and STEP Signal

2.3 Description of LEDs

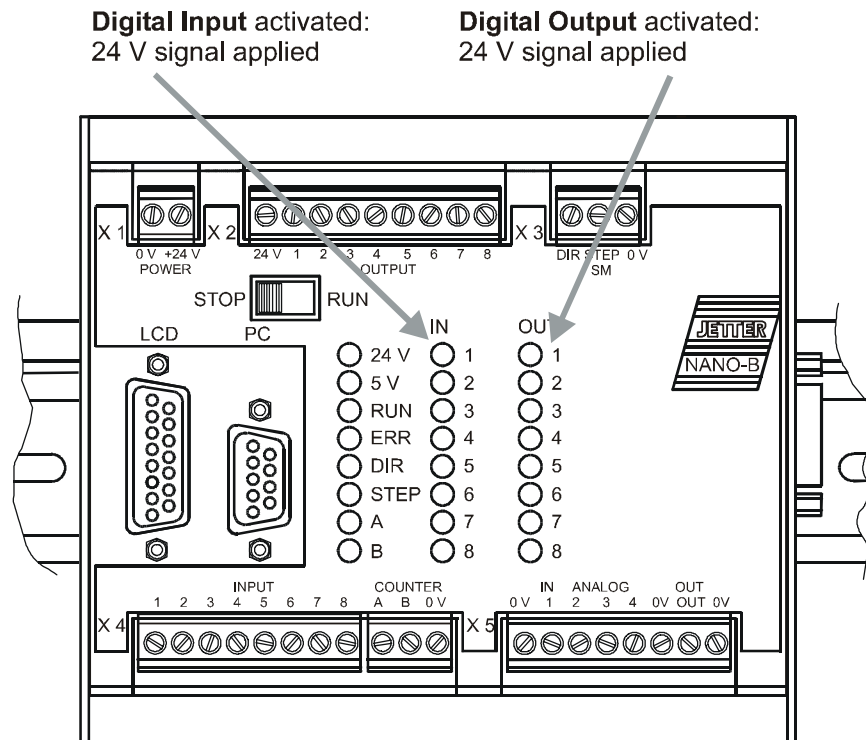

Fig. 15: Arrangement of LEDs

LED	Meaning
24 V	Output supply OK
5 V	Internal logic voltage OK
RUN lit	Application program is running
RUN flashing	<ol style="list-style-type: none"> 1. Application program is not running. Switch is set to STOP. 2. Application program was stopped. Switch is set to RUN. (To restart the program press Shift-F2 in the Setup window) 3. Program transfer -> Flash
ERR	Error. Details of the error state are specified in registers 2008 through 2012.
DIR	Direction signal for stepper motor
STEP	Stepping signal for stepper motor
A	Channel # 1 of single/dual-channel counter
B	Channel # 2 of single/dual-channel counter

2.4 Description of the STOP/RUN Switch

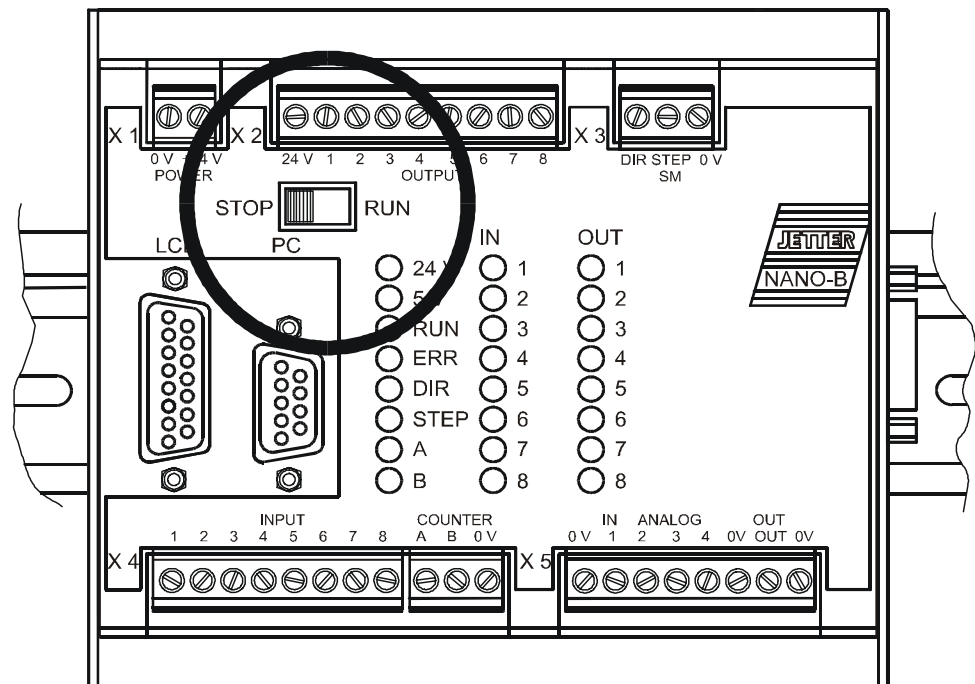

Fig. 16: STOP/RUN Switch

STOP Position If, at the time of applying the power supply voltage to the control system, the switch is in **STOP** position, the application program will not start. It can be activated by pressing SHIFT-F2 in the SYMPAS program, or through transfer of a program.

RUN Position If, at the time of applying the power supply voltage to the control system, the switch is in **RUN** position, the application program will start.

3 Basic Unit

3.1 Physical Dimensions

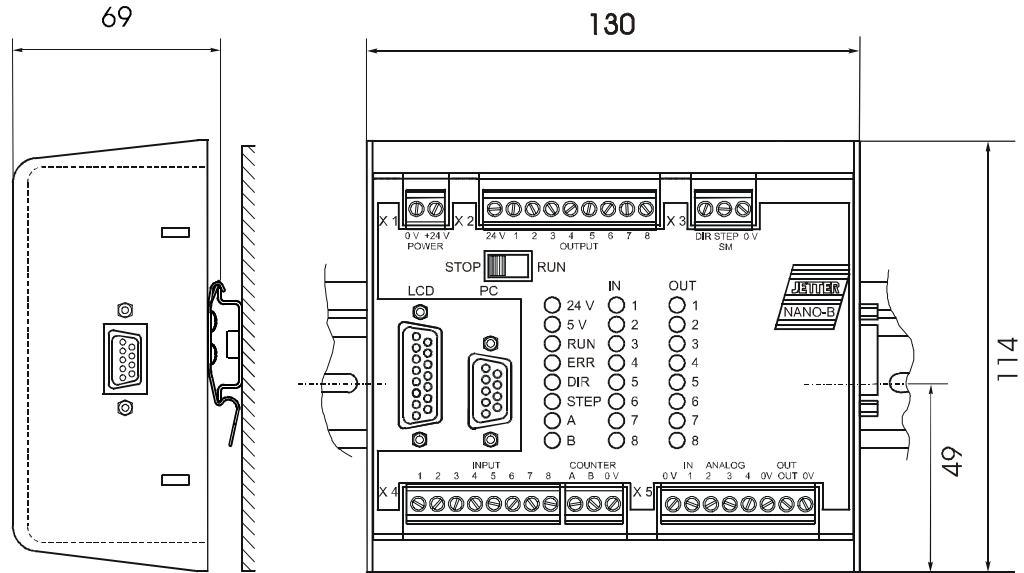

Fig. 17: Mounting Dimensions of the NANO-B Basic Unit

3.2 Technical Data

Technical Data of the NANO-B Basic Unit	
Program memory	16 KByte Flash-EPROM
User register 24 bits	2000 register in the RAM The RAM is battery-backed. The battery has a service life of approx. 10 years
Data format	24 Bit Integer: - 8.388.608 ... + 8.388.607
Internal intermediate results	32 Bit
Quantity of flags	255 buffered, and 1800 overlapped (from register 0 ... 74)
Digital inputs, cf. page 31	DC 24 V
Digital outputs, cf. page 32	Transistor DC 24 V, 0.5 A, pnp
Analog inputs, cf. page 34	4 10-bit inputs: 0 -10 V
Analog outputs, cf. page 35	1 8-bit output: 0 -10 V

Technical Data of the NANO-B Basic Unit	
Stepper motor controller cf. page 36 and page 123	1 (STEP, DIR) Open Collector
Real-time clock, cf. page 148	1
Single-/dual-channel counter 24 V cf. page 148	10 kHz
User programmable serial interface; refer to page 148	RS 232 / RS 485 / RS 422 *)
Programming interface	RS 232 *)
Interface for connecting user interface and visualisation equipment	RS 232 / RS 422 *)
Fieldbus interface JETWay	RS485 *)
System bus interface	JETTER System Bus Interface
Power supply unit requirements	DC 24 V (20 - 30 V) at the terminals X1, residual ripple < 5%, filtered; double isolation between output (SELV or PELV) and input.
Power loss	<ul style="list-style-type: none"> • Time Interval ≤ 10 ms to DIN EN 61131-2 • Time interval between two voltage dips ≥ 1 s • Severity level PS2
Heat loss of CPU logic circuit	2.5 Watt
CPU power consumption incl. 8 digital outputs, but without expansion modules	96 Watt (8 x 0.5 A x 24 V)
Enclosure	Aluminium, powder coated, black
Dimensions (H x W x D in mm)	114 x 110 x 70
Weight	720 g
Mounting	DIN Rail

*) Not all of the four interfaces are available at the same time, see chapter 2.2.2 "Interfaces", page 19.

NANO-B Basic Unit - Terminals	
Power supply	Screw terminals
Digital inputs and outputs	Screw terminals
Analog I/O's	Screw terminals
Fast dual-channel counter	Screw terminals
Stepper motor control with DIR, STEP	Screw terminals
Programming interface	Female connector SUB-D, 9 pins
User programmable serial interface	Female connector SUB-D, 9 or 15 pins depending on configuration
Field bus interface JETWAY	Female connector SUB-D, 9 or 15 pins
JETTER System Bus Interface	Female connector SUB-D, 9 pins, with additional mechanical guiding for expansion modules
Interface for connecting user inter- face and visualisation equipment	Female connector SUB-D, 9 or 15 pins

4 Operating Conditions



Note!

The general technical specifications listed below apply to all modules of the PROCESS-PLC NANO-B.

In addition to this, in the description of the expansion modules, beginning from chapter 3 "Basic Unit", page 41 and chapter 13 "Expansion Modules", page 150, further technical data and operating conditions are specified.

Operating Parameters		
Condition		Comment
Ambient Temperature	0 .. 50 °C	
Storage temperature	-25 °C .. 70 °C	to DIN EN 61131-2, DIN EN 60068-2-1 DIN EN 60068-2-2
Air Humidity	5% - 95% No condensing	to DIN EN 61131-2
Pollution Degree	2	to DIN EN 61131-2
Corrosion Immunity/ Chemical Resistance	No special protection against corrosion. Ambient air must be free from higher concentrations of acids, alkaline solutions, salts, metal vapours, or other corrosive or electroconductive contaminants.	to DIN EN 61131-2
Operating Altitude	Up to 2,000 m above sea level.	to DIN EN 61131-2

Operating Parameters		
Vibration Resistance	<ul style="list-style-type: none"> • 10 Hz ... 57 Hz: with an amplitude of 0.0375 mm for continuous operation and a peak amplitude of 0.075 mm • 57 Hz ... 150 Hz: 0,5 g constant acceleration for continuous operation and 1.0 g constant acceleration as peak value • 1 octave per minute, 10 frequency sweeps (sinusoidal), all three spatial axes 	to DIN EN 61131-2 IEC 68-2-6
Free Falls Withstanding Test	Height of fall (units within packing): 1 m	to DIN EN 61131-2, DIN EN 60068-2-32
Shock Resistance	15 g occasionally for 11 ms	to DIN EN 61131-2 IEC 68-2-27
Degree of Protection	<ul style="list-style-type: none"> • IP 20 • IP 10 (bottom side of enclosure) 	to DIN EN 60529
Mounting Position	Any position, snapped on DIN Rail	DIN Rail acc. to DIN EN 50022
Class of Protection	III	to DIN EN 61131-2
Dielectric Test Voltage	Functional ground is connected to chassis ground internally.	to DIN EN 61131-2
Overvoltage Category	II	to DIN EN 61131-2
Power Loss	<ul style="list-style-type: none"> • Time period ≤ 10 ms • Time intervall between two voltage dips ≥ 1 s • Severity level PS2 	to DIN EN 61131-2



Important!

Measures to avoid damages in transit and storage:



The packing material and the storage place are to be chosen in a way that the values given in the above table "Operating Parameters" are kept to.

EMC - NANO-B Basic Unit		
Emitted Interference		
Parameter	Value	Reference
Enclosure	<ul style="list-style-type: none"> Frequency band 30 - 230 MHz, limit 30 dB ($\mu\text{V}/\text{m}$) at 10 m Frequency band 230 - 1000 MHz, limit 37 dB ($\mu\text{V}/\text{m}$) at 10 m (class B) 	DIN EN 50081-1 DIN EN 50081-2 DIN EN 55011
Interference Immunity: Enclosure		
Parameter	Value	Reference
RF Field, amplitude-modulated	Frequency band 27 -1000 MHz; test signal strength 10 V/m AM 80 % with 1 kHz Criterion A	DIN EN 61131-2 DIN EN 50082-2 DIN EN 61000-4-3
Electromagnetic RF Field, pulse-modulated	Frequency 900 ± 5 MHz Test field strength 10 V/m 50 % ON period Repetition rate 200 Hz Criterion A	DIN EN 50082-2 DIN EN 61000-4-3
Magnetic Field with Mains Frequency	50 Hz 30 A/m	DIN EN 50082-2 DIN EN 61000-4-8
ESD	Discharge through air: Test Peak Voltage 15 kV (Humidity Rating RH-2 / ESD-4) Contact Discharge: Test peak voltage 4 kV (severity level 2) Criterion A	DIN EN 61131-2 DIN EN 50082-2 DIN EN 61000-4-2
Interference Immunity: Signal and Data Lines		
Parameter	Value	Reference
Asymmetric RF, amplitude-modulated	Frequency 0.15 - 80 MHz Test voltage 10 V AM 80 % with 1 kHz Source Impedance 150Ω Criterion A	DIN EN 50082-2 DIN EN 61000-4-6
Burst	Test voltage 2 kV tr/tn 5/50 ns Repetition rate 5 kHz Criterion A	DIN EN 50082-2 DIN EN 61131-2 DIN EN 61000-4-4

EMC - NANO-B Basic Unit		
Test with Damped Oscillation	Damped Oscillation Frequency 1 MHz Source Impedance 200 Ω Repeat Factor 400/s Test voltage 1 kV	DIN EN 61131-2 DIN EN 61000-4-12
Interference Immunity: Process, measuring and control lines, long bus lines and long control lines		
Parameter	Value	Reference
Asymmetric RF, amplitude-modulated	Frequency 0.15 - 80 MHz Test voltage 10 V AM 80 % with 1 kHz Source Impedance 150 Ω Criterion A	DIN EN 50082-2 DIN EN 61000-4-6
Burst	Test voltage 2 kV tr/tn 5/50 ns Repetition rate 5 kHz Criterion A	DIN EN 50082-2 DIN EN 61131-2 DIN EN 61000-4-4
Interference Immunity: Mains Inputs and Outputs for AC and DC		
Parameter	Value	Reference
Asymmetric RF, amplitude-modulated	Frequency 0.15 - 80 MHz Test voltage 10 V AM 80 % with 1 kHz Source Impedance 150 Ω Criterion A	DIN EN 50082-2 DIN EN 61000-4-6
Burst	Test voltage 2 kV tr/tn 5/50 ns Repetition rate 5 kHz Criterion A	DIN EN 50082-2 DIN EN 61131-2 DIN EN 61000-4-4
Test with Damped Oscillation	Damped Oscillation Frequency 1 MHz Source Impedance 200 Ω Repeat Factor 400/s Test voltage 1 kV Criterion A	DIN EN 61131-2 DIN EN 61000-4-12

5 Software Programming

5.1 Addressing Digital Inputs/Outputs

5.1.1 Basic Controller

Numbering System of Basic Controller Inputs	
Input	Number
Input # 1	101
Input # 2	102
...	...
Input # 8	108

Numbering System of Basic Controller Outputs	
Output	Number
Output # 1	101
Output # 2	102
...	...
Output # 8	108

5.1.2 Expansion Modules

The address is made up of the module number and the number of the respective input or output:

Coding of Input / Output Number: xyz

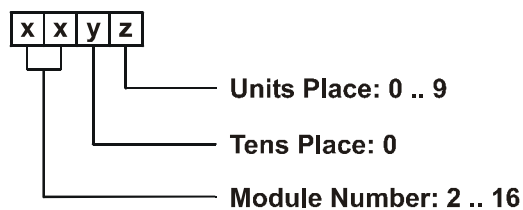

Note!



When determining the module number, only digital input or output modules are counted. Intelligent modules, such as N-SV 1, N-SM 1, N-PID 1, etc., located among the digital input and output modules, are not taken into consideration. Module number 1 is assigned to the basic control unit. Starting from there, the module numbers are counted left to right.

Example 1:

The table below shows the input/output numbering for a basic controller with two N-ID 8 modules and one N-OD 8 output module, arranged as follows:

NANO-B Basic Controller	N-OD 8 Output Module	N-ID 8 Input Module	N-ID 8 Input Module
Module # 1	Module # 2	Module # 3	Module # 4
Inputs and Outputs 101 .. 108	Output 201 .. 208	Input 301 .. 308	Input 401 .. 408

Example 2:

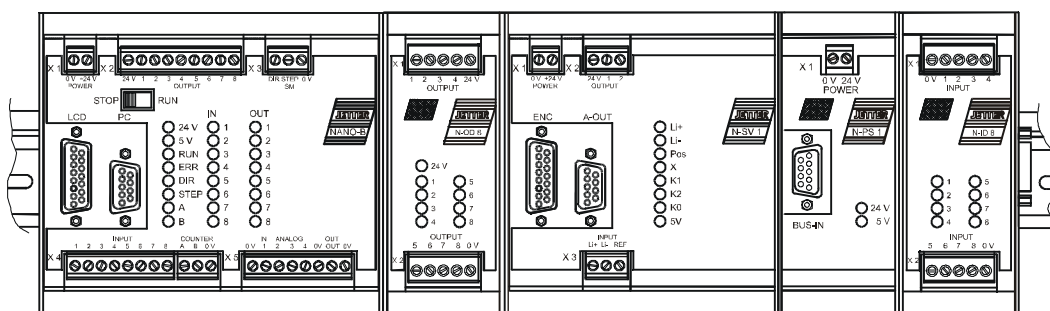

Basic controller with with a digital output module N-OD 8, an intelligent expansion module N-SV 1, a power supply module N-PS1 and digital input module N-ID 8.

NANO-B Basic Controller	N-OD 8 Output Module	N-SV 1 Servo Module	N-ID 8 Input Module
Module # 1	Module # 2	Module # 3	Module # 4
Inputs and Outputs 101 .. 108	Output 201 .. 208	SV-Module	!!! Input 301 .. 308

Note!



- From example 2 can be seen that the module N-SV 1 is not taken into account when assigning numbers to digital inputs and outputs.
- The N-PS1 module is required as voltage supply module for the non-intelligent N-ID8 module. Please refer to chapter "N-PS1 Module - Power Supply Unit for Remote Modules" on page 237.
- When assigning input and output numbers, the N-PS1 module is not taken into account.

5.2 Access to Flags

5.2.1 User Flags

Flags 0 through 255 are freely available to the user. These flags are overlaid on registers 2600 through 2610 such that whole flag ranges can be accessed through registers. Logic operations are carried out using the word-processing instructions **W-AND**, **W-OR** and **W-XOR**.



Note!

All flags of the PROCESS-PLC NANO-B are remanent.

Overlaying of
Flags on
Registers

Register	Flag
2600	0 - 23
2601	24 - 47
2602	48 - 71
2603	72 - 95
2604	96 - 119
2605	120 - 143
2606	144 - 167
2607	168 - 191
2608	192 - 215
2609	216 - 239
2610	240 - 255 ^{*)}

For the complete list of flags overlaid on registers please refer to page 72.



*)Note!

Bits 16 through 23 of register 2610 are 0.

Example:

Overlaying of flags on registers by the example of register 2609									
Bit #	0	1	2	3	4	...	21	22	23
Reg. 2609	1	0	0	0	1	...	0	1	0
Flag	216	217	218	219	220	...	237	238	239

Programming with the Aid of Flags Example 1:

A program is to start execution of a process when the start button is pressed and automatic mode is enabled through the corresponding flag being set, e.g. in another task.

```

WHEN
    E eStartButton
    Flag mAutomaticMode
THEN
...

```

Example 2:

Execution of a second task -- the automatic task -- is to be started in the main task using a flag.

```

TASK tMainTask-----
...
IF
    E eStartButton
THEN
    Flag mAutomaticMode
...
THEN
    GOTO tMainTask-----
-----

TASK tAutomaticMode-----
----
WHEN
    Flag mAutomaticMode
THEN
...
THEN
    GOTO mAutomaticMode

```

5.2.2 Special Flags























The operating system of the Process PLC makes various special flags available which can be used to control and modify functions.





















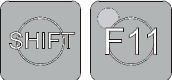



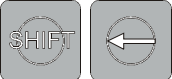

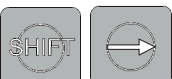









The functions of these special flags are listed in the following table.







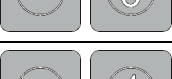



















Note!

As a rule, setting a flag means enabling the corresponding function. Exceptions will be referred to separately.

Functions of Special Flags			
Control of User Interface LEDs			
2224	LED of		2230
2225	LED of		2231
2226	LED of		2232
2227	LED of		2233
2228	LED of		2234
2229	LED of		2235
2230	LED of		2231
2231	LED of		2232
2232	LED of		2233
2233	LED of		2234
2234	LED of		2235
2235	LED of		
Scanning of user interface keys			
2181			2201
2182			2202
2183			2203
2184			2204
2185			2205

Functions of Special Flags			
2186		2206	
2187		2207	
2188		2208	
2189		2209	
2190		2210	
2191		2211	
2192		2212	
2193		2214	
2194		2213	
2195		2215	
2196		2216	
2197		2217	
2198		2218	
2199		2219	
2221		2220	
2223		2222	
2170		2160	
2171		2161	

Functions of Special Flags			
2172	 	2162	
2173	 	2163	
2174	 	2164	
2175	 	2165	
2176	 	2166	
2177	 	2167	
2178	 	2168	
2179	 	2169	
2200			
Display Format			
2060	DISPLAY_REG hexadecimal		
Prioritisation of System Tasks			
2056	PC task after each user task.		
2057	LCD task after each user task.		
2058	JETWay task		
2059	Time-out monitoring of I/O modules after each task (particularly, polling of FESTO CP modules).		
2061	Reading out of output states (not from RAM, but from the module).		
Network Control via Special Flags			
2062	Multimaster mode signals readiness to receive tokens on the network.		
2063	Master in multimaster mode.		

5.3 Register Description

5.3.1 User Registers

- In the register range 0 through 1999, 2000 remanent user registers are available to the user. They serve as buffers for storage of comparison and measured values, as well as of setpoints.
- These registers are 24 Bit wide and have got a value range from +8,388,607 through -8,388,608.
- For example, registers are loaded using the instruction **REGISTER_LOAD**.



Note!

The contents of the 2000 NANO-B user registers are maintained after switching off the power supply.

5.3.2 Programming with the Aid of Registers

The instruction

```
REGISTER_LOAD [x with a]
```

serves for loading of numeric values or contents of other registers into a register.

In the instruction above, "x" represents the number of the register value "a" is to be written into by analogy with Fig. 18 and Fig. 19.

REGISTER_LOAD	
register number	100
value	1234

Fig. 18: REGISTER_LOAD with numeric parameters

REGISTER_LOAD	
register number	rmNominalPos
value	nPosition1

Fig. 19: REGISTER_LOAD with symbolic parameters

Indirect and Double Indirect Addressing

For the **x** and the **a** in the instruction shown above, not only a number can be written, but a register can be specified as well. By pressing the space key an **R** is placed in front of the register number.

If **R(y)** is written instead of **x**, value **a** is written into the register the number of which is contained in register **y**.

If **R(b)** is written instead of **a**, not the value itself, but the content of the specified register is loaded into register **x** or **R(y)**.

If, instead of **a**, **RR** (press space key twice) is entered and then a number **b**, first, the value contained in the register with the number **b** is read.

```
REGISTER_LOAD [x with RR(b)]
```

This value then serves as register number. This means, a new value is read in the register with the specified number, and then stored to register **x**.



Fig. 20: Indirect and Double Indirect Addressing

Examples:

1. Loading of a number into a register

```
REGISTER_LOAD [rNewPosition with 1280]
```



Value 1280 is loaded into the register **rNewPosition**.

2. Copying one register into another register

```
REGISTER_LOAD [rVoltage with R(rVoltage1)]
```



The value which is contained in the register **rVoltage1** will be loaded into register **rVoltage**. In other words, the contents of register **rVoltage1** is copied into register **rVoltage**.

3. Loading by double indirect addressing

REGISTER_LOAD [rVoltage with RR(rV Pointer)]



The value of the register, the number of which is specified in register r(V Pointer), is loaded into register rVoltage.

4. Double indirect addressing: Numerical example

Register Number	Value
REG 64	111
REG 111	70035
REG 150	11
REG 11	any value

The following instruction will be carried out with the given parameters:

REGISTER_LOAD [R(150) with RR(64)]



This instruction will result in the following register values and the graphic representation shown in Fig. 21:

- Register 64 = 111 remains unchanged
- Register 64 = 70035 remains unchanged
- Register 64 = 11 remains unchanged
- Register 64 = R150 = RR64 = R111 = 70035



Fig. 21: Example for Double Indirect Addressing

5.3.3 Calculating with the Aid of Registers

The following instructions are used for calculations:

- REG <RegNo>
- REGNULL <RegNo>
- REGDEC <RegNo>
- REGINC <RegNo>

The register number can indirectly be specified for all four instructions.

```

Project File Edit Block Transfer Listing Monitor Scope Special
Length: 16 <0.1%> ARI01.PNB
0: TASK tArithmeticDemo
1: ?
2: REG rResult
3: <
4: REG rAddend1
5: +
6: REG rAddend2
7: =
8:
9: REG rMinuend
10: >
11: /
12: REG rDivisor
13: ?
14: ?
15: ?
End of program

```

Fig. 22: Example of Register Arithmetic

Programming Instruction REG

This instruction obtains direct access to the value of a register and can be dealt with like a variable. In an output instruction, a certain value is assigned to the register above the equals sign. In an input condition, the content of a register is read. In both cases, the register accesses below the equals sign result in reading the register content.

Examples:

```

1. THEN
    REG 1
    =
    REG 105
    *
    25

```

In this example an assignment (output instruction) is shown, which is initiated by **THEN**. Register 105 is read and its contents multiplied by 25. The result of this arithmetic operation will be stored in register 1. The contents of register 105 will remain unchanged.

```

2. IF
    REG 1
    =
    REG 105
    *
    25
    THEN

```

In this case the expression **REG 1 = REG 105 * 25** is not part of an output instruction, but of an input condition. In this part of the program the value of register 1 remains unchanged. It will only be compared with the product **REG 105 * 25**.

Programming Instruction REGNULL

This instruction obtains direct access to the value of a register and can be dealt with like a variable. In an output instruction, a certain value is assigned to the register above the equals sign. In an input condition, the content of a register is read. In both cases, the register accesses below the equals sign result in reading the register content.

By using the instruction **REGZERO** a register value is set to 0, or a register is sensed whether its value is 0:

```
REGNULL <RegNo>
```

The meaning of this instruction as an input condition following **IF** or **WHEN** is explained in the example below:

Example: REGZERO compared with REG	
<pre> IF REGZERO 49 THEN </pre>	<pre> IF REG 49 = 0 THEN </pre>



These two program parts have the same functions. On the righthand side of the example the comparison is carried out as a general arithmetic comparison. On the lefthand side of the example the special instruction **REGZERO** is used. Using **REGZERO** speeds up program execution.

Programming Instruction REGDEC and REGINC

These two instructions serve for decreasing (decrementing), respectively increasing (incrementing) a register value by 1. Such functions are frequently used in loops for increasing or decreasing counters and pointers.

Example: REGDEC compared with REG

```
THEN
  REGDEC 100
```

```
THEN
  REG 100
  =
  REG 100
  -
  1
```



These two program parts have the same functions. With both of them, the value of register 100 is decremented by 1.

Example: REGINC compared with REG

```
THEN
  REGDEC 88
```

```
THEN
  REG 88
  =
  REG 88
  +
  1
```



These two program parts have the same functions. With both of them, the value of register 88 is incremented by 1.

Example: REGDEC and REGZERO

```
REGISTER_LOAD [1 with 10]
```

```
Label 55
```

```
...
```

```
REGDEC 1
```

```
IF
```

```
REGZERO 1
```

```
THEN
```

```
ELSE
```

```
GOTO 55
```

```
THEN
```



This way, a loop can be realised which executes a certain number of iterations. During each run of the loop, the value of the "counting register" is decremented by one and is being checked whether it is 0 (REGZERO 1). If the value is 0, the first THEN will be ignored and the loop will go to the second THEN to continue execution of the program there. If the value of register 1 is not 0, the program will return to the starting point of the loop.

5.3.4 Special Registers

Special Register Number	Function	1) Value Range 2) Reset Value 3) Cross Reference
Operating System and Error Messages		
2000	Software version	1) 0 .. 65535 2) Version
2001	Status register	1) -8388608 .. +8388607 2) Status 3) chapter 15 "Error Handling", page 258
2002	Run Time Register: Operating time since reset in 0.1 s. The unit is dependent on register 2003.	1) 0 .. +8388607 2) 0
2003	Time base for DELAY , as well as START-TIMER and TIMER-END?	1) 0 .. 255 2) 10 (100 ms)
2006	Cycle time of all tasks in ms	1) 0 .. 255 2) not defined
2008	Operating system error	1) 0 .. 65535 2) 0 3) chapter 15 "Error Handling", page 258
2009	Number of the erroneous task	1) 0 .. 255 2) -1 and -2 3) chapter 15 "Error Handling", page 258
2010	Program address of the error for internal use	1) 0 .. 65535 2) 0
2011	Time-out of I/O module # 2, 3, 4, 5, ... , 15	1) 0 .. 255 2) 0 3) chapter 15 "Error Handling", page 258
2012	Time-out of slave module specifying module #	1) 0 .. 255 2) 0 3) chapter 15 "Error Handling", page 258
2013	Quantity of connected non-intelligent modules	1) 0 .. 255 2) Quantity
2014	Quantity of connected intelligent modules	1) 0 .. 255 2) Quantity
2015	Pointer on module array	1) 0 .. 255 2) 0

Special Register Number	Function	1) Value Range 2) Reset Value 3) Cross Reference
2016	<p><i>Module array:</i></p> <p>2015 means pointer</p> <p>2015 = 0 -> 2016 = Qty. of modules</p> <p>2015 = 1 -> 2016 = Code of the first module</p> <p>2015 = 2 -> 2016 = Code of the second module etc.</p> <p><i>Codes:</i></p> <p>0 = N-OD8 1 = N-ID8 2 = N-IO16 3 = N-IA4 4 = N-OA4 5 = N-CNT 1 6 = N-PRN 1 7 = N-SER 1 32 = Outputs of FESTO CP Modules 33 = Inputs of FESTO CP Modules 128 = N-SV1 129 = CAN-DIMA 130 = N-SM2 131 = N-SM1D 132 = N-PID 1 133 = N-Profi 1 253 = Dummy 254 = Dummy I/O 255 = not identified</p>	<p>1) 0 .. 255 2) Qty. of modules</p>
2022	Version of the application program of non-intelligent modules	
2023	<p>Bit-coded list:</p> <ul style="list-style-type: none"> - non-intelligent modules - dummy modules 	<p>1) 0 .. 65535 2) last setting</p>
2024	<p>Bit-coded list:</p> <ul style="list-style-type: none"> - non-intelligent modules - dummy modules 	<p>1) 0 .. 255 2) last setting</p>
2027	Error of output driver	1) one bit per module
2028	Monitoring interval for I/O modules	<p>1) 0 .. 255 2) 20 (200 ms)</p>

Special Register Number	Function	1) Value Range 2) Reset Value 3) Cross Reference
Task Control		
2004	Task switch conditions Task switching always if <ul style="list-style-type: none"> • DELAY • USER_INPUT • WHEN (not fulfilled), and also if • Bit 0 = 1 AND Task switch time-out (2005) • Bit 1 = 1 AND GOTO • Bit 2 = 1 AND IF (not fulfilled) 	1) 0 .. 255 2) 3 3) Please refer to chapter "Principle of Operation" on page 270.
2005	Time-out period for a task: Period after which a task is exited at the latest, refer to register 2004	1) 0 .. 255 2) 20 (20 ms) 3) Please refer to chapter "Principle of Operation" on page 270.
2006	Cycle time of all tasks in ms	1) 0 .. 255 2) not defined
2007	Number of the highest user task	1) 0 .. 31 2) Number
2025	Present task	
2026	Prioritized task	1) 0 .. 31, 255 2) 255 (no priorities assigned)
2091	Reserve capacity of the stack in which the query is carried out.	
2100 .. 2131	Task status: 255 = Task is being processed 254 = DELAY 253 = USER_INPUT 250 = WHEN_MAX 1 = TASKBREAK 0 = not existing	1) 0 .. 255 2) Status 3) SYMPAS: Index window
2200 .. 2231	Task index	1) 0 .. 65535 2) TASK Start 3) SYMPAS: Index window
2300 .. 2331	Task time register for delay	1) 0 .. +8388607 2) 0

Special Register Number	Function	1) Value Range 2) Reset Value 3) Cross Reference
Control of User Interfaces (LCD display)		
2804	Number of characters	1) 0 .. 255 2) 48 3) chapter 6.6 "Registers for User Interfaces", page 87
2805	Number of characters per line	1) 0 .. 255 2) 24 3) chapter 6.6 "Registers for User Interfaces", page 87
2806	Text choice for DISPLAY_TEXT_2 0 = Text 1 1 = Text 2	1) 0 .. 255 2) 0 3) chapter 6.6 "Registers for User Interfaces", page 87
2807	DIVISOR (USER_INPUT)	1) 0 .. 65535 2) 1 3) chapter 6.5 "Fixed-point Numbers", page 83
2808	Number of decimal places (USER_INPUT)	1) 0 .. 255 2) 0 3) chapter 6.5 "Fixed-point Numbers", page 83
2809	Divisor (DISPLAY_REG)	1) 0 .. 65535 2) 1 3) chapter 6.5 "Fixed-point Numbers", page 83
2810	Number of decimal places (DISPLAY_REG)	1) 0 .. 255 2) 0 3) chapter 6.5 "Fixed-point Numbers", page 83
2812	Field length for integer display register	1) 0 .. 255 2) 8 3) chapter 6.6 "Registers for User Interfaces", page 87

Special Register Number	Function	1) Value Range 2) Reset Value 3) Cross Reference
2813	Field length USER_INPUT	1) 0 .. 255 2) 8 3) chapter 6.6 "Registers for User Interfaces", page 87
2814	Indirect cursor position	1) 0 .. 255 2) 0 3) chapter 6.6 "Registers for User Interfaces", page 87
2815	Default value USER_INPUT	1) -8388608 .. +8388607 2) 0 3) chapter 6.6 "Registers for User Interfaces", page 87
2816	Sign suppression	1) 0 .. 255 2) 0 3) chapter 6.6 "Registers for User Interfaces", page 87
2817	Status USER_INPUT	1) 0 .. 255 2) Status 3) chapter 6.6 "Registers for User Interfaces", page 87
2818	Restrictions of monitor functions 0 = OFF 1 = ON	1) 0 .. 255 2) 255 3) chapter 6.6 "Registers for User Interfaces", page 87
2819	Display time of monitor functions	1) 0 .. 65535 2) 350 3) chapter 6.6 "Registers for User Interfaces", page 87
2820	Switch to monitor display	1) 0 .. 255 2) 0 3) chapter 6.6 "Registers for User Interfaces", page 87
2821	Dialog language: 0 = German 1 = English	1) 0 .. 255 2) 0 3) chapter 6.6 "Registers for User Interfaces", page 87

Special Register Number	Function	1) Value Range 2) Reset Value 3) Cross Reference
2822	LCD interface baud rate	1) 0 .. 7 2) 6 3) chapter 6.6 "Registers for User Interfaces", page 87
2823	PC interface baud rate	1) 0 - 7 2) 6 3) chapter 6.6 "Registers for User Interfaces", page 87
2824	Indirect buffer number when device 0 is specified	1) 0-4 2) 2 3) chapter 6.6 "Registers for User Interfaces", page 87
2825	Text buffer for display 1	1) 1-4 2) 1 3) chapter 6.6 "Registers for User Interfaces", page 87
2826	Text buffer for display 2	1) 1-4 2) 2 3) chapter 6.6 "Registers for User Interfaces", page 87
2827	Text buffer for display 3	1) 1-4 2) 3 3) chapter 6.6 "Registers for User Interfaces", page 87
2828	Text buffer for display 4	1) 1-4 2) 4 3) chapter 6.6 "Registers for User Interfaces", page 87
2829	Basic key flag number for display 1	1) -161 - 1824. 2000 2) 2000 3) chapter 6.6 "Registers for User Interfaces", page 87
2830	Basic key flag number for display 2	1) -161 - 1824. 2000 2) 2000 3) chapter 6.6 "Registers for User Interfaces", page 87

Special Register Number	Function	1) Value Range 2) Reset Value 3) Cross Reference
2831	Basic key flag number for display 3	1) -161 - 1824. 2000 2) 2000 3) chapter 6.6 "Registers for User Interfaces", page 87
2832	Basic key flag number for display 4	1) -161 - 1824. 2000 2) 2000 3) chapter 6.6 "Registers for User Interfaces", page 87
2833	Register number for controlling LEDs of display 1	1) 1 - 1999, 2622 - 2637, 2649 2) 2649 3) chapter 6.6 "Registers for User Interfaces", page 87
2834	Register number for controlling LEDs of display 2	1) 1 - 1999, 2622 - 2637, 2649 2) 2649 3) chapter 6.6 "Registers for User Interfaces", page 87
2835	Register number for controlling LEDs of display 3	1) 1 - 1999, 2622 - 2637, 2649 2) 2649 3) chapter 6.6 "Registers for User Interfaces", page 87
2836	Register number for controlling LEDs of display 4	1) 1 - 1999, 2622 - 2637, 2649 2) 2649 3) chapter 6.6 "Registers for User Interfaces", page 87
Network Control		
2700	Network number	1) 0 .. 255 2) 2 3) chapter 7.4 "Registers for Network Operation", page 112
2701	Baud Rate	1) 0 .. 255 2) 10 3) chapter 7.4 "Registers for Network Operation", page 112

Special Register Number	Function	1) Value Range 2) Reset Value 3) Cross Reference
2702	Register offset	1) 0 .. 65535 2) 0 3) chapter 7.4 "Registers for Network Operation", page 112
2703	Flag offset	1) 0 .. 65535 2) 0 3) chapter 7.4 "Registers for Network Operation", page 112
2704	Input offset	1) 0 .. 65535 2) 100 3) chapter 7.4 "Registers for Network Operation", page 112
2705	Output offset	1) 0 .. 65535 2) 100 3) chapter 7.4 "Registers for Network Operation", page 112
2706	Output mask	1) 0 .. 65535 2) 1000 3) chapter 7.4 "Registers for Network Operation", page 112
2707	Indirect network number	1) 0 .. 126 2) 0 3) chapter 7.4 "Registers for Network Operation", page 112
2708	Time-out period for network	1) 0 .. 65535 ms 2) 250 ms
2709	Network response time	1) 0 .. 65535 ms 2) 0 3) chapter 7.4 "Registers for Network Operation", page 112
2710	Quantity of network errors	1) 0 .. 255 2) 0 3) chapter 7.4 "Registers for Network Operation", page 112

Special Register Number	Function	1) Value Range 2) Reset Value 3) Cross Reference
2711	Error code of the last access to the network	1) 0 .. 255 2) 0 3) chapter 7.4 "Registers for Network Operation", page 112
2712	Next master (Multimaster mode)	1) 0 .. 255 2) 0
2713	Maximum network number (Multimaster mode)	1) 0 .. 255 2) 0
2716	Token transfer time (Multimaster mode)	1) -8388608 .. +8388607 2) 0
Time Registers		
2002	Register runtime with an increment of 0.1 s. This register is linked with register 2003.	1) 0 .. +8388607 2) 0
2003	Time base for DELAY , as well as START-TIMER and TIMER-END?	1) 0 .. 255 2) 10 (100ms)
2006	Cycle time of all tasks in ms	1) 0 .. 255 2) not defined
2300 .. 2331	Task time register for delay	1) 0 .. +8388607 2) 0
Single-/Dual-Channel Counter		
2901	Count value	1) -8388608 .. +8388067 2) 0 3) chapter 8 "Single-/Dual-Channel Counter", page 117
2918	Counting rate	1) -32768 .. +32767 2) 0
2919	Time base for counting rate	1) 0 .. 255 2) 10 (100 ms)
Other Registers		
2900	Peripheral devices monitoring register:	1) 0 .. 65535 2) 1 3) chapter 8 "Single-/Dual-Channel Counter", page 117 and chapter 9 "Analog I/Os", page 120

Special Register Number	Function	1) Value Range 2) Reset Value 3) Cross Reference
AD/DA Register		
2902	Analog OUT	1) 0 .. 255 (0 .. 10 V) 2) 2 3) chapter 9 "Analog I/Os", page 120
2903 .. 2906	Analog IN 1 .. 4	1) 0 .. 1023 2) depending on input value 3) chapter 9 "Analog I/Os", page 120
2920	Slew rate limitation AD	1) 2 .. 2000 2) 2 3) chapter 9 "Analog I/Os", page 120
RTC-Registers		
2911	Seconds	3) chapter 12 "Real-Time Clock", page 148
2912	Minutes	3) chapter 12 "Real-Time Clock", page 148
2913	Hours	3) chapter 12 "Real-Time Clock", page 148
2914	Day of the week 0 .. 6	3) chapter 12 "Real-Time Clock", page 148
2915	Day	3) chapter 12 "Real-Time Clock", page 148
2916	Month	3) chapter 12 "Real-Time Clock", page 148
2917	Year 0 .. 99	3) chapter 12 "Real-Time Clock", page 148
24 Combined Inputs		
2400	101..108, 201..208, 301..308	
2401	201..208, 301..308, 401..408	
...		
2413	1401..1408, 1501..1508, 1601..1608	

Special Register Number	Function	1) Value Range 2) Reset Value 3) Cross Reference
16 Combined Inputs		
2420	101..108, 201..208	
2421	201..208, 301..308	
...		
2434	1501..1508, 1601..1608	
8 Combined Inputs		
2440	101..108	
2441	201..208	
...		
2455	1601..1608	
24 Combined Outputs		
2500	101..108, 201..208, 301..308	
2501	201..208, 301..308, 401..408	
...		
2513	1401..1408, 1501..1508, 1601..1608	
16 Combined Outputs		
2520	101..108, 201..208	
2521	201..208, 301..308	
...		
2534	1501..1508, 1601..1608	
8 Combined Outputs		
2540	101..108	
2541	201..208	
...		
2555	1601..1608	

Special Register Number	Function	1) Value Range 2) Reset Value 3) Cross Reference
Flags Overlaid on Registers		
0	256 .. 279	
1	280 .. 303	
...		
74	2032 .. 2047	
2600	0 .. 23	
2601	24 .. 47	
...		
2610	240 .. 255	
2611	2048 .. 2071	
2612	2072 .. 2095	
...		
2620	2264 .. 2287	
2621	2288 .. 2303	
2622	0 .. 15	
2623	16 .. 31	
...		
2637	240 .. 255	
2638	2048 .. 2063	
2639	2064 .. 2079	
...		
2655	2320 .. 2335	

Special Register Number	Function	1) Value Range 2) Reset Value 3) Cross Reference	
Festo CP Valve Terminals			
2017	Quantity of Festo CP modules	1) 2) 3)	0 .. 7 0 chapter 14 "NANO Network Topology and FESTO CP Modules", page 244
2018	Index to configuration table	1) 2) 3)	1 .. 8 1 chapter 14 "NANO Network Topology and FESTO CP Modules", page 244
2019	Check number	1) 2) 3)	0 .. 65535 Check number chapter 14 "NANO Network Topology and FESTO CP Modules", page 244
2020	Type of the Festo CP module	1) 2) 3)	0 .. 65535 Type chapter 14 "NANO Network Topology and FESTO CP Modules", page 244
2021	I/O configuration	1) 2) 3)	0 .. 65535 I/O configuration chapter 14 "NANO Network Topology and FESTO CP Modules", page 244

6 User Interfaces, Operator Guidance

6.1 Technical Data

Overview: User Interfaces				
Type	Display	Keys	Comment	Interface Cable
LCD 9	2 lines of 24 characters each	<ul style="list-style-type: none"> – 12 F keys (with LED) – Special Function Keys – Numeric keypad 		OpenColl EM-DK
LCD 10	2 lines of 24 characters each	<ul style="list-style-type: none"> – 12 F keys (with LED) – Special Function Keys – Numeric keypad 	9 mm character height backlit	OpenColl EM-DK
LCD 110	4 lines of 20 characters each	<ul style="list-style-type: none"> – 12 F keys (with LED) – Special Function Keys – Numeric keypad 	backlit	RS422 DK-422
LCD 12	2 lines of 16 characters each	<ul style="list-style-type: none"> – 4 F keys – Special Function Keys – Numeric keypad 	designed for installation in hand-held operator consoles	OpenColl EM-DK
LCD 16	4 lines of 20 characters each	<ul style="list-style-type: none"> – 5 F keys (with LED) 	allows modular expansion by keyboard (NUM25) and handwheel (HR1) modules	RS422 DK-422
LCD 17	Graphic Display 128 x 240 Pixels	<ul style="list-style-type: none"> – 6 F keys (with LED) – Special Function Keys – Numeric keypad – Cursor keypad 	Visualisation with: <ul style="list-style-type: none"> – Numeric objects – Text variables – Bargraph – D/A transfer 	RS422 DK-422
LCD 19	Graphic Display 240 x 120 Pixels	<ul style="list-style-type: none"> – 6 F keys (with LED) – Special function keys with alphanumeric function – Numeric keypad – Cursor keypad 	Visualisation with: <ul style="list-style-type: none"> – Numeric objects – Text variables – Bargraph – D/A transfer 	RS422 DK-422
LCD 23	2 lines of 24 characters each	<ul style="list-style-type: none"> – Cursor left – Cursor right – ENTER 	5 mm character height	RS422 DK-422

Overview: User Interfaces				
Type	Display	Keys	Comment	Interface Cable
LCD 23L	1 line of 16 characters	<ul style="list-style-type: none"> – Cursor left – Cursor right – ENTER 	8 mm character height	RS422 DK-422
LED 23	1 line of 8 characters	–	12 mm character height 7-segment LED	RS422 DK-422
LCD 25	2 lines of 24 characters each	– 5 F keys (with LED)	5 mm character height, backlit	RS422 DK-422
LCD 25L	1 line of 16 characters	–	8 mm character height, backlit	RS422 DK-422
LED 25	1 line of 8 characters (LED)	–	12 mm character height 7-segment LED	RS422 DK-422
LCD 27	2 lines of 24 characters each	<ul style="list-style-type: none"> – 5 F keys – Cursor keypad – Clear – ENTER 		RS422 DK-422
LCD 34	2 lines of 24 characters each	<ul style="list-style-type: none"> – 5 F keys – Special Function Keys – Numeric keypad 	backlit	RS422 DK-422

6.2 Description of Connections

The user interface cables DK-422, resp. EM-DK are used to connect user interfaces to the LCD input of the NANO-B basic control unit. Refer to specification for user interface cables on page 28 and page 23.

6.3 Multi-Display Mode

Multi-display mode allows a PROCESS-PLC NANO-B to be operated with up to four LCD user interfaces. When doing so, the same or different texts and/or register contents can be displayed on the various user interfaces.

- Specific parameters for the LCD user interface used are described in the corresponding Operator's Manual.
- To each user interface a specific number has to be assigned.
- If only one LCD user interface is used, value 0 is assigned to it always.
- If more than one LCD user interface is used, a value between 1 and 4 is assigned to each LCD user interface starting with 1. In this case, a display with # 1 must be existing.

The display, to which # 1 was assigned, is the master LCD. After power-up only the first LCD user interface is synchronised with the PROCESS-PLC. The other LCDs remain inactive until they receive command signals.

Note!



User input and monitor mode can be activated **at the same time** only for one display.

Note!



- Power supply of several LCD user interfaces cannot be performed by the controller itself.
- LCD user interfaces have to be supplied by a separate 15 V to 30 V DC power supply unit.
- Power consumption of individual LCD user interfaces has to be taken into account during system design and for using the system.
- For connecting several user interfaces to the LCD port of the PROCESS-PLC you need an adaptor or modified connecting cables.
- The originally shipped cables have to be modified according to Fig. 23, page 77.
- In multi-display mode only user interfaces with RS 422 interface can be used.

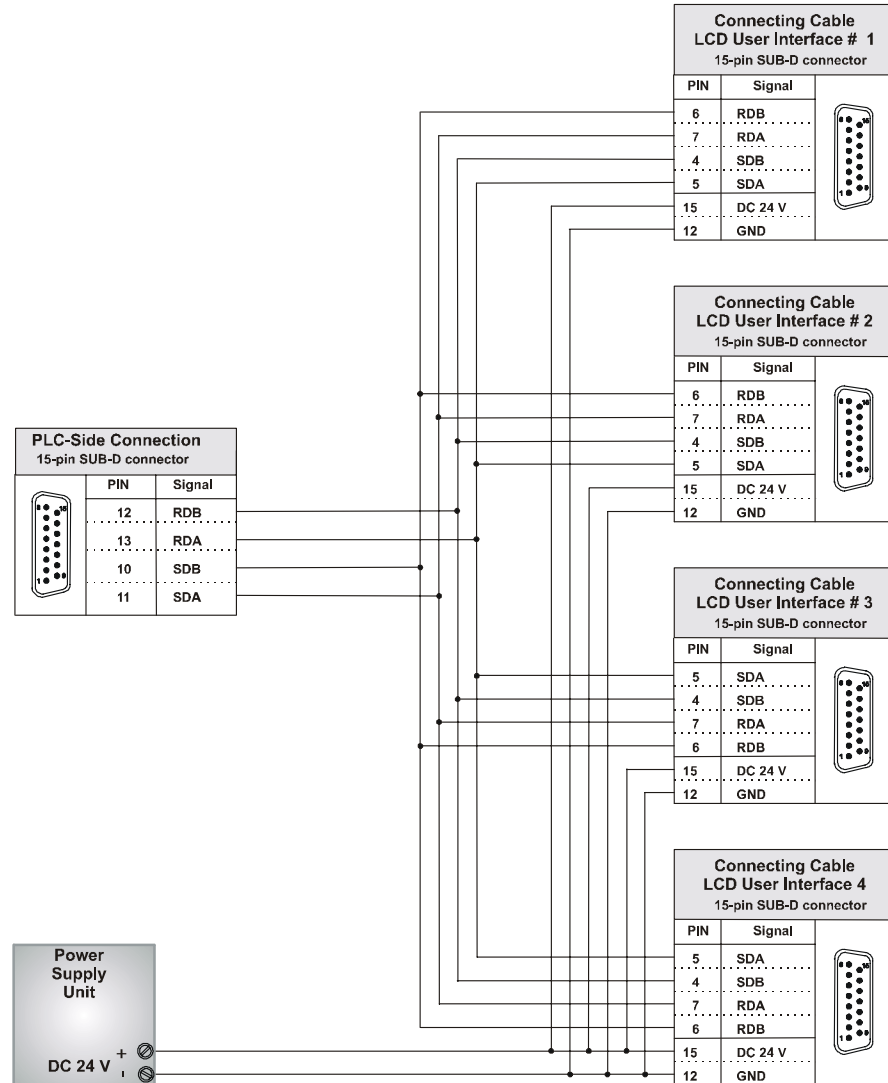

Fig. 23: Pin Assignment of Connecting Cable for Several LCD User Interfaces



Important!

- Also with a view to EMC, the following minimum requirements apply to the connecting cable fabrication:
 1. Number of cores: 6
 2. Core cross-sectional area: 0.25 mm²
 3. Connector (male): SUB-D, metallised
 4. Maximum cable length: 100 m
 5. Shield: complete shielding, no paired shielding
- The shield must be connected to the metallised connector housings on both ends of the cable with the greatest possible surface area.

6.4 Programming the User Interfaces

This chapter gives a description of such instructions necessary for programming display and keyboard modules. For programming, the following instructions will be used:

- `DISPLAY_TEXT`
- `DISPLAY_REG`
- `USER_INPUT`

6.4.1 Display of Texts

The following instruction is used to display text on the user interface:

```
DISPLAY_TEXT [#<DeviceNo>, cp=<Cursorpos> <Text>]
```

6.4.2 Text Output Parameters

Device Number The parameter "Device Number" is specified by entering numerals from 0 through 9.

#0 through #4	Selection of a user interface.
#5 through #8	Not assigned
#9	Selection of the user-programmable interface <code>PRIM</code> .

Cursor Position By this parameter, the cursor position is defined, where the first character of the text is to appear.

Cursor Positions of various User Interfaces	
Type	Cursor Positions
LCD 9	1. line: 1 through 24 2. line: 25 through 48
LCD 10	1. line: 1 through 24 2. line: 25 through 48
LCD 12	1. line: 1 through 16 2. line: 17 through 32
LCD 16	1. line: 1 through 20 2. line: 21 through 40 3. line: 41 through 60 4. line: 61 through 80
LCD 17	Status line: 1 through 40
LCD 19	Status line: 1 through 40
LCD 23	1. line: 1 through 24 2. line: 25 through 48
LCD 23L	1 through 16 1 through 16
LED 23	1 through 7 1 through 7
LCD 25	1. line: 1 through 24 2. line: 25 through 48
LCD 25L	1 through 16 1 through 16
LED 25	1 through 7 1 through 7
LCD 27	1. line: 1 through 24 2. line: 25 through 48
LCD 34	1. line: 1 through 24 2. line: 25 through 48

Cursor Position 0 The cursor position 0 has a special meaning: If cursor position 0 is set, new text will be attached to the text displayed last. The cursor is located at exactly the same position, where it had been positioned after execution of the last instruction "DISPLAY_TEXT".

6.4.3 Control Characters for Text Output

The two characters "_" and "\$" serve as control characters for text output.

DELSCR „_" When this character is used, first, the displayed text is deleted and then, irrespective of the specified parameter, the given text is displayed starting from cursor position 1. This character does only make sense, when it is placed at the beginning of the text, as otherwise the first part of the text would be displayed first, and then would be deleted immediately. This character has got the meaning **DELSCR** (Delete Screen). If this character is to be displayed, the character code for **DELSCR** can be changed in the special register.

DELEOL „\$" This character deletes the rest of a line from the present cursor position on. It is also referred to as **DELEOL** (Delete End Of Line).

Examples:

```
DISPLAY_TEXT [#0, cp=0, "_Actual Position:"]
```

By using this instruction the entire LCD display is deleted first, and "Actual position:" is then displayed on the upper line of the display (cursor position = 1). Any numeral displayed previously will be ignored following **DELSCR**. The following display will appear:

Actual Position:

```
DISPLAY_TEXT [#0, cp=25, "_Set Position:$"]
```

After issuing this instruction, the text "Set Position:" is written at the given cursor position, i.e. at the beginning of the second line of the display. Then, the rest of this line is deleted.

```
DISPLAY_TEXT [#0, cp=0, "ERROR"]
```

After issuing this instruction, the text "**ERROR**" is written, starting from the present cursor position.

While doing so, this text is simply attached to any already existing text.

Register 2814 The cursor position is indirectly specified by register 2814.



Note!

If register 2814 is containing a value $\neq 0$, this value is interpreted as cursor position and the text "**ERROR**" is written at the given position, e.g. with the following instruction:

```
DISPLAY_TEXT [#0, cp=1, "Error"]
```

6.4.4 Displaying Register Contents

A register value can be output on a user interface using the following instruction:

```
DISPLAY_TEXT [#<DeviceNo>, cp=<Cursorpos> Reg=<RegNo>]
```

The parameters "DeviceNo" and "CursorPos" have got exactly the same function as described for the `DISPLAY_TEXT` instruction, refer to chapter 6.4.3: "Control Characters for Text Output", page 80. Additionally, a register number is to be specified. Of course, this is the number of the register, the contents of which are to be displayed. For this purpose, indirect addressing can be applied as well.

Examples:

```
DISPLAY_REG [#0, cp=17, Reg=100]
```

Through this instruction, register 100 is displayed on the LCD. If register 2812 has not been changed since reset, the register value is displayed at the end of the first display line, as shown below (assumption: the display was empty before the instruction was issued, and register 100 = -3567):

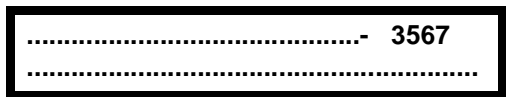

The dots are to represent the positions which have still got the „previous“ contents after issuing the instruction.

```
DISPLAY_TEXT [#0, cp=25, "Actual Position:$"]
DISPLAY_REG [#0, cp=41, Reg=12109]
```

From this example can be seen how the two `DISPLAY` instructions can be combined usefully.

First, the text "Actual Position:" is written into the second line (on the left), while the rest of the second line is deleted (dollar sign "\$"). The second instruction is used to display the contents of register 12109 on the bottom right of the display. With a servo controller module which is plugged onto module 2, the actual position is stored to this register. For example, the actual position of axis 21 has got the value 5400.



The dots are to represent the positions which have still got the „previous“ contents after issuing the instruction.

6.4.5 Query of Register Values

The instruction:

```
USER_INPUT [#<DeviceNo>, cp=<Cursorpos> Reg=<RegNo>]
```

serves to read in register values which can be input using a user interface.

To both of the parameters "Device Number" and "Cursor Position" the same conditions apply as to the `DISPLAY_TEXT` instruction. If cursor position 0 is entered, the value contained in register 2814 is taken as cursor position for user input. If the value of register 2814 is 0 (default value following reset), the present cursor position is used for user input.

The register number is the number of the register to which the value that has been entered is to be assigned. Here, simple indirect register addressing is possible as well.



Important!

As a rule, for `USER_INPUT` 8 characters available. This value which is stored to register 2813 can also be altered.

Example:

```
DISPLAY_TEXT [#0, cp=1, "_New Position?"]  
USER_INPUT [#0, cp=17, Reg=100]
```

To provide meaningful user guidance, the `USER_INPUT` instruction usually is combined with the `DISPLAY_TEXT` instruction. The effect of these two instructions is that the text "New Position?" is displayed on the top left of the display. Then, the controller is waiting for a numeral to be entered. This numeral will be stored to register 100 and will serve as new set position for positioning purposes.

6.5 Fixed-point Numbers

Fixed-point numbers can be displayed and entered with the help of the user interface. While doing so, the functions of register 2812: "Field length for `DISPLAY_REG`" and register 2813: "Field length for `USER_INPUT`" remain unchanged. These registers are specified as mentioned above.

6.5.1 Display of Fixed-point Numbers

For this purpose, two additional special registers are available, namely the registers 2809 and 2810.

Register 2809: Divisor for Value Output <code>DISPLAY_REG</code>	
Register Value	Decimal Positions
1	0
10	1
100	2
1000	3
10000	4

The number of decimal positions is defined through the value of this register. As an alternative, instead of register 2810, register 2809 can also be used. A maximum of four decimal positions is possible.

Register 2810: Decimal Positions for <code>DISPLAY_REG</code>	
Register Value	Decimal Positions
0	0
1	1
2	2
3	3
4	4

The number of decimal positions is defined through the value of this register. As an alternative, instead of register 2810, register 2809 can also be used. A maximum of four decimal positions is possible.

Example:

The instruction

```
DISPLAY_REG [#0, cp=1, reg=200]
```

is used to display the contents of register 200 on the LCD.

The number 20.00, for example, is displayed by the following register definitions:

```
Register 200 = 2000
```

```
Register 2809 = 100      [Divisor for Value Output DISPLAY_REG]
```

```
Register 2810 = 2        [Decimal Positions for DISPLAY_REG]
```

**Note!**

The numeric value of register 200 remains unchanged. For representation purposes on the display, a decimal point is added only.

6.5.2 Input of Fixed-point Numbers

For this purpose, two additional special registers are available, namely the registers 2807 and 2808.

Register 2807: Divisor for Value Input USER_INPUT	
Register Value	Decimal Positions
1	0
10	1
100	2
1000	3
10000	4

The number of decimal positions for data input is defined through the value of this register.

As an alternative, instead of register 2807, register 2808 can also be used. A maximum of four decimal positions is possible.

Register 2808: Decimal Positions for USER_INPUT	
Register Value	Decimal Positions
0	0
1	1
2	2
3	3
4	4

The number of decimal positions for data input is defined through the value of this register.

As an alternative, instead of register 2808, register 2807 can also be used. A maximum of four decimal positions is possible.

Example:

Data is downloaded from the user interface to register 200 using the following instruction:

```
USER_INPUT [#0, cp=1, reg=200]
```

Once the value 20.00 is entered by the operator, the following values appear in the relevant registers:

```
Register 200 = 2000
```

```
Register 2807 = 100      [Divisor for value output USER_INPUT]
```

```
Register 2808 = 2        [Decimal positions for USER_INPUT]
```



Note!

The numerical value of register 200 is 2000. For representation purposes, on the display a decimal point is added only. The operator has to input the value for register 200 only, together with the desired decimal places. From this input the values of register 2807 and register 2808 will result.

6.5.3 USER_INPUT: Suggested Value

Default Value in Register 2815 An additional special register, i.e. register 2815, has been provided to suggest a value (default value) to the user when issuing the `USER_INPUT` instruction.

The value contained in register 2815 will be shown on the display followed by the cursor, instead of 0. The operator may either confirm this value (default value) by pressing `ENTER`, or alter it. The altered value is accepted by pressing `ENTER`. By pressing `c` (clear), the input is deleted; then the suggested value contained in register 2815 will appear again.

Example 1:

```
USER_INPUT [#0, cp=1, Reg=100]
```



Display Text:

The displayed value 0 is the default value of register 2815.

Example 2:

```
Reg2815=88  
USER_INPUT [#0, cp=1, Reg=100]
```



Display Text:

The displayed value 88 is the defined value contained in register 2815.

6.6 Registers for User Interfaces

Register 2804: Amount of Characters of the User Interface^{*)}	
Function	Description
Read	Present value of the amount of user interface characters. Value following reset: 48
Write	New value specifying the amount of characters for the connected user interface.
Value range	1 - 127

^{*)}This register gets initialised by the connected user interface.

Register 2805: Amount of Characters per Line^{*)}	
Function	Description
Read	Present value: Amount of characters per line of user interface. Value following reset: 24
Write	New value specifying the amount of characters for the connected user interface.
Value range	1 - 127

^{*)}This register gets initialised by the connected user interface.

Register 2806: Text Choice for the DISPLAY_TEXT_2 Instruction	
Function	Description
Read	Present value for the text to be displayed in connection with the DISPLAY_TEXT_2 instruction. Value 0: Text 1 Value 1: Text 2 Value following reset: 0
Write	New value for text choice: Value 0: Text 1 Value 1: Text 2
Value range	0 - 1

Bilingual Text Output

Using the DISPLAY_TEXT_2 instruction a choice can be made between two texts to be displayed, e.g. for bilingual operator guidance. Additional example: Text 1 for the customer, text 2 for the service staff.

In this register choice is made which one of the two texts is to be displayed.

Register 2807: Divisor for USER_INPUT of Fixed-point Numbers	
Function	Description
Read	Present value for the divisor to define the amount of decimal positions for user inputs: Value 0: No decimal position Value 10: 1 decimal position Value 10000: 4 decimal positions Value following reset: 1
Write	Illegal
Value range	0 - 10000

The data being supplied by the NANO-B controller are integer values. When data are input with decimal positions by the user, these data are read out of register 2807 or 2808.

Register 2807 represents a divisor from which the amount of decimal positions results. For example, if the divisor value is 10, the resulting amount of decimal positions will be 1 ($1/10 = 0.1$).

Register 2808: Amount of Decimal Positions for USER_INPUT of Fixed-point Numbers	
Function	Description
Read	Present amount of decimal positions for user inputs: Value 0: No decimal position Value 1: 1 decimal position Value 4: 4 decimal positions Value following reset: 0
Write	-
Value range	0 - 4

Unlike register 2807 where the number of decimal positions is represented by a divisor, in register 2808 the number of decimal positions is specified directly.

Register 2809: Divisor for Displaying Fixed-point Numbers for DISPLAY_REG Instruction	
Function	Description
Read	Present value for the divisor to define the amount of decimal positions for DISPLAY_REG: Value 0: No decimal position Value 10: 1 decimal position Value 10000: 4 decimal positions Value following reset: 0
Write	New value for the divisor to define the amount of decimal positions for DISPLAY_REG.
Value range	0 - 10000

The data being supplied by the NANO-B controller are integer values. If these are to be displayed with decimal positions on the user interface using the `DISPLAY_REG` instruction, this can be achieved by using either register 2809 or 2810.

Register 2809 represents a divisor from which the amount of decimal positions results. For example, if the divisor value is 10, the resulting amount of decimal positions will be 1 ($1/10 = 0.1$).

Register 2810: Amount of Decimal Positions for Displaying Fixed-point Numbers for DISPLAY_REG	
Function	Description
Read	Present value of the amount of decimal positions for DISPLAY_REG: Value 0: No decimal position Value 1: 1 decimal position Value 4: 4 decimal positions Value following reset: 0
Write	Present value of the amount of decimal positions for DISPLAY_REG.
Value range	0 - 4

Unlike register 2809 where the amount of decimal positions is defined by a divisor, in register 2810 the amount of decimal positions can be specified directly. If, for example, 3 decimal positions are to be displayed, the value 3 can directly be input into register 2810. In register 2809, though, the divisor to be input would be 1000.

Register 2812: Field Length for DISPLAY_REG Instruction	
Function	Description
Read	Present field length for the DISPLAY_REG instruction Value following reset: 8
Write	New field length for the DISPLAY_REG instruction
Value range	0 - 9

Definition of the number of positions to be displayed. A maximum of 8 positions can be assigned to register display.

If values of two or three characters are to be displayed only, the actually required number of positions can be assigned to the display by using register 2812. This is of special importance if a great number of texts and values are to be displayed on a user interface.

The following rule applies: Contents of register 2812 = Number of positions to be displayed + sign

For example, value of register 2812 = 4 corresponds to 3 positions +1 sign

e.g. - 1 2 3



Note!

It should be considered that one position each is occupied by the sign and the decimal point. If a 6-digit value is to be displayed, into register 2812 the value 7, resp. 8 is to be entered.

Register 2813: Field Length for USER_INPUT Instruction	
Function	Description
Read	Present field length for the USER_INPUT instruction Value following reset: 0
Write	New field length for the USER_INPUT instruction
Value range	1 - 8

A maximum of 8 positions can be assigned to a user input. This also applies to the suggested value contained in register 2815.

If values of two or three characters are to be entered only, the actually required number of positions can be assigned to the display by using register 2813. This is of special importance if a great number of texts and values are to be displayed on a user interface.



Note!

It should be considered that one position is occupied by the sign. If a 6-digit value is to be input, the value 7 is to be entered into register 2813.

Register 2814: Indirect Cursor Position for DISPLAY_TEXT, DISPLAY_REG and USER_INPUT	
Function	Description
Read	Present value for indirect cursor position. Value following reset: 0
Write	New value for indirect cursor position.
Value range	0 - 127

If for the `DISPLAY_TEXT`, `DISPLAY_REG` and `USER_INPUT` instructions the cursor position 0 is specified, the cursor position contained in register 2814 will be used. If the value in this register is 0 as well, the text or value to be displayed will be attached the texts or values that have already been displayed.

Register 2815: Suggested (default) Value for the USER_INPUT instruction	
Function	Description
Read	Present default value at the cursor position defined by the <code>USER_INPUT</code> instruction. Value following reset: 0
Write	New default value for the <code>USER_INPUT</code> instruction.
Value range	- 8388608 .. + 8388607

Once a `USER_INPUT` instruction is activated, a default value will appear at the defined cursor position. This value is 0 by default. If another value is to be displayed at this position, the position is to be specified in 2815.

Register 2816: Sign Suppression with the DISPLAY_REG Instruction	
Function	Description
Read	Present value for sign suppression. Value following reset: 0
Write	New value for sign suppression. Value 0: Sign will be displayed Value 1: Sign will not be displayed
Value range	0 - 1

















Register values can be displayed either with or without sign. Values are displayed with sign by default. By using register 2816 it is possible to suppress display of signs .

Register 2817: User Input Status	
Function	Description
Read	Present user input status: Value 0: User input has not been activated Value 1: User input has been activated Value following reset: 0
Write	New user input status: Value 0: Termination without transfer of value Value 2: Termination with transfer of value
Value range	0 - 2

From this register can be seen whether a user input is activated at the moment. Thus, for example, proceeding from another task the time of the user input can be monitored. Once a defined period is expired, the user input can be terminated and the value shown on the display can be accepted by writing value 2 into register 2817. If value 0 has been written into register 2817, the user input is terminated without accepting the displayed value.

Register 2818: Keyboard Enable for User Interfaces	
Function	Description
Read	Present status of keyboard enable Value following reset: 255
Write	New status of keyboard enable, bit-coded
Value range	0 - 255

To allow the user to have access to defined operating functions, certain keyboard areas can be enabled, or disabled, by register 2818. If keyboard functions disabled for service staff are to be enabled again, this can also be carried out through this register.

Bit-specific Functions of Register 2818		
Bit		Function
Bit 0 = 1		Key with monitor function for displaying register contents.
Bit 0 = 0	 	Key "Display of register contents" disabled, but bits are set.
Bit 1 = 1		Key "Entry of flags"
Bit 1 = 0		Key "Entry of flags" disabled
Bit 2 = 1		Key "Access to outputs"
Bit 2 = 0		Key "Access to outputs" disabled
Bit 3 = 1		Key "Access to inputs"
Bit 3 = 0		Key "Access to inputs" disabled
Bit 4 = 1		Key "Change of register contents"
Bit 4 = 0		Key "Change of register contents" disabled
Bit 5 = 1		Key "Change of flags"
Bit 5 = 0		Key "Change of flags" disabled Flag "Change of state" is disabled.
Bit 6 = 1		Key "Change of outputs"
Bit 6 = 0		Key "Change of outputs" disabled
Bit 7 = 1		Key "Display of inputs"
Bit 7 = 0		Key "Display of inputs" disabled

Register 2819: Switch-over Time between Monitor Screen and Normal Display	
Function	Description
Read	Present value for switch-over time between monitor screen and normal display: A multiple of the time base specified in register 2003. Value following reset: 35
Write	New value for switch-over time between monitor screen and normal display.
Value range	0 - 65536

If the monitoring functions for registers, flags, display or change of outputs and inputs have been activated, the display of the user interface will be in monitor screen mode. In register 2819 the switching-over time between monitor screen and normal display is specified. Switching-over is carried out upon completion of inputs in monitor mode of the user interface.

Example:

A value of 35 in register 2819 stands for a switch-over time of 3.5 seconds.

Register 2820: Switching over to Monitor Display	
Function	Description
Read	Present state: Switching over to monitor screen by pressing the <i>ENTER</i> key: Value 0: Switching over by pressing <i>ENTER</i> enabled Value 1: Switching over by pressing <i>ENTER</i> disabled Value following reset: 0
Write	New state for switching over to monitor screen mode: Value 0: Switching over by pressing <i>ENTER</i> enabled Value 1: Switching over by pressing <i>ENTER</i> disabled
Value range	0 - 1

By pressing the *ENTER* key, direct switching over to monitor screen can be carried out. This function can be enabled or disabled using register 2820.

Register 2821: Display Language	
Function	Description
Read	Present setting for the language of integrated user interface functions: Value 0: German Value 1: English Value following reset: 0
Write	New setting for the language of integrated user interface functions: Value 0: German Value 1: English
Value range	0 - 1

By using this register the language for communication functions between user interface and operator is set. The language setting refers to operating system functions of the user interface, but not to texts output by the user. Such operating system functions are, for example, the monitor functions for registers, flags, inputs and outputs.

Register 2822: User Interface Baud Rate	
Function	Description
Read	Present user interface baud rate: 0 = 150 1 = 300 2 = 600 3 = 1200 4 = 2400 5 = 4800 6 = 9600 7 = 19200 Value following reset: 6
Write	New user interface baud rate: 0 = 150 1 = 300 2 = 600 3 = 1200 4 = 2400 5 = 4800 6 = 9600 7 = 19200
Value range	0 - 7

Register 2823: PC Interface Baud Rate	
Function	Description
Read	Present PC interface baud rate: Value following reset: 6
Write	New PC interface baud rate: 0 = 150 1 = 300 2 = 600 3 = 1200 4 = 2400 5 = 4800 6 = 9600 7 = 19200
Value range	0 - 7

Register 2824: Indirect Buffer Number with Device 0	
Function	Description
Read	Set buffer number Value following reset: 2
Write	New value for indirect buffer number
Value range	0 - 4

The NANO controller provides 4 text buffers for multi-display mode. Using the `DISPLAY_TEXT` or `DISPLAY_REG` commands data can be written into this buffer. When using these commands, the device number defines the buffer which is activated by the corresponding command. If a device number between 1 and 4 is used, the buffer is addressed directly. If device number 0 is used, that buffer is addressed at which register 2824 points. This way it is possible to divert a text, for which device number 0 was specified, to several displays.

With the help of registers 2825 through 2828 a buffer can be assigned to each display.

Register 2825: Text Buffer for Display 1	
Function	Description
Read	Set number of text buffer Value following reset: 1
Write	A new text buffer is assigned to display 1
Value range	1 - 4

Register 2826: Text Buffer for Display 2	
Function	Description
Read	Set number of text buffer Value following reset: 2
Write	A new text buffer is assigned to display 2
Value range	1 - 4

Register 2827: Text Buffer for Display 3	
Function	Description
Read	Set number of text buffer Value following reset: 3
Write	A new text buffer is assigned to display 3
Value range	1 - 4

Register 2828: Text Buffer for Display 4	
Function	Description
Read	Set number of text buffer Value following reset: 4
Write	A new text buffer is assigned to display 4
Value range	1 - 4

Register 2829: Basic Key Flag Number for Display 1	
Function	Description
Read	Set basic number Value following reset: 2000
Write	Basic number of flags which are used for display 1 to recognize keystrokes.
Value range	-161 ... 1824, 2000

Register 2830: Basic Key Flag Number for Display 2	
Function	Description
Read	Set basic number Value following reset: 2000
Write	Basic number of flags which are used for display 2 to recognize keystrokes.
Value range	-161 ... 1824, 2000

Register 2831: Basic Key Flag Number for Display 3	
Function	Description
Read	Set basic number Value following reset: 2000
Write	Basic number of flags which are used for display 3 to recognize keystrokes.
Value range	-161 ... 1824, 2000

Register 2832: Basic Key Flag Number for Display 4	
Function	Description
Read	Set basic number Value following reset: 2000
Write	Basic number of flags which are used for display 4 to recognize keystrokes.
Value range	-161 ... 1824, 2000

Registers 2829 through 2832 make possible to shift the flag area, reflecting the key status of the displays, within the whole flag range of the NANO controller.

Note!



The value following a reset maps the keys of all displays into the standard flag area for single-display mode, i.e. from flag 2160 through 2223.

The flag area for keys is calculated by the following formula:

Flag area for keys = Basic number + (160..223)

If, for example, the basic number is set to -161, the F1 key is mapped to flag 40.

Example:

Following a reset the F1 key is mapped to flag 2201 since the basic number is 2000.

Register 2833: Register Number for Controlling LEDs of Display 1	
Function	Description
Read	Set register number for controlling LEDs of display 1 Value following reset: 2649
Write	New register number defining which of the flags resp. register bits are for controlling LEDs of display 1
Value range	1 ... 1999, 2622 ... 2637, 2649

Register 2834: Register Number for Controlling LEDs of Display 2	
Function	Description
Read	Set register number for controlling LEDs of display 2 Value following reset: 2649
Write	New register number defining which of the flags resp. register bits are for controlling LEDs of display 2
Value range	1 ... 1999, 2622 ... 2637, 2649

Register 2835: Register Number for Controlling LEDs of Display 3	
Function	Description
Read	Set register number for controlling LEDs of display 3 Value following reset: 2649
Write	New register number defining which of the flags resp. register bits are for controlling LEDs of display 3
Value range	1 ... 1999, 2622 ... 2637, 2649

Register 2836: Register Number for Controlling LEDs of Display 4	
Function	Description
Read	Set register number for controlling LEDs of display 4 Value following reset: 2649
Write	New register number defining which of the flags resp. register bits are for controlling LEDs of display 4
Value range	1 ... 1999, 2622 ... 2637, 2649

These registers are for assigning flags, which control LEDs of displays, to several address areas. Following a reset the LEDs of all displays are assigned to those flags to which they are assigned in single-display mode, i.e. to the flags 2224 through 2235.

With the help of registers 2833 through 2836 a register can be assigned to each display. The lower 12 bits of these registers, then, control the LEDs.

If a given register is overlaid by flags, LEDs can also be addressed via these flags and not only via register bits.

Example: Flags 2224 through 2239 are overlaid on register 2649.

6.7 User Interface-related Flags

Flag 2057: LCD operation after each user task	
Function	Description
Read	<p>Present user interface priority:</p> <p>Flag = 0: The user interface will be serviced upon completion of all user tasks, low priority</p> <p>Flag = 1: The user interface will be serviced after each user task, high priority</p> <p>Value following reset: 0</p>
Write	Set flag for high user interface priority, delete flag for low user interface priority

User Interface Priority

Definition of the user interface priority. The user interface is serviced by a kind of background task. In most cases, the user interface has got a priority lower than the priority of the application program. In this case, the user interface will not be serviced before complete processing of all user tasks. Usually, this is absolutely sufficient, since processing will happen in the range of milliseconds which will not be regarded by the user as waiting time.

This waiting time increases if, especially on four-line displays, a great number of values is being displayed and the system is waiting for user inputs. Once the priority of the user interface is raised by setting flag 2057, the user interface is serviced after each user task. The operating system is then servicing sequentially: `task 0`, user interface, `task 1`, user interface, `task 2`, user interface etc.

For further details on task processing refer to register description for task control.



Note!

For normal operation, the user interface priority should be set to low, i.e. flag 2057 = 0. If during user input there are remarkable delays, the user interface priority can be raised by setting flag 2057 to 1.













In most cases, more complex user and display functions are required in manual and setting-up mode of the machinery. Thus, it is possible to set this flag in manual mode (high priority) and to delete it again in automatic mode (low priority).

































6.8 Controlling the Keys and LEDs of the User Interface

















































Note!





























All keys and LEDs mentioned below in the tables "Control of User Interfaces, Keys, and LEDs", and "Scanning of User Interface Keys" apply to user interfaces according to table "Overview: User Interfaces" of chapter 6.1: "Technical Data", page 74.

Control of User Interfaces, Keys, and LEDs					
Special Flags	LED, Key		Special Flags	LED, Key	
2224	LED		2230	LED	
2225	LED		2231	LED	
2226	LED		2232	LED	
2227	LED		2233	LED	
2228	LED		2234	LED	
2229	LED		2235	LED	

Scanning of User Interface Keys			
Special Flags	LED, Key	Special Flags	LED, Key
Function Keys			
2201		2181	
2202		2182	
2203		2183	
2204		2184	
2205		2185	
2206		2186	
2207		2187	
2208		2188	
2209		2189	
2210		2190	
2211		2191	
2212		2192	
Special function keys			
2214		2193	
2213		2194	
2215		2195	
2216		2196	

Scanning of User Interface Keys			
Special Flags	LED, Key	Special Flags	LED, Key
2217		2197	 
2218		2198	 
2219		2199	 
2220		2221	 
2222		2223	 
2200			
Numerical Keys			
2160		2170	 
2161		2171	 
2162		2172	 
2163		2173	 
2164		2174	 
2165		2175	 
2166		2176	 
2167		2177	 
2168		2178	 
2169		2179	 





























User Interfaces
with Irregular Flag
Assignment





Scanning Keys of the LCD 17 User Interface			
Flag	Key	Flag	Key
2201		2234	
2202		2235	
2203		2236	
2204		2237	
2205		2238	
2206		2239	
2221		2240	
2222		2241	
2223		2242	
2224		2243	
2230		2244	
2231		2245	
2232		2246	
2233		2248	

Note!



The user interfaces LCD 17 and LCD 19 haven't got any "SHIFT" functions.

Scanning Keys of the LCD 19 User Interface			
Flag	Key	Flag	Key
2201		2234	
2202		2235	
2203		2236	
2204		2237	
2205		2238	
2206		2239	
2221		2240	
2222		2241	
2223		2242	
2224		2243	
2230		2244	
2231		2245	
2232		2246	
2233		2248	
		2249	

Scanning Keys of the LCD 27 User Interface			
Special Flags	LED, Key	Special Flags	LED, Key
2209		2211	
2210		2212	

**Note!**

With the user interface LCD 27 merely flags 2209 through 2212 differ from table 1 : "Scanning of User Interface Keys" on page 102.

7 Network Operation

7.1 JETWay-H: JETTER Data Highway

98 Nodes The data highway JETWay-H enables several networked control systems of the PROCESS-PLC family to be controlled by a host computer. Purely technical, the maximum amount of nodes to be controlled is 126. However, with such a number of nodes reasonable communication on the network gets next to impossible, since transmission rate slows down. Therefore, it is advisable to limit the number of nodes to be controlled to 98. In detail, network operation means:

- Visualisation
- Programming
- Data transfer
- Production data acquisition
- Service functions; access to each control system

In addition to this, using a modem remote maintenance of the entire machinery of a plant is possible.

Note!

Please, refer to chapter 2.2 "Electrical Connection", page 18, for description of wiring and parameter assignment of JETWay-H.

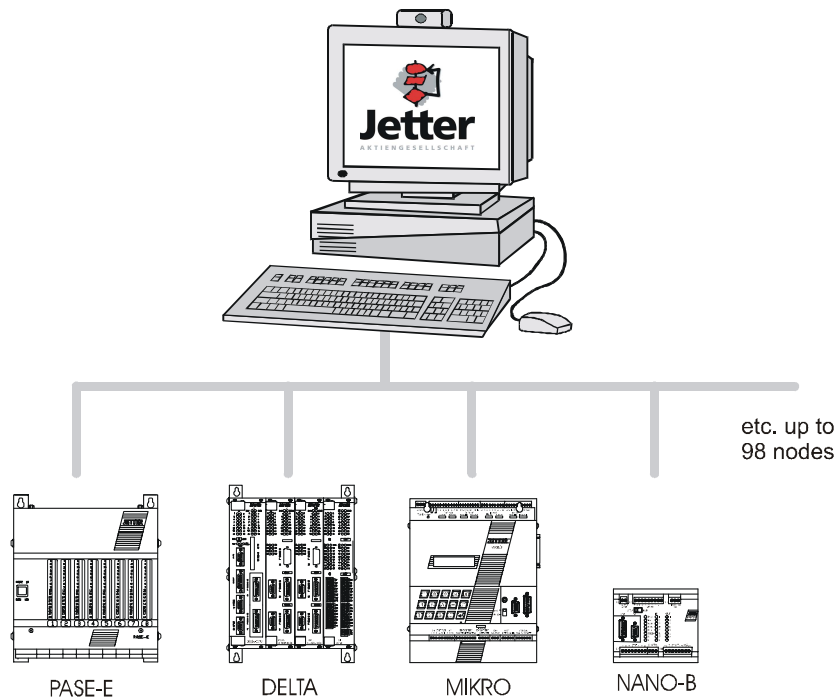

Fig. 24: JETWay-H for the Management Level

7.2 JETWay-R: Process Level

The JETWay-R network has got two functions:

- The hierarchical networking of PROCESS-PLC control systems.
- The connection of decentralized peripheral devices, such as remote I/Os or valve blocks.

The maximum amount of nodes per level is 99. This network is a monomaster network. This means that there is one master and a maximum of 98 slaves per hierarchical level.

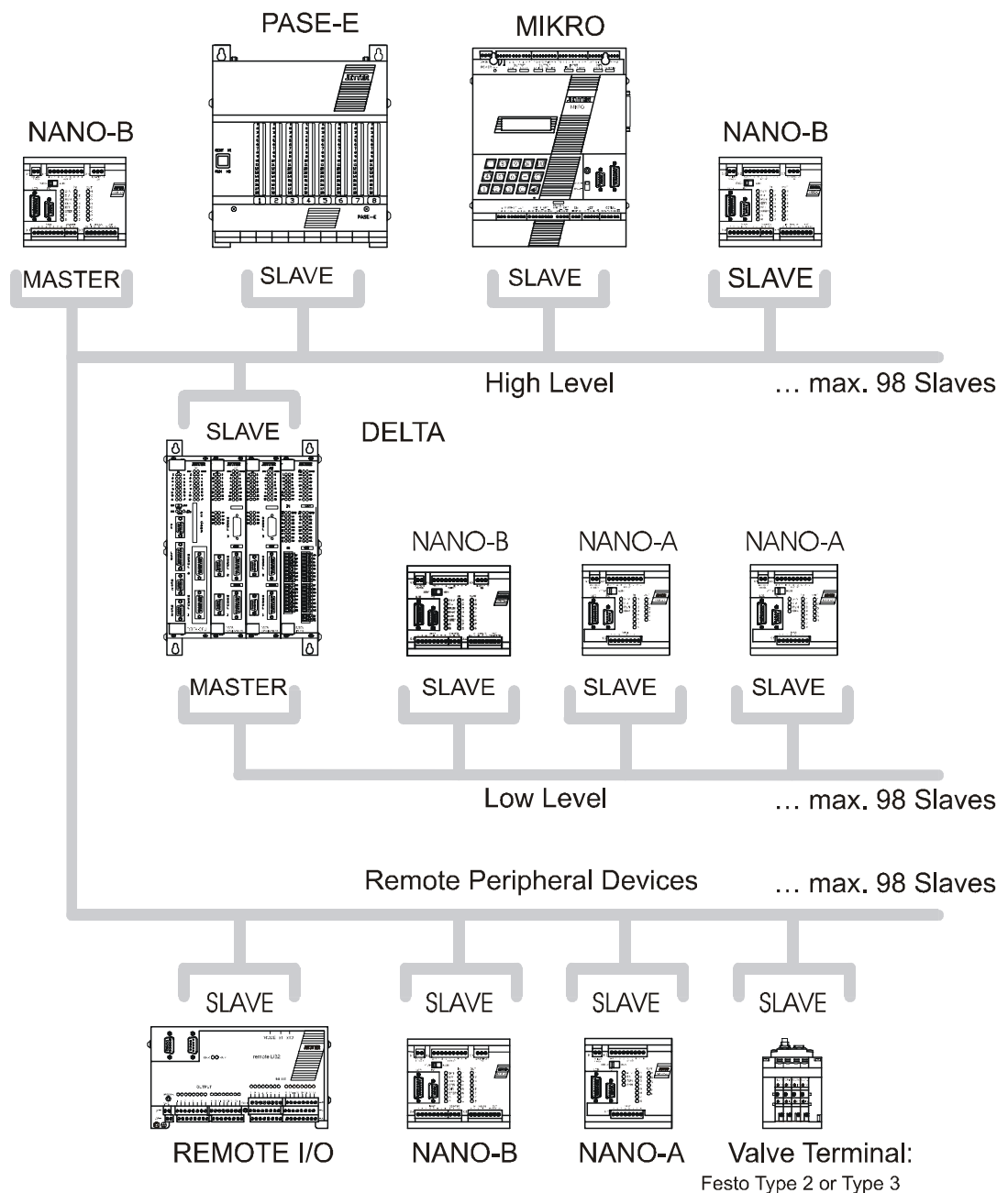

Fig. 25: JETWay-R for the Process Level

7.3 N-SEND Registers and N-GET Registers



Note!

These register numbers are not influenced by the number offset defined in register 2702.

7.3.1 N-SEND REGISTER



Note!

The PROCESS-PLC NANO-B can be operated as master or slave in a JETWAY-R network.

By using the following instruction, the master controller can write values into registers of slave controllers:

`N-SEND REGISTER [to <PASE #> from Reg<Source Reg> to Reg<Destination Reg>]`

- **<PASE #>:** PASE # stands for the network number of the slave controller which is to be addressed via the network.
- **<Source Reg>:** Here, the number of the register is specified, the value of which is to be transmitted to a slave via the network.
- **<Destination Reg>:** Here, the number of the register is specified into which the value from the master controller is to be transmitted. This register is located on the slave controller with the slave number PASE #.

Example:

`N-SEND REGISTER [to 3 from Reg=100 to Reg=200]`



Following this instruction, the value contained in register 100 of the master controller is entered into register 200 of the slave controller with the network number 3.

7.3.2 N-GET REGISTER

By using the following instruction, the master controller can read out values from registers of slave controllers:

N-GET REGISTER [from <PASE #> Reg<Source Reg>, Reg here=<Destination Reg>]

- **<PASE #>**: PASE # stands for the network number of the slave controller which is to be addressed via the network.
- **<Source Reg>**: Here, the number of the register is specified from which the value is to be transmitted to the master controller. This register is located on the slave controller.
- **<Destination Reg>**: Here, the number of the master controller register is specified into which the value from the slave controller is to be transmitted.

Example:

N-GET REGISTER [from 4 Reg=150, Reg here=102]



By this instruction, the value contained in register 150 of the slave controller with the network number 4 is copied into register 102 of the master controller.

7.3.3 Access to slave inputs, slave outputs and slave flags

In order to have access to inputs, outputs and flags of a slave overlaid registers must be used. Access is carried out in 3 steps:

1. Transfer of input registers to a slave:

To do so, overlaying of slave inputs with slave registers is used.

2. Loading an overlaid input register into the master:

The overlaid input register is to be loaded into the master by using the **N-GET REGISTER** instruction. This way, the slave inputs are mapped within the master.

3. Transfer of flag registers to the master:

Within the master the register, in which the slave inputs are mapped, in its turn is overlaid with flags. Now, access to slave inputs is carried out by the SYMPAS program with the help of flag instructions.

Example: Overlaying

1. Step: Overlaying of input registers in the slave.

Register 2400 of the NANO slave controller is overlaid with inputs 101..108, 201..208, 301..308.

Overlaying of inputs on registers by the example of register 2400									
Bit #	0	1	2	3	4	...	21	22	23
Value	1	0	0	0	1	...	0	1	0
Input	101	102	103	104	105	...	306	307	308

2. Step: Loading an overlaid input register into the master.

The contents of register 2400 (overlaid inputs) of the slave NANO with the network # 3 is loaded into register 2400 of the master NANO by using the `N-GET REGISTER` instruction.

```
N-GET REGISTER [from 3 Reg=2400, Reg here=2600]
```

3. Step: Overlaying of flag registers in the master controller.

The slave inputs are specifically loaded into the master register 2600. The user flags are overlaid on this register. This way, the program has high-rate access to slave inputs via these master flags.

Overlaying of flags on registers by the example of register 2600									
Bit #	0	1	2	3	4	...	21	22	23
Value	1	0	0	0	1	...	0	1	0
Flag	0	1	2	3	4	...	21	22	23

```
IF
    FLAG 3
OR
    FLAG 21
THEN
    ...
```

**Note!**

Overlaying of slave registers with inputs, outputs and flags of the slave controller is demonstrated here by example of overlaid inputs of a NANO slave and a NANO master.

By analogy, this procedure has to be applied to outputs, flags and additional PROCESS-PLCs, such as DELTA, and PASE-E, for differing applications.

7.4 Registers for Network Operation

Each PROCESS-PLC system has got at least one interface for networking via the JETTER network JETWay. The registers 2700 through 2711 described below serve the definition of transmission parameters and node numbers of this RS485.

Overview: Network Registers	
Register #	Designation
2700	Network number
2701	Baud Rate
2702	Register offset ^{*)}
2703	Flag offset ^{*)}
2704	Input offset ^{*)}
2705	Output offset ^{*)}
2706	Output mask ^{*)}
2707	Indirect network number
2708	Time-out period for network
2709	Network response time
2710	Number of network errors
2711	Error code of the last access to the network

^{*)} This register can only be used in slave mode if the master controller is, for example, a DELTA (no NANO-B).

Register 2700: Node Number	
Function	Description
Read	Present node number on the JETWay network. Value following reset: 2
Write	New node number on the JETWay network: Value 0: deactivated Value 1: Network master Value 2 - 127: Possible slave number
Value range	0 - 127

Register 2701: Baud Rate JETWay-R																							
Function	Description																						
Read	Present value for baud rate on the JETWay-R. Value following reset: 10 (115.2 kBaud)																						
Write	New value for baud rate on the JETWay-R. <table style="margin-left: 40px;"> <tr><td>0 =</td><td>150 Bit/s</td></tr> <tr><td>1 =</td><td>300 Bit/s</td></tr> <tr><td>2 =</td><td>600 Bit/s</td></tr> <tr><td>3 =</td><td>1200 Bit/s</td></tr> <tr><td>4 =</td><td>2400 Bit/s</td></tr> <tr><td>5 =</td><td>4800 Bit/s</td></tr> <tr><td>6 =</td><td>9600 Bit/s</td></tr> <tr><td>7 =</td><td>19200 Bit/s</td></tr> <tr><td>8 =</td><td>38400 Bit/s</td></tr> <tr><td>9 =</td><td>57600 Bit/s</td></tr> <tr><td>10 =</td><td>115200 Bit/s</td></tr> </table>	0 =	150 Bit/s	1 =	300 Bit/s	2 =	600 Bit/s	3 =	1200 Bit/s	4 =	2400 Bit/s	5 =	4800 Bit/s	6 =	9600 Bit/s	7 =	19200 Bit/s	8 =	38400 Bit/s	9 =	57600 Bit/s	10 =	115200 Bit/s
0 =	150 Bit/s																						
1 =	300 Bit/s																						
2 =	600 Bit/s																						
3 =	1200 Bit/s																						
4 =	2400 Bit/s																						
5 =	4800 Bit/s																						
6 =	9600 Bit/s																						
7 =	19200 Bit/s																						
8 =	38400 Bit/s																						
9 =	57600 Bit/s																						
10 =	115200 Bit/s																						
Value range	0 - 65536																						

Register 2702: Register Offset	
Function	Description
Read	Present value for register offset Value following reset: 0
Write	New value for register offset
Value range	0 - 65535

This value will be added to the register number of a 50000-number network access when, for example, a MIKRO controller is used.

Register 2703: Flag Offset	
Function	Description
Read	Present value for flag offset Value following reset: 0
Write	New value for flag offset
Value range	0 - 65535

This value will be added to the flag number of a 50000-number network access when, for example, a MIKRO controller is used.

Register 2704: Input Offset	
Function	Description
Read	Present value for input offset Value following reset: 100
Write	New value for input offset
Value range	0 - 65535

This value will be added to the flag number of a 50000-number network access when, for example, a MIKRO controller is used.

Register 2705: Output Offset	
Function	Description
Read	Present value for output offset Value following reset: 100
Write	New value for output offset
Value range	0 - 65535

This value will be added to the flag number of a 50000-number network access when, for example, a MIKRO controller is used.

Register 2706: Output Mask	
Function	Description
Read	Present output mask Bit 0 = 101 Bit 1 = 102 Bit 2 = 103 ... Bit 7 = 108 Bit 8 = 201 Bit 9 = 202 ... Bit 15 = 208 Value following reset: 100
Write	New output mask
Value range	0 - 65536

This register is bit-coded. Set bits have only local effect, i.e. with a remote scan, the output will be disabled and won't be overwritten. Overwriting is possible only with a master device, such as a MIKRO, by using 50000-numbers.

Register 2707: Indirect Network Number	
Function	Description
Read	Indirect network number Value following reset: 0
Write	New indirect network number
Value range	2 - 127

If as network number parameter of a network instruction 0 is specified, the contents of register 2707 serve as network number.

Register 2708: Time-out Period for Network	
Function	Description
Read	Present time-out period Value following reset: 250
Write	New time-out period
Value range	0 - 65536 ms

Register 2709: Network Response Time	
Function	Description
Read	Present response time Value following reset: 0
Write	Illegal
Value range	0 - 65536 ms

Register 2710: Amount of Network Errors	
Function	Description
Read	Present error count Value following reset: 0
Write	Illegal
Value range	0 - 255

Register 2711: Error Code of Network Access	
Function	Description
Read	Present error code 0 = No error detected. 1 = Time-out 2 = Checksum error 3 = Error message from slave 4 = No master specified Value following reset: 0
Write	New error code
Value range	0 - 65536

8 Single-/Dual-Channel Counter

8.1 Description of Connections

For connection of the single-/dual-channel counter to the basic controller NANO-B see chapter: 2.2.5 "Single- and Dual-Channel Counter", page 33.

8.2 Register Description

Register 2900: Peripherals Control Register	
Function	Description
Read	Present value of the peripherals control register Value following reset = 1
Write	New value of the peripherals control register
Value range	0 - 65536

Meaning of the individual bits:

Bit 0 = 0	A/D converter for analog inputs deactivated
Bit 0 = 1	A/D converter for analog inputs activated
Bit 1 = 0	Dual-channel counter
Bit 1 = 1	Single-channel counter

Register 2901: Count Value of the Single-/Dual-Channel Counter	
Function	Description
Read	Present count value Value following reset = 0
Write	Count value will be overwritten
Value range	-8388608 - +8388607

Register 2918: Counting Rate ^{*)}	
Function	Description
Read	Present value of the counting rate Value following reset = 0
Write	Disabled
Value range	-32768 ... +32767

Register 2919: Time Base for Counting Rate ^{*)}	
Function	Description
Read	Present value of the time base for counting rate Value following reset = 10 (100 ms)
Write	The value of the time base for counting rate will be overwritten
Value range	0 ... 255

^{*)} The counting rate is calculated by the following formula:

$$\text{Register 2918} = \frac{\text{Count}_n - \text{Count}_{n-1}}{\text{Register 2919} \times 10 \text{ ms}}$$



Note!

The count value $n-1$ is sensed earlier by the value register 2919 x 10 ms than count value n .

9 Analog I/Os

9.1 Description of Connections

For connection of analog inputs and outputs to the basic controller NANO-B see chapter: 2.2.6 "Analog Inputs", page 34, and chapter: 2.2.7 "Analog Output", page 35.

9.2 Register Description

Register 2900: Peripherals Control Register	
Function	Description
Read	Present value of the peripherals control register Value following reset = 1
Write	New value of the peripherals control register
Value range	0 - 65536

Meaning of the individual bits:

Bit 0 = 0	A/D converter for analog inputs deactivated
Bit 0 = 1	A/D converter for analog inputs activated
Bit 1 = 0	Dual-channel counter
Bit 1 = 1	Single-channel counter

Register 2902: Analog Output (X5)	
Function	Description
Read	Present value for analog output (X5) Value following reset: 0
Write	New value for analog output (X5)
Value range	0 - 255

Register 2903 - 2906: Analog Input (X5)	
Function	Description
Read	Present value for analog input (X5) Value following reset: Analog voltage
Write	Illegal
Value range	0 .. 1023

Assignment of registers to analog inputs:

Register 2903:	Analog input # 1
Register 2904:	Analog input # 2
Register 2905:	Analog input # 3
Register 2906:	Analog input # 4

Register 2920: Slew Rate Limitation for AD Conversion	
Function	Description
Read	Present value for AD conversion slew rate limitation Value following reset: 2
Write	New value for AD conversion slew rate limitation
Value range	2 .. 2000 [0 .. 32767, theoretical values] *)

*) Register 2920 specifies as a multiple of 1 digit/ms (which equals to approx. 10 mV/ms) the slew rate limitation of the voltage input for AD conversion. However, only values from 2 to 2000 are practicable. Values above 2000 have no further effect on slew rate limitation for AD conversion. For additional information refer to fig. 26, page 122.

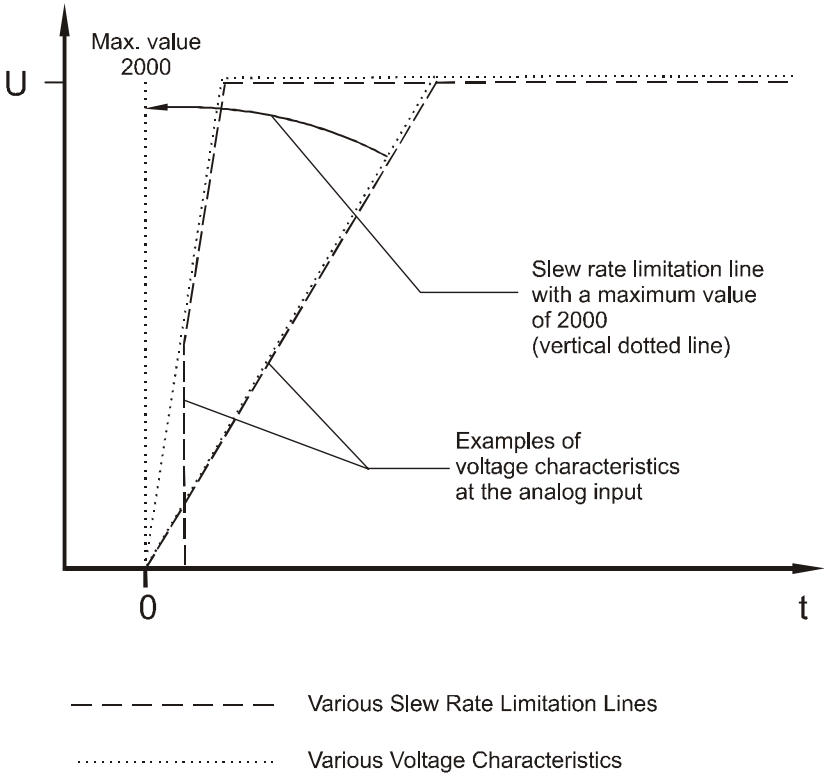

Fig. 26: Slew Rate Limitation for AD Conversion



Note!

Register 2920 addresses all analog inputs simultaneously.

10 Stepper Motor Control

10.1 Overview and Technical Data

The stepper motor control of the NANO-B controller serves to control servo amplifiers for stepper motors equipped with **STEP** and **DIR** interfaces, i.e. through stepping and direction pulses.

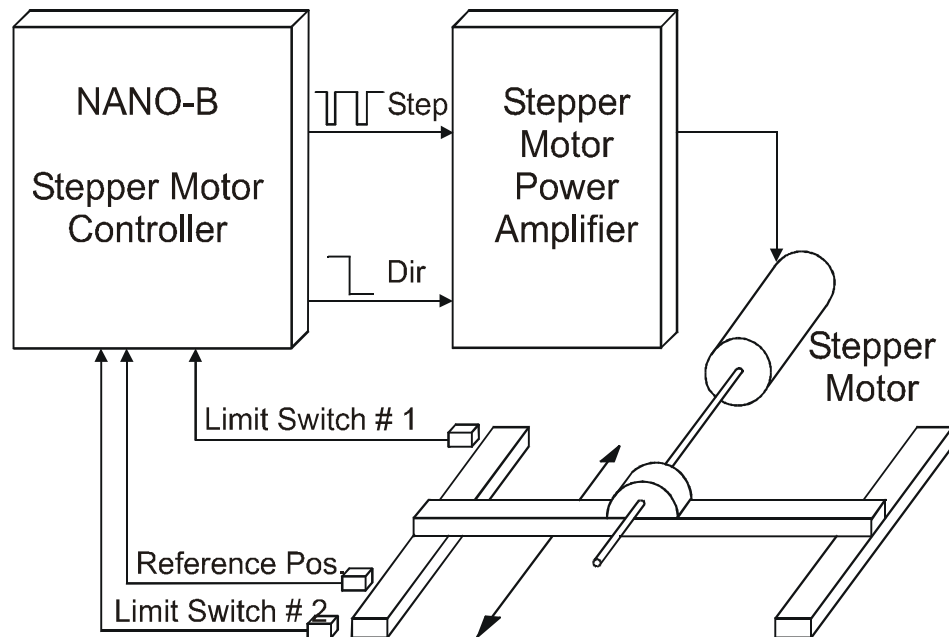

Fig. 27: Stepper Motor with Motor Control and Power Amplifier

Acceleration and deceleration are automatically preset by the microprocessor of the stepper motor control. For activation, entry of macro instructions, such as the positioning instruction, is sufficient:

```
POS [Axis<Axis #>, set position, set speed]
```

All values can be read back at any time. The parameters, including set position and set speed, can be changed at any time.

Connecting the Stepper Motor Control

For stepper motor control, 2 terminals for the DIR and STEP signal and one 0 V terminal have been provided on the basic controller (X3). Please refer to chapter 2.2.8 "Stepper Motor Control", page 36.

10.2 Firmware of Stepper Motor Control

The firmware allows a stepper motor control to operate a stepper motor axis. Configuration for operation and different operating conditions is made using different parameters.

Positioning processes are controlled by the following instructions:

POS	Positioning	
AXARR	+ Axis #:	AXARR position query / AXARR instruction
AXARR	- Axis #:	Continue to travel to old target position

There is an additional option of positioning an axis, that is, control of the stepper motor through REGISTER_LOAD instructions. The positioning process is described in the programming manual in more detail. Therefore, please refer to the programming manual for additional information.



Note!

On the basic controller the axis number of the stepper motor axis is always 11. All registers start with 111 if they are assigned to this axis. This axis is always assigned to module number 1.

Generally, the following steps are required for programming a stepper motor axis:

1. Loading of Parameters

This has to be made at the beginning of the program with the help of the axis registers 11105 through 11108.

Example:

```
TASK 0 -----
      THEN
      REGISTER_LOAD [11105 with R100] ;Acceleration
      REGISTER_LOAD [11106 with R101] ;Deceleration
      REGISTER_LOAD [11108 with R103] ;Start/stop frequency
```

The positioning parameters are defined by the program sequence as follows:

```
REGISTER 100: Value of acceleration ramp
REGISTER 101: Value of deceleration ramp
REGISTER 103: Value of start/stop frequency
```

In chapter 10.2.1 "Register Assignment", page 126, you will find a description of the characteristics of the parameters.

2. Machine Referencing

Before the first positioning process can be executed, machine referencing is required. Referencing can be initiated by entering a value into command register 11101 of the corresponding axis.

3. Positioning

Following machine referencing the positioning processes can be carried out. This can be carried out by using the following instruction:

```
POS [Axis<Axis #>, set position, set speed]
```

Example:

```
      THEN
      POS [Axis11, Pos10000, v2500)
      WHEN
      AXARR Axis11
      THEN
```

In this example, positioning is carried out as follows:

- The stepping rate is increased linearly to the steepness of the previously defined acceleration ramp up to the speed of 2500 (= 2.5 kHz) which has been set through the positioning instruction.
- The rate will remain at 2.5 kHz until the positioning algorithm recognises that, according to the previously defined steepness of the deceleration ramp, the deceleration process has to be initiated.
- Deceleration is calculated in such a way that the target position will be approached linearly to the steepness of the previously defined deceleration ramp.
- If the travel is too short, or the ramps are too flat and if the set maximum speed is not reached, transition from acceleration to deceleration is made automatically at the right time.

More of these functions, and many more possibilities are provided by the stepper motor controller. For example, values and parameters can perpetually be changed and adjusted during the positioning process. For this purpose, all internal values can be accessed directly with the help of registers.

10.2.1 Register Assignment

For each register the following items are quoted:

1. The value of the register in case of a "read access" using the following instruction:

```
LOAD_REGISTER [220 with R(111zz)].
```

2. The meaning of the register in case of a "write access" using the following instruction:

```
LOAD_REGISTER [111zz with R(220)].
```

3. The value range, i.e. valid numerical values for the registers:

- 8-bit value for numbers from 0 through 255
- 16-bit value for numbers from 0 through 65535
- 23-bit-signed integer for numbers from -8388608 through +8388607.

4. The register value following reset. Following power-up, to the registers their default values are assigned. In case of a read access, this value is uploaded.
5. An example regarding the use of the register with a description of the effect resulting from the given instruction.

10.2.2 Register Description

Register 11100: Status register	
Function	Description
Read	The conditions of the stepper motor controller are reported back. Value following reset = depending on card status
Write	Illegal
Value range	23-bit-signed integer

Meaning of the individual status register bits:

Bit 0:	Search for reference?	Reference switch has been found. 1 = Reference OK
Bit 1:	AXARR?	1 = AXARR
Bit 2:	Axis in the destination window?	1 = Yes
Bit 4:	Negative limit switch?	1 = Negative limit switch activated
Bit 5:	Positive limit switch?	1 = Positive limit switch activated
Bit 6:	Reference switch?	1 = Reference switch activated
Bit 7:	not assigned	
Bit 8:	Did the limit switch trip?	1 = Yes
Bit 9 - 11:	not assigned	
Bit 12:	Machine referencing error?	1 = Machine referencing error
Bit 13:	BUSY for instructions from 9 through 12	1 = Busy
Bit 14 -15:	not assigned	
Bit 16:	Axis in deceleration	1 = Axis in deceleration
Bit 17 -23:	not assigned	

Register 11101: Instruction Register	
Function	Description
Read	Instruction currently being executed or the last executed instruction Value following reset: 0
Write	A new instruction is issued to the stepper motor controller. The instruction remains readable in register 11101.
Value range	23-bit-signed integer

The instruction register of the stepper motor controller makes use of the following instructions:

0 AXARR with deceleration ramp:

This instruction causes the axis to be decelerated with a deceleration ramp until the start/stop frequency is preset again.

3 Setting the status "Referencing Completed":

The actual position will be set to zero by this instruction. Once the function "Stop at the reference point" (instruction 22 = Default) is activated, the set position will be set to zero as well.

4 Clearing the status "Referencing Completed":

When the reference switch is operated next time, the actual position is set to zero and the reference bit in register 11100 is set to "Reference OK".

5 Stop axis = "AXARR" instruction:

This instruction serves to stop an axis without deceleration ramp. This can be done only at low speed without skipping steps.

9 Automatic machine referencing at the speed given in register 11103:

Start in positive direction giving heed to the reference switch. Once the positive limit switch is operated during machine referencing, the axis reverses the direction of motion and continues to travel in negative direction until

- either the reference switch has been activated and the actual position is set to zero,
- or the negative limit switch has been operated. This causes machine referencing to be terminated. The set position is set to actual position, and an error is reported to the status register 11100 through bit 12.

10 Automatic machine referencing at the speed given in register 11103:

Start in negative direction giving heed to the reference switch. Once the negative limit switch is operated, the axis reverses the direction of motion and continues to travel in positive direction until

- either the reference switch has been activated and the actual position is set to zero,
- or the positive limit switch has been operated. This causes machine referencing to be terminated. The set position is set to actual position, and an error is reported to the status register 11100 through bit 12.

11 Automatic machine referencing at the speed given in register 11103:

Start in positive direction towards the positive limit switch ignoring the reference switch; there, reverse the direction of motion, travel in negative direction giving heed to the reference switch.

If the negative limit switch is operated, machine referencing is terminated and an error is reported to the status register 11100.

12 Automatic machine referencing at the speed given in register 11103:

Start in negative direction towards the negative limit switch ignoring the reference switch; there, reverse the direction of motion, travel in positive direction giving heed to the reference switch.

If the positive limit switch is operated, machine referencing is terminated and an error is reported to the status register.

13 No ramps:

Acceleration/deceleration ramps are disabled, i.e. the axis immediately travels to the target position at the stepping rate specified in register 11103. Acceleration/deceleration ramps are not being used.

14 With ramps (default): Normal mode with acceleration/deceleration ramp.**17 Relative positioning ON:**

Positioning relates to the last set position, but not to the reference position.

18 Absolute positioning ON (default):

Positioning relates to the reference position.

19 After AXARR instruction, continue to travel to former target position:

A positioning process, which has been interrupted by an AXARR instruction (or instruction **0**), is resumed and the axis travels to the initial target position.

22 Stop at the reference position (default)**23 Do not stop at the reference position:**

At the reference position, the actual position is set to zero, but not the set position. Then, the axis resumes travelling.

Register 11102: Set Position	
Function	Description
Read	Set position of the axis Value following reset: 0
Write	Specification of the next set point for the axis and immediate start of the positioning process
Value range	-8388608 .. +8388607 (23-bit-signed integer)

Examples:

```

1.      THEN
          REGISTER_LOAD [11103 with 1000]
          REGISTER_LOAD [11102 with 10000]

```

This instruction set is identical with the positioning instruction:

```
POS[Axis11, Pos10000, v1000]
```

The positioning process is started and the axis is moved to the absolute position 10000.

```

2.      THEN
          DISPLAY_REG [#0, cp=1, Reg=11102]

```

The present set position of the axis is displayed top left on the display.

```

3.      THEN
          REG 11102
          =
          REG 11102
          +
          100

```

Axis positioning to the relative position 100 is started, i.e. the axis travels 100 steps further. Positioning is carried out in absolute positioning mode.

**Important!**

Register 11102 can be altered any time during the positioning process. From then on, the positioning process will refer to the new value. While doing so, the axis does not stop.

Reversal of direction during a positioning process by means of register 11102 may result in the axis to skip steps. Therefore, it is advisable to carry out reversal of direction by means of ramp functions.

Register 11103: Set Speed (Stepping Rate)	
Function	Description
Read	Maximum set speed of the axis Value following reset: 100 (Hz)
Write	Specification of a new maximum set speed for the axis. The new value is accepted immediately.
Value range	0 .. 5000 (in Hz)

When entering a new value into register 11103 distinction must be made between two system states:

1. The axis is at standstill at the moment:

The new value is stored for the next positioning process.

2. A positioning process presently is in progress:

The new value is accepted as new maximum set speed. The maximum value is increased or decreased to suit the new value. Change of the maximum value does not take place steplessly, but with the "acceleration ramp" specified in register 11105.

Examples:

```
1.      THEN
          REGISTER_LOAD [11103 with 2500]
```

This instruction forces the axis to travel with a stepping rate of 2500 Hz.

```
2.      THEN
          REG 11103
          =
          REG 11103
          +
          1000
```

The stepping rate of the axis is increased by 1000 Hz. On principle, the limiting value of 5000 Hz must not be exceeded.

Register 11104: Polarities	
Function	Description
Read	Present polarity settings Value following reset: 7 (reference switch and limit switch: N/O)
Write	New settings for polarity of reference and limit switch
Value range	0 .. 55

This register is bit-coded:

Bit 0:	0 =	Reference switch (24 V) is negative, i.e. no voltage at the input means reference position.
	1 =	Reference switch (24 V) is positive, i.e. voltage at the input means reference position.
Bit 1:	0 =	Limit switch (24 V) is negative, i.e. no voltage at the input means limit position; N/C.
	1 =	Limit switch (24 V) is positive, i.e. voltage at the input means limit position; N/O.
Bit 2:	0 =	DIR level low for positive direction.
	1 =	DIR level high for positive direction.
Bit 4:	0 =	INPUT2 is used as reference input.
	1 =	INPUT2 is used as input and the status bit "Reference OK" is 1.
Bit 5:	0 =	INPUT3 is used as negative limit switch input. INPUT4 is used as positive limit switch input.
	1 =	INPUT2 is used as input. INPUT4 is used as input and the status bits of the limit switches are 0.

Register 11105: Acceleration Ramp	
Function	Description
Read	Present value of the acceleration ramp parameter Value following reset: 10
Write	Transfer of a new value for the acceleration ramp parameter.
Value range	1 .. 255 (Hz / 4 ms) ^{*)}

^{*)} i.e. every 4 ms the register value is increased by 10 Hz.

When during a positioning process a new value is entered into register 11105, this will have no effect on the motion in progress. The new value for acceleration ramp will be used only when the next positioning process begins, i.e. by writing into register 11102 or by issuing the POS instruction.

In register 11105 the rate of rise of the stepping rate, with which the axis accelerates when a motion is started, is defined. Please, refer to Fig. 28, page 133. The greater the value, the higher the acceleration, however, the more critical the motor performance.

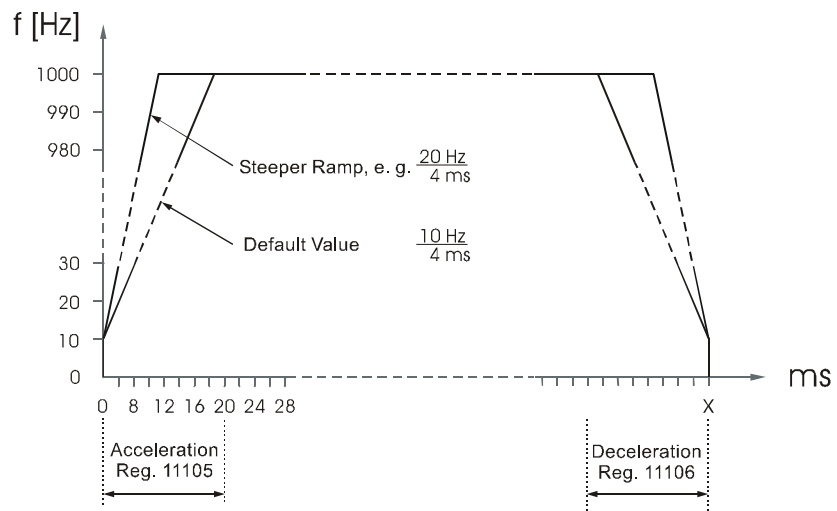

Fig. 28: Speed Profile of Acceleration/Deceleration Ramps

Register 11106: Deceleration Ramp	
Function	Description
Read	Present value of the deceleration ramp parameter Value following reset: 10
Write	Transfer of a new value for the deceleration ramp parameter.
Value range	1 .. 255 [Hz / 4 ms]

When during a positioning process a new value is entered into register 11106, this will have no effect on the motion in progress. The new value for deceleration ramp will be used only when the next positioning process begins, i.e. by writing into register 11102 or by issuing the `pos` instruction.

In register 11106 the steepness of the deceleration ramp is defined. Please, refer to Fig. 28, page 133. The greater the value, the higher the deceleration, and, however, the higher the risk of skipping steps during deceleration.

Register 11107: Destination Window	
Function	Description
Read	Present value of the destination window parameter Value following reset: 0
Write	Transfer of a new value for the destination window parameter.
Value range	0 .. 65535 [Steps]

This new value is stored and will not be effective before the next positioning process. When during a positioning process a new value is entered into register 11107, this will have no effect on the motion in progress. The new value for the destination window will be used only when the next positioning process begins, i.e. by writing into register 11102 or by issuing the `pos` instruction.

By using the destination window parameter, faster program flow can be achieved, because the step enabling condition

```

WHEN
    AXARR
THEN

```

is fulfilled already before the exact target position is reached. Nevertheless, the exact target position will be reached.



Important!

The stepper motor will skip steps if the destination window value is other than zero, and a reversal of direction of movement is carried out.

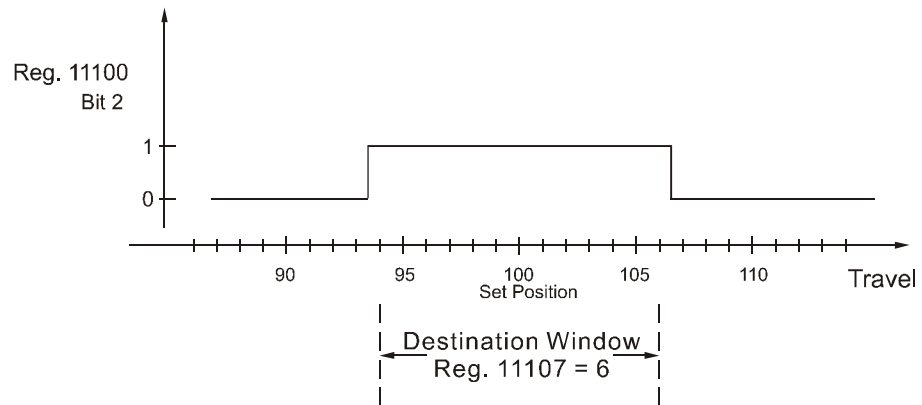

Fig. 29: Destination Window

Bit 2 of the status register 11000 indicates whether the axis is in the destination window specified in register 11107.

Register 11108: Digital Offset, Acceleration/Deceleration Stepping Rate	
Function	Description
Read	Present value of the acceleration/deceleration stepping rate Value following reset: 10
Write	Transfer of a new value for the acceleration/deceleration stepping rate parameter.
Value range	0 .. 65535 [Hz]

When during a positioning process a new value is entered into register 11108, this will have no effect on the motion in progress. The new value for acceleration/deceleration stepping rate will be used only when the next positioning process begins, i.e. by writing into register 11102 or by issuing the `POS` instruction.

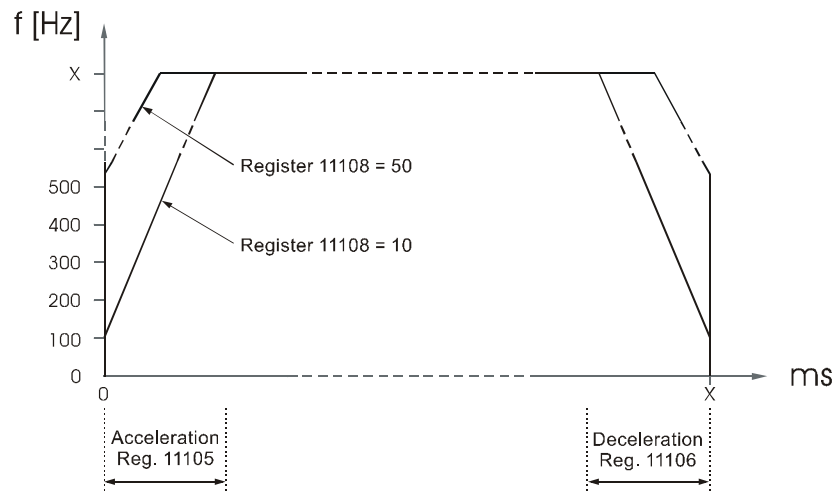

Fig. 30: Digital Offset, Acceleration/Deceleration Stepping Rate

Register 11109: Actual Position	
Function	Description
Read	Actual axis position Value following reset: 0
Write	Illegal
Value range	23-bit-signed integer

This parameter is used to display the present actual position. The "internal" count of the axis is displayed only, as there is no feedback from the motor. This value should always represent the instantaneous axis position. Skipped steps will not be recorded.

Example:

```

WHEN
  REG 11109
  >
  2000
THEN
  A 103

```

This program segment has the following meaning: Wait until the axis has crossed position 2000, then activate output 103.

Register 11110: Pulse Width of the STEP Pulse	
Function	Description
Read	Pulse Width of the STEP Pulse Value following reset: 1 = 8,68 μ s + Offset (=1.5 μ s)
Write	New value
Value range	1 ... 20 *) practicable, maximum value: 65535

*) Pulse width = value (register 11110) · 8.68 μ s + offset (=1.5 μ s)

Register 11112: Actual Speed	
Function	Description
Read	Actual speed Value following reset: 0
Write	Illegal
Value range	0 ... 5000 (Hz) *)

*) presently calculated output frequency in Hz

10.3 Sample Programs

Machine Referencing

Since there is no position feedback when positioning is carried out by means of stepper motors, machine referencing is mandatory. The internally recorded actual position is set to the present value, in case steps have been skipped during positioning.

Machine referencing is required at least after the machinery is powered up, in order to inform the control system of the actual axis position. There are two possibilities to carry out machine referencing:

- In the instruction register of the stepper motor control four different machine referencing modes have been stored which can be started by a register assignment.
- Start of an automatic search for reference by means of a program which has been written with SYMPAS programming instructions.



Important!

Before and during machine referencing the actual position, i.e. the value of register 11109, is not yet defined. Operation of machinery in such an undefined state may result in damages to machines. Therefore, the reference position must be loaded and the actual position must be set to 0 before the machinery is operated.

1. Possibility: Machine referencing with internal program

The reference switch is located somewhere within the positioning range between the two limit switches. This reference switch is active over a greater travel than merely one step of the stepper motor. In order to be able to determine a definite reference position it is necessary to approach the reference switch always from the same side. In the given case, this is to be done in positive direction. The starting point for determining the direction is the negative limit switch.

The given machine referencing program first specifies the speed for machine referencing by loading a value into the speed register. Then, automatic machine referencing is started by means of one of the instructions of the instruction register. First, the axis approaches the negative limit switch ignoring the reference switch, reverses direction and travels in positive direction until it will reach the reference switch. Here, the axis is stopped automatically, and set position and actual position are set to zero.



Note!

Machine referencing is aborted if the reference switch is ignored and the positive limit switch is reached by the axis.

On the display an error message is shown. In this case, the error must be fixed before machine referencing can be repeated by pressing the "F12" key on the display module.

```

LABEL 40
  THEN
    REG_LOAD [11103 with 25] ;Set speed
    REGISTER_LOAD [11101 ;Automatic start
with 12]
  WHEN ;Machine referencing, wait un-
;til processing is completed
    BIT_CLEAR [REG=11100, Bit=13]
  THEN
  IF ;Check for errors
    BIT_CLEAR [REG=11100, Bit=12]
  THEN

```



```

        GOTO 42
    ELSE
        DISPLAY_TEXT [#0, cp=1, "Check reference switch!"]
        DISPLAY_TEXT [#0, cp=25, "Continue with F12"]
    WHEN
        FLAG 2212                ;F12 on the display
                                ;module has been pressed
    THEN
        GOTO 40
    LABEL 42
    THEN
        ....                    ;Additional program

```

2. Possibility:

In this case, the positive limit switch also acts as reference switch; here, the reference switch and limit switch inputs must be interconnected. This means that, on principle, the reference switch can be approached only from one direction. Thus, the reference signal is unambiguously defined.

```

    LABEL 40
    THEN
        POS [Axis11, Pos4000000, v100)    ;Rapid traverse to-
                                            ;wards limit switch
    WHEN
        BIT_SET [REG=11100, Bit=5]
    THEN
        POS [Axis11, Pos-4000000, v10)    ;Low-speed reverse
                                            ;until limit switch
    WHEN
        BIT_CLEAR [REG=11100, Bit=5]      ;has been released
    THEN
        REGISTER_LOAD [11101 with 4]      ;Search for reference
        POS [Axis11, Pos4000000, v1]      ;Machine referencing
                                            ;at very low speed
    WHEN
        BIT_SET [REG=11100, Bit=0]        ;Reference point found
    THEN

```



Note!

The difference between alternative 1 and 2 is the assignment of register REG 11101. With REGISTER_LOAD [11101 with 12] the automatic program 12 is started and processed. With REGISTER_LOAD [11101 with 4] the reference is cleared and, for a while, nothing happens. When the axis approaches the next reference switch, the new reference is set. To do so, an additional program is required.

11 User-Programmable Interface

11.1 Description of Connections, Activation

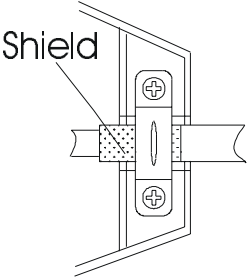
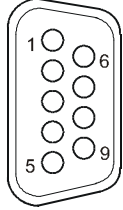
User-Programmable Interface Cables for RS232 PC or LCD Sockets			
PROCESS-PLC	Shield		VIADUKT
9-pin male SUB-D connector or 15-pin male SUB-D connector	 <p>Connect shield with the greatest possible surface area!</p> <p>Use metallised housing only!</p>		RS232 
PIN	Signal		PIN
2	TXD	RXD	2
3	RXD	TXD	3
7	Gnd		5

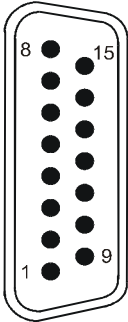
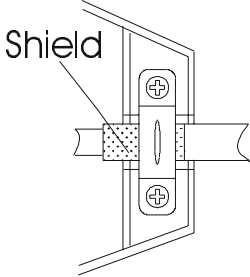
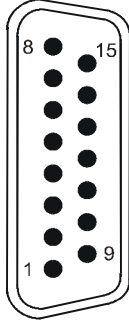
User-Programmable Interface Cables for RS422 LCD Sockets			
PROCESS-PLC	Shield	User Interface	
 <p>15-pin male SUB-D connector</p>	 <p>Connect shield with the greatest possible surface area!</p> <p>Use metallised housing only!</p>	 <p>15-pin male SUB-D connector</p>	
PIN	Signal		PIN
4	DC 24 V		15
7	Gnd		12
10	SDB	RDB	6
11	SDA	RDA	7
12	RDB	SDB	4
13	RDA	SDA	5

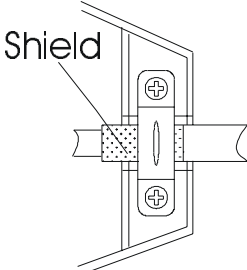
User-Programmable Interface Cables for RS232 PC or LCD Sockets		
PROCESS-PLC	Shield	Specification
9 pin male SUB-D connector (PC) or 15 pin male SUB-D connector (LCD)	 <p>Shield</p> <p>Connect shield with the greatest possible surface area!</p> <p>Use metallised housing only!</p>	RS485
PIN	Signal	Comment
7	Gnd	-
8	Data +	-
9	Data -	-

11.2 Register Description

Register 10000: Configuration for User-Programmable Interface	
Function	Description
Read	Present configuration Value following reset: 0
Write	Present output mask 0 .. No user-programmable interface 1 .. PC RS232 = PRIM 2 .. LCD RS422 / RS232 = PRIM 3 .. JETWay RS485 = PRIM
Value range	0 ... 3



Note!

The user may program one interface exclusively.

Default settings: no PRIM, 8N1, 9600!

PRIM = user-programmable interface!

Register 10001: Baud Rate	
Function	Description
Read	Present value of the baud rate Value following reset: 6
Write	new baud rate: 0 150 bits/s 1 300 bits/s 2 600 bits/s 3 1200 bits/s 4 2400 bits/s 5 4800 bits/s 6 9600 bits/s Default setting 7 19200 bits/s 8 38400 bits/s for RS485 only 9 57600 bits/s for RS485 only 10 115200 bits/s for RS485 only
Value range	0 ... 10

Register 10002: Interface Configuration	
Function	Description
Read	Present data format Value following reset: 4
Write	New baud rate: 0 = 7 bit even 1 stop bit 1 = 7 bit odd 1 stop bit 2 = 8 bit even 1 stop bit 3 = 8 bit odd 1 stop bit 4 = 8 bit no parity 1 stop bit 5 = 7 bit even 2 stop bit 6 = 7 bit odd 2 stop bit 7 = 7 bit no parity 2 stop bit
Value range	0 ... 7

Register 10003: Sending Buffer	
Function	Description
Read	Latest character that has been sent or is to be sent Value following reset: 0
Write	Send a character
Value range	0 ... 255

**Important!**

The maximum sending buffer size is 128 characters with a size of 8 bit.

Register 10004: Sending Buffer Occupancy	
Function	Description
Read	Present occupancy of the sending buffer Value following reset: 0
Write	Illegal
Value range	0 ... 128

Register 10004 displays the number of received values.

Register 10005: Receiving Buffer; characters are cleared at access	
Function	Description
Read	Received character Value following reset: 0
Write	Illegal
Value range	0 ... 255



Note!

The maximum receiving buffer size is 128 characters with a size of 8 bit. Access to register 10005 deletes the characters contained in the receiving buffer. This means that for reprocessing a character must be stored before a read access is carried out.

Register 10006: Receiving Buffer Occupancy	
Function	Description
Read	Present occupancy of the receiving buffer Value following reset: 0
Write	Illegal
Value range	0 .. 128

11.3 Programming

Use of the user-programmable interface is shown in the sample program below:

11.3.1 Program Listing

```

0:      ;*****
1:      ;* The program will receive the upper-case characters *
2:      ;* from „A“ to „Z“ via the N-SER 1 module, and will then *
3:      ;* send them back as lower-case characters. *
4:      ; *****
5:      ; DEF_FUNCTION [RecPRIM, RP]
          Par: rFirstChar, rLastChar
          Var: rHelp
6:      ; ++++++
7:      ; + This function is used to read a character from +
8:      ; + the receiving buffer +
    
```

```

 9:      ; ++++++
10:      REGISTER_LOAD [rHelp with R(RecPRIM)]
           ;read character from buffer,
           ;check character for valid range.

11:      IF
12:          LIMITS [Reg=rHelp, low=R(rFirstChar),
                   high=R(rLastChar)]
13:      Then
14:          REGISTER_LOAD [RecPRIM with R(rHelp)]
                   ;character is valid
15:      ELSE
16:          REGZERO RecPRIM           ;character is invalid
17:      THEN
18:          RETURN
19:      END_DEF
20:      DEF_FUNCTION [SendPrim, S]
           Par: rSendChar
21:      ;+++++
22:      ;+ This function is used to write a character      +
23:      ;+ into the sending buffer.                        +
24:      ;+++++
25:      WHEN
26:          REG rSendCnt           ;Is there free space
27:          <                       ;in the sending buffer?
28:          128
29:      THEN
30:          REG rPRIMSend           ;Send back modified
31:          =                       ;character
32:          REG rSendChar
33:          +
34:          32
35:      THEN
36:          RETURN
37:      END_DEF
38:      TASK tPRIMhandling -----
39:          REGISTER_LOAD [rPRIMconfig1 with 1]
                   ;RS232 PC configuration
40:          REGISTER_LOAD [rPRIMconfig2 with 2]
                   ;Configuration: even Parity,
                   ;8 bit, 1 stop bit
41:          REGISTER_LOAD [rPRIMbaud with 7]
                   ;19200 Baud
42:      LABEL mPRIMloop
43:      WHEN
44:          NOT                       ;Are there any incoming
45:          REGZERO rRecCnt           ;characters?
46:      THEN
47:          REG rChar
48:          =
49:          RecPRIM [rLastChar=90, rFirstChar=65]

```



```

50:   IF
51:       REGZERO rChar           ;Is there a valid
52:   THEN                          ;character?
53:       GOTO mPRIMloop         ;NO
54:   THEN
55:       SendPrim [rSendChar=R(rChar)]
56:       GOTO mPRIMloop
End of Program

```

11.3.2 Symbol Listing

```

***** Task *****
tPRIMhandling  0

***** Flags *****

fPRIMloop      !

***** Registers *****

rPRIMconfig1   10000
rPRIMconfig2   10002
rPRIMbaud      10001
rPRIMSend      10003   ;sending register
rPRIMRec       10005   ;receiving register
rRecCnt        10006   ;rec. buffer occupancy
rSendCnt       10004   ;send. buffer occupancy
rChar          100

```



Note!

In the example above, sending and receiving of characters are divided into several functions:

- A character is sent if the value is written into the sending register.
- Occupancy of the the receiving buffer is queried from register 10006..
- Access to register 10005 deletes characters contained in the receiving buffer.
- Occupancy of the the sending buffer is queried from register 10004..

12 Real-Time Clock

With the help of a battery buffered register set access to the functions of the real-time clock is made.

Overview: Real-Time Clock Registers	
Register #	Function
2911	Seconds
2912	Minutes
2913	Hours
2914	Day of the week with: <ul style="list-style-type: none"> – 0 = Sunday – 1 = Monday – 2 = Tuesday – 3 = Wednesday – 4 = Thursday – 5 = Friday – 6 = Saturday
2915	Day
2916	Month
2917	Year 0 .. 99

Sample Program for Real-Time Clock

The following sample program shows the present real-time clock data on the display. The following approach is used to display minutes and seconds with a leading zero:



For right justified display of numbers it is possible to specify the number of digits to be displayed by using register 2812. If less digits are allowed than there are significant digits in the number, then leading digits are suppressed.



The program uses this approach by adding the value 100 to the number of seconds and minutes. Then, display of the leading "1" will be suppressed.

```

0:  TASK 0 -----
1:      ;
2:      REGISTER_LOAD [2816 with 1]          ;No sign
3:      REGISTER_LOAD [2812 with 3]          ;2-digit numbers
4:      DISPLAY_TEXT [#0, cp=1, „_The present time is:“]
5:      ;
6:  FLAG 100
7:      SUBPROGRAM 900
8:      DELAY 5
9:      GOTO 100
10:     ;
11:  FLAG 900                                ;-> Displaying
12:  IF
13:     REG 2917
14:     < 90
15:  THEN
16:     DISPLAY_TEXT [#0, cp=27, „. .20 , : :“]
17:  ELSE
18:     DISPLAY_TEXT [#0, cp=27, „. .19 , : :“]
19:  THEN
20:     DISPLAY_REG [#0, cp=25, Reg=2915]     ;Day
21:     DISPLAY_REG [#0, cp=28, Reg=2916]     ;Month
22:     DISPLAY_REG [#0, cp=33, Reg=2917]     ;Year
23:     ;
24:     ;----- Display Time -----
25:     ;
26:     DISPLAY_REG [#0, cp=36, Reg=2913]     ;Hour
27:     REG 900                                ;Procedure for displaying
28:     =                                        ;the decimal place
29:     REG 2912                                ;even if it is „0“
30:     +
31:     100
32:     DISPLAY_REG [#0, cp=39, Reg=900]     ;Minute
33:     REG 900                                ;Procedure for displaying
34:     =                                        ;the decimal place
35:     REG 2911                                ;even if it is „0“
36:     +
37:     100
38:     DISPLAY_REG [#0, cp=42, Reg=900]     ;Second
39:     Return
End of Program

```

13 Expansion Modules

13.1 Topology of the JETTER System Bus

Centralised and Decentralised Arrangement of Expansion Modules

The NANO-B control system can be expanded via digital and analog expansion modules. The JETTER system bus port is located on the righthand side of the basic controller. The internal system bus is a JETTER system bus. The expansion modules are either centrally attached to the basic module, or located distributedly at a distance of up to 30 meters from the basic module.

The basic module can be expanded to a maximum of:

- 136 digital inputs/outputs (including CPU I/O) -> non-intelligent modules
- 64 analog inputs -> non-intelligent modules
- 61 analog outputs -> non-intelligent modules
- 16 hardware counters -> non-intelligent modules
- 3 servo axes -> intelligent modules
- 7 stepper motor axes -> intelligent modules
- 12 PID controllers -> intelligent modules

Note!



In order to ensure flawless functioning of the centralised or decentralised arrangement, the following boundary conditions as regards configuration must be met. Failure to meet these boundary conditions will result in malfunctions of individual modules or a breakdown of the entire system configuration.

- The NANO-B basic controller is designed to supply a maximum of 5 non-intelligent expansion modules.
- The N-PS 1 module is designed to supply a maximum of 5 non-intelligent expansion modules.
- For each remote module set at least one N-PS 1 module is required. Even with intelligent modules, the N-PS 1 modules must be located at the beginning of the module set, so as to meet EMC requirements.
- A maximum quantity of 15 non-intelligent expansion modules may be linked together with the N-PS 1 modules being ignored (please refer to fig. 31: "Centralised Arrangement on the JETTER System Bus", page 151, and fig. 32: "Decentralised Arrangement on the JETTER System Bus", page 151).
- Power supply of intelligent modules (CAN-DIMA, N-PID 1, N-SM1 D, N-SM 2, and N-SV1) is made through an individual power supply unit (DC 24 V), and not through a N-PS 1 module.
- Intelligent modules are not designed to supply non-intelligent expansion modules with voltage and current. Therefore, for a heterogeneous decentralised module set with intelligent and non-intelligent expansion modules at least one N-PS 1 module is required.
- One N-IO 16 module is designed to supply a maximum of 3 expansion modules.
- Power supply of a FESTO CP module is always to be made through an individual supply unit. Such a unit is for example a N-PS 1CP power supply unit or a FESTO tee connector.

13.1.1 Centralised Arrangement on the JETTER System Bus

- In case of centralised arrangement, the expansion modules are directly attached to the basic controller.
- A centralised arrangement may include up to 15 non-intelligent and 3 intelligent expansion modules.
- Electrical and mechanical connection is realised via a SUB-D connector. These connectors excel by their reliable mechanical and electrical connections, as well as good EMI characteristics.

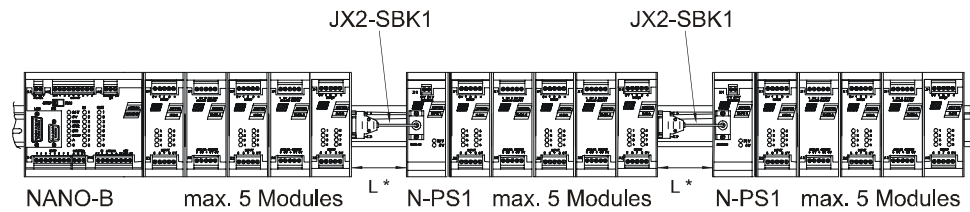

L*... Keep length L of JX2-SBK1 as short as possible!

Fig. 31: Centralised Arrangement on the JETTER System Bus

13.1.2 Decentralised Arrangement on the JETTER System Bus

- Use of the JETTER system bus as internal system bus allows that one or several modules can remotely be located at a maximum distance of 30 meters from the basic controller.
- A decentralised arrangement may include up to 15 expansion modules.
- Each decentralised module set must be connected to a N-PS 1 power supply unit. One power supply unit N-PS 1 is designed for supplying 5 expansion modules.
- The modules are controlled by the application program as if they were located in a centralised configuration.

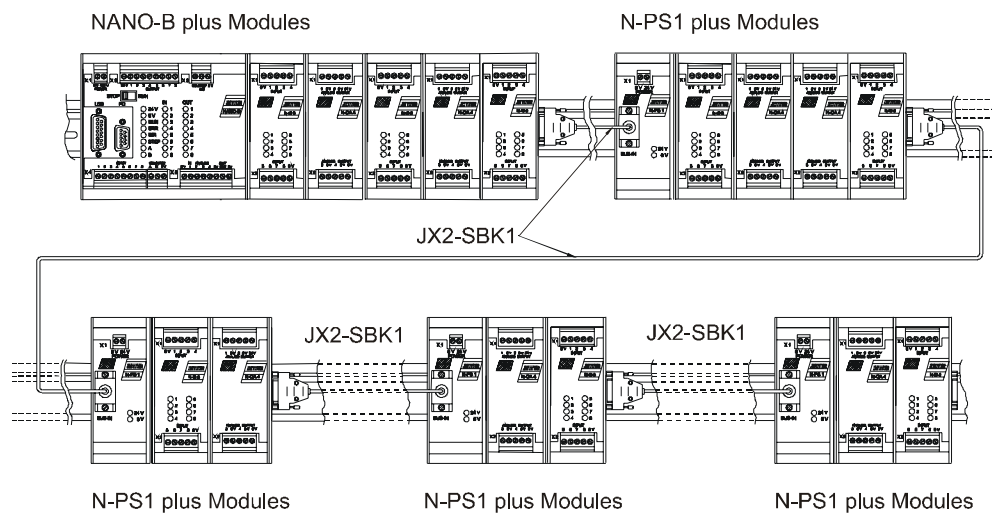

Fig. 32: Decentralised Arrangement on the JETTER System Bus

13.1.3 Direct Connection of FESTO CP Modules to the JETTER System Bus

FESTO CP modules can directly be connected to the Process PLC NANO. This means that no special bus node for either of the systems, FESTO CP module, or NANO controller, is required. Connection is carried out in the same way as for decentralised arrangement of digital and analog modules. In addition to this, a N-PS 1CP power supply unit or a FESTO tee connector is required. Either of the devices must be supplied with DC 24 V; please refer to chapter 14: "NANO Network Topology and FESTO CP Modules", page 244.

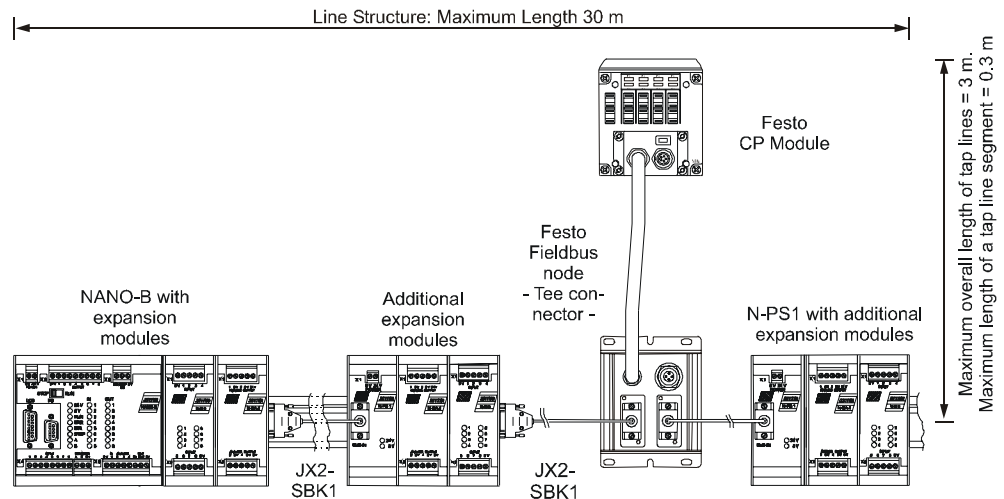

Fig. 33: Connecting FESTO CP Modules to the JETTER System Bus

13.2 N-ID 8 Module, 8 Digital Inputs

The N-ID 8 module serves to connect centralised or decentralised actuators or valves.

13.2.1 Physical Dimensions

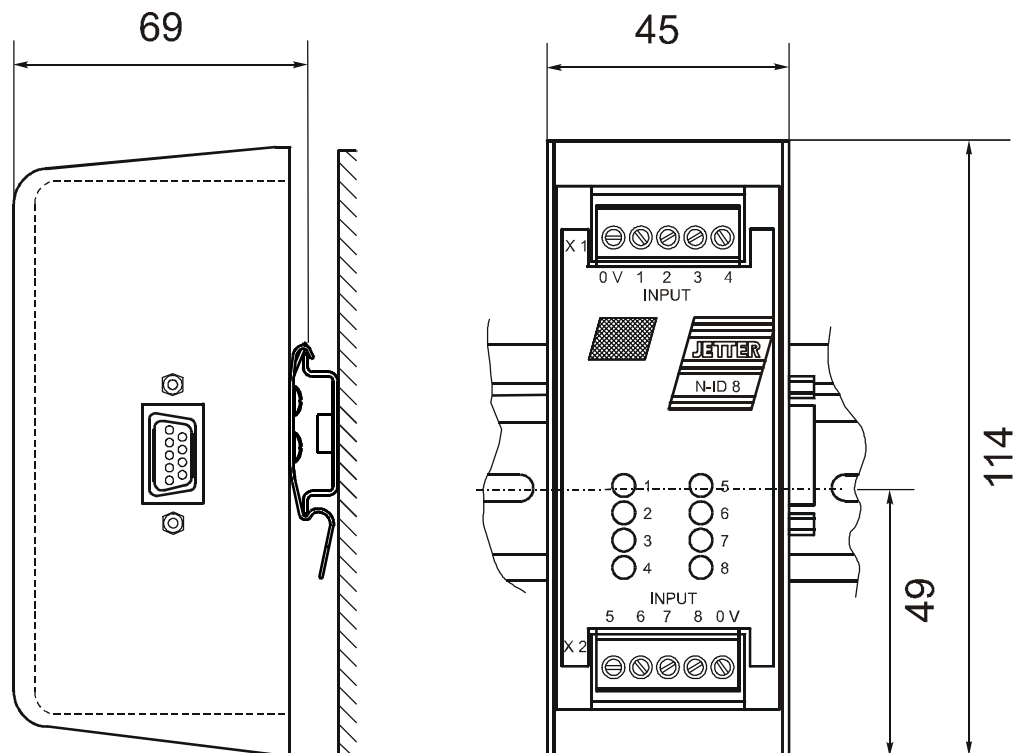

Fig. 34: Mounting Dimensions of the Digital Input Module N-ID 8

13.2.2 Overview and Technical Data

Technical Data of the N-ID 8 Module	
Digital Inputs	DC 24 V -15 % .. +20 %
Power Supply	<ul style="list-style-type: none"> • centralised arrangement: via basic unit cf. chapter 13.1.1: "Centralised Arrangement on the JETTER System Bus", page 151 • decentralised arrangement: via power supply N-PS 1, cf. chapter 13.1.2: "Decentralised Arrangement on the JETTER System Bus", page 151
Connecting to the basic unit via JETTER system bus	Male connector SUB-D, 9 pins
Input terminals	Screw terminals
LEDs, inputs 1-8	24 volt are applied to the input
Enclosure	Aluminium, powder coated, black
Dimensions (H x W x D in mm)	114 x 45 x 70
Weight	350 g
Mounting	DIN Rail
Heat loss of CPU logic circuit	0.3 Watt
Technical Data of N-ID 8 Inputs	
Input quantity	8
Rated Input Voltage	DC 24 V -15 % .. +20 %
Voltage Range	0 .. 30 V
Input current	approx. 8mA
Input resistance	3.0 k Ω
Input delay time	approx. 3 ms
Signal voltage ON	min. 15 V
Signal voltage OFF	max. 10 V
Electrical isolation	None

EMC - N-ID 8 Module		
Emitted Interference		
Parameter	Value	Reference
Enclosure	<ul style="list-style-type: none"> Frequency band 30 - 230 MHz, limit 30 dB ($\mu\text{V/m}$) at 10 m Frequency band 230 - 1000 MHz, limit 37 dB ($\mu\text{V/m}$) at 10 m (class B) 	DIN EN 50081-1 DIN EN 50081-2 DIN EN 55011
Interference Immunity: Enclosure		
Parameter	Value	Reference
RF Field, amplitude-modulated	Frequency band 27 -1000 MHz; test signal strength 10 V/m AM 80 % with 1 kHz Criterion A	DIN EN 61131-2 DIN EN 50082-2 DIN EN 61000-4-3
Electromagnetic RF Field, pulse-modulated	Frequency 900 \pm 5 MHz Test field strength 10 V/m 50 % ON period Repetition rate 200 Hz Criterion A	DIN EN 50082-2 DIN EN 61000-4-3
Magnetic Field with Mains Frequency	50 Hz 30 A/m	DIN EN 50082-2 DIN EN 61000-4-8
ESD	Discharge through air: Test Peak Voltage 15 kV (Humidity Rating RH-2 / ESD-4) Contact Discharge: Test peak voltage 4 kV (severity level 2) Criterion A	DIN EN 61131-2 DIN EN 50082-2 DIN EN 61000-4-2
Interference Immunity: Signal and Data Lines		
Parameter	Value	Reference
Asymmetric RF, amplitude-modulated	Frequency 0.15 - 80 MHz Test voltage 10 V AM 80 % with 1 kHz Source Impedance 150 Ω Criterion A	DIN EN 50082-2 DIN EN 61000-4-6
Burst	Test voltage 2 kV tr/tn 5/50 ns Repetition rate 5 kHz Criterion A	DIN EN 50082-2 DIN EN 61131-2 DIN EN 61000-4-4

EMC - N-ID 8 Module		
Test with Damped Oscillation	Damped Oscillation Frequency 1 MHz Source Impedance 200 Ω Repeat Factor 400/s Test voltage 1 kV	DIN EN 61131-2 DIN EN 61000-4-12
Interference Immunity: Process, Measuring and Control lines, Long Bus Lines and Long Control Lines		
Parameter	Value	Reference
Asymmetric RF, amplitude-modulated	Frequency 0.15 - 80 MHz Test voltage 10 V AM 80 % with 1 kHz Source Impedance 150 Ω Criterion A	DIN EN 50082-2 DIN EN 61000-4-6
Burst	Test voltage 2 kV tr/tn 5/50 ns Repetition rate 5 kHz Criterion A	DIN EN 50082-2 DIN EN 61131-2 DIN EN 61000-4-4
Interference Immunity: Mains Inputs and Outputs for AC and DC		
Parameter	Value	Reference
Asymmetric RF, amplitude-modulated	Frequency 0.15 - 80 MHz Test voltage 10 V AM 80 % with 1 kHz Source Impedance 150 Ω Criterion A	DIN EN 50082-2 DIN EN 61000-4-6
Burst	Test voltage 2 kV tr/tn 5/50 ns Repetition rate 5 kHz Criterion A	DIN EN 50082-2 DIN EN 61131-2 DIN EN 61000-4-4
Test with Damped Oscillation	Damped Oscillation Frequency 1 MHz Source Impedance 200 Ω Repeat Factor 400/s Test voltage 1 kV Criterion A	DIN EN 61131-2 DIN EN 61000-4-12

13.2.3 Description of Connections

On the expansion module, 8 terminals have been provided for 24 V signals. The 0 V signal is to be connected to the 0 V terminal of the electric cabinet.

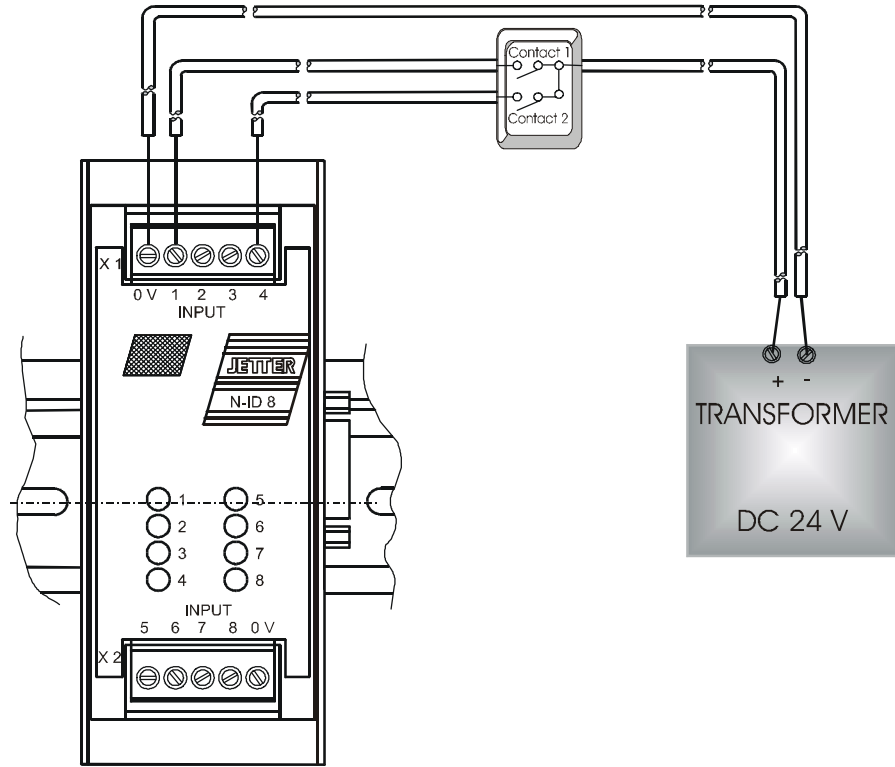

Fig. 35: Diagram of Input Wiring of a N-ID8 Module

Addressing Digital Inputs

For more information on addressing digital inputs refer to chapter 5.1: "Addressing Digital Inputs/Outputs", page 48.

13.2.4 Description of LEDs

The LEDs show that a 24 V input signal is applied to the corresponding input.

13.3 N-OD 4.2 Module, 4 Digital Outputs

The N-OD 4.2 serves for connecting centralised or decentralised actuators, valves or contactors.

13.3.1 Physical Dimensions

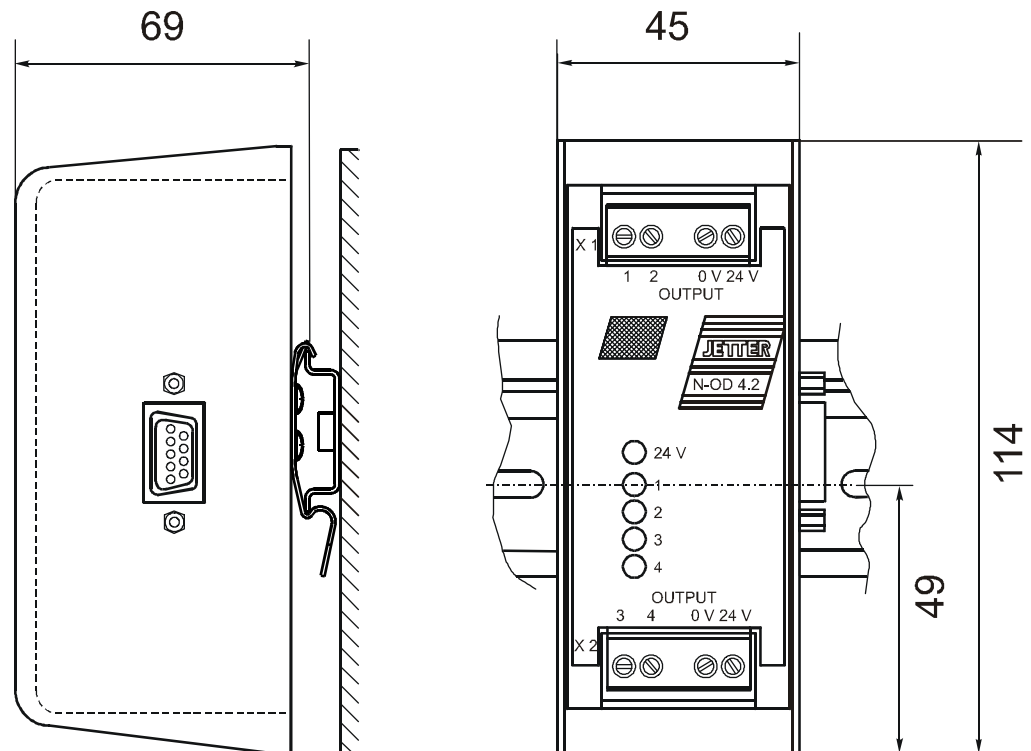

Fig. 36: Physical Dimensions of the Digital Output Module N-OD 4.2

13.3.2 Overview and Technical Data

Technical Data of the N-OD 4.2 Module	
Digital Outputs	Transistor DC 24 V, 2.0 A
Power supply of the internal logic circuit	<ul style="list-style-type: none"> centralised arrangement: via basic unit cf. chapter 13.1.1: "Centralised Arrangement on the JETTER System Bus", page 151 decentralised arrangement: via power supply N-PS 1, cf. chapter 13.1.2: "Decentralised Arrangement on the JETTER System Bus", page 151
Connecting to the basic unit via JETTER system bus	Male connector SUB-D, 9 pins
Output terminals	Screw terminals
LEDs, outputs 1 - 4	Output is set on 24 V
Enclosure	Aluminium, powder coated, black
Dimensions (H x W x D in mm)	114 x 45 x 70
Weight	350 g
Mounting	DIN Rail
Heat loss of CPU logic circuit	0.3 Watt
Technical Data of the N-OD 4.2 Outputs	
Quantity of outputs	4
Type of outputs	Transistor, pnp
Rated voltage	DC 24 V -15 % .. +20 %
Voltage Range	20 .. 30 V
Load current	max. 2.0 A per output
Output power of outputs	192 Watt
Electrical isolation	None
Protective circuit	Short circuit, overvoltage, overtemperature
Protection against inductive loads	Yes
Signal voltage ON	Typ. $V_{\text{Supply}} - 1.5 \text{ V}$

EMC - N-OD 4.2 Module		
Emitted Interference		
Parameter	Value	Reference
Enclosure	<ul style="list-style-type: none"> Frequency band 30 - 230 MHz, limit 30 dB ($\mu\text{V/m}$) at 10 m Frequency band 230 - 1000 MHz, limit 37 dB ($\mu\text{V/m}$) at 10 m (class B) 	DIN EN 50081-1 DIN EN 50081-2 DIN EN 55011
Interference Immunity: Enclosure		
Parameter	Value	Reference
RF Field, amplitude-modulated	Frequency band 27 - 1000 MHz; test signal strength 10 V/m AM 80 % with 1 kHz Criterion A	DIN EN 61131-2 DIN EN 50082-2 DIN EN 61000-4-3
Electromagnetic RF Field, pulse-modulated	Frequency 900 \pm 5 MHz Test field strength 10 V/m 50 % ON period Repetition rate 200 Hz Criterion A	DIN EN 50082-2 DIN EN 61000-4-3
Magnetic Field with Mains Frequency	50 Hz 30 A/m	DIN EN 50082-2 DIN EN 61000-4-8
ESD	Discharge through air: Test Peak Voltage 15 kV (Humidity Rating RH-2 / ESD-4) Contact Discharge: Test peak voltage 4 kV (severity level 2) Criterion A	DIN EN 61131-2 DIN EN 50082-2 DIN EN 61000-4-2
Interference Immunity: Signal and Data Lines		
Parameter	Value	Reference
Asymmetric RF, amplitude-modulated	Frequency 0.15 - 80 MHz Test voltage 10 V AM 80 % with 1 kHz Source Impedance 150 Ω Criterion A	DIN EN 50082-2 DIN EN 61000-4-6
Burst	Test voltage 2 kV tr/tn 5/50 ns Repetition rate 5 kHz Criterion A	DIN EN 50082-2 DIN EN 61131-2 DIN EN 61000-4-4

EMC - N-OD 4.2 Module		
Test with Damped Oscillation	Damped Oscillation Frequency 1 MHz Source Impedance 200 Ω Repeat Factor 400/s Test voltage 1 kV	DIN EN 61131-2 DIN EN 61000-4-12
Interference Immunity: Process, Measuring and Control lines, Long Bus Lines and Long Control Lines		
Parameter	Value	Reference
Asymmetric RF, amplitude-modulated	Frequency 0.15 - 80 MHz Test voltage 10 V AM 80 % with 1 kHz Source Impedance 150 Ω Criterion A	DIN EN 50082-2 DIN EN 61000-4-6
Burst	Test voltage 2 kV tr/tn 5/50 ns Repetition rate 5 kHz Criterion A	DIN EN 50082-2 DIN EN 61131-2 DIN EN 61000-4-4
Interference Immunity: Mains Inputs and Outputs for AC and DC		
Parameter	Value	Reference
Asymmetric RF, amplitude-modulated	Frequency 0.15 - 80 MHz Test voltage 10 V AM 80 % with 1 kHz Source Impedance 150 Ω Criterion A	DIN EN 50082-2 DIN EN 61000-4-6
Burst	Test voltage 2 kV tr/tn 5/50 ns Repetition rate 5 kHz Criterion A	DIN EN 50082-2 DIN EN 61131-2 DIN EN 61000-4-4
Test with Damped Oscillation	Damped Oscillation Frequency 1 MHz Source Impedance 200 Ω Repeat Factor 400/s Test voltage 1 kV Criterion A	DIN EN 61131-2 DIN EN 61000-4-12

13.3.3 Description of Connections

On the expansion module, 4 terminals have been provided for 24 V output signals. The 0 V signal is to be connected to the 0 V terminal of the electric cabinet.

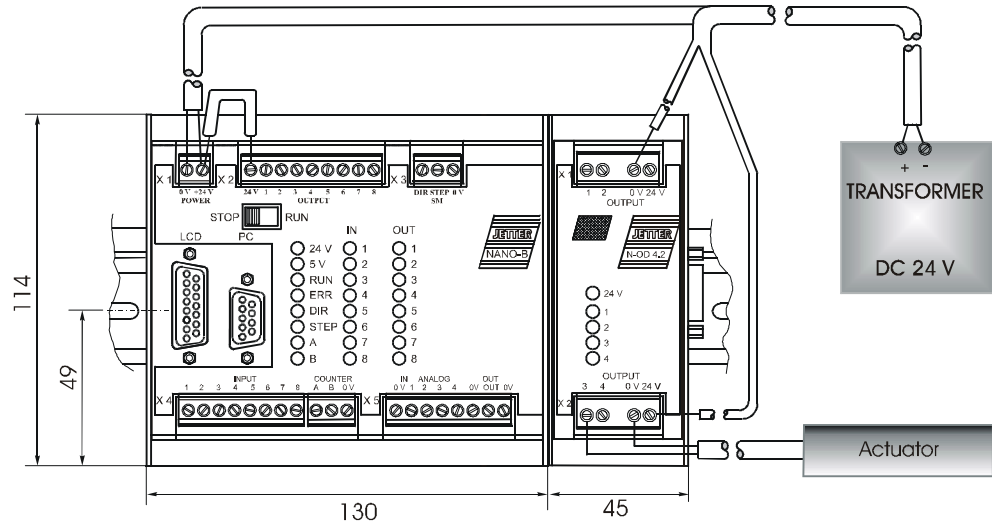

Fig. 37: Example: Output Wiring of an N-OD 4.2 Module

Addressing of Digital Outputs

For addressing of digital outputs refer to chapter 5.1: "Addressing Digital Inputs/Outputs", page 48. Addressing of outputs of N-OD 4.2 modules is carried out the same way as with the N-OD 8 module. However, it must be taken into account that there are only 4 outputs.

13.3.4 Description of LEDs

The LEDs show that a 24 V output signal is applied to the corresponding output.

13.4 N-OD 8 Module, 8 Digital Outputs

The N-OD 8 serves for connecting centralised or decentralised actuators, valves or contactors.

13.4.1 Physical Dimensions

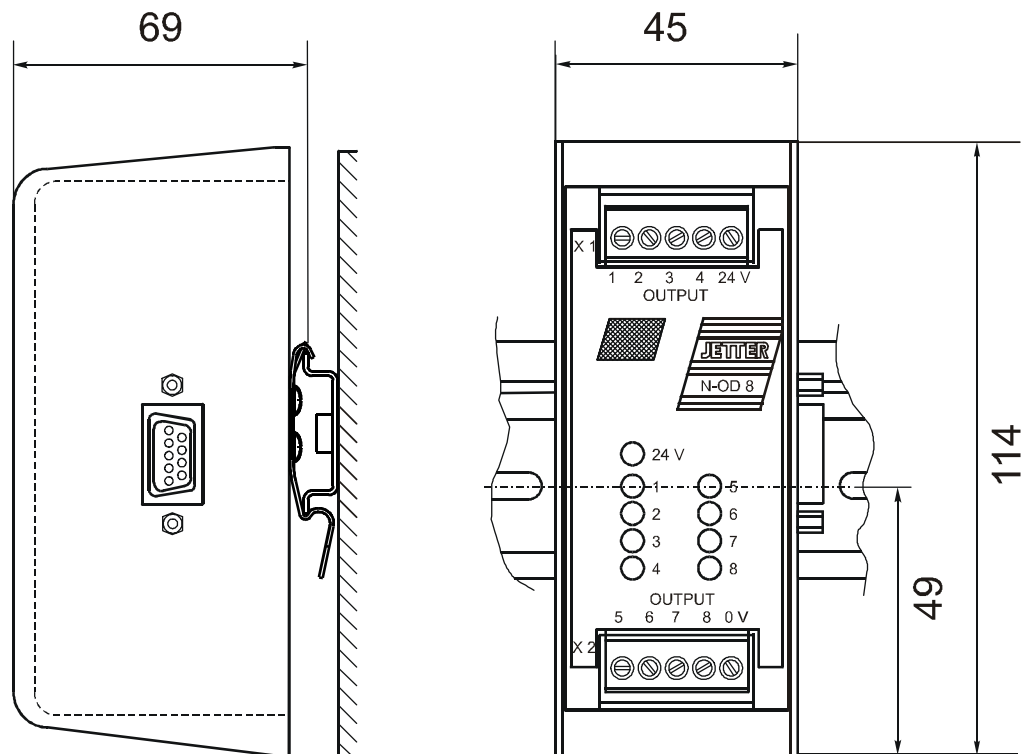

Fig. 38: Physical Dimensions of the Digital Output Module N-OD 8

13.4.2 Overview and Technical Data

Technical Data of the N-OD 8 Module	
Digital Outputs	Transistor DC 24 V, 0.5 A
Power supply of the internal logic circuit	<ul style="list-style-type: none"> • centralised arrangement: via basic unit cf. chapter 13.1.1: "Centralised Arrangement on the JETTER System Bus", page 151 • decentralised arrangement: via power supply N-PS 1, cf. chapter 13.1.2: "Decentralised Arrangement on the JETTER System Bus", page 151
Connecting to the basic unit via JETTER system bus	Male connector SUB-D, 9 pins
Output terminals	Screw terminals
LEDs, outputs 1 -8	Output is set on 24 V
Enclosure	Aluminium, powder coated, black
Dimensions (H x W x D in mm)	114 x 45 x 70
Weight	350 g
Mounting	DIN Rail
Heat loss of CPU logic circuit	0.3 Watt
Technical Data of N-OD 8 Inputs	
Quantity of outputs	8
Type of outputs	Transistor, pnp
Rated voltage	DC 24 V -15 % .. +20 %
Voltage Range	20 .. 30 V
Load current	max. 0.5 A per output
Output power of outputs	96 Watt
Electrical isolation	None
Protective circuit	Short circuit, overvoltage, overtemperature
Protection against inductive loads	yes
Signal voltage ON	typ. $V_{\text{Supply}} - 1.5 \text{ V}$

EMC - N-OD 8 Module		
Emitted Interference		
Parameter	Value	Reference
Enclosure	<ul style="list-style-type: none"> Frequency band 30 - 230 MHz, limit 30 dB ($\mu\text{V}/\text{m}$) at 10 m Frequency band 230 - 1000 MHz, limit 37 dB ($\mu\text{V}/\text{m}$) at 10 m (class B) 	DIN EN 50081-1 DIN EN 50081-2 DIN EN 55011
Interference Immunity: Enclosure		
Parameter	Value	Reference
RF Field, amplitude-modulated	Frequency band 27 -1000 MHz; test signal strength 10 V/m AM 80 % with 1 kHz Criterion A	DIN EN 61131-2 DIN EN 50082-2 DIN EN 61000-4-3
Electromagnetic RF Field, pulse-modulated	Frequency 900 \pm 5 MHz Test field strength 10 V/m 50 % ON period Repetition rate 200 Hz Criterion A	DIN EN 50082-2 DIN EN 61000-4-3
Magnetic Field with Mains Frequency	50 Hz 30 A/m	DIN EN 50082-2 DIN EN 61000-4-8
ESD	Discharge through air: Test Peak Voltage 15 kV (Humidity Rating RH-2 / ESD-4) Contact Discharge: Test peak voltage 4 kV (severity level 2) Criterion A	DIN EN 61131-2 DIN EN 50082-2 DIN EN 61000-4-2
Interference Immunity: Signal and Data Lines		
Parameter	Value	Reference
Asymmetric RF, amplitude-modulated	Frequency 0.15 - 80 MHz Test voltage 10 V AM 80 % with 1 kHz Source Impedance 150 Ω Criterion A	DIN EN 50082-2 DIN EN 61000-4-6
Burst	Test voltage 2 kV tr/tn 5/50 ns Repetition rate 5 kHz Criterion A	DIN EN 50082-2 DIN EN 61131-2 DIN EN 61000-4-4

EMC - N-OD 8 Module		
Test with Damped Oscillation	Damped Oscillation Frequency 1 MHz Source Impedance 200 Ω Repeat Factor 400/s Test voltage 1 kV	DIN EN 61131-2 DIN EN 61000-4-12
Interference Immunity: Process, Measuring and Control lines, Long Bus Lines and Long Control Lines		
Parameter	Value	Reference
Asymmetric RF, amplitude-modulated	Frequency 0.15 - 80 MHz Test voltage 10 V AM 80 % with 1 kHz Source Impedance 150 Ω Criterion A	DIN EN 50082-2 DIN EN 61000-4-6
Burst	Test voltage 2 kV tr/tn 5/50 ns Repetition rate 5 kHz Criterion A	DIN EN 50082-2 DIN EN 61131-2 DIN EN 61000-4-4
Interference Immunity: Mains Inputs and Outputs for AC and DC		
Parameter	Value	Reference
Asymmetric RF, amplitude-modulated	Frequency 0.15 - 80 MHz Test voltage 10 V AM 80 % with 1 kHz Source Impedance 150 Ω Criterion A	DIN EN 50082-2 DIN EN 61000-4-6
Burst	Test voltage 2 kV tr/tn 5/50 ns Repetition rate 5 kHz Criterion A	DIN EN 50082-2 DIN EN 61131-2 DIN EN 61000-4-4
Test with Damped Oscillation	Damped Oscillation Frequency 1 MHz Source Impedance 200 Ω Repeat Factor 400/s Test voltage 1 kV Criterion A	DIN EN 61131-2 DIN EN 61000-4-12

13.4.3 Description of Connections

On the expansion module, 8 terminals have been provided for 24 V output signals. The 0 V signal is to be connected to the 0 V terminal of the electric cabinet.

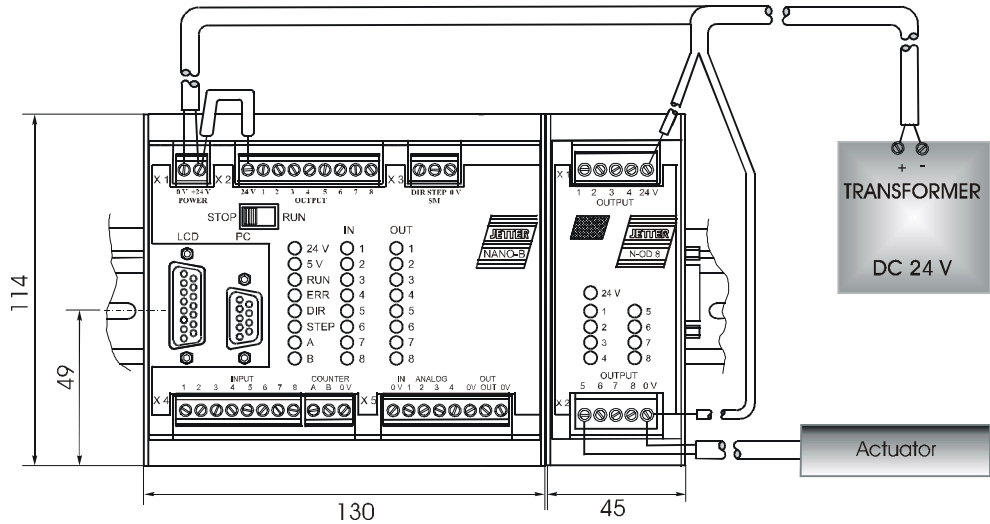

Fig. 39: Example: Output Wiring of an N-OD 8 Module

Addressing Digital Outputs

For addressing of digital outputs refer to chapter 5.1: "Addressing Digital Inputs/Outputs", page 48.

13.4.4 Description of LEDs

The LEDs show that a 24 V output signal is applied to the corresponding output.

13.5 N-IO 16 Module - Digital Inputs and Outputs

The N-IO 16 module serves to connect centralised or decentralised pushbuttons or lamps.

13.5.1 Physical Dimensions of the N-IO 16 Module

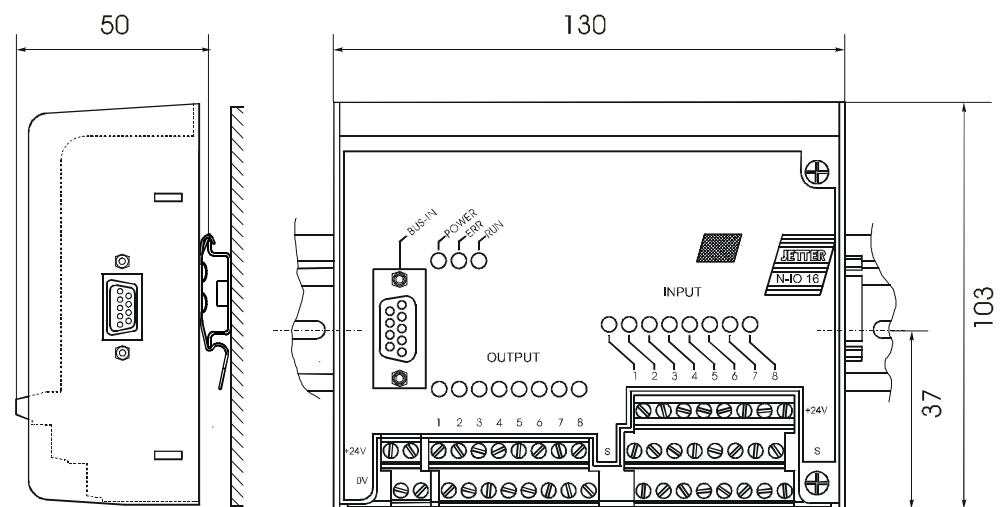

Fig. 40: Physical Dimensions of the Digital Input and Output Module N-IO 16

13.5.2 Overview and Technical Data

Technical Data of the N-IO 16 Module	
Power supply of the internal logic circuit	Own power supply unit DC 20 ... 30 V
Power Loss	<ul style="list-style-type: none"> • Time period ≤ 10 ms to DIN EN 61131-2 • Time interval between two voltage dips ≥ 1 s • Severity level PS2
Connections to the basic unit via JETTER system bus	Male connector SUB-D, 9 pins
Input and output terminal blocks	Double- and three-level terminal blocks
Enclosure	Aluminium, powder coated, black
Dimensions (H x W x D in mm)	50 x 130 x 103
Weight	326 g
Mounting	DIN Rail
Electrical isolation	None
Heat loss of CPU logic circuit	1.0 Watt
Technical Data of N-IO 16 Inputs	
Number of digital inputs	8
Rated Input Voltage	DC 24 V -15 % .. +20 %
Voltage Range	0 - 30 V
Input current	approx. 8mA
Input resistance	3.0 k Ω
Signal voltage ON	min. 15 V
Signal voltage OFF	max. 10 V
Technical Data of the N-IO 16 Outputs	
Number and type of outputs	8; transistor, pnp
Rated voltage	DC 24 V -15 % .. +20 %
Rated output current	0.5 A
Output power of outputs	96 Watt
Protection against inductive loads, short circuit, over-voltage and overtemperature	yes
Signal voltage (S) ON	typically $V_{\text{Supply}} - 1.5$ V

EMC - N-IO 16 Module		
Emitted Interference		
Parameter	Value	Reference
Enclosure	<ul style="list-style-type: none"> Frequency band 30 - 230 MHz, limit 30 dB ($\mu\text{V/m}$) at 10 m Frequency band 230 - 1000 MHz, limit 37 dB ($\mu\text{V/m}$) at 10 m (class B) 	DIN EN 50081-1 DIN EN 50081-2 DIN EN 55011
Interference Immunity: Enclosure		
Parameter	Value	Reference
RF Field, amplitude-modulated	Frequency band 27 -1000 MHz; test signal strength 10 V/m AM 80 % with 1 kHz Criterion A	DIN EN 61131-2 DIN EN 50082-2 DIN EN 61000-4-3
Electromagnetic RF Field, pulse-modulated	Frequency 900 \pm 5 MHz Test field strength 10 V/m 50 % ON period Repetition rate 200 Hz Criterion A	DIN EN 50082-2 DIN EN 61000-4-3
Magnetic Field with Mains Frequency	50 Hz 30 A/m	DIN EN 50082-2 DIN EN 61000-4-8
ESD	Discharge through air: Test Peak Voltage 15 kV (Humidity Rating RH-2 / ESD-4) Contact Discharge: Test peak voltage 4 kV (severity level 2) Criterion A	DIN EN 61131-2 DIN EN 50082-2 DIN EN 61000-4-2
Interference Immunity: Signal and Data Lines		
Parameter	Value	Reference
Asymmetric RF, amplitude-modulated	Frequency 0.15 - 80 MHz Test voltage 10 V AM 80 % with 1 kHz Source Impedance 150 Ω Criterion A	DIN EN 50082-2 DIN EN 61000-4-6
Burst	Test voltage 2 kV tr/tn 5/50 ns Repetition rate 5 kHz Criterion A	DIN EN 50082-2 DIN EN 61131-2 DIN EN 61000-4-4

EMC - N-IO 16 Module		
Test with Damped Oscillation	Damped Oscillation Frequency 1 MHz Source Impedance 200 Ω Repeat Factor 400/s Test voltage 1 kV	DIN EN 61131-2 DIN EN 61000-4-12
Interference Immunity: Process, Measuring and Control lines, Long Bus Lines and Long Control Lines		
Parameter	Value	Reference
Asymmetric RF, amplitude-modulated	Frequency 0.15 - 80 MHz Test voltage 10 V AM 80 % with 1 kHz Source Impedance 150 Ω Criterion A	DIN EN 50082-2 DIN EN 61000-4-6
Burst	Test voltage 2 kV tr/tn 5/50 ns Repetition rate 5 kHz Criterion A	DIN EN 50082-2 DIN EN 61131-2 DIN EN 61000-4-4
Interference Immunity: Mains Inputs and Outputs for AC and DC		
Parameter	Value	Reference
Asymmetric RF, amplitude-modulated	Frequency 0.15 - 80 MHz Test voltage 10 V AM 80 % with 1 kHz Source Impedance 150 Ω Criterion A	DIN EN 50082-2 DIN EN 61000-4-6
Burst	Test voltage 2 kV tr/tn 5/50 ns Repetition rate 5 kHz Criterion A	DIN EN 50082-2 DIN EN 61131-2 DIN EN 61000-4-4
Test with Damped Oscillation	Damped Oscillation Frequency 1 MHz Source Impedance 200 Ω Repeat Factor 400/s Test voltage 1 kV Criterion A	DIN EN 61131-2 DIN EN 61000-4-12

13.5.3 Description of Connections

- On the expansion module, 24 terminals have been provided for the 8 inputs. For the 8 outputs on the expansion module 16 terminals have been provided.
- Each output can be switched individually and provides voltage values according to table "Technical Data of the N-IO 16 Module", page 169.
- The left +24 Volt terminal is for supplying the internal logic and the top level of the three-level terminal block. The right +24 Volt power supply terminal is for supplying the output drivers.
- All voltage signals relate to 0 V. Within the module, the 0 V signal is connected to ground internally via the enclosure.



Note!

- Please note that in registers 2015 and 2016 the N-IO 16 module appears as 1 module, though it performs **the functions of 2 modules**. The N-IO 16 module is to be regarded as one combined N-PS 1, N-OD 8, and N-ID 8 module.
- Therefore, three non-intelligent modules, such as N-ID 8, N-OD 8, can be connected to the N-IO 16 module and be supplied with voltage.



Important!

- For Inputs three-level terminal blocks are available.
- Apply to the digital inputs of the N-IO 16 module a maximum voltage of 28.8 Volt. This will prevent the N-IO 16 module and the sensor, e.g. an inductive limit switch, from being destroyed.

Following power-up, the N-IO 16 module is initialised by the NANO-CPU via JETTER system bus. During this process, the various initialisation modes are displayed through LEDs **RUN**, and **ERR**. In the normal course of initialisation, both LEDs flash up for a short time only.



Important!

- Do not apply a **voltage** to individual **digital outputs**. If application of voltage cannot be avoided, for example, for testing inputs/ outputs with the N-IO 16 module wired in an electric cabinet, the **voltage** has to be applied to the **output drivers** of the module before-hand. The output drivers will be **destroyed** if you **fail to apply voltage** to them.



Note!

For fault-free operation, both 24 V terminals have to be connected-up. The 3 LEDs have the following meaning:

- LED **POWER** (green): ➔ Voltage supply of the outputs is provided.
- LED **ERR** (red): ➔ One or more output driver chips signal overload or error.
- LED **RUN** (green): ➔ The operating system of the N-IO 16 module has been activated.

Input and Output Terminal Assignment of the N-IO 16 Module	
Terminal	Signal
Terminal block OUTPUT	
24 Volt	Supply voltage
0 Volt	Gnd
1 .. 8	Digital outputs
Terminal block INPUT	
24 Volt	Sensor supply voltage
S	Sensor signal
0 Volt	Gnd
1 .. 8	Digital inputs

Emergency Stop Circuitry of the N-IO 16 Module

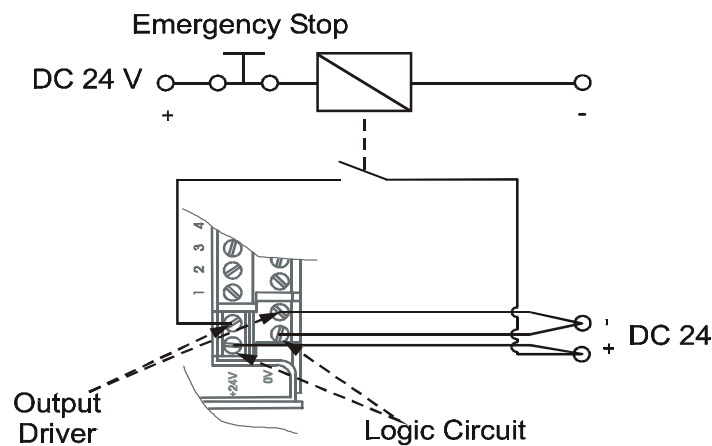

Fig. 41: Example: Emergency Stop Circuitry of the N-IO 16 Module

Note!

Once the Emergency Stop button is pressed, all outputs are disabled. However, the logic circuit remains connected, e.g. for scanning errors.



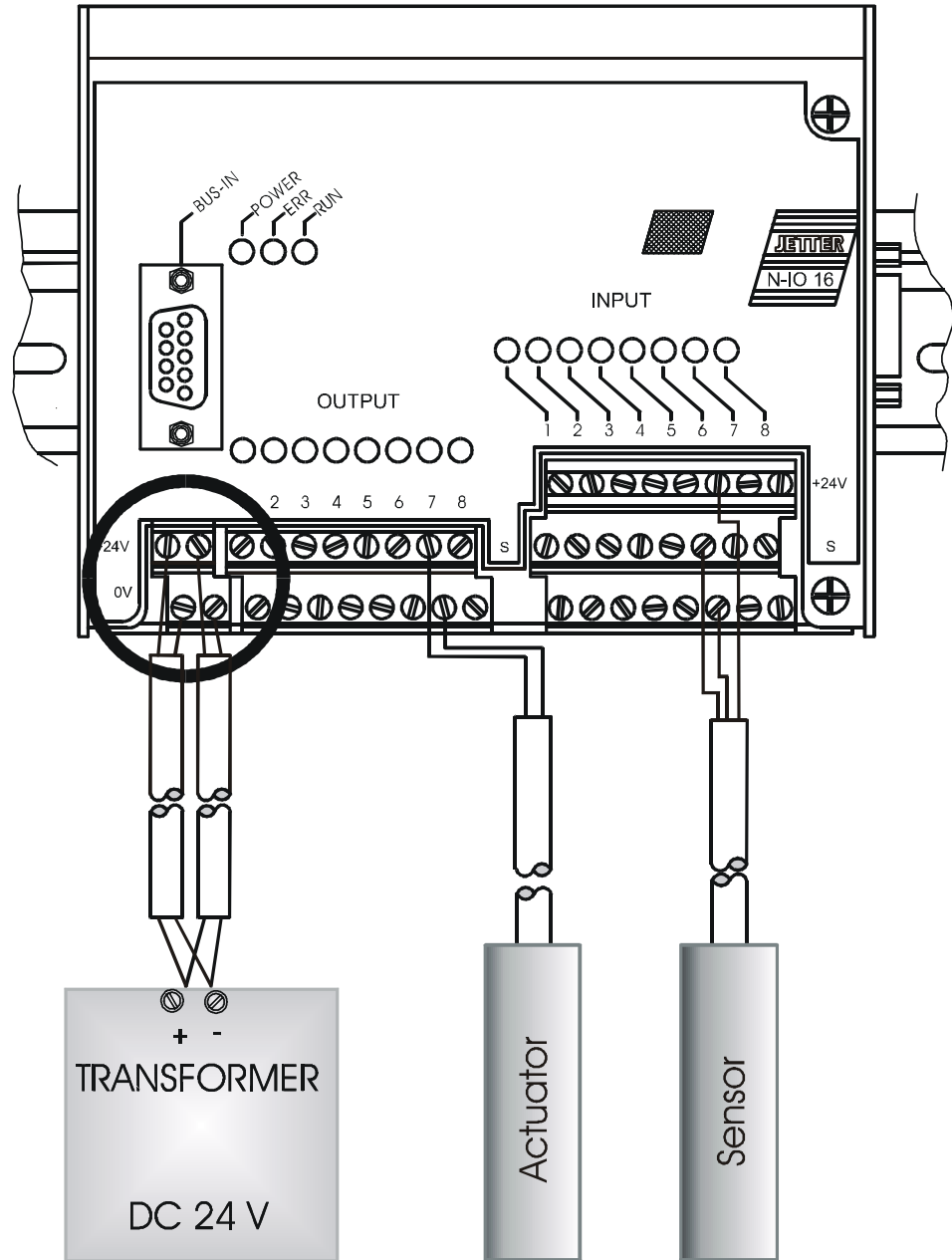
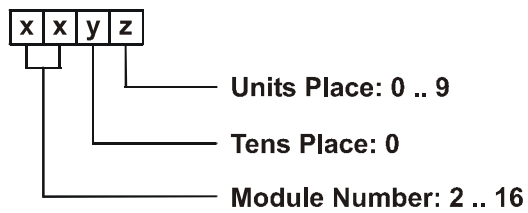

Fig. 42: Example: Input Wiring of the N-IO 16 Module

Coding of the Input / Output Number: xyz





Note!

For determination of the module number, only the non-intelligent modules will be counted. Intelligent modules, such as SV, SM, PID, etc., located among the modules, are not being taken into consideration.

Module number 1 is always assigned to the basic control unit. Starting from there, the module numbers are being counted left to right.

Numbering of Inputs and Outputs of the N-IO 16 Module

Example 1:

The table below shows the input/output numbering for a basic controller equipped with one N-ID 8 module, one N-OD 8 output module, and one N-IO 16 module:

NANO-B Basic Unit	N-OD 8 Output Module	N-IO 16 I/O Module	N-ID 8 Input Module
Module # 1	Module # 2	Module # 3	Module # 4
Inputs and Outputs 101 .. 108	Output 201 .. 208	Input 301 .. 308 Output 301 .. 308	Input 401 .. 408

Example 2:

The table below shows the input/output numbering for a basic controller equipped with one N-SV 1 module, one N-IO 16 output module, and one digital output module N-OD 8:

NANO-B Basic Unit	N-OD 8 Output Module	N-SV 1 Servo Module	N-IO 16 I/O Module
Module # 1	Module # 2	Module # 3	Module # 4
Inputs and Outputs 101 .. 108	Output 201 .. 208	SV module	!!! Input 301 .. 308

13.6 N-IA 4 Module - Analog Inputs

The N-IA 4 module is for measuring analog input voltages and currents. The measured values are evaluated and processed by the application program.

13.6.1 Physical Dimensions of the N-IA 4 Module

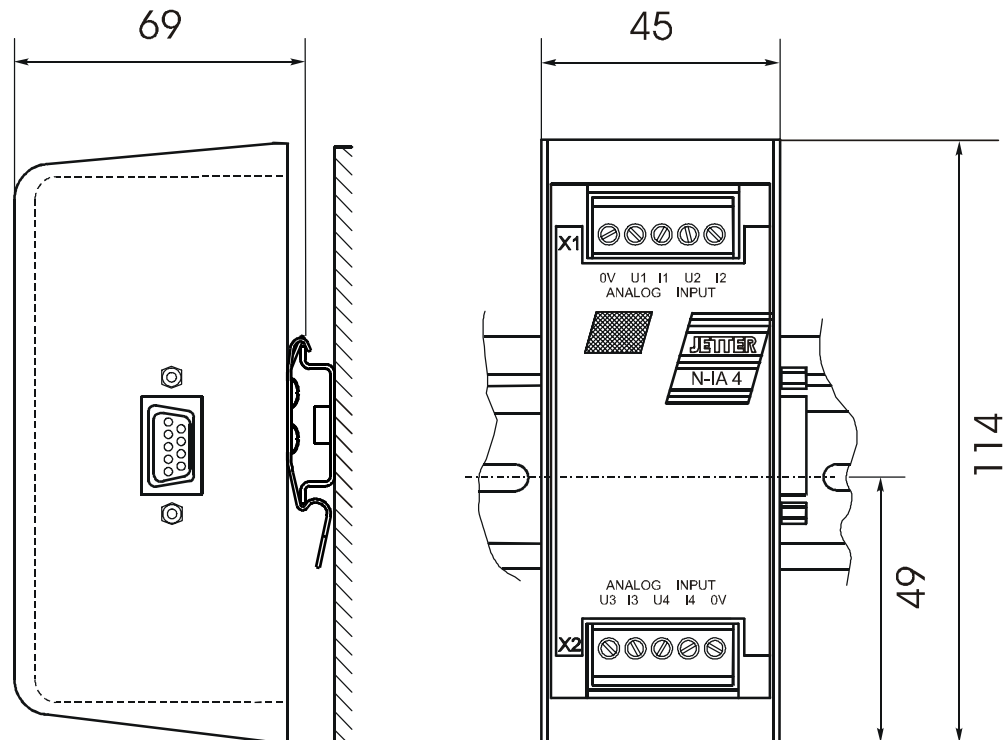

Fig. 43: Physical Dimensions of the Analog Input Module N-IA 4

13.6.2 Overview and Technical Data

Technical Data of the N-IA 4 Module	
Power Supply	<ul style="list-style-type: none"> centralised arrangement: via basic unit; cf. fig. 13.1.1: "Centralised Arrangement on the JETTER System Bus", page 151. decentralised arrangement: via power supply N-PS 1, cf. chapter 13.1.2: "Decentralised Arrangement on the JETTER System Bus", page 151
Connections to the basic unit via JETTER system bus	Male connector SUB-D, 9 pins
Input terminals	Screw terminals
Enclosure	Aluminium, powder coated, black
Dimensions (H x W x D in mm)	114 x 45 x 70
Weight	190 g
Mounting	DIN Rail
Input quantity	4 channels: - U ₁₋₄ for voltage - I ₁₋₄ for current
Voltage Range	- Unipolar 0 -10 V - Bipolar -10 V ... + 10 V
Value range (voltage)	- Unipolar 0 ... 4095 - Bipolar -2048 ... 2047
Current range	0 ... 20 mA
Value range (current)	0 ... 2047
Input impedance	- Current 220 Ω
Resolution (voltage)	12 Bit
Resolution (current)	11 Bit
Sampling interval	< 13 ms
Heat loss of CPU logic circuit	0.3 Watt
Electrical isolation	None

EMC - N-IA 4 Module		
Emitted Interference		
Parameter	Value	Reference
Enclosure	<ul style="list-style-type: none"> Frequency band 30 - 230 MHz, limit 30 dB ($\mu\text{V/m}$) at 10 m Frequency band 230 - 1000 MHz, limit 37 dB ($\mu\text{V/m}$) at 10 m (class B) 	DIN EN 50081-1 DIN EN 50081-2 DIN EN 55011
Interference Immunity: Enclosure		
Parameter	Value	Reference
RF Field, amplitude-modulated	Frequency band 27 -1000 MHz; test signal strength 10 V/m AM 80 % with 1 kHz Criterion A	DIN EN 61131-2 DIN EN 50082-2 DIN EN 61000-4-3
Electromagnetic RF Field, pulse-modulated	Frequency 900 \pm 5 MHz Test field strength 10 V/m 50 % ON period Repetition rate 200 Hz Criterion A	DIN EN 50082-2 DIN EN 61000-4-3
Magnetic Field with Mains Frequency	50 Hz 30 A/m	DIN EN 50082-2 DIN EN 61000-4-8
ESD	Discharge through air: Test Peak Voltage 15 kV (Humidity Rating RH-2 / ESD-4) Contact Discharge: Test peak voltage 4 kV (severity level 2) Criterion A	DIN EN 61131-2 DIN EN 50082-2 DIN EN 61000-4-2
Interference Immunity: Signal and Data Lines		
Parameter	Value	Reference
Asymmetric RF, amplitude-modulated	Frequency 0.15 - 80 MHz Test voltage 10 V AM 80 % with 1 kHz Source Impedance 150 Ω Criterion A	DIN EN 50082-2 DIN EN 61000-4-6
Burst	Test voltage 2 kV tr/tn 5/50 ns Repetition rate 5 kHz Criterion A	DIN EN 50082-2 DIN EN 61131-2 DIN EN 61000-4-4

EMC - N-IA 4 Module		
Test with Damped Oscillation	Damped Oscillation Frequency 1 MHz Source Impedance 200 Ω Repeat Factor 400/s Test voltage 1 kV	DIN EN 61131-2 DIN EN 61000-4-12
Interference Immunity: Process, Measuring and Control lines, Long Bus Lines and Long Control Lines		
Parameter	Value	Reference
Asymmetric RF, amplitude-modulated	Frequency 0.15 - 80 MHz Test voltage 10 V AM 80 % with 1 kHz Source Impedance 150 Ω Criterion A	DIN EN 50082-2 DIN EN 61000-4-6
Burst	Test voltage 2 kV tr/tn 5/50 ns Repetition rate 5 kHz Criterion A	DIN EN 50082-2 DIN EN 61131-2 DIN EN 61000-4-4
Interference Immunity: Mains Inputs and Outputs for AC and DC		
Parameter	Value	Reference
Asymmetric RF, amplitude-modulated	Frequency 0.15 - 80 MHz Test voltage 10 V AM 80 % with 1 kHz Source Impedance 150 Ω Criterion A	DIN EN 50082-2 DIN EN 61000-4-6
Burst	Test voltage 2 kV tr/tn 5/50 ns Repetition rate 5 kHz Criterion A	DIN EN 50082-2 DIN EN 61131-2 DIN EN 61000-4-4
Test with Damped Oscillation	Damped Oscillation Frequency 1 MHz Source Impedance 200 Ω Repeat Factor 400/s Test voltage 1 kV Criterion A	DIN EN 61131-2 DIN EN 61000-4-12

Accuracy Classes of the N-IA 4 Module			
Type of Error	Input Configuration	Maximum Error ^{*)}	
		in LSB	in LSB
Zero Error	• Unipolar	± 5 LSB	12.2 mV
	• Bipolar	± 10 LSB	48.8 mV
	• Current	± 10 LSB	98 μ A
Gain Error	• Unipolar	± 10 LSB	24.4 mV
	• Bipolar	± 10 LSB	48.8 mV
	• Current	± 10 LSB	98 μ A

^{*)} The typical measuring accuracy is higher.

13.6.3 Description of Connections

On the expansion module, 4 channels with 8 terminals have been provided for the inputs. These terminals are grouped in the following way:

- four terminals for voltage measurement ± 10 V
- four terminals for current measurement 0 through 20 mA

Each channel can be switched individually between voltage and current. All voltage and current input signals relate to 0 V. Within the module, the 0 V signal is connected to ground internally via the enclosure.



Important!

Apply to the analog inputs of the N-IA 4 module a maximum voltage of 12 V, or current of 50 mA. This will prevent the N-IA 4 module and the sensor, e.g. a temperature sensor, from being destroyed.

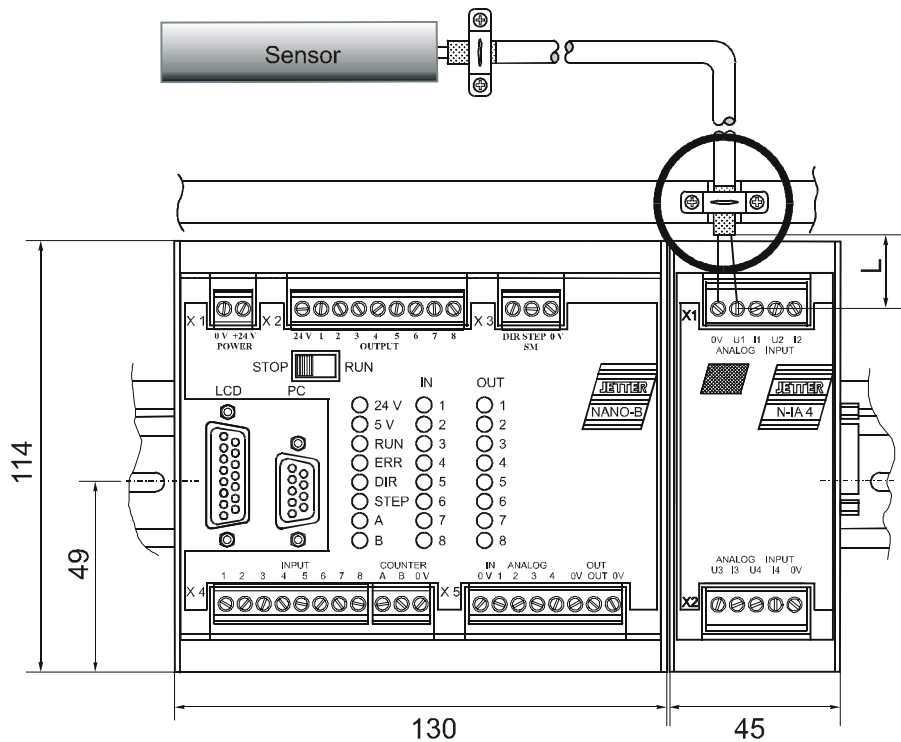

Fig. 44: Diagram of Input Wiring of an N-IA4 Module



Important!

To avoid malfunctions the following must be ensured:

- The shielding must be clamped under a strain relief with the greatest possible surface area.
- The connection between shielding and ground must be electrically conducting.
- The distance "L" of unshielded conductor ends must not exceed 8 cm.

Addressing Analog Inputs

The address is made up of the module number and the number of the respective input or output:

Coding of the registers:

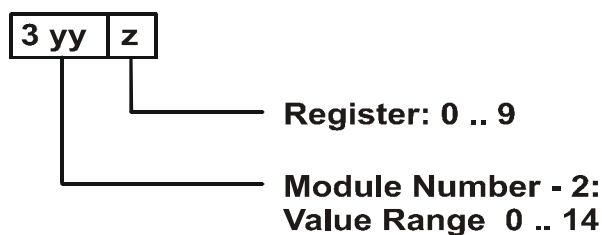



Note!

- For determination of the module number, only the non-intelligent modules will be counted. Intelligent modules, such as SV, SM, PID, etc., located among the modules, are not being taken into consideration.
- Module number 1 is always assigned to the basic control unit. Starting from there, the module numbers are being counted left to right.

For communication with the CPU, 10 registers and the output byte have been provided by the N-IA 4 module. The operating system version number of the module can always be read from register 9. The other module registers are being defined by the function of the module. The registers are addressed as follows:

$$\text{Register number} = 3000 + (\text{module number} - 2) * 10 + \text{local register number}$$

Input and Output Configuration of the N-IA 4 Module				
Inputs	A/D Value Register	Voltage		Current
		Unipolar	Bipolar	
Channel # 1	3yy0	xxx0xxx0	xxx1xxx0	xxxxxxx1
Channel # 2	3yy1	xx0xxx0x	xx1xxx0x	xxxxxx1x
Channel # 3	3yy2	x0xxx0xx	x1xxx0xx	xxxxx1xx
Channel # 4	3yy3	0xxx0xxx	1xxx0xxx	xxxx1xxx
	Output	↑↑↑↑↑↑↑↑	↑↑↑↑↑↑↑↑	↑↑↑↑↑↑↑↑
Configura- tion of virtu- al outputs	xx01-xx08	87654321	87654321 Output numbers	87654321

xx = Module number
 yy = Module number -2
 z = Local register number (predefined with 0, 1, 2 or 3). This number is of no relevance to this configuration

Example 1: Determining Register Numbers

The number of the second expansion module's register is determined as follows:

```
Module number = 3
Local register number = 9

Register number = 3019 + (3-2) * 10 + 9 = 3003
```



Note!

When the register number is called in the SYMPAS program, the number of the module's OS version is displayed. With inquiries always identify this number.

Example 2: Configuring and Evaluating Measurements

Task definitions with the first expansion module (module # 2):

1. A unipolar input voltage ranging from 0 to 10 V is to be measured using channel 1. The output register is register 3000.
2. A bipolar input voltage ranging from -10 V to +10 V is to be measured using channel 2. The output register is register 3001.
3. An input current ranging from 0 to 20 mA is to be measured using channel 3. The output register is register 3002.
4. A unipolar input voltage ranging from 0 to 10 V is to be measured using channel 4. The output register is register 3003.



Note!

To carry out measurements, the virtual outputs for the respective measuring method (unipolar, bipolar, current) have to be set in the SYMPAS program. The assignment can be seen from table "Input and Output Configuration of the N-IA 4 Module", page 183.

Comments on the approach for task # 1:

Through channel 1 a voltage ranging from 0 V to 10 V is to be measured. In the SYMPAS program, the code of output xx01 becomes 201 and that of output xx05 becomes 205, since the first expansion module is assigned to module number 2. By resetting inputs 201, and 205 to zero, a unipolar voltage measurement ranging from 0 V through 10 V with a value range from 0 ... 4095 is defined.

The other tasks are accomplished in the same way.
For details refer to the following table:

Channel #	A/D Value Register	Measurement settings for		
		Unipolar	Bipolar	Current
Channel # 1	3000	201 = 0 205 = 0		
Channel # 2	3001		202 = 0 206 = 1	
Channel # 3	3002			203 = 1
Channel # 4	3003	204 = 0 208 = 0		

13.6.4 Register Description - N-IA 4 Module

Register 3yy0: Channel # 1 for input voltage/current	
Function	Description
Read	Present value for input voltage/current Value following reset: Present value for applied input voltage/current
Write	Illegal
Value range	Voltage - unipolar: 0 ... 4095 - bipolar: -2048 ... 2047 Current: 0 ... 2047

Register 3yy1: Channel # 2 for input voltage/current	
Function	Description
Read	Present value for input voltage/current Value following reset: Present value for applied input voltage/current
Write	Illegal
Value range	Voltage - unipolar: 0 ... 4095 - bipolar: -2048 ... 2047 Current: 0 ... 2047

Register 3yy2: Channel # 3 for input voltage/current	
Function	Description
Read	Present value for input voltage/current Value following reset: Present value for applied input voltage/current
Write	Illegal
Value range	Voltage - unipolar: 0 ... 4095 - bipolar: -2048 ... 2047 Current: 0 ... 2047

Register 3yy3: Channel # 4 for input voltage/current	
Function	Description
Read	Present value for input voltage/current Value following reset: Present value for applied input voltage/current
Write	Illegal
Value range	Voltage - unipolar: 0 ... 4095 - bipolar: -2048 ... 2047 Current: 0 ... 2047

Register 3yy9: Version number of the operating system	
Function	Description
Read	Version number of the operating system e.g. 101= V 1.01
Write	Illegal
Value range	23-bit-signed integer

13.7 N-OA 2 and N-OA 4 Modules - Analog Outputs

The N-OA 2 and N-OA 4 modules are for outputting analog voltages. These voltage values are used as manipulated variables, for example, for actuators etc. Such voltage values are defined in a user program, such as SYMPAS, and are output by the module according to definition.

13.7.1 Physical Dimensions of the N-OA 2, and N-OA 4 Modules

Physical Dimensions of the N-OA 2 Module

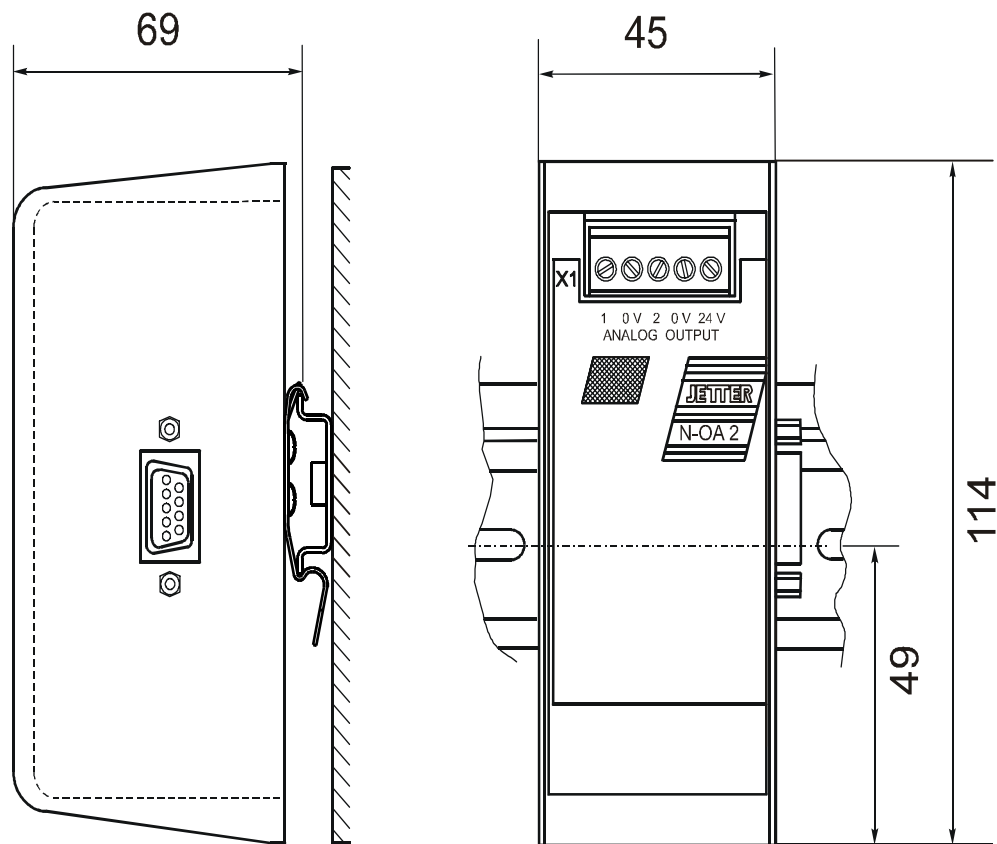

Fig. 45: Physical Dimensions of the Analog Output Module N-OA 2

**Physical
Dimensions of
the N-OA 4
Module**

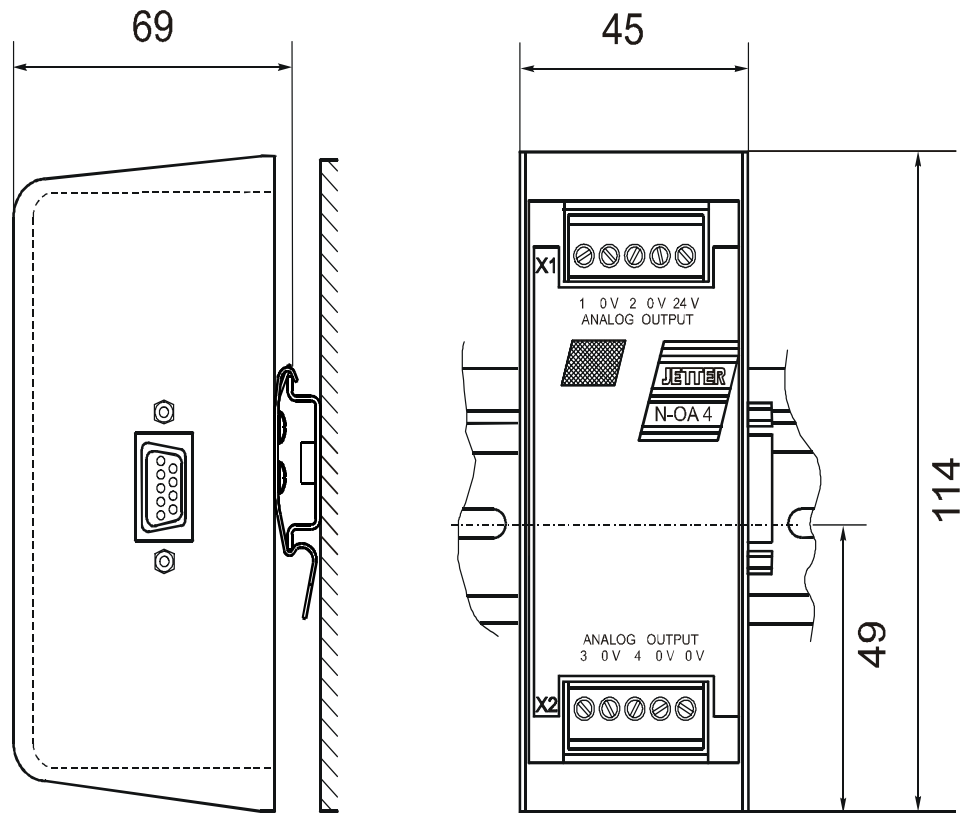

Fig. 46: Physical Dimensions of the Analog Output Module N-OA 4

13.7.2 Overview and Technical Data

Technical Data of the N-OA 2, and N-OA 4 Modules	
Power Supply	<ul style="list-style-type: none"> centralised arrangement: via basic unit; cf. chapter 13.1: "Topology of the JETTER System Bus", page 150 decentralised arrangement: via power supply N-PS 1, cf. chapter 13.1.2: "Decentralised Arrangement on the JETTER System Bus", page 151
Connections to the basic unit via JETTER system bus	Male connector SUB-D, 9 pins
Output terminals	Screw terminals
Enclosure	Aluminium, powder coated, black
Dimensions (H x W x D in mm)	114 x 45 x 70
Weight	200 g
Mounting	DIN Rail
Number of outputs (N-OA 2)	2 channels: - U ₁₋₂ for voltage
Number of outputs (N-OA 4)	4 channels: - U ₁₋₄ for voltage
Voltage Range - Bipolar	-10 V ... + 10 V
Value range (voltage): - Bipolar	-2048 ... 2047
Resolution (voltage)	12 Bit
Voltage supply of analog outputs	DC 24 V -15% through +20%, 150 mA (maximum)
Output current	max. 10 mA
Delay Time	< 4 ms
Electrical isolation	None
Heat loss of CPU logic circuit	0.3 Watt

Output Voltage Accuracy Classes of the N-OA 2, and N-OA 4 Modules			
Type of Error	Input Configuration	Maximum Error *)	
		in LSB	in mV
Zero Error	Bipolar	± 6 LSB	29.3 mV
Gain Error	Bipolar	± 6 LSB	29.3 mV

*) The typical output voltage accuracy is higher.

EMC of the N-OA 2, and N-OA 4 Modules		
Emitted Interference		
Parameter	Value	Reference
Enclosure	<ul style="list-style-type: none"> Frequency band 30 - 230 MHz, limit 30 dB ($\mu\text{V/m}$) at 10 m Frequency band 230 - 1000 MHz, limit 37 dB ($\mu\text{V/m}$) at 10 m (class B) 	DIN EN 50081-1 DIN EN 50081-2 DIN EN 55011
Interference Immunity: Enclosure		
Parameter	Value	Reference
RF Field, amplitude-modulated	Frequency band 27 -1000 MHz; test signal strength 10 V/m AM 80 % with 1 kHz Criterion A	DIN EN 61131-2 DIN EN 50082-2 DIN EN 61000-4-3
Electromagnetic RF Field, pulse-modulated	Frequency 900 \pm 5 MHz Test field strength 10 V/m 50 % ON period Repetition rate 200 Hz Criterion A	DIN EN 50082-2 DIN EN 61000-4-3
Magnetic Field with Mains Frequency	50 Hz 30 A/m	DIN EN 50082-2 DIN EN 61000-4-8
ESD	Discharge through air: Test Peak Voltage 15 kV (Humidity Rating RH-2 / ESD-4) Contact Discharge: Test peak voltage 4 kV (severity level 2) Criterion A	DIN EN 61131-2 DIN EN 50082-2 DIN EN 61000-4-2
Interference Immunity: Signal and Data Lines		
Parameter	Value	Reference
Asymmetric RF, amplitude-modulated	Frequency 0.15 - 80 MHz Test voltage 10 V AM 80 % with 1 kHz Source Impedance 150 Ω Criterion A	DIN EN 50082-2 DIN EN 61000-4-6
Burst	Test voltage 2 kV tr/tn 5/50 ns Repetition rate 5 kHz Criterion A	DIN EN 50082-2 DIN EN 61131-2 DIN EN 61000-4-4

EMC of the N-OA 2, and N-OA 4 Modules		
Test with Damped Oscillation	Damped Oscillation Frequency 1 MHz Source Impedance 200 Ω Repeat Factor 400/s Test voltage 1 kV	DIN EN 61131-2 DIN EN 61000-4-12
Interference Immunity: Process, Measuring and Control lines, Long Bus Lines and Long Control Lines		
Parameter	Value	Reference
Asymmetric RF, amplitude-modulated	Frequency 0.15 - 80 MHz Test voltage 10 V AM 80 % with 1 kHz Source Impedance 150 Ω Criterion A	DIN EN 50082-2 DIN EN 61000-4-6
Burst	Test voltage 2 kV tr/tn 5/50 ns Repetition rate 5 kHz Criterion A	DIN EN 50082-2 DIN EN 61131-2 DIN EN 61000-4-4
Interference Immunity: Mains Inputs and Outputs for AC and DC		
Parameter	Value	Reference
Asymmetric RF, amplitude-modulated	Frequency 0.15 - 80 MHz Test voltage 10 V AM 80 % with 1 kHz Source Impedance 150 Ω Criterion A	DIN EN 50082-2 DIN EN 61000-4-6
Burst	Test voltage 2 kV tr/tn 5/50 ns Repetition rate 5 kHz Criterion A	DIN EN 50082-2 DIN EN 61131-2 DIN EN 61000-4-4
Test with Damped Oscillation	Damped Oscillation Frequency 1 MHz Source Impedance 200 Ω Repeat Factor 400/s Test voltage 1 kV Criterion A	DIN EN 61131-2 DIN EN 61000-4-12

13.7.3 Description of Connections

On the expansion module, 2 resp. 4 channels have been provided for the outputs. Each channel can be switched individually and provides bipolar voltage values of ± 10 V. All voltage signals relate to 0 V. Within the module, the 0 V signal is connected to ground internally via the enclosure.



Important!

The supply voltage for analog outputs must not exceed 28.8 Volt (150 mA). This will prevent the N-OA 2, resp. N-OA 4 module and possibly the actuator from being destroyed.

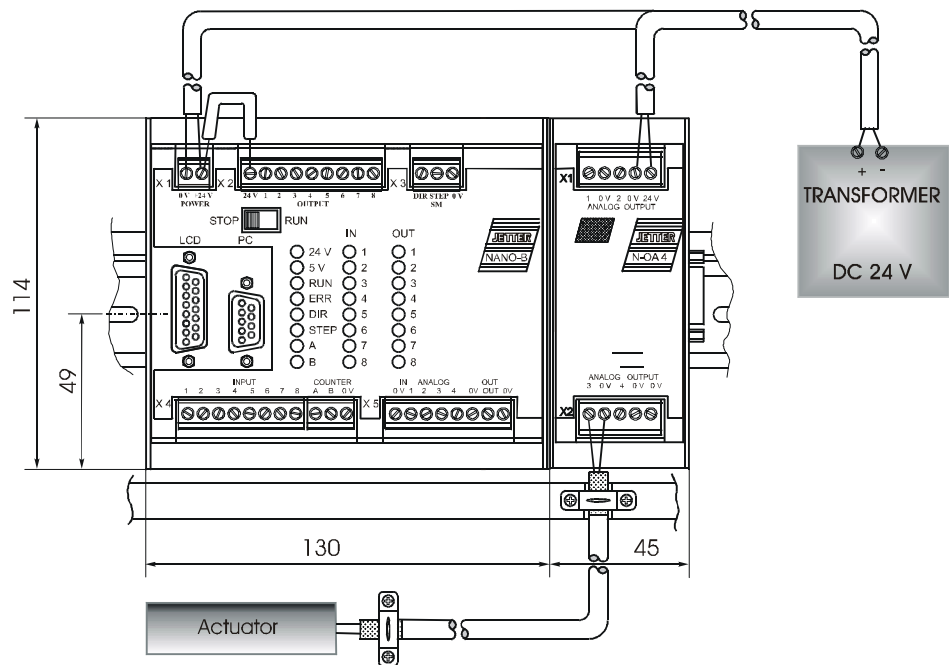
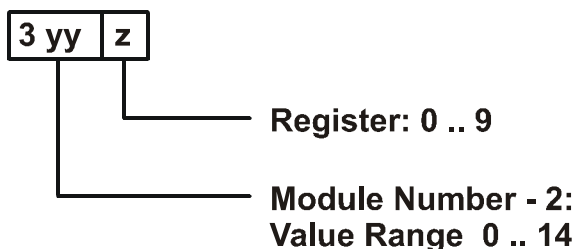

Fig. 47: Example: Wiring of Outputs of the N-OA 4 Module

Addressing Scheme for Analog Outputs

The register address is made up of the module number and the respective output number:

Coding of the registers:



Note!

- For determination of the module number, only the non-intelligent modules will be counted. Intelligent modules, such as SV, SM, PID, etc., located among the modules, are not being taken into consideration.
- Module number 1 is always assigned to the basic control unit. Starting from there, the module numbers are being counted left to right.

For communication with the CPU, 3 registers have been provided by the N-OA 2 module, and 5 registers by the N-OA 4 module. The operating system version number of the module can always be read from register 9. The registers are addressed as follows:

`Register number = 3000 + (module number - 2) * 10 + local register number`

Output of voltage values to the actuators is carried out via output channels 1 and 2 for the N-OA 2 module, resp. 1 through 4 for the N-OA 4 module.

Example: Definition of Output Voltage

Value 1534 is assigned to channel 1 (register 3000). The resulting voltage is 7.5 volt.

N-OA 2 Module: Register assignment for analog outputs		
Outputs	D/A value Register	Voltage Bipolar
Channel # 1	3yy0	-10 V through +10 V
Channel # 2	3yy1	-10 V through +10 V

YY = Module number -2

N-OA 4 Module: Register assignment for analog outputs		
Outputs	D/A value Register	Voltage Bipolar
Channel # 1	3yy0	-10 V through +10 V
Channel # 2	3yy1	-10 V through +10 V
Channel # 3	3yy2	-10 V through +10 V
Channel # 4	3yy3	-10 V through +10 V

YY = Module number -2

Example: Determining Register Numbers

The number of the second expansion module's register is determined as follows:

Module number = 3

Local register number = 9

Register number = $3019 + (3-2) * 10 + 9 = 3003$



Note!

When the register number is called in the SYMPAS program, the number of the module's OS version is displayed. With inquiries always identify this number.

13.7.4 Register Description - N-OA 2, and N-OA 4 Modules

Register 3yy0 for N-OA 2 and N-OA 4 Modules: Channel # 1 - Output Voltage	
Function	Description
Read	Present value of the output voltage Value following reset: 0
Write	New output voltage
Value range	Voltage - bipolar: -2048 ... 2047

Register 3yy1 for N-OA 2 and N-OA 4 Modules: Channel # 2 - Output Voltage	
Function	Description
Read	Present value of the output voltage Value following reset: 0
Write	New output voltage
Value range	Voltage - bipolar: -2048 ... 2047

Register 3yy2 for N-OA 4 Module only: Channel # 3 - Output Voltage	
Function	Description
Read	Present value of the output voltage Value following reset: 0
Write	New output voltage
Value range	Voltage - bipolar: -2048 ... 2047

Register 3yy3 for N-OA 4 Module only: Channel # 4 - Output Voltage	
Function	Description
Read	Present value of the output voltage Value following reset: 0
Write	New output voltage
Value range	Voltage - bipolar: -2048 ... 2047

Register 3yy9 for N-OA 2 and N-OA 4 Modules: Version Number of the Operating System	
Function	Description
Read	Version number of the operating system e.g. 101= V 1.01
Write	Illegal
Value range	23-bit-signed integer

13.8 N-CNT 1 Module - Single and Dual-Channel Counter

The N-CNT 1 module is for counting events. In this module a single- and dual-channel counter is included. The single-channel counter is used e.g. as workpiece counter, and the dual-channel counter e.g. as length counter. The measured values are evaluated and processed by the application program.

13.8.1 Physical Dimensions of the N-CNT 1 Module

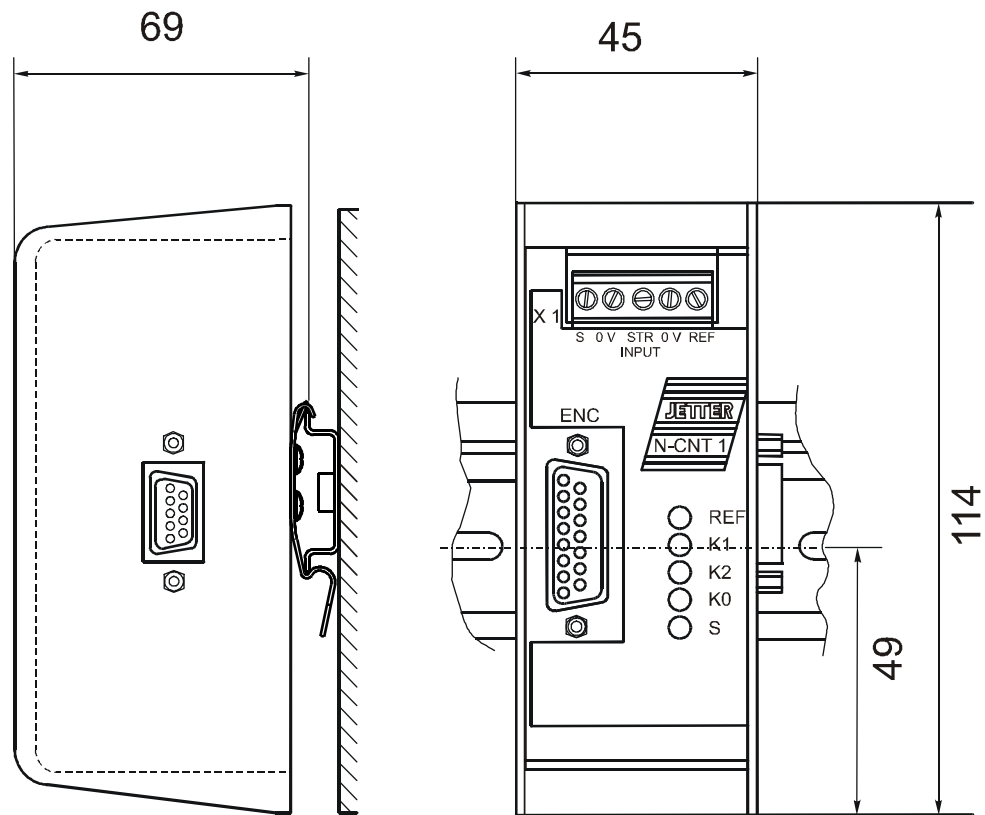

Fig. 48: Physical Dimensions of the Digital Counter Module N-CNT 1

13.8.2 Overview and Technical Data

Technical Data of the N-CNT 1 Module	
Power Supply	<ul style="list-style-type: none"> centralised arrangement: via basic unit; cf. chapter 13.1: "Topology of the JETTER System Bus", page 150 decentralised arrangement: via power supply N-PS 1, cf. chapter 13.1.2: "Decentralised Arrangement on the JETTER System Bus", page 151
Connections to the basic unit via JETTER system bus	Male connector SUB-D, 9 pins
Connection to counter inputs	<ul style="list-style-type: none"> Screw terminals Male connector SUB-D, 15 pins
Enclosure	Aluminium, powder coated, black
Dimensions (H x W x D in mm)	114 x 45 x 69
Weight	190 g
Mounting	DIN Rail
Quantity of counters	<ul style="list-style-type: none"> 1 Single-channel counter 1 dual-channel counter
Maximum counting frequency (single-channel counter)	10 kHz
Voltage input (single-channel counter)	24 Volt
Maximum counting frequency (dual-channel counter)	<ul style="list-style-type: none"> 500 kHz: at 24 Volt 1 MHz: at 5 Volt
Voltage input (dual-channel counter)	<ul style="list-style-type: none"> 24 Volt with operating point: <ul style="list-style-type: none"> signal voltage ON at 15 V minimum signal voltage OFF at 10 V maximum 5 Volt differential voltage
Electrical isolation	None
Heat loss of CPU logic circuit	0.5 Watt
Heat loss of incremental encoder input	0.5 Watt

EMC - N-CNT 1 Module		
Emitted Interference		
Parameter	Value	Reference
Enclosure	<ul style="list-style-type: none"> Frequency band 30 - 230 MHz, limit 30 dB ($\mu\text{V}/\text{m}$) at 10 m Frequency band 230 - 1000 MHz, limit 37 dB ($\mu\text{V}/\text{m}$) at 10 m (class B) 	DIN EN 50081-1 DIN EN 50081-2 DIN EN 55011
Interference Immunity: Enclosure		
Parameter	Value	Reference
RF Field, amplitude-modulated	Frequency band 27 -1000 MHz; test signal strength 10 V/m AM 80 % with 1 kHz Criterion A	DIN EN 61131-2 DIN EN 50082-2 DIN EN 61000-4-3
Electromagnetic RF Field, pulse-modulated	Frequency 900 \pm 5 MHz Test field strength 10 V/m 50 % ON period Repetition rate 200 Hz Criterion A	DIN EN 50082-2 DIN EN 61000-4-3
Magnetic Field with Mains Frequency	50 Hz 30 A/m	DIN EN 50082-2 DIN EN 61000-4-8
ESD	Discharge through air: Test Peak Voltage 15 kV (Humidity Rating RH-2 / ESD-4) Contact Discharge: Test peak voltage 4 kV (severity level 2) Criterion A	DIN EN 61131-2 DIN EN 50082-2 DIN EN 61000-4-2
Interference Immunity: Signal and Data Lines		
Parameter	Value	Reference
Asymmetric RF, amplitude-modulated	Frequency 0.15 - 80 MHz Test voltage 10 V AM 80 % with 1 kHz Source Impedance 150 Ω Criterion A	DIN EN 50082-2 DIN EN 61000-4-6
Burst	Test voltage 2 kV tr/tn 5/50 ns Repetition rate 5 kHz Criterion A	DIN EN 50082-2 DIN EN 61131-2 DIN EN 61000-4-4

EMC - N-CNT 1 Module		
Test with Damped Oscillation	Damped Oscillation Frequency 1 MHz Source Impedance 200 Ω Repeat Factor 400/s Test voltage 1 kV	DIN EN 61131-2 DIN EN 61000-4-12
Interference Immunity: Process, Measuring and Control lines, Long Bus Lines and Long Control Lines		
Parameter	Value	Reference
Asymmetric RF, amplitude-modulated	Frequency 0.15 - 80 MHz Test voltage 10 V AM 80 % with 1 kHz Source Impedance 150 Ω Criterion A	DIN EN 50082-2 DIN EN 61000-4-6
Burst	Test voltage 2 kV tr/tn 5/50 ns Repetition rate 5 kHz Criterion A	DIN EN 50082-2 DIN EN 61131-2 DIN EN 61000-4-4
Interference Immunity: Mains Inputs and Outputs for AC and DC		
Parameter	Value	Reference
Asymmetric RF, amplitude-modulated	Frequency 0.15 - 80 MHz Test voltage 10 V AM 80 % with 1 kHz Source Impedance 150 Ω Criterion A	DIN EN 50082-2 DIN EN 61000-4-6
Burst	Test voltage 2 kV tr/tn 5/50 ns Repetition rate 5 kHz Criterion A	DIN EN 50082-2 DIN EN 61131-2 DIN EN 61000-4-4
Test with Damped Oscillation	Damped Oscillation Frequency 1 MHz Source Impedance 200 Ω Repeat Factor 400/s Test voltage 1 kV Criterion A	DIN EN 61131-2 DIN EN 61000-4-12

13.8.3 Description of Connections

For input purposes the expansion module is provided with 2 counters equipped with 4 terminals and one SUB-D connector, 15 pins. It is possible to operate the single- and the dual-channel counter in parallel. Inputs are split into:

- Terminals for 24 Volt single-channel counter signals
- Terminals for 24 Volt dual-channel counter control signals
- Transducers with 24 Volt signals or 5 Volt differential signals are connected to the dual-channel counter input via the 15-pin SUB-D connector (RS422 port). Signals of such transducers can be read in through adjustable digital filters.
- As an alternative of using a dual-channel counter, an SSI absolute encoder can be connected to the 15-pin SUB-D port.

Note!



- All voltage input signals relate to 0 V. Within the module, the 0 V signal is connected to ground internally via the enclosure.
- Configuration of the module is carried out through the virtual outputs.
- Do not use inverted (negative) signals for 24 Volt encoder inputs. Inverted signals cannot be evaluated.

Important!



Make sure that to the counter inputs of the N-CNT 1 module a maximum voltage of 24 V ± 10% is applied. This will prevent the N-CNT 1 module and the incremental encoder from being destroyed.

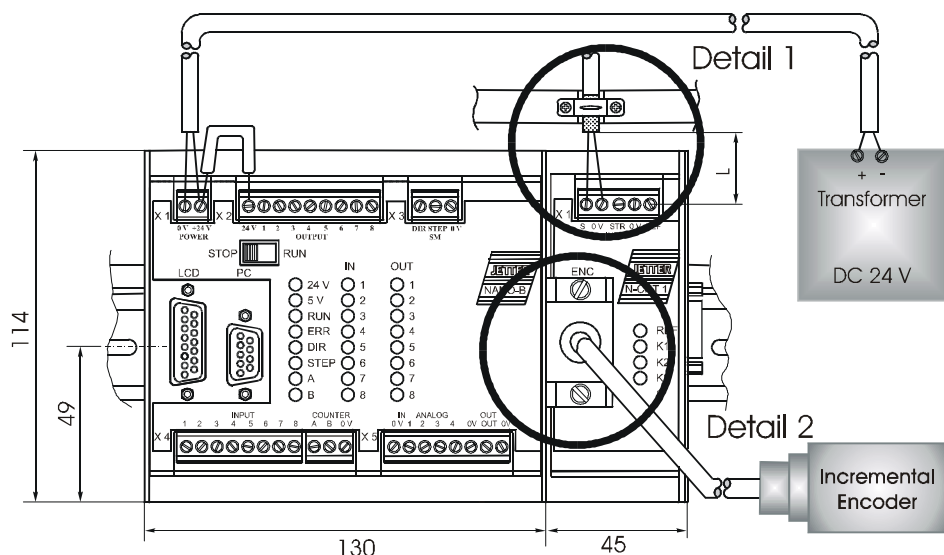

Fig. 49: Example: Input Wiring of the N-CNT 1 Module

Detail 1

Inputs of the Single-Channel Counter Module N-CNT 1

	<p>Terminals:</p> <ul style="list-style-type: none"> - 0 V - S: Counter input
--	--

Detail 2

ENC Inputs of the Dual-Channel Counter Module N-CNT 1

Male connector SUB-D, 15 pins	PIN	SSI Absolute Position Encoder	24 Volt Encoder *)	5 Volt Differential Voltage
	1	GND	GND	GND
	2	Reserved	K0 +	K0 +
	3	Reserved	Reserved	K0 -
	4	DATA +	K1 +	K1 +
	5	DATA -	Reserved	K1 -
	6	Reserved	K2 +	K2 +
	7	Reserved	Reserved	K2 -
	8	SSI-CLK -	Reserved	Reserved
	9	SSI-CLK +	Reserved	Reserved
	10	5 Volt (-5%) encoder supply with a maximum input current of 100 mA	Reserved	5 Volt (-5%) encoder supply with a maximum input current of 100 mA
	11	Reserved	Reserved	Reserved
	12	Reserved	Reserved	Reserved
	13	Reserved	Reserved	Reserved
	14	Reserved	Reserved	Reserved
	15	Reserved	Reserved	Reserved
		<p>Terminals **):</p> <ul style="list-style-type: none"> - 0 V - STR: Strobe - REF: Reference 		

*) The counting inputs, as well as the reference signal of the dual-channel counter (K0, K1, K2 and REF) can be filtered digitally. This means that a counting pulse, resp. reference pulse will only be processed if a predefined set length is exceeded. This way, noise pulses are suppressed. For more information see register 3yy8 on page 211.

**) Terminals are not shown separately as detail.



Important!

To avoid malfunctions the following must be ensured:

- The shielding must be clamped under a strain relief with the greatest possible surface area.
- The connection between shielding and ground must be electrically conducting.
- The distance "L" of unshielded conductor ends must not exceed 8 cm.

Register Addressing

The address is made up of the module number and the number of the respective input and output:

Coding of Counter Registers

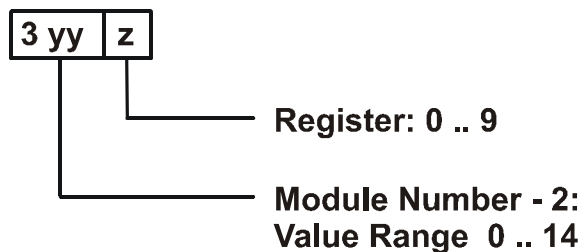

Note!

For determination of the module number, only the non-intelligent modules will be counted. Intelligent modules, such as SV, SM, PID, etc., located among the modules, are not being taken into consideration.

Module number 1 is always assigned to the basic control unit. Starting from there, the module numbers are being counted left to right.

For communication with the CPU, 6 registers have been provided by the N-CNT 1 module. The operating system version number of the module can always be read from register 9. The other module registers are being defined by the function of the module. The registers are addressed as follows:

`Register number = 3000 + (module number - 2) * 10 + local register number`

Example: Determination of the register numbers

The number of the third expansion module's register is determined as follows:

Module number = 4

Local register number = 9

Register number = $3029 + (4-2) * 10 + 9 = 3003$

**Note!**

When the register number is called in the SYMPAS program, the number of the module's OS version is displayed. With inquiries always identify this number.

Addressing the Virtual Outputs

Configuration of the N-CNT 1 Module		
Counter	Register values	Configuration and action of virtual outputs
Dual-channel counter:	3yy0	xx01: = 0 enable STR disable REF
	through	= 1 enable REF disable STR *)
	3yy3	xx02: = 0 Dual-channel circuit configuration with quadruple evaluation = 1 Single-channel circuit configuration with single evaluation. The rising edge is counted only.
	3yy5	xx03: = 0 Transmission of actual axis position is stopped. = 1 Transmission of actual axis position is started and sent to the bus.
SSI Absolute Position Encoder	3yy6	xx04: = 0 Dual-channel counter = 1 SSI Absolute Position Encoder
		xx06: = 0 Gray code evaluation = 1 Binary code evaluation
		xx07: = 0 Parity check OFF = 1 Parity check ON
		xx08: = 0 odd parity = 1 even parity
		Single-channel counter:

*) Bit 3 in the status register 3yy3 is reset by entering 1 during configuration.

xx = Module number
YY = Module number -2

It is possible to operate the dual-channel counter both as single-channel and dual-channel counter. Selection between the counter types is made by setting the virtual output **xx02**.

Whenever the dual-channel counter is operated as single-channel counter, the counting direction is defined through the voltage applied to channel 2 (K2). In this case, the following conditions apply:

- for positive counting direction $K2 = 0$ (0 V);
- for negative counting direction $K2 = 1$ (24 V).

Setting the Dual-Channel Counter to Zero

The dual-channel counter can be set to zero (initialisation) either through hardware or through software.

- For initialisation through hardware the input of terminal REF is to be set to zero (REF = 0) Through its 15-pin SUB-D connector, the incremental encoder supplies $K0 = 1$ (refer to fig. 50: "Pulse sequence of counting signals", page 206).
- Initialisation via software is carried out by entering zero into register **3yy0**.

When the dual-channel counter is set to zero, bit 3 of the status register **3yy3** is set. The status register **3yy3** is scanned by the application program.

Strobe Function

The strobe function can only be used with the dual-channel counter. In order to activate the strobe function, the virtual output **zz01** of the dual-channel counter must be set to zero.

The strobe function is used to store a count to register **3yy2** when a signal (rising edge) is applied. The delay time of the display caused by the strobe function is less than 1 ms.

Once the strobe signal is applied, bit 0 is set in the status register **3yy3** which is scanned by the application program.

Multiple strobing is indicated by bit 4.

Bits 0 and 4 have to be reset by the application program.

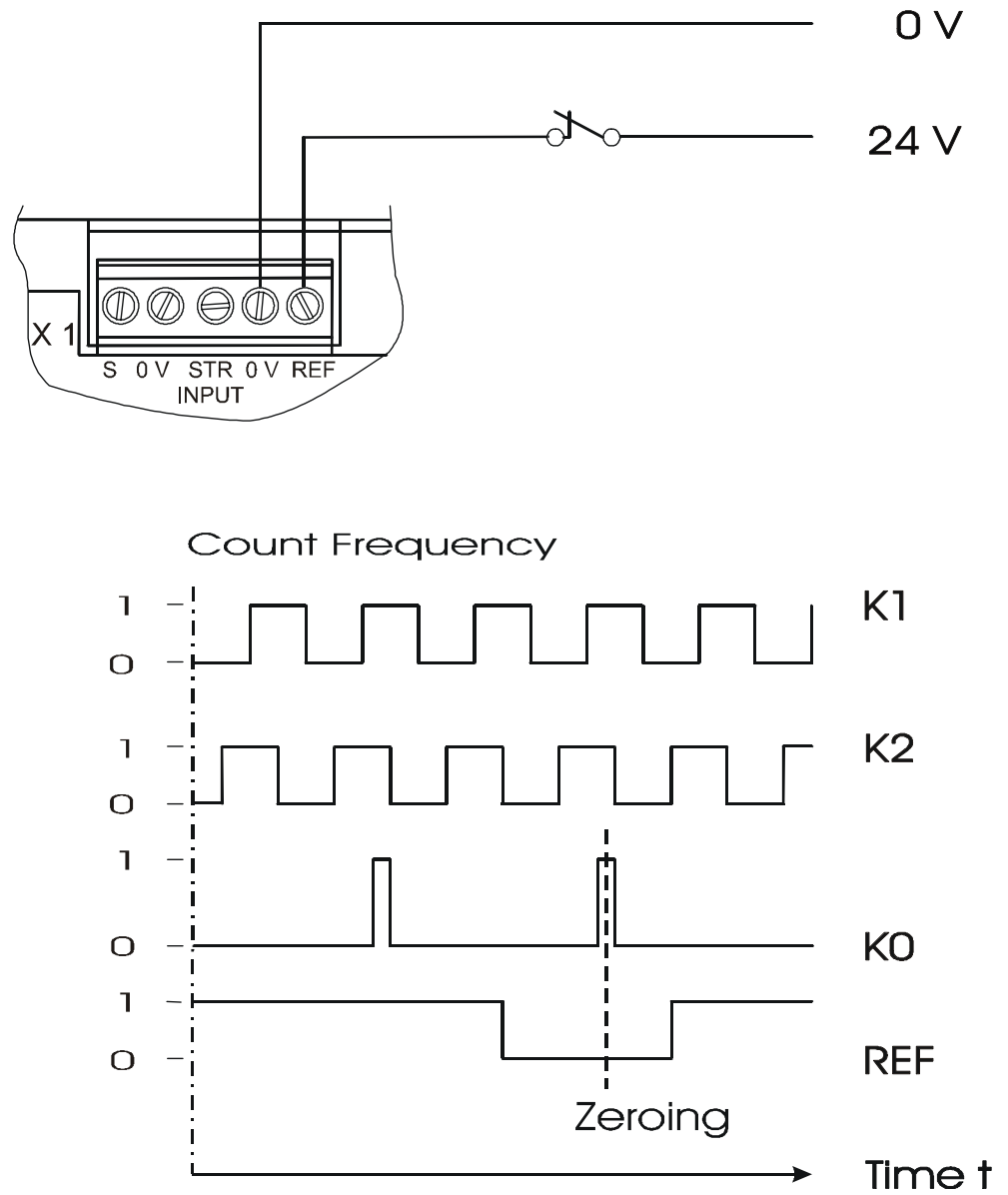

Fig. 50: Pulse sequence of counting signals

13.8.4 Register Description - N-CNT 1 Module

Register 3yy0: Count of Dual-Channel Counter	
Function	Description
Read	Maximum count of dual-channel counter Value following reset: 0
Write	New count of dual-channel counter
Value range	-8388608 ... 8388607

Register 3yy1: Offset value of Dual-Channel Counter	
Function	Description
Read	Present offset value of dual-channel counter Value following reset: 0
Write	New offset value of dual-channel counter
Value range	-8388608 ... 8388607

Register 3yy2: Strobe Value of Dual-Channel Counter	
Function	Description
Read	Last strobe value of dual-channel counter Value following reset: 0
Write	Illegal
Value range	-8388608 ... 8388607

Register 3yy3: Status of Dual-Channel Counter	
Function	Description
Read	Status of dual-channel counter (bit-coded) <ul style="list-style-type: none"> – Bit 0: Count is strobed – Bit 3: Counter set to zero – Bit 4: Strobing value is overwritten (strobing signal before reset of strobe message) Value following reset: 0
Write	Bits 0 and 4 are reset
Value range	0 ... 31

Register 3yy4: Count of Single-Channel Counter	
Function	Description
Read	Present count of Single-Channel Counter Value following reset: 0
Write	New count of Single-Channel Counter
Value range	-8388608 ... 8388607

Register 3yy5: Transmitting Rate of Actual Position to an Intelligent Servo or Stepper Motor Module	
Function	Description
Read	Present value of transmitting rate *) Value following reset: 0
Write	New value of transmitting rate
Value range	1 ... 5

*) It is possible to use the N-CNT 1 module in a servo control system as master module for position modules of the NANO series, such as N-SV1, CAN-DIMA, N-SM2, N-SM1D. In this role, the master module N-CNT 1 is not controlled. The axis which is controlled by the positioning module is to follow the master with a fixed or variable transmission ratio as to position. In this case, the position encoder, mounted on the master axis, is connected to the N-CNT 1 module. This module then transmits the read-out position and the interval between two scans to the positioning module via JETTER system bus. Then, the position value can be read out of register 1y195.

Register 3yy5 controls the transmission rate, thus, the bus load. In case register 3yy5 = 0, about every 300 µs position is sent after each scan cycle. In normal operating mode, such a high transmission rate is not required for good servo control. With insignificant bus load caused by other modules, such a high transmission rate has no adverse effect.

Register 3yy6: Word Size of Absolute Value	
Function	Description
Read	Present value of the word size of the absolute value ^{*)} Value following reset: 0
Write	New value of the word size of the absolute value
Value range	0 ... 19495 at pulse number = 9 25639 at pulse number = 12 27687 at pulse number = 13 ... 50215 at pulse number = 24 52263 at pulse number = 25

^{*)} The value of register 3yy6 is calculated using the pulse number. With the given pulse number the word size of the absolute value is calculated by the following formula:

$$\text{Register 3yy6} = (((\text{Pulse Number} + 1) \times 2) - 1) \times 1024 + 39$$

In order to use register 3yy6, an SSI absolute encoder is read in via the inputs of the dual-channel counter. The SSI cycle is read via PIN 8 and PIN 9 and the data bits via PIN 4 and PIN 5 of the 15-pin SUB-D connector (see "ENC Inputs of the Dual-Channel Counter Module N-CNT 1" auf Seite 202).

The SSI cycle is output with a frequency of 100 kHz. This clock frequency permits use of cables of up to 400 meters in length.

In order to activate the absolute encoder, it is required to switch over between the dual-channel counter and the SSI absolute encoder through output xx04.

Absolute encoders output their position value either in Gray code or in binary code. Evaluation can be switched over between Gray code and binary code using output xx06.

In order to activate parity check for an SSI absolute encoder, output xx07 must be set to 1. Once parity check is activated, you can toggle between even and odd parity through output xx08.

If the N-CNT 1 module detects a parity error, the position value received is being ignored and register 3yy7 is incremented.

Register 3yy7: Parity Error Count	
Function	Description
Read	Present parity error count ^{*)} Value following reset: 0
Write	New parity error count
Value range	-8388608 ... 8388607

^{*)} Once a parity error is detected, register 3yy7 is incremented by 1. The count is set by the application program. For normal operation, the count is set to zero.



Note!

If parity check is activated, calculations for the value of register 3yy6 have to be carried out using a PPR count incremented by 1 as against the PPR count preset by the encoder.

Example: If the encoder has got a resolution of 4096 increments per revolution and 4096 revolutions, for calculations in register 3yy6 a PPR count of 24 has to be used if a check of parity errors is not carried out. Once check of parity errors is carried out, a PPR count of 25 has to be used for calculations.

Register 3yy8: Filter Frequency	
Function	Description
Read	Present value of filter frequency ^{*)} Value following reset: 0
Write	New value of filter frequency
Value range	0: no filter frequency 192: $f_{\text{eff}} = 1 \text{ MHz}$ 65472: $f_{\text{eff}} = 3906.25 \text{ Hz}$

*) In register 3xx8 a filter frequency is preset. This filter frequency is referred to as useful signal is being processed unfilteredly. Using this useful signal, the value for register 3yy8 is calculated by the following formula:

$$\text{Register 3yy8} = \left(\frac{4000000}{f_{\text{eff}}} - 1 \right) \times 64 \quad \text{with } f_{\text{eff}} \text{ in Hz}$$



Note!

The filter frequency of register 3yy8 can **only** be used for the **dual-channel counter!**

Register 3yy9: Version number of the operating system	
Function	Description
Read	Version number of the operating system e.g. 101= V 1.01 Value following reset: Version number of the operating system
Write	Illegal
Value range	0 ... 8388607

13.9 Serial Interface Module N-SER 1

The N-SER 1 module provides the user with a programmable serial interface (PRIM). Through this module, for instance, data of a pair of scales, communicating via a RS-232 interface, can be sensed. While doing so, data are exchanged, for example, with a SYMPAS application program.

13.9.1 Physical Dimensions of the N-SER 1 Module

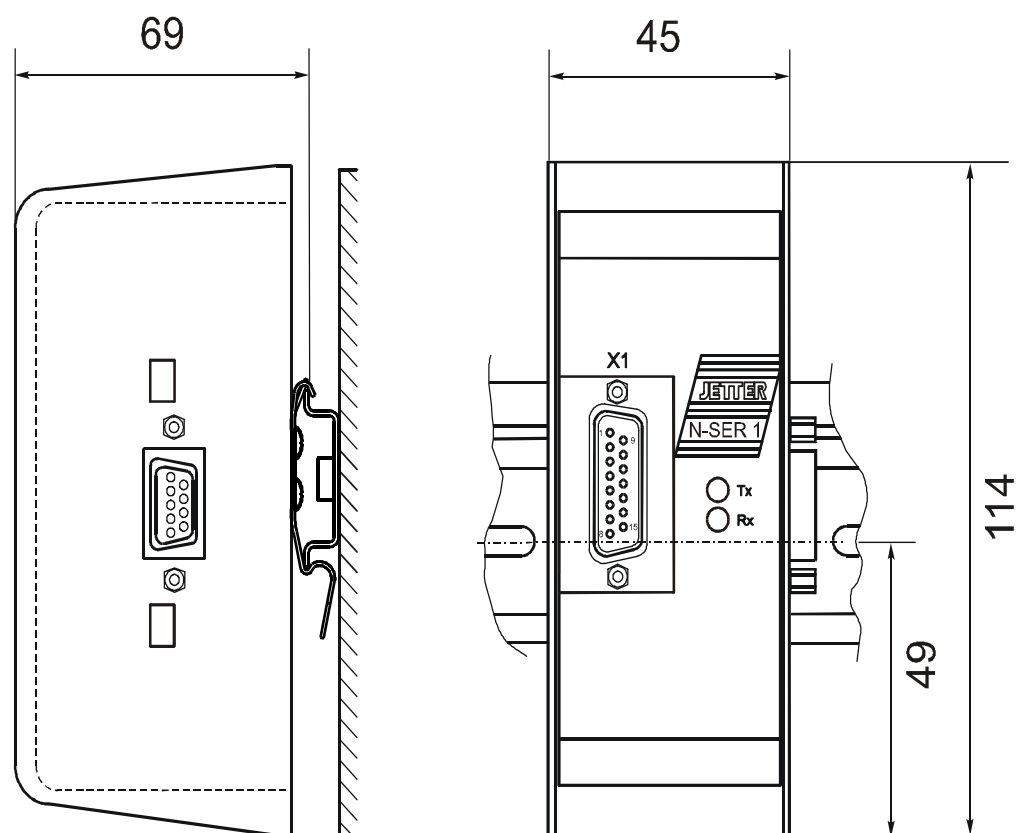

Fig. 51: Physical Dimensions of the Serial Interface Module N-SER 1

13.9.2 Overview and Technical Data

Technical Data of the N-SER 1 Module	
Power Supply	<ul style="list-style-type: none"> centralised arrangement: via basic unit; cf. chapter 13.1: "Topology of the JETTER System Bus", page 150 decentralised arrangement: via power supply N-PS 1, cf. chapter 13.1.2: "Decentralised Arrangement on the JETTER System Bus", page 151
Connections to the basic unit via JETTER system bus	Male connector SUB-D, 9 pins
Serial interface port	Male connector SUB-D, 15 pins
Enclosure	Aluminium, powder coated, black
Dimensions (H x W x D in mm)	114 x 45 x 69
Weight	190 g
Mounting	DIN Rail
User-Programmable Interface	15-pin socket for: RS 232: 150 ... 19200 bits/s ^{*)} RS 422: 150 ... 19200 bits/s ^{*)} or RS 485: 150 ... 115200 bits/s ^{*)}
Electrical isolation	None
Heat loss of CPU logic circuit	0.35 Watt
Rated current consumption	approx. 70 mA

^{*)} The N-SER 1 module supports these protocols only.

LEDs of the N-SER 1 module	
Tx (Transmit Data):	The diode will flash up each time a bit is sent.
Rx (Receive Data):	The diode will flash up each time a bit is received.

EMC - N-SER 1 Module		
Emitted Interference		
Parameter	Value	Reference
Enclosure	<ul style="list-style-type: none"> Frequency band 30 - 230 MHz, limit 30 dB ($\mu\text{V/m}$) at 10 m Frequency band 230 - 1000 MHz, limit 37 dB ($\mu\text{V/m}$) at 10 m (class B) 	DIN EN 50081-1 DIN EN 50081-2 DIN EN 55011
Interference Immunity: Enclosure		
Parameter	Value	Reference
RF Field, amplitude-modulated	Frequency band 27 -1000 MHz; test signal strength 10 V/m AM 80 % with 1 kHz Criterion A	DIN EN 61131-2 DIN EN 50082-2 DIN EN 61000-4-3
Electromagnetic RF Field, pulse-modulated	Frequency 900 \pm 5 MHz Test field strength 10 V/m 50 % ON period Repetition rate 200 Hz Criterion A	DIN EN 50082-2 DIN EN 61000-4-3
Magnetic Field with Mains Frequency	50 Hz 30 A/m	DIN EN 50082-2 DIN EN 61000-4-8
ESD	Discharge through air: Test Peak Voltage 15 kV (Humidity Rating RH-2 / ESD-4) Contact Discharge: Test peak voltage 4 kV (severity level 2) Criterion A	DIN EN 61131-2 DIN EN 50082-2 DIN EN 61000-4-2
Interference Immunity: Signal and Data Lines		
Parameter	Value	Reference
Asymmetric RF, amplitude-modulated	Frequency 0.15 - 80 MHz Test voltage 10 V AM 80 % with 1 kHz Source Impedance 150 Ω Criterion A	DIN EN 50082-2 DIN EN 61000-4-6
Burst	Test voltage 2 kV tr/tn 5/50 ns Repetition rate 5 kHz Criterion A	DIN EN 50082-2 DIN EN 61131-2 DIN EN 61000-4-4

EMC - N-SER 1 Module		
Test with Damped Oscillation	Damped Oscillation Frequency 1 MHz Source Impedance 200 Ω Repeat Factor 400/s Test voltage 1 kV	DIN EN 61131-2 DIN EN 61000-4-12
Interference Immunity: Process, Measuring and Control lines, Long Bus Lines and Long Control Lines		
Parameter	Value	Reference
Asymmetric RF, amplitude-modulated	Frequency 0.15 - 80 MHz Test voltage 10 V AM 80 % with 1 kHz Source Impedance 150 Ω Criterion A	DIN EN 50082-2 DIN EN 61000-4-6
Burst	Test voltage 2 kV tr/tn 5/50 ns Repetition rate 5 kHz Criterion A	DIN EN 50082-2 DIN EN 61131-2 DIN EN 61000-4-4
Interference Immunity: Mains Inputs and Outputs for AC and DC		
Parameter	Value	Reference
Asymmetric RF, amplitude-modulated	Frequency 0.15 - 80 MHz Test voltage 10 V AM 80 % with 1 kHz Source Impedance 150 Ω Criterion A	DIN EN 50082-2 DIN EN 61000-4-6
Burst	Test voltage 2 kV tr/tn 5/50 ns Repetition rate 5 kHz Criterion A	DIN EN 50082-2 DIN EN 61131-2 DIN EN 61000-4-4
Test with Damped Oscillation	Damped Oscillation Frequency 1 MHz Source Impedance 200 Ω Repeat Factor 400/s Test voltage 1 kV Criterion A	DIN EN 61131-2 DIN EN 61000-4-12

13.9.3 Description of Connections

The user can select from interfaces with the specifications RS-232, RS-422 or RS-485 according to the diagram depicted in fig. 52.

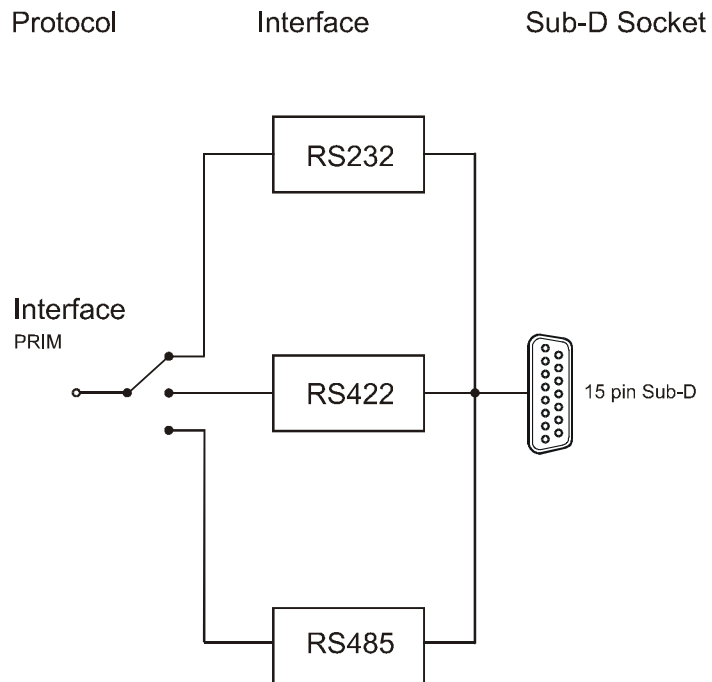
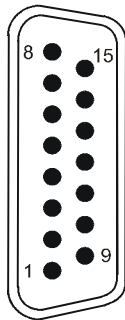

Fig. 52: Block Diagram of Interfaces of the N-SER 1 module



Pin Assignment - 15-pin male SUB-D connector *)			
PIN	Signal	Interface	Comment
1	-	-	-
2	TXD	RS232	Transmit Data
3	RXD	RS232	Receive Data
4	RTS	RS232	Output
5	CTS	RS232	Input
6	-	-	-
7	GND	-	-
8	Data +	RS485	-
9	Data -	RS485	-
10	SDB	RS422	Sending
11	SDA	RS422	Sending
12	RDB	RS422	Receiving
13	RDA	RS422	Receiving
14	-	-	-
15	-	-	-

*) For technical specifications on cable length, diameter, wiring and shielding see chapter 2.2: "Electrical Connection", page 18.

Interface with the Application Program The interface between the module and the user's program is made up of seven registers. These registers are for configuring of the modules and for querying status information.

Register Addressing The register address is made up of the module number and the respective register number.

Coding of the registers: 3yyz

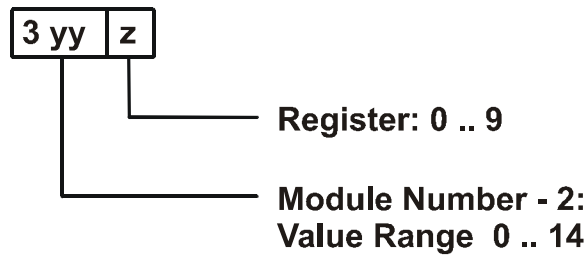

Note!

For determination of the module number, only the non-intelligent modules will be counted. Intelligent modules, such as N-SV 1, N-SM 2, N-PID 1, etc., located among the digital input and output modules, are not being taken into consideration.

Module number 1 is always assigned to the basic control unit. Starting from there, the module numbers are being counted left to right.

For communication with the CPU, 7 registers have been provided by the N-SER 1 module. The operating system version number of the module can always be read from register 9. The other module registers are being defined by the function of the module. The registers are addressed as follows:

`Register number = 3000 + (module number - 2) * 10 + local register number`

Examples: Determination of the register numbers

The number of the first expansion module's register is determined as follows:

Module number = 2
Local register number = 3 (sending buffer)

Register number = $3000 + (2-2) * 10 + 3 = 3003$

The number of the third expansion module's register is determined as follows:

Module number = 4

Local register number = 9 (OS version)

Register number = $3029 + (4-2) * 10 + 9 = 3003$



Note!

When the register number is called in the SYMPAS program, the number of the module's OS version is displayed. With inquiries always identify this number.

Addressing the Virtual Outputs

Hard and software flow control is activated via the virtual outputs, which are addressed as is being described below.

Coding of the virtual outputs yyzz

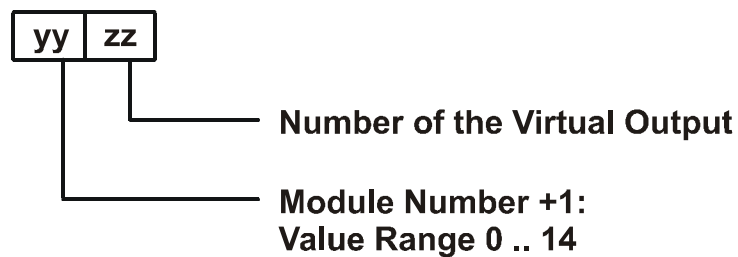

Example: Determination of virtual outputs

Determination of the virtual output 1 of the 3rd expansion module

Module number = 4

Output number = 1

Number of the virtual output = 401

13.9.4 Register Description - N-SER 1 Module

Register 3yy0: Status register	
Function	Description
Read	Present interface state Bit 0: 0 Bit 1: 1=Overflow receiving buffer Bit 2: 1=Parity error during reception Bit 3: 1=Framing error during reception Bit 4: 1=Breaking-off condition1 *) Bit 5: 0 Bit 6: 0 Bit 7: 1=Error in the present FIFO data Value following reset: 0
Write	Illegal
Value range	0 .. 255

*) Rx signal was logically 0 for the duration of one byte

The status register is bit-coded, i.e. each bit indicates a specific state.
 The status register is cleared when reading.

Register 3yy1: Baud Rate																																		
Function	Description																																	
Read	Present value of the baud rate Value following reset: 6																																	
Write	new baud rate: <table style="width: 100%; border-collapse: collapse;"> <tr><td style="width: 10%;">0</td><td style="width: 50%;">150 bits/s</td><td style="width: 40%;"></td></tr> <tr><td>1</td><td>300 bits/s</td><td></td></tr> <tr><td>2</td><td>600 bits/s</td><td></td></tr> <tr><td>3</td><td>1200 bits/s</td><td></td></tr> <tr><td>4</td><td>2400 bits/s</td><td></td></tr> <tr><td>5</td><td>4800 bits/s</td><td></td></tr> <tr><td>6</td><td>9600 bits/s</td><td>Default setting</td></tr> <tr><td>7</td><td>19200 bits/s</td><td></td></tr> <tr><td>8</td><td>38400 bits/s</td><td>for RS485 only</td></tr> <tr><td>9</td><td>57600 bits/s</td><td>for RS485 only</td></tr> <tr><td>10</td><td>115200 bits/s</td><td>for RS485 only</td></tr> </table>	0	150 bits/s		1	300 bits/s		2	600 bits/s		3	1200 bits/s		4	2400 bits/s		5	4800 bits/s		6	9600 bits/s	Default setting	7	19200 bits/s		8	38400 bits/s	for RS485 only	9	57600 bits/s	for RS485 only	10	115200 bits/s	for RS485 only
0	150 bits/s																																	
1	300 bits/s																																	
2	600 bits/s																																	
3	1200 bits/s																																	
4	2400 bits/s																																	
5	4800 bits/s																																	
6	9600 bits/s	Default setting																																
7	19200 bits/s																																	
8	38400 bits/s	for RS485 only																																
9	57600 bits/s	for RS485 only																																
10	115200 bits/s	for RS485 only																																
Value range	0 ... 256																																	

Register 3yy2: Interface Configuration	
Function	Description
Read	Present data format Value following reset: 4
Write	New data format: 0 = 7 bit even 1 stop bit 1 = 7 bit odd 1 stop bit 2 = 8 bit even 1 stop bit 3 = 8 bit odd 1 stop bit 4 = 8 bit no parity 1 stop bit 5 = 7 bit even 2 stop bit 6 = 7 bit odd 2 stop bit 7 = 7 bit no parity 2 stop bit 8 = 8 bit even 2 stop bits *) 9 = 8 bit odd 2 stop bits *) 10 = 8 bit no parity 2 stop bits *) 11 = 5 bit even 1 stop bits *) 12 = 5 bit odd 1 stop bits *) 13 = 5 bit even 1 stop bits *) 14 = 6 bit odd 1 stop bits *) 15 = 6 bit even 1 stop bits *) 16 = 6 bit odd 1 stop bits *) 17 = 5 bit no parity 1 $\frac{1}{2}$ Stop bit *) 18 = 5 bit even 1 $\frac{1}{2}$ Stop bit *) 19 = 5 bit odd 1 $\frac{1}{2}$ Stop bit *) 20 = 6 bit no parity 2 stop bits *) 21 = 6 bit even 2 stop bits *) 22 = 6 bit odd 2 stop bits *) 23 = 7 bit no parity 1 stop bit *)
Value range	0 ... 23

*) applies from firmware version 2.10 on.

Note!



To initialize the N-SER 1 module, values have to be entered into registers 3yy1 and 3yy2. Failure to do so may result in malfunctions.

Register 3yy3: Sending buffer	
Function	Description
Read	Latest character that has been sent or is to be sent Value following reset: 0
Write	Send a character
Value range	0 .. 255 (8-bit format) 0 .. 127 (7-bit format)

**Important!**

The maximum size of sending buffer is 128 characters.

**Note!**

Data are sent by the N-SER 1 module only if the value is written into the sending register 3003.

Register 3yy4: Sending Buffer Occupancy	
Function	Description
Read	Present occupancy of the sending buffer Value following reset: 0
Write	Illegal
Value range	0 .. 128

Register 3yy5: Receiving Buffer; Characters are Cleared at Access	
Function	Description
Read	Received character Value following reset: 0
Write	Illegal
Value range	0 .. 255 (8-bit format) 0 .. 127 (7-bit format)

**Note!**

- The maximum size of receiving buffer is 129 characters. Access to register 3yy5 deletes the characters contained in the receiving buffer. This means that for reprocessing a character must be stored before a read access is carried out.
- Reading from this register is only useful, if the contents of the receiving buffer occupancy register 3yy6 are greater than 0.

Register 3yy6: Receiving Buffer Occupancy	
Function	Description
Read	Present occupancy of the receiving buffer Value following reset: 0
Write	Illegal
Value range	0 .. 129

**Note!**

- The characters that have been transmitted by the N-SER 1 module via serial port are buffered in register 3yy6. They remain there until they are called up from a corresponding SYMPAS program.
- The receiving buffer can store a maximum of 129 characters. If further characters are received from sender although the receiving buffer is full, the last sent characters will get lost, while bit 1 is set in the status register.

Register 3yy9: Version number of the operating system	
Function	Description
Read	Version number of the operating system e.g. 101 = V 1.01 Value following reset: Version number of the operating system
Write	Illegal
Value range	0 .. 8388607

13.9.5 Hardware and Software Flow Control of the N-SER 1 Module

The N-SER 1 module supports hardware and software flow control. These control functions are activated or deactivated through virtual outputs.

The flow control is to prevent the loss of data due to receiving buffer overflow.

For the N-SER 1 module, there are two possibilities of flow control:

1. For hardware flow control two additional wires are used.
2. For software flow control special characters are used.

Both with hardware and software flow control, the receiving device informs the sending device that is not ready to receive data any more.

The N-SER 1 module will send the respective stop signal by hardware or software, when a receiving buffer occupancy of 60 characters has been reached. When an occupancy of 56 characters has been reached, readiness to receive will then be signaled.

Hardware Flow Control The hardware flow control will be activated by setting the virtual output `yy01` and will be deactivated by clearing output `yy01`.

The function will automatically be carried out by using the RTS and CTS signals. The RTS line will be activated by the N-SER 1 module, in order to inform the sender that no more data can be received.

During the sending process, the CTS line will be checked by the module. If the CTS line is activated, the sending process will be interrupted, until this line is deactivated again.

Software Flow Control The software flow control will be activated by setting the virtual output `yy02` and will be deactivated by clearing this output.

The function will automatically be carried out by using the characters XON (value 11H) and XOFF (value 013H).

If no more data can be received by the N-SER 1 module, the XOFF character will be sent in order to inform the sender. If data can be received again, XON will be sent.

During the sending process, it will be checked by the module, whether the receiver is sending an XOFF. If this is the case, the sending process will be interrupted, until an XON has been received.

Note!



The characters XON and XOFF must not be contained in the user data! This may result in a shutdown of the plant.

13.9.6 Sample Program

The usage of the N-SER 1 module will be illustrated by the following exemplary program.

Program Listing

```

0:      ;*****
1:      ;* The program will receive the upper-case characters *
2:      ;* from „A“ to „Z“ via the N-SER 1 module, and will then *
3:      ;* send them back as lower-case characters. *
4:      ; *****
5:      ; DEF_FUNCTION [RecPRIM, RP]
          Par: rFirstChar, rLastChar
          Var: rHelp
6:      ; ++++++
7:      ; + The RecPRIM function is used to read a character +
8:      ; + from the receiving buffer +
9:      ; ++++++
10:     REGISTER_LOAD [rHelp with R(rRecPRIM)]
          ;reading character from buffer,
          ;checking character for valid range.
11:     IF
12:     LIMITS [Reg=rHelp, low=R(rFirstChar),
              high=R(rLastChar)]
13:     THEN
14:     REGISTER_LOAD [RecPRIM with R(rHelp)]
          ;character is valid
15:     ELSE
16:     REGZERO RecPRIM ;character is invalid
17:     THEN
18:     RETURN
19:     END_DEF
20:     DEF_FUNCTION [SendPrim, S]
          Par: rSendChar
21:     ;+++++
22:     ;+ This function is used to write a character +
23:     ;+ into the sending buffer. +
24:     ;+++++
25:     WHEN
26:     REG rSendCnt ;Is there free space
27:     < ;in the sending buffer?
28:     128
29:     THEN
30:     REG rPRIMSend ;Send back modified
31:     = ;character
32:     REG rSendChar
33:     +

```

```
34:      32
35:      THEN
36:      RETURN
37: END_DEF
38: TASK tPRIMhandling -----
39:      REGISTER_LOAD [rPRIMBaud with zBaud]
                                     ;Setting Baud rate
40:      REGISTER_LOAD [rPRIMconfig with zConfig]
                                     ;Setting control byte

41: LABEL fPRIMloop
42: WHEN
43:     NOT                               ;Are there any incoming
44:     REGZERO rRecCnt                   ;characters?
45: THEN
46:     REG rChar
47:     =
48:     RecPRIM [rLastChar=90, rFirstChar=65]
49: IF
50:     REGZERO rChar                       ;Is there a valid
51: THEN                                     ;character?
52:     GOTO fPRIMloop                       ;NO
53: THEN
54:     SendPrim [rSendChar=R(rChar)]
55:     GOTO fPRIMloop
End of Program
```

Symbol Listing

***** Task *****

tPRIMhandling 0

***** Labels *****

fPRIMloop !

***** Registers *****

;The following register values are valid for a N-SER 1 module
;located on the first place after the basic controller NANO-B!

rPRIMBaud	3001	; Baud rates
rPRIMConfig	3002	; Control register
rPRIMSend	3003	; Sending register
rSendCnt	3004	; Send. buffer occupancy
rPRIMRec	3005	; Receiving registers
rRecCnt	3006	; Rec. buffer occupancy
rChar	100	

***** Baud Rates *****

zBaud 6 ; 9600

***** Control Bytes *****

zConfig 4 ; 8 data bits, no parity
; 1 stop bit

Note!



In the example above, sending and receiving of characters is divided into several functions:

- Data are sent by the N-SER 1 module only if the value is written into the sending register 3003.
- Occupancy of the the receiving buffer is queried from register 3006..
- Access to register 3005 deletes characters contained in the receiving buffer.
- Occupancy of the the sending buffer is queried from register 3004..

13.10 Parallel Interface Module N-PRN 1

The N-PRN 1 module allows data and control information to be output to a printer and status information to be read out of the printer.

Output of data is carried out via a CENTRONICS interface.

13.10.1 Physical Dimensions of the N-PRN 1 Module

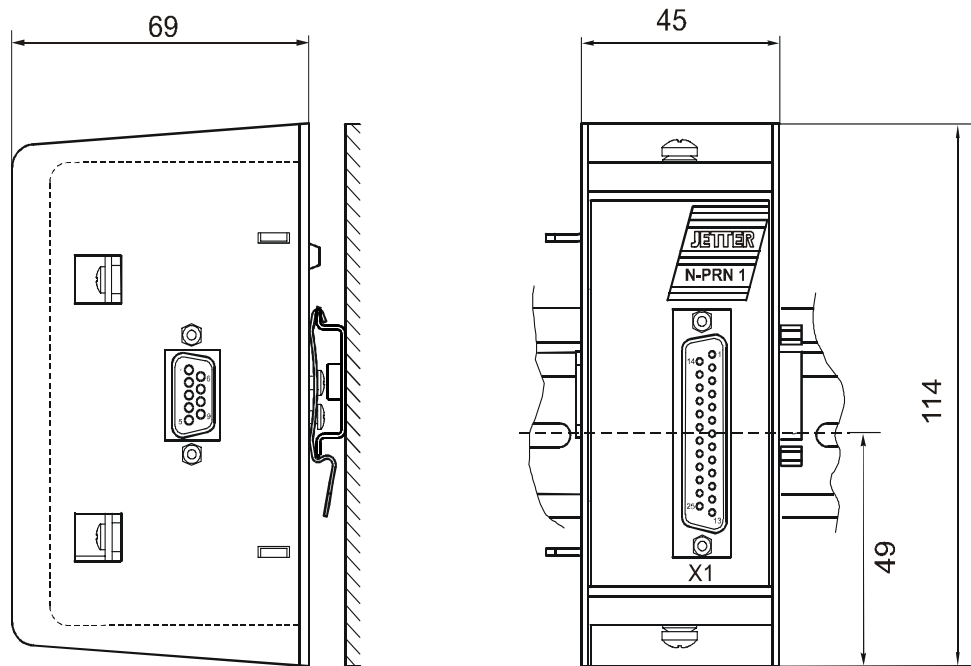

Fig. 53: Physical Dimensions of the Parallel Interface Module N-PRN 1

13.10.2 Overview and Technical Data

Technical Data of the N-PRN 1 Module	
Power Supply	<ul style="list-style-type: none"> • centralised arrangement: via basic unit; cf. chapter 13.1: "Topology of the JETTER System Bus", page 150 • decentralised arrangement: via power supply N-PS 1, cf. chapter 13.1.2: "Decentralised Arrangement on the JETTER System Bus", page 151
Connections to the basic unit via JETTER system bus	Male connector SUB-D, 9 pins
Parallel interface port	Male connector SUB-D, 25 pins
Enclosure	Aluminium, powder coated, black
Dimensions (H x W x D in mm)	114 x 45 x 69
Weight	192 g
Mounting	DIN Rail
Centronics Interface	25-pin socket
Electrical isolation	None
Heat loss of CPU logic circuit	0.35 Watt
Rated current consumption	approx. 35 mA

EMC - N-PRN 1 Module		
Emitted Interference		
Parameter	Value	Reference
Enclosure	<ul style="list-style-type: none"> Frequency band 30 - 230 MHz, limit 30 dB ($\mu\text{V/m}$) at 10 m Frequency band 230 - 1000 MHz, limit 37 dB ($\mu\text{V/m}$) at 10 m (class B) 	DIN EN 50081-1 DIN EN 50081-2 DIN EN 55011
Interference Immunity: Enclosure		
Parameter	Value	Reference
RF Field, amplitude-modulated	Frequency band 27 -1000 MHz; test signal strength 10 V/m AM 80 % with 1 kHz Criterion A	DIN EN 61131-2 DIN EN 50082-2 DIN EN 61000-4-3
Electromagnetic RF Field, pulse-modulated	Frequency 900 \pm 5 MHz Test field strength 10 V/m 50 % ON period Repetition rate 200 Hz Criterion A	DIN EN 50082-2 DIN EN 61000-4-3
Magnetic Field with Mains Frequency	50 Hz 30 A/m	DIN EN 50082-2 DIN EN 61000-4-8
ESD	Discharge through air: Test Peak Voltage 15 kV (Humidity Rating RH-2 / ESD-4) Contact Discharge: Test peak voltage 4 kV (severity level 2) Criterion A	DIN EN 61131-2 DIN EN 50082-2 DIN EN 61000-4-2
Interference Immunity: Signal and Data Lines		
Parameter	Value	Reference
Asymmetric RF, amplitude-modulated	Frequency 0.15 - 80 MHz Test voltage 10 V AM 80 % with 1 kHz Source Impedance 150 Ω Criterion A	DIN EN 50082-2 DIN EN 61000-4-6
Burst	Test voltage 2 kV tr/tn 5/50 ns Repetition rate 5 kHz Criterion A	DIN EN 50082-2 DIN EN 61131-2 DIN EN 61000-4-4

EMC - N-PRN 1 Module		
Test with Damped Oscillation	Damped Oscillation Frequency 1 MHz Source Impedance 200 Ω Repeat Factor 400/s Test voltage 1 kV	DIN EN 61131-2 DIN EN 61000-4-12
Interference Immunity: Process, Measuring and Control lines, Long Bus Lines and Long Control Lines		
Parameter	Value	Reference
Asymmetric RF, amplitude-modulated	Frequency 0.15 - 80 MHz Test voltage 10 V AM 80 % with 1 kHz Source Impedance 150 Ω Criterion A	DIN EN 50082-2 DIN EN 61000-4-6
Burst	Test voltage 2 kV tr/tn 5/50 ns Repetition rate 5 kHz Criterion A	DIN EN 50082-2 DIN EN 61131-2 DIN EN 61000-4-4
Interference Immunity: Mains Inputs and Outputs for AC and DC		
Parameter	Value	Reference
Asymmetric RF, amplitude-modulated	Frequency 0.15 - 80 MHz Test voltage 10 V AM 80 % with 1 kHz Source Impedance 150 Ω Criterion A	DIN EN 50082-2 DIN EN 61000-4-6
Burst	Test voltage 2 kV tr/tn 5/50 ns Repetition rate 5 kHz Criterion A	DIN EN 50082-2 DIN EN 61131-2 DIN EN 61000-4-4
Test with Damped Oscillation	Damped Oscillation Frequency 1 MHz Source Impedance 200 Ω Repeat Factor 400/s Test voltage 1 kV Criterion A	DIN EN 61131-2 DIN EN 61000-4-12

13.10.3 Description of Connections

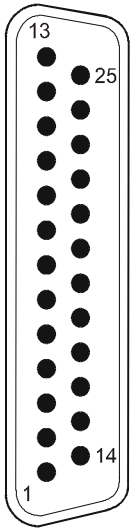

Pin Assignment - 25 pin male SUB-D connector			
PIN	Signal	Meaning	Signal Direction
1	STROBE	Signal to start data transfer	to the printer
2	DATA 1	Data bit 1	to the printer
3	DATA 2	Data bit 2	to the printer
4	DATA 3	Data bit 3	to the printer
5	DATA 4	Data bit 4	to the printer
6	DATA 5	Data bit 5	to the printer
7	DATA 6	Data bit 6	to the printer
8	DATA 7	Data bit 7	to the printer
9	DATA 8	Data bit 8	to the printer
10	ACKNLG	Acknowledgement signal	from the printer
11	BUSY	Printer is busy	from the printer
12	PAPER END	Paper tray is empty	from the printer
13	SELECT	Printer is on-/off-line	from the printer
14	AUTO FEED	Line feed	to the printer
15	ERROR	Fault message	from the printer
16	INIT	Initialisation	to the printer
17	SELECT IN	Switch printer on-line	to the printer
18	GND	Parallel ground line	
19	GND	Parallel ground line	
20	GND	Parallel ground line	
21	GND	Parallel ground line	
22	GND	Parallel ground line	
23	GND	Parallel ground line	
24	GND	Parallel ground line	
25	GND	Parallel ground line	



Important!

- In case you buy a printer cable or fabricate your own cable, the following minimum requirements, also with a view to EMC, must be met:
 1. Number of cores: 25
 2. Core cross-sectional area: 0.25 mm²
 3. Connector (male): SUB-D, metallised
 4. Maximum cable length: 2 m
 5. Shield: complete shielding, no paired shielding
- The shield must be connected to the metallised connector housings on both ends of the cable with the greatest possible surface area. The braided shield has to be made of tin-coated copper wires with a minimum degree of coverage of 85 %.

Interface with the Application Program

The interface between the module and the user's program is made up of three registers.
These registers are for configuring of the modules and for querying status information.

Register Addressing

The register address is made up of the module number and the respective register number.

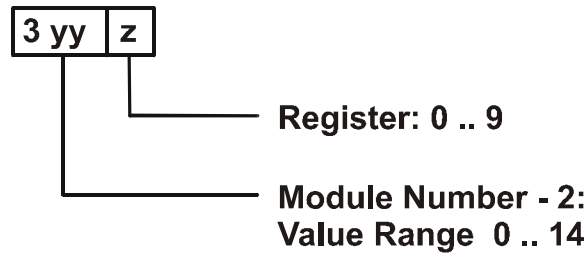
Coding of the registers: 3yyz**Note!**

For determination of the module number, only the non-intelligent modules will be counted. Intelligent modules, such as N-SV 1, N-SM1D, N-PID 1, etc., located among the digital input and output modules, are not being taken into consideration.

Module number 1 is always assigned to the basic control unit. Starting from there, the module numbers are being counted left to right.

For communication with the CPU, three registers have been provided by the N-PRN 1 module. The operating system version number of the module can always be read from register 9. The other module registers are being defined by the function of the module. The registers are addressed as follows:

`Register number = 3000 + (module number - 2) * 10 + local register number`

Examples: Determination of the register numbers

The number of the first expansion module's register is determined as follows:

Module number = 2

Local register number = 3 (control register)

Register number = $3000 + (2-2) * 10 + 3 = 3003$

13.10.4 Register Description - N-PRN 1 Module

Note!



With the N-PRN 1 module, register 3yy0 has got no function.

Register 3yy1: Data Register	
Function	Description
Read	Last sent character Value following reset: 0
Write	Sending the character to the printer ^{*)}
Value range	0 .. 255

^{*)} Once a character is entered into this register, this character is sent to the printer. Prior to sending this character, a STROBE pulse with a pulse length of 5 μ s is generated and sent.

Register 3yy2: Status register	
Function	Description
Read	Present interface state Bit 0: 1 = No function Bit 1: 1 = No function Bit 2: 1 = No function Bit 3: 0 = Error message Bit 4: 1 = Printer is online Bit 5: 1 = Paper tray is empty Bit 6: 0 = Acknowledge Bit 7: 0 = Printer is busy Value following reset: Depending on printer status
Write	Illegal
Value range	0 .. 255

The status register is bit-coded, i.e. each bit indicates a specific state. The status register is cleared when reading.

Note!



In case the printer is ready, register 3yy2 contains the value 223 (0xDF)

Register 3yy3: Control Register	
Function	Description
Read	Status of the control lines Value following reset: 0
Write	Setting the status of the control line Bit 0: 1 = Signal for starting data transmission is activated Bit 1: 1 = Line feed Bit 2: 0 = Printer reset Bit 3: 0 = Select printer Bit 4: 0 = No function Bit 5: 0 = No function Bit 6: 0 = No function Bit 7: 0 = No function
Value range	0 .. 15

**Note!**

Following reset, the value 4 should be written into register 3yy3 to select the printer and to terminate the reset state.

Register 3yy9: Version number of the operating system	
Function	Description
Read	Version number of the operating system e.g. 101 = V 1.01 Value following reset: Version number of the operating system
Write	Illegal
Value range	0 .. 8388607

13.10.5 Sample Program

The usage of the N-PRN 1 module will be illustrated by the following exemplary program.

Program Listing

```

0:          ;*****
1:          ;* Output of the characters A through Z          *
2:          ;* on the printer by the program                *
3:          ; *****
4:          ; ++++++
5:          ; + The function Print sends                    +
6:          ; + a character to the printer                  +
7:          ; ++++++
8:          ; DEF_FUNCTION [Print, PR]
              Par: rChar
9:          WHEN                                           ;Wait until the
              printer is ready
10:         BIT_SET [REG=rStatus, Bit=zbBusy]             ;Busy?
11:         THEN
12:         REGISTER_LOAD [rData with R(rChar)]           ;Output of character
13:         THEN
14:         RETURN
15:     END_DEF
16:         ;
17:     TASK tPrinter -----
18:                                     ;Terminate reset and
              select printer
19:         REGISTER_LOAD [rControl with 4]               ;Reset=1, Select=0
20:         ;
21:         REGISTER_LOAD [rChar with zFirst-             ;First character
              Char]
22:     MARKE sPrnLoop
23:     IF
24:         REG rChar                                     ;Check character
25:         <
26:         zLastChar                                   ;Last character?
27:     THEN
28:         Print [rChar=R(rChar)]                       ;Output of character
29:         REGINC rChar                                  ;Next character
30:         GOTO sPrnLoop                                ;Repeat
31:     ELSE                                             ;Received character
32:         Print [rChar=10]                             ;Line feed
33:         Print [rChar=13]                             ;Carriag return
34:     THEN                                             ;End of program
35:     LABEL sPrnLoop1
36:         GOTO sPrnLoop1
End of program

```

Sybolisting

```

;***** Task *****
tPrinter 0

;***** Labels *****

sPrnLoop      !
sPrnLoop1     !

;***** Registers *****

;The following register values are for a module located
;on the first module position after the NANO-B controller!

rData          3001      ;Data register
rStatus        3002      ;Status register
rControl       3003      ;Control register

rChar          100       ;Character

;***** Numbers *****
zbBusy         7         ;Busy bit (0=Busy)
zbError        3         ;Error bit in the status register
                  (0=Error)
zFirstChar     65        ;First character (A)
zLastChar      90        ;Last character (Z)

```

13.11 N-PS1 Module - Power Supply Unit for Remote Modules

These power supply units are to supply decentralized digital expansion modules. They convert 24 V into a logic voltage of 5 V. The power supply unit is supplied with a voltage of 24 V via two terminals. A maximum of five digital expansion modules can be connected to one power supply module.



Note!

Merely digital and analog input and output modules, as well as the N-CNT 1 module are supplied by the power supply modules N-PS 1 or N-PS 1CP. Intelligent modules have got their own 24 volt power supply unit.

13.11.1 Physical Dimensions of the N-PS 1, and N-PS 1CP Modules

Physical Dimensions of the N-PS 1 Module

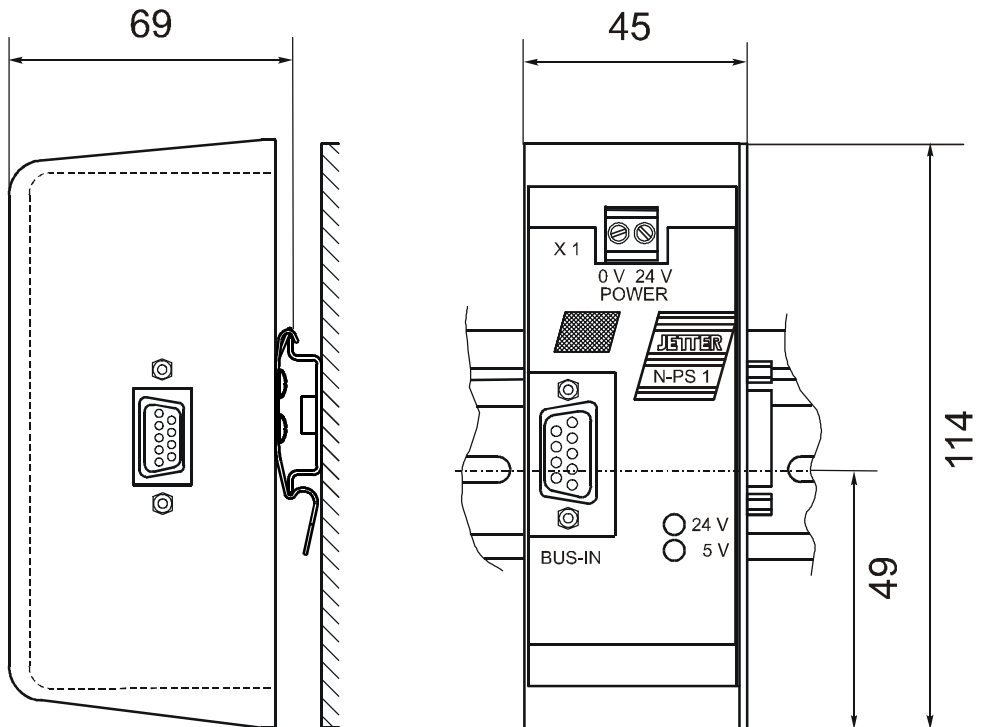

Fig. 54: Mounting Dimensions of the N-PS 1 Module

**Physical
Dimensions of
the N-PS 1CP
Module**

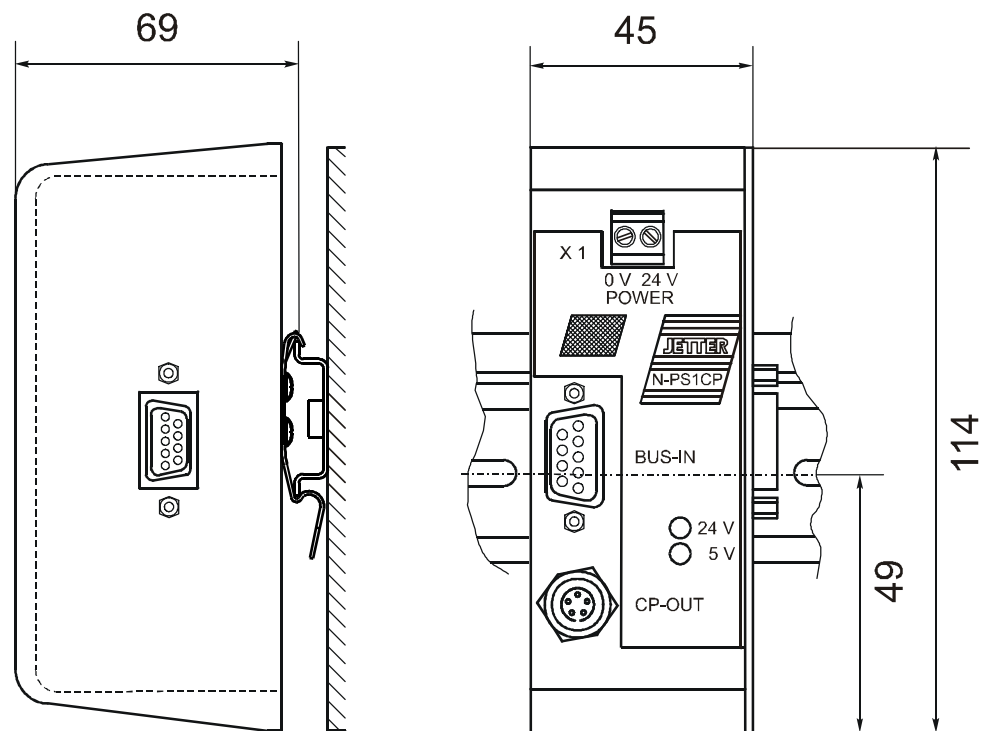

Fig. 55: Physical Dimensions of the N-PS 1CP Module

13.11.2 Technical Data

Modules N-PS 1, and N-PS 1CP: Power Supply Unit for Remote Arrangement	
Connection to the JETTER system bus	Male connector SUB-D, 9 pins
24 V connection	<ul style="list-style-type: none"> • Terminal block X1 • With the N-PS 1CP module only: FESTO CP connector socket
Power Supply	DC 20 ... 30 V at the terminal block X1
Power supply of FESTO CP valve terminal bus	DC 20 ... 30 V
Power Loss	<ul style="list-style-type: none"> • Time period ≤ 10 ms to DIN EN 61131-2 • Time interval between two voltage dips ≥ 1 s • Severity level PS2
Power consumption	Depending on type and number of modules being connected
Enclosure	Aluminium, powder coated, black
Dimensions (H x W x D in mm)	114 x 45 x 70
Weight	N-PS 1: 180 g N-PS 1CP: 199 g
Mounting	DIN Rail

Modules N-PS 1, and N-PS 1CP: Light-Emitting Diodes	
LED 24 V	Supply voltage 24 V within the range of DC 20 ... 30 V
LED 5 V	Internal logic voltage within the range of 5 V \pm 5 %

EMC of Modules N-PS 1, and N-PS 1CP		
Emitted Interference		
Parameter	Value	Reference
Enclosure	<ul style="list-style-type: none"> Frequency band 30 - 230 MHz, limit 30 dB ($\mu\text{V/m}$) at 10 m Frequency band 230 - 1000 MHz, limit 37 dB ($\mu\text{V/m}$) at 10 m (class B) 	DIN EN 50081-1 DIN EN 50081-2 DIN EN 55011
Interference Immunity: Enclosure		
Parameter	Value	Reference
RF Field, amplitude-modulated	Frequency band 27 -1000 MHz; test signal strength 10 V/m AM 80 % with 1 kHz Criterion A	DIN EN 61131-2 DIN EN 50082-2 DIN EN 61000-4-3
Electromagnetic RF Field, pulse-modulated	Frequency 900 \pm 5 MHz Test field strength 10 V/m 50 % ON period Repetition rate 200 Hz Criterion A	DIN EN 50082-2 DIN EN 61000-4-3
Magnetic Field with Mains Frequency	50 Hz 30 A/m	DIN EN 50082-2 DIN EN 61000-4-8
ESD	Discharge through air: Test Peak Voltage 15 kV (Humidity Rating RH-2 / ESD-4) Contact Discharge: Test peak voltage 4 kV (severity level 2) Criterion A	DIN EN 61131-2 DIN EN 50082-2 DIN EN 61000-4-2
Interference Immunity: Signal and Data Lines		
Parameter	Value	Reference
Asymmetric RF, amplitude-modulated	Frequency 0.15 - 80 MHz Test voltage 10 V AM 80 % with 1 kHz Source Impedance 150 Ω Criterion A	DIN EN 50082-2 DIN EN 61000-4-6
Burst	Test voltage 2 kV tr/tn 5/50 ns Repetition rate 5 kHz Criterion A	DIN EN 50082-2 DIN EN 61131-2 DIN EN 61000-4-4

EMC of Modules N-PS 1, and N-PS 1CP		
Test with Damped Oscillation	Damped Oscillation Frequency 1 MHz Source Impedance 200 Ω Repeat Factor 400/s Test voltage 1 kV	DIN EN 61131-2 DIN EN 61000-4-12
Interference Immunity: Process, Measuring and Control lines, Long Bus Lines and Long Control Lines		
Parameter	Value	Reference
Asymmetric RF, amplitude-modulated	Frequency 0.15 - 80 MHz Test voltage 10 V AM 80 % with 1 kHz Source Impedance 150 Ω Criterion A	DIN EN 50082-2 DIN EN 61000-4-6
Burst	Test voltage 2 kV tr/tn 5/50 ns Repetition rate 5 kHz Criterion A	DIN EN 50082-2 DIN EN 61131-2 DIN EN 61000-4-4
Interference Immunity: Mains Inputs and Outputs for AC and DC		
Parameter	Value	Reference
Asymmetric RF, amplitude-modulated	Frequency 0.15 - 80 MHz Test voltage 10 V AM 80 % with 1 kHz Source Impedance 150 Ω Criterion A	DIN EN 50082-2 DIN EN 61000-4-6
Burst	Test voltage 2 kV tr/tn 5/50 ns Repetition rate 5 kHz Criterion A	DIN EN 50082-2 DIN EN 61131-2 DIN EN 61000-4-4
Test with Damped Oscillation	Damped Oscillation Frequency 1 MHz Source Impedance 200 Ω Repeat Factor 400/s Test voltage 1 kV Criterion A	DIN EN 61131-2 DIN EN 61000-4-12

13.11.3 Description of Connections of the N-PS 1 Module

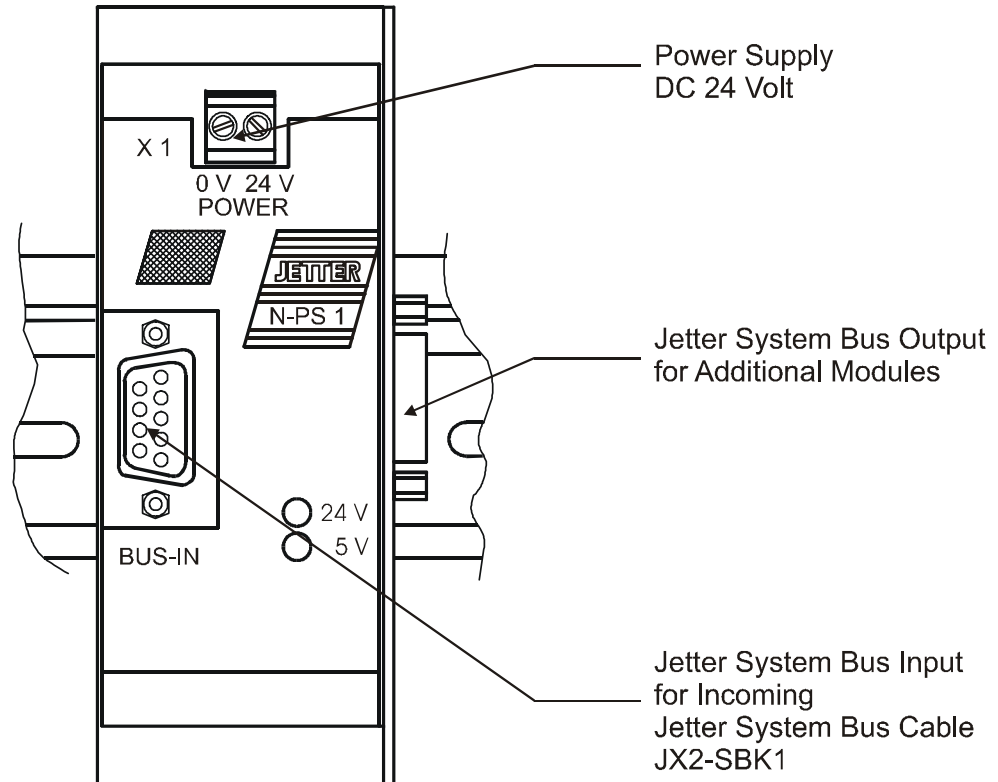

Fig. 56: Connections of the N-PS 1 Module

For the incoming JETTER system bus a SUB-D connector (male) and for the outgoing JETTER system bus a 9-pin SUB-D connector (female) are available.



Important!

The FESTO CP modules have to be connected in series at the end of the JETTER system bus. FESTO CP modules do not enable automatic termination of the bus. This must be done manually. Junctions of the bus must be avoided. If the modules are arranged in a different way, the system will exhibit errors or won't work at all.

13.11.4 Description of Connections of the N-PS 1CP Module

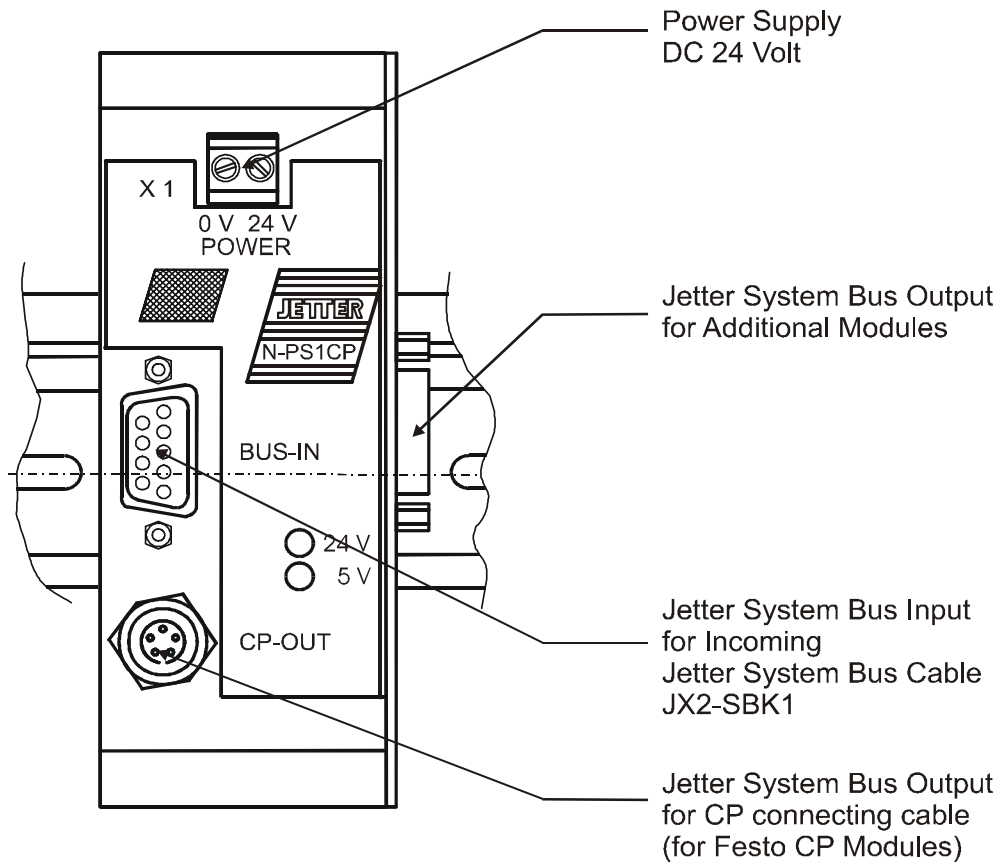

Fig. 57: Connections of the N-PS 1CP Module

There is a male SUB-D connector for the incoming JETTER system bus. For FESTO CP valve terminals a CP connector (female) and for the outgoing JETTER system bus a 9-pin SUB-D connector (female) are available.

14 NANO Network Topology and FESTO CP Modules

The PROCESS-PLC NANO-B is internally operated with the JETTER system bus. The JETTER system bus allows remote arrangement of NANO expansion modules at a distance of up to 30 meters. Instead of expansion modules, FESTO CP modules can be connected. For more information refer to chapter 13.1: "Topology of the JETTER System Bus", page 150.

14.1 FESTO CP Modules, FESTO Tee Connector

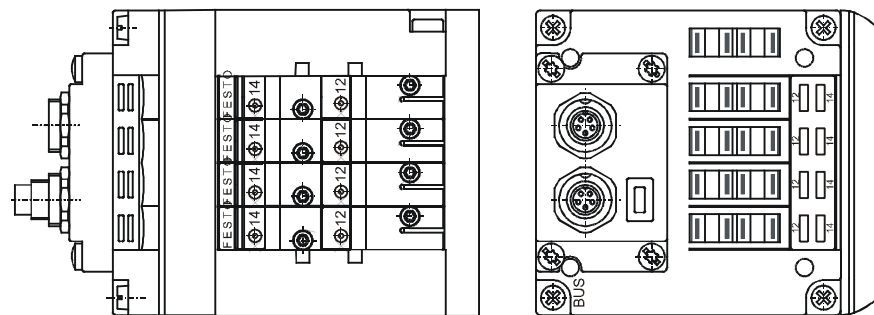

Fig. 58: Example: FESTO CP Module

FESTO CP modules are inserted into the network of NANO modules by means of FESTO tee connectors via tap lines.

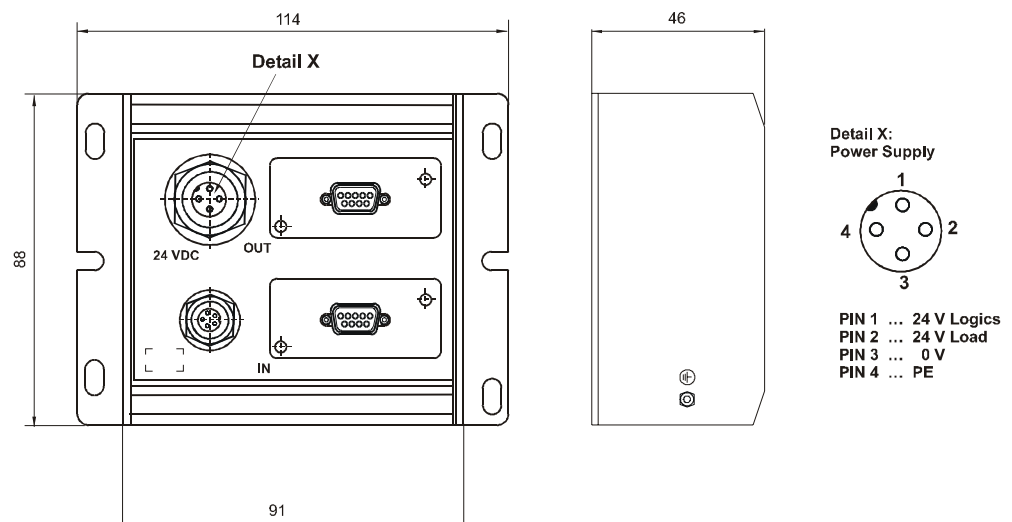

Fig. 59: Physical Dimensions of the FESTO Tee Connector



Important!

- FESTO tee connectors and the cables between tee connector and FESTO CP modules have to be purchased from FESTO.
- As interconnecting cable between the PROCESS-PLC NANO-B and the FESTO tee connector a system bus cable for NANO expansion module is to be used. For details see specification "System Bus Cable for NANO Expansion Modules" on page 30.

14.2 Networking of NANO and FESTO CP Modules

FESTO CP modules can directly be connected to the PROCESS-PLC NANO-B. This means that no special bus node for either of the systems, FESTO CP module, or NANO-B controller, is required. Connection is carried out in the same way as for decentralised arrangement of digital and analog modules on the JETTER system bus. For more information refer to chapter 13.1.2: "Decentralised Arrangement on the JETTER System Bus", page 151.

In addition to this, a N-PS 1CP power supply unit or a FESTO tee connector is required. Either of the devices must be supplied with DC 24 V.



Note!

If possible, do not use tap lines for connecting FESTO CP valve terminals. By doing so, you ensure correct operation of the system.

Arrangement without tap line:

- the FESTO CP module must always be located at the end of the bus line;
- a terminating resistor (120 Ω) must be attached to the FESTO CP module. The NANO modules do not require terminating resistors, since these are included as standard.

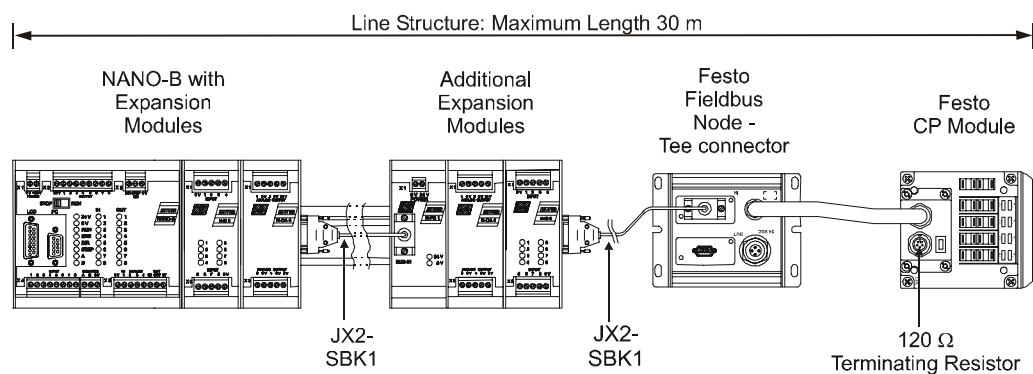

Fig. 60: Connection of FESTO CP Modules to the JETTER System Bus (bus topology)

If, due to the arrangement of the machine and the control system, a **configuration with a tap line** is required, the following constraints have to be observed:

- the maximum length of all tap lines is 3 m;
- the tap line to the FESTO CP modules must be as short as possible. In some cases, it is necessary to place a FESTO tee connector with a higher degree of protection (IP) next to the valve terminal;
- it is not allowed to attach terminating resistors to FESTO CP modules;
- a maximum of 2 valve terminals and 1 input module can be connected to 1 FESTO tee connector. Only FESTO CP modules occupy I/O numbers, but not the FESTO tee connector.

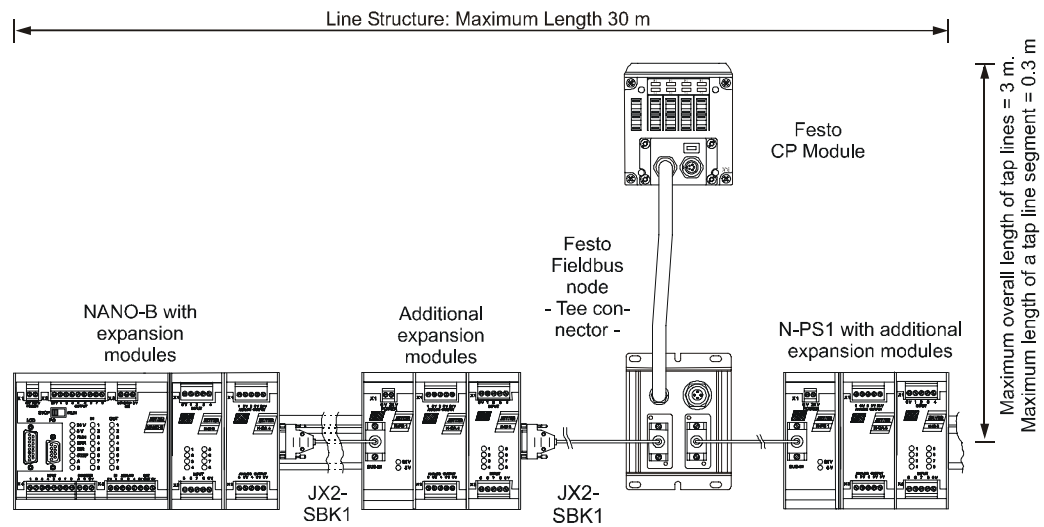

Fig. 61: Connection of FESTO CP Modules to the JETTER System Bus via Tap Lines



Important!

- If it is planned to use an arrangement of the PROCESS-PLC other than the one described in chapter 13.1: "Topology of the JETTER System Bus", page 150, please contact a representative of JETTER AG. JETTER personnel will help you to avoid malfunctions of your system, as well as time-consuming and cost-intensive troubleshooting.
- The functioning of the respective arrangement and the system-compatible termination have to be determined and tested in each particular case.

14.3 FESTO CP Modules Attached to a NANO-B Controller

The NANO-B controller is a control system for digital and analog inputs and outputs. The maximum degree of extension includes 136 digital inputs and outputs, though it should be noted that the basic controller itself occupies 8 digital inputs and 8 digital outputs. Therefore, the basic controller can be expanded by 120 digital inputs and outputs; cf. chapter 13.1: "Topology of the JETTER System Bus", page 150. Such an expansion can be carried out using either NANO expansion modules or FESTO CP modules.



Note!

- If FESTO CP modules are attached, they always occupy 16 digital outputs or 16 digital inputs.
- When a FESTO output module is attached, this means that, irrespectively of the number of valves a FESTO CP valve terminal is equipped with, always 16 digital outputs are reserved and that in register 2013 **two** inserted I/O modules are displayed. However, in the module array of register 2015 and 2016 code number 32 appears **only once**; cf. chapter 5.3.4: "Special Registers", page 61.
- By analogy, the FESTO input modules always occupy 16 input addresses, though, in the module array of register 2015 and 2016 code number 33 appears only once.
- Please give heed to the fact that per module always 16 input and output addresses have to be subtracted from the maximum number of possible digital inputs and outputs.



Important!

- A maximum of 7 FESTO CP modules can be connected to a NANO-B controller.

Example: Addressing a NANO-B equipped with a FESTO CP valve terminal

As expansion modules one digital output and input module each are attached to a NANO-B controller. Last of all, a FESTO CP valve terminal with 8 valves is added. This configuration results in the following addressing scheme:

NANO-B Basic Unit	N-OD 8 Output Module	N-ID 8 Input Module	FESTO CP with 8 Valves
Module # 1	Module # 2	Module # 3	Module # 4
Input 101 .. 108 Output 101 .. 108	Output 201 .. 208	Input 301 .. 308	Output 401 .. 408 and 501 .. 508 though unused



Important!

Address numbers are assigned to FESTO CP modules only after NANO modules. For more information refer to chapter 14.5: "Example: Register Assignment of FESTO CP Modules", page 255.

14.3.1 Commissioning a PROCESS-PLC NANO-B/C equipped with FESTO CP Modules

The PROCESS-PLC NANO-B/C and FESTO CP modules communicating via Jetter System Bus are initialised using the following flow chart:

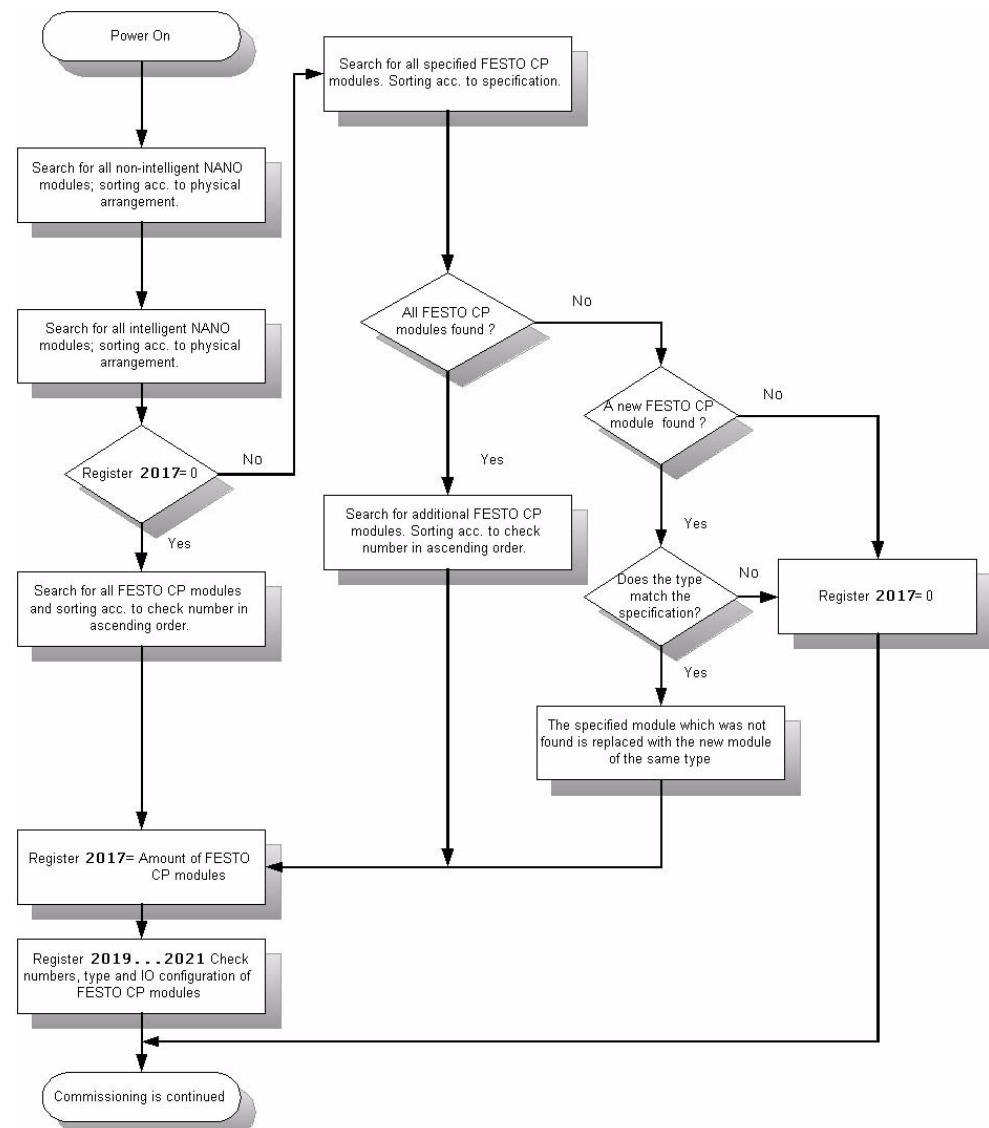

Fig. 62: Flowchart for Commissioning NANO-B/C with FESTO CP Modules

14.3.2 Comparing Set/Actual Configuration

If a FESTO CP module has to be replaced, the PROCESS-PLC must be switched off beforehand. Restart the PROCESS PLC system to activate the new FESTO CP module. During start-up the new module is detected and register 2021 is read in. While doing so, the module type is not determined. This means that a FESTO CPV valve terminal type 4 can be replaced with a FESTO CPV valve terminal type 8.

To ensure that the replacement is taken into account the user should write a SYMPAS program comparing SET with ACTUAL configuration. Examples of such a program are given in fig. 63 and fig. 64 .

The program extract given in fig. 63 shows that the set configuration of FESTO CP modules ist stored to registers starting with register 100. The information contained herein is required to compare set with actual configuration.

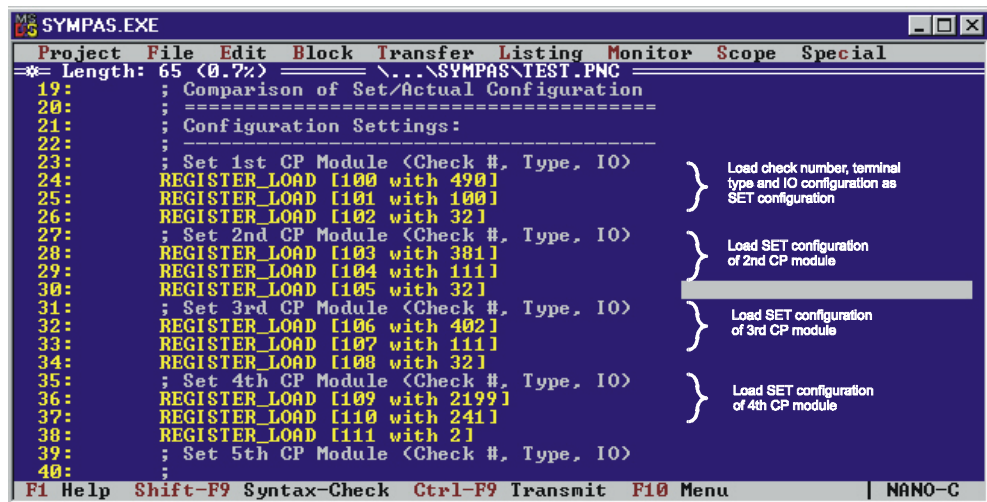

Fig. 63: Setting Configuration of FESTO CP Modules

The program extract given in fig. 64 is an example of a comparison between set and actual configuration. The set configuration is contained in the registers starting with 100 and the actual configuration in the registers starting with 2019. Comparison of set configuration with actual configuration is used to determine that all FESTO CP modules, for which the program was designed, have been detected during initialisation of the PROCESS-PLC system.

```

SYMPAS.EXE
Project File Edit Block Transfer Listing Monitor Scope Special
* Length: 65 (0.7%) \...\SYMPAS\TEST.PNC
43: ;
44: ; Addressing 1st CP Module
45: ;
46: THEN
47: REGISTER_LOAD [2018 with 1]
48: IF
49: REG 2019 ;Actual Check # 1st CP Mo
50: = ;Set Check # 1st CP Modul
51: REG 100 ;Actual Type 1st CP
52: REG 2020 ;Set Type 1st CP Mod
53: = ;Actual IO Configuration
54: REG 101 ;Set IO Configuration 1st
55: REG 2021
56: =
57: REG 102
58: THEN
59: FLAG 1
60: ;
61: ; Addressing 2nd CP Module
62: ;
63: THEN
64: REGISTER_LOAD [2018 with 2]
F1 Help Shift-F9 Syntax-Check Ctrl-F9 Transmit F10 Menu | NANO-C

```

Comparison of set check number, type and IOs with actual check number, type and IOs. The result is buffered with flag 1.

Fig. 64: Comparison of Set Configuration with Actual Configuration

14.4 Register Description of the FESTO CP Module

Register 2017: Amount of FESTO CP Modules	
Function	Description
Read	Amount of FESTO CP modules recognised as connected to the JETTER bus and appearing in the configuration table. Value following reset: 0
Write	Illegal
Value range	0 ... 8

Register 2018: Index to Configuration Table	
Function	Description
Read	This index selects the FESTO CP module, the configuration of which is to be read from registers 2019 through 2021. Register 2017 indicates how many FESTO CP modules are available. Value following reset: 1
Write	New index ^{*)}
Value range	1 ... 8

^{*)} The index is regarded as pointer. The required FESTO CP module is selected from the table by using this pointer.

Register 2019: Check Number	
Function	Description
Read	Check number of the FESTO CP module Value following reset: Last value or new check number
Write	New check number ^{*)}
Value range	0 ... 65535

^{*)} The check number of the FESTO CP module is entered into the table either manually by the user or automatically by the controller. The check number is indicated as PN number on the nameplate of the FESTO module. The following illustration is to show the elements a FESTO serial number consists of.

Example: FESTO-CP Serial Number

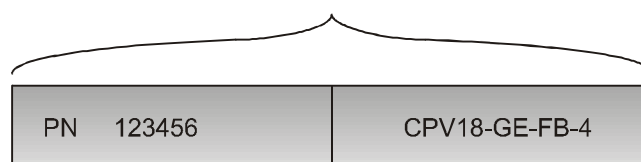

Check Number

Register 2020: Type of the FESTO CP Module	
Function	Description
Read	Type of the FESTO CP module Value following reset: Last value or new type
Write	New type; cf. the following table
Value range	0 ... 65535

**FESTO CP Module
Types and I/O
Configuration**

CP Module	Entry for Valve Terminal Type	Entry for I/O Configuration
CPV10-GE-FB-4	100	32
CPV10-GE-FB-6	101	32
CPV10-GE-FB-8	102	32
CPV14-GE-FB-4	110	32
CPV14-GE-FB-6	111	32
CPV14-GE-FB-8	112	32
CPV18-GE-FB-4	125	32
CPV18-GE-FB-6	126	32
CPV18-GE-FB-8	127	32
CP-E16-M8	240	02
CP-E16-M12	241	02
CP-E16N-M8	248	02
CP-E16N-M12	249	02
CP-A8-M12	200	32
CP-A8N-M12	208	32
CPA-10/14 MFB/IFB	150	32
CPA-18 MFB/IFB	152	32

Register 2021: I/O Configuration	
Function	Description
Read	I/O configuration of the FESTO CP module Value following reset: Last value or new I/O configuration
Write	Illegal
Value range	02: for input module *) 32: for output module *)

*) Settings by FESTO.

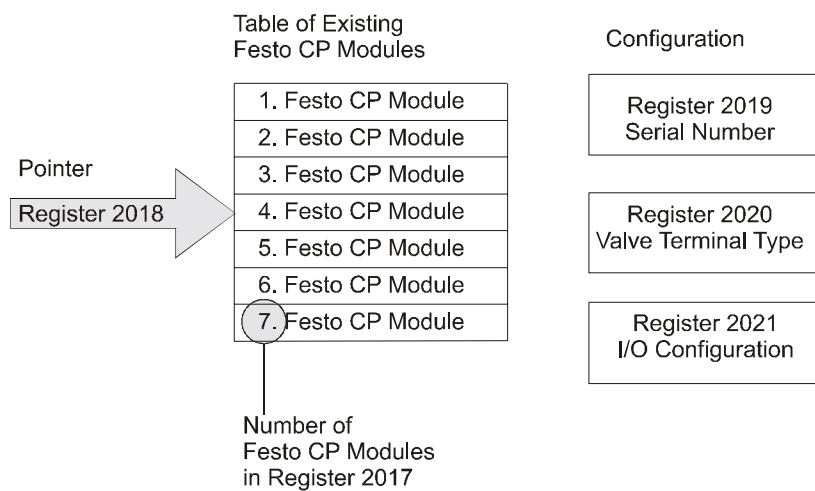

Fig. 65: Register Configuration of FESTO CP Modules



Note!

The entry of the check numbers is automated. In the basic setting, the default value for the check number in register 2019 is zero. By that means, the NANO-B automatically enters the check number of the FESTO CP modules into the configuration table of register 2018; When doing so, the controller starts with the least check number and enters the check numbers in ascending order into the configuration table.

The check numbers of FESTO CP modules are to be entered into the configuration table by means of register 2018 in the same order in which they are intended to be addressed during operation. The first entry is addressed as the first module, the second entry as second module etc.



Important!

The higher the check number, the higher the logical (not physical) location of the FESTO CP module being addressed by the controller.

Register 2027: Output Driver Error / FESTO CP Module Error	
Function	Description
Read	Present error of the output driver, resp. FESTO CP module: Bit 0 Local outputs short-circuited Bit 1-23 One of the I/O modules short-circuited; FESTO CP module error. Value following reset = 0
Write	Illegal
Value range	0 ... 65535

An error of the locals outputs of a NANO module or a FESTO CP module is displayed through register 2027. A short-circuited or an overloaded local output can be a cause for such an error.

The cause of an error message of a FESTO CP module can be read out of register 2034. To do so, the number of the FESTO CP module must have been entered into register 2018.

14.5 Example: Register Assignment of FESTO CP Modules

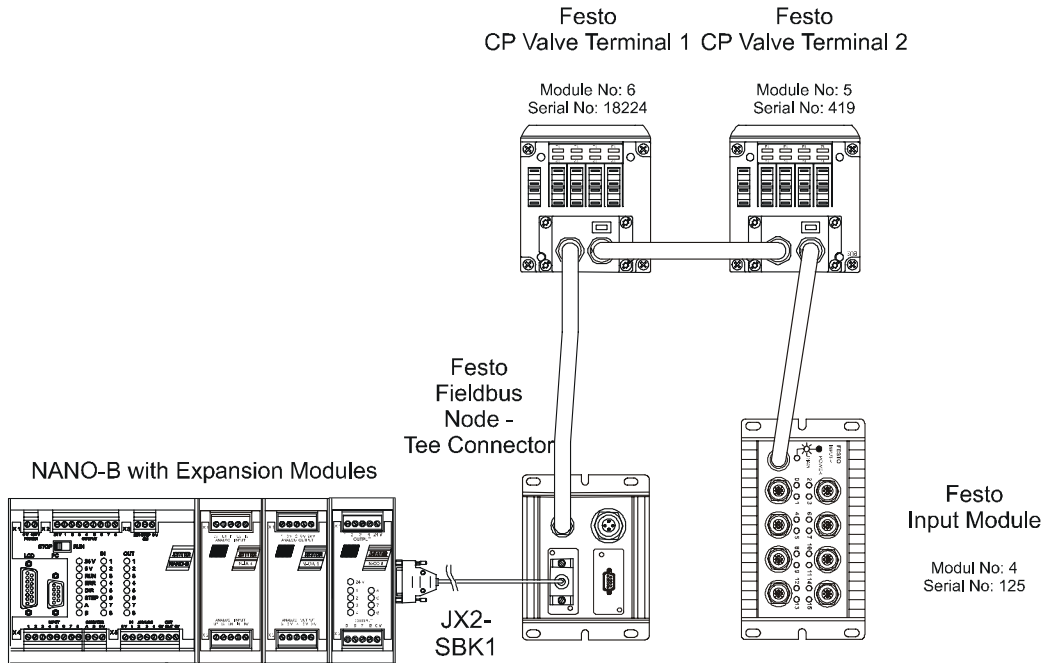

Fig. 66: Example: FESTO CP Modules connected to the JETTER System Bus

Note!



Register assignments, references to additional registers and additional information resulting from the configuration shown in fig. 66 are as follows:

Configuration of the Exemplary Arrangement:

NANO Expansion Modules	FESTO CP Modules
<p>3 non-intelligent modules:</p> <ul style="list-style-type: none"> • N-IA 4 • N-OA 4 • N-OD 8 	<p>Valve terminal 1: e.g. CPV-10-6E-FB-8, terminal type 102</p> <p>Valve terminal 2: e.g. CPV-10-6E-FB-4, terminal type 100</p> <p>Input module e.g. CP-E16-1112x2, terminal type 241</p>

Register Assignment Resulting from the Exemplary Configuration:

Register and Register Value	Reference to Additional Registers	Components	Comments
2013: 9		<ul style="list-style-type: none"> 3 non-intelligent modules 3 FESTO CP Modules 	In this register, FESTO CP modules are counted twice resulting in: $3 + 3 \times 2 = 9$
2014: 0		<ul style="list-style-type: none"> intelligent module are not being used 	
2015: 0 -> 2016:6	<p><i>with the following codes:</i></p> <p>1-> 3 for</p> <p>2-> 4 for</p> <p>3-> 0 for</p> <p>4-> 33 for</p> <p>5-> 32 for</p> <p>6-> 32 for</p>	<ul style="list-style-type: none"> 3 non-intelligent modules 3 FESTO CP Modules <p>N-IA4</p> <p>N-OA4</p> <p>N-OD8</p> <p>FESTO CP Input Module</p> <p>FESTO CP Valve Terminal 2</p> <p>FESTO CP Valve Terminal 1</p>	In this register, FESTO CP modules are counted once resulting in: $3 + 3 \times 1 = 6$
2017: 3		3 FESTO CP Modules	
2018: 1 ->	<p>2019: 125</p> <p>2020: 241</p> <p>2021: 2</p>	->FESTO CP Input Module	
2018: 2 ->	<p>2019: 419</p> <p>2020: 100</p> <p>2021: 32</p>	->FESTO CP Valve Terminal 2	
2018: 3 ->	<p>2019: 18224</p> <p>2020: 102</p> <p>2021: 32</p>	->FESTO CP Valve Terminal 1	

Input and Output Numbering with Automatic Recognition Resulting from the Exemplary Configuration:

Component	Inputs	Outputs
NANO-B	101 ... 108	101 ... 108
N-IA 4		201 ... 208 (virtually)
N-OA 4		301 ... 308 (virtually)
N-OD 8		401 ... 408
FESTO Tee Connector	The FESTO Tee Connector does not require a number!	
FESTO CP Valve Terminal 1		901 ... 908 1001 ... 1008
FESTO CP Valve Terminal 2		701 ... 708 801 ... 808
FESTO CP Input Module	501 ... 508 *) 601 ... 608	

*) I/O numbering is continued with the FESTO CP module with the least check number.

Note!



Following the numbering of NANO-B modules, numbering of inputs and outputs of the FESTO CP module is continued with the FESTO module with the least check number. Please give heed to the difference in numbering of expansion modules from Jetter AG.

15 Error Handling

When dealing with errors, the following distinction has to be made:

- Hardware errors
- Application program errors
- Operating system errors

15.1 Hardware Errors

If communication with a module connected to a NANO-B is not possible via JETTER system bus, this error is signaled by the following messages:

- register 2011 resp. 2012 shows the number of the module where a communication time-out has occurred;
- the red **LED-ERR** on the NANO-B basic controller is lit when register 2008 is not equal to zero.

If the computer is connected to the controller via a programming cable and if the SYMPAS program is activated, in the first instance, it is to be checked whether in the windows 4, 5, 8 or 9 registers with a time-out error message are displayed.

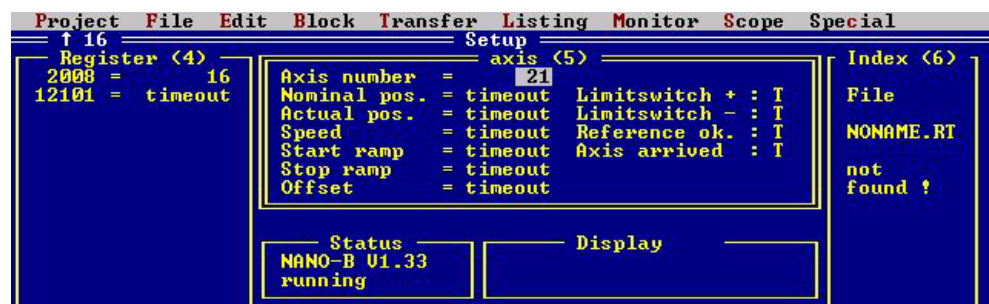

Fig. 67: Error Message: Time-out

If this is the case, the registers in the corresponding windows have to be deleted and "0" has to be entered into register 2008.

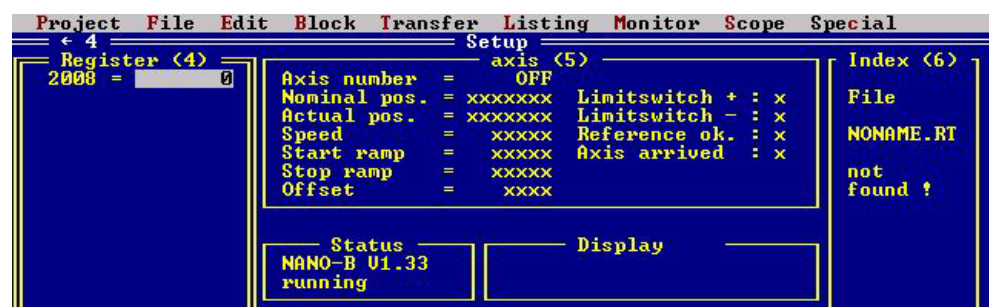

Fig. 68: Resetting Register 2008

To check whether the SYMPAS program will access to registers which cause errors, the NANO-B must be powered on while the program is stopped. If register 2008 continues to display "0", the error is caused by the SYMPAS program. If a value other than "0" is displayed, proceed according to Chapter 15.3 "OS Error Messages".

15.2 Application Program Errors

Syntax Checking The programming interface SYMPAS includes a syntax checking function which "intercepts" errors in the application program. When the program is uploaded from the PC to the controller, syntax checking can either be enabled or disabled. When working with SYMPAS, it is advisable to leave syntax checking enabled since it spots fundamental errors.

If syntax checking is disabled, it can happen that faulty programs are uploaded to the NANO-B controller. In this case, errors will be reported in register 2008. Register 2001 signals whether the program is running properly or has been stopped.

Register 2001: Status register	
Function	Description
Read	State: Bit 0 = 0: Program has been stopped Bit 0 = 1: Program is running Bit 1 not assigned Bit 2 = 0: Stepper motor disabled Bit 2 = 1: Stepper motor activated
Write	Bit 0 = 0: Stop program Bit 0 = 1: Start program
Value range	0 - 5

The status register signals whether the program in the controller is currently running or has been stopped. A program can be "stopped":

- if a syntax error in the application program has been spotted. The kind of error is displayed in register 2008 and **LED ERR** is lit.
- if the program has been stopped through the setup screen of SYMPAS by pressing SHIFT F3, [F2, F4] or by writing into register 2001;
- if the "STOP-RUN" switch is in "STOP" position when the controller is powered up.

**Note!**

The **LED RUN** signals whether the program is running properly or has been stopped.

LED RUN lit: Program is running

LED RUN is flashing: Program has been stopped

Register 2009: Status register	
Function	Description
Read	Number of the task in which an error has occurred. Value following reset: -1 – 1: No error! – 2: The program code cannot be related to a task following program start or reset.
Write	Error is deleted
Value range	0 - 31

If in the application program an error has been spotted, the number of the task, in which the error has occurred, can be read from this register.

**Note!**

The function **Autoflash** has to be activated to store a newly prepared SYMPAS program. For more information refer to Fig. 69 "Autoflash Settings in the SYMPAS Program", page 261.

Only in case the autoflash function is activated, the SYMPAS program is **permanently** stored to the **flash memory** of the **CPU**. If the autoflash function is not activated, the JETTER test program, for example, is in the CPU memory when the NANO-B is restarted.

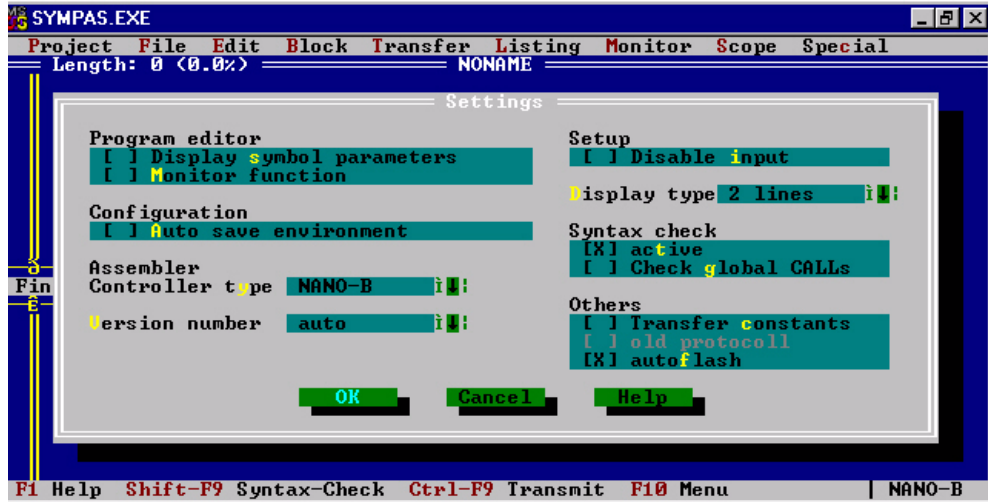
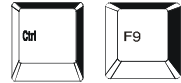

Fig. 69: Autoflash Settings in the SYMPAS Program

The SYMPAS program is transferred by pressing



Note!

SYMPAS programs should only be transferred upon completion of program creation, since the CPU's flash memory allows only a certain amount of write cycles (approx. 10000).

15.3 OS Error Messages

Register 2008: Operating System Error messages			
Error #	Type of Error	Error Cause	Troubleshooting
Bit 2 = 1	No user program in the NANO-B memory	<ul style="list-style-type: none"> No user (SYMPAS-) program present No valid user program present 	<ul style="list-style-type: none"> – Reload user program
Bit 3 = 1	I/O module timeout: Module does not answer	<ul style="list-style-type: none"> Intermittent electrical contact or break of JETTER system bus cable JX2-SBK1 	<ul style="list-style-type: none"> – Check JETTER system bus cable JX2-SBK1 for continuity and short circuit. While doing so, shake the cable.
Bit 4 = 1	Slave module timeout: Module does not answer	<ul style="list-style-type: none"> Access to intelligent modules which have not been inserted or detected. Reg. 12100 .. 14199 Access to non-intelligent modules which have not been inserted or detected. Reg. 3000 .. 3149 Intermittent electrical contact or break of JETTER system bus cable JX2-SBK1 	<ul style="list-style-type: none"> – Check power supply of the intelligent module. – Do not power up intelligent modules following power-up of the CPU, i.e. intelligent modules have to be powered up at the same time as the rest of the system. – If the 5 V LED of the relevant module is not illuminated, return the module for repair. – Check addressing of registers for the module in the SYMPAS program and correct it if necessary. The module has to be detected in the module array with register 2015 and 2016. – Wrong calculation of register address – Module defective – Too many modules connected to the JETTER system bus cable JX2-SBK1 without power supply module PS1. – Check JETTER system bus cable JX2-SBK1 for continuity and short circuit. While doing so, shake the cable.
Bit 5 = 1	Illegal op-code in the RAM	<ul style="list-style-type: none"> e.g. Modem with self-detection routine keeps sending data faulty SYMPAS program 	<ul style="list-style-type: none"> – Switch off self-detection routine of the modem. – Repeat SYMPAS program upload
Bit 6 = 1	Wrong programming of an arithmetic calculation	<ul style="list-style-type: none"> Faulty programming 	<ul style="list-style-type: none"> – Activate syntax checking. Following this, reload corrected program.

Register 2008: Operating System Error messages			
Error #	Type of Error	Error Cause	Troubleshooting
Bit 7 = 1	Multiple entry of a label number	<ul style="list-style-type: none"> Faulty programming 	<ul style="list-style-type: none"> Activate syntax checking. Following this, reload corrected program.
Bit 8 = 1	General syntax error	<ul style="list-style-type: none"> Faulty programming 	<ul style="list-style-type: none"> Activate syntax checking. Following this, reload corrected program.
Bit 9 = 1	(if flag 2065 is set) one or more output drivers on the basic controller are overloaded	<ul style="list-style-type: none"> Overload or short circuit of a set output 	<ul style="list-style-type: none"> Eliminate short circuit
Bit 10 = 1	Jump to a non-existing label or subprogram	<ul style="list-style-type: none"> No jump label defined in the SYMPAS program 	<ul style="list-style-type: none"> Activate syntax checking, check program and correct it.

Error Messages of Special Flags Specified in Chapter 5.2 "Access to Flags"	
2048	Time-out I/O module: corresponds to register 2008 Bit 3
2049	Time-out slave module: corresponds to register 2008 Bit 4
2051	Time-out during slave access through SYMPAS
2052	User programmable interface: Parity error
2053	User programmable interface: Frame error
2065	Enable error message (CPU output driver). For more information see register 2008, bit 3

16 NANO-C: Differences from NANO-B

The NANO-C module has additional or improved functions as compared with the NANO-B.

Comparison between Functions	
NANO-C Module	NANO-B Module
<ul style="list-style-type: none"> • 10000 User Registers 	<ul style="list-style-type: none"> • 2000 User Registers
<ul style="list-style-type: none"> • 64 KByte Application program 	<ul style="list-style-type: none"> • 16 KByte Application program
<ul style="list-style-type: none"> • 256 Floating point registers 	<ul style="list-style-type: none"> • No floating point registers
<ul style="list-style-type: none"> • Special Functions: <ul style="list-style-type: none"> - SF4 BCD ->HEX - SF4 BCD ->HEX - Square root - Sine - Cosine - Tangens - Arc Sin - Arc Cosin - Arc Tangens - Exponential function - Natural logarithm 	<ul style="list-style-type: none"> • Special Functions: <ul style="list-style-type: none"> - SF4 BCD ->HEX - SF4 BCD ->HEX

10000 User Registers:

Numbering of user registers is carried out as follows:

0 .. 1999 and 20000 .. 27999

256 Floating point registers (NANO-B none)

Floating point registers are numbered as follows:

65024 .. 65279

with a value range from $\pm (8.43 \cdot 10^{-37})$ through $3.38 \cdot 10^{38}$

Special Functions: (NANO-B only SF4 BCD->HEX, SF5 HEX->BCD)

Special functions are always called using two parameters. The first parameter is the number of the register containing the operand. The second parameter is the number of the register into which the results of the function have to be written, for example:

```
SPECIAL FUNCTION [#21, P1=65024, P2=65025]
```

This function calculates the sine for the number contained in register 65024 and stores the result to register 65025.

On principle, it is permitted to specify integer registers for parameter transfer or for the result. In most cases, this makes no sense due to the value range.

Function 20: Square root

Value range of argument:	0 and positive numbers
Value range of the result:	0 and positive numbers
Potential errors:	Negative number as argument
Result in case of error:	1.00
Computing time:	approx. 0.5 ms

Function 21: Sine (sin)

Value range of argument:	-1000 to +1000 in radian measure!
Value range of the result:	-1.00 through +1.00
Potential errors:	None
Computing time:	approx. 2.6 ms

Function 22: Cosine (cos)

Value range of argument:	-1000 to +1000 in radian measure!
Value range of the result:	-1.00 through +1.00
Potential errors:	None
Computing time:	approx. 2.7 ms

Function 23: Tangent (tan)

Value range of argument:	-1000 to +1000 in radian measure!
Value range of the result:	-10 ¹³ through +10 ¹³
Potential errors:	None
Computing time:	approx. 2.5 ms

Function 24: Arc Sine (arc sin)

Value range of argument:	-1.00 through +1.00
Value range of the result:	$-\pi/2$ through $+\pi/2$
Potential errors:	Argument outside -1..+1
Result in case of error:	1,00
Computing time:	approx. 3.0 ms

Function 25: Arc Cosine (arc cos)

Value range of argument:	-1.00 through +1.00
Value range of the result:	0 through $+\pi$
Potential errors:	Argument outside -1..+1
Result in case of error:	1,00
Computing time:	approx. 3.0 ms

Function 26: Arc Tangent (arc tan)

Value range of argument:	-10^{13} through $+10^{13}$
Value range of the result:	$-\pi/2$ through $+\pi/2$
Computing time:	approx. 2.5 ms

Function 27: Exponential Function (e^x)

Value range of argument:	-86.63 through +86.63
Value range of the result:	0 through 4.2^{37}
Computing time:	approx. 3.0 ms

Function 28: Natural Logarithm (ln)

Value range of argument:	0 through 4.2^{37}
Value range of the result:	-86.63 through +86.63
Computing time:	approx. 3.0 ms

Note!

SYMPAS programs for a NANO-B controller can also be used for a NANO-C controller. For this purpose, the extensions of SYMPAS files for NANO-B have to be renamed from .PNB to .PNC.

Appendices

Appendix A: Downloading the Operating System

In the menu "Transfer" of the SYMPAS programming interface the operating system can be updated.

For this purpose, operating system files (*.OS) are made available on the internet (<http://www.jetter.de>) by JETTER AG.

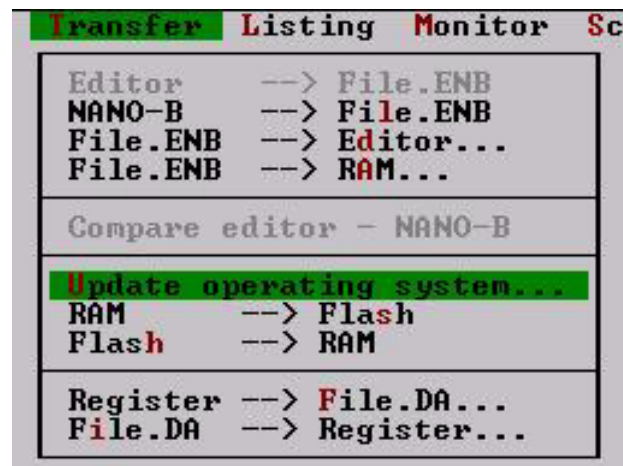

Fig. 70: SYMPAS Programming Interface



For downloading an OS update, time-out must be set to 4000 ms in the SYMPAS menu "Special / Interface". This is the default setting.



In addition to this, the OS itself must be stopped during download of an OS update.

Appendix B: Multitasking Operating System

This chapter is directed at users who in greater detail want to know how the multitasking operating system of the NANO-B basically works.

Basic Information on Multitasking

A lot of control systems are operated with a program which is cyclically processed. Cyclic processing is required if processing of several parallel programs is not feasible, thus multitasking cannot be used.

Every system, however small it may be, includes parallel functions and processes. Even if only one automatic process is required, there are parallel functions or operator guidance functions to be monitored.

Execution of Parallel Functions by Multitasking

The most practical approach to parallel processing is multitasking since it is the most distinct and, in logical terms, the simplest way of implementing parallel processing. The reasons, why this kind of technology has not yet been applied in control systems on a broad basis, are as follows:

- PLC automation technology is to a high degree committed to its traditional concept using PLC languages, such as ladder diagram, function plan and statement list, and, as a result, to the cyclic processing of programs.
- The well-known realtime-capable multitasking operating systems are very complex, thus, requiring high-performance and, therefore, expensive hardware. Also, specialists are needed for their handling.
- The realtime capability of multitasking operating systems known from the office realm is limited since numerous system functions, such as access to hard disks, mouse handling etc., get access to program flow via interrupts.
- Due to the complexity of the known multitasking operating systems, their application in the area of small and mid-sized control system has not been possible so far.

Reproduction of the Real Process Flow

Multitasking enables the program to be executed in a way that corresponds to the real process flow.

PROCESS-PLC with Multitasking OS for Automation Technology

To realise an OS with multitasking and a descriptive, process oriented execution for the whole range of automation technology, JETTER AG has developed an easy-to-use multitasking OS.

This OS was designed for meeting the demands of automation technology and already enables multitasking to be implemented into the micro controller NANO-B.

Principle of Operation

First of all, distinction must be made between single-processor and multiprocessor systems. For processing applications with great volumes of data, e.g. complex graphics, multiprocessor systems are used in the EDP realm. In such systems, data are processed in parallel by several processors.

Multitasking Using Single-Processor Systems

In most cases, parallel data processing using several processors is not being used, neither in known multitasking operating systems of the office realm nor in most other systems. Except for some few special applications, multiprocessor systems are not universally applicable to the wide range of control engineering due to the required hardware and software, thus, the high price. Therefore, in control systems a single processor is used managing parallel processing of all programs. This also applies to PROCESS-PLC systems.

There are several basic approaches to multitasking operating systems. One of them is the time-sharing method.

Time-sharing runs several tasks by interleaving portions of processing time allotted to each task. Each task is executed until its portion of time is elapsed. Then, control of the system is passed to the next task. This process is continued until the initial task gets its turn, then it starts once again.

Time-slice Multitasking

With PROCESS-PLC systems an optimized time-sharing multitasking is used. It is possible to write up to 32 parallel programs, called tasks. In many cases, in particular with micro controllers, a number of 3 to 10 task is practicable.

**Note!**

A program always starts with **TASK 0**. Thus, **TASK 0** is the only task, the existence of which is mandatory. The order, in which additional tasks are programmed, is irrelevant. For reasons of clarity, a systematic and logical order of tasks is advisable.

**Note!**

The duration of program execution primarily depends on the number of tasks being used. The program length is only of secondary importance to the processing time. Clever programming, thus, a limited number of tasks is crucial to a fast processing of a program.

Permanently Defined and User-Defined Task Switching Conditions

A task does not always make the most of the available processing time. If, for example, the next instruction of a task is a delay which has not elapsed yet, an immediate task switch takes place. Such a task switch cannot be controlled by the program. After the following instructions a task switch is inevitably carried out:

- **DELAY** process has not been completed yet
- **WHEN** condition has not been fulfilled yet
- **USER_INPUT** program waits until a value is entered by operator

Additionally, further task switching conditions can be defined in register **2004**:

- if the time specified in register **2005** has elapsed and a **THEN** instruction follows
- if the task encounters a **GOTO** instruction
- if the condition of an **IF** instruction has not been fulfilled.

In addition to the user task, three further functions are carried out in the background:

- interface for connection with the user interface
- interface for connection with PC, VIADUKT or graphic user interface
- JETWay interface

Priorities

The priority of managing the user interface and the serial interface can be defined. In default setting, both functions are carried out after all tasks have been processed. The priority of these functions can be increased by means of flags 2056 and 2057. In this case, interfaces are always "served" between two tasks.

In most cases, default setting is best since the highest priority usually is given to automatic functions, and not to operating functions. Changing these flags is practical, for example when switching the system from automatic mode to manual mode. In register 2026 the priority of a task is defined by the user.



Note!

By using the instruction **DELAY 0** with parameter 0, task switching is induced. If, during processing, a task encounters **DELAY 0**, it switches immediately to the next task.

By using the instruction **DELAY 0** low priority can be assigned to tasks or program parts. A task which is controlling the displays needs not have, for example, the same response time as a task for automatic mode. Insertion of one or more **DELAY 0** instructions into user interface tasks results in time saving which is made available to other task.

Appendix C: Glossary

Sequential Control System	Control system with sequential processing. Stepping is initiated either by feedback signals from the machine (process-dependent sequential control) or time-controlled (time-dependent sequential control).
Axis	A principal direction along which a movement of the tool or work piece occurs.
Actuator	A component which is connected to the output of a controlled system and which converts an electrical signal into mechanical motion.
Analog	A parameter, e.g. voltage, which is steplessly adjustable. Contrasted with digital.
Statement List	Application program that lists control functions in the form of statements.
Resolution	A resolution of 10 bit means that, for example, a value range of 0-10 V is divided into $2^{10} = 1024$ increments.
Output Driver	Output drivers are semiconductor components, such as transistors with the N-IO 16 module. To function correctly, they have to be connected to voltage and current.
Bit-coded	Bit-coded means that bits are evaluated individually.
Burst	1) Short period of intense activity on an otherwise quiet data channel. 2) Short isolated sequence of transmitted signals. 3) Fast transient interference.
Bus	A set of hardware lines (conductors) used for data transfer among the components of a computer system. Buses are characterised by the number of bits they can transfer at a single time. Distinction is made between serial bus systems (transmission of one bit at a time) and parallel bus systems (simultaneous transmission of a group of bits over separate wires).
CAN Bus	Controller Area Network Bus: Originally, this bus was intended for use in automobiles due to its short cable length of 30 m maximum, high bit rate of 1 Mbit/s and its noise immunity. The same demands apply to automation technology. Therefore, this bus system (serial bus) is used in Jetter control systems.
Digital	Presentation of a parameter, e.g. time, in the form of characters or figures. This parameter in digital representation can be changed in given steps only. Contrasted with analog.
DIP switch	D ual- i n- l ine P ackage S witch
DIN Rail	Rail to DIN EN 50022 for mounting modules

Download	In communications, to transfer a copy of a file from a remote computer to the requesting computer, for example, an OS from a PC to a PROCESS-PLC.
Electromagnetic Compatibility (EMC)	Definition according to the EMC regulations: EMC is the ability of a device to function in a satisfactory way in electro-magnetic surroundings without causing electromagnetic disturbances itself, which would be unbearable for other devices in these surroundings.
Fieldbus Interface	Interface for connection of field devices, such as FESTO valve terminals.
Field Level	Sensors and actuators located in the machinery.
Firmware	Software routines stored in read-only memory (ROM). For example, startup routines and low-level I/O instructions are stored in firmware. It falls between software and hardware in terms of ease of modification.
First In First Out	A method of processing a queue, in which items are removed in the same order in which they were added. The first element in is the first out.
Flash Memory	A type of nonvolatile memory. Flash memory is similar to EEPROM memory in function but it must be erased in blocks, whereas EEPROM can be erased one byte at a time.
Framing Error	With serial data transmission, a so-called frame is added to the data. This frame consists of one start bit and one or several stop bits which define the beginning and the end of a data byte. In a Jetter control, a framing error indicates that the received character has not got a valid stop bit.
Function Plan	A graphic map of the control functions. Each control job (function) is provided with a corresponding symbol.
Accuracy	The deviation between the actual position and the theoretical position
Floating Point Notation	The floating point notation is also called exponential notation. It is a numeric format that can be used to represent very large and very small numbers. Floating point numbers are stored in two parts, a mantissa and an exponent. For example, 456000 is expressed as 456E3.

Integer	<p>Also called "integral number". A positive or negative integral number, e.G. 37, -50 or 764.</p> <p>In programming, "integer" stands for a data type representing whole numbers. Calculations with integers are considerably faster than calculations with floating point numbers. Therefore, integers are commonly used for counting and numbering procedures. Integers can have a leading sign (positive or negative) or be unsigned (positive). In addition to this, distinction is made between long and short integers depending on the number of bytes they occupy in the memory.</p> <p>Short integers comprise a smaller range of numbers (e.g. - 32,768 to +32,767) than long integers do (e.g. - 2,147,483,648 to + 2,147,483,647).</p> <p>On Jetter controllers integer values are defined for a range of 24 bit = - 8 388 608 to + 8 388 607.</p>
Plaintext High-Level Language	Programming language using nonencrypted or legible text.
Ladder Diagram	Graphic representation of control functions in imitation of schematic diagrams used in contactor technology. However, current paths are horizontally located one below the other and different symbols are used.
Master	A device, e.g. a PASE-E, that controls another device, e.g. a NANO-B, called the slave.
Flag	1 bit storage position for intermediate results which are required for linkage purposes. The state of the bit is either 0 or 1.
Multiplexer	A device for funneling signals from several input lines to one output line.
Multitasking	A mode of operation offered by an operating system in which a computer works on more than one task at a time.
Monitor Mode	Using this function, registers, I/Os can be monitored and altered during operation.
Parallel Processing	A method of processing that can run only on a computer that contains two or more processors running simultaneously. Parallel processing differs from multitasking in the way a task is distributed over the available processors. Example: The process of controlling servo axes is entirely taken on by the SV module. This way, the processing time of application program is not affected.
Parity	The quality of sameness or equivalence. In the case of computers parity usually refers to an error-checking procedure. Depending on the definition, the number of 1s must always be the same - either even or odd - for each group of bits transmitted without error.

Parity error	An error in parity indicates an error in transmitted data or in data stored in memory. If a parity error occurs in communications, all or part of a message (programs) must be retransmitted.
Port Address	An address for a channel used to transmit data between an input or output device and the processor. From the CPU's point of view a port is one or more locations in memory, to which it can send data or from which it can receive data. Special hardware, such as an extension board, saves data from the device to memory addresses and sends data from these addresses to the device. Some port are meant only for input or output purposes.
Process	A program or a part of it. A related sequence of steps carried out by program.
Process level	Level of a system overriding the field level.
PROCESS-PLC	Compared with the traditional programmable logic controller an advanced control system developed by Jetter AG.
Pull-Up Resistors	A functional resistor generating defined states for measurements and evaluations. Such a resistor pulls up the potential to a high level in contrast to a pull down transistor pulling down the potential to the ground.
Register	A high-speed memory for a group of bits placed in a microprocessor or in another electronic device where data can be buffered for a specific purpose. On JETTER controllers, usually, these are 24 bit wide storage positions in a remanent RAM.
Remanent Application Registers	Registers, the information contents of which are maintained in case of a power supply interrupt.
Sensor	Electronic detector, pick-up.
Slave	A device, e.g. a NANO-B controller, which is controlled or influenced by another device called "Master", e.g. a NANO-C controller.
TASK	A stand-alone application or a subprogram that is run as an independent entity.
Time-out	The amount of time the system will wait for a peripheral device to respond before it detects and reports this as an error.
Time-sharing	The use of a computer system by more than one individual at the same time.
Token	A unique structured data object or message that circulates continuously among the nodes of a token ring and describes the current state of the network.

Valve Terminal	An array of pneumatic or hydraulic valves which are addressed via bus system. Valve terminals are used for automation jobs on the field level.
Virtual	Of or pertaining to a device, service or sensory input that is perceived to be what it is not in actuality, usually as more "real" or concrete than it actually is.
XON/XOFF	An asynchronous communications protocol in which the receiving device uses special characters to control the flow of data from the transmitting device. When the receiving device cannot continue to receive data, it transmits an XOFF control character. When transmission can resume, the device signals the sender with an XON character.

Appendix D: List of Abbreviations

AC	A lternating C urrent
A/D	A nalog/ D igital
ADC	A nalog-to- D igital C onverter
AM	A mplitude M odulation
ASCII	A merican S tandard C ode for I nformation I nterchange
COM	Device name for a serial port in Wintel systems. The first serial port is identified as COM1, the second as COM2, etc.
CPU	C entral P rocessing U nit
CSF	C ontrol S ystem F unction Chart
D/A	D igital/ A nalog
DAC	D igital-to- A nalog C onverter
DC V	D irect C urrent V oltage
DIN	D eutsches I nstitut für N ormung = German Industry Standard
DIR	D irection
EEPROM	E lectrically E rasable P rogrammable R ead O nly M emory
EMC	E lectro M agnetic C ompatibility
ENC	E ncoder
ERR	E rror
ESD	E lectro S tatical D ischarge
FIFO	F irst I n F irst O ut
Gnd	G round
HR 1	H andrad 1 = Thumbwheel 1
I/O	I nput/ O utput
IEC	I nternational E lectrotechnical C ommission
LAD	L adder D iagramm
LC	L iquid C rystal
LCD	L iquid C rystal D isplay
LED	L ight - E mitring D iode
LSB	L east S ignificant B it, e.g. of a word.
MMI	M an M achine I nterface
ms	M illisecond
NUM 25	Keyboard module for LCD 16 user interface

PASE - E	Programmierbare Ablaufsteuerungseinheit Typ E = Programmable Sequential Control, Type E
PE	Protective Earth
PELV	Protective Extra Low Voltage
PID	Proportional-Integral-Differential (Controller)
PLC	Programmable Logic Controller
PRIM	User-programmable interface
PWM	Pulse Width Modulation
RDA	Receive Data A: The first differential channel of the RS 422 interface
RDB	Receive Data B: The second differential channel of the RS 422 interface
RS 232	An accepted industry standard for serial communications connections. RS: Recommended Standard For transmission distances of up to 15 m. No differential evaluation. Transmitting and sending on different lines.
RS 422	For transmission distances over 15 m. Two lines with 2 differential evaluations each. Transmitting and sending on different lines.
RS 485	For transmission distances over 15 m. Two lines with handling of differential signals. Transmitting and sending on the same line.
RTC	Real Time Clock
RXD	Receive (RX) Data A line used to carry received serial data from one device to another.
SDA	Send Data A - The first differential channel of the RS 422 interface
SDB	Send Data B - The second differential channel of the RS 422 interface
SELV	Safe Extra Low Voltage: Voltage up to 60 V, galvanically separated from the network.
SM	Stepper Motor
SSI	Synchronous Serial Interface
STEP	Step
STL	Statement List
SUB-D	Type name of a plug-in connector
SV	Servomotor

SYMPAS	S ymbolische P rogrammablaufsprache = Symbolic Program Processing Language
tr/tn	t ime r ise/ t ime n ormal: Rise time of a pulse/total duration of a pulse
TXD	T ransmit (TX) D ata A line used to transmit received serial data from one device to another; e.g. from a computer to a modem.

Appendix E: List of Illustrations

Fig. 1:	Shielding in conformity with the EMC standards	14
Fig. 2:	Example: Connecting a LCD display to the PROCESS-PLC NANO-B	16
Fig. 3:	Power Supply Terminals	18
Fig. 4:	Block Diagram of NANO-B Interfaces	19
Fig. 5:	JETWay-H PC Board	25
Fig. 6:	SYMPAS Menu [Special -> Interface]	26
Fig. 7:	Connection Details for Digital Inputs	31
Fig. 8:	Connecting Digital Outputs	32
Fig. 9:	Connection Details for Single-/Dual-Channel Counter	33
Fig. 10:	Connection Details for Analog Inputs	34
Fig. 11:	Connection Details for Analog Output	35
Fig. 12:	Connection Details for Stepper Motor Control	36
Fig. 13:	NANO-B Stepper Motor Driving Circuit	38
Fig. 14:	Exemple: Internal Circuitry of a DIR and STEP Signal	38
Fig. 15:	Arrangement of LEDs	39
Fig. 16:	STOP/RUN Switch	40
Fig. 17:	Mounting Dimensions of the NANO-B Basic Unit	41
Fig. 18:	REGISTER_LOAD with numeric parameters	55
Fig. 19:	REGISTER_LOAD with symbolic parameters	55
Fig. 20:	Indirect and Double Indirect Addressing	56
Fig. 21:	Example for Double Indirect Addressing	57
Fig. 22:	Example of Register Arithmetic	58
Fig. 23:	Pin Assignment of Connecting Cable for Several LCD User Interfaces	77
Fig. 24:	JETWay-H for the Management Level	107
Fig. 25:	JETWay-R for the Process Level	108
Fig. 26:	Slew Rate Limitation for AD Conversion	122
Fig. 27:	Stepper Motor with Motor Control and Power Amplifier	123
Fig. 28:	Speed Profile of Acceleration/Deceleration Ramps	133
Fig. 29:	Destination Window	135
Fig. 30:	Digital Offset, Acceleration/Deceleration Stepping Rate	136
Fig. 31:	Centralised Arrangement on the JETTER System Bus	151
Fig. 32:	Decentralised Arrangement on the JETTER System Bus	151
Fig. 33:	Connecting FESTO CP Modules to the JETTER System Bus	152
Fig. 34:	Mounting Dimensions of the Digital Input Module N-ID 8	153
Fig. 35:	Diagram of Input Wiring of a N-ID8 Module	157
Fig. 36:	Physical Dimensions of the Digital Output Module N-OD 4.2	158
Fig. 37:	Example: Output Wiring of an N-OD 4.2 Module	162
Fig. 38:	Physical Dimensions of the Digital Output Module N-OD 8	163
Fig. 39:	Example: Output Wiring of an N-OD 8 Module	167
Fig. 40:	Physical Dimensions of the Digital Input and Output Module N-IO 16	168
Fig. 41:	Example: Emergency Stop Circuitry of the N-IO 16 Module	173
Fig. 42:	Example: Input Wiring of the N-IO 16 Module	174
Fig. 43:	Physical Dimensions of the Analog Input Module N-IA 4	176
Fig. 44:	Diagram of Input Wiring of an N-IA4 Module	182
Fig. 45:	Physical Dimensions of the Analog Output Module N-OA 2	187
Fig. 46:	Physical Dimensions of the Analog Output Module N-OA 4	188
Fig. 47:	Example: Wiring of Outputs of the N-OA 4 Module	192
Fig. 48:	Physical Dimensions of the Digital Counter Module N-CNT 1	197
Fig. 49:	Example: Input Wiring of the N-CNT 1 Module	201
Fig. 50:	Pulse sequence of counting signals	206
Fig. 51:	Physical Dimensions of the Serial Interface Module N-SER 1	212
Fig. 52:	Block Diagram of Interfaces of the N-SER 1 module	216
Fig. 53:	Physical Dimensions of the Parallel Interface Module N-PRN 1	227

Fig. 54: Mounting Dimensions of the N-PS 1 Module	237
Fig. 55: Physical Dimensions of the N-PS 1CP Module	238
Fig. 56: Connections of the N-PS 1 Module	242
Fig. 57: Connections of the N-PS 1CP Module	243
Fig. 58: Example: FESTO CP Module	244
Fig. 59: Physical Dimensions of the FESTO Tee Connector	244
Fig. 60: Connection of FESTO CP Modules to the JETTER System Bus (bus topology)	245
Fig. 61: Connection of FESTO CP Modules to the JETTER System Bus via Tap Lines	246
Fig. 62: Flowchart for Commissioning NANO-B/C with FESTO CP Modules	248
Fig. 63: Setting Configuration of FESTO CP Modules	249
Fig. 64: Comparison of Set Configuration with Actual Configuration	250
Fig. 65: Register Configuration of FESTO CP Modules	253
Fig. 66: Example: FESTO CP Modules connected to the JETTER System Bus	255
Fig. 67: Error Message: Time-out	258
Fig. 68: Resetting Register 2008	258
Fig. 69: Autoflash Settings in the SYMPAS Program	261
Fig. 70: SYMPAS Programming Interface	268

Appendix F: Index

A

Accuracy Classes of the N-IA 4 Module	181
Air Humidity	44
Altitude	44
Ambient Temperature	44
Analog Input	121
Analog Output	120
Arc Cosin	266
Arc Sin	266
Arc Tangens	266
Autoflash	260

B

Binary code	204
Bit-specific Functions of Register 2818	93

C

CAN-BUS	30
Centronics Interface	227
Class of Protection	45
Corrosion	44
Cosine	265
Cursor Position	79

D

Damages in transit and storage	45
Degree of Protection	45
DELEOL	80
DELSCR	80
Device Number	78
Dielectric Test Voltage	45
Digital Inputs	31
Digital Outputs	32
DIN Rail	45
DIP switch	26
Disposal	11

E

EMC	
NANO-B Basic Unit	46
N-CNT 1 Module	199
N-IA 4 Module	179
N-ID 8 Module	155
N-IO 16 Module	170
N-OA 2 Module	190
N-OA 4 Module	190, 199, 229
N-OD 4.2 Module	160
N-OD 8 Module	165
N-PRN 1 Module	229
N-PS 1 Module	240
N-PS 1CP Module	240
N-SER 1 Module	214
EM-DK Cable for LCD 9, LCD 10 and LCD 12	23
Error Messages via Special Flags	263
Exponential function	266

F

FESTO CP Module Types	252
FESTO CP Valve Terminal	244
Firmware	220
Flag 2057	100
Free Falls Withstanding Test	45
Fully metallised housing	14

G

Gray code	204
-----------	-----

H

Hardware Flow Control	223
Hardware-Handshake	22

I

Installation Accessories	17
Installation Sequence	16
Interface for LCD Displays	23

J

JETWay-H Cable	24
----------------	----

JETWay-R Cable	27	Pulse Number	209
M		R	
Maintenance	11	Register	
Monitor Mode	76	10000	143
Mounting Position	45	10001	143
		10002	144
		10003	144
		10004	144
		10005	145
NANO-B Basic Unit - Terminals	43	10006	145
Natural Logarithm	266	11100	127
Network Interface JETWay-R	27	11101	128
Networking of lines	244	11102	130
		11103	131
		11104	132
		11105	133
Open Collector	38	11106	134
Operating Conditions	44	11107	134
Output Driver	173	11108	135
Overlaying		11109	136
		11110	137
Flags on registers	111	11112	137
Inputs-Register	111	2001	259
Overlaying of flags on registers	50	2008	262
Overview		2009	260
		2017	251
Network Registers	112	2018	251
Real-Time Clock Registers	148	2019	251
Special Flags	52	2020	252
Special Registers	61	2021	253
User Interfaces	74	2027	254
Overvoltage Category	45	2700	113
		2701	113
		2702	113
		2703	114
Parity check	204	2704	114
Parity error	210	2705	114
Pin Assignment - 15 pin male SUB-D connector	21	2706	115
		2707	115
		2708	115
Pin Assignment - 9 pin male SUB-D connector	20	2709	116
		2710	116
Pollution Degree	44	2711	116
Programming Cable EM-PK	22	2804	87
Programming Instruction		2805	87
REG	58	2806	87
REGDEC and REGINC	60	2807	84, 88
REGZERO	59	2808	85, 88
		2809	83, 89
Programming interface		2810	83, 89
JETWay-H	24	2812	90
RS232	22	2813	90
Programming with the Aid of Flags	51	2814	91

2815	86, 91	Shock Resistance	45
2816	92	Sine	265
2819	94	Single-/Dual-Channel Counter	33
2820	94	Software Flow Control	223
2821	95	Special Flags	52
2822	95	Special functions	265
2823	96	Square root	265
2824	96	SSI Absolute Position En-	
2825	96	coder	202, 216, 231
2826	97	STEP and DIR Signals	38
2827	97	Storage temperature	44
2828	97	SYMPAS Menu	26
2829	97	System Bus Cable for NANO	
2830	97	Expansion Modules	30
2831	98		
2832	98		
2833	98		
2834	99		
2835	99		
2836	99		
2900	117, 120	Tangent	265
2901	117	Tap Lines	244
2902	120	Technical Data - Basic Unit	41
2903 - 2906	121	The JETWay-H board for PC's	25
2918	118	Time Base	61, 69, 94, 118
2919	118		
2920	121		
3yy0	185, 195, 207		
3yy1	185, 195, 207		
3yy2	185, 195, 207, 220	Usage as Agreed Upon	11
3yy3	186, 196, 207, 221	Usage Other Than Agreed Upon	11
3yy4	208, 221	User Flags	50
3yy5	208, 221	User Interface Cable DK-422	28
3yy6	209, 222	User Interface Port	28
3yy7	210	User-Programmable Inter-	
3yy8	211	face	143, 213
3yy9	186, 196, 211, 222, 234		
Residual Dangers	15		
S			
Scope of Supply	16		
Servo Control	208		
Shielding in conformity with the EMC standards	14		
T			
U			
V			
		VIADUKT Cable	29
		Vibration Resistance	45
		Visualisation Interface	29



Jetter AG

Gräterstrasse 2
D-71642 Ludwigsburg

Germany

Phone: +49 7141 2550-530
Fax: +49 7141 2550-484
Internet: <http://www.jetter.de>
E-mail: sales@jetter.de

Subsidiaries

Jetter UK Ltd.

43 Leighswood Road Aldridge
GB-West Midlands WS9 8AH

Great Britain

Phone: +44 1922 745200
Fax: +44 1922 745045
E-mail: jetteruk@btinternet.com

Jetter Asia Pte. Ltd.

32 Ang Mo Kio Industrial Park 2
#07-03 Sing Industrial Complex
Singapore 569510

Singapore

Phone: +65 4838200
Fax: +65 4833881
E-mail: sales@jetter.com.sg

Jetter AG Switzerland

Münchwilerstrasse 19
CH-9554 Täggerschen

Switzerland

Phone: +41 719 1879-50
Fax: +41 719 1879-69
E-mail: info@jetterag.ch

Jetter USA Inc.

165 Ken Mar Industrial Parkway
Broadview Heights
OH 44147-2950

U.S.A

Phone: +1 440 8380860
Fax: +1 440 8380861
E-mail: bernd@jetterus.com

Branches

Jetter AG Büro Nord

Am Nordbahnhof 5
D-59555 Lippstadt

Germany

Phone: +49 2941 6691-10
Fax: +49 2941 6691-22
E-mail: dschnelle@jetter.de

Jetter AG Büro Ost

Gewerbepark am Wald 3d
D-98693 Ilmenau

Germany

Phone: +49 3677 2000-54
Fax: +49 3677 2000-55
E-mail: mjakob@jetter.de

Jetter AG Büro Süd

Am Pulverl 5
D-85051 Ingolstadt

Germany

Phone: +49 841 97149-30
Fax: +49 841 97149-40
E-mail: mkos@jetter.de

Jetter AG Büro Netherlands

Amperestraat 10
NL-4004 KB Tiel

Netherlands

Phone: +31 344654-944
Fax: +31 344654-932
E-mail: ddeijs@jetter.de

Jetter AG Büro Mitte

Wohnbacher Strasse 19
D-61200 Wölfersheim

Germany

Phone: +49 6036 984382
Fax: +49 6036 984383
E-mail: jpommerening@jetter.de