

SINAMICS G120

Frequency converters with the Control Units

CU230P-2 HVAC

CU230P-2 DP

CU230P-2 CAN

Operating instructions · 01 2011

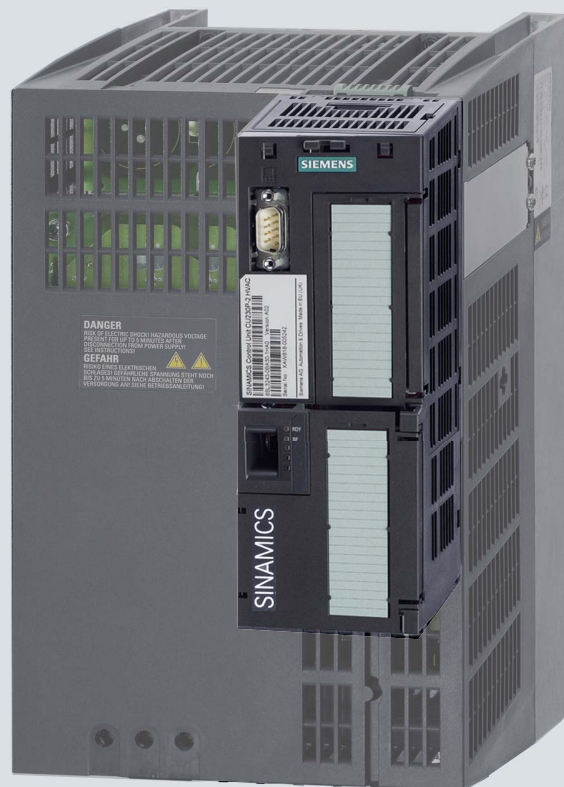

SINAMICS

Answers for industry.

SIEMENS

SIEMENS

SINAMICS

SINAMICS G120 Frequency inverters with Control Units CU230P-2 HVAC, CU230P-2 DP, CU230P-2 CAN Operating Instructions

Change history

Introduction	1
Description	2
Installing	3
Commissioning	4
Adapting the terminal strip	5
Configuring the fieldbus	6
Functions	7
Service and maintenance	8
Alarms, faults and system messages	9
Technical data	10
Appendix	A

Edition 01/2011, Firmware V4.4

Legal information

Warning notice system

This manual contains notices you have to observe in order to ensure your personal safety, as well as to prevent damage to property. The notices referring to your personal safety are highlighted in the manual by a safety alert symbol, notices referring only to property damage have no safety alert symbol. These notices shown below are graded according to the degree of danger.

 DANGER
indicates that death or severe personal injury will result if proper precautions are not taken.

 WARNING
indicates that death or severe personal injury may result if proper precautions are not taken.

 CAUTION
with a safety alert symbol, indicates that minor personal injury can result if proper precautions are not taken.

CAUTION
without a safety alert symbol, indicates that property damage can result if proper precautions are not taken.

NOTICE
indicates that an unintended result or situation can occur if the corresponding information is not taken into account.

If more than one degree of danger is present, the warning notice representing the highest degree of danger will be used. A notice warning of injury to persons with a safety alert symbol may also include a warning relating to property damage.

Qualified Personnel

The product/system described in this documentation may be operated only by **personnel qualified** for the specific task in accordance with the relevant documentation for the specific task, in particular its warning notices and safety instructions. Qualified personnel are those who, based on their training and experience, are capable of identifying risks and avoiding potential hazards when working with these products/systems.

Proper use of Siemens products

Note the following:

 WARNING
Siemens products may only be used for the applications described in the catalog and in the relevant technical documentation. If products and components from other manufacturers are used, these must be recommended or approved by Siemens. Proper transport, storage, installation, assembly, commissioning, operation and maintenance are required to ensure that the products operate safely and without any problems. The permissible ambient conditions must be adhered to. The information in the relevant documentation must be observed.

Trademarks

All names identified by ® are registered trademarks of the Siemens AG. The remaining trademarks in this publication may be trademarks whose use by third parties for their own purposes could violate the rights of the owner.

Disclaimer of Liability

We have reviewed the contents of this publication to ensure consistency with the hardware and software described. Since variance cannot be precluded entirely, we cannot guarantee full consistency. However, the information in this publication is reviewed regularly and any necessary corrections are included in subsequent editions.

Change history

Important changes with respect to the manual Edition 07/2010

New functions in firmware V4.4	In Chapter
Predefined settings for the converter interfaces	<ul style="list-style-type: none"> Installing Control Unit (Page 44)
Two- and three-wire control via terminal block	<ul style="list-style-type: none"> Inverter control (Page 185)
Unit changeover	<ul style="list-style-type: none"> Application-specific functions (Page 219)
Expanded options for controlling DC braking	<ul style="list-style-type: none"> Braking functions of the converter (Page 225)
Automatic restart expanded by a new mode	<ul style="list-style-type: none"> Automatic restart and flying restart (Page 237)
Trace via STARTER	<ul style="list-style-type: none"> Commissioning with STARTER (Page 68)

Revised descriptions	In Chapter
The description of the PM240-2 and PM250-2 Power Modules has been removed. It is expected that this Power Module will be released with firmware V4.5.	<ul style="list-style-type: none"> Installing Power Module (Page 30) Technical data, Power Modules (Page 305)
Connecting up the terminal strip	<ul style="list-style-type: none"> Installing Control Unit (Page 44) Adapting the terminal strip (Page 85)
USB interface settings for commissioning with STARTER.	<ul style="list-style-type: none"> Commissioning with STARTER (Page 68)
Slave-to-slave communication via PROFIBUS DP	<ul style="list-style-type: none"> Communication via PROFIBUS (Page 98) Application examples (Page 323)
Acyclic communication via PROFIBUS DP (data set 47)	<ul style="list-style-type: none"> Acyclic communication (Page 113) Application examples (Page 323)
Connection of the converter to CANopen	<ul style="list-style-type: none"> Configuring the fieldbus (Page 97)
Function overview	<ul style="list-style-type: none"> Functions (Page 183)

Table of contents

	Change history	3
1	Introduction.....	11
1.1	About this manual	11
1.2	Guide through this manual.....	12
1.3	Adapting inverter to application.....	13
1.3.1	General basics	13
1.3.2	Parameter	13
1.4	Frequently required parameters.....	14
1.5	Extended scope for adaptation	16
1.5.1	BICO technology: basic principles	16
1.5.2	BICO technology: example	18
2	Description.....	21
2.1	Modularity of the converter system	21
2.2	Control Units	24
2.3	Power Module	25
2.4	Reactors and filters	26
3	Installing	27
3.1	Procedure for installing the frequency inverter	27
3.2	Installing reactors and filters	28
3.3	Installing Power Module.....	30
3.3.1	Dimensions, hole drilling templates, minimum clearances, tightening torques	31
3.3.2	Connection overview for Power Modules	35
3.3.3	Connecting the line supply and motor	36
3.3.4	EMC-compliant connection.....	39
3.3.5	EMC-compliant installation for devices with degree of protection IP55 / UL Type 12.....	42
3.4	Installing Control Unit.....	44
3.4.1	Interfaces, connectors, switches, control terminals, LEDs on the CU	46
3.4.2	Terminal strips of the CU	47
3.4.3	Selecting the interface assignments	48
3.4.4	Wiring terminal strips	51
4	Commissioning	53
4.1	Restoring the factory setting	55
4.2	Preparing for commissioning	56
4.2.1	Inverter factory setting	58
4.2.2	Defining requirements for the application	59
4.3	Commissioning with factory settings.....	60

4.3.1	Wiring examples for the factory settings	61
4.4	Commissioning with the BOP-2	63
4.4.1	Menu structure	64
4.4.2	Freely selecting and changing parameters	65
4.4.3	Basic commissioning.....	66
4.4.4	Additional settings	67
4.5	Commissioning with STARTER	68
4.5.1	Adapting the USB interface.....	69
4.5.2	Generating a STARTER project.....	70
4.5.3	Go online and perform the basic commissioning	70
4.5.4	Making additional settings.....	74
4.5.5	Trace function for optimizing the drive	75
4.6	Data backup and standard commissioning	78
4.6.1	Backing up and transferring settings using a memory card.....	79
4.6.1.1	Saving setting on memory card	79
4.6.1.2	Transferring the setting from the memory card.....	81
4.6.1.3	Safely remove the memory card	82
4.6.2	Backing up and transferring settings using STARTER.....	83
4.6.3	Saving settings and transferring them using an operator panel	83
4.6.4	Other ways to back up settings.....	83
5	Adapting the terminal strip	85
5.1	Preconditions	85
5.2	Digital inputs.....	86
5.3	Digital outputs	88
5.4	Analog inputs	89
5.5	Analog outputs	93
6	Configuring the fieldbus	97
6.1	Communication via PROFIBUS	98
6.1.1	Configuring communication to the control.....	98
6.1.2	Setting the address	99
6.1.3	Basic settings for communication	100
6.1.4	Cyclic communication	101
6.1.4.1	Control and status word 1	102
6.1.4.2	Control and status word 3	105
6.1.4.3	Data structure of the parameter channel	107
6.1.4.4	Slave-to-slave communication	112
6.1.5	Acyclic communication.....	113
6.1.5.1	Reading and changing parameters via data set 47	113
6.2	Communication via RS485.....	118
6.2.1	Integrating inverters into a bus system via the RS485 interface.....	118
6.2.2	Communication via USS	119
6.2.2.1	Setting the address	119
6.2.2.2	Basic settings for communication	120
6.2.2.3	Structure of a USS telegram	120
6.2.2.4	User data range of the USS telegram.....	122
6.2.2.5	Data structure of the USS parameter channel.....	123

6.2.2.6	USS read request	128
6.2.2.7	USS write job	129
6.2.2.8	USS process data channel (PZD).....	130
6.2.2.9	Time-out and other errors	130
6.2.3	Communication over Modbus RTU.....	133
6.2.3.1	Setting the address	134
6.2.3.2	Basic settings for communication	134
6.2.3.3	Modbus RTU telegram.....	135
6.2.3.4	Baud rates and mapping tables	136
6.2.3.5	Write and read access via FC 3 and FC 6.....	139
6.2.3.6	Communication procedure.....	141
6.2.4	Communication via BACnet MS/TP	143
6.2.4.1	Setting the address	144
6.2.4.2	Basic settings for communication	144
6.2.4.3	Supported services and objects.....	145
6.3	Communication over CANopen	152
6.3.1	CANopen functionality of the converter	153
6.3.2	Commissioning CANopen.....	154
6.3.2.1	Setting the node ID and baud rate.....	154
6.3.2.2	Monitoring the communication and response of the inverter.....	155
6.3.2.3	SDO services	156
6.3.2.4	Access to SINAMICS parameters via SDO	159
6.3.2.5	PDO and PDO services	161
6.3.2.6	Predefined connection set	165
6.3.2.7	Free PDO mapping.....	166
6.3.3	Other CANopen functions	167
6.3.3.1	Network management (NMT service).....	167
6.3.4	Object directories	170
6.3.4.1	Free objects	177
6.3.4.2	Objects in drive profile DSP402.....	178
6.3.5	Configuration example.....	179
7	Functions.....	183
7.1	Overview of the inverter functions.....	183
7.2	Inverter control	185
7.2.1	Two-wire control: method 1.....	186
7.2.2	Two-wire control, method 2.....	187
7.2.3	Two-wire control, method 3.....	188
7.2.4	Three-wire control, method 1	189
7.2.5	Three-wire control, method 2.....	190
7.2.6	Switching over the inverter control (command data set)	191
7.3	Command sources.....	194
7.4	Setpoint sources	195
7.4.1	Analog input as setpoint source.....	195
7.4.2	Motorized potentiometer as setpoint source.....	196
7.4.3	Fixed speed as setpoint source	198
7.4.4	Running the motor in jog mode (JOG function)	200
7.4.5	Specifying the motor speed via the fieldbus	201
7.5	Setpoint calculation.....	202
7.5.1	Minimum speed and maximum speed.....	202

7.5.2	Ramp-function generator	203
7.6	Motor control	204
7.6.1	V/f control	206
7.6.1.1	V/f control with linear and square-law characteristic.....	206
7.6.1.2	Additional characteristics for the V/f control.....	207
7.6.1.3	Optimizing with a high break loose torque and brief overload	208
7.6.2	Vector control	210
7.6.2.1	Properties of vector control	210
7.6.2.2	Commissioning vector control.....	210
7.6.2.3	Torque control	211
7.7	Protection functions.....	212
7.7.1	Inverter temperature monitoring.....	212
7.7.2	Motor temperature monitoring using a temperature sensor.....	213
7.7.3	Protecting the motor by calculating the motor temperature	215
7.7.4	Overcurrent protection	215
7.7.5	Limiting the maximum DC link voltage.....	216
7.8	Status messages.....	218
7.8.1	System runtime	218
7.9	Application-specific functions	219
7.9.1	Unit changeover	219
7.9.1.1	Changing over the motor standard	220
7.9.1.2	Changing over the unit system	221
7.9.1.3	Changing over process variables for the technology controller	222
7.9.1.4	Changing of the units with STARTER.....	223
7.9.2	Braking functions of the converter	225
7.9.2.1	Comparison of electrical braking methods.....	225
7.9.2.2	DC braking	228
7.9.2.3	Compound braking.....	232
7.9.2.4	Dynamic braking	234
7.9.2.5	Braking with regenerative feedback to the line	236
7.9.3	Automatic restart and flying restart	237
7.9.3.1	Flying restart – switching on while the motor is running	237
7.9.3.2	Automatic switch-on	239
7.9.4	PID technology controller	243
7.9.5	Load torque monitoring (system protection)	244
7.9.6	Load failure monitoring via digital input.....	246
7.9.7	Real time clock (RTC).....	247
7.9.8	Time switch (DTC)	249
7.9.9	Temperature sensing using temperature-dependent resistors	250
7.9.10	Essential service mode	252
7.9.11	Multi-zone control.....	257
7.9.12	Cascade control	261
7.9.13	Bypass.....	265
7.9.14	Energy-saving mode	269
7.9.15	Logical and arithmetic functions using function blocks	275
7.10	Switchover between different settings	279

8	Service and maintenance	281
8.1	Overview of replacing converter components.....	281
8.2	Replacing the Control Unit.....	282
8.2	Replacing the Power Module.....	284
9	Alarms, faults and system messages.....	285
9.1	Operating states indicated on LEDs	286
9.2	Alarms	288
9.3	Faults	291
9.4	List of alarms and faults	296
10	Technical data	303
10.1	Technical data for CU230P-2.....	303
10.2	Technical data, Power Modules.....	305
10.2.1	Technical data, PM230	307
10.2.2	Technical data, PM240	312
10.2.3	Technical data, PM250	318
10.2.4	Technical data, PM260	321
A	Appendix.....	323
A.1	Application examples	323
A.1.1	Configuring communication in STEP 7	323
A.1.1.1	Task	323
A.1.1.2	Required components.....	323
A.1.1.3	Creating a STEP 7 project	324
A.1.1.4	Configuring communications to a SIMATIC control	325
A.1.1.5	Inserting the inverter into the STEP 7 project.....	326
A.1.2	STEP 7 program examples.....	328
A.1.2.1	STEP 7 program example for cyclic communication	328
A.1.2.2	STEP 7 program example for acyclic communication	330
A.1.3	Configuring slave-to-slave communication in STEP 7.....	334
A.2	Additional information on the inverter	336
A.2.1	Manuals for your inverter	336
A.3	Mistakes and improvements	338
	Index.....	339

Introduction

1.1 About this manual

Who requires the operating instructions and what for?

These operating instructions primarily address fitters, commissioning engineers and machine operators. The operating instructions describe the devices and device components and enable the target groups being addressed to install, connect-up, parameterize, and commission the inverters safely and in the correct manner.

What is described in the operating instructions?

These operating instructions provide a summary of all of the information required to operate the inverter under normal, safe conditions.

The information provided in the operating instructions has been compiled in such a way that it is sufficient for all standard applications and enables drives to be commissioned as efficiently as possible. Where it appears useful, additional information for entry level personnel has been added.

The operating instructions also contain information about special applications. Since it is assumed that readers already have a sound technical knowledge of how to configure and parameterize these applications, the relevant information is summarized accordingly. This relates, e.g. to operation with fieldbus systems and safety-related applications.

1.2 Guide through this manual

In this manual, you will find background information on your inverter, as well as a full description of the commissioning procedure:

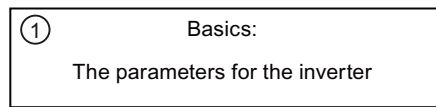

- ① Should you be unfamiliar with assigning parameters to the inverter, background information can be found here:
- Adapting inverter to application (Page 13)
 - Frequently required parameters (Page 14)
 - Extended scope for adaptation (Page 16)

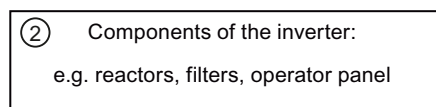

- ② Information on the inverter hardware can be found here:
- Modularity of the converter system (Page 21)

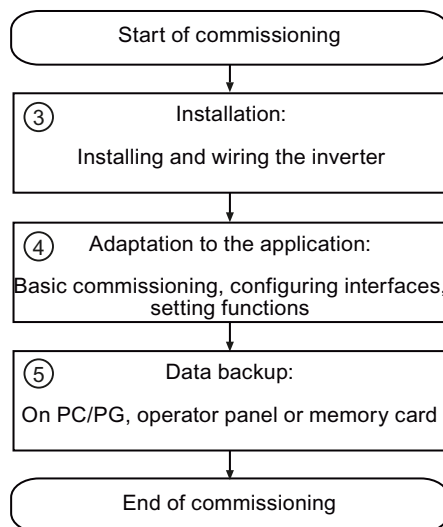

All information relating to the commissioning of your inverter is located in the following chapters:

- ③ • Procedure for installing the frequency inverter (Page 27)
- ④ • Commissioning (Page 53)
• Adapting the terminal strip (Page 85)
• Configuring the fieldbus (Page 97)
- ⑤ • Data backup and standard commissioning (Page 78)

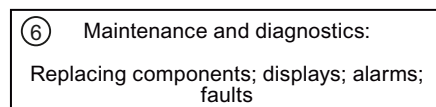

- ⑥ Information regarding the maintenance and diagnostics of your inverter is located in the following chapters:
- Service and maintenance (Page 281)
 - Alarms, faults and system messages (Page 285)

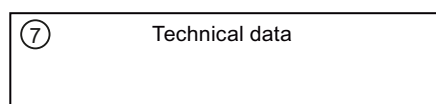

- ⑦ The most important technical data for your inverter is located in this chapter:
- Technical data (Page 303)

1.3 Adapting inverter to application

1.3.1 General basics

Inverters are used to improve and extend the starting and speed response of motors.

Adapting the inverter to the drive task

The inverter must match the motor that it is controlling and the drive task to be able to optimally operate and protect the motor.

Although the inverter can be parameterized for very specific applications, many standard applications function satisfactorily with just a few adaptations.

Use the factory settings (where possible)

In simple applications, the inverter already functions with its factory settings.

Only basic commissioning is required ... for simple, standard applications

Most standard applications function after just a few adaptations made during the basic commissioning.

1.3.2 Parameter

Parameters are the interface between the firmware of the inverter and the commissioning tool, e.g. an operator panel.

Adjustable parameters

Adjustable parameters are the "adjusting screws" with which you adapt the inverter to its particular application. If you change the value of an adjustable parameter, then the inverter behavior also changes.

Adjustable parameters are shown with a "p" as prefix, e.g. p1082 is the parameter for the maximum motor speed.

Display parameters

Display parameters allow internal measured quantities of the inverter and the motor to be read.

Display parameters are shown with a "r" as prefix, e.g. r0027 is the parameter for the inverter output current.

1.4 Frequently required parameters

Parameters that in many cases help

Table 1- 1 How to switch to commissioning mode or restore the factory setting

Parameter	Description
p0010	Commissioning parameters 0: Ready (factory setting) 1: Carry out basic commissioning 3: Perform motor commissioning 5: Technological applications and units 15: Define number of data records 30: Factory setting - initiate restore factory settings

Table 1- 2 How to determine the firmware version of the Control Unit

Parameter	Description
r0018	The firmware version is displayed:

Table 1- 3 How to select the command and setpoint sources for the inverter

Parameter	Description
p0015	Additional information is available in the section Selecting the interface assignments (Page 48).

Table 1- 4 This is how you parameterize the up and down ramps

Parameter	Description
p1080	Minimum speed 0.00 [rpm] factory setting
p1082	Maximum speed 1500.000 [rpm] factory setting
p1120	Rampup time 10.00 [s]
p1121	Rampdown time 10.00 [s]

Table 1- 5 This is how you set the closed-loop type

Parameter	Description
p1300	0: V/f control with linear characteristic 1: V/f control with linear characteristic and FCC 2: V/f control with parabolic characteristic 3: V/f control with parameterizable characteristic 4: V/f control with linear characteristic and ECO 5: V/f control for drives requiring a precise frequency (textile area) 6: V/f control for drive requiring a precise frequency and FCC 7: V/f control with parabolic characteristic and ECO 19: V/f control with independent voltage setpoint 20: Speed control (without encoder) 22: Torque control (without encoder)

Table 1- 6 This is how you optimize the starting behavior of the V/f control for a high break loose torque and overload

Parameter	Description
p1310	Voltage boost to compensate ohmic losses The voltage boost is active from standstill up to the rated speed. It is at its highest at speed 0 and continually decreases as the speed increases. Value of the voltage boost at zero speed 0 in V: $1.732 \times \text{rated motor current (p0305)} \times \text{stator resistance (r0395)} \times \text{p1310} / 100\%$
p1311	Voltage boost when accelerating The voltage boost is effective from standstill up to the rated speed. It is independent of the speed and has a value in V of: $1.732 \times \text{rated motor current (p0305)} \times \text{stator resistance (p0350)} \times \text{p1311} / 100\%$
p1312	Voltage boost when starting Setting to additionally boost the voltage when starting, however only when accelerating for the first time.

1.5 Extended scope for adaptation

1.5.1 BICO technology: basic principles

Principle of operation of BICO technology

Open/closed-loop control functions, communication functions as well as diagnostic and operator functions are implemented in the inverter. Every function comprises one or several BICO blocks that are interconnected with one another.

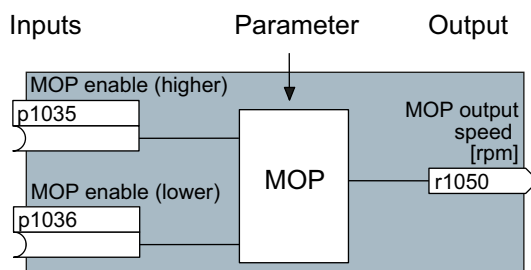

Figure 1-1 Example of a BICO block: Motorized potentiometer (MOP)

Most of the BICO blocks can be parameterized. You can adapt the blocks to your application using parameters.

You cannot change the signal interconnection within the block. However, the interconnection between blocks can be changed by interconnecting the inputs of a block with the appropriate outputs of another block.

The signal interconnection of the blocks is realized, contrary to electric circuitry, not using cables, but in the software.

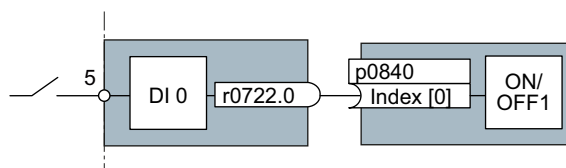

Figure 1-2 Example: Signal interconnection of two BICO blocks for digital input 0

Binectors and connectors

Connectors and binectors are used to exchange signals between the individual BICO blocks:

- Connectors are used to interconnect "analog" signals. (e.g. MOP output speed)
- Binectors are used to interconnect "digital" signals. (e.g. 'Enable MOP up' command)

Definition of BICO technology

BICO technology represents a type of parameterization that can be used to disconnect all internal signal interconnections between BICO blocks or establish new connections. This is realized using **Binectors** and **Connectors**. Hence the name **BICO** technology. (Binector Connector Technology)

BICO parameters

You can use the BICO parameters to define the sources of the input signals of a block. Using BICO parameters you define from which connectors and binectors a block reads-in its input signals. This is how you "interconnect" the blocks stored in the devices according to your particular application requirements. The five different BICO parameter types are shown in the following diagram:

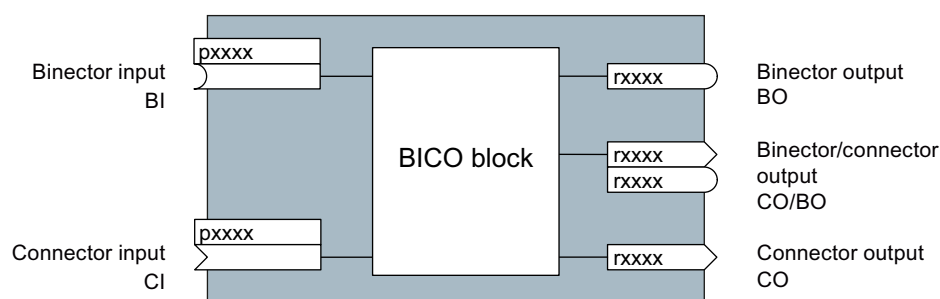

Figure 1-3 BICO symbols

Binector/connector outputs (CO/BO) are parameters that combine more than one binector output in a single word (e.g. r0052 CO/BO: status word 1). Each bit in the word represents a digital (binary) signal. This summary reduces the number of parameters and simplifies parameter assignment.

BICO outputs (CO, BO, or CO/BO) can be used more than once.

When do you need to use BICO technology?

BICO technology allows you to adapt the inverter to a wide range of different requirements. This does not necessarily have to involve highly complex functions.

Example 1: Assign a different function to a digital input.

Example 2: Switch the speed setpoint from the fixed speed to the analog input.

What precautions should you take when using BICO technology?

Always apply caution when handling internal interconnections. Note which changes you make as you go along since the process of analyzing them later can be quite difficult.

The STARTER commissioning tool offers various screens that make it much easier for you to use BICO technology. The signals that you can interconnect are displayed in plain text, which means that you do not need any prior knowledge of BICO technology.

What sources of information do you need to help you set parameters using BICO technology?

- This manual is sufficient for simple signal interconnections, e.g. assigning a different significance to the to digital inputs.
- The parameter list in the List Manual is sufficient for signal interconnections that go beyond just simple ones.
- You can also refer to the function diagrams in the List Manual for complex signal interconnections.

1.5.2 BICO technology: example

Example: Shifting a basic PLC functionality into the converter

A conveyor system is to be configured in such a way that it can only start when two signals are present simultaneously. These could be the following signals, for example:

- The oil pump is running (the required pressure level is not reached, however, until after five seconds)
- The protective door is closed

The task is realized by inserting free blocks between the digital input 0 and the internal ON/OFF1 command and interconnecting them.

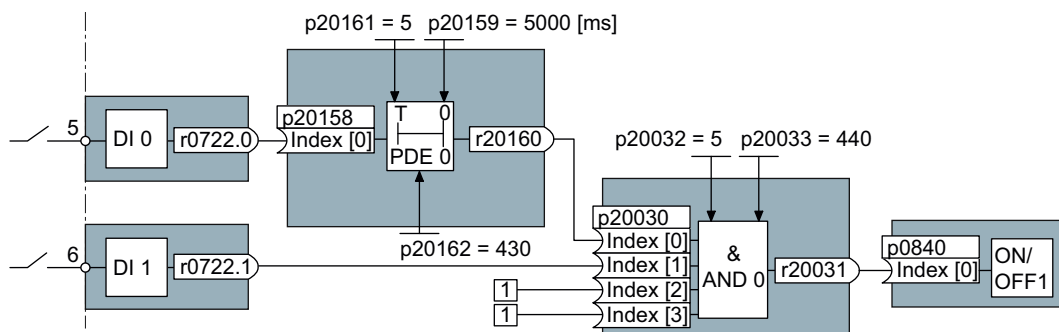

Figure 1-4 Example: Signal interconnection for interlock

The signal of digital input 0 (DI 0) is fed through a time block (PDE 0) and is interconnected with the input of a logic block (AND 0). The signal of digital input 1 (DI 1) is interconnected to the second input of the logic block. The logic block output issues the ON/OFF1 command to switch-on the motor.

Table 1- 7 Parameterizing an interlock

Parameter	Description
P20161 = 5	The time block is enabled by assigning to runtime group 5 (time slice of 128 ms)
P20162 = 430	Run sequence of the time block within runtime group 5 (processing before the AND logic block)
P20032 = 5	The AND logic block is enabled by assigning to runtime group 5 (time slice of 128 ms)
P20033 = 440	Run sequence of the AND logic block within runtime group 5 (processing after the time block)
P20159 = 5000.00	Setting the delay time [ms] of the time module: 5 seconds
P20158 = 722.0	Connect the status of DI 0 to the input of the time block r0722.0 = Parameter that displays the status of digital input 0.
P20030 [0] = 20160	Interconnecting the time block to the 1st input of the AND
P20030 [1] = 722.1	Interconnecting the status of DI 1 to the 2nd AND input r0722.1 = Parameter that displays the status of digital input 1.
P0840 = 20031	Interconnecting the AND output to the control command ON/OFF1

Explanation of the example using the ON/OFF1 command

Parameter P0840[0] is the input of the "ON/OFF1 command" block of the converter.
Parameter r20031 is the output of the AND block. To interconnect the ON/OFF1 command with the output of the AND block, set P0840 to 20031.

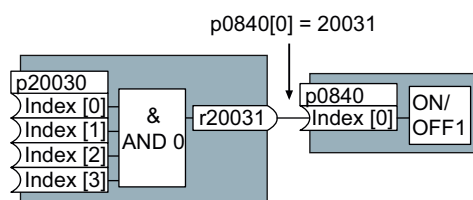

Figure 1-5 Interconnecting two BICO blocks by setting p0840[0] = 20031

Principle when connecting BICO blocks using BICO technology

An interconnection between two BICO blocks comprises a connector or binector and a BICO parameter. The interconnection is always established from the perspective of the input of a particular BICO block. This means that the output of an upstream block must always be assigned to the input of a downstream block. The assignment is always made by entering the number of the connector/binector from which the required input signals are read in a BICO parameter.

This interconnection logic involves the question: **where does the signal come from?**

Description

2.1 Modularity of the converter system

Thanks to their modular design, the converters can be used in a wide range of applications with respect to functionality and power.

The following overview describes the converter components, which you require for your application.

Main components of the converter

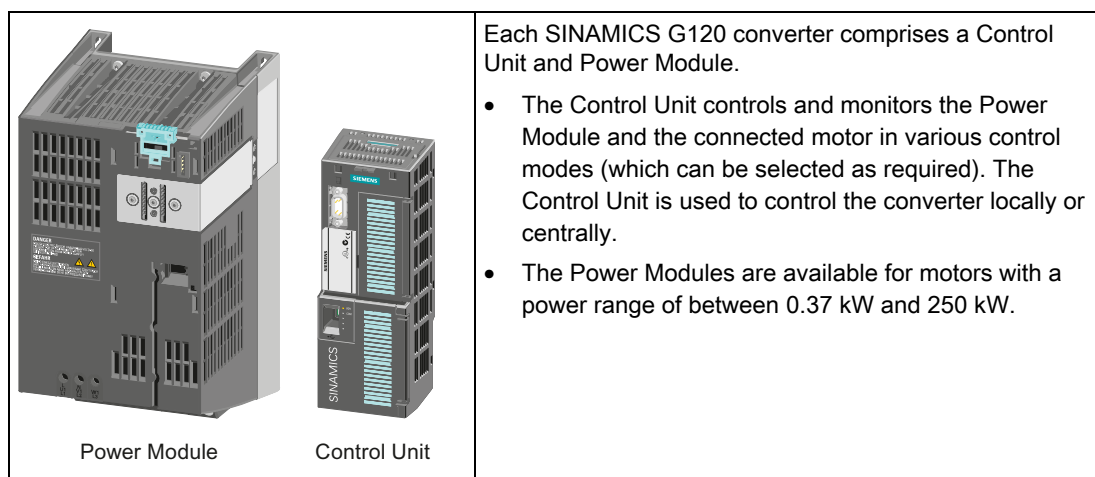

Tools to commission the inverter

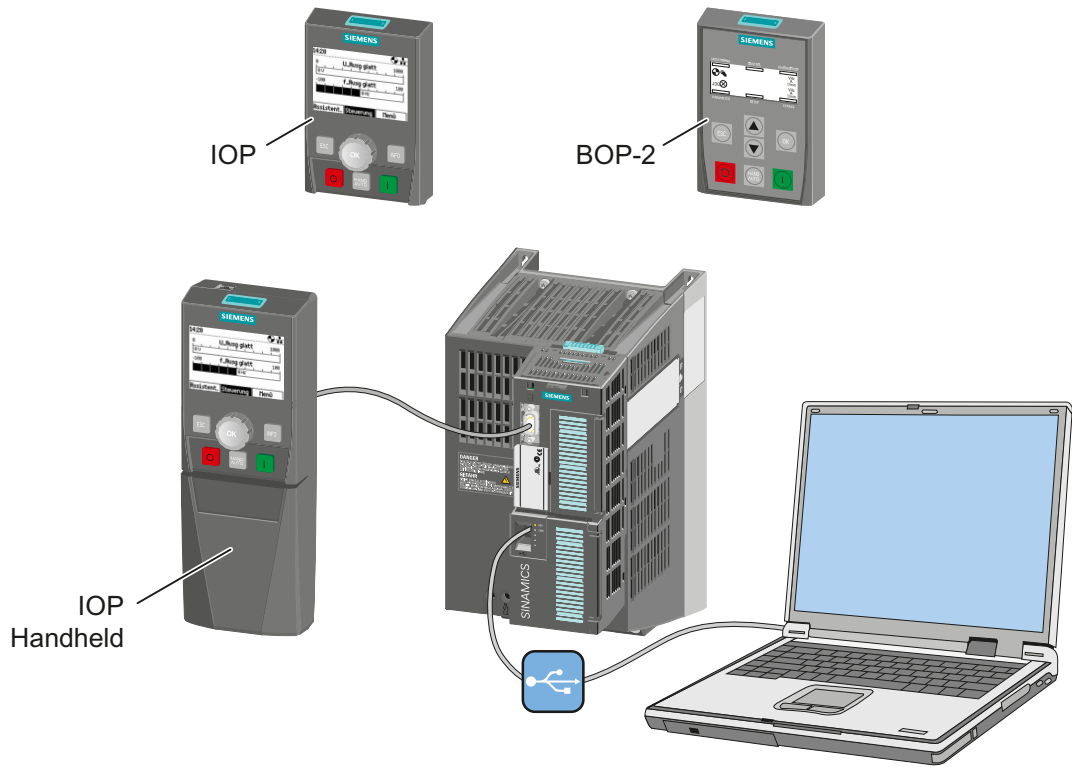



Figure 2-1 Tools to commission the inverter

Table 2- 1 Components and tools for commissioning and data backup

Component or tool		Order number
Operator panel for commissioning, diagnostics and controlling frequency converters	BOP-2 - for snapping onto the frequency converter <ul style="list-style-type: none"> Copies drive parameters Two-line display Guided commissioning 	6SL3255-0AA00-4CA1
	IOP - to snap onto the frequency converter or with the handheld <ul style="list-style-type: none"> Copies drive parameters Plain text display Menu-based operation and application wizards 	6SL3255-0AA00-4JA0 IOP Handheld: 6SL3255-0AA00-4HA0
	IOP/BOP-2 Mounting Kit IP54/UL Type 12	6SL3256-0AP00-0JA0
Tools for the PC	STARTER commissioning tool (PC software) connected to the frequency converter via USB cable	STARTER on DVD: 6SL3072-0AA00-0AG0 Downloading: STARTER (http://support.automation.siemens.com/WW/view/en/10804985/130000)
	PC Connection Kit The kit contains a STARTER DVD and USB cable	6SL3255-0AA00-2CA0

Component or tool		Order number	
	Drive ES Basic To commission the frequency converter via the PROFIBUS interface. Includes STARTER	6SW1700-5JA00-4AA0	
	Memory card to save and transfer the frequency converter settings	MMC card	6SL3254-0AM00-0AA0
		SD card	6ES7954-8LB00-0AA0

Components which you require depending on your particular application

Filters and reactors

- Line filters, Classes A and B
- Line reactors
- Braking resistors
- Output reactors
- Sine-wave filter

Further options

- Adapter for DIN rail mounting (only PM240, FSA)
- Shield plate (for Control Units and Power Module)

2.2 Control Units

The CU230P-2 Control Units have integrated technology functions for pumps, fans and compressor applications. The I/O interfaces, the fieldbus interface and the specific software functions optimally support these applications. The integration of technological functions is a significant differentiating feature to the other Control Units of the SINAMICS G120 drive family.

CU230P-2-specific functions

- Essential service mode
- Multi-zone controller
- Cascade control
- Energy-saving mode
- Bypass

The CU230P-2 is available with the following communications interfaces:

- As **CU230P-2 HVAC** with RS485 interface for:
 - USS
 - Modbus RTU
 - BACnet MS/TP
- As **CU230P-2 DP** for PROFIBUS DP
- As **CU230P-2 CAN** for CANopen

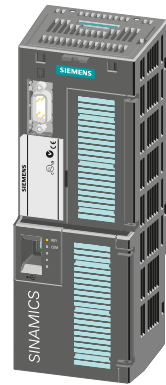

2.3 Power Module

Power Modules are available in various degrees of protection with a different topology in the power range from between 0.37 kW up to 250 kW. The Power Modules are sub-divided into various frame sizes (FS).

Power Modules with degree of protection IP20: PM240, PM250, PM260



Frame size	FSA	FSB	FSC	FSD	FSE	FSF	FSGX
PM240, 3AC 400V - power units with integrated braking chopper¹⁾							
Power range (LO) in kW	0.37 ... 1.5	2.2 ... 4	7.5 ... 15	18.5 ... 30	37 ... 45	55 ... 132	160 ... 250
line filter, Class A	○	●	●	●	●	◐	◐
PM250, 3AC 400V - power units capable of energy recovery							
Power range (LO) in kW	---	---	7.5 ... 15	18.5 ... 30	37 ... 45	55 ... 90	---
line filter, Class A	---	---	●	●	●	●	---
PM260, 3AC 690V - power units capable of energy recovery							
Power range (LO) in kW	---	---	---	11 ... 18.5	---	30 ... 55	---
line filter, Class A	---	---	---	○/●	---	○/●	---
Sine-wave filter	---	---	---	●	---	●	---

○ = without; ● = integrated; ◐ = from 110 kW for external mounting

1) The Power Module PM240 FSGX is supplied without braking chopper, but is prepared for installation of an optional braking chopper

PM230 Power Module, IP55 degree of protection / UL Type 12

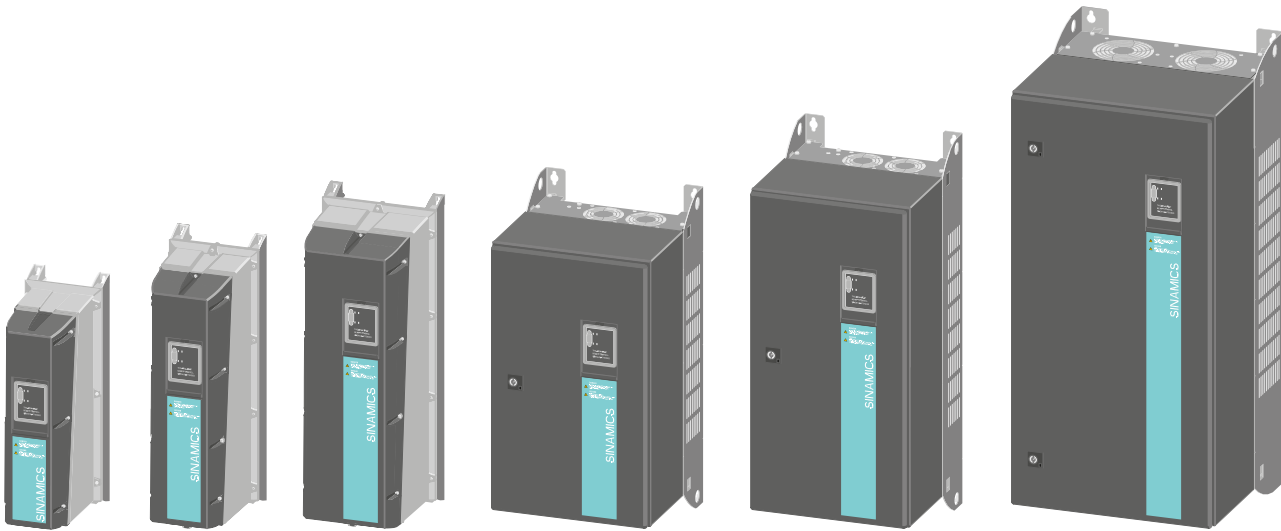

Frame size	FSA	FSB	FSC	FSD	FSE	FSF
PM230, 3AC 400V - power units with low line reactions						
Power range (LO) in kW	0,37 ... 3	4 ... 7,5	11 ... 18.5	22 ... 30	37 ... 45	55 ... 90
line filter, Class A	•	•	•	•	•	•
line filter, class B	•	•	•	•	•	•

2.4 Reactors and filters

Depending on the Power Module, the following combinations with filters and reactors are permitted:

Power Module	Line-side components			Load-side components	
	Line reactor	Line filters class B	Braking resistor	Sine-wave filter	Output reactor
PM230	-	-	-	-	-
PM240	•	•	•	•	•
PM250	-	•	-	•	•

For further details, refer to the connection example in section Procedure for installing the frequency inverter (Page 27).

Installing

3.1 Procedure for installing the frequency inverter

Preconditions for installation

Check that the following preconditions are fulfilled before installing:

- Are the required components, tools and small parts available?
- Are the ambient conditions permissible? See Technical data (Page 303).

Installation sequence

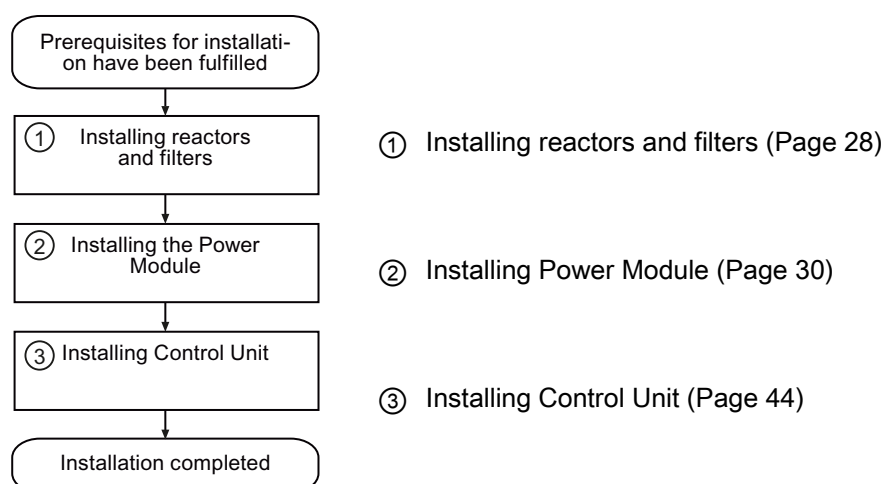

You will find details on the installation in the Internet: Hardware Installation Manual (<http://support.automation.siemens.com/WW/view/en/30563173/133300>).

You can start to commission the converter once installation has been completed.

3.2 Installing reactors and filters

Fitting inverter system components in space-saving manner

Many inverter system components are designed as base components, that is, the component is mounted on the baseplate and the inverter mounted above it to save space. Up to two base components can be mounted above one another.

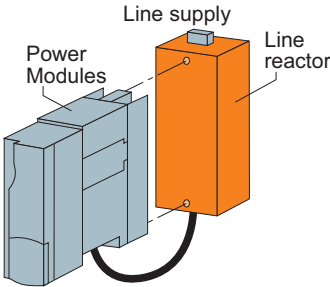
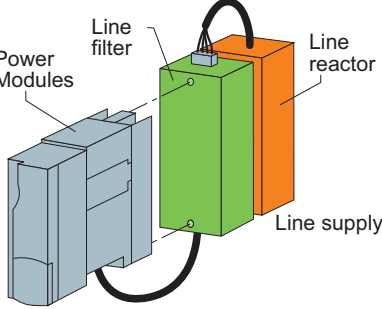
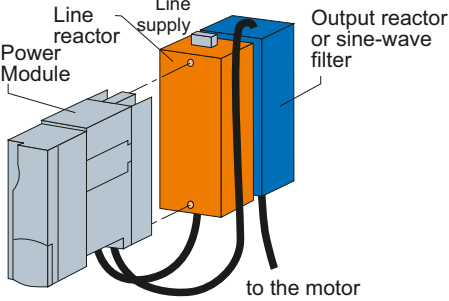
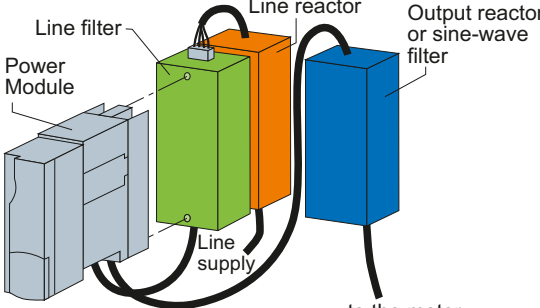
PM240	
	
<p>Basic layout of a PM240 Power Module with line reactor as base component</p>	<p>PM240 Power Module frame size FSA with line reactor and class A line filter</p>
<p>The line-side reactors are equipped with terminals while the reactors on the Power Module side are equipped with a prefabricated cable. In the final installation position, the mains terminals are at the top on frame sizes FSA to FSC, and at the bottom on frame sizes FSD to FSE.</p> <p>For frame size FSA, in addition to the line reactor, a class A line filter can be used. In this case, the mains connection is at the bottom.</p> <p>Power Modules of frame size FSB and higher are available with integrated class A line filters (an external class A line filter is not required in this case).</p>	
	
<p>PM240: frame size FSA with line reactor and output reactor or sine-wave filter</p>	<p>PM240 Power Module frame size FSA with line reactor, line filter and output reactor or sine-wave filter</p>
<p>In installations containing more than two base-type system components (e.g. line filter + line reactor + output reactor), the components must be installed to the side of the Power Module whereby the line reactor and line filter are installed under the Power Module and the output reactor to the side.</p>	

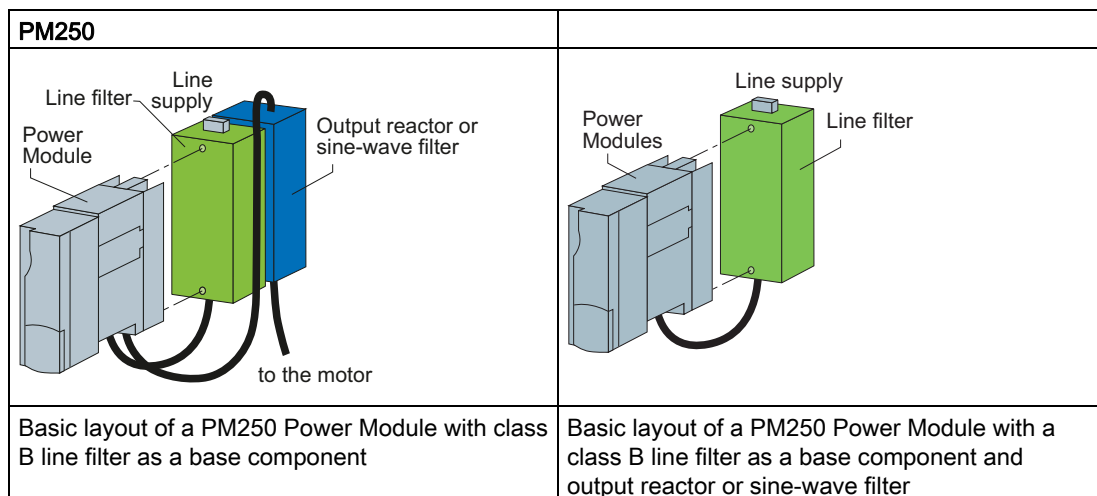

3.3 Installing Power Module

Installing Power Modules with degree of protection IP20

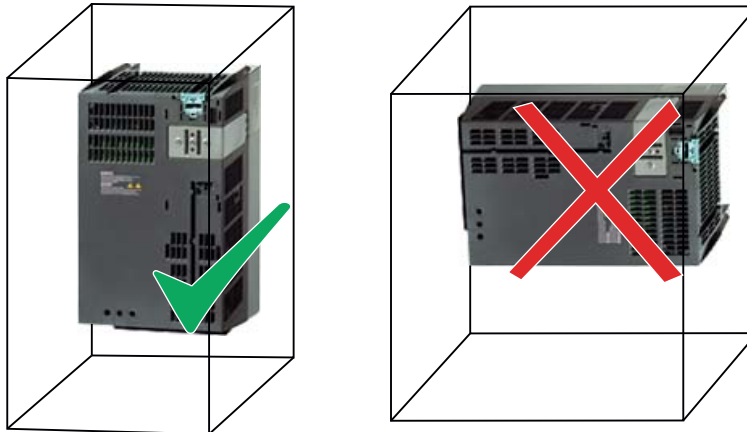

- Install the Power Module vertically on a mounting plate in a control cabinet. The smaller frame sizes of the converter (FSA and FSB) can also be mounted on DIN rails using an adapter.
- When installing, observe the minimum clearances to other components in the control cabinet. These minimum clearances are necessary to ensure adequate cooling of the converter.
- Do not cover the ventilation openings the converter.

Installing additional components

Depending on the application, additional line reactors, filters, braking resistors, brake relays etc., may also be used.

Please observe the mounting and installation instructions supplied with these components.

3.3.1 Dimensions, hole drilling templates, minimum clearances, tightening torques

Note

For Power Modules up to 132 kW, degree of protection IP20, the CU230P-2 increases the total inverter depth by 50 mm - and an additional 30 mm if you use an IOP.

Dimensions and drilling patterns for the PM230 Power Modules

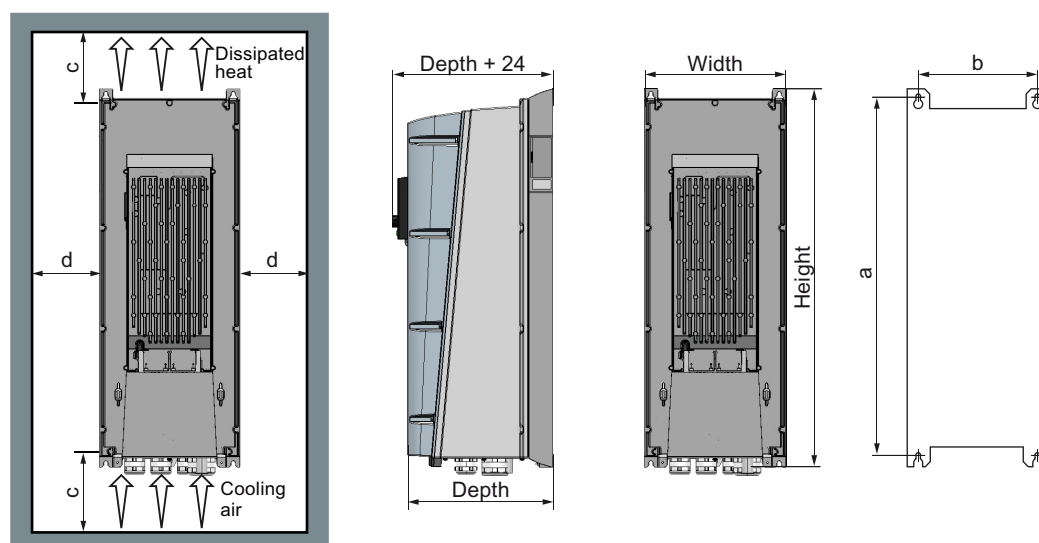

Figure 3-1 Drilling pattern for PM230

Table 3- 1 Dimensions for PM230, IP55

Frame size	Dimensions (mm)					Clearances (mm)	
	Height	Width	Depth	a	b	c	d
FSA	460	154	238	445	132	100	0
FSB	540	180	238	524	158	100	0
FSC	620	230	238	604	208	125	0
FSD	640	320	238	600	285	300	0
FSE	751	320	238	710	285	300	0
FSF	915	410	238	870	370	300	0
Fixing:	FSA/FSB: screws M4, 2.5 Nm, FSC: screws M5, 2.5 Nm,			FSD/FSE/FSF: screws M8, 13 Nm			

Dimensions and drilling patterns for the PM240 Power Modules

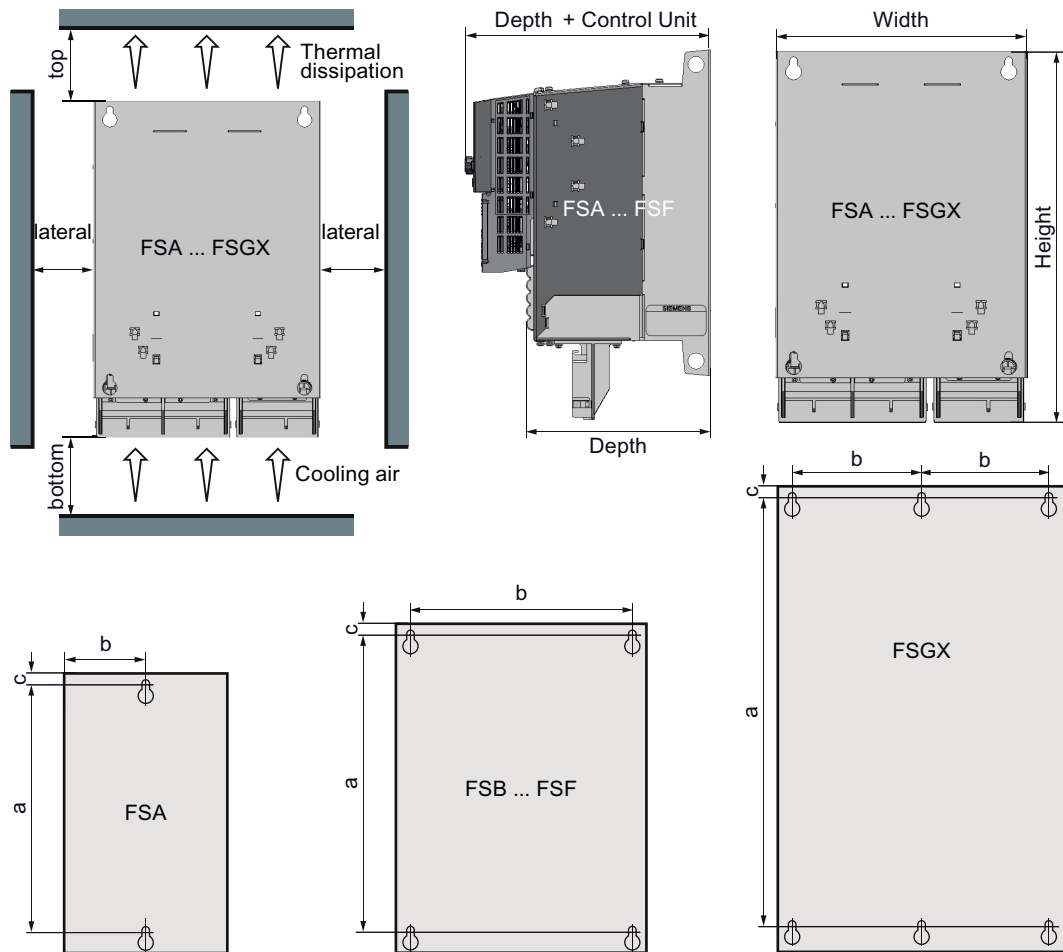

Figure 3-2 PM240 drilling pattern

Table 3-2 PM240, IP20 dimensions

Frame size	Dimensions (mm)						Clearances (mm)		
	Height	Width	Depth	a	b	c	top	bottom	lateral
FSA	173	73	145	160	36.5	--	100	100	30*
FSB	270	153	165	258	133	--	100	100	40*
FSC	334	189	185	323	167	--	125	125	50*
FSD without filter	419	275	204	325	235	11	300	300	0
FSD with filter, Class A	512	275	204	419	235	11	300	300	0
FSE without filter	499	275	204	405	235	11	300	300	0
FSE with filter, Class A	635	275	204	541	235	11	300	300	0
FSF without filter	634	350	316	598	300	11	350	350	0
FSF with filter, Class A	934	350	316	899	300	11	350	350	0
FSGX	1533	326	547	1506	125	14.5	250	150	50
Fixing:	FSA/FSB: M4 screws, 2.5 Nm / 22 lbf .in FSD/FSE: M6 screws, 6 Nm/53 lbf .in			FSC: M5 screws, 2.5 Nm / 22 lbf .in FSF/FSGX: M8 screws, 13 Nm / 115 lbf .in					

*) up to 40 °C without any lateral clearance

Dimensions and drilling patterns for the PM250 Power Modules

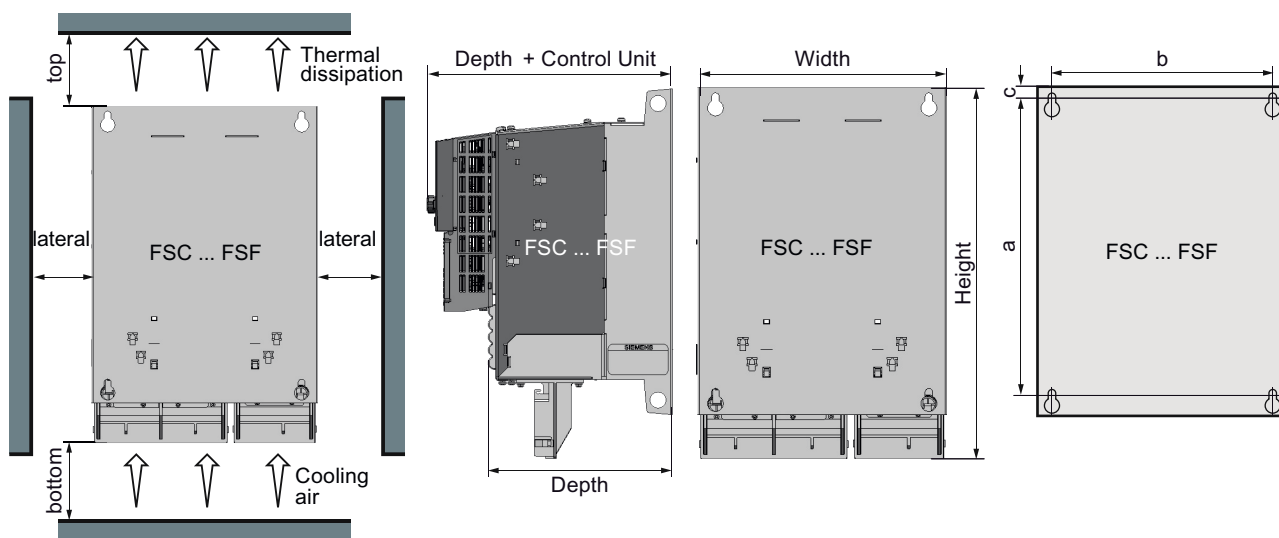

Figure 3-3 PM250 drilling pattern

Table 3- 3 PM250, IP20 dimensions

Frame size	Dimensions (mm)			Clearances (mm)					
	Height	Width	Depth	a	b	c	top	bottom	lateral
FSC	334	189	185	323	167	--	125	125	50*
FSD without filter	419	275	204	325	235	11	300	300	0
FSD with filter, Class A	512	275	204	419	235	11	300	300	0
FSE without filter	499	275	204	405	235	11	300	300	0
FSE with filter, Class A	635	275	204	541	235	11	300	300	0
FSF without filter	634	350	316	598	300	11	350	350	0
FSF with filter, Class A	934	350	316	899	300	11	350	350	0
Fixing:	FSB: M4 screws, 2.5 Nm / 22 lbf .in FSD/FSE: M6 screws, 6 Nm/53 lbf .in			FSC: M5 screws, 2.5 Nm / 22 lbf .in FSF/: M8 screws, 13 Nm / 115 lbf .in					

*) up to 40 °C without any lateral clearance

Dimensions and drilling patterns for the PM260 Power Modules

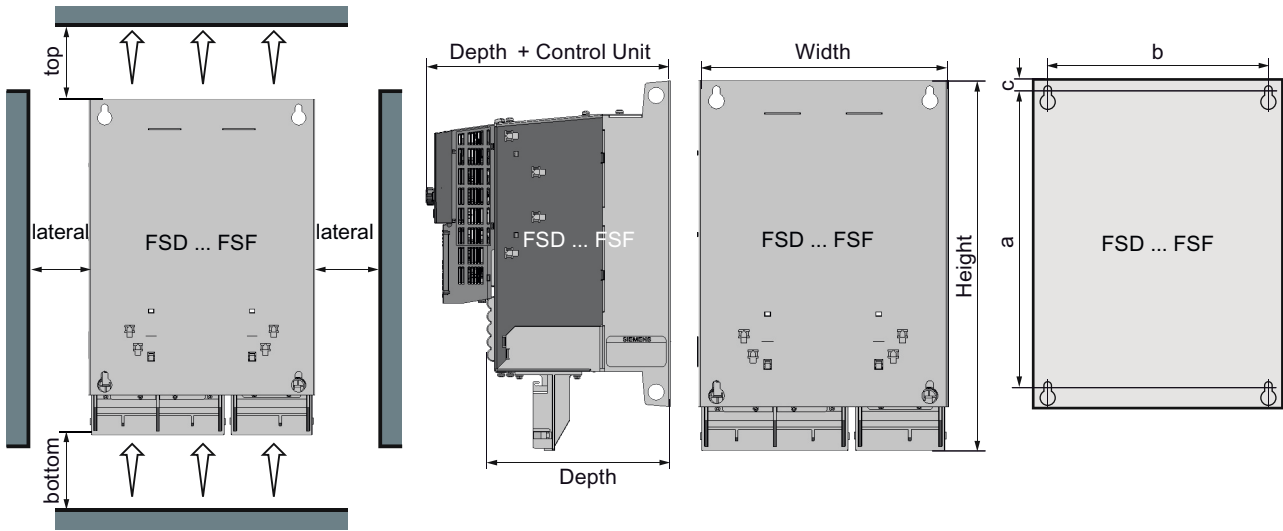

Figure 3-4 PM260 drilling pattern

Table 3- 4 PM260, IP20 dimensions

Frame size	Dimensions (mm)			Clearances (mm)					
	Height	Width	Depth	a	b	c	top	bottom	lateral
FSD without / with filter	419	275	204	419	235	11	300	300	30*
FSF without / with filter	634	350	316	598	300	11	350	350	0
Fixing:	FSD: M6 screws, 6 Nm/53 lbf.in			FSF: M8 screws, 13 Nm / 115 lbf.in					

*) up to 40 °C without any lateral clearance

3.3.2 Connection overview for Power Modules

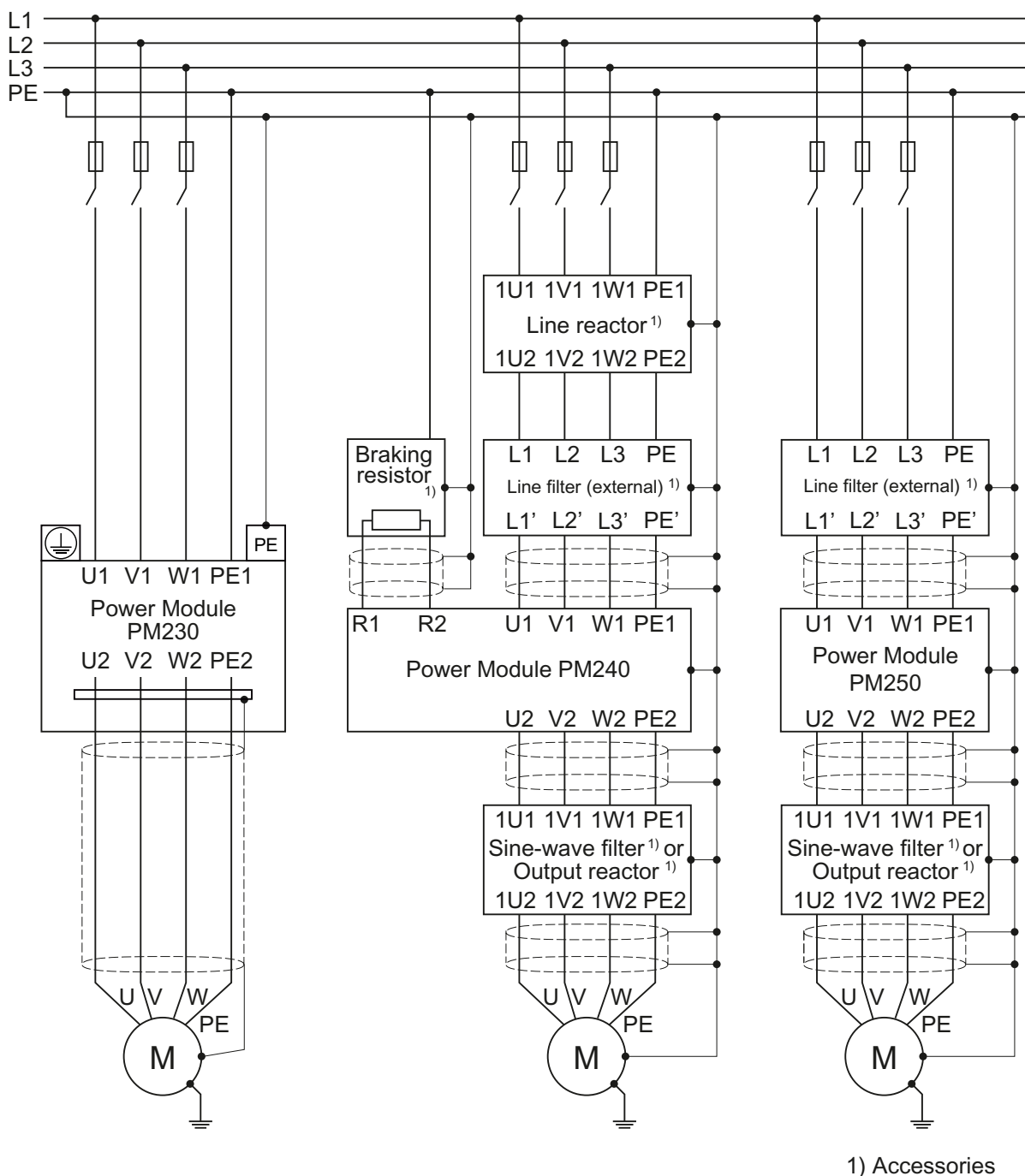

Figure 3-5 Connections for PM230, PM240 and PM250 Power Modules

PM240 and PM250 Power Modules are available with and without integrated class A line filters. Either a Class A or a Class B filter is integrated in the PM230 Power Module.

An external filter has to be installed in PM240 and PM250 Power Modules to satisfy more stringent EMC requirements (Class B).

3.3.3 Connecting the line supply and motor

Preconditions

Once the inverter has been properly installed, the line and motor connections can now be established. The following warning information must be observed here.



! WARNING
Line and motor connections
<p>The inverter must be grounded on the line supply and motor side. If the inverter is not correctly grounded, this can lead to extremely hazardous conditions which, under certain circumstances, can result in death.</p> <p>The device must be disconnected from the electrical power supply before any connections with the device are established or in any way altered.</p> <p>The inverter terminals be at hazardous voltages even after the inverter has been switched off. After disconnecting the line supply, wait at least 5 minutes until the device has discharged itself. Only then, carry out any installation and mounting work.</p> <p>When connecting the inverter to the line supply, ensure that the motor terminal box is closed.</p> <p>Even if the LED or other indicators do not light up or remain inactive when a function is switched from ON to OFF, this does not necessarily mean that the unit has been switched off or is de-energized.</p> <p>The short-circuit ratio of the power supply must be at least 100.</p> <p>Make sure that the inverter is configured for the correct supply voltage (the inverter must not be connected to a higher supply voltage).</p> <p>If a residual-current circuit breaker is installed on the supply side of the electronic devices to protect against direct or indirect contact, only type B is permissible. In all other cases, other protective measures must be implemented, such as creating a barrier between the electronic devices and the environment by means of double or reinforced insulation or isolating them from the supply using a transformer.</p>

CAUTION
Supply cable and signal lines
<p>The signal lines must be routed separately from the supply cables to ensure that the system is not affected by inductive or capacitive interference.</p>

Note

Electrical protective equipment

Ensure that the appropriate circuit breakers / fuses for the inverter's rated current are fitted between the line and inverter (see catalog D11.1).

Connecting the motor: Star connection and delta connection

With SIEMENS motors, you will see a diagram of both connection methods on the inside of the cover of the terminal box:

- Star connection (Y)
- Delta connection (Δ)

The motor rating plate provides information about the correct connection data.

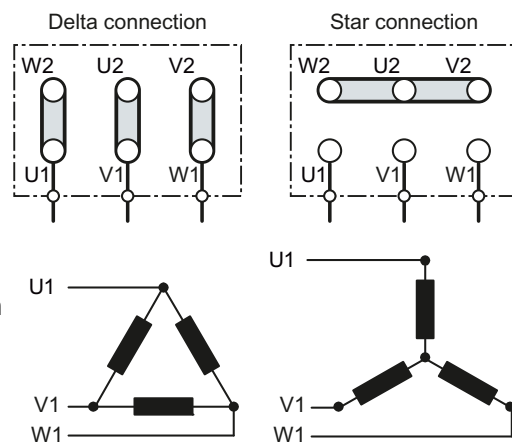

Examples for operating the inverter and motor on a 400 V line supply

Assumption: The motor rating plate states 230/400 V Δ /Y.

Example 1: A motor is normally operated between standstill and its rated speed (i.e. a speed corresponding to the line frequency). In this case, you need to connect the motor in Y. Operating the motor above its rated speed is only possible in field weakening, i.e. the motor torque available is reduced above the rated speed.

Example 2: If you want to operate the motor with the "87 Hz characteristic", you need to connect the motor in Δ .

With the 87 Hz characteristic, the motor's power output increases. The 87 Hz characteristic is mainly used with geared motors.

Connecting the inverter

Motor connection

- If available, open the terminal covers of the inverter.
- Connect the motor to terminals U2, V2 and W2.
Carefully observe the regulations for EMC-compliant wiring:
EMC-compliant connection (Page 39)
EMC-compliant installation for devices with degree of protection IP55 / UL Type 12 (Page 42)
- Connect the protective conductor of the motor to the terminal \oplus of the inverter.
The following cable lengths are permissible:
 - Unshielded 100 m
 - Shielded:
 - 50 m for inverters without filter
 - 25 m for inverters with filterYou will find additional information in Catalog D11.1 for longer cable lengths

Line supply connection

- Connect the line supply to terminals U1/L1, V1/L2 and W1/L3.
- Connect the protective conductor of the line supply to terminal PE of the inverter.
- If available, close the terminal covers of the inverter.

Note

Inverters without an integrated line filter can be connected to grounded (TN, TT) and non-grounded (IT) line supply systems. The inverters with integrated line filter are suitable only for connection to TN line supply systems.

The permissible cable cross sections for the individual devices and power ratings are provided in Section Technical data (Page 303).

3.3.4 EMC-compliant connection

The inverters are designed for operation in industrial environments where high values of electromagnetic interference are expected. Safe, reliable and disturbance-free operation is only guaranteed if the devices are professionally installed.

Inverters with degree of protection IP20 must be installed and operated in an enclosed control cabinet.

Control cabinet design

- All metal parts and components of the control cabinet (side panels, rear panels, roof and base plates) must be connected to the control cabinet frame through a good electrical connection – this is best achieved using the highest possible surface area or a high number of individual screw connections
- The PE bar and the EMC shield bar must be connected to the control cabinet frame through a good electrical connection established through a large surface area.
- All of the metal enclosures of the devices and supplementary components installed in the cabinet – e.g. inverter or line filter – must be connected to the control cabinet frame through a good electrical connection through the largest possible surface area. The most favorable design is to mount these devices and supplementary components on a bare metal mounting plate with good conducting characteristics; this in turn is connected to the control cabinet frame through a good electrical connection and the largest possible surface area. It is especially important that they are connected to the PE and EMC shield bars.
- All of the connections must be implemented so that they are durable. Screw connections to painted or anodized metal components must either be established using special contact (serrated) washers that cut through the insulating surface and therefore establish a metallic conductor contact, or the insulating surface must be removed at the contact locations.
- Coils of contactors, relays, solenoid valves and motor holding brakes must be equipped with interference suppression elements in order to dampen high-frequency radiation when switching-off (RC elements or varistors with AC coils and free-wheeling diodes or varistors for DC coils). The protective circuit must be directly connected at the coil.

Cable routing and shielding

- All inverter power cables (line supply cables, connecting cables between the braking chopper and the associated braking resistance as well as the motor cables) must be separately routed away from signal and data cables. The minimum clearance should be approx. 25 cm. As an alternative, the decoupling can be realized in the control cabinet using metal partitions (separating elements) connected to the mounting plate through a good electrical connection
- The cables from the line supply to the line filter must be routed separately away from non-filtered power cables with a high noise level (cables between the line filter and inverter, connecting cables between the braking chopper and the associated braking resistor as well as motor cables)
- Signal and data cables as well as filtered line supply cables may only cross non-filtered power cables at right angles
- All cables should be kept as short as possible

- Signal and data cables and the associated equipotential bonding cables must always be routed in parallel with the smallest possible clearance between them
- Shielded motor cables must be used
- The shielded motor cable should be routed separately away from the cables to the motor temperature sensors (PTC/KTY)
- Signal and data cables must be shielded.
- Especially sensitive control cables - such as setpoint and actual value cables - should be routed without any interruption with optimum shield support at both ends
- Shields should be connected at both ends to the grounded enclosures through a good electrical connection and through a large surface area
- Cable shields should be connected as close as possible to where the cable enters the cabinet
- EMC shield bars should be used for power cables; the shield support elements provided in the inverter should be used for signal and data cables
- If at all possible, cable shields should not be interrupted by intermediate terminals
- Cable shields should be retained both for power cables as well as for signal and data cables using the appropriate EMC clamps. The shield clamps must connect the shield to the EMC shield bar or the shield support element for control cables through a low inductive connection through a large surface area.

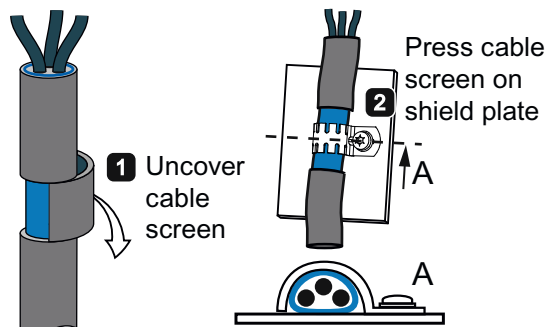
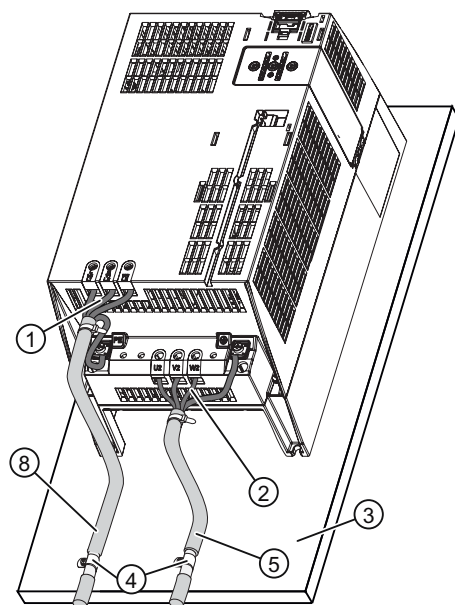

Figure 3-6 Shield support

EMC-compliant installation of Power Modules in degree of protection IP20

The EMC-compliant installation of power modules is shown in the following diagram using two examples.



Example for a connection without a shield plate via an external filter

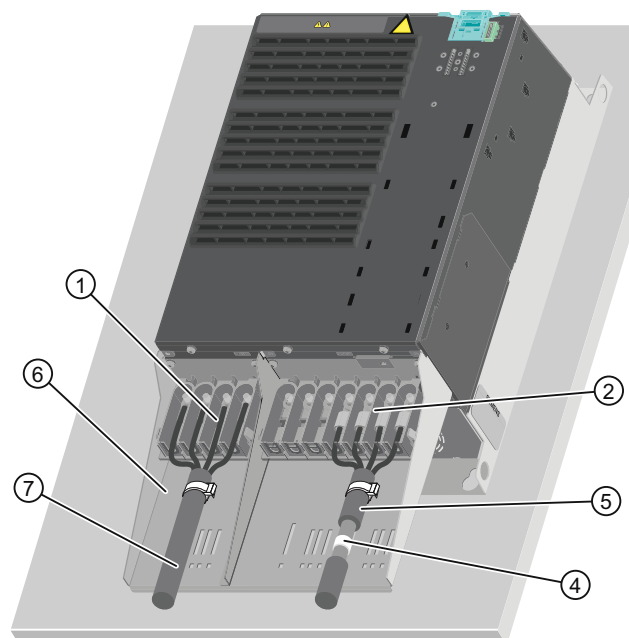

Example for a connection with a shield plate, directly to the line supply

- ① Line supply connection
- ② Motor connection
- ③ Metal mounting plate (unpainted and with a good electrical conductivity)
- ④ Cable clamps for a good conductive electrical connection through a large surface area between the shield and mounting plate or shield plate.
- ⑤ Shielded cable for the motor connection
- ⑥ Shield plate
- ⑦ Unshielded cable for connection directly to the line supply
- ⑧ Shielded cable for connection to the line supply via an external filter.

Note

An unshielded cable for the line connection should be used for Power Modules with integrated filter. Power Modules, which are connected to the line supply via an external filter, require a shielded cable between the line filter and Power Module.

Shielding with shield plate:	Shield connection kits are available for all Power Module frame sizes (you will find more information in Catalog D11.1). The cable shields must be connected to the shield plate through the greatest possible surface area using shield clamps.
Shielding without shield plate:	EMC-compliant shielding can also be implemented without an optional shield plate. In this case, you must ensure that the cable shields are connected to the ground potential through the largest possible surface area.
Braking resistor connection:	The braking resistor is connected using a shielded cable. Using a clamp, the shield should be connected to the mounting plate or to the shield plate through a good electrical connection and through the largest possible surface area.

3.3.5 EMC-compliant installation for devices with degree of protection IP55 / UL Type 12

Inverters with degree of protection IP55 / UL Type 12 (Power Module PM230) can be installed and operated in a closed control cabinet as well as without a control cabinet.

Cable routing and shielding

- Line supply cable and motor cable of the inverter should be routed separately away from signal and data cables. The minimum clearance should be approx. 25 cm
- All cables should be kept as short as possible
- Signal and data cables and the associated equipotential bonding cables must always be routed in parallel with the smallest possible clearance between them
- Shielded motor cables must be used
- The shielded motor cable should be routed separately away from the cables to the motor temperature sensors (PTC/KTY)
- Signal and data cables must be shielded.
- Especially sensitive control cables - such as setpoint and actual value cables - should be routed without any interruption with optimum shield connection at both ends
- Shields should be connected at both ends to the grounded enclosures through a good electrical connection and through a large surface area
- If at all possible, cable shields should not be interrupted by intermediate terminals
- Cable shields should be retained both for power cables as well as for signal and data cables using the appropriate EMC clamps. The shield clamps must connect the shield to the shield support of the inverter through the largest possible surface area and through a low inductive connection
- Only metallic or metallized connector enclosures must be used for plug connectors for shielded data cables (e.g. PROFIBUS cables)

EMC-compliant installation of the inverter

The EMC-compliant installation of the PM230 Power Module and Control Unit is shown in the following diagram.

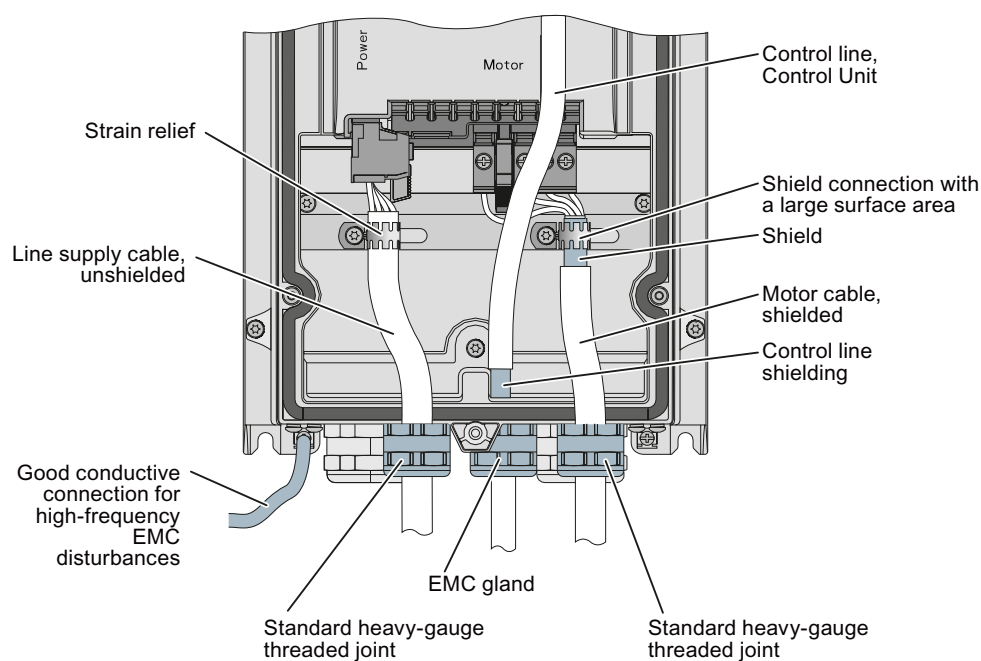

Figure 3-7 EMC-compliant connection of the Power Module PM230, degree of protection IP55 / UL Type 12

Note

You must use a shielded cable if you use the control terminals of the Control Unit. The cable shield must be connected to the gland plate through a good electrical connection using an EMC gland.

Additional information is available in the installation instructions for the Power Module PM230 (<http://support.automation.siemens.com/WW/view/en/30563173/133300>).

3.4 Installing Control Unit

Installing the Control Unit on an IP20 Power Module

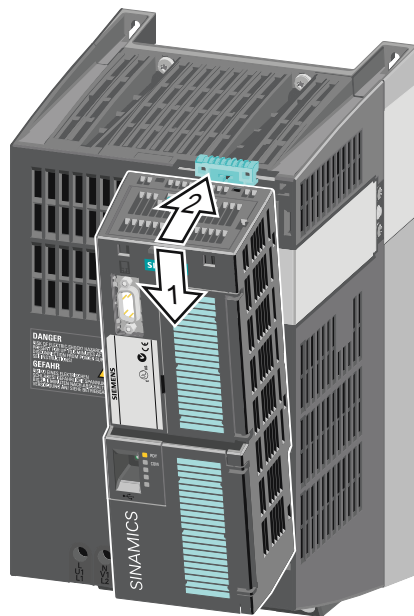

Plugging on the CU

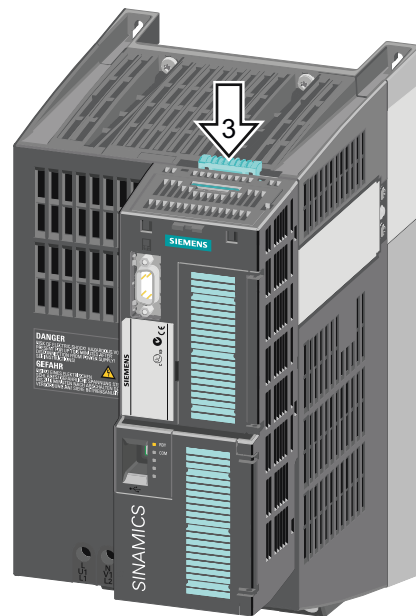

Removing the CU

To gain access to the terminal strips, open the top and bottom front doors to the right. The terminal strips use spring-loaded terminals.

IP55 Power Modules

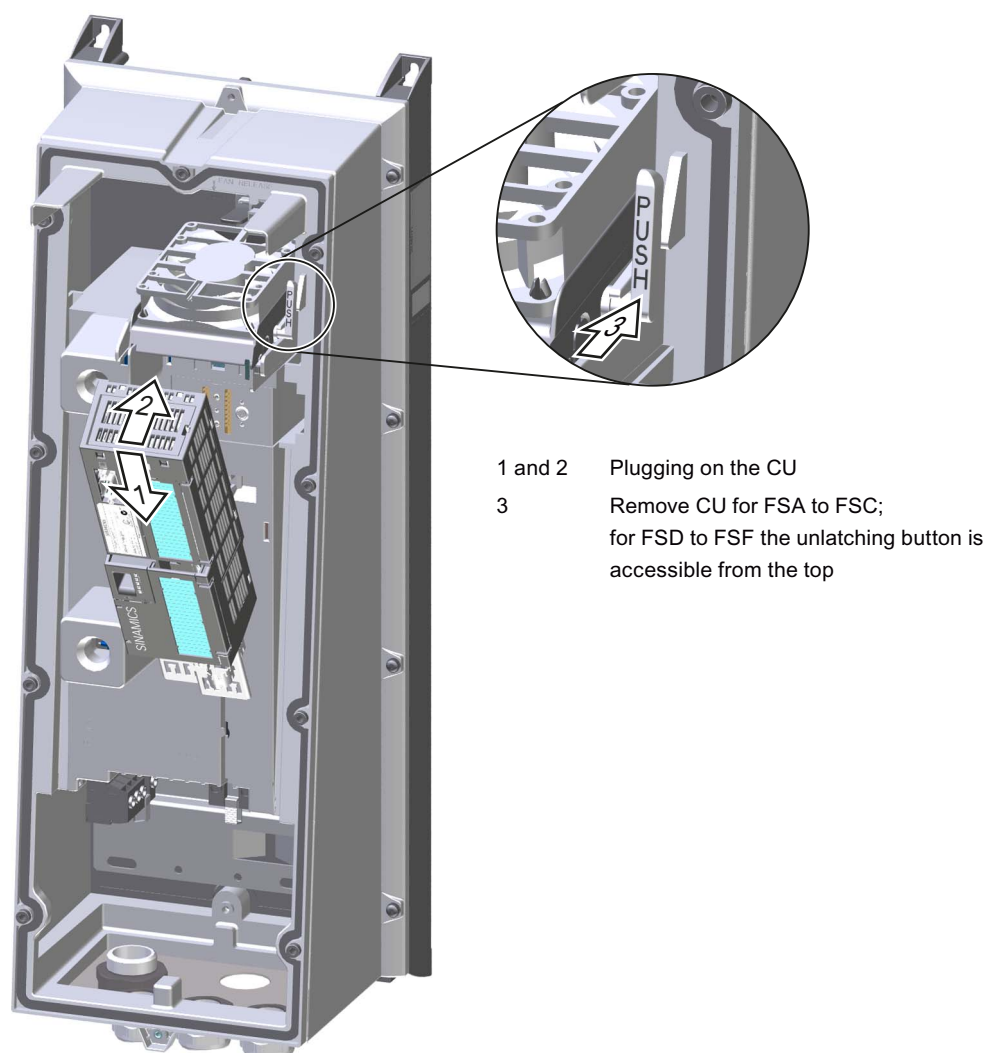
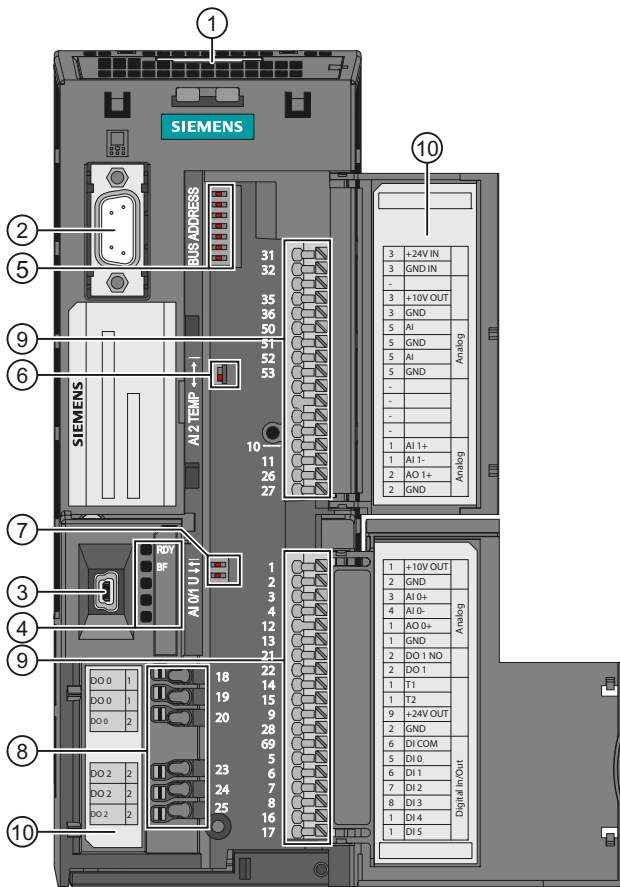

Figure 3-8 Locate the CU on the PM

You will find a detailed description in the associated Hardware Installation Manual.

3.4.1 Interfaces, connectors, switches, control terminals, LEDs on the CU



- ① Slot for memory card (MMC or SD card)
- ② Interface for operator panel (IOP or BOP-2)
- ③ USB interface for STARTER
- ④ Status LED RDY BF

- ⑤ DIP switch for fieldbus address

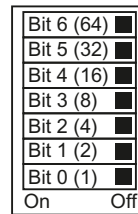

Example 1:
Address = 10
(= 2+8)

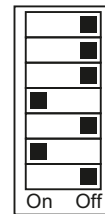

- ⑥ NI1000 Current Voltage NI1000 DIP switch AI2 (terminals 50/51)

- ⑦ AI1 AI0 Current Voltage DIP switch for AI0 and AI1 (terminals 3/4 and 10/11)

- ⑧ Digital outputs

- ⑨ Terminal strip

- ⑩ Terminal designation

CU230P-2 HVAC

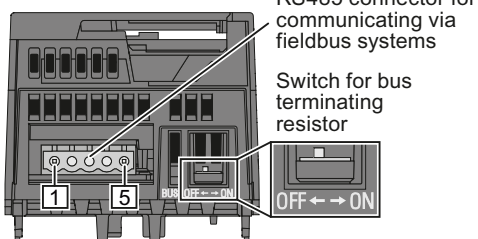

Contact	Designation
1	0 V, reference potential
2	RS485P, receiving and sending (+)
3	RS485N, receiving and sending (+)
4	Cable shield
5	Not connected

CU230P-2 CAN

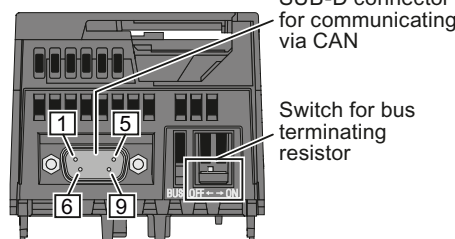

Contact	Designation
1	Not assigned
2	CAN_L, CAN signal (dominant low)
3	CAN_GND, CAN ground
4	Not assigned
5	(CAN_SHLD), optional shield
6	(GND), optional CAN ground
7	CAN_H, CAN signal (dominant high)
8	Not assigned
9	Not assigned

CU230P-2 DP

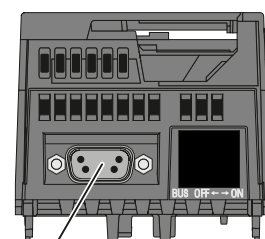

3.4.2 Terminal strips of the CU

① Terminals	Explanation
31 +24V IN	18 V ... 30 V optional electronics power supply
32 GND IN	Reference potential for terminal 31
- -	
35 +10V out	10 V output relative to GND, max. 10 mA
36 GND	Common reference potential
50 NI1000/AI2+	Input for temperature sensor NI1000 or analog input AI 2+
51 GND	Common reference potential
52 NI1000/AI3+	Input for temperature sensor NI1000 or analog input AI 3+
53 GND	Common reference potential
- -	
- -	
- -	
10 AI 1+	Analog input 1 (-10 V ... 10 V, 0/4 mA ... 20 mA, -20 mA ... 20 mA)
11 AI 1-	Reference potential for analog input 0
26 AO 1+	Analog output 1 (0 V ... 10 V, 0 mA ... 20 mA)
27 GND	Common reference potential
1 +10V out	10 V output relative to GND, max. 10 mA
2 GND	Common reference potential
3 AI 0+	Analog input 0 (-10 V ... 10 V, 0/4 mA ... 20 mA, -20 mA ... 20 mA)
4 AI 0-	Reference potential for analog input 0
12 AO 0+	Analog output 0 (0 V ... 10 V, 0 mA ... 20 mA)
13 GND	Common reference potential
21 DO 1 NO	Digital output 1, NO contact, 0,5 A, 30 V DC
22 DO 1 COM	Digital output 1, common contact, 0,5 A, 30 V DC
14 T1 MOTOR	Motor temperature sensor (PTC, KTY84-130 or bimetal NC contact)
15 T2 MOTOR	Motor temperature sensor (PTC, KTY84-130 or bimetal NC contact)
9 +24V out	24 V output, reference potential GND, max. 100 mA
28 GND	Common reference potential
69 DI COM	Reference potential for digital inputs
5 DI 0	Digital input 0, isolated
6 DI 1	Digital input 1, isolated
7 DI 2	Digital input 2, isolated
8 DI 3	Digital input 3, isolated
16 DI 4	Digital input 4, isolated
17 DI 5	Digital input 5, isolated
19 DO 0 NO	Digital output 0, NO contact, 5 A, 30 V DC / 2 A, 230V AC
20 DO 0 COM	Digital output 0, common contact
18 DO 0 NC	Digital output 0, NC contact
24 DO 2 NO	Digital output 2, NO contact, 5 A, 30 V DC / 2 A, 230V AC—
25 DO 2 COM	Digital output 2, common contact
23 DO 2 NC	Digital output 2, NC contact

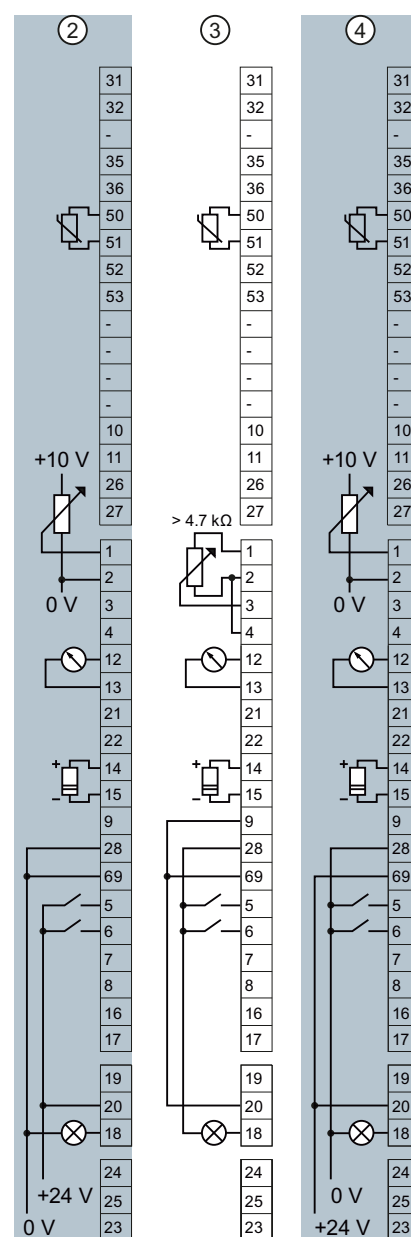

The wiring of the terminal strip is not shown completely, but as example for each terminal type.

If you require more than six digital inputs, use terminals 3 and 4 (AI 0) or terminals 10 and 11 (AI 1) as additional digital inputs DI 11 or DI 12.

- ① Wiring when using the internal power supplies. DI = high, if the switch is closed.
- ② Wiring when using external power supplies. DI = high, if the switch is closed.
- ③ Wiring when using the internal power supplies. DI = low, if the switch is closed.
- ④ Wiring when using external power supplies. DI = low, if the switch is closed.

3.4.3 Selecting the interface assignments

The inverter offers multiple predefined settings for its interfaces.

One of these predefined settings matches your particular application

Proceed as follows:

1. Wire the inverter corresponding to your application.
2. Carry-out the basic commissioning, see Section Commissioning (Page 53).
In the basic commissioning, select the macro (the predefined settings of the interfaces) that matches your particular wiring.
3. When required, configure communication via fieldbus, see Configuring the fieldbus (Page 97).

What do you do if none of the predefined settings matches your particular application 100%?

If none of the predefined settings matches your particular application, then proceed as follows:

1. Wire the inverter corresponding to your application.
2. Carry-out the basic commissioning, see Section Commissioning (Page 53).
In the basic commissioning, select the macro (the predefined settings of the interfaces) that comes the closest to matching your particular application.
3. Adapt the inputs and outputs to your application, see Section Adapting the terminal strip (Page 85).
4. When required, configure communication via fieldbus, see Configuring the fieldbus (Page 97).

The following illustrates only the inputs and outputs of the inverter, the significance of which changes according to the preassignment.

Automatic/local - Changeover between fieldbus and jog mode

Factory setting for converters with PROFIBUS interface:

Macro 7				DI 3 = LOW PROFIBUS DP fieldbus				DI 3 = HIGH Jogging via DI 0 and DI 1						
5	DI 0	---		Fault	18	DO 0		5	DI 0	Jog 1		Fault	18	DO 0
6	DI 1	---			19			6	DI 1	Jog 2			19	
7	DI 2	Acknowledge			20			7	DI 2	Acknowledge			20	
8	DI 3	LOW		Alarm	21	DO 1		8	DI 3	HIGH		Alarm	21	DO 1
16	DI 4	---			22			16	DI 4	---			22	
17	DI 5	---						17	DI 5	---				
3	AI 0	---		Speed	12	AO 0		3	AI 0	---		Speed	12	AO 0
4				0 V ... 10 V	13			4				0 V ... 10 V	13	
10	AI 1	---		Current	26	AO 1		10	AI 1	---		Current	26	AO 1
11				0 V ... 10 V	27			11				0 V ... 10 V	27	
				PROFIBUS DP Telegram 1										

p1058 = Jog 1
p1059 = Jog 2

Refer to the following Section on how you can obtain the GSD file: Configuring communication to the control (Page 98).

Motorized potentiometer

Macro 9 Motorized potentiometer (MOP)

5	DI 0	ON/OFF1	Fault	18	DO 0
6	DI 1	MOP up		19	
7	DI 2	MOP down		20	
8	DI 3	Acknowledge	Alarm	21	DO 1
16	DI 4	---		22	
17	DI 5	---			
3	AI 0	---	Speed	12	AO 0
4			0 V ... 10 V	13	
10	AI 1	---	Current	26	AO 1
11			0 V ... 10 V	27	

Process industry

Macro 14 DI 3 = LOW PROFIBUS DP fieldbus

5	DI 0	---	Fault	18	DO 0
6	DI 1	External fault		19	
7	DI 2	Acknowledge		20	
8	DI 3	LOW	Alarm	21	DO 1
16	DI 4	---		22	
17	DI 5	---			
3	AI 0	---	Speed	12	AO 0
4			0 V ... 10 V	13	
10	AI 1	---	Current	26	AO 1
11			0 V ... 10 V	27	

PROFIBUS DP
Telegram 20

DI 3 = HIGH Motorized potentiometer (MOP)

5	DI 0	ON/OFF1	Fault	18	DO 0
6	DI 1	External fault		19	
7	DI 2	Acknowledge		20	
8	DI 3	HIGH	Alarm	21	DO 1
16	DI 4	MOP up		22	
17	DI 5	MOP down			
3	AI 0	---	Speed	12	AO 0
4			0 V ... 10 V	13	
10	AI 1	---	Current	26	AO 1
11			0 V ... 10 V	27	

Refer to the following Section on how you can obtain the GSD file: Configuring communication to the control (Page 98).

Macro 15 DI 3 = LOW Analog setpoint

5	DI 0	ON/OFF1	Fault	18	DO 0
6	DI 1	External fault		19	
7	DI 2	Acknowledge		20	
8	DI 3	LOW	Alarm	21	DO 1
16	DI 4	---		22	
17	DI 5	---			
3	AI 0	Setpoint	Speed	12	AO 0
4		I □ U -10 V ... 10 V	0 V ... 10 V	13	
10	AI 1	---	Current	26	AO 1
11			0 V ... 10 V	27	

DI 3 = HIGH Motorized potentiometer (MOP)

5	DI 0	ON/OFF1	Fault	18	DO 0
6	DI 1	External fault		19	
7	DI 2	Acknowledge		20	
8	DI 3	HIGH	Alarm	21	DO 1
16	DI 4	MOP up		22	
17	DI 5	MOP down			
3	AI 0	---	Speed	12	AO 0
4			0 V ... 10 V	13	
10	AI 1	---	Current	26	AO 1
11			0 V ... 10 V	27	

Two- or three-wire control

Macro 12 is the factory setting for the converter equipped with the Control Units CU230P-2 HVAC and CU230P-2 CAN.

	Macro 12	Macro 17	Macro 18					
Two-wire control	Method 1	Method 2	Method 3	5 DI 0	Control command 1	Fault	18 DO 0	
Control command 1	ON/OFF1	ON/OFF1 right	ON/OFF1 right	6 DI 1	Control command 2		19	
Control command 2	Reversing	ON/OFF1 left	ON/OFF1 left	7 DI 2	Acknowledge		20	
				8 DI 3	---	Alarm	21 DO 1	
				16 DI 4	---		22	
				17 DI 5	---			
				3 AI 0	Setpoint	Speed	12 AO 0	
				4	I <input type="checkbox"/> U -10 V ... 10 V	0 V ... 10 V	13	
				10 AI 1	---	Current	26 AO 1	
				11		0 V ... 10 V	27	

	Macro 19	Macro 20						
Three-wire control	Method 1	Method 2	Control command 1	5 DI 0	Control command 1	Fault	18 DO 0	
Control command 1	Enable/OFF1	Enable/OFF1	Control command 2	6 DI 1	Control command 2		19	
Control command 2	ON right	ON	Control command 3	7 DI 2	Control command 3		20	
Control command 3	ON left	Reversing	Acknowledge	8 DI 3	Acknowledge	Alarm	21 DO 1	
			---	16 DI 4	---		22	
			---	17 DI 5	---			
				3 AI 0	Setpoint	Speed	12 AO 0	
				4	I <input type="checkbox"/> U -10 V ... 10 V	0 V ... 10 V	13	
				10 AI 1	---	Current	26 AO 1	
				11		0 V ... 10 V	27	

Communication with a higher-level control via USS

Macro 21	Fieldbus USS
	p2020 = Baud rate
	p2022 = PZD number
	p2023 = PKW number

5 DI 0	---	Fault	18 DO 0
6 DI 1	---		19
7 DI 2	Acknowledge		20
8 DI 3	---	Alarm	21 DO 1
16 DI 4	---		22
17 DI 5	---		
3 AI 0	---	Speed	12 AO 0
4		0 V ... 10 V	13
10 AI 1	---	Current	26 AO 1
11		0 V ... 10 V	27

USS
38400 Baud
2 PZD, PIV variable

Commissioning

You must commission the inverter after installation has been completed.

To do this, using Section "Preparing for commissioning (Page 56)" you must clarify whether the motor can be operated with the inverter factory settings or an additional adaptation of the inverter is required. The two commissioning options are shown in the following diagram.

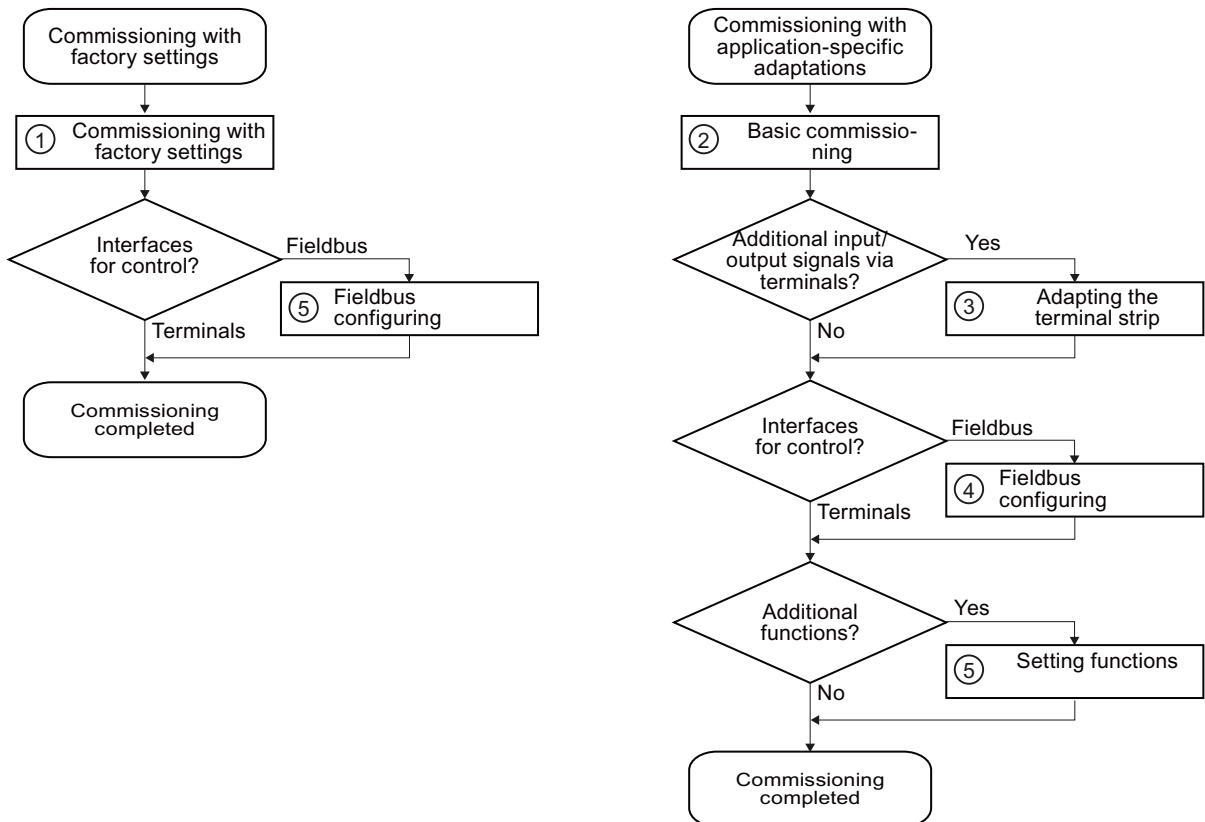

- ① Commissioning with factory settings (Page 60)
- ② Set basic commissioning with STARTER (Page 68) or BOP-2 (Page 63)
- ③ Adapting the terminal strip (Page 85)
- ④ Configuring the fieldbus (Page 97)
- ⑤ Functions (Page 183)

Figure 4-1 Commissioning procedure

NOTICE

For the basic commissioning, you determine the function of the interfaces for your inverter via predefined settings (p0015).

If you subsequently select a different predefined setting for the function of the interfaces, then all BICO interconnections that you changed will be lost.

4.1 Restoring the factory setting

There are cases where something goes wrong when commissioning a drive system e.g.:

- The line voltage was interrupted during commissioning and you were not able to complete commissioning.
- You got confused when setting the parameters and you can no longer understand the individual settings that you made.
- You don't know whether the inverter was already operational

In cases such as these, reset the inverter to the factory settings.

Restoring the factory setting with STARTER or BOP-2

This function resets the settings in the inverter to the factory settings.

Note

The communication settings and the settings of the motor standard (IEC/NEMA) are retained even after restoring the factory setting.

Table 4- 1 Procedure

STARTER	BOP-2
1. Go online with STARTER 2. In STARTER, click on the button  .	1. In the "Options" menu, select the "DRVRESET" entry 2. Confirm the reset using the OK key

4.2 Preparing for commissioning

Prerequisites: before you start

Before starting commissioning, you must answer the following questions:

- What is the data for the connected motor?
- What technological requirements must the drive fulfill?
- Via which inverter interfaces does the higher-level control operate the drive?

Which motor are you using? [P0300]

A synchronous or induction motor?

The inverters are preset in the factory for applications using 4-pole three-phase induction motors that correspond to the performance data of the inverter.

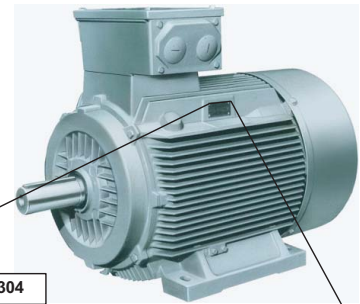

Motor data / data on the motor rating plate

If you use the STARTER commissioning tool and a SIEMENS motor, you only have to specify the motor Order No. In all other cases, you must read-off the data from the motor rating plate and enter into the appropriate parameters.

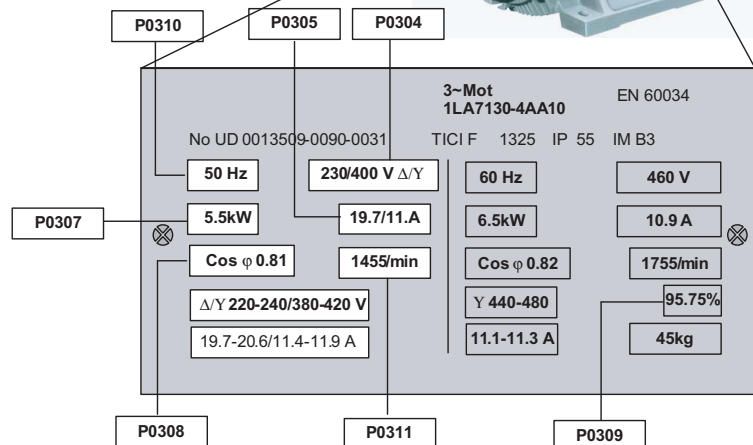

NOTICE**Information about installation**

The rating plate data that you enter must correspond to the connection type of the motor (star connection [Y]/delta connection [Δ]), i.e. for a delta motor connection, the delta rating plate data must be entered.

In which region of the world is the motor used? - Motor standard [P0100]

- Europe IEC: 50 Hz [kW] - factory setting
- North America NEMA: 60 Hz [hp] or 60 Hz [kW]

What is the prevailing temperature where the motor is operated? [P0625]

- Motor ambient temperature [P0625], if it differs from the factory setting = 20° C.

4.2.1 Inverter factory setting

Factory settings of additional important parameters

Parameter	Factory setting	Meaning of the factory setting	Name of the parameter and comments
p0010	0	Ready to be entered	Drive, commissioning parameter filter
p0100	0	Europe [50 Hz]	IEC/NEMA motor standard <ul style="list-style-type: none"> IEC, Europe NEMA, North America Note: This parameter cannot be changed in FW4.3.
p0300	1	Induction motor	Motor type selection (induction motors / synchronous motor)
p0304	400	[V]	Rated motor voltage (in accordance with the rating plate in V)
p0305	depends on the Power Module	[A]	Rated motor current (in accordance with the rating plate in A)
p0307	depends on the Power Module	[kW/hp]	Rated motor power (in accordance with the rating plate in kW/hp)
p0308	0	[cos phi]	Rated motor power factor (in accordance with the rating plate in cos 'phi'). If p0100 = 1, 2, then p0308 has no significance.
p0310	50	[Hz]	Rated motor frequency (in accordance with the rating plate in Hz)
p0311	1395	[rpm]	Rated motor speed (in accordance with the rating plate in rpm)
p0335	0	Non-ventilated: Shaft-mounted fan in the motor	Motor cooling type (specify the motor cooling system)
p0625	20	[°C]	Motor ambient temperature
p0640	200	[A]	Current limit (of the motor)
p0970	0	Locked	Reset drive parameters (restore to the factory settings)
P1080	0	[rpm]	Minimum speed
P1082	1500	[rpm]	Maximum speed
P1120	10	[s]	Ramp-function generator, ramp-up time
P1121	10	[s]	Ramp-function generator, ramp-down time
P1300	0	V/f control with linear characteristic	Open-loop/closed-loop control operating mode

4.2.2 Defining requirements for the application

What type of control is needed for the application? [P1300]

A distinction is made between V/f open-loop control and vector closed-loop control.

- The V/f open-loop control is the simplest operating mode for an inverter. For example, it is used for applications involving pumps, fans or motors with belt drives.
- For closed-loop vector control, the speed deviations between the setpoint and actual value are less than for V/f open-loop control; further, it is possible to specify a torque. It is suitable for applications such as winders, hoisting equipment or special conveyor drives.

What speed limits should be set? (Minimum and maximum speed)

The minimum and maximum speed with which the motor operates or is limited regardless of the speed setpoint.

- Minimum speed [P1080] - factory setting 0 [rpm]
- Maximum speed [P1082] - factory setting 1500 [rpm]

What motor ramp-up time and ramp-down time are needed for the application?

The ramp-up and ramp-down time define the maximum motor acceleration when the speed setpoint changes. The ramp-up and ramp-down time is the time between motor standstill and the maximum speed, or between the maximum speed and motor standstill.

- Ramp-up time [P1120] - factory setting 10 s
- Ramp-down time [P1121] - factory setting 10 s

4.3 Commissioning with factory settings

Prerequisites for using the factory settings

In simple applications, commissioning can be carried out just using the factory settings. Check which factory settings can be used and which functions need to be changed. During this check you will probably find that the factory settings only require slight adjustment:

1. The inverter and motor must match one another; compare the data on the motor rating plate with the technical data of the Power Module.
 - The rated inverter current must, as a minimum, be the same as the motor.
 - The motor power should match that of the inverter; motors can be operated in the power range from 25 % ... 100 % of the inverter power rating.
2. If you are controlling the drive using the digital and analog inputs, the inverter must be connected as shown in the wiring example. (see Wiring examples for the factory settings (Page 61))
3. If you connect the drive to a fieldbus, you must set the bus address using the DIP switches on the front of the Control Unit.

4.3.1 Wiring examples for the factory settings

Many applications function using the factory settings

The following wiring can be used for Control Units which receive their commands and setpoints via control terminals (CU230P-2 HVAC and CU230P-2 CAN) to use the factory setting.

Pre-assignment of control terminals in the factory for CU230P-2 HVAC and CU230P-2 CAN

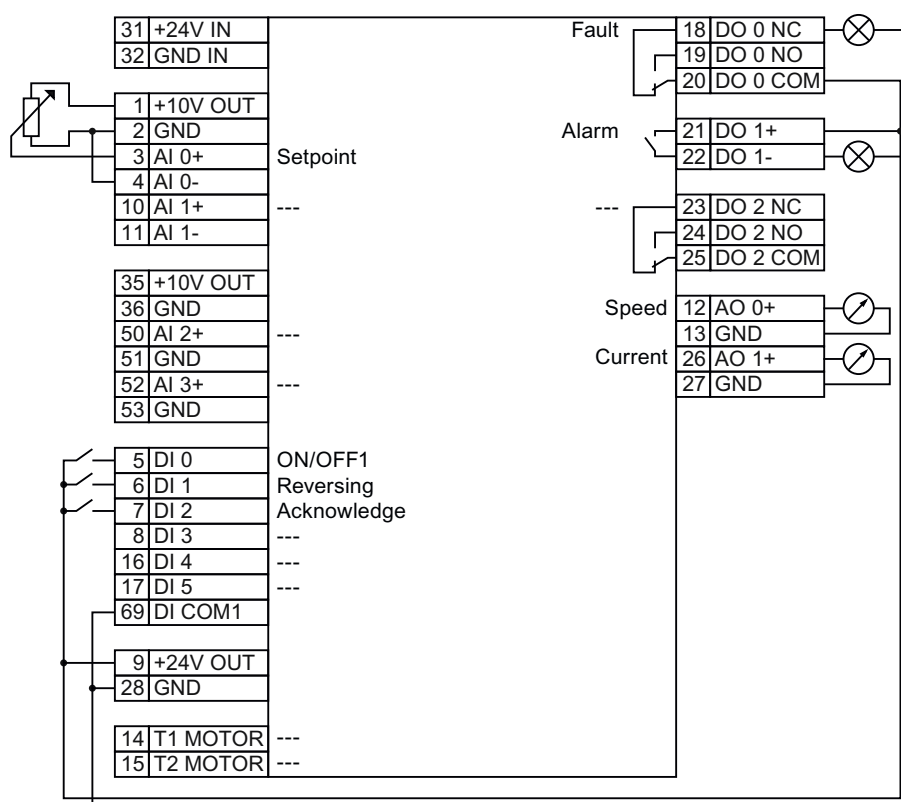

Figure 4-2 Wiring a CU230P-2 HVAC or CU230P-2 CAN to use the factory settings

Note

In the NPN mode, a ground fault between the customer contact and digital input may undesirably control the drive input.

Pre-assignment of control terminals in the factory for CU230P-2 DP

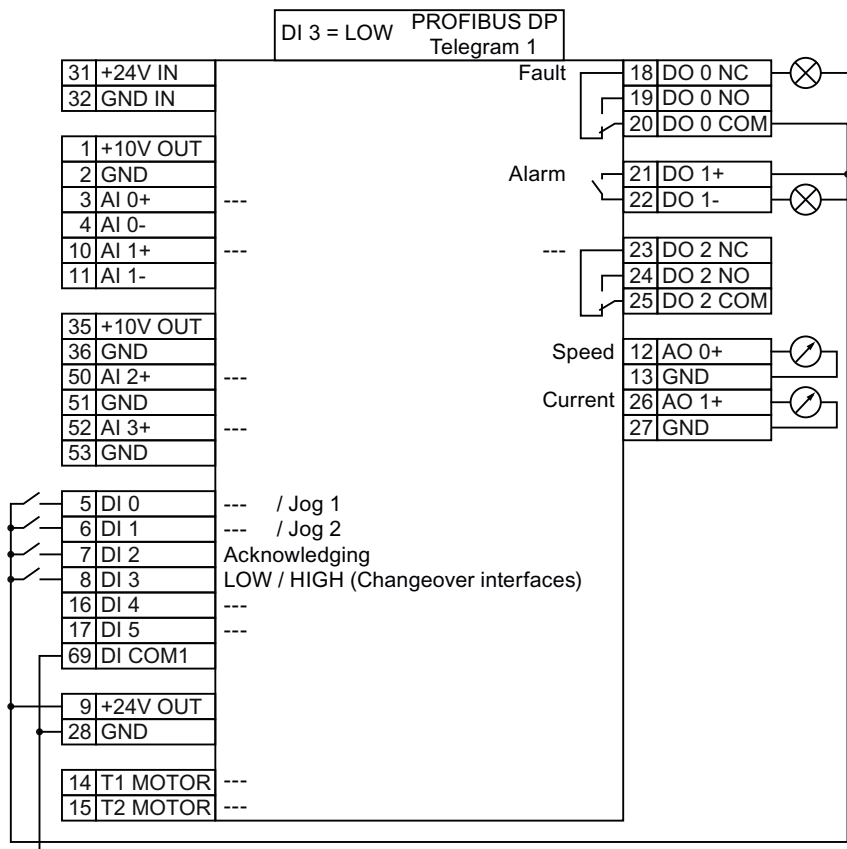
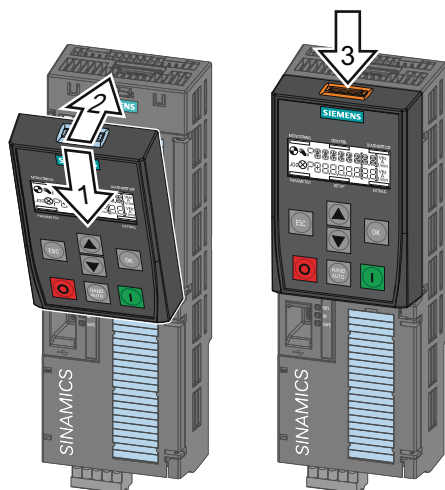

Figure 4-3 Wiring a CU230P-2 DP to use the factory settings

4.4 Commissioning with the BOP-2



The "Basic Operator Panel-2" (BOP-2) is an operation and display instrument of the converter. For commissioning, it is directly plugged onto the converter Control Unit.

Plugging on the BOP- Removing the BOP-2
2

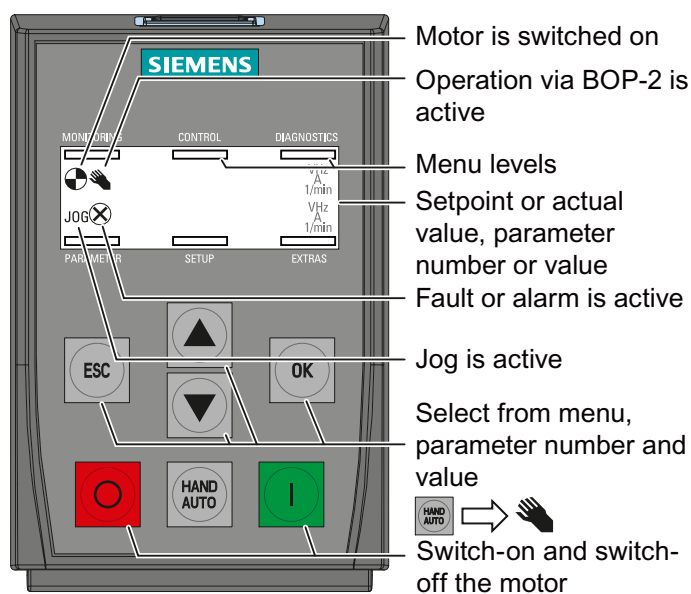
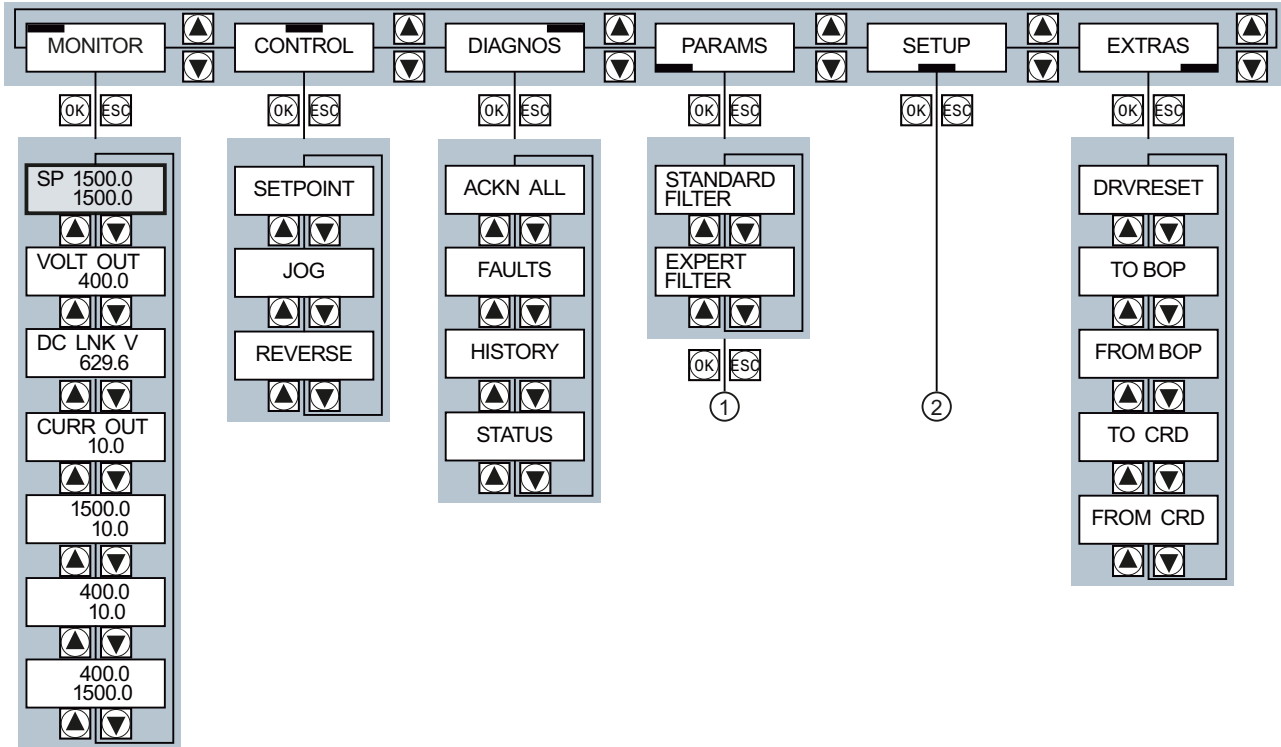

Figure 4-4 Operator control and display elements of the BOP-2

4.4.1 Menu structure



Changing parameter values:

- ① Parameter number freely selectable
- ② Basic commissioning

4.4.2 Freely selecting and changing parameters

Use BOP-2 to change your inverter settings, by selecting the appropriate parameter number and changing the parameter value. Parameter values can be changed in the "PARAMS" menu and the "SETUP" menu.

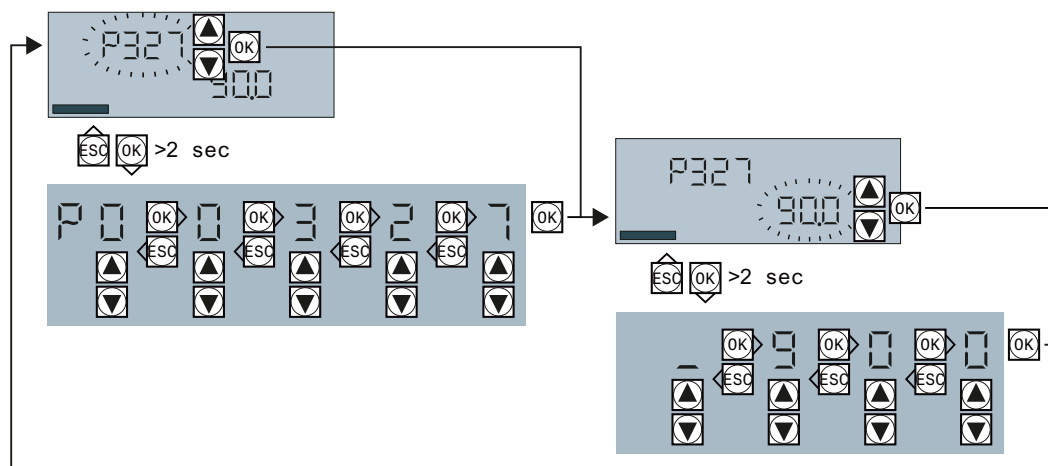

Select the parameter number		Changing a parameter value	
If the parameter number flashes in the display, you have two options for changing the number:		If the parameter value flashes in the display, you have two options of changing the value:	
1. option:	2. option:	1. option:	2. option:
Increase or decrease the parameter number using the arrow keys until the number you want is displayed.	Press and hold the OK key for more than two seconds and change the required parameter number digit by digit.	Increase or decrease the parameter value using the arrow keys until the value you want is displayed.	Press and hold the OK key for more than two seconds and enter the required value digit by digit.
Confirm the parameter number using the OK key.		Confirm the parameter value using the OK key.	

The inverter immediately saves all changes which you made using the BOP-2 so that they are protected against power failure.

4.4.3 Basic commissioning

Menu	Remark								
SETUP	Set all of the parameters of the menu "SETUP". In the BOP-2, select the menu "SETUP".								
RESET	Select reset if you wish to reset all parameters to the factory setting before the basic commissioning. NO → YES → OK								
CTRL MOD p1300	Select the motor control mode. The most important control modes are: <table border="1"> <tr> <td>VF LIN</td> <td>V/f control with linear characteristic</td> </tr> <tr> <td>VF QUAD</td> <td>V/f control with square law characteristic</td> </tr> <tr> <td>SPD N EN</td> <td>Closed-loop speed control (vector control)</td> </tr> <tr> <td>TRQ N EN</td> <td>Closed-loop torque control</td> </tr> </table>	VF LIN	V/f control with linear characteristic	VF QUAD	V/f control with square law characteristic	SPD N EN	Closed-loop speed control (vector control)	TRQ N EN	Closed-loop torque control
VF LIN	V/f control with linear characteristic								
VF QUAD	V/f control with square law characteristic								
SPD N EN	Closed-loop speed control (vector control)								
TRQ N EN	Closed-loop torque control								
EUR USA p100	② Standard: IEC or NEMA								
MOT VOLT p304	① Voltage								
MOT CURR p305	③ Current								
MOT POW p307	④ Power IEC standard (kW) ⑤ power NEMA standard (HP)								
MOT RPM p311	⑥ Rated speed								
MOT ID p1900	We recommend the setting STIL ROT (Identify motor data at standstill and with the motor rotating). If the motor cannot rotate freely, e.g. where travel is mechanically limited, select the setting STILL (Identify motor data at standstill).								
MAC PAR p15	Select the configuration for the inputs and outputs, as well as the correct fieldbus for your application. The predefined configurations can be found in the section titled Selecting the interface assignments (Page 48).								
MIN RPM p1080	Minimum motor speed.								
RAMP UP p1120	Motor ramp-up time.								
RAMP DWN p1121	Motor ramp-down time.								
FINISH	Confirm that the basic commissioning has been completed (Parameter p3900): NO → YES → OK								

SIEMENS (H) (EFF I) CE
 D-91056 Erlangen
 3-Mot. 1LE10011AC434AA0 | E0807/0496382_02 003

IEC/EN 60034 100L		IMB3	IP55
25 kg	Th.Cl. 155(F)	-20°C	Tamb 40°C
Bearing UNIREX-N3		Interval: 4000hrs	
DE 6206-2ZC3	15g	60Hz: SF 1.15 CONT NEMA MG1-12 TEFC Design A 2.0 HP	
NE 6206-2ZC3	11g		

V	Hz	A	kW	PF	NOM.EFF	rpm	V	A	CL
400 Δ	50	3.5	1.5	0.73	84.5%	970	380 - 420	3.55-3.55	
690 Y	50	2.05	1.5	0.73	84.5%	970	660 - 725	2.05-2.05	
460 Δ	60	3.15	1.5	0.69	86.5%	1175			K

① ② ③ ④ ⑤ ⑥

Motor data on the rating plate

Identifying motor data

If you select the MOT ID (p1900) during basic commissioning, alarm A07991 will be issued once basic commissioning has been completed. To enable the converter to identify the data for the connected motor, you must switch on the motor (e.g. via the BOP-2). The converter switches off the motor after the motor data identification has been completed.

 CAUTION
--

Motor data identification for dangerous loads
--

Secure dangerous plant and system parts before starting the motor data identification, e.g. by fencing off the dangerous location or lowering a suspended load to the floor.
--

4.4.4 Additional settings

The Section Commissioning (Page 53) shows you what still has to be set after the basic commissioning in order to adapt the inverter to your application.

4.5 Commissioning with STARTER

Preconditions

You require the following to commission the converter using STARTER:

- A pre-installed drive (motor and converter)
- A computer with Windows XP, Vista or Windows 7, which is connected to the converter via the USB cable and on which STARTER V4.2 or higher has been installed.

You can find updates for STARTER in the Internet under: Update or download path for STARTER (<http://support.automation.siemens.com/WW/view/en/10804985/133100>)

Commissioning steps

Commissioning with STARTER is subdivided into the following steps:

1. Adapting the USB interface (Page 69)
2. Generating a STARTER project (Page 70)
3. Go online and perform the basic commissioning (Page 70)
4. Making additional settings (Page 74)

STARTER features a project Wizard that guides you step-by-step through the commissioning process.

Note

The STARTER screens show general examples. You may therefore find that a screen contains more or fewer setting options than are shown in these instructions. A commissioning stage may also be shown using a Control Unit other than the one you are using.

4.5.1 Adapting the USB interface

Switch on the converter supply voltage and start the STARTER commissioning software.

If you are using STARTER for the first time, you must check whether the USB interface is correctly set. To do this, click in STARTER on  (accessible participants). Case 1 shows the procedure if no settings are required. In case 2, a description is provided on how you can adapt the interface.

Case 1: USB interface OK - no setting is required

If the interface is correctly set, the following screen form shows the converter, which is directly connected to your computer via the USB interface.

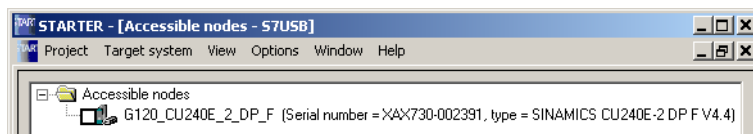

Close this screen form, without selecting the converter(s) that has/have been found. Now create your STARTER project.

Case 2: USB interface must be set

In this case, the message box "no other nodes found" is displayed. Close the window, and make the following settings in the "Accessible nodes" screen:

- ① Under "Access point activate "DEVICE (STARTER, Scout)"
- ② Under " PG/PC" select "S7USB"
- ③ Then click on "Update"

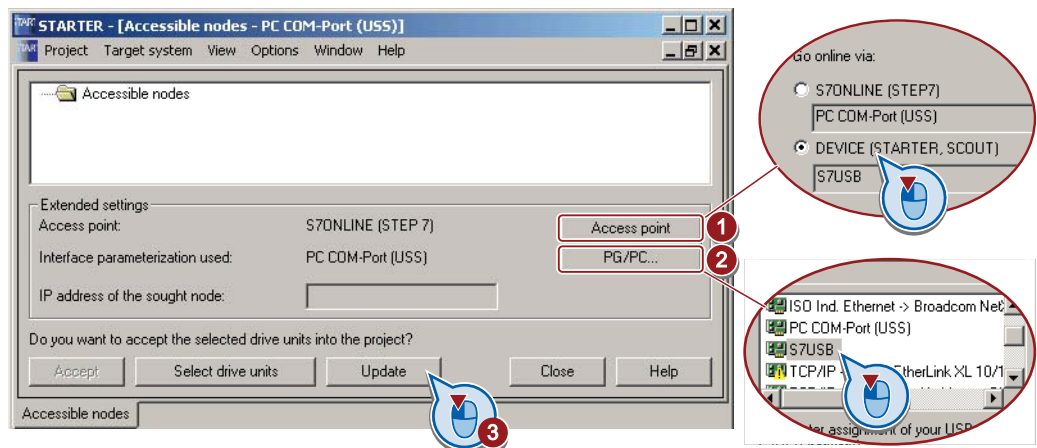

Close this screen form, without selecting the converter(s) that has/have been found. Now create your STARTER project.

4.5.2 Generating a STARTER project

Creating a STARTER project using project wizards

- Using "Project / New with wizard" create a new project.
- To start the wizard, click on "Search online for drive units ...".
- The wizard guides you through all of the settings that you need for your project.

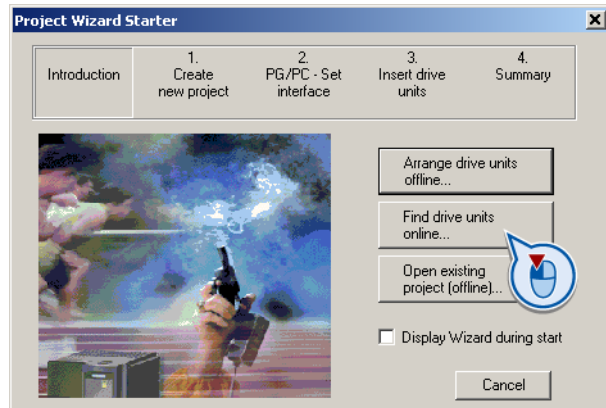

4.5.3 Go online and perform the basic commissioning

Going online

- ① Select your project and go online: .
- In the next screen form, select the device or the devices with which you want to go online. If you want to go online via the USB interface, then set the access point to "DEVICE".
- In the next screen form, download the hardware configuration that you found online into your project (PG or PC).
- STARTER shows you which converters it is accessing online and which are offline:
 - ② The converter is offline
 - ③ The converter is online
- ④ If you are online, open the screen form of the Control Unit.
- Start the wizard for the basic commissioning.

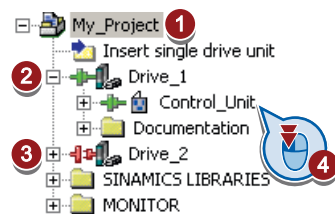

Wizard for basic commissioning

The wizard guides you step-by-step through the basic commissioning.

- In the first step of the wizard, select the control mode. If you are not certain which control mode you require for your particular application, then select U/f control for the time being. Help on how to select the control mode is provided in Chapter Motor control (Page 204).

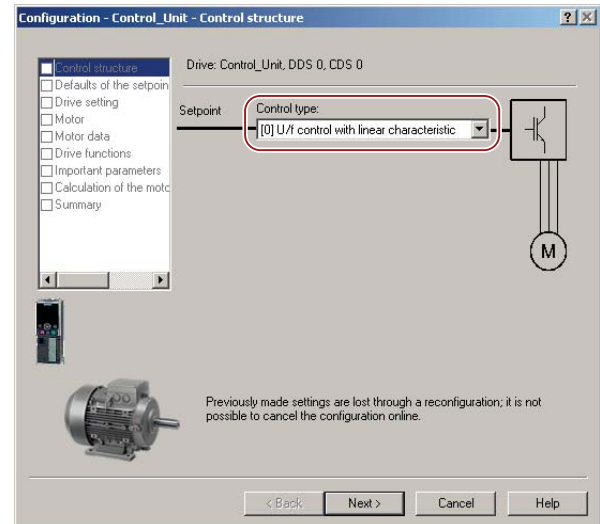

- In the next step, select the assignment of the converter interfaces (see also Section: Selecting the interface assignments (Page 48)).
Remark: The possible settings of your Control Unit can deviate from those in the diagram.

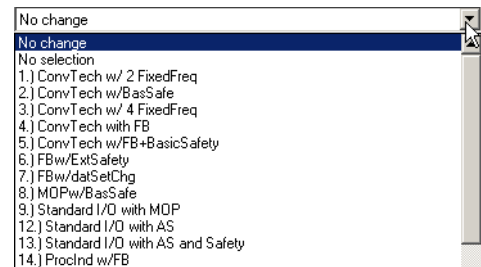

- In the next step, select the application for the converter:
Low overload for applications that only require a low dynamic performance, e.g.: Pumps or fans.
High overload for applications requiring a high dynamic performance, e.g. conveyor systems.
- In the next step, enter the motor data according to the rating plate of your motor. The motor data for SIEMENS standard motors can be called in STARTER based on their order number.

- In the next step, we recommend the setting "Identify motor data at standstill and with the motor rotating".
If the motor cannot freely rotate, e.g. due to a mechanically limited travel section, then select the "Identify motor data at standstill" setting.

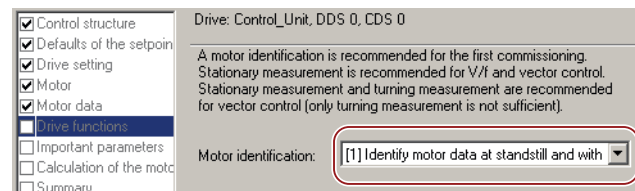

- In the next step, set the most important parameters that match your application, e.g. the ramp-up and ramp-down time of the motor.

- In the next step, we recommend the setting "Calculate motor data only".

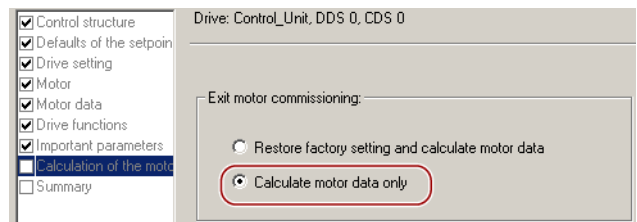

- ① In the next step, set the check mark for "RAM to ROM (save data in drive)" in order to save your data in the converter so that it is not lost when the power fails.
- ② If you exit the wizard, the converter outputs alarm A07791. You must now switch-on the motor to start motor data identification.

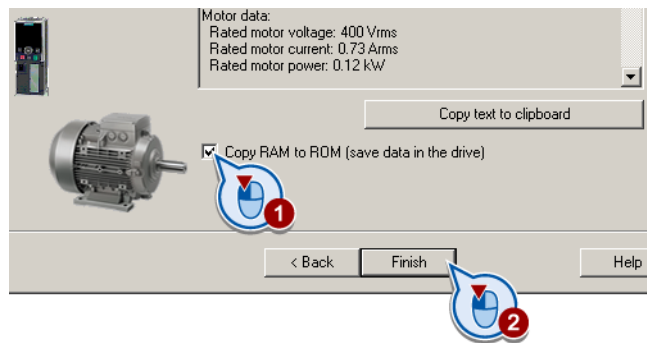

Switch on motor for motor data identification

 CAUTION
Motor data identification for dangerous loads
Secure dangerous plant and system parts before starting the motor data identification, e.g. by fencing off the dangerous location or lowering a suspended load to the floor.

- ① Open by double-clicking on the control panel in STARTER.
- ② Fetch the master control for the converter
- ③ Set the "Enable signals"
- ④ Switch on the motor.

The converter now starts to identify the motor data. This measurement can take several minutes. After the measurement the converter switches off the motor.

- Relinquish the master control after the motor data identification.

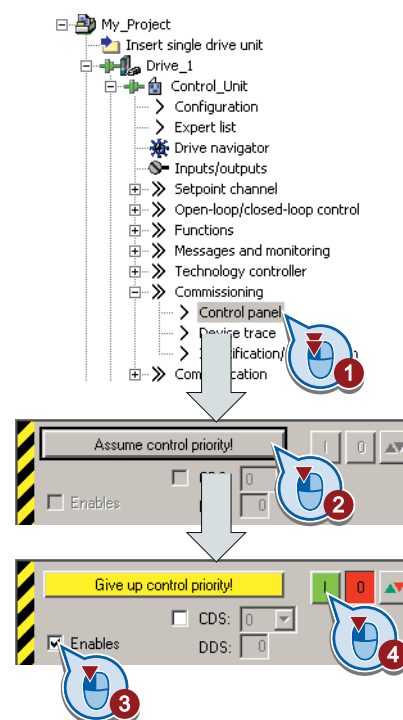

4.5.4 Making additional settings

After the basic commissioning, you can adapt the inverter to your application as described in the Commissioning (Page 53).

STARTER offers two options:

1. Change the settings using the appropriate screen forms - **our recommendation**.
 - ① Navigation bar: For each inverter function, select the corresponding screen form.
 - ② tabs: Switch between screen forms.

If you change the settings using screen forms you do not need to know the parameter numbers.

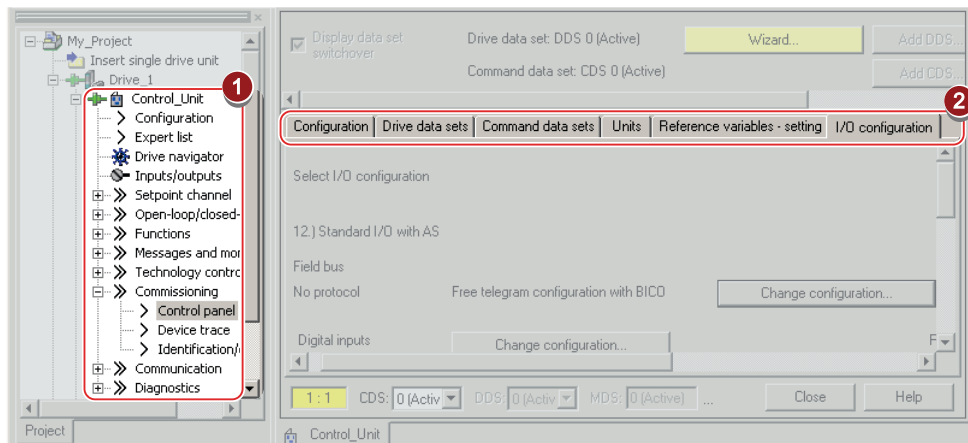

2. You change the settings using the parameters in the expert list.

If you wish to change the settings using the expert list, you need to know the corresponding parameter number and its significance.

Saving settings so that they are not lost when the power fails

All of the changes that you make are temporarily saved in the inverter and are lost the next time the power supply is switched off. For your changes to be permanently saved in the inverter, you must save the changes using the  button (RAM to ROM). Before you press the button, you need to mark the appropriate drive in the project navigator.

Go offline

You can now exit the online connection after the data backup (RAM to ROM) with  "Disconnect from target system".

4.5.5 Trace function for optimizing the drive

Description

The trace function is used for converter diagnostics and helps to optimize the behavior of the drive. Start the function in the navigation bar using "... Control_Unit/Commissioning/Device trace".



In two settings that are independent of one another, using  you can interconnect eight signals each. Each signal that you interconnect is active as standard

You can start a measurement as often as required; the results are temporarily stored (until you exit STARTER) under the "Measurements" tab, together with the date and time. When terminating STARTER or under the "Measurements" tab, you can save the measurement results in the *.trc format.

If you require more than two settings for your measurements, you can either save the individual traces in the project or export them in the *.clg format – and if necessary, load or import.

Recording

Recording is performed in a CU-dependent basic clock cycle. The maximum recording duration depends on the number of recorded signals and the trace clock cycle.

You can extend the recording duration by increasing the trace clock cycle by multiplying with an integer factor and then accepting the displayed maximum duration by . Alternatively, you can also specify the measurement period and then you can calculate the trace clock cycle of STARTER using .

Recording individual bits for bit parameters

You can record individual bits of a parameter (e.g. r0722) by allocating the relevant bit using "bit track" ().

Mathematical function

Using the mathematical function () you can define a curve, for example the difference between the speed setpoint and the speed actual value.

Note

If you use the "record individual bits" or "mathematical functions" option, then this is displayed under signal No. 9.

Trigger

You can create your own start condition (trigger) for the trace. With the factory setting (default setting) the trace starts as soon as you press the button (Start Trace). Using the button , you can define another trigger to start the measurement.

Using pretrigger, set the time for the recording before the trigger is set. As a consequence, the trigger condition traces itself.

Example of a bit pattern as trigger:

You must define the pattern and value of a bit parameter for the trigger. To do so, proceed as follows:

Using , select "Trigger to variable - bit pattern"

Using , select the bit parameter

Using , open the screen form in which you set the bits and their values for the start condition

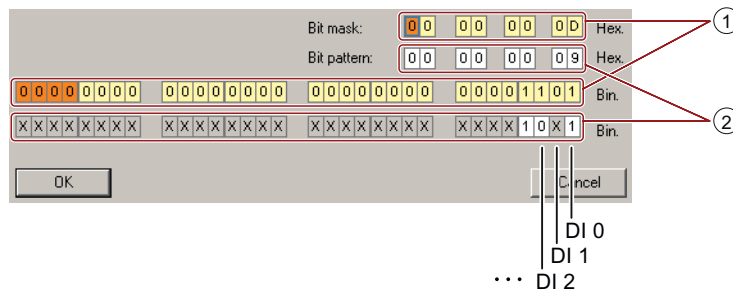

- ① Select the bits for the trace trigger, upper line hex format, lower row binary format
- ② Define the bits for the trace trigger, upper line hex format, lower row binary format

Figure 4-5 Bit pattern

In the example, the trace starts if DI0 and DI3 are high and DI2 is low. The state of the other digital inputs is not relevant for the start of the trace.

Further, you can either set an alarm or fault as start condition.

Display options

In this area, you can set how the measurement results are displayed.

- Repeat measurement:
This means that you place the measurements, which you wish to perform at different times, one above one another
- Arrange curves in tracks
This means that you define as to whether all measured values are to be displayed with a common zero line – or whether each measured value is displayed with its own zero line.
- Measuring cursor on:
This allows you to analyze the measuring intervals in detail

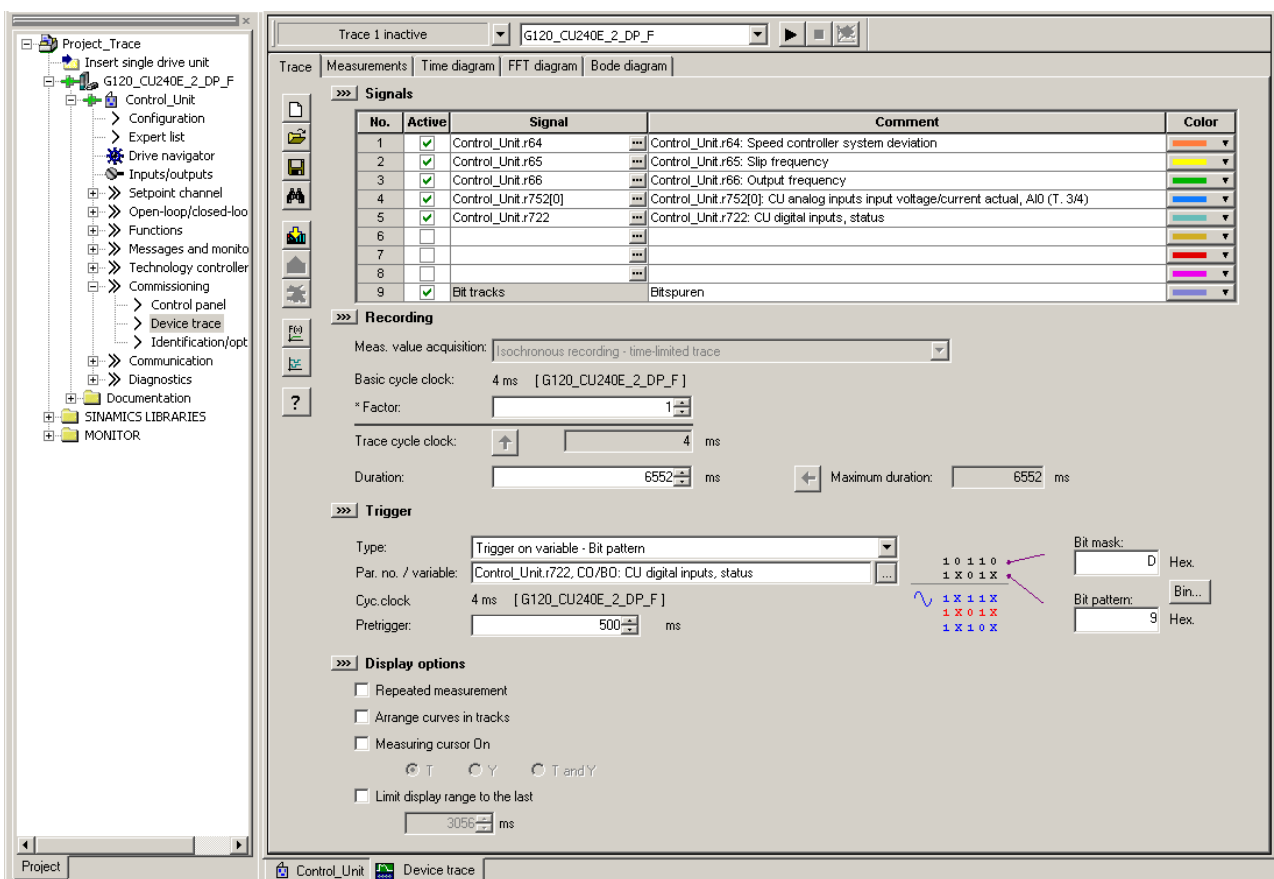

Figure 4-6 Trace dialog box

4.6 Data backup and standard commissioning

External data backup

After commissioning, your settings are saved in the inverter so that they are protected against power failure.

Further, we recommend that you externally save the parameter settings so that in the case of a defect, you can simply replace the Power Module or Control Unit (see also Overview of replacing converter components (Page 281)).

You have three different options for externally backing up data (upload):

1. Memory card
2. PC/PG with STARTER
3. Operator Panel

Series commissioning

Series commissioning means the commissioning of several identical drives in the following steps:

1. Commission the first inverter.
2. Upload the parameters of the first inverter to an external memory.
3. Download the parameters from the external memory to a second or additional inverter.

Note

The control unit to which the parameters are transferred must be of the same type and have the same or a higher firmware version as the source control unit (the same 'type' means the same MLFB).

For further information, refer to the following sections.

4.6.1 Backing up and transferring settings using a memory card

What memory cards do we recommend?

The memory card is a removable flash memory, that offers you the following options

- Automatically or manually write parameter settings from the card into the inverter (automatic or manual download)
- Automatically or manually write parameter settings from the inverter onto the card (automatic or manual upload)

We recommend that you use one of the memory cards with the following order numbers:

- MMC (order number 6SL3254-0AM00-0AA0)
- SD (order number 6ES7954-8LB00-0AA0)

Using memory cards from other manufacturers

If you use other SD or MMC memory cards, then you must format the memory card as follows:

- MMC: Format FAT 16
 - Insert the card into your PC's card reader.
 - Command to format the card:
format x: /fs:fat (x: Drive code of the memory card on your PC)
- SD: Format FAT 32
 - Insert the card into your PC's card reader.
 - Command to format the card:
format x: /fs:fat32 (x: Drive code of the memory card on your PC.)

 CAUTION
--

You use memory cards from other manufacturers at your own risk. Depending on the card manufacturer, not all functions are supported (e.g. download).
--

4.6.1.1 Saving setting on memory card

We recommend that you insert the memory card before switching on the inverter for the first time. The inverter then automatically ensures that the actual parameter setting is saved both in the inverter as well as on the card.

The following describes how you can save the inverter parameter setting on the memory card subsequently.

4.6 Data backup and standard commissioning

If you wish to transfer the parameter setting from the inverter on to a memory card (Upload), you have two options:

Automatic upload

The inverter power supply has been switched off.

1. Insert an empty memory card into the inverter.
 2. Then switch-on the inverter power supply again.
- After it has been switched-on, the inverter copies the modified parameters to the memory card

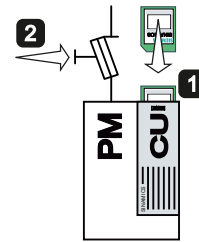

Transfer the setting to the empty memory card

NOTICE
If the memory card is not empty and already contains a parameter setting, the inverter will take on the parameter setting from the memory card. The previous setting in the inverter will be deleted.

Manual upload

If you do not wish to switch off the inverter power supply or you do not have an empty memory card available, you will need to transfer the parameter setting to the memory card as follows:

1. The inverter power supply has been switched on.
2. Insert a memory card into the inverter.

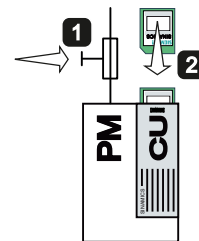

STARTER	BOP-2
<ul style="list-style-type: none"> • Start the data transfer with p0971 = 1. • Check the value of parameter p0971. If data transfer has been completed, then the inverter sets p0971 to 0. 	<ul style="list-style-type: none"> • Start data transfer in the menu "OPTIONS" - "TO CRD". • Wait until the BOP-2 signals that data transfer has been completed.

4.6.1.2 Transferring the setting from the memory card

If you wish to transfer the parameter setting from a memory card into the inverter (download), you have two options:

Automatic download

The inverter power supply has been switched off.

1. Insert the memory card into the inverter.
2. Then switch-on the inverter power supply.

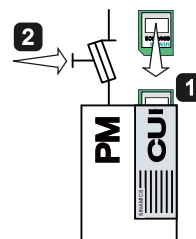

If there is valid parameter data on the memory card, then the inverter accepts this automatically.

Manual download

If you do not want to switch off the power supply, then you must transfer the parameter setting into the inverter in the following way:

1. The inverter power supply has been switched on.
2. Insert the memory card into the inverter.

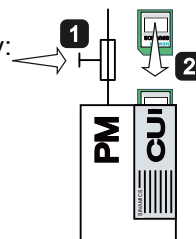

STARTER	BOP-2
<ol style="list-style-type: none"> 1. Go online with STARTER 2. In the expert list, set p0804 = 1. 3. Check the value of parameter p0804. Once data transfer has been completed, then p0804 = 0 is automatically set. 	<ol style="list-style-type: none"> 1. Start data transfer in the menu "EXTRAS" - "FROM CRD". 2. Wait until the BOP-2 signals that data transfer has been completed.

4.6.1.3 Safely remove the memory card

CAUTION



The file system on the memory card can be destroyed if the memory card is removed while the inverter is switched on without first requesting and confirming this using the "safe removal" function. The memory card will then no longer function.

Procedure with STARTER or BOP-2:



1. Set p9400 to 2.
2. Check the value of parameter p9400.
If it is permissible to remove the memory card, p9400 is set to 3.
3. Remove the memory card.

4.6.2 Backing up and transferring settings using STARTER

Backing up the inverter settings on PC/PG (upload)

1. Go online with STARTER: .
2. Click on the button "Load project to PG": .
3. To save data in the PG (computer), click on .

Transferring settings from the PC/PG into the inverter (download)

1. Go online with STARTER.
2. Click on the button "Load project to target system": .
3. To save data in the converter, click on "Copy RAM to ROM" .

4.6.3 Saving settings and transferring them using an operator panel

You start the download or upload in the "TOOLS" menu.

4.6.4 Other ways to back up settings

You can backup three additional settings of the parameters in memory areas of the inverter reserved for this purpose. You will find additional information in the List Manual under the following parameters:

Parameter	Description
p0970	Resetting drive parameters Load the back-up setting (number 10, 11 or 12). You overwrite your actual parameter setting when loading.
p0971	Saving parameters Backing up the setting (10, 11 or 12).

You can back-up up to 99 additional parameter settings on the memory card. You will find additional information in the List Manual under the following parameters:

Parameter	Description
p0802	Data transfer with memory card as source/target
p0803	Data transfer with device memory as source/target
p0804	Start data transfer

Adapting the terminal strip

5.1 Preconditions

Before you adapt the inputs and outputs of the inverter, you should have completed the basic commissioning, see Chapter Commissioning (Page 53) .

In the basic commissioning, select an assignment of the inverter interfaces from several predefined configurations, see Section Preparing for commissioning (Page 56).

If none of the predefined configurations completely matches your application, then you must adapt the assignment of the individual inputs and outputs. You do this by changing the internal interconnection of an input or output using BICO technology (Page 16).

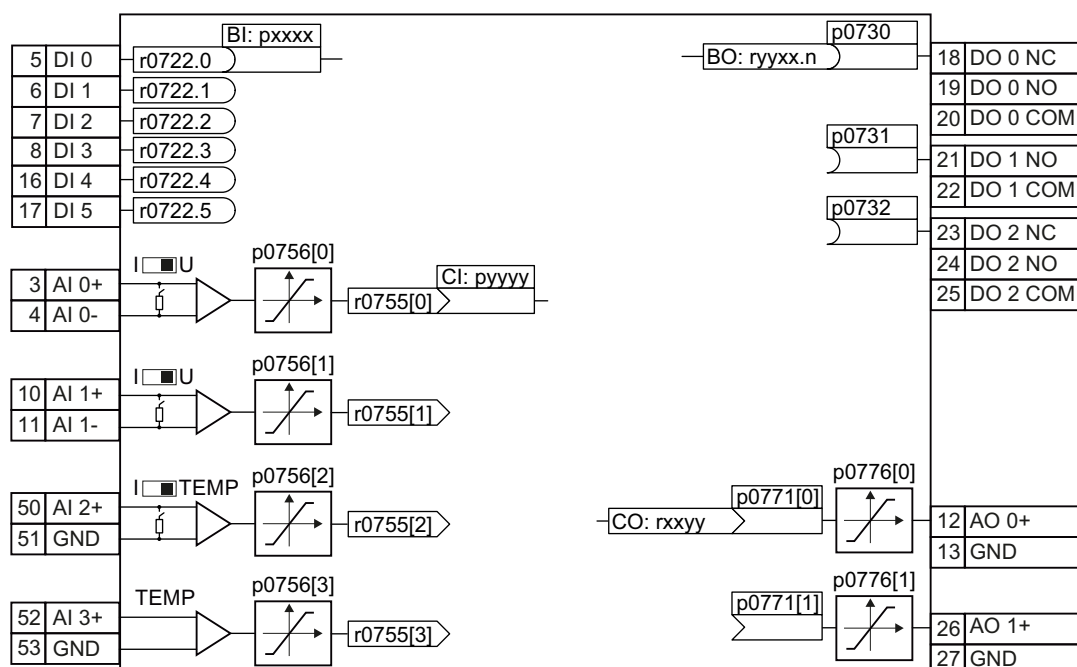

Figure 5-1 Internal interconnection of the inputs and outputs

5.2 Digital inputs

Digital input terminals	Changing the function of the digital input
	<p>Interconnect the status parameter of the digital input with a binector input of your choice.</p> <p>Binector inputs are designated with "BI" in the parameter list of the List Manual.</p>

Table 5- 1 Binector inputs (BI) of the inverter (selection)

BI	Significance	BI	Significance
p0810	Command data set selection CDS bit 0	p1036	Motorized potentiometer, setpoint, lower
p0840	ON/OFF1	p1055	Jog bit 0
p0844	OFF2	p1056	Jog bit 1
p0848	OFF3	p1113	Setpoint inversion
p0852	Enable operation	p1201	Flying restart enable signal source
p0855	Unconditionally release holding brake	p2103	1. Acknowledge faults
p0856	Enable speed controller	p2106	External fault 1
p0858	Unconditionally close holding brake	p2112	External alarm 1
p1020	Fixed speed setpoint selection bit 0	p2200	Technology controller enable
p1021	Fixed speed setpoint selection bit 1	p3330	Two-wire/three-wire control, control command 1
p1022	Fixed speed setpoint selection bit 2	p3331	Two-wire/three-wire control, control command 2
p1023	Fixed speed setpoint selection bit 3	p3332	Two-wire/three-wire control, control command 3
p1035	Motorized potentiometer, setpoint, raise		

A complete list of the binector outputs is provided in the List Manual.

Table 5- 2 Examples:

	Acknowledge fault with digital input 1
	Switch-on motor with digital input 2

Advanced settings

You can debounce the digital input signal using parameter p0724.

For more information, see the parameter list and the function block diagrams 2220 ff of the List Manual.

Analog inputs as digital inputs

When required, you can use the analog inputs as additional digital inputs.

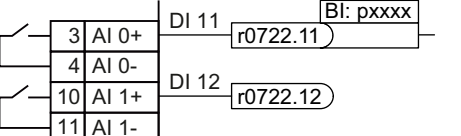
Terminals of the additional digital inputs	Changing the function of the digital input
	<p>If you use an analog input as digital input then interconnect the status parameter of the digital input with a binector input of your choice.</p>

5.3 Digital outputs

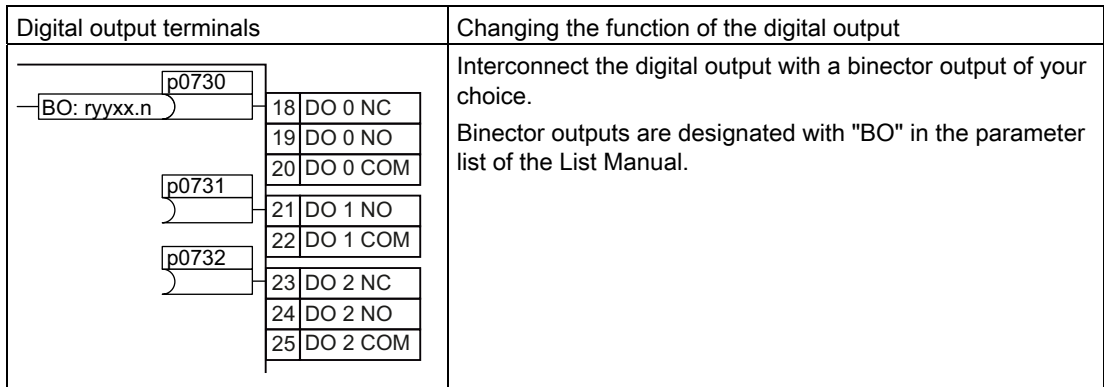
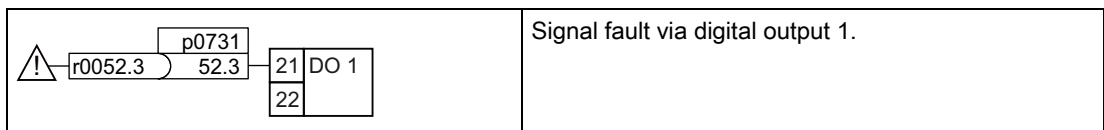

Table 5- 3 Binector outputs of the inverter (selection)

0	Deactivating digital output	r0052.9	Process data control
r0052.0	Drive ready	r0052.10	f_actual >= p1082 (f_max)
r0052.1	Drive ready for operation	r0052.11	Alarm: Motor current/torque limit
r0052.2	Drive running	r0052.12	Brake active
r0052.3	Drive fault active	r0052.13	Motor overload
r0052.4	OFF2 active	r0052.14	Motor CW rotation
r0052.5	OFF3 active	r0052.15	Inverter overload
r0052.6	Closing lockout active	r0053.0	DC braking active
r0052.7	Drive alarm active	r0053.2	f_actual > p1080 (f_min)
r0052.8	Setpoint/actual value discrepancy	r0053.6	f_actual ≥ setpoint (f_setpoint)

A complete list of the binector outputs is provided in the List Manual.

Table 5- 4 Example:



Advanced settings

You can invert the signal of the digital output using parameter p0748.

For more information, see the parameter list and the function block diagrams 2230 ff of the List Manual.

5.4 Analog inputs

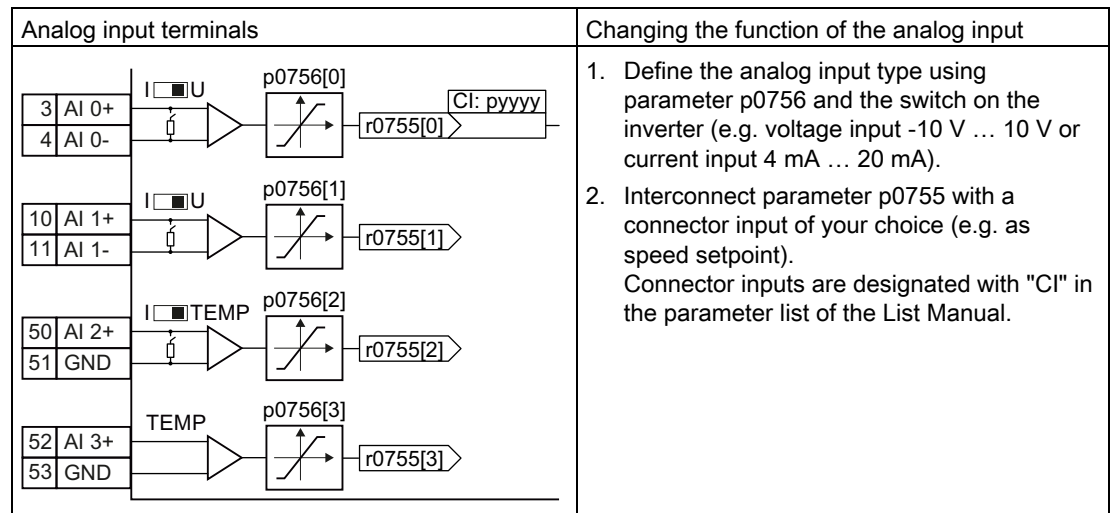

Define the analog input type

The inverter offers a series of default settings, which you can select using parameter p0756:

AI 0	Unipolar voltage input	0 V ... +10 V	p0756[0] = 0
	Unipolar voltage input monitored:	+2 V ... +10 V	1
	Unipolar current input	0 mA ... +20 mA	2
	Unipolar current input monitored	+4 mA ... +20 mA	3
	Bipolar voltage input (factory setting)	-10 V ... +10 V	4
AI 1	Unipolar voltage input	0 V ... +10 V	p0756[1] = 0
	Unipolar voltage input monitored:	+2 V ... +10 V	1
	Unipolar current input	0 mA ... +20 mA	2
	Unipolar current input monitored	+4 mA ... +20 mA	3
	Bipolar voltage input (factory setting)	-10 V ... +10 V	4
AI 2	Unipolar current input (factory setting)	0 mA ... +20 mA	p0756[2] = 2
	Unipolar current input monitored	+4 mA ... +20 mA	3
	Temperature sensor Ni1000		6
	Temperature sensor PT1000		7
	No sensor connected		8
AI 3	Temperature sensor Ni1000		p0756[3] = 6
	Temperature sensor PT1000		7
	No sensor connected (factory setting)		8

5.4 Analog inputs

In addition, you must also set the switch belonging to the analog input. You will find

- the DIP switch for AI0 and AI1 (current / voltage) on the Control Unit behind the lower front door.
- the DIP switch for AI2 (temperature / current) on the Control Unit behind the upper front door.

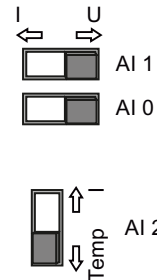

If you change the analog input type using p0756, then the inverter automatically selects the appropriate scaling of the analog input. The linear scaling characteristic is defined using two points (p0757, p0758) and (p0759, p0760). Parameters p0757 ... p0760 are assigned to an analog input via their index, e.g. parameters p0757[0] ... p0760[0] belong to analog input 0.

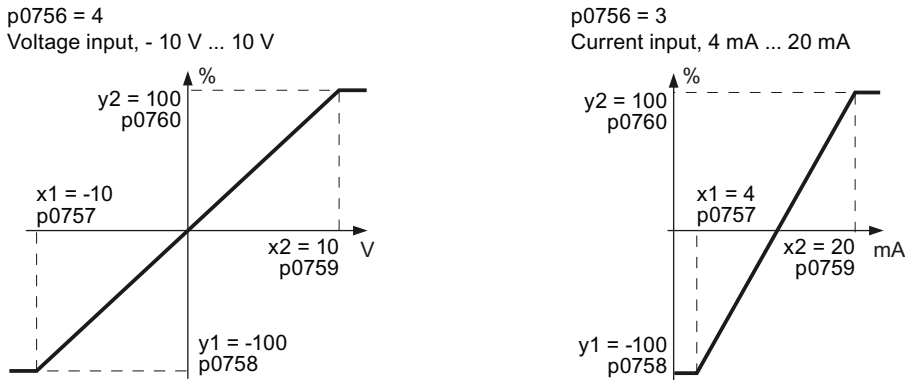

Figure 5-2 Examples for scaling characteristics

Table 5- 5 Parameters for the scaling characteristic and wire break monitoring

Parameter	Description
p0757	x-coordinate of 1st characteristic point [V or mA]
p0758	y coordinate of the 1st characteristic point [% of p200x] p200x are the parameters of the reference variables, e.g. p2000 is the reference speed.
p0759	x-coordinate of 2nd characteristic point [V or mA]
p0760	y-coordinate of 2nd characteristic point [% of p200x]
p0761	Wire breakage monitoring response threshold

You must define your own characteristic if none of the default types match your particular application.

Example

The inverter should convert a 6 mA ... 12 mA signal into the value range -100 % ... 100 % via analog input 0. The wire break monitoring of the inverter should respond when 6 mA is fallen below.

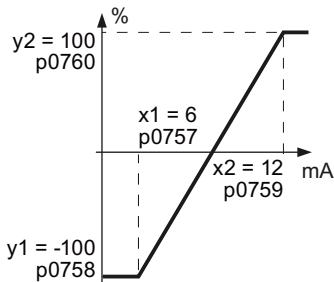
Parameter	Description	
p0756[0] = 3	Analog input type Define analog input 0 as current input with wire break monitoring.	Set DIP switch for AI 0 to current input ("I"): 
After changing p0756 to the value 3, the inverter sets the scaling characteristic parameters to the following values: p0757[0] = 4,0; p0758[0] = 0,0; p0759[0] = 20; p0760[0] = 100 Adapt the characteristic:		
p0761[0] = 6.0	Analog inputs wire break monitoring, response threshold	Current input, 6 mA ... 12 mA 
p0757[0] = 6.0	Analog inputs, characteristic (x₁, y₁)	
p0758[0] = -100.0	6 mA corresponds to -100 %	
p0759[0] = 12.0	Analog inputs, characteristic (x₂, y₂)	
p0760[0] = 100.0	12 mA corresponds to 100 %	

Define the significance of the analog input

You define the analog input function by interconnecting a connector input of your choice with parameter p0755. Parameter p0755 is assigned to the particular analog input via its index, e.g. parameter p0755[0] is assigned to analog input 0.

Table 5- 6 Connector inputs (CI) of the inverter (selection)

CI	Significance	CI	Significance
p1070	Main setpoint	p1522	Torque limit, upper
p1075	Supplementary setpoint	p2253	Technology controller setpoint 1
p1503	Torque setpoint	p2264	Technology controller actual value
p1511	Supplementary torque 1		

A complete list of the connector inputs is provided in the List Manual.

Table 5- 7 Example:

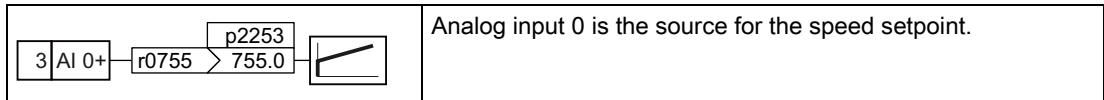

Advanced settings

When required, you can smooth the signal, which you read-in via an analog input, using parameter p0753.

For more information, see the parameter list and in the function block diagrams 9566 ff of the List Manual.

5.5 Analog outputs

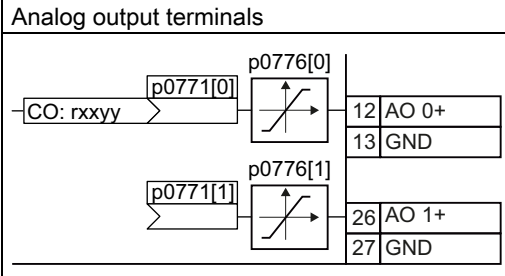
Analog output terminals	Changing the function of the analog output
	<ol style="list-style-type: none"> 1. Define the analog output type using parameter p0776 (e.g. voltage output -10 V ... 10 V or current output 4 mA ... 20 mA). 2. Interconnect parameter p0771 with a connector output of your choice (e.g. the actual speed). Connector outputs are designated with "CO" in the parameter list of the List Manual.

Defining the analog output type

The inverter offers a series of default settings, which you can select using parameter p0776:

AO 0	Current output (factory setting)	0 mA ... +20 mA	p0776[0] = 0
	Voltage output	0 V ... +10 V	1
	Current output	+4 mA ... +20 mA	2
AO 1	Current output (factory setting)	0 mA ... +20 mA	p0776[1] = 0
	Voltage output	0 V ... +10 V	1
	Current output	+4 mA ... +20 mA	2

If you change the analog output type, then the inverter automatically selects the appropriate scaling of the analog output. The linear scaling characteristic is defined using two points (p0777, p0778) and (p0779, p0780).

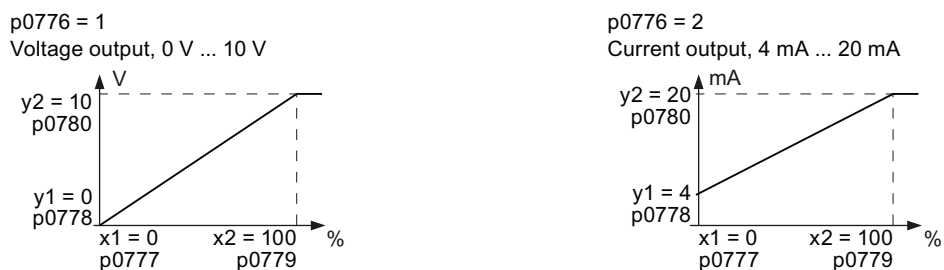

Figure 5-3 Examples for scaling characteristics

Parameters p0777 ... p0780 are assigned to an analog output via their index, e.g. parameters p0777[0] ... p0770[0] belong to analog output 0.

Table 5- 8 Parameters for the scaling characteristic

Parameter	Description
p0777	X coordinate of the 1st characteristic point [% of P200x] P200x are the parameters of the reference variables, e.g. P2000 is the reference speed.
p0778	Y coordinate of the 1st characteristic point [V or mA]
p0779	X coordinate of the 2nd characteristic point [% of P200x]
p0780	Y coordinate of the 2nd characteristic point [V or mA]

You must define your own characteristic if none of the default types match your particular application.

Example:

The inverter should convert a signal in the value range -100 % ... 100 % into a 6 mA ... 12 mA output signal via analog output 0.

Parameter	Description
p0776[0] = 2	Analog output, type Define analog output 0 as current output.
After changing p0776 to the value 2, the inverter sets the scaling characteristic parameters to the following values: p0777[0] = 0.0; p0778[0] = 4.0; p0779[0] = 100.0; p0780[0] = 20.0 Adapt the characteristic:	
p0777[0] = 0.0	Analog output, characteristic (x₁, y₁)
p0778[0] = 6.0	0.0 % corresponds to 6 mA
p0779[0] = 100.0	Analog output, characteristic (x₂, y₂)
p0780[0] = 12.0	100 % corresponds to 12 mA

Current output, 6 mA ... 12 mA

Defining the analog output function

You define the analog output function by interconnecting parameter p0771 with a connector output of your choice. Parameter p0771 is assigned to the particular analog input via its index, e.g. parameter p0771[0] is assigned to analog output 0.

Table 5- 9 Connector outputs (CO) of the inverter (selection)

CO	Significance	CO	Significance
r0021	Actual frequency	r0026	Actual DC link voltage
r0024	Output actual frequency	r0027	Output current
r0025	Output actual frequency		

A complete list of the connector outputs is provided in the List Manual.

Table 5- 10 Example:

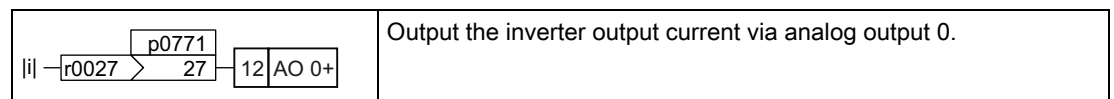

For more information, see the parameter list and the function block diagrams 9572 ff of the List Manual.

Advanced settings

You can manipulate the signal that you output via an analog output, as follows:

- Absolute-value generation of the signal (p0775)
- Signal inversion (p0782)

Additional information is provided in the parameter list of the List Manual.

Configuring the fieldbus

Before you connect the inverter to the field bus, you should have completed the basic commissioning, see Chapter Commissioning (Page 53)

Fieldbus interfaces of the Control Units

The Control Units are available in different versions for communication with higher-level controls with the subsequently listed fieldbus interfaces:

Fieldbus	Profile	Control Unit	Interface
PROFIBUS DP (Page 98)	PROFIdrive PROFIsafe	CU230P-2 DP	SUB D socket
USS (Page 119)	-	CU230P-2 HVAC	RS485 connector
Modbus RTU (Page 133)	-	CU230P-2 HVAC	RS485 connector
BACnet MS/TP (Page 143)	-	CU230P-2 HVAC	RS485 connector
CANopen (Page 152)	-	CU230P-2 CAN	SUB-D connector

Data exchange via the fieldbus

Analog signals

The converter always scales signals, which are transferred via the fieldbus, to a value of 4000 hex. The significance of this numerical value depends on the category of the signal that you are transferring.

Signal category	4000 hex corresponds to the value of the following parameters
Speeds, frequencies	p2000
Voltage	p2001
Current	p2002
Torque	p2003
Power	p2004
Angle	p2005
Temperature	p2006
Acceleration	p2007

Control and status words

Control and status words always comprise two bytes. Depending on the control type, the two bytes are differently interpreted as higher or lower significance. An example for transferring control and status words with a SIMATIC control is provided in Chapter STEP 7 program example for cyclic communication (Page 328).

6.1 Communication via PROFIBUS

Permissible cable lengths, routing and shielding the PROFIBUS cable

Information can be found in the Internet (http://www.automation.siemens.com/net/html_76/support/printkatalog.htm).

Recommended PROFIBUS connectors

We recommend connectors with the following order numbers for connecting the PROFIBUS cable:

- 6GK1500-0FC00
- 6GK1500-0EA02

Both connectors are suitable for all SINAMICS G120 inverters with respect to the angle of the outgoing cable.

Note

Communication with the controller, even when the supply voltage on the Power Module is switched off

You will have to supply the Control Unit with 24 V DC on terminals 31 and 32 if you require communication to take place with the controller when the line voltage is switched off.

6.1.1 Configuring communication to the control

The GSD is a description file for a PROFIBUS slave. You must import the GSD of the converter into the PROFIBUS master - i.e. into your control system - in order to configure communication between the control system and converter.

You have two options for obtaining the GSD of your converter:

1. You can find the SINAMICS converter GSD on the Internet (<http://support.automation.siemens.com/WW/view/en/22339653/133100>).
2. The GSD is saved in the converter. The GSD is written to the memory card if you insert the memory card in the converter and set p0804 to 12. Using the memory card, you can then transfer the GSD to your PG/your PC.

In Section Application examples (Page 323) you will find an example showing how you can connect the converter with its GSD to a SIMATIC control via PROFIBUS.

6.1.2 Setting the address

You can set the inverter's PROFIBUS address using either DIP switches on the Control Unit or parameter p0918.

Valid PROFIBUS addresses: 1 ... 125

Invalid PROFIBUS addresses: 0, 126, 127

If you have specified a valid address using DIP switches, this address will always be the one that takes effect and p0918 cannot be changed.

If you set all DIP switches to "OFF" (0) or "ON" (1), then p0918 defines the address.

The positions and settings of the DIP switches are described in Section: Interfaces, connectors, switches, control terminals, LEDs on the CU (Page 46).

CAUTION

A bus address that has been changed is only effective after the inverter has been switched off and back on again.

6.1.3 Basic settings for communication

Table 6- 1 The most important parameters

Parameter	Description														
p0015	Macro drive device Select the I/O configuration via PROFIBUS DP (e.g. p0015 = 7)														
p0922	PROFIdrive telegram selection (factory setting for converters with PROFIBUS interface: standard telegram 1, PZD-2/2) Set the send and receive telegram, see Cyclic communication (Page 101)														
	<table border="0"> <tr> <td>1:</td> <td>Standard telegram 1, PZD-2/2</td> </tr> <tr> <td>20:</td> <td>Standard telegram 20, PZD-2/6</td> </tr> <tr> <td>350:</td> <td>SIEMENS telegram 350, PZD-4/4</td> </tr> <tr> <td>352:</td> <td>SIEMENS telegram 352, PZD-6/6</td> </tr> <tr> <td>353:</td> <td>SIEMENS telegram 353, PZD-2/2, PKW-4/4</td> </tr> <tr> <td>354:</td> <td>SIEMENS telegram 354, PZD-6/6, PKW-4/4</td> </tr> <tr> <td>999:</td> <td>Free telegram configuring with BICO</td> </tr> </table>	1:	Standard telegram 1, PZD-2/2	20:	Standard telegram 20, PZD-2/6	350:	SIEMENS telegram 350, PZD-4/4	352:	SIEMENS telegram 352, PZD-6/6	353:	SIEMENS telegram 353, PZD-2/2, PKW-4/4	354:	SIEMENS telegram 354, PZD-6/6, PKW-4/4	999:	Free telegram configuring with BICO
1:	Standard telegram 1, PZD-2/2														
20:	Standard telegram 20, PZD-2/6														
350:	SIEMENS telegram 350, PZD-4/4														
352:	SIEMENS telegram 352, PZD-6/6														
353:	SIEMENS telegram 353, PZD-2/2, PKW-4/4														
354:	SIEMENS telegram 354, PZD-6/6, PKW-4/4														
999:	Free telegram configuring with BICO														

Using parameter p0922, you automatically interconnect the corresponding signals of the converter to the telegram.

This BICO interconnection can only be changed, if you set p0922 to 999. In this case, select your required telegram using p2079 and then adapt the BICO interconnection of the signals.

Table 6- 2 Advanced settings

Parameter	Description
p2079	PROFIdrive PZD telegram selection extended Contrary to p0922, using p2079, a telegram can be set and subsequently extended. For p0922 < 999, the following applies: p2079 has the same value and is locked. All of the interconnections and extensions contained in the telegram are locked. For p0922 = 999, the following applies: p2079 can be freely set. If p2079 is also set to 999, then all interconnections can be set. For p0922 = 999 and p2079 < 999, the following applies: The interconnections contained in the telegram are locked. However, the telegram can be extended.

For further information, please refer to the Parameter Manual.

6.1.4 Cyclic communication

The PROFIdrive profile defines different telegram types. Telegrams contain the data for cyclic communication with a defined meaning and sequence. The inverter has the telegram types listed in the table below.

Table 6-3 Inverter telegram types

Telegram type (p0922)	Process data (PZD) - control and status words, setpoints and actual values							
	PZD01 STW1 ZSW1	PZD02 HSW HIW	PZD03	PZD04	PZD05	PZD06	PZD07	PZD08
Telegram 1 Speed control PZD 2/2	STW1	NSOLL_A	← The inverter receives this data from the control					
	ZSW1	NIST_A	⇒ The inverter sends this data to the control					
Telegram 20 Speed control, VIK/NAMUR PZD 2/6	STW1	NSOLL_A						
	ZSW1	NIST_A_ GLATT	IAIST_ GLATT	MIST_ GLATT	PIST_ GLATT	MELD_ NAMUR		
Telegram 350 Speed control PZD 4/4	STW1	NSOLL_A	M_LIM	STW3				
	ZSW1	NIST_A_ GLATT	IAIST_ GLATT	ZSW3				
Telegram 352 Speed control, PCS7 PZD 6/6	STW1	NSOLL_A	PCS7 process data					
	ZSW1	NIST_A_ GLATT	IAIST_ GLATT	MIST_ GLATT	WARN_ CODE	FAULT_ CODE		
Telegram 353 Speed control, PKW 4/4 and PZD 2/2	STW1	NSOLL_A						
	ZSW1	NIST_A_ GLATT						
Telegram 354 Speed control, PKW 4/4 and PZD 6/6	STW1	NSOLL_A	PCS7 process data					
	ZSW1	NIST_A_ GLATT	IAIST_ GLATT	MIST_ GLATT	WARN_ CODE	FAULT_ CODE		
Telegram 999 Free interconnection via BICO PZD n/m (n,m = 1 ... 8)	STW1	Telegram length on receipt can be configured up to max. 8 words						
	ZSW1	Telegram length on transmission can be configured up to max. 8 words						

Table 6-4 Explanation of the abbreviations

Abbreviation	Significance	Abbreviation	Significance
STW1/2	Control word 1/2	PIST_GLATT	Actual active power
ZSW1/2	Status word 1/2	MELD_NAMUR	Control word according to the VIK-NAMUR definition
NSOLL_A	Speed setpoint	M_LIM	Torque limit value
NIST_A_GLATT	Smoothed speed actual value	FAULT_CODE	Fault number
IAIST_GLATT	Smoothed actual current value	WARN_CODE	Alarm number
MIST_GLATT	Actual torque		

Table 6- 5 Telegram status in the inverter

Process data item	Control ⇒ inverter		Inverter ⇒ control	
	Status of the received word	Bits 0...15 in the received word	Defining the word to be sent	Status of the sent word
PZD01	r2050[0]	r2090.0 ... r2090.15	p2051[0]	r2053[0]
PZD02	r2050[1]	r2091.0 ... r2091.15	p2051[1]	r2053[1]
PZD03	r2050[2]	r2092.0 ... r2092.15	p2051[2]	r2053[2]
PZD04	r2050[3]	r2093.0 ... r2093.15	p2051[3]	r2053[3]
PZD05	r2050[4]	-	p2051[4]	r2053[4]
PZD06	r2050[5]	-	p2051[5]	r2053[5]
PZD07	r2050[6]	-	p2051[6]	r2053[6]
PZD08	r2050[7]	-	p2051[7]	r2053[7]

Select telegram

Select the communication telegram using parameters p0922 and p2079. The following dependencies apply:

- P0922 < 999:**
 For p0922 < 999, the inverter sets p2079 to the same value as p0922.
 With this setting, the inverter defines the length and the content of the telegram. The inverter does not permit any changes to the telegram.
- p0922 = 999, p2079 < 999:**
 For p0922 = 999, select a telegram via p2079.
 Also with this setting, the inverter defines the length and the content of the telegram. The inverter does not permit any changes to the telegram content. However, you can extend the telegram.
- p0922 = p2079 = 999:**
 For p0922 = p2079 = 999, enter the length and the content of the telegram.
 With this setting, you can define the telegram length via the central PROFIdrive configuration in the master. You define the telegram contents via the signal interconnections of the BICO technology. Using p2038, you can define the assignment of the control word according to SINAMICS or VIK/NAMUR.

You will find more details on the interconnection of command and setpoint sources, depending on the selected protocol, in the List Manual in function block diagrams 2420 to 2472.

6.1.4.1 Control and status word 1

The control and status words fulfill the specifications of PROFIdrive profile version 4.1 for "speed control" mode.

Control word 1 (STW1)

Control word 1 (bits 0 ... 10 in accordance with PROFIdrive profile and VIK/NAMUR, bits 11 ... 15 specific to inverter).

Table 6- 6 Control word 1 and interconnection with parameters in the inverter

Bit	Value	Significance		Comments	P No.
		Telegram 20	All other telegrams		
0	0	OFF1		Motor brakes with the ramp-down time p1121 at standstill ($f < f_{min}$) the motor is switched off.	p0840[0] = r2090.0
	1	ON		With a positive edge, the inverter goes into the "ready" state, with additionally bit 3 = 1, the inverter switches on the motor.	
1	0	OFF2		Switch off motor immediately, motor coasts to a standstill.	p0844[0] = r2090.1
	1	No OFF2		---	
2	0	Quick stop (OFF3)		Quick stop: Motor brakes with the OFF3 ramp-down time p1135 down to standstill.	p0848[0] = r2090.2
	1	No quick stop (OFF3)		---	
3	0	Disable operation		Immediately switch-off motor (cancel pulses).	p0852[0] = r2090.3
	1	Enable operation		Switch-on motor (pulses can be enabled).	
4	0	Lock ramp-function generator		The ramp-function generator output is set to 0 (quickest possible deceleration).	p1140[0] = r2090.4
	1	Operating condition		Ramp-function generator can be enabled	
5	0	Stop ramp-function generator		The output of the ramp-function generator is "frozen".	p1141[0] = r2090.5
	1	Ramp-function generator enable			
6	0	Inhibit setpoint		Motor brakes with the ramp-down time p1121.	p1142[0] = r2090.6
	1	Enable setpoint		Motor accelerates with the ramp-up time p1120 to the setpoint.	
7	1	Acknowledging faults		Fault is acknowledged with a positive edge. If the ON command is still active, the inverter switches to "closing lockout" state.	p2103[0] = r2090.7
8		Not used			
9		Not used			
10	0	PLC has no master control		Process data invalid, "sign of life" expected.	p0854[0] = r2090.10
	1	Master control by PLC		Control via fieldbus, process data valid.	
11	1	--- ¹⁾	Direction reversal	Setpoint is inverted in the inverter.	p1113[0] = r2090.11
12		Not used			
13	1	--- ¹⁾	MOP up	The setpoint stored in the motorized potentiometer is increased.	p1035[0] = r2090.13
14	1	--- ¹⁾	MOP down	The setpoint stored in the motorized potentiometer is decreased.	p1036[0] = r2090.14
15	1	CDS bit 0	Not used	Changes over between settings for different operation interfaces (command data sets).	p0810 = r2090.15

¹⁾ If you change over from another telegram to telegram 20, then the assignment of the previous telegram is kept.

Status word 1 (ZSW1)

Status word 1 (bits 0 to 10 in accordance with PROFIdrive profile and VIK/NAMUR, bits 11 to 15 for SINAMICS G120 only).

Table 6-7 Status word 1 and interconnection with parameters in the inverter

Bit	Value	Significance		Comments	P No.
		Telegram 20	All other telegrams		
0	1	Ready for switching on		Power supply switched on; electronics initialized; pulses locked.	p2080[0] = r0899.0
1	1	Ready for operation		Motor is switched on (ON1 command present), no active fault, motor can start as soon as "enable operation" command is issued. See control word 1, bit 0.	p2080[1] = r0899.1
2	1	Operation enabled		Motor follows setpoint. See control word 1, bit 3.	p2080[2] = r0899.2
3	1	Fault present		The inverter has a fault.	p2080[3] = r2139.3
4	1	OFF2 inactive		Coast to standstill not activated (no OFF2)	p2080[4] = r0899.4
5	1	OFF3 inactive		No fast stop active	p2080[5] = r0899.5
6	1	Closing lockout active		The motor is only switched on after a further ON1 command	p2080[6] = r0899.6
7	1	Alarm active		Motor remains switched on; acknowledgement is not required; see r2110.	p2080[7] = r2139.7
8	1	Speed deviation within tolerance range		Setpoint/actual value deviation within tolerance range.	p2080[8] = r2197.7
9	1	Control requested		The automation system is requested to assume control.	p2080[9] = r0899.9
10	1	Comparison speed reached or exceeded		Speed is greater than or equal to the corresponding maximum speed.	p2080[10] = r2199.1
11	0	I, M or P limit reached		Comparison value for current, torque or power has been reached or exceeded.	p2080[11] = r1407.7
12	1	--- ¹⁾	Holding brake open	Signal to open and close a motor holding brake.	p2080[12] = r0899.12
13	0	Alarm motor overtemperature		--	p2080[13] = r2135.14
14	1	Motor rotates forwards		Internal inverter actual value > 0	p2080[14] = r2197.3
	0	Motor rotates backwards		Internal inverter actual value < 0	
15	1	CDS display	No alarm, thermal power unit overload		p2080[15] = r0836.0 / r2135.15

¹⁾ If you change over from another telegram to telegram 20, then the assignment of the previous telegram is kept.

6.1.4.2 Control and status word 3

The control and status words fulfill the specifications of PROFIdrive profile version 4.1 for "speed control" mode.

Control word 3 (STW3)

Control word 3 has the following default assignment. You can change the assignment with BICO technology.

Table 6- 8 Control word 3 and interconnection with parameters in the converter

Bit	Value	Meaning	Comments	BICO interconnection ¹⁾
		Telegram 350		
0	1	Fixed setpoint, bit 0	Selects up to 16 different fixed setpoints.	p1020[0] = r2093.0
1	1	Fixed setpoint, bit 1		p1021[0] = r2093.1
2	1	Fixed setpoint, bit 2		p1022[0] = r2093.2
3	1	Fixed setpoint, bit 3		p1023[0] = r2093.3
4	1	DDS selection, bit 0	Changes over between settings for different motors (drive data sets).	p0820 = r2093.4
5	1	DDS selection, bit 1		p0821 = r2093.5
6	–	Not used		
7	–	Not used		
8	1	Technology controller enable	--	p2200[0] = r2093.8
9	1	DC braking enable	--	p1230[0] = r2093.9
10	–	Not used		
11	1	1 = Enable droop	Enable or inhibit speed controller droop.	p1492[0] = r2093.11
12	1	Torque control active	Changes over the control mode for vector control.	p1501[0] = r2093.12
	0	Speed control active		
13	1	No external fault	--	p2106[0] = r2093.13
	0	External fault is active (F07860)		
14	–	Not used		
15	1	CDS bit 1	Changes over between settings for different operation interfaces (command data sets).	p0811[0] = r2093.15

¹⁾ If you switch from telegram 350 to a different one, then the converter sets all interconnections p1020, ... to "0".
Exception: p2106 = 1.

Status word 3 (ZSW3)

Status word 3 has the following standard assignment. You can change the assignment with BICO technology.

Table 6- 9 Status word 3 and interconnection with parameters in the converter

Bit	Value	Meaning	Description	P No.
0	1	DC braking active	--	p2051[3] = r0053
1	1	$ n_{act} > p1226$	Absolute current speed > stationary state detection	
2	1	$ n_{act} > p1080$	Absolute actual speed > minimum speed	
3	1	$i_{act} \geq p2170$	Actual current \geq current threshold value	
4	1	$ n_{act} > p2155$	Absolute actual speed > speed threshold value 2	
5	1	$ n_{act} \leq p2155$	Absolute actual speed < speed threshold value 2	
6	1	$ n_{act} \geq r1119$	Speed setpoint reached	
7	1	DC link voltage $\leq p2172$	Actual DC link voltage \leq threshold value	
8	1	DC link voltage > p2172	Actual DC link voltage > threshold value	
9	1	Ramping completed	Ramp-function generator is not active.	
10	1	Technology controller output at lower limit	Technology controller output $\leq p2292$	
11	1	Technology controller output at upper limit	Technology controller output > p2291	
12		Not used		
13		Not used		
14		Not used		
15		Not used		

6.1.4.3 Data structure of the parameter channel

Parameter channel

You can write and read parameter values via the parameter channel, e.g. in order to monitor process data. The parameter channel always comprises four words.

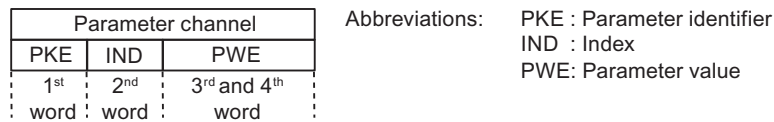

Figure 6-1 Structure of the parameter channel

Parameter identifier (PKE), 1st word

The parameter identifier (PKE) contains 16 bits.

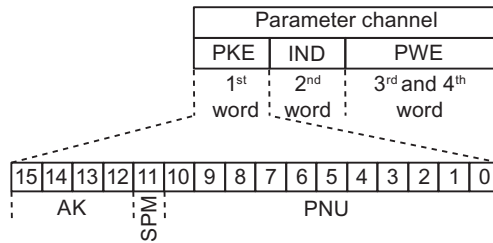

Figure 6-2 PKE - 1st word in parameter channel

- Bits 12 to 15 (AK) contain the request or response identifier.
- Bit 11 (SPM) is reserved and is always 0.
- Bits 0 to 10 (PNU) contain parameter numbers 1 ... 1999. For parameter numbers ≥ 2000 an offset must be added that is defined in the 2nd word of the parameter channel (IND).

The meaning of the request identifier for request telegrams (control → inverter) is explained in the following table.

Table 6- 10 Request identifier (control → inverter)

Request identifier	Description	Response identifier	
		positive	negative
0	No request	0	7 / 8
1	Request parameter value	1 / 2	↑
2	Change parameter value (word)	1	
3	Change parameter value (double word)	2	
4	Request descriptive element ¹⁾	3	
6	Request parameter value (field) ¹⁾	4 / 5	
7	Change parameter value (field, word) ¹⁾	4	
8	Change parameter value (field, double word) ¹⁾	5	
9	Request number of field elements	6	
11	Change parameter value (field, double word) and save in EEPROM ²⁾	5	
12	Change parameter value (field, word) and save in EEPROM ²⁾	4	
13	Change parameter value (double word) and save in EEPROM	2	↓
14	Change parameter value (word) and save in EEPROM	1	7 / 8
1) The required element of the parameter description is specified in IND (2nd word). 2) The required element of the indexed parameter is specified in IND (2nd word).			

The meaning of the response identifier for response telegrams (inverter → control) is explained in the following table. The request identifier determines which response identifiers are possible.

Table 6- 11 Response identifier (inverter → control)

Response identifier	Description
0	No response
1	Transfer parameter value (word)
2	Transfer parameter value (double word)
3	Transfer descriptive element ¹⁾
4	Transfer parameter value (field, word) ²⁾
5	Transfer parameter value (field, double word) ²⁾
6	Transfer number of field elements
7	Request cannot be processed, task cannot be executed (with error number)
8	No master controller status / no authorization to change parameters of the parameter channel interface
1) The required element of the parameter description is specified in IND (2nd word). 2) The required element of the indexed parameter is specified in IND (2nd word).	

If the response identifier is 7 (request cannot be processed), one of the error numbers listed in the following table will be saved in parameter value 2 (PWE2).

Table 6- 12 Error numbers for the response "Request cannot be processed"

No.	Description	Comments
0	Impermissible parameter number (PNU)	Parameter does not exist
1	Parameter value cannot be changed	The parameter can only be read
2	Minimum/maximum not achieved or exceeded	–
3	Wrong subindex	–
4	No field	An individual parameter was addressed with a field request and subindex > 0
5	Wrong parameter type / wrong data type	Confusion of word and double word
6	Setting is not permitted (only resetting)	–
7	The descriptive element cannot be changed	Description cannot be changed
11	Not in the "master control" mode	Change request without "master control" mode (see P0927)
12	Keyword missing	–
17	Request cannot be processed on account of the operating state	The current inverter status is not compatible with the received request
20	Illegal value	Modification access with a value which is within the value limits but which is illegal for other permanent reasons (parameter with defined individual values)
101	Parameter number is currently deactivated	Dependent on the operating state of the inverter
102	Channel width is insufficient	Communication channel is too small for response
104	Illegal parameter value	The parameter can only assume certain values.
106	Request not included / task is not supported	After request ID 5, 10, 15
107	No write access with enabled controller	The operating state of the inverter prevents a parameter change
200/201	Changed minimum/maximum not achieved or exceeded	The maximum or minimum can be limited further during operation.
204	The available access authorization does not cover parameter changes.	–

Parameter index (IND)

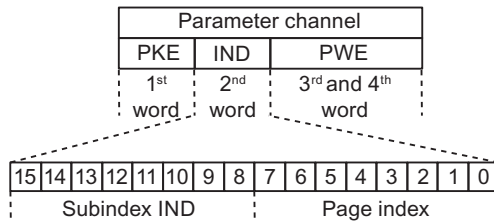

Figure 6-3 Structure of the parameter index (IND)

- For indexed parameters, select the index of the parameter by transferring the appropriate value between 0 and 254 to the subindex within a job.
- The page index is used to switch over the parameter numbers. Use this byte to add an offset to the parameter number that is transferred in the 1st word of the parameter channel (PKE).

Page index: Offset of parameter number

The parameter numbers are assigned to several parameter ranges. The following table shows which value you must transfer to the page index to achieve a particular parameter number.

Table 6- 13 Page index setting dependent on parameter range

Parameter range	Page index								Hex value
	Bit 7	Bit 6	Bit 5	Bit 4	Bit 3	Bit 2	Bit 1	Bit 0	
0000 ... 1999	0	0	0	0	0	0	0	0	0x00
2000 ... 3999	1	0	0	0	0	0	0	0	0x80
6000 ... 7999	1	0	0	1	0	0	0	0	0x90
8000 ... 9999	0	0	1	0	0	0	0	0	0x20
10000 ... 11999	1	0	1	0	0	0	0	0	0xA0
20000 ... 21999	0	1	0	1	0	0	0	0	0x50
30000 ... 31999	1	1	1	1	0	0	0	0	0xF0

Parameter value (PWE)

The parameter value (PWE) is transferred as a double word (32 bits). Only one parameter value may be transferred per telegram.

A 32 bit parameter value includes PWE1 (H word, 3rd word) and PWE2 (L word, 4th word).

A 16 bit parameter value is transferred in PWE2 (L word, 4th word). In this case, PWE1 (H word, 3rd word) must be set to 0.

Example of read request for parameter P7841[2]

To obtain the value of the indexed parameter P7841, you must fill the telegram of the parameter channel with the following data:

- Request parameter value (field): Bits 15 ... 12 in the PKE word:
Request identifier = 6
- Parameter number without offset: Bits 10 ... 0 in the PKE word:
Because you can only code parameter numbers from 1 ... 1999 in the PKE, you must deduct as large an offset as possible, a number divisible by 2000, from the parameter number, and transfer the result of this calculation to the PKE word.
In our example, this means: $7841 - 6000 = 1841$
- Coding the offset of the parameter number in the page index byte of the IND word:
In this example: When offset = 6000, this corresponds to a page index value of 0x90.
- Index of parameter in the subindex byte of the IND word:
In this example: Index = 2
- Because you want to read the parameter value, words 3 and 4 in the parameter channel for requesting the parameter value are irrelevant. They should be assigned a value of 0, for example.

Table 6- 14 Request to read parameter P7841[2]

PKE (1st word)			IND (2nd word)		PWE (3rd and 4th words)	
AK		PNU (10 bits)	Subindex (H byte)	Page index (L byte)	PWE1 (H word)	PWE2 (L word)
0x6	0	0x731 (decimal: 1841)	0x02	0x90	0x0000	0x0000

Rules for editing requests and responses

- You can only request one parameter per transmitted telegram
- Each received telegram contains only one response
- The request must be repeated until the right response is received
- The response is assigned to a request by means of the following identifiers:
 - Suitable response identifier
 - Suitable parameter number
 - Suitable parameter index IND, if required
 - Suitable parameter value PWE, if necessary
- The complete request must be sent in a telegram. Request telegrams cannot be subdivided. The same applies to responses.

6.1.4.4 Slave-to-slave communication

With "Slave-slave communication" (also called "Data Exchange Broadcast") it is possible to quickly exchange data between inverters (slaves) without the master being directly involved, for instance to use the actual value of one inverter as setpoint for other inverters.

For slave-to-slave communication, in the control system you must define which inverter acts as publisher (sender) or subscriber (receiver) - and which data or data areas (access points) you wish to use for slave-to-slave communication. In the inverters that operate as subscriber, you must define how the data transferred using slave-to-slave communication is processed. Using parameter r2077, in the inverter, you can read-out the PROFIBUS addresses of the inverters for which the slave-to-slave communication function is configured.

- **Publisher** Slave, which sends the data for slave-to-slave communication.
- **Subscriber** Slave, which receives the data from slave-to-slave communication from the publisher.
- **Links and access points** define the data that are used for slave-to-slave communication.

You must observe the following restrictions for the slave-to-slave communication function:

- a maximum of 8 PZD are permissible for each drive
- To a publisher, a maximum of 4 links are possible

An example of how you configure slave-to-slave communication between two inverters in STEP 7 is provided in Section: Configuring slave-to-slave communication in STEP 7 (Page 334).

6.1.5 Acyclic communication

As from performance level DP-V1, PROFIBUS communications offer acyclic data communications apart from cyclic communications. You can parameterize and troubleshoot (diagnostics) the inverter via acyclic data transfer. Acyclic data is transferred in parallel with cyclic data transfer but with a lower priority.

The inverter supports the following data transfer types:

- Reading and writing parameters via "data set 47" (up to 240 bytes per write or read request)
- Reading-out profile-specific parameters
- Data exchange with a SIMATIC HMI (Human Machine Interface)

You can find a STEP 7 program example for acyclic data transfer in Section STEP 7 program example for acyclic communication (Page 330).

6.1.5.1 Reading and changing parameters via data set 47

Reading parameter values

Table 6- 15 Request to read parameters

Data block	Byte n	Bytes n + 1	n
Header	Reference 01 hex ... FF hex	01 hex: Read request	0
	01 hex	Number of parameters (m) 01 hex ... 27 hex	2
Address, parameter 1	Attribute 10 hex: Parameter value 20 hex: Parameter description	Number of indices 00 hex ... EA hex (for parameters without index: 00 hex)	4
	Parameter number 0001 hex ... FFFF hex		6
	Number of the 1st index 0000 hex ... FFFF hex (for parameters without index: 0000 hex)		8

Address, parameter 2
...
Address, parameter m

Table 6- 16 Converter response to a read request

Data block	Byte n	Bytes n + 1	n
Header	Reference (identical to a read request)	01 hex: Converter has executed the read request. 81 hex: Converter was not able to completely execute the read request.	0
	01 hex	Number of parameters (m) (identical to the read request)	2
Values, parameter 1	Format 02 hex: Integer8 03 hex: Integer16 04 hex: Integer32 05 hex: Unsigned8 06 hex: Unsigned16 07 hex: Unsigned32 08 hex: FloatingPoint 10 hex OctetString 13 hex TimeDifference 41 hex: Byte 42 hex: Word 43 hex: Double word 44 hex: Error	Number of index values or - for a negative response - number of error values	4
	Value of the 1st index or - for a negative response - error value 1 You can find the error values in a table at the end of this section.		6

Values, parameter 2	...		
...	...		
Values, parameter m	...		

Changing parameter values

Table 6- 17 Request to change parameters

Data block	Byte n	Bytes n + 1	n
Header	Reference <i>01 hex ... FF hex</i>	02 hex: Change request	0
	01 hex	Number of parameters (m) <i>01 hex ... 27 hex</i>	2
Address, parameter 1	10 hex: Parameter value	Number of indices <i>00 hex ... EA hex</i> (00 hex and 01 hex have the same significance)	4
	Parameter number <i>0001 hex ... FFFF hex</i>		6
	Number of the 1st index <i>0001 hex ... FFFF hex</i>		8

Address, parameter 2	...		
...
Address, parameter m	...		
Values, parameter 1	Format <i>02 hex:</i> Integer 8 <i>03 hex:</i> Integer 16 <i>04 hex:</i> Integer 32 <i>05 hex:</i> Unsigned 8 <i>06 hex:</i> Unsigned 16 <i>07 hex:</i> Unsigned 32 <i>08 hex:</i> Floating Point <i>10 hex:</i> Octet String <i>13 hex:</i> Time Difference <i>41 hex:</i> Byte <i>42 hex:</i> Word <i>43 hex:</i> Double word	Number of index values <i>00 hex ... EA hex</i>	
	Value of the 1st index		
	...		
Values, parameter 2	...		
...	...		
Values, parameter m	...		

Table 6- 18 Response, if the converter has executed the change request

Data block	Byte n	Bytes n + 1	n
Header	Reference (identical to a change request)	02 hex	0
	01 hex	Number of parameters (identical to a change request)	2

Table 6- 19 Response, if the converter was not able to completely execute the change request

Data block	Byte n	Bytes n + 1	n
Header	Reference (identical to a change request)	82 hex	0
	01 hex	Number of parameters (identical to a change request)	2
Values, parameter 1	Format 40 hex: Zero (change request for this data block executed) 44 hex: Error (change request for this data block not executed)	Number of error values 00 hex, 01 hex or 02 hex	4
	Only for "Error"- error value 1 You can find the error values in the table at the end of this section.		6
	Only if "number of error values" = 02 hex: Error value 2 Error value 1 defines whether the converter sends error value 2 and what it means.		8
Values, parameter 2	...		
...
Values, parameter m	...		

Diagnostics

Table 6- 20 Error value in the parameter response

Error value 1	Meaning
00 hex	Illegal parameter number (access to a parameter that does not exist)
01 hex	Parameter value cannot be changed (change request for a parameter value that cannot be changed. Additional diagnostics in error value 2)
02 hex	Lower or upper value limit exceeded (change request with a value outside the value limits. Additional diagnostics in error value 2)
03 hex	Incorrect subindex (access to a subindex that does not exist. Additional diagnostics in error value 2)
04 hex	No array (access with a subindex to non-indexed parameters)
05 hex	Incorrect data type (change request with a value that does not match the data type of the parameter)
06 hex	Setting not permitted, only resetting (change request with a value not equal to 0 without permission. Additional diagnostics in error value 2)
07 hex	Descriptive element cannot be changed (change request to a descriptive element that cannot be changed. Additional diagnostics in error value 2)
09 hex	Description data not available (access to a description that does not exist, parameter value is available)
0B hex	No master control (change request but with no master control)
0F hex	Text array does not exist (although the parameter value is available, the access is made to a text array that does not exist)
11 hex	Request cannot be executed due to the operating state (access is not possible for temporary reasons that are not specified)
14 hex	Inadmissible value (change request with a value that is within the limits but which is illegal for other permanent reasons, i.e. a parameter with defined individual values. Additional diagnostics in error value 2)

Error value 1	Meaning
15 hex	Response too long (the length of the actual response exceeds the maximum transfer length)
16 hex	Illegal parameter address (<i>illegal or unsupported value for attribute, number of elements, parameter number, subindex or a combination of these</i>)
17 hex	Illegal format (change request for an illegal or unsupported format)
18 hex	Number of values not consistent (<i>number of values of the parameter data to not match the number of elements in the parameter address</i>)
19 hex	Drive object does not exist (access to a drive object that does not exist)
6B hex	No change access for a controller that is enabled.
6C hex	Unknown unit.
6E hex	Change request is only possible when the motor is being commissioned (p0010 = 3).
6F hex	Change request is only possible when the power unit is being commissioned (p0010 = 2).
70 hex	Change request is only possible for quick commissioning (basic commissioning) (p0010 = 1).
71 hex	Change request is only possible if the converter is ready (p0010 = 0).
72 hex	Change request is only possible for a parameter reset (restore to factory setting) (p0010 = 30).
73 hex	Change request is only possible when Safety Integrated is being commissioned (p0010 = 95).
74 hex	Change request is only possible when a technological application/unit is being commissioned (p0010 = 5).
75 hex	Change request is only possible in a commissioning state (p0010 ≠ 0).
76 hex	Change request is not possible for internal reasons (p0010 = 29).
77 hex	Change request is not possible at download.
81 hex	Change request is not possible at download.
82 hex	Transfer of the control authority (master) is inhibited by BI: p0806.
83 hex	Requested BICO interconnection is not possible (BICO output does not supply a float value, however the BICO input requires a float value)
84 hex	Converter does not accept a change request (converter is busy with internal calculations, see r3996)
85 hex	No access methods defined.
C8 hex	Change request below the currently valid limit (change request to a value that lies within the "absolute" limits, but is however below the currently valid lower limit)
C9 hex	Change request above the currently valid limit (change request to a value that lies within the "absolute" limits, but is however above the currently valid upper limit, e.g. specified as a result of the converter power rating)
CC hex	Change request not permitted (change is not permitted as the access code is not available)

6.2 Communication via RS485

6.2.1 Integrating inverters into a bus system via the RS485 interface

Connecting to a network via RS485

Connect the inverter to your fieldbus via the RS485 interface. Position and assignment of the RS485 interface can be found in section Interfaces, connectors, switches, control terminals, LEDs on the CU (Page 46). This connector has short-circuit proof, isolated pins.

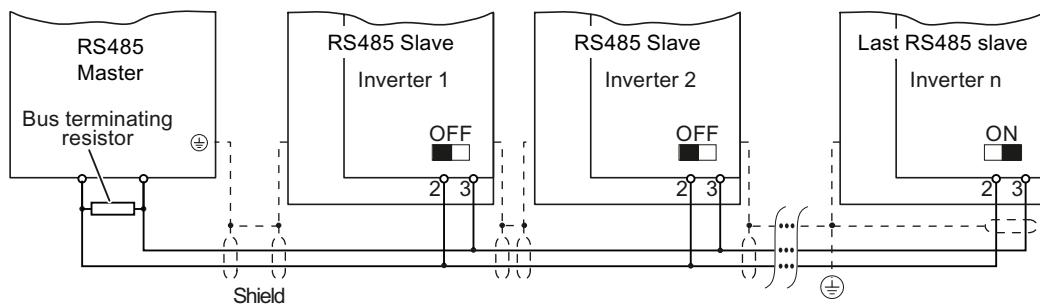

Figure 6-4 Communication network via RS485

You must switch-in the bus terminating resistor for the first and last participants. The position of the bus terminating resistor can be found in section Interfaces, connectors, switches, control terminals, LEDs on the CU (Page 46).

You can disconnect one or more slaves from the bus (by unplugging the bus connector) without interrupting the communication for the other stations, but not the first or last.

NOTICE

When the bus is operating, the first and last bus station must be continuously connected to the supply.

Note

Communication with the controller, even when the supply voltage on the Power Module is switched off

You will have to supply the Control Unit with 24 V DC on terminals 31 and 32 if you require communication to take place with the controller when the line voltage is switched off.

6.2.2 Communication via USS

Using the USS protocol (protocol of the universal serial interface), users can set up a serial data connection between a higher-level master system and several slave systems (RS 485 interface). Master systems include programmable logic controllers (e.g. SIMATIC S7-200) or PCs. The inverters are always slaves on the bus system.

Communication using the USS protocol takes place over the RS485 interface with a maximum of 31 slaves.

The maximum cable length is 1200 m (3300 ft)

Information about how to connect the inverter to the USS fieldbus is provided in Section: Integrating inverters into a bus system via the RS485 interface (Page 118).

6.2.2.1 Setting the address

You can set the inverter's USS address using either DIP switches on the Control Unit or parameter p2021.

Valid USS addresses: 1 ... 30

Invalid USS addresses: 0, 31 ... 127

If you have specified a valid address using DIP switches, this address will always be the one that takes effect and p2021 cannot be changed.

If you set all DIP switches to "OFF" (0) or "ON" (1), then p2021 defines the address.

The positions and settings of the DIP switches are described in Section Interfaces, connectors, switches, control terminals, LEDs on the CU (Page 46).

CAUTION
A bus address that has been changed is only effective after the inverter has been switched off and back on again.

6.2.2.2 Basic settings for communication

Parameter	Description																						
P0015 = 21	Macro drive unit Selecting the I/O configuration																						
p2020	<table border="1"> <thead> <tr> <th>Value</th> <th>Baud rate</th> </tr> </thead> <tbody> <tr><td>4</td><td>2400</td></tr> <tr><td>5</td><td>4800</td></tr> <tr><td>6</td><td>9600</td></tr> <tr><td>7</td><td>19200</td></tr> <tr><td>8</td><td>38400</td></tr> <tr><td>9</td><td>57600</td></tr> <tr><td>10</td><td>76800</td></tr> <tr><td>11</td><td>93750</td></tr> <tr><td>12</td><td>115200</td></tr> <tr><td>13</td><td>187500</td></tr> </tbody> </table>	Value	Baud rate	4	2400	5	4800	6	9600	7	19200	8	38400	9	57600	10	76800	11	93750	12	115200	13	187500
Value	Baud rate																						
4	2400																						
5	4800																						
6	9600																						
7	19200																						
8	38400																						
9	57600																						
10	76800																						
11	93750																						
12	115200																						
13	187500																						
p2022	Fieldbus interface, USS PZD count Setting the number of 16-bit words in the PZD part of the USS telegram																						
p2023	<table border="1"> <thead> <tr> <th>Value</th> <th>PKW count</th> </tr> </thead> <tbody> <tr><td>0</td><td>PKW 0 words</td></tr> <tr><td>3</td><td>PKW 3 words</td></tr> <tr><td>4</td><td>PKW 4 words</td></tr> <tr><td>127</td><td>PKW variable</td></tr> </tbody> </table>	Value	PKW count	0	PKW 0 words	3	PKW 3 words	4	PKW 4 words	127	PKW variable												
Value	PKW count																						
0	PKW 0 words																						
3	PKW 3 words																						
4	PKW 4 words																						
127	PKW variable																						
p2040	Fieldbus interface, monitoring time [ms] Setting the monitoring time to monitor the received process data via fieldbus. If no process data are received within this time, an appropriate message is output																						

Additional information and parameters are provided on the following pages.

6.2.2.3 Structure of a USS telegram

A USS telegram comprises a sequence of characters, which are sent in a defined sequence. Every character within the telegram comprises 11 bits. The sequence of characters of a USS telegram is shown in the following diagram.

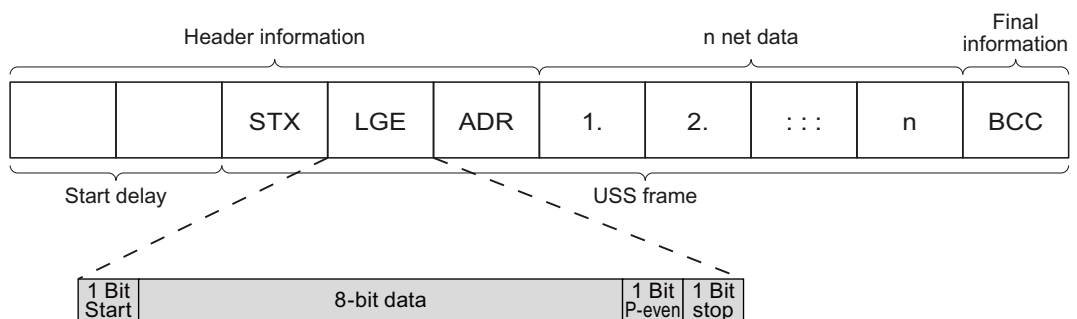

Figure 6-5 Structure of a USS telegram

Description

Telegrams with both a variable and fixed length can be used. This can be selected using parameters p2022 and p2023 to define the length of the PZD and the PKW within the net data.

STX	1 byte	
LGE	1 byte	
ADR	1 byte	
Net data	PKW	8 bytes (4 words: PKE + IND + PWE1 + PWE2)
(example)	PZD	4 bytes (2 words: PZD1 + PZD2)
BCC	1 byte	

Start delay

The start delay must be maintained before a new master telegram is started.

STX

The STX block is an ASCII character (0x02) and indicates the beginning of a message.

LGE

LGE specifies the number of bytes that following in the telegram. It is defined as the sum of the following bytes

- Net data
- ADR
- BCC

The actual overall telegram length is two bytes longer because STX and LGE are not counted in LGE.

ADR

The ADR range contains the address of the slave node (e.g. of the inverter). The individual bits in the address byte are addressed as follows:

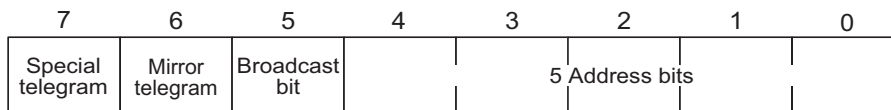

- Bit 5 broadcast bit
Bit 5 = 0: normal data exchange. Bit 5 = 1: Address (bits 0 ... 4) is not evaluated (is not supported in SINAMICS G120!).
- Bit 6 mirror telegram
Bit 6 = 0: normal data exchange. Bit 6 = 1: The slave returns the telegram unchanged to the master. Is used to test the bus connection.
- Bit 7 special telegram
Bit 7 = 0: normal data exchange. Bit 7 = 1 to transfer telegrams that require a net data structure different from the device profile.

BCC

BCC (Block Check Character). It is an exclusive OR checksum (XOR) over all telegram bytes with the exception of the BCC itself.

6.2.2.4 User data range of the USS telegram

The user data range of the USS protocol is used to transmit application data. This comprises the parameter channel data and the process data (PZD).

The user data occupy the bytes within the USS frame (STX, LGE, ADR, BCC). The size of the user data can be configured using parameters p2023 and p2022. The structure and sequence of the parameter channel and process data (PZD) are shown in the figure below.

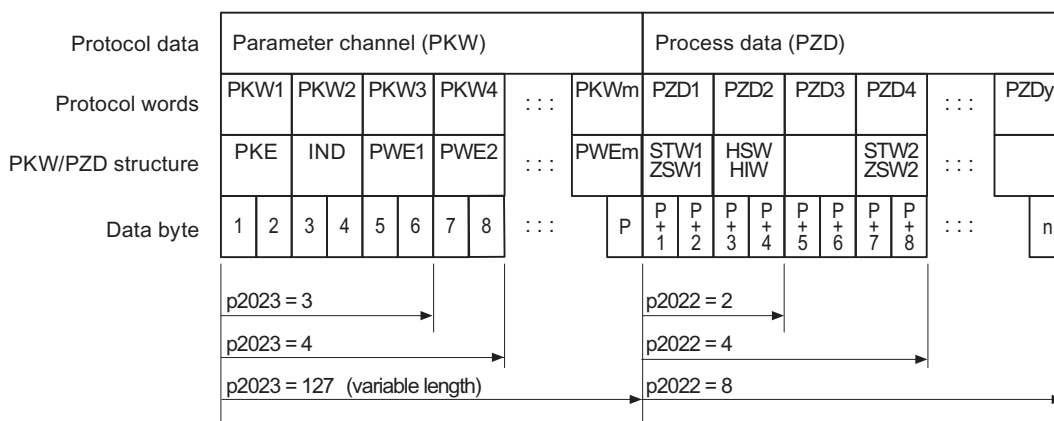

Figure 6-6 USS user data structure

The length for the parameter channel is determined by parameter p2023 and the length for the process data is specified by parameter p2022. If the parameter channel or the PZD is not required, the appropriate parameters can be set to zero ("PKW only" or "PZD only").

It is not possible to transfer "PKW only" and "PZD only" alternatively. If both channels are required, they must be transferred together.

6.2.2.5 Data structure of the USS parameter channel

The USS protocol defines for inverters the user data structure via which a master accesses the slave inverter. The parameter channel is used to read and write parameters in the inverter.

Parameter channel

You can use the parameter channel with a fixed length of 3 or 4 data words or with a variable length.

The first data word always contains the parameter identifier (PKE) and the second contains the parameter index.

The third, fourth and subsequent data words contain parameter values, texts and descriptions.

Parameter identifier (PKE), 1st word

The parameter identifier (PKE) is always a 16-bit value.

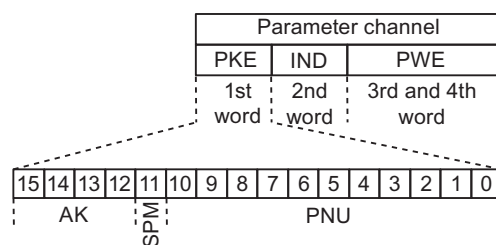

Figure 6-7 PKE structure

- Bits 12 to 15 (AK) contain the request or response identifier.
- Bit 11 (SPM) is reserved and always = 0.
- Bits 0 to 10 (PNU) contain parameter numbers 1 ... 1999. For parameter numbers ≥ 2000 , you must add an offset in the 2nd word of the parameter channel (IND).

The following table includes the request ID for telegrams between the master → inverter.

Table 6- 21 Request identifier (master → inverter)

Request identifier	Description	Response identifier	
		Positive	Negative
0	No request	0	7
1	Request parameter value	1 / 2	7
2	Change parameter value (word)	1	7
3	Change parameter value (double word)	2	7
4	Request descriptive element ¹⁾	3	7
6	Request parameter value ^{1) 2)}	4 / 5	7
7	Change parameter value (word) ^{1) 2)}	4	7
8	Change parameter value (double word) ^{1) 2)}	5	7

1) The required element of the parameter description is specified in IND (2nd word).
 2) Identifier 1 is identical to identifier 6, ID 2 is identical to 7, and 3 is identical to 8. We recommend that you use identifiers 6, 7, and 8.

The following table includes the response ID for telegrams between the inverter → master. The response ID depends on the request ID.

Table 6- 22 Response identifier (inverter → master)

Response identifier	Description
0	No response
1	Transfer parameter value (word)
2	Transfer parameter value (double word)
3	Transfer descriptive element ¹⁾
4	Transfer parameter value (field, word) ²⁾
5	Transfer parameter value (field, double word) ²⁾
6	Transfer number of field elements
7	Request cannot be processed, task cannot be executed (with error number)

1) The required element of the parameter description is specified in IND (2nd word).
 2) The required element of the indexed parameter is specified in IND (2nd word).

If the response ID = 7, then the inverter sends one of the error numbers listed in the following table in parameter value 2 (PWE2).

Table 6- 23 Error numbers for the response "Request cannot be processed"

No.	Description	Comments
0	Impermissible parameter number (PNU)	Parameter does not exist
1	Parameter value cannot be changed	The parameter can only be read
2	Minimum/maximum not achieved or exceeded	–
3	Wrong subindex	–
4	No field	An individual parameter was addressed with a field request and subindex > 0
5	Wrong parameter type / wrong data type	Confusion of word and double word
6	Setting is not permitted (only resetting)	Index is outside the parameter field[]
7	The descriptive element cannot be changed	Description cannot be changed
11	Not in the "master control" mode	Change request without "master control" state
12	Keyword missing	–
17	Request cannot be processed on account of the operating state	The actual inverter operating state is not compatible with the received request
20	Illegal value	Modification access with a value which is within the value limits but which is illegal for other permanent reasons (parameter with defined individual values)
101	Parameter number is currently deactivated	Dependent on the operating state of the inverter
102	Channel width is insufficient	Communication channel is too small for response
104	Illegal parameter value	The parameter can only assume certain values.
106	Request not included / task is not supported	After request identifier 5,11,12,13,14,15
107	No write access with enabled controller	The operating state of the inverter prevents a parameter change
200/201	Changed minimum/maximum not achieved or exceeded	The maximum or minimum can be limited further during operation.
204	The available access authorization does not cover parameter changes.	–

Parameter index (IND)

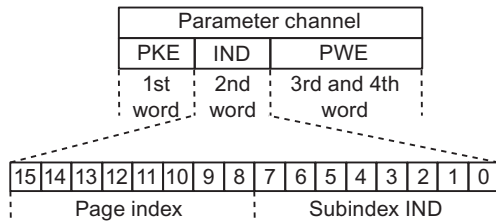

Figure 6-8 Structure of the parameter index (IND)

- For indexed parameters, select the index of the parameter by transferring the appropriate value between 0 and 254 to the subindex within a job.
- The page index is used to switch over the parameter numbers. Use this byte to add an offset to the parameter number that is transferred in the 1st word of the parameter channel (PKE).

Page index: Offset of parameter number

The parameter numbers are assigned to several parameter ranges. The following table shows which value you must transfer to the page index to achieve a particular parameter number.

Table 6- 24 Page index setting dependent on parameter range

Parameter range	Page index								Hex value
	Bit 15	Bit 14	Bit 13	Bit 12	Bit 11	Bit 10	Bit 9	Bit 8	
0000 ... 1999	0	0	0	0	0	0	0	0	0x00
2000 ... 3999	1	0	0	0	0	0	0	0	0x80
6000 ... 7999	1	0	0	1	0	0	0	0	0x90
8000 ... 9999	0	0	1	0	0	0	0	0	0x20
10000 ... 11999	1	0	1	0	0	0	0	0	0xA0
20000 ... 21999	0	1	0	1	0	0	0	0	0x50
30000 ... 31999	1	1	1	1	0	0	0	0	0xF0

Parameter value (PWE)

You can vary the number of PWEs using parameter p2023.

Parameter channel with fixed length	Parameter channel with variable length
<p>P2023 = 4</p> <p>A parameter channel with fixed length should contain 4 words as this setting is sufficient for all parameters (including double words).</p>	<p>P2023 = 127</p> <p>For a variable length of parameter channel, the master will only send the number of PWEs necessary for the task in the parameter channel. The response telegram is also no longer than necessary.</p>
<p>P2023 = 3</p> <p>You can select this setting if you only want to read or write 16-bit data or alarm signals.</p> <ul style="list-style-type: none"> • 16-bit data: e.g. p0210 supply voltage • 32-bit data: Indexed parameter, e.g. p0640[0...n] Bit parameter, e.g. 722.0...12 	
<p>The master must always transmit the permanently set number of words in the parameter channel. Otherwise the slave will not respond to the telegram.</p> <p>When the slave responds it must always respond with the defined number of words.</p>	

Note

8-bit values are transmitted as 16-bit values; the higher-order byte is zero. The fields of 8-bit values require one PWE per index.

Rules for editing requests/responses

- You can only request one parameter for each telegram sent.
- Each received telegram contains only one response.
- The master must repeat a request until it receives a suitable response.
- Request and response are assigned to one another using the following identifiers:
 - Suitable response identifier
 - Suitable parameter number
 - Suitable parameter index IND, if required
 - Suitable parameter value PWE, if necessary
- The master must send the complete request in one telegram. Request telegrams cannot be split up. The same applies to responses.

6.2.2.6 USS read request

Example: Reading out alarm messages from the inverter.

The parameter channel comprises four words (p2023 = 4). In order to obtain the values of the indexed parameter r2122, you must fill the telegram of the parameter channel with the following data:

- Request parameter value (field): Bits 15 ... 12 in the PKE word:
Request identifier = 6
- Parameter number without offset: Bits 10 ... 0 in the PKE word:
Because you can only code parameter numbers from 1 ... 1999 in the PKE, you must deduct as large an offset as possible, a number divisible by 2000, from the parameter number, and transfer the result of this calculation to the PKE word.
In our example, this means: 2122 - 2000 = 122 = 7AH
- Offset of the parameter number in the byte page index of the word IND:
for this example: When offset = 2000, this corresponds to a page index value of 0x80
- Index of the parameter in the byte subindex of the word IND:
If you wish to read-out the last alarm, then you must enter index 0, for the third from last, index 2 (example). You can find a detailed description on the history of the alarm messages in the Section Alarms (Page 288) .
- Because you want to read the parameter value, words 3 and 4 in the parameter channel for requesting the parameter value are irrelevant. They should be assigned a value of 0, for example.

Table 6- 25 Request to read parameter r2122[2]

PKE (1st word)			IND (2nd word)		PWE (3rd and 4th words)		
AK		PNU	Page index (H byte)	Subindex (L byte)	PWE1(H word)	PWE2(L word)	
15 ... 12	11	10 ... 0	15 ... 8	7 ... 0	15 ... 0	Drive Object	15 ... 10
0x6	0	0x7A (dec: 122)	0x80	0x02	0x0000	0x0000	0x0000

6.2.2.7 USS write job

Example: Define digital input 2 as source for ON/OFF in CDS1

In this case, parameter p0840[1] (source, ON/OFF) must be assigned the value 722.2 (digital input 2).

The parameter channel comprises four words (p2023 = 4). To change the value of the indexed parameter P0840, you must fill the telegram of the parameter channel with the following data:

- Change parameter value (field): Enter bit 15 ... 12 in PKE (1st word):
Request identifier = 7
- Parameter number without offset: Enter bit 10 ... 0 in PKE (1st word):
As the parameter is < 1999, it can be directly entered without an offset - converted into hex - in the example 840 = 348H.
- Enter the offset of the parameter number in byte page index of word IND (2nd word):
in this example = 0.
- Enter the index of parameter in the byte subindex of word IND (2nd word):
for this example = 1 (CDS1)
- Enter a new parameter value in PWE1 (Word3):
in the example 722 = 2D2H.
- Drive Object: Enter bit 10 ... 15 in PWE2 (4th word):
for SINAMICS G120, always 63 = 3FH
- Index of the parameter: Enter bit 0 ... 9 in PWE2 (word4):
in example 2.

Table 6- 26 Request to change p0840[1]

PKE (1st word)			IND (2nd word)		PWE (3rd and 4th words)		
AK		PNU	Page index (H byte)	Subindex (L byte)	PWE1(H word)	PWE2(L word)	
15 ... 12	11	10 ... 0	15 ... 8	7 ... 0	15 ... 0	Drive Object	9 ... 0
0x7	0	0x348 (dec: 840)	0x0000	0x01	0x2D2 (dec: 722)	3F (fixed) (dec: 63)	0x0002

6.2.2.8 USS process data channel (PZD)

Description

Process data (PZD) is exchanged between the master and slave in this telegram range. Depending on the direction of transfer, the process data channel contains request data for the slave or response data to the master. The request contains control words and setpoints for the slaves, while the response contains status words and actual values for the master.

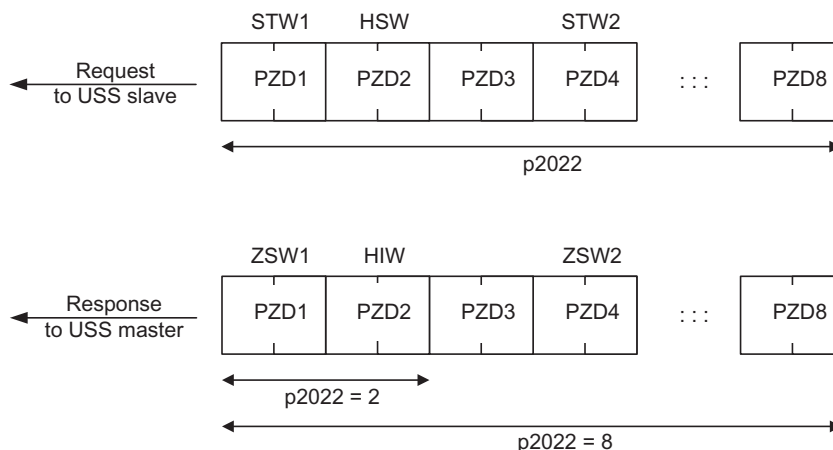

Figure 6-9 Process data channel

The number of PZD words in a USS telegram is defined by parameter p2022. The first two words are:

- Control 1 (STW1, r0054) and main setpoint (HSW)
- Status word 1 (ZSW1, r0052) and main actual value (HIW)

If P2022 is greater than or the same as 4, the additional control word (STW2, r0055) is transferred as the fourth PZD word (default setting).

You define the sources of the PZD using parameter p2051.

For further information, please refer to the Parameter Manual.

6.2.2.9 Time-out and other errors

You require the telegram runtimes in order to set the telegram monitoring. The character runtime is the basis of the telegram runtime:

Table 6- 27 Character runtime

Baud rate in bit/s	Transmission time per bit	Character run time (= 11 bits)
9600	104.170 µs	1.146 ms
19200	52.084 µs	0.573 ms
38400	26.042 µs	0.286 ms
115200	5.340 µs	0.059 ms

The telegram runtime is longer than just purely adding all of the character runtimes (=residual runtime). You must also take into consideration the character delay time between the individual characters of the telegram.

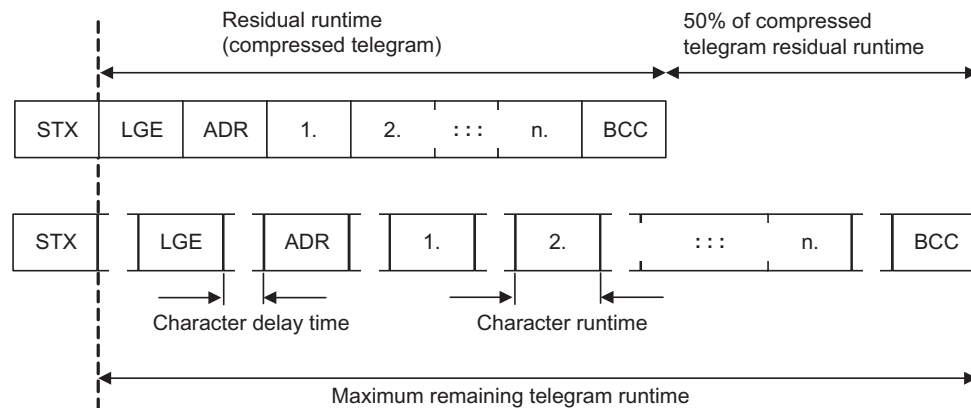

Figure 6-10 Telegram runtime as the sum of the residual runtime and character delay times

The total telegram runtime is always less than 150% of the pure residual runtime.

Before each request telegram, the master must maintain the start delay. The start delay must be $> 2 \times$ character runtime.

The slave only responds after the response delay has expired.

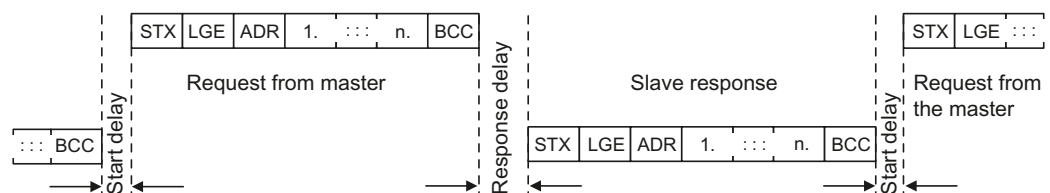

Figure 6-11 Start delay and response delay

The duration of the start delay must at least be as long as the time for two characters and depends on the baud rate.

Table 6- 28 Duration of the start delay

Baud rate in bit/s	Transmission time per character (= 11 bits)	Min. start delay
9600	1.146 ms	> 2.291 ms
19200	0.573 ms	> 1.146 ms
38400	0.286 ms	> 0.573 ms
57600	0.191 ms	> 0.382 ms
115200	0.059 ms	> 0.117 ms

Note: The character delay time must be shorter than the start delay.

Telegram monitoring of the master

With your USS master, we recommend that the following times are monitored:

- Response delay: Response time of the slave to a request from the master
The response delay must be < 20 ms, but longer than the start delay
- Telegram runtime: Transmission time of the response telegram sent from the slave

Telegram monitoring of the converter

The converter monitors the time between two requests of the master. Parameter p2040 defines the permissible time in ms. If a time $p2040 \neq 0$ is exceeded, then the converter interprets this as telegram failure and responds with fault F01910.

150% of the residual runtime is the guide value for the setting of p2040, i.e. the telegram runtime without taking into account the character delay times.

For communication via USS, the converter checks bit 10 of the received control word 1. If the bit is not set when the motor is switched on ("Operation"), then the converter responds with fault F07220.

6.2.3 Communication over Modbus RTU

Overview of communication using Modbus

The Modbus protocol is a communication protocol with linear topology based on a master/slave architecture.

Modbus offers three transmission modes:

- **Modbus ASCII**
Data is transferred in ASCII code. The data can therefore be read directly by humans, however, the data throughput is lower in comparison to RTU.
- **Modbus RTU**
Modbus RTU (RTU: Remote Terminal Unit): Data is transferred in binary format and the data throughput is greater than in ASCII code.
- **Modbus TCP**
This type of data transmission is very similar to RTU, except that TCP/IP packages are used to send the data. TCP port 502 is reserved for Modbus TCP. Modbus TCP is currently undergoing definition as a standard (IEC PAS 62030 (pre-standard)).

The Control Unit supports Modbus RTU as a slave with even parity.

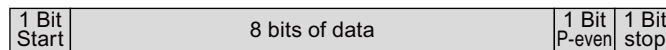

Communication settings

- Communication using Modbus RTU takes place over the RS485 interface with a maximum of 247 slaves.
- The maximum cable length is 1200 m (3281 ft).
- Two 100 k Ω resistors are provided to polarize the receive and send cables.

 CAUTION
It is not permitted to change over the units!
The "Unit changeover (Page 219)" function is not permissible with this bus system!

6.2.3.1 Setting the address

You can set the inverter's Modbus RTU address using either DIP switches on the Control Unit or parameter p2021.

Valid Modbus RTU addresses: 1 ... 247

Invalid Modbus RTU addresses: 0

If you have specified a valid address using DIP switches, this address will always be the one that takes effect and p2021 cannot be changed.

If you set all DIP switches to "OFF" (0) or "ON" (1), then p2021 defines the address.

The positions and settings of the DIP switches are described in Section Interfaces, connectors, switches, control terminals, LEDs on the CU (Page 46).

CAUTION

A bus address that has been changed is only effective after the inverter has been switched off and back on again.

6.2.3.2 Basic settings for communication

Parameter	Description
P0015 = 21	Macro drive unit Selecting the I/O configuration
p2030 = 2	Fieldbus protocol selection 2: Modbus
p2020	Fieldbus baud rate Baud rates from 4800 bit/s to 187500 bit/s can be set for communication, factory setting = 19200 bit/s.
p2024	Modbus timing (see Section "Baud rates and mapping tables (Page 136)") <ul style="list-style-type: none"> • Index 0: Maximum slave telegram processing time: The time after which the slave must have sent a response to the master. • Index 1: Character delay time: Character delay time: Maximum permissible delay time between the individual characters in the Modbus frame. (Modbus standard processing time for 1.5 bytes). • Index2: Inter-telegram delay: Maximum permissible delay time between Modbus telegrams. (Modbus standard processing time for 3.5 bytes).
p2029	Fieldbus fault statistics Displays receive faults on the fieldbus interface
p2040	Process data monitoring time Determines the time after which an alarm is generated if no process data are transferred. Note: This time must be adapted depending on the number of slaves and the baud rate set for the bus (factory setting = 100 ms).

6.2.3.3 Modbus RTU telegram

Description

For Modbus, there is precisely one master and up to 247 slaves. Communication is always triggered by the master. The slaves can only transfer data at the request of the master. Slave-to-slave communication is not possible. The Control Unit always operates as slave.

The following figure shows the structure of a Modbus RTU telegram.

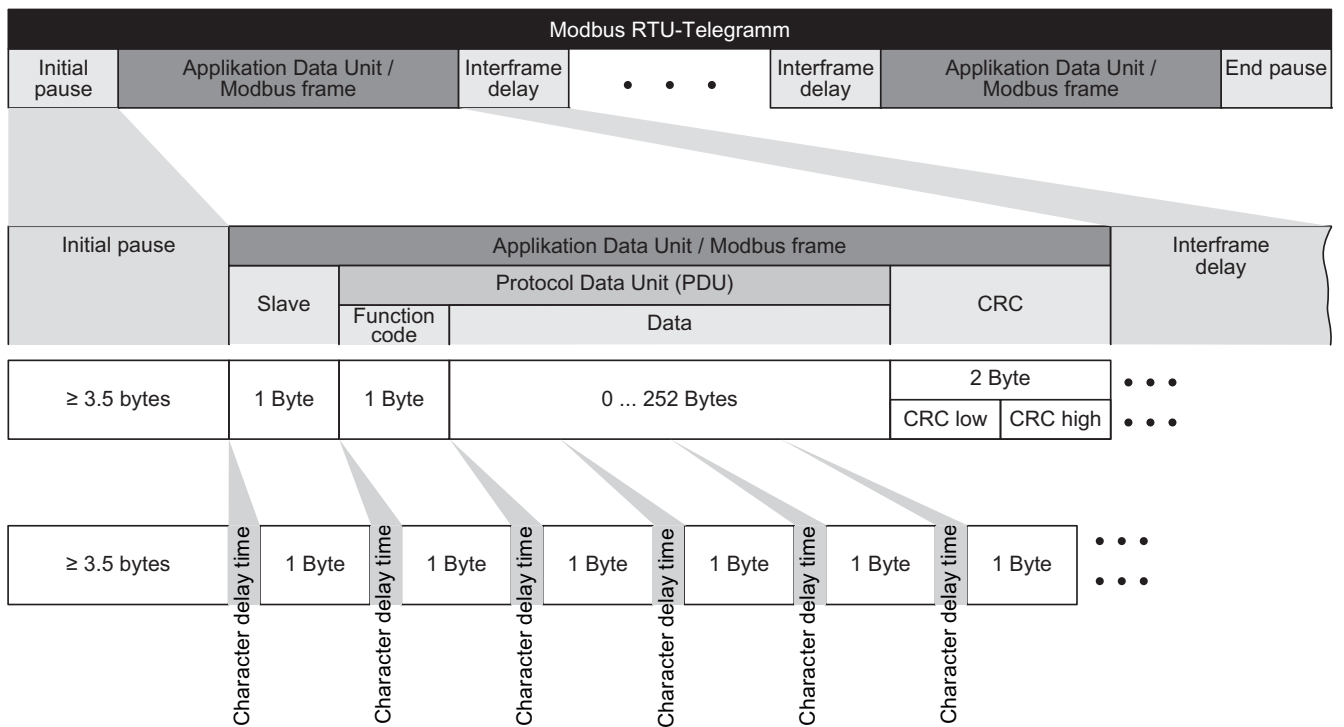

Figure 6-12 Modbus with delay times

The data area of the telegram is structured according to the mapping tables.

6.2.3.4 Baud rates and mapping tables

Permissible baud rates and telegram delay

The Modbus RTU telegram requires a pause for the following cases:

- Start detection
- Between the individual frames
- End detection

Minimum duration: Processing time for 3.5 bytes (can be set via p2024[2]).

A character delay time is also permitted between the individual bytes of a frame. Maximum duration: Processing time for 1.5 bytes (can be set via p2024[1]).

Table 6- 29 Baud rates, transmission times, and delays

Baud rate in bit/s (p2020)	Transmission time per character (11 bits)	Minimum pause between two telegrams (p2024[2])	Maximum pause between two bytes (p2024[1])
4800	2.292 ms	≥ 8.021 ms	≤ 3.438 ms
9600	1.146 ms	≥ 4.010 ms	≤ 1.719 ms
19200 (factory setting)	0.573 ms	≥ 1.75 ms	≤ 0.859 ms
38400	0.286 ms	≥ 1.75 ms	≤ 0.75 ms
57600	0.191 ms	≥ 1.75 ms	≤ 0.556 ms
76800	0.143 ms	≥ 1.75 ms	≤ 0.417 ms
93750	0.117 ms	≥ 1.75 ms	≤ 0.341 ms
115200	0.095 ms	≥ 1.75 ms	≤ 0.278 ms
187500	0.059 ms	≥ 1.75 ms	≤ 0.171 ms

Note

The factory setting for p2024[1] and p2024[2] is 0. The particular values are pre-assigned depending on the protocol selection (p2030) or the baud rate.

Modbus register and Control Unit parameters

Since the Modbus protocol can only handle register or bit numbers for addressing the memory, assignment to the appropriate control words, status words and parameters is performed on the slave side.

The converter supports the following addressing ranges:

Addressing range	Remark
40001 ... 40065	Compatible with Micromaster MM436
40100 ... 40522	

The valid holding register addressing range extends from 40001 to 40522. Access to other holding registers generates the fault "Exception Code".

The registers 40100 to 40111 are described as process data. A telegram monitoring time can be activated in p2040 for these registers.

Note

R"; "W"; "R/W" in the column Modbus access stands for read (with FC03); write (with FC06); read/write.

Table 6- 30 Assigning the Modbus register to the parameters of the Control Unit

Modbus Reg. No.	Description	Modbus access	Unit	Scaling factor	On/Off text or value range		Data / parameter
Process data							
Control data							
40100	Control word	R/W	--	1			Process data 1
40101	Main setpoint	R/W	--	1			Process data 2
Status data							
40110	Status word	R	--	1			Process data 1
40111	Main actual value	R	--	1			Process data 2
Parameter data							
Digital outputs							
40200	DO 0	R/W	--	1	HIGH	LOW	p0730, r747.0, p748.0
40201	DO 1	R/W	--	1	HIGH	LOW	p0731, r747.1, p748.1
40202	DO 2	R/W	--	1	HIGH	LOW	p0732, r747.2, p748.2
Analog outputs							
40220	AO 0	R	%	100	-100.0 ... 100.0		r0774.0
40221	AO 1	R	%	100	-100.0 ... 100.0		r0774.1
Digital inputs							
40240	DI 0	R	--	1	HIGH	LOW	r0722.0
40241	DI 1	R	--	1	HIGH	LOW	r0722.1
40242	DI 2	R	--	1	HIGH	LOW	r0722.2
40243	DI 3	R	--	1	HIGH	LOW	r0722.3
40244	DI 4	R	--	1	HIGH	LOW	r0722.4
40245	DI 5	R	--	1	HIGH	LOW	r0722.5
Analog inputs							
40260	AI 0	R	%	100	-300.0 ... 300.0		r0755 [0]
40261	AI 1	R	%	100	-300.0 ... 300.0		r0755 [1]
40262	AI 2	R	%	100	-300.0 ... 300.0		r0755 [2]
40263	AI 3	R	%	100	-300.0 ... 300.0		r0755 [3]

Modbus Reg. No.	Description	Modbus access	Unit	Scaling factor	On/Off text or value range	Data / parameter
Converter identification						
40300	Powerstack number	R	--	1	0 ... 32767	r0200
40301	Converter firmware	R	--	0.0001	0.00 ... 327.67	r0018
Converter data						
40320	Rated power of the power unit	R	kW	100	0 ... 327.67	r0206
40321	Current Limit	R/W	%	10	10.0 ... 400.0	p0640
40322	Rampup time	R/W	s	100	0.00 ... 650.0	p1120
40323	Ramp-down time	R/W	s	100	0.00 ... 650.0	p1121
40324	Reference speed	R/W	RPM	1	6.000 ... 32767	p2000
Converter diagnostics						
40340	Speed setpoint	R	RPM	1	-16250 ... 16250	r0020
40341	Speed actual value	R	RPM	1	-16250 ... 16250	r0022
40342	Output frequency	R	Hz	100	- 327.68 ... 327.67	r0024
40343	Output voltage	R	V	1	0 ... 32767	r0025
40344	DC link voltage	R	V	1	0 ... 32767	r0026
40345	Actual value of current	R	A	100	0 ... 163.83	r0027
40346	Actual torque value	R	Nm	100	- 325.00 ... 325.00	r0031
40347	Actual active power	R	kW	100	0 ... 327.67	r0032
40348	Energy consumption	R	kWh	1	0 ... 32767	r0039
40349	Control priority	R	--	1	HAND AUTO	r0807
Fault diagnostics						
40400	Fault number, Index 0	R	--	1	0 ... 32767	r0947 [0]
40401	Fault number, Index 1	R	--	1	0 ... 32767	r0947 [1]
40402	Fault number, Index 2	R	--	1	0 ... 32767	r0947 [2]
40403	Fault number, Index 2	R	--	1	0 ... 32767	r0947 [3]
40404	Fault number, Index 3	R	--	1	0 ... 32767	r0947 [4]
40405	Fault number, Index 4	R	--	1	0 ... 32767	r0947 [5]
40406	Fault number, Index 5	R	--	1	0 ... 32767	r0947 [6]
40407	Fault number, Index 6	R	--	1	0 ... 32767	r0947 [7]
40408	Alarm number	R	--	1	0 ... 32767	r2110 [0]
40499	PRM ERROR code	R	--	1	0 ... 99	--
Technology controller						
40500	Technology controller enable	R/W	--	1	0 ... 1	p2200, r2349.0
40501	Technology controller MOP	R/W	%	100	-200.0 ... 200.0	p2240

Modbus Reg. No.	Description	Modbus access	Unit	Scaling factor	On/Off text or value range	Data / parameter
Technology controller adjustment						
40510	Time constant for actual value filter of the technology controller	R/W	--	100	0.00 ... 60.0	p2265
40511	Scaling factor for actual value of the technology controller	R/W	%	100	0.00 ... 500.00	p2269
40512	Proportional amplification of the technology controller	R/W	--	1000	0.000 ... 65.000	p2280
40513	Integral time of the technology controller	R/W	s	1	0 ... 60	p2285
40514	Time constant D-component of the technology controller	R/W	--	1	0 ... 60	p2274
40515	Max. limit of technology controller	R/W	%	100	-200.0 ... 200.0	p2291
40516	Min. limit technology controller	R/W	%	100	-200.0 ... 200.0	p2292
PID diagnostics						
40520	Effective setpoint acc. to internal technology controller MOP ramp-function generator	R	%	100	-100.0 ... 100.0	r2250
40521	Actual value of technology controller after filter	R	%	100	-100.0 ... 100.0	r2266
40522	Output signal technology controller	R	%	100	-100.0 ... 100.0	r2294

6.2.3.5 Write and read access via FC 3 and FC 6

Function codes used

For data exchange between the master and slave, predefined function codes are used for communication via Modbus.

The Control Unit uses the Modbus function code 03, FC 03, (read holding registers) for reading and the Modbus function code 06, FC 06, (preset single register) for writing.

Structure of a read request via Modbus function code 03 (FC 03)

All valid register addresses are permitted as a start address. If a register address is invalid, exception code 02 (invalid data address) is returned. An attempt to read a write-only register or a reserved register is replied to with a normal telegram in which all values are set to 0.

Using FC 03, it is possible to address more than 1 register with one request. The number of addressed registers is contained in bytes 4 and 5 of the read request.

Number of registers

If more than 125 registers are addressed, exception code 03 (Illegal data value) is returned. If the start address plus the number of registers for an address are outside of a defined register block, exception code 02 (invalid data address) is returned.

Table 6- 31 Structure of a read request for slave number 17

Example		
	Byte	Description
11 h	0	Slave address
03 h	1	Function code
00 h	2	Register start address "High" (register 40110)
6D h	3	Register start address "Low"
00 h	4	No. of registers "High" (2 registers: 40110; 40111)
02 h	5	Number of registers "Low"
xx h	6	CRC "Low"
xx h	7	CRC "High"

The response returns the corresponding data set:

Table 6- 32 Slave response to the read request

Example		
	Byte	Description
11 h	0	Slave address
03 h	1	Function code
04 h	2	No. of bytes (4 bytes are returned)
11 h	3	Data of first register "High"
22 h	4	Data of first register "Low"
33 h	5	Data of second register "High"
44 h	6	Data of second register "Low"
xx h	7	CRC "Low"
xx h	8	CRC "High"

Structure of a write request via Modbus function code 06 (FC 06)

The start address is the holding register address. If an incorrect address is entered (a holding register address does not exist), exception code 02 (invalid data address) is returned. An attempt to write to a "read-only" register or a reserved register is replied to with a Modbus error telegram (Exception Code 4 - device failure). In this instance, the detailed internal error code that occurred on the last parameter access via the holding registers can be read out via holding register 40499.

Using FC 06, precisely one register can always be addressed with one request. The value which is to be written to the addressed register is contained in bytes 4 and 5 of the write request.

Table 6- 33 Structure of a write request for slave number 17

Example		
	Byte	Description
11 h	0	Slave address
06 h	1	Function code
00 h	2	Register start address "High" (write register 40100)
63 h	3	Register start address "Low"
55 h	4	Register data "High"
66 h	5	Register data "Low"
xx h	6	CRC "Low"
xx h	7	CRC "High"

The response returns the register address (bytes 2 and 3) and the value (bytes 4 and 5) that was written to the register.

Table 6- 34 Slave response to the write request

Example		
	Byte	Description
11 h	0	Slave address
06 h	1	Function code
00 h	2	Register start address "High"
63 h	3	Register start address "Low"
55 h	4	Register data "High"
66 h	5	Register data "Low"
xx h	6	CRC "Low"
xx h	7	CRC "High"

6.2.3.6 Communication procedure

Procedure for communication in a normal case

Normally, the master sends a telegram to a slave (address range 1 ... 247). The slave sends a response telegram to the master. This response telegram mirrors the function code, and the slave enters its own address in the telegram, which enables the master to assign the slave.

The slave only processes orders and telegrams which are directly addressed to it.

Communication errors

If the slave detects a communication error on receipt (parity, CRC), it does not send a response to the master (this can lead to "setpoint timeout").

Logical error

If the slave detects a logical error within a request, it responds to the master with an "exception response". In the response, the highest bit in the function code is set to 1. If the slave receives, for example, an unsupported function code from the master, the slave responds with an "exception response" with code 01 (Illegal function code).

Table 6- 35 Overview of exception codes

Exception code	Modbus name	Remark
01	Illegal function code	An unknown (not supported) function code was sent to the slave.
02	Illegal Data Address	An invalid address was requested.
03	Illegal data value	An invalid data value was detected.
04	Server failure	Slave has terminated during processing.

Maximum processing time, p2024[0]

For error-free communication, the slave response time (time within which the Modbus master expects a response to a request) must have the same value in the master and the slave (p2024[0] in the converter).

Process data monitoring time (setpoint timeout), p2040

The alarm "Setpoint timeout" (F1910) is issued by the Modbus if p2040 is set to a value > 0 ms and no process data are requested within this time period.

The alarm "Setpoint timeout" only applies for access to process data (40100, 40101, 40110, 40111). The alarm "Setpoint timeout" is not generated for parameter data (40200 ... 40522).

Note

This time must be adapted depending on the number of slaves and the baud rate set for the bus (factory setting = 100 ms).

6.2.4 Communication via BACnet MS/TP

BACnet properties

In BACnet, components and systems are considered to be black boxes which contain a number of objects. BACnet objects only define behavior outside the device, internal functions are not determined by BACnet.

Each component is represented by a series of object types and their instances.

Each BACnet device has precisely one BACnet device object. A BACnet device is clearly identified by an NSAP (Network Service Access Point - comprising network number and MAC address; MAC: **M**edium **A**ccess **C**ontrol). This address is BACnet-specific and must not be confused with the Ethernet MAC address.

Data exchange with the client

The inverter receives control commands and setpoints via service instructions from the control and transmits its status back to the control. The inverter can also send telegrams automatically itself, respectively execute services, e.g. I-Am.

Communication settings

- The Control Unit supports BACnet via RS485 (BACnet MS/TP)
- The maximum cable length is 1200 m (3281 ft).

Protocol Implementation Conformance Statement

You will find the Protocol Implementation Conformance Statement (PICS) in the Internet under the following link: BACnet files
(<http://support.automation.siemens.com/WW/view/en/38439094>)

 CAUTION
It is not permitted to change over the units!
The "Unit changeover (Page 219)" function is not permissible with this bus system!

6.2.4.1 Setting the address

You can define the MAC ID of the inverter using DIP switches on the Control Unit or using p2021.

Valid BACnet addressing range: 1 ... 127

If you specify the address using the DIP switch, then this address is always effective and p2021 cannot be changed.

If you want to specify the address using p2021, we recommend setting all the DIP switches to "OFF" (0).

The positions and settings of the DIP switches are described in Section Interfaces, connectors, switches, control terminals, LEDs on the CU (Page 46).

CAUTION
A bus address that has been changed is only effective after switching-off and switching-on again. It is particularly important that any external 24 V supply is switched off.

6.2.4.2 Basic settings for communication

P no.	Parameter name
P0015 = 21	Macro drive unit Selecting the I/O configuration
p2030 = 5	Fieldbus telegram selection 5: BACnet
p2020	Baud rate 6: 9600 (factory setting) 7: 19200 8: 38400 10: 76800
p2024[0 ... 2]	Processing times P2024 [0]: 0 ms ... 10000 ms, maximum processing time (APDU timeout), factory setting = 1000 ms, P2024 [1 ... 2]: No significance for BACnet
p2025[0...3]	BACnet communication parameter <ul style="list-style-type: none"> • p2025 [0]: 0 ... 4194303, Device object instance number, Factory setting = 1 • p2025 [1]: 1 ... 10, Maximum Info Frames, factory setting = 1 • p2025 [2]: 0 ... 99, Number of APDU Retries (repeated attempts after fault telegrams), factory setting = 3 • p2025 [3]: 1 ... 127, maximum Master address, factory setting = 127

P no.	Parameter name
p2026	<p>Setting of the COV_Increment (COV = Change of values) 0 ... 4194303.000, factory setting = 0.100</p> <p>COV_Increment: Value change of the "Present Value" of an object instance where an UnConfirmedCOVNotification or ConfirmedCOVNotification should be transferred from the server.</p> <ul style="list-style-type: none"> • p2026 [0]: COV increment of object instance "Analog Input 0" • p2026 [1]: COV increment of object instance "Analog Input 1" • p2026 [2]: COV increment of object instance "Analog Input 10" • p2026 [3]: COV increment of object instance "Analog Input 11" <p>You can use these parameters to set for which value changes an UnConfirmedCOVNotification or ConfirmedCOVNotificationresult is sent. Therefore, the factory setting 0.100 means that an UnConfirmedCOVNotification or ConfirmedCOVNotification is sent if the value being considered (e.g. for a control range from 0 ... 10 V) changes by an absolute value of ≥ 0.1. Of course this only applies if previously a SubscribeCOV service was activated for the particular object instance.</p> <p>You can also set the COV increment using the object property "COVIncrement" of the particular analog input.</p>
p2040	<p>Fieldbus monitoring time 0 ms ... 65535000 ms, factory setting = 100 ms</p> <p>Note: The factory setting for communication with BACnet is possibly too low and must be increased. Please adapt the value to the requirements and properties of your particular plant or system.</p> <p>The reason for the factory setting of 100 ms is that the communication protocols for USS and Modbus RTU should also be executed via the RS485 interface.</p>

6.2.4.3 Supported services and objects

BIBBs used by the inverter

The BIBBs are a collection of one or several BACnet services. The BACnet services are subdivided into A and B devices. An A device operates as client and B device as server.

The inverter is a server and therefore operates as B device, as "BACnet Application Specific Controller" (B-ASC).

The CU230P-2 HVAC uses the BIBBs listed below:

Table 6- 36 Overview of the BIBB used by CU230P-2 HVAC and associated services

Short designation	BIBB	Service
DS-RP-B	Data Sharing-ReadProperty-B	ReadProperty
DS-WP-B	Data Sharing-WriteProperty-B	WriteProperty
DM-DDB-B	Device Management-Dynamic Device Binding-B	<ul style="list-style-type: none"> • Who-Is • I-Am
DM-DOB-B	Device Management-Dynamic Object Binding-B	<ul style="list-style-type: none"> • Who-Has • I-Have
DM-DCC-B	Device Management-DeviceCommunicationControl-B	DeviceCommunicationControl
DS-COV-B	Data Sharing-COV-B	<ul style="list-style-type: none"> • SubscribeCOV, • ConfirmedCOVNotification, • UnConfirmedCOVNotification

The inverter can simultaneously process up to 32 SubscribeCOV services. These can all refer to the same object instances - or different object instances.

SubscribeCOV is supported for binary value objects (BVxx) and for analog input objects (AIxx).

Note

SubscribeCOV services are not retentive, i.e. when switching off, COVs, which have not been executed, are lost and must be re-initiated when the CU restarts.

Table 6- 37 Code numbers of the object types supported in BACnet

Object type	Code number for BACnet object type
Device	8
Digital input	3
Digital output	4
Digital value	5
Analog input	0
Analog output	1
Analog value	2

Table 6- 38 Object properties of the "Device" object type

• Object_Identifier	• Application_Software_Version	• APDU_Timeout
• Object_Name	• Protocol_Version	• Number_Of_APDU_Retries
• Object_Type	• Protocol_Revision	• Max Master
• System_Status	• Protocol_Services_Supported	• Max Info Frames
• Vendor_Name	• Protocol_Object_Types_Supported	• Device Address Binding
• Vendor_Identifier	• Object_List	• Database Revision
• Model_Name	• Max_APDU_Length_Accepted ¹⁾	
• Firmware_Revision	• Segmentation_Supported ²⁾	

1) Maximum value = 480, 2) is not supported

Table 6- 39 Object properties of other object types

Object property	Object type				
	Binary input	Binary output	Binary value	Analog input	Analog value
Object_Identifier	X	X	X	X	X
Object_Name	X	X	X	X	X
Object_Type	X	X	X	X	X
Present_Value	X	X	X	X	X
Status_Flags	X	X	X	X	X
Event_State	X	X	X	X	X
Out_Of_Service	X	X	X	X	X
Units				X	X
Priority_Array		X	X*		X*
Relinquish_Default		X	X*		X*
Polarity	X	X			
Active_Text	X	X	X		
Inactive_Text	X	X	X		
COV_Increment				X	

* for command values only (access type C)

Note

Access types are available in the following versions

- C: commandable
 - R: Readable
 - W: Writable
-

Table 6- 40 Binary input objects

Instance ID	Object name	Description	Possible values	Text active / text inactive	Access type	Parameter
BI0	DI0 ACT	State of DI 0	ON/OFF	ON/OFF	R	r0722.0
BI1	DI1 ACT	State of DI 1	ON/OFF	ON/OFF	R	r0722.1
BI2	DI2 ACT	State of DI 2	ON/OFF	ON/OFF	R	r0722.2
BI3	DI3 ACT	State of DI 3	ON/OFF	ON/OFF	R	r0722.3
BI4	DI4 ACT	State of DI 4	ON/OFF	ON/OFF	R	r0722.4
BI5	DI5 ACT	State of DI 5	ON/OFF	ON/OFF	R	r0722.5
BI7	DI7 ACT	State of AI 1 - used as DI	ON/OFF	ON/OFF	R	r0722.11
BI8	DI8 ACT	State of AI 2 - used as DI	ON/OFF	ON/OFF	R	r0722.12
BI10	DO0 ACT	Controls DO 0 (relay 1)	ON/OFF	ON/OFF	R	read r747.0
BI11	DO1 ACT	Controls DO 1 (relay 2)	ON/OFF	ON/OFF	R	read r747.1
BI12	DO2 ACT	Status of DO2 (relay 3)	ON/OFF	ON/OFF	R	read r747.2

Table 6- 41 Binary output objects

Instance ID	Object name	Description	Possible values	Text active / text inactive	Access type	Parameter
BO0	DO0 CMD	Controls DO 0 (relay 1)	ON/OFF	ON/OFF	C	p0730
BO1	DO1 CMD	Controls DO 1 (relay 2)	ON/OFF	ON/OFF	C	p0731
BO2	DO2 CMD	Controls DO 2 (relay 3)	ON/OFF	ON/OFF	C	p0732

Table 6- 42 Binary value objects

Instance ID	Object name	Description	Possible values	Text active	Text inactive	Access type	Parameter
BV0	RUN/ STOP ACT	Inverter status regardless of command source	RUN/STOP	STOP	RUN	R	r0052.2
BV1	FWD/ REV	Direction of rotation regardless of command source	REV/ FWD	FWD	REV	R	r0052.14
BV2	FAULT ACT	Fault status of inverter	FAULT/OK	FAULT	OK	R	r0052.3
BV3	WARN ACT	Warning status of inverter	WARN/OK	WARN	OK	R	r0052.7
BV4	HAND/ AUTO ACT	Indicates the source of the hand/auto inverter control	AUTO / MANUAL	AUTO	LOCAL	R	r0052.9
BV7	CTL OVERRIDE ACT	ACT indicates if the inverter control has been transferred to BACnet override control via BV93. Note that the operator panel's "Manual" operating mode has a higher priority than the BACnet override control.	ON/OFF	0	1	R	r2032[10]

Instance ID	Object name	Description	Possible values	Text active	Text inactive	Access type	Parameter
BV8	AT SET-POINT	Setpoint reached	YES/NO	YES	NO	R	r0052.8
BV9	AT MAX FREQ	Maximum speed reached	YES/NO	YES	NO	R	r0052.10
BV10	DRIVE READY	Inverter ready	YES/NO	YES	NO	R	r0052.1
BV15	RUN COM ACT	ACT indicates the status of the ON command, regardless of the source	YES/NO	0	1	R	r2032[0]
BV16	HIB MOD ACT	ACT means that the inverter is operating in energy-saving mode.	ON/OFF	0	1	R	r2399[1]
BV17	ESM MOD	ACT means that the inverter is operating in emergency mode.	ON/OFF	0	1	R	r3889[0]
BV20	RUN/ STOP CMD	ON command for the inverter (when controlling via BACnet)	RUN/STOP	0	1	C	r0054.0
BV21	FWD/ REV CMD	Reverse direction of rotation (when controlling via BACnet)	REV/ FWD	0	1	C	r0054.11
BV22	FAULT RESET	Acknowledge fault (when controlling via BACnet)	RESET/NO	0	1	C	r0054.7
BV24	CDS	Local/Remote	Local/Remote	YES	NO	C	r0054.15
BV26	RUN ENA CMD	Enable inverter operation		ENABLED	DIS-ABLED	C	r0054.3
BV27	OFF2	OFF2 status	RUN/STOP	0	1	C	r0054.1
BV28	OFF3	OFF3 status Note: Bits r0054.4, r0054.5 and r0054.6 are also set or reset via BV28	RUN/STOP	0	1	C	r0054.2
BV50	ENABLE PID	Enable PID controller		ENABLED	DIS-ABLED	C	p2200
BV90	LOCAL LOCK	Use HAND (operator panel) to lock inverter control		LOCK	UN-LOCK	C	p0806
BV93	CTL OVERRIDE CMD	Inverter control using BACnet override control	ON/OFF	0	1	C	r0054.10

Table 6- 43 Analog input objects

Instance ID	Object name	Description	Unit	Area	Access type	Parameter
AI0	ANALOG INPUT 0	AI0 input signal	V/mA	-300.0 ... 300.0	R	r0752[0]
AI1	ANALOG INPUT 1	AI1 input signal	V/mA	-300.0 ... 300.0	R	r0752[1]
AI10	ANALOG INPUT 0 SCALED	Standardized AI 0 input signal	%	-100.0 ... 100.0	R	r0755[0]
AI11	ANALOG INPUT 1 SCALED	Standardized AI 1 input signal	%	-100.0 ... 100.0	R	r0755[1]

Table 6- 44 Analog value objects

Instance ID	Object name	Description	Unit	Area	Access type	Parameter
AV0	OUTPUT_FREQ_Hz	Output frequency (Hz)	Hz	-327.68 ... 327.67	R	r0024
AV1	OUTPUT_FREQ_PCT	Output frequency (%)	%	-100.0 ... 100.0	R	HIW
AV2	OUTPUT_SPEED	Motor speed	RPM	-16250 ... 16250	R	r0022
AV3	DC_BUS_VOLT	DC link voltage.	V	0 ... 32767	R	r0026
AV4	OUTPUT_VOLT	Output voltage	V	0 ... 32767	R	r0025
AV5	CURRENT	Motor current	A	0 ... 163.83	R	r0027
AV6	TORQUE	Motor torque	Nm	- 325.00 ... 325.00	R	r0031
AV7	POWER	Motor power	kW	0 ... 327.67	R	r0032
AV8	DRIVE_TEMP	Heat-sink temperature	°C	0 ... 327.67	R	r0037
AV9	MOTOR_TEMP	Measured or calculated motor temperature	°C	0 ... 327.67	R	r0035
AV10	KWH (NR)	Cumulative inverter energy consumption (cannot be reset!)	kWh	0 ... 32767	R	r0039
AV12	INV_RUN_TIME (R)	Motor's operating hours (is reset by entering "0")	h	0 ... 4294967295	W	p0650
AV13	INV Model	Code number of Power Module	---		R	r0200
AV14	INV_FW_VER	Firmware version	---		R	r0018
AV15	INV_POWER	Rated power of the inverter	kW	0 ... 327.67	R	r0206
AV16	RPM_STPT_1	Inverter's reference speed	RPM	6.0 ... 210000	W	p2000
AV17	FREQ_STPT_PCT	Setpoint 1 (when controlling via BACnet)	%	-199.99 ... 199.99	C	HSW
AV18	ACT_FAULT	Fault number of fault due to be dealt with	---	0 ... 32767	R	r0947[0]
AV19	PREV_FAULT_1	Fault number of last fault	---	0 ... 32767	R	r0947[1]
AV20	PREV_FAULT_2	Fault number of last but one fault	---	0 ... 32767	R	r0947[2]
AV21	PREV_FAULT_3	Fault number of the third from last fault	---	0 ... 32767	R	r0947[3]
AV22	PREV_FAULT_4	Fault number of the fourth from last fault	---	0 ... 32767	R	r0947[4]
AV25	Select Setpoint Source	Command to select the setpoint source	---	0 ... 32767	W	p1000
AV28	AO1_ACT	Signal from AO 1	mA	-100.0 ... 100.0	R	r0774.0
AV29	AO2_ACT	Signal from AO 1	mA	-100.0 ... 100.0	R	r0774.1
AV30	MIN_SPEED	Minimum speed	RPM	0.000 – 19500.000	W	p1080
AV31	MAX_FREQ	Maximum speed	RPM	0.000 ... 210000.000	W	p1082
AV32	ACCEL_TIME	Rampup time	s	0.00 ... 999999.0	W	p1120
AV33	DECEL_TIME	Ramp-down time	s	0.00 ... 999999.0	W	P1121

Instance ID	Object name	Description	Unit	Area	Access type	Parameter
AV34	CUR LIM	Current limit	A	0.00 ... 10000.00	R	p0640
AV39	ACT WARN	Indication of pending alarm	---	0 ... 32767	R	r2110[0]
AV40	PREV WARN 1	Indication of the last alarm	---	0 ... 32767	R	r2110[1]
AV41	PREV WARN 2	Indication of the last but one alarm	---	0 ... 32767	R	r2110[2]

6.3 Communication over CANopen

Connecting an inverter to a CAN bus

Connect the inverter to the fieldbus via the 9-pin SUB-D pin connector.

The connections of this pin connector are short-circuit proof and isolated. If the inverter forms the first or last slave in the CANopen network, then you must switch-in the bus terminating resistor.

For additional information on the SUB-D pin connector and on the bus terminating resistor, please refer to Section Interfaces, connectors, switches, control terminals, LEDs on the CU (Page 46).

Integrating the converter into CANopen

We recommend the following procedure to integrate the converter into CANopen:

1. Setting the node ID and baud rate
2. Monitoring the communication and response of the inverter (Page 155) set
3. Integrating the converter into CAN using the Predefined Connection Set
4. if required, make additional specific changes using the free PDO mapping.
5. Adapting the BiCo interconnection

Note

In the configuration example (Page 179) you can find a detailed description of how you integrate the converter into a CANopen system.

More information about how to configure the communication is provided in Sections Other CANopen functions (Page 167) and Object directories (Page 170).

General information on CAN

You can find general information on CAN in the CAN Internet pages (<http://www.can-cia.org>); you can obtain an explanation of CAN terminology in the CANdictionary under CAN downloads (<http://www.can-cia.org/index.php?id=6>).

The EDS file is the description file of the SINAMICS G120 converter for CANopen networks.

If you load the EDS file into your CAN controller, you can use the objects of the DSP 402 device profile.

1. You can find the EDS file of the converter in Internet (<http://support.automation.siemens.com/WW/view/en/48351511>).

In Section Configuration example (Page 179), you can find an example of how you can integrate the converter into a CAN controller using the EDS.

6.3.1 CANopen functionality of the converter

CANopen is a CAN-based communication protocol with linear topology that operates on the basis of communication objects (COB).

Communication between the converter and control can be established via Predefined connection set (Page 165) or via Free PDO mapping (Page 166)

Communication objects (COB)

The converter operates with communication objects from the following profiles:

- CANopen communication profile DS 301 version 4.0
- Device profile DSP 402 (drives and motion control) version 2.0
- Indicator profile DR303-3 version 1.0.

Specifically, these are:

- **SDO**
Service data objects for reading and changing parameters
- **PDO**
Process data objects to transfer process data, TPDO to send, RPDO to receive
- **NMT**
Network management objects (NMT) for controlling CANopen communication and for monitoring the individual nodes on the basis of a master-slave relationship.
- **SYNC**
Synchronization objects
- **EMCY**
Time stamp and fault messages

COB ID

A communication object includes data – which is transferred – and an 11 bit COB-ID, which uniquely identifies it. The priority when executing the communication objects is controlled using the COB-ID. The communication object with the lowest COB-ID always has the highest priority.

COB ID for individual communication objects

You will find the specifications for the COB IDs of the individual communication objects below

- **COB ID_{NMT} = 0** cannot be changed
- **COB ID_{SYNC} = free** in most cases, this is preassigned with 80 hex
- **COB ID_{EMCY} = free** In most of the cases, $\text{COB ID}_{\text{SYNC}} + \text{node-ID} = \text{COB-ID}_{\text{EMCY}}$
- **COB-ID_{TPDO} = free** In the free PDO mapping *)
- **COB-ID_{RPDO} = free** In the free PDO mapping *)
- **COB ID_{TSDO} = 580 + Node-ID**
- **COB ID_{RSDO} = 600 + Node-ID**
- **COB ID_{Node Guarding/Heartbeat} = 700 + Node-ID**

*) COB-ID for RPDO and TPDO for the "Predefined Connection Set", see Page (Page 165).

6.3.2 Commissioning CANopen

6.3.2.1 Setting the node ID and baud rate

In the converter you must set the node ID and the baud rate to permit communication.

CAUTION

Changes made to the node ID or baud rate only become effective after switching off and on again. It is particularly important that any external 24 V supply is switched off.

Note that before turning off, you must save the changes using RAM -> ROM ().

The currently active Node ID is displayed in parameter r8621.

Setting the node ID

You can define the node ID either using the DIP switch on the Control Unit, using parameter p8620 or in STARTER in the screen form under "Control Unit/Communication/CAN" under the CAN interface tab.

Valid node IDs: 1 ... 126

Invalid node IDs: 0, 127

When a valid node ID has been set using DIP switches, then this is always effective and p8620 cannot be changed.

If you set all DIP switches to "OFF" (0) or "ON" (1), then the Node ID set in p8620 or STARTER is effective.

The positions and settings of the DIP switches are described in Section Interfaces, connectors, switches, control terminals, LEDs on the CU (Page 46).

Setting the data transmission rate

You can set the transmission rate in the range from 10 kbit/s ... 1 Mbit/s using parameter p8622 or in the STARTER screen form "Control Unit/Communication/CAN" under the CAN interface tab.

6.3.2.2 Monitoring the communication and response of the inverter

The communication monitoring can be used via both node guarding and heartbeat protocol (heartbeat producer).

Node guarding

The master sends monitoring queries to the slaves via the node guarding protocol.

If the converter does not receive a Node Guarding protocol within the Life Time, then it outputs fault (F08700).

Life Time = Guard time (p8601.0) * Life Time Factor (p8604.1)

Heartbeat

The slave periodically sends heartbeat messages. Other slaves and the master can monitor this message. If a heartbeat goes missing, then appropriate responses can be set in the master.

The settings for the heartbeat protocol are made in parameter p8606.

Note

Note

Node guarding and heartbeat are mutually interlocked. This means that if the parameter for one of these functions is not equal to 0, then the other cannot be used.

Both functions are deactivated in the factory setting.

Converter response to a bus fault - CAN controller state "Bus off" (converter fault F8700, fault value 1)

If you acknowledge the bus fault using OFF/ON, the bus OFF state is also canceled and communication is restarted.

If you acknowledge the bus fault via DI 2 or directly via p3981, then the converter remains in the bus OFF state. To restart communication, in this case, you must set p8608 to 1.

 WARNING
--

If you acknowledge the bus fault via DI 2 or directly via p3981 - and p8641 is set to 0 (for a bus fault, the converter does not go into a fault condition), then you must restart communication via p8608 = 1 before you can stop the motor via the control.

6.3.2.3 SDO services

You can access the object directory of the connected drive unit using the SDO services. An SDO connection is a peer-to-peer coupling between an SDO client and a server.

The drive unit with its object directory is an SDO server.

The identifiers for the SDO channel of a drive unit are defined according to CANopen as follows.

Receiving:	Server <= Client:	COB ID = 600 hex + node ID
Transmitting:	Server => Client:	COB ID = 580 hex + node ID

Properties

The SDOs have the following properties:

- SDO are transferred in the Preoperational and Operational states
- The transfer is confirmed
- Transfer is asynchronous (corresponds to acyclic data exchange for PROFIBUS DB)
- Transmission of values > 4 bytes (normal transfer)
- Transmission of values ≤ 4 bytes (expedited transfer)
- All drive unit parameters can be addressed via SDO.

Structure of the SDO protocols

The SDO services use the appropriate protocol depending on the task. The basic structure is shown below:

Header information			n user data
Byte 0	Byte 1 und 2	Byte 3	Byte 4 ... 7
CS	index	sub index	length

- The protocol type is contained in byte 0:
 - 2F hex: write 4 bytes
 - 2B hex: write 3 bytes
 - 27 hex: write 2 bytes
 - 23 hex: write 1 byte
 - 40 hex: read request
 - 4F hex: read 4 bytes
 - 4B hex: read 3 bytes
 - 47 hex: read 2 bytes
 - 43 hex: read 1 byte
 - 60 hex: write acknowledgment
 - 80 hex: error
- Bytes 1 and 2 contain the index (SINAMICS parameter number)
- Byte 3 contains the subindex (SINAMICS parameter index)
- Bytes 4 ... 7 contain the data corresponding to the second position of byte 0. In the case of an error, these bytes contain the abort code

SDO abort codes

Table 6- 45 SDO abort codes

Abort code	Description
0503 0000h	Toggle bit not alternated. Toggle bit has not changed
0504 0000h	SDO protocol timed out. Timeout for SDO protocol
0504 0001h	Client/server command specifier not valid or unknown. Client/server command not valid or unknown
0504 0005h	Out of memory. Memory overflow
0601 0000h	Unsupported access to an object. Access to an object that is not supported
0601 0001h	Attempt to read a write only object. An attempt is made to read a "write-only object"
0601 0002h	Attempt to write a read only object. An attempt is made to write to a "read-only object"
0602 0000h	Object does not exist in the object dictionary. Object does not exist in an object dictionary
0604 0041h	Object cannot be mapped to the PDO. Object cannot be linked with the PDO
0604 0042h	The number and length of the objects to be mapped would exceed PDO length. The number and length of the objects that are to be linked exceeds the PDO length
0604 0043h	General parameter incompatibility reason. Basic parameter incompatibility
0604 0047h	General internal incompatibility in the device. Basic incompatibility in the device
0602 0000h	Object does not exist in the object dictionary. Object does not exist in an object dictionary
0604 0041h	Object cannot be mapped to the PDO. Object cannot be linked with the PDO
0604 0042h	The number and length of the objects to be mapped would exceed PDO length. The number and length of the objects that are to be linked exceeds the PDO length
0604 0043h	General parameter incompatibility reason. Basic parameter incompatibility
0604 0047h	General internal incompatibility in the device. Basic incompatibility in the device
0606 0000h	Access failed due to an hardware error. Access has failed due to a hardware fault
0607 0010h	Data type does not match, length of service parameter does not match. Data type and length of the service parameter do not match

0607 0012h	Data type does not match, length of service parameter too high. Data type is not correct, service parameter is too long
0607 0013h	Data type does not match, length of service parameter too low. Data type is not correct, service parameter is too short
0609 0011h	Subindex does not exist Subindex does not exist
0609 0030h	Value range of parameter exceeded (only for write access). Value range of the parameter exceeded (only for write access)
0609 0031h	Value of parameter written too high. Subindex does not exist
0609 0032h	Value of parameter written too low. Value of written parameter too low
0609 0036h	Maximum value is less than minimum value. Maximum value is less than the minimum value
0800 0000h	General error. General error
0800 0020h	Data cannot be transferred or stored to the application. Data cannot be transferred or saved in the application
0800 0021h	Data cannot be transferred or stored to the application because of local control. Data cannot be transferred or saved due to the local control
0800 0022h	Data cannot be transferred or stored to the application because of the current device state. Data cannot be transferred or saved due to the device condition
0800 0023h	Object dictionary dynamic generation failed or no object dictionary is present (e.g. object dictionary is generated from file and generation fails because of a file error). Dynamic creation of the object dictionary failed - or an object dictionary does not exist (e.g. object directory was generated from a defective file)

6.3.2.4 Access to SINAMICS parameters via SDO

If you wish to change inverter parameters in CANopen using the control, then use the service data objects (SDO). SDO are transferred in the operational as well as in the pre-operational states.

You can also configure RPDO and TPDO telegrams via SDO. You can find the objects that are available to do this in Section Object directories (Page 170).

Adapting the parameter numbers

The inverter parameters can be addressed via the SDO parameter channel in the range from 2000 hex ... 470F hex of the CANopen object directory.

Not all of the parameters can be directly addressed via this range. This is the reason that in CAN, an inverter parameter always comprises two parameters from the inverter; these are the offset specified using parameter p8630[2] and the parameter itself.

- for all parameters < 9999 the following applies:
 - p8630[2] = 0,
 - Inverter parameters -> hex + 2000 hex
Example: For parameter p0010, 200A hex follows as object number in the SDO job
- for all parameters 9999 < 19999 the following applies:
 - p8630[2] = 1,
 - (inverter parameters - 10000) -> hex + 2000 hex
Example: For parameter p11000, 23E8 hex follows as object number in the SDO job
- for all parameters 19999 < 29999 the following applies:
 - p8630[2] = 2,
 - (inverter parameters - 20000) -> hex + 2000 hex
Example: For parameter r20001, 2001 hex follows as object number in the SDO job
- for all parameters 29999 < 39999, the following applies:
 - p8630[2] = 3,
 - (inverter parameters - 30000) -> hex + 2000 hex
Example: For parameter p31020, 23FC hex follows as object number in the SDO job

Selection, index range

Further, no more than 255 indices can be transferred in a CANopen object. This means that additional CANopen objects must be created for parameters that have more indices. This is realized using p8630[1]. It is possible to transfer a maximum of 1024 indices.

- P8630[1] = 0: 0 ... 255
- P8630[1] = 1: 256 ... 511
- P8630[1] = 2: 512 ... 767
- P8630[1] = 3: 768 ... 1023

Accessing CANopen objects and inverter parameters

- p8630[0] = 0: only accessing CANopen objects (SDO, PDO, ...)
- p8630[0] = 1: Access to virtual CANopen objects (inverter parameters)
- p8630[0] = 2: not relevant for G120 inverters

6.3.2.5 PDO and PDO services

Process data objects (PDO)

For CANopen, (real-time) transfer of process data is realized using "Process Data Objects" (PDO). There are send and receive PDO. With the G120 inverter, eight send PDO (TPDO) and eight receive PDO (RPDO) are transferred.

A PDO is defined by the PDO communication parameter and the PDO mapping parameter.

The PDO must be linked with the objects of the object dictionary which contain process data. You can use Free PDO mapping (Page 166) or the Predefined connection set (Page 165) to do this.

Note**Changing over between an interconnection via free PDO mapping and Predefined Connection Set**

For changing over from free PDO mapping (factory setting) to mapping via the Predefined Connection Set you require parameters p8744 and p8741 from the expert list.

You can select the method of the interconnection using p8744 (p8744 = 0: Free PDO mapping, p8744 = 1: Predefined Connection Set), with p8741 = 1 you confirm the transfer. After transfer, p8741 returns to 0.

Parameter area for PDO

- RPDO
 - In the inverter: p8700 ... p8717
 - In CAN: 1400 hex ff
- TPDO
 - In the inverter: p8720 ... p8737
 - In CAN: 1800 hex ff

Note

One channel in the CAN controller is assigned for each RPDO. TPDO always use two permanently set channels in the CAN controller

The structure of this communication and mapping parameter is listed in the following tables.

Table 6- 46 PDO communications parameter
 RPDO: 1400h ff (p8700 ... 8707), TPDO: 1800h ff (p8720 ... p8727)

Subindex	Name	Data type	Parameter index (inverter)
00h	Highest subindex that is supported	UNSIGNED8	---
01h	COB ID	UNSIGNED32	0
02h	Transfer mode	UNSIGNED8	1
03h	Inhibit time (only for TPDO)	UNSIGNED16	2
04h	Reserved (only for TPDO)	UNSIGNED8	3
05h	Event timer (only for TPDO)	UNSIGNED16	4

Table 6- 47 PDO mapping parameter
 RPDO: 1600h ff (p8710 ... 8717), TPDO: 1A00h ff (p8730 ... p8730)

Subindex	Name	Data type	Parameter index (inverter)
00h	Number of objects mapped to the PDO (max. 4)	UNSIGNED8	---
01h	First mapped object	UNSIGNED32	0
02h	Second mapped object	UNSIGNED32	1
03h	Third mapped object	UNSIGNED32	2
04h	Fourth mapped object	UNSIGNED32	3

For process data objects, the following transfer types are available, which you set in index 1 of the communication parameter (p8700 ... p8707 / p8720 ... p8727) in the inverter.

- Synchronous cyclic (index 1: n = 1 ... 240) - for TPDO (Transmit PDO) and RPDO (Receive PDO):
 - TPDO is sent after each nth SYNC
 - RPDO is received after each nth SYNC
- Synchronous acyclic (index 1: 0) - for TPDO
 - TPDO is sent if a SYNC is received and a process data has changed in the telegram.
- asynchronous cyclic (index 1: 254, 255 + event time) - for TPDO
 - TPDO is sent if process data has changed in the telegram.
- asynchronous acyclic (index 1: 254, 255) - for TPDO and RPDO
 - TPDO is sent if process data has changed in the telegram.
 - RPDO is directly accepted when it is received.

Synchronous data transmission

In order for the devices on the CANopen bus to remain synchronized during transmission, a synchronization object (SYNC object) must be transmitted at periodic intervals.

Each PDO that is transferred as a synchronous object must be assigned a transmission type 1 ... n. The following is applicable:

- Transmission type 1: the PDO is transferred in every SYNC cycle.
- Transmission type n: the PDO is transferred in every nth SYNC cycle.

The following diagram shows the principle of synchronous and asynchronous transmission:

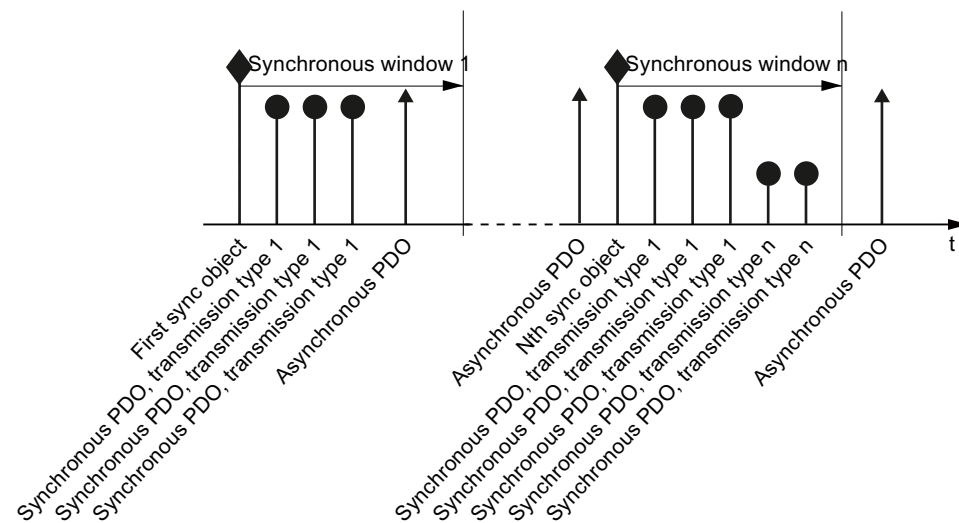

Figure 6-13 Principle of synchronous and asynchronous transmission

For synchronous TPDOs, the transmission mode also identifies the transmission rate as a factor of the SYNC object transmission intervals. Here, transmission type "1" means that the message will be transmitted in every SYNC object cycle. Transmission type "n" means that the message will be transmitted in every nth SYNC object cycle.

Data from synchronous RPDOs that are received after a SYNC signal is not transmitted to the application until after the next SYNC signal.

Note

The SYNC signal does not synchronize the applications in the SINAMICS drive, only the communication on the CANopen bus

Asynchronous data transmission

Asynchronous PDOs are transferred - cyclically or acyclically - without reference to the SYNC signal.

PDO services

The PDO services can be subdivided as follows:

- Write PDO
- Read PDO
- SYNC service

Write PDO

The "Write PDO" service is based on the "push" model. The PDO has exactly one producer. There can be no consumer, one consumer, or multiple consumers.

Via Write PDO, the producer of the PDO sends the data of the mapped application object to the individual consumer.

Read PDO

The "Read PDO" service is based on the "pull" model. The PDO has exactly one producer. There can be one consumer or multiple consumers.

Via Read PDO, the consumer of the PDO receives the data of the mapped application object from the producer.

SYNC service

The SYNC object is periodically sent from the SYNC producer. The SYNC signal represents the basic network cycle. The time interval between two SYNC signals is determined in the master by the standard parameter "Communication cycle time".

In order to ensure CANopen accesses in real-time, the SYNC object has a high priority, which is defined using the COB ID. This can be changed via p8602 (factory setting = 80hex). The service runs unconfirmed.

Note

The COB ID of the SYNC object must be set to the same value for all nodes of a bus that should respond to the SYNC telegram from the master

The COB ID of the SYNC object is defined in object 1005h (p8602).

6.3.2.6 Predefined connection set

When integrating the converter via the predefined connection set, the converter is interconnected so that the motor can be switched-on via the control and a setpoint can be entered without having to make any additional settings or requiring CANopen know-how. The converter returns the status word and the speed actual value to the control.

In the factory, the converter is set to free PDO mapping. Changeover to the Predefined Connection Set, see Section PDO and PDO services (Page 161).

Once you have made the settings for the predefined connection set, then in the screen form "Control Unit/Communication/CAN", select the Operational status under the Network-Management tab. You can then switch-on the motor from the control and enter a setpoint.

Data, which you transfer using the predefined connection set

- TPDO 1 with Control word 1
- RPDO 1 with Status word 1
- TPDO 2 with Control word 1 and speed setpoint
- RPDO 2 with Status word 1 and speed actual value

The COB IDs are calculated according to the following formula and entered into parameters p8700, p8701, p8720 and 8721.

COB-Id for TPDO and RPDO in the Predefined Connection Set

- $\text{COB-ID}_{\text{TPDO}} = 180 \text{ hex} + \text{Node-ID} + ((\text{TPDO-No.} - 1) * 100 \text{ hex})$
 Example: COB-ID of the TPDO 2, (Node ID = C hex)
 $180 \text{ hex} + \text{C hex} + ((2 - 1) * 100 \text{ hex}) = 18\text{C hex} + 100 \text{ hex} = 28\text{C hex}$ is required
- $\text{COB-ID}_{\text{RPDO}} = 200 \text{ hex} + \text{Node-ID} + ((\text{RPDO-No.} - 1) * 100 \text{ hex})$
 Example: COB-ID of the 3rd RPDO, (Node ID = C hex)
 $200 \text{ hex} + \text{C hex} + ((2 - 1) * 100 \text{ hex}) = 20\text{C hex} + 100 \text{ hex} = 30\text{C hex}$ is required

6.3.2.7 Free PDO mapping

Using the free PDO mapping, you can interconnect additional process data from the object directory corresponding to the requirements of your particular system for the PDO service.

In the factory, the converter is set to free PDO mapping. If your converter has been changed over to the Predefined Connection Set, you must change over to free PDO mapping, see Section PDO and PDO services (Page 161).

A PDO can transfer up to eight bytes of user data. With mapping, you define which user data are transferred in a PDO.

Example

The following diagram shows an example of PDO mapping (values are hexadecimal (e.g. object size 10 hex = 16 bits)):

For the control word and the setpoint speed

p08711[0] = 6040

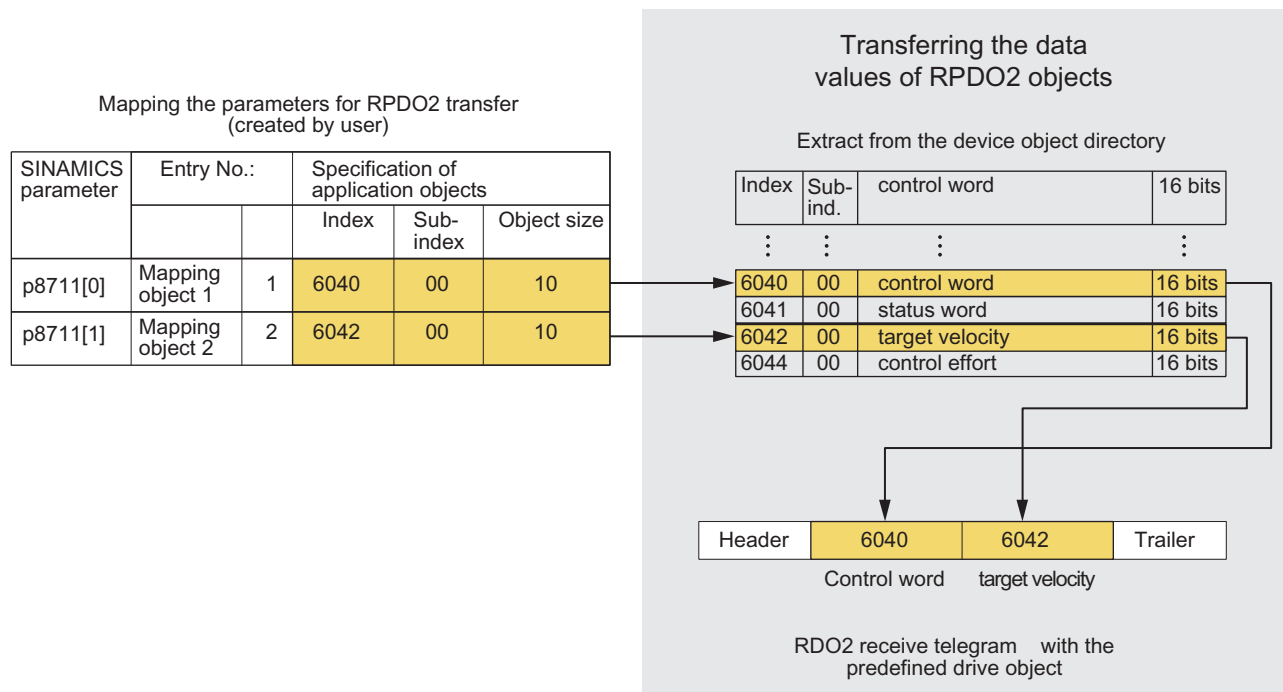

Figure 6-14 PDO mapping for control word and speed setpoint

6.3.3 Other CANopen functions

6.3.3.1 Network management (NMT service)

Network management (NMT) is node-oriented and has a master-slave topology.

The NMT services can be used to initialize, start, monitor, reset, or stop nodes. Two data bytes follow each NMT service. All NMT services have the COB ID = 0. This cannot be changed.

The SINAMICS converter is an NMT slave and can adopt the following states in CANopen:

- **Initializing**
The converter passes through this state after Power On. In the factory setting, the converter then enters the "Pre-Operational" state, which also corresponds to the CANopen standard.
Using p8684, you can set that after the bus has booted, the converter does not go into the "Pre-Operational" state, but instead, into the "Stopped" or "Operational" state.
- **Pre-Operational**
In this state, the node cannot process any process data (PDO). It can, however, be parameterized or operated via SDOs, which means that you can also enter setpoints via SDO.
- **Operational**
In this state, the node can process both SDO and PDO.
- **Stopped**
In this state, the node cannot process either PDO or SDO. The Stopped mode is exited by specifying one of the following commands:
 - Enter Pre-Operational
 - Start Remote Node
 - Reset Node
 - Reset Communication

The NMT recognizes the following transitional states:

- **Start Remote Node:**
command for switching from the "Pre-Operational" communication status to "Operational". The drive can only transmit and receive process data (PDO) in "Operational" status.
- **Stop Remote Node**
command for switching from "Pre-Operational" or "Operational" to "Stopped". The node can only process NMT commands in the "Stopped" status.
- **Enter Pre-Operational**
command for switching from "Operational" or "Stopped" to "Pre-Operational". In this state, the node cannot process any process data (PDO). It can, however, be parameterized or operated via SDOs, which means that you can also enter setpoints via SDO.
- **Reset Node:**
command for switching from "Operational", "Pre-Operational", or "Stopped" to "Initialization". When the Reset Node command is issued, all the objects (1000 hex - 9FFF hex) are reset to the status that was present after "Power On".
- **Reset Communication:**
command for switching from "Operational", "Pre-Operational", or "Stopped" to "Initialization". When the Reset Communication command is issued, all communication objects (1000 hex - 1FFF hex) are reset to the status that was present after "Power On".

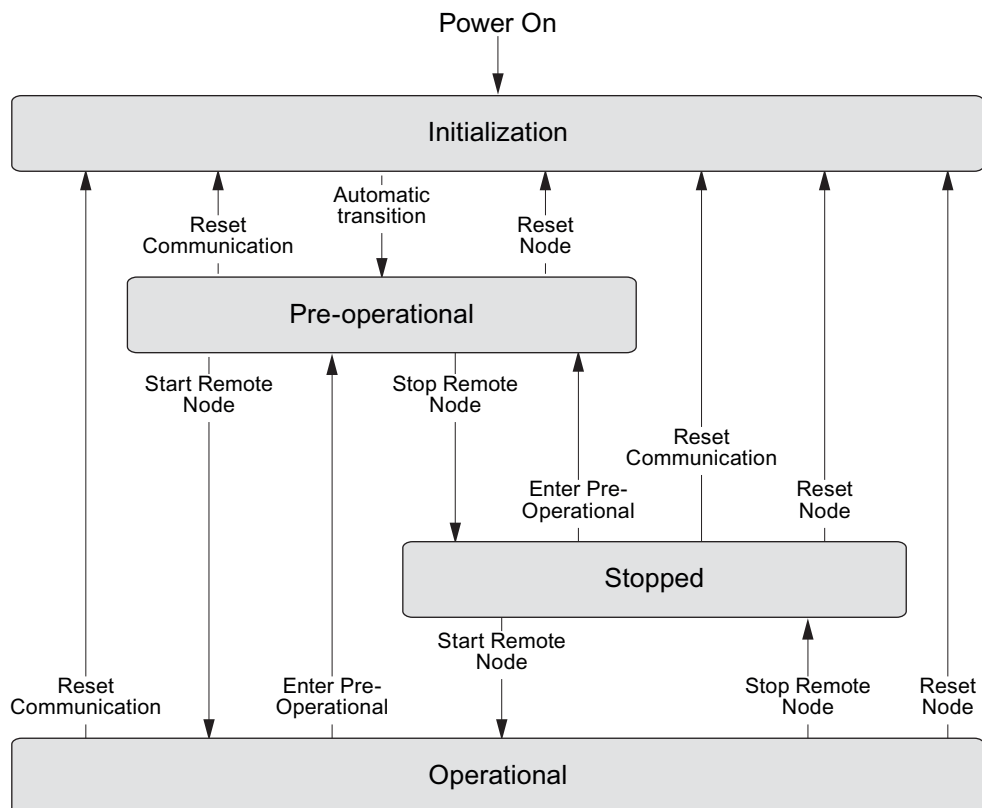

Figure 6-15 CANopen status diagram

The transition states and addressed nodes are displayed using the command specifier and the Node_ID:

Table 6- 48 Overview of NMT commands

NMT Master Request ----> NMT Slave message		
Command	Byte 0 (command specifier, CS)	Byte 1
Start	1 (01hex)	Node ID of the addressed node
Stop	2 (02hex)	Node ID of the addressed node
Enter Pre-Operational	128 (80hex)	Node ID of the addressed node
Reset Node	129 (81hex)	Node ID of the addressed node
Reset Communication	130 (82 hex)	Node ID of the addressed node

The NMT master can simultaneously direct a request to one or more slaves. The following is applicable:

- Requirement of a slave:
The slave is addressed using its node ID (1 - 127).
- Requirement for all slaves:
Node ID = 0

The current state of the node is displayed via p8685. It can also be changed directly using this parameter:

- p8685 = 0 Initializing (display only)
- p8685 = 4 Stopped
- p8685 = 5 Operational
- p8685 = 127 Pre-Operational (factory setting)
- p8685 = 128 Reset Node
- p8685 = 129 Reset Communication

You can also change the NMT status in STARTER via "Control_Unit / Communication / CAN" under the "Network-Management" tab.

6.3.4 Object directories

RPDO configuration objects

The following tables list the communication and mapping parameters together with the indices for the individual RPDO configuration objects. The configuration objects are established via SDO.

Table 6- 49 RPDO configuration objects - communication parameters

OD Index (hex)	Sub-Index (hex)	Name of the object	SINAMICS parameters	Data type	Predefined connection set	Can be read/ written to
1400		Receive PDO 1 communication parameter				
	0	Largest subindex supported		Unsigned8	2	R
	1	COB ID used by PDO	p8700.0	Unsigned32	200 hex + node ID	R/W
	2	Transmission type	p8700.1	Unsigned8	FE hex	R/W
1401		Receive PDO 2 communication parameter				
	0	Largest subindex supported		Unsigned8	2	R
	1	COB ID used by PDO	p8701.0	Unsigned32	300 hex + node ID	R/W
	2	Transmission type	p8701.1	Unsigned8	FE hex	R/W
1402		Receive PDO 3 communication parameter				
	0	Largest subindex supported		Unsigned8	2	R
	1	COB ID used by PDO	p8702.0	Unsigned32	8000 06DF hex	R/W
	2	Transmission type	p8702.1	Unsigned8	FE hex	R/W
1403		Receive PDO 4 communication parameter				
	0	Largest subindex supported		Unsigned8	2	R
	1	COB ID used by PDO	p8703.0	Unsigned32	8000 06DF hex	R/W
	2	Transmission type	p8703.1	Unsigned8	FE hex	R/W
1404		Receive PDO 5 communication parameter				
	0	Largest subindex supported		Unsigned8	2	R
	1	COB ID used by PDO	p8704.0	Unsigned32	8000 06DF hex	R/W
	2	Transmission type	p8704.1	Unsigned8	FE hex	R/W
1405		Receive PDO 6 communication parameter				
	0	Largest subindex supported		Unsigned8	2	R
	1	COB ID used by PDO	p8705.0	Unsigned32	8000 06DF hex	R/W
	2	Transmission type	p8705.1	Unsigned8	FE hex	R/W
1406		Receive PDO 7 communication parameter				
	0	Largest subindex supported		Unsigned8	2	R
	1	COB ID used by PDO	p8706.0	Unsigned32	8000 06DF hex	R/W
	2	Transmission type	p8706.1	Unsigned8	FE hex	R/W

OD Index (hex)	Sub-Index (hex)	Name of the object	SINAMICS parameters	Data type	Predefined connection set	Can be read/written to
1407		Receive PDO 8 communication parameter				
	0	Largest subindex supported		Unsigned8	2	R
	1	COB ID used by PDO	p8707.0	Unsigned32	8000 06DF hex	R/W
	2	Transmission type	p8707.1	Unsigned8	FE hex	R/W

Table 6- 50 RPDO configuration objects - mapping parameters

OD Index (hex)	Sub-Index (hex)	Name of the object	SINAMICS parameters	Data type	Predefined connection set	Can be read/written to
1600		Receive PDO 1 mapping parameter				
	0	Number of mapped application objects in PDO		Unsigned8	1	R
	1	PDO mapping for the first application object to be mapped	p8710.0	Unsigned32	6040 hex	R/W
	2	PDO mapping for the second application object to be mapped	p8710.1	Unsigned32	0	R/W
	3	PDO mapping for the third application object to be mapped	p8710.2	Unsigned32	0	R/W
	4	PDO mapping for the fourth application object to be mapped	p8710.3	Unsigned32	0	R/W
1601		Receive PDO 2 mapping parameter				
	0	Number of mapped application objects in PDO		Unsigned8	2	R
	1	PDO mapping for the first application object to be mapped	p8711.0	Unsigned32	6040 hex	R/W
	2	PDO mapping for the second application object to be mapped	p8711.1	Unsigned32	6042 hex	R/W
	3	PDO mapping for the third application object to be mapped	p8711.2	Unsigned32	0	R/W
	4	PDO mapping for the fourth application object to be mapped	p8711.3	Unsigned32	0	R/W
1602		Receive PDO 3 mapping parameter				
	0	Number of mapped application objects in PDO		Unsigned8	0	R
	1	PDO mapping for the first application object to be mapped	p8712.0	Unsigned32	0	R/W
	2	PDO mapping for the second application object to be mapped	p8712.1	Unsigned32	0	R/W
	3	PDO mapping for the third application object to be mapped	p8712.2	Unsigned32	0	R/W
	4	PDO mapping for the fourth application object to be mapped	p8712.3	Unsigned32	0	R/W

OD Index (hex)	Sub-Index (hex)	Name of the object	SINAMICS parameters	Data type	Predefined connection set	Can be read/written to
1603		Receive PDO 4 mapping parameter				
	0	Number of mapped application objects in PDO		Unsigned8	0	R
	1	PDO mapping for the first application object to be mapped	p8713.0	Unsigned32	0	R/W
	2	PDO mapping for the second application object to be mapped	p8713.1	Unsigned32	0	R/W
	3	PDO mapping for the third application object to be mapped	p8713.2	Unsigned32	0	R/W
	4	PDO mapping for the fourth application object to be mapped	p8713.3	Unsigned32	0	R/W
1604		Receive PDO 5 mapping parameter				
	0	Number of mapped application objects in PDO		Unsigned8	0	R
	1	PDO mapping for the first application object to be mapped	p8714.0	Unsigned32	0	R/W
	2	PDO mapping for the second application object to be mapped	p8714.1	Unsigned32	0	R/W
	3	PDO mapping for the third application object to be mapped	p8714.2	Unsigned32	0	R/W
	4	PDO mapping for the fourth application object to be mapped	p8714.3	Unsigned32	0	R/W
1605		Receive PDO 6 mapping parameter				
	0	Number of mapped application objects in PDO		Unsigned8	0	R
	1	PDO mapping for the first application object to be mapped	p8715.0	Unsigned32	0	R/W
	2	PDO mapping for the second application object to be mapped	p8715.1	Unsigned32	0	R/W
	3	PDO mapping for the third application object to be mapped	p8715.2	Unsigned32	0	R/W
	4	PDO mapping for the fourth application object to be mapped	p8715.3	Unsigned32	0	R/W
1606		Receive PDO 7 mapping parameter				
	0	Number of mapped application objects in PDO		Unsigned8	0	R
	1	PDO mapping for the first application object to be mapped	p8716.0	Unsigned32	0	R/W
	2	PDO mapping for the second application object to be mapped	p8716.1	Unsigned32	0	R/W
	3	PDO mapping for the third application object to be mapped	p8716.2	Unsigned32	0	R/W
	4	PDO mapping for the fourth application object to be mapped	p8716.3	Unsigned32	0	R/W

OD Index (hex)	Sub-Index (hex)	Name of the object	SINAMICS parameters	Data type	Predefined connection set	Can be read/ written to
1607		Receive PDO 8 mapping parameter				
	0	Number of mapped application objects in PDO		Unsigned8	0	R
	1	PDO mapping for the first application object to be mapped	p8717.0	Unsigned32	0	R/W
	2	PDO mapping for the second application object to be mapped	p8717.1	Unsigned32	0	R/W
	3	PDO mapping for the third application object to be mapped	p8717.2	Unsigned32	0	R/W
	4	PDO mapping for the fourth application object to be mapped	p8717.3	Unsigned32	0	R/W

TPDO configuration objects

The following tables list the communication and mapping parameters together with the indices for the individual TPDO configuration objects. The configuration objects are established via SDO.

Table 6- 51 TPDO configuration objects - communication parameters

OD Index (hex)	Sub-Index (hex)	Object name	SINAMICS parameters	Data type	Predefined connection set	Can be read/ written to
1800		Transmit PDO 1 communication parameter				
	0	Largest subindex supported		Unsigned8	5	R
	1	COB ID used by PDO	p8720.0	Unsigned32	180 hex + node ID	R/W
	2	Transmission type	p8720.1	Unsigned8	FE hex	R/W
	3	Inhibit time	p8720.2	Unsigned16	0	R/W
	4	Reserved	p8720.3	Unsigned8	---	R/W
	5	Event timer	p8720.4	Unsigned16	0	R/W
1801		Transmit PDO 2 communication parameter				
	0	Largest subindex supported		Unsigned8	5	R
	1	COB ID used by PDO	p8721.0	Unsigned32	280 hex + node ID	R/W
	2	Transmission type	p8721.1	Unsigned8	FE hex	R/W
	3	Inhibit time	p8721.2	Unsigned16	0	R/W
	4	Reserved	p8721.3	Unsigned8	---	R/W
	5	Event timer	p8721.4	Unsigned16	0	R/W
1802		Transmit PDO 3 communication parameter				
	0	Largest subindex supported		Unsigned8	5	R
	1	COB ID used by PDO	p8722.0	Unsigned32	C000 06DF hex	R/W
	2	Transmission type	p8722.1	Unsigned8	FE hex	R/W
	3	Inhibit time	p8722.2	Unsigned16	0	R/W
	4	Reserved	p8722.3	Unsigned8	---	R/W
	5	Event timer	p8722.4	Unsigned16	0	R/W

6.3 Communication over CANopen

OD Index (hex)	Sub-Index (hex)	Object name	SINAMICS parameters	Data type	Predefined connection set	Can be read/written to
1803		Transmit PDO 4 communication parameter				
	0	Largest subindex supported		Unsigned8	5	R
	1	COB ID used by PDO	p8723.0	Unsigned32	C000 06DF hex	R/W
	2	Transmission type	p8723.1	Unsigned8	FE hex	R/W
	3	Inhibit time	p8723.2	Unsigned16	0	R/W
	4	Reserved	p8723.3	Unsigned8	---	R/W
	5	Event timer	p8723.4	Unsigned16	0	R/W
1804		Transmit PDO 5 communication parameter				
	0	Largest subindex supported		Unsigned8	5	R
	1	COB ID used by PDO	p8724.0	Unsigned32	C000 06DF hex	R/W
	2	Transmission type	p8724.1	Unsigned8	FE hex	R/W
	3	Inhibit time	p8724.2	Unsigned16	0	R/W
	4	Reserved	p8724.3	Unsigned8	---	R/W
	5	Event timer	p8724.4	Unsigned16	0	R/W
1805		Transmit PDO 6 communication parameter				
	0	Largest subindex supported		Unsigned8	5	R
	1	COB ID used by PDO	p8725.0	Unsigned32	C000 06DF hex	R/W
	2	Transmission type	p8725.1	Unsigned8	FE hex	R/W
	3	Inhibit time	p8725.2	Unsigned16	0	R/W
	4	Reserved	p8725.3	Unsigned8	---	R/W
	5	Event timer	p8725.4	Unsigned16	0	R/W
1806		Transmit PDO 7 communication parameter				
	0	Largest subindex supported		Unsigned8	5	R
	1	COB ID used by PDO	p8726.0	Unsigned32	C000 06DF hex	R/W
	2	Transmission type	p8726.1	Unsigned8	FE hex	R/W
	3	Inhibit time	p8726.2	Unsigned16	0	R/W
	4	Reserved	p8726.3	Unsigned8	---	R/W
	5	Event timer	p8726.4	Unsigned16	0	R/W
1807		Transmit PDO 8 communication parameter				
	0	Largest subindex supported		Unsigned8	5	R
	1	COB ID used by PDO	p8727.0	Unsigned32	C000 06DF hex	R/W
	2	Transmission type	p8727.1	Unsigned8	FE hex	R/W
	3	Inhibit time	p8727.2	Unsigned16	0	R/W
	4	Reserved	p8727.3	Unsigned8	---	R/W
	5	Event timer	p8727.4	Unsigned16	0	R/W

Table 6- 52 TPDO configuration objects - mapping parameters

OD Index (hex)	Sub-Index (hex)	Object name	SINAMICS parameters	Data type	Predefined connection set	Can be read/ written to
1A00		Transmit PDO 1 mapping parameter				
	0	Number of mapped application objects in PDO		Unsigned8	1	R
	1	PDO mapping for the first application object to be mapped	p8730.0	Unsigned32	6041 hex	R/W
	2	PDO mapping for the second application object to be mapped	p8730.1	Unsigned32	0	R/W
	3	PDO mapping for the third application object to be mapped	p8730.2	Unsigned32	0	R/W
	4	PDO mapping for the fourth application object to be mapped	p8730.3	Unsigned32	0	R/W
1A01		Transmit PDO 2 mapping parameter				
	0	Number of mapped application objects in PDO		Unsigned8	2	R
	1	PDO mapping for the first application object to be mapped	p8731.0	Unsigned32	6041 hex	R/W
	2	PDO mapping for the second application object to be mapped	p8731.1	Unsigned32	6044 hex	R/W
	3	PDO mapping for the third application object to be mapped	p8731.2	Unsigned32	0	R/W
	4	PDO mapping for the fourth application object to be mapped	p8731.3	Unsigned32	0	R/W
1A02		Transmit PDO 3 mapping parameter				
	0	Number of mapped application objects in PDO		Unsigned8	0	R
	1	PDO mapping for the first application object to be mapped	p8732.0	Unsigned32	0	R/W
	2	PDO mapping for the second application object to be mapped	p8732.1	Unsigned32	0	R/W
	3	PDO mapping for the third application object to be mapped	p8732.2	Unsigned32	0	R/W
	4	PDO mapping for the fourth application object to be mapped	p8732.3	Unsigned32	0	R/W
1A03		Transmit PDO 4 mapping parameter				
	0	Number of mapped application objects in PDO		Unsigned8	0	R
	1	PDO mapping for the first application object to be mapped	p8733.0	Unsigned32	0	R/W
	2	PDO mapping for the second application object to be mapped	p8733.1	Unsigned32	0	R/W
	3	PDO mapping for the third application object to be mapped	p8733.2	Unsigned32	0	R/W
	4	PDO mapping for the fourth application object to be mapped	p8733.3	Unsigned32	0	R/W

OD Index (hex)	Sub-Index (hex)	Object name	SINAMICS parameters	Data type	Predefined connection set	Can be read/ written to
1A04		Transmit PDO 5 mapping parameter				
	0	Number of mapped application objects in PDO		Unsigned8	0	R
	1	PDO mapping for the first application object to be mapped	p8734.0	Unsigned32	0	R/W
	2	PDO mapping for the second application object to be mapped	p8734.1	Unsigned32	0	R/W
	3	PDO mapping for the third application object to be mapped	p8734.2	Unsigned32	0	R/W
	4	PDO mapping for the fourth application object to be mapped	p8734.3	Unsigned32	0	R/W
1A05		Transmit PDO 6 mapping parameter				
	0	Number of mapped application objects in PDO		Unsigned8	0	R
	1	PDO mapping for the first application object to be mapped	p8735.0	Unsigned32	0	R/W
	2	PDO mapping for the second application object to be mapped	p8735.1	Unsigned32	0	R/W
	3	PDO mapping for the third application object to be mapped	p8735.2	Unsigned32	0	R/W
	4	PDO mapping for the fourth application object to be mapped	p8735.3	Unsigned32	0	R/W
1A06		Transmit PDO 7 mapping parameter				
	0	Number of mapped application objects in PDO		Unsigned8	0	R
	1	PDO mapping for the first application object to be mapped	p8736.0	Unsigned32	0	R/W
	2	PDO mapping for the second application object to be mapped	p8736.1	Unsigned32	0	R/W
	3	PDO mapping for the third application object to be mapped	p8736.2	Unsigned32	0	R/W
	4	PDO mapping for the fourth application object to be mapped	p8736.3	Unsigned32	0	R/W
1A07		Transmit PDO 8 mapping parameter				
	0	Number of mapped application objects in PDO		Unsigned8	0	R
	1	PDO mapping for the first application object to be mapped	p8737.0	Unsigned32	0	R/W
	2	PDO mapping for the second application object to be mapped	p8737.1	Unsigned32	0	R/W
	3	PDO mapping for the third application object to be mapped	p8737.2	Unsigned32	0	R/W
	4	PDO mapping for the fourth application object to be mapped	p8737.3	Unsigned32	0	R/W

6.3.4.1 Free objects

You can interconnect any process data objects of the received and transmit buffer using receive and transmit double words.

- Scaling the process data of the free objects:
 - 16 bit (word): 4000hex \triangleq 100 %
 - For temperature values: 16 bit (word): 4000hex \triangleq 100 °C

OD index (hex)	Description	Data type per PZD	Default values	Can be read/written to
5800 to 580F	16 freely-interconnectable receive process data	Integer16	0	R/W
5810 to 581F	16 freely-interconnectable transmit process data	Integer16	0	R

6.3.4.2 Objects in drive profile DSP402

The following table lists the object directory with the index of the individual objects for the drives.

Table 6- 53 Objects in drive profile DSP402

OD index (hex)	Sub-index (hex)	Name of the object	SINAMICS parameters	Transmission	Data type	Default setting	Can be read/written to
Predefinitions							
67FF		Single device type		SDO	Unsigned32		R
Common entries in the object dictionary							
6007		Abort connection option code	p8641	SDO	Integer16	3	R/W
6502		Supported drive modes		SDO	Integer32		R
6504		Drive manufacturer		SDO	String	SIEMENS	R
Device control							
6040		Control word	r8795	PDO/SDO	Unsigned16	-	R/W ¹⁾
6041		Status word	r8784	PDO/SDO	Unsigned16	-	R
6060		Modes of operation	p1300	SDO	Integer8	-	R/ ²⁾
6061		Modes of operation display	p1300	SDO	Integer8	-	R
Profile torque mode							
6071		Target torque Set torque	p1513[0]	SDO/PDO	Integer16	-	R/W ¹⁾
6072		Max. torque	p1520/p1521	SDO	Real32	-	R/W
6074		Torque demand value Actual torque	r0080	SDO/PDO	Integer16	-	R
Velocity mode							
6042	0	vl target velocity	r0060	SDO/PDO	Integer16	-	R/W
6044	0	vl control effort	r0063	SDO/PDO	Integer16	-	R

1) SDO access is only possible after mapping the objects and the BICO interconnection to display parameters.

2) Object cannot be written to as a CANopen device profile is not supported, only manufacturer-specific operating data

6.3.5 Configuration example

The following example describes how you can integrate the converter into a CANopen bus system using STARTER in two steps.

In the first step, the converter is integrated into the communication via the CAN bus using the Predefined Connection Set. In this case, the control word, the speed setpoint as well the status word and speed actual value are transferred.

In the second step, using the free PDO mapping, the torque setpoint as well as the current actual value are mapped and the BiCo wiring established.

Preconditions for integrating in CAN

The following preconditions must be fulfilled in order to be able to integrate the converter into a CAN bus:

- The converter and motor must have been completely installed
- STARTER V4.2 or higher has been installed on your computer.
- You have a CAN controller via which you can control the converter.
- The converter is connected online with Starter.
- The EDS file has been installed on your CAN controller.

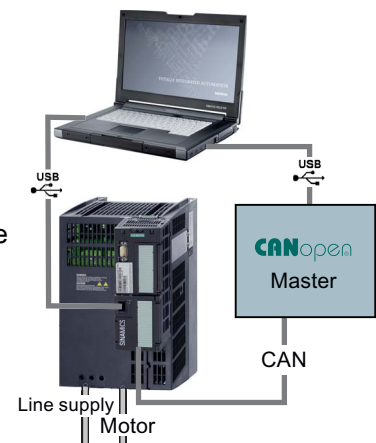

Integrate the converter into a CAN bus system using the Predefined Connection Set

- Carry out the commissioning (Page 68) using the wizards and for the I/O configuration (second commissioning step) select the setting "22 CAN fieldbus" (macro 15 = 22). As a consequence, you establish the BICO interconnection of the speed setpoint/control word as well as speed actual value/status word corresponding to the Predefined Connections Set.
- In STARTER, in the screen form ".../Control_Unit/Communication/CAN" set the node ID and data transmission rate (Page 154) - (in the example, Node ID = 50, transmission rate = 500 kbit/s).
- Using the Expert List, in Starter set the mapping via the Predefined connection set (Page 165): p8744 = 1 and accept with p8744 = 1 (p8744 jumps back to 0 again after a few seconds).

As a consequence, you have established communication with CAN via the "Predefined Connection Set" (speed setpoint/control word as well as the actual value/status word, also see Objects in drive profile DSP402 (Page 178)).

Integrate the current actual value and torque limit into the communication via the free PDO mapping

In order to integrate the current actual value and torque limit into the communication, you must switch over from the Predefined Connection Set to the free PDO mapping. The current actual value and torque limit are integrated as free objects.

In the example, the actual current value is transferred in TPDO1 and the torque limit in RPDO1, i.e. it is not necessary to create new communication parameters (node ID and transmission mode). However, you must map the OD indices for the current actual value and the torque limits and adapt to the BiCo interconnection.

1. Switching over from the Predefined Connection Set to free PDO mapping

In the expert list, set p8744 to 1.

2. Mapping the current actual value (r0068) with TPDO1

- Define the OD index for the current actual value: 5810
- Set the COB ID from TPDO1 to "Mapping permissible":
p8720[0] = 400001B2H (mapping not permitted) on p8720.0 = 800001B2H (mapping permissible)
- Set p8730[1] = 5810010H - the first four digits are the OD index for the current actual value (r0068), 00: Sub-index (corresponds to the parameter index) 10: Object size (10H = 16 bit) must be attached to the OD index
- Reset p8720[0] to 400001B2H
- r8751 shows which object has been matched to which PZD

3. Mapping the torque limit (p1522) with RPDO1

- Define the OD index for the torque limit: 5800
- Set the COB ID from RPDO1 to "Mapping permissible":
Set p8700[0] = 232H (mapping not permissible) to p8700.0 = 80000232H (mapping permissible)
- Set p8710[1] = 5800010H - the first four digits are the OD index for the torque limit (p1522), 010 is CAN-specific and for all linked parameters in free PDO mapping must be attached to the OD index
- Reset p8700[0] to 232H
- r8750 shows which object has been matched to which PZD

4. Adapting BiCo interconnections

Object	Mapped receive objects	Receive word r2050	
Control word	r8750[0] = 6040H (PZD1)	Also mapped in r2050[0] to PZD1 -> OK	
Torque limit	r8750[1] = 5800H (PZD2)	Link PZD2 with torque limit:	p1522 = 2050[1]
Speed setpoint	r8750[2] = 6042H (PZD3)	Link PZD3 with speed setpoint:	p1070 = 2050[2]

Object	Mapped send objects	Send word p2051	
Status word	r8751[0] = 6041H (PZD1)	Also mapped in r2051[0] to PZD1 -> OK	
Current actual value	r8751[1] = 5810H (PZD2)	Link PZD2 with current actual value	p2051[1] = r68[1]
Speed actual value	r8751[2] = 6044H (PZD3)	Link PZD3 with speed actual value	p2051[2] = r63[0]

You have now made all of the necessary settings, in order to transfer status and control word, speed setpoint and actual value as well as the current actual value and torque limit.

Functions

Before you set the inverter functions, you should have completed the following commissioning steps:

- Commissioning (Page 53)
- If necessary: Adapting the terminal strip (Page 85)
- If necessary: Configuring the fieldbus (Page 97)

7.1 Overview of the inverter functions

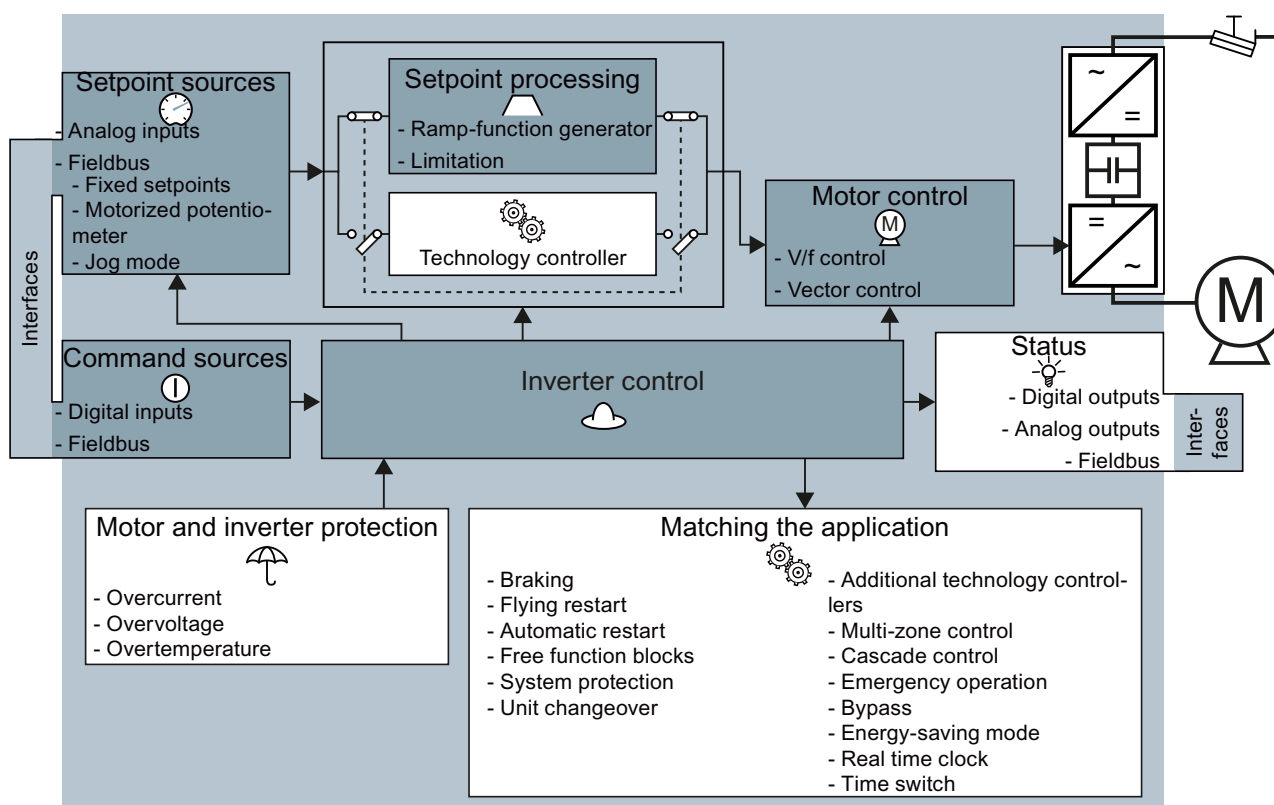





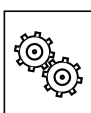



Figure 7-1 Overview of inverter functions

7.1 Overview of the inverter functions

Functions relevant to all applications		Functions required in special applications only	
<p>The functions that you require in your application are shown in a dark color in the function overview above.</p> <p>In the quick commissioning, the parameters of these functions are assigned an appropriate basic setting, so that in many cases the motor can be operated without having to assign any other parameters.</p>		<p>The functions whose parameters you only need to adapt when actually required are shown in white in the function overview above.</p>	
	<p>Inverter control is responsible for all of the other inverter functions. Among other things, it defines how the inverter responds to external control signals.</p> <p>Inverter control (Page 185)</p>		<p>The production functions avoid overloads and operating states that could cause damage to the motor, inverter and driven load. The motor temperature monitoring, for example, is set here.</p> <p>Protection functions (Page 212)</p>
	<p>The command source defines where the control signals are received from to switch on the motor, e.g. via digital inputs or a fieldbus.</p> <p>Command sources (Page 194)</p>		<p>The status messages provide digital and analog signals at the Control Unit outputs or via the fieldbus. Examples include the current speed of the motor or fault message issued by the inverter.</p> <p>Status messages (Page 218)</p>
	<p>The setpoint source defines how the speed setpoint for the motor is specified, e.g. via an analog input or a fieldbus.</p> <p>Setpoint sources (Page 195)</p>		<p>The functions matching the application provide e.g. the control of a motor holding brake or allow a higher-level pressure or temperature control to be implemented using the technology controller.</p> <p>Further, the inverter provides solution options specifically for applications in the area of pumps, fans and climate control systems (HVAC).</p> <p>Application-specific functions (Page 219)</p>
	<p>The setpoint processing uses a ramp-function generator to prevent speed steps occurring and to limit the speed to a permissible maximum value.</p> <p>Setpoint calculation (Page 202)</p>		
	<p>The motor closed-loop control ensures that the motor follows the speed setpoint.</p> <p>Motor control (Page 204)</p>		

7.2 Inverter control



If you are controlling the inverter using digital inputs, you use parameter p0015 during basic commissioning to define how the motor is switched on and off and how it is changed over from clockwise to counter-clockwise rotation.

Five different methods are available for controlling the motor. Three of the five methods just require two control commands (two-wire control). The other two methods require three control commands (three-wire control).

Table 7- 1 Two-wire control and three-wire control

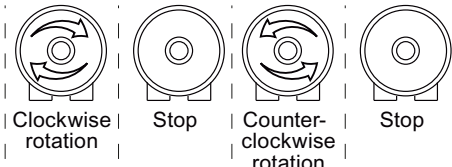
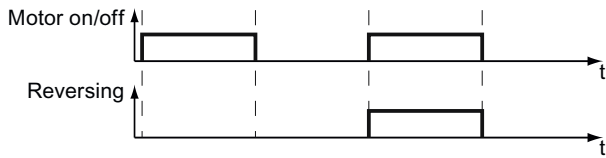
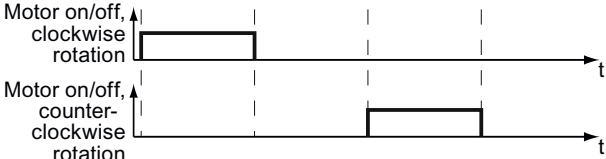
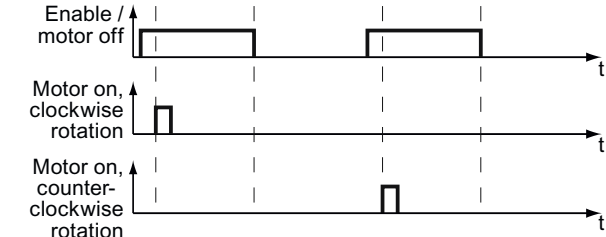
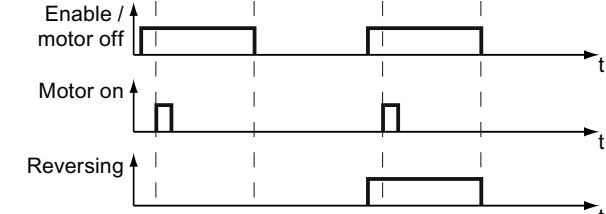
Behavior of the motor		
 <p>Clockwise rotation Stop Counter-clockwise rotation Stop</p>	<p>Control commands</p>	<p>Typical application</p>
 <p>Motor on/off Reversing</p>	<p>Two-wire control, method 1</p> <ol style="list-style-type: none"> 1. Switch the motor on and off (ON/OFF1). 2. Reverse the motor direction of rotation. 	<p>Local control in conveyor systems.</p>
 <p>Motor on/off, clockwise rotation Motor on/off, counter-clockwise rotation</p>	<p>Two-wire control, method 2 and two-wire control, method 3</p> <ol style="list-style-type: none"> 1. Switch the motor on and off (ON/OFF1), clockwise rotation. 2. Switch the motor on and off (ON/OFF1), counter-clockwise rotation. 	<p>Traction drives with control via joystick</p>
 <p>Enable / motor off Motor on, clockwise rotation Motor on, counter-clockwise rotation</p>	<p>Three-wire control, method 1</p> <ol style="list-style-type: none"> 1. Issue enable for switching on motor and switch off motor (OFF1). 2. Switch on motor (ON), clockwise rotation. 3. Switch on motor (ON), counter-clockwise rotation. 	<p>Traction drives with control via joystick</p>
 <p>Enable / motor off Motor on Reversing</p>	<p>Three-wire control, method 2</p> <ol style="list-style-type: none"> 1. Issue enable for switching on motor and switch off motor (OFF1). 2. Switch on motor (ON). 3. Reverse the motor direction of rotation. 	<p>-</p>

7.2.1 Two-wire control: method 1

You switch the motor on and off using a control command (ON/OFF1), while the other control command reverses the motor direction of rotation.

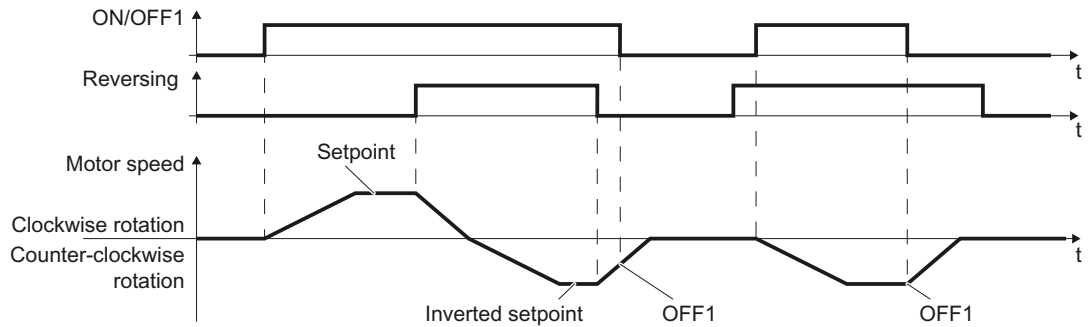

Figure 7-2 Two-wire control, method 1

Table 7-2 Function table

ON/OFF1	Reversing	Function
0	0	OFF1: The motor stops.
0	1	OFF1: The motor stops.
1	0	ON: Clockwise rotation of motor.
1	1	ON: Counter-clockwise rotation of motor.

Table 7-3 Parameter

Parameter	Description					
p0015 = 12	Macro drive unit (factory setting for inverters without PROFIBUS interface)					
	Controlling the motor using the digital inputs of the inverter:	<table border="1"> <tr> <td>DI 0</td> <td>DI 1</td> </tr> <tr> <td>ON/OFF1</td> <td>Reversing</td> </tr> </table>	DI 0	DI 1	ON/OFF1	Reversing
DI 0	DI 1					
ON/OFF1	Reversing					
Advanced setting Interconnecting control commands with digital inputs of your choice (DI x).						
p0840[0 ... n] = 722.x	BI: ON/OFF1 (ON/OFF1)					
p1113[0 ... n] = 722.x	BI: Setpoint inversion (reversing)					
Example						
p0840 = 722.3	DI 3: ON/OFF1. Also see Section Digital inputs (Page 86).					

7.2.2 Two-wire control, method 2

You switch the motor on and off using a control command (ON/OFF1) and at the same time select clockwise motor rotation. You also use the other control command to switch the motor on and off, but in this case you select counter-clockwise rotation for the motor.

The inverter only accepts a new control command when the motor is at a standstill.

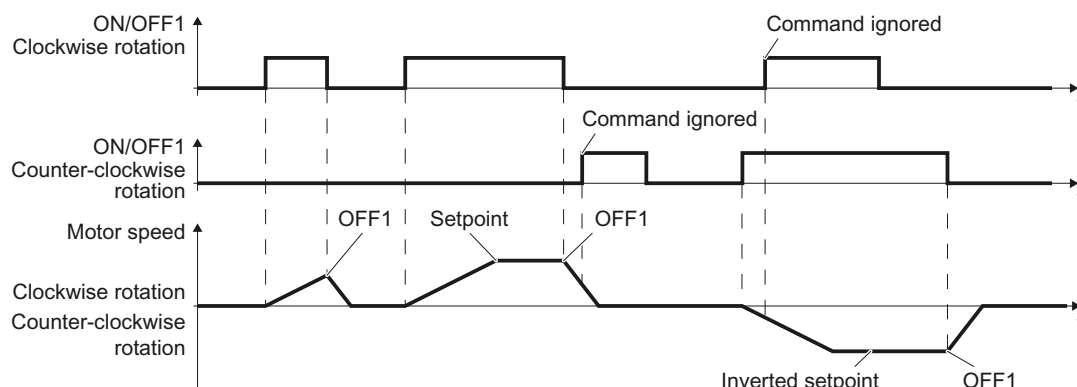

Figure 7-3 Two-wire control, method 2

Table 7-4 Function table

ON/OFF1 clockwise rotation	ON/OFF1 , counter-clockwise rotation	Function
0	0	OFF1: The motor stops.
1	0	ON: Clockwise rotation of motor.
0	1	ON: Counter-clockwise rotation of motor.
1	1	ON: The motor direction of rotation is based on the signal that takes on the status "1" first.

Table 7-5 Parameter

Parameter	Description		
p0015 = 17	Macro drive unit		
	Controlling the motor using the digital inputs of the inverter:	DI 0	DI 1
		ON/OFF1 clockwise rotation	ON/OFF1 , counter-clockwise rotation
Advanced setting Interconnecting control commands with digital inputs of your choice (DI x).			
p3330[0 ... n] = 722.x	BI: 2-3-WIRE Control Command 1 (ON/OFF1 clockwise rotation)		
p3331[0 ... n] = 722.x	BI: 2-3-WIRE Control Command 2 (ON/OFF1 , counter-clockwise rotation)		
Example			
p3331 = 722.0	DI 0: ON/OFF1 Counter-clockwise rotation Also see Section Digital inputs (Page 86).		

7.2.3 Two-wire control, method 3

You switch the motor on and off using a control command (ON/OFF1) and at the same time select clockwise motor rotation. You also use the other control command to switch the motor on and off, but in this case you select counter-clockwise rotation for the motor.

Unlike method 2, the inverter will accept the control commands at any time, regardless of the motor speed.

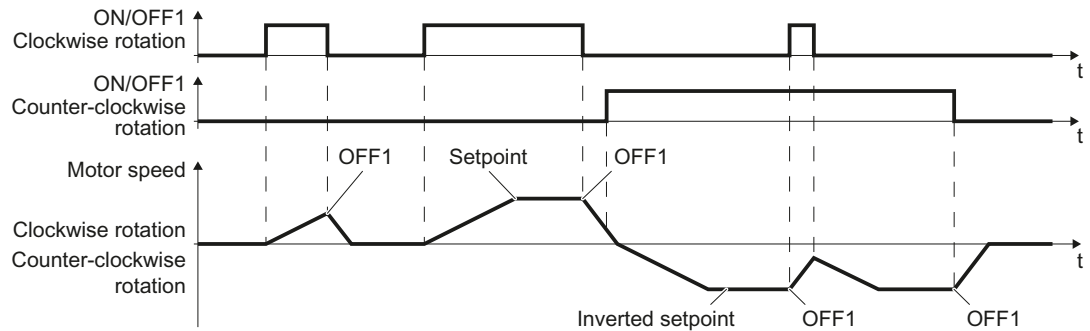

Figure 7-4 Two-wire control, method 3

Table 7-6 Function table

ON/OFF1 clockwise rotation	ON/OFF1 , counter-clockwise rotation	Function
0	0	OFF1: The motor stops.
1	0	ON: Clockwise rotation of motor.
0	1	ON: Counter-clockwise rotation of motor.
1	1	OFF1: The motor stops.

Table 7-7 Parameter

Parameter	Description		
p0015 = 18	Macro drive unit		
	Controlling the motor using the digital inputs of the inverter:	DI 0 ON/OFF1 clockwise rotation	DI 1 ON/OFF1 , counter-clockwise rotation
Advanced setting Interconnecting control commands with digital inputs of your choice (DI x).			
p3330[0 ... n] = 722.x	BI: 2-3-WIRE Control Command 1 (ON/OFF1 clockwise rotation)		
p3331[0 ... n] = 722.x	BI: 2-3-WIRE Control Command 2 (ON/OFF1 , counter-clockwise rotation)		
Example			
p3331[0 ... n] = 722.2	DI 2: ON/OFF1 Counter-clockwise rotation Also see Section Digital inputs (Page 86).		

7.2.4 Three-wire control, method 1

With one control command, you enable the two other control commands. You switch the motor off by canceling the enable (OFF1).

You switch the motor's direction of rotation to clockwise rotation with the positive edge of the second control command. If the motor is still switched off, switch it on (ON).

You switch the motor's direction of rotation to counter-clockwise rotation with the positive edge of the third control command. If the motor is still switched off, switch it on (ON).

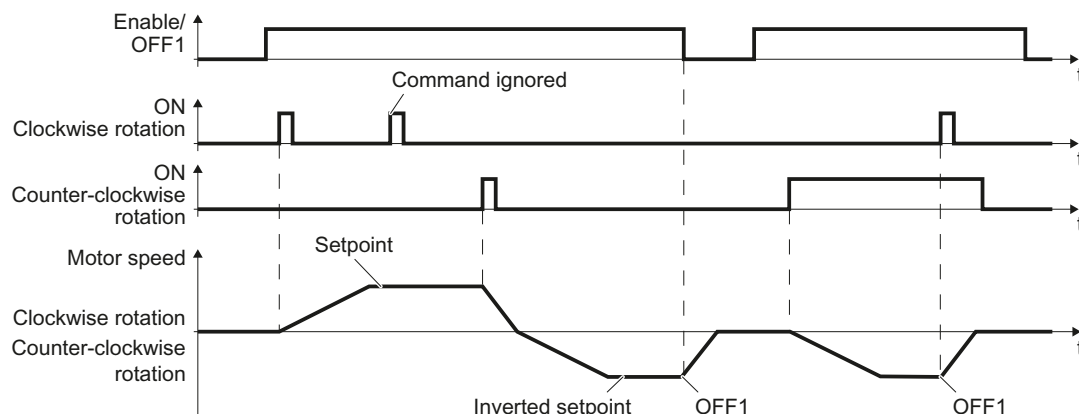

Figure 7-5 Three-wire control, method 1

Table 7- 8 Function table

Enable/OFF1	ON clockwise rotation	ON , counter-clockwise rotation	Function
0	0 or 1	0 or 1	OFF1: The motor stops.
1	0→1	0	ON: Clockwise rotation of motor.
1	0	0→1	ON: Counter-clockwise rotation of motor.
1	1	1	OFF1: The motor stops.

Table 7- 9 Parameter

Parameter	Description			
p0015 = 19	Macro drive unit			
	Controlling the motor using the digital inputs of the inverter:	DI 0 Enable/OFF1	DI 1 ON clockwise rotation	DI 2 ON , counter-clockwise rotation
Advanced setting Interconnecting control commands with digital inputs of your choice (DI x).				
p3330[0 ... n] = 722.x	BI: 2-3-WIRE Control Command 1 (enable/OFF1)			
p3331[0 ... n] = 722.x	BI: 2-3-WIRE Control Command 2 (ON clockwise rotation)			
p3332[0 ... n] = 722.x	BI: 2-3-WIRE Control Command 3 (ON , counter-clockwise rotation)			
Example				
p3332 = 722.0	DI 0: ON Counter-clockwise rotation. Also see Section Digital inputs (Page 86).			

7.2.5 Three-wire control, method 2

With one control command, you enable the two other control commands. You switch the motor off by canceling the enable (OFF1).

You switch on the motor with the positive edge of the second control command (ON).

The third control command defines the motor's direction of rotation (reversing).

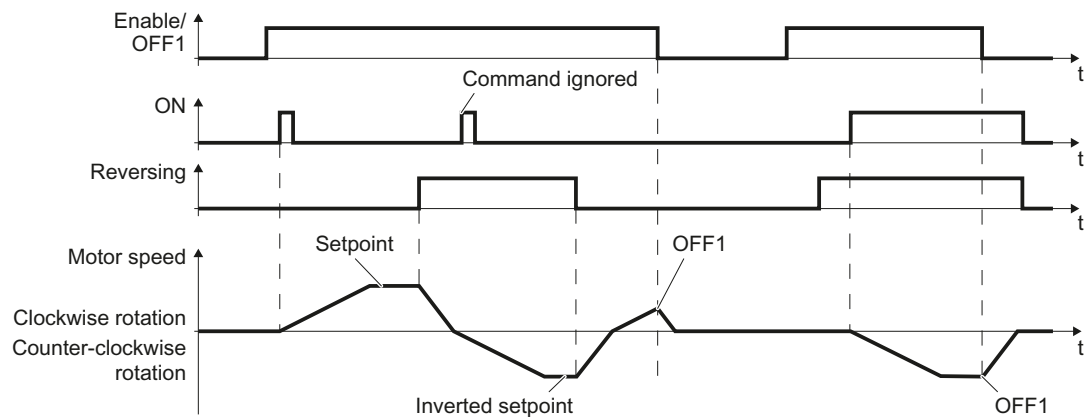

Figure 7-6 Three-wire control, method 2

Table 7- 10 Function table

Enable/OFF1	ON	Reversing	Function
0	0 or 1	0 or 1	OFF1: The motor stops.
1	0→1	0	ON: Clockwise rotation of motor.
1	0→1	1	ON: Counter-clockwise rotation of motor.

Table 7- 11 Parameter

Parameter	Description			
p0015 = 20	Macro drive unit			
	Controlling the motor using the digital inputs of the inverter:	DI 0	DI 1	DI 2
		Enable/OFF1	ON	Reversing
Advanced setting				
Interconnecting control commands with digital inputs of your choice (DI x).				
p3330[0 ... n] = 722.x	BI: 2-3-WIRE Control Command 1 (enable/OFF1)			
p3331[0 ... n] = 722.x	BI: 2-3-WIRE Control Command 2 (ON)			
p3332[0 ... n] = 722.x	BI: 2-3-WIRE Control Command 3 (reversing)			
Example				
p3331 = 722.0	DI 0: ON. Also see Section Digital inputs (Page 86).			

7.2.6 Switching over the inverter control (command data set)

In several applications, the inverter must be able to be operated from different, higher-level control systems.

Example: Switchover from automatic to manual operation

A motor is switched on and off and its speed varied either from a central control system via a fieldbus or from a local control box.

Command data set (CDS)

This means that you can set the inverter control in various ways and toggle between the settings. For instance, as described above, the inverter can either be operated via a fieldbus or via the terminal strip.

The settings in the inverter, which are associated with a certain control type of the inverter, are known as a command data set.

Example:

Command data set 0: Controlling the inverter via the fieldbus

Command data set 1: Controlling the inverter via terminal strip

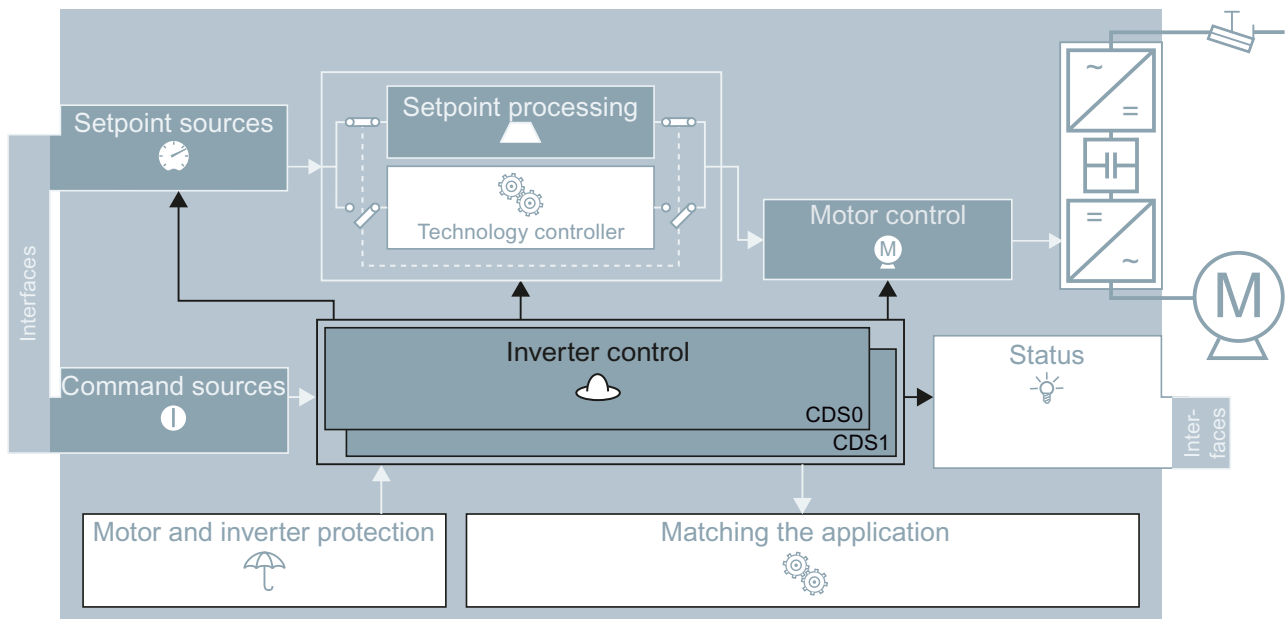

Figure 7-7 CDS switchover in the inverter

You select the command data set using parameter p0810. To do this, you must interconnect parameter p0810 with a control command of your choice, e.g. a digital input.

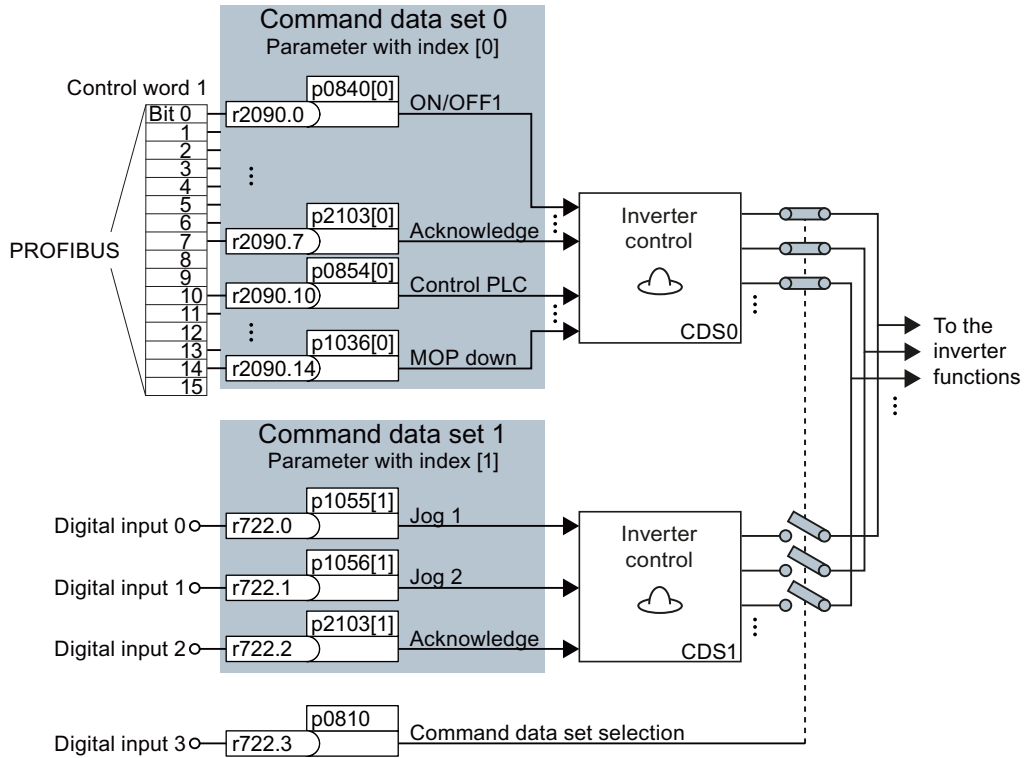

Figure 7-8 Example for the various command data sets

You obtain the interconnection as in the example above, if you configured the interfaces of the inverter with p0015 = 7 in the basic commissioning, also see Section Selecting the interface assignments (Page 48).

An overview of all the parameters that belong to the command data sets is provided in the List Manual.

Note

It takes approximately 4 ms to toggle between command data sets.

Advanced settings

If you require more than two command data sets, then define the number of command data sets (2, 3 or 4) using parameter p0170.

Table 7- 12 Defining the number of command data sets

Parameter	Description
p0010 = 15	Drive commissioning: Data sets
p0170	Number of command data sets (factory setting: 2) P0170 = 2, 3 or 4
p0010 = 0	Drive commissioning: Ready
r0050	Displaying the number of the CDS that is currently active

You require two bits to be able to make a clear selection for more than two command data sets.

Table 7- 13 Selecting a command data set

Parameter	Description
p0810	Command data set selection CDS bit 0
p0810	Command data set selection CDS bit 1
r0050	Displaying the number of the CDS that is currently active

A copy function is available making it easier to commission more than one command data set.

Table 7- 14 Parameters for copying the command data sets

Parameter	Description
P0809[0]	Number of the command data set to be copied (source)
P0809[1]	Number of the command data set to which the data is to be copied (target)
P0809[2] = 1	Copying is started Once copying has been completed, the inverter sets p0809[2] to 0.

7.3 Command sources



The command source is the interface via which the inverter receives its control commands. When commissioning, you define this using macro 15 (p0015).

Note

The "Get master control" or "Manual/Auto changeover" function can also be used to specify commands and setpoints via STARTER or the Operator Panel.

Change command source

If you subsequently change the command source using macro 15, then you must carry out commissioning again.

You also have the option to adapt the pre-assignment - which you selected using macro 15 - to the requirements of your particular system. You can obtain detailed information about this in the Sections Adapting the terminal strip (Page 85) and Configuring the fieldbus (Page 97).

7.4

Setpoint sources



The setpoint source is the interface via which the inverter receives its setpoint. The following options are available:

- Motorized potentiometer simulated in the inverter.
- Inverter analog input.
- Setpoints saved in the inverter:
 - Fixed setpoints
 - Jog
- Inverter fieldbus interface.

Depending on the parameterization, the setpoint in the inverter has one of the following meanings:

- Speed setpoint for the motor.
- Torque setpoint for the motor.
- Setpoint for a process variable.
The inverter receives a setpoint for a process variable, e.g. the level of liquid in a container, and calculates its speed setpoint using the internal technology controller.

7.4.1

Analog input as setpoint source

If you use an analog input as setpoint source, then you must adapt this analog input to the type of connected signal (± 10 V, 4 ... 20 mA, ...). Additional information is available in Section Analog inputs (Page 89).

Procedure

You have two options for interconnecting the setpoint source with an analog input:

1. Using p0015, select a configuration that is suitable for your application.
Please refer to the section titled Selecting the interface assignments (Page 48) to find out which configurations are available for your inverter.
2. Interconnect main setpoint p1070 with an analog input of your choice.

Table 7- 15 Analog inputs as setpoint source

Parameter	Setpoint source
r0755[0]	Analog input 0
r0755[1]	Analog input 1

Example: You interconnect analog input 0 as the setpoint source with p1070 = 755[0].

7.4.2 Motorized potentiometer as setpoint source

The 'motorized potentiometer' (MOP) function simulates an electromechanical potentiometer for entering setpoints. You can continuously adjust the motorized potentiometer (MOP) using the control signals "raise" and "lower". The control signals are received via the digital inputs of the inverter or from the operator panel that has been inserted.

Typical applications

- Entering the speed setpoint during the commissioning phase.
- Manual operation of the motor should the higher-level control fail.
- Entering the speed setpoint after changeover from automatic operation to manual operation.
- Applications with largely constant setpoint and without higher-level control.

Principle of operation

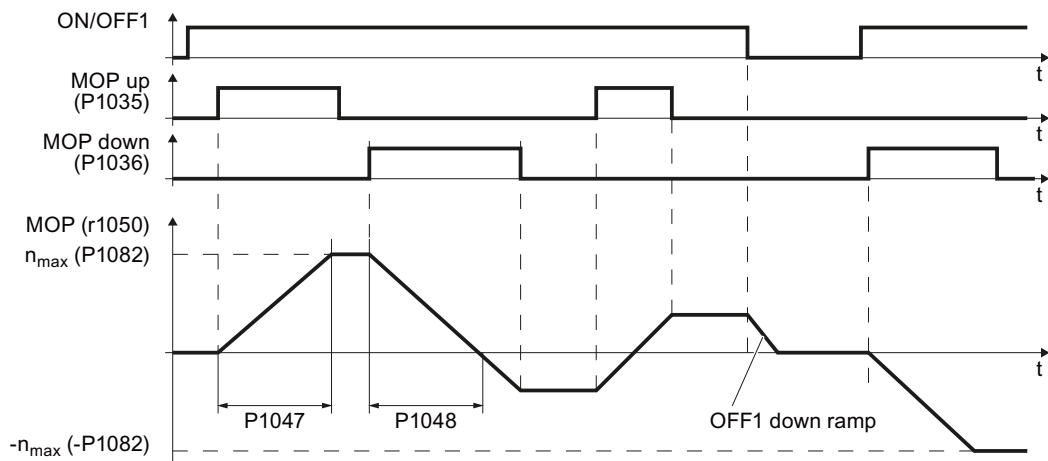

Figure 7-9 Function chart of motorized potentiometer

Motorized potentiometer parameters

Table 7- 16 Basic setup of motorized potentiometer

Parameter	Description
p1047	MOP ramp-up time (factory setting 10 s)
p1048	MOP ramp-down time (factory setting 10 s)
p1040	Start value of MOP (factory setting 0 rpm) Determines the start value [rpm] that becomes effective when the motor is switched on

Table 7- 17 Extended setup of motorized potentiometer

Parameter	Description
p1030	<p>Configuration of the MOP, parameter value with four independently adjustable bits 00 to 03 (factory setting 00110 bin)</p> <p>Bit 00: Save setpoint after switching off motor 0: After the motor is switched on, p1040 is specified as the setpoint 1: Setpoint is saved after the motor is switched off and set to the saved value once it is switched on</p> <p>Bit 01: Configure ramp-function generator in automatic mode (1-signal via BI: p1041) 0: No ramp-function generator in automatic mode (ramp-up/-down time = 0) 1: With ramp-function generator in automatic mode In manual mode (0-signal via BI: p1041) the ramp-function generator is always active</p> <p>Bit 02: Configure initial rounding 0: No initial rounding 1: With initial rounding. The initial rounding is a sensitive way of specifying small setpoint changes (progressive reaction when keys are pressed).</p> <p>Bit 03: Store setpoint in power-independent manner 0: No power-independent saving 1: Setpoint is saved in the event of a power failure (bit 00 = 1)</p> <p>Bit 04: Ramp-function generator always active 0: Setpoint is only calculated with enabled pulses 1: Setpoint is calculated independent of the pulse enable (this setting is required if the energy-saving mode has been selected).</p>
p1035	<p>Signal source to increase setpoint (factory setting 0) Automatically pre-assigned during commissioning, e.g. with the button on the Operator Panel</p>
p1036	<p>Signal source to reduce setpoint (factory setting 0) Automatically pre-assigned during commissioning, e.g. with the button on the operator panel</p>
p1037	<p>Maximum setpoint (factory setting 0 rpm) Automatically pre-assigned during commissioning</p>
p1038	<p>Minimum setpoint (factory setting 0 rpm) Automatically pre-assigned during commissioning</p>
p1039	<p>Signal source to invert minimum and maximum setpoints (factory setting 0)</p>
p1044	<p>Signal source for set value (factory setting 0)</p>

For more information about the motorized potentiometer, see the List Manual (function diagram 3020 and the parameter list).

Interconnecting the motorized potentiometer with the setpoint source

You have two options for interconnecting the motorized potentiometer with the setpoint source:

1. Using p0015, select a configuration that is suitable for your application.
Please refer to the section titled Selecting the interface assignments (Page 48) to find out which configurations are available for your inverter.
2. Interconnect the main setpoint with the motorized potentiometer by setting p1070 to 1050.

Example of parameterization of the motorized potentiometer

Table 7- 18 Implementing a motorized potentiometer using digital inputs

Parameter	Description
p0015 = 9	<p>Macro drive unit: Configure inverter on MOP as the setpoint source</p> <ul style="list-style-type: none"> • The motor is switched on and off via digital input 0. • The MOP setpoint is increased via digital input 1. • The MOP setpoint is decreased via digital input 2.
p1040 = 10	<p>MOP start value Each time the motor is switched on a setpoint corresponding to 10 rpm is specified</p>
p1047 = 5	<p>MOP ramp-up time: The MOP setpoint is increased from zero to maximum (p1082) in 5 seconds</p>
p1048 = 5	<p>MOP ramp-down time: The MOP setpoint is reduced from maximum (p1082) to zero in 5 seconds</p>

7.4.3 Fixed speed as setpoint source

In many applications after switching on the motor, all that is needed is to run the motor at a constant speed or to switch between different speeds. Examples of this simplified specification of speed setpoint are:

- Conveyor belt with two different speeds.
- Grinding machine with different speeds corresponding to the diameter of the grinding wheel.

If you use the technology controller in the inverter, then you can enter process variables that remain constant over time using a fixed setpoint, e.g.:

- Closed-loop control of a constant flow with a pump.
- Closed-loop control of a constant temperature using a fan.

Procedure

You can set up to 16 various fixed setpoints and select these either via digital inputs or the fieldbus. The fixed setpoints are defined using parameters p1001 to p1004 and can be assigned to the corresponding command sources (e.g. the digital inputs) using parameters p1020 to p1023.

The various fixed setpoints can be selected in two ways:

1. Direct selection:
Precisely one fixed speed setpoint is assigned to each selection signal (e.g. a digital input). As several selection signals are selected, the associated fixed speed setpoints are added together to form a total setpoint.
Direct selection is particularly well suited to controlling the motor using the inverter's digital inputs.
2. Binary selection:
Precisely one fixed speed setpoint is assigned to each possible combination of selection signals.
Binary selection should preferably be used with a central control and when linking the inverter to a fieldbus.

Table 7- 19 Parameters for direct selection of fixed setpoints

Parameter	Description
p1016 = 1	Direct selection of fixed setpoints (factory setting)
p1001	Fixed setpoint 1 Factory setting: 0 rpm
p1002	Fixed setpoint 2 Factory setting: 0 rpm
p1003	Fixed setpoint 3 Factory setting: 0 rpm
p1004	Fixed setpoint 4 Factory setting: 0 rpm
p1020	Signal source for selection of fixed setpoint 1 (factory setting: 722.3, i.e. selection via digital input 3)
p1021	Signal source for selection of fixed setpoint 2 (factory setting: 722.4, i.e. selection via digital input 4)
p1022	Signal source for selection of fixed setpoint 3 (factory setting: 722.5, i.e. selection via digital input 5)
p1023	Signal source for selection of fixed setpoint 4 (factory setting: 0, i.e. selection is locked)

Table 7- 20 Function diagram of direct selection of fixed setpoints

Fixed setpoint selected by	BICO interconnection of selection signals (example)	The resultant fixed setpoint corresponds to the parameter values of ...
Digital input 3 (DI 3)	p1020 = 722.3	p1001
Digital input 4 (DI 4)	p1021 = 722.4	p1002
Digital input 5 (DI 5)	p1022 = 722.5	p1003
Digital input 6 (DI 6)	p1023 = 722.6	p1004
DI 3 and DI 4		p1001 + p1002
DI 3 and DI 5		p1001 + p1003
DI 3, DI 4 and DI 5		p1001 + p1002 + p1003
DI 3, DI 4, DI 5 and DI 6		p1001 + p1002 + p1003 + p1004

You will find further information about the fixed setpoints and *binary* selection in function block diagrams 3010 and 3011 in the List Manual.

Example: Selecting two fixed speed setpoints using digital input 2 and digital input 3

The motor is to run at two different speeds:

- The motor is switched on with digital input 0
- When digital input 2 is selected, the motor is to run at a speed of 300 rpm.
- When digital input 3 is selected, the motor is to accelerate to a speed of 2000 rpm.
- When digital input 1 is selected, the motor should go into reverse

Table 7- 21 Parameter settings for the example

Parameter	Description
p0015 = 12	Macro drive unit: Configure inverter with terminal strip as the command and setpoint source. <ul style="list-style-type: none"> • The motor is switched on and off via digital input 0. • The setpoint source is analog input 0.
p1001 = 300.000	Defines the fixed setpoint 1 in [rpm]
p1002 = 2000.000	Defines the fixed setpoint 2 in [rpm]
p1016 = 1	Direct selection of fixed setpoints
p1020 = 722.2	Interconnection of fixed setpoint 2 with DI 2. r0722.2 = parameter that displays the status of digital input 2.
p1021 = 722.3	Interconnection of fixed setpoint 3 with status of DI 3. r0722.3 = parameter that displays the status of digital input 3.
p1070 = 1024	Interconnect main setpoint with fixed speed setpoint

7.4.4 Running the motor in jog mode (JOG function)

Using the "jog" function (JOG function), you can switch the motor on and off using a control command or the operator panel. The speed to which the motor accelerates for "Jog" can be set.

The motor must be switched-off before you issue the "jog" control command. "Jog" has no effect when the motor is switched on.

The "Jog" function is typically used to manually switch-on a motor after switching over from automatic to manual operation.

Setting jogging

The "Jog" function has two different speed setpoints, e.g. for motor counter-clockwise rotation and clockwise rotation.

With an operator panel, you can always select the "Jog" function. If you wish to use additional digital inputs as control commands, you must interconnect the particular signal source with a digital input.

Table 7- 22 Parameters for the "Jog" function

Parameter	Description
p1055	Signal source for jogging 1 - jog bit 0 (factory setting: 0) If you wish to jog via a digital input, then set p1055 = 722.x
p1056	Signal source for jogging 2 - jog bit 1 (factory setting: 0) If you wish to jog via a digital input, then set p1056 = 722.x
p1058	Jogging 1 speed setpoint (factory setting, 150 rpm)
p1059	Jogging 2 speed setpoint (factory setting, 150 rpm)

7.4.5 Specifying the motor speed via the fieldbus

If you enter the setpoint via a fieldbus, you must connect the inverter to a higher-level control. For additional information, see chapter Configuring the fieldbus (Page 97).

Interconnecting the fieldbus with the setpoint source

You have two options for using the fieldbus as the setpoint source:

1. Using p0015, select a configuration that is suitable for your application.
Please refer to the section titled Selecting the interface assignments (Page 48) to find out which configurations are available for your inverter.
2. Interconnect main setpoint p1070 with the fieldbus.

Table 7- 23 Fieldbus as setpoint source

Parameter	Setpoint source
r2050[x]	Receive word no. x from RS485 interface
r2090[x]	Receive word no. x from PROFIBUS interface

7.5 Setpoint calculation



The setpoint processing modifies the speed setpoint, e.g. it limits the setpoint to a maximum and minimum value and using the ramp-function generator prevents the motor from executing speed steps.

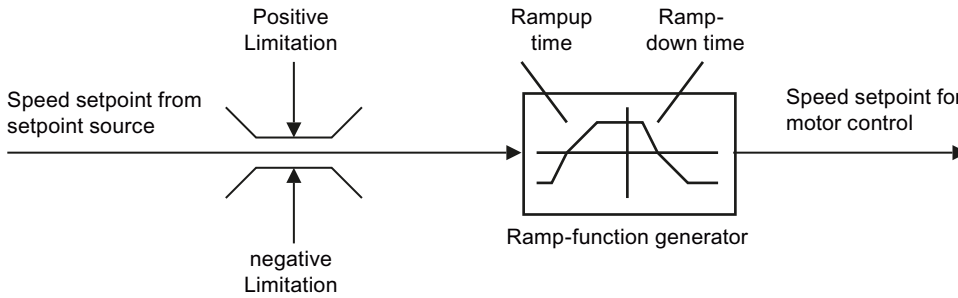

Figure 7-10 Setpoint processing in the inverter

7.5.1 Minimum speed and maximum speed

The speed setpoint is limited by both the minimum and maximum speed.

When the motor is switched on, it accelerates to the minimum speed regardless of the speed setpoint. The set parameter value applies to both directions of rotation. Beyond its limiting function, the minimum speed serves as a reference value for a series of monitoring functions.

The speed setpoint is limited to the maximum speed in both directions of rotation. The inverter generates a message (fault or alarm) when the maximum speed is exceeded.

The maximum speed also acts as an important reference value for various functions (e.g. the ramp-function generator).

Table 7- 24 Parameters for minimum and maximum speed

Parameter	Description
P1080	Minimum speed
P1082	Maximum speed

7.5.2 Ramp-function generator

The ramp-function generator in the setpoint channel limits the speed of changes to the speed setpoint. The ramp-function generator does the following:

- The soft acceleration and braking of the motor reduces the stress on the mechanical system of the driven machine.
- Acceleration and braking distance of the driven machine (e.g. a conveyor belt) are independent of the motor load.

Ramp-up/down time

The ramp-up and ramp-down times of the ramp-function generator can be set independently of each other. The times that you select depend purely on the application in question and can range from just a few 100 ms (e.g. for belt conveyor drives) to several minutes (e.g. for centrifuges).

When the motor is switched on/off via ON/OFF1, the motor also accelerates/decelerates in accordance with the times set in the ramp-function generator.

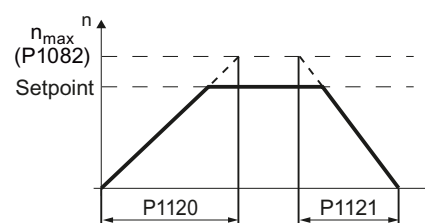

Ramp-up time (p1120)

Duration of acceleration (in seconds) from zero speed to the maximum speed P1082

Ramp-down time (P1121)

Duration of deceleration (in seconds) from the maximum speed P1082 to standstill

The quick-stop function (OFF3) has a separate ramp-down time, which is set with P1135.

Note

If the ramp-up/down times are too short, the motor accelerates/decelerates with the maximum possible torque and the set times will be exceeded.

For more information about this function, see the List Manual (function diagram 3060 and the parameter list).

Extended ramp-function generator

In the extended ramp-function generator, the acceleration process can be made "softer" using initial and final rounding via parameters p1130 ... p1134. Here, the ramp-up and ramp-down times of the motor are increased by the rounding times.

Rounding does not affect the ramp-down time in the event of a quick stop (OFF3).

For more information, see the List Manual (the parameter list and function diagram 3070).

7.6 Motor control



For induction motors, there are two different open-loop control or closed-loop control techniques:

- Open-loop control with V/f-characteristic (V/f control)
- Field-oriented control (vector control)

Criteria for selecting either V/f control or vector control

V/f control is perfectly suitable for almost any application in which the speed of induction motors is to be changed. Examples of typical applications for V/f control include:

- Pumps
- Fans
- Compressors
- Horizontal conveyors

Commissioning vector control takes more time than when commissioning V/f control. When compared to V/f control, vector control offers the following advantages:

- The speed is more stable for motor load changes.
- Shorter accelerating times when the setpoint changes.
- Acceleration and braking are possible with an adjustable maximum torque.
- Improved protection of the motor and the driven machine as a result of the adjustable torque limiting.
- The full torque is possible at standstill.
- Torque control is only possible with vector control.

Examples of typical applications in which vector control is used:

- Hoisting gear and vertical conveyors
- Winders
- Extruders

It is not permissible to use vector control in the following cases:

- If the motor is too small in comparison to the inverter (the rated motor power may not be less than one quarter of the rated inverter power)
- If several motors are connected to one inverter
- If a power contactor is used between the inverter and motor and is opened while the motor is powered up
- If the maximum motor speed exceeds the following values:

Inverter pulse frequency	2 kHz			4 kHz and higher			
	Pole number of the motor	2-pole	4-pole	6-pole	2-pole	4-pole	6-pole
Maximum motor speed [rpm]		9960	4980	3320	14400	7200	4800

7.6.1 V/f control

V/f control sets the voltage at the motor terminals on the basis of the specified speed setpoint. The relationship between the speed setpoint and stator voltage is calculated using characteristic curves. The required output frequency is calculated on the basis of the speed setpoint and the number of pole pairs of the motor ($f = n \cdot \text{number of pole pairs} / 60$, in particular: $f_{\text{max}} = p1082 \cdot \text{number of pole pairs} / 60$). The inverter provides the two most important characteristics (linear and square-law). User-defined characteristic curves are also supported.

V/f control is not a high-precision method of controlling the speed of the motor. The speed setpoint and the speed of the motor shaft are always slightly different. The deviation depends on the motor load. If the connected motor is loaded with the rated torque, the motor speed is below the speed setpoint by the amount of the rated slip. If the load is driving the motor (i.e. the motor is operating as a generator), the motor speed is above the speed setpoint.

The characteristic is selected during commissioning, using p1300.

7.6.1.1 V/f control with linear and square-law characteristic

V/f control with linear characteristic (p1300 = 0):

Mainly used in applications in which the motor torque must be independent of the motor speed. Examples of such applications include horizontal conveyors or compressors.

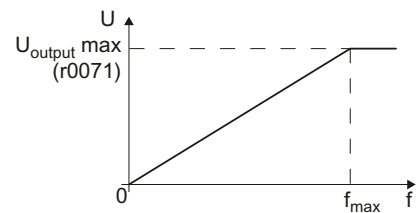

V/f control with parabolic characteristic (p1300 = 2)

Used in applications in which the motor torque increases with the motor speed. Examples of such applications include pumps and fans.

V/f control with square-law characteristic reduces the losses in the motor and inverter due to lower currents than when a linear characteristic is used.

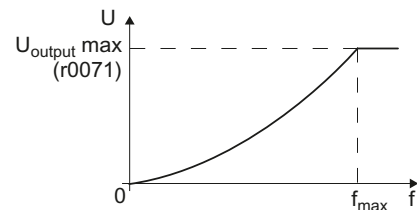

Note

V/f control with a square-law characteristic must not be used in applications in which a high torque is required at low speeds.

7.6.1.2 Additional characteristics for the V/f control

In addition to linear and square-law characteristics, there are the following additional versions of the V/f control that are suitable for special applications.

Linear V/f characteristic with Flux Current Control (FCC) (P1300 = 1)

Voltage losses across the stator resistance are automatically compensated. This is particularly useful for small motors since they have a relatively high stator resistance. The prerequisite is that the value of the stator resistance in P350 is parameterized as accurately as possible.

V/f control with parameterizable characteristic (p1300 = 3)

Variable V/f characteristic that supports the torque response of synchronous motors (SIEMOSYN motors).

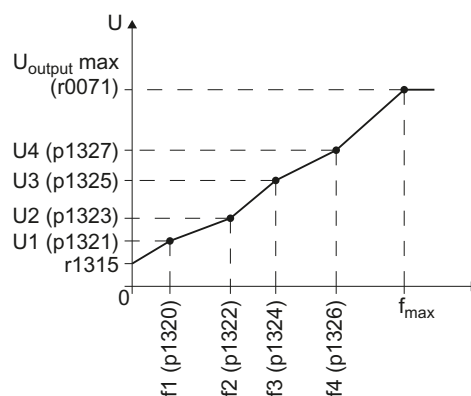

Linear V/f characteristic with ECO (p1300 = 4), quadratic V/f characteristic with ECO (p1300 = 7)

ECO mode is suitable for applications with a low dynamic response and constant speed setpoint, and allows energy savings of up to 40%.

When the setpoint is reached and remains unchanged for 5 s, the inverter automatically reduces its output voltage to optimize the motor's operating point. ECO mode is deactivated in the event of setpoint changes or if the inverter's DC-link voltage is too high or too low.

In ECO mode set the slip compensation (P1335) to 100 %. In the event of minor fluctuations in the setpoint, you have to raise the ramp-function generator tolerance using p1148.

Note: Sudden load variations can cause the motor to stall.

**V/f control for drives requiring a precise frequency (textile industry) (p1300 = 5),
V/f control for drives requiring a precise frequency and FCC (p1300 = 6)**

These characteristics require the motor speed to remain constant under all circumstances. This setting has the following effects:

- When the maximum current limit is reached, the stator voltage is reduced but not the speed.
- Slip compensation is locked.

For more information about this function, see function diagram 6300 in the List Manual.

V/f control with independent voltage setpoint

The interrelationship between the frequency and voltage is not calculated in the inverter, but is specified by the user. With BICO technology, P1330 defines the interface via which the voltage setpoint is entered (e.g. analog input → P1330 = 755).

7.6.1.3 Optimizing with a high break loose torque and brief overload

The ohmic losses in the motor stator resistance and the motor cable play a more significant role the smaller the motor and the lower the motor speed. You can compensate for these losses by raising the V/f characteristic.

There are also applications where the motor temporarily needs more than its rated current in the lower speed range or during acceleration in order to adhere to the speed setpoint. Examples of such applications are:

- Driven machines with a high break loose torque
- Utilizing the brief overload capability of the motor when accelerating

Voltage increase in V/f control (boost)

Voltage losses resulting from long motor cables and the ohmic losses in the motor are compensated for using parameter p1310. An increased break loose torque when starting and accelerating is compensated using parameter p1312 and/or p1311.

The voltage boost is active for every characteristic type of the V/f control. The figure opposite shows the voltage boost using the example of a linear V/f characteristic.

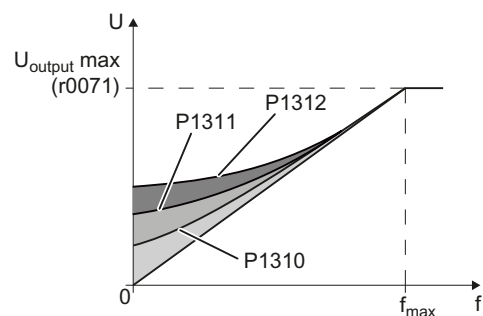

Note

Only increase the voltage boost in small steps until satisfactory motor behavior is reached. Excessively high values in p1310 ... p1312 can cause the motor to overheat and switch off (trip) the inverter due to overcurrent .

Table 7- 25 Optimizing the starting characteristics for a linear characteristic

Parameter	Description
P1310	<p>Permanent voltage boost (factory setting 50 %)</p> <p>The voltage boost is active from standstill up to the rated speed. It is at its highest at speed 0 and continually decreases as the speed increases. Value of voltage boost at zero speed in V: $1.732 \times \text{rated motor current (p0305)} \times \text{stator resistance (r0395)} \times \text{p1310} / 100 \%$.</p>
P1311	<p>Voltage boost on acceleration</p> <p>The voltage boost on acceleration is independent of speed and occurs when the setpoint is increased. It disappears as soon as the setpoint is reached. Value in V: $1.732 \times \text{rated motor current (p0305)} \times \text{stator resistance (r0395)} \times \text{p1311} / 100 \%$</p>
P1312	<p>Voltage boost at start up</p> <p>The voltage boost at start-up results in an additional voltage boost when accelerating, but only the first time the motor accelerates after it has been switched on. The voltage boost in V is: $1.732 \times \text{rated motor current (p0305)} \times \text{stator resistance (r0395)} \times \text{p1312} / 100\%$</p>

You will find more information about this function in the parameter list and in function diagram 6300 of the List Manual.

7.6.2 Vector control

7.6.2.1 Properties of vector control

Using a motor model, the vector control calculates the load and the motor slip. As a result of this calculation, the inverter controls its output voltage and frequency so that the motor speed follows the setpoint, independent of the motor load.

Vector control is possible without directly measuring the motor speed. This closed-loop control is also known as sensorless vector control.

7.6.2.2 Commissioning vector control

Vector control only functions error-free if, during the basic commissioning, the motor data were correctly parameterized and a motor data identification was performed with the motor in the cold state.

You can find the basic commissioning in the following sections:

- Commissioning with the BOP-2 (Page 63)
- Commissioning with STARTER (Page 68)

Optimizing vector control

- Carry out the automatic speed controller optimization using (p1960 = 1)

Table 7- 26 The most important vector control parameters

Parameter	Description
P1300 = 20	Control type: Vector control without speed encoder
p0300 ... p0360	Motor data is transferred from the rating plate during basic commissioning and calculated with the motor data identification
p1452 ... p1496	Speed controller parameters
p1511	Additional torque
p1520	Upper torque limit
p1521	Lower torque limit
p1530	Motoring power limit
p1531	Regenerative power limit

Additional information about this function is provided in the parameter list and in function diagrams 6030 onwards in the List Manual.

You will find more information on the Internet

(<http://support.automation.siemens.com/WW/view/en/7494205>):

7.6.2.3 Torque control

Torque control is part of the vector control and normally receives its setpoint from the speed controller output. By deactivating the speed controller and directly entering the torque setpoint, the closed-loop speed control becomes closed-loop torque control. The inverter then no longer controls the motor speed, but the torque that the motor generates.

Typical applications for torque control

The torque control is used in applications where the motor speed is specified by the connected driven load. Examples of such applications include:

- Load distribution between master and slave drives:
The master drive is speed controlled, the slave drive is torque controlled.
- Winding machines

Commissioning the torque control

The torque control only functions error-free if, during the basic commissioning, you correctly parameterized the motor data and performed the motor data identification with the motor in the cold state.

You can find the basic commissioning in the following sections:

- Commissioning with the BOP-2 (Page 63)
- Commissioning with STARTER (Page 68)

Table 7- 27 The most important torque control parameters

Parameter	Description
P1300 = ...	Control type: 20: Vector control without speed encoder 22: Torque control without speed encoder
P0300 ... P0360	Motor data is transferred from the rating plate during basic commissioning and calculated with the motor data identification
P1511 = ...	Additional torque
P1520 = ...	Upper torque limit
P1521 = ...	Lower torque limit
P1530 = ...	Motoring power limit
P1531 = ...	Regenerative power limit

Additional information about this function is provided in the parameter list and in function diagrams 6030 onwards in the List Manual.

7.7 Protection functions



The frequency inverter offers protective functions against overtemperature and overcurrent for both the frequency inverter as well as the motor. Further, the frequency inverter protects itself against an excessively high DC link voltage when the motor is regenerating.

7.7.1 Inverter temperature monitoring

The inverter temperature is essentially determined by the resistive losses of the output current and the switching losses which occur when pulsing the Power Module. The inverter temperature falls when either the output current or the pulse frequency of the Power Module is reduced.

I2t monitoring (A07805 - F30005)

The Power Module's I2t monitoring controls the inverter utilization by means of a current reference value. The utilization is specified in r0036 [%].

Monitoring the chip temperature of the power unit (A05006 - F30024)

The temperature difference between the power chip (IGBT) and heat sink is monitored using A05006 and F30024. The measured values are specified in r0037[1] [°C].

Heat sink monitoring (A05000 - F30004)

The power unit heat sink temperature is monitored using A05000 and F30004. The values are specified in r0037[0] [°C].

Inverter response

Parameter	Description
P0290	<p>Power unit overload response (factory setting for SINAMICS G120 inverters with Power Module PM260: 0; factory setting for all of the inverters: 2)</p> <p>Setting the reaction to a thermal overload of the power unit: 0: Reduce output current (in vector control mode) or speed (in V/f mode) 1: No reduction, shutdown when overload threshold is reached (F30024) 2: Reduce pulse frequency and output current (in vector control mode) or pulse frequency and speed (in V/f mode) 3: Reduce pulse frequency</p>
P0292	<p>Power unit temperature warning threshold (factory setting: Heat sink [0] 5°C, power semiconductor [1] 15°C) The value is set as a difference to the shutdown temperature.</p>

7.7.2 Motor temperature monitoring using a temperature sensor

You can use one of the following sensors to protect the motor against overtemperature:

- PTC sensor
- KTY 84 sensor
- ThermoClick sensor

The motor's temperature sensor is connected to the Control Unit.

Temperature measurement via PTC

The PTC sensor is connected to terminals 14 and 15.

- **Overtemperature:** The threshold value to switch over to an alarm or fault is 1650 Ω . After the PTC responds, alarm A07910 or shutdown with fault F07011 is initiated corresponding to the setting in p0610.
- **Short-circuit monitoring:** Resistance values < 20 Ω indicate a temperature sensor short-circuit

Temperature measurement using KTY 84

The device is connected to terminals 14 (anode) and 15 (cathode) in the forward direction of the diode. The measured temperature is limited to between -48 °C and +248°C and is made available for further evaluation.

- When the alarm threshold is reached (set via p0604; factory setting: 130 °C), alarm A7910 is triggered. Response -> p0610)
- Fault F07011 is output (depending on the setting in p0610) if
 - the fault threshold temperature (settable in p0605) is reached
 - the alarm threshold temperature (settable in p0604) is reached and is still present after the delay time as expired.

Wire-break and short-circuit monitoring via KTY 84

- Wire break: Resistance value > 2120 Ω
- Short circuit: Resistance value < 50 Ω

As soon as a resistance outside this range is measured, A07015 "Alarm temperature sensor fault" is activated and after the delay time expires, F07016 "Motor temperature sensor fault" is output.

Temperature monitoring via ThermoClick sensor

The ThermoClick sensor responds at values $\geq 100 \Omega$. After the ThermoClick sensors has responded, either alarm A07910 or shutdown with fault F07011 is initiated corresponding to the setting in p0610.

Parameters to set the motor temperature monitoring with sensor

Table 7- 28 Parameters for detecting the motor temperature via a temperature sensor

Parameter	Description		
P0335	Specify the motor cooling 0: Self-ventilated - with fan on the motor shaft (IC410* or IC411*) - (factory setting) 1: Forced ventilation - with a separately driven fan (IC416*) 2: Self-ventilated and inner cooling* (open-circuit air cooled) 3: Forced ventilated and inner cooling* (open-circuit air cooled)		
P0601	Motor temperature sensor type 0: No sensor (factory setting) 1: PTC thermistor (→ P0604) 2: KTY84 (→ P0604) 4: ThermoClick sensor	Terminal no.	
		14	PTC+ KTY anode ThermoClick
		15	PTC- KTY cathode ThermoClick
P0604	Motor temperature alarm threshold (factory setting 130 °C) The alarm threshold is the value at which the inverter is either shut down or I_{max} is reduced (P0610)		
P0605	Motor temperature fault threshold (Factory setting: 145 °C)		
P0610	Motor overtemperature response Determines the response when the motor temperature reaches the alarm threshold. 0: No motor response, only an alarm 1: Alarm and reduction of I_{max} (factory setting) reduces the output speed 2: Fault message and shutdown (F07011)		
P0640	Current limit (input in A)		

*According to EN 60034-6

7.7.3 Protecting the motor by calculating the motor temperature

The temperature calculation is only possible in the vector control mode ($P1300 \geq 20$) and functions by calculating a thermal motor model.

Table 7- 29 Parameter to sense the temperature without using a temperature sensor

Parameters	Description
P0621 = 1	Motor temperature measurement after restarting 0: No temperature measurement (factory setting) 1: Temperature measurement after the motor is switched on for the first time 2: Temperature measurement each time that the motor is switched on
P0622	Magnetization time of the motor for temperature measurement after starting (<i>set automatically as the result of motor data identification</i>)
P0625 = 20	Ambient motor temperature Enter the ambient motor temperature in °C at the instant that the motor data is acquired (factory setting: 20°C). The difference between the motor temperature and motor environment (P0625) must lie within a tolerance range of approx. ± 5 °C.

7.7.4 Overcurrent protection

During vector control, the motor current remains within the torque limits set there.

During U/f control, the maximum current controller (I_{max} controller) protects the motor and inverter against overload by limiting the output current.

Method of operation of I_{max} controller

If an overload situation occurs, the speed and stator voltage of the motor are reduced until the current is within the permissible range. If the motor is in regenerative mode, i.e. it is being driven by the connected machine, the I_{max} controller increases the speed and stator voltage of the motor to reduce the current.

Note

The inverter load is only reduced if the motor torque decreases at lower speeds (e.g. for fans).

In the regenerative mode, the current only decreases if the torque decreases at a higher speed.

Settings

You only have to change the factory settings of the I_{max} controller if the drive tends to oscillate when it reaches the current limit or it is shut down due to overcurrent.

Table 7- 30 I_{max} controller parameters

Parameter	Description
P0305	Rated motor current
P0640	Motor current limit
P1340	Proportional gain of the I_{max} controller for speed reduction
P1341	Integral time of the I_{max} controller for speed reduction
r0056.13	Status: I_{max} controller active
r1343	Speed output of I_{max} controller Shows the amount to which the I-max controller reduces the speed.

For more information about this function, see function diagram 1690 in the List Manual.

7.7.5 Limiting the maximum DC link voltage

How does the motor generate overvoltage?

An induction motor operates as a generator if it is driven by the connected load. A generator converts mechanical power into electrical power. The electric power flows back into the inverter and causes V_{DC} in the inverter to increase.

Above a critical DC link voltage both the inverter as well as the motor will be damaged. Before the voltage can reach critical levels, however, the inverter switches the motor off with the fault message "DC link overvoltage".

Protecting the motor and inverter against overvoltage

The V_{DCmax} controller prevents – as far as the application permits – the DC link voltage from reaching critical levels.

The V_{DCmax} controller is not suitable for applications in which the motor is permanently in the regenerative mode, e.g. in hoisting gear or when large flywheel masses are braked. Further information on inverter braking methods can be found in Section Braking functions of the converter (Page 225).

There are two different groups of parameters for the V_{DCmax} controller, depending on whether the motor is being operated with U/f control or vector control.

Table 7- 31 V_{DCmax} controller parameters

Parameter for V/f control	Parameter for vector control	Description
p1280 = 1	p1240 = 1	V_{DC} controller or V_{DC} monitoring configuration (factory setting: 1)1: Enable V_{DCmax} controller
r1282	r1242	V_{DCmax} controller switch-on level Shows the value of the DC-link voltage above which the V_{DCmax} controller is active
p1283	p1243	V_{DCmax} controller dynamic factor (factory setting: 100 %) scaling of the control parameters P1290, P1291 and P1292
p1290	p1250	V_{DCmax} controller proportional gain (factory setting: 1)
p1291	p1251	V_{DCmax} controller reset time (factory setting p1291: 40 ms, factory setting p1251: 0 ms)
p1292	p1252	V_{DCmax} controller rate time (factory setting p1292: 10 ms, factory setting p1252: 0 ms)
p1294	p1254	V_{DCmax} controller automatic recording ON-signal level (factory setting p1294: 0, factory setting p1254: 1)Activates or deactivates automatic detection of the switch-on levels of the V_{DCmax} controller. 0: Automatic detection disabled 1: Automatic detection enabled
p0210	p0210	Unit supply voltage If p1254 or p1294 = 0, the inverter uses this parameter to calculate the intervention thresholds of the V_{DCmax} controller. Set this parameter to the actual value of the input voltage.

For more information about this function, see the List Manual (function diagrams 6320 and 6220).

7.8 Status messages



Information about the inverter state (alarms, faults, actual values) can be output via inputs and outputs and also via the communication interface.

Details on evaluating the inverter state via inputs and outputs are provided in Section Adapting the terminal strip (Page 85).

The evaluation of the inverter state via the communication interface is realized using the inverter status word. Details on this are provided in the individual sections of Chapter Configuring the fieldbus (Page 97).

7.8.1 System runtime

By evaluating the system runtime of the inverter, you can decide when you should replace components subject to wear in time before they fail - such as fans, motors and gear units.

Principle of operation

The system runtime is started as soon as the Control Unit power supply is switched-on. The system runtime stops when the Control Unit is switched off.

The system runtime comprises r2114[0] (milliseconds) and r2114[1] (days):

System runtime = r2114[1] × days + r2114[0] × milliseconds

If r2114[0] has reached a value of 86,400,000 ms (24 hours), r2114[0] is set to the value 0 and the value of r2114[1] is increased by 1.

Parameter	Description
r2114[0]	System runtime (ms)
r2114[1]	System runtime (days)

You cannot reset the system runtime.

7.9

Application-specific functions

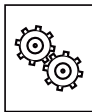

The inverter offers a series of functions that you can use depending on your particular application, e.g.:

- Unit changeover
- Braking functions
- Automatic restart and flying restart
- Basic process control functions
- Logical and arithmetic functions using function blocks that can be freely interconnected

Please refer to the following sections for detailed descriptions.

- Essential service mode
- Multi-zone controller
- Cascade control
- Bypass
- Energy-saving mode

7.9.1

Unit changeover

Description

With the unit changeover function, you can adapt the inverter to the line supply (50/60 Hz) and also select US units or SI units as base units.

Independent of this, you can define the units for process variables or change over to percentage values.

Specifically, you have the following options:

- Changing over the motor standard (Page 220) IEC/NEMA (adaptation to the line supply)
- Changing over the unit system (Page 221)
- Changing over process variables for the technology controller (Page 222)

NOTICE
The motor standard, the unit system as well as the process variables can only be changed offline.
The procedure is described in Section Changing of the units with STARTER (Page 223).

Note

Restrictions for the unit changeover function

- The values on the rating plate of the inverter or motor cannot be displayed as percentage values.
- Using the unit changeover function a multiple times (for example, percent → physical unit 1 → physical unit 2 → percent) may lead to the original value being changed by one decimal place as a result of rounding errors.
- If the unit is changed over into percent and the reference value is then changed, the percentage values relate to the new reference value.

Example:

- For a reference speed of 1500 rpm, a fixed speed of 80% corresponds to a speed of 1200 rpm.
 - If the reference speed is changed to 3000 rpm, then the value of 80% is kept and now means 2400 rpm.
-

Reference variables for unit changeover

- p2000 Reference frequency/speed
- p2001 Reference voltage
- p2002 Reference current
- p2003 Reference torque
- r2004 Reference power
- p2005 Reference angle
- p2007 Reference acceleration

7.9.1.1 Changing over the motor standard

You change over the motor standard using p0100. The following applies:

- p0100 = 0: IEC motor (50 Hz, SI units)
- p0100 = 1: NEMA motor (60 Hz, US units)
- p0100 = 2: NEMA motor (60 Hz, SI units)

The parameters listed below are affected by the changeover.

Table 7- 32 Variables affected by changing over the motor standard

P no.	Designation	Unit for p0100 =		
		0*)	1	2
r0206	Power Module rated power	kW	HP	kW
p0307	Rated motor power	kW	HP	kW
p0316	Motor torque constant	Nm/A	lbf ft/A	Nm/A
r0333	Rated motor torque	Nm	lbf ft	Nm
r0334	Motor torque constant, actual	Nm/A	lbf ft/A	Nm/A
p0341	Motor moment of inertia	kgm ²	lb ft ²	kgm ²
p0344	Motor weight (for thermal motor type)	kg	Lb	kg
r1969	Speed_cont_opt moment of inertia determined	kgm ²	lb ft ²	kgm ²

*) Factory setting

7.9.1.2 Changing over the unit system

You change over the unit system using p0505. The following selection options are available:

- P0505 = 1: SI units (factory setting)
- P0505 = 2: SI units or % relative to SI units
- P0505 = 3: US units
- P0505 = 4: US units or % relative to US units

Note

Special features

The percentage values for p0505 = 2 and for p0505 = 4 are identical. In order to perform internal calculations and output values that are changed back over to physical variables, however, an important factor is whether the changeover process relates to SI or US units.

In the case of variables for which changeover to % is not possible, the following applies:
p0505 = 1 \triangleq p0505 = 2 and p0505 = 3 \triangleq p0505 = 4.

In the case of variables whose units are identical in the SI system and US system, and which can be displayed as a percentage, the following applies:
p0505 = 1 \triangleq p0505 = 3 and p0505 = 2 \triangleq p0505 = 4.

Parameters affected by changeover

The parameters affected by changing over the unit system are grouped according to unit. An overview of the unit groups and the possible units can be found in the List Manual in the Section "Unit group and unit selection".

7.9.1.3 Changing over process variables for the technology controller

Note

We recommend that the units and reference values of the technology controller are coordinated and harmonized with one another during commissioning.

Subsequent modification in the reference variable or the unit can result in incorrect calculations or displays.

Changing over process variables of the technology controller

You change over the process variables of the technology controller using p0595. For physical values, you define the reference variable in p0596.

The parameters affected by changing over units of the technology controller belong to unit group 9_1. For details, please refer to the section titled "Unit group and unit choice" in the List Manual.

Switching the process variables of the additional technology controller 0

The process variables of the additional technology controller 0 switch over via p11026. You define the reference variable for absolute units in p11027.

The parameters affected by the unit switchover of the additional technology controller 0 belong to units group 9_2. Details can be found in the Parameter Manual, under the section entitled "units group and unit selection".

Switching the process variables of the additional technology controller 1

The process variables of the additional technology controller 1 switch over via p11126. You define the reference variable for absolute units in p11127.

The parameters affected by the unit switchover of the additional technology controller 1 belong to units group 9_3. Details can be found in the Parameter Manual, under the section entitled "units group and unit selection".

Switching the process variables of the additional technology controller 2

The process variables of the additional technology controller 2 switch over via p11226. You define the reference variable for absolute units in p11227.

The parameters affected by the unit switchover of the additional technology controller 2 belong to units group 9_4. Details can be found in the Parameter Manual, under the section entitled "units group and unit selection".

7.9.1.4 Changing of the units with STARTER

The converter must be in the offline mode in order to change over the units.

STARTER shows whether you change settings online in the converter or change offline in the PC (**Online mode** / **Offline mode**).

You switch over the mode using the adjacent buttons in the menu bar.

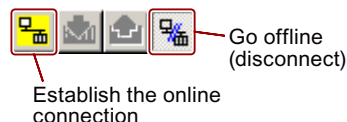

Procedure

- Go to the "Units" tab in the configuration screen form to change over the units.

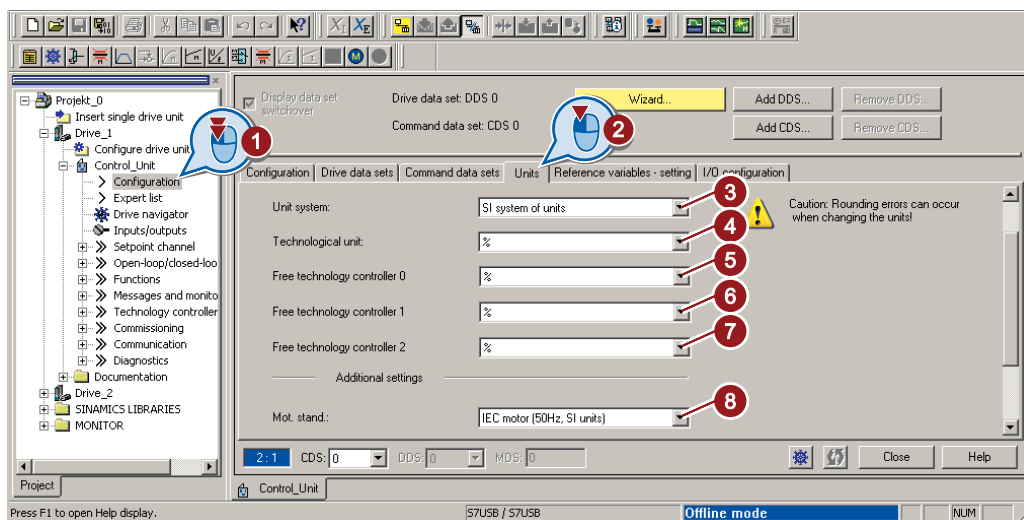

- ③ Changing over the unit system
- ④ Selecting process variables of the technology controller
- ⑤ Select process variables of the additional technology controller 0
- ⑥ Select process variables of the additional technology controller 2
- ⑦ Select process variables of the additional technology controller 1
- ⑧ adapting to the line supply

Figure 7-11 Unit changeover

- Save your settings

- Go online.
In this case, the converter detects that other units or process variables have been set offline than are actually in the converter; the converter displays this in the following screen form:

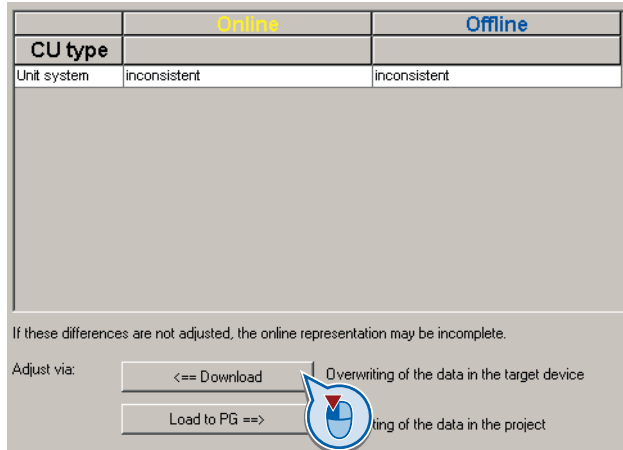

- Accept these settings in the converter.

7.9.2 Braking functions of the converter

7.9.2.1 Comparison of electrical braking methods

Regenerative power

If an induction motor electrically brakes the connected load and the mechanical power exceeds the electrical losses, then it operates as a generator. The motor converts mechanical power into electrical power. Examples of applications, in which regenerative operation briefly occurs, include:

- Grinding disk drives
- Fans

For certain drive applications, the motor can operate in the regenerative mode for longer periods of time, e.g.:

- Centrifuges
- Hoisting gear and cranes
- Conveyor belts with downward movement of load (vertical or inclined conveyors)

Depending on the Power Modules used, SINAMICS G inverters offer the following options to either convert the regenerative power of the motor into heat or to feed this power back into the line supply:

- DC braking (Page 228)
for Power Modules **PM230**, **PM240**, **PM250** and **PM260**
- Compound braking (Page 232)
for Power Module **PM240**
- Dynamic braking (Page 234)
for Power Module **PM240**
- Braking with regenerative feedback to the line (Page 236)
for Power Modules **PM250** and **260**

A comparison with the main features of the individual braking functions is listed in the following paragraphs.

Main features of the braking functions

DC braking

The motor converts the regenerative power into heat.

- *Advantage:* The motor brakes without the inverter having to process the regenerative energy
- *Disadvantages:* significant increase in the motor temperature; no defined braking characteristics; no constant braking torque; no braking torque at standstill; regenerative power is lost as heat; does not function when the line supply fails

Compound braking

The motor converts the regenerative power into heat.

- *Advantage:* Defined braking characteristics, the motor brakes without the inverter having to convert any regenerative energy
- *Disadvantages:* significant motor temperature rise; no constant braking torque; regenerative power is dissipated as heat; does not function when the line supply fails

Dynamic braking

The inverter converts the regenerative power into heat using a braking resistor.

- *Advantages:* defined braking characteristics; no additional motor temperature increase; constant braking torque; in principle, also functions when the power fails
- *Disadvantages:* Braking resistor required; regenerative power is dissipated as heat

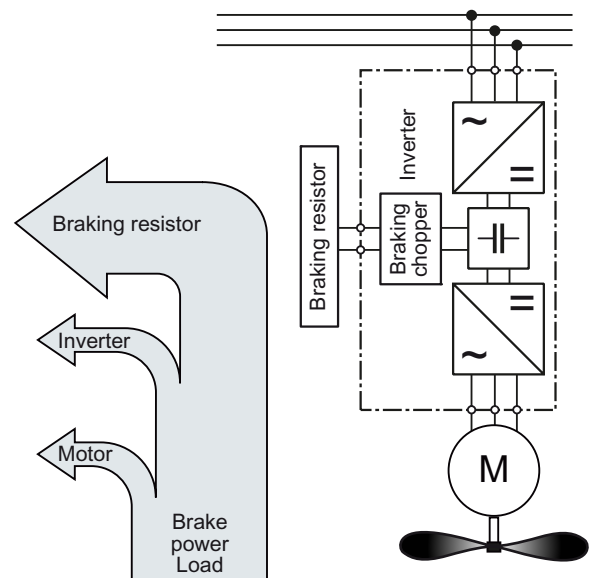
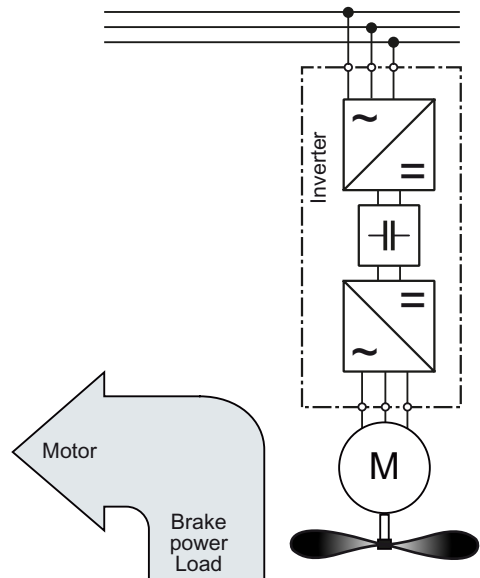

Braking with regenerative feedback into the line supply

The inverter feeds the regenerative power back into the line supply.

- *Advantages:* Constant braking torque; the regenerative power is not converted into heat, but is regenerated into the line supply; can be used in all applications; continuous regenerative operation is possible - e.g. when lowering a crane load
- *Disadvantage:* Does not function when power fails

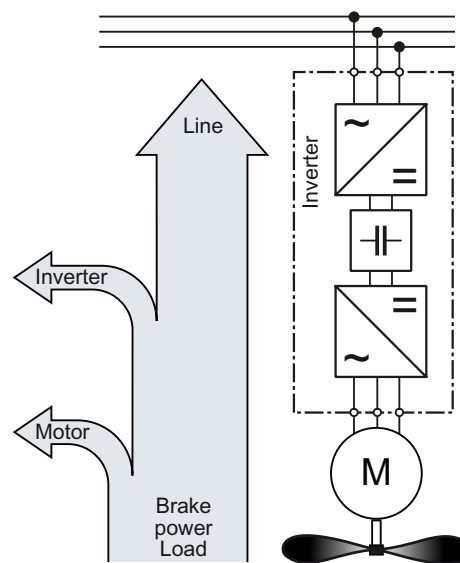

Braking with regenerative feedback into the line supply

Braking method depending on the application

Table 7- 33 What Power Module is suitable for what application?

Application examples	Electrical braking methods	Power Modules that can be used
Pumps, fans, mixers, compressors, extruders	Not required	PM230, PM240, PM250, PM260
Grinding machines, conveyor belts	DC braking, compound braking	PM240
Centrifuges, vertical conveyors, hoisting gear, cranes, winders	Dynamic braking	PM240
	Braking with regenerative feedback into the line supply	PM250, PM260

7.9.2.2 DC braking

DC braking is used for applications without regenerative feedback into the line supply, where the motor can be more quickly braked by impressing a DC current than along a braking ramp.

Typical applications for DC braking include:

- Centrifuges
- Saws
- Grinding machines
- Conveyor belts

Whether DC braking or ramp-down with an OFF1 command is more effective depends on the motor properties.

Principle of operation

With DC braking, the inverter outputs an internal OFF2 command for the time that it takes to demagnetize the motor - and then impresses the braking current for the duration of the DC braking.

The following operating modes are available for DC braking.

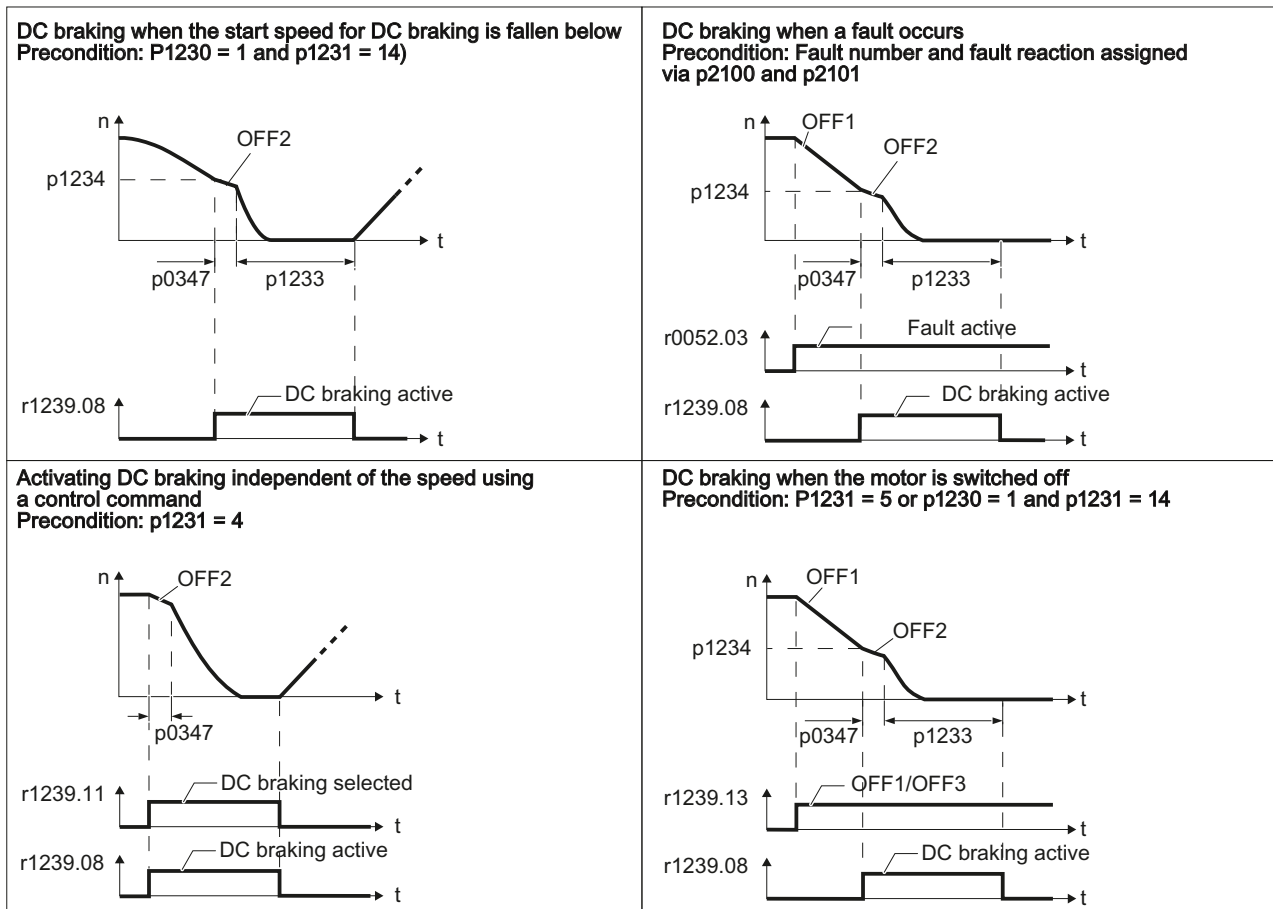

DC braking when the start speed for DC braking is fallen below

DC braking is automatically activated as soon as the motor speed falls below the start speed for DC braking. However, the motor speed must have first exceeded the start speed for DC braking. Once the DC braking time is complete, the inverter switches to normal operation. If p1230 is set to 0, DC braking can also be canceled before the time defined in p1233.

DC braking when a fault occurs

If a fault occurs, where the configured response is DC braking, then the inverter first brakes the motor along the down ramp until the start speed for DC braking is reached, and then starts DC braking.

Activating DC braking independent of the speed using a control command

DC braking starts independent of the motor speed, as soon as the control command for braking (e.g. via DI3: P1230 = 722.3) is issued. If the braking command is revoked, the inverter returns to normal operation and the motor accelerates to its setpoint.

Note: The value of p1230 is displayed in r1239.11.

DC braking when the motor is switched off

If the motor is switched off with OFF1 or OFF3, the inverter first brakes the motor along the down ramp until the start speed for DC braking is reached, and then starts DC braking. The motor is then switched into a torque-free condition (OFF2).

Note

In the following operating modes, it is possible that the motor is still rotating after DC braking. This is the reason that in these operating modes "Flying restart (Page 237)" must be activated:

- DC braking when the start speed for DC braking is fallen below
- Activating DC braking independent of the speed using a control command
- DC braking when the motor is switched off

The DC braking function can only be set for induction motors.

 CAUTION
--

DC braking converts some of the kinetic energy of the motor and load into heat in the motor (temperature rise). The motor will overheat if the braking operation lasts too long or the motor is braked too often.

DC braking parameters

Table 7- 34 Parameters for configuring DC braking

Parameter	Description
p1230	Activate DC braking (BICO parameter) The value for this parameter (0 or 1) can be either entered directly or specified by means of an interconnection with a control command.
p1231	Configure DC braking <ul style="list-style-type: none"> • p1231 = 0, no DC braking • p1231 = 4, general enabling of DC braking • p1231 = 5, DC braking for OFF1/3, independent of p1230 • P1231 = 14, enables DC braking for the case that the motor speed falls below the start speed for DC braking.

Table 7- 35 Parameters for configuring DC braking in the event of faults

Parameter	Description
p2100	Set fault number for fault reaction (factory setting: 0) Enter the fault number for which DC braking should be activated, e.g.: p2100[3] = 7860 (external fault 1).
p2101 = 6	Fault reaction setting (factory setting: 0) Assigning the fault response: p2101[3] = 6.
<p>The fault is assigned an index of p2100. The associated fault response must be assigned the same index in p2101.</p> <p>In the List Manual of the inverter - in the "Faults and alarms" list - possible fault responses are listed for every fault. The entry "DCBRAKE" means that for this particular fault, DC braking can be set as fault response.</p>	

Table 7- 36 Additional parameters for setting DC braking

Parameter	Description
p1232	DC braking braking current (factory setting: 0 A) Setting the braking current for the DC braking.
p1233	DC braking duration (factory setting: 1 s)
p1234	DC braking start speed (factory setting: 210000 rpm) DC braking starts – assuming that it has been correspondingly parameterized (p1230/p1231) – as soon as the actual speed falls below this threshold.
p0347	Motor de-excitation The parameter is calculated via p0340 = 1, 3. The inverter can trip due to an overcurrent during DC braking if the de-excitation time is too short.

7.9.2.3 Compound braking

Compound braking is typically used for applications in which the motor is normally operated at a constant speed and is only braked down to standstill in longer time intervals, e.g.:

- Centrifuges
- Saws
- Grinding machines
- Horizontal conveyors

Principle of operation

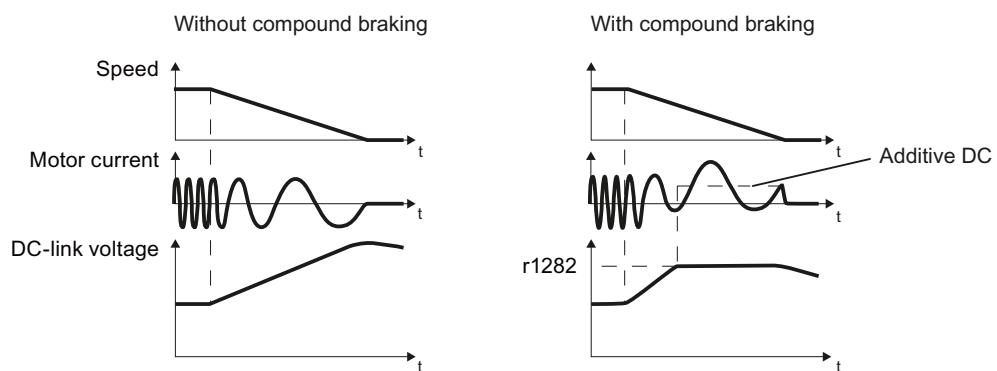

Figure 7-12 Motor brakes with and without active compound braking

Compound braking prevents the DC link voltage increasing above a critical value. The inverter activates compound braking depending on the DC link voltage. Above a DC link voltage threshold (r1282), the inverter adds a DC current to the motor current. The DC current brakes the motor and prevents an excessive increase in the DC link voltage.

Note

Compound braking is only active in conjunction with the V/f control.

Compound braking does not operate in the following cases:

- The "flying restart" function is active
 - DC braking is active
 - Vector control is selected
-

Parameterizing compound braking

Table 7- 37 Parameters to enable and set compound braking

Parameter	Description
P3856	<p>Compound braking current (%)</p> <p>With the compound braking current, the magnitude of the DC current is defined, which is additionally generated when stopping the motor for operation with V/f control to increase the braking effect.</p> <p>P3856 = 0 Compound braking locked</p> <p>P3856 = 1 ... 250 Current level of the DC braking current as a % of the rated motor current (P0305)</p> <p>Recommendation: $p3856 < 100 \% \times (r0209 - r0331) / p0305 / 2$</p>
r3859.0	<p>Status word, compound braking</p> <p>r3859.0 = 1: Compound braking is active</p>

 **CAUTION**

Compound braking converts part of the kinetic energy of the motor and load into motor heat (temperature rise). The motor can overheat if braking lasts too long or the drive is braked too frequently.

7.9.2.4 Dynamic braking

Dynamic braking is typically used in applications in which dynamic motor behavior is required at different speeds or continuous direction changes, e.g.:

- Horizontal conveyors
- Vertical and inclined conveyors
- Hoisting gear

Principle of operation

The inverter controls the braking chopper depending on its DC link voltage. The DC link voltage increases as soon as the inverter absorbs the regenerative power when braking the motor. The braking chopper converts this power into heat in the braking resistor. This therefore prevents the DC link voltage increasing above the limit value $V_{DC\ link, max}$.

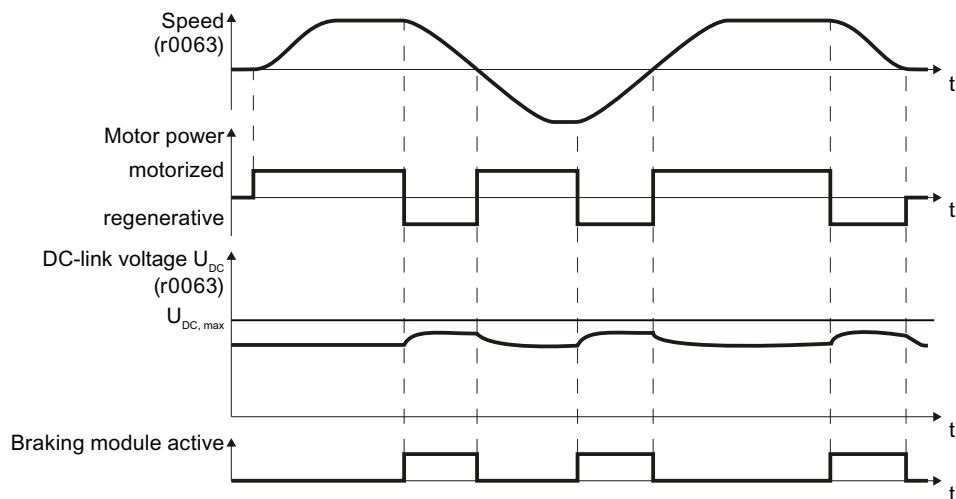

Figure 7-13 Simplified representation of dynamic braking with respect to time

Braking resistor connection

- Connect the braking resistor to terminals R1 and R2 of the Power Module
- Ground the braking resistor directly to the control cabinet's grounding bar. It is not permissible that the braking resistor is grounded via the PE terminals on the Power Module.
- If you must observe the EMC guidelines, pay special attention to the shielding.

- Evaluate the braking resistor's temperature monitoring (terminals T1 and T2) such that the motor is switched off when the resistor experiences overtemperature. You can do this in the following two ways:
 - Use a contactor to disconnect the converter from the line as soon as the temperature monitoring responds.
 - Connect the contact of the temperature monitoring function of the braking resistor with a free digital input of your choice on the converter. Set the function of this digital input to the OFF2 command.

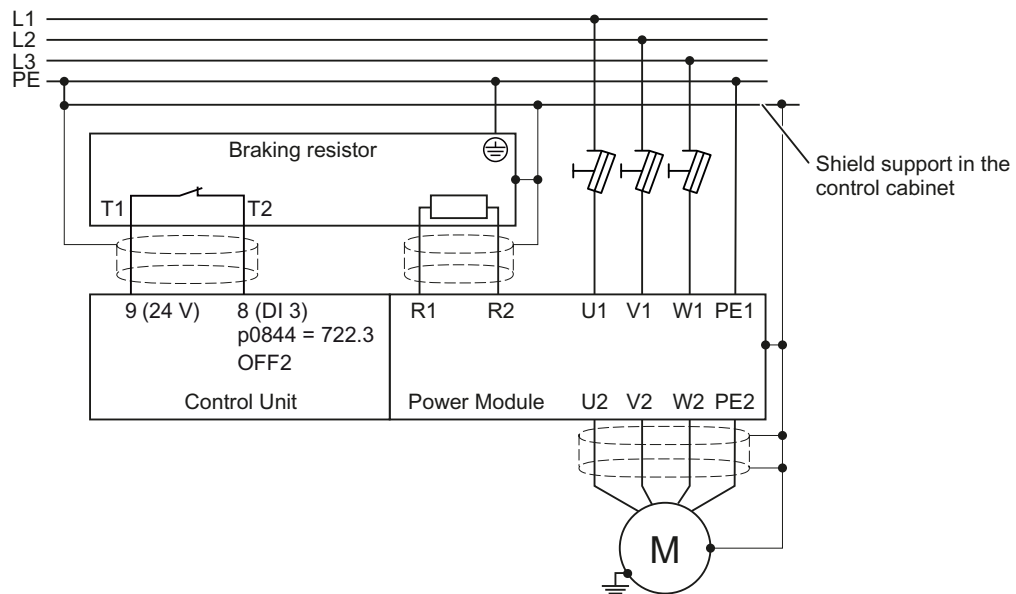



Figure 7-14 Braking resistor connection (example: Temperature monitoring via DI 3)

You will find more information about the braking resistor in the installation instructions for Power Module PM240 (<http://support.automation.siemens.com/WW/view/en/30563173/133300>).

 WARNING
<p>If an unsuitable braking resistor is used, this could result in a fire and severely damage the converter.</p> <p>The temperature of braking resistors increases during operation. For this reason, avoid coming into direct contact with braking resistors. Maintain sufficient clearances around the braking resistor and ensure that there is adequate ventilation.</p>

Parameterizing the dynamic braking

Deactivate the V_{DCmax} controller. The V_{DCmax} controller is described in Section Limiting the maximum DC link voltage (Page 216).

The dynamic braking does not have to be parameterized any further.

7.9.2.5 Braking with regenerative feedback to the line

Regenerative braking is typically used in applications where braking energy is generated either frequently or for longer periods of time, e.g.:

- Centrifuges
- Unwinders
- Cranes and hoisting gear

Pre-requisite for regenerative braking is the Power Module PM250 or PM260.

The inverter can feed back up to 100% of its power into the line supply (referred to "High Overload" base load, see Section Technical data, Power Modules (Page 305)).

Parameterization of braking with regenerative feedback to the line

Table 7- 38 Settings for braking with regenerative feedback to the line

Parameter	Description
Limiting the regenerative feedback for V/f control (P1300 < 20)	
p0640	<p>Motor overload factor</p> <p>Limiting the regenerative power is not directly possible with V/f control, but can be achieved indirectly by limiting the motor current.</p> <p>If the current exceeds this value for longer than 10 s, the inverter shuts down the motor with fault message F07806.</p>
Limiting feedback with vector control (P1300 ≥ 20)	
P1531	<p>Regenerative power limit</p> <p>The maximum regenerative load is entered as negative value via p1531. (-0.01 ... -100000.00 kW).</p> <p>Values higher than the rated value of the power unit (r0206) are not possible.</p>

7.9.3 Automatic restart and flying restart

7.9.3.1 Flying restart – switching on while the motor is running

If you switch on the motor while it is still running, then with a high degree of probability, a fault will occur due to overcurrent (overcurrent fault F07801). Examples of applications involving an unintentionally rotating motor directly before switching on:

- The motor rotates after a brief line interruption.
- A flow of air turns the fan impeller.
- A load with a high moment of inertia drives the motor.

After the ON command, the "flying restart" function initially synchronizes the inverter output frequency to the motor speed and then accelerates the motor up to the setpoint.

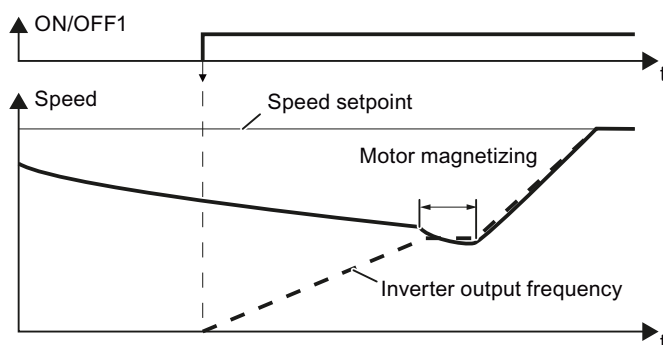

Figure 7-15 Principle of operation of the "flying restart" function

Setting "flying restart" function

If the inverter simultaneously drives several motors, then you must only use the "flying restart" function if the speed of all of the motors is always the same (group drive with a mechanical coupling).

Table 7- 39 Basic setting

Parameter	Description
P1200	Flying restart operating mode (factory setting: 0)
	0 Flying restart is locked
	1 Flying restart is enabled, look for the motor in both directions, start in direction of setpoint
	4 Flying restart is enabled, only search in direction of setpoint

Table 7- 40 Advanced settings

Parameter	Description
P1201	Flying restart enable signal source (factory setting: 1) Defines a control command, e.g. a digital input, through which the flying restart function is enabled.
P1202	Flying restart search current (Factory setting for Power Module PM230: 90 %. Factory setting for PM240, PM250 and PM260: 100%) Defines the search current with respect to the motor magnetizing current (r0331), which flows in the motor while the flying restart function is being used.
P1203	Flying restart search speed factor (Factory setting for Power Module PM230: 150 %. Factory setting for PM240, PM250 and PM260: 100%) The value influences the speed with which the output frequency is changed during the flying restart. A higher value results in a longer search time. If the inverter does not find the motor, reduce the search speed (increase p1203).

7.9.3.2 Automatic switch-on

The automatic restart includes two different functions:

1. The inverter automatically acknowledges faults.
2. After a fault occurs or after a power failure, the inverter automatically switches-on the motor again.

This automatic restart function is primarily used in applications where the motor is controlled locally via the inverter's inputs. In applications with a connection to a fieldbus, the central control should evaluate the feedback signals of the drives, specifically acknowledge faults or switch-on the motor.

The inverter interprets the following events as power failure:

- The inverter signals fault F30003 (DC link undervoltage), as the line supply voltage of the inverter has briefly failed.
- The inverter power supply has failed for a long enough time so that the inverter has been switched-off.

⚠ WARNING

When the "automatic restart" function is active ($p1210 > 1$), the motor automatically starts after a power failure. This is especially critical after longer power failures.

Reduce the risk of accidents in your machine or system to an acceptable level by applying suitable measures, e.g. protective doors or covers.

Commissioning the automatic restart

- If it is possible that the motor is still rotating for a longer period of time after a power failure or after a fault, then in addition, you must activate the "flying restart" function, see Flying restart – switching on while the motor is running (Page 237).
- Using p1210, select the automatic restart mode that best suits your application.

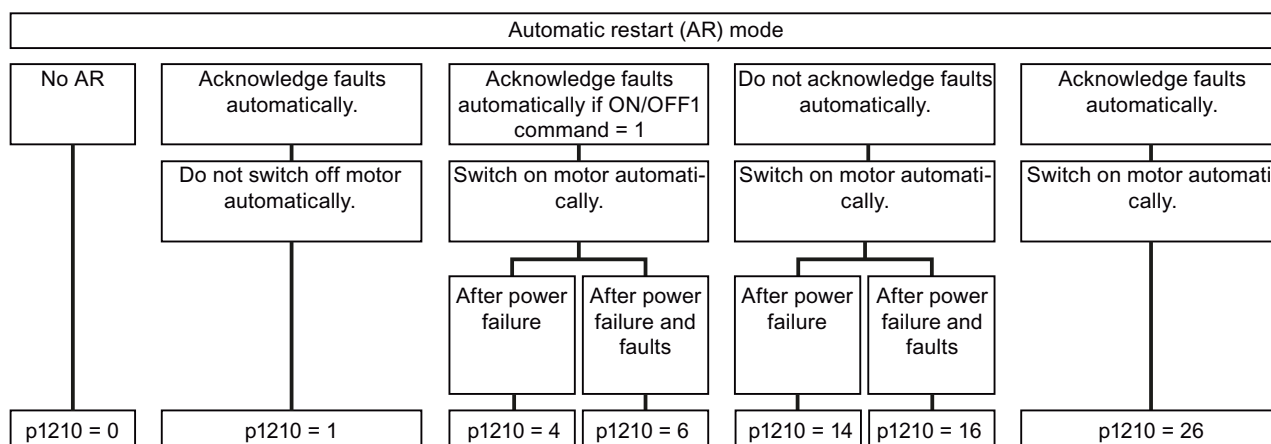
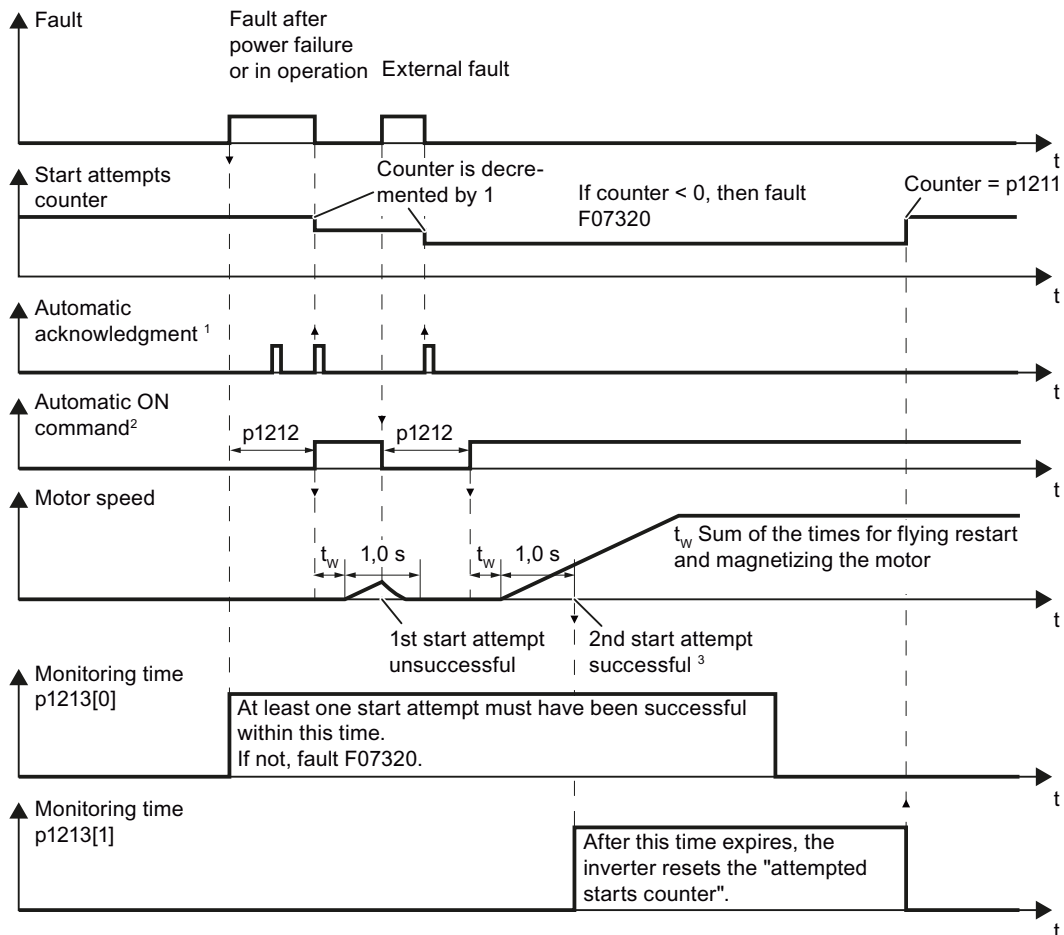

Figure 7-16 Selecting the automatic restart mode

- Set the parameters of the automatic restart function.
The method of operation of the parameters is explained in the following diagram and in the table.



¹ The inverter automatically acknowledges faults under the following conditions:

- p1210 = 1 or 26: always.
- p1210 = 4 or 6: If the command to switch on the motor is available at a digital input or via the fieldbus (ON/OFF1 command = HIGH).
- p1210 = 14 or 16: never.

² The inverter attempts to automatically switch-on the motor under the following conditions:

- p1210 = 1: never.
- p1210 = 4, 6, 14, 16, or 26: If the command to switch on the motor is available at a digital input or via the fieldbus (ON/OFF1 command = HIGH).

³ The start attempt is successful if flying restart has been completed and the motor has been magnetized (r0056.4 = 1) and one additional second has expired without a new fault having occurred.

Figure 7-17 Time response of the automatic restart

Table 7- 41 Setting the automatic restart

Parameter	Explanation
p1210	<p>Automatic restart mode (factory setting: 0)</p> <p>0: Disable automatic restart 1: Acknowledge all faults without restarting 4: Restart after power failure without further restart attempts 6: Restart after fault with further restart attempts 14: Restart after power failure after manual fault acknowledgement 16: Restart after fault after manual fault acknowledgement 26: Acknowledgement of all faults and restart with ON command</p>
p1211	<p>Automatic restart start attempts (factory setting: 3)</p> <p>This parameter is only effective for the settings p1210 = 4, 6, 14, 16, 26.</p> <p>You define the maximum number of start attempts using p1211. After each successful fault acknowledgement, the inverter decrements its internal counter of start attempts by 1.</p> <p>For p1211 = n, up to n + 1 start attempts are made. Fault F07320 is output after n + 1 unsuccessful start attempts.</p> <p>The inverter sets the start attempt counter back again to the value of p1211, if one of the following conditions is fulfilled:</p> <ul style="list-style-type: none"> • After a successful start attempt, the time in p1213[1] has expired. • After fault F07320, withdraw the ON command and acknowledge the fault. • You change the start value p1211 or the mode p1210.
p1212	<p>Automatic restart wait time start attempt (factory setting: 1.0 s)</p> <p>This parameter is only effective for the settings p1210 = 4, 6, 26.</p> <p>Examples for setting this parameter:</p> <ol style="list-style-type: none"> 1. After a power failure, a certain time must elapse before the motor can be switched-on, e.g. because other machine components are not immediately ready. In this case, set p1212 longer than the time, after which all of the fault causes have been removed. 2. In operation, the inverter develops a fault condition. The lower you select p1212, then the sooner the inverter attempts to switch-on the motor again.

Parameter	Explanation
p1213[0]	<p>Automatic restart monitoring time for restart (factory setting: 60 s)</p> <p>This parameter is only effective for the settings p1210 = 4, 6, 14, 16, 26.</p> <p>With this monitoring function, you limit the time in which the inverter may attempt to automatically switch-on the motor again.</p> <p>The monitoring function starts when a fault is identified and ends with a successful start attempt. If the motor has not successfully started after the monitoring time has expired, fault F07320 is signaled.</p> <p>Set the monitoring time longer than the sum of the following times:</p> <ul style="list-style-type: none"> + P1212 + time that the inverter requires to start the motor on the fly. + Motor magnetizing time (p0346) + 1 second <p>You deactivate the monitoring function with p1213 = 0.</p>
p1213[1]	<p>Automatic restart monitoring time to reset the fault counter (factory setting: 0 s)</p> <p>This parameter is only effective for the settings p1210 = 4, 6, 14, 16, 26.</p> <p>Using this monitoring time, you prevent that faults, which continually occur within a certain time period, are automatically acknowledged each time.</p> <p>The monitoring function starts with a successful start attempt and ends after the monitoring time has expired.</p> <p>If the inverter has made more than (p1211 + 1) successful start attempts within monitoring time p1213[1], the inverter cancels the automatic restart function and signals fault F07320. In order to switch on the motor again, you must acknowledge the fault and issue a new ON command.</p>

Additional information is provided in the parameter list of the List Manual.

Advanced settings

If you wish to suppress the automatic restart function for certain faults, then you must enter the appropriate fault numbers in p1206[0 ... 9].

Example: P1206[0] = 07331 ⇒ No restart for fault F07331.

Suppressing the automatic restart only functions for the setting p1210 = 6, 16 or 26.

 WARNING
<p>In the case of communication via the field bus interface, the motor restarts with the setting p1210 = 6 even if the communication link is interrupted. This means that the motor cannot be stopped via the open-loop control. To avoid this dangerous situation, you must enter the fault code of the communications error in parameter p1206.</p> <p>Example: A communication failure via PROFIBUS is signaled using fault code F01910. You should therefore set p1206[n] = 1910 (n = 0 ... 9).</p>

7.9.4 PID technology controller

The technology controller permits all types of simple process controls to be implemented. You can use the technology controller for e.g. pressure controllers, level controls or flow controls.

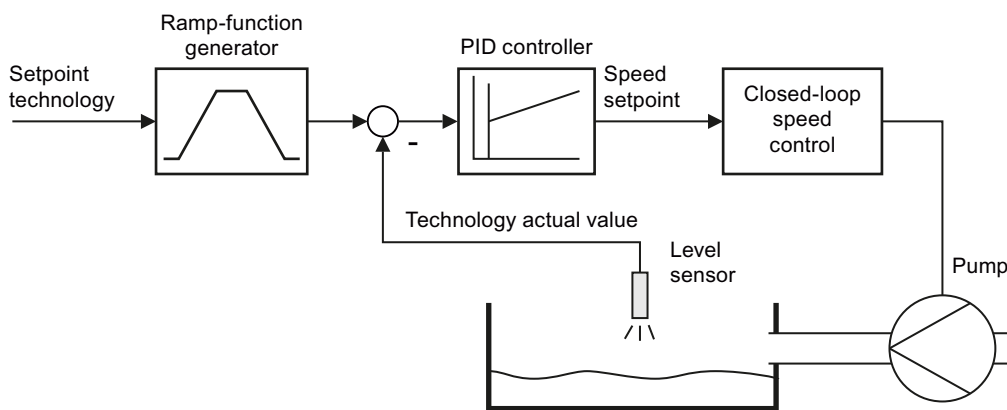

Figure 7-18 Example: technology controller as a level controller

Principle of operation

The technology controller specifies the speed setpoint of the motor in such a way that the process variable to be controlled corresponds to its setpoint. The technology controller is designed as a PID controller, which makes it highly flexible.

The technology controller setpoint is entered via an analog input or via the fieldbus.

Table 7- 42 Technology controller parameters

Parameter	Description
P2200 = ...	Enable technology controller
P2201 ... r2225	Fixed speeds for the technology controller
P2231 ... P2248	Motorized potentiometer for the technology controller
P2251 ... r2294	General adjustment parameters of the technology controller
P2345 = ...	Changing the fault reaction for the technology controller

Additional information about this function is provided in the parameter list and in the function diagrams 7950 ... 7958 in the List Manual.

Additional technology controllers

Via the parameter ranges

- p11000 ... p11099: free technology controller 0
- p11100 ... p11199: free technology controller 1
- p11200 ... p11299: free technology controller 2

additional technology controllers can be parameterized. Refer to the parameter descriptions and in function diagram 7970 of the associated List Manual for additional details.

7.9.5 Load torque monitoring (system protection)

In many applications, it is advisable to monitor the motor torque:

- Applications where the load speed can be indirectly monitored by means of the load torque. For example, in fans and conveyor belts too low a torque indicates that the drive belt is torn.
- Applications that are to be protected against overload or locking (e.g. extruders or mixers).
- Applications in which no-load operation of the motor represents an impermissible situation (e.g. pumps).

Load torque monitoring functions

The converter monitors the torque of the motor in different ways:

1. No-load monitoring:
The converter generates a message if the motor torque is too low.
2. Blocking protection:
The converter generates a message if the motor speed cannot match the speed setpoint despite maximum torque.
3. Stall protection:
The converter generates a message if the converter control has lost the orientation of the motor.
4. Speed-dependent torque monitoring
The converter measures the actual torque and compares it with a parameterized speed/torque characteristic.

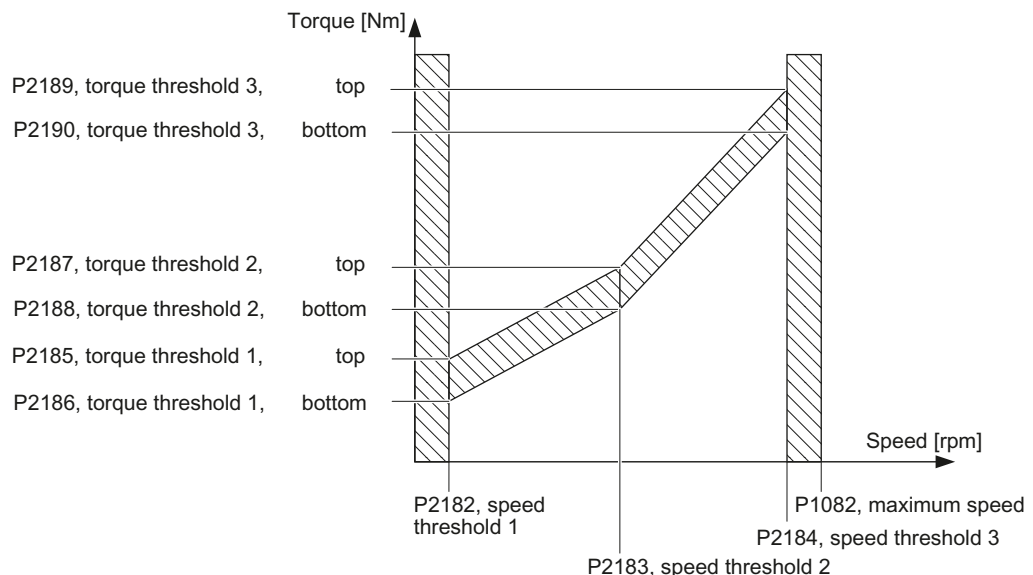

Table 7- 43 Parameterizing the monitoring functions

Parameter	Description
No-load monitoring	
P2179	Current limit for no-load detection If the converter current is below this value, the message "no load" is output.
P2180	Delay time for the "no load" message
Blocking protection	
P2177	Delay time for the "motor locked" message
Stall protection	
P2178	Delay time for the "motor stalled" message
P1745	Deviation of the setpoint from the actual value of the motor flux as of which the "motor stalled" message is generated This parameter is only evaluated as part of encoderless vector control.
Speed-dependent torque monitoring	
P2181	Load monitoring, response Setting the response when evaluating the load monitoring. 0: Load monitoring disabled >0: Load monitoring enabled
P2182	Load monitoring, speed threshold 1
P2183	Load monitoring, speed threshold 2
P2184	Load monitoring, speed threshold 3
P2185	Load monitoring torque threshold 1, upper
P2186	Load monitoring torque threshold 1, lower
P2187	Load monitoring torque threshold 2, upper
P2188	Load monitoring torque threshold 2, lower
P2189	Load monitoring torque threshold 3, upper
P2190	Load monitoring torque threshold 3, lower
P2192	Load monitoring, delay time Delay time for the message "Leave torque monitoring tolerance band"

For more information about these functions, see the List Manual (function diagram 8013 and the parameter list).

7.9.6 Load failure monitoring via digital input

Using this function, the inverter monitors the load failure of the driven machine, e.g. for fans or conveyor belts.

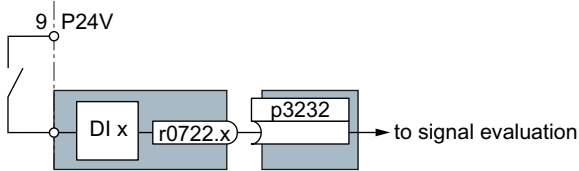

Figure 7-19 Load failure monitoring by means of a digital input

Table 7- 44 Setting load failure monitoring

Parameter	Description
p2193 = 1 ... 3	Load monitoring configuration (factory setting: 1) 1: Torque and load failure monitoring 2: Speed and load failure monitoring 3: Load failure monitoring
p2192	Load monitoring delay time (factory setting 10 s) If, after the motor is switched on, the "LOW" signal is present on the associated digital input for longer than this time, a load failure is assumed (F07936)
p3232 = 722.x	Load monitoring failure detection (factory setting: 1) Interconnect the load monitoring with a digital input of your choice.

For more information, see the List Manual (the parameter list and function diagram 8013).

7.9.7 Real time clock (RTC)

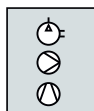

The real time clock is the basis for time-dependent process controls, e.g.:

- To reduce the temperature of a heating control during the night
- Increase the pressure of a water supply at certain times during the day

Real time clock: Format and commissioning

The real time clock starts as soon as the Control Unit power supply is switched on for the first time. The real time clock comprises the clock time in a 24 hour format and the date in the "day, month, year" format.

After a Control Unit power supply interruption, the real time clock continues to run for approx. five days.

If you wish to use the real time clock, you must set the time and date once when commissioning. If you restore the inverter factory setting, the real time clock parameters are not reset.

Parameter	Real time clock (RTC)
p8400[0]	RTC time , hour (0 ... 23)
p8400[1]	RTC time , minute (0 ... 59)
p8400[2]	RTC time , second (0 ... 59)
p8401[0]	RTC date , day (1 ... 31)
p8401[1]	RTC date , month (1 ... 12)
p8401[2]	RTC date , year (1 ... 9999)
r8404	RTC weekday 1: Monday 2: Tuesday 3: Wednesday 4: Thursday 5: Friday 6: Saturday 7: Sunday
p8405	RTC activate/deactivate alarm A01098 Sets whether the real time clock issues an alarm if the time is not running in synchronism (e.g. after a longer power supply interruption). 0: Alarm A01098 deactivated 1: Alarm A01098 activated

Accept the real time clock in the alarm and fault buffer

Using the real time clock, you can track the sequence of alarms and faults over time. When an appropriate message occurs, the real time clock is converted into the UTC time format (Universal Time Coordinated):

Date, time \Rightarrow 01.01.1970, 0:00 + d (days) + m (milliseconds)

The number "d" of the days and the number "m" of milliseconds is transferred into the alarm and fault times of the alarm or fault buffer, see Chapter Alarms, faults and system messages (Page 285).

Converting UTC into RTC

An RTC can again be calculated from the UTC. Proceed as follows to calculate a date and time from a fault or alarm time saved in the UTC format:

1. Calculate the number of seconds of UTC:
Number of seconds = ms / 1000 + days \times 86400
2. In the Internet, you will find programs to convert from UTC into RTC, e.g.:
UTC to RTC (<http://unixtime-converter.com/>)
3. Enter the number of seconds in the corresponding screen and start the calculation.

Example:

Saved as alarm time in the alarm buffer:

r2123[0] = 2345 [ms]

r2145[0] = 14580 [days]

Number of seconds = 2345 / 1000 + 14580 \times 86400 = 1259712002

Converting this number of seconds in RTC provides the date: 02.12.2009, 01:00:02.

7.9.8 Time switch (DTC)

The "time switch" (DTC) function, along with the real time clock in the inverter, offers the option of controlling when signals are switched on and off.

Examples:

- Day/night switching of a temperature control
- Switching a process control from weekday to weekend.

Principle of operation of the time switch (DTC)

The inverter has three independent parameterizable time switches. Using BICO technology, the time switch output can be interconnected with every binector of your inverter, e.g. a digital output or a technology controller's enable signal.

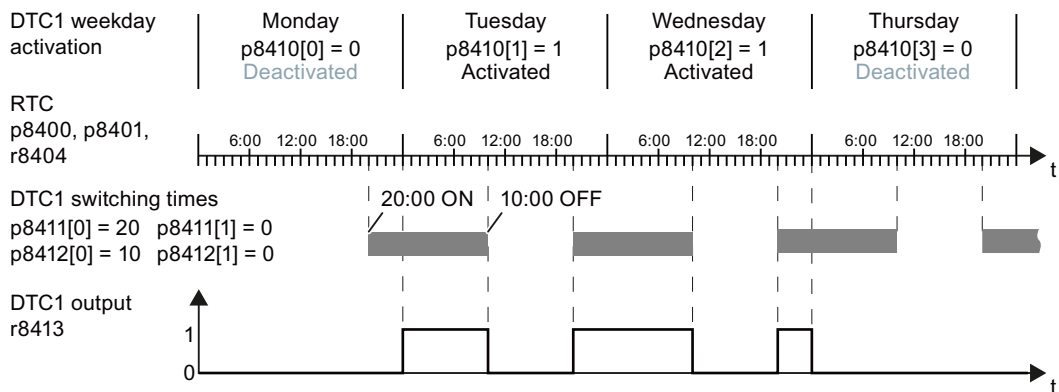

Figure 7-20 Time behavior of the time switch using example DTC1

Parameterizing the time switch

- Enable parameterization of the DTC: p8409 = 0.
As long as DTC parameterization is enabled, the inverter keeps the output of all three DTC (r84x3, x = 1, 2, 3) on LOW.
- Parameterize the activation of the weekdays; the switching on and off times.
- Enable the setting: p8409 = 1.
The inverter enables the DTC outputs once more.

Additional information is provided in the parameter list of the List Manual.

7.9.9 Temperature sensing using temperature-dependent resistors

Analog input AI 2

Analog input AI 2 can be used as a current input or resistance input for a temperature sensor. Both the DIP switch and parameter p0756.2 must be set accordingly for this purpose.

- P0756.2 = 2 or 3 -> options for setting as current input
- P0756.2 = 6, 7 or 8 -> options for setting as temperature sensor

Analog input AI 3

Analog input AI 3 is designed as a resistance input for a temperature sensor.

Setting options:

- P0756.3 = 6, 7 or 8 -> options for setting as temperature sensor

Permissible temperature sensors

The temperature-dependent PT1000 or NI1000 resistors can be used as sensors. The values of these sensors are supplied via analog input AI 2 or AI 3 (p2264 = 756.2 or 756.3) as actual values for the technology controller.

The connection is established at AI 2 (terminals 50, 51) or AI 3 (terminals 52, 53).

Measuring ranges and alarm thresholds for NI1000

The measuring range of the NI1000 sensors extends from – 88 °C ... 165 °C. For values outside this range, the inverter outputs alarm A03520 "Temperature sensor fault". The fault type is displayed in r2124.

Measuring ranges and alarm thresholds for PT1000

The measuring range of the PT1000 sensors extends from – 88 °C ... 240 °C. For values outside this range, the inverter outputs alarm A03520 "Temperature sensor fault". The fault type is displayed in r2124.

Fault values for temperature sensing via AI 2

- r2124 = 33: Wire break or sensor not connected
- r2124 = 34: Short-circuit

Fault values for temperature sensing via AI 3

- r2124 = 49: Wire break or sensor not connected
- r2124 = 50: Short-circuit

Note

If a temperature sensor is used as an input for the PID controller, the scaling of the analog input must be adjusted.

- Scaling example for NI1000:
0 °C (p0757) = 0 % (p0758); 100 °C (p0759) = 100 % (p0760)
 - Scaling example for PT1000:
0 °C (p0757) = 0 % (p0758); 100 °C (p0759) = 80 % (p0760)
-

Please refer to the parameter list for more details.

7.9.10 Essential service mode

The **Essential Service Mode (ESM)** function ensures that when required, the motor is operated for as long as possible so that, for example, smoke gases can be extracted or people affected by a fire can escape.

Application example

In order to improve air circulation in stairwells, frequently, a slight underpressure is generated using ventilation control. With this control, a fire would mean that smoke gases enter into the stairwell. This would then mean that the stairway would be blocked as escape or evacuation route.

Using the Essential Service Mode function, the ventilation switches over to control an overpressure. This prevents the propagation of smoke gases in the stairwell, thereby keeping the stairs free as an escape route.

Activating the essential service mode function

The essential service mode is activated by interconnecting p3880 with a digital input of your choice. Example: If you wish to activate the essential service mode with the digital input, set p3880 = 722.3.

Note

Command source for the essential service mode

We recommend that the digital input for the essential service mode is not logically combined with any other functions.

- The setting of the source for the essential service mode via p3880 is always referred to the data set that is currently active.
- The essential service mode can only be switched on precisely from one source.

The last setpoint recognized is taken as the emergency setpoint in the factory setting. You can use p3881 to define another value:

- P3881 = 0: Last recognized setpoint (factory setting)
- P3881 = 1: Fixed setpoint 15
- P3881 = 2: Analog setpoint
- P3881 = 3: Fieldbus
- P3881 = 4: Technology controller

If you specify the emergency setpoint via the analog setpoint, fieldbus or technology controller, you must ensure the appropriate monitoring so that an alternative setpoint can be used in the event of failure.

Possible forms of monitoring for the different setpoint sources:

- Analog setpoint: Using F03505
- Fieldbus status in r2043
- Technology controller r2349

You will find additional details on this in the List Manual in the function diagrams for essential service mode, setpoint channel and technology controller.

When in the factory setting, if the setpoint is lost, the drive continues using the last recognized setpoint. p3882 can be used to switch to the following values:

- P3882 = 0: Last recognized setpoint (factory setting)
- p3882 = 1: Fixed speed setpoint which is defined in p1015
- p3882 = 2: Maximum speed (value of p1082)

Note**Technology controller as setpoint source for the emergency operation setpoint**

For the technology controller to be able to specify the emergency setpoint, it must be activated (p2200 = 1) and set as the main setpoint (p2251 = 0).

Direction of rotation in the essential service mode

- Emergency setpoint using p3881 = 0, 1, 2, 3

Depending on your system, you may have to invert the setpoint locally for the essential service mode. The customer can therefore use p3883 to determine the direction of rotation of the emergency setpoint. To do this, p3883 must be linked with a free digital input, e.g. p3883 = r722.12.

- p3883 = 0 -> normal emergency direction of rotation,
- p3883 = 1 -> inverted emergency direction of rotation.

- Emergency setpoint using p3881 = 4

If the emergency setpoint is specified using the technology controller, it is depicted using variables within the process and depends on these. Inversion using a digital input is therefore locked in such cases and must be implemented in the technology controller.

Bypass operation in the essential service mode

- If the motor is running in bypass operation when the emergency happens, the user must query the "Bypass control/status word" (r1261) and make an appropriate interconnection to ensure that the motor is switched to the inverter and continues to run with the emergency setpoint.
- If the inverter has failed in the essential service mode because of an internal fault and if it cannot be switched back on using the automatic restart function, the user can interconnect bit 7 of the status word for the automatic restart (r1214.7) with p1266 to operate the motor directly on line. You will find additional information about bypass operation in section Bypass (Page 265).

Special features of the essential service mode

- The automatic restart function is internally activated – independent of the setting of p1210 – as soon as the essential service mode kicks in. This results in the inverter being restarted if a pulse inhibit (OFF2) occurs due to an internal fault.
- In the essential service mode, inverter shutdown due to faults is suppressed, with the exception of faults that would lead to the destruction of the inverter. You will find a list of these faults in Section Essential service mode (Page 252).
- The essential service mode is triggered by a continuous signal (level-triggered) using the digital input which was defined in p3880 as the source for the essential service mode.
- In the essential service mode, the motor can only be stopped if the line voltage is switched off.
- If the essential service mode is deactivated, the inverter reverts to normal operation and its behavior depends on the pending commands and setpoints.
- The essential service mode has priority over other operating modes

NOTICE
Loss of warranty for an inverter in the essential service mode
In the case of the essential service mode, the customer can no longer lodge any claims for warranty. The essential service mode and the faults that arise while in the essential service mode are logged in a password protected memory and can be read by the repair center.

Refer to parameters p3880 ... r3889 for more information on the essential service mode.

Note

Other preconditions for the essential service mode

In order to operate the inverter in the emergency service mode, the appropriate degrees of protection and connection and installation guidelines applicable to the system should be observed. You will find details of this in the Australian Standard: AS/NZS 1668.1:1998.

Table 7- 45 Parameters that are required to set the essential service mode

Parameter	Description
Setting the source for the essential service mode	
p3880 = 722.3	ESM activation (here, via DI3, high-active) Signal source for activating the essential service mode 722.x for high active, 723.x for low active
Additional parameters to set the essential service mode	
p3881	ESM setpoint source, 0 ... 4
p3882	ESM substitute setpoint source Setpoint should the parameterized ESM setpoint be lost
p3883	ESM direction of rotation Signal source for direction of rotation in the essential service mode, is not evaluated when p3881 = 4
p3884	ESM setpoint technology controller If p3884 is not connected up, then the technology controller uses the main setpoint corresponding to p2251 = 0.
r3887	ESM: Number of activations and faults Indicates how frequently ESM has been activated (index 0) and how many faults occurred during ESM (index 1).
p3888	ESM: Reset the number of activations and faults p3888 = 1 resets 3887[0] and 3887[1].
r3889	ESM status word

Faults, which are not ignored when operating in the essential service mode

- F01000 Internal software error
- F01001 Floating Point Exception
- F01002 Internal software error
- F01003 Time-out for memory access
- F01015 Internal software error
- F01040 Back up parameters and perform a POWER ON
- F01044 Error in description data
- F01205 Time slice overflow
- F01512 BICO: No scaling
- F01662 Error, internal communications
- F07901 Drive: Motor overspeed
- F30001 Power unit: Overcurrent
- F30002 Power unit: DC-link voltage overvoltage
- F30003 Power unit: DC-link voltage undervoltage
- F30004 Power unit: Overtemperature heatsink inverter
- F30005 Power unit: Overload I2t
- F30017 Power unit: Hardware current limit has responded too often
- F30021 Power unit: Ground fault

7.9 Application-specific functions

F30024	Power unit: Overtemperature, thermal model
F30025	Power unit: Chip overtemperature
F30027	Power unit: Time monitoring for DC link pre-charging
F30036	Power unit: Overtemperature, inside area
F30071	No new actual values received from the Power Module
F30072	Setpoints can no longer be transferred to the Power Module
F30105	PU: Actual value sensing error
F30662	Internal communication error
F30664	Fault during power-up
F30802	Power unit: Time slice overflow
F30805	Power unit: EPROM checksum not correct
F30809	Power unit: Switching information invalid

7.9.11 Multi-zone control

Multi-zone control is used to control quantities such as pressure or temperature via the technology setpoint deviation. The setpoints and actual values are fed in via the analog inputs as current (0 ... 20 mA) or voltage (0 ... 10 V) or as a percentage via temperature-dependent resistances (NI1000 / PT1000, 0 °C = 0 %; 100 °C = 100 %).

Control variants for multi-zone control

There are three control variants for multi-zone control, which are selected via p31021:

- **One setpoint and one, two or three actual values**

The actual value for the control can be calculated as mean value, maximum value or minimum value. You can find all of the setting options in the parameter list in parameter p31022.

- Average value: The deviation from the setpoint of the average value of two or three actual values is controlled.
- Minimum value: The deviation from the setpoint of the smallest actual value is controlled.
- Maximum value: The deviation from the setpoint of the highest actual value is controlled.

- **Two setpoint/actual value pairs as maximum value control (cooling)**

The maximum value control compares two setpoints/actual value pairs and controls the actual value which has the largest deviation upwards from its associated setpoint. No control takes place if both actual values lie below their setpoints.

In order to avoid frequent changeover, the inverter only switches over if the deviation of the controlled setpoint-actual value pair is more than two percent lower than the deviation of the uncontrolled value pair.

- **Two setpoint/actual value pairs as minimum value control (heating)**

The minimum value control compares two setpoints/actual value pairs and controls the actual value, which has the highest deviation downwards from its associated setpoint. No control takes place if both actual values lie above their setpoints.

In order to avoid frequent changeover, the inverter only switches over if the deviation of the controlled setpoint-actual value pair is more than two percent lower than the deviation of the uncontrolled value pair.

Day and night switching

Using a **day/night changeover** other setpoints can be entered for specific times. The day/night changeover control can be realized e.g. using an external signal via DI4 or using free blocks and the real time clock via p31025.

Note

When the multi-zone control is activated, the analog inputs are newly interconnected as sources for the setpoint and actual value of the technology controller (see table).

Table 7- 46 Parameters to set the multi-zone control:

Parameter	Description				
p2200 = ...	Technology controller enable				
p2251	Set technology controller as main setpoint				
P31020 = ...	<p>Multi-zone control interconnection (factory setting = 0) A subsequent parameterization is performed by activating or deactivating the multi-zone control.</p> <table border="1"> <tr> <td>Subsequent connection for p31020 = 1 (activate multi-zone control)</td> <td>Subsequent connection for p31020 = 0 (deactivate multi-zone control)</td> </tr> <tr> <td> p31023[0] = 0755.0 (AI0) p31023[2] = 0755.1 (AI1) p31026[0] = 0755.2 (AI2) p31026[1] = 0755.3 (AI3) p2253 = 31024 (setpoint output, technology controller) p2264 = 31027 (actual value output, technology controller) </td> <td> p31023[0] = 0 p31023[2] = 0 p31026[0] = 0 p31026[1] = 0 p2253 = 0 p2264 = 0 </td> </tr> </table>	Subsequent connection for p31020 = 1 (activate multi-zone control)	Subsequent connection for p31020 = 0 (deactivate multi-zone control)	p31023[0] = 0755.0 (AI0) p31023[2] = 0755.1 (AI1) p31026[0] = 0755.2 (AI2) p31026[1] = 0755.3 (AI3) p2253 = 31024 (setpoint output, technology controller) p2264 = 31027 (actual value output, technology controller)	p31023[0] = 0 p31023[2] = 0 p31026[0] = 0 p31026[1] = 0 p2253 = 0 p2264 = 0
Subsequent connection for p31020 = 1 (activate multi-zone control)	Subsequent connection for p31020 = 0 (deactivate multi-zone control)				
p31023[0] = 0755.0 (AI0) p31023[2] = 0755.1 (AI1) p31026[0] = 0755.2 (AI2) p31026[1] = 0755.3 (AI3) p2253 = 31024 (setpoint output, technology controller) p2264 = 31027 (actual value output, technology controller)	p31023[0] = 0 p31023[2] = 0 p31026[0] = 0 p31026[1] = 0 p2253 = 0 p2264 = 0				
P31021 = ...	<p>Configuration of multi-zone control</p> <ul style="list-style-type: none"> • 0 = Setpoint 1 / several actual values (factory setting) • 1 = Two zones / maximum value setting • 2 = Two zones / minimum value setting 				
p31022 = ...	<p>Processing of actual values for multi-zone control(only for p31021 = 0) Possible values: 0 ... 11 (factory setting = 0)</p>				
p31023[0 ... 3] = ...	<p>Setpoints for multi-zone control Parameters for selecting the source for setpoints in multi-zone control (factory setting = 0)</p>				
r31024 = ...	<p>Multi-zone control setpoint output for technology controller CO parameters</p>				
p31025 = ...	<p>Day/night changeover for multi-zone control Parameter for selecting the source for day/night changeover of the multi-zone control (factory setting = 0)</p>				
p31026[0 ... 2] = ...	<p>Actual values for multi-zone control Parameters for selecting the source for actual values of the multi-zone control (factory setting = 0)</p>				
r31027 = ...	<p>Multi-zone control actual value output for technology controller CO parameters</p>				

Note

Please note that when multi-zone control is activated, any BiCo interconnections present for analog inputs and for the technology controller's setpoint and actual value are cancelled and interconnected with the links defined in the factory.

When you deactivate multi-zone control, the associated BiCo interconnections are cancelled.

Example

The temperature in a large office is measured at three points and transferred to the inverter using analog inputs. NI1000 temperature sensors are used as actual value sensors. The setpoint temperature is specified via the analog input 0 and can be set in the range from 8 °C ... 30 °C by a controller. Overnight the average temperature should be 16 °C.

Parameter settings

p2200.0 = 1	Technology controller enable
p2251 = 0	Set technology controller as main setpoint
p2900.0 = 16	Temperature setpoint overnight as a fixed value in %.
p31020 = 1	Activate multi-zone control
p31021 = 0	Select multi-zone control with one setpoint and three actual values
p31022 = 7	Three actual values, one setpoint. The average value of the three actual values is used for the control.
p31023.0 = 755.0	Temperature setpoint via analog input 0
p0756.0 = 0	Select analog input type (voltage input 0 ... 10 V)
p0757.0 = 0 / p0758.0 = 8	Set the lower value to 8 °C (0 V Δ 8 °C)
p0759.0 = 10 / p0760.0 = 30	Set the upper value to 30 °C (10 V Δ 30 °C)
p31023.1 = 2900.0	Supply p31023.1 with the value written in P2900 to reduce the temperature overnight
p31026.0 = 755.2	Temperature actual value 1 via analog input 2 as a %
p0756.2 = 6	Select analog input type (temperature sensor Ni1000)
p0757.2 = 0 / p0758.2 = 0	Set lower value of the scaling characteristic
p0759.2 = 100 / p0760.2 = 100	Set upper value of the scaling characteristic
p31026.1 = 755.3	Temperature actual value 2 via analog input 3 as a %
p0756.3 = 6	Select analog input type (temperature sensor Ni1000)

7.9 Application-specific functions

p0757.3 = 0 / p0758.3 = 0	Set lower value of the scaling characteristic
p0759.3 = 100 / p0760.3 = 100	Set upper value of the scaling characteristic
p31026.2 = 755.1	Temperature actual value 3 via temperature sensor with current output (0 mA ... 20 mA) via analog input 1
p0756.1 = 2	Select analog input type (current input 0 ... 20 mA)
p0757.1 = 0 / p0758.1 = 0	Set lower value of the scaling characteristic (0 mA \pm 0 °C)
p0759.1 = 20 / p0760.1 = 100	Set upper value of the scaling characteristic (20 mA \pm 100 %)
p31025 = 722.4	Changeover from day to night via digital input 4

You will find more information about this multi-zone control in the parameter list and in (function diagram 7972 of the List Manual).

7.9.12 Cascade control

The cascade control function is used in applications that require between one and four motors to be run at the same time depending on load, so that e.g. highly variable pressure ratios or flow volumes can be corrected.

Cascade control consists of the speed-controlled main drive and up to three other drives that are switched-on or switched-off via contactors or motor starters, either in a fixed arrangement or dependent on the operating hours.

The PID deviation serves as the input signal for activating the other motors. The contactors or motor starters are switched by the inverter's digital outputs.

Note

Technology controller as main setpoint

For cascade control, the main setpoint must be entered via the technology controller (p2251 = 0, p2200 = 1).

Operating principle

- **Switching-in external motors**

If the main drive is run at maximum speed and the deviation on the technology controller input continues to increase, the control also switches the external motors on the line. At the same time, the main drive is ramped down to the switch-on/switch-off speed (p2378) to keep the total output power as constant as possible. The technology controller is deactivated while ramping down to the switch-on/switch-off speed.

- **Shutting down external motors**

If the main drive is running at minimum speed and the deviation on the technology controller input continues to decrease, the control switches external motors M1 to M3 off the line. The main drive is simultaneously ramped-up to the switch-on/switch-off speed to keep the total output power as constant as possible.

To avoid frequent activation/deactivation of the uncontrolled motors, a time can be specified in p2377 which must have elapsed before a further motor can be activated/deactivated. After the time set in p2377 has elapsed, a further motor will be activated immediately if the PID deviation is greater than the value set in p2376. If, after p2377 has elapsed, the PID deviation is smaller than p2376 but greater than p2373, the timer p2374 is started before the uncontrolled motor is activated.

The motors are deactivated in the same way.

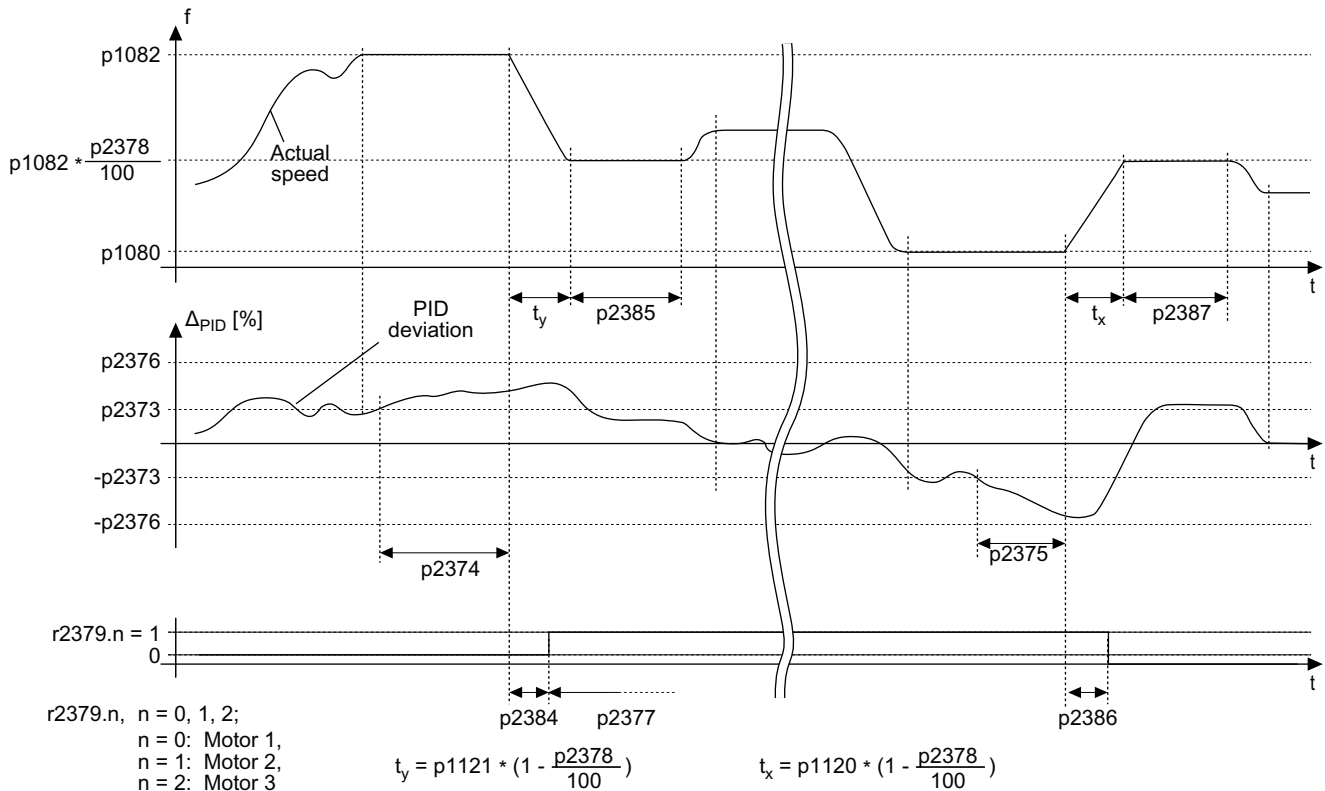

The diagram shows the conditions for activating/deactivating an uncontrolled motor

Controlling the activation and deactivation of motors

Use p2371 to determine the order of activation/deactivation for the individual external motors.

Table 7- 47 Order of activation for external motors depending on setting in p2371

p2371	Significance	Stage 1	Stage 2	Stage 3	Stage 4	Stage 5	Stage 6
0	Cascade control deactivated	---					
1	One motor can be activated	M1					
2	Two motors can be activated	M1	M1+M2				
3	Two motors can be activated	M1	M2	M1+M2			
4	Three motors can be activated	M1	M1+M2	M1+M2+M3			
5	Three motors can be activated	M1	M3	M1+M3	M1+M2+M3		
6	Three motors can be activated	M1	M2	M1+M2	M2+M3	M1+M2+M3	
7	Three motors can be activated	M1	M1+M2	M3	M1+M3	M1+M2+M3	
8	Three motors can be activated	M1	M2	M3	M1+M3	M2+M3	M1+M2+M3

Table 7- 48 Order of deactivation for external motors depending on setting in p2371

p2371	Activated motors	Stage 1	Stage 2	Stage 3	Stage 4	Stage 5	Stage 6
1	M1	M1					
2	M1+M2	M1+M2	M1				
3	M1+M2	M1+M2	M2	M1			
4	M1+M2+M3	M1+M2+M3	M1+M2	M1			
5	M1+M2+M3	M1+M2+M3	M3+M1	M3	M1		
6	M1+M2+M3	M1+M2+M3	M3+M2	M2+M1	M2	M1	
7	M1+M2+M3	M1+M2+M3	M3+M1	M3	M2+M1	M1	
8	M1+M2+M3	M1+M2+M3	M3+M2	M3+M1	M3	M2	M1

If you are using motors of the same power rating, you can use p2372 to define whether the motors are to be activated/deactivated following the setting specified in p2371 (p2372 = 0) or based on the operating hours (p2372 = 1, 2 ,3. Details see parameter list).

Parameters to set and activate the cascade control:

p0730 = r2379.0	Signal source for digital output 0 Control external motor 1 via DO 0
p0731 = r2379.1	Signal source for digital output 1 Control external motor 2 via DO 1
p0732 = r2379.2	Signal source for digital output 2 Control external motor 3 via DO 2
p2200 = 1	Technology controller enable Activate technology controller
p2251 = 0	Technology controller mode Technology controller as main speed setpoint
p2370	Cascade control - enable Signal source for staging on/off
p2371	Cascade control- configuration Activate staging and define switch-on sequence
p2372	Cascade control - motor selection mode Define automatic motor switch-on
p2373	Cascade control - switch-in threshold Define switch-on threshold
p2374	Cascade control - switch-in delay Define delay time
p2375	Cascade control switch-off delay Define delay time for destaging
p2376	Cascade control - overcontrol threshold Define overcontrol threshold
p2377	Cascade control - interlock time Define interlock time
p2378	Cascade control - switch-on/switch-off speed Defining the speed for the main drive after switching-on/switching-off a motor
r2379	Cascade control - status word
p2380	Cascade control - operating hours
p2381	Cascade control - maximum time for continuous mode
p2382	Cascade control - absolute operating time limit
p2383	Cascade control - switch-off sequence Define switch-off sequence for an OFF command
p2384	Cascade control - motor switch-on delay Define motor switch-on delay
p2385	Cascade control - switch-in speed hold time Define speed hold time after switching-in of an external motor
p2386	Cascade control - motor switch-off delay Define motor switch-off delay
p2387	Cascade control - switch-off speed hold time Define speed hold time after switching-off of an external motor

For more information about the parameters, see the List Manual.

7.9.13 Bypass

In the bypass function, the motor is either operated by the inverter or directly on the line.

The bypass control can either be realized depending on the speed via the inverter or independently of the speed via a signal from the inverter or via a higher-level control.

If the bypass is controlled by a higher-level control, the control must lock the contactors so they cannot switch on at the same time.

If controlled by inverter, the digital outputs are used to activate two contactors via which the motor is powered. The inverter is provided with contactor position feedback via the digital inputs. This is evaluated. If using direct connection logic (high level = ON), both contactors should be NO contacts.

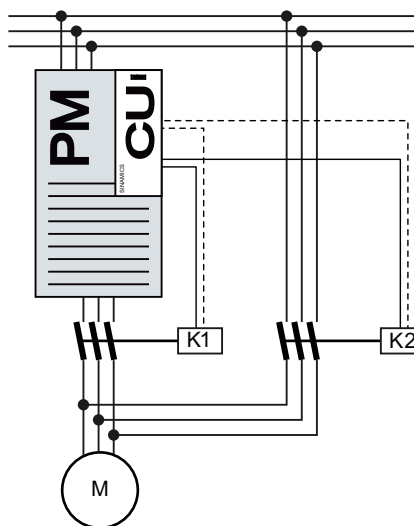

- Control via digital outputs (DO)
- - - - Feedback via digital inputs (DI)
- K1 Contactor for inverter operation
- K2 Contactor for bypass operation

Bypass circuit for control using the inverter

Note

Flying restart must be activated for the bypass function (p1200 = 1 or 4).

NOTICE

Bypass operation in the essential service mode

The special features for bypass operation in the essential service mode are described in Section Essential service mode (Page 252).

Changeover operation between line and inverter operation

At changeover to line operation, contactor K1 is opened (after the inverter pulses have been inhibited). The system then waits for the motor de-excitation time to elapse, after which contactor K2 is closed, connecting the motor directly to the line supply.

When the motor is switched to the line supply, an equalizing current flows that must be taken into account when the protective equipment is selected and dimensioned.

When changing over to inverter operation, initially contactor K2 must be opened and after the de-excitation time, contactor K1 is closed. The inverter then captures the rotating motor and the motor is operated on the inverter.

Bypass function when activating via a control signal (p1267.0 = 1)

The status of the bypass contactors is evaluated when the inverter is switched on. If the automatic restart function is active (p1210 = 4) and an ON command (r0054.0 = 1) as well as the bypass signal (p1266 = 1) are still present at power up, then after power up, the inverter goes into the "ready and bypass" state (r899.0 = 1 and r0046.25 = 1) and the motor continues to run directly connected to the line supply.

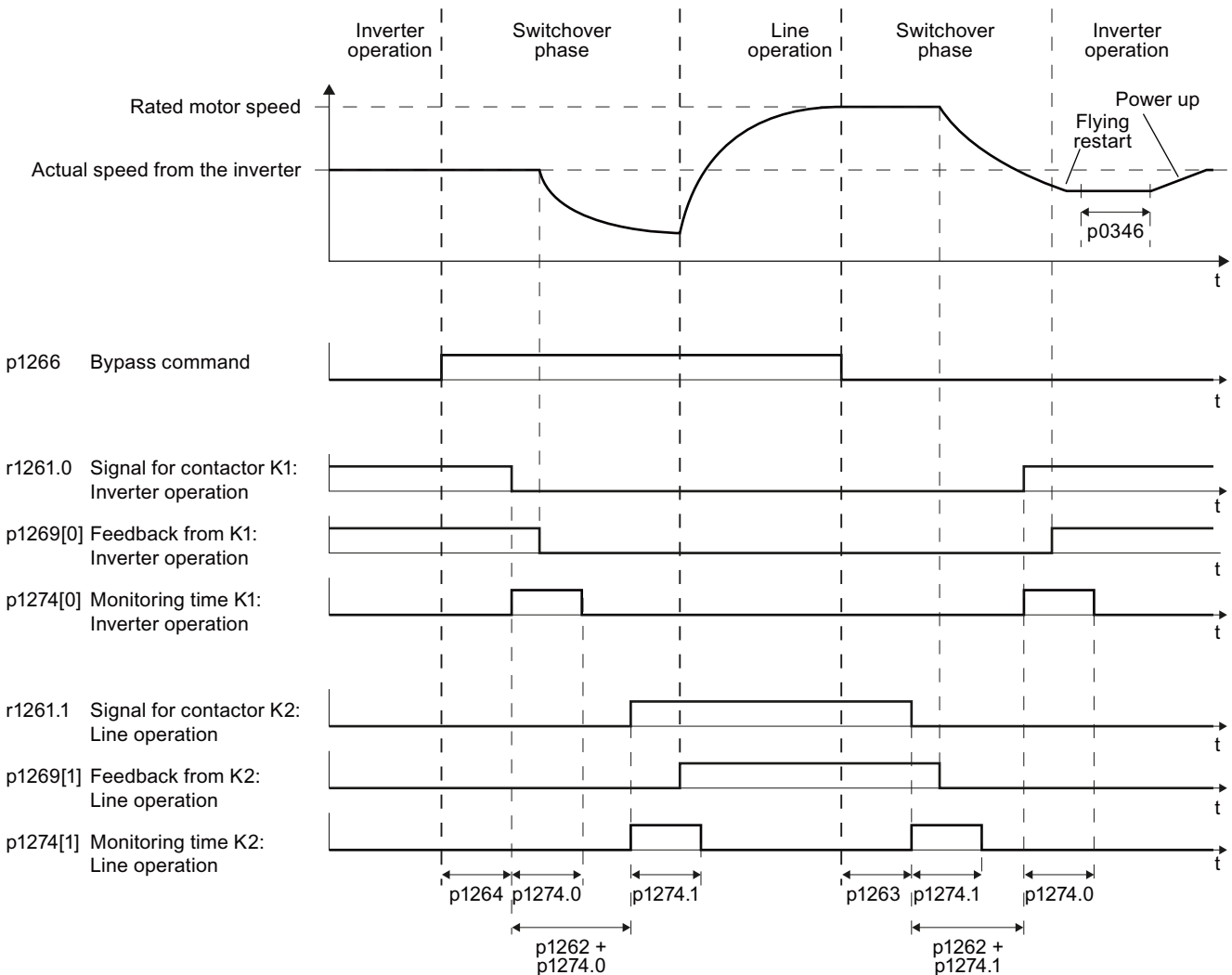

Figure 7-21 Bypass control independent of the speed via a control signal (p1267.0 = 1)

Bypass function is dependent on the speed (p1267.1 = 1)

With this function, changeover to line operation is realized corresponding to the following diagram, if the setpoint lies above the bypass threshold.

If the setpoint falls below the bypass threshold, the inverter captures the motor and the motor is fed from the inverter.

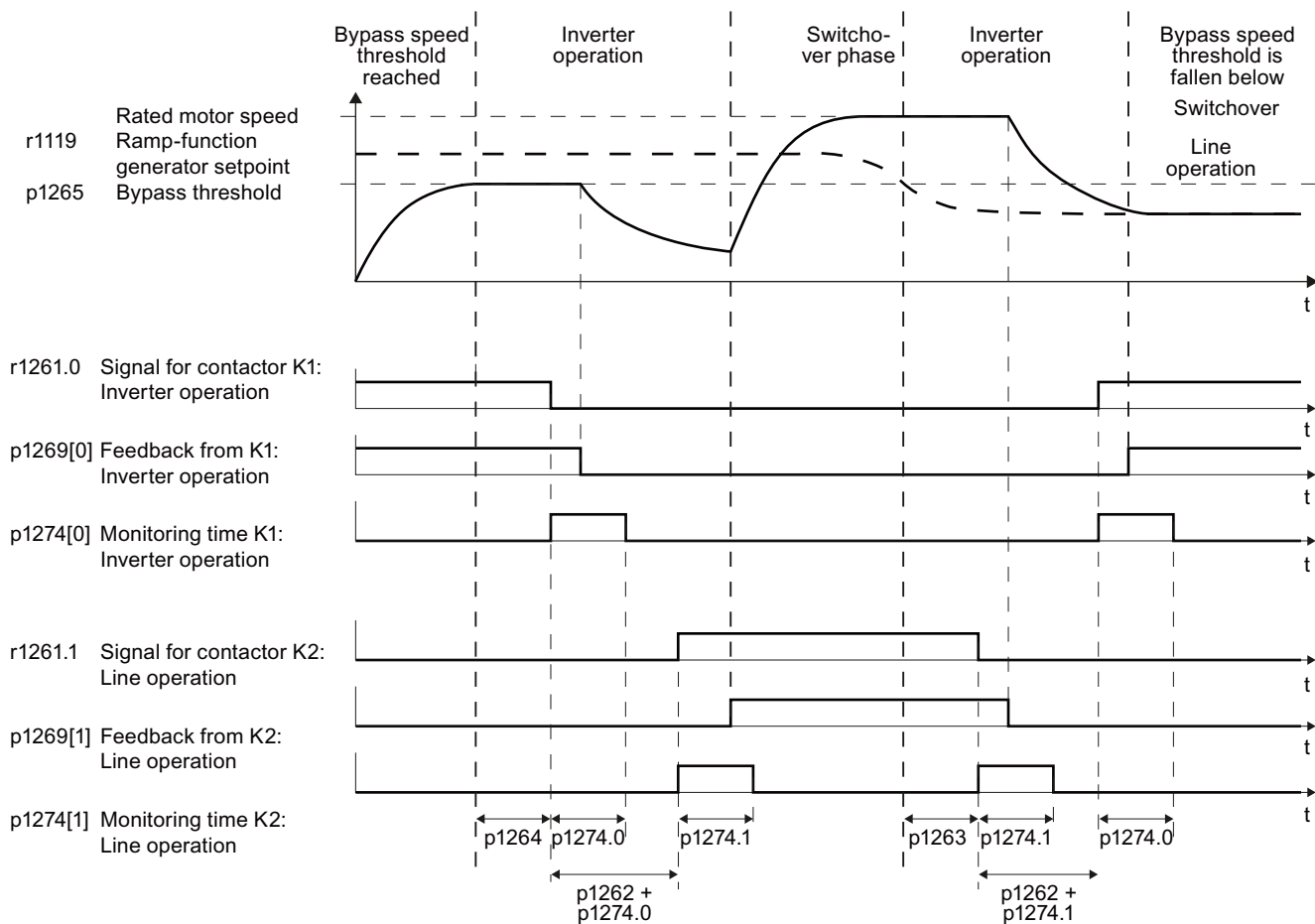

Figure 7-22 Switchover behavior from inverter to line operation dependent on the speed

General properties of the bypass function

- y
- Contactors K1 and K2 must be mutually interlocked so that they cannot close at the same time.

Shutdown behavior in bypass operation

- If the motor is in the bypass mode, it cannot be shutdown with OFF 1. The motor coasts down after an OFF2 or OFF3.
- If the motor is running in the bypass mode and the inverter is disconnected from the line supply, then also the bypass contactor does not receive control signals from the inverter and the motor coasts down. If the motor is to continue running once the inverter is switched off, the signal for the bypass contactor must therefore come from the higher-level control.

Temperature monitoring and overload protection in the bypass mode

- If the motor is running in the bypass mode, while the inverter is in the "ready and bypass" state (r899.0 = 1 and r0046.25 = 1), then the motor temperature monitoring via the temperature sensor is active.
- If the motor is running in the bypass mode, while the inverter is in the "ready and bypass" state (r899.0 = 1 and r0046.25 = 1), then the overload protection for the motor must be realized on the plant or system side.

Parameters for setting the bypass function

Parameter	Description
p1260	Bypass configuration Activating the bypass function
r1261	Bypass control/status word Control and feedback signals for the bypass function.
p1262	Bypass dead time Changeover time for contactors. This should be longer than the motor's demagnetizing time!
p1263	Debypass delay time Delay time for switching back to inverter operation.
p1264	Bypass delay time Delay time for switching to bypass operation.
p1265	Bypass speed threshold Speed threshold for switching to bypass operation.
p1266	Bypass control command Signal source for switching to bypass operation.
p1267	Bypass changeover source configuration Switch to bypass operation using speed threshold or control signal.
p1269	Bypass switch feedback Signal source for contactor feedback for the bypass mode.
p1274	Bypass switch monitoring time Monitoring time setting for bypass contactors.

For more details about parameters, please refer to the List Manual.

7.9.14 Energy-saving mode

The energy-saving mode is mainly used for pumps and fans. Typical applications include pressure and temperature controls.

In the energy-saving mode, the inverter stops and starts the motor depending on the system conditions. The energy-saving mode can be activated via the technology controller (without external commands via terminals or bus interface) and via an external setpoint input.

The energy-saving mode offers the advantages of energy saving, lowering mechanical wear and reduced noise.

Note

In the energy-saving mode, if the setpoint is to be entered from the motorized potentiometer or from the motorized potentiometer of the technology controller, you must set p1030.4 or p2230.4 = 1.

NOTICE
After the inverter has been powered up, the motor goes into the energy-saving mode if the energy-saving mode start speed has still not been reached after the highest value from p1120 (ramp-up time), p2391 (energy-saving mode delay time) and 20 s have expired.

Operating principle

The energy-saving mode starts as soon as the motor speed drops below the energy-saving mode start speed. However, the motor is only switched off after an adjustable time has expired. If, during this time, the speed setpoint increases above the energy-saving mode start speed due to pressure or temperature changes, the energy-saving mode is exited and the inverter goes into normal operation.

In the energy-saving mode, the motor is shut down; however, the speed setpoint and/or the technology controller deviation are/is monitored.

- **For an external setpoint input (without technology controller) the speed setpoint is monitored** and the motor is switched-on again as soon as the setpoint increases above the restart speed. The restart speed is calculated as follows: Restart speed = P1080 + p2390 + p2393.

In the factory setting, the positive speed setpoint is monitored, i.e. the motor is switched on as soon as the setpoint exceeds the restart speed.

If the negative speed setpoint is also to be monitored, the value of the setpoint must be monitored. This can be set using p1110 = 0.

Additional setting options are described in the parameter list, in function diagrams 3030 and 3040 as well as in the associated parameter descriptions.

- **When the setpoint is entered from the technology controller, the technology controller deviation (r2273) is monitored** and the motor is switched-on if the deviation of the technology controller exceeds the energy-saving mode restart value (2392).

In the factory setting, only the positive deviation of the technology controller is monitored, i.e. the motor is switched on as soon as the technology controller deviation is greater than the energy-saving mode restart value (p2392).

If the motor should also switch back on for negative technology controller deviation, the value of the deviation must be monitored.

In this case p2298 = 2292 must be set. The percentage value for the minimum limit can be specified in p2292.

Additional setting options are provided in the parameter list in function diagram 7958 and in the associated parameter descriptions.

In order to prevent frequent starts and stops, the speed may be boosted for a short time before shutdown (boost). This function can be disabled by setting the boost time (p2394) to 0.

To avoid tank deposits, particularly where liquids are present, it is possible to exit the energy-saving mode after an adjustable time (p2396) has expired and switch to normal operation.

The parameter settings required for the respective variant can be found in the following tables.

Energy-saving mode with setpoint input using the internal technology controller

In this operating mode, the technology controller must be activated as the setpoint source (p2200) and used as the main setpoint (p2251). The function can be operated both with and without boost.

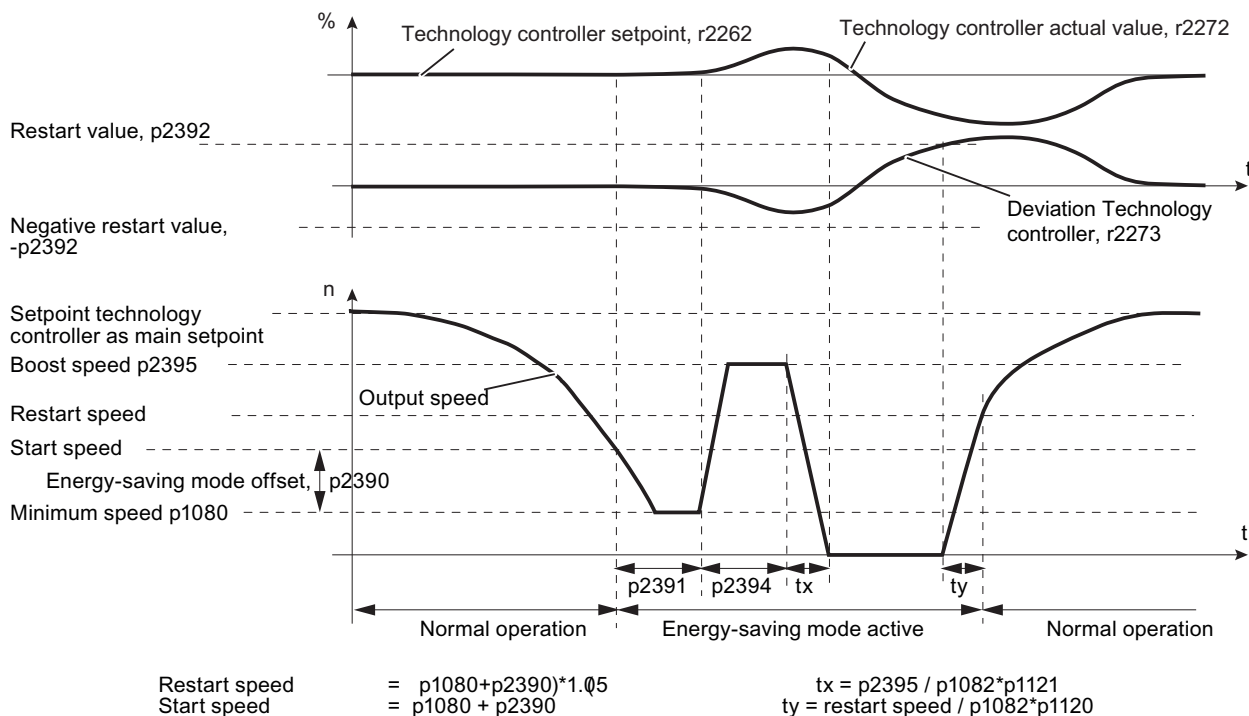

Figure 7-23 Energy-saving mode using the technology setpoint as the main setpoint with boost

Energy-saving mode with external setpoint input

In this operating mode, the setpoint is specified by an external source (e.g. a temperature sensor); the technology setpoint can be used here as a supplementary setpoint.

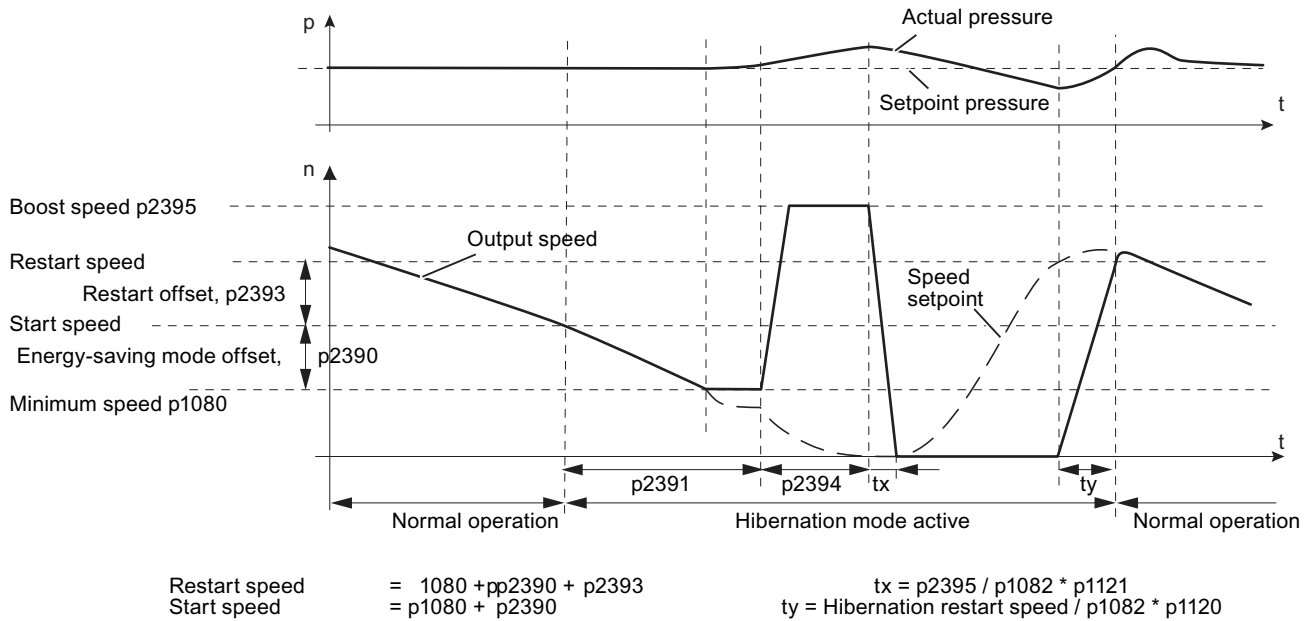

Figure 7-24 Energy-saving mode using an external setpoint with boost

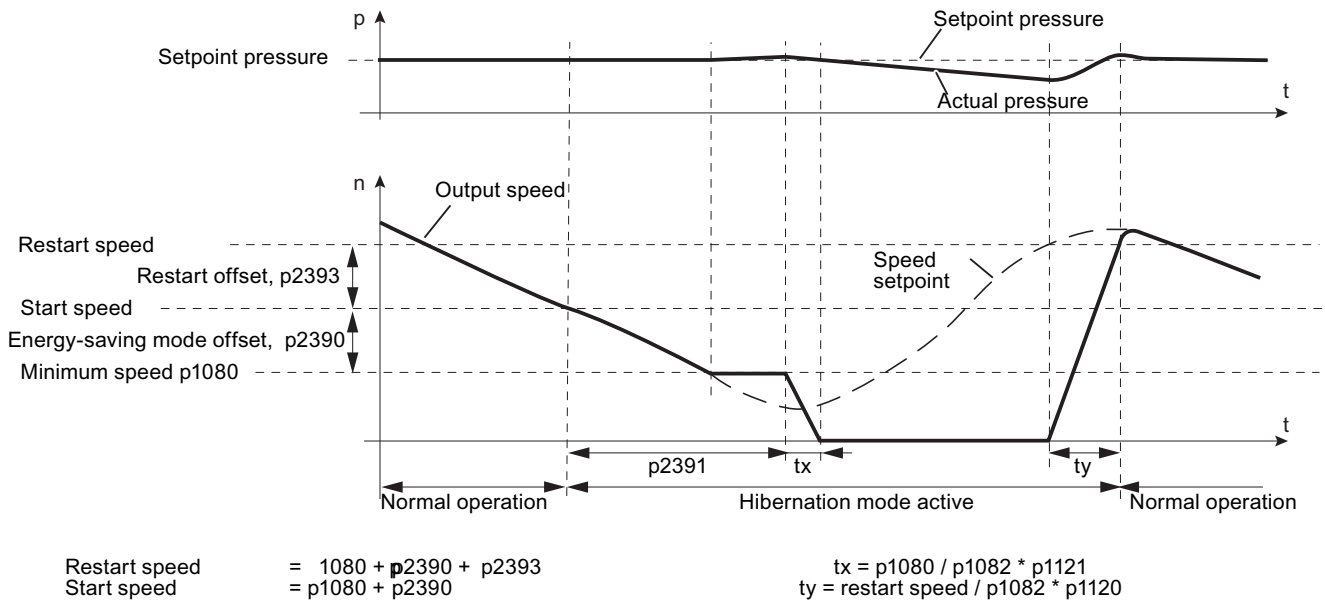

Figure 7-25 Energy-saving mode using an external setpoint without boost

Adjustable parameters for the energy-saving mode function

Table 7- 49 Main function parameters

Parameter	Description	Via tech. setpoint	Via external setpoint
P1080 = ...	Minimum speed 0 (factory setting) ... 19500 rpm. Lower limit of the motor speed is independent of the speed setpoint.	x	x
P1110 = ...	Block negative direction Parameter to block the negative direction	-	x
P2200 = ...	Technology controller enable 0: Technology controller deactivated (factory setting), 1: Technology controller activated	x	-
P2251 = 1	Technology controller mode 0: Technology controller as main setpoint (factory setting), 1: Technology controller as supplementary setpoint	x	-
p2298 = ...	Technology controller minimum limiting Parameter for the minimum limiting of the technology controller	x	-
P2398 = ...	Energy-saving operating mode 0: Energy-saving mode inhibited (factory setting) 1: Energy-saving mode enabled	x	x
P2390 = ...	Energy-saving mode start speed 0 (factory setting) ... 21000 rpm. As soon as this speed is fallen below, the energy-saving mode delay time starts and switches-off the motor once it expires. The energy-saving mode start speed is calculated as follows: Start speed = P1080 + p2390 P1080 = minimum speed p2390 = energy-saving mode start speed.	x	x
P2391 = ...	Energy-saving mode delay time 0 ... 3599 s (factory setting 120). The energy-saving mode delay time starts as soon as the output frequency of the inverter drops below the energy-saving mode start speed p2390. If the output frequency increases above this threshold during the delay time, the energy-saving mode delay time is interrupted. Otherwise, the motor is switched off after the delay time has expired (if necessary, after a short boost).	x	x
P2392 = ...	Energy-saving mode restart value (in %) is required if the technology controller is used as the main setpoint. As soon as the technology controller deviation (r2273) exceeds the energy-saving mode restart value, the inverter switches to normal operation and the motor starts with a setpoint of 1.05 * (p1080 + p2390). As soon as this value is reached, the motor continues to operate with the setpoint of the technology controller (r2260).	x	-

7.9 Application-specific functions

Parameter	Description	Via tech. setpoint	Via external setpoint
P2393 = ...	Energy-saving mode restart speed (rpm) , required in the case of external setpoint input. The motor starts as soon as the setpoint exceeds the restart speed. The restart speed is calculated as follows: Restart speed = P1080 + p2390 + p2393 P1080 = minimum speed p2390 = energy-saving mode start speed p2393 = energy-saving mode restart speed	-	x
P2394 = ...	Energy-saving mode boost duration 0 (factory setting) ... 3599 s. Before the inverter switches over into the energy-saving mode, the motor is accelerated for the time set in p2394 according to the acceleration ramp, but not to more than the speed set in P2395.	x	x
P2395 = ...	Energy-saving mode boost speed 0 (factory setting) ... 21000 rpm. Before the inverter switches over into the energy-saving mode, the motor is accelerated for the time set in p2394 according to the acceleration ramp, but not to more than the speed set in P2395. Caution: Make sure that the boost cannot cause any overpressure or overflow conditions.	x	x
P2396 = ...	Maximum energy-saving mode shutdown time 0 (factory setting) ... 863999 s. At the latest when this time expires, the inverter switches to normal operation and is accelerated up to the start speed (P1080 + P2390). If the inverter is switched to normal operation in advance, the shutdown time is reset to the value set in this parameter. With p2396 = 0, automatic changeover to normal operation after a certain time is deactivated.	x	x

Display parameters

Parameter	Description
r2273	Display of the setpoint/actual value deviation of the technology controller
r2397	Actual energy-saving mode output speed Actual boost speed before the pulses are inhibited or the actual start speed after restart.
r2399	Energy-saving mode status word 00 Energy-saving mode enabled (P2398 <> 0) 01 Energy-saving mode active 02 Energy-saving mode delay time active 03 Energy-saving mode boost active 04 Energy-saving mode motor switched off 05 Energy-saving mode motor switched off, cyclic restart active 06 Energy-saving mode motor restarts 07 Energy-saving mode supplies the total setpoint of the ramp-function generator 08 Energy-saving mode bypasses the ramp-function generator in the setpoint channel

7.9.15 Logical and arithmetic functions using function blocks

Additional signal interconnections in the inverter can be established by means of free function blocks. Every digital and analog signal available via BICO technology can be routed to the appropriate inputs of the free function blocks. The outputs of the free function blocks are also interconnected to other functions using BICO technology.

Among others, the following free function blocks are available:

- Logic modules AND, OR, XOR, NOT
- Arithmetic blocks ADD, SUB, MUL, DIV, AVA (device for forming absolute values), NCM (numeric comparator), PLI (polyline)
- Time modules MFP (pulse generator), PCL (pulse shortening), PDE (ON delay), PDF (OFF delay), PST (pulse stretching)
- Memories: RSR (RS flip-flop), DSR (D flip-flop)
- Switches NSW (numeric change-over switch) BSW (binary change-over switch)
- Controllers LIM (limiter), PT1 (smoothing element), INT (integrator), DIF (differentiating element)
- Limit value monitoring LVM

You will find an overview of all of the free function blocks and their parameters in the List Manual, in Chapter "Function diagrams" in the section "Free function blocks" (function diagrams 7210 ff).

Activating the free blocks

None of the free function blocks in the inverter are used in the factory setting. In order to be able to use a free function block, you must perform the following steps:

- In the parameter list, select the function block from the function diagrams - there you will find all of the parameters that you require to interconnect the block
- Assign the block to a runtime group
- Define the run sequence within the runtime group - this is only required if you have assigned several blocks to the same runtime group.
- Interconnect the block's inputs and outputs with the corresponding signals on the inverter.

The runtime groups are calculated at different intervals (time slices). Please refer to the following table to see which free function blocks can be assigned to which time slices.

Table 7- 50 Runtime groups and possible assignments of the free function blocks

Free function blocks	Runtime groups 1 ... 6 with associated time slices					
	1	2	3	4	5	6
	8 ms	16 ms	32 ms	64 ms	128 ms	256 ms
Logic modules AND, OR, XOR, NOT	✓	✓	✓	✓	✓	✓
Arithmetic blocks ADD, SUB, MUL, DIV, AVA, NCM, PLI	-	-	-	-	✓	✓
Time modules MFP, PCL, PDE, PDF, PST	-	-	-	-	✓	✓
Memories RSR, DSR	✓	✓	✓	✓	✓	✓
Switches NSW	-	-	-	-	✓	✓
Switches BSW	✓	✓	✓	✓	✓	✓
Controllers LIM, PT1, INT, DIF	-	-	-	-	✓	✓
Limit value monitoring LVM	-	-	-	-	✓	✓

✓: The block can be assigned to the runtime group
 -: The block cannot be assigned to this runtime group

Analog signal scaling

If you interconnect a physical quantity, e.g. speed or voltage to the input of a free function block using BICO technology, then the signal is automatically scaled to a value of 1. The analog output signals of the free function blocks are also available as scaled quantities (0 ± 0 %, 1 ± 100 %).

As soon as you have interconnected the scaled output signal of a free function block to functions, which require physical input quantities - e.g. the signal source of the upper torque limit (p1522) - then the signal is automatically converted into the physical quantity.

The quantities with their associated scaling parameters are listed in the following:

- Speeds P2000 Reference speed (±100%)
- Voltage values P2001 Reference voltage (±100%)
- Current values P2002 Reference current (±100%)
- Torque values P2003 Reference torque (±100%)
- Power values P2004 Reference power (±100%)
- Angle P2005 Reference angle (±100%)
- Acceleration P2007 Reference acceleration (±100%)
- Temperature 100 °C ± 100 %

Scaling examples

- **Speed:**
Reference speed p2000 = 3000 rpm, actual speed 2100 rpm. As a consequence, the following applies to the scaled input quantity: $2,100 / 3,000 = 0.7$.
- **Temperature:**
Reference quantity is 100 °C. For an actual temperature of 120 °C, the input value is obtained from $120\text{ °C} / 100\text{ °C} = 1.2$.

Note

Limits within the function blocks should be entered as scaled values. The scaled value can be calculated as follows using the reference parameter: Scaled limit value = physical limit value / value of the reference parameter.

The assignment to reference parameters is provided in the parameter list in the individual parameter descriptions.

Example: Logic combination of two digital inputs

You want to switch on the motor via digital input 0 and also via digital input 1:

1. Activate a free OR block by assigning it to a runtime group, and define the run sequence.
2. Interconnect the status signals of the two digital inputs DI 0 and DI 1 via BICO to the two inputs of the OR block.
3. Finally, interconnect the OR block output with the internal ON command (P0840).

Table 7- 51 Parameters for using the free function blocks

Parameter	Description
P20048 = 1	Assignment of block OR 0 to runtime group 1 (factory setting: 9999) The block OR 0 is calculated in the time slice with 8 ms
P20049 = 60	Definition of run sequence within runtime group 1 (factory setting: 60) Within one runtime group, the block with the smallest value is calculated first.
P20046 [0] = 722.0	Interconnection of first OR 0 input (factory setting: 0) The first OR 0 input is linked to digital input 0 (r0722.0)
P20046 [1] = 722.1	Interconnection of second OR 0 input (factory setting: 0) The second OR 0 input is linked to digital input 1 (r0722.1)
P0840 = 20047	Interconnection of OR 0 output (factory setting: 0) The OR 0 output (r20047) is connected with the motor's ON command

Example: AND operation

An example of an AND logic operation, explained in detail, including the use of a time block is provided in the Extended scope for adaptation (Page 16)chapter.

You can find additional information in the following manuals:

- Function Manual "Free Function Blocks"
(<http://support.automation.siemens.com/WW/view/en/35125827>)
- Function Manual "Description of the Standard DCC Blocks"
(<http://support.automation.siemens.com/WW/view/en/29193002>)

7.10 Switchover between different settings

In several applications, the inverter must be able to be operated with different settings.

Example:

You connect different motors to one inverter. Depending on the particular motor, the inverter must operate with the associated motor data and the appropriate ramp-function generator.

Drive data sets (DDS)

You can parameterize several inverter functions differently and then switch over between the different settings.

The associated parameters are indexed (index 0, 1, 2 or 3). Using control commands select one of the four indices and therefore one of the four saved settings.

The settings in the inverter with the same index are known as drive data set.

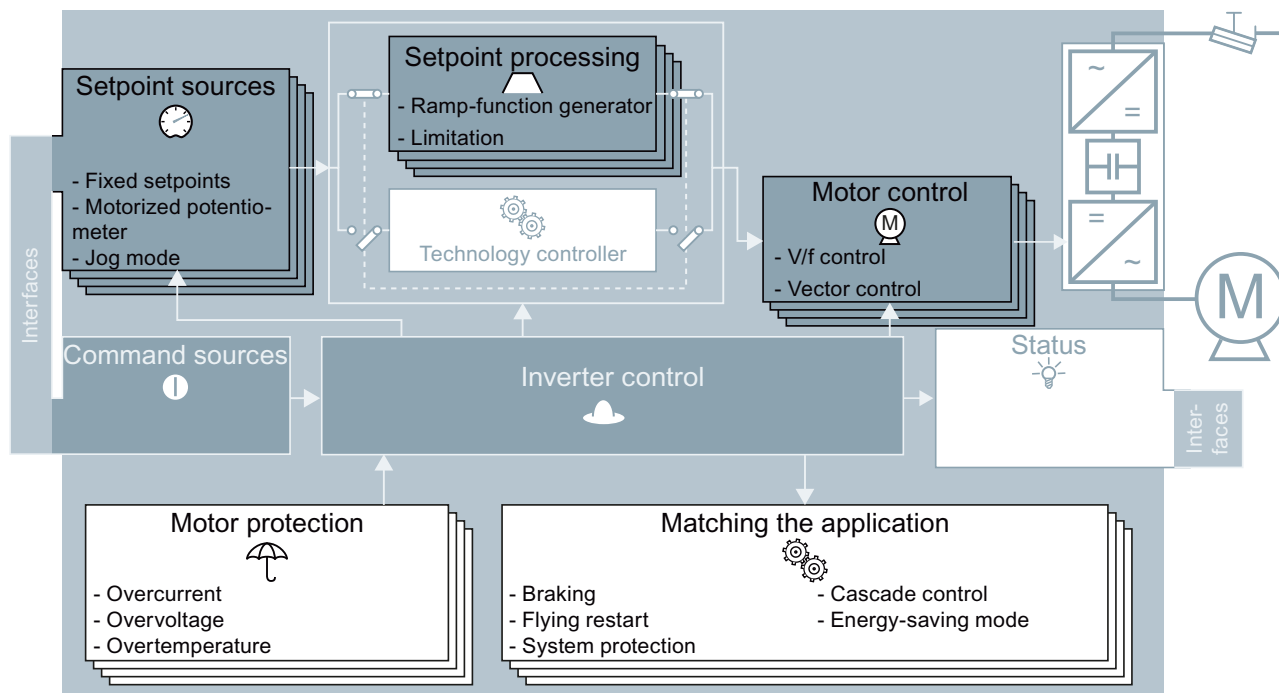

Figure 7-26 DDS switchover in the inverter

7.10 Switchover between different settings

Using parameter p0180 you can define the number of command data sets (2, 3 or 4).

Table 7- 52 Selecting the number of command data sets

Parameter	Description
p0010 = 15	Drive commissioning: Data sets
p0180	Drive data sets (DDS) number(factory setting: 1)
p0010 = 0	Drive commissioning: Ready

Table 7- 53 Parameters for switching the drive data sets:

Parameter	Description
p0820	Drive data set selection DDS bit 0
p0821	Drive data set selection DDS bit 1
p0826	Motor changeover, motor number
r0051	Displaying the number of the DDS that is currently effective

For an overview of all the parameters that belong to the drive data sets and can be switched, see the Parameter Manual.

Note

You can only switch over the motor data of the drive data sets in the "ready for operation" state with the motor switched-off. The switchover time is approx. 50 ms.

If you do not switch over the motor data together with the drive data sets (i.e. same motor number in p0826), then the drive data sets can also be switched over in operation.

Table 7- 54 Parameters for copying the drive data sets

Parameter	Description
p0819[0]	Source drive data set
p0819[1]	Target drive data set
p0819[2] = 1	Start copy operation

For more information, see the List Manual (the parameter list and function diagram 8565).

Service and maintenance

8.1 Overview of replacing converter components

In the event of a permanent function fault, you can replace the converter's Power Module or Control Unit independently of one another. In the following cases, you may immediately switch on the motor again after the replacement.

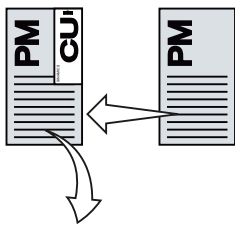
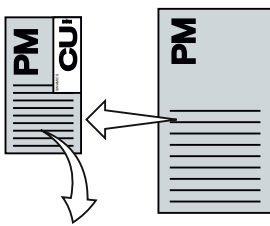
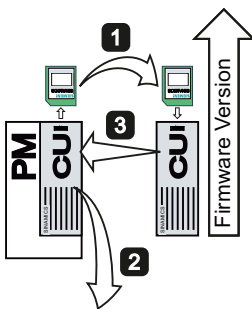
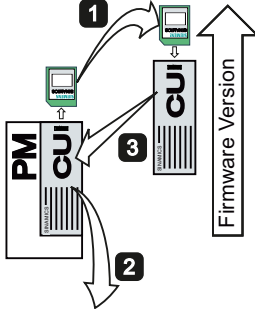
Replacing the Power Module		Replacing the Control Unit with external backup of the settings, e.g. on a memory card	
Replacement: <ul style="list-style-type: none"> • Same type • Same power rating 	Replacement: <ul style="list-style-type: none"> • Same type • <i>Higher</i> power rating 	Replacement: <ul style="list-style-type: none"> • Same type • Same firmware version 	Replacement: <ul style="list-style-type: none"> • Same type • <i>higher</i>firmware version (e.g. replace FW V4.2 by FW V4.3)
			
	Power Module and motor must be adapted to one another (ratio of motor and Power Module rated power > 1/8)	The converter automatically loads the settings on the memory card into the new CU. If you have saved the settings of your converter on another medium, e.g. on an operator panel or on a PC, then after the replacement, the settings must be loaded into the converter.	

! WARNING

In all other cases, you must recommission the drive.

8.2 Replacing the Control Unit



! WARNING

230 V AC can be connected via the relay outputs DO 0 and DO 2 of the Control Unit. These terminals can carry 230 V AC independent of the voltage condition of the Power Module. Therefore please observe appropriate safety measures when working on the inverter.

After commissioning has been completed, we recommend that you back up your settings on an external storage medium, e.g.: on a memory card or the operator panel.

If you do not back up your data, you have to recommission the drive when you replace the Control Unit.

Procedure for replacing a Control Unit with a memory card

- Disconnect the line voltage of the Power Module and (if installed) the external 24 V supply or the voltage for the relay outputs DO 0 and DO 2 of the Control Unit.
- Remove the signal cables of the Control Unit.
- Remove the defective CU from the Power Module.
- Plug the new CU on to the Power Module. The new CU must have the same order number and the same or a higher firmware version as the CU that was replaced.
- Remove the memory card from the old Control Unit and insert it in the new Control Unit.
- Reconnect the signal cables of the Control Unit.
- Connect up the line voltage again.
- The converter adopts the settings from the memory card, saves them (protected against power failure) in its internal parameter memory, and switches to "ready to start" state.
- Switch on the motor and check the function of the drive.

Procedure for replacing a Control Unit without a memory card

- Disconnect the line voltage of the Power Module and (if installed) the external 24 V supply or the voltage for the relay outputs DO 0 and DO 2 of the Control Unit.
- Remove the signal cables of the Control Unit.
- Remove the defective CU from the Power Module.
- Plug the new CU on to the Power Module.
- Reconnect the signal cables of the Control Unit.
- Connect up the line voltage again.
- The converter goes into the "ready-to-switch-on" state.
- If you have backed up your settings:
 - Load the settings from the operator panel or via STARTER into the converter.
 - For converters of the same type and the same firmware version, you can now switch-on the motor. Check the function of the drive
 - For different converter types, then the converter outputs alarm A01028. This alarm indicates that the settings that have been loaded are not compatible with the converter. In this case, clear the alarm with p0971 = 1 and recommission the drive.
- If you have not backed up your settings, then you must recommission the drive.

8.3 Replacing the Power Module

Procedure for replacing a Power Module

- Disconnect the Power Module from the line supply.
- If being used, switch off the 24 V supply of the Control Unit.



⚠ DANGER

Risk of electrical shock!

Hazardous voltage is still present for up to 5 minutes after the power supply has been switched off.

It is not permissible to carry out any installation work before this time has expired!

- Remove the connecting cables of the Power Module.
- Remove the Control Unit from the Power Module.
- Replace the old Power Module with the new Power Module.
- Snap the Control Unit onto the new Power Module.
- Connect up the new Power Module using the connecting cables.
- Switch on the line supply and, if being used, the 24 V supply for the Control Unit.
- If necessary, recommission the drive (also see Overview of replacing converter components (Page 281)).

Alarms, faults and system messages

The converter has the following diagnostic types:

- LED

The LED at the front of the converter immediately informs you about the most important converter states right at the converter.

- Alarms and faults

The converter signals alarms and faults via the fieldbus, the terminal strip (when appropriately set), on a connected operator panel or STARTER.

Alarms and faults have a unique number.

If the converter no longer responds

Due to faulty parameter settings, e.g. by loading a defective file from the memory card, the converter can adopt the following condition:

- The motor is switched off.
- You cannot communicate with the converter, either via the Operator Panel or other interfaces.

In this event proceed as follows:

- Remove the memory card if one is inserted in the converter.
- Repeat the power on reset until the converter outputs fault F01018:
 - Switch off the converter supply voltage.
 - Wait until all LEDs on the converter go dark. Now switch on the converter supply voltage again.
- If the converter signals fault F01018, repeat the power on reset one more time.
- The converter must now have been restored to its factory settings.
- Recommission the converter.

9.1 Operating states indicated on LEDs

The LED RDY (Ready) is temporarily orange after the power supply voltage is switched-on. As soon as the color of the LED RDY changes to either red or green, the LEDs signal the inverter state.

Signal states of the LED

In addition to the signal states "on" and "off" there are two different flashing frequencies:

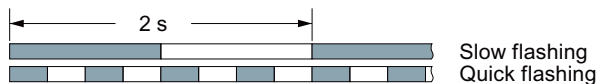

Table 9-1 Inverter diagnostics

LED		Explanation
RDY	BF	
GREEN - on	---	There is presently no fault
GREEN - slow	---	Commissioning or reset to factory settings
RED - fast	---	There is presently a fault
RED - fast	RED - fast	Incorrect memory card

Table 9-2 Communication diagnostics via RS485

LED BF	Explanation
On	Receive process data
RED - slow	Bus active - no process data
RED - fast	No bus activity

Table 9-3 Communication diagnostics via PROFIBUS DP

LED BF	Explanation
off	Cyclic data exchange (or PROFIBUS not used, p2030 = 0)
RED - slow	Bus fault - configuration fault
RED - fast	Bus fault - no data exchange - baud rate search - no connection

LED BF display for CANopen

In addition to the signal states "on" and "off" there are three different flashing frequencies:

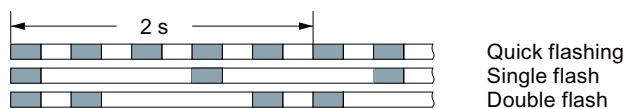



Table 9- 4 Communication diagnostics via CANopen

BF LED	Explanation
GREEN - on	Bus state "Operational"
GREEN - fast	Bus state "Pre-Operational"
GREEN - single flash	Bus state "Stopped"
RED - on	No bus
RED - single flash	Alarm - limit reached
RED - double flash	Error event in control (Error Control Event)

9.2 Alarms

Alarms have the following properties:

- They do not have a direct effect in the inverter and disappear once the cause has been removed
- They do not need have to be acknowledged
- They are signaled as follows
 - Status display via bit 7 in status word 1 (r0052)
 - at the Operator Panel with a Axxxxx
 - via STARTER, if you click on TAB  at the bottom left of the STARTER screen

In order to pinpoint the cause of an alarm, there is a unique alarm code and also a value for each alarm.

Alarm buffer

For each incoming alarm, the inverter saves the alarm, alarm value and the time that the alarm was received.

	Alarm code	Alarm value		Alarm time received		Alarm time removed	
1. Alarm	r2122[0]	r2124[0]	r2134[0]	r2145[0]	r2123[0]	r2146[0]	r2125[0]
		I32	Float	Days	ms	Days	ms

Figure 9-1 Saving the first alarm in the alarm buffer

r2124 and r2134 contain the alarm value - important for diagnostics - as "fixed point" or "floating point" number.

The alarm times are displayed in r2145 and r2146 (in complete days) as well as in r2123 and r2125 (in milliseconds referred to the day of the alarm).

The inverter uses an internal time calculation to save the alarm times. More information on the internal time calculation can be found in Chapter Real time clock (RTC) (Page 247).

As soon as the alarm has been removed, the inverter writes the associated instant in time into parameters r2125 and r2146. The alarm remains in the alarm buffer even if the alarm has been removed.

If an additional alarm is received, then this is also saved. The first alarm is still saved. The alarms that have occurred are counted in p2111.

	Alarm code	Alarm value		Alarm time received		Alarm time removed	
1. Alarm	r2122[0]	r2124[0]	r2134[0]	r2145[0]	r2123[0]	r2146[0]	r2125[0]
2. Alarm	[1]	[1]	[1]	[1]	[1]	[1]	[1]

Figure 9-2 Saving the second alarm in the alarm buffer

The alarm buffer can contain up to eight alarms. If an additional alarm is received after the eighth alarm - and none of the last eight alarms have been removed - then the next to last alarm is overwritten.

	Alarm code	Alarm value		Alarm time received		Alarm time removed	
1. Alarm	r2122[0]	r2124[0]	r2134[0]	r2145[0]	r2123[0]	r2146[0]	r2125[0]
2. Alarm	[1]	[1]	[1]	[1]	[1]	[1]	[1]
3. Alarm	[2]	[2]	[2]	[2]	[2]	[2]	[2]
4. Alarm	[3]	[3]	[3]	[3]	[3]	[3]	[3]
5. Alarm	[4]	[4]	[4]	[4]	[4]	[4]	[4]
6. Alarm	[5]	[5]	[5]	[5]	[5]	[5]	[5]
7. Alarm	[6]	[6]	[6]	[6]	[6]	[6]	[6]
Last alarm	[7]	[7]	[7]	[7]	[7]	[7]	[7]

Figure 9-3 Complete alarm buffer

Emptying the alarm buffer: Alarm history

The alarm history traces up to 56 alarms.

The alarm history only takes alarms that have been removed from the alarm buffer. If the alarm buffer is completely filled - and an additional alarm occurs - then the inverter shifts all alarms that have been removed from the alarm buffer into the alarm history. In the alarm history, alarms are also sorted according to the "alarm time received", however, when compared to the alarm buffer, in the inverse sequence:

- the youngest alarm is in index 8
- the second youngest alarm is in index 9
- etc.

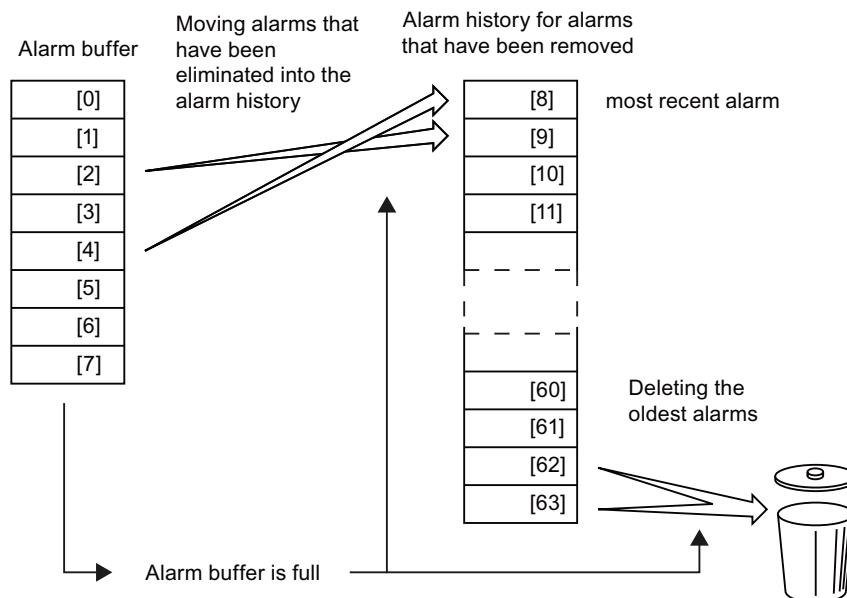

Figure 9-4 Shifting alarms that have been removed into the alarm history

The alarms that have still not been removed remain in the alarm buffer and are resorted so that gaps between the alarms are filled.

9.2 Alarms

If the alarm history is filled up to index 63, each time a new alarm is accepted in the alarm history, the oldest alarm is deleted.

Parameters of the alarm buffer and the alarm history

Table 9- 5 Important parameters for alarms

Parameter	Description
r2122	Alarm code Displays the numbers of alarms that have occurred
r2123	Alarm time received in milliseconds Displays the time in milliseconds when the alarm occurred
r2124	Alarm value Displays additional information about the alarm
r2125	Alarm time removed in milliseconds Displays the time in milliseconds when the alarm was removed
p2111	Alarm counter Number of alarms that have occurred after the last reset When setting p2111 = 0, all of the alarms that have been removed from the alarm buffer [0...7] are transferred into the alarm history [8...63]
r2145	Alarm time received in days Displays the time in days when the alarm occurred
r2132	Actual alarm code Displays the code of the alarm that last occurred
r2134	Alarm value for float values Displays additional information about the alarm that occurred for float values
r2146	Alarm time removed in days Displays the time in days when the alarm was removed

Extended settings for alarms

Table 9- 6 Extended settings for alarms

Parameter	Description
You can change up to 20 different alarms into a fault or suppress alarms:	
p2118	Setting the message number for the message type Select the alarms for which the message type should be changed
p2119	Setting the message type Setting the message type for the selected alarm 1: Fault 2: Alarm 3: No message

You will find details in function block diagram 8075 and in the parameter description of the List Manual.

9.3 Faults

A fault displays a severe fault during operation of the inverter.

The inverter signals a fault as follows:

- at the Operator Panel with Fxxxx
- at the Control Unit using the red LED RDY
- in bit 3 of the status word 1 (r0052)
- via STARTER

To delete a fault message, you need to remedy the cause of the fault and acknowledge the fault.

Every fault has a clear fault code and also a fault value. You need this information to determine the cause of the fault.

Fault buffer of actual values

For each fault received, the inverter saves the fault code, fault value and the time of the fault.

	Fault code	Fault value		Fault time received		Fault time removed	
1st fault	r0945[0]	r0949[0]	r2133[0]	r2130[0]	r0948[0]	r2136[0]	r2109[0]
		I32	Float	Days	ms	Days	ms

Figure 9-5 Saving the first fault in the fault buffer

r0949 and r2133 contain the fault value - important for diagnostics - as "fixed point" or "floating point" number.

The "fault time received" is in parameter r2130 (in complete days) as well as in parameter r0948 (in milliseconds referred to the day of the fault). The "fault time removed" is written into parameters r2109 and r2136 when the fault has been acknowledged.

The inverter uses its internal time calculation to save the fault times. More information on the internal time calculation can be found in Chapter Real time clock (RTC) (Page 247).

If an additional fault occurs before the first fault has been acknowledged, then this is also saved. The first alarm remains saved. The fault cases that have occurred are counted in p0952. A fault case can contain one or several faults.

	Fault code	Fault value		Fault time received		Fault time removed	
1st fault	r0945[0]	r0949[0]	r2133[0]	r2130[0]	r0948[0]	r2136[0]	r2109[0]
2nd fault	[1]	[1]	[1]	[1]	[1]	[1]	[1]

Figure 9-6 Saving the second fault in the fault buffer

9.3 Faults

The fault buffer can accept up to eight actual faults. The next to last fault is overwritten if an additional fault occurs after the eighth fault.

	Fault code	Fault value		Fault time received		Fault time removed	
1st fault	r0945[0]	r0949[0]	r2133[0]	r2130[0]	r0948[0]	r2136[0]	r2109[0]
2nd fault	[1]	[1]	[1]	[1]	[1]	[1]	[1]
3rd fault	[2]	[2]	[2]	[2]	[2]	[2]	[2]
4th fault	[3]	[3]	[3]	[3]	[3]	[3]	[3]
5th fault	[4]	[4]	[4]	[4]	[4]	[4]	[4]
6th fault	[5]	[5]	[5]	[5]	[5]	[5]	[5]
7th fault	[6]	[6]	[6]	[6]	[6]	[6]	[6]
Last fault	[7]	[7]	[7]	[7]	[7]	[7]	[7]



Figure 9-7 Complete fault buffer

Fault acknowledgement

In most cases, you have the following options to acknowledge a fault:

- Switch-off the inverter power supply and switch-on again.
- Press the acknowledgement button on the operator panel
- Acknowledgement signal at digital input 2
- Acknowledgement signal in bit 7 of control word 1 (r0054) for Control Units with fieldbus interface

Faults that are triggered by monitoring of hardware and firmware inside the inverter can only be acknowledged by switching off and on again. You will find a note about this restricted option to acknowledge faults in the fault list of the List Manual.

Emptying the fault buffer: Fault history

The fault history can contain up to 56 faults.

The fault acknowledgement has no effect as long as none of the fault causes of the fault buffer have been removed. If at least one of the faults in the fault buffer has been removed (the cause of the fault has been removed) and you acknowledge the faults, then the following happens:

1. The inverter accepts all faults from the fault buffer in the first eight memory locations of the fault history (indices 8 ... 15).
2. The inverter deletes the faults that have been removed from the fault buffer.
3. The inverter writes the time of acknowledgement of the faults that have been removed into parameters r2136 and r2109 (fault time removed).

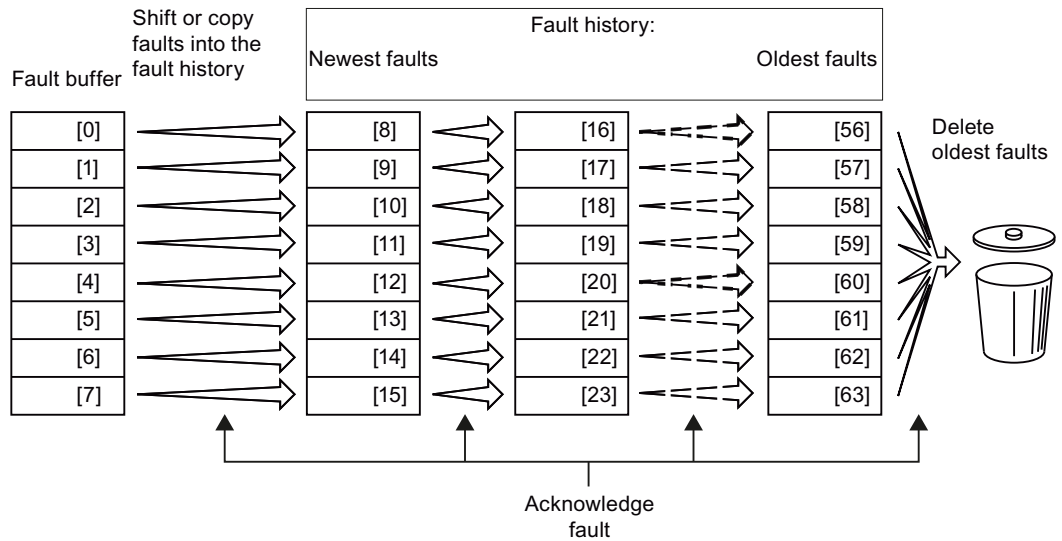

Figure 9-8 Fault history after acknowledging the faults

After acknowledgement, the faults that have not been removed are located in the fault buffer as well as in the fault history. For these faults, the "fault time coming" remains unchanged and the "fault time removed" remains empty.

If less than eight faults were shifted or copied into the fault history, the memory locations with the higher indices remain empty.

The inverters shifts the values previously saved in the fault history each by eight indices. Faults, which were saved in indices 56 ... 63 before the acknowledgement, are deleted.

Deleting the fault history

If you wish to delete all faults from the fault history, set parameter p0952 to zero.

Parameters of the fault buffer and the fault history

Table 9- 7 Important parameters for faults

Parameter	Description
r0945	Fault code Displays the numbers of faults that have occurred
r0948	Fault time received in milliseconds Displays the time in milliseconds when the fault occurred
r0949	Fault value Displays additional information about the fault
p0952	Fault cases, counter Number of fault cases that have occurred since the last acknowledgement The fault buffer is deleted with p0952 = 0.
r2109	Fault time removed in milliseconds Displays the time in milliseconds when the fault occurred
r2130	Fault time received in days Displays the time in days when the fault occurred
r2131	Actual fault code Displays the code of the oldest fault that is still active
r2133	Fault value for float values Displays additional information about the fault that occurred for float values
r2136	Fault time removed in days Displays the time in days when the fault was removed

The motor cannot be switched-on

If the motor cannot be switched-on, then check the following:

- Is a fault present?
If yes, then remove the fault cause and acknowledge the fault
- Does p0010 = 0?
If not, the inverter is e.g. still in a commissioning state.
- Is the inverter reporting the "ready to start" status (r0052.0 = 1)?
- Is the inverter missing enabling (r0046)?
- Are the command and setpoint sources for the inverter (p0015) correctly parameterized?
In other words, where is the inverter getting its speed setpoint and commands from (fieldbus or analog input)?
- Do the motor and inverter match?
Compare the data on the motor's nameplate with the corresponding parameters in the inverter (P0300 ff).

Extended settings for faults

Table 9- 8 Advanced settings

Parameter	Description
You can change the fault response of the motor for up to 20 different fault codes:	
p2100	Setting the fault number for fault response Selecting the faults for which the fault response should be changed
p2101	Setting, fault response Setting the fault response for the selected fault
You can change the acknowledgement type for up to 20 different fault codes:	
p2126	Setting the fault number for the acknowledgement mode Selecting the faults for which the acknowledgement type should be changed
p2127	Setting, acknowledgement mode Setting the acknowledgement type for the selected fault 1: Can only be acknowledged using POWER ON 2: IMMEDIATE acknowledgment after removing the fault cause
You can change up to 20 different faults into an alarm or suppress faults:	
p2118	Setting the message number for the message type Selecting the message for which the message type should be selected
p2119	Setting the message type Setting the message type for the selected fault 1: Fault 2: Alarm 3: No message

You will find details in function diagram 8075 and in the parameter description of the List Manual.

9.4 List of alarms and faults

Axxxxx Alarm

Fyyyyy: Fault

Table 9- 9 Faults, which can only be acknowledged by switching the inverter off and on again (power on reset)

Number	Cause	Remedy
F01000	Software fault in CU	Replace CU.
F01001	Floating Point Exception	Switch CU off and on again.
F01015	Software fault in CU	Upgrade firmware or contact technical support.
F01018	Power-up aborted more than once	After this fault has been output, the module is booted with the factory settings. Remedy: Back up factory setting with p0971=1. Switch CU off and on again. Recommission the inverter.
F01040	Parameters must be saved	Save parameters (p0971). Switch CU off and on again.
F01044	Loading of memory data card defective	Replace memory card or CU.
F01105	CU: Insufficient memory	Reduce number of data records.
F01205	CU: Time slice overflow	Contact technical support.
F01250	CU hardware fault	Replace CU.
F01512	An attempt has been made to establish an conversion factor for scaling which is not present	Create scaling or check transfer value.
F01662	CU hardware fault	Switch CU off and on again, upgrade firmware, or contact technical support.
F30022	Power Module: Monitoring U _{CE}	Check or replace the Power Module.
F30052	Incorrect Power Module data	Replace Power Module or upgrade CU firmware.
F30053	Error in FPGA data	Replace the Power Module.
F30662	CU hardware fault	Switch CU off and on again, upgrade firmware, or contact technical support.
F30664	CU power up aborted	Switch CU off and on again, upgrade firmware, or contact technical support.
F30850	Software fault in Power Module	Replace Power Module or contact technical support.

Table 9- 10 The most important alarms and faults

Number	Cause	Remedy
F01018	Power-up aborted more than once	<ol style="list-style-type: none"> 1. Switch the module off and on again. 2. After this fault has been output, the module is booted with the factory settings. 3. Recommission the converter.
A01028	Configuration error	<p>Explanation: Parameterization on the memory card has been created with a different type of module (order number, MLFB)</p> <p>Check the module parameters and recommission if necessary.</p>
F01033	Unit switchover: Reference parameter value invalid	Set the value of the reference parameter not equal to 0.0 (p0304, p0305, p0310, p0596, p2000, p2001, p2002, p2003, r2004).
F01034	Unit switchover: Calculation of the parameter values after reference value change unsuccessful	Select the value of the reference parameter so that the parameters involved can be calculated in the per unit notation (p0304, p0305, p0310, p0596, p2000, p2001, p2002, p2003, r2004).
F01122	Frequency at the probe input too high	Reduce the frequency of the pulses at the probe input.
A01590	Motor maintenance interval lapsed	Carry out maintenance and reset the maintenance interval (p0651).
A01900	PROFIBUS: Configuration telegram faulty	<p>Explanation: A PROFIBUS master is attempting to establish a connection with a faulty configuration telegram.</p> <p>Check the bus configuration on the master and slave side.</p>
A01910 F01910	Setpoint timeout	<p>The alarm is generated when p2040 \neq 0 ms and one of the following causes is present:</p> <ul style="list-style-type: none"> • The bus connection is interrupted • The MODBUS master is switched off • Communications error (CRC, parity bit, logical error) • An excessively low value for the fieldbus monitoring time (p2040)
A01920	PROFIBUS: Cyclic connection interrupt	<p>Explanation: The cyclic connection to PROFIBUS master is interrupted.</p> <p>Establish the PROFIBUS connection and activate the PROFIBUS master with cyclic operation.</p>
F03505	Analog input, wire break	<p>Check the connection to the signal source for interrupts.</p> <p>Check the level of the signal supplied.</p> <p>The input current measured by the analog input can be read out in r0752.</p>
A03520	Temperature sensor fault	Check that the sensor is connected correctly.
A05000 A05001 A05002 A05004 A05006	Power Module overtemperature	<p>Check the following:</p> <ul style="list-style-type: none"> - Is the ambient temperature within the defined limit values? - Are the load conditions and duty cycle configured accordingly? - Has the cooling failed?
F06310	Supply voltage (p0210) incorrectly parameterized	<p>Check the parameterized supply voltage and if required change (p0210).</p> <p>Check the line voltage.</p>

9.4 List of alarms and faults

Number	Cause	Remedy
F07011	Motor overtemperature	Reduce the motor load. Check ambient temperature. Check the wiring and connection of the sensor.
A07012	I2t Motor Module overtemperature	Check and if necessary reduce the motor load. Check the motor's ambient temperature. Check thermal time constant p0611. Check overtemperature fault threshold p0605.
A07015	Motor temperature sensor alarm	Check that the sensor is connected correctly. Check the parameter assignment (p0601).
F07016	Motor temperature sensor fault	Make sure that the sensor is connected correctly. Check the parameterization (p0601). Deactivate the temperature sensor fault (p0607 = 0).
F07086 F07088	Unit switchover: Parameter limit violation	Check the adapted parameter values and if required correct.
F07320	Automatic restart aborted	Increase the number of restart attempts (p1211). The actual number of start attempts is shown in r1214. Increase the wait time in p1212 and/or monitoring time in p1213. Connect an ON command (p0840). Increase the monitoring time of the power unit or switch off (p0857). Reduce the wait time for resetting the fault counter p1213[1] so that fewer faults are registered in the time interval.
A07321	Automatic restart active	Explanation: The automatic restart (AR) is active. During voltage recovery and/or when remedying the causes of pending faults, the drive is automatically switched back on.
F07330	Search current measured too low	Increase search current (p1202), check motor connection.
A07400	V _{DC_max} controller active	If it is not desirable that the controller intervenes: <ul style="list-style-type: none"> • Increase the ramp-down times. • Deactivate the V_{DC_max} controller (p1240 = 0 for vector control, p1280 = 0 for U/f control).
A07409	U/f control, current limiting controller active	The alarm automatically disappears after one of the following measures: <ul style="list-style-type: none"> • Increase the current limit (p0640). • Reduce the load. • Slow down the up ramp for the setpoint speed.
F07426	Technology controller actual value limited	<ul style="list-style-type: none"> • Adapt the limits to the signal level (p2267, p2268). • Check the actual value scaling (p2264).

Number	Cause	Remedy
F07801	Motor overcurrent	Check current limits (p0640). Vector control: Check current controller (p1715, p1717). U/f control: Check the current limiting controller (p1340 ... p1346). Increase acceleration ramp (p1120) or reduce load. Check motor and motor cables for short circuit and ground fault. Check motor for star-delta connection and rating plate parameterization. Check power unit / motor combination. Select flying restart function (p1200) if switched to rotating motor.
A07805	Drive: Power unit overload I2t	<ul style="list-style-type: none"> • Reduce the continuous load. • Adapt the load cycle. • Check the assignment of rated currents of the motor and power unit.
F07806	Regenerative power limit exceeded	Increase deceleration ramp. Reduce driving load. Use power unit with higher energy recovery capability. For vector control, the regenerative power limit in p1531 can be reduced until the fault is no longer activated.
F07807	Short circuit detected	<ul style="list-style-type: none"> • Check the converter connection on the motor side for any phase-phase short-circuit. • Rule out that line and motor cables have been interchanged.
A07850 A07851 A07852	External alarm 1 ... 3	The signal for "external alarm 1" has been triggered. Parameters p2112, p2116 and p2117 determine the signal sources for the external alarm 1... 3. Remedy: Rectify the cause of this alarm.
F07860 F07861 F07862	External fault 1 ... 3	Remove the external causes for this fault.
F07900	Motor blocked	Check that the motor can run freely. Check the torque limits (r1538 and r1539). Check the parameters of the "Motor blocked" message (p2175, p2177).
F07901	Motor overspeed	Activate precontrol of the speed limiting controller (p1401 bit 7 = 1). Increase hysteresis for overspeed signal p2162.
F07902	Motor stalled	Check whether the motor data has been parameterized correctly and perform motor identification. Check the current limits (p0640, r0067, r0289). If the current limits are too low, the drive cannot be magnetized. Check whether motor cables are disconnected during operation.
A07903	Motor speed deviation	Increase p2163 and/or p2166. Increase the torque, current and power limits.

9.4 List of alarms and faults

Number	Cause	Remedy
A07910	Motor overtemperature	Check the motor load. Check the motor's ambient temperature. Check the KTY84 sensor. Check the overtemperatures of the thermal model (p0626 ... p0628).
A07920	Torque/speed too low	The torque deviates from the torque/speed envelope curve.
A07921	Torque/speed too high	<ul style="list-style-type: none"> • Check the connection between the motor and the load.
A07922	Torque/speed out of tolerance	<ul style="list-style-type: none"> • Adapt the parameterization corresponding to the load.
F07923	Torque/speed too low	<ul style="list-style-type: none"> • Check the connection between the motor and the load.
F07924	Torque/speed too high	<ul style="list-style-type: none"> • Adapt the parameterization corresponding to the load.
A07927	DC braking active	Not required
A07980	Rotary measurement activated	Not required
A07981	No enabling for rotary measurement	Acknowledge pending faults. Establish missing enables (see r00002, r0046).
A07991	Motor data identification activated	Switch on the motor and identify the motor data.
F30001	Overcurrent	Check the following: <ul style="list-style-type: none"> • Motor data, if required, carry out commissioning • Motor connection method (Y / Δ) • U/f operation: Assignment of rated currents of motor and Power Module • Line quality • Make sure that the line commutating reactor is connected properly • Power cable connections • Power cables for short-circuit or ground fault • Power cable length • Line phases If this doesn't help: <ul style="list-style-type: none"> • U/f operation: Increase the acceleration ramp • Reduce the load • Replace the power unit
F30002	DC-link voltage overvoltage	Increase the ramp-down time (p1121). Set the rounding times (p1130, p1136). Activate the DC link voltage controller (p1240, p1280). Check the line voltage (p0210). Check the line phases.
F30003	DC-link voltage undervoltage	Check the line voltage (p0210).
F30004	Converter overtemperature	Check whether the converter fan is running. Check whether the ambient temperature is in the permissible range. Check whether the motor is overloaded. Reduce the pulse frequency.

Number	Cause	Remedy
F30005	I2t converter overload	Check the rated currents of the motor and Power Module. Reduce current limit p0640. When operating with U/f characteristic: Reduce p1341.
F30011	Line phase failure	Check the converter's input fuses. Check the motor cables.
F30015	Motor cable phase failure	Check the motor cables. Increase the ramp-up or ramp-down time (p1120).
F30021	Ground fault	<ul style="list-style-type: none"> • Check the power cable connections. • Check the motor. • Check the current transformer. • Check the cables and contacts of the brake connection (a wire might be broken).
F30027	Time monitoring for DC link pre-charging	Check the supply voltage at the input terminals. Check the line voltage setting (p0210).
F30035	Overtemperature, intake air	<ul style="list-style-type: none"> • Check whether the fan is running. • Check the fan filter elements. • Check whether the ambient temperature is in the permissible range.
F30036	Overtemperature, inside area	
F30037	Rectifier overtemperature	See F30035 and, in addition: <ul style="list-style-type: none"> • Check the motor load. • Check the line phases
A30049	Internal fan defective	Check the internal fan and if required replace.
A30502	DC link overvoltage	<ul style="list-style-type: none"> • Check the unit supply voltage (p0210). • Check the dimensioning of the line reactor.
A30920	Temperature sensor fault	Check that the sensor is connected correctly.
F30059	Internal fan defective	Check the internal fan and if required replace.

For further information, please refer to the List Manual.

Technical data

NOTICE

UL-certified fuses must be used

In order that the system is in compliance with UL, UL certified fuses, circuit breakers or self-protected combination motor controllers must be used.

10.1 Technical data for CU230P-2

Table 10- 1 General technical data of the CU230P-2

Feature	Data / explanation	
Order numbers	6SL3243-0BB30-1CA2:	with CANopen interface
	6SL3243-0BB30-1HA2:	with RS485 interface for communication via USS protocol, BacNet MS/TP and Modbus RTU
	6SL3243-0BB30-1PA2:	with PROFIBUS interface
Operating voltage	20.4 V DC ... 28.8 V, 1 A	Supply from the Power Module or external via terminals 31 and 32
Power loss	5.0 W	plus power loss of the output voltages
Output voltages	18 V ... 30 V (max. 200 mA)	
	18 V ... 30 V (max. 200 mA)	
	10 V ± 0.5 V (max. 10 mA)	
Setpoint resolution	0.01 Hz	
Fixed speeds	16	Adjustable
Skip speeds	4	Adjustable
Digital inputs	6 (DI0 ... DI5)	Low < 5 V, High > 11 V, maximum input voltage 30 V, current consumption 5.5 mA, isolated; SIMATIC compatible, PNP/NPN switchable, reaction time: 10 ms without debounce time (p0724)
Analog inputs	4 (AI0 ... AI3)	Differential inputs, 12 bit resolution, switchable: Current (0 mA ... 20 mA) / voltage (0 V ... 10 V, -10 V ... + 10 V) / temperature, response time: 13 ms without debounce time (p0724), AI0 and AI1 configurable as additional digital inputs: Low < 1.6 V, High > 4.0 V
Digital outputs / relay outputs	3 (DO0 ... DO2)	DO0 ... DO2: 30 V DC 5 A DO1 additional: 230 V AC, 2 A update time: 2 ms
Analog outputs	2 (AO0 ... AO1)	0 V ... 10 V / 0 mA ... 20 mA, update time: 4 ms

Technical data

10.1 Technical data for CU230P-2

Feature	Data / explanation
Motor temperature sensor	PTC: Short-circuit monitoring < 20 Ω , overtemperature 1650 Ω
	KTY84: Short-circuit monitoring < 50 Ω , wire-break: > 2120 Ω
	ThermoClick sensor with dry contact
USB interface	Mini 5-pole USB
Memory card (optional)	MMC card Recommendation: 6SL3254-0AM00-0AA0
	SD card Recommendation: 6SL3254-0AM00-0AA0
Dimensions (WxHxD)	73 mm \times 199 mm \times 65.5 mm
Weight	0.61 kg
Operating temperature	0 $^{\circ}$ C ... 60 $^{\circ}$ C For operation without operator panel
	0 $^{\circ}$ C ... 50 $^{\circ}$ C For operation with operator panel
Storage temperature	- 40 $^{\circ}$ C ... 70 $^{\circ}$ C%
Relative humidity	< 95 % Condensation must not be allowed to form
Open-loop/closed-loop control procedure	V/f control for motor speeds between 0 rpm and 210000 rpm: <ul style="list-style-type: none">• Linear V/f control,• Linear V/f control with FCC,• Linear V/f control with ECO mode,• Quadratic V/f control,• Multipoint V/f control,• V/f control for applications in the textile industry,• V/f control with FCC for applications in the textile industry,• V/f control with independent voltage setpoint,
	Vector control for motor speeds between 0 rpm and 14400 rpm: <ul style="list-style-type: none">• Speed control without encoder• Torque control without encoder

The control terminals on the Control Unit are galvanically isolated from the supply voltage (PELV).

10.2 Technical data, Power Modules

Permissible converter overload

There are two different power data specifications for the Power Modules: "Low Overload" (LO) and "High Overload" (HO), depending on the expected load.

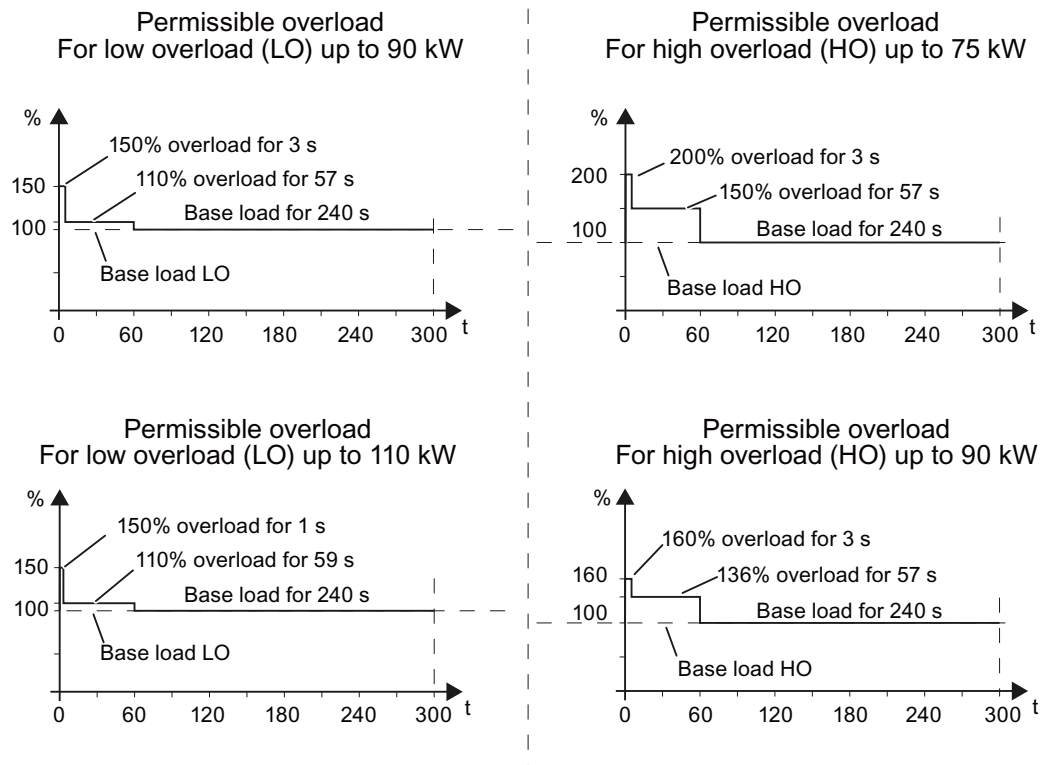

Figure 10-1 Duty cycles, "High Overload" and "Low Overload"

Note

The base load (100% power or current) of "Low Overload" is greater than the base load of "High Overload".

We recommend the "SIZER" engineering software to select the inverter based on duty cycles. See Manuals for your inverter (Page 336).

Definitions

- **LO input current** 100 % of the permissible input current for a load cycle according to Low Overload (LO base load input current).
- **LO output current** 100 % of the permissible output current for a load cycle according to Low Overload (LO base load output current).
- **LO power** Power of the inverter for LO output current.
- **HO input current** 100 % of the permissible input current for a load cycle according to High Overload (HO base load input current).
- **HO output current** 100 % of the permissible output current for a load cycle according to High Overload (HO base load output current).
- **HO power** Power of the inverter for HO output current.

If the power data comprise rated values without any further specifications they always refer to an overload capability corresponding to Low Overload.

10.2.1 Technical data, PM230

General data, PM230 - IP55 / UL Type 12

Feature	Version
Line voltage	3-ph. 380 V ... 480 V AC \pm 10 % The actual permissible line voltage depends on the installation altitude
Input frequency	47 Hz ... 63 Hz
Power factor λ	0.9
Starting current	Smaller than the input current
Permissible short-circuit current	Frame size A ... C: 42 kA Frame size D ... F: 65 kA
Pulse frequency (factory setting)	4 kHz The pulse frequency can be increased up to 16 kHz in 2 kHz steps. A higher pulse frequency reduces the permissible output current.
Electromagnetic compatibility	The devices are suitable for environmental classes C1 and C2 in conformance with IEC 61800-3. For details, see the Hardware Installation Manual, Appendix A2
Braking methods	DC braking
Degree of protection	IP55 / UL Type 12 Degree of protection IP54/ UL Type 12 is reached if an IOP is inserted.
Operating temperature	
<ul style="list-style-type: none"> • without power reduction • with power reduction 	0 °C ... +40 °C (32 °F ... 104 °F) to 60° C (140° F)
Storage temperature	-40 °C ... +70 °C (-40 °F ... 158 °F)
Relative humidity	< 95 % RH - condensation not permissible
Contamination	Protected from contact with dangerous parts, dust, spray water and water jets
Environmental requirements	Protected according to environmental class 3C2 to EN 60721-3-3 against damaging chemical substances
Shock and vibration	Do not allow the inverter to fall and avoid it being subject to hard shocks. Do not install the inverter in an area where it could be continuously subject to vibration.
Electromagnetic radiation	Do not install the inverter close to sources of electromagnetic radiation.
Installation altitude	
<ul style="list-style-type: none"> • without power reduction • with power reduction 	Up to 1000 m (3300 ft) above sea level up to 4000 m (13000 ft) above sea level, for details see the Hardware Installation Manual.
Standards	UL ¹⁾ , CE, C-tick In order that the system is UL-compliant, UL-certified fuses, overload circuit-breakers or intrinsically safe motor protection devices must be used.

¹⁾ UL available soon for frame sizes D ... F

Performance dependent data, PM230 - IP55 / UL Type 12

Table 10- 2 PM230 frame size A, 3-ph. 380 V AC... 480 V, ± 10 %

Order number	Filter Class A	6SL3223-0DE13-7AA0	6SL3223-0DE15-5AA0	6SL3223-0DE17-5AA0
	Filter Class B	6SL3223- 0DE13-7BA0	6SL3223- 0DE15-5BA0	6SL3223- 0DE17-5BA0
Values based on Low Overload				
• LO power		0.37 kW	0.55 kW	0.75 kW
• LO input current		1.3 A	1.8 A	2.3 A
• LO output current		1.3 A	1.7 A	2.2 A
Values based on High Overload				
• HO power		0.25 kW	0.37 kW	0.55 kW
• HO input current		0.9 A	1.3 A	1.8 A
• HO output current		0.9 A	1.3 A	1.7 A
General values				
• Power loss		0.06 kW	0.06 kW	0.06 kW
• Fuse		10 A	10 A	10 A
• Cooling air requirement		7 l/s	7 l/s	7 l/s
• Cable cross-section for line and motor connection		1 ... 2.5 mm ²	1 ... 2.5 mm ²	1 ... 2.5 mm ²
• Torque for line and motor and motor connection		0.5 Nm	0.5 Nm	0.5 Nm
• Weight		4.3 kg	4.3 kg	4.3 kg

Table 10- 3 PM230 frame size A, 3-ph. 380 V AC... 480 V, ± 10 %

Order number	Filter Class A	6SL3223-0DE21-1AA0	6SL3223-0DE21-5AA0	6SL3223-0DE22-2AA0
	Filter Class B	6SL3223-0DE21-1BA0	6SL3223-0DE21-5BA0	6SL3223-0DE22-2BA0
Values based on Low Overload				
• LO power		1.1 kW	1.5 kW	2.2 kW
• LO input current		3.2 A	4.2 A	6.1 A
• LO output current		3.1 A	4.1 A	5.9 A
Values based on High Overload				
• HO power		0.75 kW	1.1 kW	1.5 kW
• HO input current		2.3 A	3.2 A	4.2 A
• HO output current		2.2 A	3.1 A	4.1 A
General values				
• Power loss		0.07 kW	0.08 kW	0.1 kW
• Fuse		10 A	10 A	10 A
• Cooling air requirement		7 l/s	7 l/s	7 l/s
• Cable cross-section for line and motor connection		1 ... 2.5 mm ²	1 ... 2.5 mm ²	1.5 ... 2.5 mm ²
• Torque for line and motor and motor connection		0.5 Nm	0.5 Nm	0.5 Nm
• Weight		4.3 kg	4.3 kg	4.3 kg

Table 10- 4 PM230 frame size A, 3-ph. 380 V AC... 480 V, ± 10 %

Order number	Filter Class A	6SL3223-0DE23-0AA0
	Filter Class B	6SL3223-0DE23-0BA0
Values based on Low Overload		
• LO power		3 kW
• LO input current		8.0 A
• LO output current		7.7 A
Values based on High Overload		
• HO power		2.2 kW
• HO input current		6.1 A
• HO output current		5.9 A
General values		
• Power loss		0.12 kW
• Fuse		10 A
• Cooling air requirement		7 l/s
• Cable cross-section for line and motor connection		1.5 ... 2.5 mm ²
• Torque for line and motor and motor connection		0.5 Nm
• Weight		4.3 kg

Table 10- 5 PM230 frame size B, 3-ph. 380 V AC... 480 V, ± 10 %

Order number	Filter Class A	6SL3223-0DE24-0AA0	6SL3223-0DE25-5AA0	6SL3223-0DE27-5AA0
	Filter Class B	6SL3223-0DE24-0BA0	6SL3223-0DE25-5BA0	6SL3223-0DE27-5BA0
Values based on Low Overload				
• LO power		4 kW	5.5 kW	7.5 kW
• LO input current		10.5 A	13.6 A	18.6 A
• LO output current		10.2 A	13.2 A	18 A
Values based on High Overload				
• HO power		3 kW	4 kW	5.5 kW
• HO input current		8.0 A	10.5 A	13.6 A
• HO output current		7.7 A	10.2 A	13.2 A
General values				
• Power loss		0.14 kW	0.18 kW	0.24 kW
• Fuse		16 A	20 A	25 A
• Cooling air requirement		9 l/s	9 l/s	9 l/s
• Cable cross-section for line and motor connection		2.5 ... 6 mm ²	4 ... 6 mm ²	4 ... 6 mm ²
• Torque for line and motor and motor connection		0.5 Nm	0.5 Nm	0.5 Nm
• Weight		6.3 kg	6.3 kg	6.3 kg

Technical data

10.2 Technical data, Power Modules

Table 10- 6 PM230 frame size C, 3-ph. 380 V AC... 480 V, ± 10 %

Order number	Filter Class A	6SL3223-0DE31-1AA0	6SL3223-0DE31-5AA0	6SL3223-0DE31-8AA0
	Filter Class B	6SL3223-0DE31-1BA0	6SL3223-0DE31-5BA0	6SL3223-0DE31-8BA0
Values based on Low Overload				
• LO power		11 kW	15 kW	18.5 kW
• LO input current		26.9 A	33.1 A	39.2 A
• LO output current		26 A	32 A	38 A
Values based on High Overload				
• HO power		7.5 kW	11 kW	15 kW
• HO input current		18.6 A	26.9 A	33.1 A
• HO output current		18 A	26 A	32 A
General values				
• Power loss		0.32 kW	0.39 kW	0.46 kW
• Fuse		35 A	50 A	50 A
• Cooling air requirement		20 l/s	20 l/s	20 l/s
• Cable cross-section for line and motor connection		6 ... 16 mm ²	10 ... 16 mm ²	10 ... 16 mm ²
• Torque for line and motor and motor connection		2.0 Nm	2.0 Nm	2.0 Nm
• Weight		9.5 kg	9.5 kg	9.5 kg

Table 10- 7 PM230 frame size D, 3-ph. 380 V AC... 480 V, ± 10 %

Order number	Filter Class A	6SL3223-0DE32-2AA0	6SL3223-0DE33-0AA0
	Filter Class B	6SL3223-0DE32-2BA0	6SL3223-0DE33-0BA0
Values based on Low Overload			
• LO power		22 kW	30 kW
• LO input current		42 A	56 A
• LO output current		45 A	60 A
Values based on High Overload			
• HO power		18.5 kW	22 kW
• HO input current		36 A	42 A
• HO output current		38 A	45 A
General values			
• Power loss		0.52 kW	0.68 kW
• Fuse		63 A	80 A
• Cooling air requirement		39 l/s	39 l/s
• Cable cross-section for line and motor connection		16 ... 35 mm ²	16 ... 35 mm ²
• Torque for line and motor and motor connection		6 Nm	6 Nm
• Weight		30.2 kg	30.2 kg

Table 10- 8 PM230 frame size E, 3-ph. 380 V AC... 480 V, ± 10 %

Order number	Filter Class A	6SL3223-0DE33-7AA0	6SL3223-0DE34-5AA0
	Filter Class B	6SL3223-0DE33-7BA0	6SL3223-0DE34-5BA0
Values based on Low Overload			
• LO power		37 kW	45 kW
• LO input current		70 A	84 A
• LO output current		75 A	90 A
Values based on High Overload			
• HO power		30 kW	37 kW
• HO input current		56 A	70 A
• HO output current		60 A	75 A
General values			
• Power loss		0.99 kW	1.2 kW
• Fuse		100 A	125 A
• Cooling air requirement		39 l/s	39 l/s
• Cable cross-section for line and motor connection		25 ... 50 mm ²	25 ... 50 mm ²
• Torque for line and motor and motor connection		6 Nm	6 Nm
• Weight		35.8 kg	35.8 kg

Table 10- 9 PM230 frame size F, 3-ph. 380 V AC... 480 V, ± 10 %

Order number	Filter Class A	6SL3223-0DE35-5AA0	6SL3223-0DE37-5AA0	6SL3223-0DE38-8AA0
	Filter Class B	6SL3223-0DE35-5BA0	6SL3223-0DE37-5BA0	6SL3223-0DE38-8BA0
Values based on Low Overload				
• LO power		55 kW	75 kW	90 kW
• LO input current		102 A	135 A	166 A
• LO output current		110 A	145 A	178 A
Values based on High Overload				
• HO power		45 kW	55 kW	75 kW
• HO input current		84 A	102 A	135 A
• HO output current		90 A	110 A	145 A
General values				
• Power loss		1.4 kW	1.9 kW	2.3 kW
• Fuse		160 A	200 A	250 A
• Cooling air requirement		117 l/s	117 l/s	117 l/s
• Cable cross-section for line and motor connection		35 ... 120 mm ²	35 ... 120 mm ²	35 ... 120 mm ²
• Torque for line and motor and motor connection		13 Nm	13 Nm	13 Nm
• Weight		70.0 kg	70.0 kg	70.0 kg

10.2.2 Technical data, PM240

Note

The given input currents are valid for operation without a line reactor for a line voltage of 400 V with $V_k = 1\%$ referred to the rated power of the inverter. If a line reactor is used, the specified values are reduced by a few percent.

General data, PM240 - IP20

Feature	Version
Line voltage	3-ph. 380 V ... 480 V AC $\pm 10\%$ The actual permissible line voltage depends on the installation altitude.
Input frequency	47 Hz ... 63 Hz
Power factor λ	0,7 ... 0,85
Starting current	Less than the input current
Pulse frequency (factory setting)	4 kHz for 0.37 kW ... 90 kW 2 kHz for 110 kW ... 250 kW The pulse frequency can be increased in 2 kHz steps. A higher pulse frequency reduces the permissible output current.
Electromagnetic compatibility	The devices are suitable for environmental classes C1 and C2 in conformance with IEC61800-3. For details, see the Hardware Installation Manual, Appendix A2
Braking methods	DC braking, compound braking, dynamic braking with integrated braking chopper
Degree of protection	IP20
Operating temperature	
• without power reduction	LO operation of all power ratings 0 °C ... +40 °C (32 °F ... 104 °F) 0 °C ... +50 °C (32 °F ... 122 °F)
• with power reduction	HO operation: 0.37 kW ... 110 kW up to 60 °C (140° F), for details, refer to the Hardware Installation Manual HO operation: 132 kW ... 200 kW all power ratings, HO/LO
Storage temperature	-40 °C ... +70 °C (-40 °F ... 158 °F)
Relative humidity	< 95 % RH - condensation not permissible
Environmental requirements	Protected according to environmental class 3C2 to EN 60721-3-3 against damaging chemical substances
Shock and vibration	Do not allow the inverter to fall and avoid it being subject to hard shocks. Do not install the inverter in an area where it could be continuously subject to vibration.
Electromagnetic radiation	Do not install the inverter close to sources of electromagnetic radiation.
Installation altitude	
• without power reduction	0.37 kW ... 132 kW up to 1000 m (3300 ft) above sea level 160 kW ... 250 kW up to 2000 m (6500 ft) above sea level
• with power reduction	all power ratings up to 4000 m (13000 ft) above sea level, for details refer to the Hardware Installation Manual.
Standards	UL, cUL, CE, C-tick, SEMI F47 In order that the system is UL-compliant, UL-certified fuses, overload circuit-breakers or intrinsically safe motor protection devices must be used.

Power-dependent data, PM240 - IP20

Table 10- 10 PM240 frame size A, 3-ph. 380 V AC... 480 V, ± 10 %

Order number	Without filter	6SL3224-0BE13-7UA0	6SL3224-0BE15-5UA0	6SL3224-0BE17-5UA0
Values based on Low Overload				
• LO power		0.37 kW	0.55 kW	0.75 kW
• LO input current		1.6 A	2.0 A	2.5 A
• LO output current		1.3 A	1.7 A	2.2 A
Values based on High Overload				
• HO power		0.37 kW	0.55 kW	0.75 kW
• HO input current		1.6 A	2.0 A	2.5 A
• HO output current		1.3 A	1.7 A	2.2 A
General values				
• Power loss		0.097 kW	0.099 kW	0.102 kW
• Fuse		10 A	10 A	10 A
• Cooling air requirement		4.8 l/s	4.8 l/s	4.8 l/s
• Cable cross-section for line and motor connection		1 ... 2.5 mm ²	1 ... 2.5 mm ²	1 ... 2.5 mm ²
• Torque for line and motor and motor connection		1.1 Nm	1.1 Nm	1.1 Nm
• Weight		1.2 kg	1.2 kg	1.2 kg

Table 10- 11 PM240 frame size A, 3-ph. 380 V AC... 480 V, ± 10 %

Order number	Without filter	6SL3224-0BE21-1UA0	6SL3224-0BE21-5UA0
Values based on Low Overload			
• LO power		1.1 kW	1.5 kW
• LO input current		3.8 A	4.8 A
• LO output current		3.1 A	4.1 A
Values based on High Overload			
• HO power		1.1 kW	1.5 kW
• HO input current		3.8 A	4.8 A
• HO output current		3.1 A	4.1 A
General values			
• Power loss		0.108 kW	0.114 kW
• Fuse		10 A	10 A
• Cooling air requirement		4.8 l/s	4.8 l/s
• Cable cross-section for line and motor connection		1 ... 2.5 mm ²	1 ... 2.5 mm ²
• Torque for line and motor and motor connection		1.1 Nm	1.1 Nm
• Weight		1.2 kg	1.2 kg

Technical data

10.2 Technical data, Power Modules

Table 10- 12 PM240 frame size B, 3-ph. 380 V AC... 480 V, ± 10 %

Order number	with filter	6SL3224-0BE22-2AA0	6SL3224-0BE23-0AA0	6SL3224-0BE24-0AA0
	without filter	6SL3224-0BE22-2UA0	6SL3224-0BE23-0UA0	6SL3224-0BE24-0UA0
Values based on Low Overload				
• LO power		2.2 kW	3 kW	4 kW
• LO input current		7.6 A	10.2 A	13.4 A
• LO output current		5.9 A	7.7 A	10.2 A
Values based on High Overload				
• HO power		2.2 kW	3 kW	4 kW
• HO input current		7.6 A	10.2 A	13.4 A
• HO output current		5.9 A	7.7 A	10.2 A
General values				
• Power loss		0.139 kW	0.158 kW	0.183 kW
• Fuse		16 A	16 A	16 A
• Cooling air requirement		24 l/s	24 l/s	24 l/s
• Cable cross-section for line and motor connection		1.5 ... 6 mm ²	1.5 ... 6 mm ²	1.5 ... 6 mm ²
• Torque for line and motor and motor connection		1.5 Nm	1.5 Nm	1.5 Nm
• Weight		4.3 kg	4.3 kg	4.3 kg

Table 10- 13 PM240 frame size C, 3-ph. 380 V AC... 480 V, ± 10 %

Order number	with filter	6SL3224-0BE25-5AA0	6SL3224-0BE27-5AA0	6SL3224-0BE31-1AA0
	without filter	6SL3224-0BE25-5UA0	6SL3224-0BE27-5UA0	6SL3224-0BE31-1UA0
Values based on Low Overload				
• LO power		7.5 kW	11 kW	15 kW
• LO input current		21.9 A	31.5 A	39.4 A
• LO output current		18 A	25 A	32 A
Values based on High Overload				
• HO power		5.5 kW	7.5 kW	11 kW
• HO input current		16.7 A	23.7 A	32.7 A
• HO output current		13.2 A	19 A	26 A
General values				
• Power loss		0.240 kW	0.297 kW	0.396 kW
• Fuse		20 A	32 A	35 A
• Cooling air requirement		55 l/s	55 l/s	55 l/s
• Cable cross-section for line and motor connection		4 ... 10 mm ²	4 ... 10 mm ²	4 ... 10 mm ²
• Torque for line and motor and motor connection		2.3 Nm	2.3 Nm	2.3 Nm
• Weight		6.5 kg	6.5 kg	6.5 kg

Table 10- 14 PM240 frame size D, 3-ph. 380 V AC... 480 V, ± 10 %

Order number	with filter without filter	6SL3224-0BE31-5AA0 6SL3224-0BE31-5UA0	6SL3224-0BE31-8AA0 6SL3224-0BE31-8UA0	6SL3224-0BE32-2AA0 6SL3224-0BE32-2UA0
Values based on Low Overload				
• LO power		18.5 kW	22 kW	30 kW
• LO input current		46 A	53 A	72 A
• LO output current		38 A	45 A	60 A
Values based on High Overload				
• HO power		15 kW	18.5 kW	22 kW
• HO input current		40 A	46 A	56 A
• HO output current		32 A	38 A	45 A
General values				
• Power loss		0.44 kW	0.55 kW	0.72 kW
• Fuse		50 A	63 A	80 A
• Cooling air requirement		55 l/s	55 l/s	55 l/s
• Cable cross-section for line and motor connection		10 ... 35 mm ²	10 ... 35 mm ²	10 ... 35 mm ²
• Torque for line and motor and motor connection		6 Nm	6 Nm	6 Nm
• Weight with filter		16 kg	16 kg	16 kg
• Weight without filter		13 kg	13 kg	13 kg

Table 10- 15 PM240 frame size E, 3-ph. 380 V AC... 480 V, ± 10 %

Order number	with filter without filter	6SL3224-0BE33-0AA0 6SL3224-0BE33-0UA0	6SL3224-0BE33-7AA0 6SL3224-0BE33-7UA0
Values based on Low Overload			
• LO power		37 kW	45 kW
• LO input current		88 A	105 A
• LO output current		75 A	90 A
Values based on High Overload			
• HO power		30 kW	37 kW
• HO input current		73 A	90 A
• HO output current		60 A	75 A
General values			
• Power loss		1.04 kW	1.2 kW
• Fuse		100 A	125 A
• Cooling air requirement		110 l/s	110 l/s
• Cable cross-section for line and motor connection		25 ... 35 mm ²	25 ... 35 mm ²
• Torque for line and motor and motor connection		6 Nm	6 Nm
• Weight with filter		23 kg	23 kg
• Weight without filter		16 kg	16 kg

Technical data

10.2 Technical data, Power Modules

Table 10- 16 PM240 frame size F, 3-ph. 380 V AC... 480 V, ± 10 %

Order number	with filter without filter	6SL3224-0BE34-5AA0 6SL3224-0BE34-5UA0	6SL3224-0BE35-5AA0 6SL3224-0BE35-5UA0	6SL3224-0BE37-5AA0 6SL3224-0BE37-5UA0
Values based on Low Overload				
• LO power		55 kW	75 kW	90 kW
• LO input current		129 A	168 A	204 A
• LO output current		110 A	145 A	178 A
Values based on High Overload				
• HO power		45 kW	55 kW	75 kW
• HO input current		108 A	132 A	169 A
• HO output current		90 A	110 A	145 A
General values				
• Power loss		1.5 kW	2.0 kW	2.4 kW
• Fuse		160 A	200 A	250 A
• Cooling air requirement		150 l/s	150 l/s	150 l/s
• Cable cross-section for line and motor connection		35 ... 120 mm ²	35 ... 120 mm ²	35 ... 120 mm ²
• Torque for line and motor and motor connection		13 Nm	13 Nm	13 Nm
• Weight with filter		52 kg	52 kg	52 kg
• Weight without filter		36 kg	36 kg	36 kg

Table 10- 17 PM240 frame size F, 3-ph. 380 V AC... 480 V, ± 10 %

Order number	Without filter	6SL3224-0BE38-8UA0	6SL3224-0BE41-1UA0
Values based on Low Overload			
• LO power		110 kW	132 kW
• LO input current		234 A	284 A
• LO output current		205 A	250 A
Values based on High Overload			
• HO power		90 kW	110 kW
• HO input current		205 A	235 A
• HO output current		178 A	205 A
General values			
• Power loss		2.4 kW	2.5 kW
• Fuse		250 A	315 A
• Cooling air requirement		150 l/s	150 l/s
• Cable cross-section for line and motor connection		35 ... 120 mm ²	35 ... 120 mm ²
• Torque for line and motor and motor connection		13 Nm	13 Nm
• Weight		39 kg	39 kg

Table 10- 18 PM240 frame size GX, 3-ph. 380 V AC... 480 V, ± 10 %

Order number	Without filter	6SL3224-0BE41-3UA0	6SL3224-0BE41-6UA0	6SL3224-0BE42-0UA0
Values based on Low Overload				
• LO power		160 kW	200 kW	250 kW
• LO input current		297 A	354 A	442 A
• LO output current		302 A	370 A	477 A
Values based on High Overload				
• HO power		132 kW	160 kW	200 kW
• HO input current		245 A	297 A	354 A
• HO output current		250 A	302 A	370 A
General values				
• Power loss		3.9 kW	4.4 kW	5.5 kW
• Fuse		355 A	400 A	630 A
• Cooling air requirement		360 l/s	360 l/s	360 l/s
• Cable cross-section for line and motor connection		95 ... 240 mm ²	120 ... 240 mm ²	185 ... 240 mm ²
• Torque for line and motor and motor connection		14 Nm	14 Nm	14 Nm
• Weight		176 kg	176 kg	176 kg

10.2.3 Technical data, PM250

General data, PM250 - IP20

Feature	Version
Line voltage	3-ph. 380 V ... 480 V AC \pm 10 % The actual permissible line voltage depends on the installation altitude
Input frequency	47 Hz ... 63 Hz
Modulation depth	93 % (the maximum output voltage is 93 % of the input voltage)
Power factor λ	0.9
Starting current	Less than the input current
Pulse frequency (factory setting)	4 kHz The pulse frequency can be increased up to 16 kHz in 2 kHz steps. A higher pulse frequency reduces the permissible output current.
Electromagnetic compatibility	The devices are suitable for environmental classes C1 and C2 in conformance with IEC61800-3. For details, see the Hardware Installation Manual, Appendix A2
Braking method	DC braking, energy recovery (up to 100% of the output power)
Degree of protection	IP20
Operating temperature	
• without power reduction	LO operation: 0 °C ... +40 °C (32 °F ... 104 °F) HO operation: 0 °C ... +50 °C (32 °F ... 122 °F)
• with power reduction	HO/LO up to 60 °C (140° F), for details see the Hardware Installation Manual
Storage temperature	-40 °C ... +70 °C (-40 °F ... 158 °F)
Relative humidity	< 95 % RH - condensation not permissible
Environmental requirements	Protected according to environmental class 3C2 to EN 60721-3-3 against damaging chemical substances
Shock and vibration	Do not allow the inverter to fall and avoid it being subject to hard shocks. Do not install the inverter in an area where it could be continuously subject to vibration.
Electromagnetic radiation	Do not install the inverter close to sources of electromagnetic radiation.
Installation altitude	
• without power reduction	Up to 1000 m (3300 ft) above sea level
• with power reduction	up to 4000 m (13000 ft) above sea level, for details see the Hardware Installation Manual.
Standards	UL, CE, CE, SEMI F47 In order that the system is UL-compliant, UL-certified fuses, overload circuit-breakers or intrinsically safe motor protection devices must be used.

Power-dependent data, PM250 - IP20

Table 10- 19 PM250 frame size C, 3-ph. 380 V AC... 480 V, ± 10 %

Order number	6SL3225-0BE25-5AA0	6SL3225-0BE27-5AA0	6SL3225-0BE31-1AA0
Values based on Low Overload			
• LO power	7.5 kW	11.0 kW	15 kW
• LO input current	18.0 A	25.0 A	32.0 A
• LO output current	18.0 A	25.0 A	32.0 A
Values based on High Overload			
• HO power	5.5 kW	7.5 kW	11.0 kW
• HO input current	13.2 A	19.0 A	26.0 A
• HO output current	13.2 A	19.0 A	26.0 A
General values			
• Power loss	Available soon	Available soon	Available soon
• Fuse	20 A	32 A	35 A
• Cooling air requirement	38 l/s	38 l/s	38 l/s
• Cable cross-section for line and motor connection	2.5 ... 10 mm ²	4 to 10 mm ²	6 to 10 mm ²
• Torque for line and motor and motor connection	2.3 Nm	2.3 Nm	2.3 Nm
• Weight	7.5 kg	7.5 kg	7.5 kg

Table 10- 20 PM250 frame size D, 3-ph. 380 V AC... 480 V, ± 10 %

Order number	6SL3225-0BE31-5AA0	6SL3225-0BE31-8AA0	6SL3225-0BE32-2AA0
Values based on Low Overload			
• LO power	18.5 kW	22.0 kW	30 kW
• LO input current	36.0 A	42.0 A	56.0 A
• LO output current	38.0 A	45.0 A	60.0 A
Values based on High Overload			
• HO power	15.0 kW	18.5 kW	22.0 kW
• HO input current	30.0 A	36.0 A	42.0 A
• HO output current	32.0 A	38.0 A	45.0 A
General values			
• Power loss	0.44 kW	0.55 kW	0.72 kW
• Fuse	50 A	63 A	80 A
• Cooling air requirement	22 l/s	22 l/s	39 l/s
• Cable cross-section for line and motor connection	10 ... 35 mm ²	10 ... 35 mm ²	16 ... 35 mm ²
• Torque for line and motor and motor connection	6 Nm	6 Nm	6 Nm
• Weight	15 kg	15 kg	16 kg

Technical data

10.2 Technical data, Power Modules

Table 10- 21 PM250 frame size E, 3-ph. 380 V AC... 480 V, ± 10 %

Order number	6SL3225-0BE33-0AA0	6SL3225-0BE33-7AA0
Values based on Low Overload		
• LO power	37 kW	45 kW
• LO input current	70 A	84 A
• LO output current	75 A	90 A
Values based on High Overload		
• HO power	30.0 kW	37.0 kW
• HO input current	56 A	70 A
• HO output current	60 A	75 A
General values		
• Power loss	1 kW	1.3 kW
• Fuse	100 A	125 A
• Cooling air requirement	22 l/s	39 l/s
• Cable cross-section for line and motor connection	25 ... 35	25 ... 35
• Torque for line and motor and motor connection	6 Nm	6 Nm
• Weight	21 kg	21 kg

Table 10- 22 PM250 frame size F, 3-ph. 380 V AC... 480 V, ± 10 %

Order number	6SL3225-0BE34-5AA0	6SL3225-0BE35-5AA0	6SL3225-0BE37-5AA0
Values based on Low Overload			
• LO power	55.0 kW	75 kW	90 kW
• LO input current	102 A	190 A	223 A
• LO output current	110 A	145 A	178 A
Values based on High Overload			
• HO power	45.0 kW	55.0 kW	75 kW
• HO input current	84 A	103 A	135 A
• HO output current	90 A	110 A	145 A
General values			
• Power loss	1.5 kW	2 kW	2.4 kW
• Fuse	160 A	200 A	250 A
• Cooling air requirement	94 l/s	94 l/s	117 l/s
• Cable cross-section for line and motor connection	35 ... 150 mm ²	70 ... 150 mm ²	95 ... 150 mm ²
• Torque for line and motor and motor connection	13 Nm	13 Nm	13 Nm
• Weight	51.0 kg	51.0 kg	51.0 kg

10.2.4 Technical data, PM260

General data, PM260 - IP20

Feature	Version
Line voltage	3-ph. 660 V ... 690 V AC \pm 10% The permissible line voltage depends on the installation altitude The power units can also be operated with a minimum voltage of 500 V -10 %. In this case, the power is linearly reduced as required.
Input frequency	47 Hz ... 63 Hz
Power factor λ	0.9
Starting current	Less than the input current
Pulse frequency	16 kHz
Electromagnetic compatibility	The devices are suitable for environmental classes C1 and C2 in conformance with IEC61800-3. For details, see the Hardware Installation Manual, Appendix A2
Braking method	DC braking, energy recovery (up to 100% of the output power)
Degree of protection	IP20
Operating temperature	
• without power reduction	LO operation: 0 °C ... +40 °C (32 °F ... 104 °F) HO operation: 0 °C ... +50 °C (32 °F ... 122 °F)
• with power reduction	HO/LO up to 60 °C (140 °F), for details see the Hardware Installation Manual
Storage temperature	-40 °C ... +70 °C (-40 °F ... 158 °F)
Relative humidity	< 95% RH - condensation not permissible
Environmental requirements	Protected according to environmental class 3C2 to EN 60721-3-3 against damaging chemical substances
Shock and vibration	Do not allow the inverter to fall and avoid it being subject to hard shocks. Do not install the inverter in an area where it could be continuously subject to vibration.
Electromagnetic radiation	Do not install the inverter close to sources of electromagnetic radiation.
Installation altitude	
• without power reduction	Up to 1000 m (3300 ft) above sea level
• with power reduction	up to 4000 m (13000 ft) above sea level, for details see the Hardware Installation Manual.
Standards	CE, C-TICK

Power-dependent data, PM260 - IP20

Table 10- 23 PM260 frame size D, 3-ph. 660 V AC... 690 V, ± 10% (500 V - 10%)

Order number	with filter without filter	6SL3225- 0BH27-5AA1 6SL3225- 0BH27-5UA1	6SL3225- 0BH31-1AA1 6SL3225- 0BH31-1UA1	6SL3225- 0BH31-5AA1 6SL3225- 0BH31-5UA1
Values based on Low Overload				
• LO power		11 kW	15 kW	18.5 kW
• LO input current		13 A	18 A	22 A
• LO output current		14 A	19 A	23 A
Values based on High Overload				
• HO power		7.5 kW	11 kW	15 kW
• HO input current		10 A	13 A	18 A
• HO output current		10 A	14 A	19 A
General values				
• Power loss		No data	No data	No data
• Fuse		25 A	35 A	35 A
• Cooling air requirement		44 l/s	44 l/s	44 l/s
• Cable cross-section for line and motor connection		2.5 ... 16 mm ²	2.5 ... 16 mm ²	2.5 ... 16 mm ²
• Torque for line and motor connection		1.5 Nm	1.5 Nm	1.5 Nm
• Weight with filter		23 kg	23 kg	23 kg
• without filter		22 kg	22 kg	22 kg

Table 10- 24 PM260 frame size F, 3-ph. 660 V AC... 690 V, ± 10% (500 V - 10%)

Order number	with filter without filter	6SL3225- 0BH32-2AA1 6SL3225- 0BH32-2UA1	6SL3225- 0BH33-0AA1 6SL3225- 0BH33-0UA1	6SL3225- 0BH33-7AA1 6SL3225- 0BH33-7UA1
Values based on Low Overload				
• LO power		30 kW	37 kW	55 kW
• LO input current		34 A	41 A	60 A
• LO output current		35 A	42 A	62 A
Values based on High Overload				
• HO power		22 kW	30 kW	37 kW
• HO input current		26 A	34 A	41 A
• HO output current		26 A	35 A	42 A
General values				
• Power loss		No data	No data	No data
• Fuse		63 A	80 A	100 A
• Cooling air requirement		130 l/s	130 l/s	130 l/s
• Cable cross-section for line and motor connection		10 ... 35 mm ²	10 ... 35 mm ²	10 ... 35 mm ²
• Torque for line and motor connection		6 Nm	6 Nm	6 Nm
• Weight with filter		58 kg	58 kg	58 kg
• without filter		56 kg	56 kg	56 kg

Appendix

A.1 Application examples

A.1.1 Configuring communication in STEP 7

A.1.1.1 Task

Using a suitable example, the following section provides information on how you connect an inverter to a higher-level SIMATIC control via PROFIBUS.

What prior knowledge is required?

In this example, it is assumed that readers know how to basically use an S7 control and the STEP 7 engineering tool and is not part of this description.

A.1.1.2 Required components

The example in this manual is based on the following hardware:

Table A- 1 Hardware components

Component	Type	Order no.	Qty
Control system			
Power supply	PS307 2 A	6ES7307-1BA00-0AA0	1
S7 CPU	CPU 315-2DP	6ES7315-2AG10-0AB0	1
Memory card	MMC 2MB	6ES7953-8LL11-0AA0	1
DIN rail	DIN rail	6ES7390-1AE80-0AA0	1
PROFIBUS connector	PROFIBUS connector	6ES7972-0BB50-0XA0	1
PROFIBUS cable	PROFIBUS cable	6XV1830-3BH10	1
Converter			
SINAMICS G120 Control Unit	CU230P-2 DP	6SL3243-0BB30-1PA2	1
SINAMICS G120 Power Module	Any	-	1
PROFIBUS connector	PROFIBUS connector	6GK1500-0FC00	1

In order to configure the communication you also require the following software packages:

Table A-2 Software components

Component	Type (or higher)	Order no.	Qty
SIMATIC STEP 7	V5.3 + SP3	6ES7810-4CC07-0YA5	1
STARTER	V4.2	6SL3072-0AA00-0AG0	1

A.1.1.3 Creating a STEP 7 project

PROFIBUS communication between the inverter and a SIMATIC control is configured using the SIMATIC STEP 7 and HW Config software tools.

Procedure

- Create a new STEP 7 project and assign a project name, e.g. "G120_in_S7". Add an S7 300 CPU.

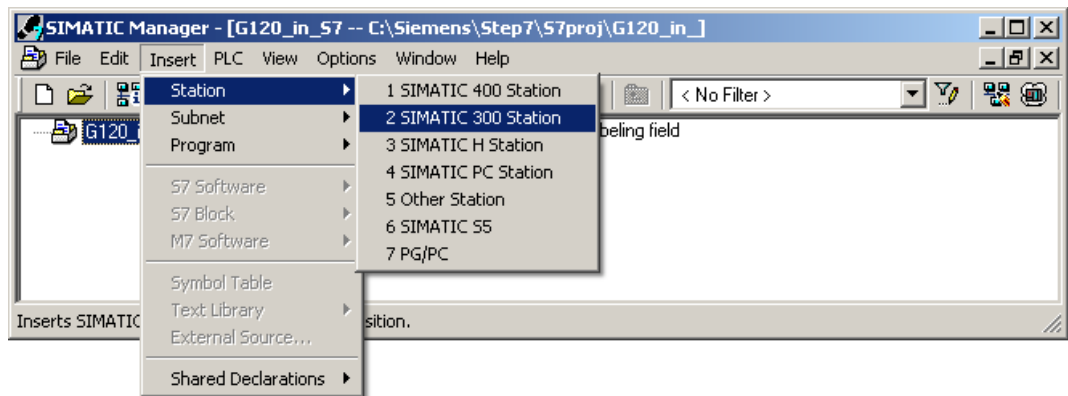

Figure A-1 Inserting a SIMATIC 300 station into a STEP 7 project

- Select the SIMATIC 300 station in your project and open the hardware configuration (HW Config) by double clicking on "Hardware".
- Add an S7 300 mounting rail to your project by dragging and dropping it from the "SIMATIC 300" hardware catalog. Locate a power supply at slot 1 of the mounting rail and a CPU 315-2 DP at slot 2.

When you add the SIMATIC 300, a window is displayed in which you can define the network.

- Create a PROFIBUS DP network.

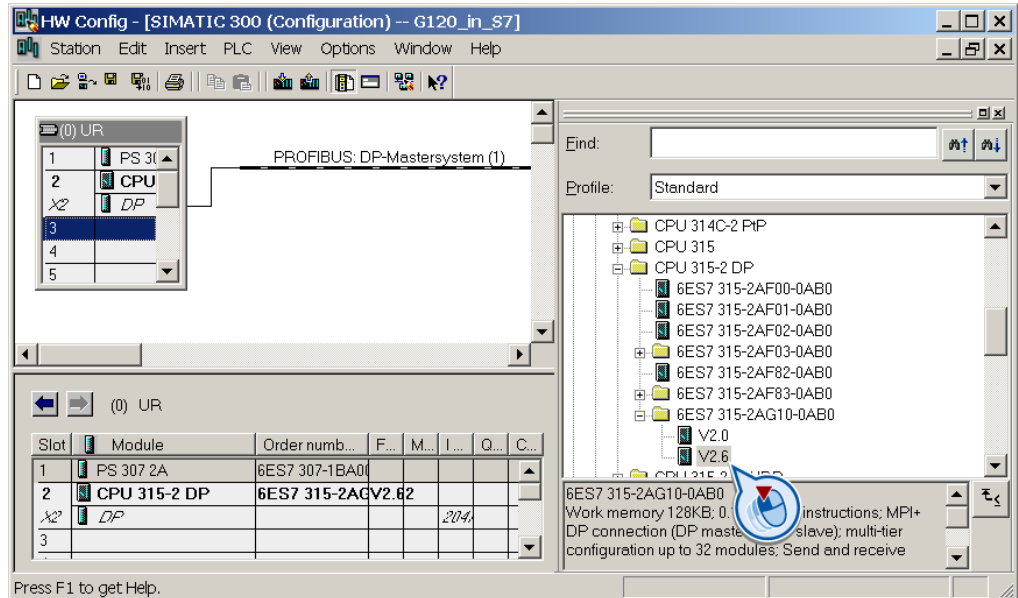

Figure A-2 Inserting a SIMATIC 300 station with PROFIBUS DP network

A.1.1.4 Configuring communications to a SIMATIC control

The inverter can be connected to a SIMATIC control in two ways:

1. Using the inverter GSD
2. Using the STEP 7 object manager

This somewhat more user-friendly method is only available for S7 controls and installed Drive ES Basic (see Section Modularity of the converter system (Page 21)).

The following section describes how to configure the inverter using the GSD.

A.1.1.5 Inserting the inverter into the STEP 7 project

- Install the GSD of the converter in STEP 7 using HW Config (menu "Options - Install GSD files").

After the GSD has been installed, the converter appears under "PROFIBUS DP - additional field devices" in the hardware catalog of HW Config.

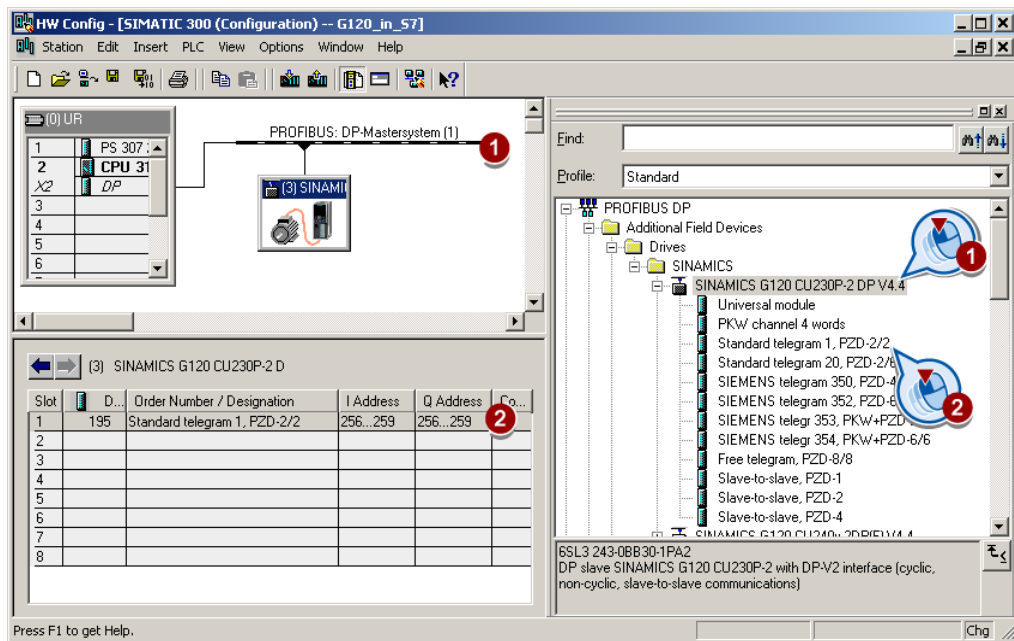

- Drag and drop the converter into the PROFIBUS network. Enter the PROFIBUS address set at the converter in HW Config.
- Insert the required telegram type from the HW catalog by "dragging and dropping" into slot 1 of the converter.
You can find more detailed information on the telegram types in Chapter Cyclic communication (Page 101).

Sequence when assigning the slots

1. PKW channel (if one is used)
2. Standard, SIEMENS or free telegram (if one is used)
3. Slave-to-slave module

If you do not use one or several of the modules 1 or 2, configure the remaining modules starting with the 1st slot.

Note regarding the universal module

It is not permissible to configure the universal module with the following properties:

- PZD length 4/4 words
- Consistent over the complete length

With these properties, the universal module has the same DP identifier (4AX) as the "PKW channel 4 words" and is therefore identified as such by the higher-level control. As a consequence, the control does not establish cyclic communication with the inverter.

Remedy: Change the length to 8/8 bytes in the properties of the DP slave. As an alternative, you can also change the consistency to "unit".

Final steps

- Save and compile the project in STEP 7.
- Establish an online connection between your PC and the S7 CPU and download the project data to the S7 CPU.
- In the inverter, select the telegram type, which you configured in STEP 7, using parameter P0922.

The inverter is now connected to the S7 CPU. This therefore defines the communication interface between the CPU and the inverter. An example of how you can supply this interface with data can be found in the next section.

A.1.2 STEP 7 program examples

A.1.2.1 STEP 7 program example for cyclic communication

Network 1: Control word 1 and setpoint

Control word 1: 047E hex
Setpoint: 2500 hex

```
L W#16#47E
T MW 1
L W#16#2500
T MW 3
```

Network 2: Acknowledge fault

--	--	--

```
U E 0.6
= M 2.7
```

Network 3: Switch the motor on and off

--	--	--

```
U E 0.0
= M 2.0
```

Network 4: Write process data

--	--	--

```
L MW 1
T PAW 256
L MW 3
T PAW 258
```

Network 4: Read process data

Status word 1: MW 5
Actual value: MW 7

```
L PEW 256
T MW 5
L PEW 258
T MW 7
```

The control and inverter communicate via standard telegram 1. The control specifies control word 1 (STW1) and the speed setpoint, while the inverter responds with status word 1 (ZSW1) and its actual speed.

In this example, inputs E0.0 and E0.6 are linked to the -bit ON/OFF1 or to the "acknowledge fault" bit of STW 1.

Control word 1 contains the numerical value 047E hex. The bits of control word 1 are listed in the following table.

The hexadecimal numeric value 2500 specifies the setpoint frequency of the inverter. The maximum frequency is the hexadecimal value 4000 (also see Configuring the fieldbus (Page 97)).

The control cyclically writes the process data to logical address 256 of the inverter. The inverter also writes its process data to logical address 256. You define the address area in HW Config, see Inserting the inverter into the STEP 7 project (Page 326).

Table A-3 Assignment of the control bits in the inverter to the SIMATIC flags and inputs

HEX	BIN	Bit in STW1	Significance	Bit in MW1	Bit in MB1	Bit in MB2	Inputs
E	0	0	ON/OFF1	8		0	E0.0
	1	1	ON/OFF2	9		1	
	1	2	ON/OFF3	10		2	
	1	3	Operation enable	11		3	
7	1	4	Ramp-function generator enable	12		4	
	1	5	Start ramp-function generator	13		5	
	1	6	Setpoint enable	14		6	
	0	7	Acknowledge fault	15	7	E0.6	
4	0	8	Jog 1	0	0		
	0	9	Jog 2	1	1		
	1	10	PLC control	2	2		
	0	11	Setpoint inversion	3	3		
0	0	12	Irrelevant	4	4		
	0	13	Motorized potentiometer ↑	5	5		
	0	14	Motorized potentiometer ↓	6	6		
	0	15	Data set changeover	7	7		

A.1.2.2 STEP 7 program example for acyclic communication

OB1: Cyclic control program



Network 1: Reading and writing parameters



```
// read parameters
O(
U   M   9.2
UN  M   9.1
)
O(
U   M   9.0
UN  M   9.1
)
R   M   9.3

SPB  RD

// write parameters
O(
U   M   9.3
UN  M   9.0
)
O(
U   M   9.1
UN  M   9.0
)
R   M   9.2

SPB  WR
BEA

RD:  NOP  0
     CALL FC  1
     BEA

WR:  NOP  0   9.1
     CALL FC  3
```

M9.0 Starts reading parameters

M9.1 Starts writing parameters

M9.2 displays the read process

M9.3 displays the write process

The number of simultaneous requests for acyclic communication is limited. More detailed information can be found in the

<http://support.automation.siemens.com/WW/view/de/15364459>

(<http://support.automation.siemens.com/WW/view/en/15364459>).

FC1: PAR_RD



Network 1: Parameters for reading



```

L   MB   40
T   DB1.DBB 0
L   B#16#01
T   DB1.DBB 1
T   DB1.DBB 2
L   MB   62
T   DB1.DBB 3
// -----
L   MW   50
T   DB1.DBW 6
L   MB   58
T   DB1.DBB 5
L   MW   63
T   DB1.DBW 8
// -----
L   MW   52
T   DB1.DBW 12
L   MB   59
T   DB1.DBB 11
L   MW   65
T   DB1.DBW 14
// -----
L   MW   54
T   DB1.DBW 18
L   MB   60
T   DB1.DBB 17
L   MW   67
T   DB1.DBW 10
// -----
L   MW   56
T   DB1.DBW 24
L   MB   61
T   DB1.DBB 23
L   MW   69
T   DB1.DBW 26

```

Network 2: Read request, part 1



```

CALL SFC 58
REQ   :=M9.0
IOID  :=B#16#54
LADDR :=W#16#170
RECNUM :=B#16#2F
RECORD :=P#DB1.DBX0.0 BYTE 28
RET_VAL :=MW10
BUSY  :=M8.1

U   M   8.1
R   M   9.0
S   M   9.2

```

Network 3: Read delay after a read request



```

U   M   8.1
UN  M   9.1
L   S5T#1s
SS  T   1
U   M   8.3
R   T   1
U   T   1
=   M   8.2

```

Network 4: Read request, part 2



```

CALL SFC 59
REQ   :=M8.2
IOID  :=B#16#54
LADDR :=W#16#170
RECNUM :=B#16#2F
RET_VAL :=MW12
BUSY  :=M8.3
RECORD :=P#DB2.DBX0.0 BYTE 36

U   M   8.3
R   M   8.2

```

Figure A-3 Reading parameters

Explanation of FC 1

Table A- 4 Request to read parameters

Data block DB 1	Byte n	Bytes n + 1	n
Header	Reference <i>MB 40</i>	01 hex: Read request	0
	01 hex	Number of parameters (m) <i>MB 62</i>	2
Address, parameter 1	Attribute <i>10 hex: Parameter value</i>	Number of indices <i>MB 58</i>	4
	Parameter number <i>MW 50</i>		6
	Number of the 1st index <i>MW 63</i>		8
Address, parameter 2	Attribute <i>10 hex: Parameter value</i>	Number of indices <i>MB 59</i>	10
	Parameter number <i>MW 52</i>		12
	Number of the 1st index <i>MW 65</i>		14
Address, parameter 3	Attribute <i>10 hex: Parameter value</i>	Number of indices <i>MB 60</i>	16
	Parameter number <i>MW 54</i>		18
	Number of the 1st index <i>MW 67</i>		20
Address, parameter 4	Attribute <i>10 hex: Parameter value</i>	Number of indices <i>MB 61</i>	22
	Parameter number <i>MW 56</i>		24
	Number of the 1st index <i>MW 69</i>		26

SFC 58 copies the specifications for the parameters to be read from DB 1 and sends them to the converter as a read request. No other read requests are permitted while this one is being processed.

After the read request and a waiting time of one second, the control takes the parameter values from the converter via SFC 59 and saves them in DB 2.

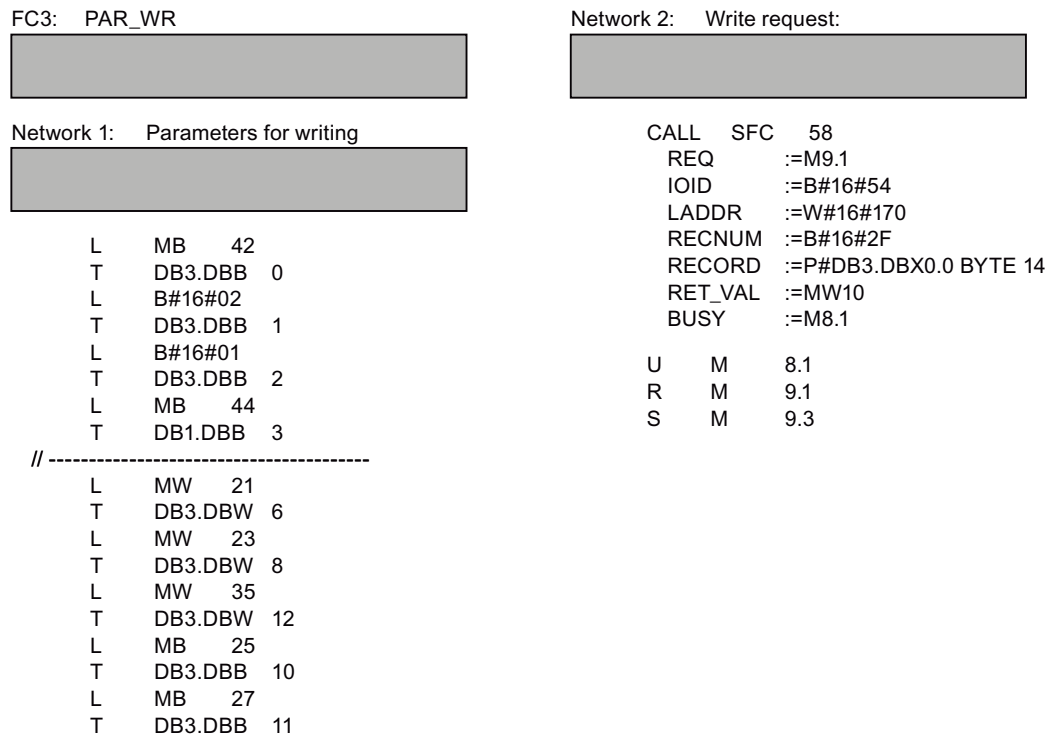

Figure A-4 Writing parameters

Explanation of FC 3

Table A-5 Request to change parameters

Data block DB 3	Byte n	Bytes n + 1	n
Header	Reference <i>MB 42</i>	02 hex: Change request	0
		01 hex	Number of parameters <i>MB 44</i>
Address, parameter 1	10 hex: Parameter value	Number of indices <i>00 hex</i>	4
	Parameter number <i>MW 21</i>		6
	Number of the 1st index <i>MW 23</i>		8
Values, parameter 1	Format <i>MB 25</i>	Number of index values <i>MB 27</i>	10
	Value of 1st index <i>MW35</i>		12

SFC 58 copies the specifications for the parameters to be written from DB 3 and sends them to the converter. No other write requests are permitted while this one is being processed.

A.1.3 Configuring slave-to-slave communication in STEP 7

Two drives communicate via standard telegram 1 with the higher-level control. In addition, drive 2 receives its speed setpoint directly from drive 1 (actual speed).

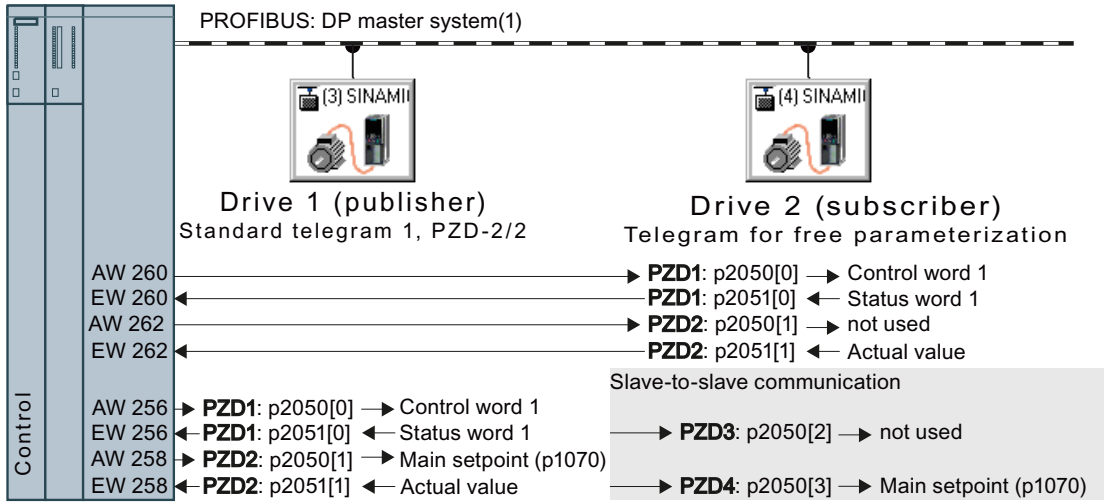
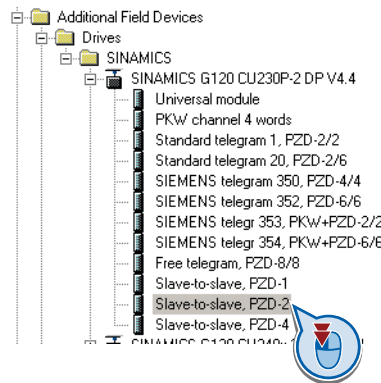

Figure A-5 Communication with the higher-level control and between the drives with slave-to-slave communication

Settings in the control

In HW Config in drive 2 (Subscriber), insert a slave-to-slave communication object, e.g. "Slave-to-slave, PZD2".



With a double-click, open the dialog box to make additional settings for the slave-to-slave communication.

Slot	D.	Order Number / Designation	I Address	Q Address	Co...
1	195	Standard telegram 1, PZD-2/2	260...263	260...263	
2	129	Slave-to-slave, PZD-2			
3					
4					
5					
6					

- ① Activate the tab "Address configuration".
- ② Select line 1.
- ③ Open the dialog box in which you define the Publisher and the address area to be transferred.

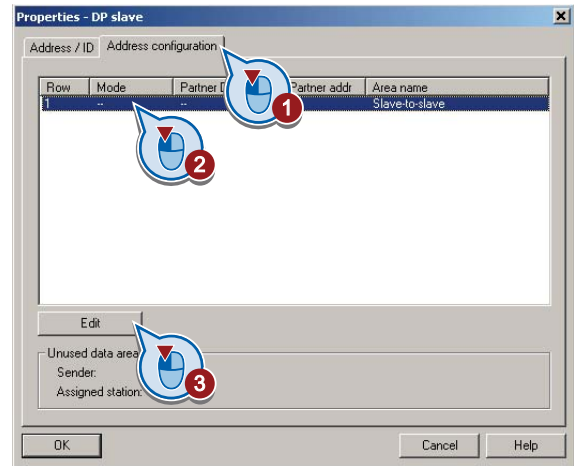

- ① Select DX for direct data exchange
- ② Select the PROFIBUS address of drive 1 (publisher).
- ③ In the address field, select the start address specifying the data area to be received from drive 1. In the example, these are the status word 1 (PZD1) and the speed actual value with the start address 256.

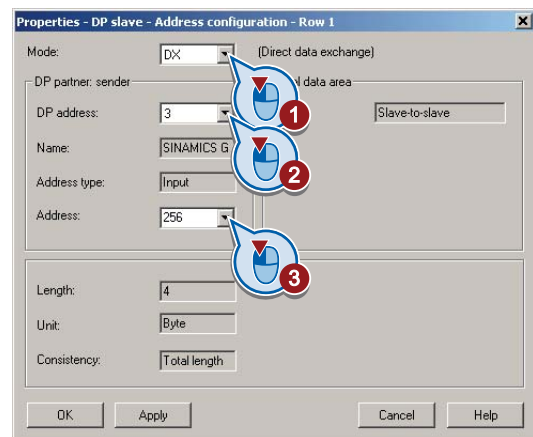

Close both screen forms with OK. You have now defined the value range for slave-to-slave communication.

In the slave-to-slave communication, drive 2 receives the sent data and writes this into the next available words, in this case, PZD3 and PZD4.

Settings in drive 2 (subscriber)

Drive 2 is preset in such a way that it receives its setpoint from the higher-level control. In order that drive 2 accepts the actual value sent from drive 1 as setpoint, you must set the following:

- In drive 2, set the PROFIdrive telegram selection to "Free telegram configuration with BICO" (p0922 = 999).
- In drive 2, set the source of the main setpoint to p1070 = 2050.3.

A.2 Additional information on the inverter

A.2.1 Manuals for your inverter

Table A- 6 Manuals for your converter

Depth of the information	Manual	Contents	Languages	Download or order number
+	Getting Started Control Units CU230P-2; CU240B-2; CU240E-2	Installing the converter and commissioning.	English, German, Italian, French, Spanish	Download manuals (http://support.automation.siemens.com/WW/view/en/22339653/133300) Order numbers: SD Manual Collection (DVD)
+	Getting Started SINAMICS G120 Power Module	Installing the Power Module		
++	Operating instructions	(this manual)		
+++	List Manual Control Units CU230P-2	Graphic function block diagrams. List of all parameters, alarms and faults.	German, English	<ul style="list-style-type: none"> • 6SL3298-0CA00-0MG0 Supplied once. • 6SL3298-0CA10-0MG0 Update Service for 1 year; supplied 4 times per year.
+++	Hardware Installation Manual <ul style="list-style-type: none"> • PM230 Power Module • PM240 Power Module • PM250 Power Module • PM260 Power Module 	Installing power modules, reactors and filters. Maintaining power modules.		
+++	Operating and installation instructions	For converter accessories, e.g. operator panel, reactors or filter.		

Table A- 7 Support when configuring and selecting the converter

Manual or tool	Contents	Languages	Download or order number
Catalog D 11.1	Ordering data and technical information for the standard SINAMICS G converters	English, German, Italian, French, Spanish	Everything about SINAMICS G120 (www.siemens.com/sinamics-g120) Everything about SINAMICS G120P (www.siemens.com/sinamics-g120p)
Online catalog (Industry Mall)	Ordering data and technical information for all SIEMENS products	English, German	
SIZER	The overall configuration tool for SINAMICS, MICROMASTER and DYNAVERT T drives, motor starters, as well as SINUMERIK, SIMOTION controls and SIMATIC technology	English, German, Italian, French	You obtain SIZER on a DVD (Order number: 6SL3070-0AA00-0AG0) and in the Internet: Download SIZER (http://support.automation.siemens.com/W/view/en/10804987/130000)
Configuration Manual	Selecting geared motors, motors and converters using calculation examples	English, German	You can obtain the Configuration Manual from your local sales office.

If you have further questions

You can find additional information on the product and more in the Internet under: Product support (<http://support.automation.siemens.com/W/view/en/4000024>).

In addition to our documentation, we offer our complete knowledge base on the Internet at: Here, you will find the following information:

- Actual product information (Update), FAQ (frequently asked questions), downloads.
- The Newsletter contains the latest information on the products you use.
- The Knowledge Manager (Intelligent Search) helps you find the documents you need.
- Users and specialists from around the world share their experience and knowledge in the Forum.
- You can find your local representative for Automation & Drives via our contact database under "Contact & Partner".
- Information about local service, repair, spare parts and much more can be found under "Services".

A.3 Mistakes and improvements

If you come across any mistakes when reading this manual or if you have any suggestions for how it can be improved, then please send your suggestions to the following address or by E-mail:

Siemens AG
Drive Technologies
Motion Control Systems
Postfach 3180
91050 Erlangen, Germany

E-mail (<mailto:documentation.standard.drives@siemens.com>)

Index

8

87 Hz characteristic, 37

A

Acyclic data transfer, 113
Additional technology controller 0, 222
Additional technology controller 1, 222
Additional technology controller 2, 222
Adjustable parameters, 13
Alarm, 248, 285, 288
Alarm buffer, 248, 288
Alarm code, 288
Alarm history, 289
Alarm time, 248, 288
Alarm value, 288
Ambient temperature, 57, 215
Analog input, 47
 Function, 85
Analog output, 47
 Function, 85
Analog outputs
 Functions of the, 93
Analog setpoint, 49
Automatic mode, 191
Automatic restart, 239

B

Back up
 Parameter, 282
Back up parameters, 282
BF (Bus Fault), 286
BICO block, 16
BICO parameters, 17
BICO technology, 17, 85
Binectors, 16
Block, 16
Blocking protection, 244, 245
Boost parameter, 208
BOP-2
 Display, 63
 Menu, 64
Braking

 Regenerative, 236
Braking chopper, 234
Braking method, 227
Braking resistor, 234
Break loose torque, 15
Bus fault, 286
Bypass, 24, 265

C

CAN
 COB, 153
 COB ID, 153
 Device profile, 153
 EMCY, 153
 NMT, 153
 PDO, 153
 SDO, 153
 SYNC, 153
CANopen, 51
CANopen communication profile, 153
Cascade control, 24, 261
Catalog, 337
CDS, 191
Centrifuge, 225, 228, 232, 236
Changing over
 Free PDO mapping / Predefined Connection
 Set, 161
Changing parameters
 BOP-2, 65
 STARTER, 74
Characteristic
 ECO mode, 207
 Linear, 206
 parabolic, 206
 square-law, 206
Clockwise, 185
COB, 153
COB ID, 153
Command Data Set, 191
Command source, 184
 Selecting, 14, 194
Command sources, 48
Commissioning
 Guidelines, 53
Commissioning tools, 22
Compound braking, 232, 233
Compressor, 204

- Configuring support, 337
- Configuring the fieldbus, 48
- Configuring the interfaces, 48
- Configuring the terminal strip, 48
- Connectors, 16
- Control Data Set, CDS, 191
- Control mode, 15, 59
- Control Units, 21
- Control word, 102, 105
- Control word 1, 103
- Control word 3, 105
- Controlling the motor, 185
- Conveyor belt, 228
- Conveyor systems, 71
- Correction manual, 338
- Counterclockwise, 185
- Crane, 225, 236

D

- Data backup, 81, 83
- Data exchange fieldbus, 97
- Data set 47, 113, 332
- Data transfer, 81, 83
- Date, 247
- DC braking, 105, 229, 230, 231
- DC link overvoltage, 216
- DC link voltage, 216
- Default settings, 58
- Delta connection (Δ), 37, 57
- Device profile, 153
- Digital input, 47
 - Function, 85
- Digital output, 47
 - Function, 85
- Digital outputs
 - Functions of the, 88
- DIP switch
 - Analog input, 90
- Direction reversal, 185
- Display parameters, 13
- Down ramp, 14
- Download, 23, 81, 83
- DP-V1 (PROFIBUS), 113
- Drive Data Set, DDS, 279
- Drive Data Sets, 279
- Drive ES Basic, 23, 325
- DS 47, 113, 332
- DTC (Digital Time Clock), 249

E

- Electromagnetic interference, 39
- EMCY, 153
- Energy recovery option, 236
- Energy-saving mode, 24
- Essential service mode, 24, 252
- Extruders, 204

F

- Factory settings, 55
 - Restoring the, 55
- Fans, 71, 204, 225
- Fault, 286
 - Acknowledge, 291, 292
- Fault buffer, 248, 291
- Fault case, 291
- Fault code, 291
- Fault history, 292
- Fault time, 248, 291
 - received, 291
 - removed, 291
- Fault value, 291
- FFC (Flux Current Control), 207
- Field weakening, 37
- Filter, 26
- Firmware version, 14
- Flow control, 243
- Flying restart, 237, 238
- Formatting, 79
- Frame size, 25
- Frame sizes, 25
- Free PDO mapping / Predefined Connection Set, 161
- FS (Frame Size), 25
- Function blocks
 - Free, 275, 277
- Functions
 - BOP-2, 64
 - Fan applications, 184
 - Heating/air-conditioning systems, 184
 - HVAC, 184
 - Overview, 183
 - Pump applications, 184
 - Technological, 184

G

- Getting Started, 336
- Grinding machine, 225, 228, 232
- GSD, 48, 49, 325
- GSD (Generic Station Description), 98, 152

H

Hardware configuration, 324
 Hardware Installation Manual, 336
 Hoisting gear, 204, 225, 234, 236
 Horizontal conveyor, 232
 Horizontal conveyors, 204, 234
 Hotline, 337
 HW Config, 324
 HW Config (hardware configuration), 324

I

I2t monitoring, 212
 Identifying motor data, 66, 72, 210, 211
 Imax controller, 215
 Inclined conveyors, 204, 225, 234
 IND, 110, 126
 Industry Mall, 337
 Installation, 336
 Interfaces, 22
 Interlock, 18
 Inverter control, 184

J

JOG function, 200
 Jogging, 48

K

KTY 84 temperature sensor, 213

L

LED
 BF, 286
 RDY, 286
 LED (light emitting diode), 285
 Level control, 243
 Line filter, 26, 28
 Line reactor, 26, 28

M

Manual Collection, 336
 Manual mode, 191
 Manuals
 Converter accessories, 336
 Download, 336

Overview, 336

Maximum current controller, 215
 Maximum speed, 14, 59, 202
 Memory card
 Formatting, 79
 MMC, 79
 SD, 79
 Menu
 BOP-2, 64
 Operator panel, 64
 Minimum speed, 14, 59, 202
 Mistakes manual, 338
 MMC (memory card), 79
 MOP (motorized potentiometer), 196
 MotID (motor data identification), 66
 Motor connection, 38
 Motor control, 184
 Motor standard, 220
 Motor temperature sensor, 47, 214
 Motorized potentiometer, 49, 196
 Multi-zone control, 257
 Multi-zone controller, 24

N

Network management (NMT service), 167
 NMT, 153
 No-load monitoring, 244, 245

O

OFF1 command, 185
 ON command, 185
 Operating instructions, 336
 Operator panel
 Display, 63
 Menu, 64
 Operator Panel
 BOP-2, 22
 Handheld, 22
 IOP, 22
 Mounting Kit IP54, 22
 Output reactor, 26, 28
 Overload, 15, 215
 Overview
 Manuals, 336
 Overview of the functions, 183
 Overvoltage, 216

P

Page index, 110, 126
Parameter channel, 107, 123
 IND, 110, 126
 PKE, 107, 123
 PWE, 110, 127
Parameter identifier, 107, 123
Parameter index, 110, 126
Parameter Manual, 336
parameter number
 Offset of, 110, 126
Parameter types, 13
PC Connection Kit, 22
PDO, 153
PID controller, 243
PKE, 107, 123
PKW (parameter, ID, value), 101
PLC functionality, 18
Power failure, 239
Power Module, 21, 25
 Technical data, 312, 318, 321
Power on reset, 285
Pressure control, 243
Process industry, 49
Process variables of the technology controller, 222
PROFIdrive, 101
Protection functions, 184
PTC temperature sensor, 213
Pump, 184
Pumps, 71
PWE, 110, 127
PZD (process data), 101

Q

Questions, 337

R

Ramp-down time, 14, 59, 203
Rampup time,
RDY (Ready), 286
Reactors, 26
Real time clock, 247
Real Time Clock, 247, 249
Regenerative power, 225
Reset
 Parameter, 55
RPDO, 159
RTC (Real Time Clock), 247, 249
Run sequence, 275

Runtime group, 275

S

Saw, 228, 232
Scaling fieldbus, 97
Scaling, analog input, 90
Scaling, analog output, 93
SD (memory card), 79
SDO, 153
SDO protocols, 157
SDO services, 156
Series commissioning, 23, 78
Setpoint processing, 184, 202
Setpoint source, 184
 Selecting, 195, 197, 20114
 Selecting, 195, 197, 20114
 Selecting, 195, 197, 20114
 Selecting, 195, 197, 20114
Setpoint sources, 48
Setting the node ID, 154
Short-circuit monitoring, 213
Signal interconnection, 16, 17
SIMATIC, 323, 325
Sine-wave filter, 26
SIZER, 337
Stall protection, 244, 245
Standard telegram 1, 48
Star connection (Y), 37, 57
STARTER
 Download, 22
 Order number, 22
Starting characteristics
 Optimization, 208
Status messages, 184
Status word, 102, 105
Status word 1, 104
Status word 3, 106
STEP 7 object manager, 325
Storage medium, 78
STW (control word), 101
STW1 (control word 1), 103
STW3 (control word 3), 105
Sub-chassis components, 28
Subindex, 110, 126
Suggestions for improvement manual, 338
Support, 337
SYNC, 153
Synchronous motor, 207
System components, 28
System runtime, 218

T

Technical data
 Power Module, 312, 318, 321
Technology controller, 105, 243
Telegram 20, 49
Telegram types, 101, 326
Temperature calculation, 215
Temperature measurement via KTY, 213
Temperature measurement via PTC, 213
Temperature monitoring, 212, 215
Temperature monitoring via ThermoClick, 213
Temperature sensor, 47
ThermoClick temperature sensor, 213
Three-wire control, 50, 185
Time, 249
Time control, 249
Time slices, 275
Time switch, 249
Torque monitoring
 Speed-dependent, 244, 245
TPDO, 159
Two-wire control, 50, 185

U

UL-certified fuses, 303
Unit changeover, 219
Unit system, 221
Unwinders, 236
Up ramp, 14
Upload, 23, 80, 83
Using the factory settings, 60
USS, 50

V

V/f control, 15, 59, 206
 additional characteristics), 207
Vector control, 15, 59
 Sensorless, 210
Vector control, 15, 59
Vector control, 15, 59
Vertical conveyors, 204, 225, 234
Voltage boost, 15, 209

W

Winders, 204, 236
Wire-break monitoring, 90, 213

Z

ZSW (status word), 101
ZSW1 (status word 1), 104
ZSW3 (status word 3), 106

Siemens AG
Industry Sector
Drive Technologies
Motion Control Systems
Postfach 3180
91050 ERLANGEN
GERMANY

www.siemens.com/sinamics-g120

We reserve the right to make technical
changes.
© Siemens AG 2011