

Rexroth IndraControl VCP 25

R911299720
Edition 02

Project Planning Manual



Title	Rexroth IndraControl VCP 25
Type of Documentation	Project Planning Manual
Document Typecode	DOK-SUPPL*-VCP25*****-PR02-EN-P
Internal File Reference	Document Number, 120-2100-B350-02/EN
Purpose of Documentation	This document serves to describe the different variants of the VCP 25.

Record of Revisions

Description	Release Date	Notes
120-2100-B350-01/EN	10.2003	First edition
120-2100-B350-02/EN	02.2004	Second edition

Copyright © Bosch Rexroth AG, 2004

Copying this document, giving it to others and the use or communication of the contents thereof without express authority, are forbidden. Offenders are liable for the payment of damages. All rights are reserved in the event of the grant of a patent or the registration of a utility model or design (DIN 34-1).

Validity The specified data is for product description purposes only and may not be deemed to be guaranteed unless expressly confirmed in the contract. All rights are reserved with respect to the content of this documentation and the availability of the product.

Published by Bosch Rexroth AG
Bgm.-Dr.-Nebel-Str. 2
D-97816 Lohr a. Main
Tel.: +49 (0) 93 52 / 40-0
Fax: +49 (0) 93 52 /40-45 85
<http://www.boschrexroth.com/>
Abt.: BRC/EPY (NH)

Note This document has been printed on chlorine-free bleached paper.

Contents

1	System Presentation.....	1-1
1.1	Brief Description of the VCP 25.....	1-1
1.2	Operating system	1-2
1.3	Commissioning	1-2
2	Important Directions for Use.....	2-1
2.1	Appropriate Use.....	2-1
2.1.1	Introduction	2-1
2.1.2	Areas of Use and Application	2-2
2.2	Inappropriate Use	2-2
3	Safety Instructions for Electric Drives and Controls	3-1
3.1	Introduction.....	3-1
3.2	Explanations	3-1
3.3	Hazards by Improper Use.....	3-2
3.4	General Information.....	3-2
3.5	Protection Against Contact with Electrical Parts.....	3-4
3.6	Protection Against Electric Shock by Protective Low Voltage (PELV).....	3-5
3.7	Protection Against Dangerous Movements	3-6
3.8	Protection Against Magnetic and Electromagnetic Fields During Operation and Mounting	3-8
3.9	Protection Against Contact with Hot Parts.....	3-8
3.10	Protection During Handling and Mounting.....	3-9
3.11	Battery Safety	3-9
3.12	Protection Against Pressurized Systems.....	3-10
4	Technical Data.....	4-1
4.1	Front Panel and Housing.....	4-1
4.2	Touch Screen and Display	4-1
4.3	Electrical Data	4-2
4.4	Interfaces.....	4-3
4.5	Central Processing Unit and Memory.....	4-3
4.6	Connection System	4-4
4.7	Ambient Conditions	4-4
4.8	Standards and Guidelines	4-4
4.9	Compatibility Test	4-5
5	Dimensions.....	5-1
5.1	Installation	5-1
5.1.1	Front Panel Dimensions	5-2
5.1.2	Mounting Cutout	5-3

Contents

5.1.3	Side View, Mounting Depth	5-4
5.1.3.1	Standard Device	5-4
5.1.3.2	Field Bus Device	5-5
6	Display and Operating Components.....	6-1
6.1	Display.....	6-1
6.1.1	Setting the Contrast / Brightness.....	6-1
6.1.2	Default Contrast / Default Brightness Setting.....	6-2
6.1.3	Character Attributes.....	6-2
6.1.4	Fonts.....	6-2
6.2	Touch Screen	6-3
6.3	Reset Key.....	6-3
6.4	User Mode Switch	6-3
7	Interfaces.....	7-1
7.1	Standard Interfaces	7-2
7.1.1	TTY / 20 mA Current Loop (X3-SER1)	7-4
7.1.1.1	Pin Assignment.....	7-4
7.1.1.2	Termination.....	7-5
7.1.2	RS485 (X3-SER1)	7-6
7.1.2.1	Pin Assignment.....	7-6
7.1.2.2	Termination.....	7-6
7.1.3	RS232c (X3-SER1)	7-8
7.1.3.1	Pin Assignment.....	7-8
7.1.3.2	Termination.....	7-8
7.1.4	RS232c (X3-SER2)	7-9
7.1.4.1	Pin Assignment.....	7-9
7.2	Field Bus Interfaces.....	7-10
7.2.1	DeviceNet	7-10
7.2.1.1	Pin Assignment.....	7-12
7.2.1.2	Cable	7-12
7.2.1.3	Termination.....	7-13
7.2.1.4	Diagnostics	7-13
7.2.2	INTERBUS	7-14
7.2.2.1	Pin Assignment.....	7-16
7.2.2.2	Cable	7-17
7.2.2.3	Diagnostics	7-17
7.2.3	PROFIBUS DP	7-18
7.2.3.1	Pin Assignment.....	7-20
7.2.3.2	Cable	7-20
7.2.3.3	Termination.....	7-21
7.2.3.4	Diagnostics	7-21
7.3	Memory Card (Option).....	7-22
7.3.1	Inserting the Memory Card	7-22
7.3.2	Ejecting the Memory Card	7-23
7.4	Shielding D-SUB Connectors	7-23
8	Maintenance and Installation.....	8-1
8.1	General Information.....	8-1
8.2	Exchange of Hardware Components	8-1

Contents

8.3	Data Backup	8-1
8.4	Unpacking the Device.....	8-1
8.5	Identification	8-2
8.6	Connecting	8-3
8.6.1	Supply Voltage 24 V	8-3
8.7	Front Panel	8-5
8.8	Fuse.....	8-5
8.9	Battery	8-6
8.9.1	Changing the Battery	8-6
8.9.2	Battery Disposal.....	8-7
9	Ordering Information	9-1
9.1	Type Code	9-1
9.2	Accessories	9-2
10	List of Figures	10-1
11	Index.....	11-1
12	Service & Support	12-1
12.1	Helpdesk.....	12-1
12.2	Service-Hotline	12-1
12.3	Internet	12-1
12.4	Vor der Kontaktaufnahme... - Before contacting us.....	12-2
12.5	Kundenbetreuungsstellen - Sales & Service Facilities ..	12-2
12.5.1	Deutschland - Germany	12-2
12.5.2	Europa (West) - Europe (West)	12-3
12.5.3	Europa (Ost) - Europe (East)	12-4
12.5.4	Afrika, Asien, Australien (inkl. Pazifischer Raum) - Africa, Asia, Australia (incl. Pacific Rim)	12-5
12.5.5	Nordamerika - North America	12-6
12.5.6	Südamerika - South America	12-6

Contents

1 System Presentation

1.1 Brief Description of the VCP 25

The small operator terminal VCP 25 is a machine operator terminal which can initiate functions in the machine as defined in the application.

Special features of the VCP 25 are its compact design and the seal running around the rear. Thus, it is suitable for various applications. Furthermore, every mounting position is possible.

Depending on the variant, the small operator terminal is equipped either with three serial standard interfaces or with a field bus interface.

The front panel with touch screen allows to operate the application software via the touch-sensitive surface of the display without keyboard.

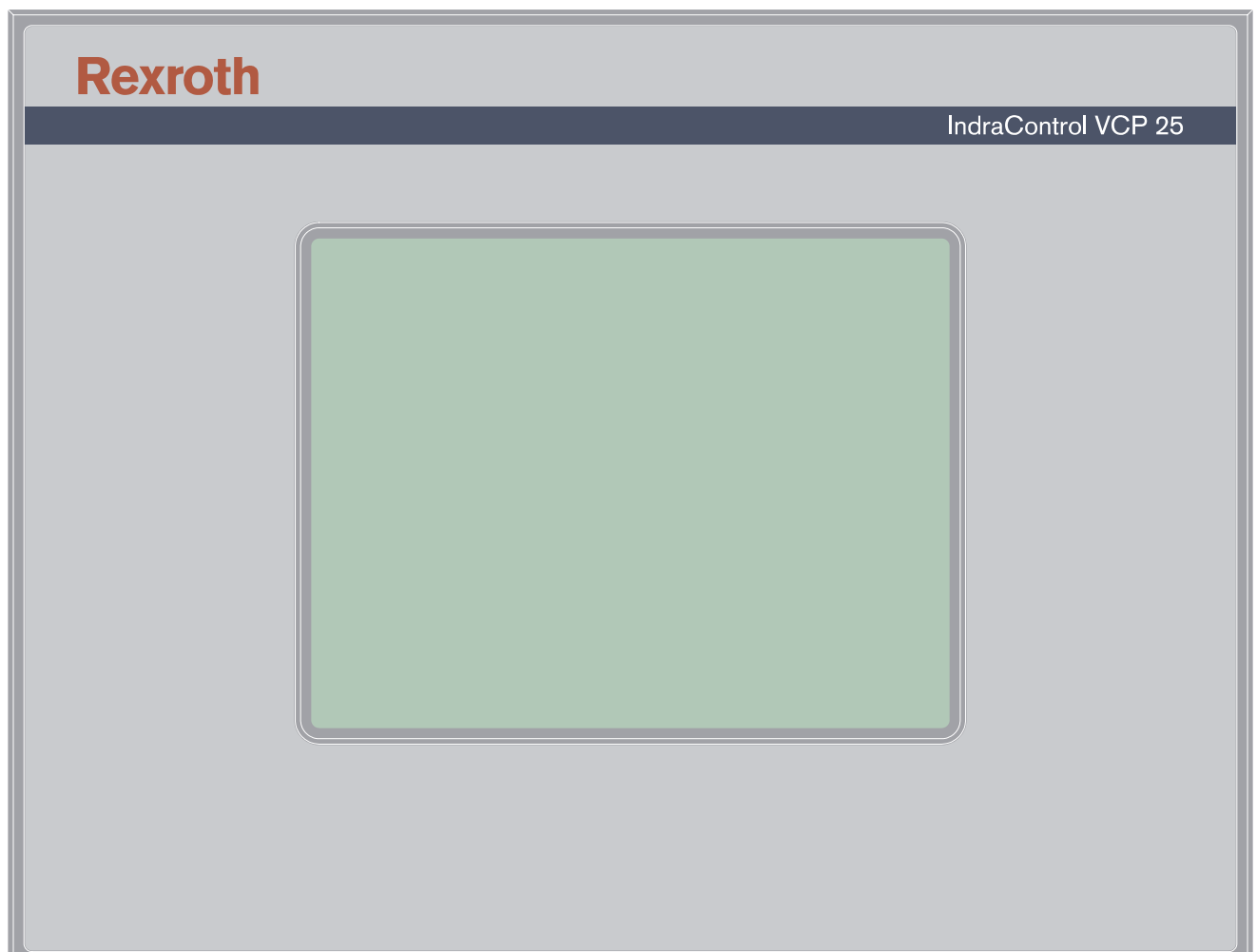

Fig. 1-1: VCP 25 with touch screen

System Presentation

1.2 Operating system

A special operating system is installed on the small operator terminal. If necessary, this operating system can be reloaded into the device (firmware download). This can be done with the associated programming software "VI Composer".

1.3 Commissioning

Mount the device properly (for more information, see chapter Dimensions). Then connect the device to the voltage supply and to the control unit or the field bus system, if required.

Important Directions for Use

2 Important Directions for Use

2.1 Appropriate Use

2.1.1 Introduction

Rexroth products represent state-of-the-art developments and manufacturing. They are tested prior to delivery to ensure operating safety and reliability.

The products may only be used in the manner that is defined as appropriate. If they are used in an inappropriate manner, then situations can develop that may lead to property damage or injury to personnel.



Bosch Rexroth, as manufacturer, is not liable for any damages resulting from inappropriate use. In such cases, the guarantee and the right to payment of damages resulting from inappropriate use are forfeited. The user alone carries all responsibility of the risks.

Before using Rexroth products, make sure that all the pre-requisites for appropriate use of the products are satisfied:

- Personnel that in any way, shape or form uses our products must first read and understand the relevant safety instructions and be familiar with appropriate use.
- If the product takes the form of hardware, then they must remain in their original state, in other words, no structural changes are permitted. It is not permitted to decompile software products or alter source codes.
- Do not mount damaged or faulty products or use them in operation.
- Make sure that the products have been installed in the manner described in the relevant documentation.

Important Directions for Use

2.1.2 Areas of Use and Application

The small operator terminal VCP 25 made by Bosch Rexroth allows to operate and control machines and installations and serves to visualize the information on the machine/installation to be operated required by the user.



The VCP 25 may only be used with the accessories and parts specified in this document. If a component has not been specifically named, then it may not be either mounted or connected. The same applies to cables and lines.

Operation is only permitted in the specified configurations and combinations of components using the software and firmware as specified in the relevant function descriptions.

The small operator terminals VCP 25 have been developed for use in single or multiple-axis control tasks.

Typical applications of the VCP 25 are:

- Handling and assembly systems,
- Packaging machines,
- Printing and paper processing machines and
- Machine tools.

The VCP 25 may only be operated under the assembly, installation and ambient conditions as described here (temperature, system of protection, humidity, EMC requirements, etc.) and in the position specified.

2.2 Inappropriate Use

Using the small operator terminal outside of the above-referenced areas of application or under operating conditions other than described in the document and the technical data specified is defined as "inappropriate use".

The small operator terminal may not be used, if

- they are subject to operating conditions that do not meet the above specified ambient conditions. This includes, for example, operation under water, in the case of extreme temperature fluctuations or extremely high maximum temperatures or if
- Bosch Rexroth has not specifically released them for that intended purpose. Please note the specifications outlined in the general Safety Guidelines!

3 Safety Instructions for Electric Drives and Controls

3.1 Introduction

Read these instructions before the initial startup of the equipment in order to eliminate the risk of bodily harm or material damage. Follow these safety instructions at all times. Do not attempt to install or start up this equipment without first reading all documentation provided with the product. Read and understand these safety instructions and all user documentation of the equipment prior to working with the equipment at any time. If you do not have the user documentation for your equipment, contact your local Bosch Rexroth representative to send this documentation immediately to the person or persons responsible for the safe operation of this equipment. If the equipment is resold, rented or transferred or passed on to others, then these safety instructions must be delivered with the equipment.



WARNING

Improper use of this equipment, failure to follow the safety instructions in this document or tampering with the product, including disabling of safety devices, may result in material damage, bodily harm, electric shock or even death!

3.2 Explanations

The safety instructions describe the following degrees of hazard seriousness in compliance with ANSI Z535. The degree of hazard seriousness informs about the consequences resulting from non-compliance with the safety instructions.



Warning symbol	Signal word and degree of hazard seriousness according to ANSI
	DANGER Death or severe bodily harm will occur.
	WARNING Death or severe bodily harm may occur.
	CAUTION Bodily harm or material damage may occur.

Fig. 3-1: Hazard classification (according to ANSI Z535)

3.3 Hazards by Improper Use

**DANGER**

High voltage and high discharge current! Danger to life or severe bodily harm by electric shock!

**DANGER**

Dangerous movements! Danger to life, severe bodily harm or material damage by unintentional motor movements!

**WARNING**

High electrical voltage due to wrong connections! Danger to life or bodily harm by electric shock!

**WARNING**

Health hazard for persons with heart pacemakers, metal implants and hearing aids in proximity to electrical equipment!

**CAUTION**

Surface of machine housing could be extremely hot! Danger of injury! Danger of burns!

**CAUTION**

Risk of injury due to improper handling! Bodily harm caused by crushing, shearing, cutting and mechanical shock or incorrect handling of pressurized systems!

**CAUTION**

Risk of injury due to incorrect handling of batteries!

3.4 General Information

- Bosch Rexroth AG is not liable for damages resulting from failure to observe the warnings provided in this documentation.
- Read the operating, maintenance and safety instructions in your language before starting up the machine. If you find that you cannot completely understand the documentation for your product, please ask your supplier to clarify.
- Proper and correct transport, storage, assembly and installation as well as care in operation and maintenance are prerequisites for optimal and safe operation of this equipment.
- Only persons who are trained and qualified for the use and operation of the equipment may work on this equipment or within its proximity.

Safety Instructions for Electric Drives and Controls

- Furthermore, they must be trained, instructed and qualified to switch electrical circuits and equipment on and off in accordance with technical safety regulations, to ground them and to mark them according to the requirements of safe work practices. They must have adequate safety equipment and be trained in first aid.
- Only use spare parts and accessories approved by the manufacturer.
- Follow all safety regulations and requirements for the specific application as practiced in the country of use.
- The equipment is designed for installation in industrial machinery.
- The ambient conditions given in the product documentation must be observed.
- Use only safety features and applications that are clearly and explicitly approved in the Project Planning Manual.
- For example, the following areas of use are not permitted: construction cranes, elevators used for people or freight, devices and vehicles to transport people, medical applications, refinery plants, transport of hazardous goods, nuclear applications, applications sensitive to high frequency, mining, food processing, control of protection equipment (also in a machine).
- The information given in the documentation of the product with regard to the use of the delivered components contains only examples of applications and suggestions.

The machine and installation manufacturer must

- make sure that the delivered components are suited for his individual application and check the information given in this documentation with regard to the use of the components,
- make sure that his application complies with the applicable safety regulations and standards and carry out the required measures, modifications and complements.
- Startup of the delivered components is only permitted once it is sure that the machine or installation in which they are installed complies with the national regulations, safety specifications and standards of the application.
- Operation is only permitted if the national EMC regulations for the application are met.
- The instructions for installation in accordance with EMC requirements can be found in the documentation "EMC in Drive and Control Systems".
- Technical data, connections and operational conditions are specified in the product documentation and must be followed at all times.

The machine or installation manufacturer is responsible for compliance with the limiting values as prescribed in the national regulations.

- Technical data, connections and operational conditions are specified in the product documentation and must be followed at all times.

3.5 Protection Against Contact with Electrical Parts



This section refers to equipment and drive components with voltages above 50 Volts.

Touching live parts with voltages of 50 Volts and more with bare hands or conductive tools or touching ungrounded housings can be dangerous and cause electric shock. In order to operate electrical equipment, certain parts must unavoidably have dangerous voltages applied to them.



DANGER

High electrical voltage! Danger to life, severe bodily harm by electric shock!

- Only those trained and qualified to work with or on electrical equipment are permitted to operate, maintain or repair this equipment.
- Follow general construction and safety regulations when working on high voltage installations.
- Before switching on power the ground wire must be permanently connected to all electrical units according to the connection diagram.
- Do not operate electrical equipment at any time, even for brief measurements or tests, if the ground wire is not permanently connected to the points of the components provided for this purpose.
- Before working with electrical parts with voltage higher than 50 V, the equipment must be disconnected from the mains voltage or power supply. Make sure the equipment cannot be switched on again unintended.
- The following should be observed with electrical drive and filter components:

Wait five (5) minutes after switching off power to allow capacitors to discharge before beginning to work. Measure the voltage on the capacitors before beginning to work to make sure that the equipment is safe to touch.

- Never touch the electrical connection points of a component while power is turned on.
- Install the covers and guards provided with the equipment properly before switching the equipment on. Prevent contact with live parts at any time.
- A residual-current-operated protective device (RCD) must not be used on electric drives! Indirect contact must be prevented by other means, for example, by an overcurrent protective device.
- Electrical components with exposed live parts and uncovered high voltage terminals must be installed in a protective housing, for example, in a control cabinet.

To be observed with electrical drive and filter components:

**DANGER**

High electrical voltage on the housing! High leakage current! Danger to life, danger of injury by electric shock!

- Connect the electrical equipment, the housings of all electrical units and motors permanently with the safety conductor at the ground points before power is switched on. Look at the connection diagram. This is even necessary for brief tests.
 - Connect the safety conductor of the electrical equipment always permanently and firmly to the supply mains. Leakage current exceeds 3.5 mA in normal operation.
 - Use a copper conductor with at least 10 mm² cross section over its entire course for this safety conductor connection!
 - Prior to startups, even for brief tests, always connect the protective conductor or connect with ground wire. Otherwise, high voltages can occur on the housing that lead to electric shock.
-

3.6 Protection Against Electric Shock by Protective Low Voltage (PELV)

All connections and terminals with voltages between 0 and 50 Volts on Rexroth products are protective low voltages designed in accordance with international standards on electrical safety.

**WARNING**

High electrical voltage due to wrong connections! Danger to life, bodily harm by electric shock!

- Only connect equipment, electrical components and cables of the protective low voltage type (PELV = Protective Extra Low Voltage) to all terminals and clamps with voltages of 0 to 50 Volts.
- Only electrical circuits may be connected which are safely isolated against high voltage circuits. Safe isolation is achieved, for example, with an isolating transformer, an opto-electronic coupler or when battery-operated.

3.7 Protection Against Dangerous Movements

Dangerous movements can be caused by faulty control of the connected motors. Some common examples are:

- improper or wrong wiring of cable connections
- incorrect operation of the equipment components
- wrong input of parameters before operation
- malfunction of sensors, encoders and monitoring devices
- defective components
- software or firmware errors

Dangerous movements can occur immediately after equipment is switched on or even after an unspecified time of trouble-free operation.

The monitoring in the drive components will normally be sufficient to avoid faulty operation in the connected drives. Regarding personal safety, especially the danger of bodily injury and material damage, this alone cannot be relied upon to ensure complete safety. Until the integrated monitoring functions become effective, it must be assumed in any case that faulty drive movements will occur. The extent of faulty drive movements depends upon the type of control and the state of operation.



DANGER

Dangerous movements! Danger to life, risk of injury, severe bodily harm or material damage!

- Ensure personal safety by means of qualified and tested higher-level monitoring devices or measures integrated in the installation. Unintended machine motion is possible if monitoring devices are disabled, bypassed or not activated.

Pay attention to unintended machine motion or other malfunction in any mode of operation.

- Keep free and clear of the machine's range of motion and moving parts. Possible measures to prevent people from accidentally entering the machine's range of motion:
 - use safety fences
 - use safety guards
 - use protective coverings
 - install light curtains or light barriers

Safety Instructions for Electric Drives and Controls

- Fences and coverings must be strong enough to resist maximum possible momentum, especially if there is a possibility of loose parts flying off.
- Mount the emergency stop switch in the immediate reach of the operator. Verify that the emergency stop works before startup. Don't operate the machine if the emergency stop is not working.
- Isolate the drive power connection by means of an emergency stop circuit or use a starting lockout to prevent unintentional start.
- Make sure that the drives are brought to a safe standstill before accessing or entering the danger zone. Safe standstill can be achieved by switching off the power supply contactor or by safe mechanical locking of moving parts.
- Secure vertical axes against falling or dropping after switching off the motor power by, for example:
 - mechanically securing the vertical axes
 - adding an external braking/ arrester/ clamping mechanism
 - ensuring sufficient equilibration of the vertical axes

The standard equipment motor brake or an external brake controlled directly by the drive controller are not sufficient to guarantee personal safety!

- Disconnect electrical power to the equipment using a master switch and secure the switch against reconnection for:
 - maintenance and repair work
 - cleaning of equipment
 - long periods of discontinued equipment use
 - Prevent the operation of high-frequency, remote control and radio equipment near electronics circuits and supply leads. If the use of such equipment cannot be avoided, verify the system and the installation for possible malfunctions in all possible positions of normal use before initial startup. If necessary, perform a special electromagnetic compatibility (EMC) test on the installation.
-

3.8 Protection Against Magnetic and Electromagnetic Fields During Operation and Mounting

Magnetic and electromagnetic fields generated near current-carrying conductors and permanent magnets in motors represent a serious health hazard to persons with heart pacemakers, metal implants and hearing aids.



WARNING

Health hazard for persons with heart pacemakers, metal implants and hearing aids in proximity to electrical equipment!

- Persons with heart pacemakers, hearing aids and metal implants are not permitted to enter the following areas:
 - Areas in which electrical equipment and parts are mounted, being operated or started up.
 - Areas in which parts of motors with permanent magnets are being stored, operated, repaired or mounted.
 - If it is necessary for a person with a heart pacemaker to enter such an area, then a doctor must be consulted prior to doing so. Heart pacemakers that are already implanted or will be implanted in the future, have a considerable variation in their electrical noise immunity. Therefore there are no rules with general validity.
 - Persons with hearing aids, metal implants or metal pieces must consult a doctor before they enter the areas described above. Otherwise, health hazards will occur.
-

3.9 Protection Against Contact with Hot Parts



CAUTION

Housing surfaces could be extremely hot! Danger of injury! Danger of burns!

- Do not touch housing surfaces near sources of heat! Danger of burns!
 - After switching the equipment off, wait at least ten (10) minutes to allow it to cool down before touching it.
 - Do not touch hot parts of the equipment, such as housings with integrated heat sinks and resistors. Danger of burns!
-

3.10 Protection During Handling and Mounting

Under certain conditions, incorrect handling and mounting of parts and components may cause injuries.

**CAUTION**

Risk of injury by incorrect handling! Bodily harm caused by crushing, shearing, cutting and mechanical shock!

- Observe general installation and safety instructions with regard to handling and mounting.
 - Use appropriate mounting and transport equipment.
 - Take precautions to avoid pinching and crushing.
 - Use only appropriate tools. If specified by the product documentation, special tools must be used.
 - Use lifting devices and tools correctly and safely.
 - For safe protection wear appropriate protective clothing, e.g. safety glasses, safety shoes and safety gloves.
 - Never stand under suspended loads.
 - Clean up liquids from the floor immediately to prevent slipping.
-

3.11 Battery Safety

Batteries contain reactive chemicals in a solid housing. Inappropriate handling may result in injuries or material damage.

**CAUTION**

Risk of injury by incorrect handling!

- Do not attempt to reactivate discharged batteries by heating or other methods (danger of explosion and cauterization).
 - Never charge non-chargeable batteries (danger of leakage and explosion).
 - Never throw batteries into a fire.
 - Do not dismantle batteries.
 - Do not damage electrical components installed in the equipment.
-



Be aware of environmental protection and disposal! The batteries contained in the product should be considered as hazardous material for land, air and sea transport in the sense of the legal requirements (danger of explosion). Dispose batteries separately from other waste. Observe the legal requirements in the country of installation.

3.12 Protection Against Pressurized Systems

Certain motors and drive controllers, corresponding to the information in the respective Project Planning Manual, must be provided with pressurized media, such as compressed air, hydraulic oil, cooling fluid and cooling lubricant supplied by external systems. Incorrect handling of the supply and connections of pressurized systems can lead to injuries or accidents. In these cases, improper handling of external supply systems, supply lines or connections can cause injuries or material damage.



CAUTION

Danger of injury by incorrect handling of pressurized systems !

- Do not attempt to disassemble, to open or to cut a pressurized system (danger of explosion).
- Observe the operation instructions of the respective manufacturer.
- Before disassembling pressurized systems, release pressure and drain off the fluid or gas.
- Use suitable protective clothing (for example safety glasses, safety shoes and safety gloves)
- Remove any fluid that has leaked out onto the floor immediately.



Environmental protection and disposal! The media used in the operation of the pressurized system equipment may not be environmentally compatible. Media that are damaging the environment must be disposed separately from normal waste. Observe the legal requirements in the country of installation.

Technical Data

4 Technical Data

4.1 Front Panel and Housing

Front Panel and Housing	
Housing	Steel Sheet, Galvanized
Front Panel	Aluminium, Varnished 180 mm x 234 mm x 5 mm (H x W x D) - (7.087" x 9.213" x 0.197")
Front Foil	Polyester Foil
Seal	Circumferential Rubber Seal on the Rear
Mounting Cutout	140 mm x 196 mm (H x W) - (5.512" x 7.717")
Mounting Depth	Standard Device: Approx. 48 mm (1.89") - (without Connector) Field Bus Device: Approx. 70 mm (2.756") - (without Connector)
Degree of Protection	Front: IP65 Rear: IP20
Total Weight	Approx. 1100 g

4.2 Touch Screen and Display

Touch Screen	
Type	Analog Resistive, 4-Wire Technology
Activation Force	15 g (Standard) With R0,8 Polyoxymethylene (POM) Pen or R8 HS60 Silicon Rubber
Durability	No Damages or Malfunctions after 3 Million Strokes under the following conditions: Stroke Element: R8, HS40 Silicon Rubber Stroke Force: 150 g Stroke Frequency: 3 Hz

Display	
Type	STN (Color)
Resolution	320 x 240 Pixels
Colors	256

Technical Data

Display	
Reading Angle	90 °
Default Contrast / Brightness Setting	By User Mode Switch
Contrast Setting	Temperature Compensated
LCD Lifetime	100.000 h
Half-Life Time of the Backlight	40.000 h
Lines	20
Characters/Line	40
Display Area (H x W)	90 mm x 120 mm (3.543" x 4.724")

4.3 Electrical Data

Electrical Data	
Supply Voltage	24 V DC (SELV in Accordance with DIN EN 61131)
Residual Ripple	Maximum 10%
Minimum Voltage	19.2 V
Maximum Voltage	30.2 V
Power Consumption (Field Bus Device)	0.4 A
Connected Load	10 W
Fuse	Semiconductor Fuse, Self-resetting
Protection against Polarity Reversal	Integrated

Technical Data

4.4 Interfaces

Standard Interfaces	
Variable Baud Rates and Data Formats	
X3 SER1 TTY / 20 mA	According to CL 2 and DIN 66 348 T1 Transmission Length: 0 - 1000 m (3280.84 ft.), Twisted Pair, Shielded Electrically Isolated
X3 SER1 RS485	According to DIN 66259-4 Transmission Length: 0 - 1200 m (3937.01 ft.), Twisted Pair, Shielded Electrically Isolated
X3 SER1 RS232c / X3 SER2 RS232c	According to DIN 66259 T1, CCITT V.28 Transmission Length: 0 - 15 m (49.21 ft.), Layer-stranded, Shielded X3 SER1: Electrically Isolated X3 SER2: Not Electrically Isolated

Field Bus Interfaces	
Variable Baud Rates and Data Formats	
X2.1 / X2.2 DeviceNet	According to ISO 11898 Electrically Isolated
X2.1 / X2.2 INTERBUS	Electrically Isolated
X2 PROFIBUS-DP	Electrically Isolated

4.5 Central Processing Unit and Memory

Central Processing Unit	
Central Processing Unit	32-bit RISC CPU
Clock Frequency	74 MHz
Other Characteristics	Watchdog Timer, Real-Time Clock, Temperature Compensation of the Display, Battery Monitoring

Memory	
Application Memory	3 MByte Flash
RAM	512 KByte Static CMOS-RAM, Battery-Backed
Memory Card (Option)	Compact Flash Card

Technical Data

4.6 Connection System

Connection System
D-SUB Female and Male Connector Strips, 9-Pin and 25-Pin
Female and Male Connector Strips Phoenix COMBICON, 3-Pin

4.7 Ambient Conditions

Ambient Conditions		
Ambient Temperature	Operation	0 °C to 50 °C (32 °F to 122 °F)
	Storage, Transport	- 25 °C to + 60 °C (-13 °F to 140 °F)
Relative Humidity	Operation	10% to 95%, No Condensation
	Storage, Transport	10% to 95%, No Condensation
Application Area		Degree of Pollution 1, Overvoltage Category II

4.8 Standards and Guidelines

Standards and Guidelines	
Interference Immunity	EN 61000-4-2 EN 61000-4-3 EN 61000-4-4 EN 61000-4-5 EN 61000-4-6 EN 61000-6-2
Emitted Interference	EN 50081-1 EN 55022
Equipment Requirements	EN 61131
Storage and Transport	EN 61131 Part 2
Power Supply	EN 61131 Part 2
Electromagnetic Compatibility	89/336/EWG (Including all Applicable Amendments)
Degree of Protection	EN 60529
Impact Load, Shocks	EN 60068 Part 2-27
Sinusoidal Vibrations	EN 60068 Part 2-6
Corrosion Protection	IEC 60068

Technical Data

4.9 Compatibility Test

All Rexroth controls and drives are developed and tested according to the technological state-of-the-art.

As it is impossible to follow the continuing development of all materials (e.g. lubricants in machine tools) which may interact with our controls and drives, it cannot be completely ruled out that any reactions with the materials used by Bosch Rexroth might occur.

For this reason, before using the respective material a compatibility test has to be carried out for new lubricants, cleaning agents etc. and our housings/our housing materials.

Technical Data

Dimensions

5 Dimensions

5.1 Installation



When installing the operator terminal, keep a minimum clearance of 30 mm (1.181") around the operator terminal to ensure adequate air circulation.



When the operator terminal is installed horizontally, please note that additional sources of heat beneath the operator terminal may result in heat accumulation.

Provide for sufficient heat dissipation!

Comply with the allowable temperature range listed in the technical data for the use of the operator terminal!



To maintain the specified degree of protection, make sure the seal is evenly seated on the installation surface and the hexagon nuts are tightened uniformly.

Ensure that the maximum torque of 1.2 Nm is not exceeded.

The operator terminal can be easily and quickly mounted from the rear of the operator terminal. This is particularly recommended for mounting in switchboards with a plate thickness of approx. 1 mm to 8 mm (approx. 0.039" to 0.315").

1. Insert the operator terminal from the front through the mounting cut-out.
2. Fasten the operator terminal using hexagon nuts.

Dimensions

5.1.1 Front Panel Dimensions

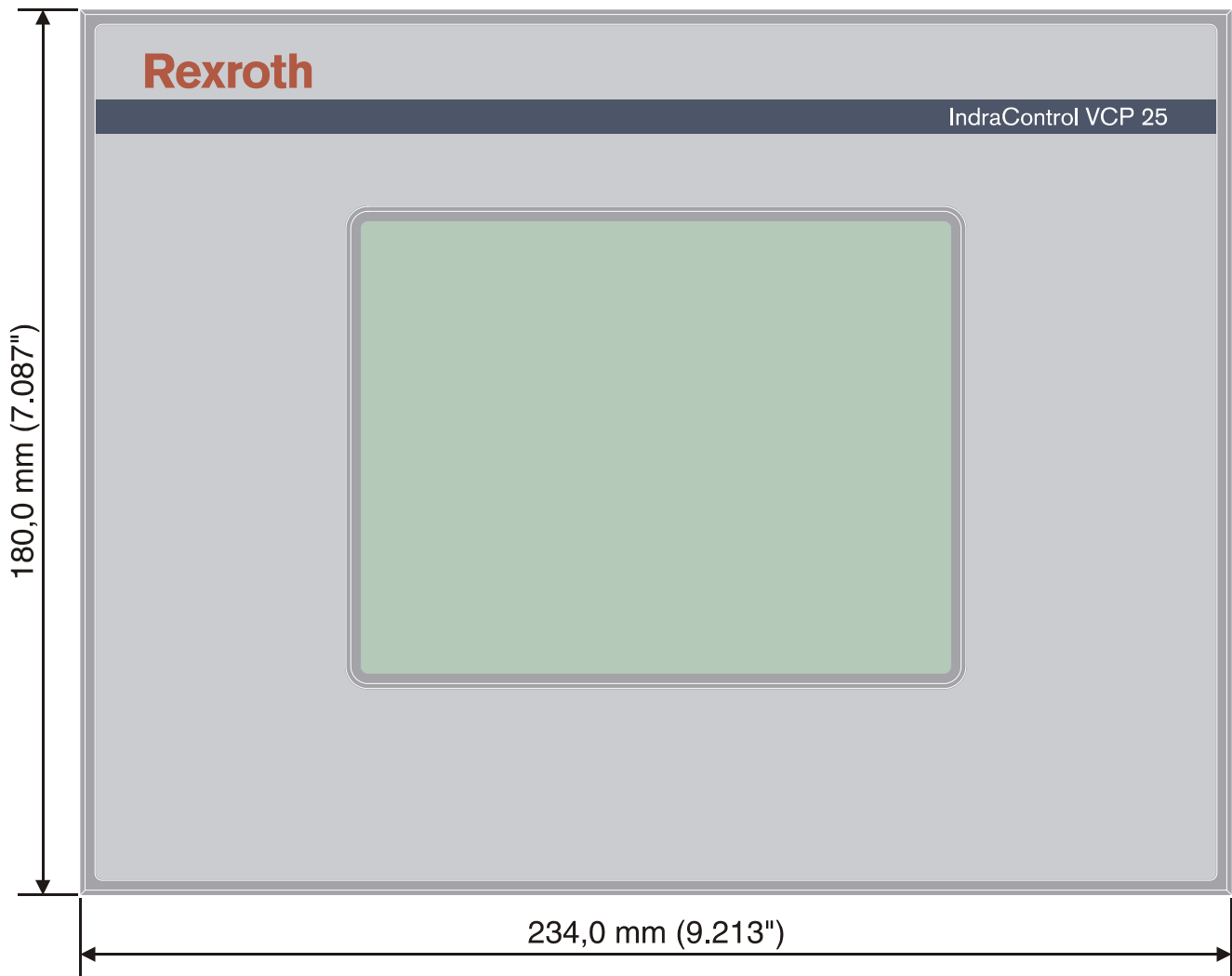

Fig. 5-1: Front panel dimensions

Dimensions

5.1.2 Mounting Cutout

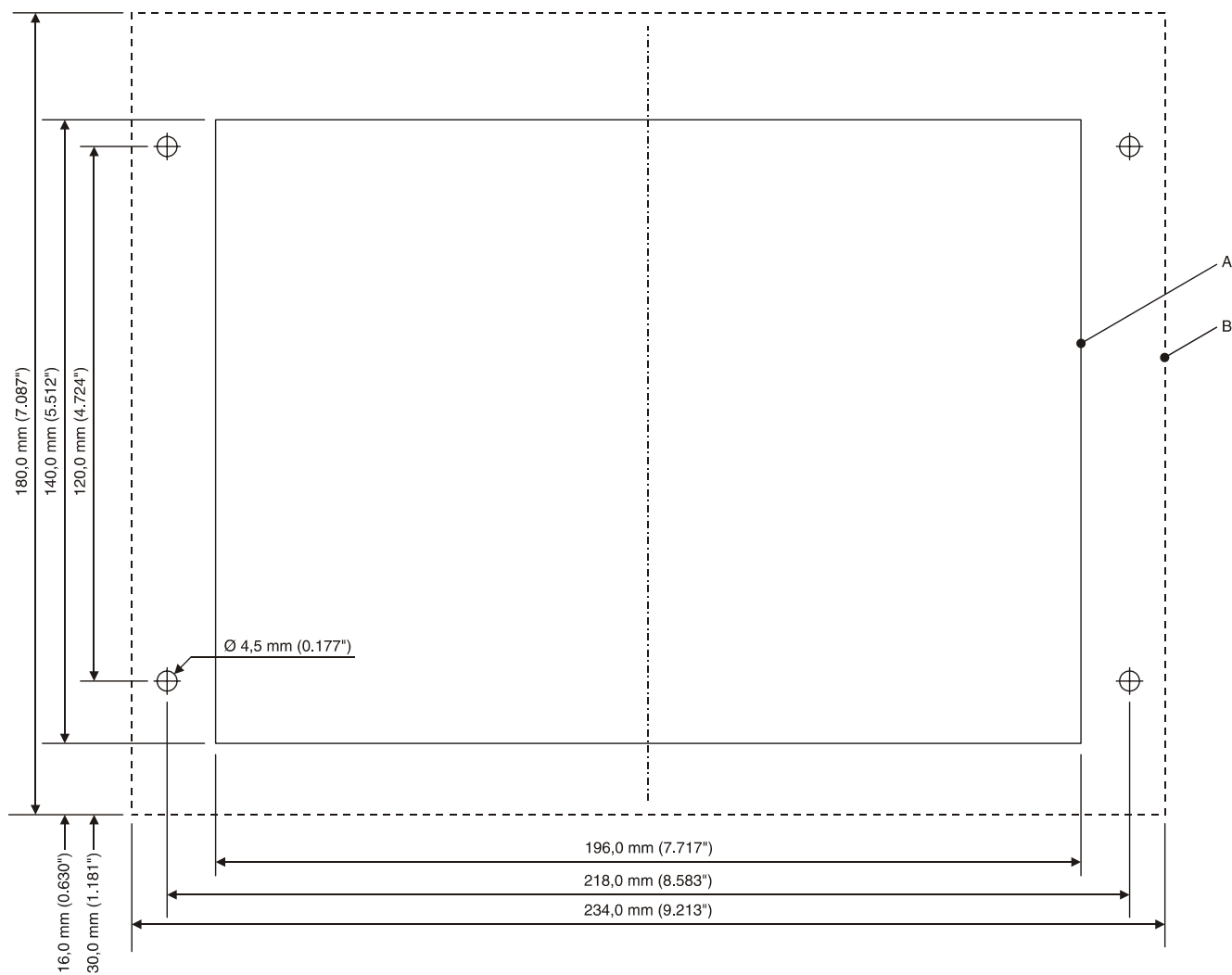

Fig. 5-2: Mounting cutout

- A** Mounting Cutout
- B** Front Panel

Dimensions

5.1.3 Side View, Mounting Depth

5.1.3.1 Standard Device

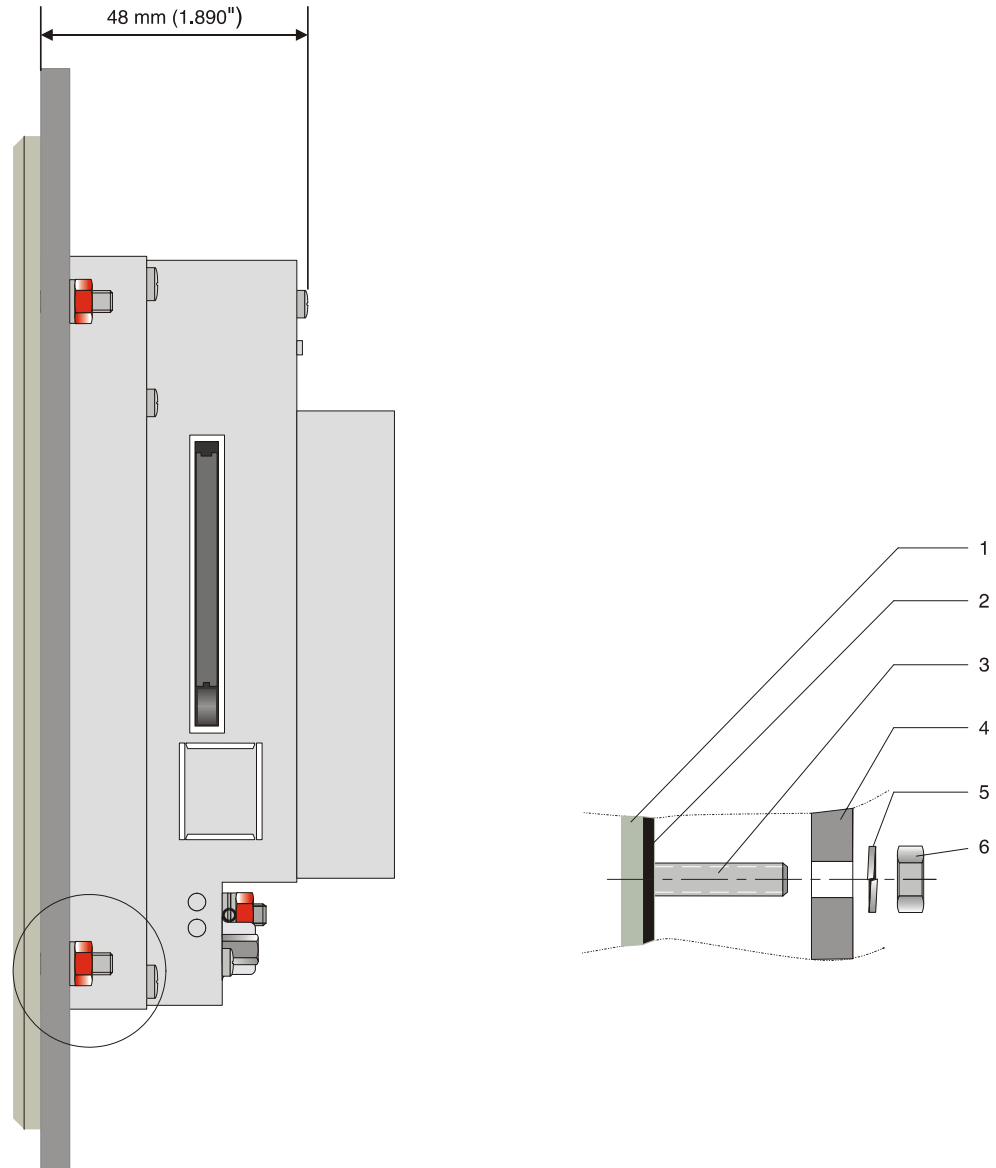

Fig. 5-3: Side view and mounting depth for the standard device

- 1 Front Panel
- 2 Circumferential Seal
- 3 Press-in Threaded Bolt M4 x 18 mm (0.709")
- 4 Mounting Surface Thickness 1 mm to 8 mm (0.039" to 0.315")
- 5 Spring Lock Washer B4 DIN 127 Form B (not supplied)
- 6 Nut M4 DIN 934 (not supplied)

Dimensions

5.1.3.2 Field Bus Device

Fig. 5-4: Side view and mounting depth for the field bus device

- 1 Front Panel
- 2 Circumferential Seal
- 3 Press-in Threaded Bolt M4 x 18 mm (0.709")
- 4 Mounting Surface Thickness 1 mm to 8 mm (0.039" to 0.315")
- 5 Spring Lock Washer B4 DIN 127 Form B (not supplied)
- 6 Nut M4 DIN 934 (not supplied)

Dimensions

6 Display and Operating Components

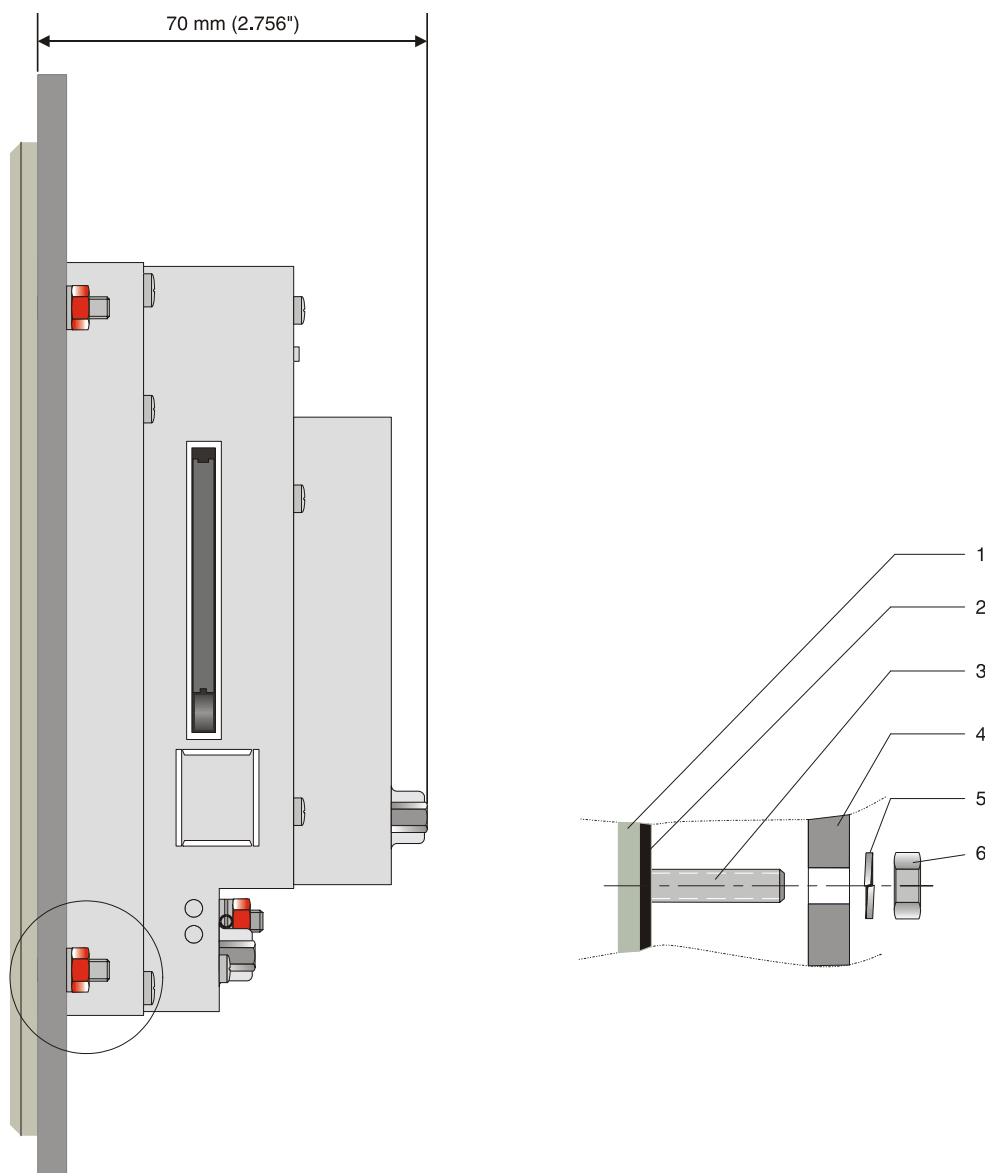
6.1 Display



Danger of intoxication!

If the display is damaged, avoid touching, swallowing or breathing in the liquids or gases which may leak out.



Danger of corrosion!

If the display is damaged, avoid touching, swallowing or breathing in the liquids or gases which may leak out.

The operator terminal is equipped with a STN display.

6.1.1 Setting the Contrast / Brightness

To define the contrast / brightness setting, use the programming software to set up the system variable **LcdContrast** or **LcdBackLight** in any mask.



To do so, follow the instructions listed in the programming software's help topic "How do I specify the contrast / brightness setting for the operator terminal".

In the programming software, enter the following values as lower and upper limits for the representation type.

System Variable	Lower Limit	Upper Limit	Default Setting
LcdContrast	0	+ 31	+ 16
LcdBackLight	0	+ 15	+ 8

Fig. 6-1: Values for the representation type



If you do not configure the system variable **LcdContrast** or **LcdBackLight**, the default setting is used when the device is initialized.

If you did set-up the system variable, you can set the contrast or brightness as follows. Open the mask where you set up the system variable and:

1. Press the contrast / brightness button.
2. Enter a new value for the contrast / brightness. To do so, use the keyboard shown on the screen.
3. Confirm with Enter.

The new contrast / brightness setting becomes effective immediately after the Enter key is pressed. If necessary, repeat steps two and three until you are satisfied with the contrast / brightness.

6.1.2 Default Contrast / Default Brightness Setting

If the contrast / brightness setting is such that it is no longer possible to read the masks, you can use the user mode switch to reset the contrast / brightness to the default value.



For the table with the switch positions of the user mode switch, see chapter "User Mode Switch".



The switch position for the default contrast / brightness is identical with the "Activate download via hardware". The contrast / brightness is reset before a corresponding message is displayed. The warning will be displayed in a legible manner.

To restore the default contrast / default brightness:

1. Switch the device off.
2. Set the switches S1 and S4 of the user mode switch to ON.
3. Switch the device on again.
4. When the warning appears, switch the device off again.
5. Set switch S4 to OFF.
6. Then switch the device on again.

The application will not be lost.

6.1.3 Character Attributes

The following character attributes can be displayed on the device:

- Normal
- Underlined
- Foreground / background color

6.1.4 Fonts

You are able to use the Windows character sets. Further you can use the font "Normal" and the font "Zoom" or create and use your own character sets.

Display and Operating Components

6.2 Touch Screen

The device is equipped with a resistive 4-wire touch screen. You operate the small operator terminal using this touch screen.

6.3 Reset Key

The reset key is located on the rear of the device. You can use this key to restart the device.

6.4 User Mode Switch

The user mode switch is located on the rear of the small operator terminal.



The switch positions for ON or OFF are printed onto the user mode switch.

S1	S2	S3	S4	Operating Mode
I	X	-	-	Standard mode with PLC (default upon delivery)
I	X	I	-	Standard mode without PLC
I	-	-	I	Activate download (erases the application memory) and default contrast / brightness setting
I	-	I	I	Activate upload
-	-	-	-	Calibration mask is called-up during start-up
-	-	I	-	Calibration mask is called-up during start-up and the calibration process is started immediately

Fig. 6-2: User mode switch

Legend for table:

I = Switch ON

- = Switch OFF

X = Any switch position

Display and Operating Components

7 Interfaces

The device can either be supplied as a standard device or field bus device.

The universal interface X3 combines several interface standards in one connector. The connector is divided into two channels. The communication channel (SER1) is operated separately from the channel for the upload/download/logging printer/scanner (SER2).

For the communication channel (SER1), the protocol-specific use only allows one of the three interface standards to be used.

Depending on the device variant, several interfaces are available to you:

Type code	Available interfaces				
	RS232c (X3-SER2)	TTY / 20mA, RS485, RS232c (X3-SER1)	DeviceNet	INTERBUS	PROFIBUS DP
VCPxx.xxxx-xxxRS-xx-xx	X	X	-	-	-
VCPxx.xxxx-xxxDN-xx-xx	X	-	X	-	-
VCPxx.xxxx-xxxIB-xx-xx	X	-	-	X	-
VCPxx.xxxx-xxxPB-xx-xx	X	-	-	-	X

Fig. 7-1: Device variants

Interfaces

7.1 Standard Interfaces

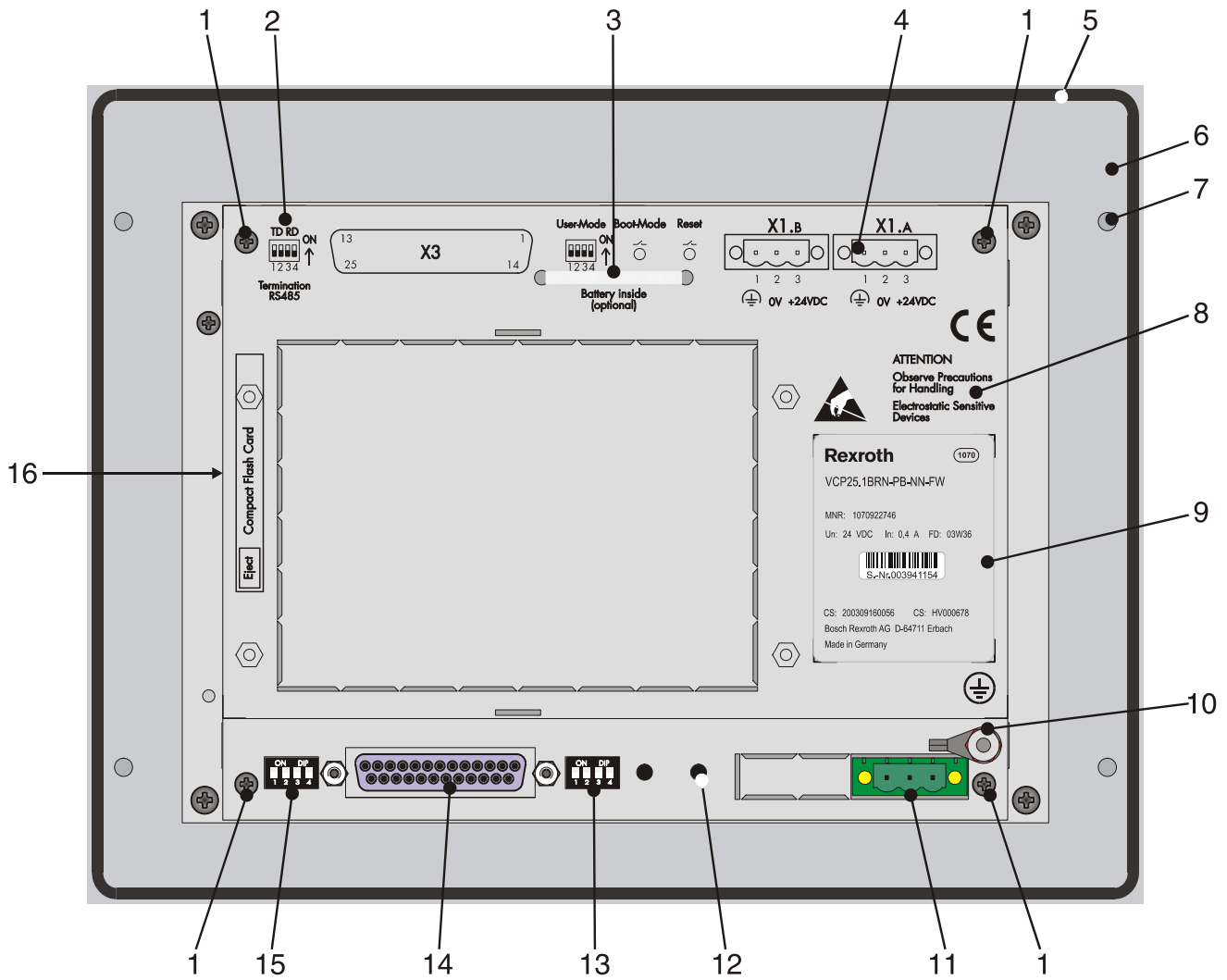

Fig. 7-2: Rear view of standard device

Interfaces

1. Fastening Screws
2. Pin Assignment for Termination Switch (X3-SER1 RS485)
3. Cable Fastener for Battery
4. Assignment Connector X1.A (Supply Voltage)
5. Seal
6. Front Panel
7. Mounting Bolt
8. Warning
9. Nameplate
10. Threaded Bolt for Protective Grounding
11. Connector X1.A (Supply Voltage)
12. Reset Key
13. User Mode Switch
14. Female Connector X3 (TTY/RS485/RS232c)
15. Termination Switch (X3-SER1 RS485)
16. Compact Flash, Inserted on the Side (Option)

Interfaces

7.1.1 TTY / 20 mA Current Loop (X3-SER1)

Depending on the wiring, it is possible to connect the interface either as an active or passive current loop. The transmit line and the receive line are each provided with a separate 20 mA power source. The compliance voltage is approx. 24 VDC.

The 20 mA power should be supplied by the transmitter unit. This decreases crosstalk on the signal lines considerably.

In idle state (signal logic 1), a 20 mA current loop can be measured in the cable.

Signal Logic 1	Current Flow 20 mA
Signal Logic 0	Current Flow Interrupted

7.1.1.1 Pin Assignment

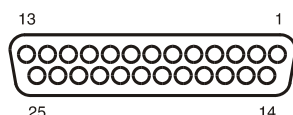

Fig. 7-3: 25 pin D-SUB female connector strip

Connector in the small operator terminal: 25-pin D-SUB female connector strip

Pin	Designation	Function
10	T+	Transmitted Data, Positive Polarity
13	R+	Received Data, Positive Polarity
14	R-	Received Data, Negative Polarity
19	T-	Transmitted Data, Negative Polarity

Fig. 7-4: Pin assignment TTY / 20 mA, passive

Interfaces

Pin	Designation	Function
10	T+	Transmitted Data, Positive Polarity
12	S1+	Power Source 1, Positive Polarity
13	R+	Received Data, Positive Polarity
14	R-	Received Data, Negative Polarity
16	S2+	Power Source 2, Positive Polarity
19	T-	Transmitted Data, Negative Polarity
21	S1-	Current Sink 1, Negative Polarity
24	S2-	Current Sink 2, Negative Polarity

Fig. 7-5: Pin assignment TTY / 20 mA, active



The D-SUB connector strips must be shielded sufficiently. See chapter „Shielding D-SUB Connectors“ on page 7-23.

7.1.1.2 Termination



When channel SER1 is operated as a current loop, the termination for the RS485 must be OFF.

Interfaces

7.1.2 RS485 (X3-SER1)

The interface is suitable for point-to-point and for multi-point connections.

The wires belonging together are marked with „A“ and „B“. Some descriptions refer to the pins with „+“ and „-“, where A = + and B = -.

Signal Logic 1	$U_A - U_B \leq -0.3 \text{ V}$ i.e. ($U_A < U_B$)
Signal Logic 0	$U_A - U_B \geq +0.3 \text{ V}$ i.e. ($U_A > U_B$)

7.1.2.1 Pin Assignment

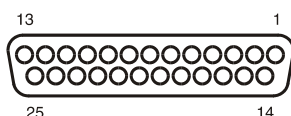

Fig. 7-6: 25 pin D-SUB female connector strip

Connector in the small operator terminal: 25-pin D-SUB female connector strip

Pin	Designation	Function
8	T(A)	Transmitted data (+)
9	T(B)	Transmitted data (-)
11	SGND	Signal Ground
22	R(A)	Received data (+)
23	R(B)	Received data (-)

Fig. 7-7: Pin assignment RS485



The D-SUB connector strips must be shielded sufficiently. See chapter „Shielding D-SUB Connectors“ on page 7-23.

7.1.2.2 Termination

For point-to-point connections, always activate the termination. For multi-point connections, only activate the termination at the cable end.

Interfaces

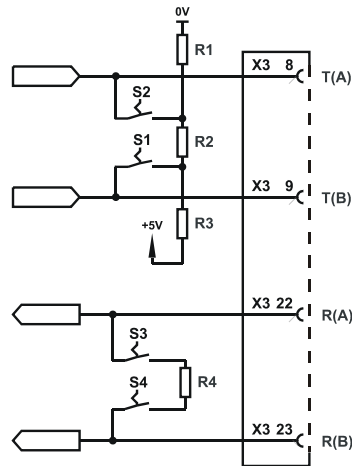

Fig. 7-8: Block diagram termination RS485

Designation	Value
R1, R3	510 Ohm
R2	150 Ohm
R4	120 Ohm

Fig. 7-9: Resistance values termination RS485



The switch positions for ON or OFF are printed onto the termination switch. Only the specified switch positions are permitted.

S1	S2	S3	S4	Function
Transmitter		Receiver		
				Termination is ON
-	-	-	-	Termination is OFF

Fig. 7-10: Termination switch

Legend for table:

| = Switch ON

- = Switch OFF

Interfaces

7.1.3 RS232c (X3-SER1)

The interface is suitable to establish a point-to-point connection.

7.1.3.1 Pin Assignment

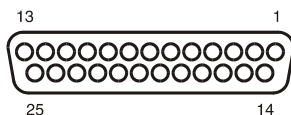

Fig. 7-11: 25 pin D-SUB female connector strip

Connector in the small operator terminal: 25-pin D-SUB female connector strip

Pin	Designation	Function
6	TD	Transmitted Data
15	CTS	Clear to Send
17	RTS	Request to Send
18	RD	Received Data
25	SGND	Signal Ground

Fig. 7-12: Pin assignment RS232c



The D-SUB connector strips must be shielded sufficiently. See chapter „Shielding D-SUB Connectors“ on page 7-23.

7.1.3.2 Termination



For the operation of channel SER1 as a RS232, the termination for the RS485 must be OFF.

Interfaces

7.1.4 RS232c (X3-SER2)

The interface is only designed to be used for downloads, uploads, a scanner or a logging printer because the interface is not electrically isolated.

7.1.4.1 Pin Assignment

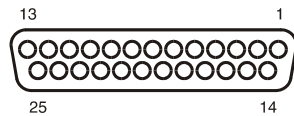

Fig. 7-13: 25-pin D-SUB female connector strip

Connector in the small operator terminal: 25-pin D-SUB female connector strip

Pin	Designation	Function
1	(⊕)	Low-Noise Ground
2	TD	Transmitted Data
3	RD	Received Data
4	RTS	Request to Send
5	CTS	Clear to Send
7	SGND	Signal Ground
20	DTR	Data Transfer Request

Fig. 7-14: Pin assignment of the RS232c interface



The D-SUB connector strips must be shielded sufficiently. See chapter „Shielding D-SUB Connectors“ on page 7-23.

Interfaces

7.2 Field Bus Interfaces

7.2.1 DeviceNet

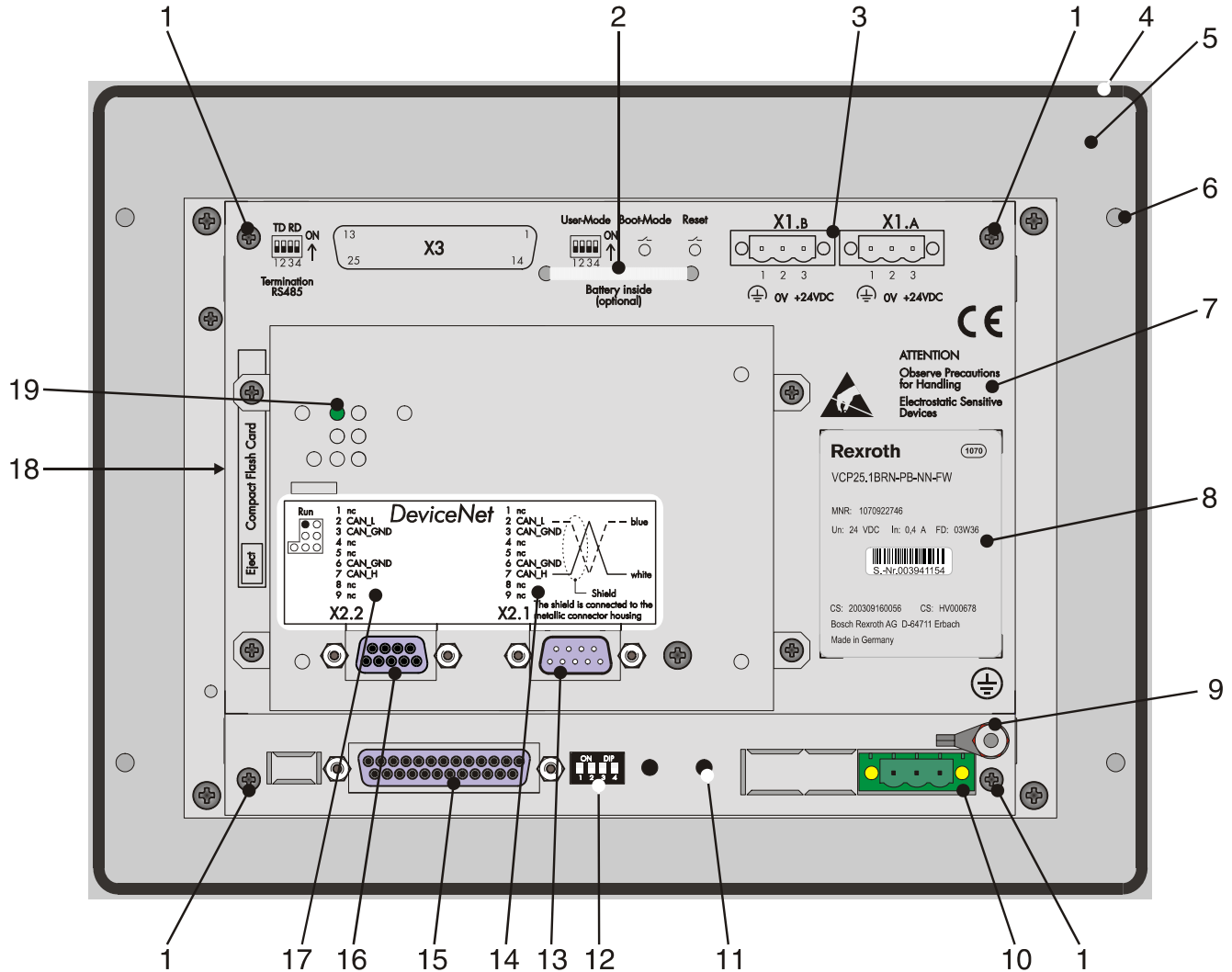

Fig. 7-15: Rear view DeviceNet

Interfaces

1. Fastening Screw
2. Cable Fastener for Battery
3. Assignment Connector X1.A (Supply Voltage)
4. Seal
5. Front Panel
6. Mounting Bolt
7. Warning
8. Nameplate
9. Threaded Bolt for Protective Grounding
10. Connector X1.A (Supply Voltage)
11. Reset Key
12. User Mode Switch
13. Connector X2.1 (DeviceNet)
14. Assignment Connector X2.1 (DeviceNet)
15. Female Connector X3 (SER2 RS232c)
16. Female Connector X2.2 (DeviceNet)
17. Assignment Female Connector X2.2 (DeviceNet)
18. Compact Flash, Inserted on the Side (Option)
19. Diagnostics LED

Interfaces

7.2.1.1 Pin Assignment

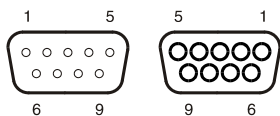

Fig. 7-16: 9-pin D-SUB male and female connector strip

Connector in the small operator terminal: 9-pin D-SUB male and female connector strip (assignment for male and female connector strip is the same).

Pin	Designation	Function
1	nc	Not Connected
2	CAN_L	CAN_L Bus Line (Dominant LOW)
3	CAN_GND	CAN Ground
4	nc	Not Connected
5	nc	Not Connected
6	CAN_GND	CAN Ground
7	CAN_H	CAN_H Bus Line (Dominant HIGH)
8	nc	Not Connected
9	nc	Not Connected

Fig. 7-17: Pin assignment DeviceNet

All signal lines are looped through from X2.1 to X2.2. The connecting cables should be connected to every pin, including the reserved pins. In this way, the cables can still be used in case of future bus specification extensions.



The D-SUB connector strips must be shielded sufficiently. See chapter „Shielding D-SUB Connectors“ on page 7-23.

7.2.1.2 Cable



A DeviceNet-certified cable must be used.

Cable type	Loop resistance	Surge impedance	Capacitance per unit length
2 x 1.1 mm	< 22.6 Ohm/km	120 Ohm	< 39.4 pf/m
2 x 0.6 mm	< 91.8 Ohm/km	120 Ohm	< 39.4 pf/m

Fig. 7-18: Data line DeviceNet

Interfaces

The maximum length allowed for spur lines connected to the bus cable is 6 meters. The overall length of the bus cable including all spur lines is not to exceed the maximum length listed in the table below.

The maximum cable length depends on the baud rate and the cable type used.

Baud rate	Cable type	Cable length
125 kBit/s	2 x 1.1 mm	500 m
	2 x 0.6 mm	100 m
250 kBit/s	2 x 1.1 mm	250 m
	2 x 0.6 mm	100 m
500 kBit/s	2 x 1.1 mm	100 m
	2 x 0.6 mm	100 m

Fig. 7-19: Baud rate DeviceNet

7.2.1.3 Termination

Terminate the DeviceNet bus at both ends by terminating resistors (120 Ohm).

7.2.1.4 Diagnostics

A diagnostics LED is located at the rear of the small operator terminal. The LED shows the states of the bus system.



Fig. 7-20: Arrangement of the DeviceNet diagnostics LED

The diagnostics LED at the small operator terminal has the following functions:

Color	State	Function
Green	Off	Terminal Disconnected from Bus
Green	On	Communication Active
Green	Flashing	Sporadic Bus Error

Fig. 7-21: Function of the DeviceNet diagnostics LED

Interfaces

7.2.2 INTERBUS

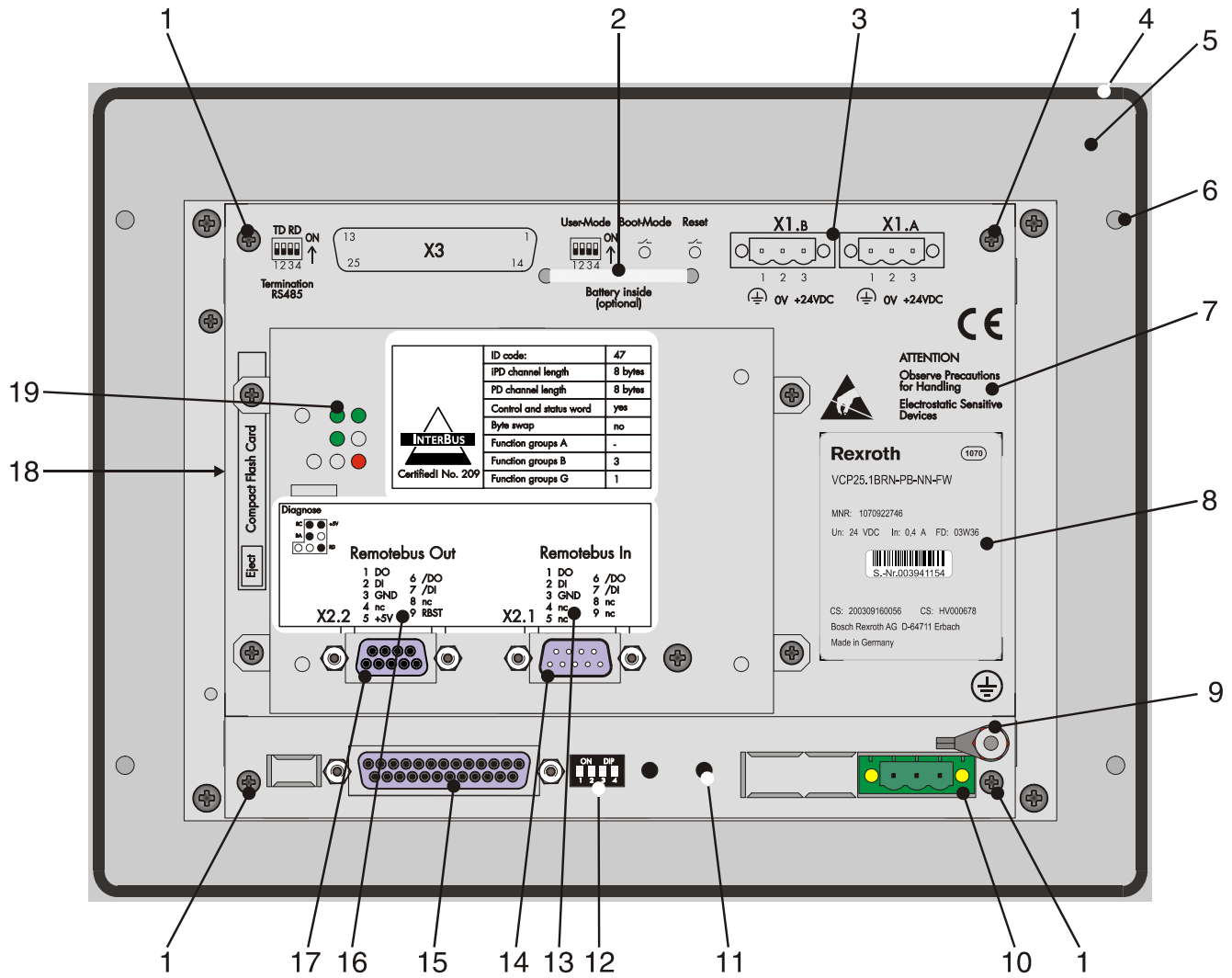

Fig. 7-22: Rear view INTERBUS

Interfaces

1. Fastening Screw
2. Cable Fastener for Battery
3. Assignment Connector X1.A (Supply Voltage)
4. Seal
5. Front Panel
6. Mounting Bolt
7. Warning
8. Nameplate
9. Threaded Bolt for Protective Grounding
10. Connector X1.A (Supply Voltage)
11. Reset Key
12. User Mode Switch
13. Assignment Connector X2.1 (Remotebus in)
14. Connector X2.1 (Remotebus in)
15. Female Connector X3 (SER2 RS232c)
16. Assignment Female Connector X2.2 (Remotebus out)
17. Female Connector X2.2 (Remotebus out)
18. CompactFlash, Inserted on the Side (Option)
19. Diagnostics LED

7.2.2.1 Pin Assignment

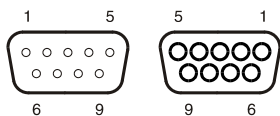

Fig. 7-23: 9-pin D-SUB male and female connector strip

Connector in the small operator terminal: 9-pin D-SUB male connector strip for remote bus in.

Pin	Designation	Function
1	DO	Data Output
2	DI	Data Input
3	GND	Ground
4	nc	Not Connected
5	nc	Not Connected
6	/DO	Data Output, Inverted
7	/DI	Data Input, Inverted
8	nc	Not Connected
9	nc	Not Connected

Fig. 7-24: Pin assignment INTERBUS

Connector in the small operator terminal: 9-pin D-SUB female connector strip for remote bus out.

Pin	Designation	Function
1	DO	Data Output
2	DI	Data Input
3	GND	Ground
4	nc	Not Connected
5	+5 V	Power Supply +5 VDC
6	/DO	Data Output, Inverted
7	/DI	Data Input, Inverted
8	nc	Not Connected
9	RBST	Remote Bus Status

Fig. 7-25: Pin assignment INTERBUS



The D-SUB connector strips must be shielded sufficiently. See chapter „Shielding D-SUB Connectors“ on page 7-23.

Interfaces

7.2.2.2 Cable



A shielded twisted-pair cable (cable type LiYCY-TP) must be used. The maximum cable length depends on its use within the INTERBUS topology.

7.2.2.3 Diagnostics

The diagnostics LEDs are located at the rear of the small operator terminal. The LEDs show the states of the bus system.

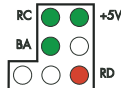

Fig. 7-26: Arrangement of the INTERBUS diagnostics LEDs

The diagnostics LEDs at the small operator terminal has the following functions:

Designation	Color	State	Function
RC	Green	On	Remote Bus Check
+5 V	Green	On	Supply Voltage OK
		Off	No Supply Voltage
BA	Green	On	Bus Active
		Off	Bus Not Active
RD	Red	On	Remote Bus Inactive

Fig. 7-27: Functions of the INTERBUS diagnostics LEDs

Interfaces

7.2.3 PROFIBUS DP

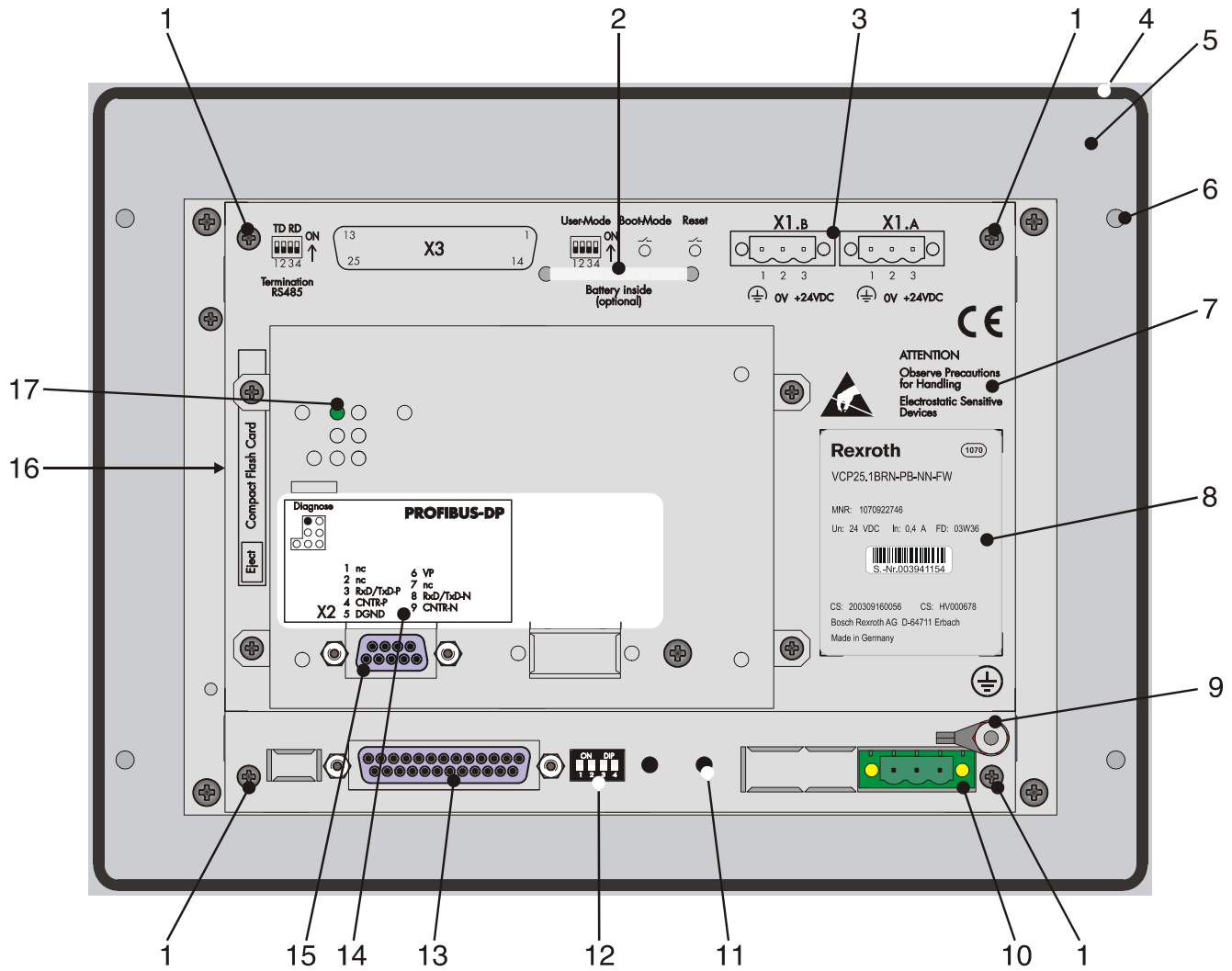

Fig. 7-28: Rear view PROFIBUS DP

Interfaces

1. Fastening Screws
2. Cable Fastener for Battery
3. Assignment Connector X1.A (Supply Voltage)
4. Seal
5. Front Panel
6. Mounting Bolt
7. Warning
8. Nameplate
9. Threaded Bolt for Protective Grounding
10. Connector X1.A (Supply Voltage)
11. Reset Key
12. User Mode Switch
13. Female Connector X3 (SER2 RS232c)
14. Assignment Female Connector X2 (PROFIBUS DP)
15. Female Connector X2 (PROFIBUS DP)
16. CompactFlash, Inserted on the Side (Option)
17. Diagnostic LED

Interfaces

7.2.3.1 Pin Assignment

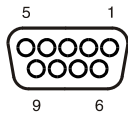

Fig. 7-29: 9-pin D-SUB female connector strip

Connector in the small operator terminal: 9-pin D-SUB female connector strip

Pin	Designation	Function
1	nc	Not Connected
2	nc	Not Connected
3	RxD/TxD-P	Received Data / Transmitted Data Plus
4	CNTR-P	Repeater Control Signal Plus
5	DGND	Data Transmission Potential
6	VP	Supply Voltage of Terminators Plus
7	nc	Not Connected
8	RxD/TxD-N	Received Data / Transmitted Data Minus
9	CNTR-N	Repeater Control Signal Minus

Fig. 7-30: Pin assignment PROFIBUS DP



The D-SUB connector strips must be shielded sufficiently. See chapter „Shielding D-SUB Connectors“ on page 7-23.

7.2.3.2 Cable



Any PROFIBUS DP-approved cables specified in the EN 50170 as cable type A can be used.

Impedance	136 to 165 Ohm
Capacity	< 30 pf/m
Loop resistance	110 Ohm/km
Wire gauge	0.64 mm

Interfaces

The maximum cable length depends on the baud rate (DIN EN 19245 Part 3).

Baud Rate	Cable Length
187.5 kbits/s	1000 m
500 kbits/s	400 m
1500 kbits/s	200 m
3000 to 12000 kbits/s	100 m

Fig. 7-31: Baud rate PROFIBUS DP

7.2.3.3 Termination

Terminate the PROFIBUS at both ends by terminating resistors. If you are using special PROFIBUS connectors, these resistors are usually integrated into the connector and can be connected.

7.2.3.4 Diagnostics

A diagnostic LED is located on the rear of the small operator terminal. The LED shows a state of the bus system.



Fig. 7-32: Arrangement of the PROFIBUS DP diagnostic LED

The diagnostic LED on the small operator terminal has the following function:

Color	State	Function
Green	On	Communication active

Fig. 7-33: Function of the PROFIBUS-DP diagnostic LED

7.3 Memory Card (Option)

You can insert a CompactFlash card on the side of your operating device. The CompactFlash card allows you to exchange projects between the PC and the operating device.

You can recognize the rear side of a CompactFlash card by the notches on each side of the card.

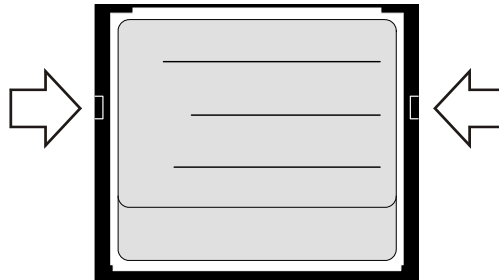

Fig. 7-34: Rear view of the memory card

7.3.1 Inserting the Memory Card

When you insert the card from the rear side of the operating device, make sure the front side of the card is visible. Insert the card until it snaps into place.

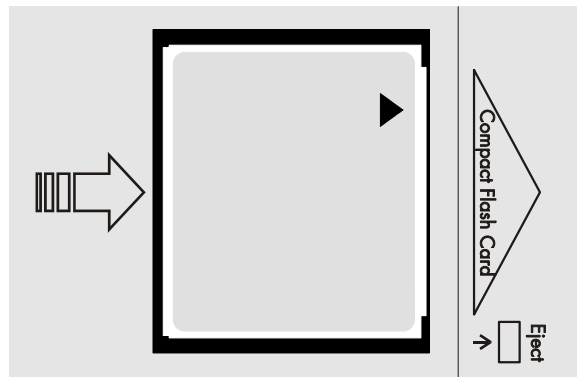

Fig. 7-35: Inserting the memory card

Interfaces

7.3.2 Ejecting the Memory Card

To remove the card, press the ejection button on the operating device.

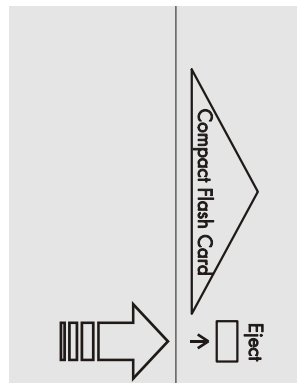

Fig. 7-36: Ejecting the memory card

7.4 Shielding D-SUB Connectors

You must shield D-SUB connectors as follows:

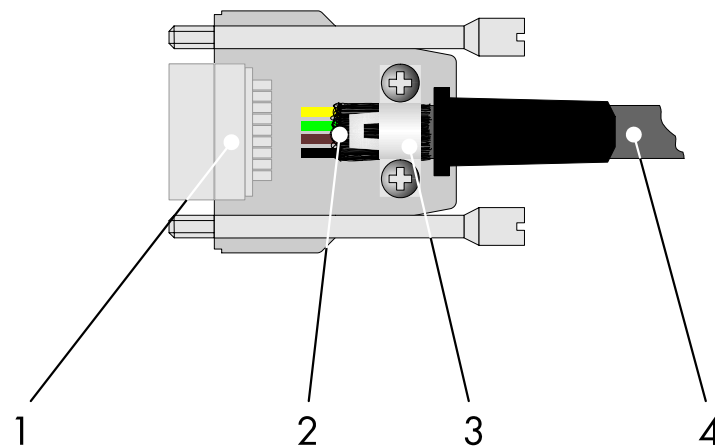

Fig. 7-37: Shielding D-SUB connectors

- 1 D-SUB connector
- 2 Shield
- 3 Cable clip
- 4 Cable

The shield must be folded back into a flat position over the cable sheath.

When fastening the cable with the cable clip, as much of the shielding as possible must be in contact with the housing and sufficient strain relieve must be ensured.

Interfaces

8 Maintenance and Installation

8.1 General Information

VCP-type operator terminals are maintenance-free. A few parts are subject to wear and must be replaced after a certain number of operating hours.

8.2 Exchange of Hardware Components

**CAUTION**

Maintenance work in the device is only permissible by skilled staff!
If hardware components have to be exchanged, please contact the Bosch Rexroth Service or ensure that only skilled staff changes the respective components.

8.3 Data Backup

**CAUTION**

The Bosch Rexroth AG is not liable for possible data loss and the damages resulting from this!

The customer himself is responsible for the backup of customer-specific data and must provide this data in case of service.

8.4 Unpacking the Device

Unpack all parts carefully and check the contents for any visible transport damage. Also check whether the shipment matches the specifications on your delivery note.

If you notice transport damages or discrepancies, please contact our sales department immediately.

8.5 Identification

You can identify the small operator terminal by the nameplate on the rear.

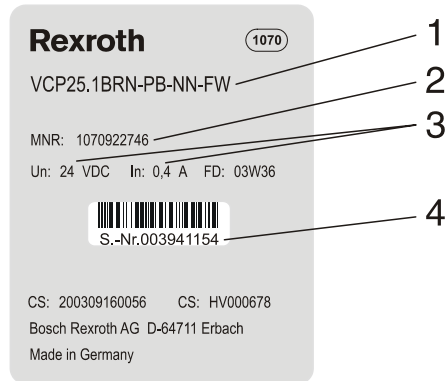

Fig. 8-1: Nameplate (example)

- 1 Ordering name / Short type designation
- 2 Part number
- 3 Voltage and power specification
- 4 Serial number

Depending on the size of the display, you will be able to read various types of information as the operating device is initialized: clock frequency, application memory size, current firmware version, programming software version, project name, time, date, number of compilation runs and a random number.

8.6 Connecting

8.6.1 Supply Voltage 24 V

The supply voltage is supplied via connector X1.A.

The device can optionally be equipped with an additional connector (X1.B). In this case, X1.A is looped through to X1.B and can be used to provide power supply to other components (e.g. bus node). The pin assignment is the same for both connectors.



The maximum continuous power allowed to flow from connector X1.A to X1.B is 5 A. To avoid an overload, an external fuse protection must be installed (e.g. fusible cut-out).

The device has reverse polarity protection. In case of wrong polarity, the device will not operate.

This is a protection class I device. For safe operation, safety extra-low voltage (SELV) in accordance with DIN EN 61131 must be used for the supply voltage.

Connector in the terminal: 3-pin connector Phoenix COMBICON MSTBV 2,5/3-GF

Pin	Designation	Function
1		Low-Noise Ground
2	0 V	Supply Voltage 0 V
3	24 VDC	Supply Voltage 24 VDC

Fig. 8-2: Pin assignment supply voltage

A suitable female connector strip of the type Phoenix COMBICON MSTB 2,5/3-STF is supplied.



A cable with finely stranded wires with a minimum cross-section of 0.75 mm² (18 AWG) and a maximum cross-section of 2.5 mm² (14 AWG) must be used for the supply voltage.



WARNING

Hazardous voltages can exist inside electrical installations that can pose a danger to humans. Coming in contact with live parts may result in electric shock!

Maintenance and Installation

Use the following procedure to connect the device to the supply voltage:

1. Remove approx. 30 mm (1.181") off the outer cable sheath and approx. 5 mm (0.197") off the wires.

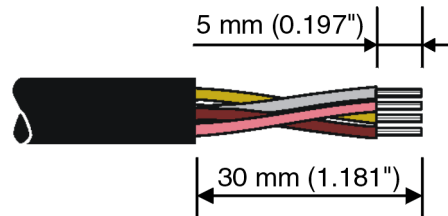

Fig. 8-3: Preparing the cable

2. Fit the wires with wire end ferrules and connect the wires to the connector.

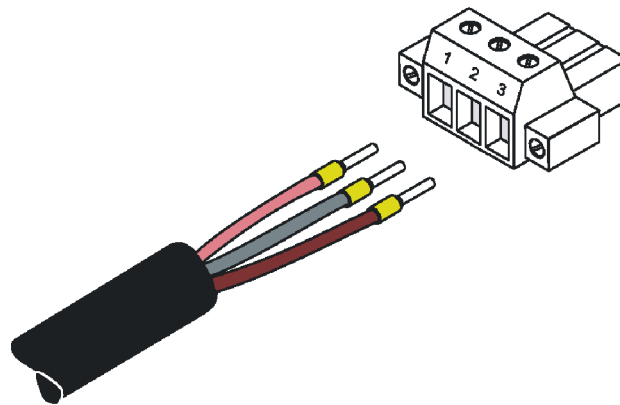

Fig. 8-4: Connecting the female connector strip



If shielded connecting cables are used in the supply voltage area, the shield should be connected to pin 1.

Maintenance and Installation

3. Plug the female connector strip onto connector X1.A.

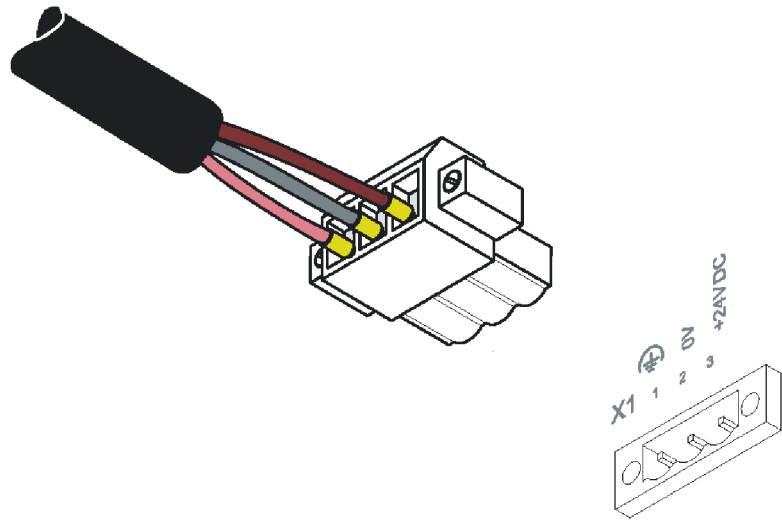

Fig. 8-5: Female connector strip is plugged on

4. Secure the female connector strip in place with a screw-type locking to prevent it from slipping out.



A separate conductor must always be provided for the protective grounding at the threaded bolt. The conductor must have a minimum cross-section of 1.5 mm² (16 AWG) and must be kept as short as possible. Complying with this will increase operating safety.

8.7 Front Panel

You should use a damp cloth only to remove any dirt from the panel.

8.8 Fuse



The semiconductor fuse cannot be replaced!

A semiconductor fuse is used to protect the device. Once the fuse has been tripped, the device must be disconnected from the supply voltage to allow the semiconductor fuse to regenerate. At an ambient temperature of 20 °C (68° F), the regeneration takes approximately 20 seconds. The higher the ambient temperature, the longer the regeneration takes.

8.9 Battery

The built-in battery preserves the data in the CMOS-RAM and supplies the real-time clock. The minimum battery life is 5 years, even under unfavorable operating conditions. When the battery runs down, the message "Change battery" is generated automatically.

We recommend you change the battery approximately every 4 years as part of the regular maintenance work. A pre-assembled battery including connector can be obtained directly from Bosch Rexroth.

If the "Change battery" message is detected too late, e.g. the real-time clock stopped or shows the wrong date, data in the CMOS-RAM may have already been lost. For this reason, after changing a battery, always check data such as passwords that can be modified, parameters in the system variables, recipe data sets and entries in the message system.

8.9.1 Changing the Battery

To ensure that the data in the CMOS-RAM and the time are preserved, it is possible to change the battery under operating voltage. Observe the safety notes!

1. Remove the threaded bolts of the interfaces (see figure).
2. Remove the screws (see figure) on the rear panel of the device and lift off the housing.
3. Remove the cable fastener securing the battery.
4. Disconnect the connector from the battery and remove the dead battery.
5. Plug in the cable of the new battery.
6. Use a cable fastener to attach the new battery to the housing.
7. Place the rear panel back onto the device.
8. Carefully tighten the screws of the rear panel and then the threaded bolts of the interfaces.

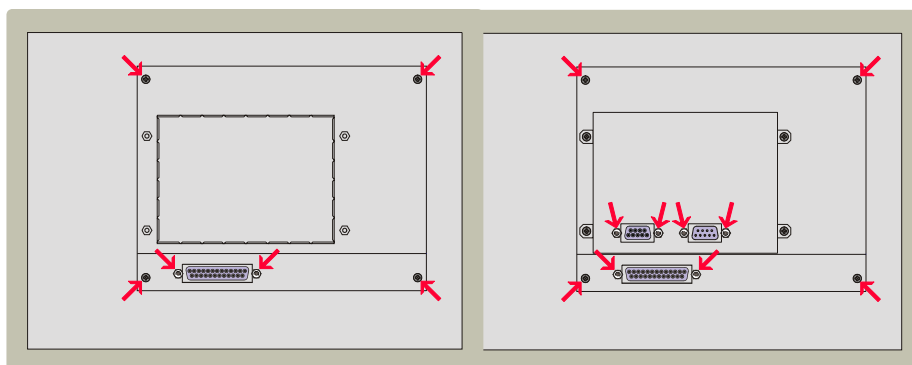

Fig. 8-6: Screws on the standard device (left) / field bus device (right)

8.9.2 Battery Disposal



To prevent short circuitry in the collection boxes, insulate the poles of each battery with insulation tape or put each single battery into a plastic bag.

You must always return old batteries to a dealer or to a returns depot set up for this purpose by the public waste disposal body or a licensed battery dealer for recycling. Only dispose of dead batteries in public or commercial collection boxes. The battery is drained when the message „Change battery“ appears on the display of the device.

Maintenance and Installation

Ordering Information

9 Ordering Information

9.1 Type Code

The small operator terminals VCP 25 are available in different variants. Type code:

Abbrev. Column	1	2	3	4	5	6	7	8	9	0	1	2	3	4	5	6	7	8	9	0	1	2	3	4	5	6	7	8	9	0	1	2	3	4	5	6	7	8	9	0			
Example:	V	C	P	2	5	.	1	B	V	N	-	0	0	3	R	S	-	N	N	-	F	W																					

1. Product		
1.1	VCP. = VCP	
2. Line		
2.1	25. = 25	
3. Design		
3.1	1. = 1	
4. Front panel and display		
4.1	5,7", Touch-Screen. = BV	
5. Upgrade option		
5.1	keine. = N	
6. Application memory capacity		
6.1	3 MB. = 003	
7. Interface		
7.1	DeviceNet. = DN	
7.2	INTERBUS. = IB	
7.3	PROFIBUS-DP. = PB	
7.4	Serial (RS232/485, TTY 20mA). = RS	
8. Additional design		
8.1	none. = NN	
9. Firmware		
9.1	Denotes that firmware must be ordered as separate subposition = FW	

Fig. 9-1: Type code of the VCP 25

Ordering Information

9.2 Accessories

Ordering Designation	Material Number	Description
On request	On request	Battery
IKB0053	R911305271	Download cable
IKB0033	R911291808	PROFIBUS cable
IKB0051	R911305089	Serial cable RS422
IKB0052	R911305090	Serial cable RS232

Fig. 9-2: Accessories

10 List of Figures

- Fig. 1-1: VCP 25 with touch screen 1-1
- Fig. 3-1: Hazard classification (according to ANSI Z535) 3-1
- Fig. 5-1: Front panel dimensions 5-2
- Fig. 5-2: Mounting cutout 5-3
- Fig. 5-3: Side view and mounting depth for the standard device 5-4
- Fig. 5-4: Side view and mounting depth for the field bus device 5-5
- Fig. 6-1: Values for the representation type 6-1
- Fig. 6-2: User mode switch 6-3
- Fig. 7-1: Device variants 7-1
- Fig. 7-2: Rear view of standard device 7-2
- Fig. 7-3: 25 pin D-SUB female connector strip 7-4
- Fig. 7-4: Pin assignment TTY / 20 mA, passive 7-4
- Fig. 7-5: Pin assignment TTY / 20 mA, active 7-5
- Fig. 7-6: 25 pin D-SUB female connector strip 7-6
- Fig. 7-7: Pin assignment RS485 7-6
- Fig. 7-8: Block diagram termination RS485 7-7
- Fig. 7-9: Resistance values termination RS485 7-7
- Fig. 7-10: Termination switch 7-7
- Fig. 7-11: 25 pin D-SUB female connector strip 7-8
- Fig. 7-12: Pin assignment RS232c 7-8
- Fig. 7-13: 25-pin D-SUB female connector strip 7-9
- Fig. 7-14: Pin assignment of the RS232c interface 7-9
- Fig. 7-15: Rear view DeviceNet 7-10
- Fig. 7-16: 9-pin D-SUB male and female connector strip 7-12
- Fig. 7-17: Pin assignment DeviceNet 7-12
- Fig. 7-18: Data line DeviceNet 7-12
- Fig. 7-19: Baud rate DeviceNet 7-13
- Fig. 7-20: Arrangement of the DeviceNet diagnostics LED 7-13
- Fig. 7-21: Function of the DeviceNet diagnostics LED 7-13
- Fig. 7-22: Rear view INTERBUS 7-14
- Fig. 7-23: 9-pin D-SUB male and female connector strip 7-16
- Fig. 7-24: Pin assignment INTERBUS 7-16
- Fig. 7-25: Pin assignment INTERBUS 7-16
- Fig. 7-26: Arrangement of the INTERBUS diagnostics LEDs 7-17
- Fig. 7-27: Functions of the INTERBUS diagnostics LEDs 7-17
- Fig. 7-28: Rear view PROFIBUS DP 7-18
- Fig. 7-29: 9-pin D-SUB female connector strip 7-20
- Fig. 7-30: Pin assignment PROFIBUS DP 7-20
- Fig. 7-31: Baud rate PROFIBUS DP 7-21
- Fig. 7-32: Arrangement of the PROFIBUS DP diagnostic LED 7-21
- Fig. 7-33: Function of the PROFIBUS-DP diagnostic LED 7-21
- Fig. 7-34: Rear view of the memory card 7-22
- Fig. 7-35: Inserting the memory card 7-22
- Fig. 7-36: Ejecting the memory card 7-23
- Fig. 7-37: Shielding D-SUB connectors 7-23
- Fig. 8-1: Nameplate (example) 8-2
- Fig. 8-2: Pin assignment supply voltage 8-3
- Fig. 8-3: Preparing the cable 8-4
- Fig. 8-4: Connecting the female connector strip 8-4
- Fig. 8-5: Female connector strip is plugged on 8-5
- Fig. 8-6: Screws on the standard device (left) / field bus device

List of Figures

- (right) 8-6
Fig. 9-1: Type code of the VCP 25 9-1
Fig. 9-2: Accessories 9-2

Index

11 Index

B

Battery 8-6
Battery disposal 8-7

C

Cable
 DeviceNet 7-12
 INTERBUS 7-17
 PROFIBUS DP 7-20
Changing the battery 8-6
Character attributes 6-2
Character set
 Normal 6-2
 Windows 6-2
 Zoom 6-2
Compatibility test 4-5
Connecting 8-3

D

Default brightness setting 6-2
Default contrast setting 6-2
Device variants 7-1
Diagnostics
 DeviceNet 7-13
 INTERBUS 7-17
 PROFIBUS DP 7-21

F

Fuse 8-5

I

Identification 8-2

L

LcdBackLight 6-1
LcdContrast 6-1

N

Nameplate 8-2

P

Pin assignment
 DeviceNet 7-12
 INTERBUS 7-16
 PROFIBUS DP 7-20
 RS232c 7-8, 7-9
 RS485 7-6
 TTY / 20 mA 7-4

Index

R

Reset key 6-3

S

Setting the brightness 6-1

Setting the contrast 6-1

Supply voltage 24 V 8-3

T

Termination

DeviceNet 7-13

PROFIBUS DP 7-21

RS232c 7-8

RS485 (X3-SER1) 7-6

TTY / 20 mA 7-5

Termination switch 7-7

Touch screen 6-3

U

Unpacking 8-1

User mode switch 6-3

Service & Support

12 Service & Support

12.1 Helpdesk

Unser Kundendienst-Helpdesk im Hauptwerk Lohr am Main steht Ihnen mit Rat und Tat zur Seite. Sie erreichen uns

Our service helpdesk at our headquarters in Lohr am Main, Germany can assist you in all kinds of inquiries. Contact us

- telefonisch - by phone:
über Service Call Entry Center
- via Service Call Entry Center
- per Fax - by fax:
- per e-Mail - by e-mail: service.svc@boschrexroth.de

49 (0) 9352 40 50 60

Mo-Fr 07:00-18:00
Mo-Fr 7:00 am - 6:00 pm

+49 (0) 9352 40 49 41

12.2 Service-Hotline

Außerhalb der Helpdesk-Zeiten ist der Service direkt ansprechbar unter

After helpdesk hours, contact our service department directly at

+49 (0) 171 333 88 26

oder - or

+49 (0) 172 660 04 06

12.3 Internet

Unter www.boschrexroth.com finden Sie ergänzende Hinweise zu Service, Reparatur und Training sowie die **aktuellen** Adressen *) unserer auf den folgenden Seiten aufgeführten Vertriebs- und Servicebüros.

- Verkaufsniederlassungen
- Niederlassungen mit Kundendienst

Außerhalb Deutschlands nehmen Sie bitte zuerst Kontakt mit unserem für Sie nächstgelegenen Ansprechpartner auf.

*) Die Angaben in der vorliegenden Dokumentation können seit Drucklegung überholt sein.

At www.boschrexroth.com you may find additional notes about service, repairs and training in the Internet, as well as the **actual** addresses *) of our sales- and service facilities figuring on the following pages.

- sales agencies
- offices providing service

Please contact our sales / service office in your area first.

*) Data in the present documentation may have become obsolete since printing.

Service & Support

12.4 Vor der Kontaktaufnahme... - Before contacting us...

Wir können Ihnen schnell und effizient helfen wenn Sie folgende Informationen bereithalten:

1. detaillierte Beschreibung der Störung und der Umstände.
2. Angaben auf dem Typenschild der betreffenden Produkte, insbesondere Typenschlüssel und Seriennummern.
3. Tel./Faxnummern und e-Mail-Adresse, unter denen Sie für Rückfragen zu erreichen sind.

For quick and efficient help, please have the following information ready:

1. Detailed description of the failure and circumstances.
2. Information on the type plate of the affected products, especially type codes and serial numbers.
3. Your phone/fax numbers and email address, so we can contact you in case of questions.

12.5 Kundenbetreuungsstellen - Sales & Service Facilities

12.5.1 Deutschland - Germany

vom Ausland:
from abroad:

(0) nach Landeskenziffer weglassen!
don't dial (0) after country code!

Vertriebsgebiet Mitte Germany Centre Rexroth Indramat GmbH Bgm.-Dr.-Nebel-Str. 2 / Postf. 1357 97816 Lohr am Main / 97803 Lohr Kompetenz-Zentrum Europa Tel.: +49 (0)9352 40-0 Fax: +49 (0)9352 40-4885	SERVICE CALL ENTRY CENTER MO – FR von 07:00 - 18:00 Uhr from 7 am – 6 pm Tel. +49 (0) 9352 40 50 60 service.svc@boschrexroth.de	SERVICE HOTLINE MO – FR von 17:00 - 07:00 Uhr from 5 pm - 7 am + SA / SO Tel.: +49 (0)172 660 04 06 oder / or Tel.: +49 (0)171 333 88 26	SERVICE ERSATZTEILE / SPARES verlängerte Ansprechzeit - extended office time - ♦ nur an Werktagen - only on working days - ♦ von 07:00 - 18:00 Uhr - from 7 am - 6 pm - Tel. +49 (0) 9352 40 42 22
Vertriebsgebiet Süd Germany South Bosch Rexroth AG Landshuter Allee 8-10 80637 München Tel.: +49 (0)89 127 14-0 Fax: +49 (0)89 127 14-490	Vertriebsgebiet West Germany West Bosch Rexroth AG Regionalzentrum West Borsigstrasse 15 40880 Ratingen Tel.: +49 (0)2102 409-0 Fax: +49 (0)2102 409-406 +49 (0)2102 409-430	Gebiet Südwest Germany South-West Bosch Rexroth AG Service-Regionalzentrum Süd-West Siemensstr.1 70736 Fellbach Tel.: +49 (0)711 51046-0 Fax: +49 (0)711 51046-248	
Vertriebsgebiet Nord Germany North Bosch Rexroth AG Walsroder Str. 93 30853 Langenhagen Tel.: +49 (0) 511 72 66 57-0 Service: +49 (0) 511 72 66 57-256 Fax: +49 (0) 511 72 66 57-93 Service: +49 (0) 511 72 66 57-783	Vertriebsgebiet Mitte Germany Centre Bosch Rexroth AG Regionalzentrum Mitte Waldecker Straße 13 64546 Mörfelden-Walldorf Tel.: +49 (0) 61 05 702-3 Fax: +49 (0) 61 05 702-444	Vertriebsgebiet Ost Germany East Bosch Rexroth AG Beckerstraße 31 09120 Chemnitz Tel.: +49 (0)371 35 55-0 Fax: +49 (0)371 35 55-333	Vertriebsgebiet Ost Germany East Bosch Rexroth AG Regionalzentrum Ost Walter-Köhn-Str. 4d 04356 Leipzig Tel.: +49 (0)341 25 61-0 Fax: +49 (0)341 25 61-111

Service & Support

12.5.2 Europa (West) - Europe (West)

vom Ausland: (0) nach Landeskenziffer weglassen,
from abroad: don't dial (0) after country code,

Italien: 0 nach Landeskenziffer mitwählen
Italy: dial 0 after country code

<p>Austria - Österreich</p> <p>Bosch Rexroth GmbH Electric Drives & Controls Stachegasse 13 1120 Wien</p> <p>Tel.: +43 (0)1 985 25 40 Fax: +43 (0)1 985 25 40-93</p>	<p>Austria – Österreich</p> <p>Bosch Rexroth GmbH Electric Drives & Controls Industriepark 18 4061 Pasching</p> <p>Tel.: +43 (0)7221 605-0 Fax: +43 (0)7221 605-21</p>	<p>Belgium - Belgien</p> <p>Bosch Rexroth NV/SA Henri Genessestraat 1 1070 Bruxelles</p> <p>Tel: +32 (0) 2 582 31 80 Fax: +32 (0) 2 582 43 10 info@boschrexroth.be service@boschrexroth.be</p>	<p>Denmark - Dänemark</p> <p>BEC A/S Zinkvej 6 8900 Randers</p> <p>Tel.: +45 (0)87 11 90 60 Fax: +45 (0)87 11 90 61</p>
<p>Great Britain – Großbritannien</p> <p>Bosch Rexroth Ltd. Electric Drives & Controls Broadway Lane, South Cerney Cirencester, Glos GL7 5UH</p> <p>Tel.: +44 (0)1285 863000 Fax: +44 (0)1285 863030 sales@boschrexroth.co.uk service@boschrexroth.co.uk</p>	<p>Finland - Finnland</p> <p>Bosch Rexroth Oy Electric Drives & Controls Ansatie 6 017 40 Vantaa</p> <p>Tel.: +358 (0)9 84 91-11 Fax: +358 (0)9 84 91-13 60</p>	<p>France - Frankreich</p> <p>Bosch Rexroth SAS Electric Drives & Controls Avenue de la Trentaine (BP. 74) 77503 Chelles Cedex</p> <p>Tel.: +33 (0)164 72-70 00 Fax: +33 (0)164 72-63 00 Hotline: +33 (0)608 33 43 28</p>	<p>France - Frankreich</p> <p>Bosch Rexroth SAS Electric Drives & Controls ZI de Thibaud, 20 bd. Thibaud (BP. 1751) 31084 Toulouse</p> <p>Tel.: +33 (0)5 61 43 61 87 Fax: +33 (0)5 61 43 94 12</p>
<p>France – Frankreich</p> <p>Bosch Rexroth SAS Electric Drives & Controls 91, Bd. Irène Joliot-Curie 69634 Vénissieux – Cedex</p> <p>Tel.: +33 (0)4 78 78 53 65 Fax: +33 (0)4 78 78 53 62</p>	<p>Italy - Italien</p> <p>Bosch Rexroth S.p.A. Via G. Di Vittorio, 1 20063 Cernusco S/N.MI</p> <p>Hotline: +39 02 92 365 563 Tel.: +39 02 92 365 1 Service: +39 02 92 365 326 Fax: +39 02 92 365 500 Service: +39 02 92 365 503</p>	<p>Italy - Italien</p> <p>Bosch Rexroth S.p.A. Via Paolo Veronesi, 250 10148 Torino</p> <p>Tel.: +39 011 224 88 11 Fax: +39 011 224 88 30</p>	<p>Italy - Italien</p> <p>Bosch Rexroth S.p.A. Via Mascia, 1 80053 Castellamare di Stabia NA</p> <p>Tel.: +39 081 8 71 57 00 Fax: +39 081 8 71 68 85</p>
<p>Italy - Italien</p> <p>Bosch Rexroth S.p.A. Via del Progresso, 16 (Zona Ind.) 35020 Padova</p> <p>Tel.: +39 049 8 70 13 70 Fax: +39 049 8 70 13 77</p>	<p>Italy - Italien</p> <p>Bosch Rexroth S.p.A. Via Isonzo, 61 40033 Casalecchio di Reno (Bo)</p> <p>Tel.: +39 051 29 86 430 Fax: +39 051 29 86 490</p>	<p>Netherlands - Niederlande/Holland</p> <p>Bosch Rexroth Services B.V. Technical Services Kruisbroeksestraat 1 (P.O. Box 32) 5281 RV Boxtel</p> <p>Tel.: +31 (0) 411 65 16 40 +31 (0) 411 65 17 27 Fax: +31 (0) 411 67 78 14 +31 (0) 411 68 28 60 services@boschrexroth.nl</p>	<p>Netherlands – Niederlande/Holland</p> <p>Bosch Rexroth B.V. Kruisbroeksestraat 1 (P.O. Box 32) 5281 RV Boxtel</p> <p>Tel.: +31 (0) 411 65 19 51 Fax: +31 (0) 411 65 14 83 www.boschrexroth.nl</p>
<p>Norway - Norwegen</p> <p>Bosch Rexroth AS Electric Drives & Controls Berghagan 1 or: Box 3007 1405 Ski-Langhus 1402 Ski</p> <p>Tel.: +47 (0) 64 86 41 00 Fax: +47 (0) 64 86 90 62</p> <p>Hotline: +47 (0)64 86 94 82 jul.ruud@rexroth.no</p>	<p>Spain - Spanien</p> <p>Bosch Rexroth S.A. Electric Drives & Controls Centro Industrial Santiga Obradors s/n 08130 Santa Perpetua de Mogoda Barcelona</p> <p>Tel.: +34 9 37 47 94 00 Fax: +34 9 37 47 94 01</p>	<p>Spain – Spanien</p> <p>Goimendi S.A. Electric Drives & Controls Parque Empresarial Zuatzu C/ Francisco Grandmontagne no.2 20018 San Sebastian</p> <p>Tel.: +34 9 43 31 84 21 - service: +34 9 43 31 84 56 Fax: +34 9 43 31 84 27 - service: +34 9 43 31 84 60 sat.indramat@goimendi.es</p>	<p>Sweden - Schweden</p> <p>Bosch Rexroth AB Electric Drives & Controls - Varuvägen 7 (Service: Konsumentvägen 4, Älfsjö) 125 81 Stockholm</p> <p>Tel.: +46 (0)8 727 92 00 Fax: +46 (0)8 647 32 77</p>
<p>Sweden - Schweden</p> <p>Bosch Rexroth AB Electric Drives & Controls Ekvåndan 7 254 67 Helsingborg</p> <p>Tel.: +46 (0) 42 38 88 -50 Fax: +46 (0) 42 38 88 -74</p>	<p>Switzerland East - Schweiz Ost</p> <p>Bosch Rexroth Schweiz AG Electric Drives & Controls Hemrietstrasse 2 8863 Buttikon</p> <p>Tel. +41 (0) 55 46 46 111 Fax +41 (0) 55 46 46 222</p>	<p>Switzerland West - Schweiz West</p> <p>Bosch Rexroth Suisse SA Av. Général Guisan 26 1800 Vevey 1</p> <p>Tel.: +41 (0)21 632 84 20 Fax: +41 (0)21 632 84 21</p>	

Service & Support

12.5.3 Europa (Ost) - Europe (East)

vom Ausland: (0) nach Landeskenziffer weglassen

from abroad: don't dial (0) after country code

<p>Czech Republic - Tschechien</p> <p>Bosch -Rexroth, spol.s.r.o. Hviezdoslavova 5 627 00 Brno Tel.: +420 (0)5 48 126 358 Fax: +420 (0)5 48 126 112</p>	<p>Czech Republic - Tschechien</p> <p>DEL a.s. Strojirenská 38 591 01 Zdar nad Sázavou Tel.: +420 566 64 3144 Fax: +420 566 62 1657</p>	<p>Hungary - Ungarn</p> <p>Bosch Rexroth Kft. Angol utca 34 1149 Budapest Tel.: +36 (1) 422 3200 Fax: +36 (1) 422 3201</p>	<p>Poland – Polen</p> <p>Bosch Rexroth Sp.zo.o. ul. Staszica 1 05-800 Pruszków Tel.: +48 22 738 18 00 – service: +48 22 738 18 46 Fax: +48 22 758 87 35 – service: +48 22 738 18 42</p>
<p>Poland – Polen</p> <p>Bosch Rexroth Sp.zo.o. Biuro Poznan ul. Dabrowskiego 81/85 60-529 Poznan Tel.: +48 061 847 64 62 /-63 Fax: +48 061 847 64 02</p>	<p>Romania - Rumänien</p> <p>East Electric S.R.L. Bdul Basarabia no.250, sector 3 73429 Bucuresti Tel./Fax:: +40 (0)21 255 35 07 +40 (0)21 255 77 13 Fax: +40 (0)21 725 61 21 eastel@rdsnet.ro</p>	<p>Romania - Rumänien</p> <p>Bosch Rexroth Sp.zo.o. Str. Drobety nr. 4-10, app. 14 70258 Bucuresti, Sector 2 Tel.: +40 (0)1 210 48 25 +40 (0)1 210 29 50 Fax: +40 (0)1 210 29 52</p>	<p>Russia - Russland</p> <p>Bosch Rexroth OOO Wjatskaja ul. 27/15 127015 Moskau Tel.: +7-095-785 74 78 +7-095 785 74 79 Fax: +7 095 785 74 77 laura.kanina@boschrexroth.ru</p>
<p>Russia - Russland</p> <p>ELMIS 10, Internationalnaya 246640 Gomel, Belarus Tel.: +375/ 232 53 42 70 +375/ 232 53 21 69 Fax: +375/ 232 53 37 69 elmis_ltd@yahoo.com</p>	<p>Turkey - Türkei</p> <p>Bosch Rexroth Otomasyon San & Tic. A..S. Fevzi Cakmak Cad No. 3 34630 Sefaköy Istanbul Tel.: +90 212 541 60 70 Fax: +90 212 599 34 07</p>	<p>Turkey - Türkei</p> <p>Servo Kontrol Ltd. Sti. Perpa Ticaret Merkezi B Blok Kat: 11 No: 1609 80270 Okmeydani-Istanbul Tel: +90 212 320 30 80 Fax: +90 212 320 30 81 remzi.sali@servokontrol.com www.servokontrol.com</p>	<p>Slovenia - Slowenien</p> <p>DOMEL Otoki 21 64 228 Zelezniki Tel.: +386 5 5117 152 Fax: +386 5 5117 225 brane.ozebek@domel.si</p>

Service & Support

12.5.4 Afrika, Asien, Australien (inkl. Pazifischer Raum) - Africa, Asia, Australia (incl. Pacific Rim)

<p>Australia - Australien</p> <p>AIMS - Australian Industrial Machinery Services Pty. Ltd. 28 Westside Drive Laverton North Vic 3026 Melbourne</p> <p>Tel.: +61 3 93 14 3321 Fax: +61 3 93 14 3329 Hotlines: +61 3 93 14 3321 +61 4 19 369 195 enquires@aimservices.com.au</p>	<p>Australia - Australien</p> <p>Bosch Rexroth Pty. Ltd. No. 7, Endeavour Way Braeside Victoria, 31 95 Melbourne</p> <p>Tel.: +61 3 95 80 39 33 Fax: +61 3 95 80 17 33 mel@rexroth.com.au</p>	<p>China</p> <p>Shanghai Bosch Rexroth Hydraulics & Automation Ltd. Waigaoqiao, Free Trade Zone No.122, Fu Te Dong Yi Road Shanghai 200131 - P.R.China</p> <p>Tel.: +86 21 58 66 30 30 Fax: +86 21 58 66 55 23 richard.yang_sh@boschrexroth.com.cn qf.zhu_sh@boschrexroth.com.cn</p>	<p>China</p> <p>Shanghai Bosch Rexroth Hydraulics & Automation Ltd. 4/f, Marine Tower No.1, Pudong Avenue Shanghai 200120 - P.R.China</p> <p>Tel.: +86 21 68 86 15 88 Fax: +86 21 58 40 65 77</p>
<p>China</p> <p>Bosch Rexroth China Ltd. 15/F China World Trade Center 1, Jianguomenwai Avenue Beijing 100004, P.R.China</p> <p>Tel.: +86 10 65 05 03 80 Fax: +86 10 65 05 03 79</p>	<p>China</p> <p>Bosch Rexroth China Ltd. Guangzhou Repres. Office Room 1014-1016, Metro Plaza, Tian He District, 183 Tian He Bei Rd Guangzhou 510075, P.R.China</p> <p>Tel.: +86 20 8755-0030 +86 20 8755-0011 Fax: +86 20 8755-2387</p>	<p>China</p> <p>Bosch Rexroth (China) Ltd. A-5F., 123 Lian Shan Street Sha He Kou District Dalian 116 023, P.R.China</p> <p>Tel.: +86 411 46 78 930 Fax: +86 411 46 78 932</p>	<p>China</p> <p>Melchers GmbH BRC-SE, Tightening & Press-fit 13 Floor Est Ocean Centre No.588 Yanan Rd. East 65 Yanan Rd. West Shanghai 200001</p> <p>Tel.: +86 21 6352 8848 Fax: +86 21 6351 3138</p>
<p>Hongkong</p> <p>Bosch Rexroth (China) Ltd. 6th Floor, Yeung Yiu Chung No.6 Ind Bldg. 19 Cheung Shun Street Cheung Sha Wan, Kowloon, Hongkong</p> <p>Tel.: +852 22 62 51 00 Fax: +852 27 41 33 44 alexis.siu@boschrexroth.com.hk</p>	<p>India - Indien</p> <p>Bosch Rexroth (India) Ltd. Electric Drives & Controls Plot. No.96, Phase III Peenya Industrial Area Bangalore – 560058</p> <p>Tel.: +91 80 51 17 0-211...-218 Fax: +91 80 83 94 345 +91 80 83 97 374 mohanvelu.t@boschrexroth.co.in</p>	<p>India - Indien</p> <p>Bosch Rexroth (India) Ltd. Electric Drives & Controls Advance House, II Floor Ark Industrial Compound Narol Naka, Makwana Road Andheri (East), Mumbai - 400 059</p> <p>Tel.: +91 22 28 56 32 90 +91 22 28 56 33 18 Fax: +91 22 28 56 32 93 singh.op@boschrexroth.co.in</p>	<p>India - Indien</p> <p>Bosch Rexroth (India) Ltd. S-10, Green Park Extension New Delhi – 110016</p> <p>Tel.: +91 11 26 56 65 25 +91 11 26 56 65 27 Fax: +91 11 26 56 68 87 koul.rp@boschrexroth.co.in</p>
<p>Indonesia - Indonesien</p> <p>PT. Bosch Rexroth Building # 202, Cilandak Commercial Estate Jl. Cilandak KKO, Jakarta 12560</p> <p>Tel.: +62 21 7891169 (5 lines) Fax: +62 21 7891170 - 71 rudu.karimun@boschrexroth.co.id</p>	<p>Japan</p> <p>Bosch Rexroth Automation Corp. Service Center Japan Yutakagaoka 1810, Meito-ku, NAGOYA 465-0035, Japan</p> <p>Tel.: +81 52 777 88 41 +81 52 777 88 53 +81 52 777 88 79 Fax: +81 52 777 89 01</p>	<p>Japan</p> <p>Bosch Rexroth Automation Corp. Electric Drives & Controls 2F, I.R. Building Nakamachidai 4-26-44, Tsuzuki-ku YOKOHAMA 224-0041, Japan</p> <p>Tel.: +81 45 942 72 10 Fax: +81 45 942 03 41</p>	<p>Korea</p> <p>Bosch Rexroth-Korea Ltd. Electric Drives and Controls Bongwoo Bldg. 7FL, 31-7, 1Ga Jangchoong-dong, Jung-gu Seoul, 100-391</p> <p>Tel.: +82 234 061 813 Fax: +82 222 641 295</p>
<p>Korea</p> <p>Bosch Rexroth-Korea Ltd. 1515-14 Dadae-Dong, Saha-gu Electric Drives & Controls Pusan Metropolitan City, 604-050</p> <p>Tel.: +82 51 26 00 741 Fax: +82 51 26 00 747 eunkyong.kim@boschrexroth.co.kr</p>	<p>Malaysia</p> <p>Bosch Rexroth Sdn.Bhd. 11, Jalan U8/82, Seksyen U8 40150 Shah Alam Selangor, Malaysia</p> <p>Tel.: +60 3 78 44 80 00 Fax: +60 3 78 45 48 00 hockhwa@hotmail.com rexroth1@tm.net.my</p>	<p>Singapore - Singapur</p> <p>Bosch Rexroth Pte Ltd 15D Tuas Road Singapore 638520</p> <p>Tel.: +65 68 61 87 33 Fax: +65 68 61 18 25 sanjay.nemade@boschrexroth.com.sg</p>	<p>South Africa - Südafrika</p> <p>TECTRA Automation (Pty) Ltd. 71 Watt Street, Meadowdale Edenvale 1609</p> <p>Tel.: +27 11 971 94 00 Fax: +27 11 971 94 40 Hotline: +27 82 903 29 23 georgv@tectra.co.za</p>
<p>Taiwan</p> <p>Bosch Rexroth Co., Ltd. Taichung Branch 1F., No. 29, Fu-Ann 5th Street, Xi-Tun Area, Taichung City Taiwan, R.O.C.</p> <p>Tel.: +886 - 4 -23580400 Fax: +886 - 4 -23580402 charlie.chen@boschrexroth.com.tw jim.lin@boschrexroth.com.tw david.lai@boschrexroth.com.tw</p>	<p>Thailand</p> <p>NC Advance Technology Co. Ltd. 59/76 Moo 9 Ramintra road 34 Tharang, Bangkokhen, Bangkok 10230</p> <p>Tel.: +66 2 943 70 62 +66 2 943 71 21 Fax: +66 2 509 23 62 Hotline: +66 1 984 61 52 sonkawin@hotmail.com</p>		

Service & Support

12.5.5 Nordamerika - North America

USA Headquarters - Hauptniederlassung Bosch Rexroth Corporation Electric Drives & Controls 5150 Prairie Stone Parkway Hoffman Estates, IL 60192-3707 Tel.: +1 847 6 45 36 00 Fax: +1 847 6 45 62 01 servicebrc@boschrexroth-us.com repairbrc@boschrexroth-us.com	USA Central Region - Mitte Bosch Rexroth Corporation Electric Drives & Controls Central Region Technical Center 1701 Harmon Road Auburn Hills, MI 48326 Tel.: +1 248 3 93 33 30 Fax: +1 248 3 93 29 06	USA Southeast Region - Südwest Bosch Rexroth Corporation Electric Drives & Controls Southeastern Technical Center 3625 Swiftwater Park Drive Suwanee, Georgia 30124 Tel.: +1 770 9 32 32 00 Fax: +1 770 9 32 19 03	USA SERVICE-HOTLINE - 7 days x 24hrs - +1-800-REX-ROTH +1 800 739 7684
USA East Region – Ost Bosch Rexroth Corporation Electric Drives & Controls Charlotte Regional Sales Office 14001 South Lakes Drive Charlotte, North Carolina 28273 Tel.: +1 704 5 83 97 62 +1 704 5 83 14 86	USA Northeast Region – Nordost Bosch Rexroth Corporation Electric Drives & Controls Northeastern Technical Center 99 Rainbow Road East Granby, Connecticut 06026 Tel.: +1 860 8 44 83 77 Fax: +1 860 8 44 85 95	USA West Region – West Bosch Rexroth Corporation 7901 Stoneridge Drive, Suite 220 Pleasant Hill, California 94588 Tel.: +1 925 227 10 84 Fax: +1 925 227 10 81	
Canada East - Kanada Ost Bosch Rexroth Canada Corporation Burlington Division 3426 Mainway Drive Burlington, Ontario Canada L7M 1A8 Tel.: +1 905 335 5511 Fax: +1 905 335 4184 Hotline: +1 905 335 5511 michael.moro@boschrexroth.ca	Canada West - Kanada West Bosch Rexroth Canada Corporation 5345 Goring St. Burnaby, British Columbia Canada V7J 1R1 Tel.: +1 604 205 5777 Fax: +1 604 205 6944 Hotline: +1 604 205 5777 david.gunby@boschrexroth.ca	Mexico Bosch Rexroth Mexico S.A. de C.V. Calle Neptuno 72 Unidad Ind. Vallejo 07700 Mexico, D.F. Tel.: +52 55 57 54 17 11 Fax: +52 55 57 54 50 73 mariofelipe.hernandez@boschrexroth.com.mx	Mexico Bosch Rexroth S.A. de C.V. Calle Argentina No 3913 Fracc. las Torres 64930 Monterrey, N.L. Tel.: +52 81 83 65 22 53 +52 81 83 65 89 11 +52 81 83 49 80 91 Fax: +52 81 83 65 52 80 mario.quiroga@boschrexroth.com.mx

12.5.6 Südamerika - South America

Argentina - Argentinien Bosch Rexroth S.A.I.C. "The Drive & Control Company" Rosario 2302 B1606DLD Carapachay Provincia de Buenos Aires Tel.: +54 11 4756 01 40 +54 11 4756 02 40 +54 11 4756 03 40 +54 11 4756 04 40 Fax: +54 11 4756 01 36 +54 11 4721 91 53 victor.iabif@boschrexroth.com.ar	Argentina - Argentinien NAKASE Servicio Tecnico CNC Calle 49, No. 5764/66 B1653AOX Villa Balester Provincia de Buenos Aires Tel.: +54 11 4768 36 43 Fax: +54 11 4768 24 13 Hotline: +54 11 155 307 6781 nakase@usa.net nakase@nakase.com gerencia@nakase.com (Service)	Brazil - Brasilien Bosch Rexroth Ltda. Av. Tégula, 888 Ponte Alta, Atibaia SP CEP 12942-440 Tel.: +55 11 4414 56 92 +55 11 4414 56 84 Fax sales: +55 11 4414 57 07 Fax serv.: +55 11 4414 56 86 alexandre.wittwer@rexroth.com.br	Brazil - Brasilien Bosch Rexroth Ltda. R. Dr.Humberto Pinheiro Vieira, 100 Distrito Industrial [Caixa Postal 1273] 89220-390 Joinville - SC Tel./Fax: +55 47 473 58 33 Mobil: +55 47 9974 6645 prochnow@zaz.com.br
Columbia - Kolumbien Reflutec de Colombia Ltda. Calle 37 No. 22-31 Santafé de Bogotá, D.C. Colombia Tel.: +57 1 368 82 67 +57 1 368 02 59 Fax: +57 1 268 97 37 reflutec@neutel.com.co reflutec@007mundo.com			

Bosch Rexroth AG
Electric Drives and Controls
P.O. Box 13 57
97803 Lohr, Germany
Bgm.-Dr.-Nebel-Str. 2
97816 Lohr, Germany
Phone +49 93 52-40-50 60
Fax +49 93 52-40-49 41
service.svc@boschrexroth.de
www.boschrexroth.com

