

# Manual Motor Protectors, Motor Protector Combinations Overview

Manual Motor Protectors,  
Motor Protector Combinations

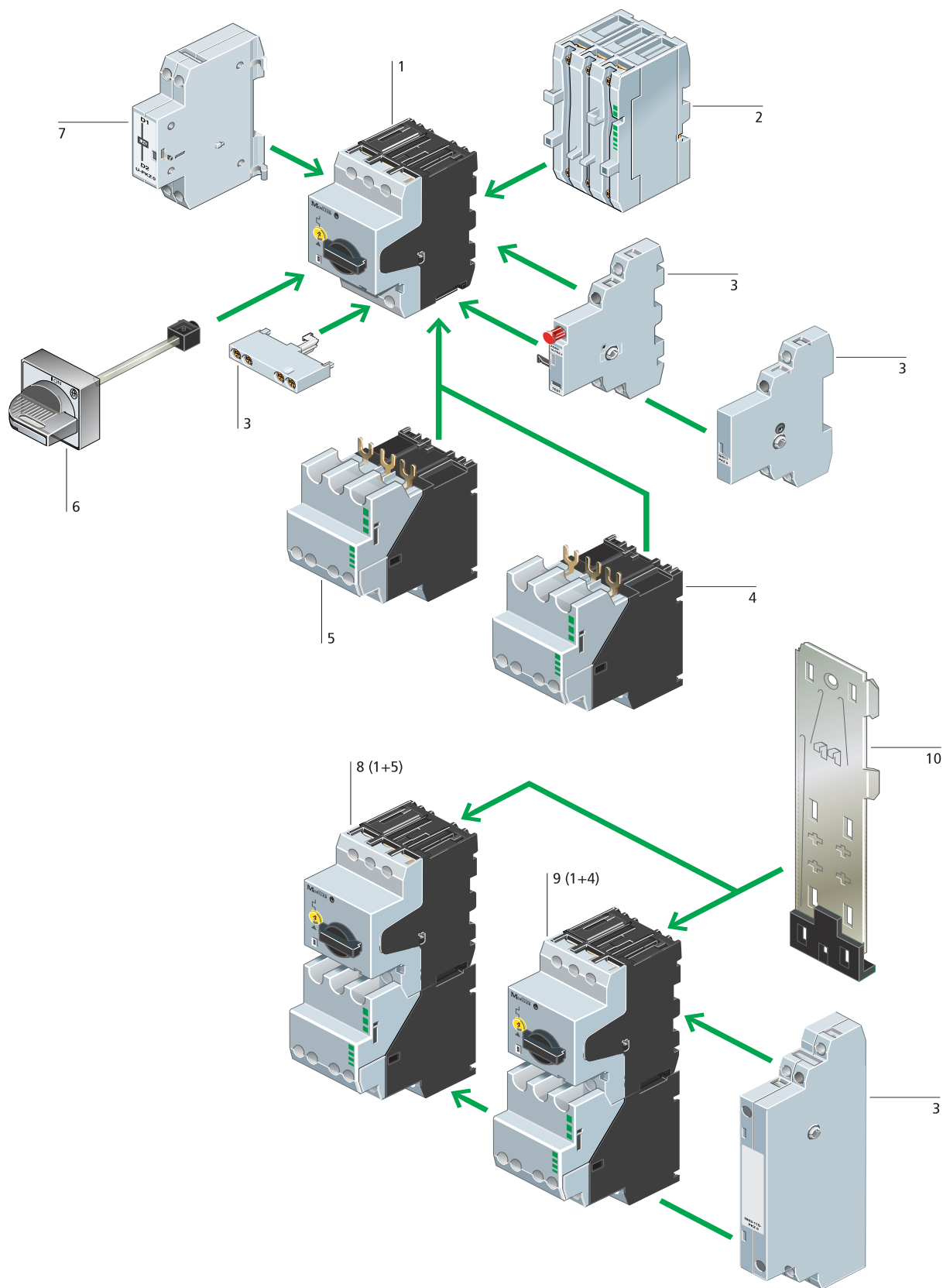

## Motor protection



Basic devices	Add-on functions	Mounting accessories
<b>Manual motor protector</b> 1	<b>Magnetic contactor module</b> 4	<b>Mounting/wiring</b> 10
Thermal-magnetic motor protector	AC and DC operated versions	Clip plate, onto which the compact motor protector combinations are mounted
Rated operational current up to 25 A	Supplied with 1 N.O./1 N.C. or 2 N.O. contacts	Suitable for DIN rail mounting (EN 50 022)
Max. 3 phase HP rating: 15/20 @ 460/575 V AC	Plugs into load side of motor protector or can be separately mounted	Other mounting/ wiring hardware:
UL listed for group installations per NEC 430-53, CSA certified for group installations per CEC part 1, 28-206	Rated 7½ HP @ 460 V AC, 10 HP @ 575 V AC	• adapters for direct busbar feeds in control panels
High short-circuit rating: up to 50 kA @ 600 V AC	UL listed with PKZM0 motor protector for group installations per NEC 430-53, CSA certified with PKZM0 for group installations per CEC part 1, 28-206	• mounting and wiring system MVS-... to combine PKZM0 protectors with DILM magnetic contactors
UL listed, CSA certified, in conformity with IEC/EN 60 947, CE marked	IEC 60 947-4-1 rated for type "1" coordination	Refer to page 08/020 for additional details on these mounting and wiring accessories
→ page 08/006	→ page 08/014	→ page 08/017
<b>Magnetic motor protector combination</b> 8	<b>High-capacity magnetic contactor module</b> 5	<b>Door coupling handle</b> 8
Thermal-magnetic motor protector (1) combined with the magnetic contactor module (4) on a clip plate, suitable for DIN rail mounting (EN 50 022).	Same approvals and features as above, except: internal current limitation feature to increase short-circuit current rating and self-protection characteristics per IEC/EN 60 947.	Rated IP 65 / NEMA/UL 12, 3R
Max. rating: 7½ HP @ 460 V AC, 10 HP @ 575 V AC	IEC 60 947-4-1 rated for type "2" coordination	3 positions: ON/OFF/Tripped
UL listed for group installations per NEC 430-53, CSA certified for group installations per CEC part 1, 28-206	→ page 08/014	Door interlocking feature and padlockable with up to 3 padlocks (also available without door interlocking or padlocking feature)
High short-circuit rating: up to 50 kA @ 600 V AC	<b>Current limiter module</b> 2	Extension with plug-in extension shaft
UL listed, CSA certified, in conformity with IEC/EN 60 947, IEC/EN 947-4-1 rated for Type 1 coordination, CE marked	Increases short-circuit current rating of PKZM0	Black, or Red/Yellow for Emergency-stop function
→ page 08/008	Fuseless current-limiting set of contacts housed in a module	→ page 08/017
<b>Magnetic motor protector combination with high-capacity contactor</b> 9	Mounts directly beneath or ahead of the PKZM0	
Thermal-magnetic motor protector (1) combined with the high-capacity magnetic contactor module (5) on a clip plate, suitable for DIN rail mounting (EN 50 022).	→ page 08/012	
Max. rating: 7½ HP @ 460 V AC, 10 HP @ 575 V AC	<b>Auxiliary contacts</b> 3	
UL listed for group installations per NEC 430-53, CSA certified for group installations per CEC part 1, 28-206	Signals ON/OFF status of PKZM0 motor protector and motor protector+contactor combination	
High short-circuit rating: up to 50 kA @ 600 V AC	Trip indicating contacts which differentiate between overload and short-circuit tripping	
UL listed, CSA certified, in conformity with IEC/EN 60 947, IEC/EN 947-4-1 rated for Type 2 coordination, CE marked	Early-make contacts for use with undervoltage trips	
→ page 08/008	→ page 08/010	
	<b>Voltage trips</b> 7	
	Undervoltage trips	
	Shunt trips	
	→ page 08/012	

### System PKZO Overview of Combinations

Enclosures			Modules			
Type	Type	Degree of protection	Standard auxiliary contacts NHI11-PKZO NHI21-PKZO NHI12-PKZO	Integrated standard auxiliary contacts NHI-E-11-PKZO NHI-E-10-PKZO	Early-make auxiliary contact VHI20-PKZO	Trip indicating contacts AGM2-10-PKZO AGM2-01-PKZO
<b>Manual motor protector</b>						
PKZM0-...(T)	-	IP 20	●	●	●	●
<b>Insulating enclosure for flush mounting</b>						
E-PKZO	-	Front IP 40 UL/NEMA/CSA 1	●	-	-	-
E-PKZO-G(R)	-	Front IP 55 UL/NEMA/CSA 1, 12, 3R	●	●	-	●
<b>Insulating enclosure for surface mounting</b>						
CI-PKZO	-	IP 40 UL/NEMA/CSA 1	●	-	-	-
CI-PKZO-G(R)	-	IP 55 UL/NEMA/CSA 1, 12, 3R	●	●	-	●
CI-PKZO-G(R)V	-	IP 55 UL/NEMA/CSA 1, 12, 3R	-	-	●	-
<b>Motor protector combinations</b>						
PKZM0-.../S(E)00	-	IP 20	●	●	●	●
<b>Insulated enclosure for surface mounting</b>						
CI23X-125-NA	-	IP 65	●	●	●	●

Notes: The possible combinations of motor protectors or (high-capacity) motor protector combinations with enclosures or modules are indicated by ●.

### System PKZO Overview of Combinations

Type	Standard auxiliary contact for motor protector combinations NH12-11S-PKZO	(High-capacity) contactor modules SE00-...PKZO S00-...PKZO	Undervoltage trip U-PKZO	Shunt trip A-PKZO	Door coupling handle H-PKZO RH-PKZO HSOV-PKZO	Indicating light L-PKZO
PKZM0-...(T)	-	● <sup>1)</sup>	●	●	●	-
E-PKZO	-	-	-	-	-	●
E-PKZO-G(R)	-	-	●	●	-	●
CI-PKZO	-	-	-	-	-	●
CI-PKZO-G(R)	-	-	●	●	-	●
CI-PKZO-G(R)V	-	-	●	-	-	●
PKZM0-.../S(E)00	-	-	●	●	●	-
CI23X-125-NA	-	-	●	●	● IP 65 ● IP 65	●

<sup>1)</sup> Transformer protecting devices cannot be combined with high capacity compact module.

**System PKZO**  
Manual Motor Protectors

UL / CSA / IEC / CE

UL/CSA Short-circuit current rating @ 600 V AC	Max. listed branch circuit protective fuse	Max. listed branch circuit protective breaker	Adjustable thermal range	Response current of magnetic trips	UL/CSA 3-phase HP ratings						
					200 V HP	230 V HP	460 V HP	575 V HP			
kA	A	A	A	A							
<b>Manual motor protectors <sup>1)</sup>, Type „1” and „2” coordination</b>											
50	600	600	0,1 – 0,16	2,2	In this range, select motor protector in accordance with the motor nameplate full load current						
			0,16 – 0,25	3,5							
			0,25 – 0,4	5,6							
			0,4 – 0,63	8,8							
			0,63 – 1	14							
								½	½		
						1 – 1,6	22		¾	1	
						1,6 – 2,5	35	½	½	1	1 ½
						2,5 – 4	56	1	1	2	3
						4 – 6,3	88	1 ½	1 ½	3	5
22 <sup>2)</sup>	150	125	6,3 – 10	140	3	3	7 ½	10			
10 <sup>2)</sup>			10 – 16	224	3	5	10	10			
			16 – 20	280	5	5	10	15			
			20 – 25	350	5	7 ½	15	20			

**Manual motor protectors <sup>1)</sup>**

for more inductive loads - higher inrush currents

UL/CSA Short-circuit current rating @ 600 V AC	Max. listed branch circuit protective fuse	Max. listed branch circuit protective breaker	Adjustable thermal range	Response current of magnetic trips	UL/CSA 3-phase HP ratings						
					200 V HP	230 V HP	460 V HP	575 V HP			
kA	A	A	A	A							
<b>Manual motor protectors <sup>1)</sup></b>											
50	600	600	0,1 – 0,16	2,4	In this range, select motor protector in accordance with the motor nameplate full load current						
			0,16 – 0,25	4,25							
			0,25 – 0,4	6,8							
			0,4 – 0,63	11,97							
			0,63 – 1	20							
								½	½		
						1 – 1,6	32		¾	1	
						1,6 – 2,5	50	½	½	1	1 ½
						2,5 – 4	84	1	1	2	3
						4 – 6,3	141	1 ½	1 ½	3	5
22 <sup>2)</sup>	150	125	6,3 – 10	224	3	3	7 ½	10			
10 <sup>2)</sup>			10 – 16	358	3	5	10	10			
			16 – 20	380	5	5	10	15			

**Notes**

- <sup>1)</sup> World market device IEC Δ UL/CSA
- <sup>2)</sup> Higher short-circuit ratings can be obtained by use of the CL-PKZO accessory
  - PKZM 0...+CL-PKZO: 50 kA @ 600 V AC, for 10A and 16A models
  - PKZM 0...+CL-PKZO: 18 kA @ 600 V AC, for 20A and 25A models

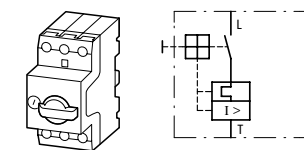
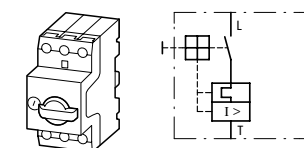

**System PKZO**  
Manual Motor Protectors

UL / CSA / IEC / CE

Type	List Price
Article No.	see price list

PKZM0-0,16 072730
PKZM0-0,25 072731
PKZM0-0,4 072732
PKZM0-0,63 072733
PKZM0-1 072734
PKZM0-1,6 072735
PKZM0-2,5 072736
PKZM0-4 072737
PKZM0-6,3 072738
PKZM0-10 072739
PKZM0-16 046938
PKZM0-20 046988
PKZM0-25 046989
PKZM0-0,16-T 088907
PKZM0-0,25-T 088908
PKZM0-0,4-T 088909
PKZM0-0,63-T 088910
PKZM0-1-T 088911
PKZM0-1,6-T 088912
PKZM0-2,5-T 088913
PKZM0-4-T 088914
PKZM0-6,3-T 088915
PKZM0-10-T 088916
PKZM0-16-T 088917
PKZM0-20-T 088918

The PKZM 0...(-T) is a 3-phase thermal magnetic motor protective device incorporating adjustable bimetal trips for motor overload protection and magnetic trips to de-energize the motor circuit in case of a short-circuit. The PKZM 0...-T has its magnetic trip set at a higher response level to provide better protection against nuisance tripping in circuits with higher current inrush ratings, e.g. in circuits employing control circuit transformers. The PKZM 0... and PKZM 0...-T are UL listed and CSA certified as HP rated motor controllers which provide motor running overload protection. In addition, they are UL listed and CSA certified for group applications as per NEC 430-53(c) and CEC part 1, Rule 28-206. This means that a group of motors, each protected and controlled by a PKZM 0...(-T) can be combined under a single branch circuit short circuit and ground fault protective device, the maximum rating of which is marked on each PKZM 0 motor protector.

**PKZM0 motor protectors in group motor applications:**  
PKZM0 motor protectors are UL listed and CSA certified for group applications as per the intent of NEC 430-53 and CEC part 1, rule 28-206. This eliminates the need for individual motor branch circuit overcurrent protective devices for each motor, thus greatly reducing the cost and space requirements of industrial control panels and assemblies.  
In group installations involving a number of PKZM0 motor protectors, the maximum rating of the group branch circuit overcurrent protective device is based on the lowest backup overcurrent rating marked on each motor in the group, combined with applicable NEC/CEC installation rules.

**Notes:**

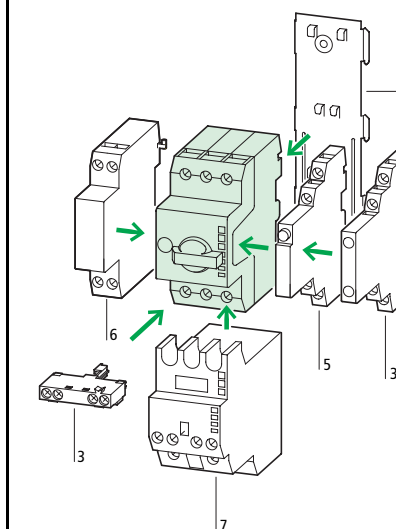

Accessories	Page
3 Standard auxiliary contact	08/010
5 Trip indicating auxiliary contact	08/010
6 Shunt trip, undervoltage trip	08/012
7 Magnetic contactor module *	08/014
8 Clip plate	08/017
Additional accessories	08/017
Rated ultimate short-circuit breaking capacity	08/055

**Features:**

- Ratings: 25A, 600 V AC - 15 Hp @ 460 V, 20 Hp @ 575 V max.
- Phase failure sensitive and ambient compensated
- Adjustable thermal trips set to motor FLC or nameplate current
- Fixed instantaneous magnetic trip response
- Open or door mounted handle, padlockable, with 3 position indication (ON/OFF/Tripped)
- Finger-safe construction
- 35 mm DIN rail or panel mounting

\* Note: The PKZM0...-T cannot be combined with the high-capacity contactor module



## System PKZ 0 Magnetic Motor Protector Combinations Type PKZM 0-.../S(E)00

UL / CSA / IEC / CE

UL/CSA Short-circuit current rating RMS sym @ 600 V AC	Max. listed branch circuit protective fuse	Max. listed branch circuit protective breaker	Adjustable thermal range	Response current of magnetic trips	UL/CSA 3-phase HP ratings for single phase rating and IEC kW ratings, see pages 08/054 and 08/056			
kA	A	A	A	A	200 V HP	230 V HP	460 V HP	575 V HP

### Magnetic motor protector combination <sup>1)</sup>

UL/CSA group installations; IEC/EN 60 947-4-1 "Type 1" coordination level

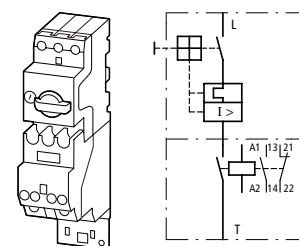

50	600	600	0,1 – 0,16	2,2	In this range select motor protector in accordance with the motor nameplate full load current			
			0,16 – 0,25	3,5				
			0,25 – 0,4	5,6				
			0,4 – 0,63	8,8				
			0,63 – 1	14		1/2	1/2	
			1 – 1,6	22		3/4	1	
			1,6 – 2,5	35	1/2	1/2	1	1 1/2
			2,5 – 4	56	1	1	2	3
			4 – 6,3	88	1 1/2	1 1/2	3	5
22	150	125	6,3 – 10	140	2	3	7 1/2	10

### Magnetic motor protector combination with high capacity contactor

UL/CSA group installations; IEC/EN 60 947-4-1 "Type 2" coordination level

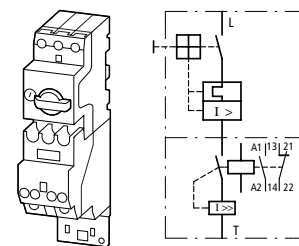

50	600	600	0,1 – 0,16	2,2	In this range select motor protector in accordance with the motor nameplate full load current			
			0,16 – 0,25	3,5				
			0,25 – 0,4	5,6				
			0,4 – 0,63	8,8				
			0,63 – 1	14		1/2	1/2	
			1 – 1,6	22		3/4	1	
			1,6 – 2,5	35	1/2	1/2	1	1 1/2
			2,5 – 4	56	1	1	2	3
			4 – 6,3	88	1 1/2	1 1/2	3	5
22	150	125	6,3 – 10	140	2	3	7 1/2	10

**Notes**

<sup>1)</sup> World market device IEC  $\Delta$  UL/CSA

## System PKZ 0 Magnetic Motor Protector Combinations Type PKZM 0-.../S(E)00

UL / CSA / IEC / CE

Type Article No.	List Price
	see price list

Coil voltages shown in ( )  
For other coil voltages,  
→ page 08/043

<b>PKZM0-0,16/SE00-11(120V60HZ)</b> 050283	
<b>PKZM0-0,25/SE00-11(120V60HZ)</b> 050651	
<b>PKZM0-0,4/SE00-11(120V60HZ)</b> 052338	
<b>PKZM0-0,63/SE00-11(120V60HZ)</b> 053007	
<b>PKZM0-1/SE00-11(120V60HZ)</b> 053346	
<b>PKZM0-1,6/SE00-11(120V60HZ)</b> 053436	
<b>PKZM0-2,5/SE00-11(120V60HZ)</b> 053445	
<b>PKZM0-4/SE00-11(120V60HZ)</b> 053454	
<b>PKZM0-6,3/SE00-11(120V60HZ)</b> 053463	
<b>PKZM0-10/SE00-11(120V60HZ)</b> 058790	

The PKZM 0-.../SE00 and PKZM 0-.../S00 are motor protector combinations made up of PKZM 0-... manual motor protectors and S(E)00 magnetic contactors.

These motor protector combinations are UL listed and CSA certified as assemblies which provide motor controller functions and running overload protection.

Group motor applications: PKZM0-.../S(E)00 motor protector combinations are UL listed and CSA certified for group applications as per the intent of NEC 430-53 and CEC part 1, rule 28-206. This eliminates the need for individual motor branch circuit overcurrent protective devices for each motor, thus greatly reducing the cost and space requirements of industrial control panels and assemblies.

In group installations involving a number of PKZM0 motor protectors, the maximum rating of the group branch circuit overcurrent protective device is based on the lowest backup overcurrent rating marked on each motor in the group, combined with applicable NEC/CEC installation rules.

PKZM0-.../SE00 motor protector combinations are in conformity with Type 1 co-ordination levels at up to 500 V AC, per IEC/EN 60 947-4-1.

PKZM0-.../S00 motor protector combinations are in conformity with Type 2 co-ordination levels at up to 500 V AC, per IEC/EN 60 947-4-1. Further, during UL/CSA short-circuit testing of this combination, no heater burn-out or contact welding occurred.

<b>PKZM0-0,16/S00-11(120V60HZ)</b> 044517	
<b>PKZM0-0,25/S00-11(120V60HZ)</b> 044526	
<b>PKZM0-0,4/S00-11(120V60HZ)</b> 044535	
<b>PKZM0-0,63/S00-11(120V60HZ)</b> 044544	
<b>PKZM0-1/S00-11(120V60HZ)</b> 044553	
<b>PKZM0-1,6/S00-11(120V60HZ)</b> 044562	
<b>PKZM0-2,5/S00-11(120V60HZ)</b> 044571	
<b>PKZM0-4/S00-11(120V60HZ)</b> 044580	
<b>PKZM0-6,3/S00-11(120V60HZ)</b> 044589	
<b>PKZM0-10/S00-11(120V60HZ)</b> 044598	

**Notes:**

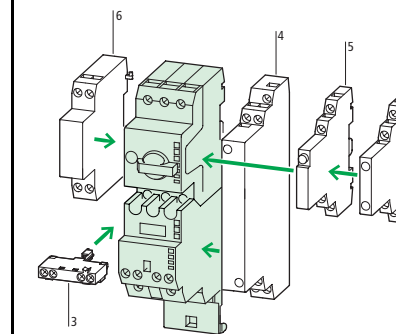

Accessories	page
3 Standard auxiliary contact	08/010
4 Standard auxiliary contact for (high capacity) motor protector combination	08/010
5 Trip-indicating auxiliary contact	08/012
6 Shunt trip, undervoltage trip	08/012
Additional accessories	08/017
Suppressors for AC	08/014

**Features:**

- Ratings: 11A, 600 V AC - 7 1/2 Hp @ 460 V 10 Hp @ 575 V max.
- Phase failure sensitive and ambient compensated
- Adjustable thermal trips set to motor FLC or nameplate current
- Fixed instantaneous magnetic trip response
- Open or door mounted handle, padlockable, with 3 position indication (ON/OFF/Tripped)
- Finger-safe construction
- Assembled on clip plate for 35 mm DIN rail or panel mounting

DC operated versions come standard with built-in surge suppressors

**Coil voltage:**

12 V DC  
24VDC  
48 V DC  
60 V DC

110 V DC  
220 V DC

**Circuit diagram:**

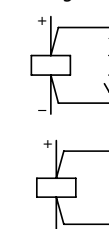

**System PKZ 0**  
Standard Auxiliary Contacts

No. of contacts	Contact sequence	Circuit diagram	Type Suffix
N.O. = normally open N.C. = normally closed N.O.    N.C.			
<b>Standard auxiliary contacts</b>			
for manual motor protectors and motor protector combinations			
1	1		<b>+NHI11-PKZ0</b> 073233
1	2		<b>+NHI12-PKZ0</b> 073234
2	1		<b>+NHI21-PKZ0</b> 073235
1	1		<b>+NHI-E-11-PKZ0</b> 082883
1	0		<b>+NHI-E-10-PKZ0</b> 082885
2	2		<b>+NHI2-115-PKZ0</b> 073236

Features two sets of contacts:

- one set actuated by motor protector
- one set actuated by contactor

**System PKZ 0**  
Standard Auxiliary Contacts

Type	List Price
Article No. when ordered separately	see price list
	<b>NHI11-PKZ0</b> 072896
	<b>NHI12-PKZ0</b> 072895
	<b>NHI21-PKZ0</b> 072894
	<b>NHI-E-11-PKZ0</b> 082882
	<b>NHI-E-10-PKZ0</b> 082884
	<b>NHI2-115-PKZ0</b> 072897

Can be mounted to the right of the motor protector and (motor protector combinations)

Can be combined with:  
AGM2-...-PKZ0 trip indicating auxiliary contact and NHI-E-...-PKZ0

Cannot be combined with NHI2-115-PKZ0 standard auxiliary contact

Can be mounted to the top of motor protectors beginning with Serial No. 01 or higher.  
45mm width of the motor protector remains unchanged

Can be mounted to the right of the motor protector combinations

Cannot be combined with standard auxiliary contacts  
NHI11-PKZ0  
NHI12-PKZ0  
NHI21-PKZ0  
trip-indicating auxiliary contact AGM2-...PKZ0

Can be combined with  
NHI-E-...

Notes

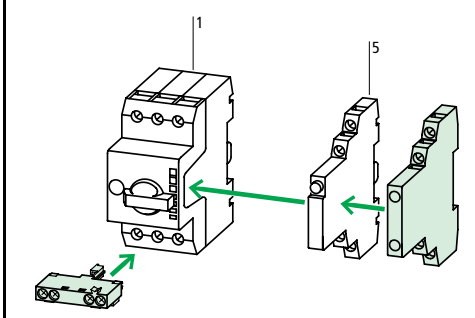

Accessories	page
1 Manual motor protector	08/006
5 Trip indicating auxiliary contact	08/012
Additional accessories	08/017

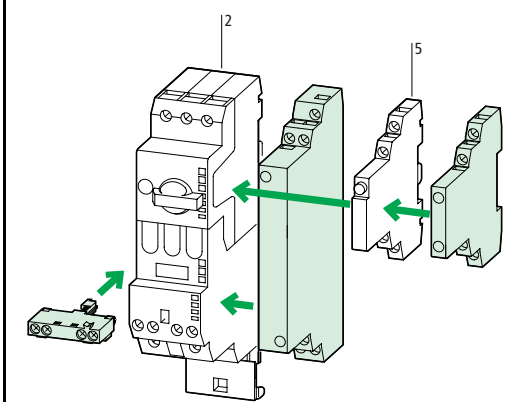

Accessories	page
2 Motor protector Motor protector combination	08/008
5 Trip indicating auxiliary contact	08/012
Additional accessories	08/017

## System PKZ 0 Auxiliary Contacts, Voltage Trips, Current Limiters

No. of contacts	Contact sequence	Circuit diagram	Type Suffix
N.O. = normally open N.C. = normally closed  N.O.    N.C.			
<b>Trip indicating auxiliary contacts</b>			
for manual motor protectors and motor protector combinations			
2 × 1	-		Differential indication: a) general trip indication (overload) b) short-circuit trip  
			<b>+AGM2-10-PKZ0</b> 073237
-	2 × 1		
			<b>+AGM2-01-PKZ0</b> 073238
<b>Early-make auxiliary contact</b>			
for manual motor protectors and motor protector combinations			
2	-		
			<b>+VHI20-PKZ0</b> 207792
<b>Shunt trips</b>			
			for AC voltage for DC voltage  
			<b>+A-PKZ0(120V60HZ)</b> 073295 <b>+A-PKZ0(24V DC)</b> 073306
<b>Undervoltage trips</b>			
			for AC voltage  Can be combined with motor protector to provide Emergency-Stop facility to VDE 0113  
			<b>+U-PKZ0(120V60HZ)</b> 073243
<b>Current limiters</b>			
Used to increase the short-circuit current ratings of PKZM0-10 and PKZM0-16 to 50 kA @ 600 V AC and PKZM0-20 and PKZM0-25 to 18 kA @ 600 V AC			
			<b>CL-PKZ0</b> 082881



## System PKZ 0 Auxiliary Contacts, Voltage Trips, Current Limiters

Type	List Price
Article No. when ordered separately Coil voltages shown in () For other coil voltages, → page 08/045	see price list
	<b>AGM2-10-PKZ0</b> 072898  Mounts to the right side of the motor protector and motor protector combination. Provides a differentiated trip signal: "+": these contacts actuate under all trip conditions. "I>": these contacts actuate only under short-circuit trip conditions. Also comes with red short-circuit trip indicator which can be reset manually.  Can be combined with auxiliary contacts: NHI11-PKZ0 NHI12-PKZ0 NHI21-PKZ0 NHI-E...  Cannot be combined with auxiliary contact NHI2-11S-PKZ0
	<b>AGM2-01-PKZ0</b> 072899
	<b>VHI20-PKZ0</b> 203595  Can be mounted to the front of motor protectors beginning with Serial No. 01 or higher 45 mm width of motor protector remains unchanged For early energization of undervoltage trip, e.g. in Emergency-Stop circuits to IEC/EN 60 204
	<b>A-PKZ0(120V60HZ)</b> 073195 <b>A-PKZ0(24V DC)</b> 073200  Can be mounted to the left of motor protector and motor protector combinations Cannot be combined with U-PKZ 0 undervoltage trip  DC: short time operation 5 s.
	<b>U-PKZ0(120V60HZ)</b> 073143  Can be mounted to the left of motor protector and motor protector combinations  Cannot be combined with A-PKZ0 shunt trip
	<b>CL-PKZ0</b> 082881  Mounts below or next to PKZM0 motor protector

Notes	
Trip indicating auxiliary contact	
Accessories	page
1 Manual motor protector	08/006
3 Standard auxiliary contacts	08/010
Additional accessories	08/017
Shunt and undervoltage trips	
Accessories	page
1 Manual motor protector	08/006
Additional accessories	08/017
Accessories	page
2 Motor protector combinations	08/008
Additional accessories	08/017
Other operating voltages	08/045

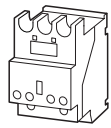
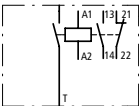
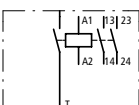
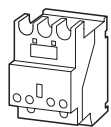
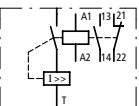
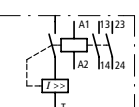
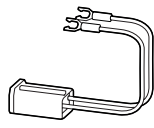
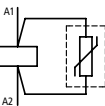
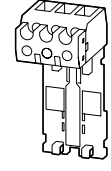

### System PKZ 0 (High Capacity) Contactor Modules, Suppressors, Auxiliary Contacts

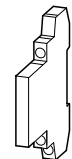
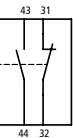
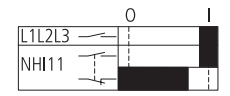
	UL/CSA max. 3-phase HP rating				Number of contacts		For use with
	200 V HP	230 V HP	460 V HP	575 V HP	N.O. = normally open N.C. = normally closed		
					N.O.	N.C.	
<b>Magnetic contactor module</b>							
AC or DC operated	2	3	5	5	1	1	PKZM0
	2	3	5	5	2	–	
	2	3	5	5	2	–	
	2	3	5	5	1	1	
<b>High capacity magnetic contactor module with current limiting contact assembly</b>							
AC or DC operated	2	3	5	5	1	1	PKZM0
	2	3	5	5	2	–	
	2	3	5	5	2	–	
	2	3	5	5	1	1	
<b>Surge suppressors for (high capacity) contactor modules in AC version</b>							
RC suppressors	24 – 48 V AC						S(E)00-...-PKZ0(...)
	110 – 250 V AC						
Varistor suppressors	24 – 48 V AC						S(E)00-...-PKZ0(...)
	110 – 250 V AC						
	380 – 415 V AC						
<b>Base for separate mounting</b>							
							S(E)00-PKZ0(...) HI11-S/EZ-PKZ0
<b>Mechanical interlock</b>							
							S(E)00-PKZ0(...)
<b>Auxiliary contact module</b>							
					1	1	
							

### System PKZ 0 (High Capacity) Contactor Modules, Suppressors, Auxiliary Contacts

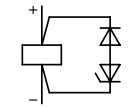
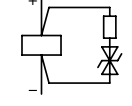
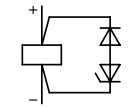
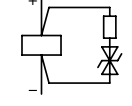
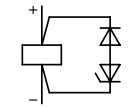
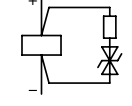



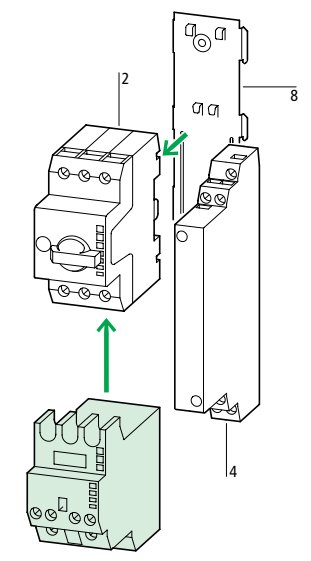

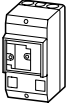
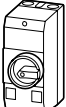

Type	List Price													
Article No.	see price list													
Coil voltages shown in ( ) For other coil voltages, → page 08/046														
<b>SE00-11-PKZ0(120V60HZ)</b> 063318		SE00 and S00 contactors are only suitable for use with PKZM0 protectors. The contactors are designed to plug into the load side of the PKZM0 motor protector to form a compact and contoured fit. A clip plate (see figure at right), onto which the combination is mounted, is a necessary part of the assembly and must be ordered separately if the motor protector combination is not purchased complete as shown on page 08/008 .  S(E)00 contactors can also be individually mounted, using the EZ-PKZ0 mounting base. Contactors so mounted can also be equipped with a side-mounted auxiliary contact module HI11-S/EZ-PKZ0 (see below),												
<b>SE00-20-PKZ0(120V60HZ)</b> 063326														
<b>SE00-20-PKZ0(24VDC)</b> 072817														
<b>SE 00-11-PKZ0(24VDC)</b> 072823														
<b>S00-11-PKZ0(120V60HZ)</b> 063335		The S00 contactor is identical to the SE00, except for the built-in current limiting contact assembly, which makes it suitable for "Type 2" coordination levels per IEC/EN 60 947 and no welding performance in combination with the PKZM0 motor protector.												
<b>S00-20-PKZ0(120V60HZ)</b> 063344														
<b>S00-20-PKZ0(24VDC)</b> 072741														
<b>S00-11-PKZ0(24VDC)</b> 072747														
<b>RCSPKZ048</b> 063976		DC rated contactor coils are supplied standard with built-in surge suppressors. Coil voltage:                      Circuit diagram:												
<b>RCSPKZ0250</b> 063975														
<b>VGSPKZ48</b> 063974		<table border="0"> <tr> <td>12 V DC</td> <td></td> </tr> <tr> <td>24 V DC</td> <td></td> </tr> <tr> <td>48 V DC</td> <td></td> </tr> <tr> <td>60 V DC</td> <td></td> </tr> <tr> <td>110 V DC</td> <td></td> </tr> <tr> <td>220 V DC</td> <td></td> </tr> </table>	12 V DC		24 V DC		48 V DC		60 V DC		110 V DC		220 V DC	
12 V DC														
24 V DC														
48 V DC														
60 V DC														
110 V DC														
220 V DC														
<b>VGSPKZ250</b> 063973														
<b>VGSPKZ415</b> 063972														
<b>EZ-PKZ0</b> 072901		SE00 and S00 contactors can be individually or separately mounted using the EZ-PKZ0 mounting base. the base can also be mounted on DIN rail (on rails of 7.5mm or 15mm heights).												
<b>MV-PKZ0</b> 072892		MV-PKZ0 is used to mechanically interlock two S(E)00 contactors, e.g. to build reversing starter combinations.												
<b>HI11-S/EZ-PKZ0</b> 072893		Cannot be combined with: PKZM0-.../S(E)00 equipped with NHI-...-PKZ0 and/or AGM-...-PKZ0.												

Notes

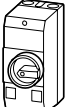
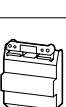

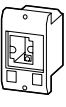



Accessories	page
2 Motor protector	08/006
4 Standard auxiliary contacts	08/010
8 Clip plate	08/017
Additional accessories	08/017
Other operating voltages	08/046



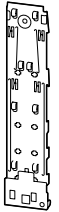





## System PKZ 0 Motor Protectors Insulated Enclosures

	Degree of protection	For use with	Type	List Price	
			Article No.	see price list	
<b>Insulated enclosures for surface mounting</b>					
for motor protectors					
	cover with opening dimensioned to accommodate front of motor protector	IP 40 UL/NEMA/ CSA 1	PKZM0-... +NHI or U or A +L-PKZO (2)	<b>CI-PKZO</b> 072903	Includes ground terminal connection, 2 PG16 cable entry knockouts, top and bottom
	with black/grey handle	IP 55 UL/NEMA/ CSA 12, 3R	PKZM0-... +NHI+NHI-E or U+NHI-E or A+NHI-E +L-PKZO (2)	<b>CI-PKZO-G</b> 072904	
	with red/yellow handle for use in Emergency-Stop circuits to VDE 0113			<b>CI-PKZO-GR</b> 072905	
for motor protector with early-make contacts					
	with black/grey handle	IP55 UL/NEMA/ CSA 12, 3R	PKZM0-... +VHI... + U... +L-PKZO (2)	<b>CI-PKZO-GV</b> 203597	Includes ground terminal connection, 2 PG16 cable entry knockouts, top and bottom
	with red/yellow handle for use in Emergency-Stop circuits to VDE 0113			<b>CI-PKZO-GRV</b> 203596	
	Padlocking assembly accommodating up to 3 padlocks with a hasp thickness of 3 - 6 mm, for use on main switches to IEC/EN 60 204		CI-PKZO-G(R)(V)	<b>SVB-PKZO-CI</b> 035129	Padlockable in the Off position of the PKZM 0 manual motor protector
For motor protector combinations					
	Door coupling handle (R)H-PKZO (IP 65, UL/NEMA/CSA 12)	IP 65 UL/NEMA/ CSA 1, 12, 13, 4X indoor	PKZM0-.../S(E)00 +NHI or NHI...S +NHI-E +U or A +R(H) +L-PKZO (2)	<b>CI23X-125-NA</b> 002209	Mounting depth 125 mm, additional M3-CI23 mounting plate required
				<b>CI23X-150-NA</b> 002212	
<b>Insulated enclosures for flush mounting</b>					
for motor protectors					
	cover with opening to accommodate front of motor protector	Front IP 40 UL/NEMA/ CSA 1	PKZM0-... +NHI or U or A +L-PKZO (2)	<b>E-PKZO</b> 072906	Includes ground terminal connection
	with black/grey rotary handle	Front IP 55	PKZM0-... +NHI+NHI-E or U+NHI-E or A+NHI-E +L-PKZO (2)	<b>E-PKZO-G</b> 072907	
	with red/yellow handle for use in Emergency-Stop circuits to VDE 0113			<b>E-PKZO-GR</b> 072908	
	padlocking accessory to accommodate up to 3 padlocks with a hasp thickness of 3 - 6 mm		E-PKZO-G(R)	<b>SVB-PKZO-E</b> 035127	Padlockable in the Off position of the PKZM 0 manual motor protector
<b>Mounting plate</b>					
	Galvanized steel thickness 3mm, including mounting screws		CI23X-125(150)-NA	<b>M3-CI23</b> 019709	
<b>Conduit adapters</b>					
	for adapting PG16 threaded cable entry to 1/2" conduit hub		Type 1, 3R, or 12 enclosures	<b>PC16X1/2"NPT</b> 105082	Ground continuity is not provided



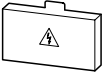
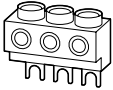

## System PKZ 0 Motor Protectors Accessories

		Type	List Price	
		Article No.	see price list	
<b>Clip plate</b>				
	Standard version	<b>C-PKZ0</b> 072900	One of the clip plates is always necessary when combining a PKZM0 manual motor protector and a S(E)00 magnetic contactor to create a magnetic motor protector combination.  Can be either panel mounted with screws or DIN rail mounted using one 15mm height rail or two 7.5mm height rails. DIN rails must conform to EN 50 022-35.	
	Short version	<b>C-PKZ0-K</b> 206740		
<b>Door coupling handles UL/NEMA 12, IP 65</b>				
	For use as main switch. Door/cover interlocked when switch is in the ON position. Color: black.	<b>H-PKZ0</b> 056320	3 positions: ON/OFF/+ (tripped). Lockable in the Off position using 3 padlocks (hasp thickness 4 - 8 mm). Can also be modified to be lockable in the ON position.	
	For use as main switch in MCC to VDE 0113, with PKZM 0 turned 90°, Color: black	<b>H-PKZ0-MCC</b> 201454		
	For use as main switch with Emergency-Stop function. Door/cover interlocking feature. Color: red/yellow	<b>RH-PKZ0</b> 056321	3 positions: ON/OFF/+ (tripped). Lockable in the Off position using 3 padlocks (hasp thickness 4 - 8 mm).	
	For use as main switch with Emergency-Stop function in MCC to VDE 0113, with PKZM 0 turned 90°. Color: red/yellow	<b>RH-PKZ0-MCC</b> 201455		
Simpler mechanism without any door/cover interlocking or padlocking capability. Color: black, with On/Off and "+" (Tripped) switch position.	<b>HSOV-PKZ0</b> 203598	Plug-in extension shaft A-H-PKZ0 supplied with all door coupling handles. The extension shaft can be cut to any required length to accommodate mounting depths of 100-240mm.		
<b>Padlockable knob handle</b>				
	Replaces standard PKZM0 knob handle with a padlockable version. Padlockable in the OFF position.	<b>AK-PKZ0</b> 030851	Accommodates 1/4" (3-6.35mm) padlocks.	
<b>Tamper-sealing cover</b>				
	To prevent unauthorized access to the motor FLC thermal trip dial setting and the test-to-trip function.	<b>PL-PKZ0</b> 203599	Uses conventional lead seal	
<b>Indicating lights with neon bulb</b>				
for CI23X-..., CI-PKZ0-..., E-PKZ0-...				
	Color white	Voltages	110 – 230 V	<b>L-PKZ0(230V)</b> 082151
			230 – 400 V	<b>L-PKZ0(400V)</b> 082152
			415 – 500 V	<b>L-PKZ0(500V)</b> 082153
			500 – 600 V	<b>L-PKZ0(600V)</b> 208112
	Color green	Voltages	110 – 230 V	<b>L-PKZ0-GN(230V)</b> 082154
			230 – 400 V	<b>L-PKZ0-GN(400V)</b> 082155
			415 – 500 V	<b>L-PKZ0-GN(500V)</b> 082156
			500 – 600 V	<b>L-PKZ0-GN(600V)</b> 208113
	Color red	Voltages	110 – 230 V	<b>L-PKZ0-RT(230V)</b> 082157
			230 – 400 V	<b>L-PKZ0-RT(400V)</b> 082158
			415 – 500 V	<b>L-PKZ0-RT(500V)</b> 082159
			500 – 600 V	<b>L-PKZ0-RT(600V)</b> 208114

## System PKZ 0 Motor Protectors Wiring Accessories

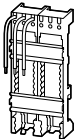
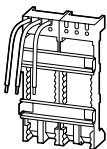
	Number of motor protectors	Length mm	Unit width available per motor protector mm	Type Article No.	List Price see price list
<b>Three-phase feeder bus connector</b>					
Finger-safe Reduces mounting space and wiring time by eliminating daisy-chain wiring; can be joined to accommodate more units.					
For motor protector and motor protector combinations without side mounted auxiliary contacts or voltage trips					
	2	90	45	<b>B3.0/2-PKZO</b> 063961	
	4	180	45	<b>B3.0/4-PKZO</b> 063960	
For motor protectors and motor protector combinations each with one side mounted auxiliary contact or trip-indicating contact module, mounted on the right					
	2	99	45 + 9	<b>B3.1/2-PKZO</b> 044945	
	3	153	45 + 9	<b>B3.1/3-PKZO</b> 044946	
	4	207	45 + 9	<b>B3.1/4-PKZO</b> 044947	
	5	261	45 + 9	<b>B3.1/5-PKZO</b> 044948	
For motor protector and motor protector combinations each having one auxiliary contact and trip-indicating auxiliary contact module mounted on the right, or a voltage trip mounted on the left, or for motor protector combinations having a long NHI2-11S-PKZO standard auxiliary contact mounted on the right					
	2	108	45 + 18	<b>B3.2/2-PKZO</b> 063963	
	4	234	45 + 18	<b>B3.2/4-PKZO</b> 063959	
<b>Protective shroud for unused terminals</b>					
	Finger-safe covers which slip over unused terminals of a three-phase feeder bus connector to protect against accidental contact			<b>H-B3-PKZO</b> 032721	
<b>Connector feeder terminal</b>					
	Incoming supply terminal to feed bus connectors, finger-safe design, maximum ampacity: 63 A Permissible conductor range: AWG 10...4, Cu only			<b>BK25/3-PKZO</b> 032720	

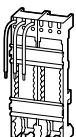
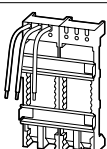

## System PKZ 0 Motor Protectors Accessories

For use with	Maximum rated current	Adapter supply leads	Adapter width	Type	List Price	
	Amps	AWG	mm	Article No.	see price list	
<b>Control panel bus adapter, 3-pole</b>						
For mounting in industrial control panels on CU 20 x 5 mm busbar arrangements with 60 mm phase separation.						
	PKZM 0-... or PKZM 0-.../S(E)00 + AGM or NHI	25	10	54	<b>AD25/5-1</b> 025395	The back of the adapter connects onto the bus. Components are mounted on top of the adapter and wired to the supply leads. All assembly is done under de-energized (Power OFF) conditions.
	2 x PKZM 0-... or 2 x PKZM 0-.../S(E)00 + AGM or NHI, or 1 x PKZM 0-... + 2 x EZ-PK Z0 + MV-PKZ 0	25	10	108	<b>AD25/5-2</b> 025397	
	2 x PKZM 0-... or 2 x PKZM 0-.../S(E)00 + AGM or NHI, or 1 x PKZM 0-... + 2 x EZ-PK Z0 + MV-PKZ 0 + AGM or NHI	25	10	144	<b>AD25/5-144</b> 025399	
For mounting in industrial control panels on CU 30 x 10 and 20 x 10 mm busbar arrangements with 60 mm phase separation.						
	PKZM 0-... or PKZM 0-.../S(E)00 + AGM or NHI	25	10	54	<b>AD25/10-1</b> 025396	The back of the adapter connects onto the bus. Components are mounted on top of the adapter and wired to the supply leads. All assembly is done under de-energized (Power OFF) conditions.
	2 x PKZM 0-... or 2 x PKZM 0-.../S(E)00 + AGM or NHI, or 1 x PKZM 0-... + 2 x EZ-PK Z0 + MV-PKZ 0	25	10	108	<b>AD25/10-2</b> 025398	
	2 x PKZM 0-... or 2 x PKZM 0-.../S(E)00 + AGM or NHI, or 1 x PKZM 0-... + 2 x EZ-PK Z0 + MV-PKZ 0 + AGM or NHI	25	10	144	<b>AD25/10-144</b> 025400	
<b>Adapter extension</b>						
	–	–	9	<b>AD-E</b> 060511		Push-fit strip can be fitted onto AD... to extend mounting width

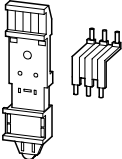
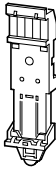
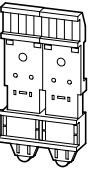
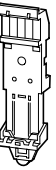

## System PKZ 0 Motor Protectors

### MVS Mounting and Wiring Accessory Kits for Motor Starter Combinations



For use with	Type	List Price
	Article No.	see price list
<b>MVS kits for full voltage non-reversing starter combinations</b>		
	PKZM0 + DILEM	<b>MVS-D0-EM</b> 220230
	PKZM0 + DIL00(A)M	<b>MVS-D5</b> 038683
	PKZM0 + DIL0(A)M	<b>MVS-D11</b> 031166
Includes mounting plate and finger-safe wiring harness to accommodate FVNR motor starter combinations consisting of PKZM 0 motor protectors and DIL ...M magnetic contactors in various HP sizes. UL listed / CSA certified for group installations and high fault short circuit current ratings (shown at bottom of this page) in association with Moeller Electric components.		
<b>Mounting plates</b>		
		<b>MVS-C45</b> 202319
		<b>MVS-C90H</b> 201491
<b>Top-hat rail adapter for motor protector combinations</b>		
	PKZ0 + S(E)00-PKZ0	<b>MVS-C45-S</b> 203204
<b>Top-hat rail extension for top-hat rail adapter</b>		
	all MVS-C...	<b>MVS-H15</b> 215554
		To allow for a wider mounting plate for reversing starters with mechanical interlock
<b>Electromechanical link between motor protector and contactor</b>		
	PKZM0+DILEM(-G)	<b>MVS-LBM0-EM</b> 220219
<b>Electrical link between motor protector and contactor</b>		
	PKZM0+DIL00(A)M(-G)	<b>MVS-LB0-00M-G</b> 226149
	PKZM0+DIL0(A)M(-G)	<b>MVS-LB0-0M-G</b> 226150
		Flexible link between PKZM0 and DILM contactor MVS-LB0-00M-G: AWG 12, length 110 mm MVS-LB0-0M-G: AWG 10, length 120 mm

#### UL/CSA Short-circuit Current / NEC Group protection ratings

System MVS used in association with PKZM0 motor protectors, DILM magnetic contactors and listed branch circuit overcurrent protective devices

	RMS Short-circuit current rating @ 600 V AC	Listed group protection back-up device	
	kA	Fuse	Breaker
PKZM0-6.3 + DILM + MVS	50	600 A	600 A
PKZM0-10 + DILM + MVS	22	150 A	125 A
PKZM0-16(20)(25) + DILM + MVS	10	150 A	125 A

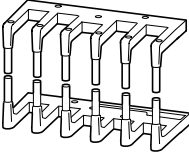
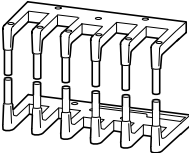
## System PKZ 0 Motor Protectors Accessories

For use with	Type Article No.	List price see price list	Notes
<b>Reversing starter wiring kits</b>			
	DILEM (+MVDILEM) DIULEM	<b>MVS-WB-EM</b> 220209	Consisting of a 3-pole paralleling link and a 3-pole reversing link with a bridge for terminal A2 on MVS-WB-EM.
	DILO0(A)M DIUL00(A)M	<b>MVS-WB-00M</b> 220210	
	DILO0(A)M+MVDILM DIUL00(A)M/MV	<b>MVS-WB5MV</b> 215512	For reversing starters with mechanical interlock (type MVS-...MV), an additional extension with MVS-H15 is required. Not required for DILEM starters.
	DILO(A)M DIULO(A)M	<b>MVS-WB-0M</b> 220211	
	DIULO(A)M+MVDILM DIULO(A)M/MV	<b>MVS-WB11MV</b> 216344	
	DIL1(A)M DIUL1(A)M	<b>MVS-WB-1M</b> 220212	
	<b>Star-delta wiring kits</b>		
 	DILEM	<b>MVS-SB-EM</b> 220213	Consisting of a 3-pole paralleling link, a 3-pole reversing link and a star-point bridge. On MVS-SB-EM reversing link with additional bridge for terminal A2 and paralleling link with interlocking of star contactor / delta contactor.
	DILO0M	<b>MVS-SB-00M</b> 220214	
	DILOM/DILO0M	<b>MVS-SB-0M</b> 220215	
	DILOAM/DILOM	<b>MVS-SB-0AM</b> 220216	
	DIL1AM/DILOM	<b>MVS-SB-1M</b> 220217	
	Mains contactor	Delta contactor	Star contactor
	DILEM	DILEM	DILEM
	DILO0AM	DILO0AM	DILO0AM
	DILOM	DILOM	DILO0M
	DILOAM	DILOAM	DILOM
	DIL1M	DIL1M	DILOM

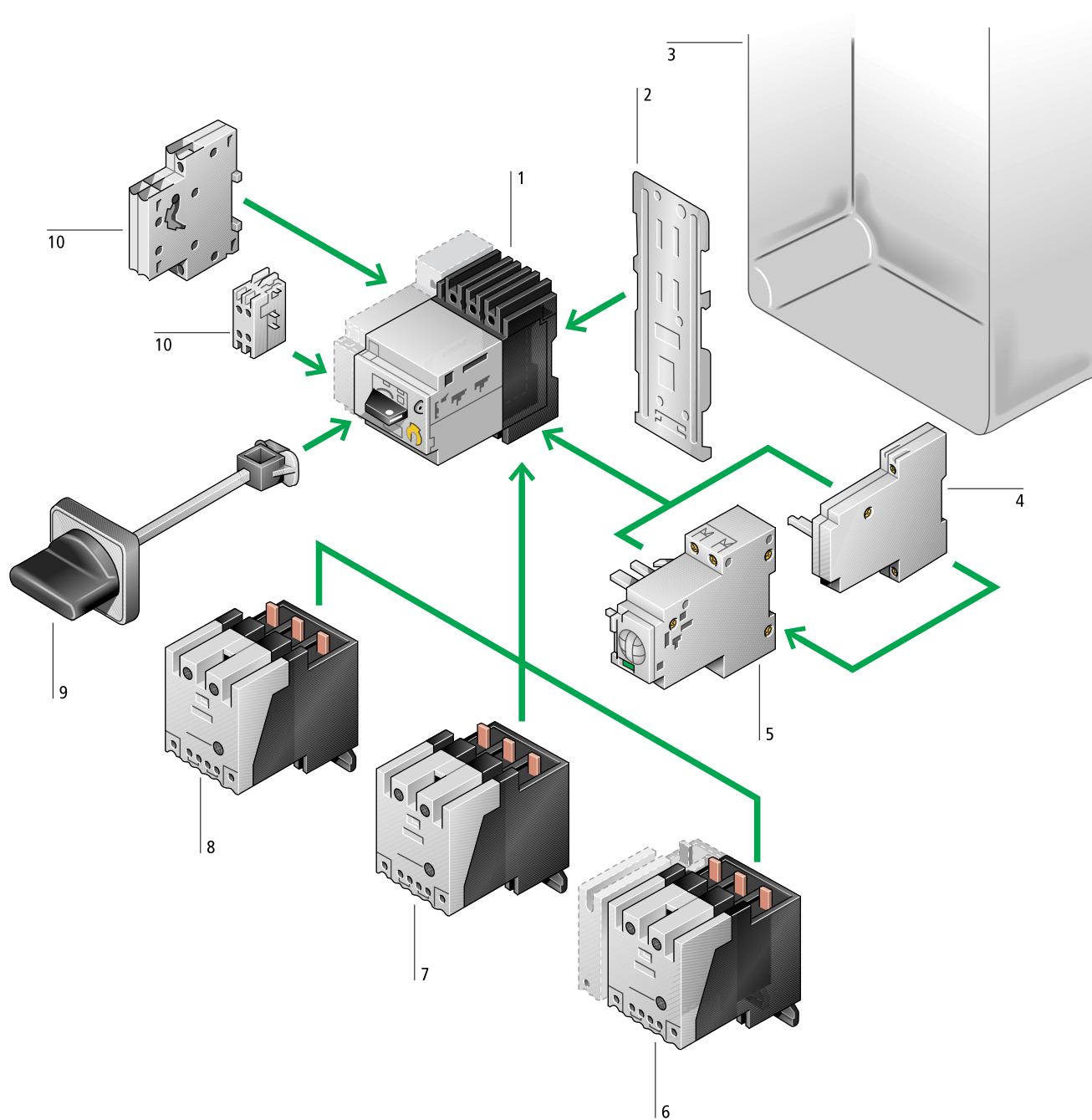



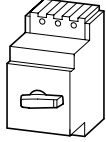
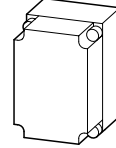
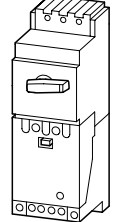
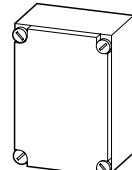

## System PKZ 2 Motor Protectors Overview of Combinations

Enclosure		Modules				
Type	Type	Degree of protection	Standard auxiliary contacts	Standard auxiliary contacts	Trip-indicating auxiliary contact	
			NHI11-PKZ2 NHI22-PKZ2	NHI11 S-PKZ2 NHI22 S-PKZ2 NHI2-11 S-PKZ2	AGM2-11-PKZ2	
<b>Manual motor protector</b>						
 without contactor	PKZ2/ZM-...	–	●	–	●	
	<b>Steel enclosure for surface mounting</b>					
	CS3-PKZ2	Type 1 General purpose	●	–	●	
<b>Insulated enclosure for surface mounting</b>		Type 12				
 CI19EE-PKZ2-NA		IP 40	●	–	●	
<b>Motor protector combination</b>						
	PKZ2/ZM-.../S	–	● or	●	●	
	<b>Insulated enclosure for surface mounting</b>					
	 CI43X-150-PKZ2-SP		Type 12 Dusttight industrial use	● or	● or	●
	<b>Steel enclosures for surface mounting</b>					
	GKP23-PKZ2		Type 1 General purpose	–	–	–
GK23-PKZ2		Type 12 Dusttight industrial use	● or	● or	●	

**Notes** The possible combinations of motor protectors or motor protector combinations with enclosures or modules are indicated by ●.

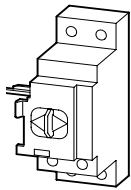
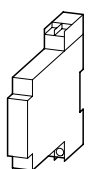
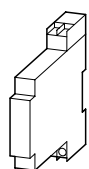
## System PKZ 2 Motor Protectors Overview of Combinations

Remote drive	Undervoltage trip	Shunt trip	Door mouting handle
 RE-PKZ2 RS-PKZ2	 U-PKZ2 UVHI-PKZ2	 U-HI20-PKZ2	 A-PKZ2 H-PKZ2 RH-PKZ2
●	● or	● or	–
● or	● or	● or	–
–	● or	● or	●
●	● or	● or	–
–	● or	● or	●
●	● or	–	–
●	● or	● or	–



UL/CSA Short-circuit current rating kA RMS sym @		Max. listed branch circuit protective fuse	Max. listed branch circuit protective breaker	Adjustable thermal range set to motor FLC	Adjustable trip setting current of magnetic trips	UL/CSA max. 3-phase HP ratings			
480 V AC	600 V AC					For single phase ratings and IEC kW rating, → page 08/065			
		A	A	A	A	200 V HP	230 V HP	460 V HP	575 V HP

Manual motor protector

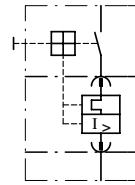
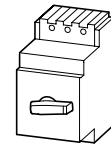

65	42	500	600	0,4 – 0,6	5 – 8	In this range, select motor protector in accordance with the motor nameplate full load current			
				0,6 – 1	8 – 14		1/2	1/2	
				1 – 1,6	14 – 22		3/4	1	
				1,6 – 2,4	20 – 35	1/2	1/2	1	1 1/2
				2,4 – 4	35 – 55	1	1	2	3
				4 – 6	50 – 80	1 1/2	1 1/2	3	5
				6 – 10	80 – 140	2	3	5	7 1/2
				10 – 16	130 – 220	3	5	10	10
				16 – 27	200 – 350	7 1/2	7 1/2	20	25
				24 – 32	275 – 425	10	10	20	30
				32 – 42	350 – 500	10	15	30	30

Magnetic motor protector combination with high capacity contactor

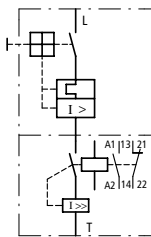
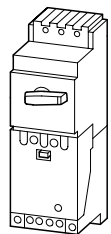

65	42	2000	2000	0,4 – 0,6	5 – 8	In this range, select motor protector in accordance with the motor nameplate full load current			
				0,6 – 1	8 – 14		1/2	1/2	
				1 – 1,6	14 – 22		3/4	1	
				1,6 – 2,4	20 – 35	1/2	1/2	1	1 1/2
				2,4 – 4	35 – 55	1	1	2	3
				4 – 6	50 – 80	1 1/2	1 1/2	3	5
				6 – 10	80 – 140	2	3	5	7 1/2
				10 – 16	130 – 220	3	5	10	10
				16 – 27	200 – 350	7 1/2	7 1/2	20	25
				24 – 32	275 – 425	10	10	20	30
				32 – 42	350 – 500	10	15	30	30

Type	List Price
Article No.	see price list
Coil voltages shown in ( )	
For other coil voltages, → page 08/047	

<b>PKZ2/ZM-0,6</b> 021859	
<b>PKZ2/ZM-1</b> 026605	
<b>PKZ2/ZM-1,6</b> 028978	
<b>PKZ2/ZM-2,4</b> 031351	
<b>PKZ2/ZM-4</b> 033724	
<b>PKZ2/ZM-6</b> 036097	
<b>PKZ2/ZM-10</b> 038470	
<b>PKZ2/ZM-16</b> 040843	
<b>PKZ2/ZM-25</b> 043216	
<b>PKZ2/ZM-32</b> 045589	
<b>PKZ2/ZM-40</b> 047962	

<b>PKZ2/ZM-0,6/S(120V60HZ)</b> 063460	
<b>PKZ2/ZM-1/S(120V60HZ)</b> 063470	
<b>PKZ2/ZM-1,6/S(120V60HZ)</b> 063480	
<b>PKZ2/ZM-2,4/S(120V60HZ)</b> 063490	
<b>PKZ2/ZM-4/S(120V60HZ)</b> 063500	
<b>PKZ2/ZM-6/S(120V60HZ)</b> 063510	
<b>PKZ2/ZM-10/S(120V60HZ)</b> 063520	
<b>PKZ2/ZM-16/S(120V60HZ)</b> 063530	
<b>PKZ2/ZM-25/S(120V60HZ)</b> 063540	
<b>PKZ2/ZM-32/S(120V60HZ)</b> 063550	
<b>PKZ2/ZM-40/S(120V60HZ)</b> 063560	

The PKZ2/ZM-... is a 3-phase thermal magnetic motor protective device incorporating adjustable bimetal trips for motor overload protection and magnetic trips to de-energize the motor circuit in case of a short-circuit.

The PKZ2/ZM-.../S is a combination of the PKZ2/ZM-... manual motor protector and the S-PKZ2 high-capacity magnetic contactor.

Both devices are UL listed and CSA certified as HP rated motor controllers which provide motor running overload protection. In addition, they are UL listed and CSA certified for group applications as per NEC 430-53(c) and CEC part 1, rule 28-206. This eliminates the need for individual motor branch circuit overcurrent protective devices for each motor, thus greatly reducing the cost and space requirements of industrial control panels and assemblies. This means that a group of motors, each protected and controlled by a PKZ2/ZM-.../S can be combined under a single branch circuit short-circuit and ground fault protective device, the maximum rating of which is marked on each PKZ2 motor protector.

In group installations involving a number of System PKZ 2 motor protectors, the maximum rating of the group branch circuit overcurrent protective device is based on the lowest backup overcurrent rating marked on each motor protector in the group, combined with applicable NEC/CEC installation rules.

Notes

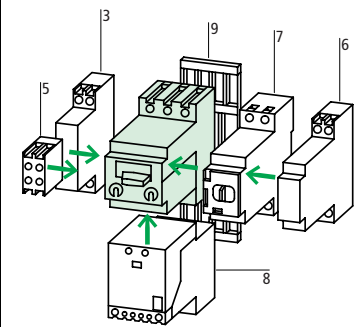

Accessories	Page
3 Standard auxiliary contact	08/030
5 Trip indicating contact	08/030
6 Shunt trip Undervoltage trip	08/032
7 Remote control operator	08/034
8 High-capacity contactor module	08/036
9 Clip plate	08/041
Other accessories	08/041

Features:

- Ratings: 42A, 600 VAC, 30HP/460V, 30HP/575V max.
- Conformity to IEC/EN 60 947 type 2 co-ordination levels
- Phase failure sensitive
- Adjustable thermal trips set to FLC. Ambient compensated.
- Adjustable magnetic trips
- Open or door mounted handle, padlockable, with 3 position indication (On - Off - Trip), see accessories
- Finger-safe construction
- 35 mm DIN rail or panel mounting

# System PKZ 2 Motor Protectors

## Motor Protectors without Trip Module

UL / CSA / IEC / CE

Manual Motor Protectors,  
Motor Protector Combinations

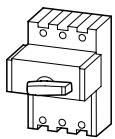
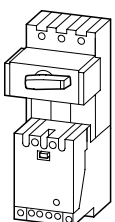
	Rated un-interrupted current	Type Article No.	List Price see price list
	A	Coil voltages shown in ( ) For other coil voltages, → page 08/048	
<b>Basic device</b>			
	42	<b>PKZ2</b> 026606	
 PKZ 2 basic unit with S-PKZ 2 high capacity contact module mounted (1 N.O., 1 N.C.) Supplied on C-PKZ2 clip plate	42	<b>PKZ2/S (120V60HZ)</b> 063570	

The PKZ 2 manual motor protector and PKZ 2/S... motor protector combination without plug-in trip modules make up one frame size rated for a maximum continuous motor load current of 42A. These devices can be stocked, or mounted and wired in a panel, without prior knowledge of motor Hp ratings. Motor overload and overcurrent protection is provided by the plug-in motor protective trip modules shown at the next page which are inserted into the slots below the handle (between the disconnect and contactor portions) and enable the motor protector to cover a motor range from fractional Hp up to 30 Hp at 460/575V AC.

Once motor loads are determined, selection of the appropriate plug-in motor protective trip module can take place. Exchanging trip modules is easy and does not require any removal of wiring or cables. Removal of the trip modules provides an additional safety benefit by creating an open circuit path to the motor. This still allows the performance of routine motor maintenance tasks and circuit function checks but effectively rules out any inadvertent energization of the motor.

**Notes**

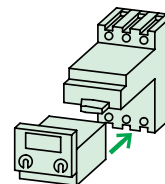

Accessories → page 08/041

**Circuit for ZM... PKZ2**

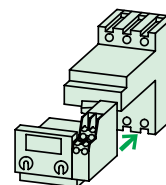
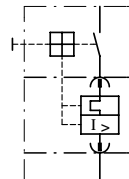

**ZMR...PKZ2**

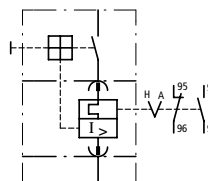

# System PKZ 2 Motor Protectors

## Motor Protective Trip Modules

UL / CSA / IEC / CE

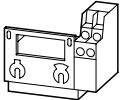
UL/CSA max. 3 phase HP rating at		Adjustable thermal range (set to motor FLC)		Setting range of adjustable magnetic trips		Type	List Price
For single phase ratings, see page 08/065 200 V 230 V 460 V 575 V						Article No.	see price list
HP	HP	HP	HP	A	A		
<b>Plug-in motor protective trip modules</b>							
with overload trip  	In this range, select motor protector in accordance with the motor name-plate FLC			0,4 – 0,6	5 – 8	<b>ZM-0,6-PKZ2</b> 024232	Standard trip modules ZM-...-PKZ2 are inserted on the load side of the motor protector disconnect handle. In case of overload or short circuit, the trip module will cause the motor protector switch mechanism to open and disconnect power to the load.  <b>Features:</b> <ul style="list-style-type: none"> <li>Adjustable thermal and magnetic trips set in accordance with the motor FLC.</li> <li>Tamper-proof lids that cover thermal and magnetic settings when the device is on.</li> <li>Ambient compensation.</li> <li>Phase failure sensitivity.</li> <li>Coding accessory to insure insertion of correct module for the motor rating</li> </ul>
	1/2	1/2	1/2	0,6 – 1	8 – 14	<b>ZM-1-PKZ2</b> 028979	
	3/4		1	1 – 1,6	14 – 22	<b>ZM-1,6-PKZ2</b> 031352	
	1/2	1/2	1	1,6 – 2,4	20 – 35	<b>ZM-2,4-PKZ2</b> 033725	
	1	1	2	2,4 – 4	35 – 55	<b>ZM-4-PKZ2</b> 036098	
	1 1/2	1 1/2	3	4 – 6	50 – 80	<b>ZM-6-PKZ2</b> 038471	
	2	3	5	6 – 10	80 – 140	<b>ZM-10-PKZ2</b> 040844	
	3	5	10	10 – 16	130 – 220	<b>ZM-16-PKZ2</b> 043217	
	7 1/2	7 1/2	20	16 – 27	200 – 350	<b>ZM-25-PKZ2</b> 045590	
	10	10	20	24 – 32	275 – 425	<b>ZM-32-PKZ2</b> 047963	
	10	15	30	32 – 42	350 – 500	<b>ZM-40-PKZ2</b> 050336	
	with overload relay function, with Hand/ Auto position  	In this range, select motor protector in accordance with the motor name-plate FLC			0,4 – 0,6	5 – 8	
1/2		1/2	1/2	0,6 – 1	8 – 14	<b>ZMR-1-PKZ2</b> 033950	
3/4			1	1 – 1,6	14 – 22	<b>ZMR-1,6-PKZ2</b> 033952	
1/2		1/2	1	1,6 – 2,4	20 – 35	<b>ZMR-2,4-PKZ2</b> 033955	
1		1	2	2,4 – 4	35 – 55	<b>ZMR-4-PKZ2</b> 033957	
1 1/2		1 1/2	3	4 – 6	50 – 80	<b>ZMR-6-PKZ2</b> 033966	
2		3	5	6 – 10	80 – 140	<b>ZMR-10-PKZ2</b> 033967	
3		5	10	10 – 16	130 – 220	<b>ZMR-16-PKZ2</b> 033968	
7 1/2		7 1/2	20	16 – 27	200 – 350	<b>ZMR-25-PKZ2</b> 033969	
10		10	20	24 – 32	275 – 425	<b>ZMR-32-PKZ2</b> 033973	
10		15	30	32 – 42	350 – 500	<b>ZMR-40-PKZ2</b> 033975	

## System PKZ 2 Motor Protectors

### Auxiliary Contacts, Trip-indicating Contacts, Trip Indicator, Current Limiter

Number of Auxiliary Contacts N.O. = normally open N.C. = normally closed N.O. N.C.	Connection Diagram	Circuit Diagram	Type
<b>Standard auxiliary contacts</b> for motor protectors and motor protector combinations			
1 1			<b>+NHI11-PKZ2</b> 093050
2 2			<b>+NHI22-PKZ2</b> 095423
<b>for motor protector combinations</b>			
1 1			<b>+NHI115-PKZ2</b> 005250
2 2			<b>+NHI225-PKZ2</b> 002877
2 x 1 2 x 1			<b>+NHI2-115-PKZ2</b> 012369
<b>Trip-indicating auxiliary contacts</b> with short-circuit indicator 2 x (1 N.O. 1 N.C.)			
			<b>+AGM2-11-PKZ2</b> 019488
<b>Short-circuit indicator</b>			
			<b>+K-AGM-PKZ2</b> 024234
<b>Current limiter</b> Fuseless, current limiting set of contacts housed in a module. Increases short-circuit current rating of PKZ 2/ZM up to 100kA/500V AC in IEC group applications. Not UL/CSA.			
			<b>+CL-PKZ2</b> 078812

## System PKZ 2 Motor Protectors

### Auxiliary Contacts, Trip-indicating Contacts, Trip Indicator, Current Limiter

Type	List Price
Article No. when ordered separately	see price list
	<b>NHI11-PKZ2</b> 090677
	<b>NHI22-PKZ2</b> 097796
	<b>NHI115-PKZ2</b> 007623
	<b>NHI225-PKZ2</b> 000504
	<b>NHI2-115-PKZ2</b> 009996
	<b>AGM2-11-PKZ2</b> 017115
	<b>K-AGM-PKZ2</b> 021861
	<b>CL-PKZ2</b> 076439

**Notes**

Standard auxiliary contacts

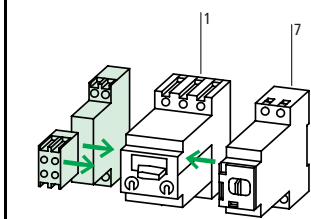

**Accessories**

	page
1 Motor protector	08/026
7 Remote drives	08/034
Other accessories	08/041

Trip-indicating auxiliary contact and short-circuit indicator

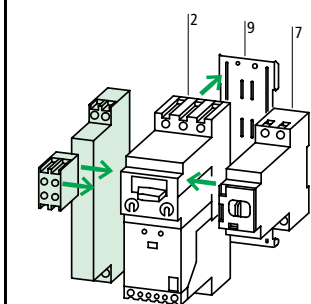

**Accessories**

	page
2 Motor protector	08/026
7 Remote drive	08/034
9 Clip plate	08/041
Other accessories	08/041

Current limiter

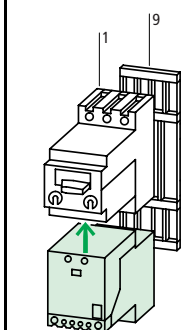

**Accessories**

	page
1 Motor protector	08/026
9 Clip plate	08/041
Other accessories	08/041

## System PKZ 2 Motor Protectors Shunt Trips, Undervoltage Trips

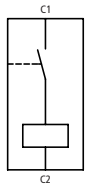
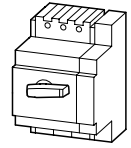
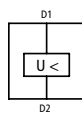
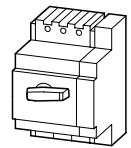
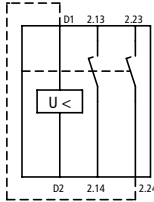
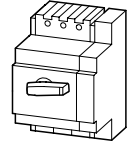
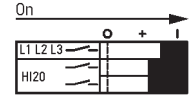
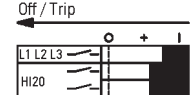
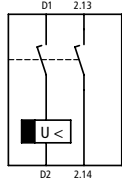
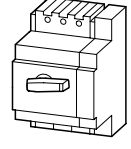
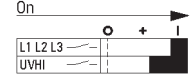
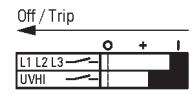
Circuit diagram	Connection diagram	Operating voltage	Type
		Voltage and frequency combinations possible with one coil in the voltage trip	Article No. When ordered with basic device  Coil voltages shown in ( )  For other coil voltages, → page 08/049
<b>Shunt trips</b>			
For AC and DC 		24 V DC    48 V DC    60 V DC 24 V 50 Hz    48 V 50 Hz 24 V 60 Hz    48 V 60 Hz	<b>+A-PKZ2-A</b> 063966
		110 V DC    125 V DC    250 V DC 110 V 50 Hz    127 V 50 Hz    220 V 50 Hz 230 V 50 Hz    240 V 50 Hz 110 V 60 Hz    120 V 60 Hz    208 V 60 Hz 220 V 60 Hz    240 V 60 Hz	<b>+A-PKZ2-B</b> 063965
		380 V 50 Hz    400 V 50 Hz    415 V 50 Hz 440 V 50 Hz    500 V 50 Hz 480 V 60 Hz    600 V 60 Hz	<b>+A-PKZ2-C</b> 063962
<b>Undervoltage trips, undelayed</b>			
		for AC	<b>+U-PKZ2(120V60HZ)</b> 063612
		for DC	<b>+U-PKZ2(24V DC)</b> 002558
For AC, with auxiliary contact 		On 	<b>+U-HI20-PKZ2(120V60HZ)</b> 063626
		Off / Trip 	
<b>Drop-off Delayed (200 ms)</b>			
For AC, with auxiliary contact 		On 	<b>+UVHI-PKZ2(120V60HZ)</b> 063637
		Off / Trip 	

## System PKZ 2 Motor Protectors Shunt Trips, Undervoltage Trips

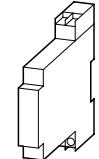
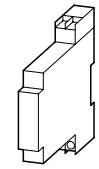
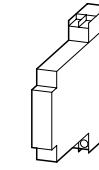
	Type	List Price
	Article No. when ordered separately  Coil voltages shown in ( ) For other coil voltages, → page 08/049	see price list
	<b>A-PKZ2-A</b> 063967	Shunt trips are available in three models which cover a wide range of AC and DC voltages. They can be used in combination with R(E)(S)-PKZ2 remote control drives.
	<b>A-PKZ2-B</b> 063964	
	<b>A-PKZ2-C</b> 063930	
	<b>U-PKZ2(120V60HZ)</b> 065686  <b>U-PKZ2(24V DC)</b> 014463	Can be combined with the motor protector to accomplish Emergency-Stop circuitry per IEC/EN 60 204. Can be used in combination with R(E)(S)-PKZ2 remote control drives.
	<b>U-HI20-PKZ2(120V60HZ)</b> 063655	
	<b>UVHI-PKZ2(120V60HZ)</b> 063664	Has a built-in time delay to prevent tripping due to momentary power losses of 200 ms or less. In the trip position, both contacts will be closed.  Can be used in combination with R(E)(S)-PKZ2 remote control drives.

Notes

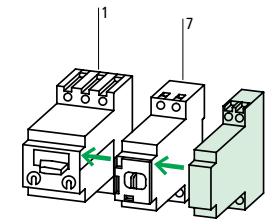

Accessories	page
1 Motor protector	08/026
7 Remote control drive	08/034
Other accessories	08/041

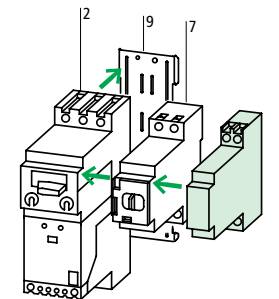

Accessories	page
2 Motor protector	08/026
7 Remote control drive	08/034
9 Clip plate	08/041
Other accessories	08/041
Other actuating voltages	08/049



# System PKZ 2 Motor Protectors Remote Control Drives

Circuit diagram for pulsed operation

## Remote control drive RE-PKZ2

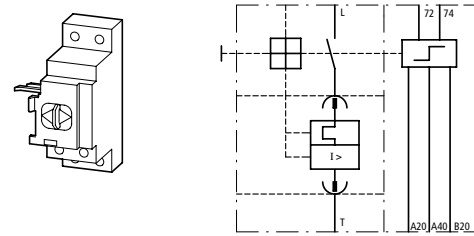

### OFF and RESET separate

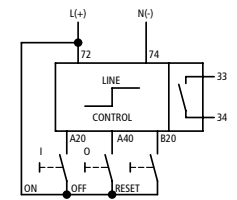

### OFF equals RESET

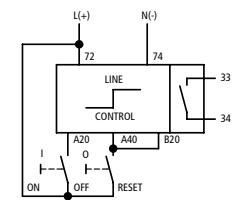

Line and control feeds have the same potential.

The control section can be energized by a single impulse ( $\leq 2$  VA/W power draw) of 15 ms duration, or by a maintained contact. Upon energizing, the line connection draws its power requirement (700 VA/W for a duration of 30 ms) directly from the line.

Control section can also be actuated via auxiliary contacts from various Moeller Electric components: NHI, AGM, ETR4-VS3, EK... and dry output contacts from PLCs with no RC filter type surge suppression.

## Remote control drive RS-PKZ2

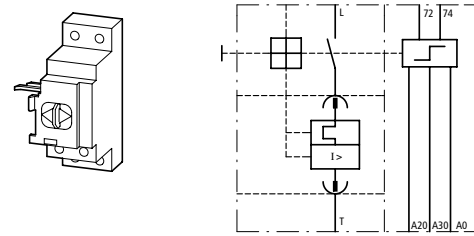

### OFF equals RESET

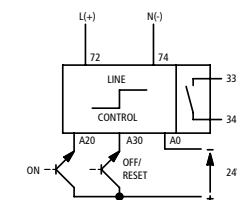
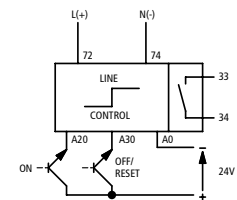

Line and control sections are galvanically separated. The control section is energized solely from a 24V DC source by a single impulse ( $\leq 2$  VA/W, 15 ms duration) or by a maintained contact. Suitable for energizing directly from an electronic PLC output.

Upon energizing, the line connection draws its power requirement (700 VA/W for a duration of 30 ms) directly from the line.

## Notes

### Minimum command time for RE-PKZ2, RS-PKZ2 remote control drives

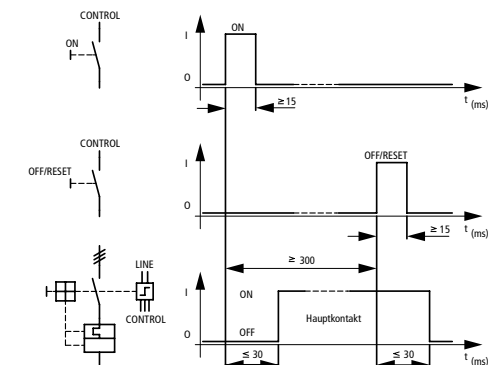

# System PKZ 2 Motor Protectors Remote Control Drives

Type	List Price
Article No.	see price list
Control voltage is shown in ( ) For other voltages, → page 08/050	

**RE-PKZ2(110–120V50/60HZ,DC)**  
063673

Remote control drives can be used with both the motor protector and motor protector combination. They are used to electrically operate the motor protector (ON / OFF and Reset to OFF (after trip) operations.) They can be switched off at the device and the thumb-grip handle can be padlocked using a 6 mm padlock. Suitable for use with either AC or DC voltages.

**RE-PKZ2(24V50/60HZ,DC)**  
063670

Can be combined with undervoltage trips and shunt trips. Always use standard auxiliary contact Type NHI... when using remote control drives to electrically signal the open or closed status of the motor protector.

Remote control drives cannot be used in conjunction with (R)H-PKZ2 door interlock handle.

**RS-PKZ2(110–120V50/60HZ,DC)**  
063685

Mounting is possible in both ON and OFF positions of the motor protector. An internal electronic interlock always sets OFF as the default setting.

The thumb-grip handle has 2 positions: HAND and AUTO

**In HAND**

- the drive displays the color GREEN and blocks any remote electrical actuation, the internal signalling contact 33/34 is open.

**RS-PKZ2(24V50/60HZ,DC)**  
063682

**In AUTO**

- the drive displays the color RED, indicating that remote electrical actuation is possible. The internal signalling contact 33/34 is closed.

## Notes

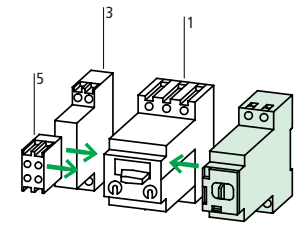

Accessories	page
1 Motor protector	08/026
3 Standard auxiliary contact	08/030
5 Trip-indicating auxiliary contact	08/030
Other accessories	08/041

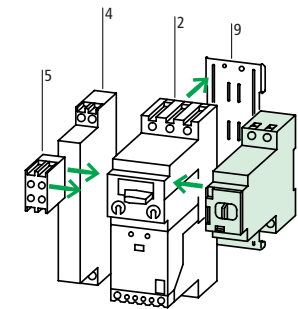

Accessories	page
2 Motor protector	08/026
4 Standard auxiliary contact	08/030
5 Trip-indicating auxiliary contact	08/030
9 Clip plate	08/041
Other actuating or supply voltages	08/050

**Note:**  
The supply voltage refers to the line and control feed for the RE-PKZ 2 and the line feed for the RS-PKZ 2. The control section of the RS-PKZ 2 is supplied with 24 V DC only. Both remote control drives will draw their power requirement (700 VA for 30 ms) directly from the line.

RE-PKZ2 and RS-PKZ2 remote control drives can be used to electrically operate the motor protector from a remote location:

- OFF to ON
- ON to OFF
- Reset to OFF after trip

Highly desirable in factory automated operations and/or physically hard to reach locations!

## System PKZ 2 Motor Protectors Magnetic Contactors, Surge Suppressors

Circuit diagram	UL/CSA Maximum 3 phase HP rating at				Number of contacts		For use with
	200 V HP	230 V HP	460 V HP	575 V HP	N.O. N.O.	N.C. N.C.	

### High capacity magnetic contactor module

With internal current limitation feature to increase short-circuit current rating and self-protection characteristics of PKZ 2/ZM-.../S motor protector combination

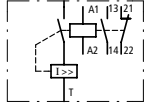
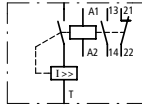
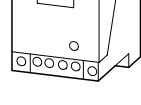
AC operated	10	15	30	30	1	1	PKZ2 PKZ2/ZM-...
							
					2	-	PKZ2 PKZ2/ZM-...
DC operated	10	15	30	30	1	-	PKZ2 PKZ2/ZM-...
							

### Surge suppressor Varistor type for AC coils

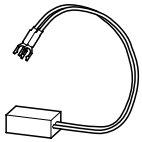
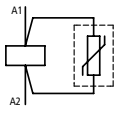
	24 – 48 V	S-...-PKZ2
	110 – 250 V	
	380 – 415 V	

### Mounting base

For separate mounting of the S-...-PKZ2 contactor

	S-...-PKZ2 CL-PKZ2
--	-----------------------

## System PKZ 2 Motor Protectors Magnetic Contactors, Surge Suppressors

Type	List Price
Article No. Coil voltages shown in ( ) For other voltages, → page 08/051	see price list
<b>S-PKZ2(120V60HZ)</b> 063694	
<b>S/HI20-S-PKZ2(120V60HZ)</b> 063701	
<b>S-G-PKZ2(24VDC)</b> 070921	
<b>VGSPKZ48</b> 063974	Surge suppressors for AC coils of S-...-PKZ2 contactors.
<b>VGSPKZ250</b> 063973	RC filters also available upon request.
<b>VGSPKZ415</b> 063972	
<b>EZ-PKZ2</b> 028596	Used to mount the S-...-PKZ2 contactor separate from the PKZ2... motor protector. Always required for reversing applications. Also, allows extra contactor operated auxiliary contacts to be added: HI11-S/EZ-PKZ2 (1 N.O. and 1 N.C.). The base can either be panel mounted using screws (M4) or clipped onto a 35mm DIN rail conforming to EN 50 022.



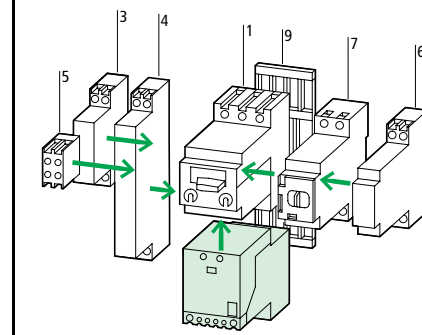

### Notes

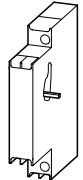
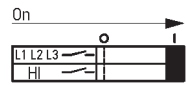
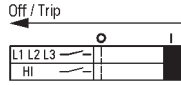
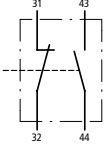

### Accessories

	page
1 Motor protector	08/026
3 Standard auxiliary contact	08/030
4 Standard auxiliary contact	08/030
5 Trip-indicating auxiliary contact	08/030
6 Shunt trip Undervoltage trip	08/032
7 Remote control drive	08/034
9 Clip plate	08/041
Other accessories	08/041
Other actuating voltages	08/051

## System PKZ 2 Motor Protectors Accessories for High Capacity Magnetic Contactors

Auxiliary contacts N.O. = normally open N.C. = normally closed	Connection diagram	Type Article No.	List Price see price list
<b>Control circuit terminal tap-offs</b> Complies with IEC and UL/CSA		<b>ST-PKZ2</b> 010998	
<b>Auxiliary contact module</b> Fits to the side of separately mounted contactors	 <div style="display: flex; justify-content: space-around; margin-top: 10px;"> <div style="text-align: center;"> <p>1 N.O.    1 N.C.</p> <p>On</p>  </div> <div style="text-align: center;"> <p>Off / Trip</p>  </div> <div style="text-align: center;">  </div> </div>	<b>HI11-S/EZ-PKZ-2</b> 090305	
<b>Auxiliary contact inserts</b> Mounts in the top portion of the contactor	 <div style="display: flex; justify-content: space-around; margin-top: 10px;"> <div style="text-align: center;"> <p>1 N.O.    1 N.C.</p> </div> <div style="text-align: center;"> <p>2 N.O.</p> </div> </div>	<b>HI11-S-PKZ2</b> 033936 <b>HI20-S-PKZ2</b> 033935	
<b>Separate coil</b>		<b>J-S-PKZ2(120V60HZ)</b> 063723	
<b>Mechanical interlock</b>		<b>MV-PKZ2</b> 033938	

## System PKZ 2 Motor Protectors Accessories for High Capacity Magnetic Contactors

<p>Provides easy access to the load side terminals of the PKZ2/ZM motor protector for control circuit tap-off purposes when the protector and S-PKZ2 high capacity magnetic contactor are mounted together as a combination unit (PKZ2/ZM-.../S). Accepts 2.8 mm fast-on connectors (insulated/non-insulated); control circuit conductor cross section range: AWG 16...20, Cu only. Max. current draw: 1A or 15% of thermal dial (FLC) value, whichever is less. Increase the setting of the dial accordingly to compensate for the tapped off current.</p>
<p>Provides an additional set of contactor operated auxiliary contacts (1 N.O. &amp; 1 N.C.) for S-PKZ2 contactors that are mounted separately using the EZ-PKZ2 mounting base.</p>
<p>Auxiliary contact inserts are used as an exchange or replacement of the insert normally supplied with the contactor. Exception: exchange or replacement of insert is not possible with DC operated contactor type S-G-PKZ2.</p>
<p>Separate coils available in AC voltages (→ page 08/051). See page 08/036 for varistor type surge suppressors. RC type filters can also be supplied upon demand.</p>
<p>To mechanically interlock two S-PKZ2 contactors. Contactors must be separately mounted using EZ-PKZ2 mounting bases. Useful for reversing applications or when there is a need to mechanically interlock the contactors of two PKZ2/ZM-.../S motor protector combinations (e.g. 2-speed motors with 2 separate windings). Supplied with 4 end brackets.</p>

### Notes

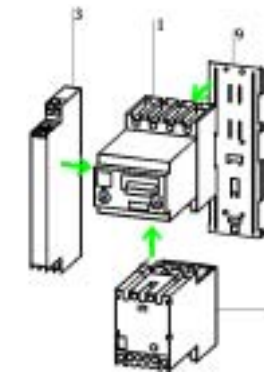

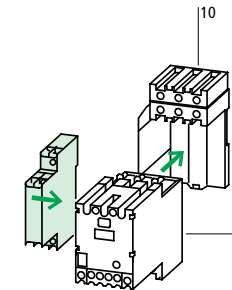

Accessories	page
1 Motor protector	08/026
3 Standard auxiliary contact	08/030
8 High capacity magnetic contactor	08/036
9 Clip plate	08/041





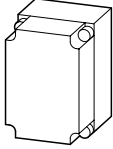
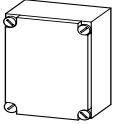

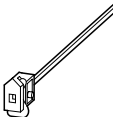

Accessories	page
8 High capacity magnetic contactor	08/036
10 Base for separate mounting	08/036
Other operating voltages	08/051

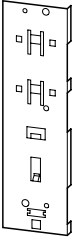
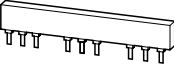
## System PKZ 2 Motor Protectors Enclosures, Accessories

	For use with	Type	List Price	
		Article No.	see price list	
<b>Enclosures for Motor Protectors</b>				
	Insulating material Dust-tight NEMA Type 12	PKZ2/ZM-... +NHI + AGM + U or A + (R)H	<b>C19EE-PKZ2-NA</b> 003183	NEMA Type 12 dust-tight industrial use enclosure with lift-off cover. Must be equipped with (R)H-PKZ2 door mounted handle. Comes with a 15 mm DIN rail, and provided with top and bottom steel plates and brass strip for continuity of ground.
	Steel General purpose NEMA Type 1	PKZ2/ZM-... +NHI + AGM + U or A or RE or RS	<b>CS3-PKZ2</b> 105073	General purpose enclosure with lift-off cover. Includes a rectangular cutout for the motor protector handle (not necessary to include the (R)H-PKZ2 door mounted handle). Also includes a knockout for the R(E)(S)-PKZ2 remote control drives and a knock-out for a pilot light.
<b>Enclosures for Motor Protector Combinations</b>				
	Insulating material Dust-tight NEMA Type 12 IEC Type IP 65	PKZ2/ZM-.../S + NHI(S) + AGM + U or A + (R)H-PKZ2	<b>C143X-150-PKZ2-NA</b> 005352	Corrosion-resistant and dust-tight insulating material enclosure. Must be equipped with the (R)H-PKZ2 door mounted handle.
	Steel General purpose NEMA Type 1	PKZ2/ZM-.../S + NHI(S) + AGM + U or A + (R)H-PKZ2	<b>GKP23-PKZ2</b> 105370	General purpose enclosure with hinged cover. Must be equipped with the (R)H-PKZ2 door mounted handle.
	Steel Dust-tight NEMA Type 12		<b>GK23-PKZ2</b> 105253	
<b>Door/cover mounted handle NEMA/UL Type 3R, 12 and IEC IP 65</b>				
	Color: black for use as a main disconnect switch		<b>H-PKZ2</b> 043218	Door/cover interlock feature. Lockable in ON or OFF position. Up to three padlocks, hasp thickness 4 - 8 mm.
	For use in MCCs with PKZ2 turned 90°. Color: black for use as a main disconnect switch		<b>H-PKZ2-MCC</b> 201427	
	Color: red/yellow for use a main disconnect switch with Emergency-Stop function		<b>RH-PKZ2</b> 045591	Door cover interlocking feature. Lockable in the ON position only. Up to three padlocks, hasp thickness 4 - 8 mm.
	For use in MCCs with PKZ2 turned 90°. Color: red/yellow for use a main disconnect switch with Emergency-Stop function		<b>RH-PKZ2-MCC</b> 201428	
<b>Plug-in extension shaft for for/cover mounted handle</b>				
	can be extended as required for mounting depths from 171 to 300 mm		<b>A-H-PKZ2</b> 047964	

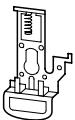



## System PKZ2 Motor Protectors Accessories

	Type	List Price
	Article No.	see price list
<b>Clip plate</b>  <p>Plate onto which the PKZ2/ZM-... motor protector and S-PKZ2 high capacity magnetic contactor are mounted as a unit.</p>	<b>C-PKZ2</b> 052710	<p>Snaps onto one 15 mm high or two 10 mm high DIN rail(s) conforming to EN 50 022-35. Can alternatively be panel mounted using M4 screws.</p> <p>Can also be mounted on AD busbar adapters (→ page 08/042)</p>
<b>Three-phase feeder bus connector</b> <p>Reduces mounting space and wiring time by eliminating daisy-chain wiring. Can be joined to accommodate more units. Finger-safe construction.</p>		
 <p>For wiring three PKZ2 motor protectors. Space is provided for either two auxiliary contacts or two voltage trips.</p>	<b>B3.1/3-PKZ2</b> 033940	222 mm wide. Can be joined to feed additional PKZ2/ZM. Max. rating: 100 A
 <p>For wiring two PKZ2 motor protectors. Space is provided for either one auxiliary contact or one voltage trip.</p>	<b>B3.1/2-PKZ2</b> 063969	140 mm wide. Can be joined to feed additional PKZ2/ZM. Max. rating: 85 A
<b>Incoming supply terminal</b>  <p>Terminal used to feed bus connectors. Accepts AWG 14 - 0, Cu only.</p>	<b>BK50/3-PKZ2</b> 033941	For connecting larger cable cross sections to feed bus connectors. Finger-safe design is maintained and protects against shock hazards.
<b>Cover for unused terminals</b>  <p>Protection against accidental contact of unused terminals on the bus connector.</p>	<b>H-B3-PKZ2</b> 063968	The feeder bus connector must have a latching provision to secure the cover.
<b>Padlocking feature</b>  <p>For padlocking the motor protector in the OFF position when the panel door is open.</p>	<b>SVB-PKZ2</b> 050337	Accepts up to three padlocks; hasp thickness 5 - 8 mm. Suitable for 1/4" padlocks.
<b>Coding pins</b>  <p>Uses binary coding to match the motor protector with a trip module.</p>	<b>CS-PKZ2</b> 055083	Coding pins prevent switching of the motor protector if an incorrect trip module is inserted.

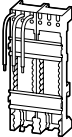

## System PKZ 2 Motor Protectors

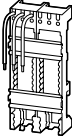
### Control Panel Busbar Adapters

	For use with	Rated operational current	Adapter supply leads	Adapter width	Type	List Price
		$I_e$ A	AWG	mm	Article No.	see price list
<b>Control panel busbar adapter, 3 pole</b>						
For mounting in industrial control panels on Cu 20 x 5 mm busbar arrangements with 60 mm phase separation.						
	PKZ2/ZM-... PKZ2/ZM-.../S without accessories	40	8	72	<b>AD40/5-1</b> 025401	The back of the adapter connects onto the bus. Components are mounted on top of the adapter and wired to the supply leads.  All assembly is done under de-energized (power OFF) conditions.
	PKZ2/ZM-... PKZ2/ZM-.../S with all possible accessories	40	8	144	<b>AD40/5-2</b> 025403	
For mounting in industrial control panels on Cu 30 x 10 and 20 x 10 mm busbar arrangements with 60 mm phase separation.						
	PKZ2/ZM-... PKZ2/ZM-.../S without accessories	40	8	72	<b>AD40/10-1</b> 025402	
	PKZ2/ZM-... PKZ2/ZM-.../S with all possible accessories	40	8	144	<b>AD40/10-2</b> 025404	
	<b>Adapter extension</b>	-	-	9	<b>AD-E</b> 060511	Push-fit strip, can be mounted onto AD... to extend mounting width

# System PKZO

## Standard Coil Voltages

Magnetic motor protector combinations PKZO										
Contactor modules with 1 N.O. and 1 N.C. contact										
AC	PKZM0 -0,16/ SE00- 11(...)	PKZM0 -0,25/ SE00- 11(...)	PKZM0 -0,4/ SE00- 11(...)	PKZM0 -0,63/ SE00- 11(...)	PKZM0 -1/ SE00- 11(...)	PKZM0 -1,6/ SE00- 11(...)	PKZM0 -2,5/ SE00- 11(...)	PKZM0 -4/ SE00- 11(...)	PKZM0 -6,3/ SE00- 11(...)	PKZM0 -10/ SE00- 11(...)
	Article No. <sup>1)</sup>	Article No. <sup>1)</sup>	Article No. <sup>1)</sup>	Article No. <sup>1)</sup>	Article No. <sup>1)</sup>	Article No. <sup>1)</sup>	Article No. <sup>1)</sup>	Article No. <sup>1)</sup>	Article No. <sup>1)</sup>	Article No. <sup>1)</sup>
Standard voltage	See price list	See price list	See price list	See price list	See price list	See price list	See price list	See price list	See price list	See price list
24V 50Hz	072919	072920	072921	072922	072923	072924	072925	072926	072927	072928
48V 50Hz	073318	073345	073372	073399	073426	073453	073480	073507	073534	074322
240V 50Hz	073320	073347	073374	073401	073428	073455	073482	073509	073536	053174
24V 60Hz	073326	073353	073380	073407	073434	073461	073488	073515	073542	055173
110V 60Hz	073329	073356	073383	073410	073437	073464	073491	073518	073545	055496
115V 60Hz	073330	073357	073384	073411	073438	073465	073492	073519	073546	055943
42V 50Hz, 48V 60Hz	050282	050424	052234	053006	053161	053435	053444	053453	053462	058775
110V 50Hz, 120V 60Hz	050283	050651	052338	053007	053346	053436	053445	053454	053463	058790
190V 50Hz, 220V 60Hz	050284	050788	052339	053008	053428	053437	053446	053455	053464	058805
220V 50Hz, 240V 60Hz	050285	050844	052703	053009	053429	053438	053447	053456	053465	058820
230V 50Hz, 240V 60Hz	050286	051145	052704	053010	053430	053439	053448	053457	053466	058835
380V 50Hz, 440V 60Hz	050287	051146	052765	053011	053431	053440	053449	053458	055100	058850
400V 50Hz, 440V 60Hz	050288	051147	052872	053158	053432	053441	053450	053459	055706	059292
415V 50Hz, 480V 60Hz	050256	051148	053004	053159	053433	053442	053451	053460	044514	059293
24V 50/60Hz	073337	073364	073391	073418	073445	073472	073499	073526	073553	057309
42V 50/60Hz	073338	073365	073392	073419	073446	073473	073500	073527	073554	057310
110V 50/60Hz	073340	073367	073394	073421	073448	073475	073502	073529	073556	057312
230V 50/60Hz	050281	050423	052233	053005	053160	053434	053443	053452	053461	057891
DC	See price list	See price list	See price list	See price list	See price list	See price list	See price list	See price list	See price list	See price list
12V DC	058163	058168	058173	058178	058183	058188	058193	058198	058203	058208
24V DC	072909	072910	072911	072912	072913	072914	072915	072916	072917	072918
48V DC	058164	058169	058174	058179	058184	058189	058194	058199	058204	058209
60V DC	058165	058170	058175	058180	058185	058190	058195	058200	058205	058210
110V DC	058166	058171	058176	058181	058186	058191	058196	058201	058206	058211
220V DC	058167	058172	058177	058182	058187	058192	058197	058202	058207	058212

### Notes

<sup>1)</sup> To obtain the article number for ordering, read under selected type and actuating voltage from the table above. Units with dual voltage coils must be ordered using one article number.

## System PKZ 0

### Standard Coil Voltages

#### PKZM0 and high capacity magnetic motor protector combinations

Contactors modules with 1 N.O. and 1 N.C. contact

AC	PKZM0 -0,16/ S00-11(...)	PKZM0 -0,25/ S00-11(...)	PKZM0 -0,4/ S00-11(...)	PKZM0 -0,63/ S00-11(...)	PKZM0 -1/ S00-11(...)	PKZM0 -1,6/ S00-11(...)	PKZM0 -2,5/ S00-11(...)	PKZM0 -4/ S00-11(...)	PKZM0 -6,3/ S00-11(...)	PKZM0 -10/ S00-11(...)
	Article No. <sup>1)</sup>	Article No. <sup>1)</sup>	Article No. <sup>1)</sup>	Article No. <sup>1)</sup>	Article No. <sup>1)</sup>	Article No. <sup>1)</sup>	Article No. <sup>1)</sup>	Article No. <sup>1)</sup>	Article No. <sup>1)</sup>	Article No. <sup>1)</sup>
<b>Standard voltage</b>	See price list	See price list	See price list	See price list	See price list	See price list	See price list	See price list	See price list	See price list
24V 50Hz	073029	073030	073031	073032	073033	073034	073035	073036	073037	073038
48V 50Hz	060820	060848	060875	060902	060929	060956	060983	061010	061037	062215
240V 50Hz	060822	060850	060877	060904	060931	060958	060985	061012	061039	062253
24V 60Hz	060828	060856	060883	060910	060937	060964	060991	061018	061045	064166
110V 60Hz	060831	060859	060886	060913	060940	060967	060994	061021	061048	064604
115V 60Hz	060832	060860	060887	060914	060941	060968	060995	061022	061049	064675
42V 50Hz, 48V 60Hz	044516	044525	044534	044543	044552	044561	044570	044579	044588	044597
110V 50Hz, 120V 60Hz	044517	044526	044535	044544	044553	044562	044571	044580	044589	044598
190V 50Hz, 220V 60Hz	044518	044527	044536	044545	044554	044563	044572	044581	044590	044599
220V 50Hz, 240V 60Hz	044519	044528	044537	044546	044555	044564	044573	044582	044591	044600
230V 50Hz, 240V 60Hz	044520	044529	044538	044547	044556	044565	044574	044583	044592	044601
380V 50Hz, 440V 60Hz	044521	044530	044539	044548	044557	044566	044575	044584	044593	044602
400V 50Hz, 440V 60Hz	044522	044531	044540	044549	044558	044567	044576	044585	044594	044603
415V 50Hz, 480V 60Hz	044523	044532	044541	044550	044559	044568	044577	044586	044595	044604
24V 50/60Hz	060839	060867	060894	060921	060948	060975	061002	061029	061056	066982
42V 50/60Hz	060840	060868	060895	060922	060949	060976	061003	061030	061057	067043
110V 50/60Hz	060842	060870	060897	060924	060951	060978	061005	061032	061059	067245
230V 50/60Hz	044515	044524	044533	044542	044551	044560	044569	044578	044587	044596
<b>DC</b>										
<b>Standard voltage</b>	See price list	See price list	See price list	See price list	See price list	See price list	See price list	See price list	See price list	See price list
12V DC	056258	056264	056270	056276	056282	056288	056294	056300	056306	056312
24V DC	056257	056263	056269	056275	056281	056287	056293	056299	056305	056311
48V DC	056259	056265	056271	056277	056283	056289	056295	056301	056307	056313
60V DC	056260	056266	056272	056278	056284	056290	056296	056302	056308	056314
110V DC	056261	056267	056273	056279	056285	056291	056297	056303	056309	056315
220V DC	056262	056268	056274	056280	056286	056292	056298	056304	056310	056316

#### Notes

<sup>1)</sup> To obtain the article number for ordering, read under selected type and actuating voltage from the table above.  
Units with dual voltage coils must be ordered using one article number..

## System PKZO

### Standard Coil Voltages

Shunt trips, undervoltage trips				
AC	when ordered with basic device		when ordered separately	
	+A-PKZO(...)	+U-PKZO(...)	A-PKZO(...)	U-PKZO(...)
	Article No. <sup>1)</sup>	Article No. <sup>1)</sup>	Article No. <sup>1)</sup>	Article No. <sup>1)</sup>
<b>Standard voltage</b>	See price list	See price list	See price list	See price list
24V 50Hz	073305	073253	073181	073129
48V 50Hz	073313	073262	073183	073131
110V 50Hz	073292	073240	073184	073132
220V 50Hz	073300	073248	073186	073134
230V 50Hz	073302	073250	073187	073135
240V 50Hz	073303	073251	073188	073136
380V 50Hz	073308	073256	073189	073137
400V 50Hz	073309	073257	073190	073138
415V 50Hz	073310	073258	073191	073139
120V 60Hz	073295	073243	073195	073143
240V 60Hz	073304	073252	073198	073146
440V 60Hz	082192	082193	082164	082161
480V 60Hz	051492	073261	073199	073147
Special voltages other than the standard coils listed above <sup>2)</sup>	See price list	See price list	See price list	See price list
...V 50Hz (24 – 500V)	110170	110171	110169	105915
...V 60Hz (24 – 600V)	110172	110173	105504	105916
<b>DC</b>				
<b>Standard voltage</b>	See price list	See price list	See price list	See price list
24V DC	073306	–	073200	–
48V DC	073314	–	073201	–
60V DC	073315	–	073202	–
110V DC	073294	–	073203	–
125V DC	073296	–	073204	–
220V DC	073301	–	073205	–
250V DC	073307	–	073206	–

#### Notes

- <sup>1)</sup> To obtain the article number for ordering, read under selected type and actuating voltage from the table above.  
<sup>2)</sup> When ordering special coils, please state the required actuating voltage from the given range (...-...V).

## System PKZ 0

### Standard Coil Voltages

Magnetic contactor module, high capacity magnetic contactor module  
with 1 N.O. and 1 N.C. auxiliary contact (S(E)00-11) or 2 N.C. auxiliary contacts (S(E)00-20)

AC	SE00-11-PKZ0(...)	SE00-20-PKZ0(...)	S00-11-PKZ0(...)	S00-20-PKZ0(...)
	Article No. <sup>1)</sup>	Article No. <sup>1)</sup>	Article No. <sup>1)</sup>	Article No. <sup>1)</sup>
<b>Standard voltage</b>	See price list	See price list	See price list	See price list
24V 50Hz	072860	072828	072784	072752
48V 50Hz	072861	072829	072785	072753
240V 50Hz	072862	072830	072786	072754
24V 60Hz	072864	072832	072788	072756
110V 60Hz	072865	072833	072789	072757
115V 60Hz	072866	072834	072790	072758
42V 50Hz, 48V 60Hz	063317	063584	063334	063343
110V 50Hz, 120V 60Hz	063318	063326	063335	063344
190V 50Hz, 220V 60Hz	063319	063327	063336	063345
220V 50Hz, 240V 60Hz	063320	063328	063337	063346
230V 50Hz, 240V 60Hz	063321	063329	063338	063347
380V 50Hz, 440V 60Hz	063322	063330	063339	063348
400V 50Hz, 440V 60Hz	063323	063331	063340	063349
415V 50Hz, 480V 60Hz	063324	063332	063341	063350
24V 50/60Hz	072884	072845	072808	052579
42V 50/60Hz	072885	072846	072809	053385
110V 50/60Hz	072887	072848	072811	052578
230V 50/60Hz	063325	063333	063342	063351
<b>DC</b>				
<b>Standard voltage</b>	See price list	See price list	See price list	See price list
12V DC	072822	072816	072746	072740
24V DC	072823	072817	072747	072741
48V DC	072824	072818	072748	072742
60V DC	072825	072819	072749	072743
110V DC	072826	072820	072750	072744
220V DC	072827	072821	072751	072745

**Notes:**

<sup>1)</sup> To obtain the article number for ordering, read under selected type and actuating voltage from the table above.  
Units with dual voltage coils must be ordered using one article number.

## System PKZO

### Standard Coil Voltages

High capacity motor protector combinations						
Contact module with 1 N.O. and 1 N.C. contact						
AC	PKZ2/ZM-0,6/ S(...)	PKZ2/ZM-1/ S(...)	PKZ2/ZM-1,6/ S(...)	PKZ2/ZM-2,4/ S(...)	PKZ2/ZM-4/ S(...)	PKZ2/ZM-6/ S(...)
	Article No. <sup>1)</sup>	Article No. <sup>1)</sup>	Article No. <sup>1)</sup>	Article No. <sup>1)</sup>	Article No. <sup>1)</sup>	Article No. <sup>1)</sup>
<b>Standard voltage</b>	See price list	See price list	See price list	See price list	See price list	See price list
<b>24V 50Hz</b>	090678	028981	000505	052711	076441	097798
<b>48V 50Hz</b>	059103	059117	059110	059138	059159	059173
<b>240V 50Hz</b>	030904	031402	031534	031616	031770	026869
<b>24V 60Hz</b>	059102	059116	059109	059137	059158	059172
<b>110V 50Hz, 120V 60Hz</b>	063460	063470	063480	063490	063500	063510
<b>190V 50Hz, 220V 60Hz</b>	063461	063471	063481	063491	063501	063511
<b>220V 50Hz, 240V 60Hz</b>	063465	063475	063485	063495	063505	063515
<b>230V 50Hz, 240V 60Hz</b>	063462	063472	063482	063492	063502	063512
<b>380V 50Hz, 440V 60Hz</b>	063466	063476	063486	063496	063506	063516
<b>400V 50Hz, 440V 60Hz</b>	063463	063473	063483	063493	063503	063513
<b>415V 50Hz, 480V 60Hz</b>	063464	063474	063484	063494	063504	063514
<b>24V 50/60Hz</b>	063467	063477	063487	063497	063507	063517
<b>110V 50/60Hz</b>	063468	063478	063488	063498	063508	063518
<b>230V 50/60Hz</b>	063469	063479	063489	063499	063509	063519
Special voltages other than the standard coils listed above <sup>2)</sup>	See price list	See price list	See price list	See price list	See price list	See price list
<b>...V 50Hz (24 – 600V)</b>	105606	105616	105611	105631	105646	105657
<b>...V 60Hz (24 – 600V)</b>	105607	105617	105612	105632	105647	105658

#### Notes

- <sup>1)</sup> To obtain the article number for ordering, read under selected type and actuating voltage from the table above.  
Units with dual voltage coils must be ordered using one article number.
- <sup>2)</sup> When ordering special coils please state the required actuating voltage from the given range (...-...V).



## System PKZ 2

### Standard Coil Voltages

High capacity motor protector combinations  
Contact module with 1 N.O. and 1 N.C. contact

AC	PKZ2/ZM-10/ S(...)	PKZ2/ZM-16/ S(...)	PKZ2/ZM-25/ S(...)	PKZ2/ZM-32/ S(...)	PKZ2/ZM-40/ S(...)	PKZ2/S(...)
	Article No. <sup>1)</sup>	Article No. <sup>1)</sup>	Article No. <sup>1)</sup>	Article No. <sup>1)</sup>	Article No. <sup>1)</sup>	Article No. <sup>1)</sup>
<b>Standard voltages</b>	See price list	See price list	See price list	See price list	See price list	See price list
24V 50Hz	095146	076165	073793	076167	002607	063580
48V 50Hz	059124	059131	059145	059152	059166	063581
240V 50Hz	027021	027125	027519	028717	029051	063582
24V 60Hz	059123	059130	059144	059151	059165	063583
110V 50Hz, 120V 60Hz	063520	063530	063540	063550	063560	063570
190V 50Hz, 220V 60Hz	063521	063531	063541	063551	063561	063571
220V 50Hz, 240V 60Hz	063525	063535	063545	063555	063565	063575
230V 50Hz, 240V 60Hz	063522	063532	063542	063552	063562	063572
380V 50Hz, 440V 60Hz	063526	063536	063546	063556	063566	063576
400V 50Hz, 440V 60Hz	063523	063533	063543	063553	063563	063573
415V 50Hz, 480V 60Hz	063524	063534	063544	063554	063564	063574
24V 50/60Hz	063527	063537	063547	063557	063567	063577
110V 50/60Hz	063528	063538	063548	063558	063568	063578
230V 50/60Hz	063529	063539	063549	063559	063569	063579
Special voltages, other than the standard coils listed above <sup>2)</sup>	See price list	See price list	See price list	See price list	See price list	See price list
...V 50Hz (24 – 600V)	105621	105626	105636	105641	105652	101279
...V 60Hz (24 – 600V)	105622	105627	105637	105642	105653	101280

#### Notes

- <sup>1)</sup> To obtain the article number for ordering, read under selected type and actuating voltage from the table above.  
Units with dual voltage coils must be ordered using one article number.
- <sup>2)</sup> When ordering special coils, please state the required actuating voltage from the given range (...-...V).

## System PKZ 2

### Standard Coil Voltages

Undervoltage trips	when ordered with basic device			when ordered separately		
	+U-PKZ2(...)	+U-HI20-PKZ2(...)	+UVHI-PKZ2(...)	U-PKZ2(...)	U-HI20-PKZ2(...)	UVHI-PKZ2(...)
AC	Article No. <sup>1)</sup>	Article No. <sup>1)</sup>	Article No. <sup>1)</sup>	Article No. <sup>1)</sup>	Article No. <sup>1)</sup>	Article No. <sup>1)</sup>
<b>Standard voltage</b>	See price list	See price list	See price list	See price list	See price list	See price list
24V 50Hz	062204	063621	071321	055085	063649	073694
48V 50Hz	012050	063622	012083	023955	063650	000226
240V 50Hz	099850	063623	066661	009717	063652	090399
208/220V 60Hz	063611	063625	063636	063632	063654	063663
110V 50Hz, 120V 60Hz	063612	063626	063637	065686	063655	063664
220V 50Hz, 240V 60Hz	063613	063627	063638	065685	063656	063665
230V 50Hz, 240V 60Hz	065760	065762	065764	065766	065768	065770
380V 50Hz, 440V 60Hz	063614	063628	063639	065689	063657	063666
400V 50Hz, 440V 60Hz	065761	065763	065765	065767	065769	065771
415V 50Hz, 480V 60Hz	063615	063629	063640	065684	063658	063667
24V 50/60Hz	063616	063630	063641	063646	063659	063668
48V 50/60Hz	063617	063631	063642	063647	063660	063669
Special voltages other than the standard coils listed above <sup>2)</sup>	See price list	See price list	See price list	See price list	See price list	See price list
...V 50Hz (24 – 600V)	110162	110164	110167	105919	105913	105928
...V 60Hz (24 – 600V)	110163	110165	110168	105920	105914	105929
<b>DC</b>						
<b>Standard voltage</b>	See price list	See price list	See price list	See price list	See price list	See price list
24V DC	002558	–	–	014463	–	–
48V DC	059510	–	–	028701	–	–
60V DC	050059	–	–	035820	–	–
110/125V DC	063620	–	–	063648	–	–

#### Notes

- <sup>1)</sup> To obtain the article number for ordering, read under selected type and actuating voltage from the table above.  
Units with dual voltage coils must be ordered using one article number.
- <sup>2)</sup> When ordering special coils please state the required actuating voltage from the given range (...-...V).

## System PKZ 2

### Standard Coil Voltages

Remote control drive		
AC, DC	RE-PKZ2(...)	RS-PKZ2(...)
	Article No. <sup>1)</sup>	Article No. <sup>1)</sup>
<b>Standard voltage</b>	See price list	See price list
24V 50/60Hz, DC	063670	063682
42V 50/60Hz, DC	063671	063683
48V 50/60Hz, DC	063672	063684
110 – 120V 50/60Hz, DC	063673	063685
120 – 130V 50/60Hz, DC	063674	063686
190 – 220V 50/60Hz, DC	063675	063687
220 – 240V 50/60Hz, DC	063676	063688
Special voltages	See price list	See price list
60V 50/60Hz, DC	063679	063691
110V 50/60Hz, DC	063680	028912
170 – 190V 50/60Hz, DC	063681	063693
<b>AC</b>		
<b>Standard voltage</b>	See price list	See price list
380 – 415V 50/60Hz	063677	063689
Special voltage	See price list	See price list
440V 50/60Hz	063678	063690

#### Notes

<sup>1)</sup> To obtain the article number for ordering, read under selected type and actuating voltage from the table above.

## System PKZ 2

### Standard Coil Voltages

High capacity magnetic contact module			
Single coil for high capacity magnetic contact module			
AC	S-PKZ2(...)	S/HI20-S-PKZ2(...)	J-S-PKZ2(...)
	Article No. <sup>1)</sup>	Article No. <sup>1)</sup>	Article No. <sup>1)</sup>
Standard voltage	See price list	See price list	See price list
24V 50Hz	026609	056378	035726
48V 50Hz	062651	056383	065114
240V 50Hz	001882	057048	065126
24V 60Hz	062501	056380	065111
110V 50Hz, 120V 60Hz	063694	063701	063723
190V 50Hz, 220V 60Hz	063695	063702	063724
220V 50Hz, 240V 60Hz	063699	063706	063728
230V 50Hz, 240V 60Hz	063696	063703	063725
380V 50Hz, 440V 60Hz	063700	063707	063729
400V 50Hz, 440V 60Hz	063697	063704	063726
415V 50Hz, 480V 60Hz	063698	063705	063727
24V 50/60Hz	062500	056379	065110
110V 50/60Hz	063063	056385	065116
230V 50/60Hz	065103	056395	065125
Special voltages other than the standard coils shown above <sup>2)</sup>	See price list	See price list	See price list
...V 50Hz (24 – 600V)	105905	105909	101845
...V 60Hz (24 – 600V)	105906	105910	101846
DC	S-G-PKZ2(...)		
	Article No. <sup>1)</sup>		
Standard voltage	See price list		
24V DC	070921		
110V DC	218934		
125V DC	203583		

#### Notes

- <sup>1)</sup> To obtain the article number for ordering, read under selected type and actuating voltage from the table above  
Units with dual voltage coils must be ordered using one article number.
- <sup>2)</sup> When ordering special coils please state the required actuating voltage from the given range (...-...V).

# PKZ 0 Motor Protectors Selection Guidelines

S00-PKZ0 high-capacity contact module, SE00-PKZ0 contact module

Normal switching duty

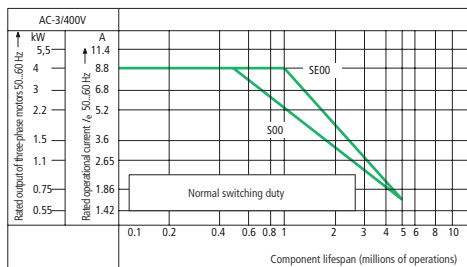

### Squirrel-cage motors

Operating characteristics: Starting: from rest  
Stopping: after attaining full running speed

Typical applications: Compressors, Pumps, Fans, Valves, Drives in general for manufacturing and processing machines

Electrical characteristics: Starting: up to 6 x motor rated current  
Stopping: 1 x motor rated current

Utilization category: 100 % AC-3

Extreme switching duty

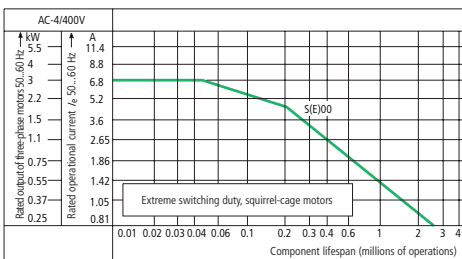

### Squirrel-cage motors

Operating characteristics: Inching, plugging, reversing

Typical applications: Printing machines, Wire-drawing machines, Centrifuges, Special drives for manufacturing and processing machines

Electrical characteristics: Starting: 6 x motor rated current  
Stopping: 6 x motor rated current

Utilization category: 100 % AC-4

Light switching duty

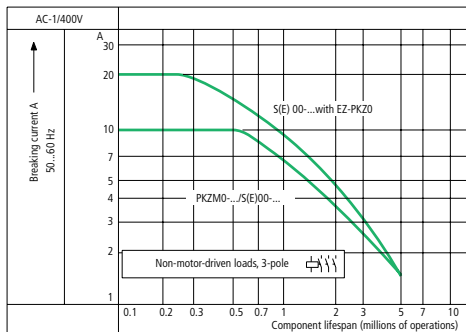

### Non-motor loads

Operating characteristics: Non-inductive or slightly inductive load

Typical applications: Electric heat

Electrical Characteristics: Starting: up to 1.5 x rated current  
Stopping: 1 x rated current

Utilization category: 100 % AC-1

Determination of the maximum number of operations per hour dependent on the switching capacity and utilization category (approximate values)

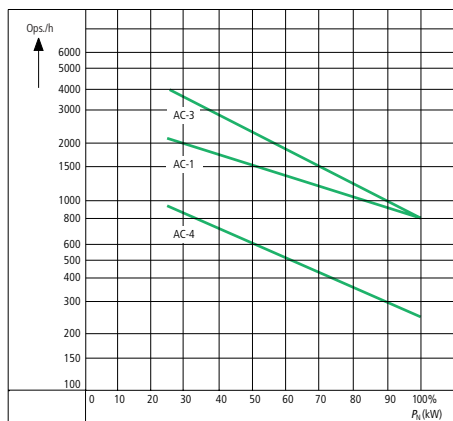

$P_N$  = Max. motor rating HP (kW) of the appropriate contactor  
Ops/h = Max. operating frequency per hour

# PKZ0 Motor Protectors Tripping Characteristics, Let-through Curves

Tripping characteristics PKZM0-...T motor protectors, (high-capacity) motor protector combinations (not for PKM0-...)

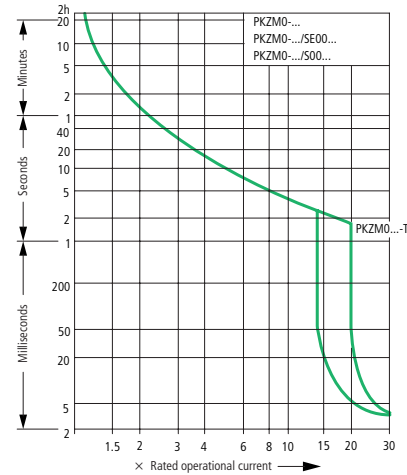

Let-through current values, manual motor protectors

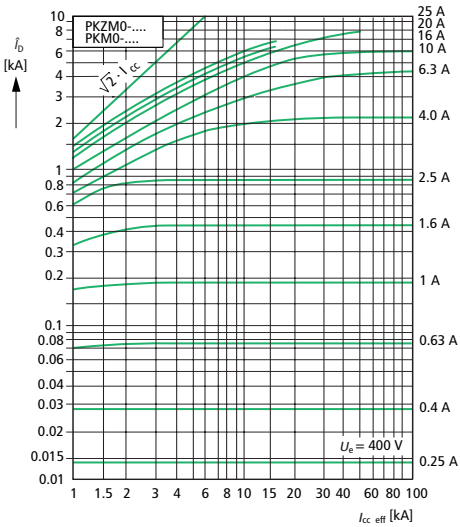

Let-through energy values, manual motor protectors

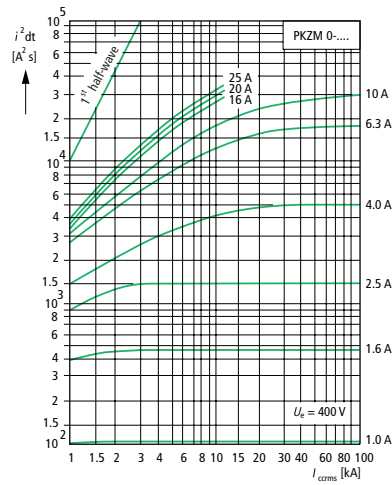

Let-through current values, motor protector combinations

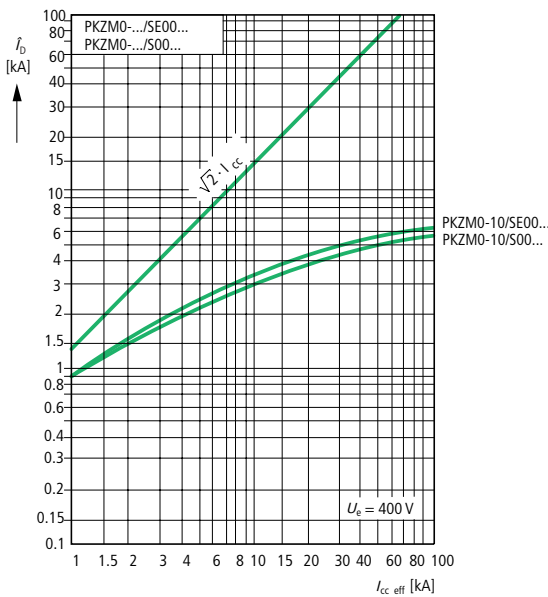

Let-through energy values, motor protector combinations

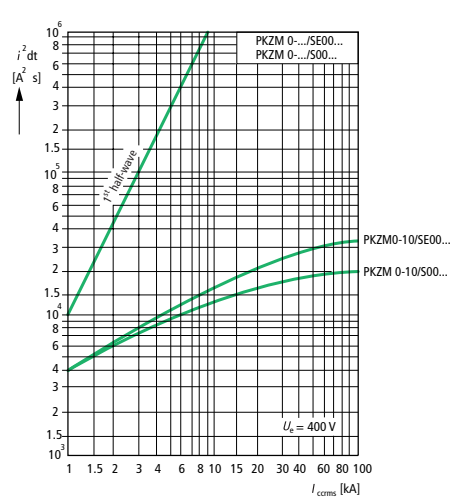



# PKZ 2 Motor Protectors Selection Guidelines

## S-PKZ2 high-capacity contact module, SE-PKZ2 contact module

### Normal switching duty

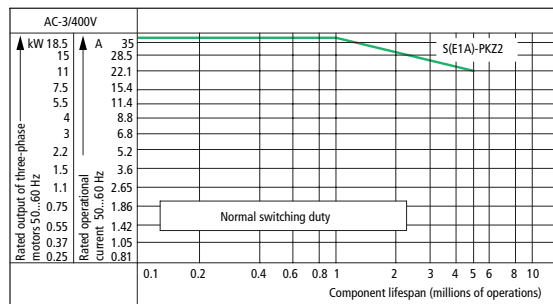

### Squirrel-cage motors

Operating characteristics: Starting: from rest  
Stopping: after attaining full running speed

Typical applications: Compressors Elevators Mixers  
Pumps Escalators Agitators  
Fans Conveyors Centrifuges  
Valves Bucket escalators Air-conditioning

Drives in general for manufacturing and processing machines

Electrical characteristics: Starting: up to 6 x motor rated current  
Stopping: 1 x motor rated current

Utilization category: 100 % AC-3

### Extreme switching duty

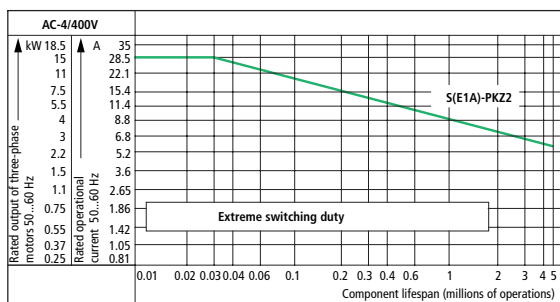

### Squirrel-cage motors

Operating characteristics: Inching, plugging, reversing

Typical applications: Printing machines  
Wire-drawing machines  
Centrifuges  
Special drives for manufacturing and processing machines

Electrical characteristics: Starting: 6 x motor rated current  
Stopping: 6 x motor rated current

Utilization category: 100 % AC-4

### Light switching duty

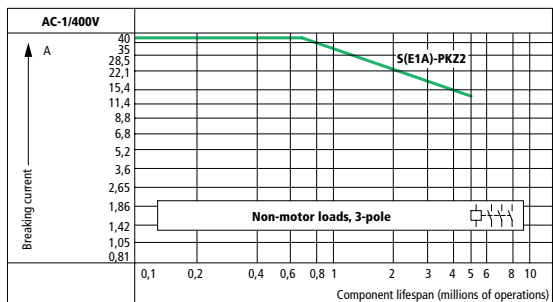

### Non-motor loads

Operating characteristics: Non-inductive or slightly inductive load

Typical applications: Electric heat

Electrical Characteristics: Starting: up to 1.5 x rated current  
Stopping: 1 x rated current

Utilization category: 100 % AC-1

### Determination of the maximum number of operations per hour dependent on the switching capacity and utilization category (approximate values)

$$P_N = \text{Max. motor rating (HP)}$$

$$\text{Ops./h} = \text{Max. operating frequency per hour}$$

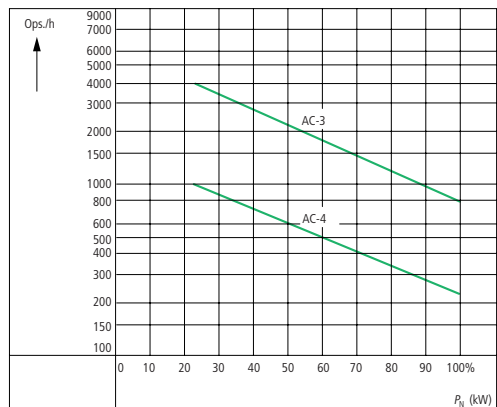

# PKZ0 Motor Protectors

## Tripping Characteristics, Let-through Curves

Tripping characteristics, manual motor protectors, motor protector combinations

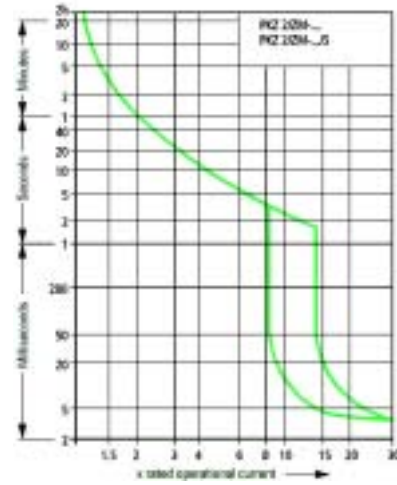

Let-through current values, manual motor protectors

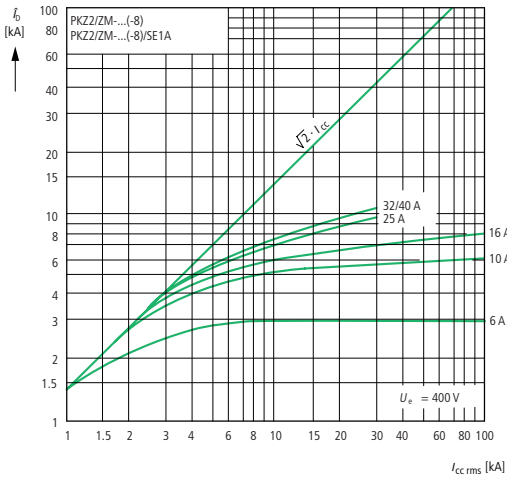

Let-through energy values, manual motor protectors

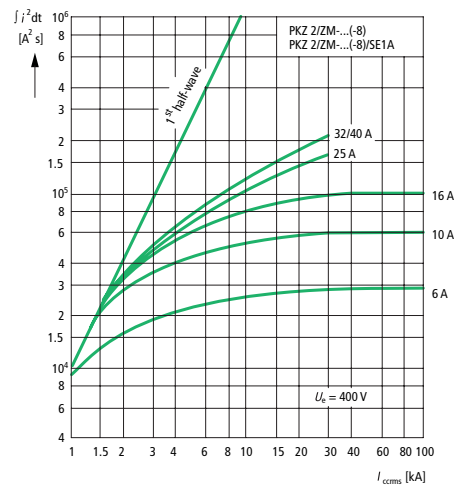

Let-through current values, motor protector combinations

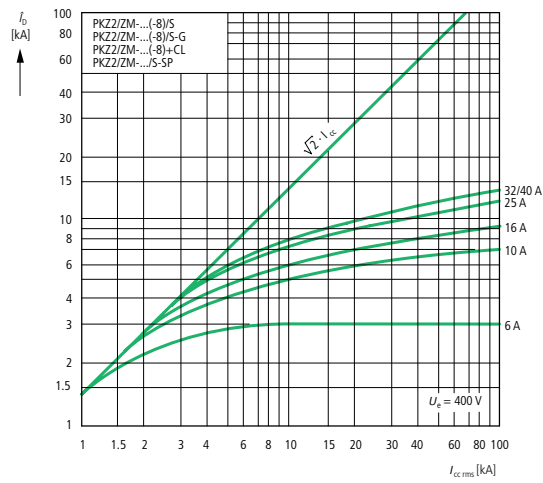

Let-through energy values, motor protector combinations

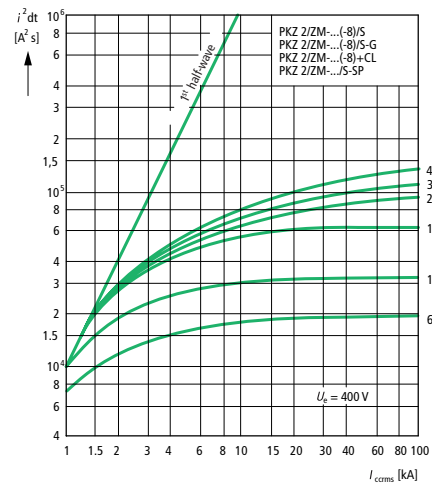

# PKZ 0 Motor Protectors

## Technical Data

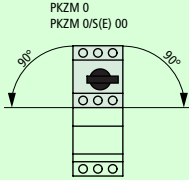
General					
Standards		UL 508, CSA C 22.2 No. 14, IEC/EN 60 947, VDE 0660 GL, LR, DNV, PRS, BV, RINA, RS, MEEI, EZU			
Climatic proofing		Damp heat, constant, to IEC 60 068-2-3 Damp heat, cyclical, to IEC 60 068-2-30			
Ambient temperature	Storage	min./max.	°C	-25/+70	
	Open	min./max.	°C	-25/+55	
	Enclosed	min./max.	°C	-25/+40	
Mounting position		 <p>PKZM 0 PKZM 0/S(E) 00</p>			
Direction of incoming supply		Motor protector: as required Motor protector combination: from above			
Degree of protection (terminals)		IP 20 (IP 00)			
Protection against electric shock to IEC 536		Finger and back-of-hand proof			
Shock resistance (half-sinusoidal shock 10 ms) to IEC 60 068-2-27		g	Motor protector: 25      Motor protector combination: 8		
Altitude		m	2000		
Terminal capacity					
IEC	solid	mm <sup>2</sup>	1 × (1 – 6)		
		mm <sup>2</sup>	2 × (1 – 2,5)		
	flexible with ferrule	mm <sup>2</sup>	1 × (1 – 4)		
		mm <sup>2</sup>	2 × (1 – 2,5)		
UL/CSA	solid or stranded	AWG	14 – 10		
Tightening torque	Power terminals	Nm	1,8		
	Control terminals	Nm	1,0		
Main contacts					
Rated impulse withstand voltage $U_{imp}$		V	6000		
Overvoltage category / pollution degree			III/3		
Rated operational voltage $U_e$		V AC	690		
Rated uninterrupted current $I_u =$ rated operational current $I_e$		A	25 or thermal trip dial setting		
Rated frequency		Hz	40 – 60		
Current heat loss	3-pole at operational temperature	W	Motor protector: 6	Motor protector combination: 9,5	
Lifespan	mechanical	ops.	Motor protector: $0,1 \times 10^6$	(High capacity) magnetic contactor: $5,0 \times 10^6$	
	electrical    100 % AC-3/400 V	ops.	Refer to utilization curves on page 08/052		
Max. operating frequency		ops./h	Motor protector: 40	Contact module characteristic curve → page 08/052	
Trip blocks					
Temperature compensation					
IEC/EN 60 947, VDE 0660	min./max.	°C	-5/+40		
	operating range	min./max.	°C	-25/+55	
Temperature compensation residual error		%/K	≤ 0,25 – 0,4		
Thermal trip dial setting range		× $I_u$	0,6 – 1		
Fixed magnetic trip response		× $I_u$	14 (20 for PKZM0-...-T)		
Magnetic trip tolerance		%	± 20		
Single phase sensitivity		UL 508, CSA 22.2 # 14, IEC/EN 60 947-4-1, VDE 0660 part 102			
UL/CSA single-phase HP ratings					
always use 3 poles for wiring		1 phase HP at	115 V AC	200 V AC	230 V AC
Manual motor protector type	PKZM0-1.6		-	-	$\frac{1}{10}$
	PKZM0-2.5		-	$\frac{1}{8}$	$\frac{1}{6}$
	PKZM0-4.0	$\frac{1}{8}$	$\frac{1}{4}$	$\frac{1}{2}$	$\frac{1}{3}$
	PKZM0-6.3	$\frac{1}{4}$	$\frac{1}{2}$	$\frac{1}{2}$	$\frac{1}{2}$
	PKZM0-10	$\frac{1}{2}$	1	1	$1 \frac{1}{2}$
	PKZM0-16	1	2	2	2
	PKZM0-20...25	$1 \frac{1}{2}$	3	3	3
(High capacity) magnetic contactor	S(E)00-...	$\frac{1}{2}$	1	1	$1 \frac{1}{2}$

# PKZM0 Motor Protectors

## Technical Data

### System PKZ0 short-circuit ratings per IEC/EN 60 947 standards for international applications

$I_u$  = Maximum continuous current rating of each device  
 $I_q$  = Conditional short-circuit current rating (per IEC/EN 60 947-2, relevant for motor starters and motor starter combinations)  
 $I_{cu}$  = Ultimate braking capacity (per IEC/EN 60 947-2, relevant for circuit breakers)  
 $I_{cs}$  = Continuity of service breaking capacity (per IEC/EN 60 947-2, relevant for circuit breakers)  
 All kA ratings are RMS Sym. values

■ Indicates self-protected range (100 kA)  
 N Not necessary. Backup protection is not required since device is operating within its self-protected range  
 A On request

	230 V				400 V				440 V				500 V				690 V			
$I_u$	$I_q$	$I_{cu}$	$I_{cs}$	A <sup>1)</sup>	$I_q$	$I_{cu}$	$I_{cs}$	A <sup>1)</sup>	$I_q$	$I_{cu}$	$I_{cs}$	A <sup>1)</sup>	$I_q$	$I_{cu}$	$I_{cs}$	A <sup>1)</sup>	$I_q$	$I_{cu}$	$I_{cs}$	A <sup>1)</sup>
A	kA	kA	kA		kA	kA	kA		kA	kA	kA		kA	kA	kA		kA	kA	kA	

### PKZM0 motor protector, coordination types "1" and "2"

0,16 – 1	■				■				■				■				■			
1,6	■				■				■				■				■			
2,5	■				■				■				■				■			
4	■				■				■				■				■			
6,3	■				■				■				■				■			
10	■				■				■				■				■			
16	16	16	8	50	16	16	8	50	10	10	10	50	6	6	6	50	3	3	2	50
20	16	16	8	50	16	16	8	50	10	10	10	50	6	6	6	50	3	3	2	50
25	16	16	8	50	16	16	8	50	10	10	10	50	6	6	6	50	3	3	2	50

### PKM0 motor protector + CL-PKZ0 current limiter

0,16 – 1	■				■				■				■				■			
1,6	■				■				■				■				■			
2,5	■				■				■				■				■			
4	■				■				■				■				■			
6,3	■				■				■				■				■			
10	■				■				■				■				■			
16	■				■				■				■				■			
20	■				■				■				■				■			
25	■				■				■				■				■			

### PKM0 + CL-PKZ0 + upstream CL-PKZ0 used as additional backup protection

0,16 – 1	■				■				■				■				■			
1,6	■				■				■				■				■			
2,5	■				■				■				■				■			
4	■				■				■				■				■			
6,3	■				■				■				■				■			
10	■				■				■				■				■			
16	■				■				■				■				■			
20	■				■				■				■				■			
25	■				■				■				■				■			

### Motor protector combination PKZM0-.../SE00... (coordination type "1") and PKZM0-.../S00... (coordination Type "1" and "2")

0,16 – 1	■				■				■				■				■			
1,6	■				■				■				■				■			
2,5	■				■				■				■				■			
4	■				■				■				■				■			
6,3	■				■				■				■				■			
10	■				■				■				■				■			

**Notes** <sup>1)</sup> Additional backup protection is required whenever the available the short-circuit current exceeds the  $I_q$  conditional short-circuit current rating shown in the table.  
 The conditional short circuit current rating is then dependent on the short-circuit rating of the fuse  
 50 A gL/gG  $I_q = 100$  kA  
 100 A gL/gG  $I_q = 30$  kA

## PKZ 0 Motor Protectors

### Technical Data

(High-capacity) contact module				
Magnet systems				
<b>AC</b>				
Operating range	Single-voltage coil 50 Hz and dual-voltage 50 Hz, 60 Hz	Pick-up	$\times U_s$	0,85 – 1,1
		Drop-out	$\times U_s$	0,4 – 0,6
	Dual-frequency coil ...V 50/60 Hz	Pick-up	$\times U_s$	0,85 – 1,1
		Drop-out	$\times U_s$	0,25 – 0,5
Power consumption	Single-voltage coil 50 Hz and dual-voltage 50 Hz, 60 Hz	Pull-in	VA/W	25/22
		Sealing	VA/W	4,6/1,3
	Dual-frequency coil ...V 50/60 Hz at 50 Hz	Pull-in	VA/W	30/26
		Sealing	VA/W	5,6/1,6
	...V 50/60 Hz at 60 Hz	Pull-in	VA/W	29/24
		Sealing	VA/W	3,9/1,1
Operating times at 100 % $U_s$ (main contacts)				
	Closing delay		ms	14 – 21
	Opening delay		ms	8 – 18
<b>DC</b>				
Operating range		Pick-up	$\times U_s$	0,85 – 1,1
Power consumption		Pull-in = sealing	W	2,6
Operating times at 100 % $U_s$ (main contacts)				
	Closing delay		ms	26 – 35
	Opening delay		ms	15 – 20
Duty factor			% DF	100

#### System PKZ0 motor protector

##### IEC kW ratings (AC-3)

	AC-3 kW rating at	220 V	380 V	440 V	500 V	660 V
		230 V 240 V	400 V 415 V			690 V
		kW	kW	kW	kW	kW
Manual motor protector type	PKZM0-0.16	-	-	-	-	0.06
	PKZM0-0.25	-	0.06	0.06	0.06	0.12
	PKZM0-0.4	0.06	0.09	0.12	0.12	0.18
	PKZM0-0.63	0.09	0.12	0.18	0.25	0.25
	PKZM0-1	0.12	0.25	0.25	0.37	0.55
	PKZM0-1.6	0.25	0.55	0.55	0.75	1.1
	PKZM0-2.5	0.37	0.75	1.1	1.1	1.5
	PKZM0-4.0	0.75	1.5	1.5	2.2	3
	PKZM0-6.3	1.1	2.2	3	3	4
	PKZM0-10	2.2	4	4	4	7.5
	PKZM0-16	4	7.5	9	9	12.5
	PKZM0-20	5.5	9	11	12.5	15
	PKZM0-25	5.5	12.5	12.5	15	22
Motor protector and contactor combination	PKZM0-0.16/S(E)00...	-	-	-	-	0.06
	PKZM0-0.25/S(E)00...	-	0.06	0.06	0.06	0.12
	PKZM0-0.4/S(E)00...	0.06	0.09	0.12	0.12	0.18
	PKZM0-0.63/S(E)00...	0.09	0.12	0.18	0.25	0.25
	PKZM0-1/S(E)00...	0.12	0.25	0.25	0.37	0.55
	PKZM0-1.6/S(E)00...	0.25	0.55	0.55	0.75	1.1
	PKZM0-2.5/S(E)00...	0.37	0.75	1.1	1.1	1.5
	PKZM0-4.0/S(E)00...	0.75	1.5	1.5	2.2	3
	PKZM0-6.3/S(E)00...	1.1	2.2	3	3	4
	PKZM0-10/S(E)00...	2.2	4	4	4	-

## PKZ0 Motor Protectors

### Technical Data

Auxiliary contacts				
UL/CSA				
Pilot duty rating			A600, Q300 NHI...(S), AGM...	E150 (for NHI-E...-PKZ0)
IEC/EN 60 947 Rated operational current $I_e$				
AC-15	220 – 240 V	A	3,5	1 (for NHI-E...-PKZ0)
	380 – 415 V	A	2	
	440 – 500 V	A	1	
DC-13 ( $L/R \leq 100$ ms)	24 V	A	2	
	60 V	A	1,5	1 (for NHI-E...-PKZ0)
	110 V	A	1	0,5 (for NHI-E...-PKZ0)
	220 V	A	0,25	
Lifespan	mechanical	ops.	NHI, NHI-E..	$0,1 \times 10^6$
			AGM	$0,01 \times 10^6$
			NHI...S, HI	$5 \times 10^6$
			NHI	$0,05 \times 10^6$
			NHI-E	$0,1 \times 10^6$
	electrical	ops.	AGM	$5 \times 10^3$
			NHI...S, HI	$1 \times 10^6$
			$< 10^{-8}$ , $< 1$ fault in $1 \times 10^8$ operations	
			NHI11, NHI12, NHI21, NHI2-11S, HI11-S/EZ	
Control circuit reliability at $U_e = 24$ V DC		Fault probability $H_f$		
$U_{\min} = 17$ V, $I_{\min} = 5,4$ mA				
Positively driven contacts to ZH 1/457				
Short-circuit rating without welding				
fuseless		A	please inquire	
fuse		A gL/gG	10	
Terminal capacity, 1 conductor or 2 conductors				
IEC/EN solid or flexible with ferrule		mm <sup>2</sup>	0,75 – 2,5	0,75 – 1,5 (for NHI-E...-PKZ0)
UL/CSA solid or stranded		AWG	18 – 14	18 – 16 (for NHI-E...-PKZ0)
Voltage trips				
Rated operational voltage $U_e$	V AC		42 – 480	
	V DC		24 – 250	
Terminal capacity, 1 conductor or 2 conductors				
IEC/EN solid or flexible with ferrule		mm <sup>2</sup>	0,75 – 2,5	
UL/CSA solid or stranded		AWG	18 – 14	
Shunt trips				
Operating range	AC	$\times U_s$	0,7 – 1,1	
	DC (short-time operation: 5 s)	$\times U_s$	0,7 – 1,1	
Power consumption	Pull-in AC	VA	5	
	Sealing AC	VA	3	
	Pull-in DC	W	3	
	Sealing DC	W	3	
Undervoltage trips				
Pick-up voltage	$\times U_s$		0,85	
Drop-out voltage	$\times U_s$		0,7 – 0,35	
Power consumption	Pull-in AC	VA	5	
	Sealing AC	VA	3	

#### PKZM0 motor protector trip curve

The trip curve shows the tripping time of the motor protector in relation to the response current. The curve shows mean values of the tolerance ranges at an ambient temperature of 20°C, starting from cold. The tripping time of the bimetal trips at operational temperature (warm state) is reduced to approximately 1/4 of the values shown. System PKZ0 motor protectors are suitable for protection of IEC type EEx - , explosion-proof motors.

Specific characteristics for each individual setting range are available on request. These characteristics, in 55 x 75 mm format, are self-adhesive and can be used as onsite documentation to verify the suitability of each motor protector for this application. The data has been independently verified by the German PTB testing agency and laboratory.

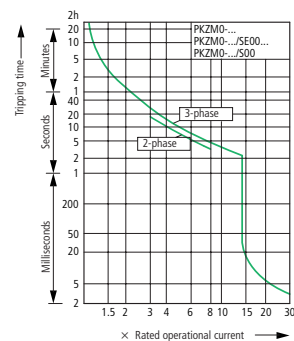



## PKZ 2 Manual Motor Protectors

### Technical Data

General			
Standards		UL 508, CSA C 22.2 No. 14, IEC/EN 60 947, VDE 0660 GL, LR, DNV, PRS, BV, RINA, RS, EZU, MEEI	
Climatic proofing		Damp heat, constant, to IEC 60 068-2-3 Damp heat, cyclical, to IEC 60 068-2-30	
Ambient temperature	Storage	min./max.	°C
	Open	min./max.	°C
	Enclosed	min./max.	°C
Mounting position			
Direction of incoming supply		as required	
Degree of protection		IP 20	
Shock resistance (half-sinoidal shock 20 ms) to IEC 60 068-2-27		g	Motor protector: 30      Motor protector combination: 8
Altitude		m	2000
Terminal capacity			
IEC/EN	solid or stranded	mm <sup>2</sup>	1 × (1 – 16) or 2 × (1 – 6)
	flexible with ferrule	mm <sup>2</sup>	1 × (1,5 – 10) or 2 × (1,5 – 6)
UL/CSA	solid or stranded	AWG	14 – 6
Tightening torque for terminal screws			
Power terminals		Nm	1,8
Control terminals		Nm	1,0
Main contacts IEC/EN 60 947 ratings			
Rated impulse withstand voltage $U_{imp}$		V	6000
Overvoltage category / pollution degree			III/3
Rated operational voltage $U_e$		V AC	690
Rated uninterrupted current $I_u =$ rated operational current $I_e$		A	40
Rated frequency		Hz	50 – 60
Current heat losses, 3-pole, at operational temperature		W	Motor protector: 14      Motor protector combination: 23
Lifespan	mechanical	ops.	Motor protector: $0,1 \times 10^6$ (High-capacity) contact module: $5 \times 10^6$ (mechanical lifespan is reduced by 30% for a dual frequency coil 50/60Hz)
	electrical	100 % AC-3 AC-4	ops. ops.
Max. operating frequency		ops./h	Motor protector: 60 (High-capacity) contact module: characteristic curve → page 08/058
Motor switching capacity	AC-3	V AC	max. 690
	DC-5	V DC	max. 250
		A DC	max. 40
DC application		PKZ2/ZM-..      PKZ2/ZM-../S(+CL)	
Rated short-circuit breaking capacity			
$I_{cn}$ (250 V DC) L/R = 15 ms		kA	30      50
$I_{cn}$ (125 V DC)		kA	50      65
Operating times under short-circuit conditions			
Minimum command time		ca. ms	2      2
Opening delay		ca. ms	0,5      0,5
Total opening time		ca. ms	6      4
Trip blocks			
Temperature compensation			
IEC/EN 60 947-4-1		min./max.	°C
Operating range		min./max.	°C
Temperature compensation residual error		%/K	0,25
Magnetic trip tolerance		%	±20
ZM-...PKZ2, ZMR-...PKZ2 motor-protective trip blocks			
Adjustable overload trips		× $I_u$	0,6 – 1,0
Adjustable magnetic trip setting range		× $I_u$	8,5 – 14
Single-phasing sensitivity		UL 508, CSA 22.2 # 14, IEC/EN 60 947-4-1, VDE 0660 part 102	

# PKZ 2 Manual Motor Protectors

## Technical Data

### System PKZ2 short-circuit ratings per IEC/EN 60 947 standards for international applications

$I_n$  = Maximum continuous current rating of each device

$I_q$  = Conditional short-circuit current rating (per IEC/EN 60 947-2, relevant for motor starters and motor starter combinations)

$I_{cu}$  = Ultimate braking capacity (per IEC/EN 60 947-2, relevant for circuit breakers)

$I_{cs}$  = Continuity of service breaking capacity (per IEC/EN 60 947-2, relevant for circuit breakers)

All kA ratings are RMS Sym. values

■ Indicates self-protected range(100 kA)

N Not necessary. Backup protection is not required whenever device is operating within its self-protected range or up to the available short-circuit fault

$I_n$ A	230 V				400 V				440 V				500 V				690 V			
	$I_q$ kA	$I_{cu}$ kA	$I_{cs}$ kA	A <sup>1)</sup>	$I_q$ kA	$I_{cu}$ kA	$I_{cs}$ kA	A <sup>1)</sup>	$I_q$ kA	$I_{cu}$ kA	$I_{cs}$ kA	A <sup>1)</sup>	$I_q$ kA	$I_{cu}$ kA	$I_{cs}$ kA	A <sup>1)</sup>	$I_q$ kA	$I_{cu}$ kA	$I_{cs}$ kA	A <sup>1)</sup>
PKZ2/ZM motor protector, coordination type "1" and "2"																				
0,16 – 1,6	■				■				■				■				■			
2,4	■				■				■				■				■			
4	■				■				■				■				■			
6	■				■				■				■				■			
10	■				■				■				■				■			
16	■				■				■				■				■			
25	30	30	7,5	160	30	30	7,5	160	10	10	5	80	7	7	3,5	80	4,5	4,5	2,5	63
32	30	30	7,5	160	30	30	7,5	160	10	10	5	160	7	7	3,5	160	4,5	4,5	2,5	100
40	30	30	7,5	160	30	30	7,5	160	10	10	5	160	7	7	3,5	160	4,5	4,5	2,5	100
PKZ2/ZM motor protector + CL-PKZ2 current limiter, coordination type "1" and "2"																				
0,16 – 1,6	■				■				■				■				■			
2,4	■				■				■				■				■			
4	■				■				■				■				■			
6	■				■				■				■				■			
10	■				■				■				■				■			
16	■				■				■				■				■			
25	30	30	7,5	N	30	30	7,5	N	5	5	3,5	N	3,5	3,5	3,5	N	10	4,5	2,5	N
32	30	30	7,5	N	30	30	7,5	N	5	5	3,5	N	3,5	3,5	3,5	N	10	4,5	2,5	N
40	30	30	7,5	N	30	30	7,5	N	5	5	3,5	N	3,5	3,5	3,5	N	10	4,5	2,5	N
PKZ2/ZM-.../S(-G) high capacity motor protector combination. coordination type "1" and "2"																				
0,6 – 2,4	■				■				■				■				■			
4 – 6	■				■				■				■				■			
10 – 16	■				■				■				■				■			
25 – 40	■				■				■				■				■			

**Notes**

<sup>1)</sup> Fuse (A gL/gG) increases the switching capacity of the motor protector to 100 kA

## PKZ 2 Manual Motor Protectors

### Technical Data

S-PKZ2 high-capacity magnetic contactor							
Operating times							
	Closing delay	ms	9 – 30				
	Opening delay	ms	4 – 12				
Duty factor		% DF	100				
Rated making capacity $\cos \varphi = 0,45$		A	400				
Rated breaking capacity $\cos \varphi = 0,45$		A	400				
Magnet systems							
AC operation ( $U_s$ - coil voltage rating)							
Operating range		Pull-in	$\times U_s$	0,85 – 1,1			
		Drop-out	$\times U_s$	0,4 – 0,6			
Power consumption		Pull-in	VA	$\leq 190$			
		Sealing	VA	$\leq 13$			
DC operation (S-G-PKZ2)							
Rated control supply voltage $U_s$		V DC	24	24V DC energization using PLC semi-conductor outputs is possible. Use PLC type: PS416-OUT-410 (HPL 0213-2001/2002, Section 02) and switch two outputs in parallel. The alternative is to use interface relay type ETS4-VS3 (section 02)			
Power consumption							
		Pull-in	VA		150		
		Pull-in	A		6,3 (16 – 22 ms)		
		Sealing	W		2,7		
		Sealing	mA		113		
Auxiliary contacts							
UL/CSA Pilot duty ratings							
NHI, NHI...S			A 600, R 300				
AGM			A 600, R 300				
NHI2-11S, HI...-S			A 600, R 300				
HI11-S/EZ			A 600, R 300				
ZMR			0.5 A @ 300 V AC				
IEC/EN 60 947 ratings							
Rated impulse withstand current $U_{imp}$		V	6000				
Overvoltage category / pollution degree			III/3				
Rated operational voltage $U_e$		V AC	500				
Rated operational current $I_e$							
AC-15			230/240 V	400/415 V	440/500 V		
		NHI11, NHI11S, NHI2-11S, HI11S/EZ	A	6	3	1,5	
		NHI22, NHI22S, HI11S, HI20-S	A	6	1,5	1,5	
		AGM2-11	A	5	3	1,5	
		ZMR... 95 – 96	A	1,5	0,7	0,5	
		ZMR... 97 – 98	A	1,5	0,5	0,3	
DC-13			24 V	60 V	110 V	220 V	
		ZMR... L/R $\leq 200$ ms	A	1	0,8	0,7	0,3
Lifespan							
mechanical		NHI, NHI..S	ops.	0,1 $\times 10^6$			
		AGM	ops.	0,01 $\times 10^6$			
		NHI2-11S, HI...-S, HI11-S/EZ	ops.	5 $\times 10^6$			
		ZMR	ops.	0,01 $\times 10^6$			
electrical		NHI, NHI..S	ops.	0,05 $\times 10^6$			
		AGM	ops.	5 $\times 10^3$			
		NHI2-11S, HI...-S, HI11-S/EZ	ops.	1 $\times 10^6$			
		ZMR	ops.	5 $\times 10^6$			
Control circuit reliability at $U_e = 24$ V DC $U_{min} = 24$ V, $I_{min} = 10$ mA		Fault probability $H_f$	Fail-safe over the entire mechanical lifespan				
Positively driven contacts to ZH 1/457			NHI2-11 S, AGM2-11				
Short-circuit rating without welding		fuseless	with PKZM0 – 6,3: 240 V PKZM0 – 4: 415 V PKZM0 – 1,6: 500 V				
		fuse	A gL/gG	10			
Terminal capacity 1 conductor or 2 conductors							
solid and flexible with ferrule		IEC/EN	mm <sup>2</sup>	0,75 – 2,5			
solid or stranded		UL/CSA	AWG	18 – 14			

## PKZ 2 Manual Motor Protectors

### Technical Data

Voltage trips				
Rated impulse withstand voltage $U_{imp}$	V	6000		
Overtoltage category / pollution degree		III/3		
Rated operational voltage $U_e$	V AC	24 – 600		
	V DC	A-PKZ2: 24 – 250, U-PKZ2: 24 – 125		
Terminal capacity 1 conductor or 2 conductors				
solid or flexible with ferrule	IEC/EN	mm <sup>2</sup>	0,75 – 2,5	
solid or stranded	UL/CSA	AWG	22 – 14	
Shunt trips ( $U_s$ = trip coil rated voltage)				
Operating range				
AC	$\times U_s$	0,7 – 1,1		
DC	$\times U_s$	0,7 – 1,1		
Power consumption				
AC Pull-in	VA	5		
	Sealing	VA	3	
DC Pull-in	W	3		
	Sealing	W	0,3	
Undervoltage trips ( $U_s$ = trip coil rated voltage)				
Drop-out voltage	$\times U_s$	0,7 – 0,35		
Power consumption				
AC Pull-in	VA	5		
	Sealing	VA	3	
DC Pull-in	W	3		
	Sealing	W	3	
Drop-out delay with UVHI-PKZ2	ms	200		
Rated operational current $I_e$				
AC-15		230 V	400 V	440 V
U-HI20-PKZ2, UVHI-PKZ2	A	6	3	1,5
UL/CSA Pilot duty rating		B 600, R 300		
Remote control drives RE-PKZ2, RS-PKZ2				
Rated impulse withstand voltage $U_{imp}$	V	6000		
Overtoltage category / pollution degree		III/3		
Rated operational current $U_e$				
AC (50/60 Hz), DC	V	24 – 240 (> 120V, IEC only)		
AC (50/60 Hz)	V	380 – 440 (IEC only)		
Required short-time rating (30 ms)	VA/W	700		
Control transformer short time rating	VA	1100 → STI 0,4		
Short-circuit voltage	%	4,35		
Closing delay	ms	≤ 30		
Opening delay	ms	≤ 30		
Reset time to OFF	ms	≤ 30		
Operating frequency	ops./h	60		
Operating range				
AC	$\times U_s$	0,85 – 1,1		
DC	$\times U_s$	0,85 – 1		
Electrical lifespan				
Integrated auxiliary contact (N.O. 33/34 Hand/Auto indication)		50 000		
UL/CSA Pilot duty rating				
		D 300, R 300		
IEC/EN Rated operational current $I_e$				
AC-14	50 Hz	230/240 V	400/415 V	440 V
	A	1,5	1	0,5
Terminal capacity 1 conductor or 2 conductors				
solid or flexible with ferrule	IEC/EN	mm <sup>2</sup>	0,75 – 2,5	
solid or stranded	UL/CSA	AWG	22 – 14	

## PKZ 2 Manual Motor Protectors

### Technical Data

Three-phase feeder bus connectors		
UL/CSA ratings		
Maximum rated voltage	V AC	600
Maximum rated current		
Type B 3.1/2-PKZ2	A	85
Type B3.1/3-PKZ2	A	100
Bus connector incoming supply terminal		
UL/CSA ratings		
Maximum rated voltage	V AC	600
Maximum rated current Type BK50/3-PKZ2	A	100
Terminal capacities min./max.	AWG	14 ... 0
Torque rating	Nm	4.5

#### PKZ2/ZM(R)-...(S) motor protector trip curve

The trip curve shows the tripping time of the motor protector in relation to the response current. The curve shows mean values of the tolerance ranges at an ambient temperature of 20°C, starting from cold. The tripping time of the bimetal trips at operating temperature (warm state) is reduced to approximately ¼ of the values shown. System PKZ2 motor protectors are suitable for protection of IEC type EEx e- explosion-proof motors.

Specific characteristics for each individual setting range are available upon request. These characteristics, in 55 x 75 mm format are self-adhesive and can be used as on-site documentation to verify the suitability of each motor protector for this application. The data has been independently verified by the German PTB testing agency and laboratory.

PTB certificate  
No. 3.53/388.299  
Tripping characteristics on  
request

Setting  
range  
A

Tripping  
characteristic to  
AWA No.

0,4 – 0,6	128-881-1
0,6 – 1,0	128-881-2
1,0 – 1,6	128-881-3
1,6 – 2,4	128-881-4
2,4 – 4,0	128-881-5
4,0 – 6,0	128-881-6
6,0 – 10	128-881-7
10 – 16	128-881-8
16 – 25	128-881-9
25 – 32	128-881-10
32 – 40	128-881-11

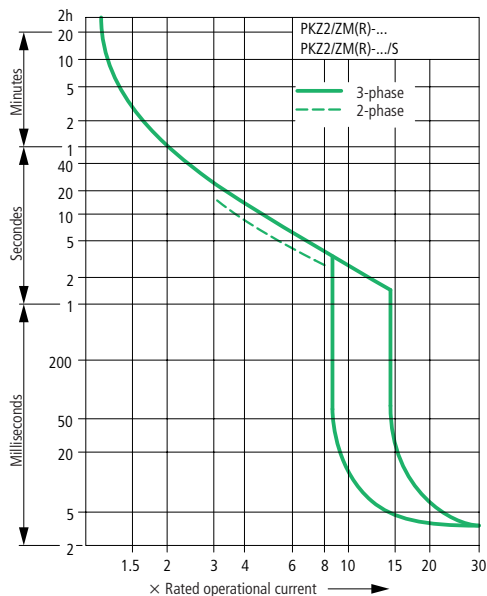

**Circuit diagram**  
for PKZ2/ZMR-...  
and PKZ2/ZMR-.../S

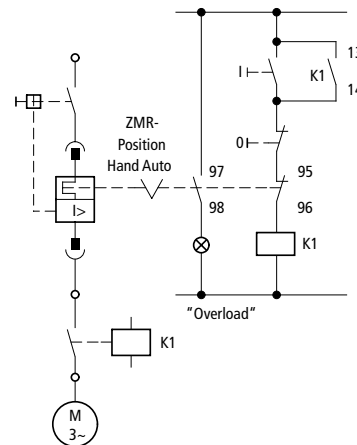

Use of the ZMR-...PKZ2 protective trip module in EEx e applications:

In EEx e applications, the N.C. contact 95-96 of the ZMR protective trip module must always be wired in series with the contactor coil in the starter circuit. See diagram above.

## PKZ 2 Manual Motor Protectors

### Technical Data

UL/CSA Single-phase HP ratings		1-phase HP @	115 V AC	200 V AC	230 V AC		
Always use 3 poles for wiring							
Manual motor protector	PKZ2/ZM-1.6		-	-	1/10		
	PKZ2/ZM-2.4		-	1/8	1/6		
	PKZ2/ZM-4		1/8	1/4	1/3		
	PKZ2/ZM-6		1/4	1/2	1/2		
	PKZ2/ZM-10		1/2	1	1 1/2		
	PKZ2/ZM-16		1	2	2		
	PKZ2/ZM-25		2	3	3		
	PKZ2/ZM-32		2	5	5		
	PKZ2/ZM-40		3	5	7 1/2		
	(High capacity) magnetic contactor	S-PKZ2		3	5	7 1/2	
Three-phase IEC/EN kW ratings (AC-3)		AC-3 kW ratings @	220 V 230 V 240 V	380 V 400 V 415 V	440 V	500 V	660 V 690 V
			kW	kW	kW	kW	kW
Manual motor protector	PKZ2/ZM-0.6		0.09	0.12	0.18	0.25	0.25
	PKZ2/ZM-1		0.18	0.25	0.25	0.37	0.55
	PKZ2/ZM-1.6		0.25	0.55	0.55	0.8	1.1
	PKZ2/ZM-2.4		0.37	0.8	1.1	1.1	1.5
	PKZ2/ZM-4		0.8	1.5	1.5	2.2	3
	PKZ2/ZM-6		1.5	2.5	3	3	4
	PKZ2/ZM-10		2.5	4	5	5.5	7.5
	PKZ2/ZM-16		4	7.5	9	10	13.5
	PKZ2/ZM-25		5.5	12.5	12.5	15	22
	PKZ2/ZM-32		7.5	15	17.5	22	22
Motor protector + contactor combination	PKZ2/ZM-40		11	20	22	24	30
	PKZ2/ZM-0.6/S...		0.09	0.12	0.18	0.25	0.25
	PKZ2/ZM-1/S...		0.18	0.25	0.25	0.37	0.55
	PKZ2/ZM-1.6/S...		0.25	0.55	0.55	0.8	1.1
	PKZ2/ZM-2.4/S...		0.37	0.8	1.1	1.1	1.5
	PKZ2/ZM-4/S...		0.8	1.5	1.5	2.2	3
	PKZ2/ZM-6/S...		1.5	2.5	3	3	4
	PKZ2/ZM-10/S...		2.5	4	5	5.5	7.5
	PKZ2/ZM-16/S...		4	7.5	9	10	13.5
	PKZ2/ZM-25/S...		5.5	12.5	12.5	15	22
PKZ2/ZM-32/S...		7.5	15	17.5	22	22	
PKZ2/ZM-40/S...		11	20	22	24	30	



# PKZ 0 Manual Motor Protectors and Motor Protector Combinations

## Dimensions

### Manual motor protectors

PKZM0-...(+NHI-E...-PKZ0)  
PKZM0-...T  
PKM0-...

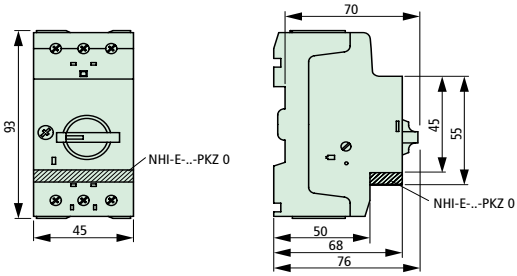

### Manual motor protector with lockable rotary handle

PKZM0-... +AK-PKZ0

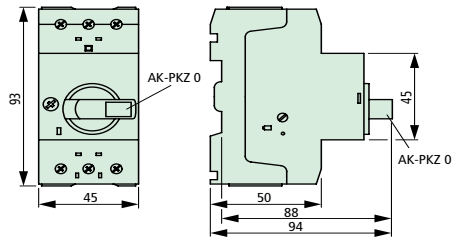

### Current limiter

CL-PKZ

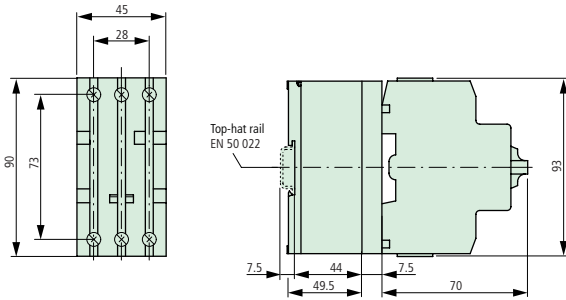

### Manual motor protectors with early-make auxiliary contacts

PKZM0-...+VHI...-PKZ0

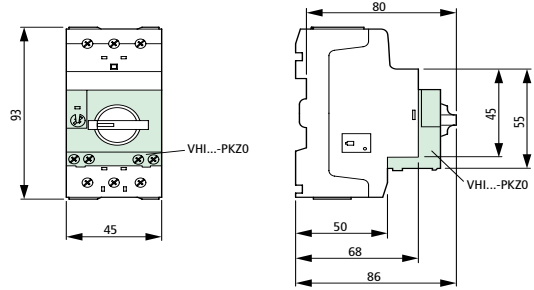

### Magnetic motor protector combinations

PKZM0-.../S(E)00 (+NHI-E...-PKZ0)

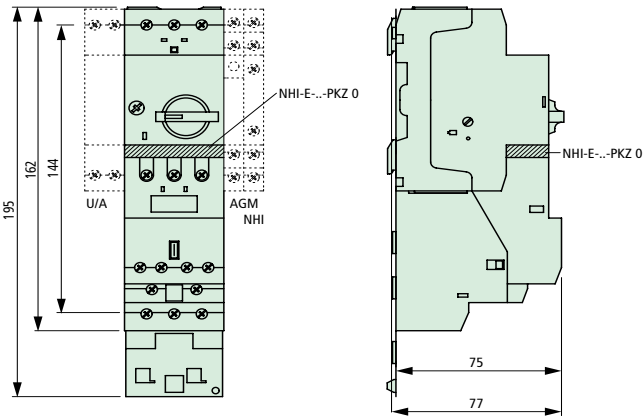

### Standard auxiliary contacts for motor protector combination

NHI 2-11S-PKZ0

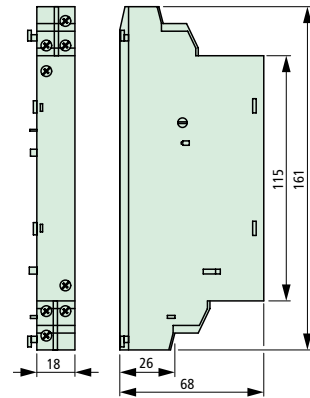

### Standard auxiliary contacts

NHI...-PKZ0

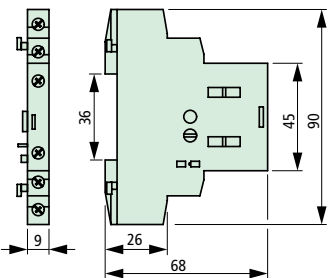

### Trip-indicating auxiliary contacts

AGM2-...-PKZ0

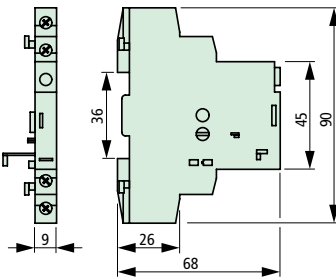

### Voltage trips

U/A-PKZ0

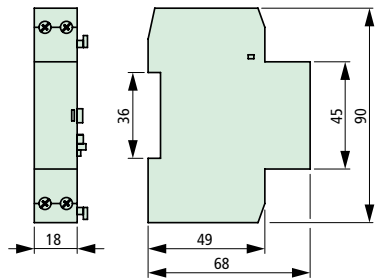

# PKZ 0 Manual Motor Protectors and Motor Protector Combinations

## Dimensions

### Magnetic contactor modules

S(E)00-PKZO

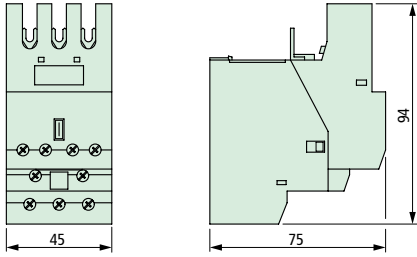

### Separate mounting

EZ-PKZO

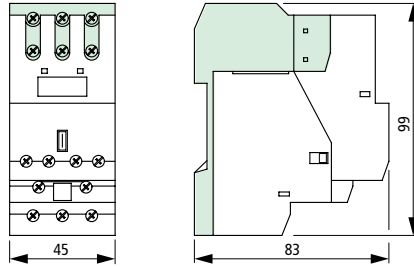

### Auxiliary contacts for magnetic contactor modules

HI11-S/EZ-PKZO

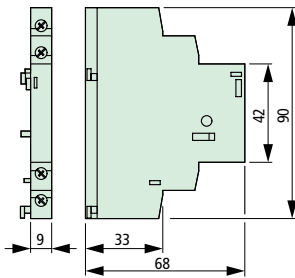

### Mechanical interlocks

MV-PKZO

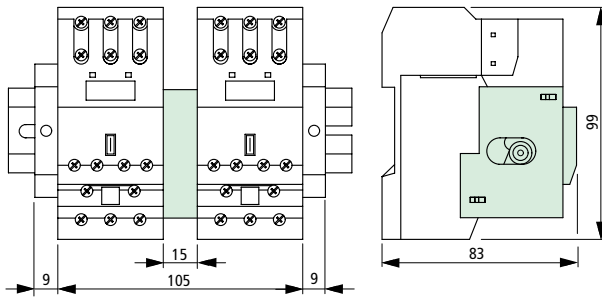

### Three-phase feeder bus connectors

B3.0/4-PKZO  
B3.0/2-PKZO

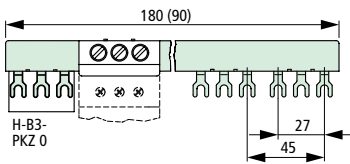

B3.2/4-PKZO  
B3.2/2-PKZO

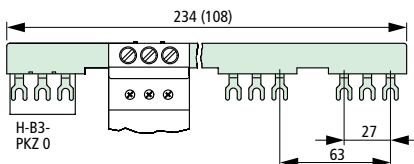

### Three-phase feeder bus connectors

B3.1/5-PKZO  
B3.1/4-PKZO  
B3.1/3-PKZO  
B3.1/2-PKZO

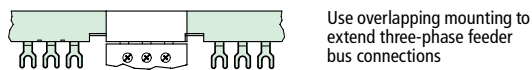
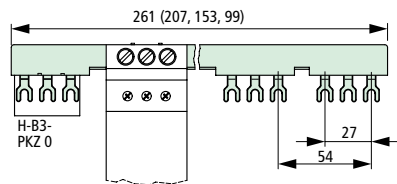

### Terminals

BK25/3-PKZO

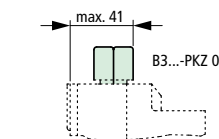
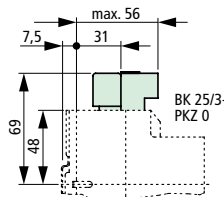

### Cover for unused terminals

H-B3-PKZO

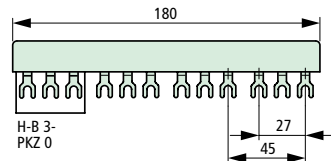

# PKZ 0 Manual Motor Protectors Dimensions

## Insulated enclosures for surface mounting

CI-PKZ0

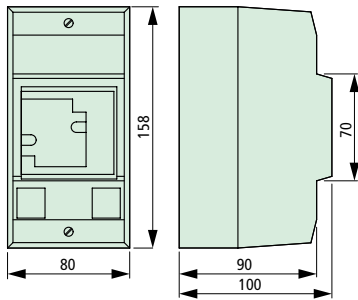

CI-PKZ0-G(R)(V)

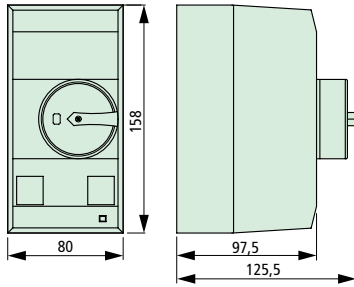

CI-PKZ0-G(R)(V)  
+ SVB-PKZ0-CI

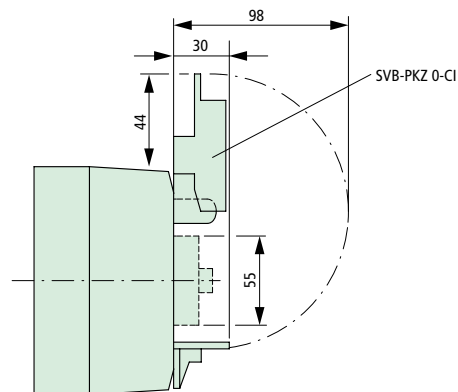

## Drilling dimensions CI-PKZ0...

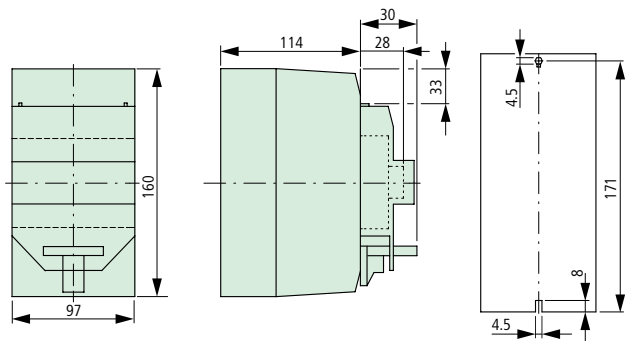

## Insulated enclosures for surface mounting

CI23X-125-NA

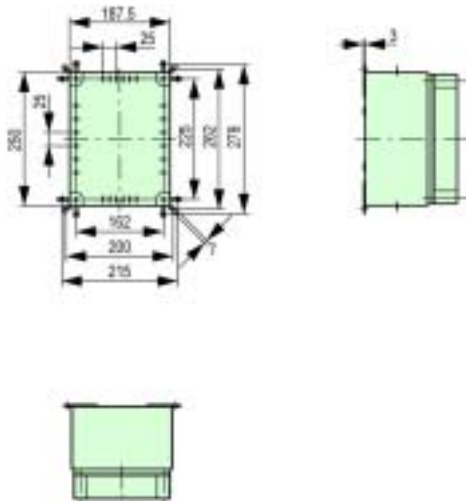

## Door coupling handles

(R)H-PKZ0, HSOV-PKZ0

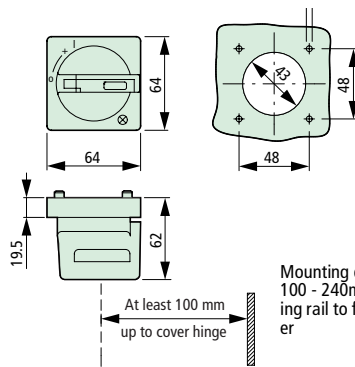

Mounting depth:  
100 - 240mm from top edge of mounting rail to front edge of panel door/cover

## Mounting plate

M3-CI23

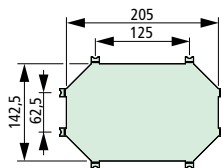

# PKZ 0 Manual Motor Protectors and Motor Protector Combinations

## Dimensions

### Insulated enclosures for flush mounting

E-PKZ0  
E-PKZ0-G(R)

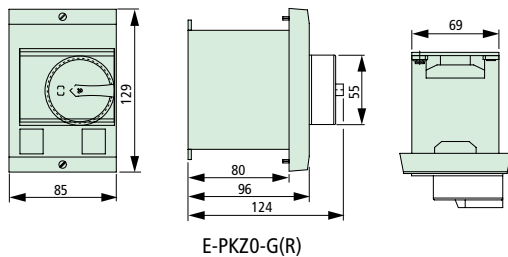

+SVB-PKZ0-E

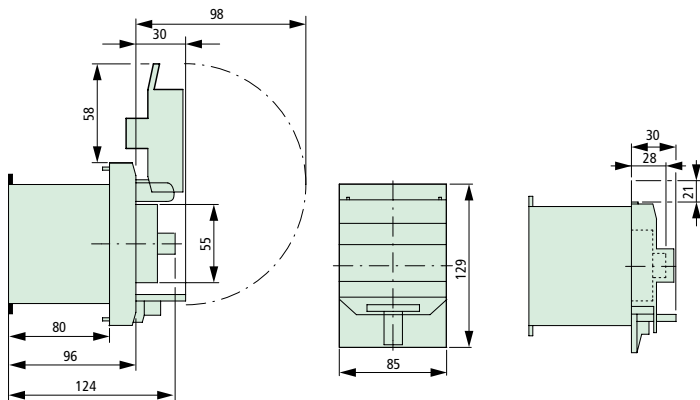

Mounting opening  
E-PKZ0...

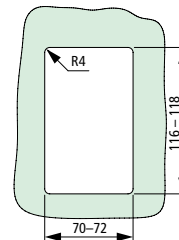

### Component adapters

AD25/5(10)-1

AD25/5(10)-2

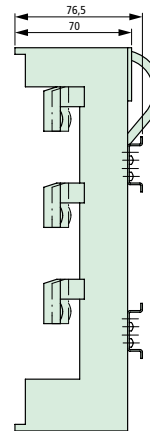
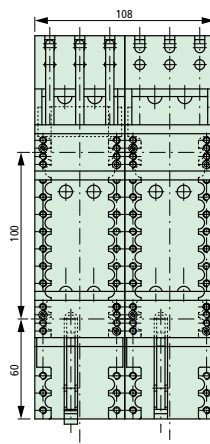
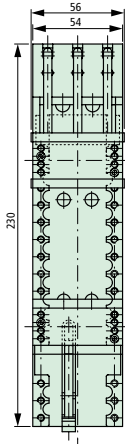

AD25/5(10)-144

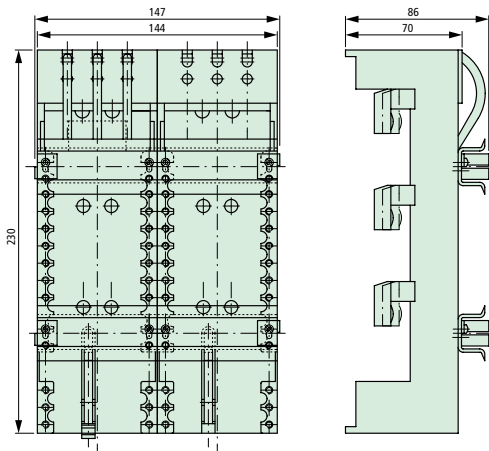

# PKZ 2 Manual Motor Protectors Dimensions

## Manual motor protector, trip blocks

PKZ2/(Z)M-...,  
ZMR-...-PKZ2

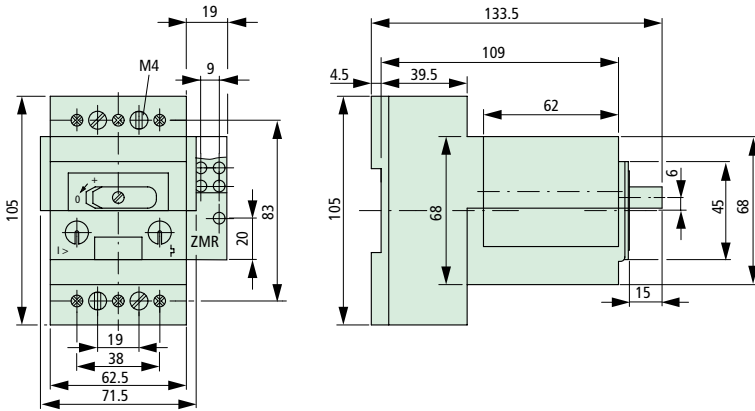

## Trip-indicating auxiliary contact

AGM 2-11-PKZ2

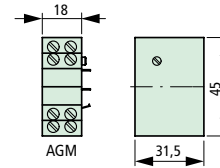

## Standard auxiliary contact

NHI...PKZ2

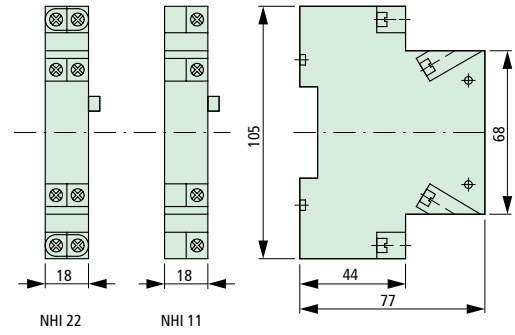

## Remote control drive

RE-PKZ2 (...)  
RS-PKZ2 (...)

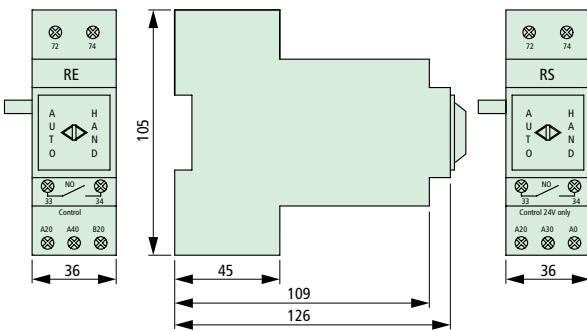

## Voltage trips

U-PKZ2 (...)  
A-PKZ2-...

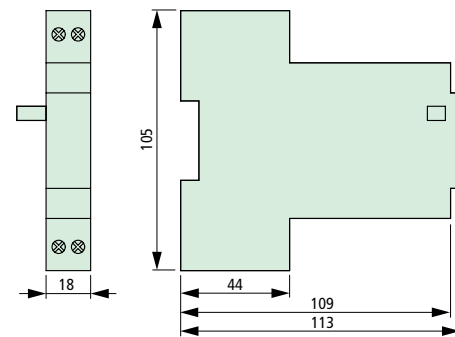

# PKZ 2 Manual Motor Protectors and Motor Protector Combinations

## Dimensions

### High-capacity magnetic motor protector combination

PKZ2/ZM-.../S(-SP)  
PKZ2/ZM-.../S-G

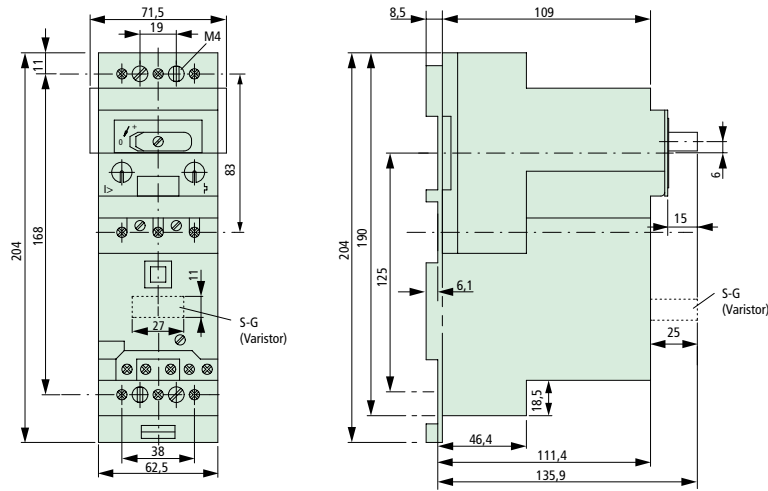

### Standard auxiliary contacts for high-capacity magnetic motor protector combination

NHI...S-PKZ2

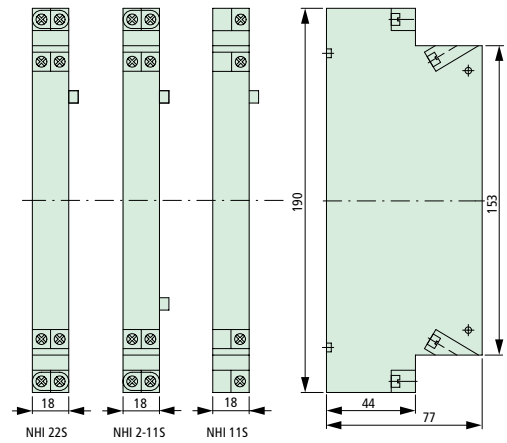

### S(-G) high-capacity contact modules CL current limiters

Type -G only

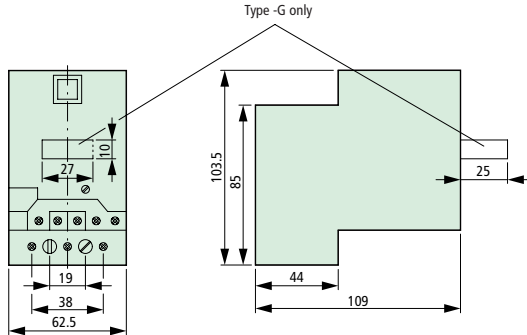

### EZ base for separate mounting

HI11-S/EZ standard auxiliary contact for EZ separate mounting

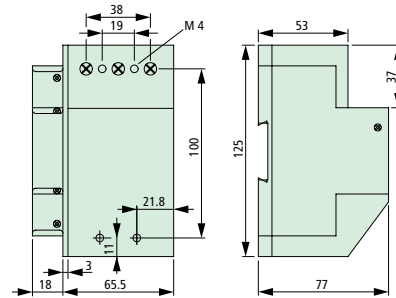

### Enclosure for surface mounting

CI19EE-PKZ2-NA

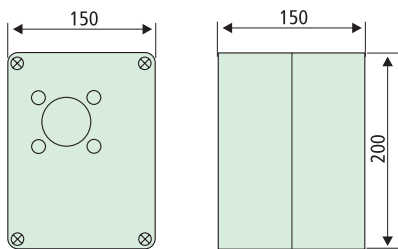

CS3-PKZ2

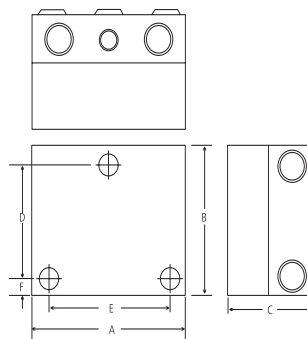

CI43X-150-PKZ2-SP

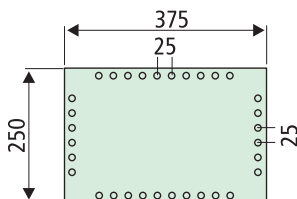

GKP23-PKZ2

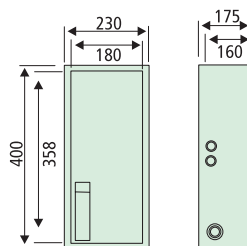

# PKZ 2 Manual Motor Protectors and Motor Protector Combinations

## Dimensions

Door coupling handle  
(R)H-PKZ2

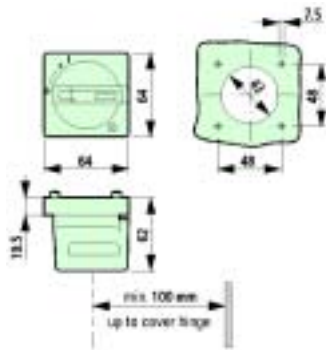

Three-phase feeder bus connector  
B3.1/3-PKZ2

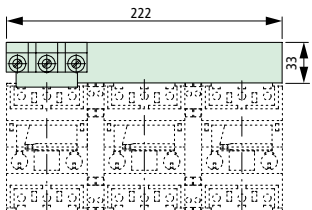

B3.1/2-PKZ2

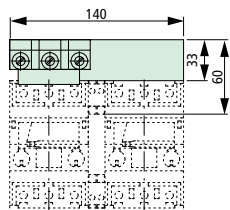

Terminal  
BK50/3-PKZ2

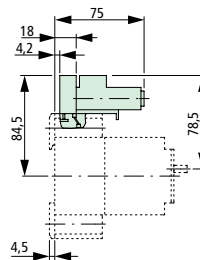

Cover for unused terminals  
HB-3-PKZ2



Mechanical interlock for high-capacity contactor modules  
MV-PKZ2

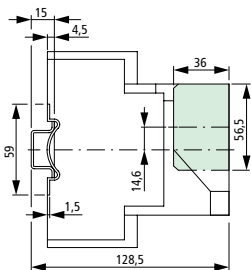
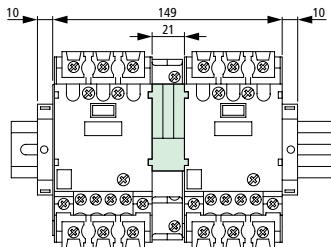

Component adapters

AD40/5(10)-1

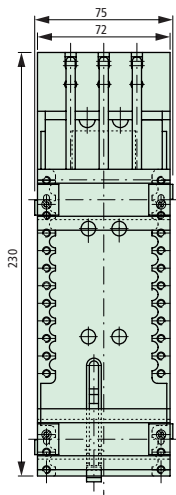

AD40/5(10)-2

