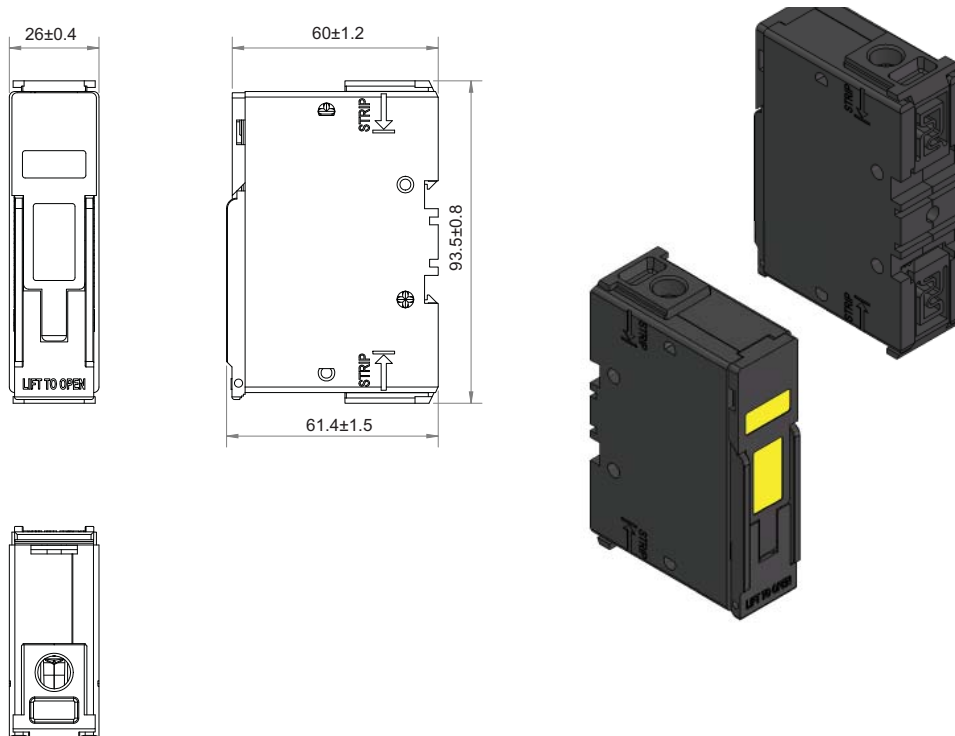

**Table 3. Accessories**

Catalogue numbers	Description	Pack quantity
32BSC	Back stud for 20-32 A Compact Camaster	10
32BS	Back stud conversion kit for 32 A Camaster	10
63-100BS	Back stud for 63-100 A Camaster	5
32CMLC	Neutral link for 32 A Compact Camaster	10
32CML	Neutral link for 32 A Camaster	1
63-100CML	Neutral link for 63-100 A Camaster	1
32LSCC	Lockable safety carrier 20-32 A Compact	3
32LSC	Lockable safety carrier 32 A	3
63-100LSC	Lockable safety carrier 63-100 A	3
NI	Neon indicator for 32-100 A	3



**Dimensions - mm**



**CM20F and CM32FC**

Dimensions - mm

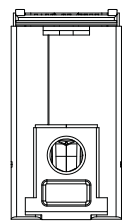
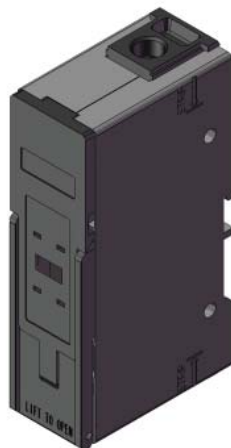
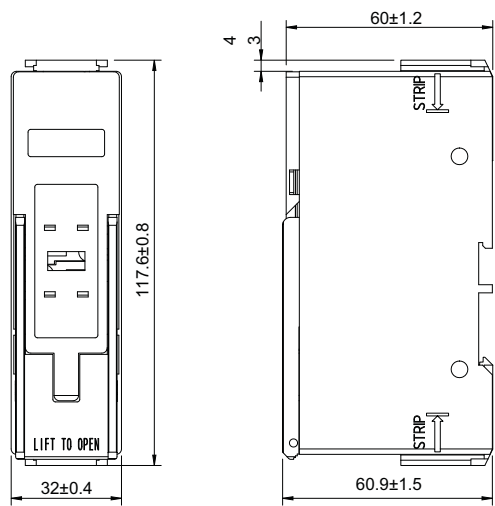

CM32F

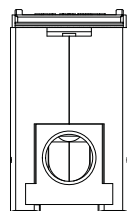
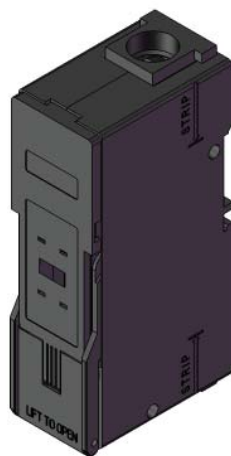
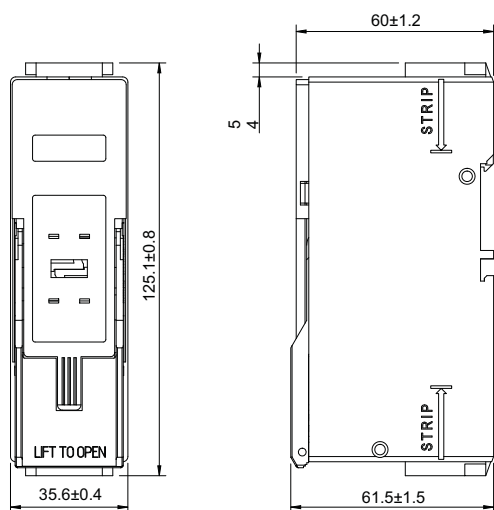

CM63F