

Model ¹	Glass Fiber Optic Mode	Range	Output
QS18VN6F	940 nm Infrared	Range varies by sensing mode and fiber optics used	NPN
QS18VP6F	 GLASS FIBER		PNP

Wiring Diagrams

QS18 with NPN Outputs

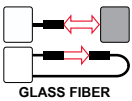
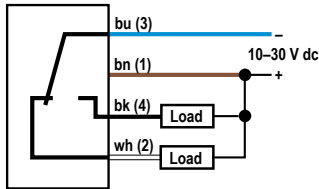

4-pin M12/Euro-style Models (Male)

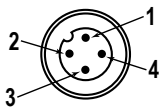

QS18 with PNP Outputs

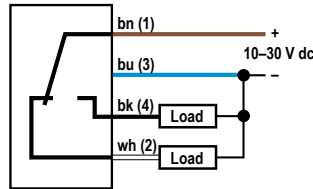

4-pin M8/Pico-style Models (Male)



QS18 Emitters

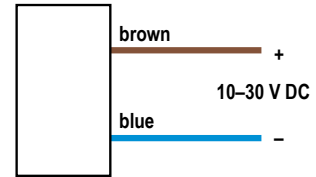

Key

- 1 = Brown
- 2 = White
- 3 = Blue
- 4 = Black

Installing Fibers

Cutting Unterminated Plastic Fibers QS18V..6FP

Unterminated plastic fibers are designed to be cut by the user to the length required for the application.

To facilitate cutting, a Banner model PFC-1 cutting device is supplied with the fiber. Cut the fiber as follows:

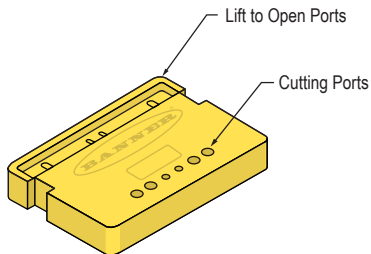

Figure 1. PFC-1 Cutting Device

Use small ports for fiber sizes:

- 0.25 mm (0.01 inches)
- 0.5 mm (0.02 inches)

Use large ports for fiber sizes:

- 0.75 mm (0.03 inches)
- 1.0 mm (0.04 inches)
- 1.5 mm (0.06 inches)

1. Locate the control end of the fiber (the unfinished end).
2. Determine the length of fiber required for the application. If using a bifurcated fiber, separate the two halves of the fiber at least 51 mm (2 inches) beyond the fiber cutting location.
3. Lift the top (blade) of the cutter to open the cutting ports.
4. Insert one of the control ends through one of the cutting ports on the cutter so that the excess fiber protrudes from the back of the cutter.
5. Double-check the fiber length, and close the cutter until the fiber is cut.
6. Using a different cutting port, cut the second control end to the required length.



Note: To ensure a clean cut each time, do not use a cutting port more than once.

7. Gently wipe the cut ends of the fiber with a clean, dry cloth to remove any contamination. Do not use solvents or abrasives on any exposed optical fiber.

Installing Plastic Fibers QS18V..6FP

Follow these steps to install the plastic fibers.

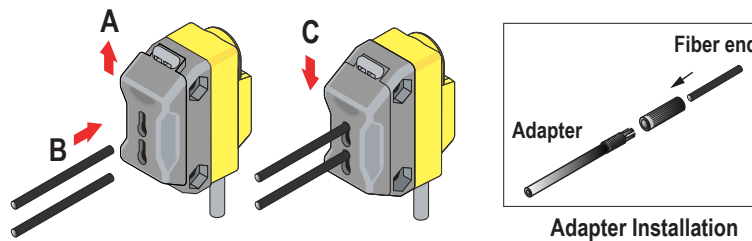

Figure 2. Installing Plastic Fibers

1. Slide the fiber gripper up to unlock it (A).
2. If using 0.25 mm or 0.5 mm core fibers, slide the plastic fiber adapters onto the fibers, flush with the fiber ends.
3. Carefully insert the prepared plastic fiber ends into the ports (B) as far as possible without applying extra force.
4. Slide the fiber gripper down to lock the fibers in place (C).

Installing Glass Fibers QS18V..6F

Follow these steps to install the glass fibers.

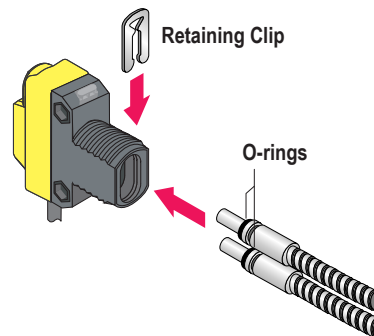

Figure 3. Installing Glass Fibers

1. Slide the supplied o-ring on the sensor end of the fibers, as shown.
2. Press the fiber ends firmly into the ports located on the front of the sensor.
3. Slide the supplied u-shaped retaining clip into the slot in the sensor's barrel until the clip snaps into place.

Specifications

Supply Voltage

10 V dc to 30 V dc (10% maximum ripple) at less than 25 mA, exclusive of load
Protected against reverse polarity and transient voltages

Light Source

Glass Fiber Optic, Opposed and Diffuse mode models: Infrared, 940 nm
Plastic Fiber Optic, Retroreflective, Convergent models: Visible red, 660 nm
Fixed-Field and DVS models: Visible red, 630 nm

Adjustments

Glass Fiber Optic, Plastic Fiber Optic, Convergent, Diffuse, and Retroreflective mode models (only): Single-turn sensitivity (Gain) adjustment potentiometer

Indicators

2 LED indicators on sensor top
Green: Power on
Amber: Light sensed
Amber flashing: Marginal excess gain (1 to 1.5 times excess gain)

Repeatability

Opposed Mode: 100 microseconds
DVS, DL and FF Modes: 90 microseconds
All Other Modes: 150 microseconds

Output Configuration

Solid-state complementary (SPDT): NPN or PNP (current sinking or sourcing), depending on model;
Rating: 100 mA maximum each output at 25 °C
DVS, DL and FF Modes ON-state Saturation Voltage: less than 1.5 V at 10 mA; less than 3 V at 100 mA
All Other Modes: ON-state Saturation Voltage: less than 1 V at 10 mA; less than 1.5 V at 100 mA
Protected against false pulse on power-up and continuous overload or short circuit of outputs

Output Response

Opposed Mode: 750 microseconds ON; 375 microseconds OFF
DVS, FF and DL Modes: 850 microseconds ON/OFF
All Other Modes: 600 microseconds ON/OFF
100 millisecond delay on power-up; outputs do not conduct during this time