

Adjustment Guide

The environments in which capacitive sensors are installed can often be unstable as regards to temperature, humidity, object distance and industrial (noise) interference. Because of this, Carlo Gavazzi offers

as standard features in all *TRIPLESHIELD™* capacitive sensors a user-friendly sensitivity adjustment instead of a fixed sensing range. Likewise, these sensors provide an extended sensing range to accommodate

mechanically demanding areas and temperature stability to ensure high immunity to electromagnetic interference (EMI) and a minimum need for adjusting sensitivity if the temperature varies.

Note: Sensors are factory set (default) to nominal sensing range S_n .

Wiring Diagram

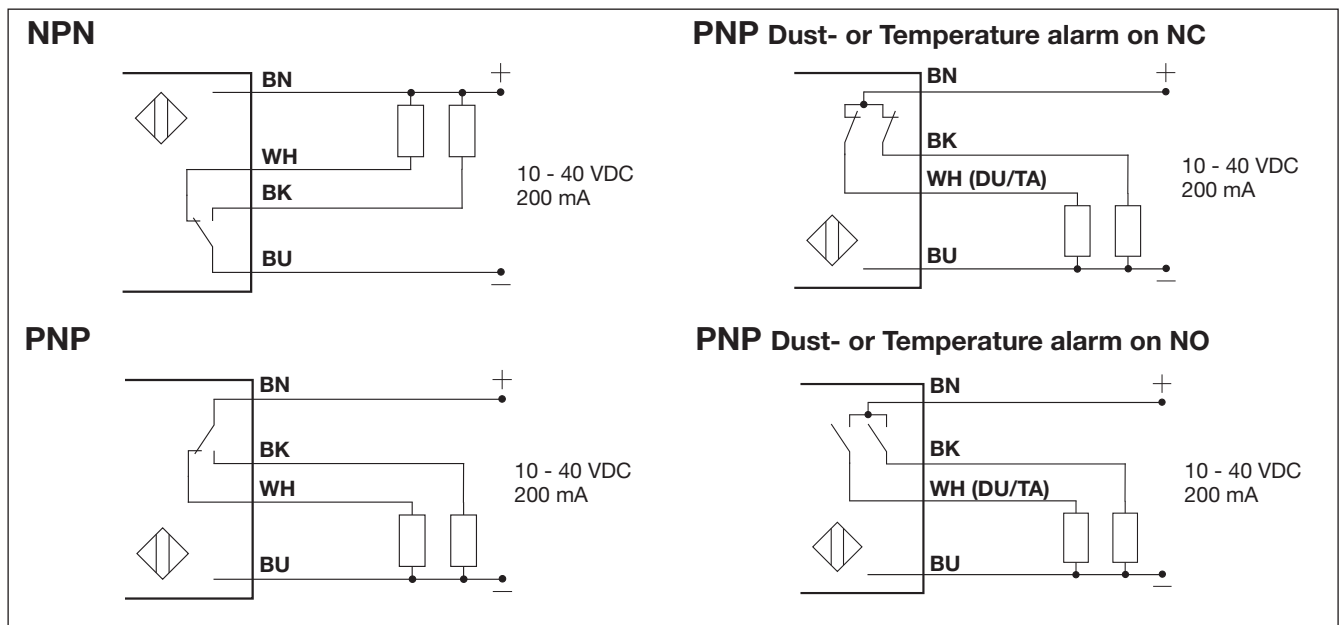

Detection Diagram

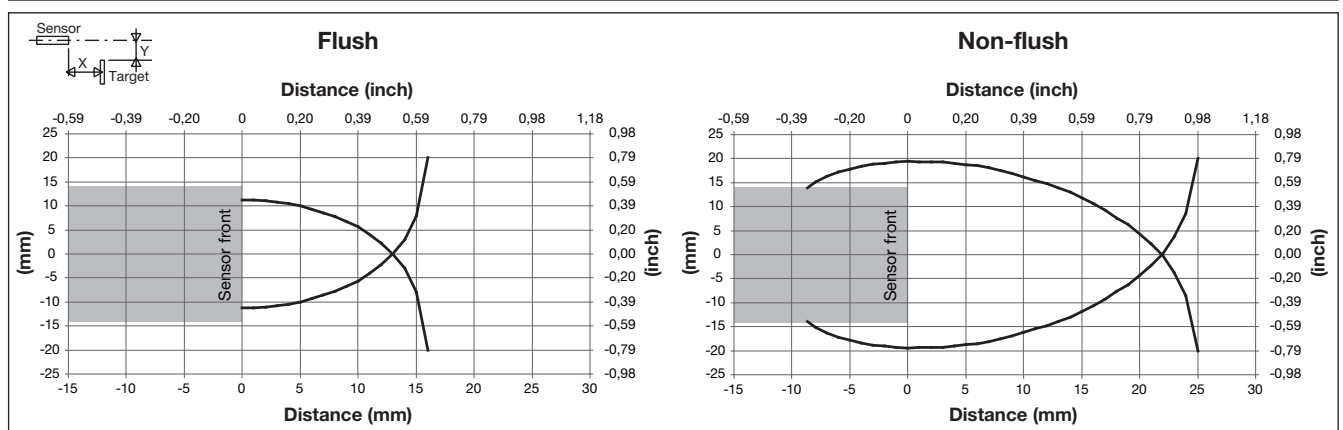

Detection Stability Indication

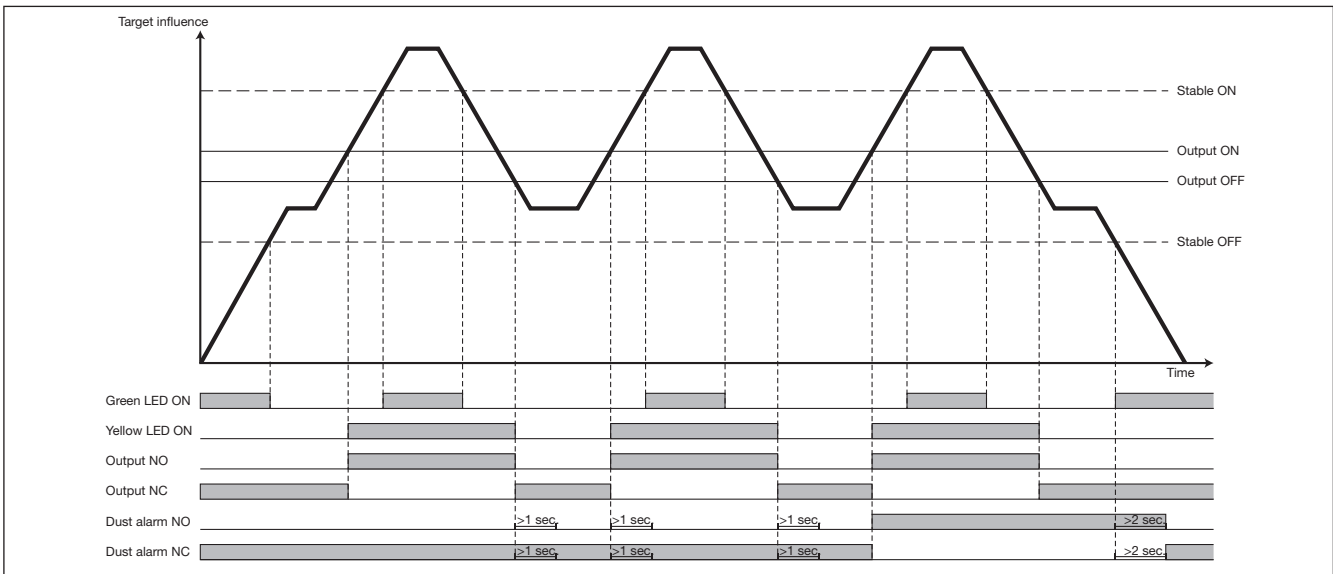

Dimensions

CA30CAF....

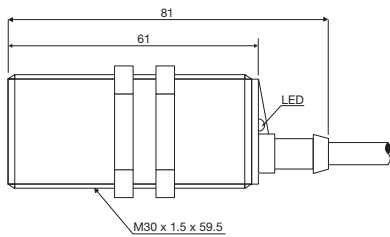

CA30CAF....M1

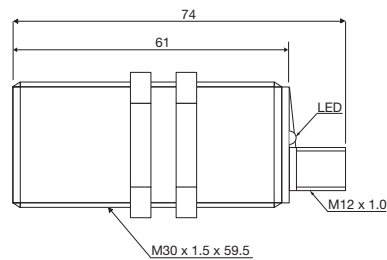

CA30CAN....

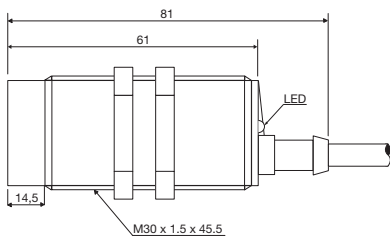

CA30CAN....M1

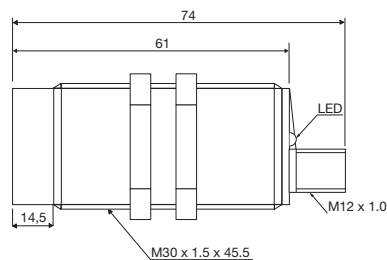

Cable

Plug

Backside of sensor

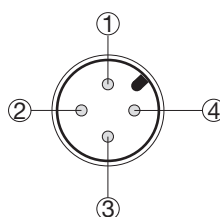
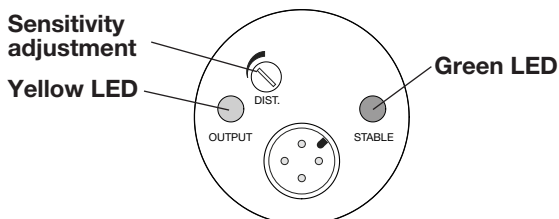

Colour code

- 1 Brown
- 2 White
- 3 Blue
- 4 Black