

### FEATURES

- High 16 A capacity  
The contacts are high capacity 16A, 125 V AC.
- Compact, flat type with low 10.9 mm .429 inch height  
Compact flat type with low surface area of 16 × 22 mm .630 × .866 inch and height of 10.9 mm .429 inch.
- High sensitivity at 200 mW  
High sensitivity at 200 mW coil power consumption.
- Represses contact terminal heat  
The contact terminals are larger and thicker compared to the existing JV relay. This limits the rise in temperature of the terminals when there is a large current flowing to approx. 28°C 62°F (normal current of 16 A).
- Conforms to the various safety standards  
UL/CSA, TÜV approved.

### COMMENTS ABOUT Cd FREE

We have introduced Cadmium free type products to reduce the material which is not good for our environment. (The suffix "F" should be added to the part number.) If you are still using Cadmium containing parts, which don't have "F" on the suffix of the part number, please use Cadmium free parts from now on. The life of the Cadmium free parts may be shorter than the Cadmium containing parts based on the load condition, so please evaluate the Cadmium free parts with your actual application before use.

## SPECIFICATIONS

### Contact

Arrangement	1 Form A	
Initial contact resistance, max. (By voltage drop 6 V DC 1 A)	Max. 100 mΩ	
Contact material	AgSnO <sub>2</sub> type	
Rating (resistive load)	Nominal switching capacity	16 A 125 V AC, 10 A 277 V AC 10 A 30 V DC, 10 A 125 V AC
	Max. switching power	2,770 VA, 300 W
	Max. switching voltage	277 V AC, 30 V DC
	Max. switching current	16 A (AC 125 V), 10 A (DC)
	Min. switching capacity <sup>#1</sup>	100 mA, 5 V DC
Expected life (min. ope.) Mechanical (at 180 cpm)	2×10 <sup>7</sup>	
Electrical at resistive load (at 20 cpm)	Sealed type 16 A 125 V AC, 10 A 30 V DC	10 <sup>5</sup>
	Flux-resistant type 10 A 125 V AC	3×10 <sup>5</sup>

### Coil

Nominal operating power	200 mW (DC 4.5 to 48 V) 600 mW (DC 100 V)
-------------------------	--

<sup>#1</sup> This value can change due to the switching frequency, environmental conditions, and desired reliability level, therefore it is recommended to check this with the actual load.

### Remarks

- \* Specifications will vary with foreign standards certification ratings.
- <sup>#1</sup> Excluding contact bounce time
- <sup>#2</sup> Excluding contact bounce time, without diode
- <sup>#3</sup> By resistive method; nominal voltage applied to the coil; contact carrying current: 16A, at 70°C 158°F
- <sup>#4</sup> Nominal voltage applied to the coil, at 60°C 140°F
- <sup>#5</sup> Half-wave pulse of sine wave: 11 ms; detection time: 10 μs
- <sup>#6</sup> Half-wave pulse of sine wave: 6 ms
- <sup>#7</sup> Detection time: 10 μs
- <sup>#8</sup> Refer to "6. Usage, Storage and Transport Conditions" in **AMBIENT ENVIRONMENT** section in **Relay Technical Information**.

### Characteristics

Max. operating speed	20 cpm	
Operate time <sup>*1</sup> (at nominal voltage)	Max. 12 ms (DC 4.5 V to 48 V) Max. 8 ms (DC 100 V)	
Release time <sup>*2</sup> (at nominal voltage)	Max. 5 ms	
Initial insulation resistance	Min. 1,000 MΩ (at 500 V DC)	
Initial breakdown voltage (Detection current: 10 mA)	Between open contacts	1,000 Vrms for 1 min.
	Between contacts and coil	2,500 Vrms for 1 min.
Surge voltage between contact and coil	Min. 4,500 V	
Temperature rise	Max. 45°C (DC 4.5 V to 48 V) <sup>*3</sup> Max. 55°C (DC 100 V) <sup>*4</sup>	
Conditions in case of operation, transport and storage <sup>*8</sup>	Ambient temperature -40 to 70°C -40 to 158°F (DC 4.5 to 48 V) -40 to 60°C -40 to 140°F (DC 100V) Humidity: 5 to 85 % R.H. (Note freezing and condensing at low temperature) Air pressure: 86 to 106 kPa	
Shock resistance	Functional	Min. 200 m/s <sup>2</sup> {20G} <sup>*5</sup>
	Destructive	Min. 1,000 m/s <sup>2</sup> {100G} <sup>*6</sup>
Vibration resistance	Functional	10 to 55 Hz <sup>*7</sup> at double amplitude of 1.6 mm
	Destructive	10 to 55 Hz at double amplitude of 2 mm
Unit weight	Approx. 8g .28 oz	

## TYPICAL APPLICATIONS ORDERING INFORMATIONS

- AV equipment: TV's, VTR's, etc.
- OA equipment
- HA equipment

Ex. JVN 1a F 4.5 V F

Contact arrangement	Protective construction	Coil voltage (DC)	Contact material
1a: 1 Form A	Nil: Sealed type F: Flux-resistant type	4.5, 6, 9, 12, 18, 24, 48, 100 V	F: AgSnO <sub>2</sub> type

UL/CSA, TÜV approved type is standard.  
Please inquire about the previous products (Cadmium containing parts).

## TYPES AND COIL DATA (at 20°C 68°F)

Part No.		Nominal voltage, V DC	Pick-up voltage V DC (max.)	Drop-out voltage V DC (min.)	Coil resistance, W (±10%)	Nominal operating current, mA (±10%)	Nominal operating power, mW	Max. allowable voltage, V DC
Sealed type	Flux-resistant type							
JVN1a-4.5V-F	JVN1aF-4.5V-F	4.5	3.375	0.23	101	44.4	200	6.75
JVN1a-6V-F	JVN1aF-6V-F	6	4.5	0.3	180	33.3	200	9
JVN1a-9V-F	JVN1aF-9V-F	9	6.75	0.45	405	22.2	200	13.5
JVN1a-12V-F	JVN1aF-12V-F	12	9	0.6	720	16.7	200	18
JVN1a-18V-F	JVN1aF-18V-F	18	13.5	0.9	1,620	11.1	200	27
JVN1a-24V-F	JVN1aF-24V-F	24	18	1.2	2,880	8.3	200	36
JVN1a-48V-F	JVN1aF-48V-F	48	36	2.4	11,520	4.2	200	72
JVN1a-100V-F	JVN1aF-100V-F	100	60	4	16,600	6	600	110

## DIMENSIONS (mm inch)

Download [CAD Data](#) from our Web site.

[CAD Data](#)

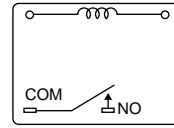
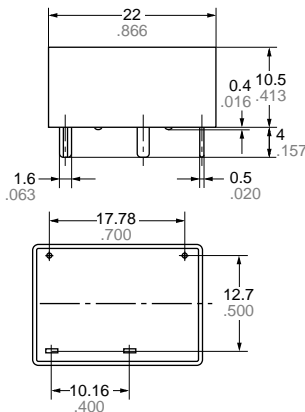

PC board pattern

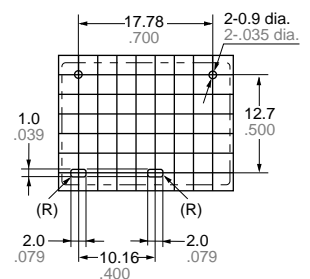

**Dimension:**  
 Max. 1mm .039 inch:  
 1 to 5mm .039 to .197 inch:  
 Min. 5mm .197 inch:

**General tolerance**  
 ±0.2 ±.008  
 ±0.3 ±.012  
 ±0.4 ±.016

## REFERENCE DATA

1. Max. switching power

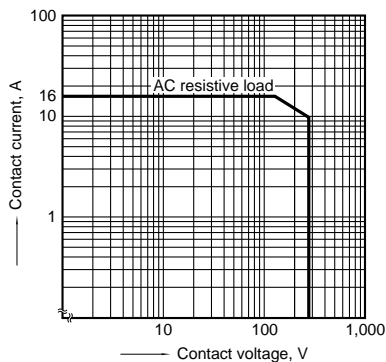

2. Operate/release time

Sample: JVN1aF-12 V-F, 6 pcs.

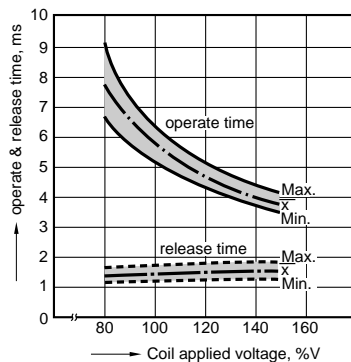

3. Coil temperature rise

Sample: JVN1aF-12 V-F, 6 pcs.  
 point measured: coil inside  
 Contact current: 16 A

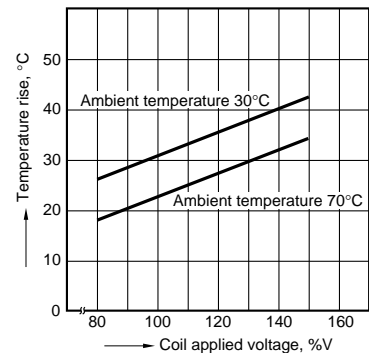

4. Ambient temperature characteristics

Sample: JVN1aF-12 V-F, 6 pcs.

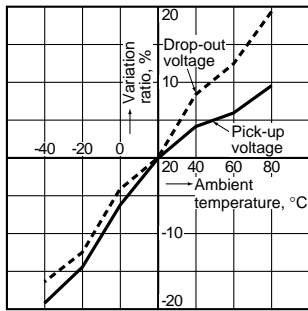

5. Life curve

Operation frequency: 20 times/min.  
Ambient temperature: room temperature

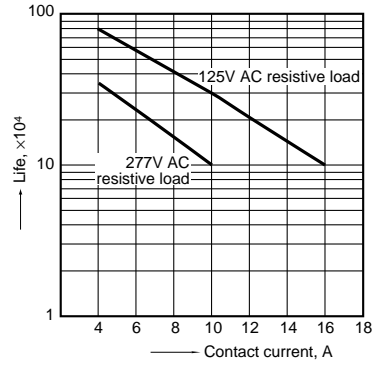

**SAFETY STANDARDS**

UL/C-UL (Recognized)		CSA (Certified)		TÜV (Certified)	
File No.	Contact rating	File No.	Contact rating	File No.	Rating
E43028	16A 125V AC, 16A 277V AC, 10A 30V DC 0.3A 110V DC, 1/10HP 125V AC, 1/10HP 277V AC	LR26550	16A 125V AC, 16A 277V AC, 10A 30V DC 0.3A 110V DC, 1/10HP 125V AC, 1/10HP 277V AC	B 08 07 13461 250	16A 250V AC (cosφ=0.4) 10A 30V DC (0ms)

**For Cautions for Use, see [Relay Technical Information](#).**