

Data sheet | Item number: 2042-3014

Relay module; Relay with 2 make contacts (2a); 24 VDC; Path

www.wago.com/2042-3014

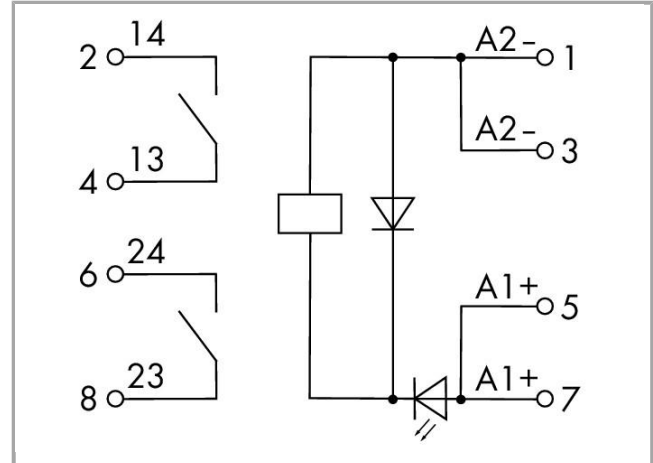

RoHS Compliant

BOMcheck.net

Similar to picture

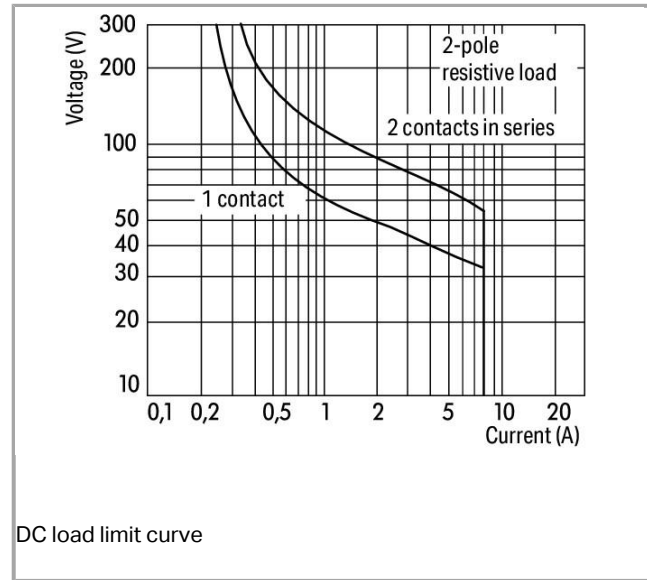
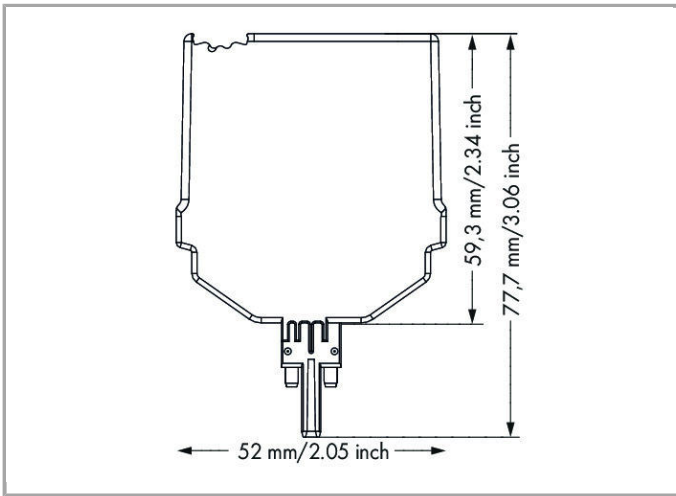

Data

Technical Data

Control circuit

Nominal input voltage U_N	DC 24 V
Input voltage range	-30 ... +25 %
Nominal input current at U_N	13.8 mA

Load circuit:

Number of make contacts/switch on contacts	2
Contact material (relay)	AgNi
Limiting continuous current	8 A
Max. make current (resistive)	(AC) 15 A / 4 s
Max. switching voltage	AC 250 V
Max. switching power (resistive)	AC 2,000 VA; DC see load limit curve
Recommended minimum load	12 V / 10 mA
Min. switching current	0 μ A
Pull-in time (typ.)	8 ms
Drop-out time (typ.)	6 ms
Bounce time (typ)	4 ms
Drop-out time	$\leq 0 \mu$ s
Electrical life (N.O.; resistive load; 23 °C)	100 x 10 ³ switching operations
Mechanical life (N.O.; resistive load; 23 °C)	10 x 10 ⁶ switching operations