

Dimensions

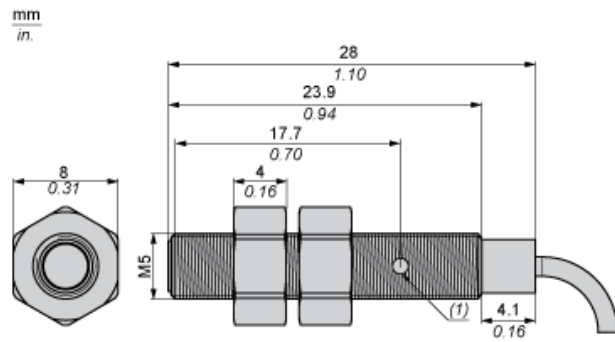

Minimum Mounting Distances in mm

Side by side



e (1) 2 mm/0.79 in.

≥

Face to face



e (2) 12 mm/0.47 in.

≥

Facing a metal object



e (3) 3 mm/0.12 in.

≥

Mounted in a metal support



$d \geq 5 \text{ mm}/0.17 \text{ in.}$

$h \geq 0 \text{ mm}/0 \text{ in.}$

Tightening torque : 1.6 N.m. (values obtained with washers mounted)

Mounting

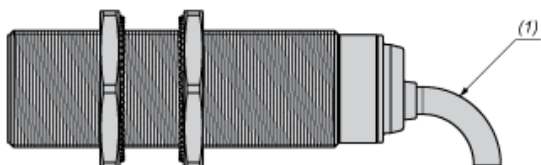

(1) Bending cable: 4 x external cable diameter