

Dimensions

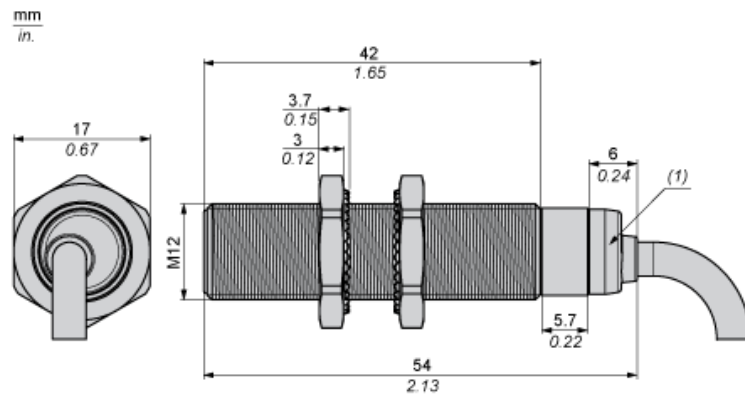

(1) LED

---

Minimum Mounting Distances

---

Side by side



$e (1) \geq 4 \text{ mm}/0.16 \text{ in.}$

Face to face



$e (2) \geq 24 \text{ mm}/0.94 \text{ in.}$

Facing a metal object



$e (3) \geq 6 \text{ mm}/0.24 \text{ in.}$