

Dimensions

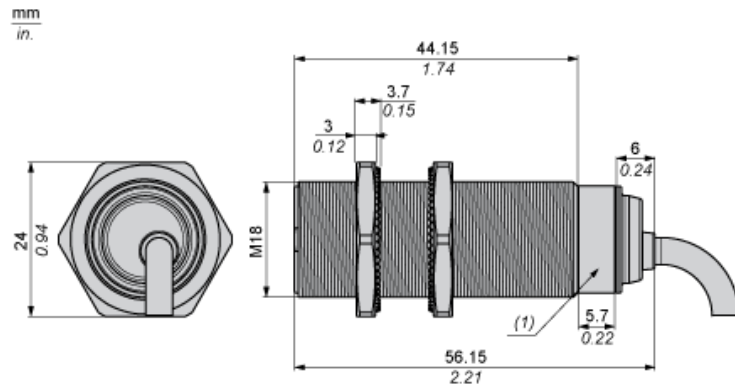

(1) LED

Minimum Mounting Distances

Side by side



e (1) 10 mm/0.39 in.

≥

Face to face

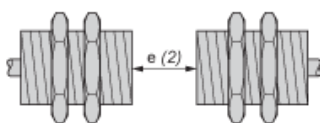

e (2) 60 mm/2.36 in.

≥

Facing a metal object

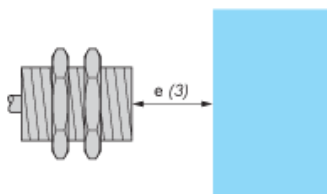

e (3) 15 mm/0.60 in.

≥

Mounting

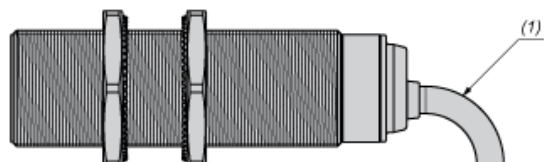

(1) Bending cable: 4 x external cable diameter